

Keysight X-Series Signal Analyzer

This manual provides documentation for the following
X-Series Analyzers:

PXA Signal Analyzer N9030A
MXA Signal Analyzer N9020A
EXA Signal Analyzer N9010A
CXA Signal Analyzer N9000A
MXE EMI Receiver N9038A



Spectrum Analyzer
Mode User's &
Programmer's
Reference

Notices

Copyright Notice

© Keysight Technologies 2011-2018

No part of this manual may be reproduced in any form or by any means (including electronic storage and retrieval or translation into a foreign language) without prior agreement and written consent from Keysight Technologies, Inc. as governed by United States and international copyright laws.

Manual Part Number

N9060-90027

Edition

Edition 23, December 2018

Published by:

Keysight Technologies, Inc.
1400 Fountaingrove Parkway
Santa Rosa, CA 95403

Technology Licenses

The hardware and/or software described in this document are furnished under a license and may be used or copied only in accordance with the terms of such license.

U.S. Government Rights

The Software is “commercial computer software,” as defined by Federal Acquisition Regulation (“FAR”) 2.101. Pursuant to FAR 12.212 and 27.405-3 and Department of Defense FAR Supplement (“DFARS”) 227.7202, the US government acquires commercial computer software under the same terms by which the software is customarily provided to the public. Accordingly, Keysight provides the Software to US government customers under its standard commercial license, which is embodied in its End User License Agreement (EULA), a copy of which can be found at <http://www.keysight.com/find/sweula>. The license set forth in the EULA represents the exclusive authority by which the US government may use, modify, distribute, or disclose the Software. The EULA and the license set forth therein, does not require or permit, among other things, that Keysight: (1) Furnish technical information related to commercial computer software or commercial computer software documentation that is not customarily provided to the public; or (2) Relinquish to, or otherwise provide, the government rights in excess of these rights customarily provided to the public to use, modify, reproduce, release, perform, display, or disclose commercial computer software or commercial computer software documentation. No additional government requirements beyond those set forth in the EULA shall apply, except to the extent that those terms, rights, or licenses are explicitly required from all providers of commercial computer software pursuant to the FAR and the DFARS and are set forth specifically in writing elsewhere in the EULA. Keysight shall be under no obligation to update, revise or otherwise modify the Software. With respect to any technical data as defined by FAR 2.101, pursuant to FAR 12.211 and 27.404.2 and DFARS 227.7102, the US government acquires no greater than Limited Rights as defined in FAR 27.401 or DFAR 227.7103-5 (c), as applicable in any technical data.

Warranty

THE MATERIAL CONTAINED IN THIS DOCUMENT IS PROVIDED “AS IS,” AND IS SUBJECT TO BEING CHANGED, WITHOUT NOTICE, IN FUTURE EDITIONS. FURTHER, TO THE MAXIMUM EXTENT PERMITTED BY APPLICABLE LAW, KEYSIGHT DISCLAIMS ALL WARRANTIES, EITHER EXPRESS OR IMPLIED, WITH REGARD TO THIS MANUAL AND ANY INFORMATION CONTAINED HEREIN, INCLUDING BUT NOT LIMITED TO THE IMPLIED WARRANTIES OF MERCHANTABILITY AND FITNESS FOR A PARTICULAR PURPOSE. KEYSIGHT SHALL NOT BE LIABLE FOR ERRORS OR FOR INCIDENTAL OR CONSEQUENTIAL DAMAGES IN CONNECTION WITH THE FURNISHING, USE, OR PERFORMANCE OF THIS DOCUMENT OR OF ANY INFORMATION CONTAINED HEREIN. SHOULD KEYSIGHT AND THE USER HAVE A SEPARATE WRITTEN AGREEMENT WITH WARRANTY TERMS COVERING THE MATERIAL IN THIS DOCUMENT THAT CONFLICT WITH THESE TERMS, THE WARRANTY TERMS IN THE SEPARATE AGREEMENT SHALL CONTROL.

Safety Information

CAUTION

A CAUTION notice denotes a hazard. It calls attention to an operating procedure, practice, or the like that, if not correctly performed or adhered to, could result in damage to the product or loss of important data. Do not proceed beyond a CAUTION notice until the indicated conditions are fully understood and met.

WARNING

A WARNING notice denotes a hazard. It calls attention to an operating procedure, practice, or the like that, if not correctly performed or adhered to, could result in personal injury or death. Do not proceed beyond a WARNING notice until the indicated conditions are fully understood and met.

Table of Contents

Spectrum Analyzer Mode User's & Programmer's Reference	i
Table of Contents	iii
1 About the Analyzer	118
Installing Application Software	119
Viewing a License Key	119
Obtaining and Installing a License Key	119
Updating Measurement Application Software	120
X-Series Options and Accessories	121
Front-Panel Features	122
Display Annotations	123
Rear-Panel Features	124
Window Control Keys	125
Multi-Window	125
Zoom	125
Next Window	126
Full Screen	127
Display Enable (Remote Command Only)	127
Mouse and Keyboard Control	129
Right-Click	129
PC Keyboard	131
Instrument Security & Memory Volatility	134
2 About the Spectrum Analyzer Mode	135
What Does Spectrum Analyzer Mode Do?	136
3 Programming the Analyzer	137
What Programming Information is Available?	138
List of SCPI Commands	139
*	139
A	139
C	139
D	148
F	152
G	152
H	152
I	152
L	154
M	154
O	155
R	156
S	156

T	179
U	183
W	183
STATus Subsystem	184
Detailed Description	186
What Are Status Registers	187
What Are Status Register SCPI Commands	188
How to Use the Status Registers	188
Using a Status Register	190
Using the Service Request (SRQ) Method	191
Generating a Service Request	192
Status Register System	192
The Status Byte Register	193
Standard Event Status Register	196
Operation and Questionable Status Registers	198
Operation Status Register	198
Questionable Status Register	198
STATus Subsystem Command Descriptions	199
Operation Register	199
Operation Condition Query	199
Operation Enable	200
Operation Event Query	200
Operation Negative Transition	200
Operation Positive Transition	201
Operation Instrument Register	201
Operation Instrument Condition	202
Operation Instrument Event Enable	202
Operation Instrument Event Query	202
Operation Instrument Negative Transition	203
Operation Instrument Positive Transition	203
Preset the Status Byte	204
Questionable Register	204
Questionable Condition	204
Questionable Enable	205
Questionable Event Query	205
Questionable Negative Transition	206
Questionable Positive Transition	206
Questionable Calibration Register	206
Questionable Calibration Condition	207
Questionable Calibration Enable	207
Questionable Calibration Event Query	207
Questionable Calibration Negative Transition	208
Questionable Calibration Positive Transition	208
Questionable Calibration Skipped Register	209

Questionable Calibration Skipped Condition	209
Questionable Calibration Skipped Enable	209
Questionable Calibration Skipped Event Query	210
Questionable Calibration Skipped Negative Transition	210
Questionable Calibration Skipped Positive Transition	211
Questionable Calibration Extended Failure Register	211
Questionable Calibration Extended Failure Condition	211
Questionable Calibration Extended Failure Enable	212
Questionable Calibration Extended Failure Event Query	212
Questionable Calibration Extended Failure Negative Transition	213
Questionable Calibration Extended Failure Positive Transition	213
Questionable Calibration Extended Needed Register	214
Questionable Calibration Extended Needed Condition	214
Questionable Calibration Extended Needed Enable	214
Questionable Calibration Extended Needed Event Query	215
Questionable Calibration Extended Needed Negative Transition	215
Questionable Calibration Extended Needed Positive Transition	216
Questionable Frequency Register	216
Questionable Frequency Condition	216
Questionable Frequency Enable	217
Questionable Frequency Event Query	217
Questionable Frequency Negative Transition	217
Questionable Frequency Positive Transition	218
Questionable Integrity Register	218
Questionable Integrity Condition	219
Questionable Integrity Enable	219
Questionable Integrity Event Query	219
Questionable Integrity Negative Transition	220
Questionable Integrity Positive Transition	220
Questionable Integrity Signal Register	221
Questionable Integrity Signal Condition	221
Questionable Integrity Signal Enable	221
Questionable Integrity Signal Event Query	222
Questionable Integrity Signal Negative Transition	222
Questionable Integrity Signal Positive Transition	223
Questionable Integrity Uncalibrated Register	223
Questionable Integrity Uncalibrated Condition	223
Questionable Integrity Uncalibrated Enable	224
Questionable Integrity Uncalibrated Event Query	224
Questionable Integrity Uncalibrated Negative Transition	225
Questionable Integrity Uncalibrated Positive Transition	225
Questionable Power Register	226
Questionable Power Condition	226

Questionable Power Enable	226
Questionable Power Event Query	227
Questionable Power Negative Transition	227
Questionable Power Positive Transition	227
Questionable Temperature Register	228
Questionable Temperature Condition	228
Questionable Temperature Enable	228
Questionable Temperature Event Query	229
Questionable Temperature Negative Transition	229
Questionable Temperature Positive Transition	230
IEEE 488.2 Common Commands	231
All	231
Clear Status	234
Standard Event Status Enable	234
Standard Event Status Register Query	235
Identification Query	235
Operation Complete	235
Query Instrument Options	236
Recall Instrument State	237
*RST (Remote Command Only)	237
Save Instrument State	238
Service Request Enable	238
Status Byte Query	238
Trigger	239
Self Test Query	239
Wait-to-Continue	239
4 Input/Output Functions	240
Input/Output	241
Input/Output variables - Preset behavior	243
RF Input	243
Input Z Correction	243
RF Coupling	244
RF Input Port	245
RF Input	246
RF Input 2	246
RF Preselector	248
External Mixer	249
More Information	249
Ext Mix Setup	252
Mixer Presets	257
Mixer Bias	264
Edit Harmonic Table	264
Refresh USB Mixer Connection	268

Mixer Path	268
User IF Freq	269
Signal ID On/Off	269
Signal ID Mode	270
Image Suppress	271
Image Shift	271
Cable IF Loss	272
I/Q	273
Baseband I/Q (Option BBA)	273
Baseband I/Q Remote Language Compatibility	275
I/Q Path	276
I+jQ	277
I Only	278
Q Only	278
I Setup	278
I Differential Input	278
I Input Z	279
I Skew	280
I Probe	280
Combined Differential/Input Z (Remote Command Only)	283
Q Setup	283
Q Same as I	284
Q Differential Input	284
Q Input Z	285
Q Skew	286
Q Probe	286
Reference Z	288
I/Q Cable Calibrate...	289
I/Q Probe Setup	290
Attenuation	290
Offset	291
Coupling	292
Calibrate	293
Clear Calibration	293
RF Calibrator	294
50 MHz	295
4.8 GHz	295
Off	295
External Gain	296
Ext Preamp	296
More Information	297
MS	298
BTS	299

I Ext Gain	300
Q Ext Gain	300
Q Gain in I+jQ	301
Restore Input/Output Defaults	301
Corrections	302
Select Correction	303
Correction On/Off	303
Properties	304
Select Correction	304
Antenna Unit	304
Frequency Interpolation	307
Description	309
Comment	309
Edit	310
Navigate	311
Frequency	311
Amplitude	311
Insert Point Below	311
Delete Point	312
Scale X Axis	312
Delete Correction	312
Apply Corrections	313
Delete All Corrections	313
Remote Correction Data Set Commands	313
Set (Replace) Data (Remote Command Only)	314
Merge Correction Data (Remote Command Only)	314
Freq Ref In	315
Sense	317
Internal	317
External	317
Pulse	318
More Information	318
Ext Ref Freq	319
Default External Ref Freq	320
External Reference Lock BW	320
External Ref Coupling	321
Output Config	323
Trig Out	323
Polarity	324
Off	324
Sweeping (HSWP)	324
Measuring	325
Main Trigger	325
Gate Trigger	325

Gate	325
Source Point Trigger	326
Odd/Even Trace Point	326
Analog Out	326
More Information	327
Auto	327
Off	328
Screen Video	328
Log Video (RF Envelope, Ref=Mixer Level)	329
Linear Video (RF Envelope, Ref=Ref Level)	330
Demod Audio	331
Digital Bus	331
Bus Out On/Off	332
I/Q Cal Out	332
1 kHz Square Wave	333
250 kHz Square Wave	333
Off	333
Aux IF Out	333
Off	334
Second IF	334
Arbitrary IF	335
Fast Log Video	336
I/Q Guided Calibration	336
I/Q Isolation Calibration	336
Next	336
Exit	337
I/Q Isolation Calibration Time (Remote Command Only)	337
I/Q Cable Calibrate...	337
I Port	338
I-bar Port	339
Q Port	340
Q-bar Port	341
I/Q Cable Calibration Time (Remote Command Only)	342
I/Q Probe Calibration	343
I Port	343
I-bar Port	345
Q Port	346
Q-bar Port	347
Show Adapter Screen	348
I/Q Probe Calibration Time (Remote Command Only)	348
Exit Confirmation	349
LISN Control	349
V-network (Remote Command Only)	349

Phase (Remote Command Only)	349
150 kHz Highpass (Remote Command Only)	350
Protective Earth (Remote Command Only)	350
5 Mode Functions	352
Mode	353
More Information	355
Spectrum Analyzer	356
EMI Receiver	356
IQ Analyzer (Basic)	357
W-CDMA with HSPA+	357
GSM/EDGE/EDGE Evo	357
802.16 OFDMA (WiMAX/WiBro)	358
Vector Signal Analyzer (VXA)	358
Phase Noise	359
Noise Figure	359
Analog Demod	359
Real Time Spectrum Analyzer	360
TD-SCDMA with HSPA/8PSK	360
cdma2000	360
1xEV-DO	361
LTE	361
LTE TDD	361
LTE-Advanced FDD	362
LTE-Advanced TDD	362
DVB-T/H with T2	363
DTMB (CTTB)	363
ISDB-T	363
CMMB	364
Combined WLAN	364
Combined Fixed WiMAX	364
802.16 OFDM (Fixed WiMAX)	365
iDEN/WiDEN/MOTOTalk	365
Remote Language Compatibility	366
89601 VSA	366
Bluetooth	367
SCPI Language Compatibility	367
Digital Cable TV	368
MSR	368
WLAN	369
Application Mode Number Selection (Remote Command Only)	369
Application Mode Catalog Query (Remote Command Only)	371
Application Identification (Remote Commands Only)	371
Current Application Model	371

Current Application Revision	372
Current Application Options	372
Application Identification Catalog (Remote Commands Only)	372
Application Catalog Number of Entries	373
Application Catalog Model Numbers	373
Application Catalog Revision	373
Application Catalog Options	374
Detailed List of Modes	374
1xEV-DO	374
802.16 OFDMA (WiMAX/WiBro)	374
802.16 OFDM (Fixed WiMAX)	375
89601 VSA	375
Analog Demod	376
Bluetooth	377
cdma2000	377
CMMB	377
Combined WLAN	378
Combined Fixed WiMAX	378
Digital Cable TV	378
DTMB (CTTB)	379
DVB-T/H with T2	379
EMI Receiver	379
GSM/EDGE/EDGE Evo	380
iDEN/WiDEN/MOTOTalk	380
IQ Analyzer (Basic)	380
ISDB-T	381
LTE	381
LTE TDD	381
MSR	382
Noise Figure	382
Phase Noise	382
Remote Language Compatibility	383
SCPI Language Compatibility	383
Spectrum Analyzer	383
TD-SCDMA with HSPA/8PSK	384
Vector Signal Analyzer (VXA)	384
W-CDMA with HSPA+	385
WLAN	385
Global Settings	385
Global Center Freq	386
Restore Defaults	387
Mode Setup	388
Radio Standard	388

GSM/EDGE	393
Device	393
3GPP W-CDMA	394
Device	394
3GPP LTE	395
Device	395
Cdma2000 1x	395
Device	396
IS-95A	396
Device	396
J-STD-008	397
Device	397
IS-97D/98D	397
Band Class	397
Device	398
NADC	398
Device	398
PDC	399
Device	399
Bluetooth	400
Std Setup	400
Antenna Unit	400
TETRA	400
Device	401
W-LAN	401
Radio Standard	402
DVB-T	407
Radio Standard	407
FCC Part 15 Subpart F	412
S-DMB System E	413
UWB Indoor	413
Enable Non-Std Measurements	413
EMC Standard	414
CISPR presets	415
Band Setup	415
Sweep Points in Band E	416
Number of points in band E	416
Noise Reduction	416
Noise Floor Extension	416
More Information	418
Global Settings	420
Global Center Freq	420
Global EMC Std	421
Restore Defaults	421

Legacy Compatibility	422
Average/Hold	422
Restore Mode Defaults	423
Preset Type (Remote Command Only)	423
6 System Functions	425
File	426
File Explorer	426
Print	427
Page Setup	427
Print	428
Restore Down	428
Minimize	428
Exit	429
Print	430
System	431
Show	431
Errors	431
Previous Page	432
Next Page	433
History	433
Status	433
Verbose SCPI On/Off	433
Refresh	434
Clear Error Queue	434
Input Overload Enable (Remote Command Only)	434
Power Up (Remote Command Only)	435
System	435
Show System contents (Remote Command Only)	436
Computer System description (Remote Command Only)	436
Hardware	437
LXI	438
Support Subscriptions	438
Next Page	439
Previous Page	439
Sort By	439
Support ID	440
Next Page	440
Previous Page	440
Sort By	441
Copy All To Clipboard	441
Power On	441
Mode and Input/Output Defaults	442
User Preset	442

Last State	443
Power On Application	443
Configure Applications	444
Preloading Applications	444
Access to Configure Applications utility	445
Virtual memory usage	445
Select All	446
Deselect All	446
Move Up	446
Move Down	446
Select/Deselect	446
Save Changes and Exit	447
Exit Without Saving	447
FPGA Configuration	447
Time Domain Scan	448
Enhanced Sweep Speed	449
Prompt at Startup	449
Selected FPGA	450
Load FPGA	450
Restore Power On Defaults	451
Configure Applications - Instrument boot-up	452
Configure Applications - Windows desktop	452
Configure Applications - Remote Commands	452
Configuration list (Remote Command Only)	452
Configuration Memory Available (Remote Command Only)	453
Configuration Memory Total (Remote Command Only)	453
Configuration Memory Used (Remote Command Only)	453
Configuration Application Memory (Remote Command Only)	453
Alignments	454
Auto Align	454
Normal	455
Partial	455
Off	456
All but RF	457
Alert	457
Execute Expired Alignments (Remote Command Only)	460
Align Now	460
All	461
All but RF	463
RF	464
External Mixer	466
Show Alignment Statistics	467
Restore Align Defaults	472
Backup or Restore Align Data...	472

Alignment Data Wizard	473
Perform Backup (Remote Command Only)	478
Perform Restore (Remote Command Only)	479
Advanced	479
Characterize Preselector	479
Characterize Reference Clock	481
Characterize Noise Floor	484
Timebase DAC	486
Calibrated	486
User	487
RF Preselector	488
Align Now, 20 Hz to 30 MHz	488
Align Now, 30 MHz to 3.6 GHz	489
Align Now, 20 Hz to 3.6 GHz	490
Alert	491
Schedule Setup	492
Scheduler	495
I/O Config	496
GPIB	496
GPIB Address	496
GPIB Controller	496
SCPI LAN	497
SCPI Telnet	498
SCPI Socket	498
SICL Server	498
HiSLIP Server	499
SCPI Socket Control Port (Remote Command Only)	500
Reset Web Password	500
LXI	501
LAN Reset	501
Device Identification (Remote Command Only)	501
System IDN Response	502
Factory	502
User	502
SYSTEM:IDN Response setting (Remote command)	503
SYSTEM:PERSONa:DEFault	503
SYSTEM:PERSONa:MANufacturer	504
SYSTEM:PERSONa:MANufacturer:DEFault	504
SYSTEM:PERSONa:MODEl	504
SYSTEM:PERSONa:MODEl:DEFault	504
Query USB Connection (Remote Command Only)	505
USB Connection Status (Remote Command Only)	505
USB Packet Count (Remote Command Only)	506

Lock Remote I/O Session (Remote Command only)	506
Unlock Remote I/O Session (Remote Command only)	507
Remote I/O Session Lock Name (Remote Command only)	508
Remote I/O Session Lock Owner (Remote Command only)	508
Restore Defaults	509
Restore Input/Output Defaults	509
Restore Power On Defaults	509
Restore Align Defaults	510
Restore Misc Defaults	510
Restore Mode Defaults (All Modes)	512
All	512
Control Panel...	513
Fixed/Transportable Licensing ...	514
Security	516
USB	516
Read-Write	517
Read only	517
Diagnostics	517
Show Hardware Statistics	517
SCPI for Show Hardware Statistics (Remote Commands Only)	518
Query the Mechanical Relay Cycle Count	519
Query the Operating Temperature Extremes	519
Query the Elapsed Time since 1st power on	520
Advanced	520
Service	521
Softkey Language	521
English	522
Russian	522
Internet Explorer...	523
System Remote Commands (Remote Commands Only)	523
System Powerdown (Remote Command Only)	523
System Log Off (Remote Command Only)	524
List installed Options (Remote Command Only)	524
Lock the Front-panel keys (Remote Command Only)	524
Front Panel activity history (Remote Command only)	525
SCPI activity history (Remote Command only)	525
Instrument start time (Remote Command only)	526
List SCPI Commands (Remote Command Only)	526
SCPI Version Query (Remote Command Only)	526
Date (Remote Command Only)	526
Time (Remote Command Only)	527
7 Trigger Functions	528
Trigger	529

Trigger Source Presets	530
RF Trigger Source	534
I/Q Trigger Source	535
More Information	536
Free Run	537
Video (IF Envelope)	538
Trigger Level	538
Trig Slope	539
Trig Delay	540
X Axis Relative to Trigger	541
Line	542
Trig Slope	542
Trig Delay	543
X Axis Relative to Trigger	543
External 1	544
Trigger Level	545
Trig Slope	545
Trig Delay	546
X Axis Relative to Trigger	546
Zero Span Delay Comp On/Off	547
External 2	547
Trigger Level	548
Trig Slope	549
Trig Delay	549
X Axis Relative to Trigger	550
Zero Span Delay Comp On/Off	550
RF Burst	551
Absolute Trigger Level	551
Relative Trigger Level	553
Trigger Slope	554
Trig Delay	554
X Axis Relative to Trigger	555
Zero Span Delay Comp On/Off	556
Periodic Timer (Frame Trigger)	556
Period	558
Offset	558
Offset Adjust (Remote Command Only)	559
Reset Offset Display	560
Sync Source	560
Off	561
External 1	561
External 2	563
RF Burst	564

Trig Delay	568
X Axis Relative to Trigger	569
Sync Holdoff	569
Baseband I/Q	570
I/Q Mag	570
Trigger Level	570
Trig Slope	571
Trig Delay	571
X Axis Relative to Trigger	572
I (Demodulated)	572
Trigger Level	573
Trig Slope	573
Trig Delay	573
X Axis Relative to Trigger	574
Q (Demodulated)	575
Trigger Level	575
Trig Slope	575
Trig Delay	576
X Axis Relative to Trigger	576
Input I	577
Trigger Level	577
Trig Slope	578
Trig Delay	578
X Axis Relative to Trigger	578
Input Q	579
Trigger Level	579
Trig Slope	580
Trig Delay	580
X Axis Relative to Trigger	581
Auxiliary Channel I/Q Mag	581
Trigger Level	582
Trig Slope	582
Trig Delay	582
X Axis Relative to Trigger	583
Trigger Center Frequency	583
Trigger Bandwidth	584
TV	585
TV Line	586
Field	586
Entire Frame	587
Field One	587
Field Two	587
Standard	588
NTSC-M	588

NTSC-Japan	588
NTSC-4.43	588
PAL-M	589
PAL-N	589
PAL-N-Combin	589
PAL-B,D,G,H,I	589
PAL-60	589
SECAM-L	590
Auto/Holdoff	590
Auto Trig	590
Trig Holdoff	591
Holdoff Type	591
8 Swept SA Measurement	593
AMPTD Y Scale	598
Reference Level	598
Amplitude Representations	599
Attenuation	599
Dual Attenuator Configurations:	600
Single Attenuator Configuration:	600
(Mech) Atten	601
Attenuator Configurations and Auto/Man	602
Enable Elec Atten	603
Mechanical Attenuator Transition Rules	604
When the Electronic Attenuation is enabled from a disabled state:	604
Examples in the dual attenuator configuration:	604
When the Electronic Attenuation is disabled from an enabled state:	605
Using the Electronic Attenuator: Pros and Cons	605
Elec Atten	605
Adjust Atten for Min Clip	606
Pre-Adjust for Min Clip	606
Off	607
Elec Atten Only	608
Mech + Elec Atten	608
(Mech) Atten Step	608
Max Mixer Level	609
Max Mixer Lvl Rules	609
Range	610
Range Auto/Man	611
I Range	612
Q Range	613
Q Same as I	613

Q Range Value	614
I/Q Gain Ranges	615
1 V Peak	615
0.5 V Peak	615
0.25 V Peak	615
0.125 V Peak	615
Scale / Div	616
Scale Type	616
Presel Center	617
Proper Preselector Operation	618
Preselector Adjust	618
Y Axis Unit	619
dBm	621
dBmV	621
dBmA	621
W	621
V	622
A	622
dB μ V	622
dB μ A	622
Antenna Unit	623
dB μ V/m	623
dB μ A/m	624
dB μ A	624
dBpT	624
dBG	624
None	625
Reference Level Offset	625
More Information	625
μ W Path Control	626
Standard Path	627
Low Noise Path Enable	628
More Information	628
μ W Preselector Bypass	630
Internal Preamp	631
Off	632
Low Band	632
Full Range	632
Auto Couple	634
More Information	634
Auto/Man Active Function keys	634
Auto/Man 1-of-N keys	634
BW	636
Res BW	636

More Information	637
Video BW	638
Annotation Examples	639
VBW:3dB RBW	640
Auto Rules	640
Span:3dB RBW	641
RBW Control	642
Filter Type	643
More Information	643
Gaussian	644
Flattop	644
Filter BW	644
More Information	645
-3 dB (Normal)	646
-6 dB	647
Noise	647
Impulse	647
Wide Bandwidths	647
Cont (Continuous Measurement/Sweep)	649
File	651
FREQ Channel	652
Auto Tune	652
Zoom Center	652
Zone Center	653
Center Freq	654
Center Frequency Presets	656
RF Center Freq	658
Ext Mix Center Freq	659
I/Q Center Freq	659
Start Freq	660
Stop Freq	662
CF Step	663
Freq Offset	665
More Information	665
Scale Type Log/Lin	666
See "More Information" on page 1	666
More Information	667
Input/Output	670
Marker	671
Marker Control Mode	672
Setting/Querying the Marker X Axis Value	672
Setting the Marker X Position in Trace Points	673
Setting/Querying the Marker Y Axis Value	674

Querying the Marker Z Axis Value	674
Setting or Querying the Marker Z Position	675
Marker Backwards Compatibility	675
Select Marker	676
Normal	676
Delta	677
Fixed	677
Fixed Marker X Axis Value	678
Fixed Marker Y Axis Value	678
Fixed Marker Z Axis Value	678
Off	679
Properties	679
Select Marker	679
Relative To	680
Select Marker	680
X Axis Scale	681
More Information	681
Auto	682
Frequency	682
Period	682
Time	683
Inverse Time	683
Marker Trace	684
Auto Init On	684
Auto Init Rules Flowchart	685
Auto Init OFF	685
Lines	686
Marker Z	686
Marker Table	687
Marker Count	687
Counter	687
Query Count Value	688
Understanding the Marker Counter	689
Counting Off-screen Markers	689
Delta Marker	689
Fixed Markers	690
More Information on "Counter"	690
Gate Time	690
Couple Markers	692
All Markers Off	692
Marker Function	693
More Information	693
Fixed marker functions	694
Interval Markers	694

Band Function Backwards Compatibility	695
Marker Mode compatibility	697
Span Pair Compatibility	697
Delta Pair/Band Pair functionality	697
Arbitrary Marker Pair functionality	698
Band changes with analyzer settings	698
Offscreen Markers	698
Direct Marker Positioning	699
Select Marker	700
Marker Noise	700
More Information	701
Off-trace Markers	701
Band/Interval Power	701
Band/Interval Density	702
More Information	703
What is band/interval density?	703
Marker Function Off	703
Band Adjust	703
Band/Interval Span	704
Band/Interval Left	705
Band/Interval Right	706
Band Span Auto/Man	708
Measure at Marker	709
Measure at Marker	709
Meas at Marker Window	712
Window	712
Position	713
Detectors	713
Detector 1	714
Detector 2	715
Detector 3	715
Detector 1 Dwell Time	716
Detector 2 Dwell Time	716
Detector 3 Dwell Time	716
BW & Avg Type	717
Center Presel On/Off	718
Marker To	719
Mkr->CF	719
Mkr->CF Step	719
Mkr->Start	720
Mkr->Stop	720
Mkr->Ref Lvl	721
Mkr Δ ->CF	721

Mkr Δ ->Span	722
Mkr -> Zoom Center	722
Mkr -> Zone Center	723
Meas	724
Remote Measurement Functions	724
Measurement Group of Commands	725
Current Measurement Query (Remote Command Only)	728
Limit Test Current Results (Remote Command Only)	728
Data Query (Remote Command Only)	728
Calculate/Compress Trace Data Query (Remote Command Only)	728
Calculate Peaks of Trace Data (Remote Command Only)	734
Hardware-Accelerated Fast Power Measurement (Remote Command Only)	735
Reset Fast Power Measurement (Remote Command Only)	736
Define Fast Power Measurement (Remote Command Only)	736
Define Fast Power Measurement Query (Remote Command Only)	745
Configure Fast Power Measurement (Remote Command Only)	746
Initiate Fast Power Measurement (Remote Command Only)	747
Fetch Fast Power Measurement (Remote Command Only)	747
Execute Fast Power Measurement (Remote Command Only)	747
Binary Read Fast Power Measurement (Remote Command Only)	748
Diagnostic Binary Read Fast Power Measurement (Remote Command Only)	748
Format Data: Numeric Data (Remote Command Only)	749
Format Data: Byte Order (Remote Command Only)	750
Meas Setup	752
Average/Hold Number	752
More Information	752
AVER:CLE command	753
Average Type	753
More Information	754
Auto	755
Log-Pwr Avg (Video)	755
Pwr Avg (RMS)	756
Voltage Avg	756
Limits	757
Select Limit	757
Limit	757
Properties	758
Select Limit	758
Test Trace	759
Type	759
Interpolation	760
Fixed / Relative	761

Description	763
Comment	763
Margin	764
Edit	764
Navigate	765
Frequency	765
Amplitude	765
Insert Point Below	766
Delete Point	766
Copy from Limit	766
Build from Trace	766
Offset	767
Scale X Axis	768
Delete Limit	769
Test Limits	769
X-Axis Unit	770
Delete All Limits	771
Limit Line Data (Remote Command Only)	771
Merge Limit Line Data (Remote Command Only)	772
Limit Line Fail? (Remote Command Only)	772
Limit Line Control (Remote Command Only, SCPI standard conformance)	773
Limit Line Upper / Lower (Remote Command Only, SCPI standard conformance)	773
Limit Fail? (Remote Command Only, SCPI standard conformance)	775
Limit Clear (Remote Command Only, SCPI standard conformance)	775
Trace Fail? (Remote Command Only)	775
Fixed / Relative Limit (Remote Command Only)	776
N dB Points	776
N dB Points Results Queries	777
More Information	778
PhNoise Opt	781
More Information	783
Auto	783
Best Close-in Φ Noise	783
Balance Noise and Spurs	784
Best Spurs	784
Best Wide-offset Φ Noise	784
Fast Tuning	784
Phase Noise Optimization Auto Rules	785
Models with Option EPO	785
Models with Option EP1	786
Models with Option EP2	786

Models with Option EP4	786
All other Models	787
ADC Dither	787
Auto	788
Medium (Log Accy)	789
Off (Best Noise)	789
Swept IF Gain	789
Auto	790
Low Gain (Best for Large Signals)	790
High Gain (Best Noise Level)	791
FFT IF Gain	791
Auto	792
Autorange (Slower – Follows Signals)	792
Low Gain (Best for Large Signals)	792
High Gain (Best Noise Level)	793
Analog Demod Tune & Listen	793
AM	794
Channel BW (AM Demod)	794
FM	794
Channel BW (FM Demod)	795
De-emphasis (FM Demod only)	795
Φ M	796
Channel BW (Φ M Demod)	796
Off	797
Demod Time	797
Demod State (Remote Command Only)	797
Noise Source	798
More Information	798
State	799
SNS Attached (Remote Command Only)	800
ACP Enhanced Dynamic Range On/Off	800
Meas Preset	801
Mode	802
Mode Preset	803
How-To Preset	804
Mode Setup	806
Peak Search	807
More Information	807
Next Peak	808
Next Pk Right	808
Next Pk Left	808
Marker Delta	809
Mkr->CF	809
Mkr->Ref Lvl	809

Peak Criteria	810
“Peak Search” Criteria	810
Highest Peak	811
Same as “Next Peak” Criteria	811
“Next Peak” Criteria	811
Pk Excursion	812
Pk Threshold	813
Pk Threshold Line	814
Peak Table	815
Peak Table On/Off	815
Peak Sort	815
Peak Readout	816
More Information	817
All	817
Above Display Line	818
Below Display Line	818
Δ to Limit On/Off	818
Δ to Limit Line	819
Continuous Peak Search	819
More Information	820
Pk-Pk Search	821
Min Search	821
Peak Search All Traces	822
Peak Data Query (RemoteCommand Only)	822
Query the Signal Peaks (Remote Command Only)	822
Query Number of Peaks Found (Remote Command Only)	822
Print	824
Quick Save	825
Recall	827
State	827
More Information	829
From File...	830
Edit Register Names	831
Register 1 thru Register 16	832
Register 1 thru Register 16	832
Trace (+State)	833
To Trace	834
Register 1 thru Register 16	835
From File...	835
Data (Import)	837
Amplitude Correction	838
Amplitude Correction	839
Trace	839

Select Trace	840
Limit	840
Limit Selection	841
Open...	842
Restart	843
More Information	843
Save	845
State	845
To File . . .	846
Edit Register Names	849
More Information	850
Register 1 thru Register 16	850
Register 1 thru Register 16	851
Mass Storage Catalog (Remote Command Only)	851
Mass Storage Change Directory (Remote Command Only)	852
Mass Storage Copy (Remote Command Only)	852
Mass Storage Device Copy (Remote Command Only)	852
Mass Storage Delete (Remote Command Only)	853
Mass Storage Data (Remote Command Only)	853
Mass Storage Make Directory (Remote Command Only)	853
Mass Storage Move (Remote Command Only)	854
Mass Storage Remove Directory (Remote Command Only)	854
Trace (+State)	854
Register 1 thru Register 16	855
From Trace	856
From File...	856
Data (Export)	858
Amplitude Correction	859
Correction Data File	860
Amplitude Correction	862
Trace	863
Trace File Contents	863
Metadata: Trace Specific	863
Metadata: Display Specific	864
Metadata: Measurement Related	864
Select Trace	867
Limit	868
Limits File Contents	869
.csv file format	869
.lim file format	870
Limit Selection	870
Measurement Results	870
Meas Results File Contents	871
Marker Table	871

Peak Table	875
Spectrogram	878
Save As . . .	882
Screen Image	883
Themes	884
3D Color	885
3D Monochrome	885
Flat Color	885
Flat Monochrome	885
Save As...	885
Mass Storage Catalog (Remote Command Only)	886
Mass Storage Change Directory (Remote Command Only)	886
Mass Storage Copy (Remote Command Only)	886
Mass Storage Delete (Remote Command Only)	887
Mass Storage Device Copy (Remote Command Only)	887
Mass Storage Data (Remote Command Only)	887
Mass Storage Make Directory (Remote Command Only)	888
Mass Storage Move (Remote Command Only)	888
Mass Storage Remove Directory (Remote Command Only)	888
Mass Storage Determine Removable Media (Remote Command Only)	889
Mass Storage Determine Removable Media Label (Remote Command Only)	889
Mass Storage Determine Removable Media Write-protect status (Remote Command Only)	889
Mass Storage Determine Removable Media size (Remote Command Only)	890
:SYSTem:SET (Remote Command Only)	890
Single (Single Measurement/Sweep)	891
More Information	891
Source	892
CXA-m TG Un-calibrated Amplitude Range	892
RF Output	892
Amplitude	893
Amplitude	893
Power Sweep	894
Amptd Offset	896
Amptd Step Auto/Man	896
Frequency	897
Multiplier Numerator	898
Multiplier Denominator	898
Source Sweep Reverse	899
Freq Offset	900
Source Mode	900

Select Source	902
Select Highlighted Source	903
Delete Highlighted Source	905
Add Source To List	905
USB	906
GPIB	907
LAN	910
Verify Current Source Connection	912
Source Setup	912
Tracking Setup Details	913
Use of the YTF (Microwave or mm Preselector) with External Source	
Control	914
Point Trigger	914
SW Trigger	915
Ext Trigger 1	915
Ext Trigger 2	916
Show Source Capabilities & Settings	916
Source Preset	917
Source Setting Query (Remote Command Only)	918
SPAN X Scale	919
Span	919
Span Presets	920
Full Span	921
Zero Span	922
Last Span	923
Signal Track (Span Zoom)	924
More Information	925
Sweep/Control	927
Sweep Time	927
Sweep Setup	929
Sweep Time Rules	929
More Information	930
Auto	931
SA - Normal	931
SA - Accuracy	931
Stimulus/Response	932
Sweep Type	932
Auto	933
Swept	933
FFT	934
Sweep Type Rules	934
Auto	935
Best Dynamic Range	935
Best Speed	935

FFT Width	936
More Information	937
Zoom Sweep Time	939
Zoom Center	939
Gate	940
Gate On/Off	940
Gate View On/Off	942
Gate View Setup	945
Gate View Sweep Time	945
Gate View Start Time	945
Gate Delay	946
Gate Length	946
Method	947
LO	947
Video	948
FFT	948
Gate Source	949
Line	950
External 1	950
External 2	952
RF Burst	954
Periodic Timer (Frame Trigger)	958
TV	970
Control Edge/Level	976
Gate Holdoff	976
Gate Delay Compensation	978
More Information	979
Min Fast Position Query (Remote Command Only)	979
Gate Preset (Remote Command Only)	980
Gate Level (Remote Command Only)	980
Gate Polarity (Remote Command Only)	980
Points	981
Zoom Points	983
Abort (Remote Command Only)	983
System	985
Trace/Detector	986
Trace Mode Backwards Compatibility	988
Trace Update Indicator	988
Trace Annunciator Panel	989
Trace Annotation	990
Select Trace	990
Clear Write	991
Trace Average	991

Trace Averaging: More Information	992
Max Hold	992
Min Hold	994
View/Blank	995
Trace Update State On/Off	996
Trace Display State On/Off	997
More Information	997
Detector	998
More Information	1000
Multiple Detectors	1001
Auto	1002
Normal	1002
Average (Log/RMS/V)	1003
Peak	1004
Sample	1004
Negative Peak	1005
Quasi Peak	1005
More Information	1006
EMI Average	1006
RMS Average	1007
Preset Detectors	1008
All Traces Auto	1008
Peak / Average / NPeak	1008
Peak / Sample / NPeak	1009
Clear Trace	1009
Clear All Traces	1009
Math	1010
Math: More Information	1011
Select Trace	1013
Power Diff (Op1 – Op2)	1013
Power Sum (Op1 + Op2)	1014
Log Offset (Op1 + Offset)	1014
Log Diff (Op1 – Op2 + Ref)	1015
More Information	1016
Off	1016
Trace Operands	1016
Operand 1	1017
Operand 2	1017
Copy/Exchange	1017
From Trace	1018
To Trace	1018
Copy Now	1019
Exchange Now	1019
Normalize	1019

Normalize On/Off	1019
More Information	1020
Measurement Details	1020
Normalize Block Diagram	1021
Store Ref (1 -> 3)	1022
Show Ref Trace (Trace 3)	1022
Norm Ref Lvl	1022
Norm Ref Posn	1022
Open/Short Cal	1023
Open/Short Guided Cal	1024
Continue	1024
Cancel	1025
Send/Query Trace Data (Remote Command Only)	1025
Query Trace Data	1025
More Information	1026
Smooth Trace Data (Remote Command Only)	1026
Number of Points for Smoothing (Remote Command Only)	1028
Mean Trace Data (Remote Command Only)	1028
Display Trace Time Query (Remote Command Only)	1029
Trigger	1030
Free Run	1030
Video	1030
Trigger Level	1030
Trig Slope	1030
Trig Delay	1030
X Axis Relative to Trigger	1030
Line	1030
Trig Slope	1030
Trig Delay	1030
X Axis Relative to Trigger	1030
External 1	1030
Trigger Level	1030
Trig Slope	1030
Trig Delay	1031
X Axis Relative to Trigger	1031
Zero Span Delay Comp	1031
External 2	1031
Trigger Level	1031
Trig Slope	1031
Trig Delay	1031
X Axis Relative to Trigger	1031
Zero Span Delay Comp	1031
RF Burst	1031

Absolute Trigger	1031
Relative Trigger	1031
Trig Slope	1031
Trig Delay	1031
X Axis Relative to Trigger	1032
Zero Span Delay Comp	1032
Periodic Timer	1032
Period	1032
Offset	1032
Offset Adjust (Remote Command Only)	1032
Reset Offset Display	1032
Sync Source	1032
Off	1032
External 1	1032
External 2	1032
RF Burst	1033
Trig Delay	1033
X Axis Relative to Trigger	1033
Sync Holdoff	1033
Baseband I/Q	1033
I/Q Mag	1033
Trigger Level	1033
Trig Slope	1033
Trig Delay	1033
X Axis Relative to Trigger	1034
I (Demodulated)	1034
Trigger Level	1034
Trig Slope	1034
Trig Delay	1034
X Axis Relative to Trigger	1034
Q (Demodulated)	1034
Trigger Level	1034
Trig Slope	1034
Trig Delay	1034
X Axis Relative to Trigger	1034
Input I	1034
Trigger Level	1034
Trig Slope	1034
Trig Delay	1035
X Axis Relative to Trigger	1035
Input Q	1035
Trigger Level	1035
Trig Slope	1035
Trig Delay	1035

X Axis Relative to Trigger	1035
Auxiliary Channel I/Q Mag	1035
Trigger Level	1035
Trig Slope	1035
Trig Delay	1035
X Axis Relative to Trigger	1035
Trigger Center Frequency	1035
Trigger Bandwidth	1035
TV	1036
TV Line	1036
Field	1036
Entire Frame	1036
Field One	1036
Field Two	1036
Standard	1036
NTSC-M	1036
NTSC-Japan	1036
NTSC-4.43	1036
PAL-M	1036
PAL-N	1036
PAL-N Combin	1036
PAL-B,D,G,H,I	1036
PAL-60	1037
SECAM-L	1037
Auto/Holdoff	1037
Auto Trig	1037
Trig Holdoff	1037
Holdoff Type	1037
User Preset	1038
User Preset	1038
User Preset All Modes	1039
Save User Preset	1040
View/Display	1041
Display	1041
Annotation	1041
Meas Bar On/Off	1042
Screen	1043
Trace	1043
Active Function Values On/Off	1044
Frequency	1044
Title	1045
Change Title	1045
Clear Title	1046

Graticule	1046
Display Line	1047
Display Lines	1047
Select Display Line	1047
Display Line 1 2 3 4	1047
Select Freq Line	1048
Freq Line 1 2 3 4	1049
Select Time Line	1050
Time Line 1 2 3 4	1050
System Display Settings	1051
Annotation Local Settings	1051
Themes	1051
Backlight	1053
Backlight Intensity	1053
Normal	1053
Spectrogram	1054
More Information	1054
Representation of Time	1057
Markers	1058
Trace Zoom	1058
Transition Rules	1060
Zone Span	1060
More Information	1061
Transition Rules	1061
9 Channel Power Measurement	1062
AMPTD Y Scale	1071
Ref Value	1071
Attenuation	1071
Dual Attenuator Configurations:	1072
Single Attenuator Configuration:	1073
(Mech) Atten	1073
Attenuator Configurations and Auto/Man	1075
Enable Elec Atten	1075
Mechanical Attenuator Transition Rules	1076
When the Electronic Attenuation is enabled from a disabled state:	1076
Examples in the dual attenuator configuration:	1077
When the Electronic Attenuation is disabled from an enabled state:	1077
Using the Electronic Attenuator: Pros and Cons	1077
Elec Atten	1078
Adjust Atten for Min Clip	1078
Pre-Adjust for Min Clip	1079

Off	1080
Elec Atten Only	1080
Mech + Elec Atten	1080
(Mech) Atten Step	1080
Scale/Div	1081
Presel Center	1082
Proper Preselector Operation	1083
Preselector Adjust	1083
Y Axis Unit	1084
dBm	1086
dBmV	1086
dBmA	1086
W	1086
V	1087
A	1087
dB μ V	1087
dB μ A	1087
Antenna Unit	1088
dB μ V/m	1088
dB μ A/m	1089
dB μ A	1089
dBpT	1089
dBG	1089
None	1090
Reference Level Offset	1090
More Information	1090
μ W Path Control	1091
Standard Path	1092
μ W Preselector Bypass	1093
Internal Preamp	1094
Off	1095
Low Band	1095
Full Range	1095
Ref Position	1096
Auto Scaling	1096
Auto Couple	1098
More Information	1098
Auto/Man Active Function keys	1098
Auto/Man 1-of-N keys	1098
BW	1100
Res BW	1100
Video BW	1101
Filter Type	1103

Cont (Continuous Measurement/Sweep)	1104
File	1106
FREQ Channel	1107
Center Freq	1107
Center Frequency Presets	1108
RF Center Freq	1111
Ext Mix Center Freq	1112
I/Q Center Freq	1112
CF Step	1113
Freq Offset	1114
More Information	1115
Input/Output	1116
Marker	1117
Select Marker	1117
Marker Type	1117
Properties	1118
Select Marker	1118
Relative To	1118
Couple Markers	1118
All Markers Off	1119
Marker X Axis Value (Remote Command Only)	1119
Marker X Axis Position (Remote Command Only)	1120
Marker Y Axis Value (Remote Command only)	1120
Backward Compatibility SCPI Commands	1121
Marker Function	1122
Marker To	1123
Meas	1124
Remote Measurement Functions	1124
Measurement Group of Commands	1125
Current Measurement Query (Remote Command Only)	1128
Limit Test Current Results (Remote Command Only)	1128
Data Query (Remote Command Only)	1128
Calculate/Compress Trace Data Query (Remote Command Only)	1128
Calculate Peaks of Trace Data (Remote Command Only)	1134
Hardware-Accelerated Fast Power Measurement (Remote Command Only)	1135
Reset Fast Power Measurement (Remote Command Only)	1136
Define Fast Power Measurement (Remote Command Only)	1136
Define Fast Power Measurement Query (Remote Command Only)	1145
Configure Fast Power Measurement (Remote Command Only)	1146
Initiate Fast Power Measurement (Remote Command Only)	1147
Fetch Fast Power Measurement (Remote Command Only)	1147
Execute Fast Power Measurement (Remote Command Only)	1147

Binary Read Fast Power Measurement (Remote Command Only)	1148
Diagnostic Binary Read Fast Power Measurement (Remote Command Only)	1148
Format Data: Numeric Data (Remote Command Only)	1149
Format Data: Byte Order (Remote Command Only)	1150
Meas Setup	1152
Avg/Hold Num	1152
Avg Mode	1153
Integ BW	1154
PhNoise Opt	1155
PhNoise Opt Auto	1155
PhNoise Opt State	1156
IF Gain	1157
IF Gain Auto	1157
IF Gain State	1157
Method	1158
Method	1159
Filter Alpha	1159
Filter BW	1160
Limits	1161
Power Limit	1162
PSD Limit	1163
Power Limit Fail (remote command only)	1164
PSD Limit Fail (remote command only)	1164
PSD Unit	1164
Meas Preset	1165
Mode	1166
Mode Preset	1167
How-To Preset	1168
Mode Setup	1170
Peak Search	1171
Print	1172
Quick Save	1173
Recall	1175
State	1175
More Information	1177
From File...	1178
Edit Register Names	1179
Register 1 thru Register 16	1180
Register 1 thru Register 16	1180
Trace (+State)	1181
To Trace	1182

Register 1 thru Register 16	1183
From File...	1183
Data (Import)	1185
Amplitude Correction	1186
Amplitude Correction	1187
Trace	1187
Select Trace	1188
Limit	1188
Limit Selection	1189
Open...	1190
Restart	1191
More Information	1191
Save	1193
State	1193
To File . . .	1194
Edit Register Names	1196
More Information	1197
Register 1 thru Register 16	1197
Register 1 thru Register 16	1198
Trace (+State)	1199
Register 1 thru Register 16	1200
From Trace	1201
From File...	1201
Data (Export)	1203
Amplitude Correction	1204
Correction Data File	1204
Amplitude Correction	1207
Trace	1208
Trace File Contents	1208
Metadata: Trace Specific	1208
Metadata: Display Specific	1209
Metadata: Measurement Related	1209
Limit	1212
Limits File Contents	1213
.csv file format	1213
.lim file format	1214
Limit Selection	1214
Measurement Results	1215
Save As . . .	1218
Screen Image	1218
Themes	1220
3D Color	1220
3D Monochrome	1220
Flat Color	1221

Flat Monochrome	1221
Save As...	1221
Mass Storage Catalog (Remote Command Only)	1221
Mass Storage Change Directory (Remote Command Only)	1222
Mass Storage Copy (Remote Command Only)	1222
Mass Storage Device Copy (Remote Command Only)	1222
Mass Storage Delete (Remote Command Only)	1223
Mass Storage Data (Remote Command Only)	1223
Mass Storage Make Directory (Remote Command Only)	1223
Mass Storage Move (Remote Command Only)	1224
Mass Storage Remove Directory (Remote Command Only)	1224
Mass Storage Determine Removable Media (Remote Command Only)	1224
Mass Storage Determine Removable Media Label (Remote Command Only)	1225
Mass Storage Determine Removable Media Write-protect status (Remote Command Only)	1225
Mass Storage Determine Removable Media size (Remote Command Only)	1225
:SYSTem:SET (Remote Command Only)	1226
Single (Single Measurement/Sweep)	1227
More Information	1227
Source	1228
CXA-m TG Un-calibrated Amplitude Range	1228
RF Output	1228
Amplitude	1229
Amplitude	1229
Power Sweep	1230
Amptd Offset	1232
Amptd Step Auto/Man	1232
Frequency	1233
Multiplier Numerator	1234
Multiplier Denominator	1234
Source Sweep Reverse	1235
Freq Offset	1236
Source Mode	1236
Select Source	1238
Select Highlighted Source	1239
Delete Highlighted Source	1241
Add Source To List	1241
USB	1241
GPIB	1243
LAN	1246
Verify Current Source Connection	1248

Source Setup	1248
Tracking Setup Details	1248
Use of the YTF (Microwave or mm Preselector) with External	
Source Control	1249
Point Trigger	1250
SW Trigger	1251
Ext Trigger 1	1251
Ext Trigger 2	1252
Show Source Capabilities & Settings	1252
Source Preset	1252
Span X Scale	1254
Span	1254
Full Span	1256
Last Span	1256
Sweep/Control	1258
Sweep Time	1258
Sweep Setup	1259
Pause	1259
Gate	1259
Gate On/Off	1260
Gate View On/Off	1261
Gate View Setup	1264
Gate View Sweep Time	1264
Gate View Start Time	1265
Gate Delay	1265
Gate Length	1266
Method	1267
LO	1267
Video	1267
FFT	1268
Gate Source	1268
Line	1269
External 1	1270
External 2	1272
RF Burst	1274
Periodic Timer (Frame Trigger)	1278
Control Edge/Level	1289
Gate Holdoff	1290
Gate Delay Compensation	1291
More Information	1292
Min Fast Position Query (Remote Command Only)	1293
Gate Preset (Remote Command Only)	1293
Gate Level (Remote Command Only)	1293
Gate Polarity (Remote Command Only)	1294

Gate	1294
System	1295
Trace/Detector	1296
Trace Type	1296
Detector	1296
Auto	1297
Detector Selection	1297
Trigger	1299
Free Run	1299
Video	1299
Trigger Level	1299
Trig Slope	1299
Trig Delay	1299
X Axis Relative to Trigger	1299
Line	1299
Trig Slope	1299
Trig Delay	1299
X Axis Relative to Trigger	1299
External 1	1299
Trigger Level	1299
Trig Slope	1299
Trig Delay	1300
X Axis Relative to Trigger	1300
Zero Span Delay Comp	1300
External 2	1300
Trigger Level	1300
Trig Slope	1300
Trig Delay	1300
X Axis Relative to Trigger	1300
Zero Span Delay Comp	1300
RF Burst	1300
Absolute Trigger	1300
Relative Trigger	1300
Trig Slope	1300
Trig Delay	1300
X Axis Relative to Trigger	1301
Zero Span Delay Comp	1301
Periodic Timer	1301
Period	1301
Offset	1301
Offset Adjust (Remote Command Only)	1301
Reset Offset Display	1301
Sync Source	1301

Table of Contents

Off	1301
External 1	1301
External 2	1301
RF Burst	1302
Trig Delay	1302
X Axis Relative to Trigger	1302
Sync Holdoff	1302
Baseband I/Q	1302
I/Q Mag	1302
Trigger Level	1302
Trig Slope	1302
Trig Delay	1302
X Axis Relative to Trigger	1303
I (Demodulated)	1303
Trigger Level	1303
Trig Slope	1303
Trig Delay	1303
X Axis Relative to Trigger	1303
Q (Demodulated)	1303
Trigger Level	1303
Trig Slope	1303
Trig Delay	1303
X Axis Relative to Trigger	1303
Input I	1303
Trigger Level	1303
Trig Slope	1303
Trig Delay	1304
X Axis Relative to Trigger	1304
Input Q	1304
Trigger Level	1304
Trig Slope	1304
Trig Delay	1304
X Axis Relative to Trigger	1304
Auxiliary Channel I/Q Mag	1304
Trigger Level	1304
Trig Slope	1304
Trig Delay	1304
X Axis Relative to Trigger	1304
Trigger Center Frequency	1304
Trigger Bandwidth	1304
TV	1305
TV Line	1305
Field	1305
Entire Frame	1305

Field One	1305
Field Two	1305
Standard	1305
NTSC-M	1305
NTSC-Japan	1305
NTSC-4.43	1305
PAL-M	1305
PAL-N	1305
PAL-N Combin	1305
PAL-B,D,G,H,I	1305
PAL-60	1306
SECAM-L	1306
Auto/Holdoff	1306
Auto Trig	1306
Trig Holdoff	1306
Holdoff Type	1306
User Preset	1307
User Preset	1307
User Preset All Modes	1308
Save User Preset	1309
View/Display	1310
View selection by name (MSR and LTE-Advanced FDD/TDD only)	1313
View selection by name (DTMB (CTTB), DVB-T/H only)	1314
View selection by name (ISDB-T, CMMB only)	1314
Display	1314
Annotation	1315
Meas Bar On/Off	1316
Screen	1317
Trace	1317
Active Function Values On/Off	1318
Title	1318
Change Title	1319
Clear Title	1319
Graticule	1320
System Display Settings	1320
Annotation Local Settings	1321
Themes	1321
Backlight	1322
Backlight Intensity	1323
Bar Graph	1323
10 Occupied Bandwidth Measurement	1325
AMPTD Y Scale (Amplitude/Y Scale)	1329
Ref Value	1329

Attenuation	1329
Dual Attenuator Configurations:	1330
Single Attenuator Configuration:	1331
(Mech) Atten	1331
Attenuator Configurations and Auto/Man	1333
Enable Elec Atten	1333
Mechanical Attenuator Transition Rules	1334
When the Electronic Attenuation is enabled from a disabled state:	1334
Examples in the dual attenuator configuration:	1335
When the Electronic Attenuation is disabled from an enabled state:	1335
Using the Electronic Attenuator: Pros and Cons	1335
Elec Atten	1336
Adjust Atten for Min Clip	1336
Pre-Adjust for Min Clip	1337
Off	1338
Elec Atten Only	1338
Mech + Elec Atten	1338
(Mech) Atten Step	1338
Scale/Div	1339
Presel Center	1340
Proper Preselector Operation	1341
Preselector Adjust	1341
Y Axis Unit	1342
dBm	1344
dBmV	1344
dBmA	1344
W	1344
V	1345
A	1345
dB μ V	1345
dB μ A	1345
Antenna Unit	1346
dB μ V/m	1346
dB μ A/m	1346
dB μ A	1347
dBpT	1347
dBG	1347
None	1348
Reference Level Offset	1348
More Information	1348
μ W Path Control	1349
Standard Path	1350

μW Preselector Bypass	1351
Internal Preamp	1352
Off	1353
Low Band	1353
Full Range	1353
Ref Position	1354
Auto Scaling	1354
Auto Couple	1356
More Information	1356
Auto/Man Active Function keys	1356
Auto/Man 1-of-N keys	1356
BW	1358
Res BW	1358
Video BW	1359
Filter Type	1360
Cont (Continuous Measurement/Sweep)	1362
File	1364
FREQ Channel	1365
Center Freq	1365
Center Frequency Presets	1366
RF Center Freq	1369
Ext Mix Center Freq	1370
I/Q Center Freq	1370
CF Step	1371
Freq Offset	1372
More Information	1373
Input/Output	1374
Marker	1375
Select Marker	1375
Select Marker	1375
Marker Type	1375
Properties	1376
Select Marker	1376
Select Marker	1376
Relative To	1376
All Markers Off	1377
Marker X Axis Value (Remote Command Only)	1377
Marker X Axis Position (Remote Command Only)	1378
Marker Y Axis Value (Remote Command Only)	1378
Backward Compatibility SCPI Commands	1379
Marker Function	1380
Marker To	1381
Meas	1382

Remote Measurement Functions	1382
Measurement Group of Commands	1383
Current Measurement Query (Remote Command Only)	1386
Limit Test Current Results (Remote Command Only)	1386
Data Query (Remote Command Only)	1386
Calculate/Compress Trace Data Query (Remote Command Only)	1386
Calculate Peaks of Trace Data (Remote Command Only)	1392
Hardware-Accelerated Fast Power Measurement (Remote Command Only)	1393
Reset Fast Power Measurement (Remote Command Only)	1394
Define Fast Power Measurement (Remote Command Only)	1394
Define Fast Power Measurement Query (Remote Command Only)	1403
Configure Fast Power Measurement (Remote Command Only)	1404
Initiate Fast Power Measurement (Remote Command Only)	1405
Fetch Fast Power Measurement (Remote Command Only)	1405
Execute Fast Power Measurement (Remote Command Only)	1405
Binary Read Fast Power Measurement (Remote Command Only)	1406
Diagnostic Binary Read Fast Power Measurement (Remote Command Only)	1406
Format Data: Numeric Data (Remote Command Only)	1407
Format Data: Byte Order (Remote Command Only)	1408
Meas Setup	1410
Avg/Hold Num	1410
Avg Mode	1411
Occ BW % Pwr	1411
x dB	1412
IF Gain	1413
IF Gain Auto	1413
IF Gain State	1413
Limit (for all modes except MSR and LTE-Advanced FDD/TDD)	1414
Meas Preset	1415
Max Hold (Remote Command Only)	1416
Mode	1417
Mode Preset	1418
How-To Preset	1419
Mode Setup	1421
Peak Search	1422
Print	1423
Quick Save	1424
Recall	1426
State	1426
More Information	1428

From File...	1429
Edit Register Names	1430
Register 1 thru Register 16	1431
Register 1 thru Register 16	1431
Trace (+State)	1432
To Trace	1433
Register 1 thru Register 16	1434
From File...	1434
Data (Import)	1436
Amplitude Correction	1437
Amplitude Correction	1438
Trace	1438
Select Trace	1439
Limit	1439
Limit Selection	1440
Open...	1441
Restart	1442
More Information	1442
Save	1444
State	1444
To File . . .	1445
Edit Register Names	1447
More Information	1448
Register 1 thru Register 16	1448
Register 1 thru Register 16	1449
Trace (+State)	1450
Register 1 thru Register 16	1451
From Trace	1452
From File...	1452
Data (Export)	1454
Amplitude Correction	1455
Correction Data File	1455
Amplitude Correction	1458
Trace	1459
Trace File Contents	1459
Metadata: Trace Specific	1459
Metadata: Display Specific	1460
Metadata: Measurement Related	1460
Limit	1463
Limits File Contents	1464
.csv file format	1464
.lim file format	1465
Limit Selection	1465

Measurement Results	1466
Meas Results File Definition	1466
Meas Results File Example	1468
Save As . . .	1469
Screen Image	1469
Themes	1471
3D Color	1471
3D Monochrome	1471
Flat Color	1472
Flat Monochrome	1472
Save As...	1472
Mass Storage Change Directory (Remote Command Only)	1472
Mass Storage Copy (Remote Command Only)	1473
Mass Storage Device Copy (Remote Command Only)	1473
Mass Storage Delete (Remote Command Only)	1473
Mass Storage Data (Remote Command Only)	1474
Mass Storage Make Directory (Remote Command Only)	1474
Mass Storage Move (Remote Command Only)	1474
Mass Storage Remove Directory (Remote Command Only)	1475
Mass Storage Catalog (Remote Command Only)	1475
Mass Storage Determine Removable Media (Remote Command Only)	1475
Mass Storage Determine Removable Media Label (Remote Command Only)	1476
Mass Storage Determine Removable Media Write-protect status (Remote Command Only)	1476
Mass Storage Determine Removable Media size (Remote Command Only)	1477
:SYSTem:SET (Remote Command Only)	1477
Single (Single Measurement/Sweep)	1478
More Information	1478
Source	1479
CXA-m TG Un-calibrated Amplitude Range	1479
RF Output	1479
Amplitude	1480
Amplitude	1480
Power Sweep	1481
Amptd Offset	1483
Amptd Step Auto/Man	1483
Frequency	1484
Multiplier Numerator	1485
Multiplier Denominator	1485
Source Sweep Reverse	1486
Freq Offset	1487
Source Mode	1487

Select Source	1489
Select Highlighted Source	1490
Delete Highlighted Source	1492
Add Source To List	1492
USB	1492
GPIB	1494
LAN	1497
Verify Current Source Connection	1499
Source Setup	1499
Tracking Setup Details	1499
Use of the YTF (Microwave or mm Preselector) with External	
Source Control	1500
Point Trigger	1501
SW Trigger	1502
Ext Trigger 1	1502
Ext Trigger 2	1503
Show Source Capabilities & Settings	1503
Source Preset	1503
Span X Scale	1505
Span	1505
Full Span	1506
Last Span	1507
Sweep/Control	1508
Sweep Time	1508
Sweep Setup	1509
Pause	1509
Gate	1509
Gate On/Off	1509
Gate View On/Off	1511
Gate View Setup	1514
Gate View Sweep Time	1514
Gate View Start Time	1515
Gate Delay	1515
Gate Length	1516
Method	1517
LO	1517
Video	1517
FFT	1518
Gate Source	1518
Line	1519
External 1	1520
External 2	1522
RF Burst	1524

Periodic Timer (Frame Trigger)	1528
TV	1540
Control Edge/Level	1545
Gate Holdoff	1546
Gate Delay Compensation	1547
More Information	1548
Min Fast Position Query (Remote Command Only)	1549
Gate Preset (Remote Command Only)	1549
Gate Level (Remote Command Only)	1549
Gate Polarity (Remote Command Only)	1550
Points	1550
System	1552
Trace/Detector	1553
Trace Type	1553
Detector	1553
Auto	1554
Detector Selection	1555
Trigger	1556
Free Run	1556
Video	1556
Trigger Level	1556
Trig Slope	1556
Trig Delay	1556
X Axis Relative to Trigger	1556
Line	1556
Trig Slope	1556
Trig Delay	1556
X Axis Relative to Trigger	1556
External 1	1556
Trigger Level	1556
Trig Slope	1556
Trig Delay	1557
X Axis Relative to Trigger	1557
Zero Span Delay Comp	1557
External 2	1557
Trigger Level	1557
Trig Slope	1557
Trig Delay	1557
X Axis Relative to Trigger	1557
Zero Span Delay Comp	1557
RF Burst	1557
Absolute Trigger	1557
Relative Trigger	1557
Trig Slope	1557

Trig Delay	1557
X Axis Relative to Trigger	1558
Zero Span Delay Comp	1558
Periodic Timer	1558
Period	1558
Offset	1558
Offset Adjust (Remote Command Only)	1558
Reset Offset Display	1558
Sync Source	1558
Off	1558
External 1	1558
External 2	1558
RF Burst	1559
Trig Delay	1559
X Axis Relative to Trigger	1559
Sync Holdoff	1559
Baseband I/Q	1559
I/Q Mag	1559
Trigger Level	1559
Trig Slope	1559
Trig Delay	1559
X Axis Relative to Trigger	1560
I (Demodulated)	1560
Trigger Level	1560
Trig Slope	1560
Trig Delay	1560
X Axis Relative to Trigger	1560
Q (Demodulated)	1560
Trigger Level	1560
Trig Slope	1560
Trig Delay	1560
X Axis Relative to Trigger	1560
Input I	1560
Trigger Level	1560
Trig Slope	1560
Trig Delay	1561
X Axis Relative to Trigger	1561
Input Q	1561
Trigger Level	1561
Trig Slope	1561
Trig Delay	1561
X Axis Relative to Trigger	1561
Auxiliary Channel I/Q Mag	1561

Trigger Level	1561
Trig Slope	1561
Trig Delay	1561
X Axis Relative to Trigger	1561
Trigger Center Frequency	1561
Trigger Bandwidth	1561
TV	1562
TV Line	1562
Field	1562
Entire Frame	1562
Field One	1562
Field Two	1562
Standard	1562
NTSC-M	1562
NTSC-Japan	1562
NTSC-4.43	1562
PAL-M	1562
PAL-N	1562
PAL-N Combin	1562
PAL-B,D,G,H,I	1562
PAL-60	1563
SECAM-L	1563
Auto/Holdoff	1563
Auto Trig	1563
Trig Holdoff	1563
Holdoff Type	1563
User Preset	1564
User Preset	1564
User Preset All Modes	1565
Save User Preset	1566
View/Display	1567
Display	1567
Annotation	1567
Meas Bar On/Off	1568
Screen	1569
Trace	1569
Active Function Values On/Off	1570
Title	1570
Change Title	1571
Clear Title	1571
Graticule	1572
System Display Settings	1572
Annotation Local Settings	1572
Themes	1573

Backlight	1574
Backlight Intensity	1575
View Selection	1575
View Selection by Name	1576
View Selection by Number	1576
OBW Results	1576
OBW Boundaries	1577
Spectrum View	1578
Boundary Frequency	1582
x dB BW Boundaries	1582
11 ACP Measurement	1584
AMPTD Y Scale	1598
Ref Value	1598
Attenuation	1598
Dual Attenuator Configurations:	1599
Single Attenuator Configuration:	1600
(Mech) Atten	1600
Attenuator Configurations and Auto/Man	1602
Enable Elec Atten	1602
Mechanical Attenuator Transition Rules	1603
When the Electronic Attenuation is enabled from a disabled state:	1603
Examples in the dual attenuator configuration:	1604
When the Electronic Attenuation is disabled from an enabled state:	1604
Using the Electronic Attenuator: Pros and Cons	1604
Elec Atten	1605
Adjust Atten for Min Clip	1605
Pre-Adjust for Min Clip	1606
Off	1607
Elec Atten Only	1607
Mech + Elec Atten	1607
(Mech) Atten Step	1607
Max Mixer Level	1608
Scale/Div	1608
Presel Center	1609
Proper Preselector Operation	1610
Preselector Adjust	1610
Y Axis Unit	1612
dBm	1613
dBmV	1613
dBmA	1613
W	1614

V	1614
A	1614
dB μ V	1615
dB μ A	1615
Antenna Unit	1615
dB μ V/m	1616
dB μ A/m	1616
dB μ A	1616
dBpT	1616
dBG	1617
None	1617
Reference Level Offset	1617
More Information	1618
μ W Path Control	1618
Standard Path	1620
μ W Preselector Bypass	1620
Internal Preamp	1621
Off	1622
Low Band	1622
Full Range	1623
Ref Position	1623
Auto Scaling	1624
Auto Couple	1625
More Information	1625
Auto/Man Active Function keys	1625
Auto/Man 1-of-N keys	1625
BW	1627
Res BW	1627
Video BW	1628
RBW Control	1630
Filter Type	1630
Filter BW	1631
Cont (Continuous Measurement/Sweep)	1632
File	1634
FREQ Channel	1635
Center Freq	1635
Center Frequency Presets	1636
RF Center Freq	1639
Ext Mix Center Freq	1640
I/Q Center Freq	1640
CF Step	1641
Freq Offset	1642
More Information	1643
Input/Output	1644

Marker	1645
Select Marker	1645
Marker Type	1645
Properties	1646
Select Marker	1646
Relative To	1646
Marker Trace	1647
Couple Markers	1647
Marker All Off	1648
Marker X Axis Value (Remote Command only)	1648
Marker X Axis Position (Remote Command only)	1649
Marker Y Axis Value (Remote Command only)	1649
Backward Compatibility Remote Commands	1650
Marker Function	1651
Marker To	1652
Meas	1653
Remote Measurement Functions	1653
Measurement Group of Commands	1654
Current Measurement Query (Remote Command Only)	1657
Limit Test Current Results (Remote Command Only)	1657
Data Query (Remote Command Only)	1657
Calculate/Compress Trace Data Query (Remote Command Only)	1657
Calculate Peaks of Trace Data (Remote Command Only)	1663
Hardware-Accelerated Fast Power Measurement (Remote Command Only)	1664
Reset Fast Power Measurement (Remote Command Only)	1665
Define Fast Power Measurement (Remote Command Only)	1665
Define Fast Power Measurement Query (Remote Command Only)	1674
Configure Fast Power Measurement (Remote Command Only)	1675
Initiate Fast Power Measurement (Remote Command Only)	1676
Fetch Fast Power Measurement (Remote Command Only)	1676
Execute Fast Power Measurement (Remote Command Only)	1676
Binary Read Fast Power Measurement (Remote Command Only)	1677
Diagnostic Binary Read Fast Power Measurement (Remote Command Only)	1677
Format Data: Numeric Data (Remote Command Only)	1678
Format Data: Byte Order (Remote Command Only)	1679
Meas Setup	1681
Average/Hold Number	1681
Avg Mode	1682
Carrier Setup (This menu is unavailable in MSR)	1682

Carriers	1682
Ref Carrier	1683
Ref Car Freq	1684
Power Ref (SA and W-CDMA Only)	1685
Configure Carriers	1686
Carrier	1686
Carrier Pwr Present	1687
Carrier Spacing	1689
Measurement Noise Bandwidth	1690
Method for Carrier	1691
Offset/Limits	1693
Select Offset	1693
Offset Freq	1693
Integ BW	1695
Offset BW	1696
Res BW	1697
Video BW	1698
RBW Control	1699
Limits	1701
Select Offset	1701
Abs Limit	1701
Rel Lim (Car)	1703
Rel Limit (PSD)	1705
Fail Mask	1707
Offset Side	1708
Method for Offset	1709
Method for Offset	1710
Offset Frequency Define	1712
Carrier Result	1713
PhNoise Opt	1713
More Information	1715
Auto	1716
Best Close-in Φ Noise	1716
Balance Noise and Spurs	1716
Best Spurs	1716
Best Wide-offset Φ Noise	1717
Fast Tuning	1717
Phase Noise Optimization Auto Rules	1717
Models with Option EP0	1718
Models with Option EP1	1718
Models with Option EP2	1719
Models with Option EP4	1719
All other Models	1719
PhNoise Opt Auto	1720

PhNoise Opt State	1720
Meas Method	1721
Meas Type	1723
PSD Ref	1724
Limit Test	1724
Noise Correction	1725
Meas Preset	1726
Offset RRC Weighting (Backward Compatibility SCPI)	1727
Offset Filter Alpha (Backward Compatibility SCPI)	1727
Method for Carrier (Backward Compatibility SCPI)	1728
Mode	1730
Mode Preset	1731
How-To Preset	1732
Mode Setup	1734
Peak Search	1735
Next Peak	1735
Next Pk Right	1735
Next Pk Left	1735
Marker Delta	1736
Pk-Pk Search	1736
Min Search	1736
Print	1738
Quick Save	1739
Recall	1741
State	1741
More Information	1743
From File...	1744
Edit Register Names	1745
Register 1 thru Register 16	1746
Register 1 thru Register 16	1746
Trace (+State)	1747
To Trace	1748
Register 1 thru Register 16	1749
From File...	1749
Data (Import)	1751
Amplitude Correction	1752
Amplitude Correction	1753
Trace	1753
Select Trace	1754
Limit	1754
Limit Selection	1755
Open...	1756
Restart	1757

More Information	1757
Save	1759
State	1759
To File . . .	1760
Edit Register Names	1762
More Information	1763
Register 1 thru Register 16	1763
Register 1 thru Register 16	1764
Trace (+State)	1765
Register 1 thru Register 16	1766
From Trace	1767
From File...	1767
Data (Export)	1769
Amplitude Correction	1770
Correction Data File	1770
Amplitude Correction	1773
Trace	1774
Trace File Contents	1774
Metadata: Trace Specific	1774
Metadata: Display Specific	1775
Metadata: Measurement Related	1775
Limit	1778
Limits File Contents	1779
.csv file format	1779
.lim file format	1780
Limit Selection	1780
Measurement Results	1781
Save As . . .	1790
Screen Image	1791
Themes	1793
3D Color	1793
3D Monochrome	1793
Flat Color	1793
Flat Monochrome	1794
Save As...	1794
Mass Storage Catalog (Remote Command Only)	1794
Mass Storage Change Directory (Remote Command Only)	1795
Mass Storage Copy (Remote Command Only)	1795
Mass Storage Device Copy (Remote Command Only)	1795
Mass Storage Delete (Remote Command Only)	1796
Mass Storage Data (Remote Command Only)	1796
Mass Storage Make Directory (Remote Command Only)	1796
Mass Storage Move (Remote Command Only)	1797
Mass Storage Remove Directory (Remote Command Only)	1797

Mass Storage Determine Removable Media (Remote Command Only)	1797
Mass Storage Determine Removable Media Label (Remote Command Only)	1798
Mass Storage Determine Removable Media Write-protect status (Remote Command Only)	1798
Mass Storage Determine Removable Media size (Remote Command Only)	1798
:SYSTem:SET (Remote Command Only)	1799
Single (Single Measurement/Sweep)	1800
More Information	1800
Source	1801
CXA-m TG Un-calibrated Amplitude Range	1801
RF Output	1801
Amplitude	1802
Amplitude	1802
Power Sweep	1803
Amptd Offset	1805
Amptd Step Auto/Man	1805
Frequency	1806
Multiplier Numerator	1807
Multiplier Denominator	1807
Source Sweep Reverse	1808
Freq Offset	1809
Source Mode	1809
Select Source	1811
Select Highlighted Source	1812
Delete Highlighted Source	1814
Add Source To List	1814
USB	1815
GPIB	1816
LAN	1819
Verify Current Source Connection	1821
Source Setup	1821
Tracking Setup Details	1822
Use of the YTF (Microwave or mm Preselector) with External	
Source Control	1823
Point Trigger	1823
SW Trigger	1824
Ext Trigger 1	1824
Ext Trigger 2	1825
Show Source Capabilities & Settings	1825
Source Preset	1826
SPAN X Scale	1827

Span	1827
Full Span	1828
Last Span	1828
Sweep/Control	1830
Sweep Time	1830
Sweep Setup	1831
Auto Sweep Time Rules	1832
Pause	1832
Gate	1832
Gate On/Off	1833
Gate View On/Off	1834
Gate View Setup	1837
Gate View Sweep Time	1837
Gate View Start Time	1838
Gate Delay	1838
Gate Length	1839
Method	1840
LO	1840
Video	1840
FFT	1841
Gate Source	1841
Line	1842
External 1	1843
External 2	1845
RF Burst	1847
Periodic Timer (Frame Trigger)	1851
TV	1863
Control Edge/Level	1868
Gate Holdoff	1869
Gate Delay Compensation	1870
More Information	1871
Min Fast Position Query (Remote Command Only)	1872
Gate Preset (Remote Command Only)	1872
Gate Level (Remote Command Only)	1872
Gate Polarity (Remote Command Only)	1873
Points	1873
System	1875
Trace/Detector	1876
Select Trace (Front-panel Only)	1876
Trace Type	1876
View/Blank	1877
Detector	1878
Auto	1879
Detector Selection	1879

Trigger	1881
Free Run	1881
Video	1881
Trigger Level	1881
Trig Slope	1881
Trig Delay	1881
X Axis Relative to Trigger	1881
Line	1881
Trig Slope	1881
Trig Delay	1881
X Axis Relative to Trigger	1881
External 1	1881
Trigger Level	1881
Trig Slope	1881
Trig Delay	1882
X Axis Relative to Trigger	1882
Zero Span Delay Comp	1882
External 2	1882
Trigger Level	1882
Trig Slope	1882
Trig Delay	1882
X Axis Relative to Trigger	1882
Zero Span Delay Comp	1882
RF Burst	1882
Absolute Trigger	1882
Relative Trigger	1882
Trig Slope	1882
Trig Delay	1882
X Axis Relative to Trigger	1883
Zero Span Delay Comp	1883
Periodic Timer	1883
Period	1883
Offset	1883
Offset Adjust (Remote Command Only)	1883
Reset Offset Display	1883
Sync Source	1883
Off	1883
External 1	1883
External 2	1883
RF Burst	1884
Trig Delay	1884
X Axis Relative to Trigger	1884
Sync Holdoff	1884

Baseband I/Q	1884
I/Q Mag	1884
Trigger Level	1884
Trig Slope	1884
Trig Delay	1884
X Axis Relative to Trigger	1885
I (Demodulated)	1885
Trigger Level	1885
Trig Slope	1885
Trig Delay	1885
X Axis Relative to Trigger	1885
Q (Demodulated)	1885
Trigger Level	1885
Trig Slope	1885
Trig Delay	1885
X Axis Relative to Trigger	1885
Input I	1885
Trigger Level	1885
Trig Slope	1885
Trig Delay	1886
X Axis Relative to Trigger	1886
Input Q	1886
Trigger Level	1886
Trig Slope	1886
Trig Delay	1886
X Axis Relative to Trigger	1886
Auxiliary Channel I/Q Mag	1886
Trigger Level	1886
Trig Slope	1886
Trig Delay	1886
X Axis Relative to Trigger	1886
Trigger Center Frequency	1886
Trigger Bandwidth	1886
TV	1887
TV Line	1887
Field	1887
Entire Frame	1887
Field One	1887
Field Two	1887
Standard	1887
NTSC-M	1887
NTSC-Japan	1887
NTSC-4.43	1887
PAL-M	1887

PAL-N	1887
PAL-N Combin	1887
PAL-B,D,G,H,I	1887
PAL-60	1888
SECAM-L	1888
Auto/Holdoff	1888
Auto Trig	1888
Trig Holdoff	1888
Holdoff Type	1888
User Preset	1889
User Preset	1889
User Preset All Modes	1890
Save User Preset	1891
View/Display	1892
Spectrum Window	1894
Results Window	1894
Display	1897
Annotation	1897
Meas Bar On/Off	1898
Screen	1899
Trace	1899
Active Function Values On/Off	1900
Title	1900
Change Title	1901
Clear Title	1901
Graticule	1902
System Display Settings	1902
Annotation Local Settings	1903
Themes	1903
Backlight	1904
Backlight Intensity	1905
Bar Graph	1905
12 Power Stat CCDF Measurement	1907
AMPTD Y Scale	1912
Attenuation	1912
Dual Attenuator Configurations:	1912
Single Attenuator Configuration:	1913
(Mech) Atten	1914
Attenuator Configurations and Auto/Man	1915
Enable Elec Atten	1915
Mechanical Attenuator Transition Rules	1916
When the Electronic Attenuation is enabled from a disabled state:	1917

Examples in the dual attenuator configuration:	1917
When the Electronic Attenuation is disabled from an enabled state:	1917
Using the Electronic Attenuator: Pros and Cons	1918
Elec Atten	1918
Adjust Atten for Min Clip	1919
Pre-Adjust for Min Clip	1919
Off	1920
Elec Atten Only	1920
Mech + Elec Atten	1921
(Mech) Atten Step	1921
Max Mixer Level	1921
Range	1922
Presel Center	1922
Proper Preselector Operation	1923
Preselector Adjust	1923
Reference Level Offset	1925
More Information	1925
μ W Path Control	1926
Standard Path	1927
μ W Preselector Bypass	1928
Internal Preamp	1929
Off	1930
Low Band	1930
Full Range	1930
Presel Center	1931
Auto Couple	1932
More Information	1932
Auto/Man Active Function keys	1932
Auto/Man 1-of-N keys	1932
BW	1934
Info BW	1934
Cont (Continuous Measurement/Sweep)	1936
File	1938
FREQ Channel	1939
Center Freq	1939
Center Frequency Presets	1940
RF Center Freq	1943
Ext Mix Center Freq	1944
I/Q Center Freq	1944
CF Step	1945
Freq Offset	1946
More Information	1947
Input/Output	1948

Marker	1949
Select Marker	1949
Marker Type	1949
Properties	1950
Select Marker	1950
Relative To	1950
Marker Trace	1951
Couple Markers	1951
All Markers Off	1951
Marker X Axis Value (Remote Command Only)	1952
Marker Y Axis Value (Remote Command Only)	1952
Marker Function	1954
Marker To	1955
Meas	1956
Remote Measurement Functions	1956
Measurement Group of Commands	1957
Current Measurement Query (Remote Command Only)	1960
Limit Test Current Results (Remote Command Only)	1960
Data Query (Remote Command Only)	1960
Calculate/Compress Trace Data Query (Remote Command Only)	1960
Calculate Peaks of Trace Data (Remote Command Only)	1966
Hardware-Accelerated Fast Power Measurement (Remote Command Only)	1967
Reset Fast Power Measurement (Remote Command Only)	1968
Define Fast Power Measurement (Remote Command Only)	1968
Define Fast Power Measurement Query (Remote Command Only)	1977
Configure Fast Power Measurement (Remote Command Only)	1978
Initiate Fast Power Measurement (Remote Command Only)	1979
Fetch Fast Power Measurement (Remote Command Only)	1979
Execute Fast Power Measurement (Remote Command Only)	1979
Binary Read Fast Power Measurement (Remote Command Only)	1980
Diagnostic Binary Read Fast Power Measurement (Remote Command Only)	1980
Format Data: Numeric Data (Remote Command Only)	1981
Format Data: Byte Order (Remote Command Only)	1982
Meas Setup	1984
Counts	1984
Meas Cycles	1984
Meas Interval (Not 1xEVDO)	1985
IF Gain	1986
IF Gain Auto	1986

IF Gain State	1987
Meas Preset	1987
Mode	1989
Mode Preset	1990
How-To Preset	1991
Mode Setup	1993
Peak Search	1994
Print	1995
Quick Save	1996
Recall	1998
State	1998
More Information	2000
From File...	2001
Edit Register Names	2002
Register 1 thru Register 16	2003
Register 1 thru Register 16	2003
Trace (+State)	2004
To Trace	2005
Register 1 thru Register 16	2006
From File...	2006
Data (Import)	2008
Amplitude Correction	2009
Amplitude Correction	2010
Trace	2010
Select Trace	2011
Limit	2011
Limit Selection	2012
Open...	2013
Restart	2014
More Information	2014
Save	2016
State	2016
To File . . .	2017
Edit Register Names	2019
More Information	2020
Register 1 thru Register 16	2020
Register 1 thru Register 16	2021
Trace (+State)	2022
Register 1 thru Register 16	2023
From Trace	2024
From File...	2024
Data (Export)	2026
Amplitude Correction	2027
Correction Data File	2027

Amplitude Correction	2030
Trace	2031
Trace File Contents	2031
Metadata: Trace Specific	2031
Metadata: Display Specific	2032
Metadata: Measurement Related	2032
Limit	2035
Limits File Contents	2036
.csv file format	2036
.lim file format	2037
Limit Selection	2037
Measurement Results	2038
Meas Results File Definition	2038
Meas Results File Example	2040
Save As . . .	2042
Screen Image	2043
Themes	2044
3D Color	2045
3D Monochrome	2045
Flat Color	2045
Flat Monochrome	2045
Save As...	2045
Mass Storage Catalog (Remote Command Only)	2046
Mass Storage Change Directory (Remote Command Only)	2046
Mass Storage Copy (Remote Command Only)	2046
Mass Storage Device Copy (Remote Command Only)	2047
Mass Storage Delete (Remote Command Only)	2047
Mass Storage Data (Remote Command Only)	2047
Mass Storage Make Directory (Remote Command Only)	2048
Mass Storage Move (Remote Command Only)	2048
Mass Storage Remove Directory (Remote Command Only)	2048
Mass Storage Determine Removable Media (Remote Command Only)	2049
Mass Storage Determine Removable Media Label (Remote Command Only)	2049
Mass Storage Determine Removable Media Write-protect status (Remote Command Only)	2049
Mass Storage Determine Removable Media size (Remote Command Only)	2050
:SYSTem:SET (Remote Command Only)	2050
Single (Single Measurement/Sweep)	2051
More Information	2051
Source	2052
Span X Scale	2053

Scale/Div	2053
Sweep/Control	2054
Pause/Resume	2054
System	2055
Trace/Detector	2056
Store Ref Trace	2056
Ref Trace	2056
Gaussian Line	2057
Trigger	2058
Free Run	2058
Video	2058
Trigger Level	2058
Trig Slope	2058
Trig Delay	2058
X Axis Relative to Trigger	2058
Line	2058
Trig Slope	2058
Trig Delay	2058
X Axis Relative to Trigger	2058
External 1	2058
Trigger Level	2058
Trig Slope	2058
Trig Delay	2059
X Axis Relative to Trigger	2059
Zero Span Delay Comp	2059
External 2	2059
Trigger Level	2059
Trig Slope	2059
Trig Delay	2059
X Axis Relative to Trigger	2059
Zero Span Delay Comp	2059
RF Burst	2059
Absolute Trigger	2059
Relative Trigger	2059
Trig Slope	2059
Trig Delay	2059
X Axis Relative to Trigger	2060
Zero Span Delay Comp	2060
Periodic Timer	2060
Period	2060
Offset	2060
Offset Adjust (Remote Command Only)	2060
Reset Offset Display	2060
Sync Source	2060

Off	2060
External 1	2060
External 2	2060
RF Burst	2061
Trig Delay	2061
X Axis Relative to Trigger	2061
Sync Holdoff	2061
Baseband I/Q	2061
I/Q Mag	2061
Trigger Level	2061
Trig Slope	2061
Trig Delay	2061
X Axis Relative to Trigger	2062
I (Demodulated)	2062
Trigger Level	2062
Trig Slope	2062
Trig Delay	2062
X Axis Relative to Trigger	2062
Q (Demodulated)	2062
Trigger Level	2062
Trig Slope	2062
Trig Delay	2062
X Axis Relative to Trigger	2062
Input I	2062
Trigger Level	2062
Trig Slope	2062
Trig Delay	2063
X Axis Relative to Trigger	2063
Input Q	2063
Trigger Level	2063
Trig Slope	2063
Trig Delay	2063
X Axis Relative to Trigger	2063
Auxiliary Channel I/Q Mag	2063
Trigger Level	2063
Trig Slope	2063
Trig Delay	2063
X Axis Relative to Trigger	2063
Trigger Center Frequency	2063
Trigger Bandwidth	2063
TV	2064
TV Line	2064
Field	2064

Entire Frame	2064
Field One	2064
Field Two	2064
Standard	2064
NTSC-M	2064
NTSC-Japan	2064
NTSC-4.43	2064
PAL-M	2064
PAL-N	2064
PAL-N Combin	2064
PAL-B,D,G,H,I	2064
PAL-60	2065
SECAM-L	2065
Auto/Holdoff	2065
Auto Trig	2065
Trig Holdoff	2065
Holdoff Type	2065
User Preset	2066
User Preset	2066
User Preset All Modes	2067
Save User Preset	2068
View/Display	2069
Metrics window	2071
Graph window	2072
Wave window (TD-SCDMA and LTE TDD only)	2072
Display	2072
Annotation	2073
Meas Bar On/Off	2074
Screen	2075
Trace	2075
Active Function Values On/Off	2076
Title	2076
Change Title	2077
Clear Title	2077
Graticule	2078
System Display Settings	2078
Annotation Local Settings	2078
Themes	2079
Backlight	2080
Backlight Intensity	2081
13 Burst Power (Transmit Power)	2082
AMPTD Y Scale	2087
Y Ref Value	2087

Attenuation	2087
Dual Attenuator Configurations:	2088
Single Attenuator Configuration:	2089
(Mech) Atten	2089
Attenuator Configurations and Auto/Man	2091
Enable Elec Atten	2091
Mechanical Attenuator Transition Rules	2092
When the Electronic Attenuation is enabled from a disabled state:	2092
Examples in the dual attenuator configuration:	2093
When the Electronic Attenuation is disabled from an enabled state:	2093
Using the Electronic Attenuator: Pros and Cons	2093
Elec Atten	2094
Adjust Atten for Min Clip	2094
Pre-Adjust for Min Clip	2095
Off	2096
Elec Atten Only	2096
Mech + Elec Atten	2096
(Mech) Atten Step	2096
Max Mixer Level	2097
Scale/Division	2097
Presel Center	2098
Proper Preselector Operation	2099
Preselector Adjust	2099
Y Axis Unit	2100
dBm	2102
dBmV	2102
dBmA	2102
W	2103
V	2103
A	2103
dB μ V	2103
dB μ A	2104
Antenna Unit	2104
dB μ V/m	2104
dB μ A/m	2105
dB μ A	2105
dBpT	2105
dBG	2105
None	2106
Reference Level Offset	2106
More Information	2107

μW Path Control	2107
Standard Path	2109
μW Preselector Bypass	2109
Internal Preamp	2110
Off	2111
Low Band	2111
Full Range	2112
Ref Position	2112
Auto Scaling	2112
Auto Couple	2114
More Information	2114
Auto/Man Active Function keys	2114
Auto/Man 1-of-N keys	2114
BW	2116
Res BW	2116
Filter Type	2117
Cont (Continuous Measurement/Sweep)	2118
File	2120
FREQ Channel	2121
Center Freq	2121
Center Frequency Presets	2122
RF Center Freq	2125
Ext Mix Center Freq	2126
I/Q Center Freq	2126
CF Step	2127
Freq Offset	2128
More Information	2129
Input/Output	2130
Marker	2131
Select Marker	2131
Marker Type	2131
Properties	2132
Select Marker	2132
Relative To	2132
Marker Trace	2132
Couple Markers	2133
All Markers Off	2133
Marker X Axis Position (Remote Command Only)	2134
Marker Y Axis Value (Remote Command Only)	2134
Marker Function	2136
Marker To	2137
Meas	2138
Remote Measurement Functions	2138
Measurement Group of Commands	2139

Current Measurement Query (Remote Command Only)	2142
Limit Test Current Results (Remote Command Only)	2142
Data Query (Remote Command Only)	2142
Calculate/Compress Trace Data Query (Remote Command Only)	2142
Calculate Peaks of Trace Data (Remote Command Only)	2148
Hardware-Accelerated Fast Power Measurement (Remote Command Only)	2149
Reset Fast Power Measurement (Remote Command Only)	2150
Define Fast Power Measurement (Remote Command Only)	2150
Define Fast Power Measurement Query (Remote Command Only)	2159
Configure Fast Power Measurement (Remote Command Only)	2160
Initiate Fast Power Measurement (Remote Command Only)	2161
Fetch Fast Power Measurement (Remote Command Only)	2161
Execute Fast Power Measurement (Remote Command Only)	2161
Binary Read Fast Power Measurement (Remote Command Only)	2162
Diagnostic Binary Read Fast Power Measurement (Remote Command Only)	2162
Format Data: Numeric Data (Remote Command Only)	2163
Format Data: Byte Order (Remote Command Only)	2164
Meas Setup	2166
Avg/Hold Num	2166
Avg Mode	2166
Avg Type	2167
Threshold Lvl	2168
Meas Method	2169
Burst Width	2171
IF Gain	2171
IF Gain Auto	2172
IF Gain State	2172
Meas Preset	2173
Mode	2174
Mode Preset	2175
How-To Preset	2176
Mode Setup	2178
Peak Search	2179
Print	2180
Quick Save	2181
Recall	2183
State	2183
More Information	2185
From File...	2186

Edit Register Names	2187
Register 1 thru Register 16	2188
Register 1 thru Register 16	2188
Trace (+State)	2189
To Trace	2190
Register 1 thru Register 16	2191
From File...	2191
Data (Import)	2193
Amplitude Correction	2194
Amplitude Correction	2195
Trace	2195
Select Trace	2196
Limit	2196
Limit Selection	2197
Open...	2198
Restart	2199
More Information	2199
Save	2201
State	2201
To File . . .	2202
Edit Register Names	2204
More Information	2205
Register 1 thru Register 16	2205
Register 1 thru Register 16	2206
Trace (+State)	2207
Register 1 thru Register 16	2208
From Trace	2209
From File...	2209
Data (Export)	2211
Amplitude Correction	2212
Correction Data File	2212
Amplitude Correction	2215
Trace	2216
Trace File Contents	2216
Metadata: Trace Specific	2216
Metadata: Display Specific	2217
Metadata: Measurement Related	2217
Limit	2220
Limits File Contents	2221
.csv file format	2221
.lim file format	2222
Limit Selection	2222
Measurement Results	2223
Meas Results File Contents	2223

Save As . . .	2224
Screen Image	2225
Themes	2227
3D Color	2227
3D Monochrome	2227
Flat Color	2227
Flat Monochrome	2228
Save As...	2228
Mass Storage Catalog (Remote Command Only)	2228
Mass Storage Change Directory (Remote Command Only)	2229
Mass Storage Copy (Remote Command Only)	2229
Mass Storage Device Copy (Remote Command Only)	2229
Mass Storage Delete (Remote Command Only)	2230
Mass Storage Data (Remote Command Only)	2230
Mass Storage Make Directory (Remote Command Only)	2230
Mass Storage Move (Remote Command Only)	2231
Mass Storage Remove Directory (Remote Command Only)	2231
Mass Storage Determine Removable Media (Remote Command Only)	2231
Mass Storage Determine Removable Media Label (Remote Command Only)	2232
Mass Storage Determine Removable Media Write-protect status (Remote Command Only)	2232
Mass Storage Determine Removable Media size (Remote Command Only)	2232
:SYSTem:SET (Remote Command Only)	2233
Single (Single Measurement/Sweep)	2234
More Information	2234
Source	2235
CXA-m TG Un-calibrated Amplitude Range	2235
RF Output	2235
Amplitude	2236
Amplitude	2236
Power Sweep	2237
Amptd Offset	2239
Amptd Step Auto/Man	2239
Frequency	2240
Multiplier Numerator	2241
Multiplier Denominator	2241
Source Sweep Reverse	2242
Freq Offset	2243
Source Mode	2243
Select Source	2245
Select Highlighted Source	2246

Delete Highlighted Source	2248
Add Source To List	2248
USB	2249
GPIB	2250
LAN	2253
Verify Current Source Connection	2255
Source Setup	2255
Tracking Setup Details	2256
Use of the YTF (Microwave or mm Preselector) with External	
Source Control	2257
Point Trigger	2257
SW Trigger	2258
Ext Trigger 1	2258
Ext Trigger 2	2259
Show Source Capabilities & Settings	2259
Source Preset	2260
SPAN X Scale	2261
Ref Value	2261
Scale/Div	2261
Ref Position	2262
Auto Scaling	2262
Sweep/Control	2263
Sweep Time (for SAmode)	2263
Pause/Resume	2263
Abort (Remote Command Only)	2264
System	2265
Trace/Detector	2266
Max Hold Trace	2266
Min Hold Trace	2266
Trigger	2268
Free Run	2268
Video	2268
Trigger Level	2268
Trig Slope	2268
Trig Delay	2268
X Axis Relative to Trigger	2268
Line	2268
Trig Slope	2268
Trig Delay	2268
X Axis Relative to Trigger	2268
External 1	2268
Trigger Level	2268
Trig Slope	2268
Trig Delay	2269

X Axis Relative to Trigger	2269
Zero Span Delay Comp	2269
External 2	2269
Trigger Level	2269
Trig Slope	2269
Trig Delay	2269
X Axis Relative to Trigger	2269
Zero Span Delay Comp	2269
RF Burst	2269
Absolute Trigger	2269
Relative Trigger	2269
Trig Slope	2269
Trig Delay	2269
X Axis Relative to Trigger	2270
Zero Span Delay Comp	2270
Periodic Timer	2270
Period	2270
Offset	2270
Offset Adjust (Remote Command Only)	2270
Reset Offset Display	2270
Sync Source	2270
Off	2270
External 1	2270
External 2	2270
RF Burst	2271
Trig Delay	2271
X Axis Relative to Trigger	2271
Sync Holdoff	2271
Baseband I/Q	2271
I/Q Mag	2271
Trigger Level	2271
Trig Slope	2271
Trig Delay	2271
X Axis Relative to Trigger	2272
I (Demodulated)	2272
Trigger Level	2272
Trig Slope	2272
Trig Delay	2272
X Axis Relative to Trigger	2272
Q (Demodulated)	2272
Trigger Level	2272
Trig Slope	2272
Trig Delay	2272

X Axis Relative to Trigger	2272
Input I	2272
Trigger Level	2272
Trig Slope	2272
Trig Delay	2273
X Axis Relative to Trigger	2273
Input Q	2273
Trigger Level	2273
Trig Slope	2273
Trig Delay	2273
X Axis Relative to Trigger	2273
Auxiliary Channel I/Q Mag	2273
Trigger Level	2273
Trig Slope	2273
Trig Delay	2273
X Axis Relative to Trigger	2273
Trigger Center Frequency	2273
Trigger Bandwidth	2273
TV	2274
TV Line	2274
Field	2274
Entire Frame	2274
Field One	2274
Field Two	2274
Standard	2274
NTSC-M	2274
NTSC-Japan	2274
NTSC-4.43	2274
PAL-M	2274
PAL-N	2274
PAL-N Combin	2274
PAL-B,D,G,H,I	2274
PAL-60	2275
SECAM-L	2275
Auto/Holdoff	2275
Auto Trig	2275
Trig Holdoff	2275
Holdoff Type	2275
User Preset	2276
User Preset	2276
User Preset All Modes	2277
Save User Preset	2278
View/Display	2279
RF Envelope view for TX Power Measurement(Above Threshold)	2279

RF Envelope view with Bar Graph for TX Power Measurement (Measured Burst Width)	2280
RF Envelope view with Bar Graph for TX Power Measurement (Single TimeSlot)	2281
Display	2282
Annotation	2283
Meas Bar On/Off	2284
Screen	2285
Trace	2285
Active Function Values On/Off	2286
Title	2286
Change Title	2287
Clear Title	2287
Graticule	2288
System Display Settings	2288
Annotation Local Settings	2289
Themes	2289
Backlight	2290
Backlight Intensity	2291
Bar Graph	2291
14 Spurious Emissions Measurement	2292
AMPTD Y Scale	2295
Ref Value	2295
Attenuation	2295
Dual Attenuator Configurations:	2296
Single Attenuator Configuration:	2297
(Mech) Atten	2297
Attenuator Configurations and Auto/Man	2299
Enable Elec Atten	2299
Mechanical Attenuator Transition Rules	2300
When the Electronic Attenuation is enabled from a disabled state:	2300
Examples in the dual attenuator configuration:	2301
When the Electronic Attenuation is disabled from an enabled state:	2301
Using the Electronic Attenuator: Pros and Cons	2301
Elec Atten	2302
Adjust Atten for Min Clip	2302
Pre-Adjust for Min Clip	2303
Off	2304
Elec Atten Only	2304
Mech + Elec Atten	2304
(Mech) Atten Step	2304

Max Mixer Level	2305
Scale/Div	2305
Presel Center	2306
Proper Preselector Operation	2307
Preselector Adjust	2308
Y Axis Unit	2309
dBm	2310
dBmV	2310
dBmA	2311
W	2311
V	2311
A	2311
dB μ V	2312
dB μ A	2312
Antenna Unit	2313
dB μ V/m	2313
dB μ A/m	2313
dB μ A	2313
dBpT	2314
dBG	2314
None	2314
Reference Level Offset	2314
More Information	2315
μ W Path Control	2316
Standard Path	2317
μ W Preselector Bypass	2317
Internal Preamp	2318
Off	2319
Low Band	2320
Full Range	2320
Auto Scaling	2320
Auto Couple	2322
More Information	2322
Auto/Man Active Function keys	2322
Auto/Man 1-of-N keys	2322
BW	2324
Cont (Continuous Measurement/Sweep)	2325
File	2327
FREQ Channel	2328
Center Freq	2328
Center Frequency Presets	2329
RF Center Freq	2332
Ext Mix Center Freq	2333
I/Q Center Freq	2333

CF Step	2334
Freq Offset	2335
More Information	2336
Input/Output	2337
Marker	2338
Select Marker	2338
Marker Type	2338
Properties	2339
Select Marker	2339
Relative To	2339
Couple Markers	2339
All Markers Off	2340
Marker X Axis Value (Remote Command only)	2340
Marker X Axis Position (Remote Command only)	2341
Marker Y Axis Value (Remote Command only)	2341
Backward Compatibility SCPI Commands	2342
Marker Function	2343
Marker To	2344
Meas	2345
Remote Measurement Functions	2345
Measurement Group of Commands	2346
Current Measurement Query (Remote Command Only)	2349
Limit Test Current Results (Remote Command Only)	2349
Data Query (Remote Command Only)	2349
Calculate/Compress Trace Data Query (Remote Command Only)	2349
Calculate Peaks of Trace Data (Remote Command Only)	2355
Hardware-Accelerated Fast Power Measurement (Remote Command Only)	2356
Reset Fast Power Measurement (Remote Command Only)	2357
Define Fast Power Measurement (Remote Command Only)	2357
Define Fast Power Measurement Query (Remote Command Only)	2366
Configure Fast Power Measurement (Remote Command Only)	2367
Initiate Fast Power Measurement (Remote Command Only)	2368
Fetch Fast Power Measurement (Remote Command Only)	2368
Execute Fast Power Measurement (Remote Command Only)	2368
Binary Read Fast Power Measurement (Remote Command Only)	2369
Diagnostic Binary Read Fast Power Measurement (Remote Command Only)	2369
Format Data: Numeric Data (Remote Command Only)	2370
Format Data: Byte Order (Remote Command Only)	2371
Meas Setup	2373

Avg/Hold Num	2373
Avg Mode	2373
Range Table	2374
Range	2375
Start Freq	2376
Stop Freq	2377
Res BW	2378
Video BW	2380
Filter Type	2381
Abs Start Limit	2382
Abs Stop Limit	2383
Peak Excursion	2385
Pk Threshold	2386
Attenuation	2386
Detector 1	2387
Detector 2	2388
Sweep Time	2389
Points	2390
IF Gain	2391
IF Gain Auto	2391
IF Gain State	2392
Meas Type	2392
Spur	2394
Spurious Report Mode	2394
Meas Preset	2395
Fast Spurious Meas (Remote Command only)	2395
Mode	2397
Mode Preset	2398
How-To Preset	2399
Mode Setup	2401
Peak Search	2402
Next Peak	2402
Next Pk Right	2402
Next Pk Left	2403
Marker Delta	2403
Pk-Pk Search	2403
Min Search	2403
Print	2405
Quick Save	2406
Recall	2408
State	2408
More Information	2410
From File...	2411
Edit Register Names	2412

Register 1 thru Register 16	2413
Register 1 thru Register 16	2413
Trace (+State)	2414
To Trace	2415
Register 1 thru Register 16	2416
From File...	2416
Data (Import)	2418
Amplitude Correction	2419
Amplitude Correction	2420
Trace	2420
Select Trace	2421
Limit	2421
Limit Selection	2422
Open...	2423
Restart	2424
More Information	2424
Save	2426
State	2426
To File . . .	2427
Edit Register Names	2430
More Information	2431
Register 1 thru Register 16	2431
Register 1 thru Register 16	2432
Trace (+State)	2432
Register 1 thru Register 16	2434
From Trace	2434
From File...	2435
Data (Export)	2436
Amplitude Correction	2437
Correction Data File	2438
Amplitude Correction	2441
Trace	2441
Trace File Contents	2441
Metadata: Trace Specific	2442
Metadata: Display Specific	2442
Metadata: Measurement Related	2442
Limit	2446
Limits File Contents	2446
.csv file format	2446
.lim file format	2448
Limit Selection	2448
Save As . . .	2448
Screen Image	2449

Themes	2450
3D Color	2450
3D Monochrome	2451
Flat Color	2451
Flat Monochrome	2451
Save As...	2451
Mass Storage Catalog (Remote Command Only)	2452
Mass Storage Change Directory (Remote Command Only)	2452
Mass Storage Copy (Remote Command Only)	2452
Mass Storage Device Copy (Remote Command Only)	2453
Mass Storage Delete (Remote Command Only)	2453
Mass Storage Data (Remote Command Only)	2453
Mass Storage Make Directory (Remote Command Only)	2454
Mass Storage Move (Remote Command Only)	2454
Mass Storage Remove Directory (Remote Command Only)	2454
Mass Storage Determine Removable Media (Remote Command Only)	2454
Mass Storage Determine Removable Media Label (Remote Command Only)	2455
Mass Storage Determine Removable Media Write-protect status (Remote Command Only)	2455
Mass Storage Determine Removable Media size (Remote Command Only)	2456
:SYSTem:SET (Remote Command Only)	2456
Single (Single Measurement/Sweep)	2457
More Information	2457
Source	2458
CXA-m TG Un-calibrated Amplitude Range	2458
RF Output	2458
Amplitude	2459
Amplitude	2459
Power Sweep	2460
Amptd Offset	2462
Amptd Step Auto/Man	2462
Frequency	2463
Multiplier Numerator	2464
Multiplier Denominator	2464
Source Sweep Reverse	2465
Freq Offset	2466
Source Mode	2466
Select Source	2468
Select Highlighted Source	2469
Delete Highlighted Source	2471
Add Source To List	2471
USB	2471

GPIB	2473
LAN	2476
Verify Current Source Connection	2478
Source Setup	2478
Tracking Setup Details	2478
Use of the YTF (Microwave or mm Preselector) with External	
Source Control	2479
Point Trigger	2480
SW Trigger	2481
Ext Trigger 1	2481
Ext Trigger 2	2482
Show Source Capabilities & Settings	2482
Source Preset	2482
Span X Scale	2484
Sweep/Control	2485
Sweep Setup	2485
Auto Sweep Time Rules	2485
Sweep Type	2486
Pause	2486
Gate	2486
Gate On/Off	2487
Gate View On/Off	2488
Gate View Setup	2491
Gate View Sweep Time	2491
Gate View Start Time	2492
Gate Delay	2492
Gate Length	2493
Method	2494
LO	2494
Video	2494
FFT	2495
Gate Source	2495
Line	2496
External 1	2497
External 2	2499
RF Burst	2501
Periodic Timer (Frame Trigger)	2505
TV	2517
Control Edge/Level	2522
Gate Holdoff	2523
Gate Delay Compensation	2524
More Information	2525
Min Fast Position Query (Remote Command Only)	2526

Gate Preset (Remote Command Only)	2526
Gate Level (Remote Command Only)	2526
Gate Polarity (Remote Command Only)	2527
System	2528
Trace/Detector	2529
Trigger	2530
Free Run	2530
Video	2530
Trigger Level	2530
Trig Slope	2530
Trig Delay	2530
X Axis Relative to Trigger	2530
Line	2530
Trig Slope	2530
Trig Delay	2530
X Axis Relative to Trigger	2530
External 1	2530
Trigger Level	2530
Trig Slope	2530
Trig Delay	2531
X Axis Relative to Trigger	2531
Zero Span Delay Comp	2531
External 2	2531
Trigger Level	2531
Trig Slope	2531
Trig Delay	2531
X Axis Relative to Trigger	2531
Zero Span Delay Comp	2531
RF Burst	2531
Absolute Trigger	2531
Relative Trigger	2531
Trig Slope	2531
Trig Delay	2531
X Axis Relative to Trigger	2532
Zero Span Delay Comp	2532
Periodic Timer	2532
Period	2532
Offset	2532
Offset Adjust (Remote Command Only)	2532
Reset Offset Display	2532
Sync Source	2532
Off	2532
External 1	2532
External 2	2532

RF Burst	2533
Trig Delay	2533
X Axis Relative to Trigger	2533
Sync Holdoff	2533
Baseband I/Q	2533
I/Q Mag	2533
Trigger Level	2533
Trig Slope	2533
Trig Delay	2533
X Axis Relative to Trigger	2534
I (Demodulated)	2534
Trigger Level	2534
Trig Slope	2534
Trig Delay	2534
X Axis Relative to Trigger	2534
Q (Demodulated)	2534
Trigger Level	2534
Trig Slope	2534
Trig Delay	2534
X Axis Relative to Trigger	2534
Input I	2534
Trigger Level	2534
Trig Slope	2534
Trig Delay	2535
X Axis Relative to Trigger	2535
Input Q	2535
Trigger Level	2535
Trig Slope	2535
Trig Delay	2535
X Axis Relative to Trigger	2535
Auxiliary Channel I/Q Mag	2535
Trigger Level	2535
Trig Slope	2535
Trig Delay	2535
X Axis Relative to Trigger	2535
Trigger Center Frequency	2535
Trigger Bandwidth	2535
TV	2536
TV Line	2536
Field	2536
Entire Frame	2536
Field One	2536
Field Two	2536

Standard	2536
NTSC-M	2536
NTSC-Japan	2536
NTSC-4.43	2536
PAL-M	2536
PAL-N	2536
PAL-N Combin	2536
PAL-B,D,G,H,I	2536
PAL-60	2537
SECAM-L	2537
Auto/Holdoff	2537
Auto Trig	2537
Trig Holdoff	2537
Holdoff Type	2537
User Preset	2538
User Preset	2538
User Preset All Modes	2539
Save User Preset	2540
View/Display	2541
Display	2541
Annotation	2541
Meas Bar On/Off	2542
Screen	2543
Trace	2543
Active Function Values On/Off	2544
Title	2544
Change Title	2545
Clear Title	2545
Graticule	2546
System Display Settings	2546
Annotation Local Settings	2547
Themes	2547
Backlight	2548
Backlight Intensity	2549
View Selection	2549
Graph + Metrics	2550
Range Table	2551
All Ranges	2554
Range Table Selection (SCPI only command)	2555
15 Spectrum Emission Mask Measurement	2556
AMPTD Y Scale	2580
Ref Value	2580
Attenuation	2580

Dual Attenuator Configurations:	2581
Single Attenuator Configuration:	2582
(Mech) Atten	2582
Attenuator Configurations and Auto/Man	2584
Enable Elec Atten	2584
Mechanical Attenuator Transition Rules	2585
When the Electronic Attenuation is enabled from a disabled state:	2585
Examples in the dual attenuator configuration:	2586
When the Electronic Attenuation is disabled from an enabled state:	2586
Using the Electronic Attenuator: Pros and Cons	2586
Elec Atten	2587
Adjust Atten for Min Clip	2587
Pre-Adjust for Min Clip	2588
Off	2589
Elec Atten Only	2589
Mech + Elec Atten	2589
(Mech) Atten Step	2589
Max Mixer Level	2590
Scale/Div	2590
Presel Center	2591
Proper Preselector Operation	2592
Preselector Adjust	2592
Y Axis Unit	2594
dBm	2595
dBmV	2595
dBmA	2595
W	2596
V	2596
A	2596
dB μ V	2597
dB μ A	2597
Antenna Unit	2597
dB μ V/m	2598
dB μ A/m	2598
dB μ A	2598
dBpT	2598
dBG	2599
None	2599
Reference Level Offset	2599
More Information	2600
μ W Path Control	2600

Standard Path	2602
μ W Preselector Bypass	2602
Internal Preamp	2603
Off	2604
Low Band	2604
Full Range	2605
Ref Position	2605
Auto Scaling	2606
Auto Couple	2607
More Information	2607
Auto/Man Active Function keys	2607
Auto/Man 1-of-N keys	2607
BW	2609
Filter Type	2609
Cont (Continuous Measurement/Sweep)	2610
File	2612
FREQ Channel	2613
Center Freq	2613
Center Frequency Presets	2614
RF Center Freq	2617
Ext Mix Center Freq	2618
I/Q Center Freq	2618
CF Step	2619
Freq Offset	2620
More Information	2621
Input/Output	2622
Marker	2623
Select Marker	2623
Marker Type	2623
Couple Markers	2624
All Markers Off	2624
Marker X Axis Value (Remote Command Only)	2624
Marker X Axis Position (Remote Command Only)	2625
Marker Y Axis Value (Remote Command Only)	2626
Marker Function	2627
Marker To	2628
Meas	2629
Remote Measurement Functions	2629
Measurement Group of Commands	2630
Current Measurement Query (Remote Command Only)	2633
Limit Test Current Results (Remote Command Only)	2633
Data Query (Remote Command Only)	2633
Calculate/Compress Trace Data Query (Remote Command Only)	2633
Calculate Peaks of Trace Data (Remote Command Only)	2639

Hardware-Accelerated Fast Power Measurement (Remote Command Only)	2640
Reset Fast Power Measurement (Remote Command Only)	2641
Define Fast Power Measurement (Remote Command Only)	2641
Define Fast Power Measurement Query (Remote Command Only)	2650
Configure Fast Power Measurement (Remote Command Only)	2651
Initiate Fast Power Measurement (Remote Command Only)	2652
Fetch Fast Power Measurement (Remote Command Only)	2652
Execute Fast Power Measurement (Remote Command Only)	2652
Binary Read Fast Power Measurement (Remote Command Only)	2653
Diagnostic Binary Read Fast Power Measurement (Remote Command Only)	2653
Format Data: Numeric Data (Remote Command Only)	2654
Format Data: Byte Order (Remote Command Only)	2655
Meas Setup	2657
Avg/Hold Num	2657
Meas Type	2657
Ref Channel	2658
Integ BW	2658
Span	2660
Sweep Time	2662
Chan Sweep Type (except for E6630A/E6640A/M90XA)	2663
Res BW	2664
Video BW	2665
VBW/RBW	2666
Power Ref (for the modes except MSR and LTE-Advanced FDD/TDD)	2668
Total Power	2668
PSD	2669
Spectrum Peak	2669
Offset/Limits	2670
Select Offset	2670
Start Freq	2671
Stop Freq	2674
Sweep Time	2677
Sweep Type (except for E6630A/E6640A/M90XA)	2678
Offset Side	2679
Res BW	2680
Meas BW	2683
Video BW	2684
VBW/RBW	2685

Limits	2686
Select Offset	2687
Abs Start	2687
Abs Stop	2689
Rel Start	2692
Rel Stop	2694
Fail Mask	2697
Offset Freq Define	2699
Offset Average Type (SCPI Only)	2701
Method	2702
Filter Alpha	2702
Meas Preset	2703
Mode	2704
Mode Preset	2705
How-To Preset	2706
Mode Setup	2708
Peak Search	2709
Print	2710
Quick Save	2711
Recall	2713
State	2713
More Information	2715
From File...	2716
Edit Register Names	2717
Register 1 thru Register 16	2718
Register 1 thru Register 16	2718
Trace (+State)	2719
To Trace	2720
Register 1 thru Register 16	2721
From File...	2721
Data (Import)	2723
Amplitude Correction	2724
Amplitude Correction	2725
Trace	2725
Select Trace	2726
Limit	2726
Limit Selection	2727
Open...	2728
Restart	2729
More Information	2729
Save	2731
State	2731
To File . . .	2732
Edit Register Names	2734

More Information	2735
Register 1 thru Register 16	2735
Register 1 thru Register 16	2736
Trace (+State)	2737
Register 1 thru Register 16	2738
From Trace	2739
From File...	2739
Data (Export)	2741
Amplitude Correction	2742
Correction Data File	2742
Amplitude Correction	2745
Trace	2746
Trace File Contents	2746
Metadata: Trace Specific	2746
Metadata: Display Specific	2747
Metadata: Measurement Related	2747
Limit	2750
Limits File Contents	2751
.csv file format	2751
.lim file format	2752
Limit Selection	2752
Measurement Results	2753
Meas Results File Contents	2753
Save As . . .	2765
Screen Image	2765
Themes	2767
3D Color	2767
3D Monochrome	2767
Flat Color	2768
Flat Monochrome	2768
Save As...	2768
Mass Storage Catalog (Remote Command Only)	2768
Mass Storage Change Directory (Remote Command Only)	2769
Mass Storage Copy (Remote Command Only)	2769
Mass Storage Device Copy (Remote Command Only)	2769
Mass Storage Delete (Remote Command Only)	2770
Mass Storage Data (Remote Command Only)	2770
Mass Storage Make Directory (Remote Command Only)	2770
Mass Storage Move (Remote Command Only)	2771
Mass Storage Remove Directory (Remote Command Only)	2771
Mass Storage Determine Removable Media (Remote Command Only)	2771
Mass Storage Determine Removable Media Label (Remote Command Only)	2772

Mass Storage Determine Removable Media Write-protect status (Remote Command Only)	2772
Mass Storage Determine Removable Media size (Remote Command Only)	2772
:SYSTem:SET (Remote Command Only)	2773
Single (Single Measurement/Sweep)	2774
More Information	2774
Source	2775
CXA-m TG Un-calibrated Amplitude Range	2775
RF Output	2775
Amplitude	2776
Amplitude	2776
Power Sweep	2777
Amptd Offset	2779
Amptd Step Auto/Man	2779
Frequency	2780
Multiplier Numerator	2781
Multiplier Denominator	2781
Source Sweep Reverse	2782
Freq Offset	2783
Source Mode	2783
Select Source	2785
Select Highlighted Source	2786
Delete Highlighted Source	2788
Add Source To List	2788
USB	2789
GPIB	2790
LAN	2793
Verify Current Source Connection	2795
Source Setup	2795
Tracking Setup Details	2796
Use of the YTF (Microwave or mm Preselector) with External	
Source Control	2797
Point Trigger	2797
SW Trigger	2798
Ext Trigger 1	2798
Ext Trigger 2	2799
Show Source Capabilities & Settings	2799
Source Preset	2800
Span X Scale	2801
Ref Value	2801
Scale/Div	2801
Ref Position	2802
Auto Scaling	2802

Sweep/Control	2804
Pause	2804
Gate	2804
Gate On/Off	2804
Gate View On/Off	2806
Gate View Setup	2809
Gate View Sweep Time	2809
Gate View Start Time	2810
Gate Delay	2810
Gate Length	2811
Method	2812
LO	2812
Video	2812
FFT	2813
Gate Source	2813
Line	2814
External 1	2815
External 2	2817
RF Burst	2819
Periodic Timer (Frame Trigger)	2823
TV	2835
Control Edge/Level	2840
Gate Holdoff	2841
Gate Delay Compensation	2842
More Information	2843
Min Fast Position Query (Remote Command Only)	2844
Gate Preset (Remote Command Only)	2844
Gate Level (Remote Command Only)	2844
Gate Polarity (Remote Command Only)	2845
System	2846
Trace/Detector	2847
Trace Type	2847
Chan Detector	2847
Chan Detector Auto	2848
Chan Detector Selection	2848
Offset Detector	2849
Offset Detector Auto	2850
Offset Detector Selection	2850
Trigger	2852
Free Run	2852
Video	2852
Trigger Level	2852
Trig Slope	2852

Trig Delay	2852
X Axis Relative to Trigger	2852
Line	2852
Trig Slope	2852
Trig Delay	2852
X Axis Relative to Trigger	2852
External 1	2852
Trigger Level	2852
Trig Slope	2852
Trig Delay	2853
X Axis Relative to Trigger	2853
Zero Span Delay Comp	2853
External 2	2853
Trigger Level	2853
Trig Slope	2853
Trig Delay	2853
X Axis Relative to Trigger	2853
Zero Span Delay Comp	2853
RF Burst	2853
Absolute Trigger	2853
Relative Trigger	2853
Trig Slope	2853
Trig Delay	2853
X Axis Relative to Trigger	2854
Zero Span Delay Comp	2854
Periodic Timer	2854
Period	2854
Offset	2854
Offset Adjust (Remote Command Only)	2854
Reset Offset Display	2854
Sync Source	2854
Off	2854
External 1	2854
External 2	2854
RF Burst	2855
Trig Delay	2855
X Axis Relative to Trigger	2855
Sync Holdoff	2855
Baseband I/Q	2855
I/Q Mag	2855
Trigger Level	2855
Trig Slope	2855
Trig Delay	2855
X Axis Relative to Trigger	2856

I (Demodulated)	2856
Trigger Level	2856
Trig Slope	2856
Trig Delay	2856
X Axis Relative to Trigger	2856
Q (Demodulated)	2856
Trigger Level	2856
Trig Slope	2856
Trig Delay	2856
X Axis Relative to Trigger	2856
Input I	2856
Trigger Level	2856
Trig Slope	2856
Trig Delay	2857
X Axis Relative to Trigger	2857
Input Q	2857
Trigger Level	2857
Trig Slope	2857
Trig Delay	2857
X Axis Relative to Trigger	2857
Auxiliary Channel I/Q Mag	2857
Trigger Level	2857
Trig Slope	2857
Trig Delay	2857
X Axis Relative to Trigger	2857
Trigger Center Frequency	2857
Trigger Bandwidth	2857
TV	2858
TV Line	2858
Field	2858
Entire Frame	2858
Field One	2858
Field Two	2858
Standard	2858
NTSC-M	2858
NTSC-Japan	2858
NTSC-4.43	2858
PAL-M	2858
PAL-N	2858
PAL-N Combin	2858
PAL-B,D,G,H,I	2858
PAL-60	2859
SECAM-L	2859

Auto/Holdoff	2859
Auto Trig	2859
Trig Holdoff	2859
Holdoff Type	2859
User Preset	2860
User Preset	2860
User Preset All Modes	2861
Save User Preset	2862
View/Display	2863
View Selection by Name (Remote Command Only)	2863
Views Selection by Number (Remote Command only)	2864
Display	2864
Annotation	2865
Meas Bar On/Off	2866
Screen	2867
Trace	2867
Active Function Values On/Off	2868
Title	2868
Change Title	2869
Clear Title	2869
Graticule	2870
System Display Settings	2870
Annotation Local Settings	2871
Themes	2871
Backlight	2872
Backlight Intensity	2873
Abs Pwr Freq	2873
Abs Peak Pwr & Freq (Total Pwr Ref)	2873
Trace Window	2875
Results Window	2875
Abs Peak Pwr & Freq (PSD Ref)	2875
Trace Window	2877
Results Window	2877
Abs Peak Pwr & Freq (Spectrum Pk Ref)	2877
Trace Window	2879
Results Window	2879
Rel Pwr Freq	2879
Rel Peak Pwr & Freq (Total Pwr Ref)	2879
Trace Window	2880
Results Window	2880
Rel Peak Pwr & Freq (PSD Ref)	2881
Trace Window	2881
Results Window	2882
Rel Peak Pwr & Freq (Spectrum Pk Ref)	2882

Trace Window	2883
Results Window	2883
Integrated Power	2884
Integrated Power (Total Pwr Ref)	2884
Trace Window	2886
Results Window	2886
Integrated Power (PSD Ref)	2887
Trace Window	2888
Results Window	2888
Integrated Power (Spectrum Pk Ref)	2889
Trace Window	2890
Results Window	2890
Limit Lines	2891
16 TOI Measurement	2892
AMPTD Y Scale	2896
Ref Value	2896
Attenuation	2896
Dual Attenuator Configurations:	2897
Single Attenuator Configuration:	2897
(Mech) Atten	2898
Attenuator Configurations and Auto/Man	2899
Enable Elec Atten	2900
Mechanical Attenuator Transition Rules	2901
When the Electronic Attenuation is enabled from a disabled state:	2901
Examples in the dual attenuator configuration:	2901
When the Electronic Attenuation is disabled from an enabled state:	2902
Using the Electronic Attenuator: Pros and Cons	2902
Elec Atten	2902
Adjust Atten for Min Clip	2903
Pre-Adjust for Min Clip	2903
Off	2904
Elec Atten Only	2905
Mech + Elec Atten	2905
(Mech) Atten Step	2905
Scale/Div	2906
Presel Center	2906
Proper Preselector Operation	2907
Preselector Adjust	2908
Y Axis Unit	2909
dBm	2910
dBmV	2910

dBmA	2911
W	2911
V	2911
A	2911
dB μ V	2912
dB μ A	2912
Antenna Unit	2913
dB μ V/m	2913
dB μ A/m	2913
dB μ A	2913
dBpT	2914
dBG	2914
None	2914
Measurement Results	2914
Measurement results contents	2915
μ W Path Control	2916
Standard Path	2917
μ W Preselector Bypass	2917
Internal Preamp	2919
Off	2920
Low Band	2920
Full Range	2920
Ref Position	2921
Auto Couple	2922
More Information	2922
Auto/Man Active Function keys	2922
Auto/Man 1-of-N keys	2922
BW	2924
Res BW	2924
Video BW	2924
VBW:3dB RBW	2925
Span:3dB RBW	2925
Cont (Continuous Measurement/Sweep)	2927
File	2929
FREQ Channel	2930
Auto Tune	2930
Center Freq	2930
Center Frequency Presets	2932
RF Center Freq	2934
Ext Mix Center Freq	2935
I/Q Center Freq	2936
Lower Tone Frequency	2936
Upper Tone Frequency	2937
CF Step	2938

Freq Offset	2939
More Information	2940
Input/Output	2941
Marker	2942
Marker Function	2943
Marker To	2944
Meas	2945
Remote Measurement Functions	2945
Measurement Group of Commands	2946
Current Measurement Query (Remote Command Only)	2949
Limit Test Current Results (Remote Command Only)	2949
Data Query (Remote Command Only)	2949
Calculate/Compress Trace Data Query (Remote Command Only)	2949
Calculate Peaks of Trace Data (Remote Command Only)	2955
Hardware-Accelerated Fast Power Measurement (Remote Command Only)	2956
Reset Fast Power Measurement (Remote Command Only)	2957
Define Fast Power Measurement (Remote Command Only)	2957
Define Fast Power Measurement Query (Remote Command Only)	2966
Configure Fast Power Measurement (Remote Command Only)	2967
Initiate Fast Power Measurement (Remote Command Only)	2968
Fetch Fast Power Measurement (Remote Command Only)	2968
Execute Fast Power Measurement (Remote Command Only)	2968
Binary Read Fast Power Measurement (Remote Command Only)	2969
Diagnostic Binary Read Fast Power Measurement (Remote Command Only)	2969
Format Data: Numeric Data (Remote Command Only)	2970
Format Data: Byte Order (Remote Command Only)	2971
Meas Setup	2973
Avg/Hold Num	2973
Avg Mode	2973
Zero-Span Measurement	2974
Zero-Span Measurement	2974
Zero-Span RBW	2975
Dwell Time	2975
Meas Preset	2976
Mode	2977
Mode Preset	2978
How-To Preset	2979
Mode Setup	2981
Peak Search	2982

Print	2983
Quick Save	2984
Recall	2986
State	2986
More Information	2988
From File...	2989
Edit Register Names	2990
Register 1 thru Register 16	2991
Register 1 thru Register 16	2991
Trace (+State)	2992
To Trace	2993
Register 1 thru Register 16	2994
From File...	2994
Data (Import)	2996
Amplitude Correction	2997
Amplitude Correction	2998
Trace	2998
Select Trace	2999
Limit	2999
Limit Selection	3000
Open...	3001
Restart	3002
More Information	3002
Save	3004
State	3004
To File . . .	3005
Edit Register Names	3008
More Information	3009
Register 1 thru Register 16	3009
Register 1 thru Register 16	3010
Trace (+State)	3010
Register 1 thru Register 16	3012
From Trace	3012
From File...	3013
Data (Export)	3014
Amplitude Correction	3015
Correction Data File	3016
Amplitude Correction	3019
Limit	3019
Limits File Contents	3020
.csv file format	3020
.lim file format	3021
Limit Selection	3021
Measurement Results	3021

Meas Results File Contents	3022
Marker Table	3022
Peak Table	3026
Spectrogram	3029
Save As . . .	3033
Screen Image	3034
Themes	3035
3D Color	3036
3D Monochrome	3036
Flat Color	3036
Flat Monochrome	3036
Save As...	3036
Mass Storage Catalog (Remote Command Only)	3037
Mass Storage Change Directory (Remote Command Only)	3037
Mass Storage Copy (Remote Command Only)	3037
Mass Storage Device Copy (Remote Command Only)	3038
Mass Storage Delete (Remote Command Only)	3038
Mass Storage Data (Remote Command Only)	3038
Mass Storage Make Directory (Remote Command Only)	3039
Mass Storage Move (Remote Command Only)	3039
Mass Storage Remove Directory (Remote Command Only)	3039
Mass Storage Determine Removable Media (Remote Command Only)	3040
Mass Storage Determine Removable Media Label (Remote Command Only)	3040
Mass Storage Determine Removable Media Write-protect status (Remote Command Only)	3040
Mass Storage Determine Removable Media size (Remote Command Only)	3041
:SYSTem:SET (Remote Command Only)	3041
Single (Single Measurement/Sweep)	3042
More Information	3042
Source	3043
CXA-m TG Un-calibrated Amplitude Range	3043
RF Output	3043
Amplitude	3044
Amplitude	3044
Power Sweep	3045
Amptd Offset	3047
Amptd Step Auto/Man	3047
Frequency	3048
Multiplier Numerator	3049
Multiplier Denominator	3049
Source Sweep Reverse	3050

Freq Offset	3051
Source Mode	3051
Select Source	3053
Select Highlighted Source	3054
Delete Highlighted Source	3056
Add Source To List	3056
USB	3057
GPIB	3058
LAN	3061
Verify Current Source Connection	3063
Source Setup	3063
Tracking Setup Details	3064
Use of the YTF (Microwave or mm Preselector) with External	
Source Control	3065
Point Trigger	3065
SW Trigger	3066
Ext Trigger 1	3066
Ext Trigger 2	3067
Show Source Capabilities & Settings	3067
Source Preset	3068
SPAN X Scale	3069
Span	3069
Sweep/Control	3070
Sweep Time	3070
Sweep Points	3070
System	3072
Trace/Detector	3073
Clear Write	3073
Max Hold	3073
Trigger	3075
Free Run	3075
Video	3075
Trigger Level	3075
Trig Slope	3075
Trig Delay	3075
X Axis Relative to Trigger	3075
Line	3075
Trig Slope	3075
Trig Delay	3075
X Axis Relative to Trigger	3075
External 1	3075
Trigger Level	3075
Trig Slope	3075
Trig Delay	3076

X Axis Relative to Trigger	3076
Zero Span Delay Comp	3076
External 2	3076
Trigger Level	3076
Trig Slope	3076
Trig Delay	3076
X Axis Relative to Trigger	3076
Zero Span Delay Comp	3076
RF Burst	3076
Absolute Trigger	3076
Relative Trigger	3076
Trig Slope	3076
Trig Delay	3076
X Axis Relative to Trigger	3077
Zero Span Delay Comp	3077
Periodic Timer	3077
Period	3077
Offset	3077
Offset Adjust (Remote Command Only)	3077
Reset Offset Display	3077
Sync Source	3077
Off	3077
External 1	3077
External 2	3077
RF Burst	3078
Trig Delay	3078
X Axis Relative to Trigger	3078
Sync Holdoff	3078
Baseband I/Q	3078
I/Q Mag	3078
Trigger Level	3078
Trig Slope	3078
Trig Delay	3078
X Axis Relative to Trigger	3079
I (Demodulated)	3079
Trigger Level	3079
Trig Slope	3079
Trig Delay	3079
X Axis Relative to Trigger	3079
Q (Demodulated)	3079
Trigger Level	3079
Trig Slope	3079
Trig Delay	3079

X Axis Relative to Trigger	3079
Input I	3079
Trigger Level	3079
Trig Slope	3079
Trig Delay	3080
X Axis Relative to Trigger	3080
Input Q	3080
Trigger Level	3080
Trig Slope	3080
Trig Delay	3080
X Axis Relative to Trigger	3080
Auxiliary Channel I/Q Mag	3080
Trigger Level	3080
Trig Slope	3080
Trig Delay	3080
X Axis Relative to Trigger	3080
Trigger Center Frequency	3080
Trigger Bandwidth	3080
TV	3081
TV Line	3081
Field	3081
Entire Frame	3081
Field One	3081
Field Two	3081
Standard	3081
NTSC-M	3081
NTSC-Japan	3081
NTSC-4.43	3081
PAL-M	3081
PAL-N	3081
PAL-N Combin	3081
PAL-B,D,G,H,I	3081
PAL-60	3082
SECAM-L	3082
Auto/Holdoff	3082
Auto Trig	3082
Trig Holdoff	3082
Holdoff Type	3082
User Preset	3083
User Preset	3083
User Preset All Modes	3084
Save User Preset	3085
View/Display	3086
Display	3086

Annotation	3086
Meas Bar On/Off	3087
Screen	3088
Trace	3088
Active Function Values On/Off	3089
Title	3089
Change Title	3090
Clear Title	3090
Graticule	3091
System Display Settings	3091
Annotation Local Settings	3091
Themes	3092
Backlight	3093
Backlight Intensity	3094
TOI View	3094
17 Harmonic Measurement	3097
AMPTD Y Scale	3101
Ref Value	3101
Attenuation	3101
Dual Attenuator Configurations:	3102
Single Attenuator Configuration:	3103
(Mech) Atten	3103
Attenuator Configurations and Auto/Man	3105
Enable Elec Atten	3105
Mechanical Attenuator Transition Rules	3106
When the Electronic Attenuation is enabled from a disabled state:	3106
Examples in the dual attenuator configuration:	3107
When the Electronic Attenuation is disabled from an enabled state:	3107
Using the Electronic Attenuator: Pros and Cons	3107
Elec Atten	3108
Adjust Atten for Min Clip	3108
Pre-Adjust for Min Clip	3109
Off	3110
Elec Atten Only	3110
Mech + Elec Atten	3110
(Mech) Atten Step	3110
Scale/Div	3111
Presel Center	3111
Proper Preselector Operation	3112
Preselector Adjust	3113
Y Axis Unit	3114

dBm	3115
dBmV	3116
dBmA	3116
W	3116
V	3116
A	3117
dB μ V	3117
dB μ A	3117
Antenna Unit	3118
dB μ V/m	3118
dB μ A/m	3118
dB μ A	3118
dBpT	3119
dBG	3119
None	3119
Reference Level Offset	3119
More Information	3120
μ W Path Control	3121
Standard Path	3122
μ W Preselector Bypass	3122
Internal Preamp	3123
Off	3125
Low Band	3125
Full Range	3125
Ref Position	3125
Auto Couple	3127
More Information	3127
Auto/Man Active Function keys	3127
Auto/Man 1-of-N keys	3127
BW	3129
Res BW	3129
Cont (Continuous Measurement/Sweep)	3130
File	3132
FREQ Channel	3133
Fundamental	3133
Freq Step	3133
Freq Offset	3134
More Information	3135
Input/Output	3136
Marker	3137
Marker Function	3138
Marker To	3139
Meas	3140
Remote Measurement Functions	3140

Measurement Group of Commands	3141
Current Measurement Query (Remote Command Only)	3144
Limit Test Current Results (Remote Command Only)	3144
Data Query (Remote Command Only)	3144
Calculate/Compress Trace Data Query (Remote Command Only)	3144
Calculate Peaks of Trace Data (Remote Command Only)	3150
Hardware-Accelerated Fast Power Measurement (Remote Command Only)	3151
Reset Fast Power Measurement (Remote Command Only)	3152
Define Fast Power Measurement (Remote Command Only)	3152
Define Fast Power Measurement Query (Remote Command Only)	3161
Configure Fast Power Measurement (Remote Command Only)	3162
Initiate Fast Power Measurement (Remote Command Only)	3163
Fetch Fast Power Measurement (Remote Command Only)	3163
Execute Fast Power Measurement (Remote Command Only)	3163
Binary Read Fast Power Measurement (Remote Command Only)	3164
Diagnostic Binary Read Fast Power Measurement (Remote Command Only)	3164
Format Data: Numeric Data (Remote Command Only)	3165
Format Data: Byte Order (Remote Command Only)	3166
Meas Setup	3168
Avg/Hold Num	3168
Avg Mode	3168
Harmonics	3169
Meas Preset	3169
Selected Harmonic	3169
Measure Tone	3170
Frequency	3170
Res BW	3171
Dwell Time	3172
Auto-Fill Range Table	3172
Mode	3174
Mode Preset	3175
How-To Preset	3176
Mode Setup	3178
Peak Search	3179
Print	3180
Quick Save	3181
Recall	3183
State	3183
More Information	3185

From File...	3186
Edit Register Names	3187
Register 1 thru Register 16	3188
Register 1 thru Register 16	3188
Trace (+State)	3189
To Trace	3190
Register 1 thru Register 16	3191
From File...	3191
Data (Import)	3193
Amplitude Correction	3194
Amplitude Correction	3195
Trace	3195
Select Trace	3196
Limit	3196
Limit Selection	3197
Open...	3198
Restart	3199
More Information	3199
Save	3201
State	3201
To File . . .	3202
Edit Register Names	3205
More Information	3206
Register 1 thru Register 16	3206
Register 1 thru Register 16	3207
Trace (+State)	3207
Register 1 thru Register 16	3209
From Trace	3209
From File...	3210
Data (Export)	3211
Amplitude Correction	3212
Correction Data File	3213
Amplitude Correction	3216
Trace	3216
Trace File Contents	3216
Metadata: Trace Specific	3217
Metadata: Display Specific	3217
Metadata: Measurement Related	3217
Limit	3221
Limits File Contents	3221
.csv file format	3221
.lim file format	3223
Limit Selection	3223
Measurement Results	3223

Meas Results File Contents	3224
Marker Table	3224
Peak Table	3227
Spectrogram	3231
Save As . . .	3235
Screen Image	3236
Themes	3237
3D Color	3238
3D Monochrome	3238
Flat Color	3238
Flat Monochrome	3238
Save As...	3238
Mass Storage Catalog (Remote Command Only)	3239
Mass Storage Change Directory (Remote Command Only)	3239
Mass Storage Copy (Remote Command Only)	3239
Mass Storage Device Copy (Remote Command Only)	3240
Mass Storage Delete (Remote Command Only)	3240
Mass Storage Data (Remote Command Only)	3240
Mass Storage Make Directory (Remote Command Only)	3241
Mass Storage Move (Remote Command Only)	3241
Mass Storage Remove Directory (Remote Command Only)	3241
Mass Storage Determine Removable Media (Remote Command Only)	3242
Mass Storage Determine Removable Media Label (Remote Command Only)	3242
Mass Storage Determine Removable Media Write-protect status (Remote Command Only)	3242
Mass Storage Determine Removable Media size (Remote Command Only)	3243
:SYSTem:SET (Remote Command Only)	3243
Single (Single Measurement/Sweep)	3244
More Information	3244
Source	3245
CXA-m TG Un-calibrated Amplitude Range	3245
RF Output	3245
Amplitude	3246
Amplitude	3246
Power Sweep	3247
Amptd Offset	3249
Amptd Step Auto/Man	3249
Frequency	3250
Multiplier Numerator	3251
Multiplier Denominator	3251
Source Sweep Reverse	3252

Freq Offset	3253
Source Mode	3253
Select Source	3255
Select Highlighted Source	3256
Delete Highlighted Source	3258
Add Source To List	3258
USB	3258
GPIB	3260
LAN	3263
Verify Current Source Connection	3265
Source Setup	3265
Tracking Setup Details	3265
Use of the YTF (Microwave or mm Preselector) with External	
Source Control	3266
Point Trigger	3267
SW Trigger	3268
Ext Trigger 1	3268
Ext Trigger 2	3269
Show Source Capabilities & Settings	3269
Source Preset	3269
SPAN X Scale	3271
Sweep/Control	3272
Dwell Time	3272
System	3273
Trace/Detector	3274
Clear Write	3274
Max Hold	3274
Trigger	3275
Free Run	3275
Video	3275
Trigger Level	3275
Trig Slope	3275
Trig Delay	3275
X Axis Relative to Trigger	3275
Line	3275
Trig Slope	3275
Trig Delay	3275
X Axis Relative to Trigger	3275
External 1	3275
Trigger Level	3275
Trig Slope	3275
Trig Delay	3276
X Axis Relative to Trigger	3276
Zero Span Delay Comp	3276

External 2	3276
Trigger Level	3276
Trig Slope	3276
Trig Delay	3276
X Axis Relative to Trigger	3276
Zero Span Delay Comp	3276
RF Burst	3276
Absolute Trigger	3276
Relative Trigger	3276
Trig Slope	3276
Trig Delay	3276
X Axis Relative to Trigger	3277
Zero Span Delay Comp	3277
Periodic Timer	3277
Period	3277
Offset	3277
Offset Adjust (Remote Command Only)	3277
Reset Offset Display	3277
Sync Source	3277
Off	3277
External 1	3277
External 2	3277
RF Burst	3278
Trig Delay	3278
X Axis Relative to Trigger	3278
Sync Holdoff	3278
Baseband I/Q	3278
I/Q Mag	3278
Trigger Level	3278
Trig Slope	3278
Trig Delay	3278
X Axis Relative to Trigger	3279
I (Demodulated)	3279
Trigger Level	3279
Trig Slope	3279
Trig Delay	3279
X Axis Relative to Trigger	3279
Q (Demodulated)	3279
Trigger Level	3279
Trig Slope	3279
Trig Delay	3279
X Axis Relative to Trigger	3279
Input I	3279

Trigger Level	3279
Trig Slope	3279
Trig Delay	3280
X Axis Relative to Trigger	3280
Input Q	3280
Trigger Level	3280
Trig Slope	3280
Trig Delay	3280
X Axis Relative to Trigger	3280
Auxiliary Channel I/Q Mag	3280
Trigger Level	3280
Trig Slope	3280
Trig Delay	3280
X Axis Relative to Trigger	3280
Trigger Center Frequency	3280
Trigger Bandwidth	3280
TV	3281
TV Line	3281
Field	3281
Entire Frame	3281
Field One	3281
Field Two	3281
Standard	3281
NTSC-M	3281
NTSC-Japan	3281
NTSC-4.43	3281
PAL-M	3281
PAL-N	3281
PAL-N Combin	3281
PAL-B,D,G,H,I	3281
PAL-60	3282
SECAM-L	3282
Auto/Holdoff	3282
Auto Trig	3282
Trig Holdoff	3282
Holdoff Type	3282
User Preset	3283
User Preset	3283
User Preset All Modes	3284
Save User Preset	3285
View/Display	3286
Harmonic Measurement Views	3286
Display	3287
Annotation	3287

Meas Bar On/Off	3288
Screen	3289
Trace	3289
Active Function Values On/Off	3290
Title	3290
Change Title	3291
Clear Title	3292
Graticule	3292
System Display Settings	3292
Annotation Local Settings	3293
Themes	3293
Backlight	3294
Backlight Intensity	3295
18 List Sweep Measurement	3296
Frequency List (Remote Command Only)	3298
Mechanical Attenuator List (Remote Command Only)	3298
Electronic Attenuation List (Remote Command Only)	3299
RBW Type List (Remote Command Only)	3299
RBW List (Remote Command Only)	3300
VBW List (Remote Command Only)	3300
Sweep Time List (Remote Command Only)	3301
Trigger Delay List (Remote Command Only)	3301
Phase Noise Optimization (Remote Command Only)	3302
Detector List (Remote Command Only)	3302
Trigger Source (Remote Command Only)	3303
Trigger Holdoff (Remote Command Only)	3304
Trigger Level (Remote Command Only)	3305
Trigger Slope (Remote Command Only)	3305
Sequencing (Remote Command Only)	3306

1 About the Analyzer

The X-Series signal analyzer measures and monitors complex RF and microwave signals. Analog baseband analysis is available on MXA. The analyzer integrates traditional spectrum measurements with advanced vector signal analysis to optimize speed, accuracy, and dynamic range. The analyzer has Windows 7[®] built in as an operating system, which expands its usability.

With a broad set of applications and demodulation capabilities, an intuitive user interface, outstanding connectivity and powerful one-button measurements, the analyzer is ideal for both R&D and manufacturing engineers working on cellular, emerging wireless communications, general purpose, aerospace and defense applications.

Installing Application Software

If you want to install a measurement application after your initial hardware purchase, you need only to license it. All of the available applications are loaded in your instrument at the time of purchase.

Thus, when you purchase a new application, you will receive an entitlement certificate that you can use to obtain a license key for that application. To activate the new measurement application, enter the license key that you obtain into the instrument.

For the latest information on Keysight Spectrum/Signal Analyzer measurement applications and upgrade kits, visit the following internet URL.

www.keysight.com/find/sa_upgrades

Viewing a License Key

Measurement applications that you purchased with your instrument have been installed and activated at the factory before shipment. The instrument requires a unique License Key for every measurement application purchased. The license key is a hexadecimal string that is specific to your measurement application, instrument model number and serial number. It enables you to install, or reactivate, that particular application.

Press **System, Show, System** to display the measurement applications that are currently licensed in your analyzer.

Go to the following location to view the license keys for the installed measurement applications:

C:\Program Files\Agilent\Licensing

You may want to keep a copy of your license key in a secure location. To do this, you can print out a copy of the display showing the license numbers. If you should lose your license key, call your nearest Keysight Technologies service or sales office for assistance.

Obtaining and Installing a License Key

If you purchase an additional application that requires installation, you will receive an "Entitlement Certificate", which may be redeemed for a license key for one instrument. To obtain your license key, follow the instructions that accompany the certificate.

Installing a license key for the selected application can be done automatically using a USB memory device. To do this, you copy the license file to the USB memory device, at the root level. Follow the instructions that come with your software installation kit.

Installing a license key can also be done manually using the built-in license management application, which may be found via the instrument front panel keys at **System, Licensing. . .**, or on-disk at:

C:\Program Files\Agilent\Licensing

You can also use these procedures to reinstall a license key that has been accidentally deleted, or lost due to a memory failure.

Updating Measurement Application Software

All the software applications were loaded at the time of original instrument manufacture. It is a good idea to regularly update your software with the latest available version. This helps to ensure that you receive any improvements and expanded functionality.

Because the software was loaded at the initial purchase, further additional measurement applications may now be available. If the application you are interested in licensing is not available, you will need to do a software update. (To display a list of installed applications, press **System, Show, System.**)

Check the appropriate page of the Keysight web site for the latest available software versions, according to the name of your instrument, as follows:

www.keysight.com/find/pxa_software

www.keysight.com/find/mxa_software

www.keysight.com/find/exa_software

www.keysight.com/find/cxa_software

www.keysight.com/find/mxe_software

You can load the updated software package into the instrument from a USB drive, or directly from the internet. An automatic loading program is included with the files.

X-Series Options and Accessories

You can view an online list of available Options and Accessories for your instrument as follows:

1. Browse to one of the following URLs, according to the product name of your instrument:

www.keysight.com/find/cxa

www.keysight.com/find/exa

www.keysight.com/find/mxa

www.keysight.com/find/pxa

www.keysight.com/find/mxe

2. The home page for your instrument appears (in some cases, you may see an initial splash screen containing a button named View the Webpage, which you should click to display the home page).
3. Locate the Options tab, as highlighted in the example below, which shows the home page for the MXA.

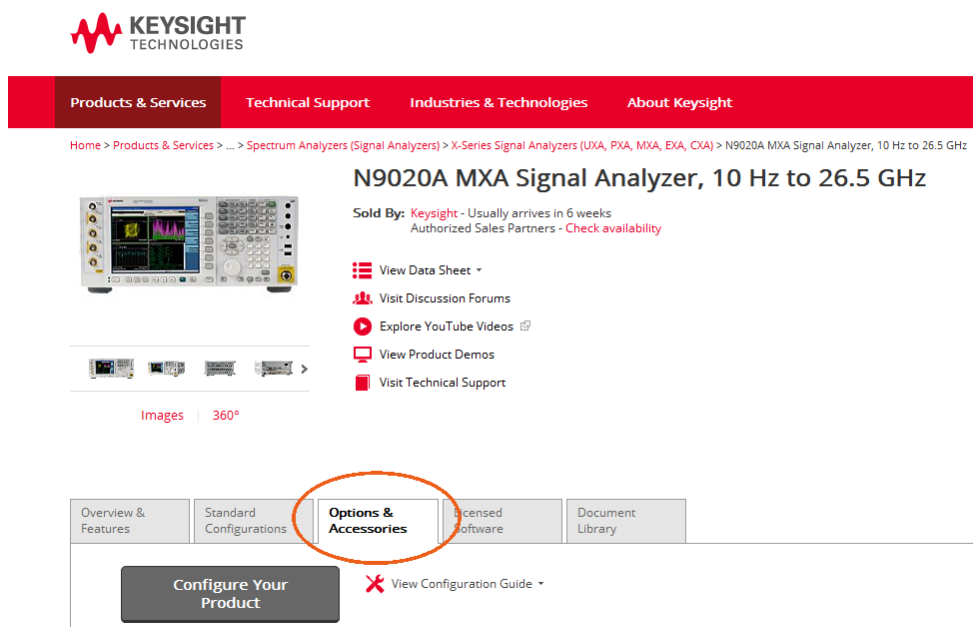

4. Click the Options tab, to display a list of available options and accessories for your instrument.

Front-Panel Features

The instrument's Front-panel features are fully detailed in the section "Front-Panel Features" (under the chapter "Front and Rear Panel Features") of the document:

[Getting Started Guide](#)

If you are viewing this information as a Help file in the instrument, then you can click on the link above to open the PDF document.

Display Annotations

Display Annotations are fully detailed under the chapter "Front and Rear Panel Features" of the document:

[Getting Started Guide](#)

If you are viewing this information as a Help file in the instrument, then you can click on the link above to open the PDF document.

Rear-Panel Features

The instrument's Rear-panel features are fully detailed in the section "Rear-Panel Features" (under the chapter "Front and Rear Panel Features") of the document:

[Getting Started Guide](#)

If you are viewing this information as a Help file in the instrument, then you can click on the link above to open the PDF document.

Window Control Keys

The instrument provides three front-panel keys for controlling windows. They are Multi Window, Zoom, and Next Window. These are all “immediate action” keys.

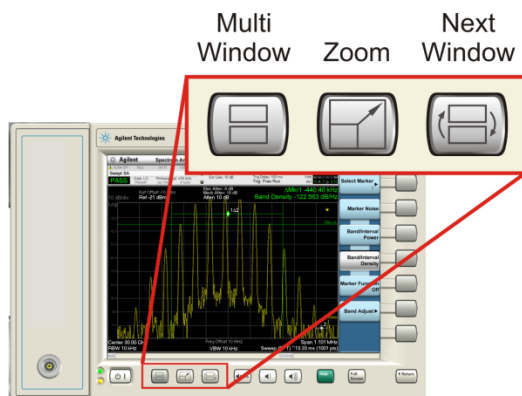

Multi-Window

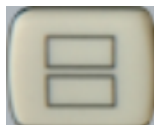

The **Multi Window** front-panel key will toggle you back and forth between the Normal View and the last Multi Window View (Zone Span, Trace Zoom or Spectrogram) that you were in, when using the Swept SA measurement of the Spectrum Analyzer Mode. It remembers which View you were in through a Preset. This “previous view” is set to Zone Span on a Restore Mode Defaults.

Key Path	Front-panel key
Initial S/W Revision	Prior to A.02.00

Zoom

Zoom is a toggle function. Pressing this key once increases the size of the selected window. Pressing the key again returns the window to the original size.

When Zoom is on for a window, that window will get the entire primary display area. The zoomed window, since it is the selected window, is outlined in green.

Zoom is local to each Measurement. Each Measurement remembers its Zoom state. The Zoom state of each Measurement is part of the Mode’s state.

NOTE

Data acquisition and processing for the other windows continues while a window is zoomed, as does all SCPI communication with the other windows.

Remote Command	:DISPlay:WINDow:FORMat:ZOOM
Remote Command	:DISPlay:WINDow:FORMat:TILE

Example	:DISP:WIND:FORM:ZOOM sets zoomed :DISP:WIND:FORM:TILE sets un-zoomed
Preset	TILE
Initial S/W Revision	Prior to A.02.00

Next Window

Selects the next window of the current view. When the Next Window key is pressed, the next window in the order of precedence becomes selected. If the selected window was zoomed, the next window will also be zoomed.

The window numbers are as follows. Note that these numbers also determine the order of precedence (that is, Next Window goes from 1 to 2, then 2 to 3, etc.):



RTSA measurements:

Only two windows are available in the Spectrogram view under the Spectrum measurement and up to three windows are available in the Power vs. Time measurement, depending on the view set up.

Remote Command	:DISPlay:WINDow[:SElect] <number> :DISPlay:WINDow[:SElect]?
Example	:DISP:WIND 1
Preset	1
Min	1
Max	If <number> is greater than the number of windows, limit to <number of windows>
Initial S/W Revision	Prior to A.02.00

One and only one window is always selected. The selected window has the focus; this means that all window-specific key presses apply only to that window. You can tell which window is selected by the thick green border around it. If a window is not selected, its boundary is gray.

If a window in a multi-window display is zoomed it is still outlined in green. If there is only one window, the green outline is not used. This allows the user to distinguish between a zoomed window and a display with only one window.

The selected window is local to each Measurement. Each Measurement remembers which window is selected. The selected window for each Measurement is remembered in Mode state.

NOTE

When this key is pressed in Help Mode, it toggles focus between the table of contents window and the topic pane window.

Full Screen

When **Full Screen** is pressed the measurement window expands horizontally over the entire instrument display. The screen graticule area expands to fill the available display area.

It turns off the display of the softkey labels, however the menus and active functions still work. (Though it would obviously be very hard to navigate without the key labels displayed.) Pressing **Full Screen** again while Full Screen is in effect cancels Full Screen.

Note that the banner and status lines are unaffected. You can get even more screen area for your data display by turning off the Meas Bar (in the Display menu) which also turns off the settings panel.

Full Screen is a Meas Global function. Therefore it is cancelled by the **Preset** key.

Key Path	Display
Remote Command	:DISPlay:FSCReen[:STATe] OFF ON 0 1 :DISPlay:FSCReen[:STATe]?
Preset	Unaffected by Preset but set to Off by Restore Misc Defaults or shutdown and restart
State Saved	Not saved in instrument state.
Backwards Compatibility SCPI	:DISPlay:MENU[:STATe] OFF ON 0 1 This emulates ESA full screen functionality, which is the same as the FSCReen command in PSA except that the sense of on/off is reversed (that is, OFF means the menus are OFF, so Fullscreen is ON) and the default is ON (meaning Fullscreen is OFF).
Backwards Compatibility Notes	In ESA/PSA, Full Screen was turned on with a softkey, so pressing any other key turned Full Screen off. In the X-Series, because a hardkey is provided to turn this function on and off, pressing any other key no longer turns off Full Screen
Initial S/W Revision	Prior to A.02.00

Display Enable (Remote Command Only)

Turns the display on/off, including the display drive circuitry. The backlight stays lit so you can tell that the instrument is on. The display enable setting is mode global. The reasons for turning the display off are three:

- To increase speed as much as possible by freeing the instrument from having to update the display
- To reduce emissions from the display, drive circuitry
- For security purposes

If you have turned off the display:

- and you are in local operation, the display can be turned back on by pressing any key or by sending the SYSTem:DEFaults MISC command or the DISPlay:ENABle ON (neither *RST nor SYSTem:PRESet enable the display.)
- and you are in remote operation, the display can be turned back on by pressing the **Local** or **Esc** keys or by sending the SYSTem:DEFaults MISC command or the DISPlay:ENABle ON (neither *RST nor SYSTem:PRESet enable the display.)

and you are using either the SYSTem:KLOCK command or GPIB local lockout, then no front-panel key press will turn the display back on. You must turn it back on remotely.

Remote Command	:DISPlay:ENABle OFF ON 0 1 :DISPlay:ENABle?
Example	DISP:ENAB OFF
Couplings	DISP:ENAB OFF turns Backlight OFF and DISP:ENAB ON turns Backlight ON. However, settings of Backlight do not change the state of DISP:ENAB
Preset	On Set by SYST:DEF MISC, but Not affected by *RST or SYSTem:PRESet.
State Saved	Not saved in instrument state.
Backwards Compatibility Notes	SYST:PRES no longer turns on DISPlay:ENABle as it did in legacy analyzers
Initial S/W Revision	Prior to A.02.00

Mouse and Keyboard Control

If you do not have access to the instrument front-panel, there are several ways that a mouse and PC Keyboard can give you access to functions normally accessed using the front-panel keys.

Right-Click

If you plug in a mouse and right-click on the analyzer screen, a menu will appear as below:

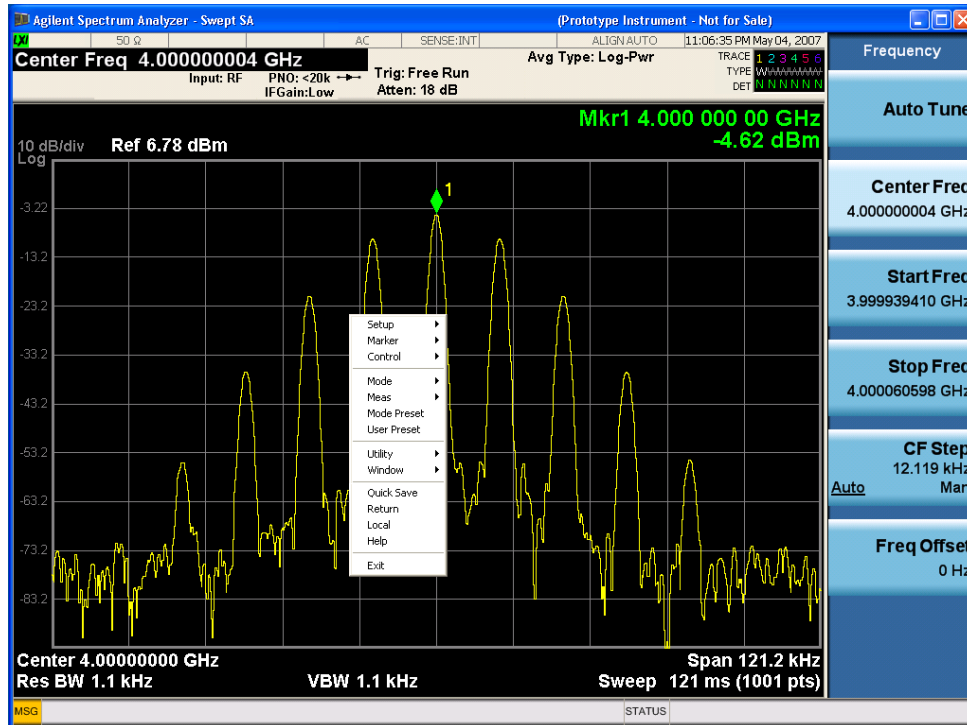

Placing the mouse on one of the rows marked with a right arrow symbol will cause that row to expand, as for example below where the mouse is hovered over the “Utility” row:

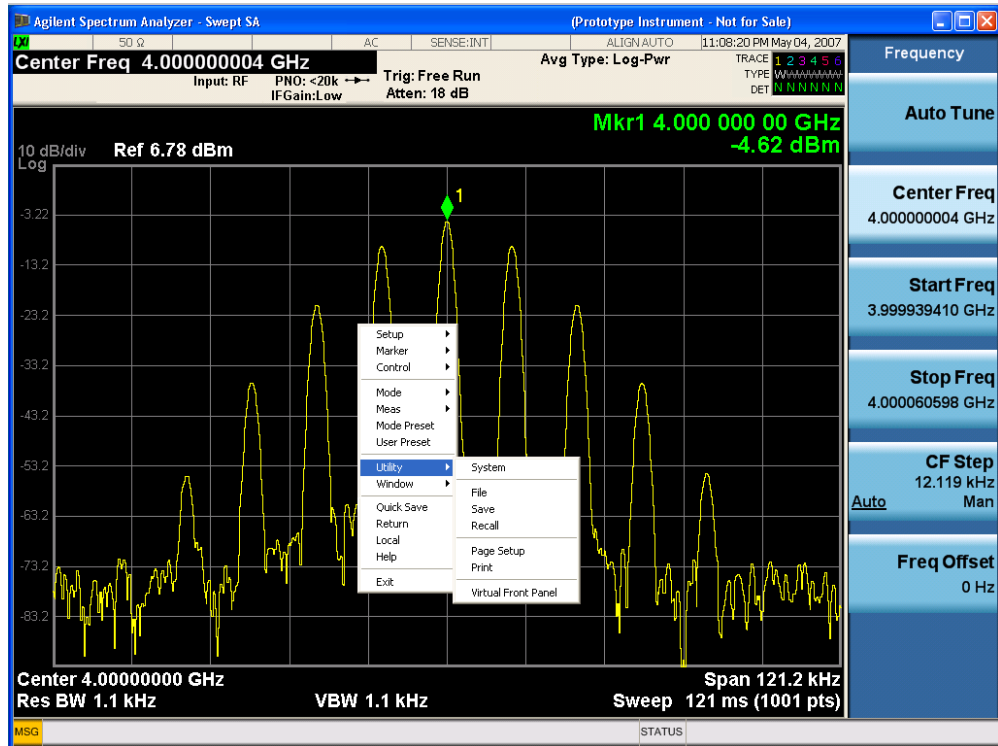

This method can be used to access any of the front-panel keys by using a mouse; as for example if you are accessing the instrument through Remote Desktop.

The array of keys thus available is shown below:

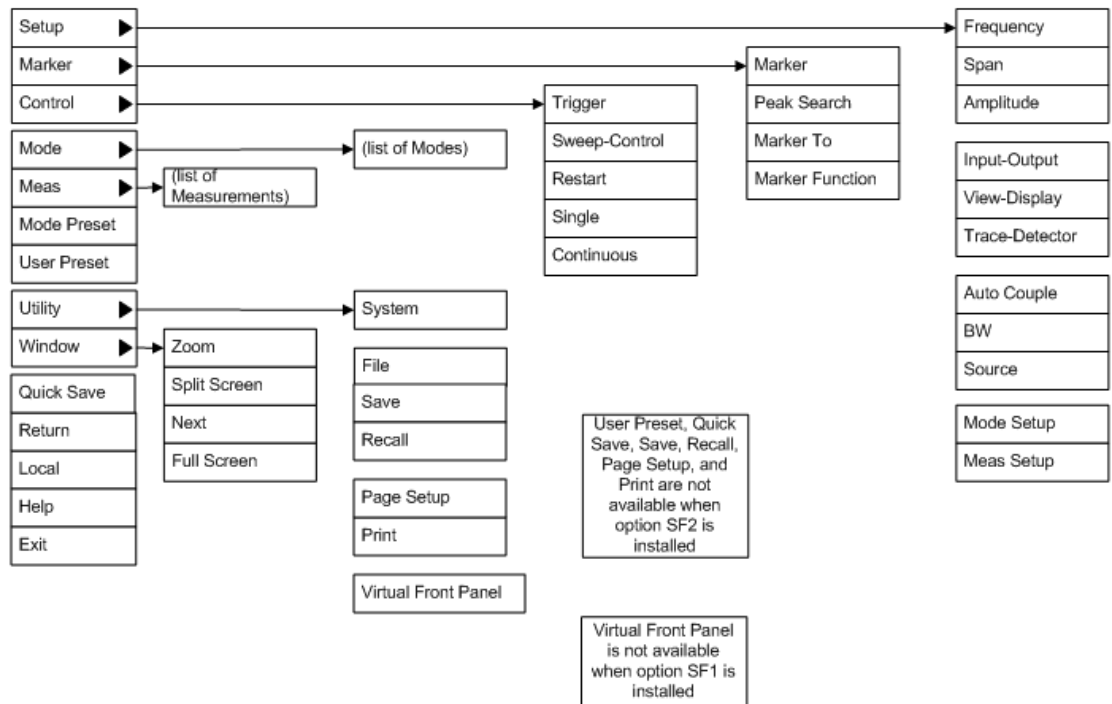

PC Keyboard

If you have a PC keyboard plugged in (or via Remote Desktop), certain key codes on the PC keyboard map to front-panel keys on the GPSA front panel. These key codes are shown below:

Front-panel key	Key code
Frequency	CTRL+SHIFT+F
Span	CTRL+SHIFT+S
Amplitude	CTRL+SHIFT+A
Input/Output	CTRL+SHIFT+O
View/Display	CTRL+SHIFT+V
Trace/Detector	CTRL+ALT+T
Auto Couple	CTRL+SHIFT+C
Bandwidth	CTRL+ALT+B
Source	CTRL+ALT-U
Marker	CTRL+ALT+K
Peak Search	CTRL+ALT+P
Marker To	CTRL+ALT+N
Marker Function	CTRL+ALT+F
System	CTRL+SHIFT+Y
Quick Save	CTRL+Q
Save	CTRL+S
Recall	CTRL+R
Mode Preset	CTRL+M
User Preset	CTRL+U
Print	CTRL+P
File	CTRL+SHIFT+L
Mode	CTRL+SHIFT+M
Measure	CTRL+ALT+M
Mode Setup	CTRL+SHIFT+E
Meas Setup	CTRL+ALT+E
Trigger	CTRL+SHIFT+T
Sweep/Control	CTRL+SHIFT+W
Restart	CTRL+ALT+R
Single	CTRL+ALT+S
Cont	CTRL+ALT+C
Zoom	CTRL+SHIFT+Z
Next Window	CTRL+SHIFT+N

Front-panel key	Key code
Split Screen	CTRL+L
Full Screen	CTRL+SHIFT+B
Return	CTRL+SHIFT+R
Mute	Mute
Inc Audio	Volume Up
Dec Audio	Volume Down
Help	F1
Control	CTRL
Alt	ALT
Enter	Return
Cancel	Esc
Del	Delete
Backspace	Backspace
Select	Space
Up Arrow	Up
Down Arrow	Down
Left Arrow	Left
Right Arrow	Right
Menu key 1	CTRL+SHIFT+F1
Menu key 2	CTRL+SHIFT+F2
Menu key 3	CTRL+SHIFT+F3
Menu key 4	CTRL+SHIFT+F4
Menu key 5	CTRL+SHIFT+F5
Menu key 6	CTRL+SHIFT+F6
Menu key 7	CTRL+SHIFT+F7
Backspace	BACKSPACE
Enter	ENTER
Tab	Tab
1	1
2	2
3	3
4	4
5	5
6	6
7	7
8	8

Front-panel key	Key code
9	9
0	0

This is a pictorial view of the table:

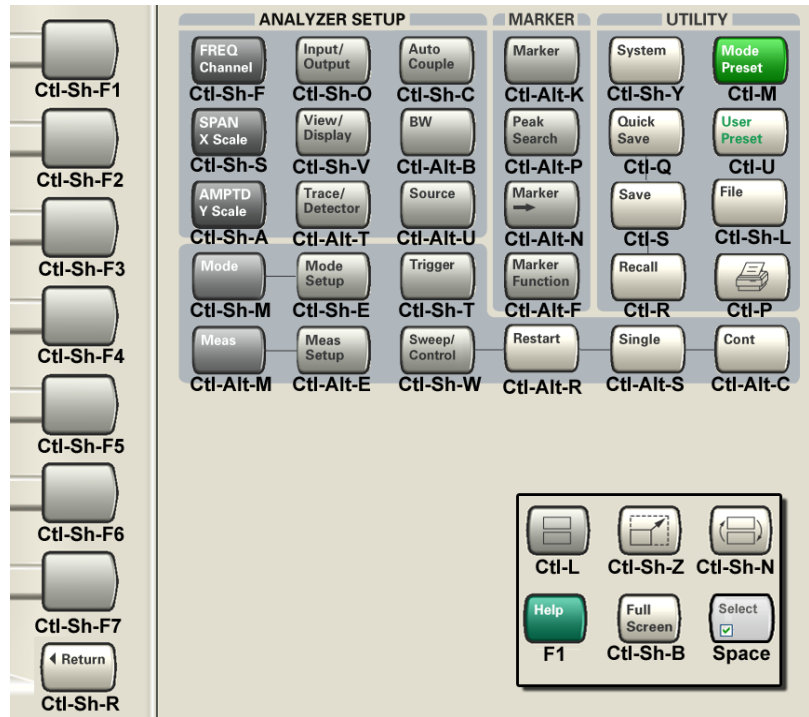

Instrument Security & Memory Volatility

If you are using the instrument in a secure environment, you may need details of how to clear or sanitize its memory, in compliance with published security standards of the United States Department of Defense, or other similar authorities.

For X-Series instruments, this information is contained in the document "Security Features and Document of Volatility". This document is **not** included in the Documentation DVD, or the instrument's on-disk library, but it may be downloaded from Keysight's web site.

To obtain a copy of the document, click on or browse to the following URL:

www.keysight.com/find/security

To locate and download the document, select Model Number "N9020A", then click "Submit". Then, follow the on-screen instructions to download the file.

2 About the Spectrum Analyzer Mode

This section provides information on using the Spectrum Analyzer Mode in your Keysight Signal Analyzer.

What Does Spectrum Analyzer Mode Do?

This Mode includes three types of measurements:

1. The Swept SA measurement provides a general purpose spectrum analyzer measurement environment. It offers a wide range of flexible measurement functions, like a traditional swept frequency spectrum analyzer and FFT analyzer. It lets you locate and measure all the different types of signals in your devices and systems.
2. The List Sweep measurement can only be used remotely. It is designed for fast measurement throughput. The available measurement setup functions are a limited subset of the functions available in Swept SA. This measurement lets you remotely extract amplitude values for multiple detectors at known frequencies. You configure the analyzer to make a list of single-point measurements. This list can then be run multiple times, saving measurement setup time and reducing I/O overhead and traffic. The measurements in the list are all performed in zero-span.
3. Most of the other measurements in the mode measure a specific type of signal. These pre-configured measurements limit the available setup functions to a subset that is appropriate for each particular measurement. This saves you a lot of measurement setup time and complexity. These one-button measurements apply a measurement algorithm to the instrument functions themselves, coupling some settings for optimum measurement integrity. These one-button measurements include:
 - Adjacent Channel Power Ratio (ACPR or ACLR)
 - Channel Power
 - Occupied BW
 - Power Stat CCDF
 - Spectrum Emission Mask
 - Spurious Emissions

3 Programming the Analyzer

This section provides introductory information about the programming documentation included with your product.

- ["What Programming Information is Available?" on page 138](#)
- ["List of SCPI Commands" on page 139](#)
- ["STATus Subsystem " on page 184](#)
- ["IEEE 488.2 Common Commands" on page 231](#)

What Programming Information is Available?

X-Series Documentation can be accessed through the Additional Documentation page in the instrument Help system and is included on the Documentation DVD shipped with the instrument. It can also be found online at:
http://www.keysight.com/find/mxa_manuals.

The following resources are available to help you create programs for automating your X-Series measurements:

Resource	Description
X-Series Programmer's Guide	Provides general SCPI programming information on the following topics: <ul style="list-style-type: none">– Programming the X-Series Applications– Programming fundamentals– Programming examples Note that SCPI command descriptions for measurement applications are not in this manual, but are included in the User's and Programmer's Reference manuals and the embedded help.
User's and Programmer's Reference manuals	Describes all front-panel keys and softkeys, including SCPI commands for a measurement application. Note that: <ul style="list-style-type: none">– Each measurement application has its own User's and Programmer's Reference.– The content in this manual is duplicated in the instrument's Help (the Help that you see for a key is identical to what you see in this manual).
Embedded Help in your instrument	Describes all front-panel keys and softkeys, including SCPI commands, for a measurement application. Note that the content that you see in Help when you press a key is identical to what you see in the User's and Programmer's Reference.
X-Series Getting Started Guide	Provides valuable sections related to programming including: <ul style="list-style-type: none">– Licensing New Measurement Application Software - After Initial Purchase– Configuring instrument LAN Hostname, IP Address, and Gateway Address– Using the controller to connect to the instrument remotely– Using the Embedded Web Server Telnet connection to communicate SCPI This printed document is shipped with the instrument.
Keysight Application Notes	Printable PDF versions of pertinent application notes.
Keysight VISA User's Guide	Describes the Keysight Virtual Instrument Software Architecture (VISA) library and shows how to use it to develop I/O applications and instrument drivers on Windows PCs.

List of SCPI Commands

*

*CAL?
*CLS
*ESE
*ESE?
*ESR?
*IDN?
*OPC
*OPC?
*OPT?
*RCL
*RST
*SAV
*SRE
*SRE?
*STB?
*TRG
*TST?
*WAI

A

ABORT

C

CALC:MARKer[n]:FUNction:BAND:RIGHT
CALCulate:ACPower:LIMit:STATE
CALCulate:ACPower:LIMit:STATE?
CALCulate:ACPower:MARKer:AOFF
CALCulate:ACPower:MARKer:COUPle[:STATe]
CALCulate:ACPower:MARKer:COUPle[:STATe]?
CALCulate:ACPower:MARKer[1]|2|...|12:FUNction:RESult?
CALCulate:ACPower:MARKer[1]|2|...|12:MAXimum
CALCulate:ACPower:MARKer[1]|2|...|12:MAXimum:LEFT
CALCulate:ACPower:MARKer[1]|2|...|12:MAXimum:NEXT
CALCulate:ACPower:MARKer[1]|2|...|12:MAXimum:RIGHT
CALCulate:ACPower:MARKer[1]|2|...|12:MINimum
CALCulate:ACPower:MARKer[1]|2|...|12:MODE
CALCulate:ACPower:MARKer[1]|2|...|12:MODE?
CALCulate:ACPower:MARKer[1]|2|...|12:PTPeak
CALCulate:ACPower:MARKer[1]|2|...|12:REFerence
CALCulate:ACPower:MARKer[1]|2|...|12:REFerence?
CALCulate:ACPower:MARKer[1]|2|...|12:STATe
CALCulate:ACPower:MARKer[1]|2|...|12:STATe?
CALCulate:ACPower:MARKer[1]|2|...|12:TRACe
CALCulate:ACPower:MARKer[1]|2|...|12:TRACe?

```

CALCulate:ACPower:MARKer[1] | 2 | ... | 12:X
CALCulate:ACPower:MARKer[1] | 2 | ... | 12:X?
CALCulate:ACPower:MARKer[1] | 2 | ... | 12:X:POSition
CALCulate:ACPower:MARKer[1] | 2 | ... | 12:X:POSition?
CALCulate:ACPower:MARKer[1] | 2 | ... | 12:Y?
CALCulate:ACPower:OFFSet[:OUTer]:LIST:LIMit:NEGative[:UPPer]:DATA
CALCulate:ACPower:OFFSet[:OUTer]:LIST:LIMit:NEGative[:UPPer]:DATA?
CALCulate:ACPower:OFFSet[:OUTer]:LIST:LIMit:POSitive[:UPPer]:DATA
CALCulate:ACPower:OFFSet[:OUTer]:LIST:LIMit:POSitive[:UPPer]:DATA?
CALCulate:BPOwer:MARKer:AOFF
CALCulate:BPOwer:MARKer[1] | 2 | ... | 12:FUNCtion:RESult?
CALCulate:BPOwer:MARKer[1] | 2 | ... | 12:MODE
CALCulate:BPOwer:MARKer[1] | 2 | ... | 12:TRACe
CALCulate:BPOwer:MARKer[1] | 2 | ... | 12:X:POSition
CALCulate:BPOwer:MARKer[1] | 2 | ... | 12:Y?
CALCulate:BWIDth | BANDwidth:NDB
CALCulate:BWIDth | BANDwidth:NDB?
CALCulate:BWIDth | BANDwidth:RESult?
CALCulate:BWIDth | BANDwidth:RLEFt?
CALCulate:BWIDth | BANDwidth:RRIGHt?
CALCulate:BWIDth | BANDwidth[:STATE]
CALCulate:BWIDth | BANDwidth[:STATE]?
CALCulate:CHPower:LIMit:POwer
CALCulate:CHPower:LIMit:POwer?
CALCulate:CHPower:LIMit:POwer:FAIL?
CALCulate:CHPower:LIMit:POwer:STATE
CALCulate:CHPower:LIMit:POwer:STATE?
CALCulate:CHPower:LIMit:PSDensity
CALCulate:CHPower:LIMit:PSDensity?
CALCulate:CHPower:LIMit:PSDensity:STATE
CALCulate:CHPower:LIMit:PSDensity:STATE?
CALCulate:CHPower:LIMit:PSD:FAIL?
CALCulate:CHPower:MARKer:AOFF
CALCulate:CHPower:MARKer:COUPle[:STATE]
CALCulate:CHPower:MARKer:COUPle[:STATE]?
CALCulate:CHPower:MARKer[1] | 2 | ... | 12:MAXimum
CALCulate:CHPower:MARKer[1] | 2 | ... | 12:MODE
CALCulate:CHPower:MARKer[1] | 2 | ... | 12:MODE?
CALCulate:CHPower:MARKer[1] | 2 | ... | 12:REFerence
CALCulate:CHPower:MARKer[1] | 2 | ... | 12:REFerence?
CALCulate:CHPower:MARKer[1] | 2 | ... | 12:STATE
CALCulate:CHPower:MARKer[1] | 2 | ... | 12:STATE?
CALCulate:CHPower:MARKer[1] | 2 | ... | 12:X
CALCulate:CHPower:MARKer[1] | 2 | ... | 12:X?
CALCulate:CHPower:MARKer[1] | 2 | ... | 12:X:POSition
CALCulate:CHPower:MARKer[1] | 2 | ... | 12:X:POSition?
CALCulate:CHPower:MARKer[1] | 2 | ... | 12:Y?
CALCulate:CLIMits:FAIL?
CALCulate:DATA<n>:COMPRESS?
CALCulate:DATA[n]?
CALCulate:DATA[1] | 2 | ... | 6:PEAKs?
CALCulate:DATA[1] | 2 | ... | 6:PEAKs?
CALCulate:FPOwer:POwer[1,2,...,999]?

```

CALCulate:FPOwer:POwer[1,2,...,999]:CONFigure
 CALCulate:FPOwer:POwer[1,2,...,999]:DEFine
 CALCulate:FPOwer:POwer[1,2,...,999]:DEFine?
 CALCulate:FPOwer:POwer[1,2,...,999]:FETCh?
 CALCulate:FPOwer:POwer[1,2,...,999]:INITiate
 CALCulate:FPOwer:POwer[1,2,...,999]:READ?
 CALCulate:FPOwer:POwer[1,2,...,999]:READ1?
 CALCulate:FPOwer:POwer[1,2,...,999]:READ2?
 CALCulate:FPOwer:POwer[1,2,...,999]:RESet
 CALCulate:LIMit[1]|2|...|6:CLEar
 CALCulate:LIMit[1]|2|...|6:CONTRol[:DATA]
 CALCulate:LIMit[1]|2|...|6:CONTRol[:DATA]?
 CALCulate:LIMit[1]|2|...|6:CONTRol:POINts?
 CALCulate:LIMit[1]|2|...|6:FAIL?
 CALCulate:LIMit[1]|2|...|6:LOWer[:DATA]
 CALCulate:LIMit[1]|2|...|6:LOWer[:DATA]?
 CALCulate:LIMit[1]|2|...|6:LOWer:POINts?
 CALCulate:LIMit[1]|2|...|6:UPPer[:DATA]
 CALCulate:LIMit[1]|2|...|6:UPPer[:DATA]?
 CALCulate:LIMit[1]|2|...|6:UPPer:POINts?
 CALCulate:LLINE:ALL:DELeTe
 CALCulate:LLINE[1]|2|...|6:AMPLitude:CMODE:RELative
 CALCulate:LLINE[1]|2|...|6:AMPLitude:CMODE:RELative?
 CALCulate:LLINE[1]|2|...|6:AMPLitude:INTerpolate:TYPE
 CALCulate:LLINE[1]|2|...|6:AMPLitude:INTerpolate:TYPE?
 CALCulate:LLINE[1]|2|...|6:BUILd
 CALCulate:LLINE:CMODE
 CALCulate:LLINE:CMODE?
 CALCulate:LLINE[1]|2|...|6:COMMeNt
 CALCulate:LLINE[1]|2|...|6:COMMeNt?
 CALCulate:LLINE:CONTRol:DOMain
 CALCulate:LLINE:CONTRol:DOMain?
 CALCulate:LLINE[1]|2|...|6:CONTRol:INTerpolate:TYPE
 CALCulate:LLINE[1]|2|...|6:CONTRol:INTerpolate:TYPE?
 CALCulate:LLINE[1]|2|...|6:COpy
 CALCulate:LLINE[1]|2|...|6:DATA
 CALCulate:LLINE[1]|2|...|6:DATA?
 CALCulate:LLINE[1]|2|...|6:DATA:MERGe
 CALCulate:LLINE[1]|2|...|6:DELeTe
 CALCulate:LLINE[1]|2|...|6:DESCRIption
 CALCulate:LLINE[1]|2|...|6:DESCRIption?
 CALCulate:LLINE[1]|2|...|6:DISPLay
 CALCulate:LLINE[1]|2|...|6:DISPLay?
 CALCulate:LLINE[1]|2|...|6:FAIL?
 CALCulate:LLINE[1]|2|...|6:FREQuency:CMODE:RELative
 CALCulate:LLINE[1]|2|...|6:FREQuency:CMODE:RELative?
 CALCulate:LLINE[1]|2|...|6:MARGIn
 CALCulate:LLINE[1]|2|...|6:MARGIn?
 CALCulate:LLINE[1]|2|...|6:MARGIn:STATe
 CALCulate:LLINE[1]|2|...|6:MARGIn:STATe?
 CALCulate:LLINE[1]|2|...|6:OFFSet:UPDate
 CALCulate:LLINE[1]|2|...|6:OFFSet:X
 CALCulate:LLINE[1]|2|...|6:OFFSet:X?

```

CALCulate:LLINE[1]|2|...|6:OFFSet:Y
CALCulate:LLINE[1]|2|...|6:OFFSet:Y?
CALCulate:LLINE[1]|2:STATe
CALCulate:LLINE:TEST
CALCulate:LLINE:TEST?
CALCulate:LLINE[1]|2|...|6:TRACe
CALCulate:LLINE[1]|2|...|6:TRACe?
CALCulate:LLINE[1]|2|...|6:TYPE
CALCulate:LLINE[1]|2|...|6:TYPE?
CALCulate:MAMarker:COUPling
CALCulate:MAMarker:COUPling?
CALCulate:MAMarker:DETEctor[1]
CALCulate:MAMarker:DETEctor[1]|2|3?
CALCulate:MAMarker:DETEctor[1]|2|3:DWELl
CALCulate:MAMarker:DETEctor[1]|2|3:DWELl?
CALCulate:MAMarker:PCENter
CALCulate:MAMarker:PCENter?
CALCulate:MARKer:AOFF
CALCulate:MARKer:COUPlE[:STATe]
CALCulate:MARKer:COUPlE[:STATe]?
CALCulate:MARKer[1]|2|...|12:CPSeArch[:STATe]
CALCulate:MARKer[1]|2|...|12:CPSeArch[:STATe]?
CALCulate:MARKer[1]|2|...|12:FCOunt:GATeTime
CALCulate:MARKer[1]|2|...|12:FCOunt:GATeTime?
CALCulate:MARKer[1]|2|...|12:FCOunt:GATeTime:AUTO
CALCulate:MARKer[1]|2|...|12:FCOunt:GATeTime:AUTO?
CALCulate:MARKer[1]|2|...|4:FCOunt:RESolution
CALCulate:MARKer[1]|2|...|4:FCOunt:RESolution?
CALCulate:MARKer[1]|2|...|4:FCOunt:RESolution:AUTO
CALCulate:MARKer[1]|2|...|4:FCOunt:RESolution:AUTO?
CALCulate:MARKer[1]|2|...|12:FCOunt[:STATe]
CALCulate:MARKer[1]|2|...|12:FCOunt[:STATe]?
CALCulate:MARKer[1]|2|...|12:FCOunt:X?
CALCulate:MARKer[1]|2|...|12:FUNCTion
CALCulate:MARKer[1]|2|...|12:FUNCTion?
CALCulate:MARKer[1]|2|...|12:FUNCTion:BAND:LEFT
CALCulate:MARKer[1]|2|...|12:FUNCTion:BAND:LEFT?
CALCulate:MARKer[1]|2|...|12:FUNCTion:BAND:RIGHT
CALCulate:MARKer[1]|2|...|12:FUNCTion:BAND:RIGHT?
CALCulate:MARKer[1]|2|...|12:FUNCTion:BAND:SPAN
CALCulate:MARKer[1]|2|...|12:FUNCTion:BAND:SPAN?
CALCulate:MARKer[1]|2|...|12:FUNCTion:BAND:SPAN:AUTO
CALCulate:MARKer[1]|2|...|12:FUNCTion:BAND:SPAN:AUTO?
CALCulate:MARKer[1]|2|...|12:FUNCTion:MAMarker?
CALCulate:MARKer[1]|2|...|12:LINEs[:STATe]
CALCulate:MARKer[1]|2|...|12:LINEs[:STATe]?
CALCulate:MARKer[1]|2|...|12:MAXimum
CALCulate:MARKer[1]|2|...|12:MAXimum:ALL
CALCulate:MARKer[1]|2|...|12:MAXimum:LEFT
CALCulate:MARKer[1]|2|...|12:MAXimum:NEXT
CALCulate:MARKer[1]|2|...|12:MAXimum:RIGHT
CALCulate:MARKer[1]|2|...|12:MINimum
CALCulate:MARKer[1]|2|...|12:MODE

```

CALCulate:MARKer[1]|2|...|12:MODE
 CALCulate:MARKer[1]|2|...|12:MODE?
 CALCulate:MARKer[n]:X:POSition:STOP
 CALCulate:MARKer:PEAK:EXCursion
 CALCulate:MARKer:PEAK:EXCursion?
 CALCulate:MARKer:PEAK:EXCursion:STATE
 CALCulate:MARKer:PEAK:EXCursion:STATE?
 CALCulate:MARKer:PEAK:SEARCh:MODE
 CALCulate:MARKer:PEAK:SEARCh:MODE?
 CALCulate:MARKer:PEAK:SORT
 CALCulate:MARKer:PEAK:SORT?
 CALCulate:MARKer:PEAK:TABLE:DTLimit
 CALCulate:MARKer:PEAK:TABLE:DTLimit:STATE
 CALCulate:MARKer:PEAK:TABLE:DTLimit:STATE?
 CALCulate:MARKer:PEAK:TABLE:READout
 CALCulate:MARKer:PEAK:TABLE:READout?
 CALCulate:MARKer:PEAK:TABLE:STATE
 CALCulate:MARKer:PEAK:TABLE:STATE?
 CALCulate:MARKer:PEAK:THReshold
 CALCulate:MARKer:PEAK:THReshold?
 CALCulate:MARKer:PEAK:THReshold:STATE
 CALCulate:MARKer:PEAK:THReshold:STATE?
 CALCulate:MARKer[1]|2|...|12:PTPeak
 CALCulate:MARKer[1]|2|...|12:REference
 CALCulate:MARKer[1]|2|...|12:REference?
 CALCulate:MARKer[1]|2|...|12[:SET]:CENTER
 CALCulate:MARKer[1]|2|...|12[:SET]:DELTA:CENTER
 CALCulate:MARKer[1]|2|...|12[:SET]:DELTA:SPAN
 CALCulate:MARKer[1]|2|...|12[:SET]:RLeve1
 CALCulate:MARKer[1]|2|...|12[:SET]:SPAN
 CALCulate:MARKer[1]|2|...|12[:SET]:START
 CALCulate:MARKer[1]|2|...|12[:SET]:STEP
 CALCulate:MARKer[1]|2|...|12[:SET]:STOP
 CALCulate:MARKer[1]|2|...|12[:SET]:TZOOM:CENTER
 CALCulate:MARKer[1]|2|...|12[:SET]:ZSPAN:CENTER
 CALCulate:MARKer[1]|2|...|12:STATE
 CALCulate:MARKer[1]|2|...|12:STATE
 CALCulate:MARKer[1]|2|...|12:STATE
 CALCulate:MARKer[1]|2|...|12:STATE?
 CALCulate:MARKer:TABLE[:STATE]
 CALCulate:MARKer:TABLE[:STATE]?
 CALCulate:MARKer[1]|2|...|12:TRACe
 CALCulate:MARKer[1]|2|...|12:TRACe?
 CALCulate:MARKer[1]|2|...|12:TRACe:AUTO
 CALCulate:MARKer[1]|2|...|12:TRACe:AUTO?
 CALCulate:MARKer:TRCKing[:STATE]
 CALCulate:MARKer:TRCKing[:STATE]?
 CALCulate:MARKer[1]|2|...|12:X
 CALCulate:MARKer[1]|2|...|12:X?
 CALCulate:MARKer[1]|2|...|4:X:CENTer
 CALCulate:MARKer[1]|2|...|12:X:POSition
 CALCulate:MARKer[1]|2|...|12:X:POSition?
 CALCulate:MARKer[1]|2|...|4:X:POSition:CENTer

```

CALCulate:MARKer[1] | 2 | ... | 4:X:POSition:SPAN
CALCulate:MARKer[1] | 2 | ... | 4:X:POSition:SPAN?
CALCulate:MARKer[1] | 2 | ... | 4:X:POSition:START
CALCulate:MARKer[1] | 2 | ... | 4:X:POSition:START?
CALCulate:MARKer[1] | 2 | ... | 4:X:POSition:STOP
CALCulate:MARKer[1] | 2 | ... | 4:X:POSition:STOP?
CALCulate:MARKer[1] | 2 | ... | 12:X:READout
CALCulate:MARKer[1] | 2 | ... | 12:X:READout?
CALCulate:MARKer[1] | 2 | ... | 12:X:READout:AUTO
CALCulate:MARKer[1] | 2 | ... | 12:X:READout:AUTO?
CALCulate:MARKer[1] | 2 | ... | 4:X:SPAN
CALCulate:MARKer[1] | 2 | ... | 4:X:START
CALCulate:MARKer[1] | 2 | ... | 4:X:STOP
CALCulate:MARKer[1] | 2 | ... | 12:Y
CALCulate:MARKer[1] | 2 | ... | 12:Y?
CALCulate:MARKer[1] | 2 | ... | 12:Z?
CALCulate:MARKer[1] | 2 | ... | 12:Z:POSition
CALCulate:MARKer[1] | 2 | ... | 12:Z:POSition?
CALCulate:MATH
CALCulate:MATH?
CALCulate:MCPower:OFFSet:LIST:LIMit:NEGative[:UPPer]:DATA
CALCulate:MCPower:OFFSet:LIST:LIMit:POSitive[:UPPer]:DATA
CALCulate:NTData[:STATe]
CALCulate:NTData[:STATe]?
CALCulate:OBwidth:LIMit:FBLimit
CALCulate:OBwidth:LIMit:FBLimit?
CALCulate:OBwidth:LIMit[:TEST]
CALCulate:OBwidth:LIMit[:TEST]?
CALCulate:OBwidth:MARKer:AOFF
CALCulate:OBwidth:MARKer[1] | 2 | ... | 12:MAXimum
CALCulate:OBwidth:MARKer[1] | 2 | ... | 12:MODE
CALCulate:OBwidth:MARKer[1] | 2 | ... | 12:MODE?
CALCulate:OBwidth:MARKer[1] | 2 | ... | 12:REFerence
CALCulate:OBwidth:MARKer[1] | 2 | ... | 12:REFerence?
CALCulate:OBwidth:MARKer[1] | 2 | ... | 12:STATe
CALCulate:OBwidth:MARKer[1] | 2 | ... | 12:STATe?
CALCulate:OBwidth:MARKer[1] | 2 | ... | 12:X
CALCulate:OBwidth:MARKer[1] | 2 | ... | 12:X?
CALCulate:OBwidth:MARKer[1] | 2 | ... | 12:X:POSition
CALCulate:OBwidth:MARKer[1] | 2 | ... | 12:X:POSition?
CALCulate:OBwidth:MARKer[1] | 2 | ... | 12:Y?
CALCulate:PStatistic:MARKer:AOFF
CALCulate:PStatistic:MARKer[1] | 2 | ... | 12:FUNCTion:RESult?
CALCulate:PStatistic:MARKer[1] | 2 | ... | 12:MODE
CALCulate:PStatistic:MARKer[1] | 2 | ... | 12:MODE?
CALCulate:PStatistic:MARKer[1] | 2 | ... | 12:REFerence
CALCulate:PStatistic:MARKer[1] | 2 | ... | 12:REFerence?
CALCulate:PStatistic:MARKer[1] | 2 | ... | 12:TRACe
CALCulate:PStatistic:MARKer[1] | 2 | ... | 12:TRACe?
CALCulate:PStatistic:MARKer[1] | 2 | ... | 12:X
CALCulate:PStatistic:MARKer[1] | 2 | ... | 12:X?
CALCulate:PStatistic:MARKer[1] | 2 | ... | 12:Y?
CALCulate:PStatistic:STORE:REFerence

```

CALCulate:SEMask:LLINE:STATE
 CALCulate:SEMask:LLINE:STATE?
 CALCulate:SEMask:MARKer:AOff
 CALCulate:SEMask:MARKer:COUple[:STATE]
 CALCulate:SEMask:MARKer:COUple[:STATE]?
 CALCulate:SEMask:MARKer[1]|2|...|12:FUNCTION:RESult?
 CALCulate:SEMask:MARKer[1]|2|...|12:MODE
 CALCulate:SEMask:MARKer[1]|2|...|12:MODE?
 CALCulate:SEMask:MARKer[1]|2|...|12:X
 CALCulate:SEMask:MARKer[1]|2|...|12:X?
 CALCulate:SEMask:MARKer[1]|2|...|12:X:POSition
 CALCulate:SEMask:MARKer[1]|2|...|12:X:POSition?
 CALCulate:SEMask:MARKer[1]|2|...|12:Y?
 CALCulate:SPURious:MARKer:AOff
 CALCulate:SPURious:MARKer:COUple[:STATE]
 CALCulate:SPURious:MARKer:COUple[:STATE]?
 CALCulate:SPURious:MARKer[1]|2|...|12:MAXimum
 CALCulate:SPURious:MARKer[1]|2|...|12:MAXimum:LEFT
 CALCulate:SPURious:MARKer[1]|2|...|12:MAXimum:NEXT
 CALCulate:SPURious:MARKer[1]|2|...|12:MAXimum:RIGHT
 CALCulate:SPURious:MARKer[1]|2|...|12:MINimum
 CALCulate:SPURious:MARKer[1]|2|...|12:MODE
 CALCulate:SPURious:MARKer[1]|2|...|12:MODE?
 CALCulate:SPURious:MARKer[1]|2|...|12:PTPeak
 CALCulate:SPURious:MARKer[1]|2|...|12:REFerence
 CALCulate:SPURious:MARKer[1]|2|...|12:REFerence?
 CALCulate:SPURious:MARKer[1]|2|...|12:STATE
 CALCulate:SPURious:MARKer[1]|2|...|12:STATE?
 CALCulate:SPURious:MARKer[1]|2|...|12:X
 CALCulate:SPURious:MARKer[1]|2|...|12:X?
 CALCulate:SPURious:MARKer[1]|2|...|12:X:POSition
 CALCulate:SPURious:MARKer[1]|2|...|12:X:POSition?
 CALCulate:SPURious:MARKer[1]|2|...|12:Y?
 CALCulate:SPURious[:RANGE][:LIST]:LIMit:ABSolute[:UPPer]:DATA
 [:START]
 CALCulate:SPURious[:RANGE][:LIST]:LIMit:ABSolute[:UPPer]:DATA
 [:START]?
 CALCulate:SPURious[:RANGE][:LIST]:LIMit:ABSolute[:UPPer]:DATA:STOP
 CALCulate:SPURious[:RANGE][:LIST]:LIMit:ABSolute
 [:UPPer]:DATA:STOP?
 CALCulate:SPURious[:RANGE][:LIST]:LIMit:ABSolute
 [:UPPer]:DATA:STOP:AUTO
 CALCulate:SPURious[:RANGE][:LIST]:LIMit:ABSolute
 [:UPPer]:DATA:STOP:AUTO?
 CALCulate:TRACe[1]|2|...|6:FAIL?
 CALCulate:TXPower:MARKer:AOff
 CALCulate:TXPower:MARKer:COUple[:STATE]
 CALCulate:TXPower:MARKer:COUple[:STATE]?
 CALCulate:TXPower:MARKer[1]|2|...|12:FUNCTION:RESult?
 CALCulate:TXPower:MARKer[1]|2|...|12:MAXimum
 CALCulate:TXPower:MARKer[1]|2|...|12:MODE
 CALCulate:TXPower:MARKer[1]|2|...|12:MODE?

```
CALCulate:TXPower:MARKer[1]|2|...|12:REference
CALCulate:TXPower:MARKer[1]|2|...|12:REference?
CALCulate:TXPower:MARKer[1]|2|...|12:TRACe
CALCulate:TXPower:MARKer[1]|2|...|12:TRACe?
CALCulate:TXPower:MARKer[1]|2|...|12:X:POSition
CALCulate:TXPower:MARKer[1]|2|...|12:X:POSition?
CALCulate:TXPower:MARKer[1]|2|...|12:Y?
CALibration[:ALL]
CALibration[:ALL]?
CALibration[:ALL]:NPENding
CALibration:AUTO
CALibration:AUTO
CALibration:AUTO?
CALibration:AUTO:ALERT
CALibration:AUTO:ALERT?
CALibration:AUTO:MODE
CALibration:AUTO:MODE?
CALibration:AUTO:TIME:OFF?
CALibration:DATA:BACKUp
CALibration:DATA:DEFault
CALibration:DATA:REStore
CALibration:EMIXer
CALibration:EMIXer?
CALibration:EXPIred?
CALibration:FREQuency:REFeRence:COARse
CALibration:FREQuency:REFeRence:COARse?
CALibration:FREQuency:REFeRence:COARse?
CALibration:FREQuency:REFeRence:FINE
CALibration:FREQuency:REFeRence:FINE?
CALibration:FREQuency:REFeRence:MODE
CALibration:FREQuency:REFeRence:MODE?
CALibration:IQ:FLATness:I
CALibration:IQ:FLATness:IBAR
CALibration:IQ:FLATness:I|IBAR|Q|QBAR:TIME?
CALibration:IQ:FLATness:Q
CALibration:IQ:FLATness:QBAR
CALibration:IQ:ISOLation
CALibration:IQ:ISOLation:TIME?
CALibration:IQ:PROBe:I
CALibration:IQ:PROBe:IBar
CALibration:IQ:PROBe:I|IBAR|Q|QBAR:TIME?
CALibration:IQ:PROBe:I|Q:CLEar
CALibration:IQ:PROBe:Q
CALibration:IQ:PROBe:QBar
CALibration:NFLoor
CALibration:NFLoor?
CALibration:NRF
CALibration:NRF?
CALibration:NRF:NPENding
CALibration:REFeRence:CLOCK?
CALibration:REFeRence:CLOCK:END?
CALibration:REFeRence:CLOCK:INITialize?
CALibration:RF
```

CALibration:RF?
CALibration:RF:NPending
CALibration:RFPSelector:ALERT
CALibration:RFPSelector:ALERT?
CALibration:RFPSelector:CONDUCTed
CALibration:RFPSelector:CONDUCTed?
CALibration:RFPSelector:FULL
CALibration:RFPSelector:FULL?
CALibration:RFPSelector:RADiated
CALibration:RFPSelector:RADiated?
CALibration:RFPSelector:SCHEDuler:RECurrence
CALibration:RFPSelector:SCHEDuler:RECurrence?
CALibration:RFPSelector:SCHEDuler:RECurrence:DAY
CALibration:RFPSelector:SCHEDuler:RECurrence:DAY?
CALibration:RFPSelector:SCHEDuler:RECurrence:WEEK
CALibration:RFPSelector:SCHEDuler:RECurrence:WEEK?
CALibration:RFPSelector:SCHEDuler:STATE
CALibration:RFPSelector:SCHEDuler:STATE?
CALibration:RFPSelector:SCHEDuler:TASK
CALibration:RFPSelector:SCHEDuler:TASK?
CALibration:RFPSelector:SCHEDuler:TIME:NEXT?
CALibration:RFPSelector:SCHEDuler:TIME:START
CALibration:RFPSelector:SCHEDuler:TIME:START?
CALibration:SOURce:STATE
CALibration:SOURce:STATE?
CALibration:TEMPerature:CURRent?
CALibration:TEMPerature:LALL?
CALibration:TEMPerature:LPReselector?
CALibration:TEMPerature:LRF?
CALibration:TEMPerature:NFLoor?
CALibration:TEMPerature:RFPSelector:LCONDUCTed?
CALibration:TEMPerature:RFPSelector:LRADiated?
CALibration:TIME:ELAPsed:NFLoor?
CALibration:TIME:LALL?
CALibration:TIME:LPReselector?
CALibration:TIME:LRF?
CALibration:TIME:NFLoor?
CALibration:TIME:REFerence:CLOCK?
CALibration:TIME:RFPSelector:LCONDUCTed?
CALibration:TIME:RFPSelector:LRADiated?
CALibration:YTF
CALibration:YTF?
CALibration:YTF:NPending
CONF
CONFigure?
CONFigure:ACPower
CONFigure:ACPower
CONFigure:ACPower:NDEFault
CONFigure:CHPower
CONFigure:CHPower
CONFigure:CHPower:NDEFault
CONFigure:HARMonics
CONFigure:HARMonics

CONFigure:HARMonics:NDEFault
CONFigure:LIST
CONFigure:OBWidth
CONFigure:OBWidth
CONFigure:OBWidth:NDEFault
CONFigure:PStatistic
CONFigure:PStatistic
CONFigure:PStatistic:NDEFault
CONFigure:SEMask
CONFigure:SEMask
CONFigure:SEMask:NDEFault
CONFigure:SPURious
CONFigure:SPURious
CONFigure:SPURious:NDEFault
CONFigure:TOI
CONFigure:TOI
CONFigure:TOI:NDEFault
CONFigure:TXPower
CONFigure:TXPower|BPOwer
CONFigure:TXPower|BPOwer:NDEFault
CONTrol:COMPAtible:TRACe
CONTrol:COMPAtible:TRACe?
COUPle

D

DISPlay:<measurement>:ANNotation:TITLe:DATA
DISPlay:<measurement>:ANNotation:TITLe:DATA?
DISPlay:ACPower:VIEW:NSElect
DISPlay:ACPower:VIEW:NSElect?
DISPlay:ACPower:VIEW[:SElect]
DISPlay:ACPower:VIEW[:SElect]?
DISPlay:ACPower:VIEW[1]:WINDow[1]:BGRaph
DISPlay:ACPower:VIEW[1]:WINDow[1]:BGRaph?
DISPlay:ACPower:VIEW[1]:WINDow[1]:TRACe:Y[:SCALe]:COUPle
DISPlay:ACPower:VIEW[1]:WINDow[1]:TRACe:Y[:SCALe]:COUPle?
DISPlay:ACPower:VIEW[1]:WINDow[1]:TRACe:Y[:SCALe]:PDIVision
DISPlay:ACPower:VIEW[1]:WINDow[1]:TRACe:Y[:SCALe]:PDIVision?
DISPlay:ACPower:VIEW[1]:WINDow[1]:TRACe:Y[:SCALe]:RLEVel
DISPlay:ACPower:VIEW[1]:WINDow[1]:TRACe:Y[:SCALe]:RLEVel?
DISPlay:ACPower:VIEW[1]:WINDow[1]:TRACe:Y[:SCALe]:RPOStition
DISPlay:ACPower:VIEW[1]:WINDow[1]:TRACe:Y[:SCALe]:RPOStition?
DISPlay:ACTivefunc[:STATe]
DISPlay:ACTivefunc[:STATe]?
DISPlay:ANNotation:FREQuency[:STATe]
DISPlay:ANNotation:FREQuency[:STATe]?
DISPlay:ANNotation:MBAR[:STATe]
DISPlay:ANNotation:MBAR[:STATe]?
DISPlay:ANNotation:SCReen[:STATe]
DISPlay:ANNotation:SCReen[:STATe]?
DISPlay:ANNotation:TRACe[:STATe]
DISPlay:ANNotation:TRACe[:STATe]?

DISPlay:BACKlight
DISPlay:BACKlight?
DISPlay:BACKlight:INTensity
DISPlay:BACKlight:INTensity?
DISPlay:CHPower:VIEW:NSElect
DISPlay:CHPower:VIEW:NSElect?
DISPlay:CHPower:VIEW[:SElect]
DISPlay:CHPower:VIEW[:SElect]
DISPlay:CHPower:VIEW[:SElect]
DISPlay:CHPower:VIEW[:SElect]?
DISPlay:CHPower:VIEW[:SElect]?
DISPlay:CHPower:VIEW[:SElect]?
DISPlay:CHPower:VIEW[1]:WINDow[1]:BGRaph
DISPlay:CHPower:VIEW[1]:WINDow[1]:BGRaph?
DISPlay:CHPower:VIEW[1]:WINDow[1]:TRACe:Y[:SCALe]:COUPle
DISPlay:CHPower:VIEW[1]:WINDow[1]:TRACe:Y[:SCALe]:COUPle?
DISPlay:CHPower:VIEW[1]:WINDow[1]:TRACe:Y[:SCALe]:PDIVision
DISPlay:CHPower:VIEW[1]:WINDow[1]:TRACe:Y[:SCALe]:PDIVision?
DISPlay:CHPower:VIEW[1]:WINDow[1]:TRACe:Y[:SCALe]:RLEVel
DISPlay:CHPower:VIEW[1]:WINDow[1]:TRACe:Y[:SCALe]:RLEVel?
DISPlay:CHPower:VIEW[1]:WINDow[1]:TRACe:Y[:SCALe]:RPOsition
DISPlay:CHPower:VIEW[1]:WINDow[1]:TRACe:Y[:SCALe]:RPOsition?
DISPlay:ENABle
DISPlay:ENABle?
DISPlay:FSCReen[:STATe]
DISPlay:FSCReen[:STATe]?
DISPlay:HARMonics:VIEW:WINDow:TRACe:Y[:SCALe]:PDIVision
DISPlay:HARMonics:VIEW:WINDow:TRACe:Y[:SCALe]:PDIVision?
DISPlay:HARMonics:VIEW:WINDow:TRACe:Y[:SCALe]:RLEVel
DISPlay:HARMonics:VIEW:WINDow:TRACe:Y[:SCALe]:RLEVel?
DISPlay:HARMonics:VIEW:WINDow:TRACe:Y[:SCALe]:RPOsition
DISPlay:HARMonics:VIEW:WINDow:TRACe:Y[:SCALe]:RPOsition?
DISPlay:MENU[:STATe]
DISPlay:OBWidth:VIEW:NSElect
DISPlay:OBWidth:VIEW:NSElect?
DISPlay:OBWidth:VIEW[:SElect]
DISPlay:OBWidth:VIEW[:SElect]?
DISPlay:OBWidth:VIEW2:WINDow2:BOUNdaries:FREQuency
DISPlay:OBWidth:VIEW2:WINDow2:BOUNdaries:FREQuency?
DISPlay:OBWidth:VIEW[1]:WINDow[1]:TRACe:Y[:SCALe]:COUPle
DISPlay:OBWidth:VIEW[1]:WINDow[1]:TRACe:Y[:SCALe]:COUPle?
DISPlay:OBWidth:VIEW[1]:WINDow[1]:TRACe:Y[:SCALe]:PDIVision
DISPlay:OBWidth:VIEW[1]:WINDow[1]:TRACe:Y[:SCALe]:PDIVision?
DISPlay:OBWidth:VIEW[1]:WINDow[1]:TRACe:Y[:SCALe]:RLEVel
DISPlay:OBWidth:VIEW[1]:WINDow[1]:TRACe:Y[:SCALe]:RLEVel?
DISPlay:OBWidth:VIEW[1]:WINDow[1]:TRACe:Y[:SCALe]:RPOsition
DISPlay:OBWidth:VIEW[1]:WINDow[1]:TRACe:Y[:SCALe]:RPOsition?
DISPlay:OBWidth:VIEW:WINDow[1]:XDB
DISPlay:OBWidth:VIEW:WINDow[1]:XDB?
DISPlay:PSTATistic:GAUSSian[:STATe]
DISPlay:PSTATistic:GAUSSian[:STATe]?
DISPlay:PSTATistic:RTRace[:STATe]
DISPlay:PSTATistic:RTRace[:STATe]?

DISPlay:PStatistic:VIEW[1]:WINDow2:TRACe:X[:SCALE]:PDIVision
DISPlay:PStatistic:VIEW[1]:WINDow2:TRACe:X[:SCALE]:PDIVision?
DISPlay:PStatistic:XSCale
DISPlay:SEMask:VIEW:NSElect
DISPlay:SEMask:VIEW:NSElect?
DISPlay:SEMask:VIEW[:SElect]
DISPlay:SEMask:VIEW[:SElect]?
DISPlay:SEMask:VIEW[1]:WINDow[1]:TRACe:X[:SCALE]:COUPLE
DISPlay:SEMask:VIEW[1]:WINDow[1]:TRACe:X[:SCALE]:COUPLE?
DISPlay:SEMask:VIEW[1]:WINDow[1]:TRACe:X[:SCALE]:PDIVision
DISPlay:SEMask:VIEW[1]:WINDow[1]:TRACe:X[:SCALE]:PDIVision?
DISPlay:SEMask:VIEW[1]:WINDow[1]:TRACe:X[:SCALE]:RLEVel
DISPlay:SEMask:VIEW[1]:WINDow[1]:TRACe:X[:SCALE]:RLEVel?
DISPlay:SEMask:VIEW[1]:WINDow[1]:TRACe:X[:SCALE]:RPOSITION
DISPlay:SEMask:VIEW[1]:WINDow[1]:TRACe:X[:SCALE]:RPOSITION?
DISPlay:SEMask:VIEW[1]:WINDow[1]:TRACe:Y[:SCALE]:COUPLE
DISPlay:SEMask:VIEW[1]:WINDow[1]:TRACe:Y[:SCALE]:COUPLE?
DISPlay:SEMask:VIEW[1]:WINDow[1]:TRACe:Y[:SCALE]:PDIVision
DISPlay:SEMask:VIEW[1]:WINDow[1]:TRACe:Y[:SCALE]:PDIVision?
DISPlay:SEMask:VIEW[1]:WINDow[1]:TRACe:Y[:SCALE]:RLEVel
DISPlay:SEMask:VIEW[1]:WINDow[1]:TRACe:Y[:SCALE]:RLEVel?
DISPlay:SEMask:VIEW[1]:WINDow[1]:TRACe:Y[:SCALE]:RPOSITION
DISPlay:SEMask:VIEW[1]:WINDow[1]:TRACe:Y[:SCALE]:RPOSITION?
DISPlay:SPURious:VIEW:RANGe[:SElect]
DISPlay:SPURious:VIEW:RANGe[:SElect]?
DISPlay:SPURious:VIEW:RANGe:TABLE
DISPlay:SPURious:VIEW:RANGe:TABLE?
DISPlay:SPURious:VIEW[:SElect]
DISPlay:SPURious:VIEW[:SElect]?
DISPlay:SPURious:VIEW[1]:WINDow[1]:TRACe:Y[:SCALE]:COUPLE
DISPlay:SPURious:VIEW[1]:WINDow[1]:TRACe:Y[:SCALE]:COUPLE?
DISPlay:SPURious:VIEW[1]:WINDow[1]:TRACe:Y[:SCALE]:PDIVision
DISPlay:SPURious:VIEW[1]:WINDow[1]:TRACe:Y[:SCALE]:PDIVision?
DISPlay:SPURious:VIEW[1]:WINDow[1]:TRACe:Y[:SCALE]:RLEVel
DISPlay:SPURious:VIEW[1]:WINDow[1]:TRACe:Y[:SCALE]:RLEVel?
DISPlay:TOI:VIEW:WINDow:TRACe:Y[:SCALE]:PDIVision
DISPlay:TOI:VIEW:WINDow:TRACe:Y[:SCALE]:PDIVision?
DISPlay:TOI:VIEW:WINDow:TRACe:Y[:SCALE]:RLEVel
DISPlay:TOI:VIEW:WINDow:TRACe:Y[:SCALE]:RLEVel?
DISPlay:TOI:VIEW:WINDow:TRACe:Y[:SCALE]:RPOSITION
DISPlay:TOI:VIEW:WINDow:TRACe:Y[:SCALE]:RPOSITION?
DISPlay:TXPower:BARGraph[:STATE]
DISPlay:TXPower:BARGraph[:STATE]?
DISPlay:TXPower:VIEW[1]:WINDow[1]:TRACe:MAXHold[:STATE]
DISPlay:TXPower:VIEW[1]:WINDow[1]:TRACe:MAXHold[:STATE]?
DISPlay:TXPower:VIEW[1]:WINDow[1]:TRACe:MINHold[:STATE]
DISPlay:TXPower:VIEW[1]:WINDow[1]:TRACe:MINHold[:STATE]?
DISPlay:TXPower:VIEW[1]:WINDow[1]:TRACe:X[:SCALE]:COUPLE
DISPlay:TXPower:VIEW[1]:WINDow[1]:TRACe:X[:SCALE]:COUPLE?
DISPlay:TXPower:VIEW[1]:WINDow[1]:TRACe:X[:SCALE]:PDIVision
DISPlay:TXPower:VIEW[1]:WINDow[1]:TRACe:X[:SCALE]:PDIVision?
DISPlay:TXPower:VIEW[1]:WINDow[1]:TRACe:X[:SCALE]:RLEVel
DISPlay:TXPower:VIEW[1]:WINDow[1]:TRACe:X[:SCALE]:RLEVel?

```

DISPlay:TXPower:VIEW[1]:WINDow[1]:TRACe:X[:SCALE]:RPOsition
DISPlay:TXPower:VIEW[1]:WINDow[1]:TRACe:X[:SCALE]:RPOsition?
DISPlay:TXPower:VIEW[1]:WINDow[1]:TRACe:Y[:SCALE]:COUPle
DISPlay:TXPower:VIEW[1]:WINDow[1]:TRACe:Y[:SCALE]:COUPle?
DISPlay:TXPower:VIEW[1]:WINDow[1]:TRACe:Y[:SCALE]:PDIVision
DISPlay:TXPower:VIEW[1]:WINDow[1]:TRACe:Y[:SCALE]:PDIVision?
DISPlay:TXPower:VIEW[1]:WINDow[1]:TRACe:Y[:SCALE]:RLEVel
DISPlay:TXPower:VIEW[1]:WINDow[1]:TRACe:Y[:SCALE]:RLEVel?
DISPlay:TXPower:VIEW[1]:WINDow[1]:TRACe:Y[:SCALE]:RPOsition
DISPlay:TXPower:VIEW[1]:WINDow[1]:TRACe:Y[:SCALE]:RPOsition?
DISPlay:WINDow[1]:ANNOtation[:ALL]
DISPlay:WINDow[1]:ANNOtation[:ALL]?
DISPlay:WINDow:FORMat:TILE
DISPlay:WINDow:FORMat:ZOOM
DISPlay:WINDow:MAMarker:POsition
DISPlay:WINDow:MAMarker:POsition?
DISPlay:WINDow:MAMarker[:STATE]
DISPlay:WINDow:MAMarker[:STATE]?
DISPlay:WINDow[:SELEct]
DISPlay:WINDow[:SELEct]?
DISPlay:WINDow[1]:TRACe:GRATICule:GRID[:STATE]
DISPlay:WINDow[1]:TRACe:GRATICule:GRID[:STATE]?
DISPlay:WINDow[1]:TRACe:X:FLINE[1]|2|...|4
DISPlay:WINDow[1]:TRACe:X:FLINE[1]|2|...|4?
DISPlay:WINDow[1]:TRACe:X:FLINE[1]|2|...|4:STATE
DISPlay:WINDow[1]:TRACe:X:FLINE[1]|2|...|4:STATE?
DISPlay:WINDow[1]:TRACe:X[:SCALE]:OFFSet
DISPlay:WINDow[1]:TRACe:X[:SCALE]:SPACing
DISPlay:WINDow[1]:TRACe:X[:SCALE]:SPACing?
DISPlay:WINDow[1]:TRACe:X:TLINE[1]|2|...|4
DISPlay:WINDow[1]:TRACe:X:TLINE[1]|2|...|4?
DISPlay:WINDow[1]:TRACe:X:TLINE[1]|2|...|4:STATE
DISPlay:WINDow[1]:TRACe:X:TLINE[1]|2|...|4:STATE?
DISPlay:WINDow[1]:TRACe:Y:DLINE[1]|2|...|4
DISPlay:WINDow[1]:TRACe:Y:DLINE[1]|2|...|4?
DISPlay:WINDow[1]:TRACe:Y:DLINE[1]|2|...|4:STATE
DISPlay:WINDow[1]:TRACe:Y:DLINE[1]|2|...|4:STATE?
DISPlay:WINDow[1]:TRACe:Y[:SCALE]:LOG:RANGE:AUTO
DISPlay:WINDow[1]:TRACe:Y[:SCALE]:NRLevel
DISPlay:WINDow[1]:TRACe:Y[:SCALE]:NRLevel?
DISPlay:WINDow[1]:TRACe:Y[:SCALE]:NRPosition
DISPlay:WINDow[1]:TRACe:Y[:SCALE]:NRPosition?
DISPlay:WINDow[1]:TRACe:Y[:SCALE]:PDIVision
DISPlay:WINDow[1]:TRACe:Y[:SCALE]:PDIVision?
DISPlay:WINDow[1]:TRACe:Y[:SCALE]:RLEVel
DISPlay:WINDow[1]:TRACe:Y[:SCALE]:RLEVel?
DISPlay:WINDow[1]:TRACe:Y[:SCALE]:RLEVel:OFFSet
DISPlay:WINDow[1]:TRACe:Y[:SCALE]:RLEVel:OFFSet?
DISPlay:WINDow[1]:TRACe:Y[:SCALE]:SPACing
DISPlay:WINDow[1]:TRACe:Y[:SCALE]:SPACing?

```

F

FETCh:ACPower[n]?
FETCh:CHPower:CHPower?
FETCh:CHPower:DENSity?
FETCh:CHPower[n]?
FETCh:HARMonics:AMPLitude:ALL?
FETCh:HARMonics:AMPLitude[n]?
FETCh:HARMonics:DIS TORTion?
FETCh:HARMonics:FREQuency:ALL?
FETCh:HARMonics:FREQuency[n]?
FETCh:HARMonics:FUNDamental?
FETCh:HARMonics[n]?
FETCh:LIST?
FETCh:OBWidth:FERRor?
FETCh:OBWidth[n]?
FETCh:OBWidth:OBWidth?
FETCh:OBWidth:XDB?
FETCh:PSTatistic[n]?
FETCh:SEMask[n]?
FETCh:SPURious[n]?
FETCh:TOI:IP3?
FETCh:TOI[n]?
FETCh:TOI[n]?
FETCh:TXPower|BPOWER[n]?
FORMat:BORDER
FORMat:BORDER?
FORMat[:TRACe][:DATA]
FORMat[:TRACe][:DATA]?

G

GLOBal:DEFault
GLOBal:FREQuency:CENTer[:STATE]
GLOBal:FREQuency:CENTer[:STATE]?

H

HCOPY:ABORT
HCOPY[:IMMediate]
HCOPY:SDUMp:DATA?

I

INITiate:ACPower
INITiate:CHPower
INITiate:CONTinuous
INITiate:CONTinuous?
INITiate:HARM
INITiate:HARMonics

```

INITiate[:IMMediate]
INITiate:LIST
INITiate:OBWidth
INITiate:PAUSE
INITiate:PStatistic
INITiate:REStart
INITiate:RESume
INITiate:SEMask
INITiate:SPURious
INITiate:TOI
INITiate:TXPower|BPOwer
INPut<1|2>:PRESelection[:STATE]
INPut<1|2>:PRESelection[:STATE]?
INPut<1|2>:TYPE
INPut<1|2>:TYPE?
INPut:COUPling
INPut:COUPling?
INPut:COUPling:I|Q
INPut:COUPling:I|Q?
INPut:IMPedance:IQ
INPut:IMPedance:IQ?
INPut:IMPedance:REfERENCE
INPut:IMPedance:REfERENCE?
INPut[1]:IQ:BALEnced[:STATE]
INPut[1]:IQ:BALEnced[:STATE]?
INPut:IQ[:I]:DIFFerential
INPut:IQ[:I]:DIFFerential?
INPut[1]:IQ[:I]:IMPedance
INPut[1]:IQ[:I]:IMPedance?
INPut:IQ:MIRROred
INPut:IQ:MIRROred?
INPut:IQ:Q:DIFFerential
INPut:IQ:Q:DIFFerential?
INPut[1]:IQ:Q:IMPedance
INPut[1]:IQ:Q:IMPedance?
INPut[1]:IQ:TYPE
INPut[1]:IQ:TYPE?
INPut[1]|2:LISN:FILTer:HPAS[:STATE]
INPut[1]|2:LISN:FILTer:HPAS[:STATE]?
INPut[1]|2:LISN:PEARth
INPut[1]|2:LISN:PEARth?
INPut[1]|2:LISN:PHASe
INPut[1]|2:LISN:PHASe?
INPut[1]|2:LISN[:TYPE]
INPut[1]|2:LISN[:TYPE]?
INPut:MIXer
INPut:MIXer?
INPut:OFFSet:I|Q
INPut:OFFSet:I|Q?
INST:NSEL
INST:NSEL
INSTrument:CATalog?
INSTrument:CONFigure:<mode>:<meas>

```

INSTRument:COUPle:DEFault
INSTRument:COUPle:EMC:STANdard
INSTRument:COUPle:EMC:STANdard?
INSTRument:COUPle:FREQuency:CENTer
INSTRument:COUPle:FREQuency:CENTer?
INSTRument:DEFault
INSTRument:NSElect
INSTRument:NSElect?
INSTRument[:SElect]
INSTRument[:SElect]
INSTRument[:SElect]
INSTRument[:SElect]
INSTRument[:SElect]
INSTRument[:SElect]?
INSTRument:SOURce[:SElect]
INSTRument:SOURce[:SElect]?
INST:SEL
INST:SEL
INST:SEL
INST:SEL

L

LXI:IDENTify[:STATe]
LXI:IDENTify[:STATe]?

M

MEASure:ACPower[n]?
MEASure:CHPower:CHPower?
MEASure:CHPower:DENSity?
MEASure:CHPower[n]?
MEASure:EMI:MARKer[1]|2|...|12?
MEASure:HARMonics:AMPLitude:ALL?
MEASure:HARMonics:AMPLitude[n]?
MEASure:HARMonics:DISToRTion?
MEASure:HARMonics:FREQuency:ALL?
MEASure:HARMonics:FREQuency[n]?
MEASure:HARMonics:FUNDamental?
MEASure:HARMonics[n]?
MEASure:OBWidth:FERRor?
MEASure:OBWidth[n]?
MEASure:OBWidth:OBWidth?
MEASure:OBWidth:XDB?
MEASure:PSTatistic[n]?
MEASure:SEMask[n]?
MEASure:SPURious[n]?
MEASure:TOI:IP3?
MEASure:TOI[n]?
MEASure:TOI[n]?
MEASure:TXPower|BPOwer[n]?

MMEMemory:CATalog?
MMEMemory:CDIRectory
MMEMemory:CDIRectory?
MMEMemory:COPIY
MMEMemory:COPIY:DEVIce
MMEMemory:DATA
MMEMemory:DATA?
MMEMemory:DELeTe
MMEMemory:LOAD:CORRection
MMEMemory:LOAD:CORRection
MMEMemory:LOAD:LIMit
MMEMemory:LOAD:STATe
MMEMemory:LOAD:STATe
MMEMemory:LOAD:TRACe
MMEMemory:LOAD:TRACe:DATA
MMEMemory:LOAD:TRACe:REGister
MMEMemory:MDIRectory
MMEMemory:MOVE
MMEMemory:RDIRectory
MMEMemory:REGister:STATe:LABel
MMEMemory:REGister:STATe:LABel?
MMEMemory:RMEDIA:LABel
MMEMemory:RMEDIA:LABel?
MMEMemory:RMEDIA:LIST?
MMEMemory:RMEDIA:SIZE?
MMEMemory:RMEDIA:WPRotect?
MMEMemory:STORE:CORRection
MMEMemory:STORE:CORRection
MMEMemory:STORE:LIMit
MMEMemory:STORE:RESulTs
MMEMemory:STORE:RESulTs
MMEMemory:STORE:RESulTs
MMEMemory:STORE:RESulTs
MMEMemory:STORE:RESulTs
MMEMemory:STORE:RESulTs
MMEMemory:STORE:RESulTs:MTABLE|PTABLE|SPECTrogram
MMEMemory:STORE:SCREen
MMEMemory:STORE:SCREen:THEMe
MMEMemory:STORE:SCREen:THEMe?
MMEMemory:STORE:STATe
MMEMemory:STORE:STATe
MMEMemory:STORE:TRACe
MMEMemory:STORE:TRACe:DATA
MMEMemory:STORE:TRACe:REGister

O

OUTPut:ANALog
OUTPut:ANALog?
OUTPut:ANALog:AUTO
OUTPut:ANALog:AUTO?

OUTPut:AUX
OUTPut:AUX?
OUTPut:AUX:AIF
OUTPut:AUX:AIF?
OUTPut:DBUS[1][:STATE]
OUTPut:DBUS[1][:STATE]?
OUTPut[:EXTErnal]
OUTPut[:EXTErnal]
OUTPut:IQ:OUTPut
OUTPut:IQ:OUTPut?

R

READ:ACPower[n]?
READ:CHPower:CHPower?
READ:CHPower:DENSity
READ:CHPower[n]?
READ:HARMonics:AMPLitude:ALL?
READ:HARMonics:AMPLitude[n]?
READ:HARMonics:DISToRTion?
READ:HARMonics:FREQuency:ALL?
READ:HARMonics:FREQuency[n]?
READ:HARMonics:FUNDamental?
READ:HARMonics[n]?
READ:LIST?
READ:OBWidth:FERRor?
READ:OBWidth[n]?
READ:OBWidth:OBWidth?
READ:OBWidth:XDB?
READ:PStAtistic[n]?
READ:SEMAsk[n]?
READ:SPURious[n]?
READ:TOI:IP3?
READ:TOI[n]?
READ:TOI[n]?
READ:TXPower|BPOwer[n]?

S

[:SENSe]:<measurement>:TRIGger:SOURce
[:SENSe]:<measurement>:TRIGger:SOURce
[:SENSe]:ACPower:AVERAge:COUNT
[:SENSe]:ACPower:AVERAge:COUNT?
[:SENSe]:ACPower:AVERAge[:STATE]
[:SENSe]:ACPower:AVERAge[:STATE]?
[:SENSe]:ACPower:AVERAge:TCONtrol
[:SENSe]:ACPower:AVERAge:TCONtrol?
[:SENSe]:ACPower:BANDwidth:INTEgration
[:SENSe]:ACPower:BANDwidth[:RESolution]
[:SENSe]:ACPower:BANDwidth[:RESolution]?
[:SENSe]:ACPower:BANDwidth[:RESolution]:AUTO

```

[:SENSe]:ACPower:BANDwidth[:RESolution]:AUTO?
[:SENSe]:ACPower:BANDwidth:SHAPE
[:SENSe]:ACPower:BANDwidth:SHAPE?
[:SENSe]:ACPower:BANDwidth:TYPE
[:SENSe]:ACPower:BANDwidth:TYPE?
[:SENSe]:ACPower:BANDwidth:VIDeo
[:SENSe]:ACPower:BANDwidth:VIDeo?
[:SENSe]:ACPower:BANDwidth:VIDeo:AUTO
[:SENSe]:ACPower:BANDwidth:VIDeo:AUTO?
[:SENSe]:ACPower:BWIDth:INTEgration
[:SENSe]:ACPower:BWIDth[:RESolution]
[:SENSe]:ACPower:BWIDth:SHAPE
[:SENSe]:ACPower:BWIDth:TYPE
[:SENSe]:ACPower:BWIDth:VIDeo
[:SENSe]:ACPower:CARRier[1]|2:COUNT
[:SENSe]:ACPower:CARRier[1]|2:COUNT?
[:SENSe]:ACPower:CARRier[1]|2:LIST:BANDwidth[:INTEgration]
[:SENSe]:ACPower:CARRier[1]|2:LIST:BANDwidth[:INTEgration]?
[:SENSe]:ACPower:CARRier[1]|2:LIST:BWIDth[:INTEgration]
[:SENSe]:ACPower:CARRier[1]|2:LIST:COUPLE
[:SENSe]:ACPower:CARRier[1]|2:LIST:COUPLE?
[:SENSe]:ACPower:CARRier[1]|2:LIST:FILTer:ALPHA
[:SENSe]:ACPower:CARRier[1]|2:LIST:FILTer:ALPHA?
[:SENSe]:ACPower:CARRier[1]|2:LIST:FILTer[:RRC][:STATE]
[:SENSe]:ACPower:CARRier[1]|2:LIST:FILTer[:RRC][:STATE]?
[:SENSe]:ACPower:CARRier[1]|2:LIST:METHod
[:SENSe]:ACPower:CARRier[1]|2:LIST:METHod?
[:SENSe]:ACPower:CARRier[1]|2:LIST:PPResent
[:SENSe]:ACPower:CARRier[1]|2:LIST:PPResent?
[:SENSe]:ACPower:CARRier[1]|2:LIST:WIDTh
[:SENSe]:ACPower:CARRier[1]|2:LIST:WIDTh?
[:SENSe]:ACPower:CARRier[1]|2:PREFerence:TYPE
[:SENSe]:ACPower:CARRier[1]|2:PREFerence:TYPE?
[:SENSe]:ACPower:CARRier[1]|2:RCARRier
[:SENSe]:ACPower:CARRier[1]|2:RCARRier?
[:SENSe]:ACPower:CARRier[1]|2:RCARRier:AUTO
[:SENSe]:ACPower:CARRier[1]|2:RCARRier:AUTO?
[:SENSe]:ACPower:CARRier[1]|2:RCFRequency
[:SENSe]:ACPower:CARRier[1]|2:RCFRequency?
[:SENSe]:ACPower:CARRier[1]|2:RCFRequency:AUTO
[:SENSe]:ACPower:CARRier[1]|2:RCFRequency:AUTO?
[:SENSe]:ACPower:CORRection:NOISe[:AUTO]
[:SENSe]:ACPower:CORRection:NOISe[:AUTO]?
[:SENSe]:ACPower:DETEctor:AUTO
[:SENSe]:ACPower:DETEctor:AUTO?
[:SENSe]:ACPower:DETEctor[:FUNction]
[:SENSe]:ACPower:DETEctor[:FUNction]?
[:SENSe]:ACPower:FILTer[:RRC]:ALPHA
[:SENSe]:ACPower:FILTer[:RRC]:ALPHA?
[:SENSe]:ACPower:FILTer[:RRC][:STATE]
[:SENSe]:ACPower:FILTer[:RRC][:STATE]?
[:SENSe]:ACPower:FREQuency:SPAN
[:SENSe]:ACPower:FREQuency:SPAN?

```

```

[:SENSe]:ACPower:FREQuency:SPAN:FULL
[:SENSe]:ACPower:FREQuency:SPAN:PREVious
[:SENSe]:ACPower:FREQuency:SYNTHeSis:AUTO[:STATE]
[:SENSe]:ACPower:FREQuency:SYNTHeSis:AUTO[:STATE]?
[:SENSe]:ACPower:FREQuency:SYNTHeSis[:STATE]
[:SENSe]:ACPower:FREQuency:SYNTHeSis[:STATE]?
[:SENSe]:ACPower:LIMit[:STATE]
[:SENSe]:ACPower:METHod
[:SENSe]:ACPower:METHod?
[:SENSe]:ACPower:OFFSet[1]|2:LIST:BWIDth[:INTEgration]
[:SENSe]:ACPower:OFFSet[1]|2:LIST:BWIDth:RESolution
[:SENSe]:ACPower:OFFSet[1]|2:LIST:BWIDth:SHAPE
[:SENSe]:ACPower:OFFSet[1]|2:LIST:BWIDth:TYPE
[:SENSe]:ACPower:OFFSet[1]|2:LIST:BWIDth:VIDeo
[:SENSe]:ACPower:OFFSet[1]|2[:OUTer]:LIST:ABSolute
[:SENSe]:ACPower:OFFSet[1]|2[:OUTer]:LIST:ABSolute?
[:SENSe]:ACPower:OFFSet[1]|2[:OUTer]:LIST:BANDwidth[:INTEgration]
[:SENSe]:ACPower:OFFSet[1]|2[:OUTer]:LIST:BANDwidth[:INTEgration]?
[:SENSe]:ACPower:OFFSet[1]|2[:OUTer]:LIST:BANDwidth:RESolution
[:SENSe]:ACPower:OFFSet[1]|2[:OUTer]:LIST:BANDwidth:RESolution?
[:SENSe]:ACPower:OFFSet[1]|2
[:OUTer]:LIST:BANDwidth:RESolution:AUTO
[:SENSe]:ACPower:OFFSet[1]|2
[:OUTer]:LIST:BANDwidth:RESolution:AUTO?
[:SENSe]:ACPower:OFFSet[1]|2[:OUTer]:LIST:BANDwidth:SHAPE
[:SENSe]:ACPower:OFFSet[1]|2[:OUTer]:LIST:BANDwidth:SHAPE?
[:SENSe]:ACPower:OFFSet[1]|2[:OUTer]:LIST:BANDwidth:TYPE
[:SENSe]:ACPower:OFFSet[1]|2[:OUTer]:LIST:BANDwidth:TYPE?
[:SENSe]:ACPower:OFFSet[1]|2[:OUTer]:LIST:BANDwidth:VIDeo
[:SENSe]:ACPower:OFFSet[1]|2[:OUTer]:LIST:BANDwidth:VIDeo?
[:SENSe]:ACPower:OFFSet[1]|2[:OUTer]:LIST:BANDwidth:VIDeo:AUTO
[:SENSe]:ACPower:OFFSet[1]|2[:OUTer]:LIST:BANDwidth:VIDeo:AUTO?
[:SENSe]:ACPower:OFFSet[1]|2[:OUTer]:LIST:FILTer:ALPHA
[:SENSe]:ACPower:OFFSet[1]|2[:OUTer]:LIST:FILTer:ALPHA?
[:SENSe]:ACPower:OFFSet[1]|2[:OUTer]:LIST:FILTer[:RRC][:STATE]
[:SENSe]:ACPower:OFFSet[1]|2[:OUTer]:LIST:FILTer[:RRC][:STATE]?
[:SENSe]:ACPower:OFFSet[1]|2[:OUTer]:LIST[:FREQuency]
[:SENSe]:ACPower:OFFSet[1]|2[:OUTer]:LIST[:FREQuency]?
[:SENSe]:ACPower:OFFSet[1]|2[:OUTer]:LIST:RCARrier
[:SENSe]:ACPower:OFFSet[1]|2[:OUTer]:LIST:RCARrier?
[:SENSe]:ACPower:OFFSet[1]|2[:OUTer]:LIST:RPSDensity
[:SENSe]:ACPower:OFFSet[1]|2[:OUTer]:LIST:RPSDensity?
[:SENSe]:ACPower:OFFSet[1]|2[:OUTer]:LIST:SIDE
[:SENSe]:ACPower:OFFSet[1]|2[:OUTer]:LIST:SIDE?
[:SENSe]:ACPower:OFFSet[1]|2[:OUTer]:LIST:STATE
[:SENSe]:ACPower:OFFSet[1]|2[:OUTer]:LIST:STATE?
[:SENSe]:ACPower:OFFSet[1]|2[:OUTer]:LIST:TEST
[:SENSe]:ACPower:OFFSet[1]|2[:OUTer]:LIST:TEST?
[:SENSe]:ACPower:OFFSet[1]|2[:OUTer]:TYPE
[:SENSe]:ACPower:OFFSet[1]|2[:OUTer]:TYPE?
[:SENSe]:ACPower:SWEEp:POINts
[:SENSe]:ACPower:SWEEp:POINts?
[:SENSe]:ACPower:SWEEp:TIME

```

```

[:SENSe]:ACPower:SWEep:TIME?
[:SENSe]:ACPower:SWEep:TIME:AUTO
[:SENSe]:ACPower:SWEep:TIME:AUTO?
[:SENSe]:ACPower:SWEep:TIME:AUTO:RULEs
[:SENSe]:ACPower:SWEep:TIME:AUTO:RULEs?
[:SENSe]:ACPower:TYPE
[:SENSe]:ACPower:TYPE?
[:SENSe]:ACPR:AVERAge:COUNT
[:SENSe]:ACPR:AVERAge:TCONtrol
[:SENSe]:ACPR:FILTer[:RRC]:ALPHA
[:SENSe]:ACPR:FILTer[:RRC][:STATE]
[:SENSe]:ACPR:OFFSet[1]|2:LIST:ABSolute
[:SENSe]:ACPR:OFFSet[1]|2:LIST:BANDwidth
[:SENSe]:ACPR:OFFSet[1]|2:LIST:BWIDth
[:SENSe]:ACPR:SWEep:DETEctor[:FUNction]
[:SENSe]:ACPR:SWEep:TYPE
[:SENSe]:ACPR:TRIGger:SOURce
[:SENSe]:ACP:SWEep:BANDwidth|BWIDth[:RESolution]
[:SENSe]:ADC:DITHer:AUTO[:STATE]
[:SENSe]:ADC:DITHer:AUTO[:STATE]?
[:SENSe]:ADC:DITHer[:STATE]
[:SENSe]:ADC:DITHer[:STATE]?
[:SENSe]:ADC:RANGE
[:SENSe]:AVERAge:CLear
[:SENSe]:AVERAge:COUNT
[:SENSe]:AVERAge:COUNT?
[:SENSe]:AVERAge[:STATE]
[:SENSe]:AVERAge[:STATE]?
[:SENSe]:AVERAge:TYPE
[:SENSe]:AVERAge:TYPE:AUTO
[:SENSe]:AVERAge:TYPE:AUTO?
[:SENSe]:BANDwidth|BWIDth[:RESolution]
[:SENSe]:BANDwidth|BWIDth[:RESolution]?
[:SENSe]:BANDwidth|BWIDth[:RESolution]:AUTO
[:SENSe]:BANDwidth|BWIDth[:RESolution]:AUTO?
[:SENSe]:BANDwidth|BWIDth[:RESolution]:MODE
[:SENSe]:BANDwidth|BWIDth[:RESolution]:MODE?
[:SENSe]:BANDwidth|BWIDth[:RESolution]:WIDE
[:SENSe]:BANDwidth|BWIDth[:RESolution]:WIDE?
[:SENSe]:BANDwidth|BWIDth:SHAPE
[:SENSe]:BANDwidth|BWIDth:SHAPE?
[:SENSe]:BANDwidth|BWIDth:TYPE
[:SENSe]:BANDwidth|BWIDth:TYPE?
[:SENSe]:BANDwidth|BWIDth:VIDeo
[:SENSe]:BANDwidth|BWIDth:VIDeo?
[:SENSe]:BANDwidth|BWIDth:VIDeo:AUTO
[:SENSe]:BANDwidth|BWIDth:VIDeo:AUTO?
[:SENSe]:BANDwidth|BWIDth:VIDeo:RATio
[:SENSe]:BANDwidth|BWIDth:VIDeo:RATio?
[:SENSe]:BANDwidth|BWIDth:VIDeo:RATio:AUTO
[:SENSe]:BANDwidth|BWIDth:VIDeo:RATio:AUTO?
[:SENSe]:BPOWER:AVERAge:COUNT
[:SENSe]:BPOWER:AVERAge:TCONtrol

```

```

[:SENSe]:BPOWer:AVERAge:TYPE
[:SENSe]:BPOWer:METhod
[:SENSe]:BPOWer:THReshold
[:SENSe]:CHPower:AVERAge:COUnT
[:SENSe]:CHPower:AVERAge:COUnT?
[:SENSe]:CHPower:AVERAge[:STATe]
[:SENSe]:CHPower:AVERAge[:STATe]?
[:SENSe]:CHPower:AVERAge:TCONTrOl
[:SENSe]:CHPower:AVERAge:TCONTrOl?
[:SENSe]:CHPower:BANDwidth:INTEgration
[:SENSe]:CHPower:BANDwidth:INTEgration?
[:SENSe]:CHPower:BANDwidth[:RESolution]
[:SENSe]:CHPower:BANDwidth[:RESolution]?
[:SENSe]:CHPower:BANDwidth[:RESolution]:AUTO
[:SENSe]:CHPower:BANDwidth[:RESolution]:AUTO?
[:SENSe]:CHPower:BANDwidth:SHApe
[:SENSe]:CHPower:BANDwidth:SHApe?
[:SENSe]:CHPower:BANDwidth:VIDeo
[:SENSe]:CHPower:BANDwidth:VIDeo?
[:SENSe]:CHPower:BANDwidth:VIDeo:AUTO
[:SENSe]:CHPower:BANDwidth:VIDeo:AUTO?
[:SENSe]:CHPower:BwIDth[:RESolution]
[:SENSe]:CHPower:BwIDth:SHApe
[:SENSe]:CHPower:DETEctor:AUTO
[:SENSe]:CHPower:DETEctor:AUTO?
[:SENSe]:CHPower:DETEctor[:FUNCTion]
[:SENSe]:CHPower:DETEctor[:FUNCTion]?
[:SENSe]:CHPower:FILTer[:RRC]:ALPHa
[:SENSe]:CHPower:FILTer[:RRC]:ALPHa?
[:SENSe]:CHPower:FILTer[:RRC]:BANDwidth
[:SENSe]:CHPower:FILTer[:RRC]:BANDwidth?
[:SENSe]:CHPower:FILTer[:RRC]:BwIDth
[:SENSe]:CHPower:FILTer[:RRC][:STATe]
[:SENSe]:CHPower:FILTer[:RRC][:STATe]?
[:SENSe]:CHPower:FREQuency:SPAN
[:SENSe]:CHPower:FREQuency:SPAN?
[:SENSe]:CHPower:FREQuency:SPAN:AUTO
[:SENSe]:CHPower:FREQuency:SPAN:AUTO?
[:SENSe]:CHPower:FREQuency:SPAN:FULL
[:SENSe]:CHPower:FREQuency:SPAN:PREVious
[:SENSe]:CHPower:FREQuency:SYNThesis:AUTO[:STATe]
[:SENSe]:CHPower:FREQuency:SYNThesis:AUTO[:STATe]?
[:SENSe]:CHPower:FREQuency:SYNThesis[:STATe]
[:SENSe]:CHPower:FREQuency:SYNThesis[:STATe]?
[:SENSe]:CHPower:IF:GAIN:AUTO[:STATe]
[:SENSe]:CHPower:IF:GAIN:AUTO[:STATe]?
[:SENSe]:CHPower:IF:GAIN[:STATe]
[:SENSe]:CHPower:IF:GAIN[:STATe]?
[:SENSe]:CHPower:SWEEp:TIME
[:SENSe]:CHPower:SWEEp:TIME?
[:SENSe]:CHPower:SWEEp:TIME:AUTO
[:SENSe]:CHPower:SWEEp:TIME:AUTO?
[:SENSe]:CORREction:BTS[:RF]:GAIN

```

```

[:SENSe]:CORRection:BTS[:RF]:GAIN?
[:SENSe]:CORRection:BTS[:RF]:LOSS
[:SENSe]:CORRection:BTS[:RF]:LOSS?
[:SENSe]:CORRection:CSET:ALL:DELeTe
[:SENSe]:CORRection:CSET:ALL[:STATe]
[:SENSe]:CORRection:CSET:ALL[:STATe]?
[:SENSe]:CORRection:CSET[1]:ANTenna[:UNIT]
[:SENSe]:CORRection:CSET[1]:ANTenna[:UNIT]?
[:SENSe]:CORRection:CSET[1]|2|...|8:COMMeNt
[:SENSe]:CORRection:CSET[1]|2|...|8:COMMeNt?
[:SENSe]:CORRection:CSET[1]|2|...|8:DATA
[:SENSe]:CORRection:CSET[1]|2|...|8:DATA?
[:SENSe]:CORRection:CSET[1]|2|...|8:DATA:MERGe
[:SENSe]:CORRection:CSET[1]|2|...|6:DELeTe
[:SENSe]:CORRection:CSET[1]|2|...|8:DESCription
[:SENSe]:CORRection:CSET[1]|2|...|8:DESCription?
[:SENSe]:CORRection:CSET[1]|2|...|8[:STATe]
[:SENSe]:CORRection:CSET[1]|2|...|8[:STATe]?
[:SENSe]:CORRection:CSET[1]|2|...|8:X:SPACing
[:SENSe]:CORRection:CSET[1]|2|...|8:X:SPACing?
[:SENSe]:CORRection:IMPedance[:INPut][:MAGNitude]
[:SENSe]:CORRection:IMPedance[:INPut][:MAGNitude]?
[:SENSe]:CORRection:IQ:I:GAIN
[:SENSe]:CORRection:IQ:I:GAIN?
[:SENSe]:CORRection:IQ:I|Q:ATTenuation
[:SENSe]:CORRection:IQ:I|Q:ATTenuation?
[:SENSe]:CORRection:IQ:I|Q:ATTenuation:RATio
[:SENSe]:CORRection:IQ:I|Q:ATTenuation:RATio?
[:SENSe]:CORRection:IQ[:I]:SKEW
[:SENSe]:CORRection:IQ[:I]:SKEW?
[:SENSe]:CORRection:IQ:Q:GAIN
[:SENSe]:CORRection:IQ:Q:GAIN?
[:SENSe]:CORRection:IQ:Q:GAIN:COUPle
[:SENSe]:CORRection:IQ:Q:GAIN:COUPle?
[:SENSe]:CORRection:IQ:Q:SKEW
[:SENSe]:CORRection:IQ:Q:SKEW?
[:SENSe]:CORRection:MS[:RF]:GAIN
[:SENSe]:CORRection:MS[:RF]:GAIN?
[:SENSe]:CORRection:MS[:RF]:LOSS
[:SENSe]:CORRection:MS[:RF]:LOSS?
[:SENSe]:CORRection:NOISe:FLOor
[:SENSe]:CORRection:NOISe:FLOor?
[:SENSe]:CORRection:NOISe:FLOor:ADAPtive
[:SENSe]:CORRection:NOISe:FLOor:ADAPtive?
[:SENSe]:CORRection:OFFSet[:MAGNitude]
[:SENSe]:CORRection:SA[:RF]:GAIN
[:SENSe]:CORRection:SA[:RF]:GAIN?
[:SENSe]:DEMod
[:SENSe]:DEMod?
[:SENSe]:DEMod:AM:BANDwidth:CHANnel
[:SENSe]:DEMod:AM:BANDwidth:CHANnel?
[:SENSe]:DEMod:FM:BANDwidth:CHANnel
[:SENSe]:DEMod:FM:BANDwidth:CHANnel?

```

```
[ :SENSe ]:DEMod:FM:DEEMphasis  
[ :SENSe ]:DEMod:FM:DEEMphasis?  
[ :SENSe ]:DEMod:PM:BANDwidth:CHANnel  
[ :SENSe ]:DEMod:PM:BANDwidth:CHANnel?  
[ :SENSe ]:DEMod:STATe  
[ :SENSe ]:DEMod:STATe  
[ :SENSe ]:DEMod:STATe  
[ :SENSe ]:DEMod:STATe?  
[ :SENSe ]:DEMod:TIME  
[ :SENSe ]:DEMod:TIME?  
[ :SENSe ]:DETEctor:AUTO  
[ :SENSe ]:DETEctor:AUTO?  
[ :SENSe ]:DETEctor[:FUNction]  
[ :SENSe ]:DETEctor[:FUNction]?  
[ :SENSe ]:DETEctor:TRACe[1]  
[ :SENSe ]:DETEctor:TRACe[1]|2|...|6?  
[ :SENSe ]:DETEctor:TRACe[1]|2|...|6:AUTO  
[ :SENSe ]:DETEctor:TRACe[1]|2|...|6:AUTO?  
[ :SENSe ]:EBwidth:AVERage:COUNT  
[ :SENSe ]:EBwidth:FREQuency:SPAN  
[ :SENSe ]:EBwidth:MAXHold  
[ :SENSe ]:EBwidth:XDB  
[ :SENSe ]:EMC:STANdard[:SElect]  
[ :SENSe ]:EMC:STANdard[:SElect]?  
[ :SENSe ]:EMI:MEASure:DETEctor:AVERage[:STATe]  
[ :SENSe ]:EMI:MEASure:DETEctor:DWELl  
[ :SENSe ]:EMI:MEASure:DETEctor:QPEak[:STATe]  
[ :SENSe ]:EMI:MEASure:PCENter[:STATe]  
[ :SENSe ]:EMI:MEASure:PCENter[:STATe]?  
[ :SENSe ]:FEED  
[ :SENSe ]:FEED  
[ :SENSe ]:FEED  
[ :SENSe ]:FEED?  
[ :SENSe ]:FEED?  
[ :SENSe ]:FEED:AREFERENCE  
[ :SENSe ]:FEED:AREFERENCE?  
[ :SENSe ]:FEED:IQ:TYPE  
[ :SENSe ]:FEED:IQ:TYPE?  
[ :SENSe ]:FEED:RF:PORT[:INPut]  
[ :SENSe ]:FEED:RF:PORT[:INPut]?  
[ :SENSe ]:FREQuency:CENTer  
[ :SENSe ]:FREQuency:CENTer?  
[ :SENSe ]:FREQuency:CENTer:STEP:AUTO  
[ :SENSe ]:FREQuency:CENTer:STEP:AUTO?  
[ :SENSe ]:FREQuency:CENTer:STEP[:INCRement]  
[ :SENSe ]:FREQuency:CENTer:STEP[:INCRement]?  
[ :SENSe ]:FREQuency:CISPr:BAND  
[ :SENSe ]:FREQuency:EMIXer:CENTer  
[ :SENSe ]:FREQuency:EMIXer:CENTer?  
[ :SENSe ]:FREQuency:IQ:CENTer  
[ :SENSe ]:FREQuency:IQ:CENTer?  
[ :SENSe ]:FREQuency:OFFSet  
[ :SENSe ]:FREQuency:OFFSet?
```

```

[:SENSe]:FREQuency:RF:CENTer
[:SENSe]:FREQuency:RF:CENTer?
[:SENSe]:FREQuency:SPAN
[:SENSe]:FREQuency:SPAN?
[:SENSe]:FREQuency:SPAN:BANDwidth[:RESolution]:RATio
[:SENSe]:FREQuency:SPAN:BANDwidth[:RESolution]:RATio?
[:SENSe]:FREQuency:SPAN:BANDwidth[:RESolution]:RATio:AUTO
[:SENSe]:FREQuency:SPAN:BANDwidth[:RESolution]:RATio:AUTO?
[:SENSe]:FREQuency:SPAN:FULL
[:SENSe]:FREQuency:SPAN:PREVIOUS
[:SENSe]:FREQuency:START
[:SENSe]:FREQuency:START?
[:SENSe]:FREQuency:STOP
[:SENSe]:FREQuency:STOP?
[:SENSe]:FREQuency:SYNThesis:AUTO[:STATe]
[:SENSe]:FREQuency:SYNThesis:AUTO[:STATe]?
[:SENSe]:FREQuency:SYNThesis[:STATe]
[:SENSe]:FREQuency:SYNThesis[:STATe]?
[:SENSe]:FREQuency:TUNE:IMMEDIATE
[:SENSe]:FREQuency:TZOom
[:SENSe]:FREQuency:TZOom:CENTer
[:SENSe]:FREQuency:TZOom:TIME:CENTer
[:SENSe]:FREQuency:TZOom:TIME:CENTer?
[:SENSe]:FREQuency:ZSPAN:CENTer
[:SENSe]:FREQuency:ZSPAN:CENTer?
[:SENSe]:HARMonics:AVERAge:COUNT
[:SENSe]:HARMonics:AVERAge:COUNT?
[:SENSe]:HARMonics:AVERAge[:STATe]
[:SENSe]:HARMonics:AVERAge[:STATe]?
[:SENSe]:HARMonics:AVERAge:TCONTRol
[:SENSe]:HARMonics:AVERAge:TCONTRol?
[:SENSe]:HARMonics:BANDwidth|BWIDth[:RESolution]
[:SENSe]:HARMonics:BANDwidth|BWIDth[:RESolution]?
[:SENSe]:HARMonics:BANDwidth|BWIDth[:RESolution]:AUTO
[:SENSe]:HARMonics:BANDwidth|BWIDth[:RESolution]:AUTO?
[:SENSe]:HARMonics:FREQuency:FUNDamental
[:SENSe]:HARMonics:FREQuency:FUNDamental?
[:SENSe]:HARMonics:FREQuency:FUNDamental:AUTO
[:SENSe]:HARMonics:FREQuency:FUNDamental:AUTO?
[:SENSe]:HARMonics:FREQuency:STEP[:INCRement]
[:SENSe]:HARMonics:FREQuency:STEP[:INCRement]?
[:SENSe]:HARMonics:NUMBer
[:SENSe]:HARMonics:NUMBer?
[:SENSe]:HARMonics:RANGe[:LIST]:FREQuency
[:SENSe]:HARMonics:RANGe[:LIST]:FREQuency?
[:SENSe]:HARMonics:RANGe[:LIST]:STATe
[:SENSe]:HARMonics:RANGe[:LIST]:STATe
[:SENSe]:HARMonics:RANGe[:LIST]:SWEeptime
[:SENSe]:HARMonics:RANGe[:LIST]:SWEeptime?
[:SENSe]:HARMonics:RANGe[:LIST]:SWEeptime:AUTO
[:SENSe]:HARMonics:RANGe[:LIST]:SWEeptime:AUTO?
[:SENSe]:HARMonics:RTABLE:FILL
[:SENSe]:HARMonics:SWEeptime

```

```

[:SENSe]:HARMonics:SWEeptime?
[:SENSe]:HARMonics:SWEeptime:AUTO
[:SENSe]:HARMonics:SWEeptime:AUTO?
[:SENSe]:HARMonics:TONE[1]|2|...|10:BANDwidth|BWIDth[:RESolution]
[:SENSe]:HARMonics:TONE[1]|2|...|10:BANDwidth|BWIDth[:RESolution]?
[:SENSe]:HARMonics:TONE[1]|2|...|10:BANDwidth|BWIDth
[:RESolution]:AUTO
[:SENSe]:HARMonics:TONE[1]|2|...|10:BANDwidth|BWIDth
[:RESolution]:AUTO?
[:SENSe]:HARMonics:TONE[1]|2|...|10:FREQuency
[:SENSe]:HARMonics:TONE[1]|2|...|10:FREQuency?
[:SENSe]:HARMonics:TONE[1]|2|...|10:STATE
[:SENSe]:HARMonics:TONE[1]|2|...|10:STATE
[:SENSe]:HARMonics:TONE[1]|2|...|10:SWEEp:TIME
[:SENSe]:HARMonics:TONE[1]|2|...|10:SWEEp:TIME?
[:SENSe]:HARMonics:TONE[1]|2|...|10:SWEEp:TIME:AUTO
[:SENSe]:HARMonics:TONE[1]|2|...|10:SWEEp:TIME:AUTO?
[:SENSe]:HARMonics:TRACe:TYPE
[:SENSe]:IF:EDRange
[:SENSe]:IF:EDRange?
[:SENSe]:IF:GAIN:FFT:AUTO[:STATE]
[:SENSe]:IF:GAIN:FFT:AUTO[:STATE]?
[:SENSe]:IF:GAIN:FFT[:STATE]
[:SENSe]:IF:GAIN:FFT[:STATE]?
[:SENSe]:IF:GAIN:SWEPT:AUTO[:STATE]
[:SENSe]:IF:GAIN:SWEPT:AUTO[:STATE]?
[:SENSe]:IF:GAIN:SWEPT[:STATE]
[:SENSe]:IF:GAIN:SWEPT[:STATE]?
[:SENSe]:LIST:ATTenuation
[:SENSe]:LIST:ATTenuation?
[:SENSe]:LIST:ATTenuation:POINTs?
[:SENSe]:LIST:BANDwidth|BWIDth:RESolution
[:SENSe]:LIST:BANDwidthBWIDth:RESolution?
[:SENSe]:LIST:BANDwidthBWIDth:RESolution:POINTs?
[:SENSe]:LIST:BANDwidth|BWIDth:RESolution:TYPE
[:SENSe]:LIST:BANDwidth|BWIDth:RESolution:TYPE?
[:SENSe]:LIST:BANDwidth|BWIDth:RESolution:TYPE:POINTs?
[:SENSe]:LIST:BANDwidth|BWIDth:VIDeo
[:SENSe]:LIST:BANDwidth|BWIDth:VIDeo?
[:SENSe]:LIST:BANDwidth|BWIDth:VIDeo:POINTs?
[:SENSe]:LIST:DETector
[:SENSe]:LIST:DETector?
[:SENSe]:LIST:DETector:POINTs?
[:SENSe]:LIST:EATTenuation
[:SENSe]:LIST:EATTenuation?
[:SENSe]:LIST:EATTenuation:POINTs?
[:SENSe]:LIST:FREQuency
[:SENSe]:LIST:FREQuency?
[:SENSe]:LIST:FREQuency:POINTs?
[:SENSe]:LIST:FREQuency:SYNThesis
[:SENSe]:LIST:FREQuency:SYNThesis?
[:SENSe]:LIST:FREQuency:SYNThesis:AUTO
[:SENSe]:LIST:FREQuency:SYNThesis:AUTO?

```



```

[:SENSe]:LIST:SEQuence
[:SENSe]:LIST:SEQuence?
[:SENSe]:LIST:SEQuence:AUTO
[:SENSe]:LIST:SEQuence:AUTO?
[:SENSe]:LIST:SEQuence:POINts?
[:SENSe]:LIST:SWEp:TIME
[:SENSe]:LIST:SWEp:TIME?
[:SENSe]:LIST:SWEp:TIME:POINts?
[:SENSe]:LIST:TRIGger:DELAy
[:SENSe]:LIST:TRIGger:DELAy?
[:SENSe]:LIST:TRIGger:DELAy:POINts?
[:SENSe]:LIST:TRIGger:HOLDoff
[:SENSe]:LIST:TRIGger:HOLDoff?
[:SENSe]:LIST:TRIGger:HOLDoff:POINts?
[:SENSe]:LIST:TRIGger:LEVel
[:SENSe]:LIST:TRIGger:LEVel?
[:SENSe]:LIST:TRIGger:LEVel:POINts?
[:SENSe]:LIST:TRIGger:SLOPe
[:SENSe]:LIST:TRIGger:SLOPe?
[:SENSe]:LIST:TRIGger:SLOPe:POINts?
[:SENSe]:LIST:TRIGger:SOURce
[:SENSe]:LIST:TRIGger:SOURce?
[:SENSe]:LIST:TRIGger:SOURce:POINts?
[:SENSe]:MCPower:AVERage:COUNT
[:SENSe]:MCPower:CARRier[1]|2:LIST:BANDwidth[:INTEgration]
[:SENSe]:MCPower:CARRier[1]|2:LIST:BWIDth[:INTEgration]
[:SENSe]:MCPower:CARRier[1]|2:LIST:PPResent
[:SENSe]:MCPower:CARRier[1]|2:LIST:WIDTh
[:SENSe]:MCPower:FILTer[:RRC]:ALPHA
[:SENSe]:MCPower:FILTer[:RRC][:STATE]
[:SENSe]:MCPower:LIMit[:STATE]
[:SENSe]:MCPower:METHod
[:SENSe]:MCPower:OFFSet[1]|2:LIST:ABSolute
[:SENSe]:MCPower:OFFSet[1]|2:LIST:BANDwidth[:INTEgration]
[:SENSe]:MCPower:OFFSet[1]|2:LIST:BWIDth[:INTEgration]
[:SENSe]:MCPower:OFFSet[1]|2:LIST[:FREQuency]
[:SENSe]:MCPower:OFFSet[1]|2:LIST:RCARRier
[:SENSe]:MCPower:OFFSet[1]|2:LIST:TEST
[:SENSe]:MCPower:RCARRier[1]|2
[:SENSe]:MIXer:BAND
[:SENSe]:MIXer:BAND?
[:SENSe]:MIXer:BIAS
[:SENSe]:MIXer:BIAS?
[:SENSe]:MIXer:BIAS:STATE
[:SENSe]:MIXer:BIAS:STATE?
[:SENSe]:MIXer:CIFLoss
[:SENSe]:MIXer:CIFLoss?
[:SENSe]:MIXer:HARMonic
[:SENSe]:MIXer:HARMonic?
[:SENSe]:MIXer:LODoubler
[:SENSe]:MIXer:LODoubler?
[:SENSe]:MIXer:MPATH
[:SENSe]:MIXer:MPATH?

```

```
[ :SENSe ]:MIXer:TTYPe
[ :SENSe ]:MIXer:TTYPe?
[ :SENSe ]:MIXer:UIFFfreq
[ :SENSe ]:MIXer:UIFFreq?
[ :SENSe ]:OBwidth:AVERAge:COUNT
[ :SENSe ]:OBwidth:AVERAge:COUNT?
[ :SENSe ]:OBwidth:AVERAge[ :STATe ]
[ :SENSe ]:OBwidth:AVERAge[ :STATe ]?
[ :SENSe ]:OBwidth:AVERAge:TCONTRol
[ :SENSe ]:OBwidth:AVERAge:TCONTRol?
[ :SENSe ]:OBwidth:BANDwidth[ :RESolution ]
[ :SENSe ]:OBwidth:BANDwidth[ :RESolution ]?
[ :SENSe ]:OBwidth:BANDwidth[ :RESolution]:AUTO
[ :SENSe ]:OBwidth:BANDwidth[ :RESolution]:AUTO?
[ :SENSe ]:OBwidth:BANDwidth:SHAPE
[ :SENSe ]:OBwidth:BANDwidth:SHAPE?
[ :SENSe ]:OBwidth:BANDwidth:VIDeo
[ :SENSe ]:OBwidth:BANDwidth:VIDeo?
[ :SENSe ]:OBwidth:BANDwidth:VIDeo:AUTO
[ :SENSe ]:OBwidth:BANDwidth:VIDeo:AUTO?
[ :SENSe ]:OBwidth:BWIDth[ :RESolution ]
[ :SENSe ]:OBwidth:BWIDth:SHAPE
[ :SENSe ]:OBwidth:BWIDth:VIDeo
[ :SENSe ]:OBwidth:DETEctor:AUTO
[ :SENSe ]:OBwidth:DETEctor:AUTO?
[ :SENSe ]:OBwidth:DETEctor[ :FUNCTion ]
[ :SENSe ]:OBwidth:DETEctor[ :FUNCTion ]?
[ :SENSe ]:OBwidth:FREQuency:SPAN
[ :SENSe ]:OBwidth:FREQuency:SPAN?
[ :SENSe ]:OBwidth:FREQuency:SPAN:AUTO
[ :SENSe ]:OBwidth:FREQuency:SPAN:AUTO?
[ :SENSe ]:OBwidth:FREQuency:SPAN:FULL
[ :SENSe ]:OBwidth:FREQuency:SPAN:PREVious
[ :SENSe ]:OBwidth:IF:GAIN:AUTO[ :STATe ]
[ :SENSe ]:OBwidth:IF:GAIN:AUTO[ :STATe ]?
[ :SENSe ]:OBwidth:IF:GAIN[ :STATe ]
[ :SENSe ]:OBwidth:IF:GAIN[ :STATe ]?
[ :SENSe ]:OBwidth:MAXHold
[ :SENSe ]:OBwidth:MAXHold?
[ :SENSe ]:OBwidth:PERCent
[ :SENSe ]:OBwidth:PERCent?
[ :SENSe ]:OBwidth:SWEp:POINts
[ :SENSe ]:OBwidth:SWEp:POINts?
[ :SENSe ]:OBwidth:SWEp:TIME
[ :SENSe ]:OBwidth:SWEp:TIME?
[ :SENSe ]:OBwidth:SWEp:TIME:AUTO
[ :SENSe ]:OBwidth:SWEp:TIME:AUTO?
[ :SENSe ]:OBwidth:XDB
[ :SENSe ]:OBwidth:XDB?
[ :SENSe ]:POWer:IQ[ :I ]:RANGe[ :UPPer ]
[ :SENSe ]:POWer:IQ[ :I ]:RANGe[ :UPPer ]?
[ :SENSe ]:POWer:IQ:Q:RANGe[ :UPPer ]
[ :SENSe ]:POWer:IQ:Q:RANGe[ :UPPer ]?
```

```

[:SENSe]:POWer:IQ:RANGe:AUTO
[:SENSe]:POWer:IQ:RANGe:AUTO?
[:SENSe]:POWer[:RF]:ATTenuation
[:SENSe]:POWer[:RF]:ATTenuation?
[:SENSe]:POWer[:RF]:ATTenuation:AUTO
[:SENSe]:POWer[:RF]:ATTenuation:AUTO?
[:SENSe]:POWer[:RF]:ATTenuation:STEP[:INCRement]
[:SENSe]:POWer[:RF]:ATTenuation:STEP[:INCRement]?
[:SENSe]:POWer[:RF]:EATTenuation
[:SENSe]:POWer[:RF]:EATTenuation?
[:SENSe]:POWer[:RF]:EATTenuation:STATe
[:SENSe]:POWer[:RF]:EATTenuation:STATe?
[:SENSe]:POWer[:RF]:GAIN:BAND
[:SENSe]:POWer[:RF]:GAIN:BAND?
[:SENSe]:POWer[:RF]:GAIN[:STATe]
[:SENSe]:POWer[:RF]:GAIN[:STATe]?
[:SENSe]:POWer[:RF]:MIXer:RANGe[:UPPer]
[:SENSe]:POWer[:RF]:MIXer:RANGe[:UPPer]?
[:SENSe]:POWer[:RF]:MIXer:RULEs
[:SENSe]:POWer[:RF]:MIXer:RULEs?
[:SENSe]:POWer[:RF]:MMW:PADJust
[:SENSe]:POWer[:RF]:Mw:PADJust
[:SENSe]:POWer[:RF]:Mw:PATH
[:SENSe]:POWer[:RF]:Mw:PATH?
[:SENSe]:POWer[:RF]:Mw:PRESelector[:STATe]
[:SENSe]:POWer[:RF]:Mw:PRESelector[:STATe]?
[:SENSe]:POWer[:RF]:PADJust
[:SENSe]:POWer[:RF]:PADJust?
[:SENSe]:POWer[:RF]:PADJust:PRESelector
[:SENSe]:POWer[:RF]:PADJust:PRESelector?
[:SENSe]:POWer[:RF]:PCENter
[:SENSe]:POWer[:RF]:RANGe:AUTO
[:SENSe]:POWer[:RF]:RANGe:AUTO?
[:SENSe]:POWer[:RF]:RANGe:OPTimize
[:SENSe]:POWer[:RF]:RANGe:OPTimize:ATTenuation
[:SENSe]:POWer[:RF]:RANGe:OPTimize:ATTenuation?
[:SENSe]:POWer[:RF]:RFPSelector[:STATe]
[:SENSe]:POWer[:RF]:RFPSelector[:STATe]?
[:SENSe]:PStatistic:BANDwidth
[:SENSe]:PStatistic:BANDwidth?
[:SENSe]:PStatistic:BWIDth
[:SENSe]:PStatistic:COUNTs
[:SENSe]:PStatistic:COUNTs?
[:SENSe]:PStatistic:GAUSSian[:STATe]
[:SENSe]:PStatistic:IF:GAIN:AUTO[:STATe]
[:SENSe]:PStatistic:IF:GAIN:AUTO[:STATe]?
[:SENSe]:PStatistic:IF:GAIN[:STATe]
[:SENSe]:PStatistic:IF:GAIN[:STATe]?
[:SENSe]:PStatistic:RTRace[:STATe]
[:SENSe]:PStatistic:SRTRace
[:SENSe]:PStatistic:SWEp:CYCLes
[:SENSe]:PStatistic:SWEp:CYCLes?
[:SENSe]:PStatistic:SWEp:TIME

```

```

[:SENSe]:PStAtistic:SWEEp:TIME?
[:SENSe]:RADio:STANdard:BAND:CLASs
[:SENSe]:RADio:STANdard:BAND:CLASs?
[:SENSe]:RADio:STANdard:DEvIce
[:SENSe]:RADio:STANdard:DEvIce?
[:SENSe]:RADio:STANdard:EAMeas
[:SENSe]:RADio:STANdard:EAMeas?
[:SENSe]:RADio:STANdard:PACKet
[:SENSe]:RADio:STANdard:PACKet?
[:SENSe]:RADio:STANdard[:SELEct]
[:SENSe]:RADio:STANdard[:SELEct]?
[:SENSe]:ROSCillator:BANDwidth
[:SENSe]:ROSCillator:BANDwidth?
[:SENSe]:ROSCillator:COUPling
[:SENSe]:ROSCillator:COUPling?
[:SENSe]:ROSCillator:EXTernal:FREQuency
[:SENSe]:ROSCillator:EXTernal:FREQuency?
[:SENSe]:ROSCillator:EXTernal:FREQuency:DEFault
[:SENSe]:ROSCillator:SOURce
[:SENSe]:ROSCillator:SOURce?
[:SENSe]:ROSCillator:SOURce:TYPE
[:SENSe]:ROSCillator:SOURce:TYPE?
[:SENSe]:SEMask:AVERAge:COUNT
[:SENSe]:SEMask:AVERAge:COUNT?
[:SENSe]:SEMask:AVERAge:OFFSet:TYPE
[:SENSe]:SEMask:AVERAge[:STATe]
[:SENSe]:SEMask:AVERAge[:STATe]?
[:SENSe]:SEMask:BANDwidth[1]|2:INTegration
[:SENSe]:SEMask:BANDwidth[1]|2:INTegration?
[:SENSe]:SEMask:BANDwidth[1]|2[:RESolution]
[:SENSe]:SEMask:BANDwidth[1]|2[:RESolution]?
[:SENSe]:SEMask:BANDwidth[1]|2[:RESolution]:AUTO
[:SENSe]:SEMask:BANDwidth[1]|2[:RESolution]:AUTO?
[:SENSe]:SEMask:BANDwidth:SHAPE
[:SENSe]:SEMask:BANDwidth:SHAPE?
[:SENSe]:SEMask:BANDwidth[1]|2:VIDeo
[:SENSe]:SEMask:BANDwidth[1]|2:VIDeo?
[:SENSe]:SEMask:BANDwidth[1]|2:VIDeo:AUTO
[:SENSe]:SEMask:BANDwidth[1]|2:VIDeo:AUTO?
[:SENSe]:SEMask:BANDwidth[1]|2:VIDeo:RATio
[:SENSe]:SEMask:BANDwidth[1]|2:VIDeo:RATio
[:SENSe]:SEMask:BANDwidth[1]|2:VIDeo:RATio:AUTO
[:SENSe]:SEMask:BANDwidth[1]|2:VIDeo:RATio:AUTO?
[:SENSe]:SEMask:BwIDth[1]|2[:RESolution]
[:SENSe]:SEMask:BwIDth[1]|2:VIDeo
[:SENSe]:SEMask:BwIDth[1]|2:VIDeo:RATio
[:SENSe]:SEMask:CARRier:AUTO[:STATe]
[:SENSe]:SEMask:CARRier:AUTO[:STATe]?
[:SENSe]:SEMask:CARRier:CPSD
[:SENSe]:SEMask:CARRier:CPSD?
[:SENSe]:SEMask:CARRier:PEAK[:POWer]
[:SENSe]:SEMask:CARRier:PEAK[:POWer]?
[:SENSe]:SEMask:CARRier[:POWer]

```

```

[:SENSe]:SEMask:CARRier[:POWer]?
[:SENSe]:SEMask:DETEctor:CARRier:AUTO
[:SENSe]:SEMask:DETEctor:CARRier:AUTO?
[:SENSe]:SEMask:DETEctor:CARRier[:FUNction]
[:SENSe]:SEMask:DETEctor:CARRier[:FUNction]?
[:SENSe]:SEMask:DETEctor:OFFSet:AUTO
[:SENSe]:SEMask:DETEctor:OFFSet:AUTO?
[:SENSe]:SEMask:DETEctor:OFFSet[:FUNction]
[:SENSe]:SEMask:DETEctor:OFFSet[:FUNction]?
[:SENSe]:SEMask:FILTer[:RRC]:ALPHa
[:SENSe]:SEMask:FILTer[:RRC]:ALPHa?
[:SENSe]:SEMask:FILTer[:RRC][:STATe]
[:SENSe]:SEMask:FILTer[:RRC][:STATe]?
[:SENSe]:SEMask:FREQuency[1]|2:SPAN
[:SENSe]:SEMask:FREQuency[1]|2:SPAN?
[:SENSe]:SEMask:FREQuency[1]|2:SPAN:AUTO
[:SENSe]:SEMask:FREQuency[1]|2:SPAN:AUTO?
[:SENSe]:SEMask:OFFSet[1]|2:LIST:BWIDth:IMULti
[:SENSe]:SEMask:OFFSet[1]|2:LIST:BWIDth[:RESolution]
[:SENSe]:SEMask:OFFSet[1]|2:LIST:BWIDth:VIDeo
[:SENSe]:SEMask:OFFSet[1]|2:LIST:SWEEp[:TIME]
[:SENSe]:SEMask:OFFSet[1]|2[:OUTer]:LIST:BANDwidth:IMULti
[:SENSe]:SEMask:OFFSet[1]|2[:OUTer]:LIST:BANDwidth:IMULti?
[:SENSe]:SEMask:OFFSet[1]|2[:OUTer]:LIST:BANDwidth[:RESolution]
[:SENSe]:SEMask:OFFSet[1]|2[:OUTer]:LIST:BANDwidth[:RESolution]?
[:SENSe]:SEMask:OFFSet[1]|2[:OUTer]:LIST:BANDwidth
[:RESolution]:AUTO
[:SENSe]:SEMask:OFFSet[1]|2[:OUTer]:LIST:BANDwidth
[:RESolution]:AUTO?
[:SENSe]:SEMask:OFFSet[1]|2[:OUTer]:LIST:BANDwidth:VIDeo
[:SENSe]:SEMask:OFFSet[1]|2[:OUTer]:LIST:BANDwidth:VIDeo?
[:SENSe]:SEMask:OFFSet[1]|2[:OUTer]:LIST:BANDwidth:VIDeo:AUTO
[:SENSe]:SEMask:OFFSet[1]|2[:OUTer]:LIST:BANDwidth:VIDeo:AUTO?
[:SENSe]:SEMask:OFFSet[1]|2[:OUTer]:LIST:BANDwidth:VIDeo:RATio
[:SENSe]:SEMask:OFFSet[1]|2[:OUTer]:LIST:BANDwidth:VIDeo:RATio?
[:SENSe]:SEMask:OFFSet[1]|2
[:OUTer]:LIST:BANDwidth:VIDeo:RATio:AUTO
[:SENSe]:SEMask:OFFSet[1]|2
[:OUTer]:LIST:BANDwidth:VIDeo:RATio:AUTO?
[:SENSe]:SEMask:OFFSet[1]|2[:OUTer]:LIST:FREQuency:START
[:SENSe]:SEMask:OFFSet[1]|2[:OUTer]:LIST:FREQuency:START?
[:SENSe]:SEMask:OFFSet[1]|2[:OUTer]:LIST:FREQuency:STOP
[:SENSe]:SEMask:OFFSet[1]|2[:OUTer]:LIST:FREQuency:STOP?
[:SENSe]:SEMask:OFFSet[1]|2[:OUTer]:LIST:SIDE
[:SENSe]:SEMask:OFFSet[1]|2[:OUTer]:LIST:SIDE?
[:SENSe]:SEMask:OFFSet[1]|2[:OUTer]:LIST:START:ABSolute
[:SENSe]:SEMask:OFFSet[1]|2[:OUTer]:LIST:START:ABSolute?
[:SENSe]:SEMask:OFFSet[1]|2[:OUTer]:LIST:START:RCARRier
[:SENSe]:SEMask:OFFSet[1]|2[:OUTer]:LIST:START:RCARRier?
[:SENSe]:SEMask:OFFSet[1]|2[:OUTer]:LIST:STATe
[:SENSe]:SEMask:OFFSet[1]|2[:OUTer]:LIST:STATe?
[:SENSe]:SEMask:OFFSet[1]|2[:OUTer]:LIST:STOP:ABSolute

```

```

[:SENSe]:SEMask:OFFSet[1]|2[:OUTer]:LIST:STOP:ABSolute?
[:SENSe]:SEMask:OFFSet[1]|2[:OUTer]:LIST:STOP:ABSolute:COUPle
[:SENSe]:SEMask:OFFSet[1]|2[:OUTer]:LIST:STOP:ABSolute:COUPle?
[:SENSe]:SEMask:OFFSet[1]|2[:OUTer]:LIST:STOP:RCARrier
[:SENSe]:SEMask:OFFSet[1]|2[:OUTer]:LIST:STOP:RCARrier?
[:SENSe]:SEMask:OFFSet[1]|2[:OUTer]:LIST:STOP:RCARrier:COUPle
[:SENSe]:SEMask:OFFSet[1]|2[:OUTer]:LIST:STOP:RCARrier:COUPle?
[:SENSe]:SEMask:OFFSet[1]|2[:OUTer]:LIST:SWEep:TIME
[:SENSe]:SEMask:OFFSet[1]|2[:OUTer]:LIST:SWEep:TIME?
[:SENSe]:SEMask:OFFSet[1]|2[:OUTer]:LIST:SWEep:TIME:AUTO
[:SENSe]:SEMask:OFFSet[1]|2[:OUTer]:LIST:SWEep:TIME:AUTO?
[:SENSe]:SEMask:OFFSet[1]|2[:OUTer]:LIST:SWEep:TYPE
[:SENSe]:SEMask:OFFSet[1]|2[:OUTer]:LIST:SWEep:TYPE?
[:SENSe]:SEMask:OFFSet[1]|2[:OUTer]:LIST:SWEep:TYPE:AUTO
[:SENSe]:SEMask:OFFSet[1]|2[:OUTer]:LIST:SWEep:TYPE:AUTO?
[:SENSe]:SEMask:OFFSet[1]|2[:OUTer]:LIST:TEST
[:SENSe]:SEMask:OFFSet[1]|2[:OUTer]:LIST:TEST?
[:SENSe]:SEMask:OFFSet[1]|2:TYPE
[:SENSe]:SEMask:OFFSet[1]|2:TYPE?
[:SENSe]:SEMask:SWEep[1]|2:TIME
[:SENSe]:SEMask:SWEep[1]|2:TIME?
[:SENSe]:SEMask:SWEep[1]|2:TIME:AUTO
[:SENSe]:SEMask:SWEep[1]|2:TIME:AUTO?
[:SENSe]:SEMask:SWEep[1]|2:TYPE
[:SENSe]:SEMask:SWEep[1]|2:TYPE?
[:SENSe]:SEMask:SWEep[1]|2:TYPE:AUTO
[:SENSe]:SEMask:SWEep[1]|2:TYPE:AUTO?
[:SENSe]:SEMask:TYPE
[:SENSe]:SEMask:TYPE?
[:SENSe]:SIDentify:MODE
[:SENSe]:SIDentify:MODE?
[:SENSe]:SIDentify[:STATe]
[:SENSe]:SIDentify[:STATe]?
[:SENSe]:SPURious:AVERage:COUNT
[:SENSe]:SPURious:AVERage:COUNT?
[:SENSe]:SPURious:AVERage[:STATe]
[:SENSe]:SPURious:AVERage[:STATe]?
[:SENSe]:SPURious:AVERage:TCONtrol
[:SENSe]:SPURious:AVERage:TCONtrol?
[:SENSe]:SPURious:FSMeas
[:SENSe]:SPURious:FSMeas?
[:SENSe]:SPURious:IF:GAIN:AUTO[:STATe]
[:SENSe]:SPURious:IF:GAIN:AUTO[:STATe]?
[:SENSe]:SPURious:IF:GAIN[:STATe]
[:SENSe]:SPURious:IF:GAIN[:STATe]?
[:SENSe]:SPURious:POWer[:RF]:RANGe:AUTO
[:SENSe]:SPURious[:RANGe]:ALL:SWEep:TYPE:AUTO
[:SENSe]:SPURious[:RANGe]:ALL:SWEep:TYPE:AUTO?
[:SENSe]:SPURious[:RANGe][:LIST]:ATTenuation
[:SENSe]:SPURious[:RANGe][:LIST]:ATTenuation?
[:SENSe]:SPURious[:RANGe][:LIST]:ATTenuation:AUTO
[:SENSe]:SPURious[:RANGe][:LIST]:ATTenuation:AUTO?
[:SENSe]:SPURious[:RANGe][:LIST]:BANDwidth[:RESolution]

```

```

[:SENSe]:SPURious[:RANGe][:LIST]:BANDwidth[:RESolution]?
[:SENSe]:SPURious[:RANGe][:LIST]:BANDwidth[:RESolution]:AUTO
[:SENSe]:SPURious[:RANGe][:LIST]:BANDwidth[:RESolution]:AUTO?
[:SENSe]:SPURious[:RANGe][:LIST]:BANDwidth:SHAPE
[:SENSe]:SPURious[:RANGe][:LIST]:BANDwidth:SHAPE?
[:SENSe]:SPURious[:RANGe][:LIST]:BANDwidth:VIDeo
[:SENSe]:SPURious[:RANGe][:LIST]:BANDwidth:VIDeo?
[:SENSe]:SPURious[:RANGe][:LIST]:BANDwidth:VIDeo:AUTO
[:SENSe]:SPURious[:RANGe][:LIST]:BANDwidth:VIDeo:AUTO?
[:SENSe]:SPURious[:RANGe][:LIST]:BWIDth[:RESolution]
[:SENSe]:SPURious[:RANGe][:LIST]:BWIDth:SHAPE
[:SENSe]:SPURious[:RANGe][:LIST]:BWIDth:VIDeo
[:SENSe]:SPURious[:RANGe][:LIST]:DETEctor2[:FUNction]
[:SENSe]:SPURious[:RANGe][:LIST]:DETEctor[1][:FUNction]
[:SENSe]:SPURious[:RANGe][:LIST]:DETEctor[1][:FUNction]?
[:SENSe]:SPURious[:RANGe][:LIST]:DETEctor2[:FUNction]?
[:SENSe]:SPURious[:RANGe][:LIST]:FREquency:START
[:SENSe]:SPURious[:RANGe][:LIST]:FREquency:START?
[:SENSe]:SPURious[:RANGe][:LIST]:FREquency:STOP
[:SENSe]:SPURious[:RANGe][:LIST]:FREquency:STOP?
[:SENSe]:SPURious[:RANGe][:LIST]:PEAK:EXCURsion
[:SENSe]:SPURious[:RANGe][:LIST]:PEAK:EXCURsion?
[:SENSe]:SPURious[:RANGe][:LIST]:PEAK:THREshold
[:SENSe]:SPURious[:RANGe][:LIST]:PEAK:THREshold?
[:SENSe]:SPURious[:RANGe][:LIST]:STATE
[:SENSe]:SPURious[:RANGe][:LIST]:STATE?
[:SENSe]:SPURious[:RANGe][:LIST]:SWEep:POINts
[:SENSe]:SPURious[:RANGe][:LIST]:SWEep:POINts?
[:SENSe]:SPURious[:RANGe][:LIST]:SWEep:POINts:AUTO
[:SENSe]:SPURious[:RANGe][:LIST]:SWEep:POINts:AUTO?
[:SENSe]:SPURious[:RANGe][:LIST]:SWEep:TIME
[:SENSe]:SPURious[:RANGe][:LIST]:SWEep:TIME?
[:SENSe]:SPURious[:RANGe][:LIST]:SWEep:TIME:AUTO
[:SENSe]:SPURious[:RANGe][:LIST]:SWEep:TIME:AUTO?
[:SENSe]:SPURious:REPT:MODE
[:SENSe]:SPURious:REPT:MODE?
[:SENSe]:SPURious:SPUR
[:SENSe]:SPURious:SPUR?
[:SENSe]:SPURious:SWEep:TIME:AUTO:RULEs
[:SENSe]:SPURious:SWEep:TIME:AUTO:RULEs?
[:SENSe]:SPURious:TYPE
[:SENSe]:SPURious:TYPE?
[:SENSe]:SWEep:EGATE:CONTRol
[:SENSe]:SWEep:EGATE:CONTRol?
[:SENSe]:SWEep:EGATE:DELay
[:SENSe]:SWEep:EGATE:DELay?
[:SENSe]:SWEep:EGATE:DELay:COMPensation:TYPE
[:SENSe]:SWEep:EGATE:DELay:COMPensation:TYPE?
[:SENSe]:SWEep:EGATE:EXTernal[1]|2:LEVel
[:SENSe]:SWEep:EGATE:EXTernal[1]|2:LEVel?
[:SENSe]:SWEep:EGATE:HOLDoff
[:SENSe]:SWEep:EGATE:HOLDoff?
[:SENSe]:SWEep:EGATE:HOLDoff:AUTO

```

```
[ :SENSe ] :SWEep:EGATe:HOLDoff:AUTO?  
[ :SENSe ] :SWEep:EGATe:LENGth  
[ :SENSe ] :SWEep:EGATe:LENGth?  
[ :SENSe ] :SWEep:EGATe:METhod  
[ :SENSe ] :SWEep:EGATe:METhod?  
[ :SENSe ] :SWEep:EGATe:MINFast?  
[ :SENSe ] :SWEep:EGATe:POLarity  
[ :SENSe ] :SWEep:EGATe:POLarity?  
[ :SENSe ] :SWEep:EGATe:SOURce  
[ :SENSe ] :SWEep:EGATe:SOURce?  
[ :SENSe ] :SWEep:EGATe[ :STATe ]  
[ :SENSe ] :SWEep:EGATe[ :STATe ]?  
[ :SENSe ] :SWEep:EGATe:TIME  
[ :SENSe ] :SWEep:EGATe:TIME?  
[ :SENSe ] :SWEep:EGATe:VIEW  
[ :SENSe ] :SWEep:EGATe:VIEW?  
[ :SENSe ] :SWEep:EGATe:VIEW:START  
[ :SENSe ] :SWEep:EGATe:VIEW:START?  
[ :SENSe ] :SWEep:FFT:SPAN:RATio  
[ :SENSe ] :SWEep:FFT:SPAN:RATio?  
[ :SENSe ] :SWEep:FFT:WIDTh  
[ :SENSe ] :SWEep:FFT:WIDTh?  
[ :SENSe ] :SWEep:FFT:WIDTh:AUTO  
[ :SENSe ] :SWEep:FFT:WIDTh:AUTO?  
[ :SENSe ] :SWEep:POINts  
[ :SENSe ] :SWEep:POINts?  
[ :SENSe ] :SWEep:SPACing  
[ :SENSe ] :SWEep:TIME  
[ :SENSe ] :SWEep:TIME?  
[ :SENSe ] :SWEep:TIME:AUTO  
[ :SENSe ] :SWEep:TIME:AUTO?  
[ :SENSe ] :SWEep:TIME:AUTO:RULEs  
[ :SENSe ] :SWEep:TIME:AUTO:RULEs?  
[ :SENSe ] :SWEep:TIME:AUTO:RULEs:AUTO[ :STATe ]  
[ :SENSe ] :SWEep:TIME:AUTO:RULEs:AUTO[ :STATe ]?  
[ :SENSe ] :SWEep:TIME:GATE:LEVe1  
[ :SENSe ] :SWEep:TIME:GATE:LEVe1?  
[ :SENSe ] :SWEep:TYPE  
[ :SENSe ] :SWEep:TYPE  
[ :SENSe ] :SWEep:TYPE  
[ :SENSe ] :SWEep:TYPE?  
[ :SENSe ] :SWEep:TYPE:AUTO  
[ :SENSe ] :SWEep:TYPE:AUTO?  
[ :SENSe ] :SWEep:TYPE:AUTO:RULEs  
[ :SENSe ] :SWEep:TYPE:AUTO:RULEs?  
[ :SENSe ] :SWEep:TYPE:AUTO:RULEs:AUTO[ :STATe ]  
[ :SENSe ] :SWEep:TYPE:AUTO:RULEs:AUTO[ :STATe ]?  
[ :SENSe ] :SWEep:TZOom:POINts  
[ :SENSe ] :SWEep:TZOom:POINts?  
[ :SENSe ] :SWEep:TZOom:TIME  
[ :SENSe ] :SWEep:TZO:TIME?  
[ :SENSe ] :TOI:AVERage:COUNT  
[ :SENSe ] :TOI:AVERage:COUNT?
```



```

[:SENSe]:TOI:AVERAge[:STATe]
[:SENSe]:TOI:AVERAge[:STATe]?
[:SENSe]:TOI:AVERAge:TCONtrol
[:SENSe]:TOI:AVERAge:TCONtrol?
[:SENSe]:TOI:BANDwidth|BWIDth[:RESolution]
[:SENSe]:TOI:BANDwidth|BWIDth[:RESolution]?
[:SENSe]:TOI:BANDwidth|BWIDth[:RESolution]:AUTO
[:SENSe]:TOI:BANDwidth|BWIDth[:RESolution]:AUTO?
[:SENSe]:TOI:BANDwidth|BWIDth:VIDeo
[:SENSe]:TOI:BANDwidth|BWIDth:VIDeo?
[:SENSe]:TOI:BANDwidth|BWIDth:VIDeo:AUTO
[:SENSe]:TOI:BANDwidth|BWIDth:VIDeo:AUTO?
[:SENSe]:TOI:BANDwidth|BWIDth:VIDeo:RATio
[:SENSe]:TOI:BANDwidth|BWIDth:VIDeo:RATio?
[:SENSe]:TOI:BANDwidth|BWIDth:VIDeo:RATio:AUTO
[:SENSe]:TOI:BANDwidth|BWIDth:VIDeo:RATio:AUTO?
[:SENSe]:TOI:FREQuency:BASE:LOWer
[:SENSe]:TOI:FREQuency:BASE:LOWer?
[:SENSe]:TOI:FREQuency:BASE:LOWer:AUTO
[:SENSe]:TOI:FREQuency:BASE:LOWer:AUTO?
[:SENSe]:TOI:FREQuency:BASE:UPPer
[:SENSe]:TOI:FREQuency:BASE:UPPer?
[:SENSe]:TOI:FREQuency:BASE:UPPer:AUTO
[:SENSe]:TOI:FREQuency:BASE:UPPer:AUTO?
[:SENSe]:TOI:FREQuency:SPAN
[:SENSe]:TOI:FREQuency:SPAN?
[:SENSe]:TOI:FREQuency:SPAN:BANDwidth[:RESolution]:RATio
[:SENSe]:TOI:FREQuency:SPAN:BANDwidth[:RESolution]:RATio?
[:SENSe]:TOI:FREQuency:SPAN:BANDwidth[:RESolution]:RATio:AUTO
[:SENSe]:TOI:FREQuency:SPAN:BANDwidth[:RESolution]:RATio:AUTO?
[:SENSe]:TOI:FREQuency:TUNE:IMMediate
[:SENSe]:TOINtercept:AVERAge:COUNT
[:SENSe]:TOINtercept:AVERAge:TCONtrol
[:SENSe]:TOINtercept:FREQuency:SPAN
[:SENSe]:TOI:SWEp:POINTs
[:SENSe]:TOI:SWEp:POINTs?
[:SENSe]:TOI:SWEp:TIME
[:SENSe]:TOI:SWEp:TIME?
[:SENSe]:TOI:SWEp:TIME:AUTO
[:SENSe]:TOI:SWEp:TIME:AUTO?
[:SENSe]:TOI:ZSPan:BANDwidth|BWIDth
[:SENSe]:TOI:ZSPan:BANDwidth|BWIDth?
[:SENSe]:TOI:ZSPan:BANDwidth|BWIDth:AUTO
[:SENSe]:TOI:ZSPan:BANDwidth|BWIDth:AUTO?
[:SENSe]:TOI:ZSPan:STATe
[:SENSe]:TOI:ZSPan:STATe?
[:SENSe]:TOI:ZSPan:SWEp:TIME
[:SENSe]:TOI:ZSPan:SWEp:TIME?
[:SENSe]:TOI:ZSPan:SWEp:TIME:AUTO
[:SENSe]:TOI:ZSPan:SWEp:TIME:AUTO?
[:SENSe]:TXPower:AVERAge:COUNT
[:SENSe]:TXPower:AVERAge:COUNT?
[:SENSe]:TXPower:AVERAge[:STATe]

```

```
[ :SENSe ]:TXPower:AVERage[ :STATe ]?  
[ :SENSe ]:TXPower:AVERage:TCONtrol  
[ :SENSe ]:TXPower:AVERage:TCONtrol?  
[ :SENSe ]:TXPower:AVERage:TYPE  
[ :SENSe ]:TXPower:AVERage:TYPE  
[ :SENSe ]:TXPower:AVERage:TYPE?  
[ :SENSe ]:TXPower:AVERage:TYPE?  
[ :SENSe ]:TXPower:BANDwidth[ :RESolution ]  
[ :SENSe ]:TXPower:BANDwidth[ :RESolution ]?  
[ :SENSe ]:TXPower:BANDwidth:TYPE  
[ :SENSe ]:TXPower:BANDwidth:TYPE?  
[ :SENSe ]:TXPower:BURSt:AUTO  
[ :SENSe ]:TXPower:BURSt:AUTO?  
[ :SENSe ]:TXPower:BURSt:WIDTh  
[ :SENSe ]:TXPower:BURSt:WIDTh?  
[ :SENSe ]:TXPower:BWIDth[ :RESolution ]  
[ :SENSe ]:TXPower:BWIDth:TYPE  
[ :SENSe ]:TXPower:IF:GAIN:AUTO[ :STATe ]  
[ :SENSe ]:TXPower:IF:GAIN:AUTO[ :STATe ]?  
[ :SENSe ]:TXPower:IF:GAIN[ :STATe ]  
[ :SENSe ]:TXPower:IF:GAIN[ :STATe ]?  
[ :SENSe ]:TXPower:METhod  
[ :SENSe ]:TXPower:METhod  
[ :SENSe ]:TXPower:METhod?  
[ :SENSe ]:TXPower:METhod?  
[ :SENSe ]:TXPower:SWEep:TIME  
[ :SENSe ]:TXPower:SWEep:TIME?  
[ :SENSe ]:TXPower:THReshold  
[ :SENSe ]:TXPower:THReshold?  
[ :SENSe ]:TXPower:THReshold:TYPE  
[ :SENSe ]:TXPower:THReshold:TYPE?  
[ :SENSe ]:VOLTage:IQ[ :I ]:RANGe[ :UPPer ]  
[ :SENSe ]:VOLTage:IQ[ :I ]:RANGe[ :UPPer ]?  
[ :SENSe ]:VOLTage:IQ:Q:RANGe[ :UPPer ]  
[ :SENSe ]:VOLTage:IQ:Q:RANGe[ :UPPer ]?  
[ :SENSe ]:VOLTage:IQ:RANGe:AUTO  
[ :SENSe ]:VOLTage:IQ:RANGe:AUTO?  
[ :SENSe ]:VOLTage|POWer:IQ:MIRROred  
[ :SENSe ]:VOLTage|POWer:IQ:MIRROred?  
SOURce:CORREction:OFFSet  
SOURce:CORREction:OFFSet?  
SOURce[ :EXtErnal ]:POWer[ :LEVel ][ :IMMediate ][ :AMPLitude ]  
SOURce[ :EXtErnal ]:POWer[ :LEVel ][ :IMMediate ][ :AMPLitude ]?  
SOURce[ :EXtErnal ]:POWer:MODE  
SOURce[ :EXtErnal ]:POWer:MODE?  
SOURce:EXtErnal:SWEep:OFFSet:FREQuency  
SOURce:EXtErnal:SWEep:OFFSet:FREQuency?  
SOURce[ :EXtErnal ][ :SWEep ]:POWer:SPAN  
SOURce[ :EXtErnal ][ :SWEep ]:POWer:SPAN?  
SOURce:FREQuency[ :MULTiplier ]:DENominator  
SOURce:FREQuency[ :MULTiplier ]:DENominator?  
SOURce:FREQuency[ :MULTiplier ]:NUMerator  
SOURce:FREQuency[ :MULTiplier ]:NUMerator?
```

SOURce:FREQuency:OFFSet
SOURce:FREQuency:OFFSet?
SOURce:FREQuency:OFFSet:STATE
SOURce:FREQuency:OFFSet:STATE?
SOURce:FREQuency:SSReverse?
SOURce:FREQuency:SSReverse:ON|OFF|0|1
SOURce:NOISe:SNS:ATTached?
SOURce:NOISe[:STATE]
SOURce:NOISe[:STATE]?
SOURce:NOISe:TYPE
SOURce:NOISe:TYPE?
SOURce:POWer:START
SOURce:POWer:START?
SOURce:POWer:STEP:AUTO
SOURce:POWer:STEP:AUTO?
SOURce:POWer:STEP[:INCRement]
SOURce:POWer:STEP[:INCRement]?
SOURce:POWer:SWEep
SOURce:POWer:SWEep?
SOURce:POWer:SWEep:STATE
SOURce:POWer:SWEep:STATE?
SOURce:PRESet
SOURce:SETtings?
SOURce:TRIGger:TYPE
SOURce:TRIGger:TYPE?
STATus:OPERation:CONDition?
STATus:OPERation:ENABLE
STATus:OPERation:ENABLE?
STATus:OPERation[:EVENT]?
STATus:OPERation:INSTRument:CONDition?
STATus:OPERation:INSTRument:ENABLE
STATus:OPERation:INSTRument:ENABLE?
STATus:OPERation:INSTRument[:EVENT]?
STATus:OPERation:INSTRument:NTRansition
STATus:OPERation:INSTRument:NTRansition?
STATus:OPERation:INSTRument:PTRansition
STATus:OPERation:INSTRument:PTRansition?
STATus:OPERation:NTRansition
STATus:OPERation:NTRansition?
STATus:OPERation:PTRansition
STATus:OPERation:PTRansition?
STATus:PRESet
STATus:QUESTionable:CALibration:CONDition?
STATus:QUESTionable:CALibration:ENABLE
STATus:QUESTionable:CALibration:ENABLE?
STATus:QUESTionable:CALibration[:EVENT]?
STATus:QUESTionable:CALibration:EXTended:FAILure:CONDition?
STATus:QUESTionable:CALibration:EXTended:FAILure:ENABLE
STATus:QUESTionable:CALibration:EXTended:FAILure:ENABLE?
STATus:QUESTionable:CALibration:EXTended:FAILure[:EVENT]?
STATus:QUESTionable:CALibration:EXTended:FAILure:NTRansition
STATus:QUESTionable:CALibration:EXTended:FAILure:NTRansition?
STATus:QUESTionable:CALibration:EXTended:FAILure:PTRansition

STATus:QUESTionable:CALibration:EXTended:FAILure:PTRansition?
STATus:QUESTionable:CALibration:EXTended:NEEDed:CONDition?
STATus:QUESTionable:CALibration:EXTended:NEEDed:ENABLE
STATus:QUESTionable:CALibration:EXTended:NEEDed:ENABLE?
STATus:QUESTionable:CALibration:EXTended:NEEDed[:EVENT]?
STATus:QUESTionable:CALibration:EXTended:NEEDed:NTRansition
STATus:QUESTionable:CALibration:EXTended:NEEDed:NTRansition?
STATus:QUESTionable:CALibration:EXTended:NEEDed:PTRansition
STATus:QUESTionable:CALibration:EXTended:NEEDed:PTRansition?
STATus:QUESTionable:CALibration:NTRansition
STATus:QUESTionable:CALibration:NTRansition?
STATus:QUESTionable:CALibration:PTRansition
STATus:QUESTionable:CALibration:PTRansition?
STATus:QUESTionable:CALibration:SKIPPed:CONDition?
STATus:QUESTionable:CALibration:SKIPPed:ENABLE
STATus:QUESTionable:CALibration:SKIPPed:ENABLE?
STATus:QUESTionable:CALibration:SKIPPed[:EVENT]?
STATus:QUESTionable:CALibration:SKIPPed:NTRansition
STATus:QUESTionable:CALibration:SKIPPed:NTRansition?
STATus:QUESTionable:CALibration:SKIPPed:PTRansition
STATus:QUESTionable:CALibration:SKIPPed:PTRansition?
STATus:QUESTionable:CONDition?
STATus:QUESTionable:ENABLE
STATus:QUESTionable:ENABLE?
STATus:QUESTionable[:EVENT]?
STATus:QUESTionable:FREQuency:CONDition?
STATus:QUESTionable:FREQuency:ENABLE
STATus:QUESTionable:FREQuency:ENABLE?
STATus:QUESTionable:FREQuency[:EVENT]?
STATus:QUESTionable:FREQuency:NTRansition
STATus:QUESTionable:FREQuency:NTRansition?
STATus:QUESTionable:FREQuency:PTRansition
STATus:QUESTionable:FREQuency:PTRansition?
STATus:QUESTionable:INTEgrity:CONDition?
STATus:QUESTionable:INTEgrity:ENABLE
STATus:QUESTionable:INTEgrity:ENABLE?
STATus:QUESTionable:INTEgrity[:EVENT]?
STATus:QUESTionable:INTEgrity:NTRansition
STATus:QUESTionable:INTEgrity:NTRansition?
STATus:QUESTionable:INTEgrity:PTRansition
STATus:QUESTionable:INTEgrity:PTRansition?
STATus:QUESTionable:INTEgrity:SIGNal:CONDition?
STATus:QUESTionable:INTEgrity:SIGNal:ENABLE
STATus:QUESTionable:INTEgrity:SIGNal:ENABLE?
STATus:QUESTionable:INTEgrity:SIGNal[:EVENT]?
STATus:QUESTionable:INTEgrity:SIGNal:NTRansition
STATus:QUESTionable:INTEgrity:SIGNal:NTRansition?
STATus:QUESTionable:INTEgrity:SIGNal:PTRansition
STATus:QUESTionable:INTEgrity:SIGNal:PTRansition?
STATus:QUESTionable:INTEgrity:UNCalibrated:CONDition?
STATus:QUESTionable:INTEgrity:UNCalibrated:ENABLE
STATus:QUESTionable:INTEgrity:UNCalibrated:ENABLE?
STATus:QUESTionable:INTEgrity:UNCalibrated[:EVENT]?

STATus:QUESTionable:INTEgrity:UNCalibrated:NTRansition
STATus:QUESTionable:INTEgrity:UNCalibrated:NTRansition?
STATus:QUESTionable:INTEgrity:UNCalibrated:PTRansition
STATus:QUESTionable:INTEgrity:UNCalibrated:PTRansition?
STATus:QUESTionable:NTRansition
STATus:QUESTionable:NTRansition?
STATus:QUESTionable:POWER:CONDition?
STATus:QUESTionable:POWER:ENABLE
STATus:QUESTionable:POWER:ENABLE?
STATus:QUESTionable:POWER[:EVENT]?
STATus:QUESTionable:POWER:NTRansition
STATus:QUESTionable:POWER:NTRansition?
STATus:QUESTionable:POWER:PTRansition
STATus:QUESTionable:POWER:PTRansition?>
STATus:QUESTionable:PTRansition
STATus:QUESTionable:PTRansition?
STATus:QUESTionable:TEMPerature:CONDition?
STATus:QUESTionable:TEMPerature:ENABLE
STATus:QUESTionable:TEMPerature:ENABLE?
STATus:QUESTionable:TEMPerature[:EVENT]?
STATus:QUESTionable:TEMPerature:NTRansition
STATus:QUESTionable:TEMPerature:NTRansition?
STATus:QUESTionable:TEMPerature:PTRansition
STATus:QUESTionable:TEMPerature:PTRansition?
SWEep:TIME:AUTO:MODE
SWEep:TIME:AUTO:MODE
SWEep:TIME:AUTO:MODE?
SYSTem:APPLication:CATalog[:NAME]?
SYSTem:APPLication:CATalog[:NAME]:COUNT?
SYSTem:APPLication:CATalog:OPTion?
SYSTem:APPLication:CATalog:REVision?
SYSTem:APPLication[:CURRENT][:NAME]?
SYSTem:APPLication[:CURRENT]:OPTion?
SYSTem:APPLication[:CURRENT]:REVision?
SYSTem:COMMunicate:GPIB[1][:SELF]:ADDResS
SYSTem:COMMunicate:GPIB[1][:SELF]:ADDResS?
SYSTem:COMMunicate:GPIB[1][:SELF]:CONTRoller[:ENABLE]
SYSTem:COMMunicate:GPIB[1][:SELF]:CONTRoller[:ENABLE]?
SYSTem:COMMunicate:LAN:SCPI:HISLip:ENABLE
SYSTem:COMMunicate:LAN:SCPI:HISLip:ENABLE?
SYSTem:COMMunicate:LAN:SCPI:SICL:ENABLE
SYSTem:COMMunicate:LAN:SCPI:SICL:ENABLE?
SYSTem:COMMunicate:LAN:SCPI:SOCKEt:CONTROl?
SYSTem:COMMunicate:LAN:SCPI:SOCKEt:ENABLE
SYSTem:COMMunicate:LAN:SCPI:SOCKEt:ENABLE?
SYSTem:COMMunicate:LAN:SCPI:TELNet:ENABLE
SYSTem:COMMunicate:LAN:SCPI:TELNet:ENABLE?
SYSTem:COMMunicate:LAN:SOURce[:EXTernal]:IP
SYSTem:COMMunicate:LAN:SOURce[:EXTernal]:IP?
SYSTem:COMMunicate:SOURce[1]:ADDResS
SYSTem:COMMunicate:SOURce[1]:ADDResS?
SYSTem:COMMunicate:TCPip:CONTROl?
SYSTem:COMMunicate:USB:CONNEction?

SYSTem:COMMunicate:USB:PACKets?
SYSTem:COMMunicate:USB:STATus?
SYSTem:CONFigure[:SYSTem]?
SYSTem:CSYSTem?
SYSTem:DATE
SYSTem:DATE?
SYSTem:DEFault
SYSTem:DISPlay:LANGuage
SYSTem:DISPlay:LANGuage?
SYSTem:ERRor[:NEXT]?
SYSTem:ERRor:OVERload[:STATe]
SYSTem:ERRor:PUP?
SYSTem:ERRor:VERBose
SYSTem:ERRor:VERBose?
SYSTem:HELP:HEADers?
SYSTem:HID?
SYSTem:IDN
SYSTem:IDN?
SYSTem:IDN:CONFigure
SYSTem:IDN:CONFigure?
SYSTem:KLOCK
SYSTem:KLOCK?
SYSTem:LKEY
SYSTem:LKEY?
SYSTem:LKEY:DELete
SYSTem:LKEY:LIST?
SYSTem:LOCK:NAME?
SYSTem:LOCK:OWNer?
SYSTem:LOCK:RELease
SYSTem:LOCK:REQuest?
SYSTem:LOFF
SYSTem:METRics:FPANel?
SYSTem:METRics:SCPI?
SYSTem:METRics:STIME?
SYSTem:MRELay:COUNT?
SYSTem:OPTions?
SYSTem:PDOWN
SYSTem:PERSONa:DEFault
SYSTem:PERSONa:DEFault?
SYSTem:PERSONa:MANUFACTurer
SYSTem:PERSONa:MANUFACTurer?
SYSTem:PERSONa:MANUFACTurer:DEFault
SYSTem:PERSONa:MANUFACTurer:DEFault?
SYSTem:PERSONa:MODEl
SYSTem:PERSONa:MODEl?
SYSTem:PERSONa:MODEl:DEFault
SYSTem:PERSONa:MODEl:DEFault?
SYSTem:PON:APPLication:LLIST
SYSTem:PON:APPLication:LLIST?
SYSTem:PON:APPLication:VMEMory[:AVAILable]?
SYSTem:PON:APPLication:VMEMory:TOTAL?
SYSTem:PON:APPLication:VMEMory:USED?
SYSTem:PON:APPLication:VMEMory:USED:NAME?

SYSTem:PON:ETIme?
 SYSTem:PON:FPGA:LOAD
 SYSTem:PON:FPGA:LOAD?
 SYSTem:PON:FPGA:PREFereNce
 SYSTem:PON:FPGA:PREFereNce?
 SYSTem:PON:MODE
 SYSTem:PON:MODE?
 SYSTem:PON:TIME?
 SYSTem:PON:TYPE
 SYSTem:PON:TYPE
 SYSTem:PON:TYPE?
 SYSTem:PRESet
 SYSTem:PRESet:TYPE
 SYSTem:PRESet:TYPE?
 SYSTem:PRESet:USER
 SYSTem:PRESet:USER:ALL
 SYSTem:PRESet:USER:SAVE
 SYSTem:PRINT:THEMe
 SYSTem:PRINT:THEMe?
 SYSTem:PUP:PROcEss
 SYSTem:SECurity:USB:WPRotect[:ENABle]
 SYSTem:SECurity:USB:WPRotect[:ENABle]?
 SYSTem:SET
 SYSTem:SET?
 SYSTem:SHOW
 SYSTem:SHOW?
 SYSTem:TEMPerature:HEXTreme?
 SYSTem:TEMPerature:LEXTreme?
 SYSTem:TIME
 SYSTem:TIME?
 SYSTem:VERSion?

T

TRACe[1]|2|3:ACPowEr:DISPlay[:STATe]
 TRACe[1]|2|3:ACPowEr:DISPlay[:STATe]?
 TRACe[1]|2|3:ACPowEr:TYPE
 TRACe[1]|2|3:ACPowEr:TYPE?
 TRACe[1]|2|3:ACPowEr:UPDate[:STATe]
 TRACe[1]|2|3:ACPowEr:UPDate[:STATe]?
 TRACe:CHPowEr:TYPE
 TRACe:CHPowEr:TYPE?
 TRACe:CLear
 TRACe:CLear:ALL
 TRACe:COpy
 TRACe:COpy?
 TRACe[:DATA]
 TRACe[:DATA]?
 TRACe[1]|2|...|6:DISPlay[:STATe]
 TRACe[1]|2|...|6:DISPlay[:STATe]?
 TRACe:DISPlay:VIEW:SPECTrogram:TIME?
 TRACe:EXCHange

TRACe:EXCHange?
TRACe:MATH:MEAN?
TRACe:MATH:PEAK[:DATA]?
TRACe:MATH:PEAK:POINTs?
TRACe:MATH:PEAK:SORT
TRACe:MATH:SMOoth
TRACe:MATH:SMOoth:POINTs
TRACe:MATH:SMOoth:POINTs?
TRACe[1]|2|...|6:MODE
TRACe:MODE
TRACe:MODE
TRACe[1]|2|...|6:MODE?
TRACe:OBWidth:TYPE
TRACe:OBWidth:TYPE?
TRACe:PRESet:ALL
TRACe:SEMask:TYPE
TRACe:SEMask:TYPE?
TRACe:TOI:TYPE
TRACe[1]|2|...|6:TYPE
TRACe[1]|2|...|6:TYPE?
TRACe[1]|2|...|6:UPDate[:STATe]
TRACe[1]|2|...|6:UPDate[:STATe]?
TRIGger:<measurement>[:SEquence]:IQ:SOURce
TRIGger:<measurement>[:SEquence]:IQ:SOURce?
TRIGger:<measurement>[:SEquence]:RF:SOURce
TRIGger:<measurement>[:SEquence]:RF:SOURce?
TRIGger:<measurement>[:SEquence]:SOURce
TRIGger:<measurement>[:SEquence]:SOURce?
TRIGger[:SEquence]:AIQMag:BANDwidth
TRIGger[:SEquence]:AIQMag:BANDwidth?
TRIGger[:SEquence]:AIQMag:CENTer
TRIGger[:SEquence]:AIQMag:CENTer?
TRIGger[:SEquence]:AIQMag:DELay
TRIGger[:SEquence]:AIQMag:DELay?
TRIGger[:SEquence]:AIQMag:DELay:STATe
TRIGger[:SEquence]:AIQMag:DELay:STATe?
TRIGger[:SEquence]:AIQMag:LEVel
TRIGger[:SEquence]:AIQMag:LEVel?
TRIGger[:SEquence]:AIQMag:SLOPe
TRIGger[:SEquence]:AIQMag:SLOPe?
TRIGger[:SEquence]:ATRigger
TRIGger[:SEquence]:ATRigger?
TRIGger[:SEquence]:ATRigger:STATe
TRIGger[:SEquence]:ATRigger:STATe?
TRIGger[:SEquence]:DELay
TRIGger[:SEquence]:DELay?
TRIGger[:SEquence]:DELay:STATe
TRIGger[:SEquence]:DELay:STATe?
TRIGger[:SEquence]:EXTernal2:DELay
TRIGger[:SEquence]:EXTernal1:DELay
TRIGger[:SEquence]:EXTernal:DELay
TRIGger[:SEquence]:EXTernal2:DELay?
TRIGger[:SEquence]:EXTernal1:DELay?

TRIGger[:SEquence]:EXternal2:DELay:COMPensation
 TRIGger[:SEquence]:EXternal1:DELay:COMPensation
 TRIGger[:SEquence]:EXternal1:DELay:COMPensation?
 TRIGger[:SEquence]:EXternal2:DELay:COMPensation?
 TRIGger[:SEquence]:EXternal2:DELay:STATe
 TRIGger[:SEquence]:EXternal1:DELay:STATe
 TRIGger[:SEquence]:EXternal1:DELay:STATe?
 TRIGger[:SEquence]:EXternal2:DELay:STATe?
 TRIGger[:SEquence]:EXternal1:LEVel
 TRIGger[:SEquence]:EXternal2:LEVel
 TRIGger[:SEquence]:EXternal:LEVel
 TRIGger[:SEquence]:EXternal2:LEVel?
 TRIGger[:SEquence]:EXternal1:LEVel?
 TRIGger[:SEquence]:EXternal:SLOPe
 TRIGger[:SEquence]:EXternal2:SLOPe
 TRIGger[:SEquence]:EXternal1:SLOPe
 TRIGger[:SEquence]:EXternal1:SLOPe?
 TRIGger[:SEquence]:EXternal2:SLOPe?
 TRIGger[:SEquence]:FRAMe:ADJust
 TRIGger[:SEquence]:FRAMe:DELay
 TRIGger[:SEquence]:FRAMe:DELay?
 TRIGger[:SEquence]:FRAMe:DELay:STATe
 TRIGger[:SEquence]:FRAMe:DELay:STATe?
 TRIGger[:SEquence]:FRAMe:EXternal1:LEVel
 TRIGger[:SEquence]:FRAMe:EXternal2:LEVel
 TRIGger[:SEquence]:FRAMe:EXternal2:SLOPe
 TRIGger[:SEquence]:FRAMe:EXternal1:SLOPe
 TRIGger[:SEquence]:FRAMe:OFFSet
 TRIGger[:SEquence]:FRAMe:OFFSet?
 TRIGger[:SEquence]:FRAMe:OFFSet:DISPlay:RESet
 TRIGger[:SEquence]:FRAMe:PERiod
 TRIGger[:SEquence]:FRAMe:PERiod?
 TRIGger[:SEquence]:FRAMe:RFBurst:LEVel:ABSolute
 TRIGger[:SEquence]:FRAMe:RFBurst:SLOPe
 TRIGger[:SEquence]:FRAMe:SYNC
 TRIGger[:SEquence]:FRAMe:SYNC
 TRIGger[:SEquence]:FRAMe:SYNC?
 TRIGger[:SEquence]:FRAMe:SYNC:HOLDoff
 TRIGger[:SEquence]:FRAMe:SYNC:HOLDoff?
 TRIGger[:SEquence]:FRAMe:SYNC:HOLDoff:STATe
 TRIGger[:SEquence]:FRAMe:SYNC:HOLDoff:STATe?
 TRIGger[:SEquence]:HOLDoff
 TRIGger[:SEquence]:HOLDoff?
 TRIGger[:SEquence]:HOLDoff:STATe
 TRIGger[:SEquence]:HOLDoff:STATe?
 TRIGger[:SEquence]:HOLDoff:TYPE
 TRIGger[:SEquence]:HOLDoff:TYPE?
 TRIGger[:SEquence]:IDEMod:DELay
 TRIGger[:SEquence]:IDEMod:DELay?
 TRIGger[:SEquence]:IDEMod:DELay:STATe
 TRIGger[:SEquence]:IDEMod:DELay:STATe?
 TRIGger[:SEquence]:IDEMod:LEVel
 TRIGger[:SEquence]:IDEMod:LEVel?

TRIGger[:SEquence]:IDEMod:SLOPe
TRIGger[:SEquence]:IDEMod:SLOPe?
TRIGger[:SEquence]:IF:LEVel
TRIGger[:SEquence]:IF:LEVel?
TRIGger[:SEquence]:IF:SLOPe
TRIGger[:SEquence]:IF:SLOPe?
TRIGger[:SEquence]:IINPut:DELay
TRIGger[:SEquence]:IINPut:DELay?
TRIGger[:SEquence]:IINPut:DELay:STATE
TRIGger[:SEquence]:IINPut:DELay:STATE?
TRIGger[:SEquence]:IINPut:LEVel
TRIGger[:SEquence]:IINPut:LEVel?
TRIGger[:SEquence]:IINPut:SLOPe
TRIGger[:SEquence]:IINPut:SLOPe?
TRIGger[:SEquence]:IQMag:DELay
TRIGger[:SEquence]:IQMag:DELay?
TRIGger[:SEquence]:IQMag:DELay:STATE
TRIGger[:SEquence]:IQMag:DELay:STATE?
TRIGger[:SEquence]:IQMag:LEVel
TRIGger[:SEquence]:IQMag:LEVel?
TRIGger[:SEquence]:IQMag:SLOPe
TRIGger[:SEquence]:IQMag:SLOPe?
TRIGger[:SEquence]:LINE:DELay
TRIGger[:SEquence]:LINE:DELay?
TRIGger[:SEquence]:LINE:DELay:STATE
TRIGger[:SEquence]:LINE:DELay:STATE?
TRIGger[:SEquence]:LINE:SLOPe
TRIGger[:SEquence]:LINE:SLOPe?
TRIGger[:SEquence]:OFFSet
TRIGger[:SEquence]:OFFSet?
TRIGger[:SEquence]:OFFSet:STATE
TRIGger[:SEquence]:OFFSet:STATE?
TRIGger[:SEquence]:QDEMod:DELay
TRIGger[:SEquence]:QDEMod:DELay?
TRIGger[:SEquence]:QDEMod:DELay:STATE
TRIGger[:SEquence]:QDEMod:DELay:STATE?
TRIGger[:SEquence]:QDEMod:LEVel
TRIGger[:SEquence]:QDEMod:LEVel?
TRIGger[:SEquence]:QDEMod:SLOPe
TRIGger[:SEquence]:QDEMod:SLOPe?
TRIGger[:SEquence]:QINPut:DELay
TRIGger[:SEquence]:QINPut:DELay?
TRIGger[:SEquence]:QINPut:DELay:STATE
TRIGger[:SEquence]:QINPut:DELay:STATE?
TRIGger[:SEquence]:QINPut:LEVel
TRIGger[:SEquence]:QINPut:LEVel?
TRIGger[:SEquence]:QINPut:SLOPe
TRIGger[:SEquence]:QINPut:SLOPe?
TRIGger[:SEquence]:RFBurst:DELay
TRIGger[:SEquence]:RFBurst:DELay?
TRIGger[:SEquence]:RFBurst:DELay:COMPensation
TRIGger[:SEquence]:RFBurst:DELay:COMPensation?
TRIGger[:SEquence]:RFBurst:DELay:STATE

TRIGger[:SEquence]:RFBurst:DELay:STATe?
TRIGger[:SEquence]:RFBurst:LEVel
TRIGger[:SEquence]:RFBurst:LEVel:ABSolute
TRIGger[:SEquence]:RFBurst:LEVel:ABSolute?
TRIGger[:SEquence]:RFBurst:LEVel:RELative
TRIGger[:SEquence]:RFBurst:LEVel:RELative?
TRIGger[:SEquence]:RFBurst:LEVel:TYPE
TRIGger[:SEquence]:RFBurst:LEVel:TYPE?
TRIGger[:SEquence]:RFBurst:SLOPe
TRIGger[:SEquence]:RFBurst:SLOPe?
TRIGger[:SEquence]:SLOPe
TRIGger[:SEquence]:SLOPe?
TRIGger[:SEquence]:SOURCe
TRIGger[:SEquence]:TV:FMODE
TRIGger[:SEquence]:TV:FMODE?
TRIGger[:SEquence]:TV:LINE
TRIGger[:SEquence]:TV:LINE?
TRIGger[:SEquence]:TV:STANdard
TRIGger[:SEquence]:TV:STANdard?
TRIGger[:SEquence]:VIDeo:DELay
TRIGger[:SEquence]:VIDeo:DELay?
TRIGger[:SEquence]:VIDeo:DELay:STATe
TRIGger[:SEquence]:VIDeo:DELay:STATe?
TRIGger[:SEquence]:VIDeo:LEVel
TRIGger[:SEquence]:VIDeo:LEVel?
TRIGger[:SEquence]:VIDeo:SLOPe
TRIGger[:SEquence]:VIDeo:SLOPe?
TRIGger[:SEquence]:XRELative
TRIGger[:SEquence]:XRELative?
TRIGger|TRIGger1|TRIGger2[:SEquence]:OUTPut
TRIGger|TRIGger1|TRIGger2[:SEquence]:OUTPut?
TRIGger|TRIGger1|TRIGger2[:SEquence]:OUTPut:POLarity
TRIGger|TRIGger1|TRIGger2[:SEquence]:OUTPut:POLarity?

U

UNIT:ACPower:POWer:PSD
UNIT:ACPower:POWer:PSD?
UNIT:CHPower:POWer:PSD
UNIT:CHPower:POWer:PSD?
UNIT:POWer
UNIT:POWer?

W

where

STATus Subsystem

The following diagram provides a graphical overview of the entire X-Series Status Register System.

For readability, the diagram is split into two sections:

- ["X-Series Status Register System \(1\)" on page 185](#)
- ["X-Series Status Register System \(2\)" on page 186](#)

X-Series Status Register System (1)

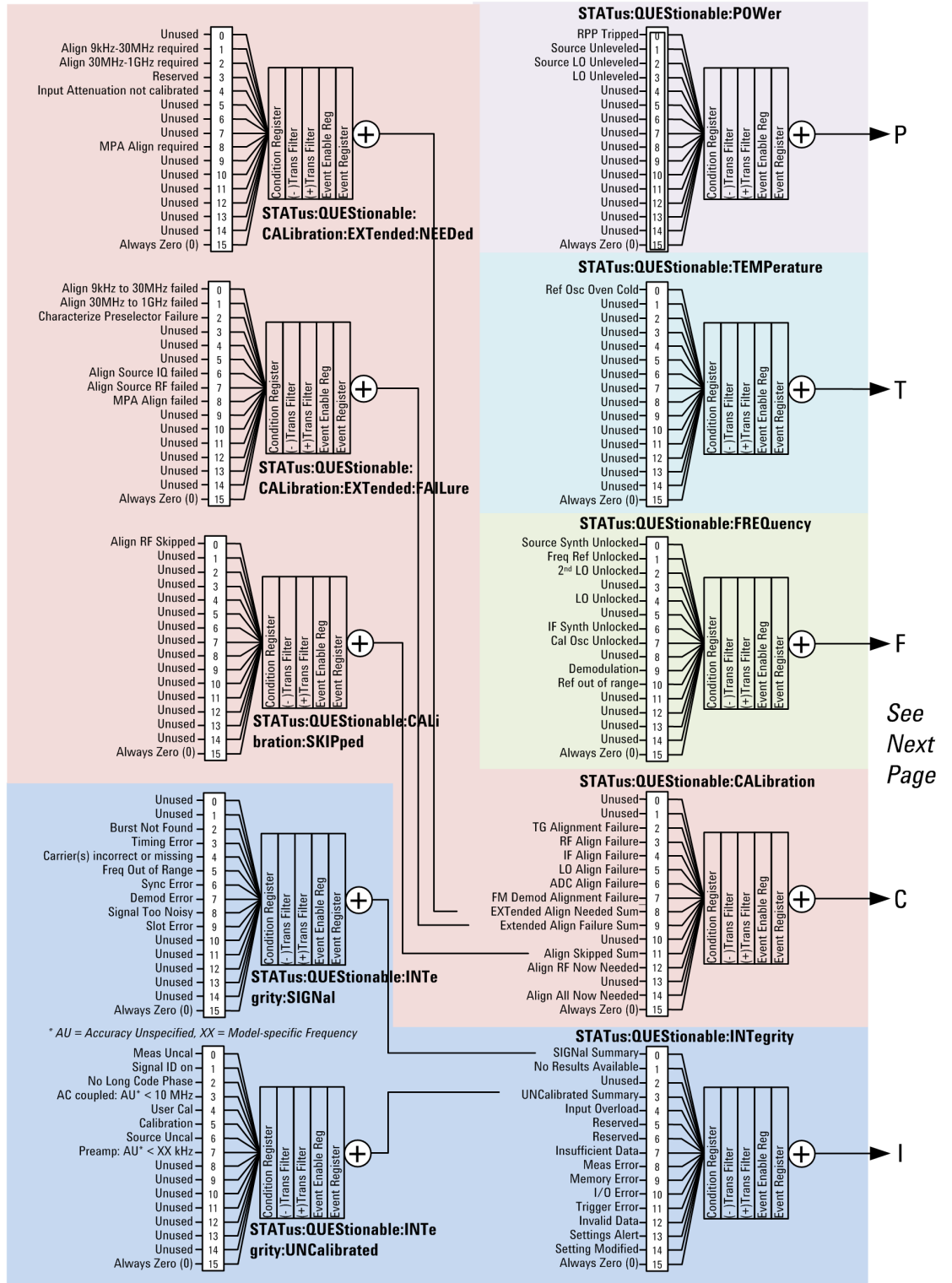

X-Series Status Register System (2)

See
 Previous
 Page

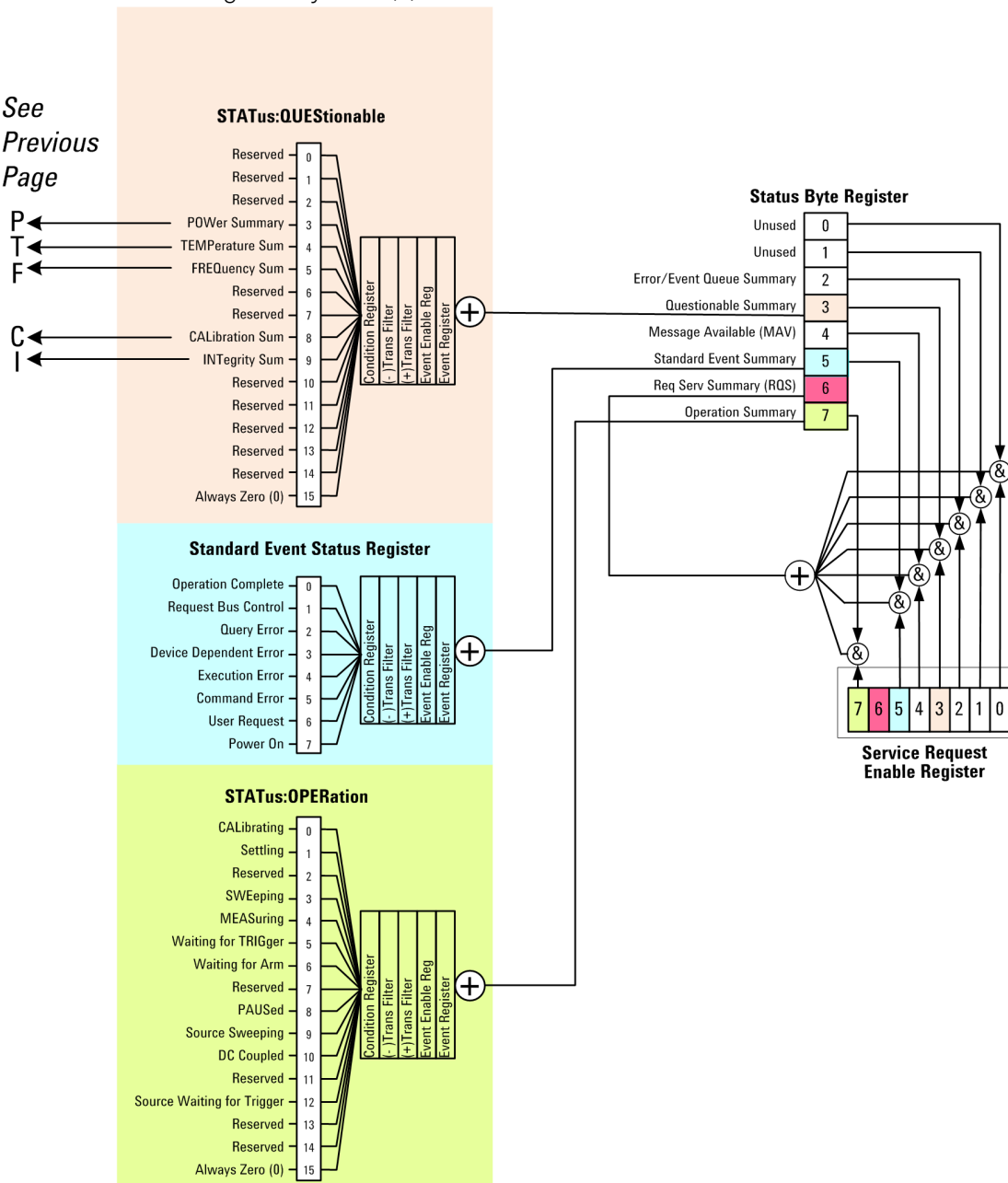

Detailed Description

The STATus subsystem remote commands set and query the status hardware registers. This system of registers monitors various events and conditions in the instrument. Software written to control the instrument may need to monitor some of these events and conditions.

NOTE

All status register commands are sequential. Most commands can be started immediately and will overlap with any existing commands that are already running. This is not true of status commands. All the commands in the spectrum analyzer are assumed to be overlapped unless a command description specifically says that it is sequential.

What Are Status Registers

The status system contains multiple registers that are arranged in a hierarchical order. The lower-level status registers propagate their data to the higher-level registers in the data structures by means of summary bits. The status byte register is at the top of the hierarchy and contains general status information for the instrument's events and conditions. All other individual registers are used to determine the specific events or conditions. For a diagram of the registers and their interconnections, see above.

The operation and questionable status registers are sets of registers that monitor the overall instrument condition. They are accessed with the STATus:OPERation and STATus:QUESTionable commands in the STATus command subsystem. Each register set is made up of five registers:

- Condition Register—It reports the real-time state of the signals monitored by this register set. There is no latching or buffering for a condition register.
- Positive Transition Register—This filter register controls which signals will set a bit in the event register when the signal makes a low to high transition (when the condition bit changes from 0 to 1).
- Negative Transition Register—This filter register controls which signals will set a bit in the event register when the signal makes a high to low transition (when the condition bit changes from 1 to 0).
- Event Register—It latches any signal state changes, in the way specified by the filter registers. Bits in the event register are never cleared by signal state changes. Event registers are cleared when read. They are also cleared by *CLS and by presetting the instrument.
- Event Enable Register—It controls which of the bits, being set in the event register, will be summarized as a single output for the register set. Summary bits are then used by the next higher register.

The STATus:QUESTionable registers report abnormal operating conditions. The status register hierarchy is:

1. The summary outputs from the six STATus:QUESTionable:<keyword> detail registers are inputs to the STATus:QUESTionable register.
2. The summary output from the STATus:QUESTionable register is an input to the Status Byte Register. See the overall system in Figure at the beginning of this

section.

The STATus:OPERation register set has no summarized inputs. The inputs to the STATus:OPERation:CONDition register indicate the real time state of the instrument. The STATus:OPERation:EVENT register summary output is an input to the Status Byte Register.

What Are Status Register SCPI Commands

Most monitoring of the instrument conditions is done at the highest level using the IEEE common commands indicated below. Complete command descriptions are available in the IEEE commands section at the beginning of the language reference. Individual status registers can be set and queried using the commands in the STATus subsystem of the language reference.

- *CLS (clear status) clears the status byte by emptying the error queue and clearing all the event registers.
- *ESE, *ESE? (event status enable) sets and queries the bits in the enable register part of the standard event status register.
- *ESR? (event status register) queries and clears the event register part of the standard event status register.
- *OPC, *OPC? (operation complete) sets the standard event status register to monitor the completion of all commands. The query stops any new commands from being processed until the current processing is complete, then returns a '1'.
- *PSC, *PSC? (power-on state clear) sets the power-on state so that it clears the service request enable register and the event status enable register at power on.
- *SRE, *SRE? (service request enable) sets and queries the value of the service request enable register.
- *STB? (status byte) queries the value of the status byte register without erasing its contents.

How to Use the Status Registers

A program often needs to be able to detect and manage error conditions or changes in instrument status. There are two methods you can use to programmatically access the information in status registers:

- The polling method
- The service request (SRQ) method

In the polling method, the instrument has a passive role. It only tells the controller that conditions have changed when the controller asks the right question. In the SRQ method, the instrument takes a more active role. It tells the controller when there has been a condition change without the controller asking. Either method allows you to monitor one or more conditions.

The polling method works well if you do not need to know about changes the moment they occur. The SRQ method should be used if you must know immediately when a condition changes. To detect a change using the polling method, the program must repeatedly read the registers.

Use the SRQ method when:

- you need time-critical notification of changes
- you are monitoring more than one device which supports SRQs
- you need to have the controller do something else while waiting
- you can't afford the performance penalty inherent to polling

Use polling when:

- your programming language/development environment does not support SRQ interrupts
- you want to write a simple, single-purpose program and don't want the added complexity of setting up an SRQ handler
- To monitor a condition:
 - a. Determine which register contains the bit that reports the condition.
 - b. Send the unique SCPI query that reads that register.
 - c. Examine the bit to see if the condition has changed.

You can monitor conditions in different ways.

- Check the current instrument hardware and firmware status. Do this by querying the condition registers which continuously monitor status. These registers represent the current state of the instrument. Bits in a condition register are updated in real time. When the condition monitored by a particular bit becomes true, the bit is set to 1. When the condition becomes false, the bit is reset to 0.
- Monitor a particular condition (bit). You can enable a particular bit(s), using the event enable register. The instrument will then monitor that particular condition(s). If the bit becomes true (0 to 1 transition) in the event register, it will stay set until the event register is cleared. Querying the event register allows you to detect that this condition occurred even if the condition no

Example 2:

1. Suppose you want to know if an Auto-trigger Timeout occurs, but you only cared about that specific condition. So you would want to know what was happening with bit 10 in the Status Questionable Integrity register, and not about any other bits.
2. It's usually a good idea to start by clearing all the status registers with *CLS.
3. Sending the STAT:QUES:INT:ENAB 1024 command lets you monitor only bit 10 events, instead of the default monitoring all the bits in the register. The register default is for positive transition events (0 to 1 transition). That is, when an auto-trigger timeout occurs. If instead, you wanted to know when the Auto-trigger timeout condition is cleared, then you would set the STAT:QUES:INT:PTR 0 and the STAT:QUES:INT:NTR 32767.
4. So now the only output from the Status Questionable Integrity register will come from a bit 10 positive transition. That output goes to the Integrity Sum bit 9 of the Status Questionable register.
5. You can do a similar thing with this register to only look at bit 9 using, STAT:QUES:ENAB 512.
6. The Status Questionable register output goes to the "Status Questionable Summary" bit 3 of the Status Byte Register. The output from this register can be enabled using the *SRE 8 command.
7. Finally, you would use the serial polling functionality available for the particular bus/software that you are using to monitor the Status Byte Register. (You could also use *STB? to poll the Status Byte Register.)

Using the Service Request (SRQ) Method

Your language, bus, and programming environment must be able to support SRQ interrupts. (For example, BASIC used with VXI-11.3 (GPIB over LAN). When you monitor a condition with the SRQ method, you must:

1. Determine which bit monitors the condition.
2. Determine how that bit reports to the request service (RQS) bit of the status byte.
3. Send SCPI commands to enable the bit that monitors the condition and to enable the summary bits that report the condition to the RQS bit.
4. Enable the controller to respond to service requests.

When the condition changes, the instrument sets its RQS bit. The controller is informed of the change as soon as it occurs. As a result, the time the controller

would otherwise have used to monitor the condition can be used to perform other tasks. Your program determines how the controller responds to the SRQ.

Generating a Service Request

To use the SRQ method, you must understand how service requests are generated. Bit 6 of the status byte register is the request service (RQS) bit. The *SRE command is used to configure the RQS bit to report changes in instrument status. When such a change occurs, the RQS bit is set. It is cleared when the status byte register is queried using *SRE? (with a serial poll.) It can be queried without erasing the contents with *STB?.

When a register set causes a summary bit in the status byte to change from 0 to 1, the instrument can initiate the service request (SRQ) process. However, the process is only initiated if both of the following conditions are true:

- The corresponding bit of the service request enable register is also set to 1.
- The instrument does not have a service request pending. (A service request is considered to be pending between the time the instrument's SRQ process is initiated and the time the controller reads the status byte register.)

The SRQ process sets the SRQ true. It also sets the status byte's request service (RQS) bit to 1. Both actions are necessary to inform the controller that the instrument requires service. Setting the SRQ line only informs the controller that some device on the bus requires service. Setting the RQS bit allows the controller to determine which instrument requires service.

If your program enables the controller to detect and respond to service requests, it should instruct the controller to perform a serial poll when the SRQ is set true. Each device on the bus returns the contents of its status byte register in response to this poll. The device whose RQS bit is set to 1 is the device that requested service.

When you read the instrument's status byte register with a serial poll, the RQS bit is reset to 0. Other bits in the register are not affected.

If the status register is configured to SRQ on end-of-measurement and the measurement is in continuous mode, then restarting a measurement (INIT command) can cause the measuring bit to pulse low. This causes an SRQ when you have not actually reached the "end-of-measurement" condition. To avoid this:

1. Set INITiate:CONTinuous off.
2. Set/enable the status registers.
3. Restart the measurement (send INIT).

Status Register System

The hardware status registers are combined to form the instrument status system. Specific status bits are assigned to monitor various aspects of the instrument operation and status. See the diagram of the status system above for information about the bit assignments and status register interconnections.

The Status Byte Register

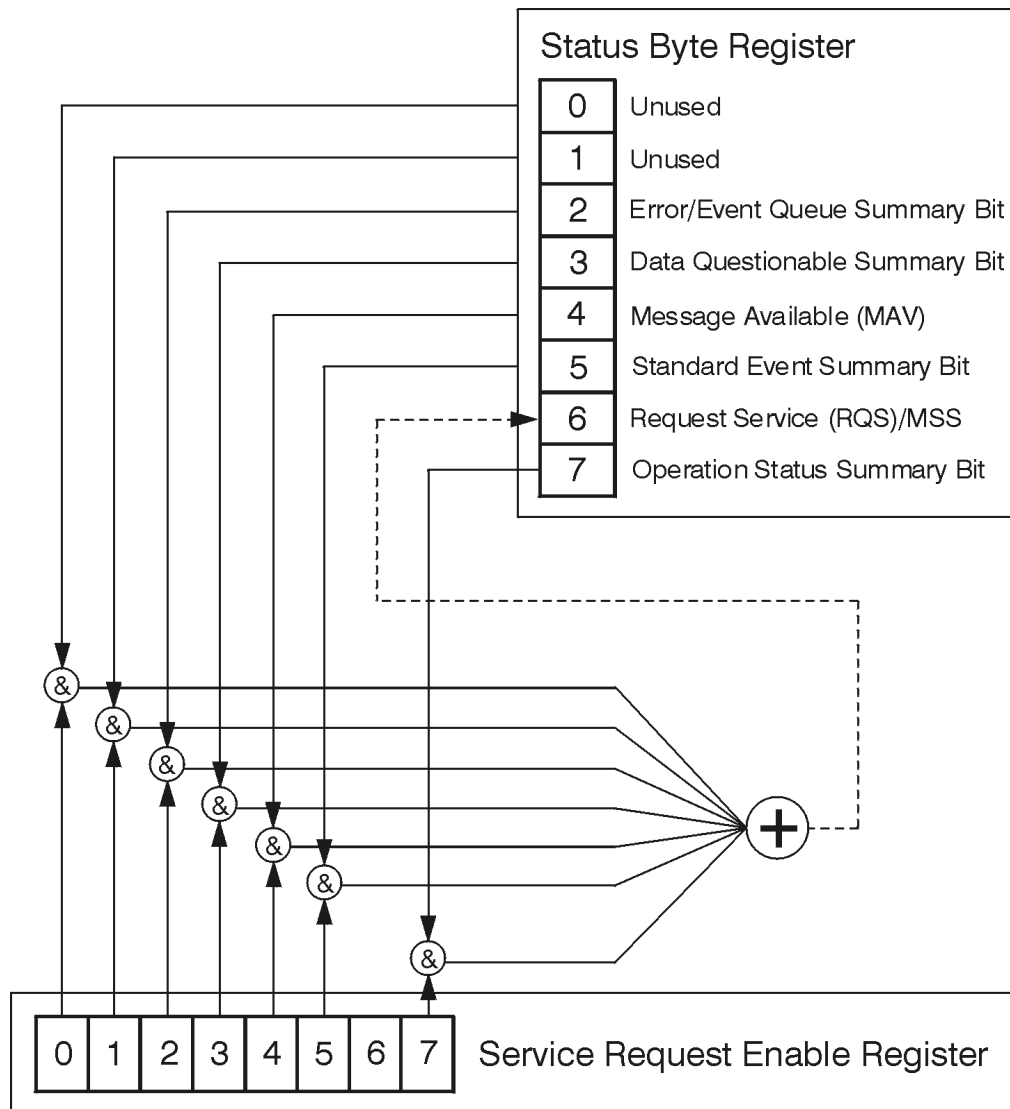

ck776a

The RQS bit is read and reset by a serial poll. The same bit position (MSS) is read, non-destructively by the *STB? command. If you serial poll bit 6 it is read as RQS, but if you send *STB it reads bit 6 as MSS. For more information refer to IEEE 488.2 standards, section 11.

	Description	Standard Operation Status Summary Bit	Request Service (RQS) Summary Bit	Standard Event Status Summary Bit	Message Available (MAV)	Data Questionable Status Summary Bit	Error/Event Queue Summary Bit	Unused	Unused
Bit Number	7	6	5	4	3	2	1	0	

*STB?

Status Byte Register

ck725a

Bit	Description
0, 1	These bits are always set to 0.
2	A 1 in this bit position indicates that the SCPI error queue is not empty which means that it contains at least one error message.
3	A 1 in this bit position indicates that the data questionable summary bit has been set. The data questionable event register can then be read to determine the specific condition that caused this bit to be set.
4	A 1 in this bit position indicates that the instrument has data ready in the output queue. There are no lower status groups that provide input to this bit.
5	A 1 in this bit position indicates that the standard event summary bit has been set. The standard event status register can then be read to determine the specific event that caused this bit to be set.
6	A 1 in this bit position indicates that the instrument has at least one reason to report a status change. This bit is also called the master summary status bit (MSS).
7	A 1 in this bit position indicates that the standard operation summary bit has been set. The standard operation event register can then be read to determine the specific condition that caused this bit to be set.

To query the status byte register, send the command *STB?. The response will be the decimal sum of the bits which are set to 1. For example, if bit number 7 and bit number 3 are set to 1, the decimal sum of the 2 bits is 128 plus 8. So the decimal value 136 is returned. The *STB command does not clear the status register.

In addition to the status byte register, the status byte group also contains the service request enable register. This register lets you choose which bits in the status byte register will trigger a service request.

Send the *SRE <integer> command where <integer> is the sum of the decimal values of the bits you want to enable plus the decimal value of bit 6. For example, assume that you want to enable bit 7 so that whenever the standard operation status register summary bit is set to 1 it will trigger a service request. Send the command *SRE 192 (because $192 = 128 + 64$). You must always add 64 (the numeric value of RQS bit 6) to your numeric sum when you enable any bits for a service request. The command *SRE? returns the decimal value of the sum of the bits previously enabled with the *SRE <integer> command.

The service request enable register presets to zeros (0).

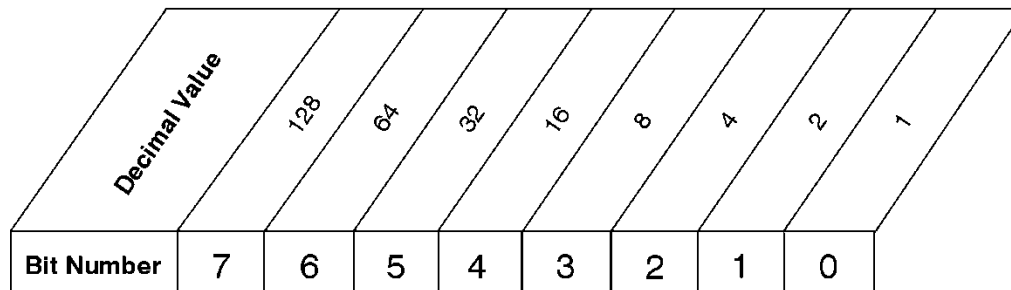

*SRE <num>
 *SRE?

Service Request Enable Register

ck726a

Standard Event Status Register

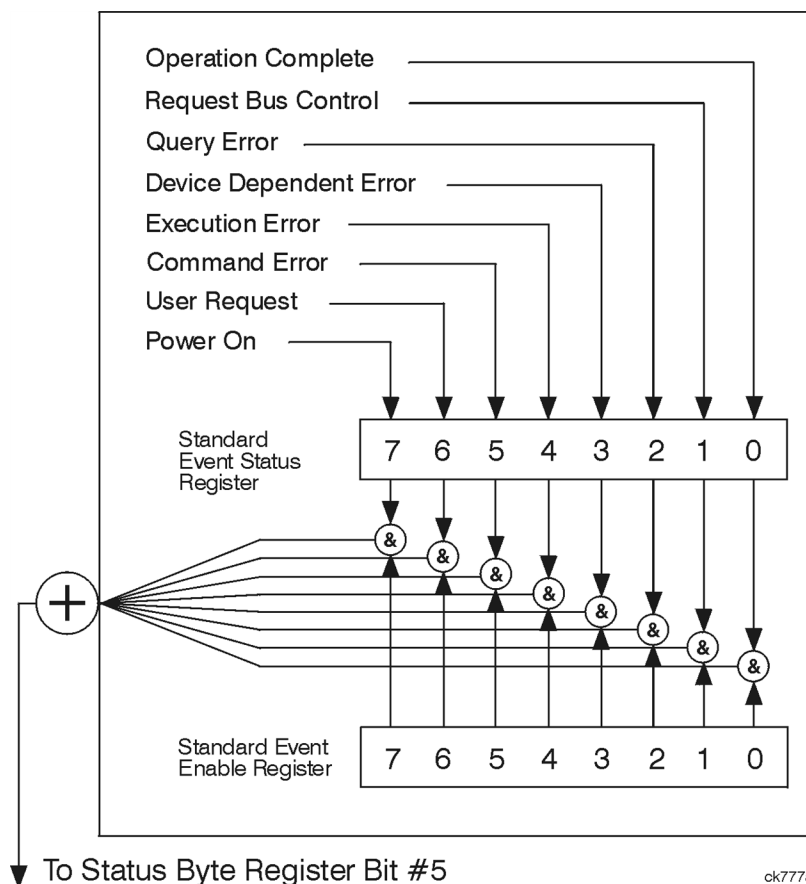

The standard event status register contains the following bits:

Bit Number	7	6	5	4	3	2	1	0
Description	Power On	User Request Key (Local)	Command Error	Execution Error	Device Dependent Error	Query Error	Request Control	Operation Complete

*ESR?

Standard Event Status Register

ck727a

Bit	Description
0	A 1 in this bit position indicates that all pending operations were

	completed following execution of the *OPC command.
1	This bit is for GPIB handshaking to request control. Currently it is set to 0 because there are no implementations where the spectrum analyzer controls another instrument.
2	A 1 in this bit position indicates that a query error has occurred. Query errors have SCPI error numbers from -499 to -400.
3	A 1 in this bit position indicates that a device dependent error has occurred. Device dependent errors have SCPI error numbers from -399 to -300 and 1 to 32767.
4	A 1 in this bit position indicates that an execution error has occurred. Execution errors have SCPI error numbers from -299 to -200.
5	A 1 in this bit position indicates that a command error has occurred. Command errors have SCPI error numbers from -199 to -100.
6	A 1 in this bit position indicates that the LOCAL key has been pressed. This is true even if the instrument is in local lockout mode.
7	A 1 in this bit position indicates that the instrument has been turned off and then on.

The standard event status register is used to determine the specific event that set bit 5 in the status byte register. To query the standard event status register, send the command *ESR?. The response will be the decimal sum of the bits which are enabled (set to 1). For example, if bit number 7 and bit number 3 are enabled, the decimal sum of the 2 bits is 128 plus 8. So the decimal value 136 is returned.

In addition to the standard event status register, the standard event status group also contains a standard event status enable register. This register lets you choose which bits in the standard event status register will set the summary bit (bit 5 of the status byte register) to 1. Send the *ESE <integer> command where <integer> is the sum of the decimal values of the bits you want to enable. For example, to enable bit 7 and bit 6 so that whenever either of those bits is set to 1, the standard event status summary bit of the status byte register will be set to 1, send the command *ESE 192 (128 + 64). The command *ESE? returns the decimal value of the sum of the bits previously enabled with the *ESE <integer> command.

The standard event status enable register presets to zeros (0).

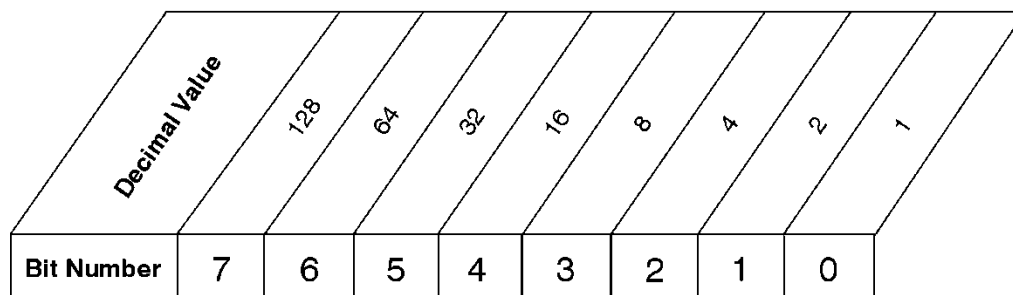

*ESE <num>
 *ESE?

Standard Event Status Enable Register

ck728a

Operation and Questionable Status Registers

The operation and questionable status registers are registers that monitor the overall instrument condition. They are accessed with the STATus:OPERation and STATus:QUESTionable commands in the STATus command subsystem. See the figure at the beginning of this chapter.

Operation Status Register

The operation status register monitors the current instrument measurement state. It checks to see if the instrument is calibrating, sweeping, or waiting for a trigger. For more information see the *OPC? command located in the IEEE Common Commands section.

Bit	Condition	Operation
0	Calibrating	The instrument is busy executing its Align Now process
3	Sweeping	The instrument is busy taking a sweep.
4	Measuring	The instrument is busy making a measurement. Measurements often require multiple sweeps. They are initiated by keys under the MEASURE key or with the MEASure group of commands. The bit is valid for most X-Series Modes.
5	Waiting for trigger	The instrument is waiting for the trigger conditions to be met, then it will trigger a sweep or measurement.

Questionable Status Register

The questionable status register monitors the instrument's condition to see if anything questionable has happened to it. It is looking for anything that might cause an error or a bad measurement like a hardware problem, an out of calibration situation, or a unusual signal. All the bits are summary bits from lower-level event registers.

Bit	Condition	Operation
3	Power summary	The instrument hardware has detected a power unlevelled condition.

4	Temperature summary	The instrument is still warming up.
5	Frequency summary	The instrument hardware has detected an unlocked condition or a problem with the external frequency reference.
8	Calibration summary	The instrument has detected a hardware problem while doing the automatic internal alignment process.
9	Integrity summary	The instrument has detected a questionable measurement condition such as: bad timing, bad signal/data, timeout problem, signal overload, or "meas uncal".

STATus Subsystem Command Descriptions

The STATus subsystem controls the SCPI-defined instrument status reporting structures. Each status register has a set of five commands used for querying or masking that particular register.

Numeric values for bit patterns can be entered using decimal or hexadecimal representations. (i.e. 0 to 32767 is equivalent to #H0 to #H7FFF. It is also equal to all ones, 111111111111111) See the SCPI Basics information about using bit patterns for variable parameters.

Operation Register

- "Operation Condition Query" on page 199
- "Operation Enable" on page 200
- "Operation Event Query" on page 200
- "Operation Negative Transition" on page 200
- "Operation Positive Transition" on page 201

Operation Condition Query

This query returns the decimal value of the sum of the bits in the Status Operation Condition register.

NOTE

The data in this register is continuously updated and reflects the current conditions.

Mode	All
Remote Command	:STATus:OPERation:CONDition?
Example	STAT:OPER:COND?
Preset	0
Status Bits/OPC dependencies	Sequential command
Initial S/W Revision	Prior to A.02.00

Operation Enable

This command determines which bits in the Operation Event register, will set the Operation Status Summary bit (bit 7) in the Status Byte Register. The variable <integer> is the sum of the decimal values of the bits you want to enable.

NOTE

The preset condition is to have all bits in this enable register set to 0. To have any Operation Events reported to the Status Byte Register, one or more bits need to be set to 1.

Mode	All
Remote Command	:STATus:OPERation:ENABle <integer> :STATus:OPERation:ENABle?
Example	STAT:OPER:ENAB 1 Sets the register so that Align Now operation will be reported to the Status Byte Register.
Preset	0
Min	0
Max	32767
Status Bits/OPC dependencies	Sequential command
Initial S/W Revision	Prior to A.02.00

Operation Event Query

This query returns the decimal value of the sum of the bits in the Operation Event register.

NOTE

The register requires that the associated PTR or NTR filters be set before a condition register bit can set a bit in the event register. The data in this register is latched until it is queried. Once queried, the register is cleared.

Mode	All
Remote Command	:STATus:OPERation[:EVENT]?
Example	STAT:OPER?
Preset	0
Status Bits/OPC dependencies	Sequential command
Initial S/W Revision	Prior to A.02.00

Operation Negative Transition

This command determines which bits in the Operation Condition register will set the corresponding bit in the Operation Event register when the condition register bit has

a negative transition (1 to 0). The variable <integer> is the sum of the decimal values of the bits that you want to enable.

Mode	All
Remote Command	:STATus:OPERation:NTRansition <integer> :STATus:OPERation:NTRansition?
Example	STAT:OPER:NTR 1 Align Now operation complete will be reported to the Status Byte Register.
Preset	0
Min	0
Max	32767
Status Bits/OPC dependencies	Sequential command
Initial S/W Revision	Prior to A.02.00

Operation Positive Transition

This command determines which bits in the Operation Condition register will set the corresponding bit in the Operation Event register when the condition register bit has a positive transition (0 to 1). The variable <integer> is the sum of the decimal values of the bits that you want to enable.

Mode	All
Remote Command	:STATus:OPERation:PTRansition <integer> :STATus:OPERation:PTRansition?
Example	STAT:OPER:PTR 1 Align Now operation beginning will be reported to the Status Byte Register.
Preset	32767
Min	0
Max	32767
Status Bits/OPC dependencies	Sequential command
Initial S/W Revision	Prior to A.02.00

Operation Instrument Register

- "Operation Instrument Condition" on page 202
- "Operation Instrument Event Enable " on page 202
- "Operation Instrument Event Query " on page 202
- "Operation Instrument Negative Transition " on page 203
- "Operation Instrument Positive Transition" on page 203

- "Preset the Status Byte " on page 204

Operation Instrument Condition

This query returns the decimal value of the sum of the bits in the Operation Instrument Condition register.

NOTE

The data in this register is continuously updated and reflects the current conditions.

Mode	All
Remote Command	:STATus:OPERation:INSTrument:CONDition?
Example	STAT:OPER:INST:COND?
Status Bits/OPC dependencies	Sequential command
Initial S/W Revision	x.16.10

Operation Instrument Event Enable

This command determines which bits in the Operation Instrument Event Register will propagate to setting the Instrument Summary bit (bit 11) in the Operation Register. The variable <integer> is the sum of the decimal values of the bits you want to enable.

Mode	All
Remote Command	:STATus:OPERation:INSTrument:ENABle <integer> :STATus:OPERation:INSTrument:ENABle?
Example	STAT:OPER:INST:ENAB 1 can be used to propagate Instrument Locked bit (bit 0) of Operation Instrument Event Register.
Min	0
Max	32767
Status Bits/OPC dependencies	Sequential command
Initial S/W Revision	x.16.10

Operation Instrument Event Query

This query returns the decimal value of the sum of the bits in the Operation Instrument Event register.

NOTE

The register requires that the associated PTR or NTR filters be set before a condition register bit can set a bit in the event register. The data in this register is latched until it is queried. Once queried, the register is cleared.

Mode	All
Remote Command	:STATus:OPERation:INSTrument[:EVENT]?
Example	STAT:OPER:INST?
Status Bits/OPC dependencies	Sequential command
Initial S/W Revision	x.16.10

Operation Instrument Negative Transition

This command determines which bits in the Operation Instrument Condition register will set the corresponding bit in the Operation Instrument Event register when the condition register bit has a negative transition (1 to 0). The variable <integer> is the sum of the decimal values of the bits that you want to enable.

Mode	All
Remote Command	:STATus:OPERation:INSTrument:NTRansition <integer> :STATus:OPERation:INSTrument:NTRansition?
Example	STAT:OPER:INST:NTR 1 to set event register when SCPI Lock is released.
Preset	0
Min	0
Max	32767
Status Bits/OPC dependencies	Sequential command
Initial S/W Revision	x.16.10

Operation Instrument Positive Transition

This command determines which bits in the Operation Instrument Condition register will set the corresponding bit in the Operation Instrument Event register when the condition register bit has a positive transition (0 to 1). The variable <integer> is the sum of the decimal values of the bits that you want to enable.

Mode	All
Remote Command	:STATus:OPERation:INSTrument:PTRansition <integer> :STATus:OPERation:INSTrument:PTRansition?
Example	STAT:OPER:INST:PTR 1 to set event register when SCPI Lock is required.
Preset	32767
Min	0
Max	32767
Status Bits/OPC dependencies	Sequential command

dependencies	
Initial S/W Revision	x.16.10

Preset the Status Byte

Sets bits in most of the enable and transition registers to their default state. It presets all the Transition Filters, Enable Registers, and the Error/Event Queue Enable. It has no effect on Event Registers, Error/Event QUEUE, IEEE 488.2 ESE, and SRE Registers as described in IEEE Standard 488.2–1992, IEEE Standard Codes, Formats, Protocols, and Common Commands for Use with ANSI/IEEE Std 488.1–1987. New York, NY, 1992.

Remote Command	:STATus:PRESet
Example	STAT:PRES
Initial S/W Revision	Prior to A.02.00

Questionable Register

- "Questionable Condition " on page 204
- "Questionable Enable" on page 205
- "Questionable Event Query " on page 205
- "Questionable Negative Transition " on page 206
- "Questionable Positive Transition" on page 206

Questionable Condition

This query returns the decimal value of the sum of the bits in the Questionable Condition register.

NOTE

The data in this register is continuously updated and reflects the current conditions.

Mode	All
Remote Command	:STATus:QUEStionable:CONDition?
Example	STAT:QUES:COND?
Preset	0
Status Bits/OPC dependencies	Sequential command
Initial S/W Revision	Prior to A.02.00

Questionable Enable

This command determines which bits in the Questionable Event register will set the Questionable Status Summary bit (bit3) in the Status Byte Register. The variable <integer> is the sum of the decimal values of the bits you want to enable.

NOTE

The preset condition is all bits in this enable register set to 0. To have any Questionable Events reported to the Status Byte Register, one or more bits need to be set to 1. The Status Byte Event Register should be queried after each measurement to check the Questionable Status Summary (bit 3). If it is equal to 1, a condition during the test may have made the test results invalid. If it is equal to 0, this indicates that no hardware problem or measurement problem was detected by the analyzer.

Mode	All
Remote Command	:STATus:QUESTionable:ENABle <integer> :STATus:QUESTionable:ENABle?
Example	STAT:OPER:PTR 1 Align Now operation beginning will be reported to the Status Byte Register.
Preset	0
Min	0
Max	32767
Status Bits/OPC dependencies	Sequential command
Initial S/W Revision	Prior to A.02.00

Questionable Event Query

This query returns the decimal value of the sum of the bits in the Questionable Event register.

NOTE

The register requires that the associated PTR or NTR filters be set before a condition register bit can set a bit in the event register. The data in this register is latched until it is queried. Once queried, the register is cleared.

Mode	All
Remote Command	:STATus:QUESTionable[:EVENT]?
Example	STAT:QUES?
Preset	0
Status Bits/OPC dependencies	Sequential command
Initial S/W Revision	Prior to A.02.00

Questionable Negative Transition

This command determines which bits in the Questionable Condition register will set the corresponding bit in the Questionable Event register when the condition register bit has a negative transition (1 to 0). The variable <integer> is the sum of the decimal values of the bits that you want to enable.

Mode	All
Remote Command	:STATus:QUESTionable:NTRansition <integer> :STATus:QUESTionable:NTRansition?
Example	STAT:QUES:NTR 16 Temperature summary 'questionable cleared' will be reported to the Status Byte Register.
Preset	0
Min	0
Max	32767
Status Bits/OPC dependencies	Sequential command
Initial S/W Revision	Prior to A.02.00

Questionable Positive Transition

This command determines which bits in the Questionable Condition register will set the corresponding bit in the Questionable Event register when the condition register bit has a positive transition (0 to 1). The variable <integer> is the sum of the decimal values of the bits that you want to enable.

Mode	All
Remote Command	:STATus:QUESTionable:PTRansition <integer> :STATus:QUESTionable:PTRansition?
Example	STAT:QUES:PTR 16 Temperature summary 'questionable asserted' will be reported to the Status Byte Register.
Preset	32767
Min	0
Max	32767
Status Bits/OPC dependencies	Sequential command
Initial S/W Revision	Prior to A.02.00

Questionable Calibration Register

- "Questionable Calibration Condition " on page 207
- "Questionable Calibration Enable " on page 207

- "Questionable Calibration Event Query " on page 207
- "Questionable Calibration Negative Transition " on page 208
- "Questionable Calibration Positive Transition " on page 208

Questionable Calibration Condition

This query returns the decimal value of the sum of the bits in the Questionable Calibration Condition register.

NOTE

The data in this register is continuously updated and reflects the current conditions.

Mode	All
Remote Command	:STATus:QUESTionable:CALibration:CONDition?
Example	STAT:QUES:CAL:COND?
Preset	0
Status Bits/OPC dependencies	Sequential command
Initial S/W Revision	Prior to A.02.00

Questionable Calibration Enable

This command determines which bits in the Questionable Calibration Condition Register will set bits in the Questionable Calibration Event register, which also sets the Calibration Summary bit (bit 8) in the Questionable Register. The variable <integer> is the sum of the decimal values of the bits you want to enable.

Mode	All
Remote Command	:STATus:QUESTionable:CALibration:ENABle <integer> :STATus:QUESTionable:CALibration:ENABle?
Example	STAT:QUES:CAL:ENAB 16384 Can be used to query if an alignment is needed, if you have turned off the automatic alignment process.
Min	0
Max	32767
Status Bits/OPC dependencies	Sequential command
Initial S/W Revision	Prior to A.02.00

Questionable Calibration Event Query

This query returns the decimal value of the sum of the bits in the Questionable Calibration Event register.

NOTE

The register requires that the associated PTR or NTR filters be set before a condition register bit can set a bit in the event register. The data in this register is latched until it is queried. Once queried, the register is cleared.

Mode	All
Remote Command	:STATus:QUESTionable:CALibration[:EVENT]?
Example	STAT:QUES:CAL?
Preset	0
Status Bits/OPC dependencies	Sequential command
Initial S/W Revision	Prior to A.02.00

Questionable Calibration Negative Transition

This command determines which bits in the Questionable Calibration Condition register will set the corresponding bit in the Questionable Calibration Event register when the condition register bit has a negative transition (1 to 0). The variable <integer> is the sum of the decimal values of the bits that you want to enable.

Mode	All
Remote Command	:STATus:QUESTionable:CALibration:NTRansition <integer> :STATus:QUESTionable:CALibration:NTRansition?
Example	STAT:QUES:CAL:NTR 16384 Alignment is not required.
Preset	0
Min	0
Max	32767
Status Bits/OPC dependencies	Sequential command
Initial S/W Revision	Prior to A.02.00

Questionable Calibration Positive Transition

This command determines which bits in the Questionable Calibration Condition register will set the corresponding bit in the Questionable Calibration Event register when the condition register bit has a positive transition (0 to 1). The variable <integer> is the sum of the decimal values of the bits that you want to enable.

Mode	All
Remote Command	:STATus:QUESTionable:CALibration:PTRansition <integer> :STATus:QUESTionable:CALibration:PTRansition?
Example	STAT:QUES:CAL:PTR 16384 Alignment is required.
Preset	32767

Min	0
Max	32767
Status Bits/OPC dependencies	Sequential command
Initial S/W Revision	Prior to A.02.00

Questionable Calibration Skipped Register

- "Questionable Calibration Skipped Condition " on page 209
- "Questionable Calibration Skipped Enable " on page 209
- "Questionable Calibration Skipped Event Query " on page 210
- "Questionable Calibration Skipped Negative Transition " on page 210
- "Questionable Calibration Skipped Positive Transition " on page 211

Questionable Calibration Skipped Condition

This query returns the decimal value of the sum of the bits in the Questionable Calibration Skipped Condition register.

NOTE

The data in this register is continuously updated and reflects the current conditions.

Mode	All
Remote Command	:STATus:QUESTionable:CALibration:SKIPPed:CONDition?
Example	STAT:QUES:CAL:SKIP:COND?
Preset	0
Status Bits/OPC dependencies	Sequential command
Initial S/W Revision	Prior to A.02.00

Questionable Calibration Skipped Enable

This command determines which bits in the Questionable Calibration Skipped Condition Register will set bits in the Questionable Calibration Skipped Event register, which also sets bit 11 of the Questionable Calibration Register. The variable <integer> is the sum of the decimal values of the bits you want to enable.

Mode	All
Remote Command	:STATus:QUESTionable:CALibration:SKIPPed:ENABle <integer> :STATus:QUESTionable:CALibration:SKIPPed:ENABle?
Example	STAT:QUES:CAL:SKIP:ENAB 1 Can be used to query if an EMI alignment skipped condition is

	detected
Preset	32767
Min	0
Max	32767
Status Bits/OPC dependencies	Sequential command
Initial S/W Revision	Prior to A.02.00

Questionable Calibration Skipped Event Query

This query returns the decimal value of the sum of the bits in the Questionable Calibration Event register.

NOTE

The register requires that the associated PTR or NTR filters be set before a condition register bit can set a bit in the event register. The data in this register is latched until it is queried. Once queried, the register is cleared.

Mode	All
Remote Command	:STATus:QUESTionable:CALibration:SKIPped[:EVENT]?
Example	STAT:QUES:CAL:SKIP?
Preset	0
Status Bits/OPC dependencies	Sequential command
Initial S/W Revision	Prior to A.02.00

Questionable Calibration Skipped Negative Transition

This command determines which bits in the Questionable Calibration Skipped Condition register will set the corresponding bit in the Questionable Calibration Skipped Event register when the condition register bit has a negative transition (1 to 0). The variable <integer> is the sum of the decimal values of the bits that you want to enable.

Mode	All
Remote Command	:STATus:QUESTionable:CALibration:SKIPped:NTRansition <integer> :STATus:QUESTionable:CALibration:SKIPped:NTRansition?
Example	STAT:QUES:CAL:SKIP:NTR 1 Align RF skipped is not required.
Preset	0
Min	0
Max	32767
Status Bits/OPC dependencies	Sequential command

Initial S/W Revision	Prior to A.02.00
----------------------	------------------

Questionable Calibration Skipped Positive Transition

This command determines which bits in the Questionable Calibration Skipped Condition register will set the corresponding bit in the Questionable Calibration Skipped Event register when the condition register bit has a positive transition (0 to 1). The variable <integer> is the sum of the decimal values of the bits that you want to enable.

Mode	All
Remote Command	:STATus:QUESTionable:CALibration:SKIPped:PTRansition <integer> :STATus:QUESTionable:CALibration:SKIPped:PTRansition?
Example	STAT:QUES:CAL:SKIP:PTR 1 Align RF skipped is required.
Preset	32767
Min	0
Max	32767
Status Bits/OPC dependencies	Sequential command
Initial S/W Revision	Prior to A.02.00

Questionable Calibration Extended Failure Register

- "Questionable Calibration Extended Failure Condition " on page 211
- "Questionable Calibration Extended Failure Enable " on page 212
- "Questionable Calibration Extended Failure Event Query " on page 212
- "Questionable Calibration Extended Failure Negative Transition " on page 213
- "Questionable Calibration Extended Failure Positive Transition " on page 213

Questionable Calibration Extended Failure Condition

This query returns the decimal value of the sum of the bits in the Questionable Calibration Extended Failure Condition register.

NOTE

The data in this register is continuously updated and reflects the current conditions.

Mode	All
------	-----

Remote Command	:STATus:QUEStionable:CALibration:EXTended:FAILure:CONDition?
Example	STAT:QUES:CAL:EXT:FAIL:COND?
Preset	0
Status Bits/OPC dependencies	Sequential command
Initial S/W Revision	Prior to A.02.00

Questionable Calibration Extended Failure Enable

This command determines which bits in the Questionable Calibration Extended Failure Condition Register will set bits in the Questionable Calibration Extended Failure Event register, which also sets bit 9 of the Questionable Calibration Register. The variable <integer> is the sum of the decimal values of the bits you want to enable.

Mode	All
Remote Command	:STATus:QUEStionable:CALibration:EXTended:FAILure:ENABle <integer> :STATus:QUEStionable:CALibration:EXTended:FAILure:ENABle?
Example	STAT:QUES:CAL:EXT:FAIL:ENAB 1 Can be used to query if an EMI conducted alignment is needed.
Preset	32767
Min	0
Max	32767
Status Bits/OPC dependencies	Sequential command
Initial S/W Revision	Prior to A.02.00

Questionable Calibration Extended Failure Event Query

This query returns the decimal value of the sum of the bits in the Questionable Calibration Extended Failure Event register.

NOTE

The register requires that the associated PTR or NTR filters be set before a condition register bit can set a bit in the event register. The data in this register is latched until it is queried. Once queried, the register is cleared.

Mode	All
Remote Command	:STATus:QUEStionable:CALibration:EXTended:FAILure[:EVENT]?
Example	STAT:QUES:CAL:EXT:FAIL?
Preset	0
Status Bits/OPC dependencies	Sequential command
Initial S/W Revision	Prior to A.02.00

Questionable Calibration Extended Failure Negative Transition

This command determines which bits in the Questionable Calibration Extended Failure Condition register will set the corresponding bit in the Questionable Calibration Extended Failure Event register when the condition register bit has a negative transition (1 to 0). The variable <integer> is the sum of the decimal values of the bits that you want to enable.

Mode	All
Remote Command	<code>:STATus:QUESTionable:CALibration:EXTended:FAILure:NTRansition <integer></code> <code>:STATus:QUESTionable:CALibration:EXTended:FAILure:NTRansition?</code>
Example	STAT:QUES:CAL:EXT:FAIL:NTR 1 EMI conducted align failure is not required.
Preset	0
Min	0
Max	32767
Status Bits/OPC dependencies	Sequential command
Initial S/W Revision	Prior to A.02.00

Questionable Calibration Extended Failure Positive Transition

This command determines which bits in the Questionable Calibration Extended Failure Condition register will set the corresponding bit in the Questionable Calibration Extended Failure Event register when the condition register bit has a positive transition (0 to 1). The variable <integer> is the sum of the decimal values of the bits that you want to enable.

Mode	All
Remote Command	<code>:STATus:QUESTionable:CALibration:EXTended:FAILure:PTRansition <integer></code> <code>:STATus:QUESTionable:CALibration:EXTended:FAILure:PTRansition?</code>
Example	STAT:QUES:CAL:EXT:FAIL:PTR 1 EMI conducted align failure is required.
Preset	32767
Min	0
Max	32767
Status Bits/OPC dependencies	Sequential command
Initial S/W Revision	Prior to A.02.00

Questionable Calibration Extended Needed Register

- "Questionable Calibration Extended Needed Condition " on page 214
- "Questionable Calibration Extended Needed Enable " on page 214
- "Questionable Calibration Extended Needed Event Query " on page 215
- "Questionable Calibration Extended Needed Negative Transition " on page 215
- "Questionable Calibration Extended Needed Positive Transition " on page 216

Questionable Calibration Extended Needed Condition

This query returns the decimal value of the sum of the bits in the Questionable Calibration Extended Needed Condition register.

NOTE

The data in this register is continuously updated and reflects the current conditions.

Mode	All
Remote Command	:STATus:QUESTionable:CALibration:EXTended:NEEDed:CONDition?
Example	STAT:QUES:CAL:EXT:NEED:COND?
Preset	0
Status Bits/OPC dependencies	Sequential command
Initial S/W Revision	Prior to A.02.00

Questionable Calibration Extended Needed Enable

This command determines which bits in the Questionable Calibration Extended Needed Condition Register will set bits in the Questionable Calibration Extended Needed Event register, which also sets bit 14 of the Questionable Calibration Register. The variable <integer> is the sum of the decimal values of the bits you want to enable.

Mode	All
Remote Command	:STATus:QUESTionable:CALibration:EXTended:NEEDed:ENABle <integer> :STATus:QUESTionable:CALibration:EXTended:NEEDed:ENABle?
Example	STAT:QUES:CAL:EXT:NEED:ENAB 2 Can be used to query if an EMI conducted alignment is needed.
Preset	32767
Min	0
Max	32767
Status Bits/OPC	Sequential command

dependencies	
Initial S/W Revision	Prior to A.02.00

Questionable Calibration Extended Needed Event Query

This query returns the decimal value of the sum of the bits in the Questionable Calibration Extended Needed Event register.

NOTE

The register requires that the associated PTR or NTR filters be set before a condition register bit can set a bit in the event register. The data in this register is latched until it is queried. Once queried, the register is cleared.

Mode	All
Remote Command	:STATus:QUESTionable:CALibration:EXTended:NEEDED[:EVENT]?
Example	STAT:QUES:CAL:EXT:NEED?
Preset	0
Status Bits/OPC dependencies	Sequential command
Initial S/W Revision	Prior to A.02.00

Questionable Calibration Extended Needed Negative Transition

This command determines which bits in the Questionable Calibration Extended Needed Condition register will set the corresponding bit in the Questionable Calibration Extended Needed Event register when the condition register bit has a negative transition (1 to 0). The variable <integer> is the sum of the decimal values of the bits that you want to enable.

Mode	All
Remote Command	:STATus:QUESTionable:CALibration:EXTended:NEEDED:NTRansition <integer> :STATus:QUESTionable:CALibration:EXTended:NEEDED:NTRansition?
Example	STAT:QUES:CAL:EXT:NEED:NTR 2 Align EMI conducted is not required.
Preset	0
Min	0
Max	32767
Status Bits/OPC dependencies	Sequential command
Initial S/W Revision	Prior to A.02.00

Questionable Calibration Extended Needed Positive Transition

This command determines which bits in the Questionable Calibration Extended Needed Condition register will set the corresponding bit in the Questionable Calibration Extended Needed Event register when the condition register bit has a positive transition (0 to 1). The variable <integer> is the sum of the decimal values of the bits that you want to enable.

Mode	All
Remote Command	:STATus:QUESTionable:CALibration:EXTended:NEEDED:PTRansition <integer> :STATus:QUESTionable:CALibration:EXTended:NEEDED:PTRansition?
Example	STAT:QUES:CAL:EXT:NEED:PTR 2 Align EMI conducted is required.
Preset	32767
Min	0
Max	32767
Status Bits/OPC dependencies	Sequential command
Initial S/W Revision	Prior to A.02.00

Questionable Frequency Register

- "Questionable Frequency Condition " on page 216
- "Questionable Frequency Enable " on page 217
- "Questionable Frequency Event Query " on page 217
- "Questionable Frequency Negative Transition " on page 217
- "Questionable Frequency Positive Transition " on page 218

Questionable Frequency Condition

This query returns the decimal value of the sum of the bits in the Questionable Frequency Condition register.

NOTE

The data in this register is continuously updated and reflects the current conditions.

Mode	All
Remote Command	:STATus:QUESTionable:FREQuency:CONDition?
Example	STAT:QUES:FREQ:COND?
Preset	0
Status Bits/OPC dependencies	Sequential command
Initial S/W Revision	Prior to A.02.00

Questionable Frequency Enable

This command determines which bits in the Questionable Frequency Condition Register will set bits in the Questionable Frequency Event register, which also sets the Frequency Summary bit (bit 5) in the Questionable Register. The variable <integer> is the sum of the decimal values of the bits you want to enable.

Mode	All
Remote Command	:STATus:QUESTionable:FREQuency:ENABle <integer> :STATus:QUESTionable:FREQuency:ENABle?
Example	STAT:QUES:FREQ:ENAB 2 Frequency Reference Unlocked will be reported to the Frequency Summary of the Status Questionable register.
Preset	32767
Min	0
Max	32767
Status Bits/OPC dependencies	Sequential command
Initial S/W Revision	Prior to A.02.00

Questionable Frequency Event Query

This query returns the decimal value of the sum of the bits in the Questionable Frequency Event register.

NOTE

The register requires that the associated PTR or NTR filters be set before a condition register bit can set a bit in the event register. The data in this register is latched until it is queried. Once queried, the register is cleared.

Mode	All
Remote Command	:STATus:QUESTionable:FREQuency[:EVENT]?
Example	STAT:QUES:FREQ?
Preset	0
Status Bits/OPC dependencies	Sequential command
Initial S/W Revision	Prior to A.02.00

Questionable Frequency Negative Transition

This command determines which bits in the Questionable Frequency Condition register will set the corresponding bit in the Questionable Frequency Event register when the condition register bit has a negative transition (1 to 0). The variable <integer> is the sum of the decimal values of the bits that you want to enable.

Mode	All
Remote Command	:STATus:QUESTionable:FREQuency:NTRansition <integer> :STATus:QUESTionable:FREQuency:NTRansition?
Example	STAT:QUES:FREQ:NTR 2 Frequency Reference 'regained lock' will be reported to the Frequency Summary of the Status Questionable register.
Preset	0
Min	0
Max	32767
Status Bits/OPC dependencies	Sequential command
Initial S/W Revision	Prior to A.02.00

Questionable Frequency Positive Transition

This command determines which bits in the Questionable Frequency Condition register will set the corresponding bit in the Questionable Frequency Event register when the condition register bit has a positive transition (0 to 1). The variable <integer> is the sum of the decimal values of the bits that you want to enable.

Mode	All
Remote Command	:STATus:QUESTionable:FREQuency:PTRansition <integer> :STATus:QUESTionable:FREQuency:PTRansition?
Example	STAT:QUES:FREQ:PTR 2 Frequency Reference 'became unlocked' will be reported to the Frequency Summary of the Status Questionable register.
Preset	32767
Min	0
Max	32767
Status Bits/OPC dependencies	Sequential command
Initial S/W Revision	Prior to A.02.00

Questionable Integrity Register

- "Questionable Integrity Condition " on page 219
- "Questionable Integrity Enable " on page 219
- "Questionable Integrity Event Query " on page 219
- "Questionable Integrity Negative Transition " on page 220
- "Questionable Integrity Positive Transition " on page 220

Questionable Integrity Condition

This query returns the decimal value of the sum of the bits in the Questionable Integrity Condition register.

NOTE

The data in this register is continuously updated and reflects the current conditions.

Mode	All
Remote Command	:STATus:QUESTionable:INTEgrity:CONDition?
Example	STAT:QUES:INT:COND?
Preset	0
Status Bits/OPC dependencies	Sequential command
Initial S/W Revision	Prior to A.02.00

Questionable Integrity Enable

This command determines which bits in the Questionable Integrity Condition Register will set bits in the Questionable Integrity Event register, which also sets the Integrity Summary bit (bit 9) in the Questionable Register. The variable <integer> is the sum of the decimal values of the bits you want to enable.

Mode	All
Remote Command	:STATus:QUESTionable:INTEgrity:ENABle <integer> :STATus:QUESTionable:INTEgrity:ENABle?
Example	STAT:QUES:INT:ENAB 8 Measurement Uncalibrated Summary will be reported to the Integrity Summary of the Status Questionable register.
Preset	32767
Min	0
Max	32767
Status Bits/OPC dependencies	Sequential command
Initial S/W Revision	Prior to A.02.00

Questionable Integrity Event Query

This query returns the decimal value of the sum of the bits in the Questionable Integrity Event register.

NOTE

The register requires that the associated PTR or NTR filters be set before a condition register bit can set a bit in the event register. The data in this register is latched until it is queried. Once queried, the register is cleared.

Mode	All
Remote Command	:STATus:QUESTionable:INTEgrity[:EVENT]?
Example	STAT:QUES:INT?
Preset	0
Status Bits/OPC dependencies	Sequential command
Initial S/W Revision	Prior to A.02.00

Questionable Integrity Negative Transition

This command determines which bits in the Questionable Integrity Condition register will set the corresponding bit in the Questionable Integrity Event register when the condition register bit has a negative transition (1 to 0)

The variable <integer> is the sum of the decimal values of the bits that you want to enable.

Mode	All
Remote Command	:STATus:QUESTionable:INTEgrity:NTRansition <integer> :STATus:QUESTionable:INTEgrity:NTRansition?
Example	STAT:QUES:INT:NTR 8 Measurement 'regained calibration' Summary will be reported to the Integrity Summary of the Status Questionable register.
Preset	0
Min	0
Max	32767
Status Bits/OPC dependencies	Sequential command
Initial S/W Revision	Prior to A.02.00

Questionable Integrity Positive Transition

This command determines which bits in the Questionable Integrity Condition register will set the corresponding bit in the Questionable Integrity Event register when the condition register bit has a positive transition (0 to 1). The variable <integer> is the sum of the decimal values of the bits that you want to enable.

Mode	All
Remote Command	:STATus:QUESTionable:INTEgrity:PTRansition <integer> :STATus:QUESTionable:INTEgrity:PTRansition?
Example	STAT:QUES:INT:PTR 8 Measurement 'became uncalibrated' Summary will be reported to the Integrity Summary of the Status Questionable register.
Preset	32767

Min	0
Max	32767
Status Bits/OPC dependencies	Sequential command
Initial S/W Revision	Prior to A.02.00

Questionable Integrity Signal Register

- "Questionable Integrity Signal Condition" on page 221
- "Questionable Integrity Signal Enable" on page 221
- "Questionable Integrity Signal Event Query" on page 222
- "Questionable Integrity Signal Negative Transition" on page 222
- "Questionable Integrity Signal Positive Transition" on page 223

Questionable Integrity Signal Condition

This query returns the decimal value of the sum of the bits in the Questionable Integrity Signal Condition register.

NOTE

The data in this register is continuously updated and reflects the current conditions.

Mode	All
Remote Command	:STATus:QUESTionable:INTEgrity:SIGNal:CONDition?
Example	STAT:QUES:INT:SIGN:COND?
Preset	0
Status Bits/OPC dependencies	Sequential command
Initial S/W Revision	Prior to A.02.00

Questionable Integrity Signal Enable

This command determines which bits in the Questionable Integrity Signal Condition Register will set bits in the Questionable Integrity Signal Event register, which also sets the Integrity Summary bit (bit 9) in the Questionable Register. The variable <integer> is the sum of the decimal values of the bits you want to enable.

Mode	All
Remote Command	:STATus:QUESTionable:INTEgrity:SIGNal:ENABle <integer> :STATus:QUESTionable:INTEgrity:SIGNal:ENABle?
Example	STAT:QUES:INT:SIGN:ENAB 4 Burst Not Found will be reported to the Integrity Summary of the

	Status Questionable register.
Preset	32767
Min	0
Max	32767
Status Bits/OPC dependencies	Sequential command
Initial S/W Revision	Prior to A.02.00

Questionable Integrity Signal Event Query

This query returns the decimal value of the sum of the bits in the Questionable Integrity Signal Event register.

NOTE

The register requires that the associated PTR or NTR filters be set before a condition register bit can set a bit in the event register. The data in this register is latched until it is queried. Once queried, the register is cleared.

Mode	All
Remote Command	:STATus:QUESTionable:INTEgrity:SIGNal[:EVENT]?
Example	STAT:QUES:INT:SIGN?
Preset	0
Status Bits/OPC dependencies	Sequential command
Initial S/W Revision	Prior to A.02.00

Questionable Integrity Signal Negative Transition

This command determines which bits in the Questionable Integrity Signal Condition register will set the corresponding bit in the Questionable Integrity Signal Event register when the condition register bit has a negative transition (1 to 0). The variable <integer> is the sum of the decimal values of the bits that you want to enable.

Mode	All
Remote Command	:STATus:QUESTionable:INTEgrity:SIGNal:NTRansition <integer> :STATus:QUESTionable:INTEgrity:SIGNal:NTRansition?
Example	STAT:QUES:INT:SIGN:NTR 4 Burst found will be reported to the Integrity Summary of the Status Questionable register.
Preset	0
Min	0
Max	32767
Status Bits/OPC dependencies	Sequential command

Initial S/W Revision Prior to A.02.00

Questionable Integrity Signal Positive Transition

This command determines which bits in the Questionable Integrity Signal Condition register will set the corresponding bit in the Questionable Integrity Signal Event register when the condition register bit has a positive transition (0 to 1). The variable <integer> is the sum of the decimal values of the bits that you want to enable.

Mode	All
Remote Command	:STATus:QUESTionable:INTEgrity:SIGNal:PTRansition <integer> :STATus:QUESTionable:INTEgrity:SIGNal:PTRansition?
Example	STAT:QUES:INT:SIGN:PTR 4 Burst not found will be reported to the Integrity Summary of the Status Questionable register.
Preset	32767
Min	0
Max	32767
Status Bits/OPC dependencies	Sequential command
Initial S/W Revision	Prior to A.02.00

Questionable Integrity Uncalibrated Register

- ["Questionable Integrity Uncalibrated Condition "](#) on page 223
- ["Questionable Integrity Uncalibrated Enable "](#) on page 224
- ["Questionable Integrity Uncalibrated Event Query "](#) on page 224
- ["Questionable Integrity Uncalibrated Negative Transition "](#) on page 225
- ["Questionable Integrity Uncalibrated Positive Transition "](#) on page 225

Questionable Integrity Uncalibrated Condition

This query returns the decimal value of the sum of the bits in the Questionable Integrity Uncalibrated Condition register.

NOTE

The data in this register is continuously updated and reflects the current conditions.

Mode	All
Remote Command	:STATus:QUESTionable:INTEgrity:UNCalibrated:CONDition?
Example	STAT:QUES:INT:UNC:COND?

Preset	0
Status Bits/OPC dependencies	Sequential command
Initial S/W Revision	Prior to A.02.00

Questionable Integrity Uncalibrated Enable

This command determines which bits in the Questionable Integrity Uncalibrated Condition Register will set bits in the Questionable Integrity Uncalibrated Event register, which also sets the Data Uncalibrated Summary bit (bit 3) in the Questionable Integrity Register. The variable <integer> is the sum of the decimal values of the bits you want to enable.

Mode	All
Remote Command	:STATus:QUEStionable:INTEgrity:UNCalibrated:ENABle :STATus:QUEStionable:INTEgrity:UNCalibrated:ENABle?
Example	STAT:QUES:INT:UNC:ENAB 1 Oversweep (Meas Uncal) will be reported to the Integrity Summary of the Status Questionable register.
Preset	32767
Min	0
Max	32767
Status Bits/OPC dependencies	Sequential command
Initial S/W Revision	Prior to A.02.00

Questionable Integrity Uncalibrated Event Query

This query returns the decimal value of the sum of the bits in the Questionable Integrity Uncalibrated Event register.

NOTE

The register requires that the associated PTR or NTR filters be set before a condition register bit can set a bit in the event register. The data in this register is latched until it is queried. Once queried, the register is cleared.

Mode	All
Remote Command	:STATus:QUEStionable:INTEgrity:UNCalibrated[:EVENT]?
Example	STAT:QUES:INT:UNC?
Preset	0
Status Bits/OPC dependencies	Sequential command
Initial S/W Revision	Prior to A.02.00

Questionable Integrity Uncalibrated Negative Transition

This command determines which bits in the Questionable Integrity Uncalibrated Condition register will set the corresponding bit in the Questionable Integrity Uncalibrated Event register when the condition register bit has a negative transition (1 to 0). The variable <integer> is the sum of the decimal values of the bits that you want to enable.

Mode	All
Remote Command	:STATus:QUEStionable:INTEgrity:UNCalibrated:NTRansition <integer> :STATus:QUEStionable:INTEgrity:UNCalibrated:NTRansition?
Example	STAT:QUES:INT:UNC:NTR 1 Oversweep cleared will be reported to the Integrity Summary of the Status Questionable register.
Preset	0
Min	0
Max	32767
Status Bits/OPC dependencies	Sequential command
Initial S/W Revision	Prior to A.02.00

Questionable Integrity Uncalibrated Positive Transition

This command determines which bits in the Questionable Integrity Uncalibrated Condition register will set the corresponding bit in the Questionable Integrity Uncalibrated Event register when the condition register bit has a positive transition (0 to 1). The variable <integer> is the sum of the decimal values of the bits that you want to enable.

Mode	All
Remote Command	:STATus:QUEStionable:INTEgrity:UNCalibrated:PTRansition <integer> :STATus:QUEStionable:INTEgrity:UNCalibrated:PTRansition?
Example	STAT:QUES:INT:UNC:PTR 1 Oversweep (Meas Uncal) occurred will be reported to the Integrity Summary of the Status Questionable register.
Preset	32767
Min	0
Max	32767
Status Bits/OPC dependencies	Sequential command
Initial S/W Revision	Prior to A.02.00

Questionable Power Register

- "Questionable Power Condition " on page 226
- "Questionable Power Enable " on page 226
- "Questionable Power Event Query " on page 227
- "Questionable Power Negative Transition " on page 227
- "Questionable Power Positive Transition " on page 227

Questionable Power Condition

This query returns the decimal value of the sum of the bits in the Questionable Power Condition register.

NOTE

The data in this register is continuously updated and reflects the current conditions.

Mode	All
Remote Command	:STATus:QUESTionable:POWer:CONDition?
Example	STAT:QUES:POW:COND?
Preset	0
Status Bits/OPC dependencies	Sequential command
Initial S/W Revision	Prior to A.02.00

Questionable Power Enable

This command determines which bits in the Questionable Power Condition Register will set bits in the Questionable Power Event register, which also sets the Power Summary bit (bit 3) in the Questionable Register. The variable <integer> is the sum of the decimal values of the bits you want to enable.

Mode	All
Remote Command	:STATus:QUESTionable:POWer:ENABle <integer> :STATus:QUESTionable:POWer:ENABle?
Example	STAT:QUES:POW:ENAB 32 50 MHz Input Pwr too High for Cal will be reported to the Power Summary of the Status Questionable register.
Preset	32767
Min	0
Max	32767
Status Bits/OPC dependencies	Sequential command
Initial S/W Revision	Prior to A.02.00

Questionable Power Event Query

This query returns the decimal value of the sum of the bits in the Questionable Power Event register.

NOTE

The register requires that the associated PTR or NTR filters be set before a condition register bit can set a bit in the event register. The data in this register is latched until it is queried. Once queried, the register is cleared.

Mode	All
Remote Command	:STATus:QUESTionable:POWer[:EVENT]?
Example	STAT:QUES:POW?
Preset	0
Status Bits/OPC dependencies	Sequential command
Initial S/W Revision	Prior to A.02.00

Questionable Power Negative Transition

This command determines which bits in the Questionable Power Condition register will set the corresponding bit in the Questionable Power Event register when the condition register bit has a negative transition (1 to 0). The variable <integer> is the sum of the decimal values of the bits that you want to enable.

Mode	All
Remote Command	:STATus:QUESTionable:POWer:NTRansition <integer> :STATus:QUESTionable:POWer:NTRansition?
Example	STAT:QUES:POW:NTR 32 50 MHz Input Power became OK for Cal will be reported to the Power Summary of the Status Questionable register.
Preset	0
Min	0
Max	32767
Status Bits/OPC dependencies	Sequential command
Initial S/W Revision	Prior to A.02.00

Questionable Power Positive Transition

This command determines which bits in the Questionable Power Condition register will set the corresponding bit in the Questionable Power Event register when the condition register bit has a positive transition (0 to 1). The variable <integer> is the sum of the decimal values of the bits that you want to enable.

Mode	All
Remote Command	:STATus:QUESTionable:POWer:PTRansition <integer> :STATus:QUESTionable:POWer:PTRansition?>
Example	STAT:QUES:POW:PTR 32 50 MHz Input Power became too high for Cal will be reported to the Power Summary of the Status Questionable register.
Preset	32767
Min	0
Max	32767
Status Bits/OPC dependencies	Sequential command
Initial S/W Revision	Prior to A.02.00

Questionable Temperature Register

- "Questionable Temperature Condition" on page 228
- "Questionable Temperature Enable" on page 228
- "Questionable Temperature Event Query" on page 229
- "Questionable Temperature Negative Transition" on page 229
- "Questionable Temperature Positive Transition" on page 230

Questionable Temperature Condition

This query returns the decimal value of the sum of the bits in the Questionable Temperature Condition register.

NOTE

The data in this register is continuously updated and reflects the current conditions.

Mode	All
Remote Command	:STATus:QUESTionable:TEMPerature:CONDition?
Example	STAT:QUES:TEMP:COND?
Preset	0
Status Bits/OPC dependencies	Sequential command
Initial S/W Revision	Prior to A.02.00

Questionable Temperature Enable

This command determines which bits in the Questionable Temperature Condition Register will set bits in the Questionable Temperature Event register, which also

sets the Temperature Summary bit (bit 4) in the Questionable Register. The variable <integer> is the sum of the decimal values of the bits you want to enable.

Mode	All
Remote Command	:STATus:QUESTionable:TEMPerature:ENABle <integer> :STATus:QUESTionable:TEMPerature:ENABle?
Example	STAT:QUES:TEMP:ENAB 1 Reference Oscillator Oven Cold will be reported to the Temperature Summary of the Status Questionable register.
Preset	32767
Min	0
Max	32767
Status Bits/OPC dependencies	Sequential command
Initial S/W Revision	Prior to A.02.00

Questionable Temperature Event Query

This query returns the decimal value of the sum of the bits in the Questionable Temperature Event register.

NOTE

The register requires that the associated PTR or NTR filters be set before a condition register bit can set a bit in the event register. The data in this register is latched until it is queried. Once queried, the register is cleared

Mode	All
Remote Command	:STATus:QUESTionable:TEMPerature[:EVENT]?
Example	STAT:QUES:TEMP?
Preset	0
Status Bits/OPC dependencies	Sequential command
Initial S/W Revision	Prior to A.02.00

Questionable Temperature Negative Transition

This command determines which bits in the Questionable Temperature Condition register will set the corresponding bit in the Questionable Temperature Event register when the condition register bit has a negative transition (1 to 0). The variable <integer> is the sum of the decimal values of the bits that you want to enable.

Mode	All
Remote Command	:STATus:QUESTionable:TEMPerature:NTRansition <integer> :STATus:QUESTionable:TEMPerature:NTRansition?

Example	STAT:QUES:TEMP:NTR 1 Reference Oscillator Oven not cold will be reported to the Temperature Summary of the Status Questionable register.
Preset	0
Min	0
Max	32767
Status Bits/OPC dependencies	Sequential command
Initial S/W Revision	Prior to A.02.00

Questionable Temperature Positive Transition

This command determines which bits in the Questionable Temperature Condition register will set the corresponding bit in the Questionable Temperature Event register when the condition register bit has a positive transition (0 to 1). The variable <integer> is the sum of the decimal values of the bits that you want to enable.

Mode	All
Remote Command	:STATus:QUEStionable:TEMPerature:PTRansition <integer> :STATus:QUEStionable:TEMPerature:PTRansition?
Example	STAT:QUES:TEMP:PTR 1 Reference Oscillator Oven became cold will be reported to the Temperature Summary of the Status Questionable register.
Preset	32767
Min	0
Max	32767
Status Bits/OPC dependencies	Sequential command
Initial S/W Revision	Prior to A.02.00

IEEE 488.2 Common Commands

The instrument supports the following subset of IEEE 488.2 Common Commands, as defined in Chapter 10 of [IEEE Standard 488.2-1992](#). As indicated in the detailed descriptions, some of these commands correspond directly to instrument front-panel key functionality, while others are available only as remote commands.

Command	Description
*CAL?	Align Now "All " on page 461
*CLS	"Clear Status" on page 234
*ESE	"Standard Event Status Enable " on page 234
*ESE?	
*ESR?	"Standard Event Status Register Query" on page 235
*IDN?	"Identification Query" on page 235
*OPC	"Operation Complete" on page 235
*OPC?	
*OPT?	"Query Instrument Options" on page 236
*RCL	"Recall Instrument State" on page 237
*RST	"*RST (Remote Command Only)" on page 237
*SAV	"Save Instrument State" on page 238
*SRE	"Service Request Enable" on page 238
*SRE?	
*STB?	"Status Byte Query" on page 238
*TRG	"Trigger" on page 239
*TST?	"Self Test Query" on page 239
*WAI	"Wait-to-Continue" on page 239

All

(In MXE the key label is "**All (plus RF Presel 20 Hz – 3.6 GHz)**") Immediately executes an alignment of all subsystems.

In MXE, the Align Now All is followed by additionally aligning the RF Preselector section, so in MXE, the key label contains the parenthetical note "(plus RF Presel 20 Hz – 3.6 GHz)". The instrument stops any measurement currently underway, performs the alignment, then restarts the measurement from the beginning (similar to pressing the **Restart** key).

If an interfering user signal is present at the RF Input, the alignment is performed on all subsystems except the RF. After completion, the Error Condition message "Align skipped: 50 MHz interference" or "Align skipped: 4.8 GHz interference" is generated. In addition the Error Condition message "Align Now, RF required" is generated, and bits 11 and 12 are set in the Status Questionable Calibration register.

The query form of the remote commands (:CALibration[:ALL]? or *CAL?) invokes the alignment of all subsystems and returns a success or failure value. An interfering user signal is not grounds for failure; if the alignment was able to succeed on all portions but unable to align the RF because of an interfering signal, the resultant will be the success value.

Successful completion of **Align Now, All** will clear the “Align Now, All required” Error Condition, and clear bit 14 in the Status Questionable Calibration register. It will also begin the elapsed time counter for Last Align Now, All Time, and capture the Last Align Now, All Temperature.

In the MXE, successful completion will also clear the “Align 20 Hz to 30 MHz required” Error Condition, the “Align 30 MHz to 3.6 GHz required” Error Condition, and the “Align 20 Hz to 3.6 GHz required” Error Condition, and clear bits 1 and bit 2 and clear the bit 1 in the Status Questionable Calibration Extended Needed register.

If the Align RF subsystem succeeded in aligning (no interfering signal present), the elapsed time counter begins for Last Align Now, RF Time, and the temperature is captured for the Last Align Now, RF Temperature. In addition the Error Conditions “Align skipped: 50 MHz interference” and “Align skipped: 4.8 GHz interference” are cleared, the Error Condition “Align Now, RF required” is cleared, and bits 11 and 12 are cleared in the Status Questionable Calibration register

Align Now, All can be interrupted by pressing the Cancel (ESC) front-panel key or remotely with Device Clear followed by the :ABORt SCPI command. When this occurs the Error Condition message “Align Now, All required” is generated, and bit 14 is set in the Status Questionable Condition register. This is because new alignment data may be employed for an individual subsystem, but not a cohesive set of data for all subsystems.

In many cases, you might find it more convenient to change alignments to Normal, instead of executing Align Now, All. When the Auto Align process transitions to Normal, the analyzer will immediately start to update only the alignments that have expired, thus efficiently restoring the alignment process.

Key Path	System, Alignments, Align Now
Mode	All
Remote Command	:CALibration[:ALL] :CALibration[:ALL]?
Example	:CAL
Notes	:CALibration[:ALL]? returns 0 if successful :CALibration[:ALL]? returns 1 if failed :CALibration[:ALL]? is the same as *CAL? While Align Now, All is performing the alignment, bit 0 in the Status Operation register is set. Completion, or termination, will clear bit 0 in the Status Operation register. This command is sequential; it must complete before further SCPI commands are processed. Interrupting the alignment from remote is accomplished by invoking Device Clear followed by the :ABORt command. Successful completion will clear bit 14 in the Status Questionable Calibration register.

	<p>An interfering user signal is not grounds for failure of Align Now, All. However, bits 11 and 12 are set in the Status Questionable Calibration register to indicate Align Now, RF is required.</p> <p>An interfering user supplied signal will result in the instrument requiring an Align Now, RF with the interfering signal removed.</p>
Couplings	<p>Initializes the time for the Last Align Now, All Time.</p> <p>Records the temperature for the Last Align Now, All Temperature.</p> <p>If Align RF component succeeded, initializes the time for the Last Align Now, RF Time.</p> <p>If Align RF component succeeded, records the temperature for the Last Align Now, RF Temperature.</p>
Status Bits/OPC dependencies	Bits 11, 12, or 14 may be set in the Status Questionable Calibration register.
Initial S/W Revision	Prior to A.02.00

Mode	All
Remote Command	*CAL?
Example	*CAL?
Notes	<p>*CAL? returns 0 if successful</p> <p>*CAL? returns 1 if failed</p> <p>:CALibration[:ALL]? is the same as *CAL?</p> <p>See additional remarks described with :CALibration[:ALL]?</p> <p>Everything about :CALibration[:ALL]? is synonymous with *CAL? including all conditions, status register bits, and couplings</p>
Initial S/W Revision	Prior to A.02.00

Mode	All
Remote Command	:CALibration[:ALL]:NPending
Example	CAL:NPEN
Notes	<p>:CALibration[:ALL]:NPending is the same as :CALibration[:ALL] including all conditions, status register bits, except this scpi command does not BLOCK the scpi session, so the user should use status register bits to query if the calibration is successfully completed or not.</p> <p>Typical usage is:</p> <ol style="list-style-type: none"> 1) :CALibration:ALL:NPending (Start a calibration) 2) :STATus:OPERation:CONDition? (Check if the calibration is completed or not, If bit 0 is set, then the system is doing calibration, the user should repeat this scpi query until the bit is cleared) 3):STATus:QUESTionable:CALibration:CONDition? (Check if there are any errors/failures in previous calibration procedure
Initial S/W Revision	X.14.20

Clear Status

Clears the status byte register. It does this by emptying the error queue and clearing all bits in all of the event registers. The status byte register summarizes the states of the other registers. It is also responsible for generating service requests.

Key Path	No equivalent key. Related key System, Show Errors, Clear Error Queue
Remote Command	*CLS
Example	*CLS Clears the error queue and the Status Byte Register.
Notes	For related commands, see the SYSTem:ERRor[:NEXT]? command. See also the STATus:PRESet command and all commands in the STATus subsystem.
Status Bits/OPC dependencies	Resets all bits in all event registers to 0, which resets all the status byte register bits to 0 also.
Backwards Compatibility Notes	In general the status bits used in the X-Series status system will be backwards compatible with ESA and PSA. However, note that all conditions will generate events that go into the event log, and some will also generate status bits.
Initial S/W Revision	Prior to A.02.00

Standard Event Status Enable

Selects the desired bits from the standard event status enable register. This register monitors I/O errors and synchronization conditions such as operation complete, request control, query error, device dependent error, status execution error, command error, and power on. The selected bits are OR'd to become a summary bit (bit 5) in the byte register which can be queried.

The query returns the state of the standard event status enable register.

Key Path	No equivalent key. Related key System, Show Errors, Clear Error Queue
Remote Command	*ESE <integer> *ESE?
Example	*ESE 36 Enables the Standard Event Status Register to monitor query and command errors (bits 2 and 5). *ESE? Returns a 36 indicating that the query and command status bits are enabled.
Notes	For related commands, see the STATus subsystem and SYSTem:ERRor[:NEXT]? commands.
Preset	255
State Saved	Not saved in state.
Min	0
Max	255
Status Bits/OPC dependencies	Event Enable Register of the Standard Event Status Register.
Initial S/W Revision	Prior to A.02.00

Standard Event Status Register Query

Queries and clears the standard event status event register. (This is a destructive read.) The value returned is a hexadecimal number that reflects the current state (0/1) of all the bits in the register.

Remote Command	*ESR?
Example	*ESR? Returns a 1 if there is either a query or command error, otherwise it returns a zero.
Notes	For related commands, see the STATus subsystem commands.
Preset	0
Min	0
Max	255
Status Bits/OPC dependencies	Standard Event Status Register (bits 0 – 7).
Initial S/W Revision	Prior to A.02.00

Identification Query

Returns a string of instrument identification information. The string will contain the model number, serial number, and firmware revision.

The response is organized into four fields separated by commas. The field definitions are as follows:

- Manufacturer
- Model
- Serial number
- Firmware version

Key Path	No equivalent key. See related key System , Show System .
Remote Command	*IDN?
Example	*IDN? Returns instrument identification information, such as: Keysight Technologies, N9020A, US01020004, A.01.02
Initial S/W Revision	Prior to A.02.00
Modified at S/W Revision	x.14.50

Operation Complete

The *OPC command sets bit 0 in the standard event status register (SER) to “1” when pending operations have finished, that is when all overlapped commands are complete. It does not hold off subsequent operations. You can determine when the overlapped commands have completed either by polling the OPC bit in SER, or by

setting up the status system such that a service request (SRQ) is asserted when the OPC bit is set.

The *OPC? query returns a "1" after all the current overlapped commands are complete. So it holds off subsequent commands until the "1" is returned, then the program continues. This query can be used to synchronize events of other instruments on the external bus.

Remote Command	*OPC *OPC?
Example	INIT:CONT 0 Selects single sweeping. INIT:IMM Initiates a sweep. *OPC? Holds off any further commands until the sweep is complete.
Status Bits/OPC dependencies	Not global to all remote ports or front panel. *OPC only considers operation that was initiated on the same port as the *OPC command was issued from. *OPC is an overlapped command, but *OPC? is sequential.
Backwards Compatibility Notes	<ol style="list-style-type: none"> 1. The ESA/PSA/VSA products do not meet all the requirements for the *OPC command specified by IEEE 488.2. This is corrected for X-Series. This will sometimes cause behavior that is not backward compatible, but it will work as customers expect. 2. Commands such as, *OPC/*OPC?/*WAI/*RST used to be global. They considered front panel operation in conjunction with the GPIB functionality. Now they are evaluated on a per channel basis. That is, the various rear panel remote ports and the front panel i/o are all considered separately. Only the functionality initiated on the port where the *OPC was sent, is considered for its operation. 3. *OPC used to hold off until the operation bits were cleared. Now it holds off until all overlapping commands are completed. Also, earlier instruments did not wait for completion of all processes, only the ones identified here (in the STATus:OPERation register): Calibrating: monitored by PSA, ESA, VSA (E4406A) Sweeping: monitored by PSA, ESA, VSA (E4406A) Waiting for Trigger: monitored by PSA, ESA, VSA (E4406A) Measuring: monitored by PSA and ESA (but not in all Modes). Paused: monitored by VSA (E4406A). Printing: monitored by VSA (E4406A). Mass memory busy: monitored by VSA (E4406A).
Initial S/W Revision	Prior to A.02.00

Query Instrument Options

Returns a string of all the installed instrument options. It is a comma separated list with quotes, such as: "503,P03,PFR".

To be IEEE compliant, this command should return an arbitrary ascii variable that would not begin and end with quotes. But the quotes are needed to be backward compatible with previous SA products and software. So, the actual implementation

will use arbitrary ascii. But quotes will be sent as the first and last ascii characters that are sent with the comma-separated option list.

Remote Command	*OPT?
Initial S/W Revision	Prior to A.02.00

Recall Instrument State

This command recalls the instrument state from the specified instrument memory register.

- If the state being loaded has a newer firmware revision than the revision of the instrument, no state is recalled and an error is reported
- If the state being loaded has an equal firmware revision than the revision of the instrument, the state will be loaded.
- If the state being loaded has an older firmware revision than the revision of the instrument, the instrument will only load the parts of the state that apply to the older revision.

Remote Command	*RCL <register #>
Example	*RCL 7 Recalls the instrument state that is currently stored in register 7.
Notes	Registers 0 through 6 are accessible from the front panel in menu keys for Recall Registers.
Min	0
Max	127
Status Bits/OPC dependencies	The command is sequential.
Initial S/W Revision	Prior to A.02.00

*RST (Remote Command Only)

*RST is equivalent to :SYST:PRES;:INIT:CONT OFF, which is a Mode Preset in the Single measurement state. This remote command is preferred over Mode Preset remote command - :SYST:PRES, as optimal remote programming occurs with the instrument in the single measurement state.

Remote Command	*RST
Example	*RST
Notes	Sequential Clears all pending OPC bits and the Status Byte is set to 0.
Couplings	A *RST will cause the currently running measurement to be aborted and cause the default measurement to be active. *RST gets the mode to a consistent state with all of the default couplings set.
Backwards Compatibility Notes	In legacy analyzers *RST did not set the analyzer to Single, but in the X-Series it does, for compliance with the IEEE 488.2 specification.

In the X-Series, *RST does not do a *CLS (clear the status bits and the error queue). In legacy analyzers, *RST used to do the equivalent of SYSTem:PRESet, *CLS and INITiate:CONTinuous OFF. But to be 488.2 compliant, *RST in the X-Series does not do a *CLS.

Initial S/W Revision Prior to A.02.00

Save Instrument State

This command saves the current instrument state and mode to the specified instrument memory register.

Remote Command	*SAV <register #>
Example	*SAV 9 Saves the instrument state in register 9.
Notes	Registers 0 through 6 are accessible from the front panel in menu keys for Save Registers.
Min	0
Max	127
Status Bits/OPC dependencies	The command is sequential.
Initial S/W Revision	Prior to A.02.00

Service Request Enable

This command enables the desired bits of the service request enable register.
The query returns the value of the register, indicating which bits are currently enabled.

Remote Command	*SRE <integer> *SRE?
Example	*SRE 22 Enables bits 1, 2, and 4 in the service request enable register.
Notes	For related commands, see the STATus subsystem and SYSTem:ERRor[:NEXT]? commands.
Preset	0
Min	0
Max	255
Status Bits/OPC dependencies	Service Request Enable Register (all bits, 0 – 7).
Initial S/W Revision	Prior to A.02.00

Status Byte Query

Returns the value of the status byte register without erasing its contents.

Remote Command	*STB?
Example	*STB? Returns a decimal value for the bits in the status byte register. For example, if a 16 is returned, it indicates that bit 5 is set and one of the conditions monitored in the standard event status register is set.

Notes	See related command *CLS.
Status Bits/OPC dependencies	Status Byte Register (all bits, 0 – 7).
Initial S/W Revision	Prior to A.02.00

Trigger

This command triggers the instrument. Use the :TRIGger[:SEQuence]:SOURce command to select the trigger source.

Key Path	No equivalent key. See related keys Single and Restart.
Remote Command	*TRG
Example	*TRG Triggers the instrument to take a sweep or start a measurement, depending on the current instrument settings.
Notes	See related command :INITiate:IMMEDIATE.
Initial S/W Revision	Prior to A.02.00

Self Test Query

This query performs the internal self-test routines and returns a number indicating the success of the testing. A zero is returned if the test is successful, 1 if it fails.

Remote Command	*TST?
Example	*TST? Runs the self-test routines and returns 0=passed, 1=some part failed.
Initial S/W Revision	Prior to A.02.00

Wait-to-Continue

This command causes the instrument to wait until all overlapped commands are completed before executing any additional commands. There is no query form for the command.

Remote Command	*WAI
Example	INIT:CONT OFF; INIT:*WAI Sets the instrument to single sweep. Starts a sweep and waits for its completion.
Status Bits/OPC dependencies	Not global to all remote ports or front panel. *OPC only considers operation that was initiated on the same port as the *OPC command was issued from.
Initial S/W Revision	Prior to A.02.00

4 Input/Output Functions

Input/Output

The Input/Output features are common across multiple Modes and Measurements. These common features are described in this section. See the Measurement description for information on features that are unique.

The Input/Output key accesses the keys that control the Input/Output parameters of the instrument. In general, these are functions associated with external connections to the analyzer, either to the inputs or the outputs. Since these connections tend to be fairly stable within a given setup, in general, the input/output settings do not change when you Preset the analyzer.

Other functions related to the input/output connections, but which tend to change on a measurement by measurement basis, can be found under the **Trigger** and **AMPTD Y Scale** keys. In addition, some of the digital I/O bus configurations can be found under the **System** key.

NOTE

The functions in the Input/Output menu are "global" (common) to all Modes (applications). But individual Input/Output functions only appear in a Mode if they apply to that Mode. Functions that apply to a Mode but not to all measurements in the Mode may be grayed-out in some measurements.

["Input/Output variables - Preset behavior" on page 243](#)

The Input Port selection is the first menu under the **Input/Output** key:

Key Path	Front-panel key
Remote Command	[:SENSe] : FEED RF AIQ EMIXer [:SENSe] : FEED?
Example	:FEED RF :FEED?
Couplings	The [:SENSe] : FEED RF command turns the calibrator OFF
Preset	This setting is unaffected by a Preset or power cycle. It survives a Mode Preset and mode changes. It is set to RF on a "Restore Input/Output Defaults" or "Restore System Defaults->All"
State Saved	Saved in instrument state
Backwards Compatibility SCPI	[:SENSe] : FEED AREference In the PSA the calibrator was one of the inputs and selected using the AREF parameter to the same :FEED command that switched the inputs. In the X-Series it is controlled in a separate menu and overrides the input selection. For code compatibility the [:SENSe] : FEED AREference command is provided, and is aliased to [:SENSe] : FEED : AREF REF50, which causes the input to be switched to the 50 MHz calibrator. The [:SENSe] : FEED RF command switches the input back to the RF port and turns the calibrator OFF, thus providing full compatibility with the PSA calibrator function. Note that after sending this, the query [:SENSe] : FEED? will NOT return "AREF" but instead the currently selected input.
Backwards Compatibility SCPI	[:SENSe] : FEED IQ IONLY QONLY [:SENSe] : FEED?

	<p>The parameters IQ IONLy QONLy are supported for backwards compatibility with the E44406A.</p> <p>[:SENSe]:FEED IQ aliases to [:SENSe]:FEED:IQ:TYPE IQ</p> <p>[:SENSe]:FEED IONLy aliases to [:SENSe]:FEED:IQ:TYPE IONLy</p> <p>[:SENSe]:FEED QONLy aliases to [:SENSe]:FEED:IQ:TYPE QONLy</p> <p>The query [:SENSe]:FEED? will always returns AIQ whatever the type of legacy parameters IQ IONLy QONLy has been used.</p>
Backwards Compatibility Notes	<p>Most of the settings in the X-Series Input/Output system, including External Gain, Amplitude Corrections settings and data, etc., are shared by all modes and are not changed by a mode switch. Furthermore, most variables in the Input/Output system key are not affected by Mode Preset. Both of these behaviors represent a departure from legacy behavior.</p> <p>In the X-Series. Input/Output settings are reset by using the "Restore Input/Output Defaults" function. They can also be reset to their default values through the System->Restore System Defaults-> In/Out Config key or through the System ->Restore System Defaults -> All key (and corresponding SCPI).</p> <p>While this matches most use cases better, it does create some code compatibility issues. For example, Amplitude Corrections are no longer turned off by a Mode Preset, but instead by using the "Restore Input/Output Defaults" key/SCPI.</p> <p>Although Input/Output settings are not part of each Mode's State, they are saved in the Save State files, so that all of the instrument settings can be recalled with Recall State, as in legacy instruments.</p>
Initial S/W Revision	Prior to A.02.00
Remote Command	:INPut:MIxer EXTernal INTernal :INPut:MIxer?
Example	INP:MIX INT INP:MIX?
Notes	<p>In legacy analyzers you choose between the Internal mixer or an External Mixer. In the X-Series, the External Mixer is one of the choices for the Input and is selected using the FEED command (:SENSe:FEED EXTMixer).</p> <p>For compatibility, the INPut:MIxer EXTernal INTernal legacy command is mapped as follows:</p> <ol style="list-style-type: none"> 1. When INPut:MIxer EXTernal is received, SENSe:FEED EMIXer is executed. 2. When INPut:MIxer INTernal is received, SENSe:FEED RF is executed. 3. When INPut:MIxer? is received, the response will be INT if any input other than the external mixer is selected and EXT if the external mixer is selected
Preset	INT
Backwards Compatibility Notes	<p>PSA supports the following SCPI Command :</p> <p>:INPut:MIxer:TYPE PRESelected UNPReselect</p> <p>:INPut:MIxer:TYPE?</p> <p>PXA does not support the :INPut:MIxer:TYPE command.</p>
Initial S/W Revision	A.08.01

Input/Output variables - Preset behavior

Virtually all the input/output settings are NOT a part of mode preset. They can be set to their default value by one of the three ways:

- by using the Restore Input/Output Defaults key on the first page of the input/output menu,
- by using the System->Restore System Defaults->Input/Output Settings or,
- by using the System -> Restore System Defaults->All. Also, they survive a Preset and a Power cycle.

A very few of the Input/Output settings do respond to a Mode Preset; for example, if the Calibrator is on it turns off on a Preset, and if DC coupling is in effect it switches to AC on a Preset. These exceptions are made in the interest of reliability and usability, which overrides the need for absolute consistency. Exceptions are noted in the SCPI table for the excepted functions.

RF Input

Selects the front-panel RF input port to be the analyzer signal input. If RF is already selected, pressing this key accesses the RF input setup functions.

Key Path	Input/Output
Example	[:SENSe]:FEED RF
Couplings	The act of connecting the U7227A USB Preamplifier to one of the analyzer's USB ports will cause the Input to automatically switch to the RF Input. If the RF Calibrator is on, it is turned off. Subsequently disconnecting the USB Preamp from USB does not change the Input selection nor restore the previous selection.
Readback	The RF input port, RF coupling, and current input impedance settings appear on this key as: "XX, YY, ZZ" where XX is RF, RF2, RFIO1, RFIO2, depending on what input is selected (only appears on analyzers with multiple RF inputs) YY is AC or DC ZZ is 50Ω or 75Ω
Initial S/W Revision	Prior to A.02.00
Modified at S/W Revision	A.14.00

Input Z Correction

Sets the input impedance for unit conversions. This affects the results when the y-axis unit is voltage or current units (dBmV, dBμV, dBμA, V, A), but not when it is power units (dBm, W). The impedance you select is for computational purposes only, since the actual impedance is set by internal hardware to 50 ohms. Setting the

computational input impedance to 75 ohms is useful when using a 75 ohm to 50 ohm adapter to measure a 75 ohm device on an analyzer with a 50 ohm input impedance.

There are a variety ways to make 50 to 75 ohm transitions, such as impedance transformers or minimum loss pads. The choice of the solution that is best for your measurement situation requires balancing the amount of loss that you can tolerate with the amount of measurement frequency range that you need. If you are using one of these pads/adaptors with the **Input Z Corr** function, you might also want to use the **Ext Gain** key. This function is used to set a correction value to compensate for the gain (loss) through your pad. This correction factor is applied to the displayed measurement values.

Key Path	Input/Output, RF Input
Remote Command	[:SENSe]:CORRection:IMPedance[:INPut][:MAGNitude] 50 75 [:SENSe]:CORRection:IMPedance[:INPut][:MAGNitude]?
Example	CORR:IMP 75 sets the input impedance correction to 75 ohms. CORR:IMP?
Couplings	In the N9000A option C75, when RF Input 2 is selected, the Input Z Correction will automatically change to 75 ohms. You may then change it to whatever is desired. When the main RF Input is selected, the Input Z Correction will automatically change to 50 ohms. You may then change it to whatever is desired.
Preset	This is unaffected by a Preset but is set to 50 ohms on a "Restore Input/Output Defaults" or "Restore System Defaults->All" Some instruments/options may have 75 ohms available.
State Saved	Saved in instrument state
Readback	50 Ω or 75 Ω. Current setting reads back to the RF key.
Initial S/W Revision	Prior to A.02.00

RF Coupling

Specifies alternating current (AC) or direct current (DC) coupling at the analyzer RF input port. Selecting AC coupling switches in a blocking capacitor that blocks any DC voltage present at the analyzer input. This decreases the input frequency range of the analyzer, but prevents damage to the input circuitry of the analyzer if there is a DC voltage present at the RF input.

In AC coupling mode, you can view signals below the corner frequency of the DC block, but below a certain frequency the amplitude accuracy is not specified. The frequency below which specifications do not apply is:

X-Series Model	Lowest Freq for meeting specs when AC coupled	Lowest Freq for meeting specs when DC coupled
N9000A-	100 kHz	n/a

X-Series Model	Lowest Freq for meeting specs when AC coupled	Lowest Freq for meeting specs when DC coupled
503/507		
N9000A-C75 Input 2	1 MHz	n/a
N9000A-513/526	10 MHz	9 kHz
M9290A	10 MHz	9 kHz
N9010A	10 MHz	9 kHz
N9020A	10 MHz	20 Hz
N9030A	10 MHz	3 Hz

Some amplitude specifications apply only when coupling is set to DC. Refer to the appropriate amplitude specifications and characteristics for your analyzer.

When operating in DC coupled mode, ensure protection of the analyzer input circuitry by limiting the DC part of the input level to within 200 mV of 0 Vdc. In AC or DC coupling, limit the input RF power to +30 dBm (1 Watt).

Key Path	Input/Output, RF Input
Remote Command	:INPut:COUPling AC DC :INPut:COUPling?
Example	INP:COUP DC
Dependencies	This key does not appear in models that are always AC coupled. When the SCPI command to set DC coupling is sent to these models, it results in the error "Illegal parameter value; This model is always AC coupled" In these models, the SCPI query INP:COUP? always returns AC. This key does not appear in models that are always DC coupled. When the SCPI command to set AC coupling is sent to these models, it results in the error "Illegal parameter value; This instrument is always DC coupled" In these models, the SCPI query INP:COUP? always returns DC.
Preset	AC on models that support AC coupling On models that are always DC coupled, such as millimeter wave models (frequency ranges 30 GHz and above), the preset is DC.
State Saved	Saved in instrument state.
Initial S/W Revision	Prior to A.02.00
Modified at S/W Revision	A.03.00

RF Input Port

Specifies the RF input port used. The RF Input Port key only appears on units with multiple inputs, and lets you switch between the two inputs.

Switching from the RF input port to one of the RFIO ports, on units that have them, changes the receiver performance of the instrument.

Key Path	Input/Output, RF Input
Remote Command	<code>[:SENSe] :FEED:RF:PORT [:INPut] RFIN RFIN2 RFIO1 RFIO2 RFIO3 RFIO4 RFHD RFFD</code> <code>[:SENSe] :FEED:RF:PORT [:INPut] ?</code>
Example	:FEED:RF:PORT RFIN
Dependencies	This key only appears in models that support multiple inputs. If the SCPI command is sent with unsupported parameters in any other model, an error is generated, -221.1900, "Settings conflict;option not installed" When any input is selected in a measurement that does not support it, the "No result; Meas invalid with this input" error condition occurs, and the measurement returns invalid data when queried. RFHD and RFFD are only available on M9420A, option "HDX" is required to enable RFHD port and option "FDX" is required to enable RFFD port.
Preset	This is unaffected by Mode Preset but is set to RF on a "Restore Input/Output Defaults" or "Restore System Defaults -> All"
State Saved	Saved in instrument state
Readback	The current RF Input Port selected is read back to this key
Backwards Compatibility SCPI	<code>INPut<1 2>:TYPE INPUT1 INPUT2</code> <code>INPut<1 2>:TYPE?</code> Included for R&S ESU compatibility. In the MXE, the INPUT1 parameter is aliased to RFIN and the INPUT2 parameter is aliased to RFIN2
Initial S/W Revision	A.05.01
Modified at S/W Revision	A.14.00

RF Input

Specifies using the main RF port for the current measurement

Key Path	Input/Output, RF Input, RF Input Port
Example	:FEED:RF:PORT RFIN
ReadBack	RF Input
Initial S/W Revision	A.05.01
Modified at S/W Revision	A.14.00

RF Input 2

Specifies using the second RF port, if supported, for the current measurement.

See ["More Information" on page 247](#)

Key Path	Input/Output, RF Input, RF Input Port
Example	:FEED:RF:PORT RFIN2
Couplings	<p>When switching from Input 1 to Input 2:</p> <ul style="list-style-type: none"> - If the Stop Freq is above the Max Freq, it is set to the Max Freq, otherwise it does not change. - If the Start Freq is above (Max Freq – Min Span), it is set to (Max Freq – Min Span), otherwise it does not change. <p>When switching from Input 2 to Input 1, neither the Start Freq nor the Stop Freq change. For the Swept SA measurement, Min Span is 10 Hz. This may vary from measurement to measurement.</p>
ReadBack	RF Input 2
Initial S/W Revision	A.05.01

More Information

In models with two inputs, the second input usually has a different maximum frequency than the first input. For your convenience, the actual “Max Freq” value is allowed to go slightly higher than the nominal Max Freq for the second input, just as is the case with the first input.

Model	Nominal Input 2 Max Freq	Absolute Input 2 Max Freq	Transition rule for switching from Input 1 to Input 2
N9038A	1 GHz	1.000025 GHz	<ul style="list-style-type: none"> - If the Stop Freq is above 1.000025 GHz, it is set to 1.000025 GHz, otherwise it does not change. - If the Start Freq is above 1.000024990 Hz, Start Freq is set to 1.000024990 Hz and Span to 10 Hz, otherwise nothing changes.
N9000A with option C75	1.5 GHz	1.58 GHz	<ul style="list-style-type: none"> - If the Stop Freq is above 1.58 GHz, it is set to 1.58 GHz, otherwise it does not change. - If the Start Freq is above 1.579999990 GHz, Start Freq is set to 1.579999990 GHz and Span to 10 Hz, otherwise nothing changes.

RF Preselector

In models that support the RF Preselector, such as MXE (N9038A), this key allows you to turn the preselector on and off.

NOTE

When using the RF Preselector, if your measurement starts below 3.6 GHz and finishes above 3.6 GHz, the preselector bypass switch will have to switch in and out for every measurement. When this is the case, you will hear a clicking sound from the instrument and a warning message will be displayed: “Settings Alert:Mechanical switch cycling”. You are advised to avoid such setups as much as possible, to minimize switch wear. Pressing Mode Preset will reset the Stop Freq to 3.6 GHz and get you out of this state, or you can manually set the Stop Freq to be below 3.6 GHz.

Key Path	Input/Output, RF Input
Mode	All
Remote Command	[:SENSe]:POWer[:RF]:RFPreselector[:STATe] 1 0 ON OFF [:SENSe]:POWer[:RF]:RFPreselector[:STATe]?
Example	:POW:RFPS 1
Example	:INP:PRE:STAT ON
Notes	[:SENSe]:POWer[:RF]:RFPreselector[:STATe] 1 ON. Sets to full compliance measurement. [:SENSe]:POWer[:RF]:RFPreselector[:STATe] 0 OFF. Sets to pre-compliance measurement.
Dependencies	The RF Preselector is not available in all measurements. The key is grayed out in measurements that do not support it, unless you are in a Mode in which no measurements support it, in that case the key does not appear at all. If the preselector is unavailable it is forced to Off. Attempting to turn it on or off in measurements that do not support it generates an error message: -221.3200, Settings conflict; Feature not supported for this measurement. The RF Preselector is not available when FFT Sweep Type is manually selected. Attempting to turn it on or off when this is the case generates an error message: “-221, Settings conflict; RF Presel unavailable when Sweep Type=Manual FFT”. This key only appears in Modes that support the RF Preselector, in other Modes, setting or querying the SCPI will generate an error. This key only appears in models that support the RF Preselector, in other models, setting or querying the SCPI will generate an error.
Preset	It is set to Off when the selected mode is SA. If the selected mode is EMI Receiver, then it will be set to On.
Backwards Compatibility SCPI	INPut<1 2>:PRESelection[:STATe] ON OFF INPut<1 2>:PRESelection[:STATe]? Included for R&S ESU compatibility
Initial S/W Revision	A.05.01

External Mixer

This key allows you to choose an External Mixer through which to apply signal input to the analyzer. When chosen, the LO/IF port becomes the input to the analyzer.

External Mixing requires option EXM. The External Mixer key will not appear unless option EXM is installed. The presence of the LO/IF connector alone does not indicate that you have Option EXM licensed. To verify that option EXM is installed, press **System, Show, System**.

When External Mixer is selected, the **Center Freq** key controls the setting of the Center Freq in external mixing, which is separate from the settings of Center Freq for the RF Input or BBIQ. Each input retains its unique settings for Center Freq. A unique SCPI command is provided solely for the external mixing Center Freq (see the **Center Freq** key description), which only affects the External Mixer CF, although sending the generic Center Freq command while External Mixer is selected also controls the External Mixer CF.

See ["More Information" on page 249](#)

Key Path	Input/Output
Example	:FEED EMIX
Notes	Not all measurements support the use of the External Mixer input. When External Mixer is selected in a measurement that does not support it, the "No result; Meas invalid with Ext Mixing" error condition occurs.
Dependencies	Unless option EXM is present, the External Mixer key is blanked, and all SCPI commands associated with menus accessed by this key return an error Manual FFT mode is available with external mixing, but not with Signal ID.
Preset	All settings under this key are returned to their default state when Restore Input/Output Defaults is pressed.
State Saved	All settings under this key, and all Frequency settings, are remembered when you go out of External Mixer, so that when External Mixer is chosen again, all the external mixer functions will retain their previous settings, with the exception of Signal ID which is set to OFF (Signal ID is also set to Off unless External Mixer is the selected Input).
Readback Text	The readback text on this key shows the currently selected mixer, in square brackets.
Backwards Compatibility Notes	Unlike PSA, all external mixer settings including Center Frequency are retained when you go in and out of External Mixing. Also, Preset does not take you out of External Mixing (Restore Input/Output Defaults does).
Initial S/W Revision	A.08.01

More Information

X-series analyzers have a combined LO Out/IF In connection, whereas earlier analyzers used separate ports for the LO Out and the IF in. Internal diplexers in the analyzer and the mixer simplify the connection for the user – only a single SMA cable is required.

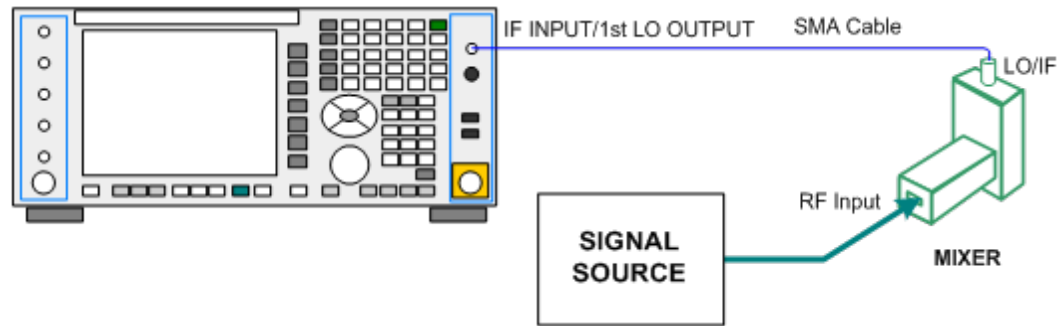

Legacy Keysight and some third party mixers have separate LO In and IF out connections. This requires you to use an external diplexer to connect these mixers. A diplexer can easily be purchased for this purpose (for example, Diplexer Model # DPL.26 or # DPL.313B from OML Inc., Morgan Hill CA)

The connection diagram for such a legacy mixer is:

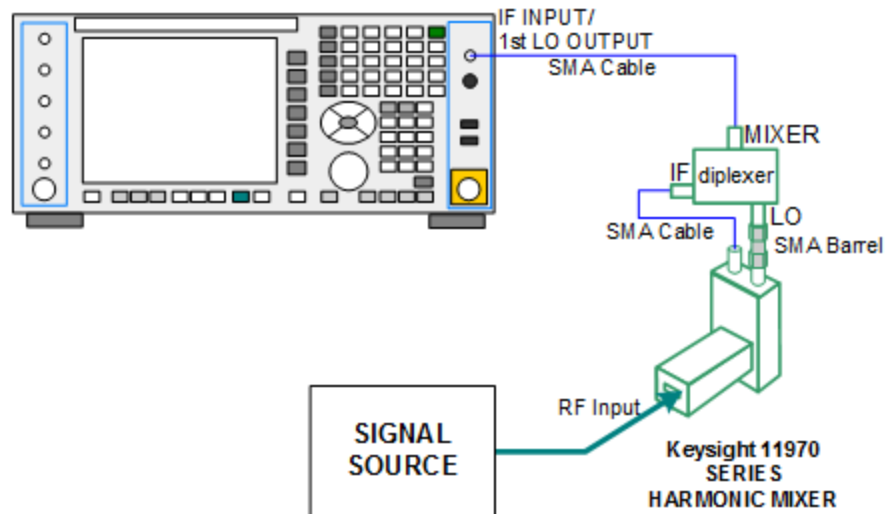

In addition, External Mixing in the X-Series supports the new Keysight M1970 series of Harmonic Mixers, which provide a USB connection for download of calibration data and additional control.

The connection diagram for one of the Keysight USB mixers is:

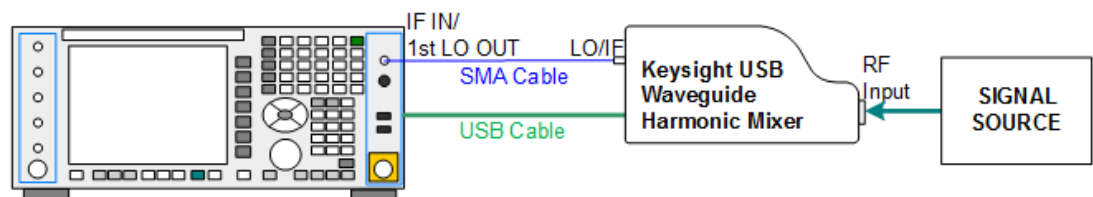

Also available in the M197x series are the M1971 series USB Mixers, which provide additional inputs and outputs for special functionality as described below. These mixers have multiple signal paths which allow them to function in three different states:

- Normal, in which the mixer functions as a classic external mixer with a single conversion:

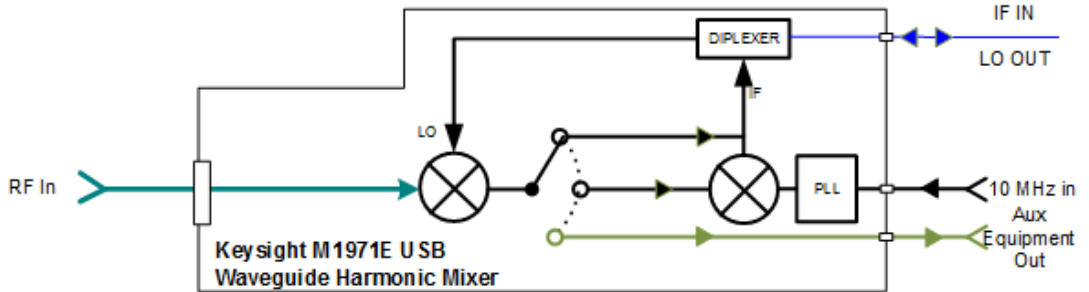

- Dual Conversion, which gives you a wider image-free range. In Dual Conversion, the first conversion is to a higher IF frequency and you provide a 10 MHz signal to which an internal PLL is locked, to effect a second downconversion:

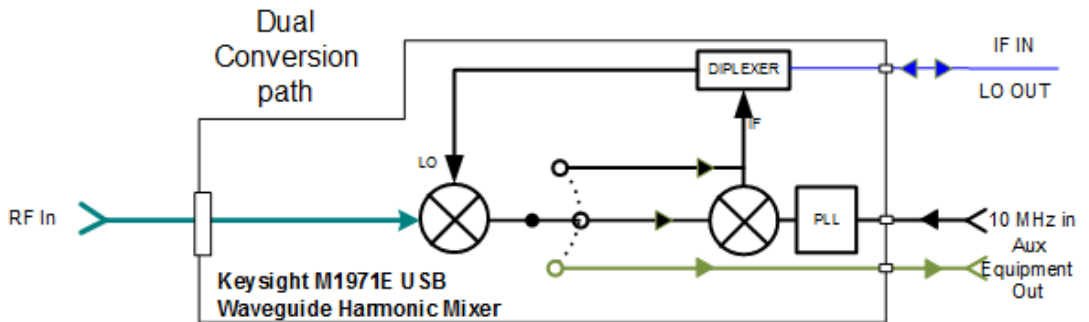

- Aux Equipment, wherein the first mixer output drives an output connector on the mixer and the analyzer is out of the circuit:

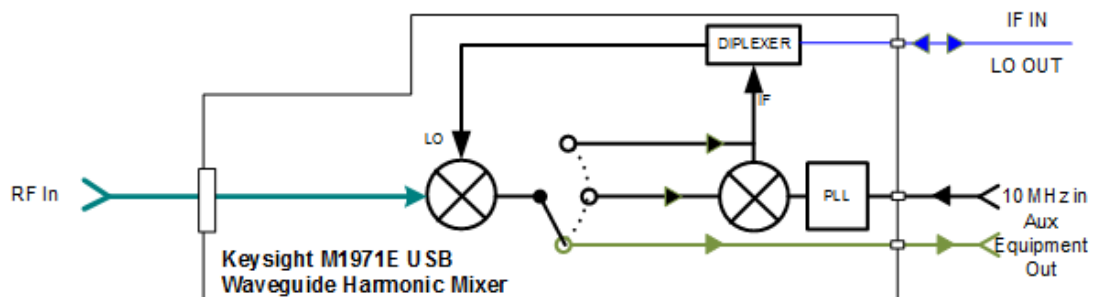

External Mixing is only supported in certain Modes and Measurements in the X-Series, as shown in the table below:

Mode	Measurements	Sig ID (Image Suppress only)
Spectrum Analyzer	Swept SA	Y*
	TOI	Y
	Harmonics	N
	Spurious Emissions	Y
	Channel Power	Y
	Occupied BW	Y
	ACP	Y
	Spectrum Emissions Mask	Y
	CCDF	N
	Burst Power	N
	List Sweep	N
	Phase Noise	Monitor Spectrum
Log Plot		Y
Spot Frequency		N
Waveform		N
I/Q Analyzer	Complex Spectrum	N
	Waveform	N
Vector Signal Analyzer	Vector Analysis	N
	Analog Demod	N
	Digital Demod	N

* the Swept SA measurement also supports Image Shift

Ext Mix Setup

This menu lets you select the mixer type, and lets you configure your mixer (if necessary). While in this menu, and any of its submenus, the External Mixer Setup screen appears, showing you the current settings for the selected mixer. These settings may be dependent on which IF path is currently in use, whether a + or – harmonic is currently selected, etc.

To apply any amplitude correction factors needed to correct mixer flatness, you enter values into one of the Correction tables (under Input/Output, Corrections). The correction conversion loss values can be extracted from data supplied with the mixer or from manual measurements you make to determine the conversion loss. Note

that the correction applied by the Correction tables is global to the analyzer; therefore you should make sure to turn off the External Mixer corrections when you are not using the External Mixer input.

NOTE

The Keysight USB Mixers automatically give their flatness data to the analyzer, and the correction is applied internally. No correction needs to be entered by the user, and the correction does not appear in the user-accessible Corrections tables. The user is free to enter additional corrections into the Correction tables under Input/Output, Corrections.

Key Path	Input/Output, External Mixer
State Saved	All settings in the Mixer Setup are part of the Input/Output system, and hence are saved whenever State is saved.
Readback Text	The readback line on this key shows the currently selected mixer, in square brackets.
Initial S/W Revision	A.08.01
Modified at S/W Revision	A.08.50

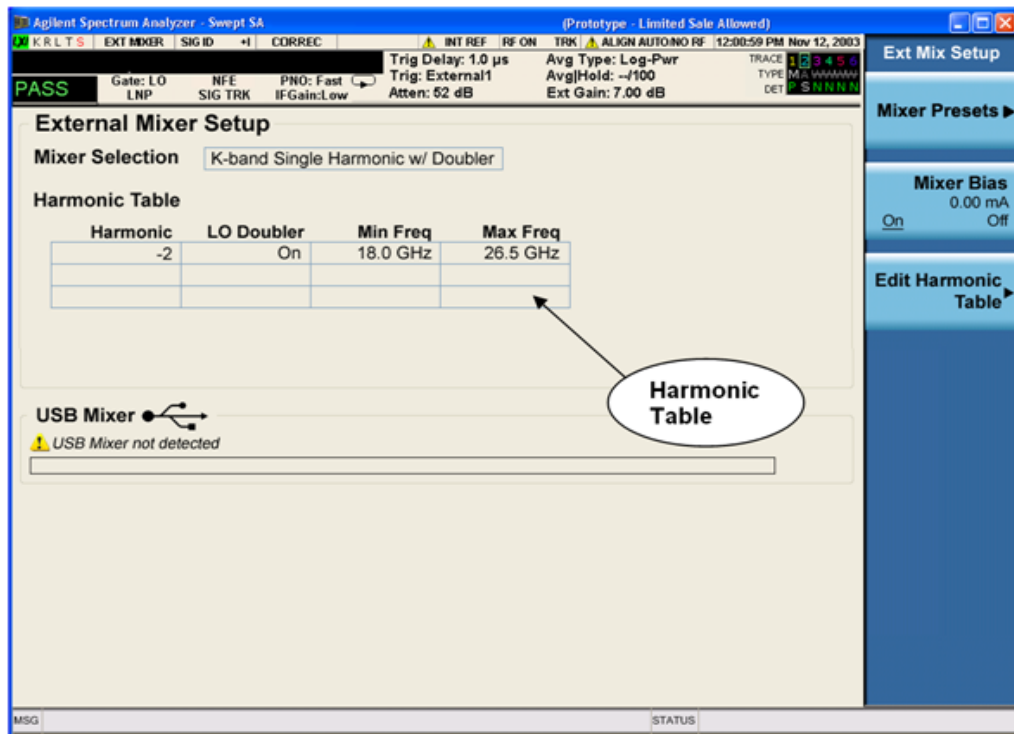

The External Mixer Setup screen looks like this

The current Mixer selection (the current or most recently connected USB Mixer, or the most recent Mixer Preset, or “Custom” if the user has modified the setup) reads out at the top of this screen.

The Harmonic Table currently being used reads out below the Mixer Selection. It shows each range being used for the current mixer. Note that a band may be made

up of up to 3 ranges. Each range represents a choice of mixer harmonic and doubler state. When you select a Mixer Preset, it sets the analyzer Start and Stop frequency to the values shown in the Harmonic Table; Start Freq is set to the Min Freq for the bottom range, and Stop Freq is set to the Max Freq for the top range. In many cases you can exceed these nominal values; the absolute maximum and minimum frequency for each preset are shown in the tables that accompany the key descriptions for the Mixer Presets.

NOTE

If the current measurement has a limited Span available to it, and cannot achieve the Span shown in the table (Span=Stop Freq – Start Freq), the analyzer uses the maximum Span the measurement allows, and sets the Center Freq to the midpoint of the Start and Stop Freq values in the Harmonic Table.

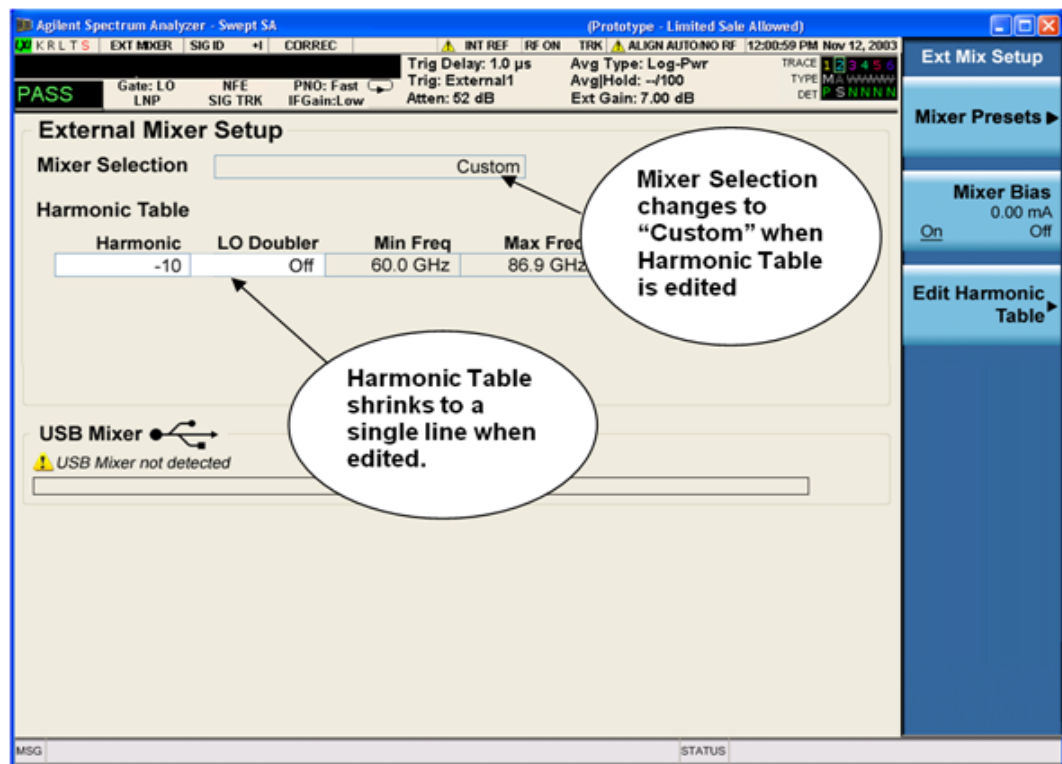

You may customize the Harmonic Table, but when you do this the analyzer goes into “single harmonic” mode. You may enter the harmonic number and whether to use the doubler or not, but now range switching is not supported, so you can only have one harmonic.

When you edit the Harmonic Table, the Mixer Selection changes to “Custom.” To change it back you must go back into the Mixer Presets menu and select a Preset.

When you edit the Harmonic Table, the nominal Min Freq and Max Freq that are available will usually be different than the Preset you were using; and the absolute frequency limits will change as well. This may result in a change to your Start and/or Stop Freq, if the current values fall outside the new range, requiring you to retune your Center Freq to get your signal back in the center.

The analyzer supports the Keysight M1970 Series Harmonic Mixers with USB connection. While in External Mixing, if one of these mixers is plugged in to a USB port, it is automatically detected and displayed in the “USB Mixer” area of the setup screen, including its model number and serial number.

The analyzer assumes that if you plug a mixer into the USB, that is the mixer you want to use. Therefore:

1. If a USB mixer is connected to the USB port, the Mixer Presets menu is grayed out, as none of the presets make sense with a USB Mixer connected. Note that once the analyzer has acquired the USB Mixer, the mixer selection will remain if it is subsequently unplugged from the USB, allowing you to plug it back in with no change to your settings. However, once you unplug it, the Mixer Presets key will stop being grayed out, allowing you to preset to a different mixer.
2. When **Restore Input/Output Defaults** is performed, if an Keysight USB Mixer is plugged into the analyzer’s USB port, the Mixer Selection remains unchanged.
3. When recalling an instrument state, if an Keysight USB Mixer is plugged into the analyzer’s USB port, and the Mixer Selection in the recalled state is for a USB Mixer that does not match the mixer currently plugged in, you will have to unplug your mixer and then plug it back in to get the analyzer to recognize your mixer.

As long as the selection in Ext Mixer Setup shows one of the USB mixers, both the **Mixer Bias** and **Edit Harmonic Table** keys will be grayed out.

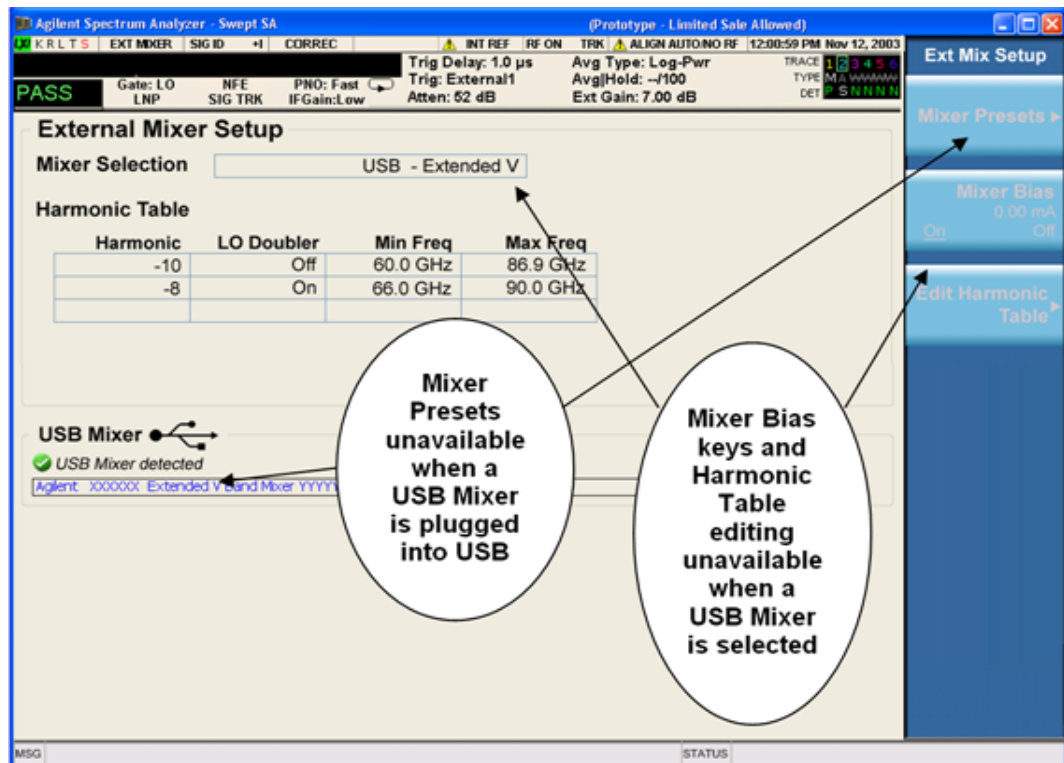

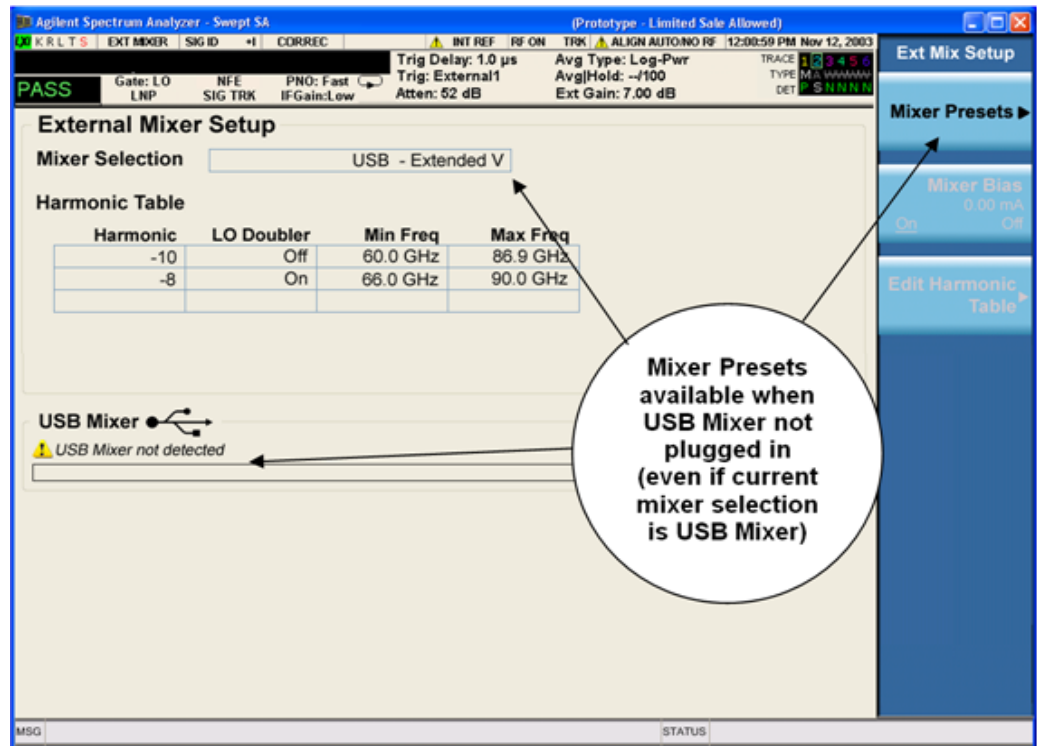

Only one USB Mixer is supported at a time. To switch to a different USB Mixer, disconnect the one that is no longer being used prior to connecting a new one.

The Mixer Selection displayed and softkey readback for the Keysight M1970 series mixers is:

Mixer Model	Mixer Selection display on Setup Screen	Readback on softkeys
Keysight M1970E: Option 001: 60 to 90 GHz Waveguide Harmonic Mixer	USB - M1970E-001 E-Band	USB Mixer E-Band
Keysight M1971E: Option 001: 60 to 90 GHz Waveguide Harmonic Mixer	USB - M1971E-001 E-Band	USB Mixer E-Band
Keysight M1971E: Option 003: 55 to 90 GHz Waveguide Harmonic Mixer	USB - M1971E-003 Extended E-Band	USB Mixer Extended E
Keysight M1971V: Option 001: 50 to 75 GHz Waveguide Harmonic Mixer	USB - M1971E-001 V-Band	USB Mixer V-Band
Keysight M1971W: Option 001: 75 to 110 GHz	USB - M1971E-001 W-Band	USB Mixer W-Band

Mixer Model	Mixer Selection display on Setup Screen	Readback on softkeys
Waveguide Harmonic Mixer		
Keysight M1970V Option 001: 50 to 75 GHz	USB - M1970V-001 V-Band	USB Mixer V-Band
Waveguide Harmonic Mixer		
Keysight M1970V Option 002: 50 to 80 GHz	USB - M1970V-002 Extended V-Band	USB Mixer Extended V
Waveguide Harmonic Mixer		
Keysight M1970W Option 001: 75 to 110 GHz	USB - M1970W-001 W-Band	USB Mixer W-Band
Waveguide Harmonic Mixer		

The Keysight USB mixer essentially acts as a “remote front end” and is fully calibrated over the specified frequency range, without requiring any user interaction. This is particularly useful at high mm-wave frequencies, where cable loss is typically quite large, and it is desirable to bring the front end right up to the device under test, rather than bringing the mm-wave signal to the analyzer using a lossy and uncalibrated cable or waveguide connection.

Connecting the mixer to the USB port on the analyzer switches you to External Mixing, aborts the current measurement, and initiates an alignment of the mixer. A popup message, “USB Mixer connected” appears on the display. When a USB mixer and the LO/IF cable are connected the alignment is performed. When the alignment begins, an “Aligning” popup replaces the previous message on the display. When the alignment completes, the current measurement restarts.

Mixer Presets

This menu lets you preset the mixer setup for the particular type of mixer that you are using.

These presets are divided into four groups:

- one for Keysight legacy mixers,
- three for general purpose mixers:
 - presets that use a single harmonic and no doubling
 - presets that use a single harmonic but double the LO
 - presets that use multiple harmonics

Note that the IF/LO port provides a 3.8-14 GHz LO in two bands: 3.8-8.7 (LO fundamental), and 8.6-14 GHz (doubled LO).

In most cases, once you have executed the preset, you will not need to adjust any further settings.

Key Path	Input/Output, External Mixer, Ext Mix Setup
Remote Command	[:SENSe]:MIXer: BAND A Q U V W NA ND NE NF NG NJ NK NQ NU NV NW NY NEXT DD DF DG DJ DK DQ DV DW DY DEXT MA ME MU MCOAX USB [:SENSe]:MIXer: BAND?
Example	:MIX: BAND A :MIX: BAND?
Notes	A Q U V W select Keysight 11970 mixer presets NA ND NE NF NG NJ NK NQ NU NV NW NY NEXT select single harmonic, non-doubled LO presets DD DF DG DJ DK DQ DV DW DY DEXT select single harmonic, doubled LO presets MA ME MU MCOAX select multiple harmonic presets All of these presets are detailed in their respective key descriptions The query form of this command returns the most recent preset, UNLESS the harmonic table has been edited after the preset was executed. If the harmonic table has been edited it returns CUSTOM The command USB will refresh the USB mixer connection and automatically detect the mixer band. The query form of this command returns the following if an Keysight USB Mixer is plugged into the analyzer's USB port: USB E Keysight E-Band USB Mixer USB V Keysight V-Band USB Mixer USB VEXT Keysight Extended V-Band USB Mixer USB W Keysight W-Band USB Mixer Note that the parameters CUSTOM, USB V, USB VEXT, and USB W are query responses only, and cannot be sent TO the analyzer. The following cross-reference matches the mixer band designators used by Keysight to the EIA waveguide designations: EIA Keysight Freq Range WR-28 A26.5 - 40 GHz WR-22 Q33 - 50 GHz WR-19 U40 - 60 GHz WR-15 V50 - 75 GHz WR-12 E60 - 90 GHz WR-10 W75 - 110 GHz WR-8 F90 - 140 GHz WR-6 D110 - 170 GHz WR-5 G140 - 220 GHz WR-3 J220 - 325 GHz
Preset	When Restore Input/Output Defaults is performed, an "A" mixer preset is also issued (11970A band), unless an Keysight USB Mixer is plugged into the analyzer's USB port, in which case the Mixer Selection remains unchanged. When using Keysight USB Mixers, if a Restore All Defaults (SCPI command SYSTEM: DEFault) has

	been perform, either remove and reinsert the USB cable or press the Refresh USB Mixer Connection softkey.
Backwards Compatibility Notes	The [:SENSE]:MIXer:BAND command was used in PSA and ESA to select the mixer band. In the X-Series, only the legacy parameters A, Q, U, V, and W are honored, and they preset the analyzer to match the corresponding Keysight 11970 legacy mixer. Parameters D, E, F, G, J, K, Y, which were accepted in ESA and PSA, return an error if sent. If you are using a mixer in one of these bands, you should study the tables of presets and choose the appropriate preset to match your application. Also the USER parameter is no longer accepted, as the control model for mixer customization is very different in the X-Series.
Initial S/W Revision	A.08.01
Modified at S/W Revision	A.14.00

Keysight 11970

This menu allows you to preset for one of the models in the Keysight 11970 series.

Because the X-Series has an LO range of 3.8 - 14 GHz, and older analyzers had an LO range of 3.0 - 6.8 GHz, the harmonic numbers used in the X-Series may differ from those used on older analyzers for the same mixers. Additionally, some of the 11970 mixers cannot be operated over their full range with the X-Series without switching harmonics. Consequently, you will find that some of the bands (A-Band, for example) are broken into two ranges for use with the X-Series.

See ["More Information" on page 260](#)

Key Path	Input/Output, External Mixer, Ext Mix Setup, Mixer Presets
Example	MIX:BAND A
Initial S/W Revision	A.08.01

More Information

Below are the 11970A presets. The 11970U and the 11970W use a single harmonic. The other three switch harmonics mid-band. Both harmonic ranges are shown in the table. None of these mixers use LO doubling.

The 11970 K-band mixer and the 11974 preselected mixer series are not supported.

Preset	Readout in setup screen	Readback on softkeys	Range	Harm #	RF start	RF stop	RF center
A-band	Keysight 11970A	Keysight 11970A	1	-6	26.5	30.45	28.475
			2	-8	30.35	40	35.175
Q-band	Keysight 11970Q	Keysight 11970Q	1	-8	33	40.8	36.9
			2	-10	39.8	50	44.9
U-band	Keysight 11970U	Keysight 11970U	..	-10	40	60	50
V-band	Keysight 11970V	Keysight 11970V	1	-12	50	66	58
			2	-14	53	75	64
W-band	Keysight 11970W	Keysight 11970W	..	-18	75	110	92.5

Single Harmonic

These presets choose a setup that uses a single harmonic and no doubling for the LO.

Key Path	Input/Output, External Mixer, Ext Mix Setup, Mixer Presets
Example	MIX:BAND NA
Initial S/W Revision	A.08.01

These are the presets for single harmonic operation with no doubler:

Mixer	Readout in setup screen	Readback on softkeys	Harm #	RF start	RF stop	RF center
K-band	K-band Single Harmonic, no doubler	Sngl harm LOx1 K-band	-4	18	26.5	22.25
A-band	A-band Single Harmonic,	Sngl harm LOx1 A-band	-6	26.5	40	33.25

Mixer	Readout in setup screen	Readback on softkeys	Harm #	RF start	RF stop	RF center
	no doubler					
D-band	D-band Single Harmonic, no doubler	Sngl harm LOx1 D-band	-20	110	170	140
E-band	E-band Single Harmonic, no doubler	Sngl harm LOx1 E-band	-12	60	90	75
F-band	F-band Single Harmonic, no doubler	Sngl harm LOx1 F-band	-18	90	140	115
Q-band	Q-band Single Harmonic, no doubler	Sngl harm LOx1 Q-band	-6	33	50	41.5
U-band	U-band Single Harmonic, no doubler	Sngl harm LOx1 U-band	-8	40	60	50
V-band	V-band Single Harmonic, no doubler	Sngl harm LOx1 V-band	-10	50	75	62.5
W-band	W-band Single Harmonic, no doubler	Sngl harm LOx1 W-band	-14	75	110	92.5
G-band	G-band Single Harmonic, no doubler	Sngl harm LOx1 G-band	-26	140	220	180
Y-band	Y-band Single Harmonic, no doubler	Sngl harm LOx1 Y-band	-30	170	260	215
J -band	J-band Single Harmonic, no doubler	Sngl harm LOx1 J-band	-38	220	325	272.5
Extended	Extended Single Harmonic, no doubler	Sngl harm LOx1 Extended	-40	155	345	250

Single Harmonic w/doubler

These presets choose a setup that uses a single harmonic and doubling for the LO.

Key Path	Input/Output, External Mixer, Ext Mix Setup, Mixer Presets
Example	MIX:BAND DW
Initial S/W Revision	A.08.01

These are the presets for single harmonic operation with LO doubling:

Mixer	Readout in setup screen	Readback on softkeys	Harm #	RF start	RF stop	RF center
D-band	D-band Single Harmonic w/doubler	Sngl harm LOx2 K-band	-14	110	170	140
F-band	F-band Single Harmonic w/doubler	Sngl harm LOx2 A-band	-10	90	140	115
G-band	G-band Single Harmonic w/doubler	Sngl harm LOx2 A-band	-16	140	220	180
J-band	J-band Single Harmonic w/doubler	Sngl harm LOx2 A-band	-24	220	325	272.5
K-band	K-band Single Harmonic w/doubler	Sngl harm LOx2 A-band	-2	18	26.5	22.25
Q-band	Q-band Single Harmonic w/doubler	Sngl harm LOx2 A-band	-4	33	50	41.5
V-band	V-band Single Harmonic w/doubler	Sngl harm LOx2 A-band	-6	50	75	62.5
W-band	W-band Single Harmonic w/doubler	Sngl harm LOx2 A-band	-8	75	110	92.5

Mixer	Readout in setup screen	Readback on softkeys	Harm #	RF start	RF stop	RF center
Y-band	Y-band Single Harmonic w/doubler	Sngl harm LOx2 A-band	-20	170	260	215
Extended	Extended Single Harmonic w/doubler	Sngl harm LOx2 A-band	-28	245	390	317.5

Multiple Harmonics

These presets choose a setup that uses multiple harmonics and may or may not use doubling for the LO.

Key Path	Input/Output, External Mixer, Ext Mix Setup, Mixer Presets
Example	MIX:BAND MA
Initial S/W Revision	A.08.01

These are the presets for multiple harmonic operation:

Mixer	Readout in setup screen	Readback on softkeys	Range	Harm #	Dbl r?	RF start	RF stop	RF Center
A-band	A-band Multiple Harmonic	Multi harm A-band	1	-4	N	26.5	34.1	30.3
			2	-4	Y	33.1	40	36.55
E-band	E-band Multiple Harmonic	Multi harm E-band	1	-6	Y	60	83	71.5
			2	-8	Y	65	90	77.5
U-band	U-band Multiple Harmonic	Multi harm U-band	1	-6	N	40	51.5	45.75
			2	-6	Y	49.5	60	54.75
Coaxial	Coaxial Multiple Harmonic	Multi harm Coaxial	1	-4	N	26.5	34	30.25
			2	-4	Y	32.5	55	43.75
			3	-6	Y	50	70	60

Mixer Bias

Adjusts an internal bias source for use with external mixers. The bias signal is present on the center conductor of the IF input connector on the front panel. The shunt current range is from -10 mA to 10 mA and it can be set whether Mixer Bias state is On or Off, but it will only be applied if it is On.

The bias remains as set if the user switches to another input (e.g., the RF Input).

Key Path	Input/Output, External Mixer, Ext Mix Setup
Remote Command	[:SENSe]:MIXer:BIAS <real> [:SENSe]:MIXer:BIAS? [:SENSe]:MIXer:BIAS:STATe OFF ON 0 1 [:SENSe]:MIXer:BIAS:STATe?
Example	:MIX:BIAS 0 :MIX:BIAS? MIX:BIAS:STAT 0 MIX:BIAS:STAT?
Preset	This is unaffected by Preset but is set to OFF and 0 on a "Restore Input/Output Defaults"
State Saved	Saved in instrument state
Min	-10 mA
Max	10 mA
Initial S/W Revision	A.08.01

Edit Harmonic Table

This menu lets you directly configure the Harmonic number and LO Doubler state of your mixer by editing the Harmonic Table. The Harmonic Table can be configured:

- as a single row (meaning only one harmonic number is used and the LO Doubler is either on or off),
- as two rows where the harmonic number switches between the first row and the second, or
- as two rows where the LO Doubler state switches between the first row and the second

When you press the **Edit Harmonic Table** key, a dialog appears on the display informing you that when you edit the Harmonic Table you will go into Custom mixer mode, and that to undo your changes you must go to the Mixer Presets menu and choose the preset appropriate for your mixer. You may cancel out of this dialog and not enter the Edit Harmonic Table menu. If you choose to enter the menu, the Mixer Selection changes to "Custom".

In Custom mode, your maximum start and stop frequencies are strictly set by the LO range and the harmonic number you have chosen. The undoubled LO range is approximately 3.8 – 8.7 GHz, and (for LO's that support doubling) the doubled range is approximately 8.0 – 14.0 GHz. That range times the harmonic you have selected will determine your tuning range. If your frequency is currently outside that range when you edit the Harmonic Table, your frequency will be changed to fall at the edge of the range. To change it back you must go into the Mixer Presets menu and select a Preset.

Whenever you are in the **Edit Harmonic Table** menu, the editable fields in the table have a white background, indicating that they can be edited. These fields vary depending on the Table Type.

Table Type	Fields you can edit
Single Row	Harmonic and LO Doubler cells
Harmonic Switching	Harmonic and LO Doubler cells (only the first row)
Doubler Switching	Harmonics cell (only the first row)

Note that you cannot add or delete rows from the table; you can only modify the rows that are already there.

Key Path	Input/Output, External Mixer, Ext Mix Setup
Initial S/W Revision	A.08.01
Modified at S/W Revision	A.09.491

Table Type

This parameter determines which type of configuration you want the Custom Mixer to be. You can choose Single Row, Harmonic Switching, or Doubler Switching. See detail under each of these keys.

Key Path	Input/Output, External Mixer, Ext Mix Setup, Edit Harmonic Table
Remote Command	[:SENSe] :MIXer :TTYPe SINGle HARMonic DOUBler [:SENSe] :MIXer :TTYPe ?
Example	:MIX:TTYP SING
Couplings	When you change the Table Type, the Mixer Selection changes to "Custom"
Preset	Depends on the current Mixer Preset. This is unaffected by Mode Preset, but on a "Restore Input/Output Defaults" the Mixer is preset to 11970A, for which the Table Type is Harmonic Switching
State Saved	Saved in instrument state
Initial S/W Revision	A.09.491

Single Row

In the Single Row type, the External Mixer always stays in the same Harmonic Number and the LO Doubler is either on or off and does not change state during a sweep. You may change the Harmonic Number and you may change the state of the Doubler.

Key Path	Input/Output, External Mixer, Ext Mix Setup, Edit Harmonic Table, Table Type
Example	:MIX:TTYP SING
State Saved	Saved in instrument state
Initial S/W Revision	A.09.491

Harmonic Switching

In the Harmonic Switching type, the External Mixer switches the Harmonic Number in the middle of the sweep. The Lo Doubler may be on or off but it is the same for both Harmonic Numbers. You can set the initial Harmonic Number, and when it switches it decrements by two when the harmonic is negative and increments by two when the harmonic is positive. For example, if you set the initial number to -6, when it switches it will go to -8. If you set the harmonic number to 8 when it switches it will go to 10.

Key Path	Input/Output, External Mixer, Ext Mix Setup, Edit Harmonic Table, Table Type
Example	:MIX:TTYP HARM
State Saved	Saved in instrument state
Initial S/W Revision	A.09.491

Doubler Switching

In the Doubler Switching type, the External Mixer switches the doubler from Off to On in the middle of the sweep. You can set the Harmonic Number but it stays the same for the Doubler Off state as for the Doubler On state. The LO Doubler key is grayed out in this table type.

Key Path	Input/Output, External Mixer, Ext Mix Setup, Edit Harmonic Table, Table Type
Example	:MIX:TTYP DOUB
State Saved	Saved in instrument state
Initial S/W Revision	A.09.491

Harmonic

This lets you enter the Harmonic value with its associated sign (mixing mode).

The harmonic number is a signed integer, where the sign has the meaning of choosing between positive and negative mixing products. Desired mixing products occur at an IF frequency which equals the difference between the RF frequency (f_{RF}) and the LO frequency (Nf_{LO}). When this difference is positive, we can say $f_{IF} = f_{RF} - Nf_{LO}$. When this difference is negative, we can say $f_{IF} = Nf_{LO} - f_{RF}$. Thus, a negative harmonic means the analyzer will be tuned such that the harmonic of the LO is higher than the indicated frequency by the frequency of the first IF. A positive harmonic means the analyzer will be tuned such that the harmonic of the LO is lower than the indicated frequency by the frequency of the first IF.

Key Path	Input/Output, External Mixer, Ext Mix Setup, Edit Harmonic Table
Remote Command	[:SENSe]:MIXer:HARMonic <integer> [:SENSe]:MIXer:HARMonic?
Example	:MIX:HARM -28 :MIX:HARM?
Notes	The query returns the harmonic value of the first row of the harmonic table.
Couplings	When you set a value for the Harmonic via SCPI, the Mixer Selection changes to "Custom"
Preset	This is unaffected by Mode Preset, but on a "Restore Input/Output Defaults" editing is turned off, the Harmonic Table returns to normal, and the Mixer is preset to 11970A, which has -6 in the first row of its Harmonic Table
State Saved	Saved in instrument state
Min	-400
Max	400
Initial S/W Revision	A.08.01
Modified at S/W Revision	A.09.491

LO Doubler

This lets you enter the LO Doubler setting. The LO Doubler setting controls the choice of the LO doubler state for LO's that support doubled operation.

In LO's that support doubling, the fundamental band is approximately 3.8 – 8.7 GHz, and the doubled band is approximately 8.0 – 14 GHz. The higher LO frequency can result in a lower mixer harmonic and reduced mixer conversion loss.

Key Path	Input/Output, External Mixer, Ext Mix Setup, Edit Harmonic Table
Remote Command	[:SENSe]:MIXer:LODoubler ON OFF 0 1 [:SENSe]:MIXer:LODoubler?
Example	:MIX:LOD 0 :MIX:LOD?
Notes	The query returns the doubler value of the first row of the harmonic table.
Dependencies	This key is grayed out and set to Off when Table Type is set to Doubler Switching.

Couplings	When you set a value for the doubler setting via SCPI, the Mixer Selection changes to "Custom"
Preset	This is unaffected by Mode Preset, but on a "Restore Input/Output Defaults" editing is turned off, the Harmonic Table returns to normal, and the Mixer is preset to 11970A, which has the doubler Off in the first row of its Harmonic Table
State Saved	Saved in instrument state
Initial S/W Revision	A.08.01
Modified at S/W Revision	A.09.491

Refresh USB Mixer Connection

This operation re-reads the USB devices and refreshes connection to Keysight USB mixers. This operation is the same as physically removing and reinserting the mixer's USB connection.

Key Path	Input/Output, External Mixer, Ext Mix Setup
Example	:MIX:BAND USB
Notes	When using Keysight USB Mixers, if a Restore All Defaults (SCPI command SYSTem:DEFault) has been perform, either remove and reinsert the USB cable or press the Refresh USB Mixer Connection softkey.
Initial S/W Revision	A.14.00

Mixer Path

This parameter determines which path you wish to use when using M1971 series USB mixers:

- Normal, in which they function as a classic external mixer with a single conversion
- Dual Conversion, in which the first conversion is to a higher IF frequency (nominally 1.5 GHz) and you provide a 10 MHz signal to which an internal PLL is locked, to effect a second downconversion. The higher IF frequency used in Dual Conversion increases the image frequency offset, giving you a wider image-free conversion range. This reduces aliasing effects and improves the image suppress functionality for wideband signals.
- Aux Equipment, wherein the first mixer output drives an output connector on the mixer and the analyzer is out of the circuit. When you connect an M1971 Mixer to USB, the instrument will pull the IF and RF flatness data from the USB mixer and write this data to a user-accessible file in .csv format for your use when Aux Equipment is selected.

Key Path	Input/Output, Input, Ext Mix Setup, Mixer Path
Remote Command	[:SENSe] :MIXer :MPATH NORMa1 DUAL AUX [:SENSe] :MIXer :MPATH?
Example	:MIX:MPAT NORM
Dependencies	This control only appears when an M1971 series USB Mixer is connected to the USB port of the instrument When Aux Equipment is the selection, Sig Id is turned off to avoid shifting the LO. It is not turned back on when a different path is selected. When Aux Equipment is the selection, there is no valid result, so the analyzer displays a “No Result; Meas invalid with Aux Equip” error condition message. This is error 135. When Dual Conversion is selected, if no signal is sensed at the 10 MHz input port, an error condition will be generated, “Ref missing or out of range;M1971” (error 521). This also lights the Error LED on the mixer itself.
Couplings	When the Aux Equipment path is chosen, the analyzer switches to Zero Span.
Preset	NORMal
State Saved	Saved in instrument state
Initial S/W Revision	A.16.00

User IF Freq

Specifies the user’s desired IF frequency when using the Aux Equipment path. This setting will determine the LO frequency the instrument will drive into the mixer to correspond to the center frequency specified by the user.

Key Path	Input/Output, External Mixer, Ext Mix Setup
Remote Command	[:SENSe] :MIXer :UIFFfreq <real> [:SENSe] :MIXer :UIFFreq?
Example	:MIX:UIFF 300 MHz
Dependencies	Only appears if an M1971 mixer is connected to USB and the Mixer Path is Aux Equipment
Preset	1.2 GHz
State Saved	Saved in Input/Output state
Min	-4 GHz
Max	4 GHz
Initial S/W Revision	A.16.00

Signal ID On/Off

Activates or deactivates an algorithm that aids with the identification of multiple responses

Toggles the Signal ID (signal identification) function On or Off. This function lets you identify multiple responses of a single input signal that are generated when using

un-preselected external mixers. The use of mixers without pre-selecting filters offers the advantage of improved receiver sensitivity because of the absence of the filter insertion loss, but results in multiple responses due to images and undesired harmonic mixing products.

While in Signal ID, basic spectrum analyzer functions work normally (for example, you can change Span normally), but some functions are disabled (for example, some traces are unavailable).

There are two forms of Signal ID, Image Suppress and Image Shift. Choose the one most appropriate for your application. For Image Shift, an LO-shifted and an unshifted trace are taken in Trace 1 and Trace 2 and displayed together. Any peaks that are not the same in both traces are images. For Image Suppress, image cancellation is performed in the background using two hidden traces, and the result displayed in Trace 1, which shows only the valid signals.

Key Path	Input/Output, External Mixer
Remote Command	[:SENSe]:SIDentify[:STATe] OFF ON 0 1 [:SENSe]:SIDentify[:STATe]?
Example	:SID 0 :SID?
Notes	Signal ID uses data from two successive sweeps. Therefore, if the analyzer is in single sweep mode, two sweep triggers are used to generate the data needed for signal identification.
Dependencies	Signal ID is not available in some measurements. If the Signal ID key does not appear or is grayed out while in your measurement, then it is not available. Because Signal ID uses data from two successive sweeps, several trace and sweep functions are grayed out in Signal ID. See the documentation for your measurement for details on which trace keys are grayed out. Signal ID is not available with Signal Track so Signal ID will be grayed out if in Signal Track. Signal ID will be turned off when External Mixer is turned off. Signal ID cannot be turned on when using internal mixing. Rules for auto coupling of the Sweep and FFT keys are changed with Signal ID on. For both the dynamic range case and the speed case, swept is chosen whenever any form of Signal ID is on. If Manual FFT is selected, the Signal ID key is grayed out. Whenever Signal ID is on, a warning message will be generated If Signal ID is selected in a measurement that does not support it, a warning message is generated
Couplings	The Auto Rules for detector selection select Normal for all active traces when Signal ID is turned on.
Preset	This is unaffected by Preset but is set to OFF on a "Restore Input/Output Defaults"
Initial S/W Revision	A.08.01

Signal ID Mode

Lets you set which Signal ID mode you will use, either Image Suppress or Image Shift.

Key Path	Input/Output, External Mixer
Remote Command	[:SENSe]:SIDentify:MODE ISUPpress ISHift [:SENSe]:SIDentify:MODE?
Example	:SID:MODE ISUP :SID:MODE?
Preset	This is unaffected by Preset but is set to ISUPpress on a "Restore Input/Output Defaults"
State Saved	Saved in instrument state
Initial S/W Revision	A.08.01

Image Suppress

The Image Suppress mode of Signal ID mathematically removes all image and multiple responses of signals present at the mixer input. Two hidden sweeps are taken in succession. The second sweep is offset in LO frequency by $2*IF/N$. For each point in each trace, the smaller amplitude from the two traces is taken and placed in that point in the selected Trace. Responses of each trace that lie on top of one another will remain and are valid signals, others are images and are suppressed. The action of taking the smaller of the two traces will make the average noise level lower in all points that do not have an image, thus reducing the accuracy of the measurement of noise and noise-like signals.

Key Path	Input/Output, External Mixer, Signal ID Mode
Example	:SID:MODE ISUP
Notes	In Image Suppress Mode, synchronization is ensured by first turning off Signal ID, initiating a single sweep, then turning on Signal ID followed by two single sweeps.
Couplings	In Image Suppress the Peak detector is auto-selected to improve the image suppression effectiveness.
Initial S/W Revision	A.08.01
Modified at S/W Revision	A.16.00

Image Shift

Like the Image Suppress mode, Image Shift is a two sweep sequence. The data from the first sweep is placed in Trace 1 and the data from the second (LO frequency shifted by $2*IF/N$) sweep is placed in Trace 2. On alternate sweeps, the alternate trace (trace 2) is placed in front of trace 1. This way, you can see a signal at the same place on alternate sweeps, showing in yellow (trace1) and blue (trace2). Signal responses of Trace 1 and Trace 2 that have the same horizontal position are considered to be in the current band and therefore can be analyzed with the amplitude and frequency measurement systems of the SA. All other responses are invalid and should be ignored.

NOTE

This function takes control of and uses Trace 1 and Trace 2. Any data in these traces prior to activating Image Shift will be lost.

Key Path	Input/Output, External Mixer, Signal ID Mode
Example	:SID:MODE ISH
Notes	To synchronize in Image Shift Mode, turn off Signal ID and then initiate a single sweep. Then turn on Signal ID and initiate two single sweeps. The results of the first sweep after Signal ID is turned on are available in Trace 1. The next sweep is shifted and the data from that sweep is available in Trace 2. The unshifted and shifted data can then be compared.
Couplings	Trace 2 is turned off when Image Shift is turned Off.
Initial S/W Revision	A.08.01

Cable IF Loss

The loss at the IF in the IF/LO cable can be compensated for with this function, by entering the loss in dB for your cable.

The cable loss will depend on the IF frequency. The IF frequency varies depending on which IF path your measurement is using. For best accuracy, characterize your cable's loss for the IF frequency or frequencies you will be using.

IF Frequencies:

10 MHz path: 322.5 MHz

25 MHz path: 322.5 MHz

40 MHz path: 250 MHz

140 MHz path: 300 MHz

Key Path	Input/Output, External Mixer
Key Path	Input/Output, External Mixer, Calibrate Mixer
Remote Command	[:SENSe]:MIXer:CIFLoss <rel_amp1> [:SENSe]:MIXer:CIFLoss?
Example	:MIX:CIFL 0.23 DB :MIX:CIFL?
Preset	0.26 dB
State Saved	Saved in instrument state
Min	-100
Max	100
Initial S/W Revision	A.08.01

I/Q

This feature is not available unless the **"Baseband I/Q (Option BBA)"** on page 273 is installed.

Selects the front-panel I/Q input ports to be the analyzer signal input. If I/Q is already selected, pressing this key accesses the I/Q setup menu.

Key Path	Input/Output
Mode	BASIC, CDMA2K, EDGE GSM, TDSCDMA, VSA89601, WIMAX OFDMA, LTE, LTETDD, LTEAFDD, LTEATDD, DCTV, DTMB (CTTB), DVB-T/H with T2, CMMB, ISDBT, WCDMA, VXA, CDMA1XEV, WLAN
Example	FEED AIQ
Notes	Not all measurements support the use of the I/Q signal input. When I/Q is selected in a measurement that does not support it, the "No Result; Meas invalid with I/Q inputs" error condition message appears. This is error 135
Initial S/W Revision	Prior to A.02.00

Baseband I/Q (Option BBA)

The Baseband I/Q functionality is a hardware option. It is option BBA. If the option is not installed, none of the I/Q functionality is enabled.

The Baseband I/Q has four input ports and one output port. The input ports are I, I-bar, Q, and Q-bar. The I and I-bar together compose the I channel and the Q and Q-bar together compose the Q channel. Each channel has two modes of operation, Single-Ended (also called "unbalanced") and Differential Input (also called "balanced"). When in Single-Ended operation, only the main port (I or Q) is used and the complementary port (I-bar or Q-bar) is ignored. When in Differential Input mode, both main and complementary ports are used.

The input settings (range, attenuation, skew, impedance, external gain) apply to the channels, not the individual ports.

The system supports a variety of 1 M Ω input passive probes as well as the Keysight 113x Series active differential probes using the Infinimax probe interface.

The Keysight 113x Series active probes can be used for both single ended and differential measurements. In either case a single connection is made for each channel (on either the I or Q input). The input is automatically configured to 50 Ω single ended and the probe power is supplied through the Infinimax interface. The probe can be configured for a variety of input coupling and low frequency rejection modes. In addition, a wide range of offset voltages and probe attenuation accessories are supported at the probe interface. The active probe has the advantage that it does not significantly load the circuit under test, even with unity gain probing.

With passive 1 M Ω probes, the probe will introduce a capacitive load on the circuit, unless higher attenuation is used at the probe interface. Higher attenuation reduces the signal level and degrades the signal-to-noise-ratio of the measurement. Passive

probes are available with a variety of attenuation values for a moderate cost. Most Keysight passive probes can be automatically identified by the system, setting the input impedance setting required as well as the nominal attenuation. For single ended measurements a single probe is used for each channel. Other passive probes can be used, with the attenuation and impedance settings configured manually.

For full differential measurements, the system supports probes on each of the four inputs. The attenuation of the probes should be the same for good common mode rejection and channel match.

Both active and passive probes in single ended and differential configurations can be calibrated. This calibration uses the Cal Out BNC connection and a probe connection accessory. The calibration achieves excellent absolute gain flatness in a probed measurement. It matches both the gain and frequency response of the I and Q channels as well as any delay skew, resulting in high accuracy in derived measurements such as Error Vector Magnitude (EVM).

When a probe is connected a status message will be displayed. The message will indicate if calibration data is available or not. Calibration data is saved for each type of probe (including "none") for each port and will be reapplied whenever that type of probe is re-connected to the same port. For probes with EEPROM identification, the calibration data will be stored based on the unique probe identifier and will reapply data for that particular probe if it is available. The data will not follow a probe from one port to another. For probes without EEPROM identification, the instrument cannot distinguish between different probes of the same type and it will use the data from the last calibration for that probe type on that port.

When in differential mode, both the main and complementary probes are expected to be of the same type.

In some situations, the I and Q channels should be configured identically. In other situations it is convenient to control them independently. Some menus have a "Q Same as I" setting that will cause the Q channel configuration to mirror the I channel configuration, avoiding the overhead of double data entry when the channels should be the same.

The output port is for calibrating the I/Q input ports, although it can also be manually controlled.

There are two types of calibrations available: cable calibration and probe calibration. The cable calibration will guide the user through connecting each input port in turn. All ports must be calibrated together. The probe calibration is done for a specific channel (I or Q). If in Single-Ended mode, only the main port is calibrated. When in Differential Input mode, the user is guided through calibrating both main and complementary ports.

The front panel I/Q port LEDs indicate the current state of that port. On (green) indicates it is active, and off (dark) indicates it is not in use. For example, the Cal Out port LED is on if and only if there is signal coming out of that port.

The input is a context and some parameters have separate values for each context. The SCPI for these parameters has an optional "[:RF|IQ]" node. If the specific context

is omitted, the command acts on the current input context's value. Here are the parameters that are input context sensitive:

- Center Frequency
- Trigger Source

It is important to distinguish between the I and Q input ports and the displayed I and Q data values. The I and Q input ports feed into a digital receiver that does digital tuning and filtering. The I and Q data seen by the user (either on the display or through SCPI) corresponds to the real ("I") and the imaginary ("Q") output from the digital receiver. When the input path is I+jQ or I Only and the center frequency is 0 Hz, the I input ends up in as the real output from the receiver and appears as "I" data. Likewise, when the input path is I+jQ and the center frequency is 0 Hz, the Q input ends up as the imaginary output from the receiver and appears as "Q" data. However, when the input path is Q Only, the Q input is sent to the receiver as $Q+j0$, so the receiver output has the Q input coming out on the real output, and so in Q Only, the signal from the Q input port appears as the "I" data. Another situation where the I and Q data do not necessarily correspond directly to the I and Q inputs is when the center frequency is non-zero. The digital processing involved in the tuning is a complex operation. This will result in I Only data appearing as both "I" and "Q" data, the same as that signal would appear if seen through the RF input port.

Baseband I/Q Remote Language Compatibility

For the Keysight E4406A VSA Series Transmitter Tester, Option B7C provided baseband I/Q inputs. Code compatibility has been provided to allow many of the commands for option B7C to function properly with the X-Series. The X-Series has hardware differences and additional capabilities (e.g., E4406A does not have independent settings of I & Q nor does it provide for probe calibrations) which make 100% compatibility impossible.

4. The following commands are supported:

:CALibration:IQ:FLATness

:INPut:IMPedance:IQ U50|B50|U1M|B1M

:INPut:IMPedance:REFerence <integer>

5. The [:SENSe]:FEED RF|IQ|IONLy|QONLy|AREFerence|IFALign command supports all parameters except IFALign. The FEED? query will return only RF|AIQ|AREF.

6. The following commands are not supported:

:CALibration:GIQ

:CALibration:IQ:CMR

:INPut:IQ:ALIGn OFF|ON|0|1

The Rohde & Schwarz FSQ-B71 also provides baseband I/Q inputs. A certain amount of code compatibility is provided in the X-Series, however hardware differences make this a somewhat limited set.

Supported:

The "<1|2>" is supported as "[1]".

INPut<1|2>:IQ:BAALanced[:STATe] ON | OFF

INPut<1|2>:IQ:TYPE I | Q | IQ

INPut<1|2>:IQ:IMPedance LOW | HIGH

Not Supported:

INPut<1|2>:SElect AIQ | RF

TRACe<1|2>:IQ:DATA:FORMat COMPatible | IQBLock | IQPair>

TRACe<1|2>:IQ:DATA:MEMory? <offset samples>, <# of samples>

TRACe<1|2>:IQ:DATA?

TRACe<1|2>:IQ:SET <filter type>, <rbw>, <sample rate>, <trigger source>, <trigger slope>, <pretrigger samples>, <# of samples>

TRACe<1|2>:IQ:SRATe 10.0kHz to 81.6MHz

TRACe<1|2>:IQ[:STATe] ON|OFF

The Rohde & Schwarz FMU has the following SCPI, which is not supported (these commands start/abort the probe calibration procedure, which is manually interactive from the front panel):

CALibration:ABORt

CALibration:PROBe[:START]

I/Q Path

Selects which I/Q input channels are active. The LED next to each I/Q input port will be on when that port is active.

The analysis bandwidth for each channel is the same as that of the instrument. For example, the base N9020A has a bandwidth of 10 MHz. With I/Q input the I and Q channels would each have an analysis bandwidth of 10 MHz, giving 20 MHz of bandwidth when the I/Q Path is I+jQ. With option B25, the available bandwidth becomes 25 MHz, giving 25 MHz each to I and Q and 50 MHz to I+jQ.

I/Q voltage to power conversion processing is dependent on the I/Q Path selected.

- With I+jQ input we know that the input signal may not be symmetrical about 0 Hz, because it has a complex component. Therefore, above 0 Hz only the positive frequency information is displayed, and below 0 Hz only the negative frequency information is displayed.

- With all other Input Path selections, the input signal has no complex component and therefore is always symmetrical about 0 Hz. In this case, by convention, the power conversion shows the combined voltage for both the positive and negative frequencies. The information displayed below 0 Hz is the mirror of the information displayed above 0 Hz. This results in a power reading 6.02 dB higher (for both) than would be seen with only the positive frequency voltage. Note also that, in this case the real signal may have complex modulation embedded in it, but that must be recovered by further signal processing.

Key Path	Input/Output, I/Q
Remote Command	[:SENSe] :FEED:IQ:TYPE IQ IONLY QONLY [:SENSe] :FEED:IQ:TYPE?
Example	Set the input to be both the I and Q channels, combined as $I + j * Q$. FEED:IQ:TYPE IQ
Preset	IQ
State Saved	Yes This is unaffected by a Preset but is set to the default value on a "Restore Input/Output Defaults" or "Restore System Defaults->All"
Range	I+jQ I Only Q Only
Readback Text	I+jQ I Only Q Only
Initial S/W Revision	Prior to A.02.00

Remote Command	:INPut[1]:IQ:TYPE IQ I Q :INPut[1]:IQ:TYPE?
Notes	For R&S FSQ-B71 compatibility
Preset	IQ
Initial S/W Revision	Prior to A.02.00

I+jQ

Sets the signal input to be both the I and Q channels. The I and Q channel data will be combined as $I + j * Q$.

Key Path	Input/Output, I/Q, I/Q Path
Example	Set the input to be both the I and Q channels, combined as $I + j * Q$. FEED:IQ:TYPE IQ
Initial S/W Revision	Prior to A.02.00

I Only

Sets the signal input to be only the I channel. The Q channel will be ignored. The data collected is still complex. When the center frequency is 0 the imaginary part will always be zero, but for any other center frequency both the real and imaginary parts will be significant.

Key Path	Input/Output, I/Q, I/Q Path
Example	Set the input to be only the I channel. FEED:IQ:TYPE IONL
Initial S/W Revision	Prior to A.02.00

Q Only

Sets the signal input to be only the Q channel. The I channel will be ignored. The Q channel will be sent to the digital receiver block as $Q+j0$. The receiver's output is still complex. When the center frequency is 0 the imaginary part will always be zero, but for any other center frequency both the real and imaginary parts will be significant. Note that since the receiver's real output is displayed as the "I" data, when the center frequency is 0, the Q Only input appears as the "I" data.

Key Path	Input/Output, I/Q, I/Q Path
Example	Set the input to be only the Q channel. FEED:IQ:TYPE QONL
Initial S/W Revision	Prior to A.02.00

I Setup

Access the channel setup parameters for the I channel.

Key Path	Input/Output, I/Q
Initial S/W Revision	Prior to A.02.00

I Differential Input

Selects differential input on or off for the I channel. For differential input (also called balanced input), the analyzer uses both main and complementary ports. When differential input is off (also called single-ended or unbalanced input), the analyzer uses only the main port.

Key Path	Input/Output, I/Q, I Setup
Remote Command	:INPut:IQ[:I]:DIFFerential OFF ON 0 1 :INPut:IQ[:I]:DIFFerential?

Example	Put the I channel in Differential Input mode INP:IQ:DIFF ON
Notes	When I Differential Input = On, the analyzer will check for attenuation mismatches between the I and I-bar ports. If the difference in attenuation values exceeds 0.5 dB a Settings Alert error condition, error 159 will be set. When I Differential Input = On, and IQ Path is I+jQ, the Q Differential input must also be On. Similarly, when I Differential Input = Off, and IQ Path is I+jQ, the Q Differential input must also be Off. If the states of the two inputs do not match, an error condition message is generated, 159;Settings Alert;I/Q mismatch:Differential.
Couplings	Some active probes include built-in differential capability. When one of these probes is sensed, this key is disabled. Since the differential capability is handled in the probe, the Analyzer will use only the main port and the key will show that the Analyzer's Differential Input mode is Off (indicating that the complementary port is not in use). When Q Same as I is On, the value set for I will also be copied to Q.
Preset	Off
State Saved	Yes This is unaffected by a Preset but is set to the default value on a "Restore Input/Output Defaults" or "Restore System Defaults->All"
Range	Off On
Initial S/W Revision	Prior to A.02.00

Remote Command	:INPut[1]:IQ:BALanced[:STATE] OFF ON 0 1 :INPut[1]:IQ:BALanced[:STATE]?
Notes	For R&S FSQ-B71 compatibility, with no independent settings for the I and Q channels. Therefore, it is tied only to the I channel and does not provide an equivalent for the Q channel. For proper operation of the backwards compatibility command Q Same as I should be set to On.
Preset	OFF
Initial S/W Revision	Prior to A.02.00

I Input Z

Selects the input impedance for the I channel. The impedance applies to both the I and I-bar ports.

The input impedance controls the hardware signal path impedance match. It is not used for converting voltage to power. The voltage to power conversion always uses the Reference Z parameter. The Reference Z parameter applies to both I and Q channels.

Key Path	Input/Output, I/Q, I Setup
Remote Command	:INPut[1]:IQ[:I]:IMPedance LOW HIGH :INPut[1]:IQ[:I]:IMPedance?

Example	Set the I channel input impedance to 1 M Ω INP:IQ:IMP HIGH
Notes	LOW = 50 Ω , HIGH = 1 M Ω When IQ Path is I+jQ, the I Input Z setting must be the same as the Q Input Z setting. If the settings of the two inputs do not match, an error condition message is generated, 159;Settings Alert;I/Q mismatch:Input Z.
Couplings	Input impedance is a built-in characteristic of a probe. Therefore, whenever a probe is sensed, this key is disabled and the value is set to match the probe. When no probe is sensed on Q and Q Same as I is On, the value set for I will also be copied to Q.
Preset	LOW
State Saved	Yes This is unaffected by a Preset but is set to the default value on a "Restore Input/Output Defaults" or "Restore System Defaults->All"
Range	50 Ω 1 M Ω
Initial S/W Revision	Prior to A.02.00

I Skew

Sets the skew factor for the I channel. The skew will shift the channel's data in time. Use this to compensate for differences in the electrical lengths of the input paths due to cabling.

Key Path	Input/Output, I/Q, I Setup
Remote Command	[:SENSe]:CORRection:IQ[:I]:SKEW <seconds> [:SENSe]:CORRection:IQ[:I]:SKEW?
Example	Delay the data for the I channel by 10 ns. CORR:IQ:SKEW 10 ns
Preset	0
State Saved	Yes This is unaffected by Preset but is set to the default value on a "Restore Input/Output Defaults" or "Restore System Defaults->All"
Range	0 s to 100 ns
Min	0 s
Max	+100 ns
Initial S/W Revision	Prior to A.02.00

I Probe

Access the probe setup parameters for the I channel. See "[I/Q Probe Setup](#)" on page 290.

Key Path	Input/Output, I/Q, I Setup
State Saved	No
Readback Text	[<I port probe id> This is reporting the type of probe sensed on the I port. There is no parameter for overriding what is sensed.
Initial S/W Revision	Prior to A.02.00

Attenuation

The attenuation is part of the calibration data stored with the probe type and is initially the value that was returned by the last calibration. You can modify this value and any changes will be stored with the calibration data and will survive power cycles and presets. When a probe calibration is performed the attenuation value will be overwritten by the calibration.

Key Path	Input/Output, I/Q, I Setup Q Setup, I Probe Q Probe
Remote Command	<code>[:SENSe] :CORRection:IQ:I Q:ATTenuation:RATio <real></code> <code>[:SENSe] :CORRection:IQ:I Q:ATTenuation:RATio?</code>
Example	Set the attenuation for the current I probe to 100.00:1. CORR:IQ:I:ATT:RAT 100
Notes	Each probe type has its own attenuation setting. As probes are changed the attenuation value will reflect the new probe's setting. Changing the attenuation affects only the current probe type's setting and leaves all others unchanged. When the IQ Path is I+jQ, the Q probe attenuation setting must match the I Probe attenuation setting within 1 dB. If this is not the case, an error condition message is generated, 159;Settings Alert;I/Q mismatch:Attenuation.
Preset	Each probe type has its own default. The default for the "Unknown" probe type is 1:1.
State Saved	Saved with probe calibration data. It survives a power cycle and is not affected by a Preset or Restore.
Range	0.001 to 10000
Min	0.001
Max	10000
Initial S/W Revision	Prior to A.02.00

This is an alternate form of the SCPI that allows input as a power instead of a ratio.

Remote Command	<code>[:SENSe] :CORRection:IQ:I Q:ATTenuation <rel_amp1></code> <code>[:SENSe] :CORRection:IQ:I Q:ATTenuation?</code>
Example	Set the attenuation for the current I probe type to 100.00:1. CORR:IQ:I:ATT 20 dB

Range	-60 dB to +80 dB
Min	-60 dB
Max	+80 dB
Initial S/W Revision	Prior to A.02.00

Calibrate

Invokes the guided probe calibration. The guided probe calibration is context sensitive and depends on the channel (I or Q) and the Differential Input state. The calibration is only performed on the selected channel. When Differential Input is on, both the probe attached to the main port and the probe attached to the complementary port are calibrated. When Differential Input is off, only the probe attached to the main port is calibrated. See "[I/Q Guided Calibration](#)" on page 336.

Key Path	Input/Output, I/Q, I Setup Q Setup, I Probe Q Probe, Coupling
Readback Text	The last calibration date, or if no calibration exists, "(empty)". Last: <cal date> <cal time> Example: Last: 8/22/2007 1:02:49 PM
Initial S/W Revision	Prior to A.02.00

Clear Calibration

Clears the calibration data for the current port and probe. It does not clear the data for other probe types or other ports. If the sensed probe has EEPROM identification, only the data for that specific probe is cleared. After this command has completed, the probe calibration state will be the same as if no probe calibration had ever been performed for the specified channel and probe. The probe attenuation will be the default value for that probe type and the Cable Calibration frequency response corrections will be used. This command is dependent on the Differential Input state. When Differential Input is on, both the data for the probe attached to the main port and the data for the probe attached to the complementary port are cleared. When Differential Input is off, only data for the probe attached to the main port is cleared.

Key Path	Input/Output, I/Q, I Setup Q Setup, I Probe Q Probe
Remote Command	:CALibration:IQ:PROBe:I Q:CLEar
Example	Clear the calibration data for the I channel and the current probe (with EEPROM identification) or probe type (without EEPROM identification). :CAL:IQ:PROBe:I:CLE
Initial S/W Revision	Prior to A.02.00

Combined Differential/Input Z (Remote Command Only)

This is Remote Command only (no front panel) and is for backwards compatibility only. It combines the Differential Input and Input Z selections into a single SCPI command.

Remote Command	<code>:INPut:IMPedance:IQ U50 B50 U1M B1M</code> <code>:INPut:IMPedance:IQ?</code>
Example	<code>:INPut:IMPedance:IQ U50</code> This is equivalent to the following two SCPI commands: <code>:INP:IQ:DIFF OFF</code> <code>:INP:IQ:IMP 50</code>
Notes	<p>Provided for E4406A code compatibility.</p> <p>The enum values translate as follows:</p> <p>U50: Differential Input = Off, Input Z = 50Ω</p> <p>B50: Differential Input = On, Input Z = 50Ω</p> <p>U1M: Differential Input = Off, Input Z = 1 MΩ</p> <p>B1M: Differential Input = On, Input Z = 1 MΩ</p> <p>This command is for backwards compatibility. It combines the Input Z (50Ω or 1 MΩ) parameter with the Differential Input (Off = "Unbalanced", On = "Balanced") parameter into a single enumeration.</p> <p>This backwards compatibility SCPI command was for an instrument without independent settings for the I and Q channels. Therefore, it is tied only to the I channel and does not provide an equivalent for the Q channel. For proper operation of the backwards compatibility command Q Same as I should be set to On.</p> <p>Also, note the subtle difference between this SCPI command and the backwards compatibility command for Input Z. The Input Z SCPI has "IQ" before "IMP" while this command has that order reversed.</p>
Couplings	This command does not have an independent parameter, but instead is tied to the Differential Input and Input Z parameters. The coupling for those parameters apply to this command too.
Preset	U50
Initial S/W Revision	Prior to A.02.00

Q Setup

Access the channel setup parameters for the Q channel.

Key Path	Input/Output, I/Q
Readback Text	When Q Same as I is On the readback is "Q Same as I".
Initial S/W Revision	Prior to A.02.00

Q Same as I

Many, but not all, usages require the I and Q channels have an identical setup. To simplify channel setup, the Q Same as I will cause the Q channel parameters to be mirrored from the I channel. That way you only need to set up one channel (the I channel). The I channel values are copied to the Q channel, so at the time Q Same as I is turned off the I and Q channel setups will be identical. This does not apply to Probe settings or to parameters that are determined by the probe.

Key Path	Input/Output, I/Q, Q Setup
Remote Command	:INPut:IQ:MIRROred OFF ON 0 1 :INPut:IQ:MIRROred?
Example	Turn off the mirroring of parameters from I to Q. INP:IQ:MIRR OFF
Couplings	Only displayed for the Q channel. When Yes, the I channel values for some parameters are mirrored (copied) to the Q channel. However, when a parameter is determined by the type of probe and a probe is sensed, the probe setting is always used and the I channel setting is ignored. The following parameters are mirrored: Differential Input (when not determined by probe) Input Z (when not determined by probe)
Preset	This is unaffected by a Preset but is set to the default value (Q Same as I set to "On") on a "Restore Input/Output Defaults" or "Restore System Defaults->All"
State Saved	Saved in instrument state
Range	On Off
Readback Text	"Q Same as I" when On, otherwise none.
Initial S/W Revision	Prior to A.02.00

Q Differential Input

Selects differential input on or off for the Q channel. For differential input (also called balanced input), the analyzer uses both the Q and Q-bar ports. When differential input is off (also called single-ended or unbalanced input), the analyzer uses only the Q port.

Key Path	Input/Output, I/Q, Q Setup
Remote Command	:INPut:IQ:Q:DIFFerential OFF ON 0 1 :INPut:IQ:Q:DIFFerential?
Example	Put the Q channel in Differential Input mode INP:IQ:Q:DIFF ON
Notes	When Differential Input = On, the analyzer will check for attenuation mismatches between the Q and Q-bar ports. If the difference in attenuation values exceeds 0.5 dB a Settings Alert error condition, error 159 will be set. When Q Differential Input = On, and IQ Path is I+jQ, the I Differential input must also be On.

	Similarly, when Q Differential Input = Off, and IQ Path is I+jQ, the I Differential input must also be Off. If the states of the two inputs do not match, an error condition message is generated, 159;Settings Alert;I/Q mismatch:Differential.
Couplings	Some active probes include built-in differential capability. When one of these probes is sensed, this key is disabled. Since the differential capability is handled in the probe, the Analyzer will use only the main port and the key will show that the Analyzer's Differential Input mode is Off (indicating that the complementary port not in use). When a differential probe is not sensed and Q Same as I is On, the value set for I will be copied to Q. This key is disabled when Q Same as I is On.
Preset	Off
State Saved	Yes This is unaffected by a Preset but is set to the default value on a "Restore Input/Output Defaults" or "Restore System Defaults->All"
Range	Off On
Initial S/W Revision	Prior to A.02.00

Q Input Z

Selects the input impedance for the Q channel. The impedance applies to both the Q and Q-bar ports.

The input impedance controls the hardware signal path impedance match. It is not used for converting voltage to power. The voltage to power conversion always uses the Reference Z parameter. The Reference Z parameter applies to both I and Q channels.

Key Path	Input/Output, I/Q, Q Setup
Remote Command	:INPut[1]:IQ:Q:IMPedance LOW HIGH :INPut[1]:IQ:Q:IMPedance?
Example	Set the Q channel input impedance to 1 M Ω INP:IQ:Q:IMP HIGH
Notes	LOW = 50 Ω , HIGH = 1 M Ω When IQ Path is I+jQ, the I Input Z setting must be the same as the Q Input Z setting. If the settings of the two inputs do not match, an error condition message is generated, 159;Settings Alert;I/Q mismatch:Input Z.
Couplings	Input impedance is a built-in characteristic of a probe. Therefore, whenever a probe is sensed, this key is disabled and the value is set to match the probe. When no probe is sensed and Q Same as I is On, the value set for I will also be copied to Q. This key is disabled when Q Same as I is On.
Preset	LOW
State Saved	Yes This is unaffected by Preset but is set to the default value on a "Restore Input/Output Defaults" or "Restore System Defaults->All"

Range	50 Ω 1 M Ω
Initial S/W Revision	Prior to A.02.00

Q Skew

Sets the skew factor for the Q channel. The skew will shift the channel's data in time. Use this to compensate for differences in the electrical lengths of the input paths due to cabling and probes.

Key Path	Input/Output, I/Q, Q Setup
Remote Command	[:SENSe]:CORRection:IQ:Q:SKEW <seconds> [:SENSe]:CORRection:IQ:Q:SKEW?
Example	Delay the data for the Q channel by 10 ns. CORR:IQ:Q:SKEW 10 ns
Preset	0
State Saved	Yes This is unaffected by a Preset but is set to the default value on a "Restore Input/Output Defaults" or "Restore System Defaults->All"
Range	0 s to 100 ns
Min	0 s
Max	+100 ns
Initial S/W Revision	Prior to A.02.00

Q Probe

Accesses the probe setup parameters for the Q channel. See "[I/Q Probe Setup](#)" on [page 290](#).

Key Path	Input/Output, I/Q, Q Setup
State Saved	No
Readback Text	[<Q port probe id>] This is reporting the type of probe sensed on the Q port. There is no parameter for overriding what is sensed.
Initial S/W Revision	Prior to A.02.00

Attenuation

The attenuation is part of the calibration data stored with the probe type and is initially the value that was returned by the last calibration. You can modify this value and any changes will be stored with the calibration data and will survive power

cycles and presets. When a probe calibration is performed the attenuation value will be overwritten by the calibration.

Key Path	Input/Output, I/Q, I Setup Q Setup, I Probe Q Probe
Remote Command	[:SENSe]:CORRection:IQ:I Q:ATTenuation:RATio <real> [:SENSe]:CORRection:IQ:I Q:ATTenuation:RATio?
Example	Set the attenuation for the current I probe to 100.00:1. CORR:IQ:I:ATT:RAT 100
Notes	Each probe type has its own attenuation setting. As probes are changed the attenuation value will reflect the new probe's setting. Changing the attenuation affects only the current probe type's setting and leaves all others unchanged. When the IQ Path is I+jQ, the Q probe attenuation setting must match the I Probe attenuation setting within 1 dB. If this is not the case, an error condition message is generated, 159;Settings Alert;l/Q mismatch:Attenuation.
Preset	Each probe type has its own default. The default for the "Unknown" probe type is 1:1.
State Saved	Saved with probe calibration data. It survives a power cycle and is not affected by a Preset or Restore.
Range	0.001 to 10000
Min	0.001
Max	10000
Initial S/W Revision	Prior to A.02.00

This is an alternate form of the SCPI that allows input as a power instead of a ratio.

Remote Command	[:SENSe]:CORRection:IQ:I Q:ATTenuation <rel_amp1> [:SENSe]:CORRection:IQ:I Q:ATTenuation?
Example	Set the attenuation for the current I probe type to 100.00:1. CORR:IQ:I:ATT 20 dB
Range	-60 dB to +80 dB
Min	-60 dB
Max	+80 dB
Initial S/W Revision	Prior to A.02.00

Calibrate

Invokes the guided probe calibration. The guided probe calibration is context sensitive and depends on the channel (I or Q) and the Differential Input state. The calibration is only performed on the selected channel. When Differential Input is on, both the probe attached to the main port and the probe attached to the complementary port are calibrated. When Differential Input is off, only the probe attached to the main port is calibrated. See "[I/Q Guided Calibration](#)" on page 336.

Key Path	Input/Output, I/Q, I Setup Q Setup, I Probe Q Probe, Coupling
Readback Text	The last calibration date, or if no calibration exists, "(empty)". Last: <cal date> <cal time> Example: Last: 8/22/2007 1:02:49 PM
Initial S/W Revision	Prior to A.02.00

Clear Calibration

Clears the calibration data for the current port and probe. It does not clear the data for other probe types or other ports. If the sensed probe has EEPROM identification, only the data for that specific probe is cleared. After this command has completed, the probe calibration state will be the same as if no probe calibration had ever been performed for the specified channel and probe. The probe attenuation will be the default value for that probe type and the Cable Calibration frequency response corrections will be used. This command is dependent on the Differential Input state. When Differential Input is on, both the data for the probe attached to the main port and the data for the probe attached to the complementary port are cleared. When Differential Input is off, only data for the probe attached to the main port is cleared.

Key Path	Input/Output, I/Q, I Setup Q Setup, I Probe Q Probe
Remote Command	:CALibration:IQ:PROBe:I Q:CLEAr
Example	Clear the calibration data for the I channel and the current probe (with EEPROM identification) or probe type (without EEPROM identification). :CAL:IQ:PROBe:I:CLE
Initial S/W Revision	Prior to A.02.00

Reference Z

Sets the value of the impedance to be used in converting voltage to power for the I and Q channels. This does not change the hardware's path impedance (see "[I Input Z](#)" on page 279).

Key Path	Input/Output, I/Q
Remote Command	:INPut:IMPedance:REFerence <integer> :INPut:IMPedance:REFerence?
Example	Set the I/Q reference impedance to 50 Ω INP:IMP:REF 50
Preset	50 Ω

State Saved	Yes This is unaffected by a Preset but is set to the default value on a "Restore Input/Output Defaults" or "Restore System Defaults->All"
Range	1 Ω to 1 M Ω
Min	1 Ω
Max	1 M Ω
Initial S/W Revision	Prior to A.02.00

I/Q Cable Calibrate...

The I/Q cable calibration creates correction data for each of the front panel I/Q ports. This calibration data is used whenever no probe specific calibration data is available. It is important that all ports are calibrated using the same short BNC cable so that the data is comparable from port to port.

The guided calibration (front panel only) will show connection diagrams and guide you through the isolation calibration and calibrating each port. The calibration data for each port is stored separately, so as soon as a port is calibrated that data is saved and will be used. If you press "Exit" to exit the calibration process, the data for the ports already completed will still be used. It is recommended that a calibration be completed once started, or if exited, that it be properly done before the next use of the I/Q ports. The "Next" button will perform the calibration for the current port and then proceed to the next step in the calibration procedure. The "Back" button will return to the prior port in the procedure. Both keys and dialog buttons are supplied for ease of use. The dialog buttons are for mouse use and the softkeys for front panel use.

The calibration can also be done via SCPI, but no connection diagrams will be shown. You will have to make the correct connections before issuing each port calibration command. Again, it is recommended that all ports be calibrated at the same time.

The instrument state remains as it was prior to entering the calibration procedure except while a port is actually being calibrated. Once a port is calibrated it returns to the prior state. A port calibration is in process only from the time the "Next" button is pressed until the next screen is shown. For SCPI, this corresponds to the time from issuing the CAL:IQ:FLAT:I|IB|Q|QB command until the operation is complete.

For example, if the prior instrument state is Cal Out = Off, Input = I+jQ, and Differential = Off, then up until the time the "Next" button is pressed the I Input and Q Input LEDs are on and the Cal Out, I-bar Input and Q-bar Input LEDs are off. Once the "Next" button is pressed for the I port calibration, only the Cal Out and I Input LEDs will be on and the others will be off. When the screen progresses to the next step ("Next" button again enabled), the prior state is restored and only the I Input and Q Input LEDs are on (Cal Out is off again).

The last calibration date and time for each port will be displayed. Any calibrations that are more than a day older than the most recent calibration will be displayed with the color amber.

Key Path	Input/Output, I/Q
Initial S/W Revision	Prior to A.02.00

I/Q Probe Setup

The set of I/Q probe setup parameters will change based on the type of probe that is sensed. All probe types have the Attenuation parameter, and all probe types can be calibrated. The remaining parameters are only available for some probe types and will not be shown when not available. The probe type is determined by and reported for only for the I and Q ports, never the I-bar or Q-bar ports. The menu title will be "<ch>: <probe id>", where "<ch>" is either "I" or "Q" and "<probe id>" is the type of probe. For example, for the I Probe setup with an Keysight 1130A probe connected to the I port, the title will be "I: 1130A".

Probe calibration data is stored for each probe type for each channel. When no probe is sensed, the probe type "Unknown" is used, and this is also treated like a probe type with its own calibration data. When a probe is changed, the calibration data for that probe type for that port is restored. An advisory message will be displayed showing the new probe type and the calibration status. The calibration data is stored permanently (survives a power cycle) and is not affected by a Preset or any of the Restore commands. When the probe has EEPROM identification (most newer Keysight probes have this), the calibration data is stored by probe serial number and port, so if you have two probes of the same type, the correct calibration data will be used for each. For probes that do not have EEPROM identification, the calibration data is stored by probe type and port and the instrument cannot distinguish between different probes of the same type. In all cases (with or without EEPROM identification), the calibration data is port specific, so it will not follow a specific probe from port to port if the probe is moved.

The "Unknown" probe type is used whenever no probe is sensed. When no calibration data exists for "Unknown" the latest cable calibration data is used (see ["I/Q Guided Calibration " on page 336](#)).

Attenuation

The attenuation is part of the calibration data stored with the probe type and is initially the value that was returned by the last calibration. You can modify this value and any changes will be stored with the calibration data and will survive power cycles and presets. When a probe calibration is performed the attenuation value will be overwritten by the calibration.

Key Path	Input/Output, I/Q, I Setup Q Setup, I Probe Q Probe
Remote Command	[:SENSe]:CORRection:IQ:I Q:ATTenuation:RATio <real> [:SENSe]:CORRection:IQ:I Q:ATTenuation:RATio?

Example	Set the attenuation for the current I probe to 100.00:1. CORR:IQ:I:ATT:RAT 100
Notes	Each probe type has its own attenuation setting. As probes are changed the attenuation value will reflect the new probe's setting. Changing the attenuation affects only the current probe type's setting and leaves all others unchanged. When the IQ Path is I+jQ, the Q probe attenuation setting must match the I Probe attenuation setting within 1 dB. If this is not the case, an error condition message is generated, 159;Settings Alert;l/Q mismatch:Attenuation.
Preset	Each probe type has its own default. The default for the "Unknown" probe type is 1:1.
State Saved	Saved with probe calibration data. It survives a power cycle and is not affected by a Preset or Restore.
Range	0.001 to 10000
Min	0.001
Max	10000
Initial S/W Revision	Prior to A.02.00

This is an alternate form of the SCPI that allows input as a power instead of a ratio.

Remote Command	<code>[:SENSe]:CORRection:IQ:I Q:ATTenuation <rel_amp1></code> <code>[:SENSe]:CORRection:IQ:I Q:ATTenuation?</code>
Example	Set the attenuation for the current I probe type to 100.00:1. CORR:IQ:I:ATT 20 dB
Range	-60 dB to +80 dB
Min	-60 dB
Max	+80 dB
Initial S/W Revision	Prior to A.02.00

Offset

Some active probes have DC offset capability. When one of these probes is connected this control will be visible. The signal is adjusted for the DC offset before entering the analyzer's port. This allows for removal of a DC offset before reaching the analyzer's input port voltage limits. For example, a signal that varies 1 V peak-to-peak with a DC offset equal to the analyzer's max input voltage would exceed the input limits of the analyzer for half its cycle. Removing the DC offset allows the analyzer to correctly process the entire signal.

Key Path	Input/Output, I/Q, I Setup Q Setup, I Probe Q Probe
Remote Command	<code>:INPut:OFFSet:I Q <voltage></code> <code>:INPut:OFFSet:I Q?</code>
Example	Remove a DC offset of -0.5 V from the I channel input.

	INP:OFFS:I -0.5
Notes	Only some probe types support Offset. For those that do, each probe type has its own Offset setting. As probes are changed the Offset value will reflect the new probe's setting. Changing the Offset affects only the current probe type's setting and leaves all others unchanged.
Preset	0 V
State Saved	Saved with probe calibration data. It survives power cycle and is not affected by Preset or Restore.
Range	-18 V to +18 V
Min	-18 V
Max	+18 V
Initial S/W Revision	Prior to A.02.00

Coupling

Some probe types allow coupling to reject low frequencies. This will filter out the DC component of a signal that is composed of a DC bias plus some AC signal. This control is visible only for probe types that have this capability.

Key Path	Input/Output, I/Q, I Setup Q Setup, I Probe Q Probe
Remote Command	:INPut:COUPling:I Q DC LFR1 LFR2 :INPut:COUPling:I Q?
Example	Set the probe to low frequency rejection below 1.7 Hz. INP:COUP:I LFR1
Notes	Only some probe types support Coupling. For those that do, each probe type has its own Coupling setting. As probes are changed the Coupling value will reflect the new probe's setting. Changing the Coupling affects only the current probe type's setting and leaves all others unchanged.
Preset	DC
State Saved	Saved with probe calibration data. It survives a power cycle and is not affected by a Preset or Restore.
Range	DC AC 1.7 Hz LFR1 AC 0.14 Hz LFR2
Readback Text	DC LFR1 LFR2
Initial S/W Revision	Prior to A.02.00

DC

Turns off low frequency rejection, allowing signals down to DC.

Key Path	Input/Output, I/Q, I Setup Q Setup, I Probe Q Probe, Coupling
Example	Turn off low frequency rejection on the I channel INP:COUP:I DC
Initial S/W Revision	Prior to A.02.00

LFR1

Turns on low frequency rejection, rejecting signal component lower than 1.7 Hz.

Key Path	Input/Output, I/Q, I Setup Q Setup, I Probe Q Probe, Coupling
Example	Turn on low frequency rejection on the I channel for frequencies lower than 1.7 Hz INP:COUP:I LFR1
Initial S/W Revision	Prior to A.02.00

LFR2

Turns on low frequency rejection, rejecting signal component lower than 0.14 Hz.

Key Path	Input/Output, I/Q, I Setup Q Setup, I Probe Q Probe, Coupling
Example	Turn on low frequency rejection on the I channel for frequencies lower than 0.14 Hz INP:COUP:I LFR2
Initial S/W Revision	Prior to A.02.00

Calibrate

Invokes the guided probe calibration. The guided probe calibration is context sensitive and depends on the channel (I or Q) and the Differential Input state. The calibration is only performed on the selected channel. When Differential Input is on, both the probe attached to the main port and the probe attached to the complementary port are calibrated. When Differential Input is off, only the probe attached to the main port is calibrated. See "[I/Q Guided Calibration](#)" on page 336.

Key Path	Input/Output, I/Q, I Setup Q Setup, I Probe Q Probe, Coupling
Readback Text	The last calibration date, or if no calibration exists, "(empty)". Last: <cal date> <cal time> Example: Last: 8/22/2007 1:02:49 PM
Initial S/W Revision	Prior to A.02.00

Clear Calibration

Clears the calibration data for the current port and probe. It does not clear the data for other probe types or other ports. If the sensed probe has EEPROM identification, only the data for that specific probe is cleared. After this command has completed,

the probe calibration state will be the same as if no probe calibration had ever been performed for the specified channel and probe. The probe attenuation will be the default value for that probe type and the Cable Calibration frequency response corrections will be used. This command is dependent on the Differential Input state. When Differential Input is on, both the data for the probe attached to the main port and the data for the probe attached to the complementary port are cleared. When Differential Input is off, only data for the probe attached to the main port is cleared.

Key Path	Input/Output, I/Q, I Setup Q Setup, I Probe Q Probe
Remote Command	:CALibration:IQ:PROBe:I Q:CLEar
Example	Clear the calibration data for the I channel and the current probe (with EEPROM identification) or probe type (without EEPROM identification). :CAL:IQ:PROBe:I:CLE
Initial S/W Revision	Prior to A.02.00

RF Calibrator

Lets you choose a calibrator signal to look at or turns the calibrator "off".

Key Path	Input/Output
Remote Command	[:SENSe] : FEED : AREFereNce REF50 REF4800 OFF [:SENSe] : FEED : AREFereNce ?
Example	FEED:AREF REF50 selects the 50 MHz amplitude reference as the signal input. FEED:AREF REF4800 selects the 4.8 GHz amplitude reference as the signal input FEED:AREF OFF turns the calibrator "off" (switches back to the selected input – RF or I/Q)
Dependencies	Selecting an input (RF or I/Q) turns the Calibrator OFF. This is true whether the input is selected by the keys or with the [:SENSe]:FEED command. The 4.8 GHz internal reference is only available in some models and frequency range options. If the 4.8 GHz reference is not present, the 4.8 GHz softkey will be blanked, and if the REF4800 parameter is sent, the analyzer will generate an error.
Couplings	When one of the calibrator signals is selected, the analyzer routes that signal (an internal amplitude reference) to the analyzer, and changes the main input selection to RF so the calibrator signal can be seen. When you turn the calibrator off it does not switch back to the previously selected input.
Preset	OFF
State Saved	Saved in instrument state
Readback	Off, 50 MHz, 4.8 GHz
Initial S/W Revision	Prior to A.02.00
Remote Command	:CALibration:SOURce:STATE OFF ON 0 1

:CALibration:SOURce:STATe?	
Notes	<p>For ESA backwards compatibility.</p> <p>In the ESA the calibrator was a separate output which you connected to the input and switched on with this command.</p> <p>In the X-Series, the ON parameter is aliased to the [SENSe]:FEED:AREF REF50 command and the OFF parameter is aliased to [SENSe]:FEED:AREF OFF.</p> <p>When CALibration:SOURce:STATe? is received, 1 will be returned if any of the references is selected and 0 if the Calibrator is "Off"</p>
Preset	OFF
Initial S/W Revision	Prior to A.02.00

50 MHz

Selects the 50 MHz internal reference as the input signal.

Key Path	Input/Output, RF Calibrator
Example	:FEED:AREF REF50
Readback	50 MHz
Initial S/W Revision	Prior to A.02.00

4.8 GHz

Selects the 4.8 GHz internal reference as the input signal.

Key Path	Input/Output, RF Calibrator
Example	:FEED:AREF REF4800
Dependencies	The 4.8 GHz internal reference is only available in some models and frequency range options. If the 4.8 GHz reference is not present, the 4.8 GHz softkey will be blanked, and if the REF4800 parameter is sent, the analyzer will generate an error.
Readback	4.8 GHz
Initial S/W Revision	Prior to A.02.00
Modified at S/W Revision	A.03.00

Off

Switches the input back to the selected input (RF or I/Q)

Key Path	Input/Output, RF Calibrator
----------	------------------------------------

Example	:FEED:AREF OFF
Readback	Off
Initial S/W Revision	Prior to A.02.00

External Gain

Compensates for gain or loss in the measurement system outside the spectrum analyzer. The External Gain is subtracted from the amplitude readout (or the loss is added to the amplitude readout). So, the displayed signal level represents the signal level at the output of the device-under-test, which can be the input of an external device that provides gain or loss.

Entering an External Gain value does not affect the Reference Level, therefore the trace position on screen changes, as do all of the values represented by the trace data. Thus, the values of exported trace data, queried trace data, marker amplitudes, trace data used in calculations such as N dB points, trace math, peak threshold, etc., are all affected by External Gain. Changing the External Gain, even on a trace that is not updating, will immediately change all of the above, without new data needing to be taken.

NOTE

Changing the External Gain causes the analyzer to immediately stop the current sweep and prepare to begin a new sweep. The data will not change until the trace data updates because the offset is applied to the data as it is taken. If a trace is exported with a nonzero External Gain, the exported data will contain the trace data with the offset applied.

In the Spectrum Analyzer mode, a Preamp is the common external device providing gain or loss. In a measurement application mode like GSM or W-CDMA, the gain or loss could be from a BTS (Base Transceiver Station) or an MS (Mobile Station). So in the Spectrum Analyzer mode MS and BTS would be grayed out and the only choice would be Ext Preamp. Similarly in some of the digital communications applications, Ext Preamp will be grayed out and you would have a choice of MS or BTS.

Key Path	Input/Output
Couplings	The Ext Preamp, MS, and BS keys may be grayed out depending on which measurement is currently selected. If any of the grayed out keys are pressed, or the equivalent SCPI command is sent, an advisory message is generated.
Readback	1-of-N selection [variable]
Initial S/W Revision	Prior to A.02.00

Ext Preamp

This function is similar to the reference level offset function. Both affect the displayed signal level. Ref Lvl Offset is a mathematical offset only, no analyzer configuration is affected. Ext Preamp gain is used when determining the auto-

coupled value of the Attenuator. The External Gain value and the Maximum Mixer Level settings are both part of the automatic setting equation for the RF attenuation setting. (10 dB of Attenuation is added for every 10 dB of External Gain.)

Note that the Ref Lvl Offset and Maximum Mixer Level are described in the Amplitude section. They are reset by the instrument Preset. The External Preamp Gain is reset by the "Restore Input/Output Defaults" or "Restore System Defaults->All functions. . The External Gain is subtracted from the amplitude readout so that the displayed signal level represents the signal level at the output of the device-under-test, which is the input of the external device that is providing gain or loss.

["More Information" on page 297](#)

Key Path	Input/Output, External Gain
Remote Command	[:SENSe]:CORRection:SA[:RF]:GAIN <rel_amp1> [:SENSe]:CORRection:SA[:RF]:GAIN?
Example	CORR:SA:GAIN 10 sets the Ext Gain value to 10 dB CORR:SA:GAIN -10 sets the Ext Gain value to -10 dB (that is, an attenuation of 10 dB)
Notes	Does not auto return.
Dependencies	The reference level limits are determined in part by the External Gain/Atten, Max Mixer Level, and RF Atten. This key is grayed out in Modes that do not support External Gain
Preset	This is unaffected by Preset but is set to 0 dB on a "Restore Input/Output Defaults" or "Restore System Defaults->All"
State Saved	Saved in instrument state
Min	-120 dB
Max	120 dB
Readback	Preamp Gain, <Ext Gain value> dB
Backwards Compatibility SCPI	[:SENSe]:CORRection:OFFSet[:MAGNitude] The legacy "Ext Preamp Gain" key is now called "Ext Gain" and the sub-menu has choices of Ext Preamp MS BTS for backwards compatibility.
Initial S/W Revision	Prior to A.02.00
Modified at S/W Revision	A.14.00

More Information

The U7227A USB Preamplifier is an accessory for the X-Series Signal Analyzer that provides gain externally, and whose gain settings are automatically loaded into the analyzer over USB whenever it is connected to one of the analyzer's USB ports.

While the USB Preamplifier is plugged into one of the analyzer's USB ports, the analyzer will consider it to be in the signal path of the RF Input and will apply the calibration data from the USB Preamp to measurements taken at the RF Input (on 2

input boxes, it will be considered to be in the signal path of RF Input 1; it is not supported for RF Input 2).

The USB Preamplifier contains its own cal data. This includes a noise trace suitable for use with NFE, for those models which support NFE. The act of connecting the Preamp to USB will cause the cal data to be downloaded from the preamp. When this happens an informational message is provided saying "Cal data loaded from USB Preamp". The analyzer will then automatically apply the calibration factors loaded from the Preamp in any measurement that supports the USB Preamp.

The External Preamp Gain setting may still be used, even though it is not required for the USB Preamp (since the USB Preamp supplies its own gain data to the analyzer which is applied automatically). Connecting the USB Preamp does not change the External Preamp Gain setting, however unless you have another gain or attenuation element in the signal path, the appropriate setting for External Preamp Gain is 0 dB.

Overload detection and reporting will apply when the USB preamplifier is connected to USB. The USB Preamplifier has its own overload detector which reports overloads to the instrument over USB. This generates an error condition, "Input Overload;USB Preamp."

If, while the USB Preamp is connected to USB, a measurement is selected that does not support the USB preamplifier, the "No result; Meas invalid with Preamp" error condition is generated.

MS

Sets an external gain/attenuation value for MS (Mobile Station) tests.

Key Path	Input/Output, External Gain
Remote Command	<code>[:SENSe]:CORRection:MS[:RF]:GAIN <rel_amp1></code> <code>[:SENSe]:CORRection:MS[:RF]:GAIN?</code>
Example	CORR:MS:GAIN 10 sets the Ext Gain value to 10 dB CORR:MS:GAIN -10 sets the Ext Gain value to -10 dB (that is, a loss of 10 dB.)
Notes	Does not auto return.
Dependencies	The reference level limits are determined in part by the External Gain, Max Mixer Level, RF Atten This key is grayed out in modes that do not support MS.
Preset	This is unaffected by a Preset but is set to 0 dB on a "Restore Input/Output Defaults" or "Restore System Defaults->All"
State Saved	Saved in instrument state.
Min	-100 dB
Max	100 dB
Readback	MS, <Ext Gain value> dB
Initial S/W Revision	Prior to A.02.00

Remote Command	<code>[:SENSe]:CORRection:MS[:RF]:LOSS <rel_ampl></code> <code>[:SENSe]:CORRection:MS[:RF]:LOSS?</code>
Example	CORR:MS:LOSS 10 sets the Ext Gain value to -10 dB, and subsequently querying :LOSS will give 10 dB CORR:MS:LOSS -10 sets the Ext Gain value to 10 dB, and subsequently querying :LOSS will give -10 dB
Notes	A positive value of <rel_ampl> in the above command means a loss and a negative value indicates a gain. Anytime :LOSS is set it sets :GAIN to the negative value of the parameter sent. Anytime :LOSS is queried it gives the negative of :GAIN
Preset	This is unaffected by a Preset but is set to 0 dB on a "Restore Input/Output Defaults" or "Restore System Defaults->All"
Min	100 dB
Max	-100 dB
Initial S/W Revision	Prior to A.02.00

BTS

Sets an external attenuation value for BTS (Base Transceiver Station) tests.

Key Path	Input/Output, External Gain
Remote Command	<code>[:SENSe]:CORRection:BTS[:RF]:GAIN <rel_ampl></code> <code>[:SENSe]:CORRection:BTS[:RF]:GAIN?</code>
Example	CORR:BTS:GAIN 10 sets the Ext Gain value to 10 dB CORR:BTS:GAIN -10 sets the Ext Gain value to -10 dB (that is, a loss of 10 dB.)
Notes	Does not auto return.
Dependencies	The reference level limits are determined in part by the External Gain, Max Mixer Level, RF Atten This key is grayed out in modes that do not support BTS.
Preset	This is unaffected by a Preset but is set to 0 dB on a "Restore Input/Output Defaults" or "Restore System Defaults->All"
State Saved	Saved in instrument state.
Min	-100 dB
Max	100 dB
Readback	BTS, <Ext Gain value> dB
Initial S/W Revision	Prior to A.02.00

Remote Command	<code>[:SENSe]:CORRection:BTS[:RF]:LOSS <rel_ampl></code> <code>[:SENSe]:CORRection:BTS[:RF]:LOSS?</code>
-----------------------	--

Example	CORR:BTS:LOSS 10 sets the Ext Gain value to -10 dB, and subsequently querying :LOSS will give 10 dB CORR:BTS:LOSS -10 sets the Ext Gain value to 10 dB, and subsequently querying :LOSS will give -10 dB
Notes	A positive value of <rel_amp1> in the above command means a loss and a negative value indicates a gain. Anytime :LOSS is set it sets :GAIN to the negative value of the parameter sent. Anytime :LOSS is queried it gives the negative of :GAIN
Preset	This is unaffected by a Preset but is set to 0 dB on a "Restore Input/Output Defaults" or "Restore System Defaults->All"
Min	100 dB
Max	-100 dB
Initial S/W Revision	Prior to A.02.00

I Ext Gain

This function affects the I channel input. However, when Q Gain in I+jQ is set to Same as I Gain, this value is applied to both I and Q channel inputs.

Key Path	Input/Output, External Gain
Remote Command	[:SENSe] :CORRection:IQ:I:GAIN <rel_amp1> [:SENSe] :CORRection:IQ:I:GAIN?
Example	Set the I Ext Gain to 10 dB CORR:IQ:I:GAIN 10 Set the I Ext Gain to -10 dB (that is, a loss of 10 dB.) CORR:IQ:I:GAIN -10
Dependencies	Not available unless option BBA is installed
Preset	0 dB This is unaffected by a Preset but is set to 0 dB on a "Restore Input/Output Defaults" or "Restore System Defaults->All"
State Saved	Saved in instrument state.
Min	-100 dB
Max	100 dB
Readback Text	I Gain, <I Ext Gain> dB
Initial S/W Revision	Prior to A.02.00

Q Ext Gain

This function affects the Q channel input.

Key Path	Input/Output, External Gain
Remote Command	[:SENSe]:CORRection:IQ:Q:GAIN <rel_amp1> [:SENSe]:CORRection:IQ:Q:GAIN?
Example	Set the Q Ext Gain to 10 dB CORR:IQ:Q:GAIN 10 Set the Q Ext Gain to -10 dB (that is, a loss of 10 dB.) CORR:IQ:Q:GAIN -10
Dependencies	Not available unless option BBA is installed.
Preset	0 dB This is unaffected by a Preset but is set to 0 dB on a "Restore Input/Output Defaults" or "Restore System Defaults->All"
State Saved	Saved in instrument state
Min	-100 dB
Max	100 dB
Readback Text	Q Gain, <I Ext Gain> dB
Initial S/W Revision	Prior to A.02.00

Q Gain in I+jQ

When Same as I Gain is selected, I Ext Gain value is applied to both I and Q channel input if the Input Path is I+jQ. When Independent is selected, I and Q Ext Gain values are applied to I and Q channel input independently.

Key Path	Input/Output, External Gain
Remote Command	[:SENSe]:CORRection:IQ:Q:GAIN:COUPlE ON OFF 0 1 [:SENSe]:CORRection:IQ:Q:GAIN:COUPlE?
Example	CORR:IQ:Q:GAIN:COUP ON CORR:IQ:Q:GAIN:COUP?
Preset	ON
State Saved	Saved in instrument state.
Range	Same as I Gain Independent
Initial S/W Revision	14.50

Restore Input/Output Defaults

This selection causes the group of settings and data associated with the **Input/Output** key to be a reset to their default values. In addition, when a Source is installed, licensed and selected, Restore Input/Output defaults will initiate a Source Preset.

This level of Restore System Defaults does not affect any other system settings or mode settings and does not cause a mode switch. All the features described in this section are reset using this key, including Input Corrections and Data (described in the Corrections section).

Key Path	Input/Output
Example	:SYST:DEF INP presets all the Input/Output variables to their factory default values.
Notes	Refer to the Utility Functions for information about Restore System Defaults and the complete description of the :SYSTEM:Default INPut: command.
Initial S/W Revision	Prior to A.02.00

Corrections

This key accesses the Amplitude Corrections menu.

Amplitude Corrections arrays can be entered, sent over SCPI, or loaded from a file. They allow you to correct the response of the analyzer for various use cases. The X-series supports four separate Corrections arrays, each of which can contain up to 2000 points. They can be turned on and off individually and any or all can be on at the same time.

Trace data is in absolute units and corrections data is in relative units, but we want to be able to display trace data at the same time as corrections data. Therefore we establish a reference line to be used while building or editing a Corrections table. The reference line is halfway up the display and represents 0 dB of correction. It is labeled "0 dB CORREC". It is drawn in blue.

Corrections data is always in dB. Whatever dB value appears in the correction table represents the correction applied to that trace at that frequency. So if a table entry shows 30 dB that means we ADD 30 dB to each trace to correct it before displaying it.

In zero span, where the frequency is always the center frequency of the analyzer, we apply the (interpolated) correction for the center frequency to all points in the trace. In the event where there are two correction amplitudes at the center frequency, we apply the first one in the table.

Note that the corrections are applied as the data is taken; therefore, a trace in **View** (Update Off) will not be affected by changes made to the corrections table after the trace is put in **View**.

Key Path	Input/Output, Corrections
Mode	SA, I/Q Analyzer, Phase Noise, VXA, RTSA, EMI Receiver, DVB-T/H, DTMB, DVB-T/H, DTMB, W-CDMA, LTE & LTE-Adv FDD, LTE & LTE-Adv TDD, Sequence Analyzer, BTooth, WLAN
Dependencies	This key will only appear if you have the proper option installed in your instrument. Amplitude correction may not be available in all modes; if a mode does not support amplitude correction, the Corrections key should be blanked while in that mode. If an application supports corrections but the current measurement does not, then the key should be grayed out in that

	measurement
Preset	Corrections arrays are reset (deleted) by Restore Input/Output Defaults. They survive shutdown and restarting of the analyzer application, which means they will survive a power cycle.
Initial S/W Revision	A.02.00
Modified at S/W Revision	x.14.50

Select Correction

Specifies the selected correction. The term "selected correction" is used throughout this document to specify which correction will be affected by the functions.

Key Path	Input/Output, Corrections
Mode	SA, I/Q Analyzer, Phase Noise, VXA, RTSA, EMI Receiver, DVB-T/H, DTMB, DVB-T/H, DTMB, W-CDMA, LTE & LTE-Adv FDD, LTE & LTE-Adv TDD, Sequence Analyzer, BTooth
Notes	The selected correction is remembered even when not in the correction menu.
Preset	Set to Correction 1 by Restore Input/Output Defaults
Readback	Correction 1 Correction 2 Correction 3 Correction 4 Correction 5 Correction 6 Correction 7 Correction 8
Initial S/W Revision	A.02.00
Modified at S/W Revision	x.14.50

Correction On/Off

Turning the Selected Correction from the OFF state to the ON state allows the values in it to be applied to the data. This state transition also automatically turns on "Apply Corrections" (sets it to ON), otherwise the correction would not take effect.

A new sweep is initiated if an amplitude correction is switched on or off. Note that changing, sending or loading corrections data does NOT directly initiate a sweep, however in general these operations will turn corrections on, which DOES initiate a sweep.

Key Path	Input/Output, Corrections
Remote Command	[:SENSe]:CORRection:CSET[1] 2 ... 8[:STATe] ON OFF 1 0 [:SENSe]:CORRection:CSET[1] 2 ... 8[:STATe]?
Example	SENS:CORR:CSET1 ON
Dependencies	Changing this from the OFF state to the ON state automatically turns on "Apply Corrections". Only the first correction array (Correction 1) supports antenna units. When this array is turned on, and it contains an Antenna Unit other than "None", the Y Axis Unit of the analyzer is forced to that Antenna Unit. All other Y Axis Unit choices are grayed out.

	Note that this means that a correction file with an Antenna Unit can only be loaded into the Corrections 1 register. Consequently only for Correction 1 does the dropdown in the Recall dialog include.ant, and if an attempt is made to load a correction file into any other Correction register which DOES contain an antenna unit, a Mass Storage error is generated. This command will generate an "Option not available" error unless you have the proper option installed in your instrument.
Preset	Not affected by a Preset. Set to OFF by Restore Input/Output Defaults
State Saved	Saved in instrument state.
Backwards Compatibility Notes	Unlike legacy analyzers, Preset does not turn Corrections off (Restore Input/Output Defaults does).
Initial S/W Revision	A.02.00
Modified at S/W Revision	A.14.00

Properties

Accesses a menu that lets you set the properties of the selected correction.

Key Path	Input/Output, Corrections
Initial S/W Revision	A.02.00

Select Correction

Specifies the selected correction. The term "selected correction" is used throughout this document to specify which correction will be affected by the functions.

Key Path	Input/Output, Corrections
Mode	SA, I/Q Analyzer, Phase Noise, VXA, RTSA, EMI Receiver, DVB-T/H, DTMB, DVB-T/H, DTMB, W-CDMA, LTE & LTE-Adv FDD, LTE & LTE-Adv TDD, Sequence Analyzer, BTooth
Notes	The selected correction is remembered even when not in the correction menu.
Preset	Set to Correction 1 by Restore Input/Output Defaults
Readback	Correction 1 Correction 2 Correction 3 Correction 4 Correction 5 Correction 6 Correction 7 Correction 8
Initial S/W Revision	A.02.00
Modified at S/W Revision	x.14.50

Antenna Unit

For devices (like antennas) that make measurements of field strength or flux density, the correction array should contain within its values the appropriate conversion

factors such that, when the data on the analyzer is presented in dB μ V, the display is calibrated in the appropriate units. The "Antenna Unit" used for the conversion is contained within the corrections array database. It may be specified or loaded in from an external file or SCPI.

When an array with an Antenna Unit other than "None" is turned on, the Y Axis Unit of the analyzer is forced to that unit. When this array is turned on, and it contains an Antenna Unit other than "None", the Y Axis Unit of the analyzer is forced to that Antenna Unit., and all other Y Axis Unit choices are grayed out.

Antenna Unit does not appear in all Modes that support Corrections. Only the modes listed in the Mode row of the table below support Antenna Units.

Key Path	Input/Output, Corrections, Properties
Mode	SA, I/Q Analyzer, Phase Noise, VXA, RTSA, EMI Receiver, DVB-T/H, DTMB, DVB-T/H, DTMB, W-CDMA, LTE & LTE-Adv FDD, LTE & LTE-Adv TDD, Sequence Analyzer, BTooth
Remote Command	<code>[:SENSE] :CORREction:CSET[1]:ANTenna[:UNIT] GAUSS PTES1a UVM UAM UA NOConversion</code> <code>[:SENSE] :CORREction:CSET[1]:ANTenna[:UNIT] ?</code>
Example	CORR:CSET:ANT GAUS
Dependencies	Only the first correction array (Correction 1) supports antenna units. Note that this means that a correction file with an Antenna Unit can only be loaded into the Corrections 1 register. Consequently only for Correction 1 does the dropdown in the Recall dialog include.ant, and if an attempt is made to load a correction file into any other Correction register which DOES contain an antenna unit, a Mass Storage error is generated.
Preset	Unaffected by Preset. Set to NOC by Restore Input/Output Defaults
State Saved	Saved in instrument state
Initial S/W Revision	A.02.00
Modified at S/W Revision	x.14.50

None

Selects no antenna unit for this Correction set. Thus no Y Axis unit will be forced.

Key Path	Input/Output, Corrections, Properties, Antenna Unit
Example	:CORR:CSET:ANT NOC
Readback	"None"
Initial S/W Revision	A.02.00

dB μ V/m

Sets the antenna unit to dB μ V/m. If this correction is turned on, and Apply Corrections is on, the Y Axis Unit will then be forced to dB μ V/m and all other Y Axis Unit selections will be grayed out.

Key Path	Input/Output, Corrections, Properties, Antenna Unit
Example	:CORR:CSET:ANT UVM
Readback	"dB μ V/m"
Initial S/W Revision	A.02.00

dB μ A/m

Sets the antenna unit to dB μ A/m. If this correction is turned on, and Apply Corrections is on, the Y Axis Unit will then be forced to dB μ A/m and all other Y Axis Unit selections will be grayed out.

Key Path	Input/Output, Corrections, Properties, Antenna Unit
Example	:CORR:CSET:ANT UVA
Readback	" dB μ A/m"
Initial S/W Revision	A.02.00

dBpT

Sets the antenna unit to dBpT. If this correction is turned on, and Apply Corrections is on, the Y Axis Unit will then be forced to dBpT and all other Y Axis Unit selections will be grayed out.

Key Path	Input/Output, Corrections, Properties, Antenna Unit
Example	:CORR:CSET:ANT PTES
Readback	"dBpT"
Initial S/W Revision	A.02.00

dBG

Sets the antenna unit to dBG. If this correction is turned on, and Apply Corrections is on, the Y Axis Unit will then be forced to dBG and all other Y Axis Unit selections will be grayed out.

Key Path	Input/Output, Corrections, Properties, Antenna Unit
Example	:CORR:CSET:ANT GAUS
Readback	" dBG"
Initial S/W Revision	A.02.00

dB μ A

Sets the amplitude unit for the selected amplitude scale (log/lin) to dB μ A. This is an antenna unit, and this key is grayed out unless a Correction with this Antenna Unit selected is ON. If this is the case, all of the other Antenna Units are grayed out.

Key Path	AMPTD Y Scale, Y Axis Unit, Antenna Unit
Example	UNIT:POW DBUAM
Dependencies	Grayed out if no Amplitude Correction with an Antenna Unit is on.
Readback	dB μ A
Initial S/W Revision	A.11.00

Frequency Interpolation

This setting controls how the correction values per-bucket are calculated. We interpolate between frequencies in either the logarithmic or linear scale.

This setting is handled and stored individually per correction set.

See ["Interpolation" on page 307](#)

Key Path	Input/Output, Corrections, Properties
Remote Command	[:SENSe]:CORRection:CSET[1] 2 ... 8:X:SPACing LINear LOGarithmic [:SENSe]:CORRection:CSET[1] 2 ... 8:X:SPACing?
Example	CORR:CSET:X:SPAC LIN
Preset	Unaffected by a Preset. Set to Linear by Restore Input/Output Defaults.
State Saved	Saved in instrument state.
Initial S/W Revision	A.02.00
Modified at S/W Revision	A.14.00

Interpolation

For each bucket processed by the application, all of the correction factors at the frequency of interest (center frequency of each bucket) are summed and added to the amplitude. All trace operations and post processing treat this post-summation value as the true signal to use.

To effect this correction, the goal, for any particular start and stop frequency, is to build a correction trace, whose number of points matches the current Sweep Points setting of the instrument, which will be used to apply corrections on a bucket by bucket basis to the data traces.

For amplitudes that lie between two user specified frequency points, we interpolate to determine the amplitude value. You may select either linear or logarithmic interpolation between the frequencies.

If we interpolate on a log scale, we assume that the line between the two points is a straight line on the log scale. For example, let's say the two points are (2,4) and (20,1). A straight line between them on a log scale looks like:

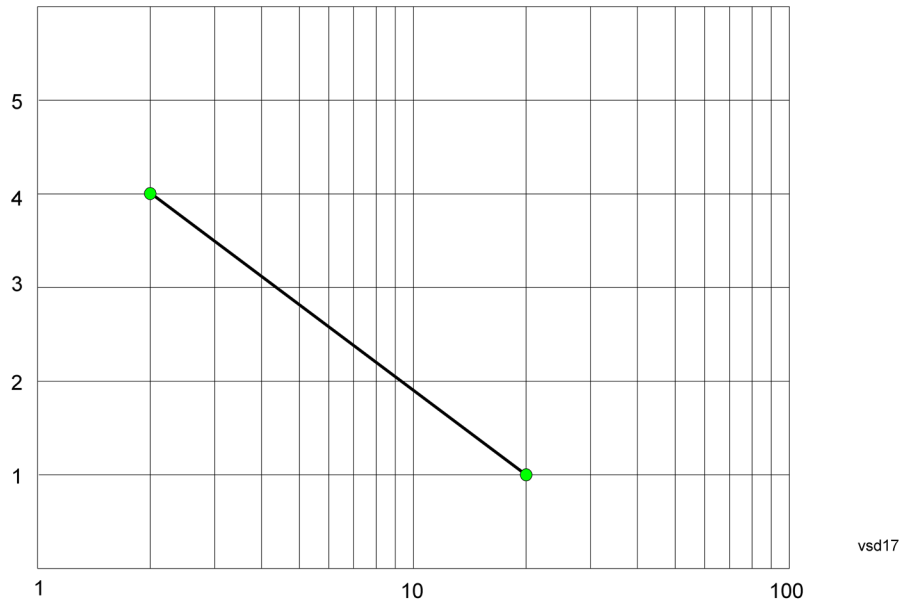

On a linear scale (like that of the spectrum analyzer), this translates to:

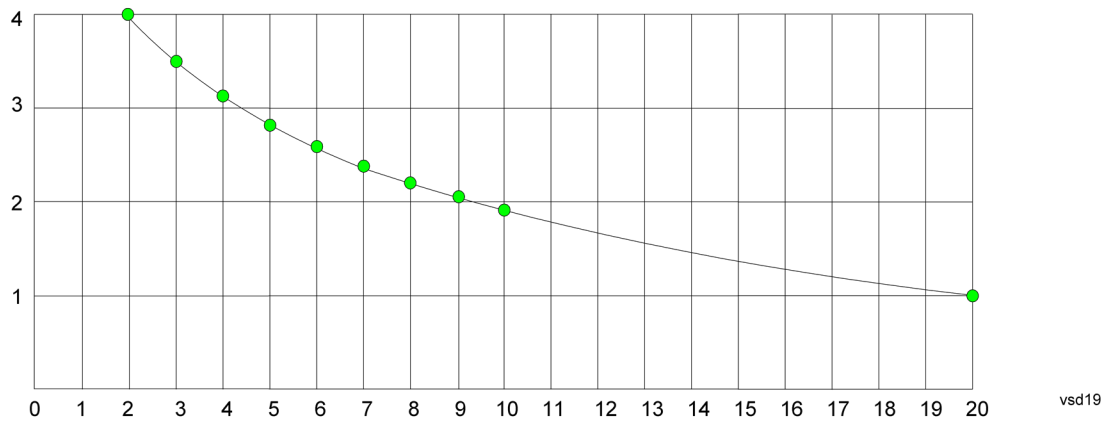

If we interpolate on a linear scale, we assume that the two points are connected by a straight line on the linear scale, as below:

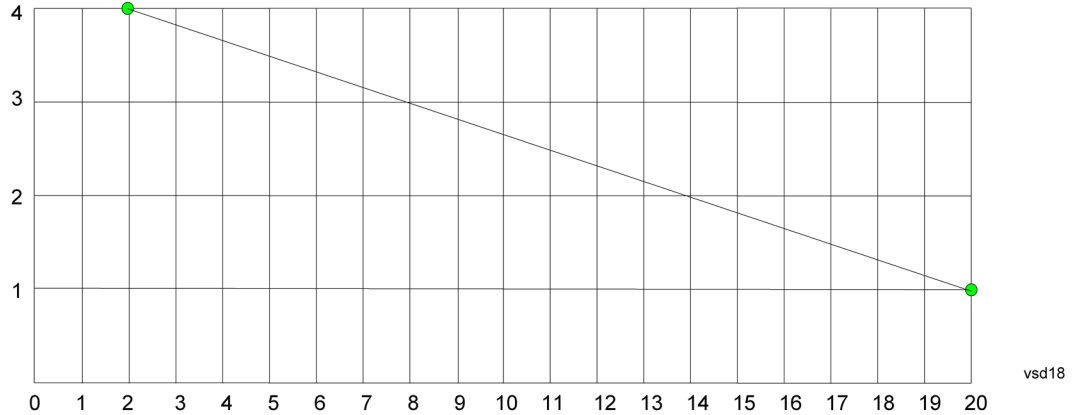

The correction to be used for each bucket is taken from the interpolated correction curve at the center of the bucket.

Description

Sets an ASCII description field which will be stored in an exported file. Can be displayed in the active function area by selecting as the active function, if desired to appear in a screen capture.

Key Path	Input/Output, Corrections, Properties
Remote Command	<code>[:SENSE]:CORRection:CSET[1] 2 ... 8:DESCRiption "text"</code> <code>[:SENSe]:CORRection:CSET[1] 2 ... 8:DESCRiption?</code>
Example	<code>:CORR:CSET1:DESC "11941A Antenna correction"</code>
Notes	45 chars max; may not fit on display if max chars used
Preset	Unaffected by a Preset. Set to empty by Restore Input/Output Defaults
State Saved	Saved in instrument state.
Initial S/W Revision	A.02.00
Modified at S/W Revision	A.14.00

Comment

Sets an ASCII comment field which will be stored in an exported file. Can be displayed in the active function area by selecting as the active function, if desired to appear in a screen capture.

Key Path	Input/Output, Corrections, Properties
Remote Command	<code>[:SENSe]:CORRection:CSET[1] 2 ... 8:COMMent "text"</code> <code>[:SENSe]:CORRection:CSET[1] 2 ... 8:COMMent?</code>
Example	<code>:CORR:CSET1:COMM "this is a comment"</code>
Notes	60 chars max; may not fit on display if max chars used
Preset	Unaffected by Preset. Set to empty by Restore Input/Output Defaults

State Saved	Saved in instrument state
Initial S/W Revision	A.02.00
Modified at S/W Revision	A.14.00

Edit

Invokes the integrated editing facility for this correction set.

When entering the menu, the editor window turns on, the selected correction is turned **On**, **Apply Corrections** is set to **On**, the amplitude scale is set to **Log**, and the Amplitude Correction (“Ampcor”) trace is displayed. The actual, interpolated correction trace is shown in green for the selected correction. Note that since the actual interpolated correction is shown, the correction trace may have some curvature to it. This trace represents only the correction currently being edited, rather than the total, accumulated amplitude correction for all amplitude corrections which are currently on, although the total, accumulated correction for all corrections which are turned on is still applied to the data traces.

Because corrections data is always in dB, but the Y-axis of the analyzer is in absolute units, it is necessary to establish a reference line for display of the Corrections data. The reference line is halfway up the display and represents 0 dB of correction. It is labeled “0 dB CORREC”. It is drawn in blue.

Corrections data is always in dB. Whatever dB value appears in the correction table represents the correction to be applied to that trace at that frequency. So if a table entry shows 30 dB that means we ADD 30 dB to each trace to correct it before displaying it. By definition all points are connected. If a gap is desired for corrections data, enter 0 dB.

Note that a well-designed Corrections array should start at 0 dB and end at 0 dB. This is because whatever the high end point is will be extended to the top frequency of the instrument, and whatever the low end point is will be extended down to 0 Hz. So for a Corrections array to have no effect outside its range, you should start and end the array at 0 dB.

NOTE

The table editor will only operate properly if the analyzer is sweeping, because its updates are tied to the sweep system. Thus, you should not try to use the editor in single sweep, and it will be sluggish during compute-intensive operations like narrow-span FFT sweeps.

When exiting the edit menu (by using the **Return** key or by pressing an instrument front-panel key), the editor window turns off and the Ampcor trace is no longer displayed; however, **Apply Corrections** remains **On**, any correction that was on while in the editor remains on, and the amplitude scale returns to its previous setting.

Corrections arrays are not affected by a Preset, because they are in the Input/Output system. They also survive shutdown and restarting of the analyzer application, which means they will survive a power cycle.

When editing a correction, the editor remembers which correction and which element in the correction array you were editing, and returns you to that correction and that element when you return to the editor after leaving it.

Key Path	Input/Output, Corrections
Initial S/W Revision	A.02.00

Navigate

Lets you move through the table to edit the desired point.

Key Path	Input/Output, Corrections, Edit
Notes	There is no value readback on the key
Min	1
Max	2000
Initial S/W Revision	A.02.00

Frequency

Lets you edit the frequency of the current row.

Key Path	Input/Output, Corrections, Edit
Notes	There is no value readback on the key.
Min	0
Max	1 THz
Initial S/W Revision	A.02.00

Amplitude

Lets you edit the Amplitude of the current row.

Key Path	Input/Output, Corrections, Edit
Notes	There is no value readback on the key.
Min	-1000 dB
Max	1000 dB
Initial S/W Revision	A.02.00

Insert Point Below

Inserts a point below the current point. The new point is a copy of the current point and becomes the current point. The new point is not yet entered into the underlying

table, and the data in the row is displayed in light gray.

Key Path	Input/Output, Corrections, Edit
Initial S/W Revision	A.02.00

Delete Point

Deletes the currently-selected point, whether or not that point is being edited, and selects the Navigate functionality. The point following the currently-selected point (or the point preceding if there is none) will be selected.

Key Path	Input/Output, Corrections, Edit
Initial S/W Revision	A.02.00

Scale X Axis

Matches the X Axis to the selected Correction, as well as possible. Sets the Start and Stop Frequency to contain the minimum and maximum Frequency of the selected Correction. The range between Start Frequency and Stop Frequency is 12.5% above the range between the minimum and maximum Frequency, so that span exceeds this range by one graticule division on either side. If in zero-span, or there is no data in the Ampcor table, or the frequency range represented by the table is zero, no action is taken. Standard clipping rules apply if the value in the table is outside the allowable range for the X axis.

Key Path	Input/Output, Corrections, Edit
Dependencies	If either the first or last point in the array is outside the frequency range of the current input, an error message is generated: “-221. Settings conflict; Start or Stop Freq out of range for current input settings”
Initial S/W Revision	A.02.00

Delete Correction

Deletes the correction values for this set. When this key is pressed a prompt is placed on the screen that says “Please press Enter or OK key to delete correction. Press ESC or Cancel to close this dialog.” The deletion is only performed if you press OK or Enter.

Key Path	Input/Output, Corrections
Remote Command	[:SENSe] :CORRection :CSET [1] 2 . . . 6 :DELete
Example	CORR:CSET:DEL CORR:CSET1:DEL CORR:CSET4:DEL

Notes	Pressing this key when no corrections are present is accepted without error.
Initial S/W Revision	A.02.00

Apply Corrections

Applies amplitude corrections, which are marked as ON to the measured data. If this is set to OFF, then no amplitude correction sets will be used, regardless of their individual on/off settings. If set to ON, the corrections that are marked as ON (see ["Correction On/Off" on page 303](#)) are used.

Key Path	Input/Output, Corrections
Remote Command	[:SENSe]:CORRection:CSET:ALL[:STATe] ON OFF 1 0 [:SENSe]:CORRection:CSET:ALL[:STATe]?
Example	SENS:CORR:CSET:ALL OFF This command makes sure that no amplitude corrections are applied, regardless of their individual on/off settings.
Preset	Not affected by Preset. Set to OFF by Restore Input/Output Defaults
State Saved	Saved in instrument state.
Initial S/W Revision	A.02.00

Delete All Corrections

Erases all correction values for all 4 Amplitude Correction sets.

When this key is pressed a prompt is placed on the screen that says "Please press Enter or OK key to delete all corrections. Press ESC or Cancel to close this dialog." The deletion is only performed if you press OK or Enter.

Key Path	Input/Output, Corrections
Remote Command	[:SENSe]:CORRection:CSET:ALL:DELeTe
Example	CORR:CSET:ALL:DEL
Initial S/W Revision	A.02.00

Remote Correction Data Set Commands

This section describes the remote (SCPI) commands used to put values into correction sets. See the correction / table editor section of the Input/Output section for the information on front panel entry of correction data.

["Set \(Replace\) Data \(Remote Command Only\)" on page 314](#)

["Merge Correction Data \(Remote Command Only\)" on page 314](#)

Set (Replace) Data (Remote Command Only)

The command takes an ASCII series of alternating frequency and amplitude points, each value separated by commas.

The values sent in the command will totally replace all existing correction points in the specified set.

An Ampcor array can contain 2000 points maximum.

Remote Command	<code>[:SENSe]:CORRection:CSET[1] 2 ... 8:DATA <freq>, <amp1>, . . .</code> <code>[:SENSe]:CORRection:CSET[1] 2 ... 8:DATA?</code>
Example	<code>CORR:CSET1:DATA 10000000, -1.0, 20000000, 1.0</code> This defines two correction points at (10 MHz, -1.0 dB) and (20 MHz, 1.0 dB) for correction set 1.
Preset	Empty after Restore Input/Output Defaults. Survives a shutdown or restart of analyzer application (including a power cycle).
State Saved	Saved in instrument state.
Min	Freq: 0 Hz Amptd: -1000 dBm
Max	Freq: 1 THz Amptd: +1000 dBm
Initial S/W Revision	A.02.00
Modified at S/W Revision	A.14.00

Merge Correction Data (Remote Command Only)

The command takes an ASCII series of alternating frequency and amplitude points, each value separated by commas. The difference between this command and Set Data is that this merges new correction points into an existing set.

Any new point with the same frequency as an existing correction point will replace the existing point's amplitude with that of the new point.

An Ampcor array can contain 2000 total points, maximum.

Remote Command	<code>[:SENSe]:CORRection:CSET[1] 2 ... 8:DATA:MERGe <freq>, <amp1>, ...</code>
Example	<code>CORR:CSET1:DATA:MERGE 15000000, -5.0, 25000000, 5.0</code> This adds two correction points at (15 MHz, -5.0 dB) and (25 MHz, 5.0 dB) to whatever values already exist in correction set 1.
Preset	Empty after Restore Input/Output Defaults. Survives shutdown/restart of analyzer application (including power cycle)
Min	Freq: 0 Hz Amptd: -1000 dBm
Max	Freq: 1 THz

	Amptd: +1000 dBm
Initial S/W Revision	A.02.00
Modified at S/W Revision	A.14.00

Freq Ref In

Specifies the frequency reference as being the internal reference at the rear panel input labeled EXT REF IN, a 1 pulse per second signal at the EXT REF IN input,, external reference or sensing the presence of a signal at the EXT REF IN input.

When the frequency reference is set to internal, the internal 10 MHz reference is used even if an external reference is connected.

When the frequency reference is set to external, the instrument will use the external reference. However, if there is no external signal present, or it is not within the proper amplitude range, a condition error message is generated. When the external signal becomes valid, the error is cleared.

When the frequency reference is set to Pulse, the instrument expects a 1 pulse per second signal at the EXT REF IN input. The instrument uses this signal to adjust the frequency of the internal reference.

If Sense is selected, the instrument checks whether a signal is present at the external reference connector. If it senses a signal within 5 ppm of the External Ref Freq (as set on the **External Ref Freq** softkey), it will automatically switch to the external reference. If it senses a 1 pulse per second signal, it enters Pulse mode, wherein the signal is used to adjust the internal reference. When no signal is present, it automatically switches to the internal reference. No message is generated as the reference switches between pulse, external and internal. The monitoring of the external reference occurs approximately on 1 millisecond intervals, and never occurs in the middle of a measurement acquisition, only at the end of the measurement (end of the request).

If for any reason the instrument's frequency reference is not able to obtain lock, Status bit 1 in the Questionable Frequency register will be true and a condition error message is generated. When lock is regained, Status bit 1 in the Questionable Frequency register will be cleared and the condition error will be cleared.

If an external frequency reference is being used, you must enter the frequency of the external reference if it is not exactly 10 MHz. The External Ref Freq key is provided for this purpose.

On the M9420A module, there is no internal frequency reference. To work correctly, a 100MHz external frequency reference signal is needed to connect to the front panel of the module. The default Freq Ref In setting is "External" and it cannot be set to any other types.

Key Path	Input/Output
----------	---------------------

Remote Command	[:SENSe]:ROSCillator:SOURce:TYPE INTernal EXTernal SENSe PULSe [:SENSe]:ROSCillator:SOURce:TYPE?
Dependencies	The PULSe parameter, and support of the 1 pps signal at the EXT REF IN input, are not available in firmware prior to A.13.00. They are also not available in some model numbers. If not available, the Pulse key will be blank, and sending the PULSe parameter via SCPI will generate an error. On the M9420A, only the EXTernal choice is available.
Preset	This is unaffected by Mode Preset but is set to the Preset value on a "Restore Input/Output Defaults" or "Restore System Defaults->All".
State Saved	Saved in instrument state.
Status Bits/OPC dependencies	STATus:QUEStionable:FREQuency bit 1 set if unlocked.
Backwards Compatibility Notes	Freq Ref In was not saved in state in the legacy instruments. It is a part of state in the X-Series.
Initial S/W Revision	Prior to A.02.00
Modified at S/W Revision	A.14.00

Remote Command	[:SENSe]:ROSCillator:SOURce?
Notes	The query [SENSe]:ROSCillator:SOURce? returns the current switch setting. This means: <ul style="list-style-type: none"> 7. If it was set to SENSe but there is no external reference nor 1pps signal so the instrument is actually using the internal reference, then this query returns INTernal and not SENSe. 8. If it was set to SENSe and there is an external reference present, the query returns EXTernal and not SENSe. 9. If it was set to SENSe and there is a 1 pps signal present, the query returns PULSe and not SENSe. 10. If it was set to EXTernal, then the query returns "EXTernal" 11. If it was set to INTernal, then the query returns "INTernal". 12. If it was set to PULSe, then the query returns "PULSe"
Backwards Compatibility Notes	The query [:SENSe]:ROSCillator:SOURce? was a query-only command in ESA which always returned whichever reference the instrument was using. The instrument automatically switched to the ext ref if it was present. In PSA (which had no sensing) the command [:SENSe]:ROSCillator:SOURce set the reference (INT or EXT), so again its query returned the actual routing. Thus the query form of this command is 100% backwards compatible with both instruments.
Initial S/W Revision	Prior to A.02.00

Remote Command	<code>[:SENSe]:ROSCillator:SOURce INTernal EXTernal</code>
Notes	For PSA compatibility the command form is provided and is directly mapped to <code>[:SENSe]:ROSCillator:SOURce:TYPE</code>
Initial S/W Revision	Prior to A.02.00

Sense

If Sense is selected, the instrument checks whether a signal is present at the external reference connector. If it senses a signal within 5 ppm of the External Ref Freq (as set on the **External Ref Freq** softkey), it will use this signal as an External Reference. If it senses a 1 pulse per second signal, it will use this signal to adjust the internal reference by adjusting the User setting of the Timebase DAC. When no signal is present, it automatically switches to the internal reference.

Key Path	Input/Output, Freq Ref In
Example	<code>:ROSC:SOUR:TYPE SENS</code>
Couplings	If set to SENSE and the analyzer senses a 1 pulse per second signal, it sets the System, Alignments, Timebase DAC setting to "User". This setting survives Preset and Power Cycle but is set to "Calibrated" on a System, Restore Defaults, Align or a System, Restore Defaults, All
Readback	Sense
Initial S/W Revision	Prior to A.02.00
Modified at S/W Revision	A.14.00

Internal

The internal reference is used. A 1 pps signal at the EXT REF IN port, or a signal there between 1 and 50 MHz, will cause a warning triangle to appear in the settings panel next to the word "INTERNAL", but will otherwise be ignored.

Key Path	Input/Output, Freq Ref In
Example	<code>:ROSC:SOUR:TYPE INT</code>
Readback	Internal
Initial S/W Revision	Prior to A.02.00
Modified at S/W Revision	A.14.00

External

The external reference is used.

Key Path	Input/Output, Freq Ref In
Example	:ROSC:SOUR:TYPE EXT
Readback	External
Initial S/W Revision	Prior to A.02.00

Pulse

The internal reference continues to be the frequency reference for the instrument in that it determines the reference contribution to the phase noise, but its average frequency is adjusted to follow the 1 pps signal at the EXT REF IN input. Therefore, the analyzer frequency accuracy will be dominated by the aging rate of the 1 pps signal instead of the aging rate of the internal reference, except during the time it takes to lock to a new 1 pps signal, approximately 10 minutes.

See "[More Information](#)" on page 318

Key Path	Input/Output, Freq Ref In
Example	:ROSC:SOUR:TYPE PULS
Couplings	Sets the System, Alignments, Timebase DAC setting to "User". This setting survives Preset and Power Cycle but it set to "Calibrated" on a System, Restore Defaults, Align or a System, Restore Defaults, All
Readback	Pulse
Initial S/W Revision	A.14.00

More Information

When a 1 pps signal is present at the EXT REF IN input, and either **Pulse** or **Sense** is selected, the internal reference frequency is affected by this signal; in effect, it "learns" a new accuracy setting. This setting can be seen by going to the **System, Alignments, Timebase Dac** menu, and looking at the **User** key in that menu. You will note that User has become automatically selected, and that the value shown on the **User** key is the updated value of the timebase DAC as "learned" from the 1 pps signal. Note that this replaces any value the user might have previously set on this key.

Once the setting is learned the user may remove the 1 pps signal; the User setting for the Timebase DAC is retained until you manually select "Calibrated" or execute a System, Restore Defaults, Align or a System, Restore Defaults, All. If you want to make the User setting permanent there is information in the Service Guide that tells you how to change the Calibrated setting of the Timebase DAC.

Note also that if the 1 pps signal is removed when Sense is selected, the analyzer will simply switch to the normal state of the Internal reference and display SENSE:INT in the Settings Panel. However, if the 1 pps signal is removed when Pulse is selected, the analyzer will generate an error

The J7203A Atomic Frequency Reference is an accessory for the X-Series Signal Analyzer that provides a highly accurate 1 pps timebase to use in conjunction with the Pulse setting. With the J7203A, the 1 pps signal is guaranteed to meet the input requirements of the EXT REF IN port, and the improved accuracy of the analyzer's internal frequency reference is specified. This is the only 1 pps signal that is guaranteed to function properly with the X-Series.

Ext Ref Freq

This key tells the analyzer the frequency of the external reference. When the external reference is in use (either because the reference has been switched to External or because the Reference has been switched to Sense and there is a valid external reference present) this information is used by the analyzer to determine the internal settings needed to lock to that particular external reference signal.

For the instrument to stay locked, the value entered must be within 5 ppm of the actual external reference frequency. So it is important to get it close, or you risk an unlock condition.

Note that this value only affects the instrument's ability to lock. It does not affect any calculations or measurement results. See "Freq Offset" in the Frequency section for information on how to offset frequency values.

Key Path	Input/Output, Freq Ref In
Remote Command	[:SENSE]:ROSCillator:EXTernal:FREQuency <freq> [:SENSE]:ROSCillator:EXTernal:FREQuency?
Example	ROSC:EXT:FREQ 20 MHz sets the external reference frequency to 20 MHz, but does not select the external reference. ROSC:SOUR:TYPE EXT selects the external reference.
Dependencies	Still available with Internal or Pulse selected, to allow setup for when External is in use. However, the setting has no effect if the Internal Reference is in use (Freq Ref In set to Internal, Pulse, or SENSE:INT or SENSE:PULSE).
Preset	This is unaffected by a Mode Preset or an "Input/Output Preset" or "Restore Defaults, Input/Output" but is set to 10 MHz on a "Restore Defaults, Misc" or "Restore Defaults, All" or by pressing the "Default External Ref Freq" button.
Min	CXA: 10 MHz EXA: 10 MHz MXA: 1 MHz PXA: 1 MHz M9420A: 100 MHz N8973B, N8974B, N8975B, or N8976B: 10 MHz M9420A: 100 MHz
Max	CXA: 10 MHz EXA: 10 MHz EXA with option R13: 20 MHz

	MXA: 50 MHz PXA: 50 MHz N8973B, N8974B, N8975B, or N8976B: 10 MHz M9420A: 100 MHz
Default Unit	Hz
Initial S/W Revision	Prior to A.02.00
Modified at S/W Revision	A.14.00

Default External Ref Freq

This button restores the External Ref Freq to its default of 10 MHz.

When you set an External Ref Freq value with the Ext Ref Freq control, that Frequency is persistent; is not affected by Mode Preset or Input/Output Preset, and survives shutdown and power cycle. This control allows you to reset the External Ref Freq to its default value.

NOTE

The persistence of the External Ref Freq is a new behavior as of firmware version A.18.00, necessitating the addition of this control. In versions before A.18.00, the frequency reset on a power cycle/restart. Thus you may need to use this command to retain backwards compatibility.

Key Path	Input/Output, Freq Ref Input
Remote Command	[:SENSe]:ROSCillator:EXTernal:FREQuency:DEFault
Example	ROSC:EXT:FREQ:DEF resets the external ref frequency
Notes	This is command only, there is no query
Dependencies	Grayed out if the Ext Ref Freq is already set to the default
Initial S/W Revision	A.18.00

External Reference Lock BW

This control lets you adjust the External Reference phase lock bandwidth. This control is available in some models of the X-Series.

The PXA variable reference loop bandwidth allows an external reference to be used and have the analyzer close-in phase noise improved to match that of the reference. This could result in an improvement of tens of decibels. The choice of “Wide” or “Narrow” affects the phase noise at low offset frequencies, especially 4 to 400 Hz offset. When using an external reference with superior phase noise, we recommend setting the external reference phase-locked-loop bandwidth to wide (60 Hz), to take advantage of that superior performance. When using an external reference with inferior phase noise performance, we recommend setting that bandwidth to narrow (15 Hz). In these relationships, inferior and superior phase noise are with respect to

-134 dBc/Hz at 30 Hz offset from a 10 MHz reference. Because most reference sources have phase noise behavior that falls off at a rate of 30 dB/decade, this is usually equivalent to -120 dBc/Hz at 10 Hz offset.

Key Path	Input/Output, Freq Ref In
Scope	Mode Global
Remote Command	[:SENSe]:ROSCillator:BANDwidth WIDE NARROW [:SENSe]:ROSCillator:BANDwidth?
Example	ROSC:BAND WIDE
Dependencies	Still available with Internal or Pulse selected, to allow setup for when External is in use. However, the setting has no effect if the Internal Reference is in use (Freq Ref In set to Internal, Pulse, or SENSE:INT or SENSE:PULSE). This key only appears in analyzers equipped with the required hardware.
Preset	This is unaffected by a Preset but is set to Narrow on a "Restore Input/Output Defaults" or "Restore System Defaults -> All"
State Saved	Saved in Input/Output state.
Initial S/W Revision	A.04.00
Modified at S/W Revision	A.14.00

External Ref Coupling

Only appears with option ERC installed and licensed.

This function lets you couple the sweep system of the analyzer to the state of the External Reference. If **Normal** is selected, data acquisition proceeds regardless of the state of the External Reference. When you select **Ext Ref Out Of Range Stops Acquisition**, the data acquisition (sweep or measurement) stops when either the "521, External ref out of range" or the "503, Frequency Reference unlocked" error message is asserted. Note that this will only take place if the **Freq Ref In** selection is **External**.

With the acquisition stopped, the data display will stop updating (even if this occurs in the middle of a sweep or measurement) and no data will be returned to a READ? or MEASure? query; that is, these queries will not complete because the analyzer will not respond to them. Furthermore, no response will be generated to a *WAI? or *OPC? query.

Proper SCPI sequences are shown below, which will always fail to return if the acquisition stops during the requested sweep or measurement. Note that, for predictable operation of this function, it is best to operate the analyzer in single measurement mode (INIT:CONT OFF), because if operating in continuous mode, the analyzer may respond to the above queries even after the acquisition stops, with data left over from the previous acquisition.

```
:INIT:CONT OFF
```

```
:INIT:IMM;*OPC?
```

```
--
```

```
:INIT:CONT OFF
```

```
:INIT:IMM;*WAI?
```

```
--
```

```
:INIT:CONT OFF
```

```
:READ?
```

```
--
```

```
:INIT:CONT OFF
```

```
:MEASure?
```

When the acquisition ceases, in addition to the error condition(s) described above, a popup error message will be generated informing you that the acquisition has ceased due to an invalid external reference. This message will stay on the screen while the acquisition is suspended.

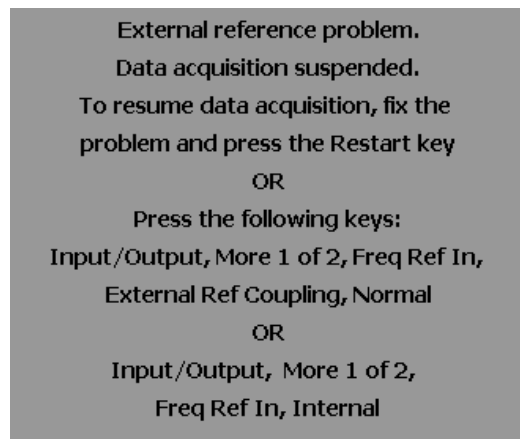

```

External reference problem.
Data acquisition suspended.
To resume data acquisition, fix the
problem and press the Restart key
OR
Press the following keys:
Input/Output, More 1 of 2, Freq Ref In,
External Ref Coupling, Normal
OR
Input/Output, More 1 of 2,
Freq Ref In, Internal

```

If you press the Restart key this message will be taken off the screen and a new acquisition will be attempted. If the External Reference problem persists the message will re-appear. You can also remove the message by changing back to the **Normal** setting of Sweep/Ext Ref Coupling, or by pressing **Freq Ref In, Internal**, or **Freq Ref In, Sense**, or **Restore Input/Output Defaults**.

The setting of External Ref Coupling is persistent across power-cycling and is not reset with a Preset. It is reset to the default state (Normal) when **Restore Input/Output Defaults** is invoked, which will also restart normal data acquisition.

The detection of invalid external reference is under interrupt processing. If the external reference becomes invalid then returns to valid in too short a time, no error condition will be detected or reported and therefore the acquisition will not be stopped.

Key Path	Input/Output, Freq Ref In
Mode	All
Remote Command	<code>[:SENSe]:ROSCillator:COUPling NORMal NACQuisition</code> <code>[:SENSe]:ROSCillator:COUPling?</code>
Preset	This setting is persistent: it survives power-cycling or a Preset and is reset with Restore Input/Output defaults.
State Saved	Not saved in instrument state
Readback	Normal Stop Acq
Initial S/W Revision	A.02.00

Output Config

Accesses keys that configure various output settings, like the frequency reference output, trigger output and analog output.

Key Path	Input/Output
Backwards Compatibility Notes	In ESA there was not a user interface to enable the Video Output (Analog Output), Trigger Output, or Gate Output. In the X-Series each of these physical connectors requires configuration, thus the user interface has been added for X-Series, along with the potential for an output you think is always on to be switched off.
Initial S/W Revision	Prior to A.02.00

Trig Out

Select the type of output signal that will be output from the Trig 1 Out, or Trig 2 Out connectors.

Key Path	Input/Output, Output Config
Remote Command	<code>:TRIGger TRIGger1 TRIGger2[:SEQuence]:OUTPut HSWP MEASuring MAIN GATE GTRigger OEVEN SPOint SSweep SSETtled S1Marker S2Marker S3Marker S4Marker OFF</code> <code>:TRIGger TRIGger1 TRIGger2[:SEQuence]:OUTPut?</code>
Example	TRIG:OUTP HSWP TRIG2:OUTP GATE
Dependencies	The second Trigger output (Trig 2 Out) does not appear in all models; in models that do not support it, the Trig 2 Out key is blanked, and sending the SCPI command for this output generates an error, "Hardware missing; Not available for this model number" In models that do not support the Trigger 2 output, this error is returned if trying to set Trig 2 Out and a query of Trig 2 Out returns OFF.
Preset	Trigger 1: Sweeping (HSWP) Trigger 2: Gate

	This is unaffected by a Preset but is preset to the above values on a "Restore Input/Output Defaults" or "Restore System Defaults->All"
State Saved	Saved in instrument state
Initial S/W Revision	Prior to A.02.00

Polarity

Sets the output to the Trig 1 Out, or Trig 2 Out, connector to trigger on either the positive or negative polarity.

Key Path	Input/Output, Output Config, Trig 1/2 Output
Remote Command	:TRIGger TRIGger1 TRIGger2[:SEQUence]:OUTPut:POLarity POSitive NEGative :TRIGger TRIGger1 TRIGger2[:SEQUence]:OUTPut:POLarity?
Example	TRIG1:OUTP:POL POS
Preset	This is unaffected by a Preset but is set to POSitive on a "Restore Input/Output Defaults" or "Restore System Defaults->All"
State Saved	Saved in instrument state
Initial S/W Revision	Prior to A.02.00

Off

Selects no signal to be output to the Trig 1 Out, or Trig 2 Out, connector.

Key Path	Input/Output, Output Config, Trig 1/2 Output
Example	TRIG1:OUTP OFF
Readback	Off
Initial S/W Revision	Prior to A.02.00

Sweeping (HSWP)

Selects the Sweeping Trigger signal to be output to the Trig 1 Out, or Trig 2 Out, connector when a measurement is made. This signal has historically been known as "HSWP" (High = Sweeping), and is 5 V TTL level with 50 ohm output impedance.

Key Path	Input/Output, Output Config, Trig 1/2 Output
Example	TRIG1:OUTP HSWP
Readback	Sweeping
Initial S/W Revision	Prior to A.02.00

Measuring

Selects the Measuring trigger signal to be output to the Trig 1 Out, or Trig 2 Out, connector. This signal is true while the Measuring status bit is true.

Key Path	Input/Output, Output Config, Trig 1/2 Output
Example	TRIG1:OUTP MEAS
Readback	Measuring
Initial S/W Revision	Prior to A.02.00

Main Trigger

Selects the current instrument trigger signal to be output to the Trig 1 Out, or Trig 2 Out, connector.

Key Path	Input/Output, Output Config, Trig 1/2 Output
Example	TRIG1:OUTP MAIN
Readback	Main Trigger
Initial S/W Revision	Prior to A.02.00

Gate Trigger

Selects the gate trigger signal to be output to the Trig 1 Out, or Trig 2 Out, connector. This is the source of the gate timing, not the actual gate signal.

Key Path	Input/Output, Output Config, Trig 1/2 Output
Example	TRIG1:OUTP GTR
Readback	Gate Trigger
Initial S/W Revision	Prior to A.02.00

Gate

Selects the gate signal to be output to the Trig 1 Out, or Trig 2 Out, connector. The gate signal has been delayed and its length determined by delay and length settings. When the polarity is positive, a high on the Trig 1 Out, or Trig 2 Out, represents the time the gate is configured to pass the signal.

Key Path	Input/Output, Output Config, Trig 1/2 Output
Example	TRIG1:OUTP GATE
Readback	Gate
Initial S/W Revision	Prior to A.02.00

Source Point Trigger

Selects the gate signal to be output to the Trig 1 Out, or Trig 2 Out, connector for use as the Point Trigger when operating an external source in Tracking mode. When Ext Trigger 1 is selected as the Point Trigger under Source, the Source Point Trigger under Trig1 Out automatically gets selected. Similarly, when Ext Trigger 2 is selected as the Point Trigger under Source, the Source Point Trigger key under Trig 2 Out automatically gets selected

Key Path	Input/Output, Output Config, Trig 1/2 Output
Example	TRIG1:OUTP SPO
Readback	Source Point
Initial S/W Revision	Prior to A.02.00

Odd/Even Trace Point

Selects either the odd or even trace points as the signal to be output to the Trig 1 Out, or Trig 2 Out, connector when performing swept spectrum analysis. When the polarity is positive, this output goes high during the time the analyzer is sweeping past the first point (Point 0) and every other following trace point. The opposite is true if the polarity is negative.

Key Path	Input/Output, Output Config, Trig 1/2 Output
Example	TRIG1:OUTP OEV
Readback	Odd/Even
Initial S/W Revision	Prior to A.02.00

Analog Out

This menu lets you control which signal is fed to the "Analog Out" connector on the analyzer rear panel.

See ["More Information" on page 327](#)

Key Path	Input/Output, Output Config
Remote Command	:OUTPut:ANALog OFF SVIDeo LOGVideo LINVideo DAUDio :OUTPut:ANALog?
Example	OUTP:ANAL SVIDeo ! causes the analog output type to be Screen Video
Preset	This is unaffected by Preset but is set to DAUDio on a "Restore Input/Output Defaults" or "Restore System Defaults->All
Preset	OFF

State Saved	Saved in Input/Output State
Readback line	1-of-N selection [variable]
Backwards Compatibility Notes	<p>Prior to A.04.00, OFF was the default functionality except when in the Analog Demod application or with Tune and Listen, in which case it was DAUDio, and there was no selection menu. So for backwards compatibility with earlier X-Series firmware versions, Auto (:OUTP:ANAL:AUTO ON) will duplicate the prior behavior.</p> <p>The DNWB and SANalyzer parameters, which were legal in PSA but perform no function in the X-Series, are accepted without error.</p>
Initial S/W Revision	A.04.00

More Information

The table below gives the range for each output.

Analog Out	Nominal Range exc. (10% overrange)	Scale Factor	Notes
Off	0 V		
Screen Video	0 – 1 V open circuit	10%/division	8566 compatible
Log Video	0 – 1 V terminated	1/(192.66 dB/V)	dB referenced to mixer level, 1V out for –10 dBm at the mixer.
Linear Video	0 – 1 V terminated	100%/V	Linear referenced to Ref Level, 1 V out for RF envelope at the Ref Level.
Demod Audio	(varies with analyzer setting)		

Auto

Selects the Auto state for the Analog Output menu. In this state, the Analog Output will automatically be set to the most sensible setting for the current mode or measurement.

If you make a selection manually from the Analog Out menu, this selection will remain in force until you change it (or re-select Auto), even if you go to a mode or measurement for which the selected output does not apply.

Key Path	Input/Output, Output Config, Analog Out
Remote Command	<p>OUTPut:ANALog:AUTO OFF ON 0 1</p> <p>OUTPut:ANALog:AUTO?</p>
Example	OUTP:ANAL:AUTO ON
Preset	ON

State Saved	Saved in Input/Output State
Initial S/W Revision	A.04.00

Off

Turns off the analog output.

Key Path	Input/Output, Output Config, Analog Out
Example	OUTP:ANAL OFF ! causes the analog output to be off
Readback Text	Off
Initial S/W Revision	A.04.00

Screen Video

Selects the analog output to be the screen video signal. In this mode, the pre-detector data is output to the Analog Out connector. The output looks very much like the trace displayed on the analyzer's screen, and depends on the Log/Lin display Scale, Reference Level, and dB per division, but is not influenced by the selected detector or any digital flatness corrections or trace post-processing (like Trace Averaging).

Note that this mode is similar to the Analog Output of the HP 8566 family and the Video Out (opt 124) capability of the Keysight PSA analyzer (E444x), although there are differences in the behavior.

Key Path	Input/Output, Output Config, Analog Out
Example	OUTP:ANAL SVID
Dependencies	<p>Because the Screen Video output uses one of the two IF processing channels, only one detector is available while Screen Video is selected. All active traces will change to use the same detector as the selected trace when Screen Video is activated.</p> <p>Screen Video output is not available while any EMI Detector is selected (Quasi Peak, RMS Average or EMI Average), because these detectors use both IF processing channels. Consequently, if the user chooses an EMI Detector, there will be no Screen Video output.</p> <p>The output holds at its last value during an alignment and during a marker count. After a sweep:</p> <ul style="list-style-type: none"> - If a new sweep is to follow (as in Continuous sweep mode), the output holds at its last value during the retrace before the next sweep starts. If the analyzer is in zero-span, there is no retrace, as the analyzer remains tuned to the Center Frequency and does not sweep. Therefore, in zero-span, the output simply remains live between display updates. - If no new sweep is to follow (as in Single sweep mode), the output remains live, and continues to show the pre-detector data <p>This function depends on optional capability; the key will be blanked and the command will</p>

	generate an "Option not available" error unless you have Option YAV or YAS licensed in your instrument.
Couplings	Screen Video output changes while in FFT Sweeps, so for measurements that use exclusively FFT Sweeps, or if the user manually chooses FFT Sweeps, the Screen Video output will look different than it does in swept mode.
Readback Text	Screen Video
Backwards Compatibility Notes	See " Backwards Compatibility: " on page 329, below.
Initial S/W Revision	A.04.00

Backwards Compatibility:

The Screen Video function is intended to be very similar to the 8566 Video Output and the PSA Option 124. However, unlike the PSA, it is not always on; it must be switched on by the Screen Video key. Also, unlike the PSA, there are certain dependencies (detailed above) – for example, the Quasi Peak Detector is unavailable when Screen Video is on.

Furthermore, the PSA Option 124 hardware was unipolar and its large range was padded to be exactly right for use as a Screen Video output. In the X-Series, the hardware is bipolar and has a wider range to accommodate the other output choices. Therefore, the outputs won't match up exactly and users may have to modify their setup when applying the X-Series in a PSA application.

Log Video (RF Envelope, Ref=Mixer Level)

Selects the analog output to be the log of the video signal. In this mode, the pre-detector data is output to the Analog Out connector with a Log scaling. The output is referenced to the current level at the mixer, does not depend on display settings like Reference Level or dB per division, and it is not influenced by the selected detector or any digital flatness corrections or trace post-processing (like Trace Averaging), but does change with input attenuation.

The output is designed so that full scale (1 V) corresponds to -10 dBm at the mixer. The full range (0-1 V) covers 192.66 dB ; thus, 0 V corresponds to -202.66 dBm at the mixer.

Key Path	Input/Output, Output Config, Analog Out
Example	OUTP:ANAL LOGV
Dependencies	<p>Because the Log Video output uses one of the two IF processing channels, only one detector is available while Screen Video is selected. All active traces will change to use the same detector as the selected trace when Log Video is activated.</p> <p>Log Video output is not available while any EMI Detector is selected (Quasi Peak, RMS Average or EMI Average), because these detectors use both IF processing channels. Consequently, if the user chooses an EMI Detector, there will be no Log Video output.</p> <p>The output holds at its last value during an alignment, during a marker count, and during retrace (after a sweep and before the next sweep starts).</p>

	This function depends on optional capability. The key will be blanked and the command will generate an "Option not available" error unless you have Option YAV licensed in your instrument.
Couplings	Log Video output changes while in FFT Sweeps, so for measurements that use exclusively FFT Sweeps, or if the user manually chooses FFT Sweeps, the Log Video output will look different than it does in swept mode.
Readback Text	Log Video
Initial S/W Revision	A.04.00

Linear Video (RF Envelope, Ref=Ref Level)

Selects the analog output to be the envelope signal on a linear (voltage) scale. In this mode, the pre-detector data is output to the Analog Out connector with a Linear scaling. The output is based on the current Reference Level, and is not influenced by the selected detector or any digital flatness corrections or trace post-processing (like Trace Averaging).

The scaling is set so that 1 V output occurs with an instantaneous video level equal to the reference level, and 0 V occurs at the bottom of the graticule. This scaling gives you the ability to control the gain without having another setup control for the key. But it requires you to control the look of the display (the reference level) in order to control the analog output.

This mode is ideal for looking at Amplitude Modulated signals, as the linear envelope effectively demodulates the signal.

Key Path	Input/Output, Output Config, Analog Out
Example	OUTP:ANAL LINV
Dependencies	<p>Because the Linear Video output uses one of the two IF processing channels, only one detector is available while Linear Video is selected. All active traces will change to use the same detector as the selected trace when Log Video is activated.</p> <p>Linear Video output is not available while any EMI Detector is selected (Quasi Peak, RMS Average or EMI Average), because these detectors use both IF processing channels. Consequently, if the user chooses an EMI Detector, there will be no Linear Video output.</p> <p>The output holds at its last value during an alignment and during a marker count and during retrace (after a sweep and before the next sweep starts).</p> <p>This function depends on optional capability; the key will be blanked and the command will generate an "Option not available" error unless you have Option YAV licensed in your instrument.</p>
Couplings	Linear Video output changes while in FFT Sweeps, so for measurements that use exclusively FFT Sweeps, or if the user manually chooses FFT Sweeps, the Linear Video output will look different than it does in swept mode.
Readback Text	Linear Video
Initial S/W Revision	A.04.00

Demod Audio

Selects the analog output to be the demodulation of the video signal.

When Demod Audio is selected, the demodulated audio signal appears at this output whenever the Analog Demod application is demodulating a signal or when **Analog Demod Tune and Listen** is operating in the Swept SA measurement.

When Analog Out is in the Auto state, this output is auto-selected when in the Analog Demod mode or when **Analog Demod Tune and Listen** is operating in the Swept SA measurement.

If any other Analog Output is manually selected when in the Analog Demod mode or when **Analog Demod Tune and Listen** is operating in the Swept SA measurement, a condition warning message appears.

Key Path	Input/Output, Output Config, Analog Out
Example	OUTP:ANAL DAUD
Dependencies	<p>This key only appears if the Analog Demod application (N9063A), the N6141A or W6141A application, or Option EMC is installed and licensed, otherwise the key will be blanked and the command will generate an "Option not available" error.</p> <p>The output holds at its last value during an alignment and during a marker count. It is not held between sweeps, in order for Tune and Listen to work properly.</p> <p>When Demod Audio is the selected Analog Output:</p> <ul style="list-style-type: none"> - all active traces are forced to use the same detector. - CISPR detectors (QPD, EMI Avg, RMS Avg) are unavailable
Readback Text	Demod Audio
Initial S/W Revision	Prior to A.02.00 (this was the default functionality, and there was no selection)
Modified at S/W Revision	A.04.00

Digital Bus

This menu allows you to configure the LVDS connector located on the rear panel of the instrument. It is a unidirectional link of real time data at a 90 MSa/s rate. The ADC is sampling a 22.5 MHz IF.

The data that appears on this port is raw, uncorrected ADC samples, unless you have option RTL. With option RTL, you get fully corrected I/Q data.

This connector will only be active when the Narrowband IF Path is currently in use.

Key Path	Input/Output, Output Config
Initial S/W Revision	A.04.00

Bus Out On/Off

When Bus Out is on, all acquisitions are streamed to the output port including acquisitions for internal purposes such as Alignment. The internal processing and routing of acquisitions continues as usual and is unaffected by the state of Bus Out.

When Bus Out is off, no signal appears on the LVDS port.

Key Path	Input/Output, Output Config, Digital Bus
Scope	Mode Global
Remote Command	:OUTPut:DBUS[1][:STATe] ON OFF 1 0 :OUTPut:DBUS[1][:STATe]?
Example	OUTP:DBUS ON
Preset	This is unaffected by a Preset but is set to Off on a "Restore Input/Output Defaults" or "Restore System Defaults -> All"
State Saved	Saved in Input/Output State
Initial S/W Revision	Prior to A.02.00
Modified at S/W Revision	A.04.00

I/Q Cal Out

The Baseband I/Q "Cal Out" port can be turned on with either a 1 kHz or a 250 kHz square wave. This can be turned on independent of the input selection. A Preset will reset this to Off.

Key Path	Input/Output, Output Config
Remote Command	:OUTPut:IQ:OUTPut IQ1 IQ250 OFF :OUTPut:IQ:OUTPut?
Example	OUTP:IQ:OUTP IQ1
Couplings	An I/Q Cable Calibration or an I/Q Probe Calibration will change the state of the Cal Out port as needed by the calibration routine. When the calibration is finished the I/Q Cal Out is restored to the pre-calibration state.
Preset	Off
State Saved	Saved in instrument state
Range	1 kHz Square Wave 250 kHz Square Wave Off
Readback Text	1 kHz 250 kHz Off
Initial S/W Revision	Prior to A.02.00

1 kHz Square Wave

Turns on the 1 kHz square wave signal at the Cal Out port. This choice is only available with option BBA.

Key Path	Input/Output, Output Config, I/Q Cal Out
Readback	I/Q 1kHz
Initial S/W Revision	Prior to A.02.00

250 kHz Square Wave

Turns on the 250 kHz square wave signal at the Cal Out port. This choice is only available with option BBA.

Key Path	Input/Output, Output Config, I/Q Cal Out
Readback	I/Q 250kHz
Initial S/W Revision	Prior to A.02.00

Off

Turns off the signal at the Cal Out port. This choice is only available with option BBA.

Key Path	Input/Output, Output Config, I/Q Cal Out
Readback	Off
Initial S/W Revision	Prior to A.02.00

Aux IF Out

This menu controls the signals that appear on the SMA output on the rear panel labeled "AUX IF OUT"

The Aux IF Out functionality is only valid for RF and External Mixer inputs. When using the External Mixing path, the Aux IF Out levels (for all three Options CR3, CRP, and ALV) will be uncalibrated because the factory default Aux IF level was set to accommodate the expected IF levels for the RF path.

Key Path	Input/Output, Output Config
Remote Command	:OUTPut:AUX SIF AIF LOGVideo OFF :OUTPut:AUX?
Dependencies	The softkey does not appear in models that do not support the Aux IF Out.
Preset	This is unaffected by a Preset but is set to OFF on a "Restore Input/Output Defaults" or "Restore System Defaults->All"
State Saved	Saved in Input/Output state

Readback line	1-of-N selection [variable]
Backwards Compatibility Notes	In the PSA, the IF output has functionality equivalent to the "Second IF" function in the X-Series' Aux IF Out menu. In the X-Series, it is necessary to switch the Aux IF Out to "Second IF" to get this functionality, whereas in PSA it is always on, since there are no other choices. Hence a command to switch this function to "Second IF" will have to be added by customers migrating from PSA who use the IF Output in PSA.
Initial S/W Revision	A.04.00

Off

In this mode nothing comes out of the "AUX IF OUT" connector on the rear panel. The connector appears as an open-circuit (that is, it is not terminated in any way).

Key Path	Input/Output, Output Config, Aux IF Out
Example	OUTP:AUX OFF causes the aux output type to be off
Readback Text	Off
Initial S/W Revision	A.04.00

Second IF

In this mode the 2nd IF output is routed to the rear panel connector. The annotation on the key shows the current 2nd IF frequency in use in the analyzer.

The frequency of the 2nd IF depends on the current IF signal path as shown in the table below:

IF Path Selected	Frequency of "Second IF" Output
10 MHz	322.5 MHz
25 MHz	322.5 MHz
40 MHz	250 MHz
140 MHz	300 MHz

The signal quality, such as signal to noise ratio and phase noise, are excellent in this mode.

Key Path	Input/Output, Output Config, Aux IF Out
Example	OUTP:AUX SIF causes the aux output type to be Second IF
Dependencies	Does not appear unless Option CR3 is installed.

Readback Text	Second IF
Initial S/W Revision	A.04.00

Arbitrary IF

In this mode the 2nd IF output is mixed with a local oscillator and mixer to produce an arbitrary IF output between 10 MHz and 75 MHz with 500 kHz resolution. The phase noise in this mode will not be as good as in Second IF mode.

The IF output frequency is adjustable, through an active function which appears on the Arbitrary IF selection key, from 10 MHz to 75 MHz with 500 kHz resolution.

The bandwidth of this IF output varies with band and center frequency, but is about 40 MHz at the -3 dB width. When the output is centered at lower frequencies in its range, signal frequencies at the bottom of the bandwidth will “fold”. For example, with a 40 MHz bandwidth (20 MHz half-bandwidth), and a 15 MHz IF center, a signal -20 MHz relative to the spectrum analyzer center frequency will have a relative response of about -3 dB with a frequency 20 MHz below the 15 MHz IF center. This -5 MHz frequency will fold to become a +5 MHz signal at the IF output. Therefore, lower IF output frequencies are only useful with known band-limited signals.

Key Path	Input/Output, Output Config, Aux IF Out
Example	OUTP:AUX AIF causes the aux output type to be the Arbitrary IF
Dependencies	Does not appear unless Option CRP is installed.
Readback Text	Arbitrary IF
Initial S/W Revision	A.04.00

Key Path	Input/Output, Output Config, Aux IF Out
Scope	Mode Global
Remote Command	:OUTPut:AUX:AIF <value> :OUTPut:AUX:AIF?
Example	:OUTP:AUX:AIF 50 MHZ
Preset	This is unaffected by a Preset but is set to 70 MHz on a "Restore Input/Output Defaults" or "Restore System Defaults->All"
State Saved	Saved in Input/Output State
Min	10 MHz
Max	75 MHz
Default Unit	Hz
Initial S/W Revision	A.04.00

Fast Log Video

In this mode the 2nd IF output is passed through a log amp and the log envelope of the IF signal is sent to the rear panel. The open circuit output level varies by about 25 mV per dB, with a top-of-screen signal producing about 1.6 Volts. The output impedance is nominally 50 ohms.

This mode is intended to meet the same needs as Option E4440A-H7L Fast Rise Time Video Output on the Keysight E4440A PSA Series, allowing you to characterize pulses with fast rise times using standard measurement suites on modern digital scopes.

Key Path	Input/Output, Output Config, Aux IF Out
Example	OUTP:AUX LOGVideo causes the aux output type to be Fast Log Video
Dependencies	Does not appear unless Option ALV is installed. The output is off during an alignment but not during a marker count, and is not blanked during retrace (after a sweep and before the next sweep starts).
Readback Text	Fast Log Video
Initial S/W Revision	A.04.00

I/Q Guided Calibration

Calibrating the Baseband I/Q ports requires several steps and manual connections. The Guided Calibration will interactively step you through the required steps, displaying diagrams to help with the connections. The steps will vary depending on the setup.

In the Guided Calibration windows, the date and time of the last calibration are displayed. If any of the items listed are displayed in yellow, this indicates that the calibration for that item is inconsistent with the latest calibration, and you should complete the entire calibration process before you exit the calibration.

I/Q Isolation Calibration

The I/Q Isolation Calibration must be run before calibrating any port with either the I/Q Cable Calibration or I/Q Probe Calibration. This calibration is performed with nothing connected to any of the front panel I/Q ports. This is the first step in both the I/Q Cable Calibration and the I/Q Probe Calibration.

Next

Perform the I/Q Isolation calibration.

Key Path	Input/Output, I/Q, I/Q Cable Calibration
Remote Command	:CALibration:IQ:ISOLation
Example	CAL:IQ:ISOL

Notes	All front panel I/Q ports must not be connected to anything.
Notes	All cables and probes should be disconnected from the I/Q ports before issuing the SCPI command.
State Saved	No.
Initial S/W Revision	Prior to A.02.00

Exit

Exits the calibration procedure. All ports calibrated before pressing Exit will use the newly acquired calibration data.

Key Path	Input/Output, I/Q, I/Q Cable Calibration
Notes	Using the Exit button will not restore the calibration data to the state prior to entering the guided calibration. Once a port is calibrated the data is stored immediately and the only way to change it is to redo the calibration step. When the calibration may be left in an inconsistent state, a confirmation dialog will be displayed (see " Exit Confirmation " on page 349).
Initial S/W Revision	Prior to A.02.00

I/Q Isolation Calibration Time (Remote Command Only)

Returns the last date and time that the I/Q Isolation Calibration was performed. This is a remote query command only.

Remote Command	:CALibration:IQ:ISOLation:TIME?
Example	:CAL:IQ:ISOL:TIME?
Notes	This returns 6 integer values: year, month, day, hour, minute, second. When no calibration has been performed, all values will be 0.
Initial S/W Revision	A.02.00

I/Q Cable Calibrate...

The I/Q cable calibration creates correction data for each of the front panel I/Q ports. This calibration data is used whenever no probe specific calibration data is available. It is important that all ports are calibrated using the same short BNC cable so that the data is comparable from port to port.

The guided calibration (front panel only) will show connection diagrams and guide you through the isolation calibration and calibrating each port. The calibration data for each port is stored separately, so as soon as a port is calibrated that data is saved and will be used. If you press "Exit" to exit the calibration process, the data for the ports already completed will still be used. It is recommended that a calibration be completed once started, or if exited, that it be properly done before the next use of the I/Q ports. The "Next" button will perform the calibration for the current port

and then proceed to the next step in the calibration procedure. The "Back" button will return to the prior port in the procedure. Both keys and dialog buttons are supplied for ease of use. The dialog buttons are for mouse use and the softkeys for front panel use.

The calibration can also be done via SCPI, but no connection diagrams will be shown. You will have to make the correct connections before issuing each port calibration command. Again, it is recommended that all ports be calibrated at the same time.

The instrument state remains as it was prior to entering the calibration procedure except while a port is actually being calibrated. Once a port is calibrated it returns to the prior state. A port calibration is in process only from the time the "Next" button is pressed until the next screen is shown. For SCPI, this corresponds to the time from issuing the CAL:IQ:FLAT:I|I|B|Q|QB command until the operation is complete.

For example, if the prior instrument state is Cal Out = Off, Input = I+jQ, and Differential = Off, then up until the time the "Next" button is pressed the I Input and Q Input LEDs are on and the Cal Out, I-bar Input and Q-bar Input LEDs are off. Once the "Next" button is pressed for the I port calibration, only the Cal Out and I Input LEDs will be on and the others will be off. When the screen progresses to the next step ("Next" button again enabled), the prior state is restored and only the I Input and Q Input LEDs are on (Cal Out is off again).

The last calibration date and time for each port will be displayed. Any calibrations that are more than a day older than the most recent calibration will be displayed with the color amber.

Key Path	Input/Output, I/Q
Initial S/W Revision	Prior to A.02.00

I Port

The I port calibration is performed with the front panel's I port connected via a short BNC cable to the Cal Out port. The guided calibration will show a diagram of the required connections.

Back

Return to the prior step in the calibration procedure.

Key Path	Input/Output, I/Q, Q Setup, Q Probe, Calibrate
Initial S/W Revision	Prior to A.02.00

Next

Perform the I port calibration.

Key Path	Input/Output, I/Q, I/Q Cable Calibrate...
Remote Command	:CALibration:IQ:FLATness:I
Example	CAL:IQ:FLAT:I
Notes	The recommended procedure is to use the same BNC cable to calibrate all I/Q ports. All I/Q ports should be calibrated sequentially during the procedure. The calibration data is saved as soon as the port is calibrated and will survive power cycles. It is not reset by any preset or restore data commands.
Notes	The I port must be connected to the Cal Out port before issuing the SCPI command.
State Saved	No.
Initial S/W Revision	Prior to A.02.00

Exit

Exit the calibration procedure. All ports calibrated before pressing Exit will use the newly acquired calibration data.

Key Path	Input/Output, I/Q, I/Q Cable Calibrate...
Notes	Using the Exit button will not restore the calibration data to the state prior to entering the guided calibration. Once a port is calibrated the data is stored immediately and the only way to change it is to redo the calibration step. When the calibration may be left in an inconsistent state, a confirmation dialog will be displayed (see " Exit Confirmation " on page 349).
Initial S/W Revision	Prior to A.02.00

I-bar Port

The I-bar port calibration is performed with the front panel's I-bar port connected via a short BNC cable to the Cal Out port. The guided calibration will show a diagram of the required connections.

Back

Return to the prior step in the calibration procedure.

Key Path	Input/Output, I/Q, I/Q Cable Calibration
Notes	Using the Back button will not restore the calibration data to a prior state. Once a port is calibrated the data is stored immediately and the only way to change it is to redo the calibration step. The Back button allows the user to go back to a prior step to redo that calibration step.
Initial S/W Revision	Prior to A.02.00

Next

Perform the I-bar port calibration.

Key Path	Input/Output, I/Q, I/Q Cable Calibrate...
Remote Command	:CALibration:IQ:FLATness:IBAR
Example	CAL:IQ:FLAT:IBAR
Notes	The recommended procedure is to use the same BNC cable to calibrate all I/Q ports. All I/Q ports should be calibrated sequentially during the procedure. The calibration data is saved as soon as the port is calibrated and will survive power cycles. It is not reset by any preset or restore data commands.
Notes	The I-bar port must be connected to the Cal Out port before issuing the SCPI command.
State Saved	No
Initial S/W Revision	Prior to A.02.00

Exit

Exit the calibration procedure. All ports calibrated before pressing Exit will use the newly acquired calibration data.

Key Path	Input/Output, I/Q, I/Q Cable Calibrate...
Notes	Using the Exit button will not restore the calibration data to the state prior to entering the guided calibration. Once a port is calibrated the data is stored immediately and the only way to change it is to redo the calibration step. When the calibration may be left in an inconsistent state, a confirmation dialog will be displayed (see " Exit Confirmation " on page 349).
Initial S/W Revision	Prior to A.02.00

Q Port

The Q port calibration is performed with the front panel's Q port connected via a short BNC cable to the Cal Out port. The guided calibration will show a diagram of the required connections.

Back

Return to the prior step in the calibration procedure.

Key Path	Input/Output, I/Q, I/Q Cable Calibrate...
Notes	Using the Back button will not restore the calibration data to a prior state. Once a port is calibrated the data is stored immediately and the only way to change it is to redo the calibration step. The Back button allows the user to go back to a prior step to redo that calibration step.
Initial S/W Revision	Prior to A.02.00

Next

Perform the Q port calibration.

Key Path	Input/Output, I/Q, I/Q Cable Calibrate...
Remote Command	:CALibration:IQ:FLATness:Q
Example	CAL:IQ:FLAT:Q
Notes	The recommended procedure is to use the same BNC cable to calibrate all I/Q ports. All I/Q ports should be calibrated sequentially during the procedure. The calibration data is saved as soon as the port is calibrated and will survive power cycles. It is not reset by any preset or restore data commands.
Notes	The Q port must be connected to the Cal Out port before issuing the SCPI command.
State Saved	No
Initial S/W Revision	Prior to A.02.00

Exit

Exit the calibration procedure. All ports calibrated before pressing Exit will use the newly acquired calibration data.

Key Path	Input/Output, I/Q, I/Q Cable Calibrate...
Notes	Using the Exit button will not restore the calibration data to the state prior to entering the guided calibration. Once a port is calibrated the data is stored immediately and the only way to change it is to redo the calibration step. When the calibration may be left in an inconsistent state, a confirmation dialog will be displayed (see " Exit Confirmation " on page 349).
Initial S/W Revision	Prior to A.02.00

Q-bar Port

The Q-bar port calibration is performed with the front panel's Q-bar port connected via a short BNC cable to the Cal Out port. The guided calibration will show a diagram of the required connections.

Back

Return to the prior step in the calibration procedure.

Key Path	Input/Output, I/Q, I/Q Cable Calibrate...
Notes	Using the Back button will not restore the calibration data to a prior state. Once a port is calibrated the data is stored immediately and the only way to change it is to redo the calibration step. The Back button allows the user to go back to a prior step to redo that calibration step.
Initial S/W Revision	Prior to A.02.00

Next

Perform the Q-bar port calibration.

Key Path	Input/Output, I/Q, I/Q Cable Calibrate...
Remote Command	:CALibration:IQ:FLATness:QBAR
Example	CAL:IQ:FLAT:QBAR
Notes	The recommended procedure is to use the same BNC cable to calibrate all I/Q ports. All I/Q ports should be calibrated sequentially during the procedure. The calibration data is saved as soon as the port is calibrated and will survive power cycles. It is not reset by any preset or restore data commands.
Notes	The Q-bar port must be connected to the Cal Out port before issuing the SCPI command.
State Saved	No
Initial S/W Revision	Prior to A.02.00

Exit

Exit the calibration procedure. All ports calibrated before pressing Exit will use the newly acquired calibration data.

Key Path	Input/Output, I/Q, I/Q Cable Calibrate...
Notes	Using the Exit button will not restore the calibration data to the state prior to entering the guided calibration. Once a port is calibrated the data is stored immediately and the only way to change it is to redo the calibration step. When the calibration may be left in an inconsistent state, a confirmation dialog will be displayed (see " Exit Confirmation " on page 349).
Initial S/W Revision	Prior to A.02.00

I/Q Cable Calibration Time (Remote Command Only)

Returns the last date and time that the I/Q Cable Calibration was performed for a specific port. This is a remote query command only.

Remote Command	:CALibration:IQ:FLATness:I IBAR Q QBAR:TIME?
Example	:CAL:IQ:FLAT:I:TIME?
Notes	This returns 6 integer values: year, month, day, hour, minute, second. When no calibration has been performed, all values will be 0.
Initial S/W Revision	A.02.00

I/Q Probe Calibration

The I/Q probe calibration creates correction data for one of the front panel I/Q channels. When the probe has EEPROM identification, the data is unique to that specific probe. When the probe does not have EEPROM identification, the data will be used for all probes of the same type. The data is also unique to the channel, so calibration data for the I channel will not be used for the Q channel and vice versa.

The guided calibration (front panel only) will show connection diagrams and guide the user through the I/Q Isolation Calibration and through calibrating each port. The calibration data for each port is stored separately, so as soon as a port is calibrated that data is saved and will be used. If a user presses "Exit" to exit the calibration process, the data for the port already completed will still be used. It is recommended that a calibration be completed once started, or if exited, that it be properly done before the next use of the probe. The "Next" button will perform the calibration for the current port and then proceed to the next step in the calibration procedure. The "Back" button will return to the prior port in the procedure. Both softkeys and dialog buttons are supplied for ease of use. The dialog buttons are for mouse use and the softkeys for front panel use.

The calibration can also be done via SCPI, but no connection diagrams will be shown. The user will have to make the correct connections before issuing each port calibration command. Again, it is recommended that all ports be calibrated at the same time.

For Active probes or when Differential is Off, only the main port is calibrated, otherwise both the main and complementary ports are calibrated.

The instrument state remains as it was prior to entering the calibration procedure except while a port is actually being calibrated. Once a port is calibrated it returns to the prior state. A port calibration is in process only from the time the "Next" button is pressed until the next screen is shown. For SCPI, this corresponds to the time from issuing the CAL:IQ:PROB:I|B|Q|QB command until the operation is complete.

For example, if the prior instrument state is Cal Out = Off, Input = I+jQ, and Differential = Off, then up until the time the "Next" button is pressed the I Input and Q Input LEDs are on and the Cal Out, I-bar Input and Q-bar Input LEDs are off. Once the "Next" button is pressed for the I port calibration, only the Cal Out and I Input LEDs will be on and the others will be off. When the screen progresses to the next step ("Next" button again enabled), the prior state is restored and only the I Input and Q Input LEDs are on (Cal Out is off again).

The last calibration date and time for each relevant port will be displayed. For passive probes with Differential On, any calibration that is more than a day older than the most recent calibration will be displayed with the color amber.

I Port

The I port calibration is performed with the probe body attached to the front panel's I port and the probe tip connected via an adapter to the Cal Out port. The guided calibration will show a diagram of the required connections.

Show Adapter

Show a connection diagram and instructions for the probe and adapter. See ["Show Adapter Screen" on page 348](#).

Key Path	Input/Output, I/Q, I Setup, I Probe, Calibrate
Notes	Either a passive or an active probe adapter diagram will be shown, depending on the type of probe attached.
Initial S/W Revision	Prior to A.02.00

Back

Return to the prior step in the calibration procedure.

Key Path	Input/Output, I/Q, Q Setup, Q Probe, Calibrate
Initial S/W Revision	Prior to A.02.00

Next

Perform the I port calibration.

Key Path	Input/Output, I/Q, I Setup, I Probe, Calibrate
Remote Command	:CALibration:IQ:PROBE:I
Example	CAL:IQ:PROB:I
Notes	The I port must be connected to the Cal Out port before issuing the SCPI command. The calibration data is saved as soon as the port is calibrated and will survive power cycles. It is not reset by any preset or restore data commands.
State Saved	No
Initial S/W Revision	Prior to A.02.00

Exit

Exit the calibration procedure. All ports calibrated before pressing Exit will use the newly acquired calibration data.

Key Path	Input/Output, I/Q, I Setup, I Probe, Calibrate
Notes	Using the Exit button will not restore the calibration data to the state prior to entering the guided calibration. Once a port is calibrated the data is stored immediately and the only way to change it is to redo the calibration step. When the calibration may be left in an inconsistent state, a confirmation dialog will be displayed (see "Exit Confirmation" on page 349).
Initial S/W Revision	Prior to A.02.00

I-bar Port

The I-bar port calibration is performed with the probe body attached to the front panel's I-bar port and the probe tip connected via an adapter to the Cal Out port. The I-bar probe calibration is only available for passive probes with Differential On. The guided calibration will show a diagram of the required connections.

Show Adapter

Show a connection diagram and instructions for the probe and adapter. See ["Show Adapter Screen" on page 348](#).

Key Path	Input/Output, I/Q, I Setup, I Probe, Calibrate
Notes	Either a passive or an active probe adapter diagram will be shown, depending on the type of probe attached.
Initial S/W Revision	Prior to A.02.00

Back

Return to the prior step in the calibration procedure.

Key Path	Input/Output, I/Q, I Setup, I Probe, Calibrate
Notes	Using the Back button will not restore the calibration data to a prior state. Once a port is calibrated the data is stored immediately and the only way to change it is to redo the calibration step. The Back button allows the user to go back to a prior step to redo that calibration step.
Initial S/W Revision	Prior to A.02.00

Next

Perform the I-bar port calibration.

Key Path	Input/Output, I/Q, I Setup, I Probe, Calibrate
Remote Command	:CALibration:IQ:PROBe:IBar
Example	CAL:IQ:PROB:IB
Notes	The I-bar port must be connected to the Cal Out port before issuing the SCPI command. The calibration data is saved as soon as the port is calibrated and will survive power cycles. It is not reset by any preset or restore data commands.
State Saved	No
Initial S/W Revision	Prior to A.02.00

Exit

Exit the calibration procedure. All ports calibrated before pressing Exit will use the newly acquired calibration data.

Key Path	Input/Output, I/Q, I Setup, I Probe, Calibrate
Notes	Using the Exit button will not restore the calibration data to the state prior to entering the guided calibration. Once a port is calibrated the data is stored immediately and the only way to change it is to redo the calibration step. When the calibration may be left in an inconsistent state, a confirmation dialog will be displayed (see " Exit Confirmation " on page 349).
Initial S/W Revision	Prior to A.02.00

Q Port

The Q port calibration is performed with the probe body attached to the front panel's Q port and the probe tip connected via an adapter to the Cal Out port. The guided calibration will show a diagram of the required connections.

Show Adapter

Show a connection diagram and instructions for the probe and adapter. See "[Show Adapter Screen](#)" on page 348.

Key Path	Input/Output, I/Q, Q Setup, Q Probe, Calibrate
Notes	Either a passive or an active probe adapter diagram will be shown, depending on the type of probe attached.
Initial S/W Revision	Prior to A.02.00

Back

Return to the prior step in the calibration procedure.

Key Path	Input/Output, I/Q, Q Setup, Q Probe, Calibrate
Initial S/W Revision	Prior to A.02.00

Next

Perform the Q port calibration.

Key Path	Input/Output, I/Q, Q Setup, Q Probe, Calibrate
Remote Command	:CALibration:IQ:PROBE:Q
Example	CAL:IQ:PROB:Q

Notes	The Q port must be connected to the Cal Out port before issuing the SCPI command. The calibration data is saved as soon as the port is calibrated and will survive power cycles. It is not reset by any preset or restore data commands.
State Saved	No
Initial S/W Revision	Prior to A.02.00

Exit

Exit the calibration procedure. All ports calibrated before pressing Exit will use the newly acquired calibration data.

Key Path	Input/Output, I/Q, Q Setup, Q Probe, Calibrate
Notes	Using the Exit button will not restore the calibration data to the state prior to entering the guided calibration. Once a port is calibrated the data is stored immediately and the only way to change it is to redo the calibration step. When the calibration may be left in an inconsistent state, a confirmation dialog will be displayed (see " Exit Confirmation " on page 349).
Initial S/W Revision	Prior to A.02.00

Q-bar Port

The Q-bar port calibration is performed with the probe body attached to the front panel's Q-bar port and the probe tip connected via an adapter to the Cal Out port. The Q-bar probe calibration is only available for passive probes with Differential On. The guided calibration will show a diagram of the required connections.

Show Adapter

Show a connection diagram and instructions for the probe and adapter. See "[Show Adapter Screen](#)" on page 348.

Key Path	Input/Output, I/Q, Q Setup, Q Probe, Calibrate
Notes	Either a passive or an active probe adapter diagram will be shown, depending on the type of probe attached.
Initial S/W Revision	Prior to A.02.00

Back

Return to the prior step in the calibration procedure.

Key Path	Input/Output, I/Q, Q Setup, Q Probe, Calibrate
Notes	Using the Back button will not restore the calibration data to a prior state. Once a port is calibrated the data is stored immediately and the only way to change it is to redo the calibration

step. The Back button allows the user to go back to a prior step to redo that calibration step.

Initial S/W Revision Prior to A.02.00

Next

Perform the Q-bar port calibration.

Key Path	Input/Output, I/Q, Q Setup, Q Probe, Calibrate
Remote Command	:CALibration:IQ:PROBe:QBar
Example	CAL:IQ:PROB:QB
Notes	The Q-bar port must be connected to the Cal Out port before issuing the SCPI command. The calibration data is saved as soon as the port is calibrated and will survive power cycles. It is not reset by any preset or restore data commands.
State Saved	No
Initial S/W Revision	Prior to A.02.00

Exit

Exit the calibration procedure. All ports calibrated before pressing Exit will use the newly acquired calibration data.

Key Path	Input/Output, I/Q, Q Setup, Q Probe, Calibrate
Notes	Using the Exit button will not restore the calibration data to the state prior to entering the guided calibration. Once a port is calibrated the data is stored immediately and the only way to change it is to redo the calibration step. When the calibration may be left in an inconsistent state, a confirmation dialog will be displayed (see " Exit Confirmation " on page 349).
Initial S/W Revision	Prior to A.02.00

Show Adapter Screen

When one of the Probe Calibration Show Adapter buttons is pressed, a diagram of the probe with its adapter will be shown. Depending on the type of probe attached, either the Passive Probe Adapter or the Active Probe Adapter diagram will be shown.

I/Q Probe Calibration Time (Remote Command Only)

Return the last date and time that the I/Q Probe Calibration was performed for a specific port. This is a remote query command only.

Remote Command	:CALibration:IQ:PROBe:I IBAR Q QBAR:TIME?
-----------------------	---

Example	:CAL:IQ:PROB:I:TIME?
Notes	This returns 6 integer values: year, month, day, hour, minute, second. When no calibration has been performed, all values will be 0. The value is specific to both the port and probe, so the value will change as probes are connected or disconnected.
Initial S/W Revision	A.02.00

Exit Confirmation

When Exit is pressed during one of the calibration routines, the calibration may be in an inconsistent state with some of the ports having newly measured calibration data and others with old data. If this is the case, a dialog box will appear to confirm that the user really wants to exit. A "Yes" answer will exit the calibration procedure, leaving potentially inconsistent calibration data in place. A "No" answer will return to the calibration procedure.

LISN Control

Enables you to access LISN related functions. LISN control is only available with option LSN indicating that the LISN IO board is installed. This is a remote query command only.

V-network (Remote Command Only)

Enables you to select the V-network that is controlled via the AUX IO port.

Remote Command	INPut [1] 2 : LISN [: TYPE] FOURphase ESH2Z5 ENV216 OFF INPut [1] 2 : LISN [: TYPE] ?
Example	:INP:LISN FOUR
Notes	FOURPhase and ESH2-Z5 R&S ESH2-Z5 (four phases and protective earth are controllable) ENV216 R&S ENV216 (two phases and highpass are controllable) OFF Remote control deactivated This query will return :- FOUR when ESH2-Z5 is selected.
Preset	Set to off on a "Restore Input/Output Defaults"
State Saved	Saved in instrument state
Initial S/W Revision	A.14.50

Phase (Remote Command Only)

This command enables you to select the phase of the V-network that is used, which is controlled via the AUX IO port. The permissible selection depends on the selected

V-network.

Remote Command	<code>INPut[1] 2:LISN:PHASe L1 L2 L3 N</code> <code>INPut[1] 2:LISN:PHASe?</code>
Example	<code>:INP:LISN:PHAS L1</code>
Couplings	L2, L3 keys are grayed out when ENV216 is selected. If the grayed out key is pressed, an advisory message is generated. If the equivalent SCPI command is sent, this same message is generated as part of a “-224, Illegal parameter value; must apply ESH2Z5 to make this phase available” warning.
Preset	Set to N on a "Restore Input/Output Defaults"
State Saved	Saved in instrument state
Range	Phase N Phase L1 Phase L2 Phase L3 Only one phase can be selected.
Initial S/W Revision	A.14.50

150 kHz Highpass (Remote Command Only)

Controls highpass setting on the V-network.

Remote Command	<code>INPut[1] 2:LISN:FILTer:HPAS[:STATe] ON OFF</code> <code>INPut[1] 2:LISN:FILTer:HPAS[:STATe]?</code>
Example	<code>:INP:LISN:FILT:HPAS ON</code>
Dependencies	Only available for ENV216 V-network . This key is grayed out when a V-network that is not ENV216 is selected. If the grayed out key is pressed, an advisory message is generated. If the equivalent SCPI command is sent, this same message is generated as part of a “-221, Settings conflicts; LISN function not available” warning.
Preset	Set to off on a "Restore Input/Output Defaults"
State Saved	Saved in instrument state
Range	ON OFF
Initial S/W Revision	A.14.50

Protective Earth (Remote Command Only)

Enables you to set the Protective Earth setting that is controlled via the AUX IO port.

Remote Command	<code>INPut[1] 2:LISN:PEARth GROunded FLOating</code> <code>INPut[1] 2:LISN:PEARth?</code>
Example	<code>:INP:LISN:PEAR GRO</code>
Dependencies	Only available for ESH2Z5. This key is grayed out when a v-network other than ESH2Z5 is selected. If the grayed out key is pressed, an advisory message is generated. If the equivalent SCPI command is sent, this same message is generated as part of a “-221, Settings conflict; LISN function not available” warning.

4 Input/Output Functions Input/Output

Preset	Set to GRO on a "Restore Input/Output Defaults"
State Saved	Saved in instrument state
Range	GRO FLO
Initial S/W Revision	A.14.50

5 Mode Functions

Mode

The Mode key allows you to select the available measurement applications or “Modes”. Modes are a collection of measurement capabilities packaged together to provide an instrument personality that is specific to your measurement needs. Each application software product is ordered separately by Model Number and must be licensed to be available. Once an instrument mode is selected, only the commands that are valid for that mode can be executed.

NOTE

Key operation can be different between modes. The information displayed in Help is about the current mode.

To access Help for a different Mode you must first exit Help (by pressing the Cancel (Esc) key). Then select the desired mode and re-access Help.

For more information on Modes, preloading Modes, and memory requirements for Modes,

see ["More Information" on page 355](#)

Key Path	Front-panel key
Remote Command	:INSTRument[:SElect] SA RTSA SEQAN EMI BASIC WCDMA EDGEgSM WIMAXOFDMA VSA PNOISE NFIGure ADEMOD BTooth TDSCDMA CDMA2K CDMA1XEV LTE LTETDD LTEAFDD LTEATDD MSR DVB DTMB DCTV ISDBT CMMB WLAN CWLAN CWIMAXOFDM WIMAXFIXED IDEN RLC SCPILC VSA89601 :INSTRument[:SElect]?
Example	:INST SA
Notes	The available parameters are dependent upon installed and licensed applications resident in the instrument. Parameters given here are an example, specific parameters are in the individual Application. A list of the valid mode choices is returned with the INST:CAT? Query.
Preset	This is unaffected by a Preset but is set on a “Restore System Defaults->All” to: For N9038A: EMI For N8973B, N8974B, N8975B, or N8976B: NFIG For all other models: SA
State Saved	Saved in instrument state
Backwards Compatibility SCPI	:INSTRument[:SElect] GSM provided for backwards compatibility. Mapped to EDGEgSM.
Backwards Compatibility SCPI	:INSTRument[:SElect] SANalyzer provided for ESU compatibility. When this command is received, the analyzer aliases it to the following: INST:SEL SCPI LC

	This results in the analyzer being placed in SCPI Language Compatibility Mode, in order to emulate the ESU Spectrum Analyzer Mode.
Backwards Compatibility SCPI	<p>:INSTrument[:SElect] RECeiver</p> <p>provided for ESU compatibility. When this command is received, the analyzer aliases it to the following:</p> <p>:INST:SEL EMI</p> <p>:CONF FSC</p> <p>This results in the analyzer being placed in the EMI Receiver Mode, running the Frequency Scan measurement, in order to emulate the ESU Receiver Mode.</p>
Initial S/W Revision	Prior to A.02.00
Modified at S/W Revision	A.13.00
Control Type	SCPI only
Remote Command	<p>:INSTrument:CONFigure:<mode>:<meas></p> <p>Where <mode> is a valid parameter for the INST:SEL command and <meas> is a valid parameter for the CONF command in the Mode specified by <mode></p>
Example	<p>:INST:CONF:SA:SAN selects the Spectrum Analyzer mode and the Swept SA measurement</p> <p>:INST:CONF:WCDMA:RHO selects the WCDMA mode and the Mod Accuracy measurement</p>
Notes	<p>The available parameters for <mode> are dependent upon installed and licensed applications resident in the instrument. The available parameters for <meas> are dependent on the <mode> parameter and the valid measurements available for that mode, which can depend on model numbers and installed options.</p> <p>In general this command will execute more quickly than sending the equivalent separate INST:SEL and :CONF commands.</p>
Initial S/W Revision	A.17.50
Example	:INST 'SA'
Notes	<p>NOTE The query is not a quoted string. It is an enumeration as indicated in the Instrument Select table above.</p> <p>The command must be sequential: i.e. continued parsing of commands cannot proceed until the instrument select is complete and the resultant SCPI trees are available.</p>
Backwards Compatibility SCPI	:INSTrument[:SElect] 'SA' 'PNOISE' 'EDGE' 'GSM' 'BASIC'
Initial S/W Revision	Prior to A.02.00

More Information

The Mode name appears on the banner after the word “Keysight” followed by the Measurement Title. For example, for the Spectrum Analyzer mode with the Swept SA measurement running:

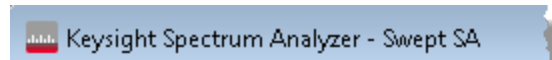

It is possible to specify the order in which the Modes appear in the Mode menu, using the Configure Applications utility (**System, Power On, Configure Applications**). It is also possible, using the same utility, to specify a subset of the available applications to load into memory at startup time, which can significantly decrease the startup time of the analyzer. During runtime, if an application that is not loaded into memory is selected (by either pressing that applications Mode key or sending that applications :INST:SEL command over SCPI), there will be a pause while the Application is loaded. During this pause a message box that says “Loading application, please wait...” is displayed.

Each application (Mode) that runs in the X-Series signal analyzers consumes virtual memory. The various applications consume varying amounts of virtual memory, and as more applications run, the memory consumption increases. Once an application is run, some of its memory remains allocated even when it is not running, and is not released until the analyzer program (xSA.exe) is shut down.

Keysight characterizes each Mode and assigns a memory usage quantity based on a conservative estimate. There is a limited amount of virtual memory available to applications (note that this is virtual memory and is independent of how much physical RAM is in the instrument). The instrument keeps track of how much memory is being used by all loaded applications – which includes those that preloaded at startup, and all of those that have been run since startup.

When you request a Mode that is not currently loaded, the instrument looks up the memory estimate for that Mode, and adds it to the residual total for all currently loaded Modes. If there is not enough virtual memory to load the Mode, a dialog box and menu will appear that gives you four options:

1. Close and restart the analyzer program without changing your configured preloads. This may free up enough memory to load the requested Mode, depending on your configured preloads
2. Clear out all preloads and close and restart the analyzer program with only the requested application preloaded, and with that application running. This choice is guaranteed to allow you to run the requested application; but you will lose your previously configured preloads. In addition, there may be little or no room for other applications, depending on the size of the requested application.
3. Bring up the Configure Applications utility in order to reconfigure the preloaded apps to make room for the applications you want to run (this will

then require restarting the analyzer program with your new configuration). This is the recommended choice because it gives you full flexibility to select exactly what you want.

4. Exit the dialog box without doing anything, which means you will be unable to load the application you requested.

In each case except 4, this will cause the analyzer software to close, and you will lose all unsaved traces and results.

If you attempt to load a mode via SCPI that will exceed memory capacity, the Mode does not load and an error message is returned:

-225, "Out of memory;Insufficient resources to load Mode (mode name)"

where "mode name" is the SCPI parameter for the Mode in question, for example, SA for Spectrum Analyzer Mode.

Spectrum Analyzer

Selects the Spectrum Analyzer mode for general purpose measurements. There are several measurements available in this mode. General spectrum analysis measurements, in swept and zero span, can be done using the first key in the Meas menu, labeled Swept SA. Other measurements in the Meas Menu are designed to perform specialized measurement tasks, including power and demod measurements.

If you are using the Help feature, this mode must be currently active to access its detailed information. If it is not active, exit the Help feature (Esc key), select the mode, and re-access Help.

Key Path	Mode
Example	INST:SEL SA INST:NSEL 1
Initial S/W Revision	Prior to A.02.00

EMI Receiver

The EMI Receiver Mode makes EMC measurements. Several measurements are provided to aid the user in characterizing EMC performance of their systems, including looking at signals with CISPR-16 compliant detectors, performing scans for interfering signals, and determining and charting interfering signals over time.

If you are using the Help feature, this mode must be currently active to access its detailed information. If it is not active, exit the Help feature (Esc key), select the mode, and re-access Help.

Key Path	Mode
Example	INST:SEL EMI INST:NSEL 141
Initial S/W Revision	A.07.01

IQ Analyzer (Basic)

The IQ Analyzer Mode makes general purpose frequency domain and time domain measurements. These measurements often use alternate hardware signal paths when compared with a similar measurement in the Signal Analysis Mode using the Swept SA measurement. These frequency domain and time domain measurements can be used to output I/Q data results when measuring complex modulated digital signals.

If you are using the Help feature, this mode must be currently active to access its detailed information. If it is not active, exit the Help feature (Esc key), select the mode, and re-access Help.

Key Path	Mode
Example	INST:SEL BASIC INST:NSEL 8
Initial S/W Revision	Prior to A.02.00

W-CDMA with HSPA+

Selects the W-CDMA with HSPA+ mode for general purpose measurements of signals following this standard. There are several measurements available in this mode.

If you are using the Help feature, this mode must be currently active to access its detailed information. If it is not active, exit the Help feature (Esc key), select the mode, and re-access Help.

Key Path	Mode
Example	INST:SEL WCDMA INST:NSEL 9
Initial S/W Revision	Prior to A.02.00

GSM/EDGE/EDGE Evo

Selects the GSM with EDGE mode for general purpose measurements of signals following this standard. There are several measurements available in this mode.

If you are using the Help feature, this mode must be currently active to access its detailed information. If it is not active, exit the Help feature (Esc key), select the mode, and re-access Help.

Key Path	Mode
Example	INST:SEL EDGE GSM INST:NSEL 13
Initial S/W Revision	Prior to A.02.00
Modified at S/W Revision	A.02.00

802.16 OFDMA (WiMAX/WiBro)

Selects the OFDMA mode for general purpose measurements of WiMAX signals. There are several measurements available in this mode.

If you are using the Help feature, this mode must be currently active to access its detailed information. If it is not active, exit the Help feature (Esc key), select the mode, and re-access Help.

Key Path	Mode
Example	INST:SEL WIMAX OFDMA INST:NSEL 75
Initial S/W Revision	Prior to A.02.00

Vector Signal Analyzer (VXA)

The N9064A (formerly 89601X) VXA Vector signal and WLAN modulation analysis application provides solutions for basic vector signal analysis, analog demodulation, and digital demodulation. The digital demodulation portion of N9064A allows you to perform measurements on standard-based formats such as cellular, wireless networking and digital video as well as general purpose flexible modulation analysis for wide range of digital formats, FSK to 1024QAM, with easy-to-use measurements and display tools such as constellation and eye diagram, EVM traces and up to four simultaneous displays. Analog baseband analysis is available using the MXA and PXA with option BBA. Option 3FP WLAN has been discontinued.

N9064A honors existing 89601X licenses with all features and functionalities found on X-Series software versions prior to A.06.00. Specifically:

N9064A-1 is equivalent to 89601X-205

N9064A-2 is equivalent to 89601X-AYA

If you are using the Help feature, this mode must be currently active to access its detailed information. If it is not active, exit the Help feature (Esc key), select the mode, and re-access Help.

Key Path	Mode
Example	INST:SEL VSA INST:NSEL 100
Initial S/W Revision	Prior to A.02.00

Phase Noise

The Phase Noise mode provides pre-configured measurements for making general purpose measurements of device phase noise.

If you are using the Help feature, this mode must be currently active to access its detailed information. If it is not active, exit the Help feature (Esc key), select the mode, and re-access Help.

Key Path	Mode
Example	INST:SEL PNOISE or INST:NSEL 14
Initial S/W Revision	Prior to A.02.00

Noise Figure

The Noise Figure mode provides pre-configured measurements for making general purpose measurements of device noise figure.

If you are using the Help feature, this mode must be currently active to access its detailed information. If it is not active, exit the Help feature (Esc key), select the mode, and re-access Help.

Key Path	Mode
Example	INST:SEL NFIGURE INST:NSEL 219
Initial S/W Revision	Prior to A.02.00

Analog Demod

Selects the Analog Demod mode for making measurements of AM, FM and phase modulated signals.

If you are using the Help feature, this mode must be currently active to access its detailed information. If it is not active, exit the Help feature (Esc key), select the mode, and re-access Help.

Key Path	Mode
Example	INST:SEL ADEMOD INST:NSEL 234
Initial S/W Revision	Prior to A.02.00

Real Time Spectrum Analyzer

The Real Time Spectrum Analyzer (RTSA) mode provides real-time signal analysis, very high probability-of-intercept for intermittent signals with appropriate triggers.

If you are using the Help feature, this mode must be currently active to access its detailed information. If it is not active, exit the Help feature (Esc key), select the mode, and re-access Help.

Key Path	Mode
Example	INST:SEL RTSA or INST:NSEL 2
Initial S/W Revision	A.13.00

TD-SCDMA with HSPA/8PSK

Selects the TD-SCDMA mode for general purpose measurements of signals following this standard. There are several measurements available in this mode.

If you are using the Help feature, this mode must be currently active to access its detailed information. If it is not active, exit the Help feature (Esc key), select the mode, and re-access Help.

Key Path	Mode
Example	INST:SEL TDSCDMA INST:NSEL 211
Initial S/W Revision	Prior to A.02.00

cdma2000

Selects the cdma2000 mode for general purpose measurements of signals following this standard. There are several measurements available in this mode.

If you are using the Help feature, this mode must be currently active to access its detailed information. If it is not active, exit the Help feature (Esc key), select the mode, and re-access Help.

Key Path	Mode
Example	INST:SEL CDMA2K INST:NSEL 10
Initial S/W Revision	Prior to A.02.00

1xEV-DO

Selects the 1xEV-DO mode for general purpose measurements of signals following this standard. There are several measurements available in this mode.

If you are using the Help feature, this mode must be currently active to access its detailed information. If it is not active, exit the Help feature (Esc key), select the mode, and re-access Help.

Key Path	Mode
Example	INST:SEL CDMA1XEV INST:NSEL 15
Initial S/W Revision	Prior to A.02.00

LTE

Selects the LTE mode for general purpose measurements of signals following the LTE FDD standard. There are several measurements available in this mode.

If you are using the Help feature, this mode must be currently active to access its detailed information. If it is not active, exit the Help feature (Esc key), select the mode, and re-access Help.

Key Path	Mode
Example	INST:SEL LTE INST:NSEL 102
Initial S/W Revision	Prior to A.02.00

LTE TDD

Selects the LTE TDD mode for general purpose measurements of signals following the LTE TDD standard. There are several measurements available in this mode.

If you are using the Help feature, this mode must be currently active to access its detailed information. If it is not active, exit the Help feature (Esc key), select the mode, and re-access Help.

Key Path	Mode
Example	INST:SEL LTETDD INST:NSEL 105
Initial S/W Revision	A.03.00

LTE-Advanced FDD

As LTE-Advanced FDD and LTE modes are converged into one single application, the single softkey under Mode menu is designed to select the converged mode. The display mode of the LTE and LTE-Advanced FDD are distinguished by the licenses.

If you are using the Help feature, this mode must be currently active to access its detailed information. If it is not active, exit the Help feature (Esc key), select the mode, and re-access Help.

Key Path	Mode
Example	INST:SEL LTEAFDD INST:NSEL 107
Notes	When the N9080A/80B-1FP exists, the display mode name is LTE. When the N9080A/80B-1FP and N9080B-2FP all exist, the display mode name is LTE FDD & LTE-A FDD.
Backwards Compatibility SCPI	INST:SEL LTE INST:NSEL 102
Initial S/W Revision	A.14.00
Modified at S/W Revision	A.14.50

LTE-Advanced TDD

As LTE-Advanced TDD and LTE TDD modes are converged into one single application, the single softkey under Mode menu is designed to select the converged mode. The display mode of the LTE TDD and LTE-Advanced TDD are distinguished by the licenses.

If you are using the Help feature, this mode must be currently active to access its detailed information. If it is not active, exit the Help feature (Esc key), select the mode, and re-access Help.

Key Path	Mode
Example	INST:SEL LTEATDD INST:NSEL 108
Notes	When the N9082A/82B-1FP exists, the display mode name is LTE TDD.

	When the N9082A/82B-1FP and N9082B-2FP all exist, the display mode name is LTE TDD & LTE-A TDD.
Backwards Compatibility SCPI	INST:SEL LTETDD INST:NSEL 105
Initial S/W Revision	A.14.00
Modified at S/W Revision	A.14.50

DVB-T/H with T2

Selects the DVB-T/H mode for measurements of digital video signals using this format. There are several power and demod measurements available in this mode.

If you are using the Help feature, this mode must be currently active to access its detailed information. If it is not active, exit the Help feature (Esc key), select the mode, and re-access Help.

Key Path	Mode
Example	INST:SEL DVB INST:NSEL 235
Initial S/W Revision	A.02.00
Modified at S/W Revision	A.07.00

DTMB (CTTB)

Selects the DTMB (CTTB) mode for measurements of digital video signals using this format. There are several power and demod measurements available in this mode.

If you are using the Help feature, this mode must be currently active to access its detailed information. If it is not active, exit the Help feature (Esc key), select the mode, and re-access Help.

Key Path	Mode
Example	INST:SEL DTMB INST:NSEL 236
Initial S/W Revision	A.02.00

ISDB-T

Selects the ISDB-T mode for measurements of digital video signals using this format. There are several power and demod measurements available in this mode.

If you are using the Help feature, this mode must be currently active to access its detailed information. If it is not active, exit the Help feature (Esc key), select the mode, and re-access Help.

Key Path	Mode
Example	INST:SEL ISDBT INST:NSEL 239
Initial S/W Revision	A.03.00

CMMB

Selects the CMMB mode for measurements of digital video signals using this format. There are several power and demod measurements available in this mode.

If you are using the Help feature, this mode must be currently active to access its detailed information. If it is not active, exit the Help feature (Esc key), select the mode, and re-access Help.

Key Path	Mode
Example	INST:SEL CMMB INST:NSEL 240
Initial S/W Revision	A.03.00

Combined WLAN

Selects the CWLAN mode for general purpose measurements of signals following this standard. There are several measurements available in this mode.

If you are using the Help feature, this mode must be currently active to access its detailed information. If it is not active, exit the Help feature (Esc key), select the mode, and re-access Help.

Key Path	Mode
Example	INST:SEL CWLAN INST:NSEL 19
Initial S/W Revision	A.02.00

Combined Fixed WiMAX

Selects the Combined Fixed WiMAX mode for general purpose measurements of signals following this standard. There are several measurements available in this mode.

If you are using the Help feature, this mode must be currently active to access its detailed information. If it is not active, exit the Help feature (Esc key), select the mode, and re-access Help.

Key Path	Mode
Example	INST:SEL CWIMAXOFDM INST:NSEL 81
Initial S/W Revision	A.02.00

802.16 OFDM (Fixed WiMAX)

Selects the 802.16 OFDM (Fixed WiMAX) mode. This mode allows modulation quality measurements of signals that comply with IEEE 802.16a-2003 and IEEE 802.16-2004 standards, with flexibility to measure nonstandard OFDM formats. Along with the typical digital demodulation measurement results, several additional 802.16 OFDM unique trace data formats and numeric error data results provide enhanced data analysis.

If you are using the Help feature, this mode must be currently active to access its detailed information. If it is not active, exit the Help feature (Esc key), select the mode, and re-access Help.

Key Path	Mode
Example	INST:SEL WIMAXFIXED INST:NSEL 104
Initial S/W Revision	A.02.00

iDEN/WiDEN/MOTOTalk

Selects the iDEN/WiDEN/MOTOTalk mode for general purpose measurements of iDEN and iDEN-related signals. There are several measurements available in this mode.

If you are using the Help feature, this mode must be currently active to access its detailed information. If it is not active, exit the Help feature (Esc key), select the mode, and re-access Help.

Key Path	Mode
Example	INST:SEL IDEN INST:NSEL 103
Initial S/W Revision	A.02.00

Remote Language Compatibility

The Remote Language Compatibility (RLC) mode provides remote command backwards compatibility for the 8560 series of spectrum analyzers, known as legacy spectrum analyzers.

NOTE

After changing into or out of this mode, allow a 1 second delay before sending any subsequent commands.

If you are using the Help feature, this mode must be currently active to access its detailed information. If it is not active, exit the Help feature (Esc key), select the mode, and re-access Help.

Key Path	Mode
Example	INST:SEL RLC Or INST:NSEL 266
Initial S/W Revision	Prior to A.02.00

89601 VSA

Selecting the 89601 VSA mode will start the 89600 VSA software. The 89600 VSA software is powerful, PC-based software, offering the industry's most sophisticated general purpose and standards specific signal evaluation and troubleshooting tools for R&D engineers. Even for proprietary and non-standard signals in SATCOM or MILCOM applications, you can make signal quality measurements with customized IQ constellation. Reach deeper into signals, gather more data on signal problems, and gain greater insight.

- Over 35 general-purpose analog and digital demodulators ranging from 2FSK to 4096QAM
- Flexible and custom IQ and OFDM signal analysis for single carrier
- Standards specific modulation analysis including:
 - Cellular: GSM/EDGE, cdma2000, W-CDMA, TD-SCDMA, LTE (FDD/TDD),
 - LTE-Advanced and more
 - Wireless networking: 802.11a/b/g, 802.11n, 802.ac, 802.16 WiMAX (fixed/mobile), WiSUN (MR-FSK PHY)
 - RFID
 - Digital satellite video and other satellite signals, radar, LMDS

- Up to 400K bin FFT, for the highest resolution spectrum analysis
- A full suite of time domain analysis tools, including signal capture and playback, time gating, and CCDF measurements
- 20 simultaneous trace displays and the industry's most complete set of marker functions
- Easy-to-use Microsoft Windows graphical user interface

For more information see the Keysight 89600 Series VSA web site at www.keysight.com/find/89600vsa

To learn more about how to use the 89600 VSA running in the X-Series, after the 89600 VSA software is running, open the 89600 VSA Help and open the "About Keysight X-Series Signal Analyzer with 89600 VSA Software" help topic.

Key Path	Mode
Example	INST:SEL VSA89601 INST:NSEL 101
Initial S/W Revision	Prior to A.02.00

Bluetooth

Selects the Bluetooth mode for Bluetooth specific measurements. There are several measurements available in this mode.

If you are using the Help feature, this mode must be currently active to access its detailed information. If it is not active, exit the Help feature (Esc key), select the mode, and re-access Help.

Key Path	Mode
Example	INST:SEL BT INST:NSEL 228
Initial S/W Revision	A.06.01

SCPI Language Compatibility

The SCPI Language Compatibility mode provides remote language compatibility for SCPI-based instruments, such as the Rohde and Schwartz FSP and related series of spectrum analyzers.

NOTE

After changing into or out of this mode, allow a 1 second delay before sending any subsequent commands.

If you are using the Help feature, this mode must be currently active to access its detailed information. If it is not active, exit the Help feature (Esc key), select the mode, and re-access Help.

Key Path	Mode
Example	INST:SEL SCPILC Or INST:NSEL 270
Initial S/W Revision	A.06.00

Digital Cable TV

Selects the Digital Cable TV mode for measurements of digital cable television systems. There are several power and demod measurements available in this mode.

If you are using the Help feature, this mode must be currently active to access its detailed information. If it is not active, exit the Help feature (Esc key), select the mode, and re-access Help.

Key Path	Mode
Example	INST:SEL DCTV INST:NSEL 238
Initial S/W Revision	A.07.00

MSR

Selects the MSR mode. The MSR mode makes several measurements for Cellular Communication devices that can be configured with multiple radio formats simultaneously following the 3GPP standard of Multi-Standard Radio, including GSM/EDGE, WCDMA/HSPA+ and LTE.

If you are using the Help feature, this mode must be currently active to access its detailed information. If it is not active, exit the Help feature (Esc key), select the mode, and re-access Help.

Key Path	Mode
Example	INST:SEL MSR INST:NSEL 106
Initial S/W Revision	A.09.491

WLAN

Selects the WLAN mode for general purpose measurements of signals following this standard. There are several measurements available in this mode.

If you are using the Help feature, this mode must be currently active to access its detailed information. If it is not active, exit the Help feature (Esc key), select the mode, and re-access Help.

Key Path	Mode
Example	INST:SEL WLAN INST:NSEL 217
Initial S/W Revision	A.09.491

Application Mode Number Selection (Remote Command Only)

Select the measurement mode by its mode number. The actual available choices depend upon which applications are installed in your instrument. The modes appear in this table in the same order they appear in the Mode menu (if the order is not changed by the Configure Applications utility found in the **System, Power On** menu). See "[Detailed List of Modes](#)" on page 374 for Mode details.

The Mode Number is the parameter for use with the :INSTrument:NSElect command. The Mode Parameter is the parameter for use with the :INSTrument[:SElect] command.

Mode	Mode Number	Mode Parameter
Spectrum Analyzer	1	SA
Real Time Spectrum Analyzer	2	RTSA
Sequence Analyzer	123	SEQAN
EMI Receiver	141	EMI
I/Q Analyzer (Basic)	8	BASIC
WCDMA with HSPA+	9	WCDMA
GSM/EDGE/EDGE Evo	13	EDGE GSM
802.16 OFDMA (WiMAX/WiBro)	75	WIMAX OFDMA
Vector Signal Analyzer (VXA)	100	VSA
Phase Noise	14	PNOISE
Noise Figure	219	NFIGure
Analog Demod	234	ADEMOD
Bluetooth	228	BTtooth
TD-SCDMA with HSPA/8PSK	211	TDSCDMA

Mode	Mode Number	Mode Parameter
cdma2000	10	CDMA2K
1xEV-DO	15	CDMA1XEV
LTE	102	LTE
LTE TDD	105	LTETDD
LTE-Advanced FDD	107	LTEAFDD
LTE-Advanced TDD	108	LTEATDD
MSR	106	MSR
DVB-T/H with T2	235	DVB
DTMB (CTTB)	236	DTMB
Digital Cable TV	238	DCTV
ISDB-T	239	ISDBT
CMMB	240	CMMB
WLAN	217	WLAN
Combined WLAN	19	CWLAN
Combined Fixed WiMAX	81	CWIMAXOFDM
802.16 OFDM (Fixed WiMAX)	104	WIMAXFIXED
iDEN/WiDEN/MotoTalk	103	IDEN
Remote Language Compatibility	266	RLC
SCPI Language Compatibility	270	SCPILC
89601 VSA	101	VSA89601
Electronic Toll Collection	61	ETC

Remote Command	:INSTRument:NSElect <integer> :INSTRument:NSElect?
Example	:INST:NSEL 1
Notes	SA mode is 1 The command must be sequential: i.e. continued parsing of commands cannot proceed until the instrument select is complete and the resultant SCPI trees are available.
Preset	Not affected by Preset. Set to default mode (1 for SA mode) following Restore System Defaults.
State Saved	Saved in instrument state
Initial S/W Revision	Prior to A.02.00

Application Mode Catalog Query (Remote Command Only)

Returns a string containing a comma separated list of names of all the installed and licensed measurement modes (applications). These names can only be used with the :INSTrument[:SElect] command.

Remote Command	:INSTrument:CATalog?
Example	:INST:CAT?
Notes	Query returns a quoted string of the installed and licensed modes separated with a comma. Example: "SA,PNOISE,WCDMA"
Backward Compatibility Notes	VSA (E4406A) :INSTrument:CATalog? returned a list of installed INSTrument:SELECT items as a comma separated list of string values: "BASIC","GSM","EDGEgSM","CDMA","NADC","PDC","WCDMA","CDMA2K","CDMA1XEV","IDEN","WIDEN","WLAN","SERVICE" X-Series uses the ESA/PSA compatible query of a string contain comma separated values: "SA,PNOISE,NFIGURE,BASIC,CDMA,CDMA2K,WCDMA,CDMA1XEV,EDGEgSM,GSM,NADC,PDC,TDSCDMA,DMODULATION,WLAN"
Initial S/W Revision	Prior to A.02.00

Application Identification (Remote Commands Only)

Each entry in the Mode Menu will have a Model Number and associated information: Version, and Options.

This information is displayed in the Show System screen. The corresponding SCPI remote commands are defined here.

["Current Application Model " on page 371](#)

["Current Application Revision" on page 372](#)

["Current Application Options" on page 372](#)

Current Application Model

Returns a string that is the Model Number of the currently selected application (mode).

Remote Command	:SYSTem:APPLication[:CURRent][[:NAME]]?
Example	:SYST:APPL?
Notes	Query returns a quoted string that is the Model Number of the currently selected application (Mode). Example: "N9060A" String length is 6 characters.

Preset	Not affected by Preset
State Saved	Not saved in state, the value will be the selected application when a Save is done.
Initial S/W Revision	Prior to A.02.00

Current Application Revision

Returns a string that is the Revision of the currently selected application (mode).

Remote Command	:SYSTem:APPLication[:CURRent]:REVision?
Example	:SYST:APPL:REV?
Notes	Query returns a quoted string that is the Revision of the currently selected application (Mode). Example: "1.0.0.0" String length is a maximum of 23 characters. (each numeral can be an integer + 3 decimal points)
Preset	Not affected by a Preset
State Saved	Not saved in state, the value will be the selected application when a Save is done.
Initial S/W Revision	Prior to A.02.00

Current Application Options

Returns a string that is the Options list of the currently selected application (Mode).

Remote Command	:SYSTem:APPLication[:CURRent]:OPTion?
Example	:SYST:APPL:OPT?
Notes	Query returns a quoted string that is the Option list of the currently selected application (Mode). The format is the name as the *OPT? or SYSTem:OPTion command: a comma separated list of option identifiers. Example: "1FP,2FP" String length is a maximum of 255 characters.
Preset	Not affected by a Preset
State Saved	Not saved in state per se, the value will be the selected application when a Save is invoked.
Initial S/W Revision	Prior to A.02.00

Application Identification Catalog (Remote Commands Only)

A catalog of the installed and licensed applications (Modes) can be queried for their identification.

"Application Catalog Number of Entries" on page 373

["Application Catalog Model Numbers" on page 373](#)

["Application Catalog Revision" on page 373](#)

["Application Catalog Options" on page 374](#)

Application Catalog Number of Entries

Returns the number of installed and licensed applications (Modes).

Remote Command	<code>:SYSTem:APPLication:CATalog[:NAME]:COUNT?</code>
Example	<code>:SYST:APPL:CAT:COUNT?</code>
Preset	Not affected by Preset
State Saved	Not saved in instrument state.
Initial S/W Revision	Prior to A.02.00

Application Catalog Model Numbers

Returns a list of Model Numbers for the installed and licensed applications (Modes).

Remote Command	<code>:SYSTem:APPLication:CATalog[:NAME]?</code>
Example	<code>:SYST:APPL:CAT?</code>
Notes	Returned value is a quoted string of a comma separated list of Model Numbers. Example, if SAMS and Phase Noise are installed and licensed: "N9060A,N9068A" String length is $COUNT * 7 - 1$. (7 = Model Number length + 1 for comma. -1 = no comma for the 1st entry.)
Preset	Not affected by a Preset
State Saved	Not saved in instrument state.
Initial S/W Revision	Prior to A.02.00

Application Catalog Revision

Returns the Revision of the provided Model Number.

Remote Command	<code>:SYSTem:APPLication:CATalog:REVision? <model></code>
Example	<code>:SYST:APPL:CAT:REV? 'N9060A'</code>
Notes	Returned value is a quoted string of revision for the provided Model Number. The revision will be a null-string ("") if the provided Model Number is not installed and licensed. Example, if SAMS is installed and licensed: "1.0.0.0"
Preset	Not affected by a Preset.
State Saved	Not saved in instrument state.
Initial S/W Revision	Prior to A.02.00

Application Catalog Options

Returns a list of Options for the provided Model Number

Remote Command	:SYSTem:APPLication:CATalog:OPTion? <model>
Example	:SYST:APPL:CAT:OPT? 'N9060A'
Notes	Returned value is a quoted string of a comma separated list of Options, in the same format as *OPT? or :SYSTem:OPTion?. If the provided Model Number is not installed and licensed a null-string ("") will be returned. Example, if SAMS is installed and licensed: "2FP" String length is a maximum of 255 characters.
Preset	Not affected by a Preset
State Saved	Not saved in instrument state.
Initial S/W Revision	Prior to A.02.00

Detailed List of Modes

This section contains an alphabetical list of Modes available in the X-Series, along with a brief description of each Mode.

Note that with the exception of the 89601 VSA, only licensed applications appear in the Mode menu. The 89601 will always appear, because it's licensing is handled differently.

1xEV-DO

Selects the 1xEV-DO mode for general purpose measurements of signals following this standard. There are several measurements available in this mode.

If you are using the Help feature, this mode must be currently active to access its detailed information. If it is not active, exit the Help feature (Esc key), select the mode, and re-access Help.

Key Path	Mode
Example	INST:SEL CDMA1XEV INST:NSEL 15
Initial S/W Revision	Prior to A.02.00

802.16 OFDMA (WiMAX/WiBro)

Selects the OFDMA mode for general purpose measurements of WiMAX signals. There are several measurements available in this mode.

If you are using the Help feature, this mode must be currently active to access its detailed information. If it is not active, exit the Help feature (Esc key), select the mode, and re-access Help.

Key Path	Mode
Example	INST:SEL WIMAXOFDMA INST:NSEL 75
Initial S/W Revision	Prior to A.02.00

802.16 OFDM (Fixed WiMAX)

Selects the 802.16 OFDM (Fixed WiMAX) mode. This mode allows modulation quality measurements of signals that comply with IEEE 802.16a-2003 and IEEE 802.16-2004 standards, with flexibility to measure nonstandard OFDM formats. Along with the typical digital demodulation measurement results, several additional 802.16 OFDM unique trace data formats and numeric error data results provide enhanced data analysis.

If you are using the Help feature, this mode must be currently active to access its detailed information. If it is not active, exit the Help feature (Esc key), select the mode, and re-access Help.

Key Path	Mode
Example	INST:SEL WIMAXFIXED INST:NSEL 104
Initial S/W Revision	A.02.00

89601 VSA

Selecting the 89601 VSA mode will start the 89600 VSA software. The 89600 VSA software is powerful, PC-based software, offering the industry's most sophisticated general purpose and standards specific signal evaluation and troubleshooting tools for R&D engineers. Even for proprietary and non-standard signals in SATCOM or MILCOM applications, you can make signal quality measurements with customized IQ constellation. Reach deeper into signals, gather more data on signal problems, and gain greater insight.

- Over 35 general-purpose analog and digital demodulators ranging from 2FSK to 4096QAM
- Flexible and custom IQ and OFDM signal analysis for single carrier
- Standards specific modulation analysis including:
 - Cellular: GSM/EDGE, cdma2000, W-CDMA, TD-SCDMA, LTE (FDD/TDD),

- LTE-Advanced and more
- Wireless networking: 802.11a/b/g, 802.11n, 802.ac, 802.16 WiMAX (fixed/mobile), WiSUN (MR-FSK PHY)
- RFID
- Digital satellite video and other satellite signals, radar, LMDS
- Up to 400K bin FFT, for the highest resolution spectrum analysis
- A full suite of time domain analysis tools, including signal capture and playback, time gating, and CCDF measurements
- 20 simultaneous trace displays and the industry's most complete set of marker functions
- Easy-to-use Microsoft Windows graphical user interface

For more information see the Keysight 89600 Series VSA web site at www.keysight.com/find/89600vsa

To learn more about how to use the 89600 VSA running in the X-Series, after the 89600 VSA software is running, open the 89600 VSA Help and open the "About Keysight X-Series Signal Analyzer with 89600 VSA Software" help topic.

Key Path	Mode
Example	INST:SEL VSA89601 INST:NSEL 101
Initial S/W Revision	Prior to A.02.00

Analog Demod

Selects the Analog Demod mode for making measurements of AM, FM and phase modulated signals.

If you are using the Help feature, this mode must be currently active to access its detailed information. If it is not active, exit the Help feature (Esc key), select the mode, and re-access Help.

Key Path	Mode
Example	INST:SEL ADEMODO INST:NSEL 234
Initial S/W Revision	Prior to A.02.00

Bluetooth

Selects the Bluetooth mode for Bluetooth specific measurements. There are several measurements available in this mode.

If you are using the Help feature, this mode must be currently active to access its detailed information. If it is not active, exit the Help feature (Esc key), select the mode, and re-access Help.

Key Path	Mode
Example	INST:SEL BT INST:NSEL 228
Initial S/W Revision	A.06.01

cdma2000

Selects the cdma2000 mode for general purpose measurements of signals following this standard. There are several measurements available in this mode.

If you are using the Help feature, this mode must be currently active to access its detailed information. If it is not active, exit the Help feature (Esc key), select the mode, and re-access Help.

Key Path	Mode
Example	INST:SEL CDMA2K INST:NSEL 10
Initial S/W Revision	Prior to A.02.00

CMMB

Selects the CMMB mode for measurements of digital video signals using this format. There are several power and demod measurements available in this mode.

If you are using the Help feature, this mode must be currently active to access its detailed information. If it is not active, exit the Help feature (Esc key), select the mode, and re-access Help.

Key Path	Mode
Example	INST:SEL CMMB INST:NSEL 240
Initial S/W Revision	A.03.00

Combined WLAN

Selects the CWLAN mode for general purpose measurements of signals following this standard. There are several measurements available in this mode.

If you are using the Help feature, this mode must be currently active to access its detailed information. If it is not active, exit the Help feature (Esc key), select the mode, and re-access Help.

Key Path	Mode
Example	INST:SEL CWLAN INST:NSEL 19
Initial S/W Revision	A.02.00

Combined Fixed WiMAX

Selects the Combined Fixed WiMAX mode for general purpose measurements of signals following this standard. There are several measurements available in this mode.

If you are using the Help feature, this mode must be currently active to access its detailed information. If it is not active, exit the Help feature (Esc key), select the mode, and re-access Help.

Key Path	Mode
Example	INST:SEL CWIMAXOFDM INST:NSEL 81
Initial S/W Revision	A.02.00

Digital Cable TV

Selects the Digital Cable TV mode for measurements of digital cable television systems. There are several power and demod measurements available in this mode.

If you are using the Help feature, this mode must be currently active to access its detailed information. If it is not active, exit the Help feature (Esc key), select the mode, and re-access Help.

Key Path	Mode
Example	INST:SEL DCTV INST:NSEL 238
Initial S/W Revision	A.07.00

DTMB (CTTB)

Selects the DTMB (CTTB) mode for measurements of digital video signals using this format. There are several power and demod measurements available in this mode.

If you are using the Help feature, this mode must be currently active to access its detailed information. If it is not active, exit the Help feature (Esc key), select the mode, and re-access Help.

Key Path	Mode
Example	INST:SEL DTMB INST:NSEL 236
Initial S/W Revision	A.02.00

DVB-T/H with T2

Selects the DVB-T/H mode for measurements of digital video signals using this format. There are several power and demod measurements available in this mode.

If you are using the Help feature, this mode must be currently active to access its detailed information. If it is not active, exit the Help feature (Esc key), select the mode, and re-access Help.

Key Path	Mode
Example	INST:SEL DVB INST:NSEL 235
Initial S/W Revision	A.02.00
Modified at S/W Revision	A.07.00

EMI Receiver

The EMI Receiver Mode makes EMC measurements. Several measurements are provided to aid the user in characterizing EMC performance of their systems, including looking at signals with CISPR-16 compliant detectors, performing scans for interfering signals, and determining and charting interfering signals over time.

If you are using the Help feature, this mode must be currently active to access its detailed information. If it is not active, exit the Help feature (Esc key), select the mode, and re-access Help.

Key Path	Mode
Example	INST:SEL EMI INST:NSEL 141
Initial S/W Revision	A.07.01

GSM/EDGE/EDGE Evo

Selects the GSM with EDGE mode for general purpose measurements of signals following this standard. There are several measurements available in this mode.

If you are using the Help feature, this mode must be currently active to access its detailed information. If it is not active, exit the Help feature (Esc key), select the mode, and re-access Help.

Key Path	Mode
Example	INST:SEL EDGEGSM INST:NSEL 13
Initial S/W Revision	Prior to A.02.00
Modified at S/W Revision	A.02.00

iDEN/WiDEN/MOTOTalk

Selects the iDEN/WiDEN/MOTOTalk mode for general purpose measurements of iDEN and iDEN-related signals. There are several measurements available in this mode.

If you are using the Help feature, this mode must be currently active to access its detailed information. If it is not active, exit the Help feature (Esc key), select the mode, and re-access Help.

Key Path	Mode
Example	INST:SEL IDEN INST:NSEL 103
Initial S/W Revision	A.02.00

IQ Analyzer (Basic)

The IQ Analyzer Mode makes general purpose frequency domain and time domain measurements. These measurements often use alternate hardware signal paths when compared with a similar measurement in the Signal Analysis Mode using the Swept SA measurement. These frequency domain and time domain measurements can be used to output I/Q data results when measuring complex modulated digital signals.

If you are using the Help feature, this mode must be currently active to access its detailed information. If it is not active, exit the Help feature (Esc key), select the mode, and re-access Help.

Key Path	Mode
Example	INST:SEL BASIC

	INST:NSEL 8
Initial S/W Revision	Prior to A.02.00

ISDB-T

Selects the ISDB-T mode for measurements of digital video signals using this format. There are several power and demod measurements available in this mode.

If you are using the Help feature, this mode must be currently active to access its detailed information. If it is not active, exit the Help feature (Esc key), select the mode, and re-access Help.

Key Path	Mode
Example	INST:SEL ISDBT INST:NSEL 239
Initial S/W Revision	A.03.00

LTE

Selects the LTE mode for general purpose measurements of signals following the LTE FDD standard. There are several measurements available in this mode.

If you are using the Help feature, this mode must be currently active to access its detailed information. If it is not active, exit the Help feature (Esc key), select the mode, and re-access Help.

Key Path	Mode
Example	INST:SEL LTE INST:NSEL 102
Initial S/W Revision	Prior to A.02.00

LTE TDD

Selects the LTE TDD mode for general purpose measurements of signals following the LTE TDD standard. There are several measurements available in this mode.

If you are using the Help feature, this mode must be currently active to access its detailed information. If it is not active, exit the Help feature (Esc key), select the mode, and re-access Help.

Key Path	Mode
Example	INST:SEL LTETDD INST:NSEL 105
Initial S/W Revision	A.03.00

MSR

Selects the MSR mode. The MSR mode makes several measurements for Cellular Communication devices that can be configured with multiple radio formats simultaneously following the 3GPP standard of Multi-Standard Radio, including GSM/EDGE, WCDMA/HSPA+ and LTE.

If you are using the Help feature, this mode must be currently active to access its detailed information. If it is not active, exit the Help feature (Esc key), select the mode, and re-access Help.

Key Path	Mode
Example	INST:SEL MSR INST:NSEL 106
Initial S/W Revision	A.09.491

Noise Figure

The Noise Figure mode provides pre-configured measurements for making general purpose measurements of device noise figure.

If you are using the Help feature, this mode must be currently active to access its detailed information. If it is not active, exit the Help feature (Esc key), select the mode, and re-access Help.

Key Path	Mode
Example	INST:SEL NFIGURE INST:NSEL 219
Initial S/W Revision	Prior to A.02.00

Phase Noise

The Phase Noise mode provides pre-configured measurements for making general purpose measurements of device phase noise.

If you are using the Help feature, this mode must be currently active to access its detailed information. If it is not active, exit the Help feature (Esc key), select the mode, and re-access Help.

Key Path	Mode
Example	INST:SEL PNOISE or INST:NSEL 14
Initial S/W Revision	Prior to A.02.00

Remote Language Compatibility

The Remote Language Compatibility (RLC) mode provides remote command backwards compatibility for the 8560 series of spectrum analyzers, known as legacy spectrum analyzers.

NOTE

After changing into or out of this mode, allow a 1 second delay before sending any subsequent commands.

If you are using the Help feature, this mode must be currently active to access its detailed information. If it is not active, exit the Help feature (Esc key), select the mode, and re-access Help.

Key Path	Mode
Example	INST:SEL RLC Or INST:NSEL 266
Initial S/W Revision	Prior to A.02.00

SCPI Language Compatibility

The SCPI Language Compatibility mode provides remote language compatibility for SCPI-based instruments, such as the Rohde and Schwartz FSP and related series of spectrum analyzers.

NOTE

After changing into or out of this mode, allow a 1 second delay before sending any subsequent commands.

If you are using the Help feature, this mode must be currently active to access its detailed information. If it is not active, exit the Help feature (Esc key), select the mode, and re-access Help.

Key Path	Mode
Example	INST:SEL SCPILC Or INST:NSEL 270
Initial S/W Revision	A.06.00

Spectrum Analyzer

Selects the Spectrum Analyzer mode for general purpose measurements. There are several measurements available in this mode. General spectrum analysis measurements, in swept and zero span, can be done using the first key in the Meas menu, labeled Swept SA. Other measurements in the Meas Menu are designed to

perform specialized measurement tasks, including power and demod measurements.

If you are using the Help feature, this mode must be currently active to access its detailed information. If it is not active, exit the Help feature (Esc key), select the mode, and re-access Help.

Key Path	Mode
Example	INST:SEL SA INST:NSEL 1
Initial S/W Revision	Prior to A.02.00

TD-SCDMA with HSPA/8PSK

Selects the TD-SCDMA mode for general purpose measurements of signals following this standard. There are several measurements available in this mode.

If you are using the Help feature, this mode must be currently active to access its detailed information. If it is not active, exit the Help feature (Esc key), select the mode, and re-access Help.

Key Path	Mode
Example	INST:SEL TDSCDMA INST:NSEL 211
Initial S/W Revision	Prior to A.02.00

Vector Signal Analyzer (VXA)

The N9064A (formerly 89601X) VXA Vector signal and WLAN modulation analysis application provides solutions for basic vector signal analysis, analog demodulation, and digital demodulation. The digital demodulation portion of N9064A allows you to perform measurements on standard-based formats such as cellular, wireless networking and digital video as well as general purpose flexible modulation analysis for wide range of digital formats, FSK to 1024QAM, with easy-to-use measurements and display tools such as constellation and eye diagram, EVM traces and up to four simultaneous displays. Analog baseband analysis is available using the MXA and PXA with option BBA. Option 3FP WLAN has been discontinued.

N9064A honors existing 89601X licenses with all features and functionalities found on X-Series software versions prior to A.06.00. Specifically:

N9064A-1 is equivalent to 89601X-205

N9064A-2 is equivalent to 89601X-AYA

If you are using the Help feature, this mode must be currently active to access its detailed information. If it is not active, exit the Help feature (Esc key), select the mode, and re-access Help.

Key Path	Mode
Example	INST:SEL VSA INST:NSEL 100
Initial S/W Revision	Prior to A.02.00

W-CDMA with HSPA+

Selects the W-CDMA with HSPA+ mode for general purpose measurements of signals following this standard. There are several measurements available in this mode.

If you are using the Help feature, this mode must be currently active to access its detailed information. If it is not active, exit the Help feature (Esc key), select the mode, and re-access Help.

Key Path	Mode
Example	INST:SEL WCDMA INST:NSEL 9
Initial S/W Revision	Prior to A.02.00

WLAN

Selects the WLAN mode for general purpose measurements of signals following this standard. There are several measurements available in this mode.

If you are using the Help feature, this mode must be currently active to access its detailed information. If it is not active, exit the Help feature (Esc key), select the mode, and re-access Help.

Key Path	Mode
Example	INST:SEL WLAN INST:NSEL 217
Initial S/W Revision	A.09.491

Global Settings

Opens a menu that allows you to switch certain Meas Global parameters to a Mode Global state. These switches apply to all Modes that support global settings. No matter what Mode you are in when you set the “Global Center Frequency” switch to on, it applies to all Modes that support Global Settings.

Key Path	Mode Setup
Initial S/W Revision	Prior to A.02.00

Global Center Freq

The software maintains a Mode Global value called “Global Center Freq”.

When the **Global Center Freq** key is switched to **On** in any mode, the current mode’s center frequency is copied into the Global Center Frequency, and from then on all modes that support global settings use the Global Center Frequency. So you can switch between any of these modes and the Center Freq will remain unchanged.

Adjusting the Center Freq of any mode which supports Global Settings, while **Global Center Freq** is **On**, will modify the Global Center Frequency.

When **Global Center Freq** is turned **Off**, the Center Freq of the current mode is unchanged, but now the Center Freq of each mode is once again independent.

When **Mode Preset** is pressed while **Global Center Freq** is **On**, the Global Center Freq is preset to the preset Center Freq of the current mode.

This function is reset to Off when the Restore Defaults key is pressed in the Global Settings menu, or when **System, Restore Defaults, All Modes** is pressed.

Key Path	Mode Setup, Global Settings
Scope	Mode Global
Remote Command	:INSTrument:COUPle:FREQuency:CENTer ALL NONE :INSTrument:COUPle:FREQuency:CENTer?
Example	INST:COUP:FREQ:CENT ALL INST:COUP:FREQ:CENT?
Preset	Set to Off on Global Settings, Restore Defaults and System, Restore Defaults, All Modes
Range	On Off
Initial S/W Revision	Prior to A.02.00

Remote Command	:GLOBa1:FREQuency:CENTer[:STATe] 1 0 ON OFF :GLOBa1:FREQuency:CENTer[:STATe]?
Preset	Off
Initial S/W Revision	Prior to A.02.00

Restore Defaults

This key resets all of the functions in the Global Settings menu to Off. This also occurs when **System, Restore Defaults, All Modes** is pressed.

Key Path	Mode Setup, Global Settings
Remote Command	:INSTrument:COUPle:DEFault
Example	INST:COUP:DEF
Backwards Compatibility SCPI	:GLOBal:DEFault
Initial S/W Revision	Prior to A.02.00

Mode Setup

The Mode Setup menu contains setup functions that are global across the entire Mode. These functions are independent of which measurement is currently running – they are global to all measurements in the mode, or "Meas Global." The Mode Setup functions are not the only Meas Global functions in the analyzer; for example, the Trigger Setup functions are Meas Global, and there are even Mode Global functions (that is, the same for all Modes) in the Input/Output menu, but the fact that they are all Meas Global is a distinguishing characteristic of the Mode Setup functions.

The Mode Setup menu also contains the **Restore Mode Defaults** key. Most Meas Global functions are restored to their preset values by **Mode Preset**, however some variables are more persistent and are not preset until the **Restore Mode Defaults** key is pressed.

There are also a few Meas Global variables (for example, Global Center Frequency) that can be switched to be Mode Global, that is, the same for all modes. The keys under the Global Settings key control whether these variables are Mode Global or not.

In the Spectrum Analyzer mode, the Mode Setup functions include which radio standard and/or EMC standard is in use and how it is configured. A set of CISPR EMC presets is available as well.

The EMC keys require either the N6141A or W6141A application or Option EMC to be installed and licensed.

Key Path	Front-panel key
Initial S/W Revision	Prior to A.02.00

Radio Standard

Allows you to specify the radio standard to be used. Spectrum Analyzer mode supports many radio standards. You can select the desired radio standard using the **Radio Std** key.

Key Path	Mode Setup
Scope	Meas Global
Remote Command	[:SENSE]:RADio:STANdard[:SElect] NONE JSTD IS95a IS97D IS98D GSM W3GPP C2000MC1 C20001X NADC PDC BLUEtooth TETRa WL802DOT11A WL802DOT11B WL802DOT11G HIPERLAN2 DVBTLSN DVBTGPN DVBTIPN FCC15 SDBSE UWBINDOOR LTEB1M4 LTEB3M LTEB5M LTEB10M LTEB15M LTEB20M WL11N20M WL11N40M WL11AC20M WL11AC40M WL11AC80M WL11AC160M WL11AD2G [:SENSE]:RADio:STANdard[:SElect]?
Example	RAD:STAN NONE RAD:STAN?
Couplings	By changing the radio standard, the measurement parameters will be automatically set to an appropriate default value.

State Saved	Saved in instrument state
Range	None GSM/EDGE 3GPP W-CDMA 3GPP LTE cdma2000 1x IS-95A J-STD-008 IS-97D/98D NADC PDC Bluetooth W-LAN TETRA DVB-T FCC Part 15 Subpart F S-DMB System E UWB Indoor
Initial S/W Revision	Prior to A.02.00
Modified at S/W Revision	A.14.50, A.18.00

Note that not every measurement in the Spectrum Analyzer mode is available with every standard. The chart below describes which measurements are available with each radio standard.

	None	GSM/EDGE	3GPP W-CDMA	3GPP LTE	cdma2000 1x	IS-95A	J-STD-008	IS-97D/98D	NADC	PDC	Bluetooth	W-LAN 802.11a	W-LAN 802.11b	W-LAN 802.11g	W-LAN 802.11n	W-LAN 802.11ac	W-LAN 802.11ad	W-LAN HyperLAN2	TETRA	DVB-T USEC/AM/ICAM	DVB-T G/PAL/NTSC/AM	DVB-T I/PAL/NTSC/AM	FCC Part 15 Subpart F	S-DMB System E	UWB Indoor
Swept SA	X	(X)	(X)	(X)	(X)	(X)	(X)	(X)	(X)	(X)	(X)	(X)	(X)	(X)	(X)	(X)	(X)	(X)	(X)	(X)	(X)	(X)	(X)	(X)	(X)
Channel Power	X		X	X	X	X	X	X	X	X					X	X	X		X	X	X			X	
Occupied BW	X		X	X	X	X	X	X	X	X					X	X	X								X
ACP	X		X	X	X	X	X	X	X	X									X						X
Power Stat CCDF	X	X	X	X	X	X	X	X	X	X	X				X	X	X			X	X	X			
Burst Power	X	X	X		X	X	X		X	X	X														
Spurious Emission	X																						X		X
Spectrum Emission Mask	X		X	X								X	X	X	X	X	X	X							
TOI																									
Harmonics																									
List Sweep	(X)	(X)	(X)	(X)	(X)	(X)	(X)	(X)	(X)	(X)	(X)	(X)	(X)	(X)	(X)	(X)	(X)	(X)	(X)	(X)	(X)	(X)	(X)	(X)	(X)

The tables below give the setting used for each standard:

IBW	2MHz
Span	3MHz
RBW	Auto rules
VBW	Auto rules

3GPP W-CDMA

IBW	5MHz
Span	7.5MHz
RBW	240kHz
VBW	Auto rules
RRC Filter	Off
RRC Filter Alpha	0.22

3GPP LTE 1.4 MHz	
IBW	1.4 MHz
Span	2.1 MHz
RBW	Auto rules
VBW	Auto rules

3GPP LTE 3 MHz	
IBW	3 MHz
Span	4.5 MHz
RBW	Auto rules
VBW	Auto rules

3GPP LTE 5 MHz	
IBW	5 MHz
Span	7.5 MHz
RBW	Auto rules
VBW	Auto rules

3GPP LTE 10 MHz	
IBW	10 MHz
Span	15 MHz
RBW	Auto rules
VBW	Auto rules

3GPP LTE 15 MHz	
IBW	15 MHz
Span	22.5 MHz
RBW	Auto rules
VBW	Auto rules

3GPP LTE 20 MHz	
IBW	20 MHz
Span	30 MHz
RBW	Auto rules
VBW	Auto rules

IS-95A, J-STD-008, IS-97D/98D, cdma2000	
--	--

IBW	1.23MHz
Span	1.845MHz
RBW	24kHz
VBW	Auto rules
NADC	
IBW	32.8kHz
Span	49.2kHz
RBW	1.2kHz
VBW	Auto rules
PDC	
IBW	21kHz
Span	31.5kHz
RBW	6.2kHz
VBW	Auto rules
WLAN 802.11a/g	
IBW	20 MHz
Span	30 MHz
RBW	100 kHz
VBW	Auto rules
WLAN 802.11b	
IBW	25 MHz
Span	37.5 MHz
RBW	100 kHz
VBW	Auto rules
WLAN 802.11n 20 MHz	
IBW	20 MHz
Span	30 MHz
RBW	100 kHz
VBW	Auto rules
WLAN 802.11n 40 MHz	
IBW	40 MHz

Span	60 MHz
RBW	100 kHz
VBW	Auto rules
WLAN 802.11ac 20 MHz	
IBW	20 MHz
Span	30 MHz
RBW	100 kHz
VBW	Auto rules
WLAN 802.11ac 40 MHz	
IBW	40 MHz
Span	60 MHz
RBW	100 kHz
VBW	Auto rules
WLAN 802.11ac 80 MHz	
IBW	80 MHz
Span	120 MHz
RBW	100 kHz
VBW	Auto rules
WLAN 802.11ac 160 MHz	
IBW	160 MHz
Span	240 MHz
RBW	100 kHz
VBW	Auto rules
WLAN 802.11ad 2 GHz	
IBW	2.0 GHz
Span	3 GHz
RBW	1 MHz
VBW	Auto rules
TETRA	
IBW	18kHz
Span	27kHz

RBW	1.2kHz
VBW	Auto rules
RRC Filter	On
RRC Filter Alpha	0.35

DVB-T L/SECAM/NICAM, G/PAL/NICAM, I/PAL/NICAM

IBW	7.61MHz
Span	24MHz
RBW	3.9kHz
VBW	Auto rules
Sweep Points	8001

S-DMB System E

IBW	25MHz
Span	37.5MHz
RBW	360kHz
VBW	Auto rules
RRC Filter	Off
RRC Filter Alpha	0.22

Some standards are used by only one or two measurements, and their settings are documented in those measurements. These are:

GSM/EDGE – used only in CCDF and Burst Power

Bluetooth - used only in CCDF and Burst Power

FCC Part15 - used only in Spurious Emissions

UWB Inband - used only in Spurious Emissions

GSM/EDGE

Sets the specific parameters for the selected measurement appropriate for industry standard GSM/EDGE. For the available measurements with this radio standard, see the chart in the "[Radio Standard](#)" on page 407 section.

Key Path	Mode Setup, Radio Std
Example	:RAD:STAN GSM
Initial S/W Revision	Prior to A.02.00

Device

Allows you to specify the device to be used. This key appears in the Setup menu of most of the Radio Stds. It is a global setting that affects the Device selection,

between Mobile (MS) and Base Station (BTS) settings, for all relevant Power Suite measurements.

Key Path	Mode Setup, Radio Std
Scope	Meas Global
Remote Command	[:SENSe]:RADio:STANdard:DEVIce BTS MS [:SENSe]:RADio:STANdard:DEVIce?
Example	RAD:STAN:DEV MS RAD:STAN:DEV?
Preset	BTS
State Saved	Saved in instrument state
Range	BTS MS
Initial S/W Revision	Prior to A.02.00

3GPP W-CDMA

Sets the specific parameters for the selected measurement appropriate for industry standard 3GPP W-CDMA. For the available measurements with this radio standard, see the chart in the ["Radio Standard" on page 407](#) section.

Key Path	Mode Setup, Radio Std
Example	:RAD:STAN W3GPP
Initial S/W Revision	Prior to A.02.00

Device

Allows you to specify the device to be used. This key appears in the Setup menu of most of the Radio Stds. It is a global setting that affects the Device selection, between Mobile (MS) and Base Station (BTS) settings, for all relevant Power Suite measurements.

Key Path	Mode Setup, Radio Std
Scope	Meas Global
Remote Command	[:SENSe]:RADio:STANdard:DEVIce BTS MS [:SENSe]:RADio:STANdard:DEVIce?
Example	RAD:STAN:DEV MS RAD:STAN:DEV?
Preset	BTS
State Saved	Saved in instrument state
Range	BTS MS
Initial S/W Revision	Prior to A.02.00

3GPP LTE

Sets the specific parameters for the selected measurement appropriate for industry standard 3GPP LTE. For the available measurements with this radio standard, see the chart in the "Radio Standard" on page 407 section.

Key Path	Mode Setup, Radio Std
Example	:RAD:STAN LTEB1M4 :RAD:STAN LTEB3M :RAD:STAN LTEB5M :RAD:STAN LTEB10M :RAD:STAN LTEB15M :RAD:STAN LTEB20M
Range	1.4 MHz (6 RB) 3 MHz (15 RB) 5 MHz (25 RB) 10 MHz (50 RB) 15 MHz (75 RB) 20 MHz (100 RB)
Initial S/W Revision	A.14.50

Device

Allows you to specify the device to be used. This key appears in the Setup menu of most of the Radio Stds. It is a global setting that affects the Device selection, between Mobile (MS) and Base Station (BTS) settings, for all relevant Power Suite measurements.

Key Path	Mode Setup, Radio Std
Scope	Meas Global
Remote Command	[:SENSe]:RADio:STANdard:DEVIce BTS MS [:SENSe]:RADio:STANdard:DEVIce?
Example	RAD:STAN:DEV MS RAD:STAN:DEV?
Preset	BTS
State Saved	Saved in instrument state
Range	BTS MS
Initial S/W Revision	Prior to A.02.00

Cdma2000 1x

Sets the specific parameters for the selected measurement appropriate for industry standard cdma2000-1x. For the available measurements with this radio standard, see the chart in the "Radio Standard" on page 407 section.

Key Path	Mode Setup, Radio Std
Example	RAD:STAN C20001X RAD:STAN C2000MC1
Notes	Regardless of whether C20001X or C2000MC1 is used to select this standard, the query always returns C20001X
Initial S/W Revision	Prior to A.02.00

Device

Allows you to specify the device to be used. This key appears in the Setup menu of most of the Radio Stds. It is a global setting that affects the Device selection, between Mobile (MS) and Base Station (BTS) settings, for all relevant Power Suite measurements.

Key Path	Mode Setup, Radio Std
Scope	Meas Global
Remote Command	<code>[:SENSe]:RADio:STANdard:DEVIce BTS MS</code> <code>[:SENSe]:RADio:STANdard:DEVIce?</code>
Example	RAD:STAN:DEV MS RAD:STAN:DEV?
Preset	BTS
State Saved	Saved in instrument state
Range	BTS MS
Initial S/W Revision	Prior to A.02.00

IS-95A

Sets the specific parameters for the selected measurement appropriate for industry standard IS-95A. For the available measurements with this radio standard, see the chart in the "[Radio Standard](#)" on page 407 section.

Key Path	Mode Setup, Radio Std
Example	:RAD:STAN IS95
Initial S/W Revision	Prior to A.02.00

Device

Allows you to specify the device to be used. This key appears in the Setup menu of most of the Radio Stds. It is a global setting that affects the Device selection, between Mobile (MS) and Base Station (BTS) settings, for all relevant Power Suite measurements.

Key Path	Mode Setup, Radio Std
Scope	Meas Global
Remote Command	<code>[:SENSe]:RADio:STANdard:DEVIce BTS MS</code> <code>[:SENSe]:RADio:STANdard:DEVIce?</code>
Example	RAD:STAN:DEV MS RAD:STAN:DEV?
Preset	BTS
State Saved	Saved in instrument state
Range	BTS MS
Initial S/W Revision	Prior to A.02.00

J-STD-008

Sets the specific parameters for the selected measurement appropriate for industry standard J-STD-008. For the available measurements with this radio standard, see the chart in the "[Radio Standard](#)" on page 407 section.

Key Path	Mode Setup, Radio Std
Example	:RAD:STAN JSTD
Initial S/W Revision	Prior to A.02.00

Device

Allows you to specify the device to be used. This key appears in the Setup menu of most of the Radio Stds. It is a global setting that affects the Device selection, between Mobile (MS) and Base Station (BTS) settings, for all relevant Power Suite measurements.

Key Path	Mode Setup, Radio Std
Scope	Meas Global
Remote Command	[:SENSe]:RADio:STANdard:DEVIce BTS MS [:SENSe]:RADio:STANdard:DEVIce?
Example	RAD:STAN:DEV MS RAD:STAN:DEV?
Preset	BTS
State Saved	Saved in instrument state
Range	BTS MS
Initial S/W Revision	Prior to A.02.00

IS-97D/98D

Sets the specific parameters for the selected measurement appropriate for industry standard IS-97D/98D. For the available measurements with this radio standard, see the chart in the "[Radio Standard](#)" on page 407 section.

Key Path	Mode Setup, Radio Std
Example	:RAD:STAN IS97D :RAD:STAN IS98D :RAD:STAN IS95C
Notes	Regardless of whether IS97D, IS98D or IS95C is used to select this standard, the query always returns IS97D
Initial S/W Revision	Prior to A.02.00

Band Class

This function is only available when you have selected the standard: IS-97D/98D. It enables you to select the band class.

Key Path	Mode Setup, Radio Std, IS-97D/98D, IS-97D/98D
Scope	Meas Global
Remote Command	[:SENSe]:RADio:STANdard:BAND:CLASs BC0 BC1 [:SENSe]:RADio:STANdard:BAND:CLASs?
Example	RAD:STAN:BAND:CLAS BC0 RAD:STAN:BAND:CLAS?
Preset	BC0
State Saved	Saved in instrument state
Range	0 (800 MHz Band) 1 (1900 MHz Band)
Initial S/W Revision	Prior to A.02.00

Device

Allows you to specify the device to be used. This key appears in the Setup menu of most of the Radio Stds. It is a global setting that affects the Device selection, between Mobile (MS) and Base Station (BTS) settings, for all relevant Power Suite measurements.

Key Path	Mode Setup, Radio Std
Scope	Meas Global
Remote Command	[:SENSe]:RADio:STANdard:DEVIce BTS MS [:SENSe]:RADio:STANdard:DEVIce?
Example	RAD:STAN:DEV MS RAD:STAN:DEV?
Preset	BTS
State Saved	Saved in instrument state
Range	BTS MS
Initial S/W Revision	Prior to A.02.00

NADC

Sets the specific parameters for the selected measurement appropriate for industry standard NADC. For the available measurements with this radio standard, see the chart in the "[Radio Standard](#)" on page 407 section.

Key Path	Mode Setup, Radio Std
Example	:RAD:STAN NADC
Initial S/W Revision	Prior to A.02.00

Device

Allows you to specify the device to be used. This key appears in the Setup menu of most of the Radio Stds. It is a global setting that affects the Device selection,

between Mobile (MS) and Base Station (BTS) settings, for all relevant Power Suite measurements.

Key Path	Mode Setup, Radio Std
Scope	Meas Global
Remote Command	<code>[:SENSe]:RADio:STANdard:DEVIce BTS MS</code> <code>[:SENSe]:RADio:STANdard:DEVIce?</code>
Example	RAD:STAN:DEV MS RAD:STAN:DEV?
Preset	BTS
State Saved	Saved in instrument state
Range	BTS MS
Initial S/W Revision	Prior to A.02.00

PDC

Sets the specific parameters for the selected measurement appropriate for industry standard PDC. For the available measurements with this radio standard, see the chart in the "[Radio Standard](#)" on page 407 section.

Key Path	Mode Setup, Radio Std
Example	:RAD:STAN PDC
Initial S/W Revision	Prior to A.02.00

Device

Allows you to specify the device to be used. This key appears in the Setup menu of most of the Radio Stds. It is a global setting that affects the Device selection, between Mobile (MS) and Base Station (BTS) settings, for all relevant Power Suite measurements.

Key Path	Mode Setup, Radio Std
Scope	Meas Global
Remote Command	<code>[:SENSe]:RADio:STANdard:DEVIce BTS MS</code> <code>[:SENSe]:RADio:STANdard:DEVIce?</code>
Example	RAD:STAN:DEV MS RAD:STAN:DEV?
Preset	BTS
State Saved	Saved in instrument state
Range	BTS MS
Initial S/W Revision	Prior to A.02.00

Bluetooth

Sets the specific parameters for the selected measurement appropriate for industry standard Bluetooth™. For the available measurements with this radio standard, see the chart in the "[Radio Standard](#)" on page 407 section.

Key Path	Mode Setup, Radio Std
Example	:RAD:STAN BLUE
Initial S/W Revision	Prior to A.02.00

Std Setup

Sets the packet type for the Bluetooth measurement

Key Path	Mode Setup, Radio Std, Bluetooth
Scope	Meas Global
Remote Command	[:SENSe]:RADio:STANdard:PACKet DH1 DH3 DH5 [:SENSe]:RADio:STANdard:PACKet?
Example	RAD:STAN:PACK DH1 RAD:STAN:PACK?
Notes	The packet length is DH1 -> 366 μ s DH3 -> 1622 μ s DH5 -> 2870 μ s
Preset	DH1
State Saved	Saved in instrument state
Range	DH1 DH3 DH5
Initial S/W Revision	Prior to A.02.00

Antenna Unit

When a Correction is turned on that uses an Antenna Unit, the Y Axis Unit changes to that Antenna Unit. All of the keys in the Y-Axis Unit menu are then greyed out, except the Antenna Unit key. The unit being used is shown on this key and is shown as selected in the submenu.

Key Path	AMPTD Y Scale, Y Axis Unit
Dependencies	Grayed out if no Amplitude Correction with an Antenna Unit is on.
Readback line	Currently selected unit
Initial S/W Revision	A.11.00

TETRA

Sets the specific parameters for the selected measurement appropriate for industry standard TETRA. For the available measurements with this radio standard, see the

chart in the "Radio Standard" on page 407 section.

Key Path	Mode Setup, Radio Std
Example	:RAD:STAN TETR
Initial S/W Revision	Prior to A.02.00

Device

Allows you to specify the device to be used. This key appears in the Setup menu of most of the Radio Stds. It is a global setting that affects the Device selection, between Mobile (MS) and Base Station (BTS) settings, for all relevant Power Suite measurements.

Key Path	Mode Setup, Radio Std
Scope	Meas Global
Remote Command	[:SENSe]:RADio:STANdard:DEVIce BTS MS [:SENSe]:RADio:STANdard:DEVIce?
Example	RAD:STAN:DEV MS RAD:STAN:DEV?
Preset	BTS
State Saved	Saved in instrument state
Range	BTS MS
Initial S/W Revision	Prior to A.02.00

W-LAN

Accesses the W-LAN radio standards key menu to enable you to select a W-LAN standard. Selecting a W-LAN standard modifies spectrum analyzer settings for the measurement activated under the Meas menu. For the available measurements with this radio standard, see the chart in the "Radio Standard" on page 407 section.

Key Path	Mode Setup, Radio Std
Example	:RAD:STAN WL802DOT11A 802.11a :RAD:STAN WL802DOT11B 802.11b :RAD:STAN WL802DOT11G 802.11g :RAD:STAN WL11N20M 802.11n 20 MHz :RAD:STAN WL11N40M 802.11n 40 MHz :RAD:STAN WL11AC20M 802.11ac 20 MHz :RAD:STAN WL11AC40M 802.11ac 40 MHz :RAD:STAN WL11AC80M 802.11ac 80 MHz :RAD:STAN WL11AC160M 802.11ac 160 MHz :RAD:STAN WL11AD2G 802.11ad 2 GHz :RAD:STAN HIPERLAN2 HiperLAN/2
Range	802.11a 802.11b 802.11g 802.11n 802.11ac 802.11ad HiperLAN/2

Initial S/W Revision	Prior to A.02.00
Modified at S/W Revision	A.14.50, A.18.00

Radio Standard

Allows you to specify the radio standard to be used. Spectrum Analyzer mode supports many radio standards. You can select the desired radio standard using the **Radio Std** key.

Key Path	Mode Setup
Scope	Meas Global
Remote Command	[:SENSe]:RADio:STANdard[:SElect] NONE JSTD IS95a IS97D IS98D GSM W3GPP C2000MC1 C20001X NADC PDC BLUEtooth TETRA WL802DOT11A WL802DOT11B WL802DOT11G HIPERLAN2 DVBTLSN DVBTGPN DVBTIPN FCC15 SDMBSE UWBINDOOR LTEB1M4 LTEB3M LTEB5M LTEB10M LTEB15M LTEB20M WL11N20M WL11N40M WL11AC20M WL11AC40M WL11AC80M WL11AC160M WL11AD2G [:SENSe]:RADio:STANdard[:SElect]?
Example	RAD:STAN NONE RAD:STAN?
Couplings	By changing the radio standard, the measurement parameters will be automatically set to an appropriate default value.
State Saved	Saved in instrument state
Range	None GSM/EDGE 3GPP W-CDMA 3GPP LTE cdma2000 1x IS-95A J-STD-008 IS-97D/98D NADC PDC Bluetooth W-LAN TETRA DVB-T FCC Part 15 Subpart F S-DMB System E UWB Indoor
Initial S/W Revision	Prior to A.02.00
Modified at S/W Revision	A.14.50, A.18.00

Note that not every measurement in the Spectrum Analyzer mode is available with every standard. The chart below describes which measurements are available with each radio standard.

	None	GSMEDGE	3GPP W-CDMA	3GPP LTE	cdma2000 1x	IS-95A	J-STD-008	IS-97D/98D	NADC	PDC	Bluetooth	W-LAN 802.11a	W-LAN 802.11b	W-LAN 802.11g	W-LAN 802.11n	W-LAN 802.11ac	W-LAN 802.11ad	W-LAN HiperLAN/2	TETRA	DVB-T LSEC/AM/NIC/AM	DVB-T G/PAL/NIC/AM	DVB-T IP/PAL/NIC/AM	FCC Part 15 Subpart F	S-DMB System E	UWB Indoor	
Swept SA	X	(X)	(X)	(X)	(X)	(X)	(X)	(X)	(X)	(X)	(X)	(X)	(X)	(X)	(X)	(X)	(X)	(X)	(X)	(X)	(X)	(X)	(X)	(X)	(X)	(X)
Channel Power	X		X	X	X	X	X	X	X	X					X	X	X		X	X	X	X		X		
Occupied BW	X		X	X	X	X	X	X	X	X					X	X	X							X		
ACP	X		X	X	X	X	X	X	X	X									X					X		
Power Stat CCDF	X	X	X	X	X	X	X	X	X	X	X				X	X	X			X	X	X				
Burst Power	X	X	X		X	X	X		X	X	X															
Spurious Emission	X																						X		X	
Spectrum Emission Mask	X		X	X								X	X	X	X	X	X	X								
TOI																										
Harmonics																										
List Sweep	(X)	(X)	(X)	(X)	(X)	(X)	(X)	(X)	(X)	(X)	(X)	(X)	(X)	(X)	(X)	(X)	(X)	(X)	(X)	(X)	(X)	(X)	(X)	(X)	(X)	(X)

The tables below give the setting used for each standard:

IBW	2MHz
Span	3MHz
RBW	Auto rules
VBW	Auto rules

3GPP W-CDMA

IBW	5MHz
Span	7.5MHz
RBW	240kHz
VBW	Auto rules
RRC Filter	Off
RRC Filter Alpha	0.22

3GPP LTE 1.4 MHz

IBW	1.4 MHz
Span	2.1 MHz
RBW	Auto rules
VBW	Auto rules

3GPP LTE 3 MHz

IBW	3 MHz
Span	4.5 MHz
RBW	Auto rules

VBW	Auto rules
3GPP LTE 5 MHz	
IBW	5 MHz
Span	7.5 MHz
RBW	Auto rules
VBW	Auto rules
3GPP LTE 10 MHz	
IBW	10 MHz
Span	15 MHz
RBW	Auto rules
VBW	Auto rules
3GPP LTE 15 MHz	
IBW	15 MHz
Span	22.5 MHz
RBW	Auto rules
VBW	Auto rules
3GPP LTE 20 MHz	
IBW	20 MHz
Span	30 MHz
RBW	Auto rules
VBW	Auto rules
IS-95A, J-STD-008, IS-97D/98D, cdma2000	
IBW	1.23MHz
Span	1.845MHz
RBW	24kHz
VBW	Auto rules
NADC	
IBW	32.8kHz
Span	49.2kHz
RBW	1.2kHz
VBW	Auto rules

PDC

IBW	21kHz
Span	31.5kHz
RBW	6.2kHz
VBW	Auto rules

WLAN 802.11a/g

IBW	20 MHz
Span	30 MHz
RBW	100 kHz
VBW	Auto rules

WLAN 802.11b

IBW	25 MHz
Span	37.5 MHz
RBW	100 kHz
VBW	Auto rules

WLAN 802.11n 20 MHz

IBW	20 MHz
Span	30 MHz
RBW	100 kHz
VBW	Auto rules

WLAN 802.11n 40 MHz

IBW	40 MHz
Span	60 MHz
RBW	100 kHz
VBW	Auto rules

WLAN 802.11ac 20 MHz

IBW	20 MHz
Span	30 MHz
RBW	100 kHz
VBW	Auto rules

WLAN 802.11ac 40 MHz	
IBW	40 MHz
Span	60 MHz
RBW	100 kHz
VBW	Auto rules

WLAN 802.11ac 80 MHz	
IBW	80 MHz
Span	120 MHz
RBW	100 kHz
VBW	Auto rules

WLAN 802.11ac 160 MHz	
IBW	160 MHz
Span	240 MHz
RBW	100 kHz
VBW	Auto rules

WLAN 802.11ad 2 GHz	
IBW	2.0 GHz
Span	3 GHz
RBW	1 MHz
VBW	Auto rules

TETRA	
IBW	18kHz
Span	27kHz
RBW	1.2kHz
VBW	Auto rules
RRC Filter	On
RRC Filter Alpha	0.35

DVB-T L/SECAM/NICAM, G/PAL/NICAM, I/PAL/NICAM	
IBW	7.61MHz
Span	24MHz
RBW	3.9kHz
VBW	Auto rules

Sweep Points	8001
S-DMB System E	
IBW	25MHz
Span	37.5MHz
RBW	360kHz
VBW	Auto rules
RRC Filter	Off
RRC Filter Alpha	0.22

Some standards are used by only one or two measurements, and their settings are documented in those measurements. These are:

GSM/EDGE – used only in CCDF and Burst Power

Bluetooth – used only in CCDF and Burst Power

FCC Part15 – used only in Spurious Emissions

UWB Inband – used only in Spurious Emissions

DVB-T

Accesses the DVB-T key menu to enable you to select a DVB-T mask filtering standard. Selecting a DVB-T filtering standard modifies spectrum analyzer settings for the measurement activated under the Meas menu. For the available measurements with this radio standard, see the chart in the ["Radio Standard" on page 407](#) section.

Key Path	Mode Setup, Radio Std
Example	:RAD:STAN DVBTLSN L/SECAM/NICAM :RAD:STAN DVBTGPN G/PAL/NICAM :RAD:STAN DVBTIPN I/PAL/NICAM
Range	L/SECAM/NICAM G/PAL/NICAM I/PAL/NICAM
Initial S/W Revision	Prior to A.02.00

Radio Standard

Allows you to specify the radio standard to be used. Spectrum Analyzer mode supports many radio standards. You can select the desired radio standard using the **Radio Std** key.

Key Path	Mode Setup
Scope	Meas Global
Remote Command	[[:SENSE]:RADio:STANdard[:SElect] NONE JSTD IS95a IS97D IS98D GSM W3GPP C2000MC1 C20001X NADC PDC BLUEtooth TETRa WL802DOT11A WL802DOT11B WL802DOT11G HIPERLAN2 DVBTLSN DVBTGPN DVBTIPN FCC15 SDMBSE UWBINDOOR LTEB1M4 LTEB3M

	LTEB5M LTEB10M LTEB15M LTEB20M WL11N20M WL11N40M WL11AC20M WL11AC40M WL11AC80M WL11AC160M WL11AD2G [:SENSE]:RADio:STANdard[:SElect]?
Example	RAD:STAN NONE RAD:STAN?
Couplings	By changing the radio standard, the measurement parameters will be automatically set to an appropriate default value.
State Saved	Saved in instrument state
Range	None GSM/EDGE 3GPP W-CDMA 3GPP LTE cdma2000 1x IS-95A J-STD-008 IS-97D/98D NADC PDC Bluetooth W-LAN TETRA DVB-T FCC Part 15 Subpart F S-DMB System E UWB Indoor
Initial S/W Revision	Prior to A.02.00
Modified at S/W Revision	A.14.50, A.18.00

Note that not every measurement in the Spectrum Analyzer mode is available with every standard. The chart below describes which measurements are available with each radio standard.

	None	GSM/EDGE	3GPP W-CDMA	3GPP LTE	cdma2000 1x	IS-95A	J-STD-008	IS-97D/98D	NADC	PDC	Bluetooth	W-LAN 802.11a	W-LAN 802.11b	W-LAN 802.11g	W-LAN 802.11n	W-LAN 802.11ac	W-LAN 802.11ad	W-LAN HiperLAN/2	TETRA	DVB-T L/SEC/M/N/C/A/M	DVB-T G/P/L/N/C/A/M	DVB-T I/P/L/N/C/A/M	FCC Part 15 Subpart F	S-DMB System E	UWB Indoor	
Swept SA	X	(X)	(X)	(X)	(X)	(X)	(X)	(X)	(X)	(X)	(X)	(X)	(X)	(X)	(X)	(X)	(X)	(X)	(X)	(X)	(X)	(X)	(X)	(X)	(X)	(X)
Channel Power	X		X	X	X	X	X	X	X	X					X	X	X		X	X	X			X		
Occupied BW	X		X	X	X	X	X	X	X	X					X	X	X								X	
ACP	X		X	X	X	X	X	X	X	X									X						X	
Power Stat	X	X	X	X	X	X	X	X	X	X	X				X	X	X			X	X	X				
CCDF	X	X	X	X	X	X	X	X	X	X	X										X	X	X			
Burst Power	X	X	X		X	X	X		X	X	X															
Spurious Emission	X																						X		X	
Spectrum Emission Mask	X		X	X								X	X	X	X	X	X	X								
TOI																										
Harmonics																										
List Sweep	(X)	(X)	(X)	(X)	(X)	(X)	(X)	(X)	(X)	(X)	(X)	(X)	(X)	(X)	(X)	(X)	(X)	(X)	(X)	(X)	(X)	(X)	(X)	(X)	(X)	(X)

The tables below give the setting used for each standard:

IBW	2MHz
Span	3MHz
RBW	Auto rules
VBW	Auto rules

3GPP W-CDMA

IBW	5MHz
Span	7.5MHz
RBW	240kHz
VBW	Auto rules
RRC Filter	Off
RRC Filter Alpha	0.22

3GPP LTE 1.4 MHz

IBW	1.4 MHz
Span	2.1 MHz
RBW	Auto rules
VBW	Auto rules

3GPP LTE 3 MHz

IBW	3 MHz
Span	4.5 MHz
RBW	Auto rules
VBW	Auto rules

3GPP LTE 5 MHz

IBW	5 MHz
Span	7.5 MHz
RBW	Auto rules
VBW	Auto rules

3GPP LTE 10 MHz

IBW	10 MHz
Span	15 MHz
RBW	Auto rules
VBW	Auto rules

3GPP LTE 15 MHz

IBW	15 MHz
Span	22.5 MHz
RBW	Auto rules
VBW	Auto rules

3GPP LTE 20 MHz	
IBW	20 MHz
Span	30 MHz
RBW	Auto rules
VBW	Auto rules

IS-95A, J-STD-008, IS-97D/98D, cdma2000	
IBW	1.23MHz
Span	1.845MHz
RBW	24kHz
VBW	Auto rules

NADC	
IBW	32.8kHz
Span	49.2kHz
RBW	1.2kHz
VBW	Auto rules

PDC	
IBW	21kHz
Span	31.5kHz
RBW	6.2kHz
VBW	Auto rules

WLAN 802.11a/g	
IBW	20 MHz
Span	30 MHz
RBW	100 kHz
VBW	Auto rules

WLAN 802.11b	
IBW	25 MHz
Span	37.5 MHz
RBW	100 kHz
VBW	Auto rules

WLAN 802.11n 20 MHz	
----------------------------	--

IBW	20 MHz
Span	30 MHz
RBW	100 kHz
VBW	Auto rules

WLAN 802.11n 40 MHz

IBW	40 MHz
Span	60 MHz
RBW	100 kHz
VBW	Auto rules

WLAN 802.11ac 20 MHz

IBW	20 MHz
Span	30 MHz
RBW	100 kHz
VBW	Auto rules

WLAN 802.11ac 40 MHz

IBW	40 MHz
Span	60 MHz
RBW	100 kHz
VBW	Auto rules

WLAN 802.11ac 80 MHz

IBW	80 MHz
Span	120 MHz
RBW	100 kHz
VBW	Auto rules

WLAN 802.11ac 160 MHz

IBW	160 MHz
Span	240 MHz
RBW	100 kHz
VBW	Auto rules

WLAN 802.11ad 2 GHz

IBW	2.0 GHz
-----	---------

Span	3 GHz
RBW	1 MHz
VBW	Auto rules
TETRA	
IBW	18kHz
Span	27kHz
RBW	1.2kHz
VBW	Auto rules
RRC Filter	On
RRC Filter Alpha	0.35
DVB-T L/SECAM/NICAM, G/PAL/NICAM, I/PAL/NICAM	
IBW	7.61MHz
Span	24MHz
RBW	3.9kHz
VBW	Auto rules
Sweep Points	8001
S-DMB System E	
IBW	25MHz
Span	37.5MHz
RBW	360kHz
VBW	Auto rules
RRC Filter	Off
RRC Filter Alpha	0.22

Some standards are used by only one or two measurements, and their settings are documented in those measurements. These are:

GSM/EDGE – used only in CCDF and Burst Power

Bluetooth – used only in CCDF and Burst Power

FCC Part15 – used only in Spurious Emissions

UWB Inband – used only in Spurious Emissions

FCC Part 15 Subpart F

Sets the specific parameters for the selected measurement appropriate for unlicensed devices. For the available measurements with this radio standard, see the chart in the "[Radio Standard](#)" on page 407 section.

Key Path	Mode Setup, Radio Std
Example	:RAD:STAN FCC15
Initial S/W Revision	Prior to A.02.00

S-DMB System E

Sets the specific parameters for the selected measurement appropriate for industry standard System E. For the available measurements with this radio standard, see the chart in the "[Radio Standard](#)" on page 407 section.

Key Path	Mode Setup, Radio Std
Example	:RAD:STAN SDMBSE
Initial S/W Revision	Prior to A.02.00

UWB Indoor

Sets the specific parameters for the selected measurement appropriate for UWB Indoor standard. For the available measurements with this radio standard, see the chart in the "[Radio Standard](#)" on page 407 section.

Key Path	Mode Setup, Radio Std
Example	:RAD:STAN UWBINDOOR
Initial S/W Revision	Prior to A.02.00

Enable Non-Std Measurements

Allows you to specify whether all measurements and radio standards are enabled or not. In default, Enable All Measurements is set to No, so you can select only the valid combination of preset available standard and measurement. Any measurement or standard that make the combination that have no valid preset value are grayed out. When Enable Non-Std Measurements is set to Yes, all measurements and standard selections are enabled so that you can choose any.

If you select an unavailable measurement or unavailable radio standard using the Enable Non-Std Measurement key, the measurement results may not conform to the selected standard.

Key Path	Mode Setup
Scope	Meas Global
Remote Command	[:SENSe]:RADio:STANdard:EAMeas YES NO [:SENSe]:RADio:STANdard:EAMeas ?
Example	RAD:STAN:EAM YES RAD:STAN:EAM?
Preset	NO
State Saved	Saved in instrument state

Range	Yes No
Initial S/W Revision	Prior to A.02.00

EMC Standard

Only appears with the N6141A or W6141A application or Option EMC installed and licensed.

This menu allows you to select None (no EMI standard), CISPR (CISPR 16-1-1), and MIL (MIL-461A). Each standard has a unique way of determining the couplings between detectors and RBWs, as well as its own set of available RBW's.

Note that Auto Couple will have no effect on the EMC Standard setting.

Key Path	Mode Setup
Scope	Meas Global
Remote Command	<code>[:SENSe] :EMC :STANdard [:SELEct] NONE CISPr MIL</code> <code>[:SENSe] :EMC :STANdard [:SELEct] ?</code>
Example	:EMC:STAN CISP
Dependencies	When the EMC Standard changes to CISPR or MIL , the RBW Control key is grayed out. The Filter Type is then always Gaussian; the Filter BW is chosen as appropriate for the filter and the standard. When the EMC Standard changes to None, the Filter Type is set to Gaussian and the Filter BW is set to -3 dB. Only appears with the N6141A or W6141A application or Option EMC installed and licensed. If not, the SCPI command generates a message.
Couplings	The auto rules for detector select Peak for any trace in Auto when the EMI Standard is CISPR or MIL. Choosing a CISPR detector or CISPR presets automatically picks the CISPR Standard, however switching from a CISPR detector has no impact on EMC Standard.
State Saved	Saved in instrument state
Initial S/W Revision	A.02.00

Remote Command	<code>[:SENSe] :BANDwidth BWIDth : [:RESolution] :MODE EMI SAN OFF</code> <code>[:SENSe] :BANDwidth BWIDth : [:RESolution] :MODE ?</code>
Notes	This command is mapped to the EMC:STANdard command with the following mappings: EMI=>CISPr, SAN =>None, and if the legacy command comes in with the OFF parameter, it sets EMC Standard to None and Res BW to Manual . The query returns "OFF" if Res BW in Manual, otherwise "EMI" if EMC Standard is CISPR or MIL, and "SAN" if EMC Standard is None
Dependencies	Only appears with the N6141A or W6141A applications or Option EMC installed and licensed. If not, the SCPI command generates a message.
Preset	SAN
Initial S/W Revision	A.02.00

CISPR presets

Only appears with the N6141A or W6141A application or Option EMC installed and licensed.

This key lets you easily set up the analyzer for CISPR measurements.

This topic contains the following sections:

- "Band Setup" on page 415
- "Sweep Points in Band E" on page 416
- "Number of points in band E" on page 416

Key Path	Mode Setup, CISPR Presets
Remote Command	[:SENSE] :FREQuency :CISPr :BAND A B C CD D E
Example	FREQ:CISPR:BAND A activates the CISPR preset for Band A
Couplings	Selecting a CISPR preset sets the EMI Standard to CISPR, performs an autocouple all, and sets the Y Axis Unit to dB μ V (unless dBuV is grayed out, in which case it will leave the Y Axis Unit unaffected).
Initial S/W Revision	A.02.00

Band Setup

The number of sweep points for each band is roughly calculated by the formula $2 * (\text{Stop Frequency} - \text{Start Frequency}) / \text{RBW}$, so that you get two points for every RBW width. This number is increased as necessary to make it an odd integer, so that you always end up with an odd number of sweep points. This is desirable so that you always have a sweep point at the Center Freq.

Band Setup	Band A	Band B	Band C	Band D	Band C&D	Band E
Start Frequency	9kHz	150kHz	30MHz	300MHz	30MHz	1GHz
Stop Frequency	150kHz	30MHz	300MHz	1GHz	1GHz	Max freq of analyzer or 18 GHz, whichever is lower
Sweep Point	1411	6635	4501	11667	16167	See below

The table above is based on the fact that the Res BW autocouples to the center frequency when in the CISPR EMC standard as follows:

Center Frequency	RBW
<150 kHz	200 Hz
150 kHz to 30 MHz	9 kHz
>30 MHz to 1 GHz	120 kHz
>1 GHz	1 MHz

Sweep Points in Band E

Note that the Res BW will be 1 MHz in band E. The number of sweep points for band E is dependent on the maximum frequency of the analyzer. The formula above gives the following values for Band E:

Number of points in band E

Option	Max Analyzer Freq (nominal)	Width of Band E	Number of Points
503 (3.0 GHz models)	3.0 GHz	2.0 GHz	4001
503 (3.6 GHz models)	3.6 GHz	2.6 GHz	5201
507 (7 GHz models)	7.0 GHz	6.0 GHz	12001
507 (7.5 GHz models)	7.5 GHz	6.5 GHz	13001
508	8.4 GHz	7.4 GHz	14801
513	13.2 GHz	12.2 GHz	24401
526 (and above)	26.5 GHz	17 GHz	34001

Noise Reduction

Noise Reduction accesses a menu for configuring the noise compensation of the instrument. This menu only appears in models that support Noise Reduction.

Key Path	Mode Setup
Initial S/W Revision	A.04.00

Noise Floor Extension

Allows you to turn on the **Noise Floor Extension** function in either of two states, Full or Adaptive.

In Full NFE, the expected noise power of the analyzer (derived from a factory calibration) is subtracted from the trace data. This will usually reduce the apparent noise level by about 10 dB in low band, and 8 dB in high band (>~3.6 GHz).

In Adaptive NFE, there is not the same dramatic visual impact on the noise floor as there is in Full NFE. Adaptive NFE controls the amount of correction that is applied based on other analyzer settings like RBW, averaging and sweep time. Adaptive NFE controls the degree of potential improvement in the noise floor to give more improvement for those analyzer settings that can make good use of the potential improvement, such as settings that provide more averaging. The result is that when not much averaging is being performed, the signal displays more like the NFE-off case; and when lots of averaging is being performed, the signal displays more like the full-NFE case.

Adaptive NFE is recommended for general-purpose use. For fully ATE (automatic test equipment) applications, where the distraction of a person using the instrument is not a risk, Full NFE is recommended.

NFE works with any RBW, VBW, detector, any setting of Average Type, any amount of trace averaging, and any signal type. It is ineffective when the trace is not smoothed (smoothing processes include narrow VBWs, trace averaging, and long sweep times with the detector set to Average or Peak). It works best with extreme amounts of smoothing, and with the average detector, with the Average Type set to Power.

In those cases where the cancellation is ineffective, it nonetheless has no undesirable side-effects. There is no significant speed impact to having **Noise Floor Extension** on.

The best accuracy is achieved when substantial smoothing occurs in each point before trace averaging. Thus, when using the average detector, results are better with long sweep times and fewer trace averages. When using the sample detector, the VBW filter should be set narrow with less trace averaging, instead of a wide VBW filter with more trace averaging.

NOTE

Noise Floor Extensions has no effect unless the RF Input is selected, therefore it does nothing when External Mixing is selected.

With the introduction of Adaptive NFE, in firmware version A.18.00, the default state of NFE is now Adaptive. Before the introduction of Adaptive NFE, NFE was Off by default.

With the introduction of Adaptive NFE, the menu control is changed from On|Off to Full|Adaptive|Off. For SCPI Backwards Compatibility, the existing SCPI command to turn NFE on and off is retained, and a new command is added to set the state to turn Adaptive On and Off, as follows:

- `[:SENSe]:CORRection:NOISe:FLOor ON|OFF|1|0` is retained, default changed to **ON**
- `[:SENSe]:CORRection:NOISe:FLOor:ADAPtive ON|OFF|1|0` is added, default=**ON**, **OFF**=Full

See ["More Information" on page 418](#)

Key Path	Mode Setup, Noise Reduction
Scope	Meas Global
Remote Command	<code>[:SENSe]:CORRection:NOISe:FLOor ON OFF 1 0</code> <code>[:SENSe]:CORRection:NOISe:FLOor?</code>
Example	CORR:NOIS:FLO ON
Dependencies	This key only appears in instruments with the NFE or NF2 license installed. In all others, the key does not appear, however the SCPI command will be accepted without error (but will have no effect).
Couplings	When NFE is enabled in any mode manually, a prompt will be displayed reminding you to perform the Characterize Noise Floor operation if it is needed. If NFE is enabled through SCPI and a Characterize Noise Floor operation is needed, an error will be entered in the system error queue.
Preset	Unaffected by Mode Preset. Turned ON at startup and by Restore Mode Defaults. This is a change, in S/W versions prior to A.18.00, this function was turned OFF at startup and by Restore Mode Defaults
State Saved	No
Initial S/W Revision	A.04.00
Modified at S/W Revision	A.18.00

Key Path	Meas Setup, Advanced
Scope	Meas Global
Remote Command	<code>[:SENSe]:CORRection:NOISe:FLOor:ADAPtive ON OFF 1 0</code> <code>[:SENSe]:CORRection:NOISe:FLOor:ADAPtive?</code>
Example	CORR:NOIS:FLO ON First turn NFE on CORR:NOIS:FLO:ADAP ON Then set it to Adaptive
Dependencies	This control only appears in instruments with the NFE or NF2 license installed. In all others, the control does not appear, however the SCPI command will be accepted without error (but will have no effect).
Couplings	Sending CORR:NOIS:FLO ON turns NFE Adaptive OFF for backwards compatibility. So to turn Adaptive on, you must issue the commands in the proper order, as shown in the example above
Preset	Not affected by Mode Preset, but set to ON at startup and by Restore Mode Defaults
State Saved	No
Initial S/W Revision	A.18.00

More Information

The analyzer is characterized in the factory (or during a field calibration) with a model of the noise, referred to the input mixer, versus frequency in each band and path combination. Bands are 0 (low band) and 1 through 4 (high band) in a 26.5 GHz instrument, for example. Paths include normal paths, preamp paths, the electronic attenuator, etc.

In most band/path combinations, the noise can be well characterized based on just two parameters and the analyzer frequency response before compensation for frequency-dependent losses.

After the noise density at the input mixer is estimated, the effects of the input attenuator, RBW, detector, etc. are computed to get the estimated input-port-referred noise level.

In the simplest case, the measured power (signal plus analyzer noise) in each display point (bucket) is compensated by subtracting the estimated noise power, leaving just the signal power. This is the operation when the detector is Average and the Average Type is set to Power.

In other cases, operation is often not quite as good but still highly effective. With peak detection, the noise floor is estimated based on the RBW and the duration of the bucket using the same equations used in the noise marker function. The voltage of the noise is subtracted from the voltage of the observed signal-plus-noise measurement to compute the estimated signal voltage. The peak detector is one example of processing that varies with detector to give good estimates of the signal level without the analyzer noise.

For best operation, the average detector and the power scale are recommended, as already stated. Peak detection for pulsed-RF can still give excellent effectiveness. FFT analysis does not work well, and does not do NFE well, with pulsed-RF signals, so this combination is not recommended. Negative peak detection is not very useful, either. Sample detection works well, but is never better than the average detector because it doesn't smooth as well. The Normal detector is a combination of peak and negative peak behaviors, and works about as well as these.

For best operation, extreme smoothing is desirable, as already stated. Using narrow VBWs works well, but using very long bucket durations and the average detector works best. Reducing the number of trace points will make the buckets longer.

For best operation, the power scale (Average Type = Power) is optimum. When making CW measurements in the presence of noise without NFE, averaging on the decibel scale has the advantage of reducing the effect of noise. When using NFE, the NFE does an even better job than using the log scale ever could. Using NFE with the log scale is not synergistic, though; NFE with the power scale works a little better than NFE with log averaging type.

The results from NFE with internal preamp can often be lower than the theoretical noise in a signal source at room temperature, a noise density of -174 dBm/Hz. This is expected and useful behavior, because NFE is designed to report the amount of input signal that is in excess of the thermal noise, not the amount that includes the thermal noise. This can be a useful behavior because thermal noise often interferes with what you want to measure, instead of being part of what you want to measure. Note that NFE is not adequately accurate to always be able to read below kTB.

On instruments with the NF2 license installed, the calibrated Noise Floor used by Noise Floor Extensions should be refreshed periodically. Keysight recommends that the **Characterize Noise Floor** operation be performed after the first 500 hours of operation, and once every calendar year. The key to perform this is located in the **System, Alignments, Advanced** menu. If you have not done this yourself at the

recommended interval, then when you turn on Noise Floor Extensions, the analyzer will prompt you to do so with a dialog that says:

“This action will take several minutes to perform. Please disconnect all cables from the RF input and press Enter to proceed. Press ESC to cancel, or Postpone to postpone for a week.”

If you Cancel, you will be prompted again the next time you turn NFE on. If you postpone, you will be prompted again after a week passes and you then turn NFE on.

Global Settings

Opens a menu that allows you to switch certain Meas Global parameters to a Mode Global state. These switches apply to all Modes that support global settings. No matter what Mode you are in when you set the “Global Center Frequency” switch to on, it applies to all Modes that support Global Settings.

Key Path	Mode Setup
Initial S/W Revision	Prior to A.02.00

Global Center Freq

The software maintains a Mode Global value called “Global Center Freq”.

When the **Global Center Freq** key is switched to **On** in any mode, the current mode’s center frequency is copied into the Global Center Frequency, and from then on all modes that support global settings use the Global Center Frequency. So you can switch between any of these modes and the Center Freq will remain unchanged.

Adjusting the Center Freq of any mode which supports Global Settings, while **Global Center Freq** is **On**, will modify the Global Center Frequency.

When **Global Center Freq** is turned **Off**, the Center Freq of the current mode is unchanged, but now the Center Freq of each mode is once again independent.

When **Mode Preset** is pressed while **Global Center Freq** is **On**, the Global Center Freq is preset to the preset Center Freq of the current mode.

This function is reset to Off when the Restore Defaults key is pressed in the Global Settings menu, or when **System, Restore Defaults, All Modes** is pressed.

Key Path	Mode Setup, Global Settings
Scope	Mode Global
Remote Command	:INSTrument:COUPlE:FREQuency:CENTer ALL NONE :INSTrument:COUPlE:FREQuency:CENTer?
Example	INST:COUP:FREQ:CENT ALL INST:COUP:FREQ:CENT?
Preset	Set to Off on Global Settings, Restore Defaults and System, Restore Defaults, All Modes

Range	On Off
Initial S/W Revision	Prior to A.02.00
Remote Command	
	:GLOBal:FREQuency:CENTer[:STATe] 1 0 ON OFF
	:GLOBal:FREQuency:CENTer[:STATe]?
Preset	Off
Initial S/W Revision	Prior to A.02.00

Global EMC Std

When the Global EMC Std key is switched to On in any mode, the current mode's EMC Std is copied into the Global EMC Std, and from then on all modes that support global settings use the Global EMC Std. So you can switch between any of these modes and the EMC Std will remain unchanged.

Adjusting the EMC Std of any mode that supports Global Settings, while Global EMC Std is On, will modify the Global EMC Std.

When Global EMC Std is turned Off, the EMC Std of the current mode is unchanged, but now the EMC Std of each mode is once again independent. When Mode Preset is pressed while Global EMC Std is On, the Global EMC Std is preset to the preset EMC Std of the current mode.

This function is reset to Off when the Restore Defaults key is pressed in the Global Settings menu, or when System, Restore Defaults, All Modes is pressed.

Key Path	Mode Setup, Global Settings
Scope	Mode Global
Remote Command	:INSTrument:COUPle:EMC:STANdard ALL NONE :INSTrument:COUPle:EMC:STANdard?
Example	INST:COUP:EMC:STAN ALL INST:COUP:EMC:STAN?
Preset	Set to Off on Global Settings, Restore Defaults and System, Restore Defaults, All Modes
Range	On Off
Initial S/W Revision	A.07.00

Restore Defaults

This key resets all of the functions in the Global Settings menu to Off. This also occurs when **System, Restore Defaults, All Modes** is pressed.

Key Path	Mode Setup, Global Settings
----------	------------------------------------

Remote Command	:INSTrument:COUPle:DEFault
Example	INST:COUP:DEF
Backwards Compatibility SCPI	:GLOBa1:DEFault
Initial S/W Revision	Prior to A.02.00

Legacy Compatibility

Certain behaviors in the X-Series analyzers were changed from legacy analyzers, in order to give users access to new, more powerful functionality. Keysight recognizes that from time to time, it is necessary to EXACTLY match legacy behaviors. The Legacy Compatibility menu lets you modify certain X-Series behaviors to exactly match our legacy products.

Key Path	Mode Setup
Initial S/W Revision	A.11.00

Average/Hold

In the X-Series analyzers, Max Hold and Min Hold traces were added to the trace types that were controlled by the Average Number (which became the Average/Hold Number). In other words, setting an Average/Hold number of 100 and then performing a Max Hold in Single sweep takes 100 traces and then stops, and pressing Restart restarts the Max Hold Sequence. This allows the user to exactly control how the number of Max Hold traces taken; however many users need a way of stopping and then resuming a Max/Min Hold without clearing the accumulated result.

In the past you could stop and start Max Hold by going back and forth between Single and Continuous. Currently, neither the X-Series nor the legacy analyzers like ESA and PSA clear the Max or Min Hold when going from Cont to Single and vice versa; so you can go to Single to stop temporarily and then resume the Max or Min Hold by going back to Cont. However, in the X-Series, because Max and Min Hold obey the Average/Hold number, this is not an effective method for stopping a sweep, until you have reached the terminal count. Also, Restart is sometimes used as part of this method and in the X-Series, Restart clears the accumulated Max/Min Hold, whereas in the PSA (for example) it does not.

The Average/Hold switch in the Legacy Compatibility menu solves this problem. When this switch is in the “Legacy” position, the following is true for traces in Max Hold or Min Hold:

- They pay no attention to the Average/Hold number; “Single” for Max Hold and Min Hold causes one sweep only, so going to Single stops after the current sweep, and going to Cont starts you going again without clearing the

accumulated result

- They don't clear the Max or Min Hold on a Restart or Single or INIT:IMM (changing a measurement parameter like frequency or bandwidth, etc. would still restart the max/min hold).

Note that whenever any trace is in Average, the Single/Cont controls DO tie in to the Avg/Hold number and pressing Single WILL cause a set of sweeps (100 by default). This is also true in PSA.

Key Path	Mode Setup, Legacy Compatibility
Remote Command	:CONTrol:COMPAtible:TRACe ON OFF 1 0 :CONTrol:COMPAtible:TRACe?
Example	CONT:COMP:TRAC ON ON means exhibit legacy average/hold behavior
Preset	Unaffected by Mode Preset. Set to OFF by Restore Mode Defaults.
State Saved	Saved in State
Initial S/W Revision	A.11.00

Restore Mode Defaults

Resets the state for the currently active mode by resetting the mode persistent settings to their factory default values, clearing mode data and by performing a Mode Preset. This function will never cause a mode switch. This function performs a full preset for the currently active mode; whereas, Mode Preset performs a partial preset. Restore Mode Defaults does not affect any system settings. System settings are reset by the Restore System Defaults function. This function does reset mode data; as well as settings.

Key Path	Mode Setup
Remote Command	:INSTrument:DEFault
Example	:INST:DEF
Notes	Clears all pending OPC bits. The Status Byte is set to 0. A message comes up saying: "If you are sure, press key again".
Couplings	A Restore Mode Defaults will cause the currently running measurement to be aborted and causes the default measurement to be active. It gets the mode to a consistent state with all of the default couplings set.
Initial S/W Revision	Prior to A.02.00

Preset Type (Remote Command Only)

As stated in the Backward Compatibility section, to be compatible with ESA/PSA the PRESet:TYPE command will be implemented as a no-op.

Mode	All
Remote Command	:SYSTem:PRESet:TYPE FACTory MODE USER

	:SYSTem:PRESet:TYPE?
Example	:SYST:PRES:TYPE FACT
Notes	This command is supported for backward compatibility only. It is a no-op which does not change the behavior of any preset operation.
Preset	This is unaffected by Preset but is set to Mode on a "Restore System Defaults->All"
State Saved	No
Initial S/W Revision	Prior to A.02.00

6 System Functions

File

Opens a menu that enables you to access various standard and custom Windows functions. Press any other front-panel key to exit

Key Path	Front-panel key
Initial S/W Revision	Prior to A.02.00

File Explorer

Opens the standard Windows File Explorer. The File Explorer opens in the My Documents directory for the current user.

The File Explorer is a separate Windows application, so to return to the analyzer once you are in the File Explorer, you may either:

Exit the File Explorer by clicking on the red X in the upper right corner, with a mouse

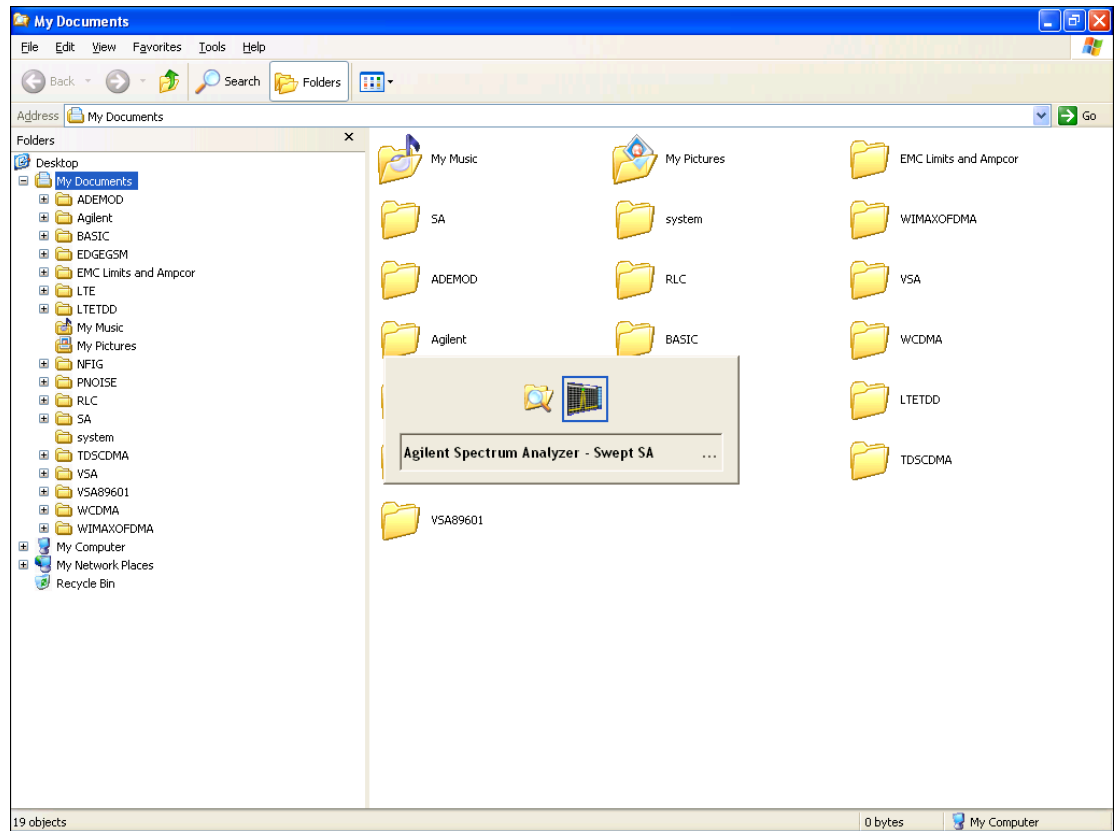

Or use Alt-Tab: press and hold the Alt key and press and release the Tab key until the Analyzer logo is showing in the window in the center of the screen, as shown above, then release the Alt key.

The ability to access File Explorer is not available if Option SF1 is installed.

Key Path	File
Initial S/W Revision	Prior to A.02.00

Print

The Print key opens a Print dialog for configured printing (for example, to the printer of your choice). Refer to your Microsoft Windows Operating System manual for more information.

Page Setup

The Page Setup key brings up a Windows Page Setup dialog that allows you to control aspects of the pages sent to the printer when the PRINT hardkey is pressed.

Key Path	File
Initial S/W Revision	Prior to A.02.00

Paper size, the printer paper source, the page orientation and the margins are all settable. Just like any standard Windows dialog, you may navigate the dialog using the front-panel keys, or a mouse. There are no SCPI commands for controlling these parameters.

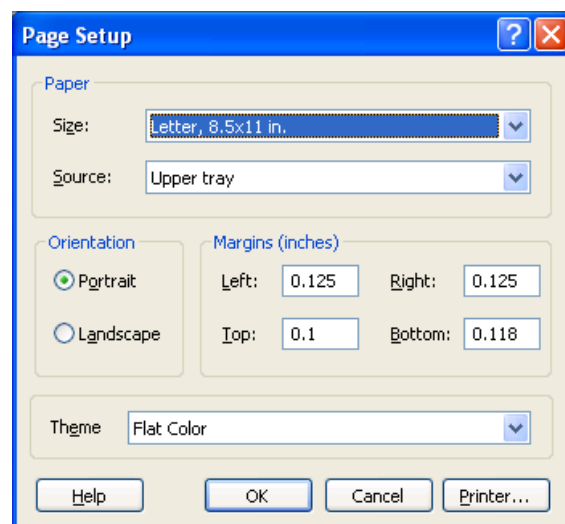

Also contained in this dialog is a drop-down control that lets you select the Theme to use when printing. For more on Themes, see information under View/Display, Display, System Display Settings, Theme. The Theme control has a corresponding SCPI command.

Parameter Name	Print Themes
Parameter Type	Enum
Mode	All
Remote Command	:SYSTem:PRINT:THEMe TDCoLor TDMonochrome FCOLor FMONochrome

	:SYSTem:PRINt:THEMe?
Example	:SYST:PRIN:THEM FCOL
Setup	:SYSTem:DEFault MISC
Preset	FCOL; not part of Preset, but is reset by Restore Misc Defaults or Restore System Defaults All and survives subsequent running of the modes.
State Saved	No
Initial S/W Revision	Prior to A.02.00

Print

This front-panel key is equivalent to performing a File, Print, OK. It immediately performs the currently configured Print to the Default printer.

The :HCOPY command is equivalent to pressing the PRINT key. The HCOpy:ABORt command can be used to abort a print which is already in progress. Sending HCOpy:ABORt will cause the analyzer to stop sending data to the printer, although the printer may continue or even complete the print, depending on how much data was sent to the printer before the user sent the ABORt command.

Key Path	Front-panel key
Remote Command	:HCOPY[:IMMEDIATE]
Initial S/W Revision	Prior to A.02.00

Key Path	SCPI command only
Remote Command	:HCOPY:ABORt
Initial S/W Revision	Prior to A.02.00

Restore Down

This key allows you to Restore Down the Instrument Application and reverses the action taken by Maximize. This key is only visible when the application has been maximized, and after the Restore Down action has been completed this key is replaced by the Maximize key.

Key Path	File
Mode	All
Notes	No equivalent remote command for this key.
State Saved	No
Initial S/W Revision	A.05.01

Minimize

The Minimize key causes the analyzer display to disappear down into the task bar, allowing you to see the Windows Desktop. You can use Alt-Tab (press and hold the

Alt  key and press and release the Tab key) to restore the analyzer display.

Key Path	File
Mode	All
Notes	No equivalent remote command for this key.
State Saved	No
Initial S/W Revision	A.05.01

Exit

This key, when pressed, will exit the Instrument Application. A dialog box is used to confirm that you intended to exit the application:

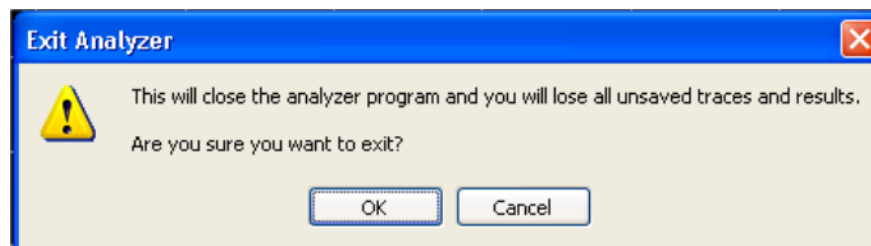

Key Path	File
Mode	All
Notes	The Instrument Application will close. No further SCPI commands can be sent. Use with caution!
Initial S/W Revision	Prior to A.02.00

Print

This front-panel key is equivalent to performing a File, Print, OK. It immediately performs the currently configured Print to the Default printer.

The :HCOPY command is equivalent to pressing the PRINT key. The HCOPY:ABORT command can be used to abort a print which is already in progress. Sending HCOPY:ABORT will cause the analyzer to stop sending data to the printer, although the printer may continue or even complete the print, depending on how much data was sent to the printer before the user sent the ABORT command.

Key Path	Front-panel key
Remote Command	:HCOPY[:IMMEDIATE]
Initial S/W Revision	Prior to A.02.00

Key Path	SCPI command only
Remote Command	:HCOPY:ABORT
Initial S/W Revision	Prior to A.02.00

System

Opens a menu of keys that access various configuration menus and dialogs.

Key Path	Front-panel key
Notes	No remote command for this key specifically.
Initial S/W Revision	Prior to A.02.00

Show

Accesses a menu of choices that enable you to select the information window you want to view.

Key Path	System
Mode	All
Remote Command	:SYSTem:SHOW OFF ERRor SYSTem HARDware LXI HWSTatistics ALIGNment SOFTware CAPPlIcation :SYSTem:SHOW?
Example	:SYST:SHOW SYST
Notes	This command displays (or exits) the various System information screens.
Preset	OFF
State Saved	No
Range	OFF ERRor SYSTem HARDware LXI HWSTatistics ALIGNment SOFTware CAPPlIcation
Initial S/W Revision	Prior to A.02.00

Errors

There are two modes for the Errors selection, History and Status.

The list of errors displayed in the Errors screen does not automatically refresh. You must press the Refresh key or leave the screen and return to it to refresh it.

History brings up a screen displaying the event log in chronological order, with the newest event at the top. The history queue can hold up to 100 messages (if a message has a repeat count greater than 1 it only counts once against this number of 100). Note that this count bears no relation to the size of the SCPI queue. If the queue extends onto a second page, a scroll bar appears to allow scrolling with a mouse. Time is displayed to the second.

Status brings up a screen summarizing the status conditions currently in effect. Note that the time is displayed to the second.

The fields on the Errors display are:

Type (unlabeled) - Displays the icon identifying the event or condition as an error or warning.

ID - Displays the error number.

Message - Displays the message text.

Repeat (RPT) - This field shows the number of consecutive instances of the event, uninterrupted by other events. If an event occurs 5 times with no other intervening event, the value of repeat will be 5.

If the value of Repeat is 1 the field does not display. If the value of Repeat is >1, the time and date shown are those of the most recent occurrence. If the value of repeat reaches 999,999 it stops there.

Time - Shows the most recent time (including the date) at which the event occurred.

Key Path	System, Show
Mode	All
Remote Command	:SYSTem:ERRor[:NEXT]?
Example	:SYST:ERR?
Notes	The return string has the format: “<Error Number>,<Error>” Where <Error Number> and <Error> are those shown on the Show Errors screen
Backwards Compatibility Notes	In some legacy analyzers, the Repeat field shows the number of times the message has repeated since the last time the error queue was cleared. In the X-Series, the Repeat field shows the number of times the error has repeated since the last intervening error. So the count may very well be different than in the past even for identical signal conditions Unlike previous analyzers, in the X-Series all errors are reported through the Message or Status lines and are logged to the event queue. They never appear as text in the graticule area (as they sometimes do in previous analyzers) and they are never displayed in the settings panel at the top of the screen (as they sometimes do, by changing color, in previous analyzers). As a consequence of the above, the user can only see one status condition (the most recently generated) without looking at the queue. In the past, at least in the Spectrum Analyzer, multiple status conditions might display on the right side of the graticule. In general, there is no backwards compatibility specified or guaranteed between the error numbers in the X-Series and those of earlier products. Error, event, and status processing code in customers' software will probably need to be rewritten to work with X-Series. In the legacy analyzers, some conditions report as errors and others simply turn on status bits. Conditions that report as errors often report over and over as long as the condition exists. In the X-series, all conditions report as start and stop events. Consequently, software that repeatedly queries for a condition error until it stops reporting will have to be rewritten for the X-series.
Initial S/W Revision	Prior to A.02.00

Previous Page

See ["Next Page" on page 440.](#)

Key Path	System, Show, Errors
Initial S/W Revision	Prior to A.02.00

Next Page

Next Page and Previous Page menu keys move you between pages of the log, if it fills more than one page. These keys are grayed out in some cases:

- If on the last page of the log, the Next Page key is grayed-out
- If on the first page of the log, the Previous Page key is grayed-out.
- If there is only one page, both keys are grayed out.

Key Path	System, Show, Errors
Initial S/W Revision	Prior to A.02.00

History

The History and Status keys select the Errors view. The Status key has a second line that shows a number in [square brackets]. This is the number of currently open status items.

Key Path	System, Show, Errors
Initial S/W Revision	Prior to A.02.00

Status

See ["History" on page 433](#).

Verbose SCPI On/Off

When you turn Verbose SCPI on, additional information is returned when you send the :SYSTem:ERRor? query. The additional information consists of the characters that stimulated the error. This can aid you in debugging your test programs by indicating where in the parsing of a SCPI command the instrument encountered an invalid command or query.

Specifically, with Verbose SCPI on, the SYSTem:ERRor? query is expanded to show the SCPI data received, with the indicator <Err> at the point in the stream that the error occurred.

Verbose SCPI has no effect on the Show Errors screen or front panel Message Line; it only changes the response to the :SYST:ERR? query.

See the example below, where the invalid command "SENS:BOGUS" is sent:

Normal response to :SYST:ERR (using the Telnet window):

```
SCPI> SENS:BOGUS
```

```
SCPI> SYST:ERR?
```

```
-113,"Undefined header"
```

Now after turning on Verbose SCPI:

```
SCPI> SYST:BOGUS
```

```
SCPI> SYST:ERR?
-113,"Undefined header;SYST:BOGUS<Err>"
```

Key Path	System, Show, Errors
Mode	All
Remote Command	:SYSTem:ERRor:VERBoSe OFF ON 0 1 :SYSTem:ERRor:VERBoSe?
Example	:SYST:ERR:VERB ON
Preset	This is unaffected by Preset but is set to OFF on a "Restore System Defaults->Misc"
State Saved	No
Range	On Off
Initial S/W Revision	Prior to A.02.00

Refresh

When pressed, refreshes the Show Errors display.

Key Path	System, Show, Errors
Initial S/W Revision	Prior to A.02.00

Clear Error Queue

This clears all errors in all error queues.

Note the following:

- Clear Error Queue does not affect the current status conditions.
- Mode Preset does not clear the error queue.
- Restore System Defaults will clear all error queues.
- *CLS only clears the queue if it is sent remotely and *RST does not affect any error queue.
- Switching modes does not affect any error queues.

Key Path	System, Show, Errors
Initial S/W Revision	Prior to A.02.00

Input Overload Enable (Remote Command Only)

Input Overload errors are reported using the Input Overload status bit (bit 12 in the Measurement Integrity status register). Input Overloads (for example, ADC Overload errors) can come and go with great frequency, generating many error events (for example, for signals just on the verge of overload), and so are not put into the SCPI error queue by default. Normally the status bit is the only way for detecting these errors remotely.

It is possible to enable Input Overload reporting to the SCPI queue, by issuing the :SYSTEM:ERROR:OVERload ON command. To return to the default state, issue the :SYSTEM:ERROR:OVERload OFF command. In either case, Input Overloads always set the status bit.

NOTE

For versions of firmware before A.10.01, the Input Overload was only a Warning and so was never available in the SCPI queue, although it did set the status bit. For A.10.01 and later, the Input Overload is an error and can be enabled to the SCPI queue using this command.

Key Path	SCPI only
Remote Command	:SYSTem:ERRor:OVERload[:STATe] 0 1 OFF ON
Example	:SYST:ERR:OVER 1 Enable overload errors
Preset	Set to OFF by Restore Misc Defaults (no Overload errors go to SCPI)
State Saved	Saved in instrument state.
Initial S/W Revision	A.10.01

Power Up (Remote Command Only)

This serves to show the errors encountered during the application boot-up, such as: mismatch FW-FPGA, missing Calibration data, missing hardware and construction errors.

Remote Command	:SYSTem:ERRor:PUP?
Notes	<p>If no error occurs, the return value will be: "No Power Up Errors." Return Value: <list of error strings>. <List of error strings> is an <IEEE488 Block> format. Return Value Example: "Power up errors, see details in Windows Event Log" "Unmatched FPGA Version(s), See details in Windows Event Log"</p>
Initial S/W Revision	E.14.30

System

The System screen is formatted into three groupings: product descriptive information, options tied to the hardware, and software products:

```

<Product Name> <Product Description>
Product Number: N9020A
Serial Number: US46220924
Firmware Revision: A.01.01
Computer Name: <hostname>
Host ID: N9020A,US44220924

N9020A-503      Frequency Range to 3.6 GHz
N9020A-PFR      Precison Frequency Reference
N9020A-P03      Preamp 3.6 GHz

N9060A-2FP      Spectrum Analysis Measurement Suite  1.0.0.0
N9073A-1FP      WCDMA 1.0.0.0
N9073A-2FP      WCDMA with HSDPA 1.0.0.0
    
```

The Previous Page is grayed-out if the first page of information is presently displayed. The Next Page menu key is grayed-out if the last page is information is presently displayed.

Key Path	System, Show
Mode	All
Example	SYST:SHOW SYST
Backwards Compatibility Notes	The hardware statistics that are displayed in the PSA Show System screen have been moved to a dedicated Show Hardware Statistics screen in the Service Menu.
Initial S/W Revision	Prior to A.02.00

Show System contents (Remote Command Only)

A remote command is available to obtain the contents of the Show System screen (the entire contents, not just the currently displayed page).

Remote Command	:SYSTem:CONFIgure[:SYSTem]?
Example	:SYST:CONF?
Notes	The output is an IEEE Block format of the Show System contents. Each line is separated with a new-line character.
Initial S/W Revision	Prior to A.02.00

Computer System description (Remote Command Only)

A remote command is available to obtain the Computer System description. The Computer System is the operating system and patch level as reported by operating system.

Remote Command	:SYSTem:CSYSTem?
-----------------------	-------------------------

LXI

This key shows you the product number, serial number, firmware revision, computer name, IP address, Host ID, LXI Class, LXI Version, MAC Address, and the Auto-MDIX Capability.

Key Path	System, Show
Initial S/W Revision	Prior to A.02.00

Support Subscriptions

Shows you the software support subscription information for the licenses you have available on the instrument. It shows the software license, description, software support expiration date (format is YYYY.MMDD), and the software support status. The Software Version Date (format is YYYY.MMDD) shown in the header indicates the date required to access the latest software enhancements included in this version of the software. If any license has a software support expiration date earlier than the Software Version Date, then there may be enhancements available that the license does not enable.

Keysight MXA	Keysight MXA Signal Analyzer		
Product Number	N9020A		
Instrument S/W Revision	A.20.10		
Software Version Date	2017.1221		
Software License	Description	SW Sup Exp	SW Support Status
N6141EM0D-1FP	EMI Measurement Application	2018.0430	OK
N6141EM0E-1NP	EMC Software for X-Series (Network)	2019.0123	OK
N6152EM0D-1FP	Digital Cable TV Measurement App, DVB-C (J.83...	2018.0430	OK
N6153EM0D-1FP	DVB Measurement Application	2018.0430	OK
N6155EM0D-1FP	ISDB Measurement Application	2018.0430	OK
N6156EM0D-1FP	DTMB Measurement Application	2018.0430	OK
N9020EMCA-1FP	Basic Electro-Magnetic Compatibility Functionality	2018.0430	OK
N9020FP2A-1FP	Fast Power Measurements, up to 40 MHz bandw...	2018.0430	OK
N9020FT2A-1FP	Frequency Mask Trigger >3.6 us signal duration	2018.0430	OK
N9020RBEA-1FP	RBW Extended, >10 MHz RBW Filter	2018.0430	OK
N9020RT2A-1FP	Real-time analysis up to maximum BW, optimum ...	2018.0430	OK
N9020TDSA-1FP	Time Domain Scan, requires N6141A/C, and DP2...	2018.0430	OK
N9061EM0D-1FP	Remote Language Compatibility	2018.0430	OK
N9062EM0D-1FP	RS FSP, FSU, FSE SCPI Language Compatibility	2018.0430	OK
N9063EM0D-1FP	Analog Demod Measurement Application	2018.0430	OK
N9063EM0E-1NP	Analog Demod Measurement Application (Netwo...	2019.0206	OK
N9064EM0D-1FP	Vector Signal Analysis App, VXA	2018.0430	OK
N9065EM0D-1FP	Sequence Analyzer for BTS Applications	2018.0430	OK
N9068EM0D-1FP	Phase Noise Measurement Application	2018.0430	OK
N9068EM0E-1NP	Phase Noise Measurement Application (Network)	2019.0206	OK
N9069EM0D-1FP	Noise Figure Measurement Application	2018.0430	OK

Key Path	System, Show
Initial S/W Revision	A.20.10

Next Page

Next Page and Previous Page menu keys move you between pages of the log, if it fills more than one page. These keys are grayed out in some cases:

- If on the last page of the log, the Next Page key is grayed-out
- If on the first page of the log, the Previous Page key is grayed-out.
- If there is only one page, both keys are grayed out.

Key Path	System, Show, Errors
Initial S/W Revision	Prior to A.02.00

Previous Page

See ["Next Page" on page 440](#).

Key Path	System, Show, Errors
Initial S/W Revision	Prior to A.02.00

Sort By

Key Path	System, Show, Support Subscriptions
Initial S/W Revision	A.20.10

SW Support Status

Sorts the data in the SW Support table by the SW Support Status column.

Key Path	System, Show, Support Subscriptions
Initial S/W Revision	A.20.10

SW Sup Exp

Sorts the data in the SW Support table by the SW Sup Exp column.

Key Path	System, Show, Support Subscriptions
Initial S/W Revision	A.20.10

Software License

Sorts the data in the SW Support table by the Software License column.

Key Path	System, Show, Support Subscriptions
Initial S/W Revision	A.20.10

Support ID

This key shows you the Support ID for each license available for the instrument. It shows the software license, descriptions, software support expiration date, and the Support ID for that license.

Keysight MXA	Keysight MXA Signal Analyzer		
Product Number	N9020A		
Instrument S/W Revision	A.20.10		
Software Version Date	2017.1221		
Software License	Description	Version	Support ID
N6141EM0D-1FP	EMI Measurement Application	2018.0430	N9020A,MY52330011
N6141EM0E-1NP	EMC Software for X-Series (Network)	2019.0123	705A0F491DBB
N6152EM0D-1FP	Digital Cable TV Measurement App, DVB-C (J.8...	2018.0430	N9020A,MY52330011
N6153EM0D-1FP	DVB Measurement Application	2018.0430	N9020A,MY52330011
N6155EM0D-1FP	ISDB Measurement Application	2018.0430	N9020A,MY52330011
N6156EM0D-1FP	DTMB Measurement Application	2018.0430	N9020A,MY52330011
N9020EMCA-1FP	Basic Electro-Magnetic Compatibility Functiona...	2018.0430	N9020A,MY52330011
N9020FP2A-1FP	Fast Power Measurements, up to 40 MHz band...	2018.0430	N9020A,MY52330011
N9020FT2A-1FP	Frequency Mask Trigger >3.6 us signal duration	2018.0430	N9020A,MY52330011
N9020RBEA-1FP	RBW Extended, >10 MHz RBW Filter	2018.0430	N9020A,MY52330011
N9020RT2A-1FP	Real-time analysis up to maximum BW, optimu...	2018.0430	N9020A,MY52330011
N9020TDSA-1FP	Time Domain Scan, requires N6141A/C, and D...	2018.0430	N9020A,MY52330011
N9061EM0D-1FP	Remote Language Compatibility	2018.0430	N9020A,MY52330011
N9062EM0D-1FP	RS FSP, FSU, FSE SCPI Language Compatibil...	2018.0430	N9020A,MY52330011
N9063EM0D-1FP	Analog Demod Measurement Application	2018.0430	N9020A,MY52330011
N9063EM0E-1NP	Analog Demod Measurement Application (Netw...	2019.0206	705A0F491DBB
N9064EM0D-1FP	Vector Signal Analysis App, VXA	2018.0430	N9020A,MY52330011
N9065EM0D-1FP	Sequence Analyzer for BTS Applications	2018.0430	N9020A,MY52330011
N9068EM0D-1FP	Phase Noise Measurement Application	2018.0430	N9020A,MY52330011
N9068EM0E-1NP	Phase Noise Measurement Application (Network)	2019.0206	705A0F491DBB
N9069EM0D-1FP	Noise Figure Measurement Application	2018.0430	N9020A,MY52330011

Key Path	System, Show
Initial S/W Revision	A.20.10

Next Page

Next Page and Previous Page menu keys move you between pages of the log, if it fills more than one page. These keys are grayed out in some cases:

- If on the last page of the log, the Next Page key is grayed-out
- If on the first page of the log, the Previous Page key is grayed-out.
- If there is only one page, both keys are grayed out.

Key Path	System, Show, Errors
Initial S/W Revision	Prior to A.02.00

Previous Page

See "Next Page" on page 440.

Key Path	System, Show, Errors
Initial S/W Revision	Prior to A.02.00

Sort By

Key Path	System, Show, Support ID
Initial S/W Revision	A.20.10

Software License

Sorts the data in the Support ID table by the Software License column.

Key Path	System, Show, Support ID
Initial S/W Revision	A.20.10

Support ID

Sorts the data in the Support ID table by the Support ID column.

Key Path	System, Show, Support ID
Initial S/W Revision	A.20.10

Version

Sorts the data in the Support ID table by the Version column.

Key Path	System, Show, Support ID
Initial S/W Revision	A.20.10

Copy All To Clipboard

Copies all the data in the table to the Windows clipboard. The data is in comma-separated values (CSV) format.

Key Path	System, Show, Support ID
Initial S/W Revision	A.20.10

Power On

Enables you to select how the instrument should power on. The options are: Mode and Input/Output Defaults, User Preset and Last State.

Key Path	System
Mode	All
Remote Command	:SYSTem:PON:TYPE MODE USER LAST :SYSTem:PON:TYPE?

Example	:SYST:PON:TYPE MODE
Preset	This is unaffected by a Preset but is set to Mode on a “Restore System Defaults->All”
State Saved	No
Backwards Compatibility SCPI	:SYSTem:PON:TYPE PRESet
	the “PRESet” parameter is supported for backward compatibility only and behaves the same as MODE.
Backwards Compatibility Notes	The Preset Type key in legacy analyzers has been removed, and the Power On toggle key has been replaced by this 1-of-N key in the System menu.
Initial S/W Revision	Prior to A.02.00

Mode and Input/Output Defaults

When the analyzer is powered on in Mode and Input/Output Defaults, it performs a Restore Mode Defaults to all modes in the instrument and also performs a Restore Input/Output Defaults.

Persistent parameters (such as Amplitude Correction tables or Limit tables) are not affected at power on, even though they are normally cleared by Restore Input/Output Defaults and/or Restore Mode Defaults.

Key Path	System, Power On
Mode	All
Example	SYST:PON:TYPE MODE
Readback Text	Defaults
Initial S/W Revision	Prior to A.02.00

User Preset

Sets **Power On** to **User Preset**. When the analyzer is powered on in User Preset, it will User Preset each mode and switch to the power-on mode. Power On User Preset will not affect any settings beyond what a normal User Preset affects.

NOTE

An instrument could never power up for the first time in User Preset.

Key Path	System, Power On
Mode	All
Example	SYST:PON:TYPE USER
Readback Text	User Preset
Backwards Compatibility Notes	Power On User Preset will cause the instrument to power up in the power-on mode, not the last mode the instrument was in prior to shut down. Also, Power On User Preset will User Preset all modes. This does not exactly match legacy behavior.
Initial S/W Revision	Prior to A.02.00

Last State

Sets **Power On** to **Last**. When the analyzer is powered on, it will put all modes in the last state they were in prior to when the analyzer was put into Power Standby and it will wake up in the mode it was last in prior to powering off the instrument. The saving of the active mode prior to shutdown happens behind the scenes when a controlled shutdown is requested by using the front panel power **Standby** key or by using the remote command **SYSTem:PDOWn**. The non-active modes are saved as they are deactivated and recalled by Power On Last State.

NOTE

An instrument can never power up for the first time in Last.

If line power to the analyzer is interrupted, for example by pulling the line cord plug or by switching off power to a test rack, Power On Last State may not work properly. For proper operation, Power On Last State depends on you shutting down the instrument using the Standby key or the SYSTem:PDOWn SCPI command. This will ensure the last state of each mode is saved and can be recalled during a power up.

Key Path	System, Power On
Mode	All
Example	SYST:PON:TYPE LAST
Notes	Power on Last State only works if you have done a controlled shutdown prior to powering on in Last. If a controlled shutdown is not done when in Power On Last State, the instrument will power up in the last active mode, but it may not power up in the active mode's last state. If an invalid mode state is detected, a Mode Preset will occur. To control the shutdown under remote control use the :SYSTem:PDOWn command.
Readback Text	Last State
Backwards Compatibility Notes	It is no longer possible to power-up the analyzer in the last mode the analyzer was running with that mode in the preset state. (ESA/PSA SYST:PRESET:TYPE MODE with SYST:PON:PRESET) You can power-on the analyzer in the last mode the instrument was running in its last state (SYST:PON:TYPE LAST), or you can specify the mode to power-up in its preset state (SYST:PON:MODE <mode>).
Initial S/W Revision	Prior to A.02.00

Power On Application

Accesses a menu that lists the available Modes and lets you select which Mode is to be the power-on application.

This application is used for Power On Type "Mode and Input/Output Defaults" and Restore System Defaults All.

Key Path	System, Power On
Mode	All
Remote Command	:SYSTem:PON:MODE <mode> where <mode> is the identical list from the :INSTrument[:SElect] command :SYSTem:PON:MODE?

Example	SYST:PON:MODE SA
Notes	The list of possible modes (and remote parameters) to choose from is dependent on which modes are installed in the instrument.
Preset	This is unaffected by a Preset but is set on a "Restore System Defaults->All" to: For N9038A: EMI For N8973B, N8974B, N8975B, or N8976B: NFIG For all other models: SA
State Saved	No
Initial S/W Revision	Prior to A.02.00

Configure Applications

The Configure Applications utility can be used to:

- select applications for preload
- determine how many applications can fit in memory at one time
- specify the order of the Modes in the Mode menu.

This utility consists of a window with instructions, a set of "Select Application" checkboxes, a "fuel bar" style memory gauge, and keys that help you set up your configuration.

For more information, see the following topics:

["Preloading Applications" on page 444](#)

["Access to Configure Applications utility" on page 445](#)

["Virtual memory usage" on page 445](#)

Key Path	System, Power On
Example	:SYST:SHOW CAPP Displays the Config Applications screen
Initial S/W Revision	A.02.00

Preloading Applications

During runtime, if a Mode that is not preloaded is selected using the Mode menu or sending SCPI commands, there will be a pause while the Application is loaded. During this pause a message that says "Loading application, please wait ..." is displayed. Once loaded, the application stays loaded, so the next time you select it during a session, there is no delay.

Preloading enables you to "preload" at startup, to eliminate the runtime delay. Preloading an application will cause it to be loaded into the analyzer's memory when the analyzer program starts up. If you do this, the delay will increase the time it takes

to start up the analyzer program, but this may be preferable to having to wait the first time you select an application. Note that, once an application is loaded into memory, it cannot be unloaded without exiting and restarting the analyzer program.

Note that there are more applications available for the X-Series than can fit into Windows Virtual Memory. By allowing you to choose which licensed applications to load at startup, the Configure Applications utility allows you to make optimal use of your memory.

Access to Configure Applications utility

A version of the utility runs the first time you power up the analyzer after purchasing it from Keysight. The utility automatically configures preloads so that as many licensed applications as possible are preloaded while keeping the total estimated virtual memory usage below the limit. This auto-configuration only takes place at the very first run, and after analyzer software upgrades.

You may, at any time, manually call up the Configure Applications utility by pressing System, Power On, Configure Applications, to find a configuration that works best for you, and then restart the analyzer program.

The utility may also be called if, during operation of the analyzer, you attempt to load more applications than can fit in memory at once.

Virtual memory usage

There are more applications available for the X-Series than can fit into memory at any one time, so the Configure Applications utility includes a memory tracker that serves two purposes:

1. It will not let you preload more applications than will fit into memory at once.
2. You can determine how many of your favorite applications can reside in memory at one time.

The utility provides a graphical representation of the amount of memory (note that the memory in question here is Virtual memory and is a limitation imposed by the operating system, not by the amount of physical memory you have in your analyzer). You select applications to preload by checking the boxes on the left. Checked applications preload at startup. The colored fuel bar indicates the total memory required when all the checked applications are loaded (either preloaded or selected during runtime).

Here is what the fuel bar colors mean:

RED: the applications you have selected cannot all fit into the analyzer's memory. You must deselect applications until the fuel bar turns yellow.

YELLOW: the applications you have selected can all fit into the analyzer's memory, but there is less than 10% of the memory left, probably not enough to load any other applications, either via preload or by selecting a Mode while the analyzer is running..

GREEN: The indicator is green when <90% of the memory limit is consumed. This means the applications you have selected can all fit into the analyzer's memory with room to spare. You will likely be able to load one or more other applications without running out of memory.

Select All

Marks all applications in the selection list. This allows you to enable all applications licensed on the instrument for pre-loading, or is a convenience for selecting all applications in one operation and then letting you deselect individual applications.

Key Path	System, Power On, Configure Applications
Initial S/W Revision	A.02.00

Deselect All

Clears the marks from all applications in the selection list, except the Power On application. The Power On application cannot be eliminated from the pre-load list.

Key Path	System, Power On, Configure Applications
Initial S/W Revision	A.02.00

Move Up

The application list is the order that applications appear in the Mode Menu. This key enables you to shift the selected application up in the list, thus moving the selected application earlier in the Mode Menu.

Key Path	System, Power On, Configure Applications
Initial S/W Revision	A.02.00

Move Down

The application list is the order that applications appear in the Mode Menu. This key enables you to shift the selected application down in the list, thus moving the selected application later in the Mode Menu.

Key Path	System, Power On, Configure Applications
Initial S/W Revision	A.02.00

Select/Deselect

Toggles the currently highlighted application in the list.

Key Path	System, Power On, Configure Applications
Initial S/W Revision	A.02.00

Save Changes and Exit

Applies the configuration of the applications list. The marked applications will be pre-loaded in memory the next time the instrument application is started, and the order of the applications in the list will be the order of the applications in the Mode Menu.

After saving your changes, the analyzer asks you if you would like it to restart so that your changes can take effect (see dialog box, below). If you choose not to restart, the changes will not take affect until the next time you shut down and restart the analyzer.

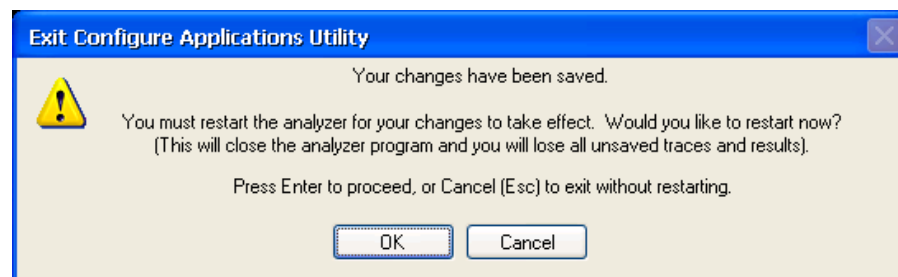

Key Path	System, Power On, Configure Applications
Remote Command	:SYSTem:PUP:PROcEss
Example	:SYST:PUP:PROC This is the SCPI command for restarting the analyzer. You must Wait after this command for the instrument application to restart
Notes	The softkey will be grayed-out when the virtual memory of the selected applications exceeds 100% of the limit.
Notes	You cannot use *WAI or *OPC? to synchronize operation after a restart. This command stops and restarts the instrument application, thus the SCPI operation is terminated and restarted. A remote program must use fixed wait time to resume sending commands to the instrument. The wait time will be dependent upon which applications are pre-loaded.
Initial S/W Revision	A.02.00
Modified at S/W Revision	A.04.00

Exit Without Saving

Pressing this key will exit the Configure Applications utility without saving your changes.

Key Path	System, Power On, Configure Applications
Initial S/W Revision	A.02.00
Modified at S/W Revision	A.04.00

FPGA Configuration

Available only when the EMC Application, TDS and FS2 are all licensed.

When installing new firmware, this setting is used to select the preferred FPGA version if more than one version is available. It also allows you to be prompted at each startup to select which version of the FPGA is wanted at that time.

TDS - Load the Time Domain Scan version of the FPGA

FS2 - Load the Enhanced Sweep Speed version of the FPGA

PROMpt – Initiate a prompt at each startup and show the FPGA Configuration dialog. You can choose to continue with the currently loaded FPGA version or load a different version.

See ["Time Domain Scan" on page 448](#) and ["Prompt at Startup" on page 449](#).

The read back on the FPGA Configuration key is “[<preference>, <currently loaded>]”.

Control Path	System, Power On
Remote Command	SYSTem:PON:FPGA:PREFence TDS FS2 PROMpt SYSTem:PON:FPGA:PREFence?
Example	SYST:PON:FPGA:PREF TDS SYST:PON:FPGA:PREF?
Preset	PROMpt (not affected by Mode Preset but set to PROMpt by “Restore System Default” -> “All” or “Power On”)
Notes	This SCPI is always available, but if the hardware does not support multiple FPGA image choices, the value will always be: NA = Not available for this hardware Also when not supported, any attempt to change away from NA will result in the error -224, “Illegal parameter value”.
Initial S/W Revision	A.18.20

Time Domain Scan

When this key is pressed, the Time Domain Scan version of the FPGA is selected for use by the EMC application.

If this is not the FPGA version currently loaded, it will be loaded when the Load FPGA key is pressed or when new firmware is loaded.

It should be noted that load time for this version may be longer than the previous version.

Available only when the EMC Application, TDS and FS2 are all licensed.

Key Path	System, Power On, FPGA Configuration
Example	SYST:PON:FPGA:PREF TDS
Initial S/W Revision	A.18.20

Enhanced Sweep Speed

When this key is pressed, the Enhanced Sweep Speed version of the FPGA is selected. This implements fast sweep capability in the FPGA for swept measurements.

If this is not the FPGA version currently loaded, it will be loaded when the Load FPGA key is pressed or when new firmware is loaded.

Available only when the EMC Application, TDS and FS2 are all licensed.

Key Path	System, Power On, FPGA Configuration
Example	SYST:PON:FPGA:PREF FS2
Initial S/W Revision	A.18.20

Prompt at Startup

When multiple capabilities are licensed and this key is pressed, the following dialog will display at startup:

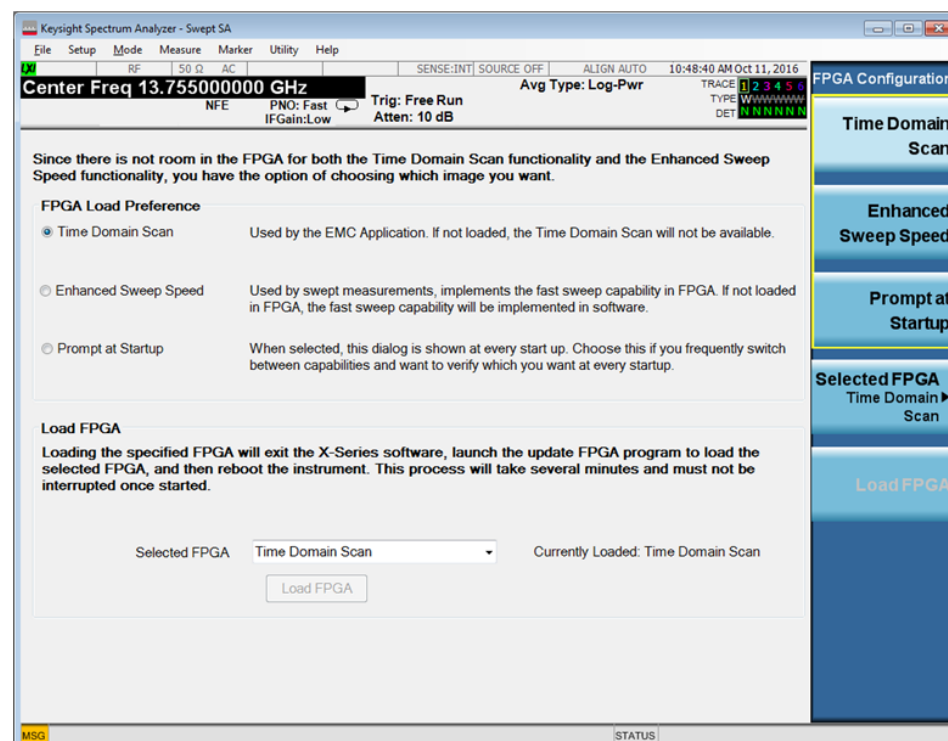

This can be useful for those who frequently switch between capabilities.

Available only when the EMC Application, TDS and FS2 are all licensed.

Key Path	System, Power On, FPGA Configuration
Example	SYST:PON:FPGA:PREF PROMpt
Initial S/W Revision	A.18.20

Selected FPGA

This key accesses a menu that enables you to select the desired FPGA version.

Available only when the EMC Application, TDS and FS2 are all licensed.

Key Path	System, Power On, FPGA Configuration
Initial S/W Revision	A.18.20

Time Domain Scan

When this key is pressed, the Time Domain Scan version of the FPGA is selected for use by the EMC application.

If this is not the FPGA version currently loaded, it will be loaded when the Load FPGA key is pressed or when new firmware is loaded.

It should be noted that load time for this version may be longer than the previous version.

Available only when the EMC Application, TDS and FS2 are all licensed.

Key Path	System, Power On, FPGA Configuration, Selected FPGA
Initial S/W Revision	A.18.20

Enhanced Sweep Speed

When this key is pressed, the Enhanced Sweep Speed version of the FPGA is selected. This implements fast sweep capability in the FPGA for swept measurements.

If this is not the FPGA version currently loaded, it will be loaded when the Load FPGA key is pressed or when new firmware is loaded.

Available only when the EMC Application, TDS and FS2 are all licensed.

Key Path	System, Power On, FPGA Configuration, Selected FPGA
Initial S/W Revision	A.18.20

Load FPGA

When this key is pressed, the selected FPGA version will load. This key is grayed out if the selected version is already loaded.

CAUTION

Loading the specified FPGA will exit the X-Series software, launch the update FPGA program to load the selected FPGA, and then reboot the instrument. This process will take several minutes and must not be interrupted once started.

Available only when the EMC Application, TDS and FS2 are all licensed.

See ["Restore Power On Defaults" on page 451](#)

Key Path	System, Power On, FPGA Configuration
----------	--------------------------------------

Remote Command	<code>SYSTem:PON:FPGA:LOAD TDS FS2</code> <code>SYSTem:PON:FPGA:LOAD?</code>
Example	<code>SYST:PON:FPGA:LOAD TDS</code> <code>SYST:PON:FPGA:Load?</code>
Notes	<p>The command will do nothing if the specified FPGA version is the one already loaded. If the FPGA needs to change, it will exit the analyzer software (terminating the SCPI session) and launch the FPGA update utility. When the FPGA is updated, the instrument will reboot.</p> <p>This SCPI is always available, but if the hardware does not support multiple FPGA image choices, the value will always be:</p> <p>NA = Not available for this hardware</p> <p>Also when not supported, any attempt to change away from NA will result in the error -224, "Illegal parameter value".</p>
Dependencies	<p>Available only when there are multiple versions of the FPGA that could be loaded.</p> <p>Selection limited to licensed features:</p> <ul style="list-style-type: none"> - TDS selection requires the EMC Application and the TDS hardware option - FS2 requires the FS2 hardware option <p>The UI is blanked when there is only one licensed selection and that selection is already loaded. Sending the SCPI for an unlicensed selection will result in the following message: -224, "Illegal parameter value; <option> is not licensed"</p>
Preset	None. Not affected by Mode Preset or any Restore Defaults.
Initial S/W Revision	A.18.20

Restore Power On Defaults

This selection causes the Power On Type and Power On Application settings to be a reset to their default values. This level of Restore System Defaults does not affect any other system settings, mode settings and does not cause a mode switch. The Power On key, under the Restore System Defaults menu, causes the same action.

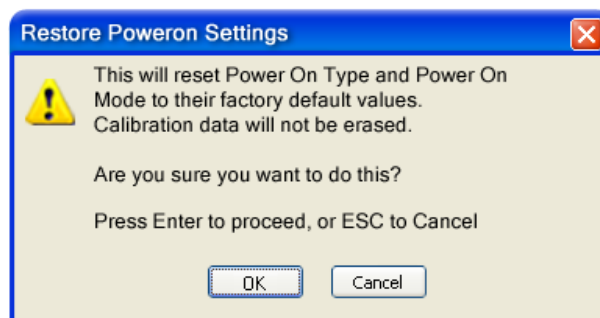

If you press any key other than OK or Enter, it is construed as a Cancel, because the only path that will actually cause the reset to be executed is through OK or Enter.

Key Path	System, Power On
-----------------	-------------------------

Example	:SYST:DEF PON
Initial S/W Revision	Prior to A.02.00

Configure Applications - Instrument boot-up

At start-up of the analyzer program a dialog box similar to the one under the **System, Power On, Configure Applications** key will be displayed allowing you to choose which licensed applications are to be loaded. This dialog will only be displayed if the memory required to pre-load all of the licensed applications exceeds the Virtual Memory available.

Configure Applications - Windows desktop

The Configure Applications Utility may be run from the Windows Desktop. The utility



is launched by double-clicking the icon on the desktop, which brings-up a dialog box similar to the one under the **System, Power On, Configure Applications** key, allowing you to choose which licensed applications are to be loaded when the analyzer program starts up. This dialog box has mouse buttons on it that do the job the softkeys normally do in the **System, Power On, Configure Applications** menu.

Configure Applications - Remote Commands

The following topics provide details on using remote commands to configure the list of applications you want to load into the instrument memory or query the Virtual Memory utilization for your applications.

- "Configuration list (Remote Command Only)" on page 452
- "Configuration Memory Available (Remote Command Only)" on page 453
- "Configuration Memory Total (Remote Command Only)" on page 453
- "Configuration Memory Used (Remote Command Only)" on page 453
- "Configuration Application Memory (Remote Command Only)" on page 453

Configuration list (Remote Command Only)

This remote command is used to set or query the list of applications to be loaded in-memory.

Remote Command	:SYSTem:PON:APPLication:LLISt <string of INSTRument:SElect names> :SYSTem:PON:APPLication:LLISt?
Example	:SYST:PON:APPL:LLIS "SA,BASIC,WCDMA"
Notes	<string of INSTRument:SElect names> are from the enums of the :INSTRument:SElect command. The order of the <INSTRument:SElect names> is the order that the applications are loaded into memory, and the order that they appear in the Mode Menu. Error message -225 "Out of Memory" is reported when more applications are listed than can

	reside in Virtual Memory. When this occurs, the existing applications load list is unchanged.
Preset	Not affected by Preset
State Saved	Not saved in instrument state
Initial S/W Revision	A.02.00

Configuration Memory Available (Remote Command Only)

This remote command is used to query the amount of Virtual Memory remaining.

Remote Command	:SYSTem:PON:APPLication:VMEMory[:AVAIlable]?
Example	:SYST:PON:APPL:VMEM?
Preset	Not affected by Preset
Initial S/W Revision	A.02.00

Configuration Memory Total (Remote Command Only)

This remote command is used to query the limit of Virtual Memory allowed for applications.

Remote Command	:SYSTem:PON:APPLication:VMEMory:TOTal?
Example	:SYST:PON:APPL:VMEM:TOT?
Preset	Not affected by Preset
Initial S/W Revision	A.02.00

Configuration Memory Used (Remote Command Only)

This remote command is a query of the amount of Virtual Memory used by all measurement applications.

Remote Command	:SYSTem:PON:APPLication:VMEMory:USED?
Example	:SYST:PON:APPL:VMEM:USED?
Preset	Not affected by Preset
Initial S/W Revision	A.02.00

Configuration Application Memory (Remote Command Only)

This remote command is used to query the amount of Virtual Memory a particular application consumes.

Remote Command	:SYSTem:PON:APPLication:VMEMory:USED:NAME? <INSTrument:SElect name>
Example	:SYST:PON:APPL:VMEM:USED:NAME? CDMA2K
Notes	<INSTrument:SElect name> is from the enums of the :INSTrument:SElect command Value returned will be 0 (zero) if the name provided is invalid.
Preset	Not affected by Preset
Initial S/W Revision	Prior to A.02.00

Alignments

The Alignments Menu controls and displays the automatic alignment of the instrument, and provides the ability to restore the default alignment values.

The current setting of the alignment system is displayed in the system Settings Panel along the top of the display, including a warning icon for conditions that may cause specifications to be impacted.



Key Path	System
Initial S/W Revision	Prior to A.02.00

Auto Align

Configures the method for which the automatic background alignment is run.

Automatic background alignments are run periodically between measurement acquisitions. The instrument's software determines when alignments are to be performed to maintain warranted operation. The recommended setting for Auto Align is Normal.

An Auto Align execution cannot be aborted with the Cancel (ESC) key. To interrupt an Auto Align execution, select **Auto Align Off**.

Key Path	System, Alignments
Mode	All
Remote Command	:CALibration:AUTO ON LIGHt PARTial OFF :CALibration:AUTO?
Example	:CAL:AUTO ON
Notes	While Auto Align is executing, bit 0 of Status Operation register is set.
Couplings	Auto Align is set to Off if Restore Align Data is invoked.
Preset	This is unaffected by Preset but is set to ON upon a "Restore System Defaults->Align".
State Saved	No
Status Bits/OPC dependencies	When Auto Align is executing, bit 0 in the Status Operational register is set.
Backwards Compatibility SCPI	:CALibration:AUTO ALERt Parameter ALERt is for backward compatibility only and is mapped to PARTial
Backwards Compatibility Notes	<ol style="list-style-type: none"> 1. ESA SCPI for Auto Align is :CALibration:AUTO <Boolean>. The command for X-Series is an enumeration. Thus the parameters of "0" and "1" are not possible in X-Series. 2. Similarly, the ESA SCPI for :CALibration:AUTO? returned the Boolean value 1 or 0, in X-Series it is an Enumeration (string). Thus, queries by customer applications into numeric variables will result in an error 3. In PSA Auto Align OFF was not completely off, it is equivalent to PARTial in X-Series. In X-Series, OFF will be fully OFF. This means users of PSA SCPI who choose OFF may see

degraded performance and should migrate their software to use PARTial.

Initial S/W Revision Prior to A.02.00

Normal

Auto Align, Normal turns on the automatic alignment of all measurement systems. The Auto Align, Normal selection maintains the instrument in warranted operation across varying temperature and over time.

If the condition “Align Now, All required” is set, transition to Auto Align, Normal will perform the required alignments and clear the “Align Now, All required” condition and then continue with further alignments as required to maintain the instrument adequately aligned for warranted operation.

When **Auto Align, Normal** is selected the Auto Align Off time is set to zero.

When **Auto Align, Normal** is selected the Settings Panel indicates ALIGN AUTO.

Key Path	System, Alignments, Auto Align
Mode	All
Example	:CAL:AUTO ON
Notes	Alignment processing as a result of the transition to Normal will be executed sequentially. Thus, *OPC? or *WAI following CAL:AUTO ON will return when the alignment processing is complete. The presence of an external signal may interfere with the RF portion of the alignment. If so, the Error Condition message “Align skipped: 50 MHz interference” or “Align skipped: 4.8 GHz interference” is reported, and bit 11 is set in the Status Questionable Calibration register. After the interfering signal is removed, subsequent alignment of the RF will clear the condition, and clear bit 11 in the Status Questionable Calibration register.
Readback Text	Normal
Status Bits/OPC dependencies	An interfering user signal may prevent automatic alignment of the RF subsystem. If this occurs, the Error Condition message “Align skipped: 50 MHz interference” or “Align skipped: 4.8 GHz interference” is reported, the Status Questionable Calibration bit 11 is set, and the alignment proceeds. When a subsequent alignment of the RF subsystem succeeds, either by the next cycle of automatic alignment or from an Align Now, RF, the Error Condition and Status Questionable Calibration bit 11 are cleared.
Initial S/W Revision	Prior to A.02.00

Partial

Auto Align, Partial disables the full automatic alignment and the maintenance of warranted operation for the benefit of improved measurement throughput. Accuracy is retained for the Resolution Bandwidth filters and the IF Passband, which is critical to FFT accuracy, demodulation, and many measurement applications. With Auto Align set to Partial, you are now responsible for maintaining warranted operation by updating the alignments when they expire. The Auto Align, Alert mechanism will notify you when alignments have expired. One solution to expired alignments is to perform the Align All, Now operation. Another is to return the Auto Align selection to Normal.

Auto Align, Partial is recommended for measurements where the throughput is so important that a few percent of improvement is more valued than an increase in the accuracy errors of a few tenths of a decibel. One good application of Auto Align, Partial would be an automated environment where the alignments can be called during overhead time when the device-under-test is exchanged.

When **Auto Align, Partial** is selected the elapsed time counter begins for Auto Align Off time.

When **Auto Align, Partial** is selected the Settings Panel indicates ALIGN PARTIAL with a warning icon. The warning icon is to inform the operator that they are responsible for maintaining the warranted operation of the instrument

Key Path	System, Alignments, Auto Align
Mode	All
Example	:CAL:AUTO PART
Notes	Auto Align Partial begins the elapsed time counter for Auto Align Off time.
Readback Text	Partial
Initial S/W Revision	Prior to A.02.00

Off

Auto Align, Off disables automatic alignment and the maintenance of warranted operation, for the benefit of maximum measurement throughput. With Auto Align set to Off, you are now responsible for maintaining warranted operation by updating the alignments when they expire. The Auto Align, Alert mechanism will notify you when alignments have expired. One solution to expired alignments is to perform the Align All, Now operation. Another is to return the Auto Align selection to Normal.

The Auto Align, Off setting is rarely the best choice, because Partial gives almost the same improvement in throughput while maintaining the warranted performance for a much longer time. The choice is intended for unusual circumstances such as the measurement of radar pulses where you might like the revisit time to be as consistent as possible.

When **Auto Align, Off** is selected the Auto Align Off time is initialized and the elapsed time counter begins.

When **Auto Align, Off** is selected the Settings Panel indicates ALIGN OFF with a warning icon. The warning icon is to inform the operator that they are responsible for maintaining the warranted operation of the instrument:

Key Path	System, Alignments, Auto Align
Mode	All
Example	:CAL:AUTO OFF
Notes	Auto Align Off begins the elapsed time counter for Auto Align Off time.
Couplings	Auto Align is set to Off if Restore Align Data is invoked.
Readback Text	Off
Initial S/W Revision	Prior to A.02.00

All but RF

Auto Align, All but RF, configures automatic alignment to include or exclude the RF subsystem. (Eliminating the automatic alignment of the RF subsystem prevents the input impedance from changing. The normal input impedance of 50 ohms can change to an open circuit when alignments are being used. Some devices under test do not behave acceptably under such circumstances, for example by showing instability.) When Auto Align, All but RF ON is selected, the operator is responsible for performing an Align Now, RF when RF-related alignments expire. The Auto Align, Alert mechanism will notify the operator to perform an Align Now, All when the combination of time and temperature variation is exceeded.

When Auto Align, All but RF ON is selected the Settings Panel indicates ALIGN AUTO/NO RF with a warning icon (warning icon is intended to inform the operator they are responsible for the maintaining the RF alignment of the instrument):

Key Path	System, Alignments, Auto Align
Mode	All
Remote Command	:CALibration:AUTO:MODE ALL NRF :CALibration:AUTO:MODE?
Example	:CAL:AUTO:MODE NRF
Preset	This is unaffected by Preset but is set to ALL on a “Restore System Defaults->Align”.
State Saved	No
Readback Text	RF or NRF
Initial S/W Revision	Prior to A.02.00

Alert

The instrument will signal an Alert when conditions exist such that you will need to perform a full alignment (for example, Align Now, All). The Alert can be configured in one of four settings; Time & Temperature, 24 hours, 7 days, or None. A confirmation is required when a selection other than Time & Temperature is chosen. This prevents accidental deactivation of alerts.

With Auto Align set to Normal, the configuration of Alert is not relevant because the instrument’s software maintains the instrument in warranted operation.

Key Path	System, Alignments, Auto Align
Mode	All
Remote Command	:CALibration:AUTO:ALERT TTEMPerature DAY WEEK NONE :CALibration:AUTO:ALERT?
Example	:CAL:AUTO:ALERT TEM
Notes	The alert that alignment is needed is the setting of bit 14 in the Status Questionable Calibration register.
Preset	This is unaffected by Preset but is set to TTEMPerature on a “Restore System Defaults->Align”.

State Saved	No
Status Bits/OPC dependencies	The alert is the Error Condition message “Align Now, All required” and bit 14 is set in the Status Questionable Calibration register.
Initial S/W Revision	Prior to A.02.00

Time & Temperature

With Auto Align Alert set to Time & Temperature the instrument will signal an alert when alignments expire due to the combination of the passage of time and changes in temperature. The alert is the Error Condition message “Align Now, All required”. If this choice for Alert is selected, the absence of an alert means that the analyzer alignment is sufficiently up-to-date to maintain warranted accuracy.

Key Path	System, Alignments, Auto Align, Alert
Mode	All
Example	:CAL:AUTO:ALER TTEM
Readback Text	Time & Temp
Status Bits/OPC dependencies	Bit 14 is set in the Status Questionable Calibration register.
Initial S/W Revision	Prior to A.02.00

24 hours

With Auto Align Alert set to 24 Hours the instrument will signal an alert after a time span of 24 hours since the last successful full alignment (for example, Align Now, All or completion of a full Auto Align). You may choose this selection in an environment where the temperature is stable on a daily basis at a small risk of accuracy errors in excess of the warranted specifications. The alert is the Error Condition message “Align Now, All required”.

For front-panel operation, confirmation is required to transition into this setting of Alert. The confirmation dialog is:

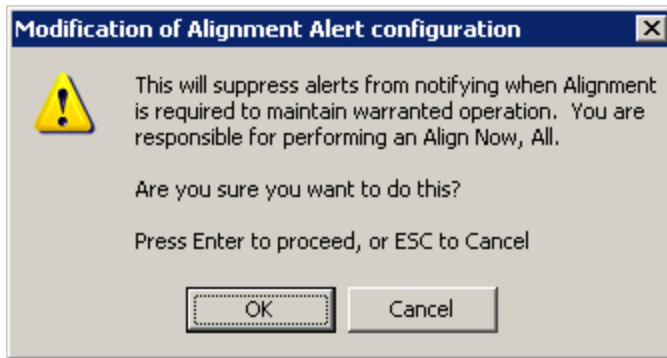

No confirmation is required when Alert is configured through a remote command.

Key Path	System, Alignments, Auto Align, Alert
Mode	All
Example	:CAL:AUTO:ALER DAY
Readback Text	24 hours
Status Bits/OPC dependencies	Bit 14 is set in the Status Questionable Calibration register.
Initial S/W Revision	Prior to A.02.00

7 days

With Auto Align Alert is set to 7 days the instrument will signal an alert after a time span of 168 hours since the last successful full alignment (for example, Align Now, All or completion of a full Auto Align). You may choose this selection in an environment where the temperature is stable on a weekly basis, at a modest risk of accuracy degradations in excess of warranted performance. The alert is the Error Condition message “Align Now, All required”.

For front panel operation, confirmation is required for the customer to transition into this setting of Alert. The confirmation dialog is:

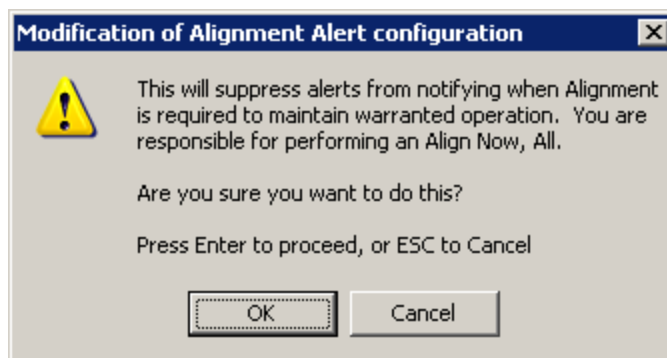

No confirmation is required when Alert is configured through a remote command.

Key Path	System, Alignments, Auto Align, Alert
Mode	All
Example	:CAL:AUTO:ALER WEEK
Readback Text	7 days
Status Bits/OPC dependencies	Bit 14 is set in the Status Questionable Calibration register.
Initial S/W Revision	Prior to A.02.00

None

With Auto Align Alert set to None the instrument will not signal an alert. This is provided for rare occasions where you are making a long measurement which cannot tolerate Auto Align interruptions, and must have the ability to capture a

screen image at the end of the measurement without an alert posted to the display. Keysight does not recommend using this selection in any other circumstances, because of the risk of accuracy performance drifting well beyond expected levels without the operator being informed.

For front panel operation, confirmation is required to transition into this setting of Alert. The confirmation dialog is:

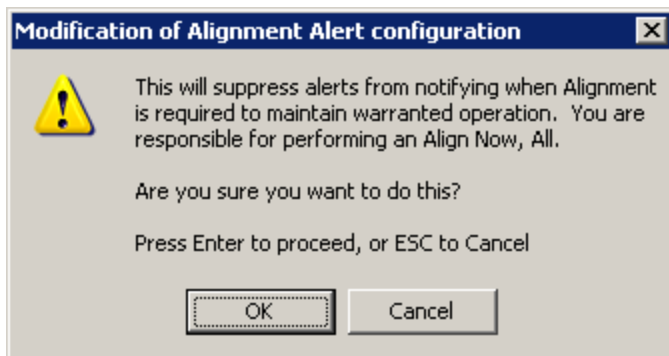

No confirmation is required when Alert is configured through a remote command.

Key Path	System, Alignments, Auto Align, Alert
Mode	All
Example	:CAL:AUTO:ALER NONE
Initial S/W Revision	Prior to A.02.00

Execute Expired Alignments (Remote Command Only)

Alignments can be expired in the situation where Auto Align is in the state of Partial or Off. This feature runs the alignments that have expired. This is different than performing an Align All, Now operation. Align All, Now performs an alignment of all subsystems regardless of whether they are needed or not, with Execute Expired Alignments, only the individual subsystems that have become due are aligned.

Mode	All
Remote Command	:CALibration:EXPIred?
Example	:CAL:EXP?
Notes	:CALibration:EXPIred? returns 0 if successful :CALibration:EXPIred? returns 1 if failed
Initial S/W Revision	Prior to A.02.00

Align Now

Accesses alignment processes that are immediate action operations. They perform complete operations and run until they are complete.

Key Path	System, Alignments
Initial S/W Revision	Prior to A.02.00

All

(In MXE the key label is “**All (plus RF Presel 20 Hz – 3.6 GHz)**”) Immediately executes an alignment of all subsystems.

In MXE, the Align Now All is followed by additionally aligning the RF Preselector section, so in MXE, the key label contains the parenthetical note “(plus RF Presel 20 Hz – 3.6 GHz)”. The instrument stops any measurement currently underway, performs the alignment, then restarts the measurement from the beginning (similar to pressing the **Restart** key).

If an interfering user signal is present at the RF Input, the alignment is performed on all subsystems except the RF. After completion, the Error Condition message “Align skipped: 50 MHz interference” or “Align skipped: 4.8 GHz interference” is generated. In addition the Error Condition message “Align Now, RF required” is generated, and bits 11 and 12 are set in the Status Questionable Calibration register.

The query form of the remote commands (:CALibration[:ALL]? or *CAL?) invokes the alignment of all subsystems and returns a success or failure value. An interfering user signal is not grounds for failure; if the alignment was able to succeed on all portions but unable to align the RF because of an interfering signal, the resultant will be the success value.

Successful completion of **Align Now, All** will clear the “Align Now, All required” Error Condition, and clear bit 14 in the Status Questionable Calibration register. It will also begin the elapsed time counter for Last Align Now, All Time, and capture the Last Align Now, All Temperature.

In the MXE, successful completion will also clear the “Align 20 Hz to 30 MHz required” Error Condition, the “Align 30 MHz to 3.6 GHz required” Error Condition, and the “Align 20 Hz to 3.6 GHz required” Error Condition, and clear bits 1 and bit 2 and clear the bit 1 in the Status Questionable Calibration Extended Needed register.

If the Align RF subsystem succeeded in aligning (no interfering signal present), the elapsed time counter begins for Last Align Now, RF Time, and the temperature is captured for the Last Align Now, RF Temperature. In addition the Error Conditions “Align skipped: 50 MHz interference” and “Align skipped: 4.8 GHz interference” are cleared, the Error Condition “Align Now, RF required” is cleared, and bits 11 and 12 are cleared in the Status Questionable Calibration register

Align Now, All can be interrupted by pressing the Cancel (ESC) front-panel key or remotely with Device Clear followed by the :ABORt SCPI command. When this occurs the Error Condition message “Align Now, All required” is generated, and bit 14 is set in the Status Questionable Condition register. This is because new alignment data may be employed for an individual subsystem, but not a cohesive set of data for all subsystems.

In many cases, you might find it more convenient to change alignments to Normal, instead of executing Align Now, All. When the Auto Align process transitions to Normal, the analyzer will immediately start to update only the alignments that have expired, thus efficiently restoring the alignment process.

Key Path	System, Alignments, Align Now
Mode	All
Remote Command	:CALibration[:ALL] :CALibration[:ALL]?
Example	:CAL
Notes	:CALibration[:ALL]? returns 0 if successful :CALibration[:ALL]? returns 1 if failed :CALibration[:ALL]? is the same as *CAL? While Align Now, All is performing the alignment, bit 0 in the Status Operation register is set. Completion, or termination, will clear bit 0 in the Status Operation register. This command is sequential; it must complete before further SCPI commands are processed. Interrupting the alignment from remote is accomplished by invoking Device Clear followed by the :ABORt command. Successful completion will clear bit 14 in the Status Questionable Calibration register. An interfering user signal is not grounds for failure of Align Now, All. However, bits 11 and 12 are set in the Status Questionable Calibration register to indicate Align Now, RF is required. An interfering user supplied signal will result in the instrument requiring an Align Now, RF with the interfering signal removed.
Couplings	Initializes the time for the Last Align Now, All Time. Records the temperature for the Last Align Now, All Temperature. If Align RF component succeeded, initializes the time for the Last Align Now, RF Time. If Align RF component succeeded, records the temperature for the Last Align Now, RF Temperature.
Status Bits/OPC dependencies	Bits 11, 12, or 14 may be set in the Status Questionable Calibration register.
Initial S/W Revision	Prior to A.02.00
Mode	All
Remote Command	*CAL?
Example	*CAL?
Notes	*CAL? returns 0 if successful *CAL? returns 1 if failed :CALibration[:ALL]? is the same as *CAL? See additional remarks described with :CALibration[:ALL]? Everything about :CALibration[:ALL]? is synonymous with *CAL? including all conditions, status register bits, and couplings
Initial S/W Revision	Prior to A.02.00
Mode	All

Remote Command	<code>:CALibration[:ALL]:NPending</code>
Example	<code>CAL:NPEN</code>
Notes	<p><code>:CALibration[:ALL]:NPending</code> is the same as <code>:CALibration[:ALL]</code> including all conditions, status register bits, except this scpi command does not BLOCK the scpi session, so the user should use status register bits to query if the calibration is successfully completed or not.</p> <p>Typical usage is:</p> <ol style="list-style-type: none"> 1) <code>:CALibration:ALL:NPending</code> (Start a calibration) 2) <code>:STATus:OPERation:CONDition?</code> (Check if the calibration is completed or not, If bit 0 is set, then the system is doing calibration, the user should repeat this scpi query until the bit is cleared) 3) <code>:STATus:QUEStionable:CALibration:CONDition?</code> (Check if there are any errors/failures in previous calibration procedure)
Initial S/W Revision	X.14.20

All but RF

(In MXE the key label is “**All but RF (not including RF Presel)**”)

Immediately executes an alignment of all subsystems except the RF subsystem . The instrument will stop any measurement currently underway, perform the alignment, and then restart the measurement from the beginning (similar to pressing the Restart key). This can be used to align portions of the instrument that are not impacted by an interfering user input signal.

This operation might be chosen instead of **All** if you do not want the device under test to experience a large change in input impedance, such as a temporary open circuit at the analyzer input.

The query form of the remote commands (`:CALibration:NRF?`) will invoke the alignment and return a success or failure value.

Successful completion of Align Now, All but RF will clear the “Align Now, All required” Error Condition, and clear bit 14 in the Status Questionable Calibration register. If “Align Now, All required” was in effect prior to executing the All but RF, the Error Condition message “Align Now, RF required” is generated and bit 12 in the Status Questionable Calibration register is set. It will also begin the elapsed time counter for Last Align Now, All Time, and capture the Last Align Now, All Temperature.

Align Now, All but RF can be interrupted by pressing the Cancel (ESC) front-panel key or remotely with Device Clear followed by the `:ABORt` SCPI command. When this occurs the Error Condition message “Align Now, All required” is generated, and bit 14 is set in the Status Questionable Condition register. This is because new alignment data may be used for an individual subsystem, but not a full new set of data for all subsystems.

In models with the RF Preselector, such as the N9038A, the “All but RF” alignment will execute an alignment of all subsystems except the RF subsystem of the Spectrum Analyzer, as well as the system gain of the RF Preselector.

Key Path	System, Alignments, Align Now
Mode	All
Remote Command	:CALibration:NRF :CALibration:NRF?
Example	:CAL:NRF
Notes	:CALibration:NRF? returns 0 if successful :CALibration:NRF? returns 1 if failed While Align Now, All but RF is performing the alignment, bit 0 in the Status Operation register is set. Completion, or termination, will clear bit 0 in the Status Operation register. This command is sequential; it must complete before further SCPI commands are processed. Interrupting the alignment from remote is accomplished by invoking Device Clear followed by the :ABORT command. Successful completion will clear bit 14 in the Status Questionable Calibration register and set bit 12 if invoked with "Align Now, All required".
Couplings	Initializes the time for the Last Align Now, All Time. Records the temperature for the Last Align Now, All Temperature.
Status Bits/OPC dependencies	Bits 12 or 14 may be set in the Status Questionable Calibration register.
Initial S/W Revision	Prior to A.02.00

Mode	All
Remote Command	:CALibration:NRF:NPending
Example	CAL:NRF:NPEN
Notes	:CALibration:NRF:NPending is the same as :CALibration:NRF including all conditions, status register bits, except that this scpi command does not BLOCK the scpi session, so the user should use status register bits to query if the calibration is successfully completed or not. Typical usage is: 1):CALibration:NRF:NPending (start the All but RF calibration) 2):STATus:OPERation:CONDition? (If bit 0 is set, then the system is doing calibration, the user should do re-query until this bit is cleared) 3):STATus:QUESTionable:CALibration:CONDition? (to check if there are any errors/failures in previous calibration procedure)
Initial S/W Revision	X.14.20

RF

(In MXE the key label is "RF Only")

Immediately executes an alignment of the RF subsystem . The instrument stops any measurement currently underway, performs the alignment, then restarts the measurement from the beginning (similar to pressing the **Restart** key).

This operation might be desirable if the alignments had been set to not include RF alignments, or if previous RF alignments could not complete because of interference which has since been removed.

If an interfering user signal is present at the RF Input, the alignment will terminate and generate the Error Condition message “Align skipped: 50 MHz interference” or “Align skipped: 4.8 GHz interference”, and Error Condition “Align Now, RF required”. In addition, bits 11 and 12 will be set in the Status Questionable Calibration register.

The query form of the remote commands (:CALibration:RF?) will invoke the alignment of the RF subsystem and return a success or failure value. An interfering user signal is grounds for failure.

Successful completion of Align Now, RF will begin the elapsed time counter for Last Align Now, RF Time, and capture the Last Align Now, RF Temperature.

Align Now, RF can be interrupted by pressing the Cancel (ESC) front-panel key or remotely with Device Clear followed by the :ABORt SCPI command. When this occurs, the Error Condition message “Align Now, RF required” is generated, and bit 12 is set in the Status Questionable Condition register. None of the new alignment data is used.

In models with the RF Preselector, such as the N9038A, the RF alignment will execute an alignment of the RF subsystem of the Spectrum Analyzer, as well as the RF subsystem on RF Preselector path.

Key Path	System, Alignments, Align Now
Mode	All
Remote Command	:CALibration:RF :CALibration:RF?
Example	:CAL:RF
Notes	:CALibration:RF? returns 0 if successful :CALibration:RF? returns 1 if failed (including interfering user signal) While Align Now, RF is performing the alignment, bit 0 in the Status Operation register is set. Completion, or termination, will clear bit 0 in the Status Operation register. This command is sequential; it must complete before further SCPI commands are processed. Interrupting the alignment from remote is accomplished by invoking Device Clear followed by the :ABORt command. Successful completion clears the Error Conditions “Align skipped: 50 MHz interference” and “Align skipped: 4800 MHz interference” and the Error Conditions “Align RF failed” and “Align Now, RF required”, and clears bits 3, 11, and 12 in the Status Questionable Calibration register. A failure encountered during alignment will generate the Error Condition message “Align RF failed” and set bit 3 in the Status Questionable Calibration register. An interfering user signal will result in bits 11 and 12 to be set in the Status Questionable Calibration register to indicate Align Now, RF is required. An interfering user supplied signal will result in the instrument requiring an Align Now, RF with the interfering signal removed.
Couplings	Initializes the time for the Last Align Now, RF Time.

	Records the temperature for the Last Align Now, RF Temperature.
Status Bits/OPC dependencies	Bits 11, 12, or 14 may be set in the Status Questionable Calibration register.
Initial S/W Revision	Prior to A.02.00
<hr/>	
Mode	All
Remote Command	:CALibration:RF:NPENding
Example	CAL:RF:NPEN
Notes	:CALibration:RF:NPENding is the same as :CALibration:RF including all conditions, status register bits, except that this scpi command does not BLOCK the scpi session, so the user should use status register bits to query if the calibration is successfully completed or not. Typical usage is: 1):CALibration:RF:NPENding (Start a RF calibration) 2):STATus:OPERation:CONDition? (If bit 0 is set, then the system is doing calibration, the user should do re-query until this bit is cleared) 3):STATus:QUEStionable:CALibration:CONDition? (to check if there are any errors/failures in previous calibration procedure)
Initial S/W Revision	X.14.20

External Mixer

Immediately executes an alignment of the External Mixer that is plugged into the USB port. The instrument stops any measurement currently underway, performs the alignment, then restarts the measurement from the beginning (similar to pressing the Restart key). As this alignment calibrates the LO power to the mixer, this is considered an LO alignment; and failure is classified as an LO alignment failure.

The query form of the remote commands (:CALibration:EMIXer?) will invoke the alignment of the External Mixer and return a success or failure value.

Key Path	System, Alignments, Align Now
Mode	All
Remote Command	:CALibration:EMIXer :CALibration:EMIXer?
Example	:CAL:EMIX
Notes	:CAL:EMIX? returns 0 if successful :CAL:EMIX? returns 1 if failed While Align Now, Ext Mix is performing the alignment, bit 0 in the Status Operation register is set. Completion, or termination, will clear bit 0 in the Status Operation register. This command is sequential; it must complete before further SCPI commands are processed. Interrupting the alignment from remote is accomplished by invoking Device Clear followed by the :ABORT command.

	A failure encountered during alignment will generate the Error Condition message "Align LO failed" and set bit 5 in the Status Questionable Calibration register. Successful completion will clear the "Align LO failed" message and bit 5 in the Status Questionable Calibration register.
Dependencies	This key does not appear unless option EXM is present and is grayed-out unless a USB mixer is plugged in to the USB.
Status Bits/OPC dependencies	Bit3 may be set in the Status Questionable Calibration Extended Failure register.
Initial S/W Revision	A.08.00

Show Alignment Statistics

Shows alignment information you can use to ensure that the instrument is operating in a specific manner. The Show Alignment Statistics screen is where you can view time and temperature information.

Values which are displayed are only updated when the Show Alignment Statistics screen is invoked, they are not updated while the Show Alignment Statistics screen is being displayed. The remote commands that access this information obtain current values.

An example of the Show Alignment Statistics screen would be similar to:

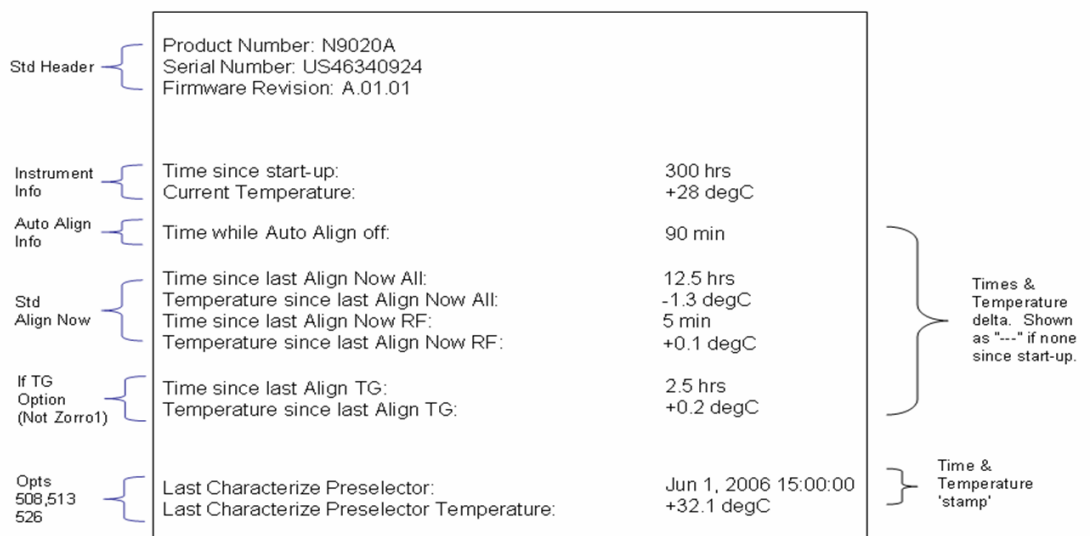

A successful Align Now, RF will set the Last Align RF temperature to the current temperature, and reset the Last Align RF time. A successful Align Now, All or Align Now, All but RF will set the Last Align Now All temperature to the current temperature, and reset the Last Align Now All time. A successful Align Now, All will also reset the Last Align RF items if the RF portion of the Align Now succeeded.

Key Path	System, Alignments
Mode	All

Notes	The values displayed on the screen are only updated upon entry to the screen and not updated while the screen is being displayed.
Initial S/W Revision	Prior to A.02.00

Key Path	Visual annotation in the Show Alignment Statistics screen
Mode	All
Remote Command	:SYSTem:PON:TIME?
Example	:SYST:PON:TIME?
Notes	Value is the time since the most recent start-up in seconds.
State Saved	No
Initial S/W Revision	Prior to A.02.00

Key Path	Visual annotation in the Show Alignment Statistics screen
Mode	All
Remote Command	:CALibration:TEMPerature:CURRent?
Example	:CAL:TEMP:CURR?
Notes	Value is in degrees Centigrade. Value is invalid if using default alignment data (Align Now, All required)
State Saved	No
Initial S/W Revision	Prior to A.02.00

Key Path	Visual annotation in the Show Alignment Statistics screen
Mode	All
Remote Command	:CALibration:TIME:LALL?
Example	:CAL:TIME:LALL?
Notes	Value is the elapsed time, in seconds, since the last successful Align Now, All or Align Now, All but RF was executed.
State Saved	No
Initial S/W Revision	Prior to A.02.00

Key Path	Visual annotation in the Show Alignment Statistics screen
Mode	All
Remote Command	:CALibration:TEMPerature:LALL?
Example	:CAL:TEMP:LALL?
Notes	Value is in degrees Centigrade at which the last successful Align Now, All or Align Now, All but

	RF was executed.
State Saved	No
Initial S/W Revision	Prior to A.02.00

Key Path	Visual annotation in the Show Alignment Statistics screen
Mode	All
Remote Command	:CALibration:TIME:LRF?
Example	:CAL:TIME:LRF?
Notes	Value is the elapsed time, in seconds, since the last successful Align Now, RF was executed, either individually or as a component of Align Now, All.
State Saved	No
Initial S/W Revision	Prior to A.02.00

Key Path	Visual annotation in the Show Alignment Statistics screen
Mode	All
Remote Command	:CALibration:TEMPerature:LRF?
Example	:CAL:TEMP:LRF?
Notes	Value is in degrees Centigrade at which the last successful Align Now, RF was executed, either individually or as a component of Align Now, All.
State Saved	No
Initial S/W Revision	Prior to A.02.00

Key Path	Visual annotation in the Show Alignment Statistics screen
Mode	All
Remote Command	:CALibration:TIME:LPReselector?
Example	:CAL:TIME:LPR?
Notes	Value is the date and time the last successful Characterize Preselector was executed. The date is separated from the time by a space character. Returns "" if no Characterize Preselector has ever been performed on the instrument.
Dependencies	In models that do not include preselectors, this command is not enabled and any attempt to set or query will yield an error.
State Saved	No
Initial S/W Revision	Prior to A.02.00

Key Path	Visual annotation in the Show Alignment Statistics screen
Mode	All
Remote Command	:CALibration:TEMPerature:LPReselector?
Example	:CAL:TEMP:LPR?
Notes	Value is in degrees Centigrade at which the last successful Characterize Preselector was executed.
Dependencies	In models that do not include preselectors, this command is not enabled and any attempt to set or query will yield an error.
State Saved	No
Initial S/W Revision	Prior to A.02.00

Key Path	Visual annotation in the Show Alignment Statistics screen
Mode	All
Remote Command	:CALibration:AUTO:TIME:OFF?
Example	:CAL:AUTO:TIME:OFF?
Notes	Value is the elapsed time, in seconds, since Auto Align has been set to Off or Off with Alert. The value is 0 if Auto Align is ALL or NORF.
State Saved	No
Initial S/W Revision	Prior to A.02.00

Key Path	Visual annotation in the Show Alignment Statistics screen
Mode	All (N9038A only)
Remote Command	:CALibration:TIME:RFPSelector:LCONducted?
Example	:CAL:TIME:RFPS:LCON?
Notes	Values are the date and time the last successful Align Now, 20 Hz – 30 MHz was executed. The date is separated from the time by a semi-colon character.
State Saved	No

Key Path	Visual annotation in the Show Alignment Statistics screen
Mode	All (N9038A only)
Remote Command	:CALibration:TEMPerature:RFPSelector:LCONducted?
Example	:CAL:TEMP:RFPS:LCON?
Notes	Value is in degrees Centigrade at which the last successful Align Now, 20 Hz – 30 MHz was executed.
State Saved	No

Key Path	Visual annotation in the Show Alignment Statistics screen
Mode	All (N9038A only)
Remote Command	:CALibration:TIME:RFPSelector:LRADiated?
Example	:CAL:TIME:RFPS:LRAD?
Notes	Value is the date and time the last successful Align Now, 30 MHz – 3.6 GHz was executed. The date is separated from the time by a semi-colon character.
State Saved	No

Key Path	Visual annotation in the Show Alignment Statistics screen
Mode	All (N9038A only)
Remote Command	:CALibration:TEMPerature:RFPSelector:LRADiated?
Example	:CAL:TEMP:RFPS:LRAD?
Notes	Value is in degrees Centigrade at which the last successful Align Now, 30 MHz – 3.6 GHz was executed.
State Saved	No

Key Path	Visual annotation in the Show Alignment Statistics screen
Mode	All (N9038A only)
Remote Command	:CALibration:RFPSelector:SCHeduler:TIME:NEXT? This query returns data using the following format “YYYY/MM/DD; HH:MM:SS”
Example	:CAL:RFPS:SCH:TIME:NEXT?
Notes	For model N9038A only. The next run time will be updated based on the start date/time and recurrence set by the users. “date” is representation of the date the task will run in the form of “YYYY/MM/DD” where: <ul style="list-style-type: none"> – YYYY is the four digit representation of year. (for example, 2009) – MM is the two digit representation of month. (for example, 01 to 12) – DD is the two digit representation of the day. (for example, 01 to 28, 29, 30 or 31 depending on the month and year) “time” is a representation of the time of day the task will run in the form of “HH:MM:SS” where: <ul style="list-style-type: none"> – HH is the two digit representation of the hour in 24 hour format – MM is the two digit representation of minute – SS is the two digit representation of seconds
State Saved	No

Restore Align Defaults

Initializes the alignment user interface settings, not alignment data, to the factory default values. Align Now, All must be executed if the value of the Timebase DAC results in a change.

For front panel operation, you are prompted to confirm action before setting the alignment parameters to factory defaults:

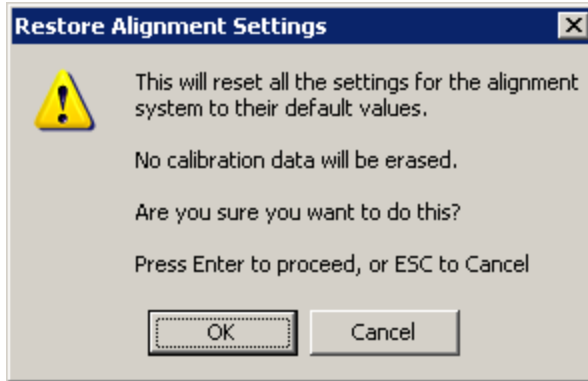

The parameters affected are:

Parameter	Setting
Timebase DAC	Calibrated
Timebase DAC setting	Calibrated value
Auto Align State	Normal (if the instrument is not operating with default alignment data, Off otherwise)
Auto Align All but RF	Off
Auto Align Alert	Time & Temperature

Key Path	System, Alignments
Mode	All
Example	:SYST:DEF ALIG
Notes	Alignment processing that results as the transition to Auto Alignment Normal will be executed sequentially; thus *OPC? or *WAI will wait until the alignment processing is complete.
Initial S/W Revision	Prior to A.02.00

Backup or Restore Align Data...

Opens the utility for backing-up or restoring the alignment data.

Alignment data for the instrument resides on the hard drive in a database. Keysight uses high quality hard drives; however it is highly recommended the alignment data be backed-up to storage outside of the instrument. Additionally, for customers who use multiple CPU Assemblies or multiple disk drives, the alignment that pertains to

the instrument must be transferred to the resident hard drive after a CPU or hard drive is replaced. This utility facilitates backing-up and restoring the alignment data.

NOTE

This utility allows the operator to navigate to any location of the Windows file system. It is intended that the operator use a USB memory device or Mapped Network Drive to back up the alignment data to storage outside of the instrument.

The PC6 and PC7 CPUs contain a removable SD memory card. With one of these CPU's installed the Backup and Restore Alignment Data wizard will default to the SD card as the backup location. At (every) power-on, the software will check to determine if the calibration data on the SD memory card (the backup) is newer than the data in use on the SSD. In such situations, before the application is loaded the operator will be given the opportunity to restore the data from the backup. If the operator responds "Yes", the Backup and Restore Alignment Data wizard will be invoked to perform the restore.

Key Path	System, Alignments
Initial S/W Revision	A.02.00
<hr/>	
Key Path	System, Alignments
Mode	All
Remote Command	:CALibration:DATA:DEFault
Example	:CAL:DATA:DEF
Couplings	Sets Auto Align to Off. Sets bit 14 in the Status Questionable Calibration register. The Error Condition message "Align Now, All required" is generated.
Initial S/W Revision	Prior to A.02.00

Alignment Data Wizard

The Backup or Restore Alignment Data wizard guides you through the operation of backing-up or restoring the alignment data.

The following dialog boxes operate without a mouse or external keyboard when you use the default file names.

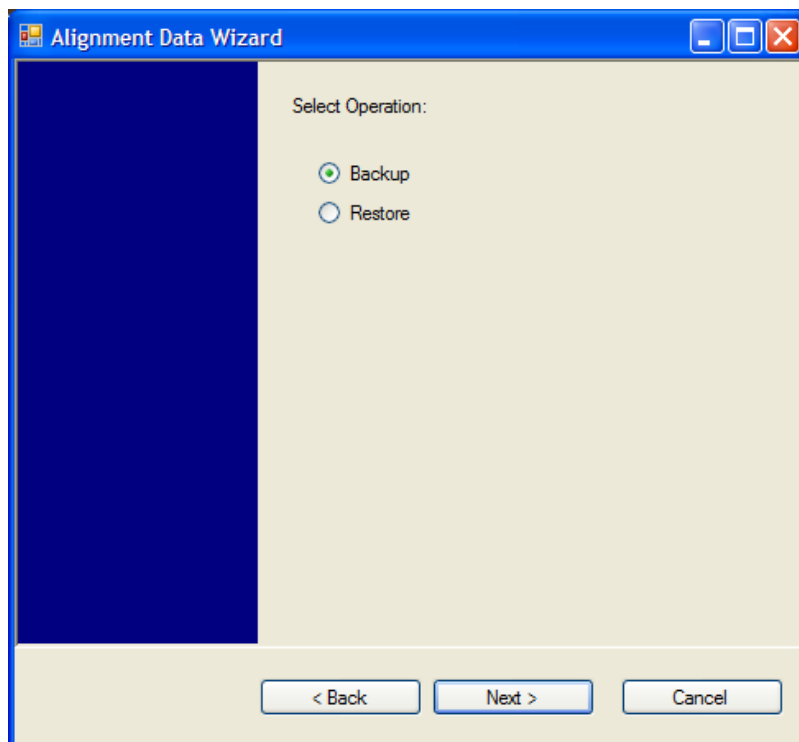
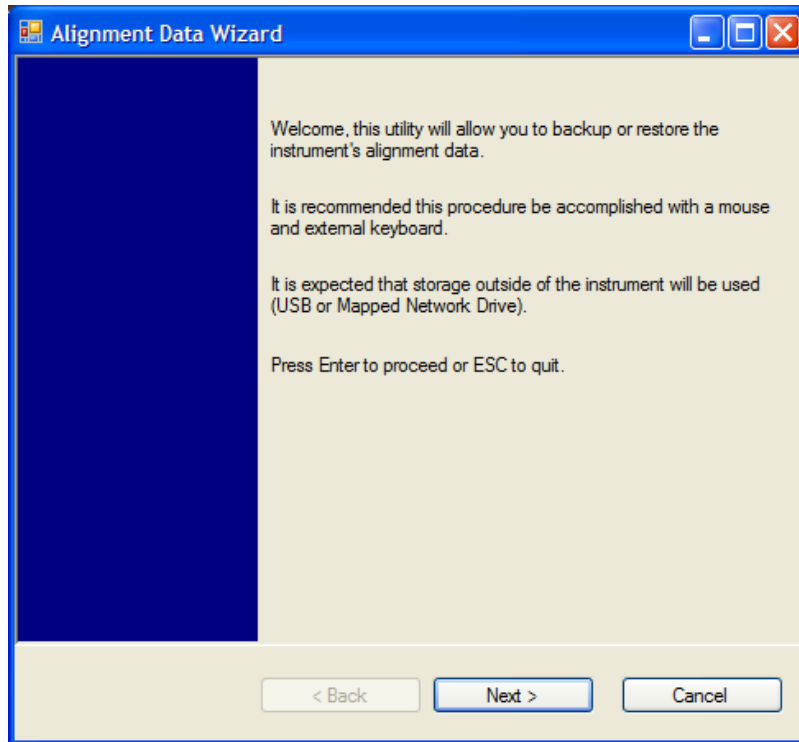

The backup screen indicates the approximate amount of space required to contain the backup file.

The default file name will be AlignDataBackup_<model number>_<serial number>_<date in YYYYMMDDHHMMSS>.bak.

The default backup location will be first drive identified as an external drive (USB or LAN) if such is available; if not, the internal D: partition will be selected.

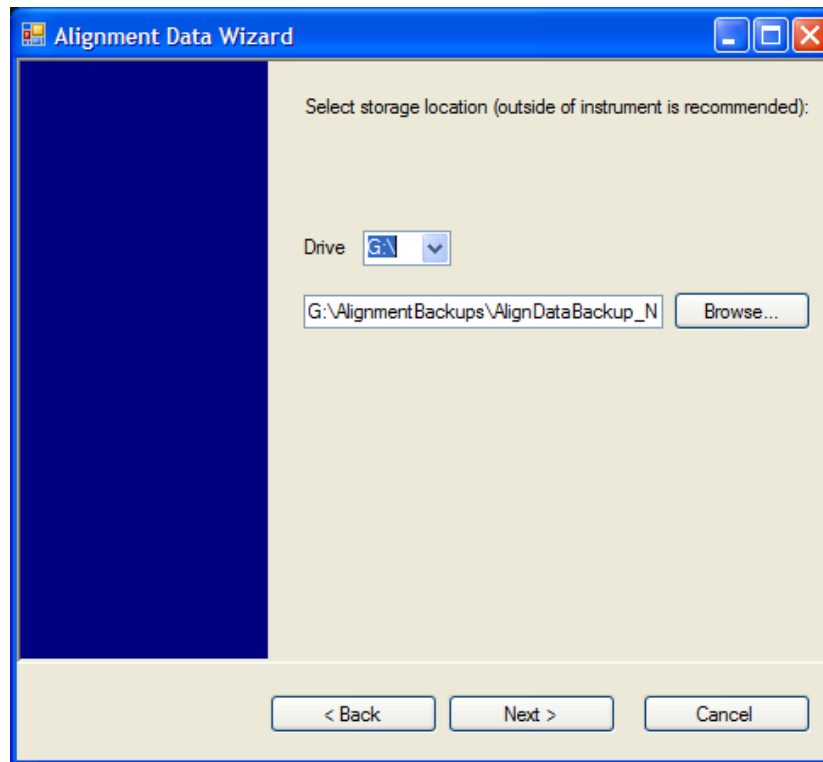

Changing the drive letter will also modify the path displayed in the box below. When this step is first loaded, the drive drop-down menu is populated with connected drives, which provide the user with write access. If there are many unreachable network drives connected to the instrument, this step can take a few seconds. If a USB drive is present, it will be selected by default. The path defaults to the AlignmentBackups folder, and a filename is automatically created in the form of AlignDataBackup_<model>_<serial number>_<date><time>. When the "Next >" button is pressed, you will be prompted to create a new folder if the chosen path does not yet exist.

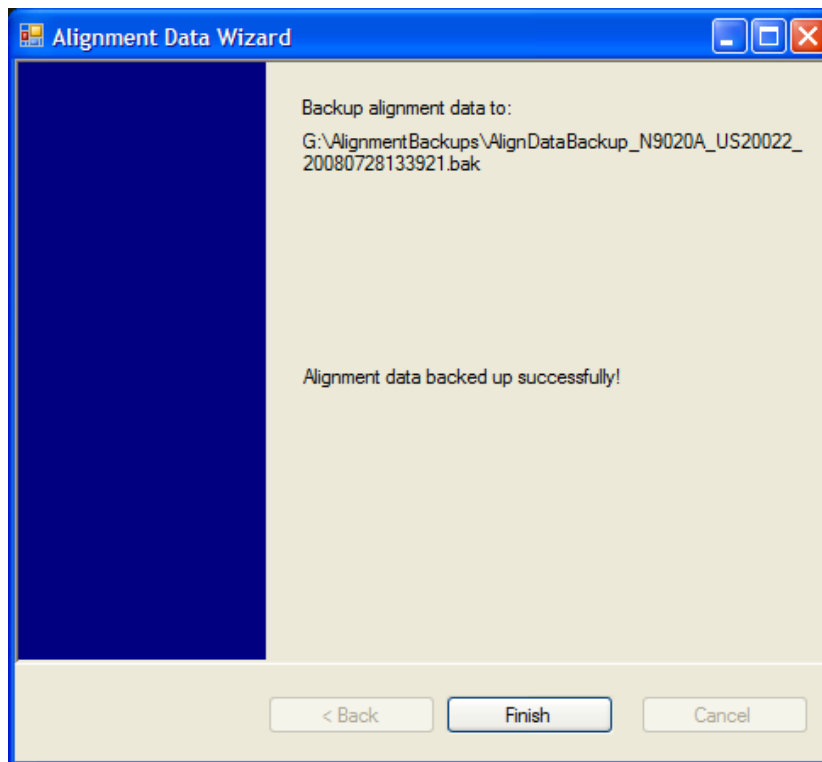
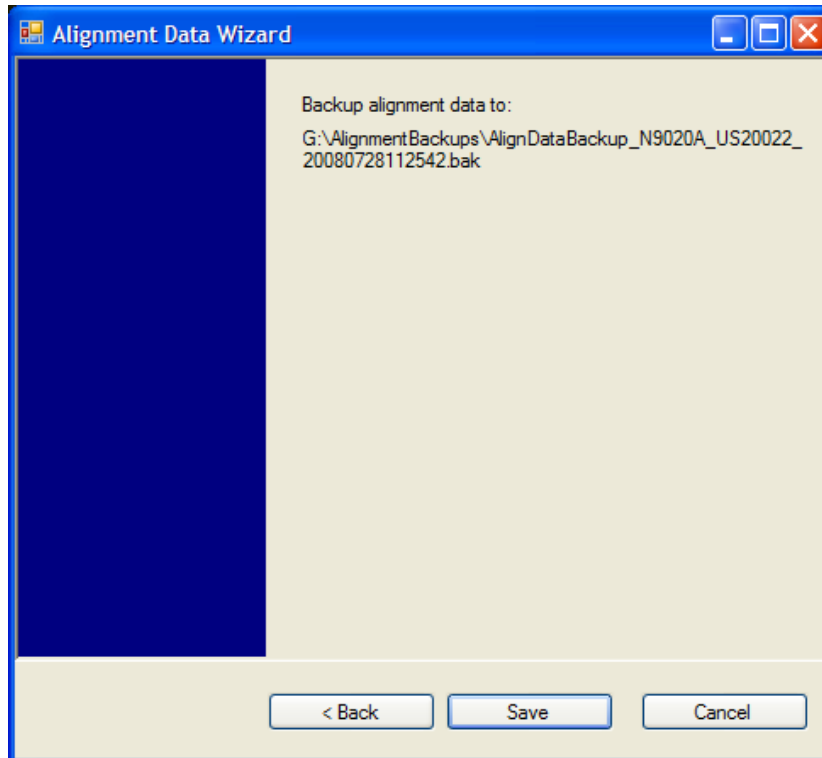

The restore operation checks the validity of the restore file using the database's built-in file validation. If the restore file is corrupt, the existing alignment data will remain in use.

If the serial number information in the backup file being restored is different from that of the instrument, the following message appears (the serial number shown are examples):

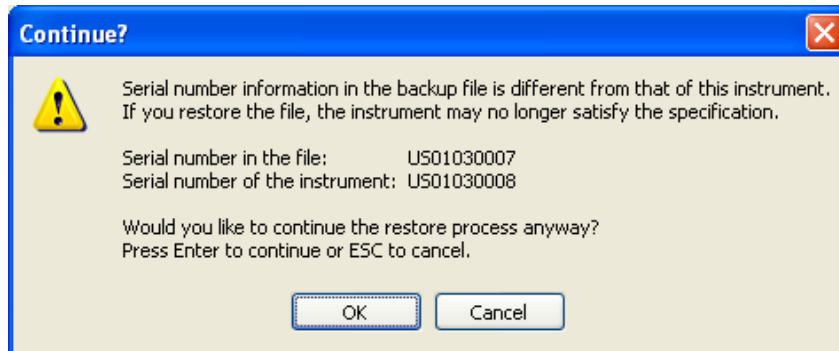

The default restore location will be first drive identified as an external drive (USB or LAN) if such is available; if not, the internal D: partition will be selected. The default restore file will be the most recent file that matches the default backup file name format: AlignDataBackup_<model number>_<serial number>_<date>.bak

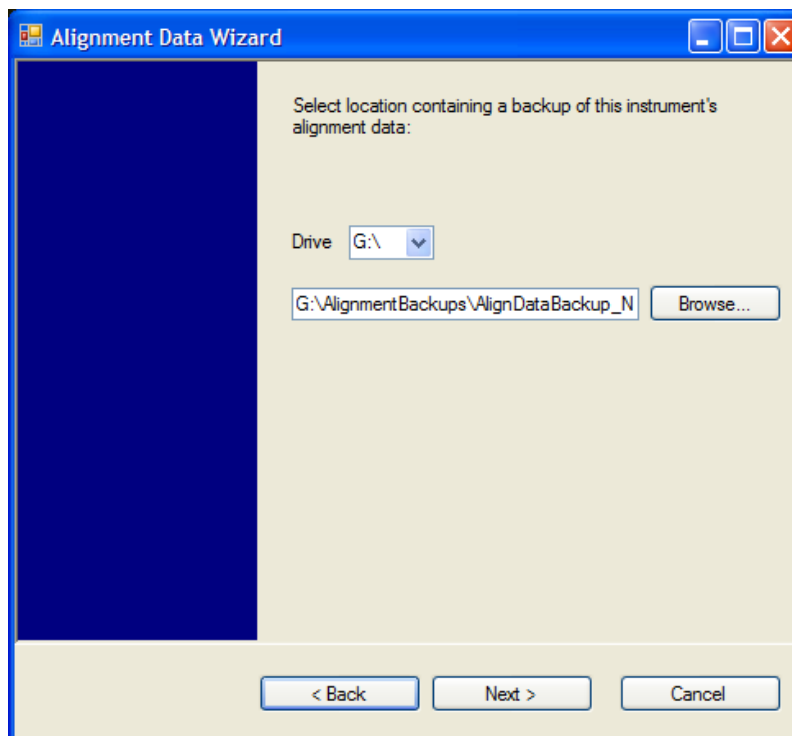

Changing the drive letter also modifies the path displayed in the box below. When this step is first loaded, the drive drop-down menu is populated with connected drives, which provide you with read access. The path defaults to the AlignBackups folder. The most recent *.bak file in the folder will also be selected by default.

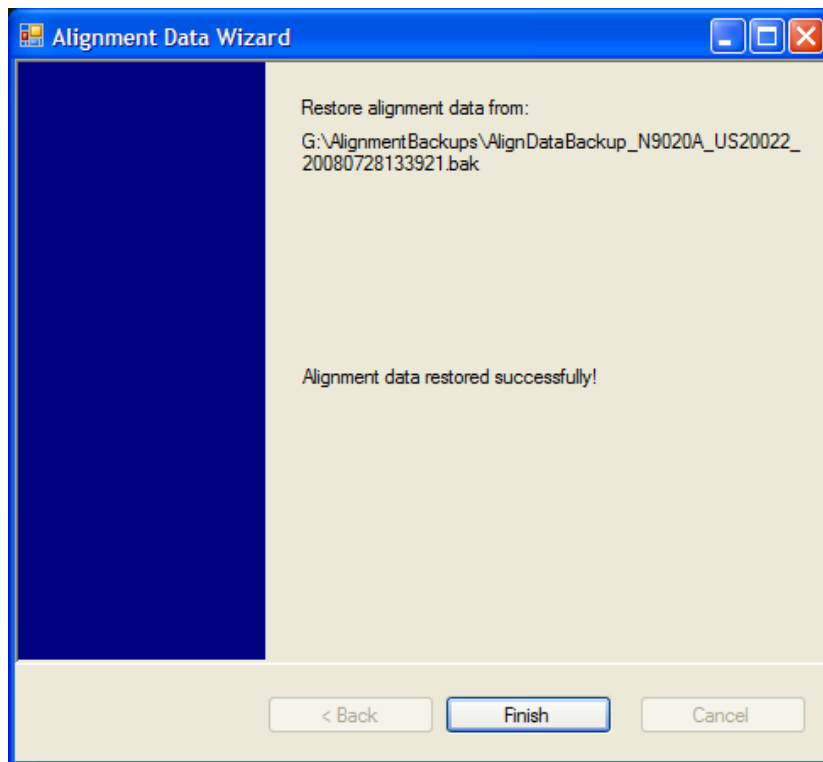
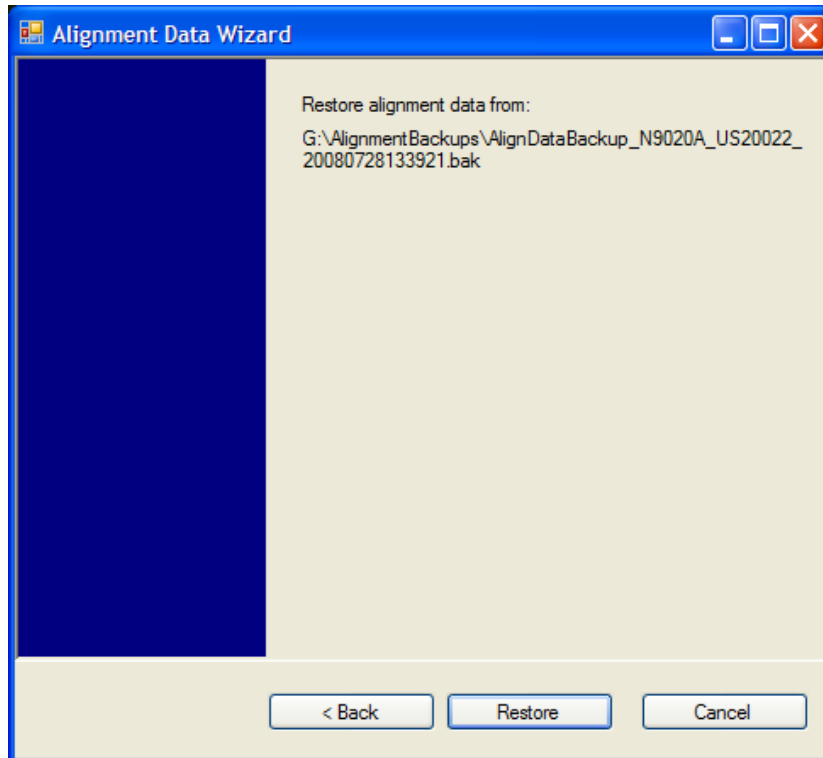

Perform Backup (Remote Command Only)

Invokes an alignment data backup operation to the provided Folder.

NOTE

It is recommended that the Folder provided is outside of the instrument (USB or Mapped Network Drive).

Remote Command	:CALibration:DATA:BACKup <filename>
-----------------------	-------------------------------------

Example	:CAL:DATA:BACK "F:\AlignDataBackup_N9020A_US00000001_2008140100.bak"
----------------	--

Initial S/W Revision	A.02.00
----------------------	---------

Perform Restore (Remote Command Only)

Invokes an alignment data restore operation from the provided filename.

Remote Command	:CALibration:DATA:RESTore <filename>
-----------------------	--------------------------------------

Example	:CAL:DATA:REST "F:\AlignDataBackup_N9020A_US00000001_2008140100.bak "
----------------	---

Initial S/W Revision	A.02.00
----------------------	---------

Advanced

Accesses alignment processes that are immediate action operations that perform operations that run until complete. Advanced alignments are performed on an irregular basis, or require additional operator interaction

Key Path	System, Alignments
----------	---------------------------

Initial S/W Revision	Prior to A.02.00
----------------------	------------------

Characterize Preselector

The Preselector tuning curve drifts over temperature and time. Recognize that the Amplitude, Presel Center function adjusts the preselector for accurate amplitude measurements at an individual frequency. Characterize Preselector improves the amplitude accuracy by ensuring the Preselector is approximately centered at all frequencies without the use of the Amplitude, Presel Center function. Characterize Preselector can be useful in situations where absolute amplitude accuracy is not of utmost importance, and the throughput savings or convenience of not performing a Presel Center is desired. Presel Center is required prior to any measurement for best (and warranted) amplitude accuracy.

Keysight recommends that the Characterize Preselector operation be performed yearly as part of any calibration, but performing this operation every three months can be worthwhile.

Characterize Preselector immediately executes a characterization of the Preselector, which is a YIG-tuned filter (YTF). The instrument stops any measurement currently underway, performs the characterization, then restarts the measurement from the beginning (similar to pressing the Restart key).

The query form of the remote commands (:CALibration:YTF?) will invoke the alignment of the YTF subsystem and return a success or failure value.

A failure encountered during alignment will generate the Error Condition message "Characterize Preselector failure" and set bit 3 in the

STATUS:QUESTIONable:CALibration:EXTended:FAILure status register. Successful completion of Characterize Preselector will clear this Condition. It will also begin the elapsed time counter for Last Characterize Preselector Time, and capture the Last Characterize Preselector Temperature.

The last Characterize Preselector Time and Temperature survives across the power cycle as this operation is performed infrequently.

NOTE

The Characterize Preselector function can be interrupted by pressing the Cancel (ESC) front-panel key or remotely with Device Clear followed by the :ABORt SCPI command. None of the new characterization data is then used. However, since the old characterization data is purged at the beginning of the characterization, you now have an uncharacterized preselector. You should re-execute this function and allow it to finish before making any further preselected measurements.

Key Path	System, Alignments, Advanced
Mode	All
Remote Command	:CALibration:YTF :CALibration:YTF?
Example	:CAL:YTF
Notes	:CALibration:YTF? returns 0 if successful :CALibration:YTF? returns 1 if failed (including interfering user signal) While Advanced, Characterize Preselector is performing the alignment, bit 0 in the Status Operation register is set. Completion, or termination, will clear bit 0 in the Status Operation register. This command is sequential; it must complete before further SCPI commands are processed. Interrupting the alignment from remote is accomplished by invoking Device Clear followed by the :ABORt command. Successful completion will clear bit 9 in the Status Questionable Calibration register. A failure encountered during alignment will generate the Error Condition message "Characterize Preselector failed" and set bit 9 in the Status Questionable Calibration register. For Options that support frequencies > 3.6 GHz only.
Dependencies	This key does not appear in models that do not contain preselectors. In these models the SCPI command is accepted without error but no action is taken.
Couplings	Initializes the time for the Last Characterize Preselector Time. Records the temperature for the Last Characterize Preselector Temperature.
Initial S/W Revision	Prior to A.02.00

Mode	All
Remote Command	:CALibration:YTF:NPENding
Example	CAL:YTF:NPEN
Notes	:CALibration:YTF:NPENding is the same as :CALibration:YTF including all conditions, status register bits, except that this scpi command does not BLOCK the scpi session, so the user should use status register bits to query if the calibration is successfully

	completed or not. Typical usage is: 1) :CALibration:YTF:NPENding (Start a YTF calibration) 2) :STATus:OPERation:CONDition? (Check if the calibration is completed or not, If bit 0 is set, then the system is doing calibration, the user should repeat this scpi query until the bit is cleared) 3):STATus:QUESTionable:CALibration:EXTended:FAILure:CONDition? (Check if bit 2 is set or not. If this bit is set, that means there are some errors in previous internal source calibration)
Initial S/W Revision	X.14.20

Characterize Reference Clock

Characterizing the reference clock is calibrating the Reference Input Phase with the External Reference Output. This feature is only available when either option DP2 or B40 is present. It requires connecting the 10 MHz OUT to the EXT REF IN port with a BNC cable before running the characterization.

See ["Front panel guided calibration sequence" on page 482](#)

Key Path	System, Alignments, Advanced
Mode	All
Remote Command	:CALibration:REFerence:CLOCK?
Example	:CAL:REF:CLOC:INIT? //connect cable :CAL:REF:CLOC? //disconnect cable :CAL:REF:CLOC:END?
Notes	:CALibration:REFerence:CLOCK? returns 0 if successful :CALibration:REFerence:CLOCK? returns 1 if failed
Dependencies	Option DP2 or B40
Couplings	Initializes the time for the Last Characterize Reference Clock Time. Records the temperature for the Last Characterize Reference Clock Temperature. Expected to be run after :CAL:REF:CLOC:INIT, and before :CAL:REF:CLOC:END.
Initial S/W Revision	A.13.00

Parameter Name	Characterize Reference Clock Initialization
Mode	All
Remote Command	:CALibration:REFerence:CLOCK:INITialize?
Example	:CAL:REF:CLOC:INIT?
Notes	:CALibration:REFerence:CLOCK:INIT? returns 0 if successful :CALibration:REFerence:CLOCK:INIT? returns 1 if failed

Dependencies	Option DP2 or B40
Couplings	Expected to be run before sending the :CAL:REF:CLOC? command. This will stop the current measurement when it has completed (does not abort the current data acquisition), and it will prepare the instrument for the expected cabling.
Force Restart	Yes
Initial S/W Revision	A.12.00

Parameter Name	Characterize Reference Clock End
Mode	All
Remote Command	:CALibration:REFeRence:CLOCK:END?
Example	:CAL:REF:CLOC:END?
Notes	:CALibration:REFeRence:CLOCK:END? returns 0 if successful :CALibration:REFeRence:CLOCK:END? returns 1 if failed
Dependencies	Option DP2 or B40
Couplings	Expected to be run after sending the :CAL:REF:CLOC? command, and after removing the cable used in that Characterize Reference Clock step. This will resume any queued measurements, and it concludes the reference clock characterization.
Force Restart	Yes
Initial S/W Revision	A.12.00

Parameter Name	Last Characterize Reference Clock
Key Path	Visual annotation in the Show Alignment Statistics screen
Parameter Type	String
Mode	All
Remote Command	:CALibration:TIME:REFeRence:CLOCK?
Example	:CAL:TIME:REFeRence:CLOCK?
Notes	Value is the date and time the last successful Characterize Reference Clock was executed. The date is separated from the time by a space character. Returns "" if Characterize Reference Clock has never been performed on the instrument.
Dependencies	Option DP2 or B40
State Saved	No
Initial S/W Revision	A.12.00

Front panel guided calibration sequence

When selecting "Characterize Reference Clock" through the front panel, the following form will be shown.

Step 1 of the guided calibration sequence:

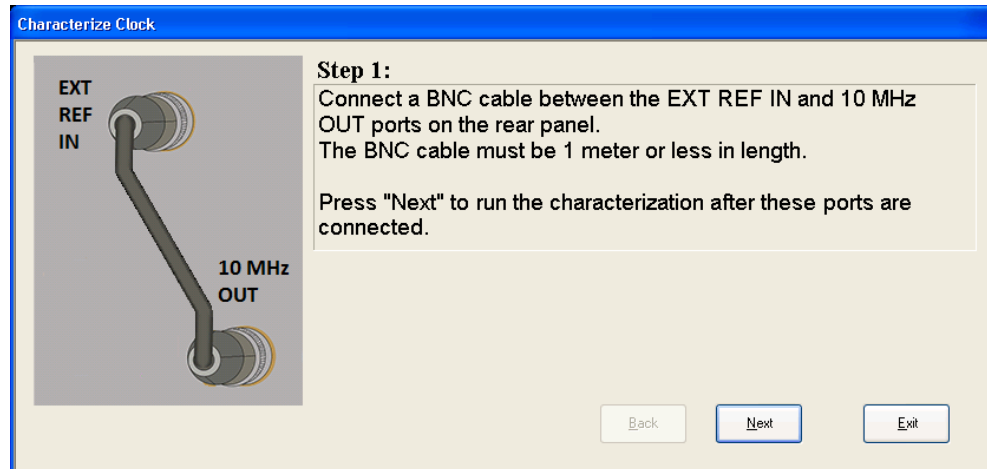

Step 2 of the guided calibration sequence:

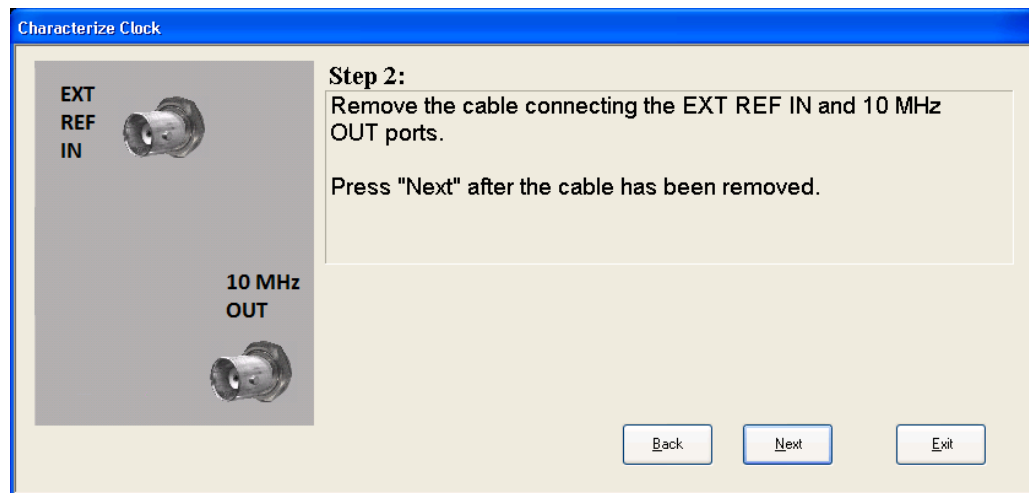

Step 3 of the guided calibration sequence:

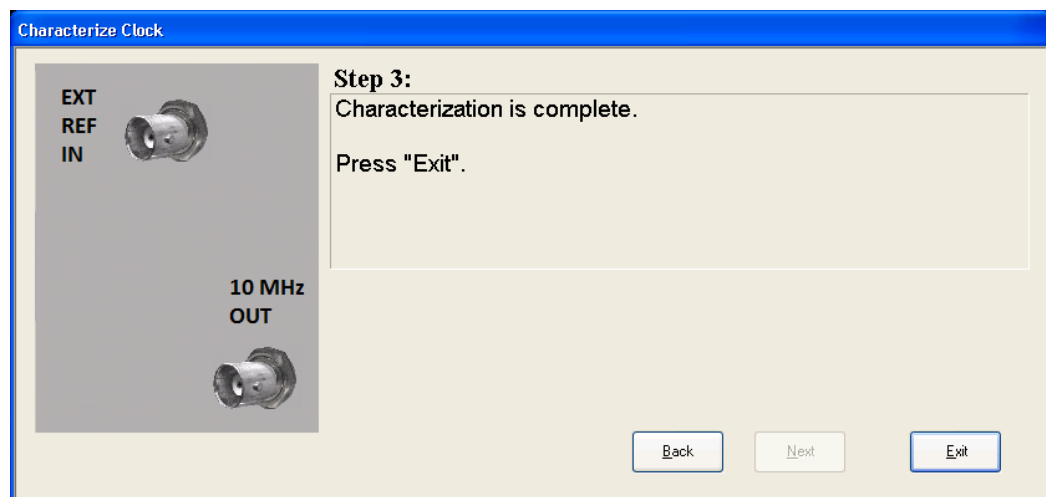

Characterize Noise Floor

On instruments with the NF2 license installed, the calibrated Noise Floor used by Noise Floor Extensions should be refreshed periodically. To do this, press the **Characterize Noise Floor** key. When you press this key, the instrument stops any measurement currently underway, and a dialog appears with an OK and Cancel button which says:

“This action will take several minutes to perform. Please disconnect all cables from the RF input and press Enter to proceed. Press ESC to cancel.”

When you press Enter or OK, the characterization proceeds. After the characterization, the analyzer restarts the measurement from the beginning (similar to pressing the Restart key). The characterization takes many minutes to run.

The noise floor model used by Noise Floor Extensions includes an estimation of the temperature behavior of the noise floor, but this is only an estimation. The noise floor changes little with the age of the components. However, even small changes in the estimated level of the noise floor can make large changes in the effective noise floor, because the effective noise floor is the error in the estimation of the noise floor. Keysight recommends that the Characterize Noise Floor operation be performed when the analyzer is operating at an ambient temperature that is significantly different than the ambient temperature at which this alignment was last run. In addition, Keysight recommends that the Characterize Noise Floor operation be performed after the first 500 hours of operation, and once every calendar year.

The noise floor model from the last operation of Characterize Noise Floor survives across the power cycle.

NOTE

The Characterize Noise Floor function can be interrupted by pressing the Cancel (ESC) front-panel key or remotely with Device Clear followed by the :ABORT SCPI command. None of the new characterization data is then used. However, since the old characterization data is purged at the beginning of the characterization, you now have an uncharacterized noise floor. You should re-execute this function and allow it to finish before making any further measurements with NFE. Until you do, the analyzer will display a “Characterize Noise Floor required” message and set bit 12 in the Status Questionable Calibration register (STATus:QUESTionable:CALibration:EXTended:NEEDED).

Key Path	System, Alignments, Advanced
Mode	All
Remote Command	:CALibration:NFLoor :CALibration:NFLoor?
Example	:CAL:NFL
Notes	:CALibration:NFLoor? returns 0 if successful :CALibration:NFLoor? returns 1 if failed (including interfering user signal) While Characterize Noise Floor is performing the alignment, bit ? in the Status Operation register is set. Completion, or termination, will clear bit ? in the Status Operation register. This command is sequential; it must complete before further SCPI commands are processed.

	<p>Interrupting the alignment from remote is accomplished by invoking Device Clear followed by the :ABORt command.</p> <p>A failure encountered during characterization will generate the Error Condition message "Characterize Noise Floor failed" message and set bit ? in the Status Questionable Calibration register. Successful completion will clear bit ? in the Status Questionable Calibration register.</p>
Dependencies	This key does not appear in models that do not contain NF2. In these models the SCPI command is accepted without error but no action is taken.
Couplings	Successful completion of Characterize Noise Floor will begin the elapsed time counter or the Last Characterize Noise Floor Time.
Initial S/W Revision	A.14.00

Key Path	Visual annotation in the Show Alignment Statistics screen
Mode	All
Remote Command	:CALibration:TIME:NFLoor?
Example	:CAL:TIME:NFL?
Notes	Value is the date and time the last successful Characterize Noise Floor was executed. The date is separated from the time by a space character. Returns "" if no Characterize Noise Floor has ever been performed on the instrument.
Dependencies	In models that do not include NF2, this command is not enabled and any attempt to set or query will yield an error.
State Saved	No
Initial S/W Revision	A.14.00

Key Path	Visual annotation in the Show Alignment Statistics screen
Mode	All
Remote Command	:CALibration:TEMPerature:NFLoor?
Example	:CAL:TEMP:NFL?
Notes	Value is the temperature of the last successful Characterize Noise Floor was executed. Returns "" if no Characterize Noise Floor has ever been performed on the instrument.
Dependencies	In models that do not include NF2, this command is not enabled and any attempt to set or query will yield an error.
State Saved	No
Initial S/W Revision	A.14.00

Key Path	Visual annotation in the Show Alignment Statistics screen
Mode	All
Remote Command	:CALibration:TIME:ELAPsed:NFLoor?

Example	:CAL:TIME:ELAP:NFL?
Notes	Value is the elapsed time the instrument was powered-on since the last successful Characterize Noise Floor was executed. Returns "" if no Characterize Noise Floor has ever been performed on the instrument.
Dependencies	In models that do not include NF2, this command is not enabled and any attempt to set or query will yield an error.
State Saved	No
Initial S/W Revision	A.14.00

Timebase DAC

Allows control of the internal 10 MHz reference oscillator timebase. This may be used to adjust for minor frequency alignment between the signal and the internal frequency reference. This adjustment has no effect if the instrument is operating with an External Frequency Reference.

If the value of the Timebase DAC changes (by switching to Calibrated from User with User set to a different value, or in User with a new value entered) an alignment may be necessary. The alignment system will take appropriate action; which will either invoke an alignment or cause an Alert.

Key Path	System, Alignments
Mode	All
Remote Command	:CALibration:FREQUENCY:REFERENCE:MODE CALibrated USER :CALibration:FREQUENCY:REFERENCE:MODE?
Example	:CAL:FREQ:REF:MODE CAL
Notes	If the value of the timebase is changed the alignment system automatically performs an alignment or alerts that an alignment is due. If the value of the timebase is changed the alignment system automatically performs an alignment or alerts that an alignment is due.
Preset	This is unaffected by Preset but is set to CALibrated on a "Restore System Defaults->Align".
State Saved	No
Initial S/W Revision	Prior to A.02.00

Calibrated

Sets the Timebase DAC to the value established during factory or field calibration. The value displayed on the menu key is the calibrated value.

Key Path	System, Alignments, Timebase DAC
Mode	All
Example	:CAL:FREQ:REF:MODE CAL
Readback Text	[xxx] < where xxx is the calibrated value
Initial S/W Revision	Prior to A.02.00

User

Allows setting the Timebase DAC to a value other than the value established during the factory or field calibration. The value displayed on the menu key is the calibrated value.

Key Path	System, Alignments, Timebase DAC
Mode	All
Example	:CAL:FREQ:REF:MODE USER
Readback Text	xxx < where xxx is the Timebase DAC setting
Initial S/W Revision	Prior to A.02.00

Key Path	System, Alignments, Timebase DAC
Mode	All
Remote Command	:CALibration:FREQuency:REFerence:FINE <integer> :CALibration:FREQuency:REFerence:FINE?
Example	:CAL:FREQ:REF:FINE 8191
Notes	If the value of the timebase is changed the alignment system automatically performs an alignment or alerts that an alignment is due.
Couplings	Setting :CAL:FREQ:REF:FINE sets :CAL:FREQ:REF:MODE USER
Preset	This is unaffected by Preset but is set to the factory setting on a "Restore System Defaults->Align".
State Saved	No
Min	0
Max	16383
Backwards Compatibility SCPI	:CALibration:FREQuency:REFerence:COARse ESA hardware contained two DAC controls for the Timebase. In X-Series the command :CALibration:FREQuency:REFerence:FINE is the method for adjusting the timebase. The :COARse command is provided as an alias to :FINE.
Initial S/W Revision	Prior to A.02.00

Remote Command	:CALibration:FREQuency:REFerence:COARse <integer> :CALibration:FREQuency:REFerence:COARse?
Example	:CAL:FREQ:REF:COAR 8191
Notes	This is an alias for CAL:FREQ:REF:FINE any change to COARse is reflected in FINE and vice-versa. See CAL:FREQ:REF:FINE for description of functionality.
Couplings	Setting :CAL:FREQ:REF:COAR sets :CAL:FREQ:REF:MODE USER
Initial S/W Revision	Prior to A.02.00

RF Preselector

This menu and all of its submenus are only available in models with the RF Preselector, such as the N9038A.

See ["Align Now, 20 Hz to 30 MHz" on page 488](#)

See ["Align Now, 30 MHz to 3.6 GHz" on page 489](#)

See ["Align Now, 20 Hz to 3.6 GHz" on page 490](#)

See ["Alert" on page 491](#)

Key Path	System, Alignments
Initial S/W Revision	Prior to A.08..00

Align Now, 20 Hz to 30 MHz

Immediately executes an alignment of the receiver subsystem. The receiver will stop any measurement currently underway, perform an Align Now All, then perform the RF Preselector alignment, and then restart the measurement from the beginning (similar to pressing the Restart key).

The query form of the remote commands (:CALibration:RFPSelector:CONDUCTed?) will invoke the alignment of the RF Preselector on Conducted Band and return a success or failure value. Successful completion will clear the "Align 20 Hz to 30 MHz required" Error Condition, and clear the bit 1 in the Status Questionable Calibration Extended Needed register. The elapsed time counter will begin for Last Align Now, Conducted Time, and the temperature is captured for the Last Align Now, Conducted Temperature. The alignment can be interrupted by pressing the Cancel (ESC) front-panel key or remotely with Device Clear followed by the :ABORt SCPI command. When this occurs, the Error Condition "Align 20 Hz to 30 MHz required" is set because new alignment data may be employed for an individual subsystem, but not a cohesive set of data for all subsystems.

The "Align 20 Hz to 30 MHz required" Error Condition will appear when this alignment has expired. User is now responsible to perform the Align Now, 20 Hz to 30 MHz in order to keep the receiver in warranted operation. This alignment can only be performed by user as it is not part of the Auto Align process.

Key Path	System, Alignments, RF Preselector, Align Now
Mode	All
Remote Command	:CALibration:RFPSelector:CONDUCTed :CALibration:RFPSelector:CONDUCTed?
Example	:CAL:RFPS:COND
Notes	For model N9038A only. :CALibration:RFPSelector:CONDUCTed? Return 0 if successful :CALibration:RFPSelector:CONDUCTed? Return 1 if failed When Align 20 Hz to 30 MHz is performing the alignment, bit 0 in the Status Operation register is set. Completion, or termination, will clear bit 0 in the Status Operation register.

	<p>This command is sequential; it must complete before further SCPI commands are processed. Interrupting the alignment from remote is accomplished by invoking Device Clear followed by the :ABORt command. Successful completion will clear bit 1 in the Status Questionable Calibration Extended Needed register and bit 0 in Status Questionable Calibration Extended Failure register.</p> <p>A failure encountered during alignment will set the Error Condition “20 Hz to 30 MHz Alignment Failure” and set both bit 1 in the Status Questionable Calibration Extended Needed register and bit 9 in Status Questionable Calibration register.</p>
Dependencies	This key does not appear in other than N9038A models, setting or querying the SCPI will generate an error.
Couplings	<p>Initializes the time for the Last Align Conducted Now, Conducted Time.</p> <p>Records the temperature for the Last Align Conducted Now, Conducted Temperature.</p>
Status Bits/OPC Dependencies	<p>Bit 8 or 9 may be set in the Status Questionable Calibration register.</p> <p>Bit 1 may be set in the Status Questionable Calibration Extended Needed register.</p> <p>Bit 0 may be set in the Status Questionable Calibration Extended Failure register.</p>
Initial S/W Revision	A.08.00

Align Now, 30 MHz to 3.6 GHz

Immediately executes an alignment of the receiver subsystem. The receiver will stop any measurement currently underway, perform an Align Now All, then perform the RF Preselector alignment, and then restart the measurement from the beginning (similar to pressing the Restart key).

The query form of the remote commands (:CALibration:RFPreselector:RADiated?) will invoke the alignment of the RF Preselector on Radiated Band and return a success or failure value. Successful completion will clear the “Align 30 MHz to 3.6 GHz required” Error Condition, and clear the bit 2 in the Status Questionable Calibration Extended Needed register. The elapsed time counter will begin for Last Align Now, Radiated Time, and the temperature is captured for the Last Align Now, Radiated Temperature. The alignment can be interrupted by pressing the Cancel (ESC) front-panel key or remotely with Device Clear followed by the :ABORt SCPI command. When this occurs, the Error Condition “Align 30 MHz to 3.6 GHz required” is set because new alignment data may be employed for an individual subsystem, but not a cohesive set of data for all subsystems.

The “Align 30 MHz to 3.6 GHz required” Error Condition will appear when this alignment has expired. User is now responsible to perform the Align Now, 30 MHz to 3.6 GHz in order to keep the receiver in warranted operation. This alignment can only be performed by user as it is not part of the Auto Align process.

Key Path	System, Alignments, RF Preselector, Align Now
Mode	All
Remote Command	:CALibration:RFPreselector:RADiated :CALibration:RFPreselector:RADiated?

Example	:CAL:RFPS:RAD
Notes	<p>For model N9038A only.</p> <p>:CALibration:RFPSector:RADiated? Return 0 if successful</p> <p>:CALibration:RFPSector:RADiated? Return 1 if failed</p> <p>When Align 30 MHz to 3.6 GHz is performing the alignment, bit 0 in the Status Operation register is set. Completion, or termination, will clear bit 0 in the Status Operation register.</p> <p>This command is sequential; it must complete before further SCPI commands are processed. Interrupting the alignment from remote is accomplished by invoking Device Clear followed by the :ABORt command. Successful completion will clear bit 2 in the Status Questionable Calibration Extended Needed register and bit 1 in Status Questionable Calibration Extended Failure register.</p> <p>A failure encountered during alignment will set the Error Condition “30 MHz to 3.6 GHz Alignment Failure” and set both bit 2 in the Status Questionable Calibration Extended Needed register and bit 9 in Status Questionable Calibration register.</p>
Dependencies	This key does not appear in other than N9038A models, setting or querying the SCPI will generate an error.
Couplings	<p>Initializes the time for the Last Align Radiated Now, Radiated Time.</p> <p>Records the temperature for the Last Align Radiated Now, Radiated Temperature.</p>
Status Bits/OPC Dependencies	<p>Bit 8 or 9 may be set in the Status Questionable Calibration register.</p> <p>Bit 2 may be set in the Status Questionable Calibration Extended Needed register.</p> <p>Bit 1 may be set in the Status Questionable Calibration Extended Failure register.</p>
Initial S/W Revision	A.08.00

Align Now, 20 Hz to 3.6 GHz

Immediately executes an alignment of the receiver subsystem. The receiver will stop any measurement currently underway, perform an Align Now All, then perform the RF Preselector alignment, and then restart the measurement from the beginning (similar to pressing the Restart key).

The query form of the remote commands (:CALibration:RFPSector:FULL?) will invoke the alignment of the RF Preselector on both Conducted and Radiated Band and return a success or failure value. Successful completion will clear the “Align 20 Hz to 3.6 GHz required” Error Condition, and clear the bit 1 and bit 2 in the Status Questionable Calibration Extended Needed register. The elapsed time counter will begin for Last Align Now, Conducted Time and Last Align Now Radiated Time and the temperature is captured for Last Align Now, Conducted Temperature and Last Align Now, Radiated Temperature. The alignment can be interrupted by pressing the Cancel (ESC) front-panel key or remotely with Device Clear followed by the :ABORt SCPI command. When this occurs, the Error Condition “Align 20 Hz to 3.6 GHz required” is set because new alignment data may be employed for an individual subsystem, but not a cohesive set of data for all subsystems.

The “Align 20 Hz to 3.6 GHz required” Error Condition will appear when this alignment has expired. It is now your responsibility to perform the Align Now, 20 Hz to 3.6 GHz to keep the receiver in warranted operation. This alignment can only be performed by the user as it is not part of the Auto Align process.

Key Path	System, Alignments, RF Preselector, Align Now
Mode	All
Remote Command	:CALibration:RFPSelector:FULL :CALibration:RFPSelector:FULL?
Example	:CAL:RFPS:FULL
Notes	For model N9038A only. :CALibration:RFPSelector:FULL? Return 0 if successful :CALibration:RFPSelector:FULL? Return 1 if failed When Align 20 Hz to 3.6 GHz is performing the alignment, bit 0 in the Status Operation register is set. Completion, or termination, will clear bit 0 in the Status Operation register. This command is sequential; it must complete before further SCPI commands are processed. Interrupting the alignment from remote is accomplished by invoking Device Clear followed by the :ABORT command. Successful completion will clear bit 1, bit 2 in the Status Questionable Calibration Extended Needed register and bit 0, bit 1 in Status Questionable Calibration Extended Failure register. A failure encountered during alignment will set the Error Condition "20 Hz to 3.6 GHz Alignment Failure" and set bit 1, bit 2 in the Status Questionable Calibration Extended Needed register and bit 9 in Status Questionable Calibration register.
Dependencies	This key only appears in N9038A models, setting or querying the SCPI in other models will generate an error.
Couplings	Initializes the time for the Last Align Conducted Now, Conducted Time. Initializes the time for the Last Align Radiated Now, Radiated Time. Records the temperature for the Last Align Conducted Now, Conducted Temperature. Records the temperature for the Last Align Radiated Now, Radiated Temperature.
Status Bits/OPC Dependencies	Bit 8 or 9 may be set in the Status Questionable Calibration register. Bit 1 and 2 may be set in the Status Questionable Calibration Extended Needed register. Bit 0 and 1 may be set in the Status Questionable Calibration Extended Failure register.
Initial S/W Revision	A.08.00

Alert

Setting Alert to ON/OFF will enable/disable the display of RF Preselector alignment required message on the status line. The instrument will power up with Alert On mode.

Key Path	System, Alignments, RF Preselector
Mode	All
Remote Command	:CALibration:RFPSelector:ALERT ON OFF 0 1 :CALibration:RFPSelector:ALERT?
Example	:CAL:RFPS:ALER OFF
Notes	For model N9038A only.

	Error Condition will be generated when the alert is On and any of the RF Preselector alignments has expired.
Preset	This is unaffected by Preset, but is set to ON on a "Restore System Defaults->Align".
State Saved	No
Initial S/W Revision	A.08.00

Schedule Setup

Enables you to schedule a task to run automatically at the background based on the recurrence and time set in the scheduler. Make sure that the Instrument's local time is accurate as the Scheduler relies on this information to execute the task.

Key Path	System, Alignments, RF Preselector
Initial S/W Revision	A.08.00

Task

There are 3 tasks that can be selected for the scheduler to run.

Task 1 is the 20 Hz to 30 MHz alignment

Task 2 is the 30 MHz to 3.6 GHz alignment

Task 3 is the 20 Hz to 3.6 GHz alignment.

Key Path	System, Alignments, RF Preselector, Schedule Setup
Mode	All
Remote Command	:CALibration:RFPSelector:Scheduler:TASK T1 T2 T3 :CALibration:RFPSelector:Scheduler:TASK?
Example	:CAL:RFPS:SCH:TASK T1
Notes	Changing the task will not reset the Scheduler time and the alignment is based on the current scheduled configuration to occur. For model N9038A only.
Preset	This is unaffected by Preset but is set to T3 on a "Restore System Defaults->Align".
State Saved	No
Range	Task 1 Task 2 Task 3
Initial S/W Revision	A.08.00

Date/Time

Enables you to configure the scheduler to run a task starting from this date and time. The date and time rely on the instrument's local time to execute a scheduled task. The date is based on the format "YYYY/MM/DD" and the time is based on a 24 hour clock.

Key Path	System, Alignments, RF Preselector, Schedule Setup
----------	---

Mode	All
Remote Command	:CALibration:RFPSelector:SCHeuler:TIME:STARt "date","time" :CALibration:RFPSelector:SCHeuler:TIME:STARt?
	This query returns data using the following format "YYYY/MM/DD; HH:MM:SS"
Example	:CAL:RFPS:SCH:TIME:STAR "2009/8/20", "12:00:00"
Notes	<p>"date" is representation of the date the task will run in the form of "YYYY/MM/DD" where:</p> <ul style="list-style-type: none"> - YYYY is the four digit representation of year. (for example, 2009) - MM is the two digit representation of month. (for example, 01 to 12) - DD is the two digit representation of the day. (for example, 01 to 28, 29, 30 or 31 depending on the month and year) <p>"time" is a representation of the time of day the task will run in the form of "HH:MM:SS" where:</p> <ul style="list-style-type: none"> - HH is the two digit representation of the hour in 24 hour format - MM is the two digit representation of minute - SS is the two digit representation of seconds <p>For model N9038A only.</p>
Preset	This is unaffected by Preset but is set to Current date and 00:00:00 on a "Restore System Defaults->Align".
State Saved	No
Initial S/W Revision	A.08.00

Date

Enables you to configure the date of the scheduled task. The SCPI command to configure the date and time parameters of the scheduler is the same; however, they each have their own front-panel control.

Key Path	System, Alignments, RF Preselector, Schedule Setup, Date/Time
Notes	See " Date/Time " on page 492. For model N9038A only.
Preset	This is unaffected by Preset but is set to Current date and 00:00:00 on a "Restore System Defaults->Align".
State Saved	No
Initial S/W Revision	A.08.00

Time

Enables you to configure the time of the scheduled task. The SCPI command to configure the date and time parameters of the scheduler is the same; however, they each have their own front panel-control.

Key Path	System, Alignments, RF Preselector, Schedule Setup, Date/Time
Notes	See " Date/Time " on page 492. For model N9038A only.
Preset	This is unaffected by Preset but is set to Current date and 00:00:00 on a "Restore System Defaults->Align".
State Saved	No
Initial S/W Revision	A.08.00

Recurrence

Enables you to configure the scheduler to run the task recurrently on a scheduled date and time. You can schedule it to run daily, weekly or alternate weeks.

Key Path	System, Alignments, RF Preselector, Schedule Setup
Mode	All
Remote Command	:CALibration:RFPSelector:SCHeDuler:RECurrence DAY WEEK OFF :CALibration:RFPSelector:SCHeDuler:RECurrence?
Example	:CAL:RFPS:SCH:REC DAY
Notes	For model N9038A only.
Preset	This is unaffected by Preset but is set to OFF on a "Restore System Defaults->Align".
State Saved	No
Range	DAY WEEK OFF
Initial S/W Revision	A.08.00

Every N Weeks

Enables you to configure the scheduler to run the task on a day in every number of week's duration.

Key Path	System, Alignments, RF Preselector, Schedule Setup, Recurrence
Initial S/W Revision	A.08.00

N of Weeks

Enables you to set the number of weeks that the scheduler will wait to trigger a task.

Key Path	System, Alignments, RF Preselector, Schedule Setup, Recurrence, Every N Weeks
Mode	All
Remote Command	:CALibration:RFPSelector:SCHeDuler:RECurrence:WEEK <integer> :CALibration:RFPSelector:SCHeDuler:RECurrence:WEEK?
Example	:CAL:RFPS:SCH:REC:WEEK 2
Notes	New scheduled date to run the alignment task will get updated when this parameter is changed. For model N9038A only.

Preset	This is unaffected by Preset but is set to 1 on a "Restore System Defaults->Align".
State Saved	No
Range	1-52
Min	1
Max	52
Initial S/W Revision	A.08.00

Day

Enables you to set the Day of the Week the scheduler will run a scheduled task.

Key Path	System, Alignments, RF Preselector, Schedule Setup, Recurrence, Every N Weeks
Mode	All
Remote Command	:CALibration:RFPreselector:Scheduler:REcurrence:DAY SUN MON TUE WED THU FRI SAT :CALibration:RFPreselector:Scheduler:REcurrence:DAY?
Example	:CAL:RFPS:SCH:REC:DAY SUN
Notes	For model N9038A only.
Preset	This is unaffected by Preset but is set to SUN on a "Restore System Defaults->Align".
State Saved	No
Range	Sunday Monday Tuesday Wednesday Thursday Friday Saturday
Initial S/W Revision	A.08.00

Scheduler

Setting the Scheduler to ON will trigger the execution of the scheduled task based on the recurrence and time set in the scheduler since the last successful of the specific alignment. A warning condition of "RF Preselector alignment scheduler is ON" will be appeared when the scheduler is set to ON. OFF will turn off the Scheduler from running any scheduled task.

Key Path	System, Alignments, RF Preselector
Mode	All
Remote Command	:CALibration:RFPreselector:Scheduler:STATe ON OFF 0 1 :CALibration:RFPreselector:Scheduler:STATe?
Example	:CAL:RFPS:SCH:STAT OFF
Notes	For model N9038A only.
Preset	This is unaffected by Preset but is set to OFF on a "Restore System Defaults->Align".
State Saved	No
Initial S/W Revision	A.08.00

I/O Config

Activates a menu for identifying and changing the I/O configuration for remote control.

Key Path	System
Initial S/W Revision	Prior to A.02.00

GPIB

Activates a menu for configuring the GPIB I/O port.

Key Path	System, I/O Config
Initial S/W Revision	A.02.00

GPIB Address

Select the GPIB remote address.

Key Path	System, I/O Config, GPIB
Mode	All
Remote Command	:SYSTem:COMMunicate:GPIB[1][:SELF]:ADDRess <integer> :SYSTem:COMMunicate:GPIB[1][:SELF]:ADDRess?
Example	:SYST:COMM:GPIB:ADDR 17
Notes	Changing the Address on the GPIB port requires all further communication to use the new address.
Preset	This is unaffected by Preset but is set to 18 on a "Restore System Defaults->Misc"
State Saved	No
Range	0 to 30
Min	0
Max	30
Initial S/W Revision	Prior to A.02.00

GPIB Controller

Sets the GPIB port into controller or device mode. In the normal state, GPIB controller is disabled, which allows the analyzer to be controlled by a remote computer. When GPIB Controller is enabled, the instrument can run software applications that use the instrument's computer as a GPIB controller; controlling devices connected to the instrument's GPIB port.

NOTE

When GPIB Controller is enabled, the analyzer application itself cannot be controlled over GPIB. In this case it can easily be controlled via LAN or USB. The GPIB port cannot be a controller and device at the same time. Only one controller can be active on the GPIB bus at any given time. If the analyzer is the controller, an external PC cannot be a controller.

To control the instrument from the software that is performing GPIB controller operation, you can use an internal TCP/IP connection to the analyzer application. Use the address TCPIP0:localhost:inst0:INSTR to send SCPI commands to the analyzer application.

Key Path	System, I/O Config, GPIB
Mode	All
Scope	Mode Global
Remote Command	:SYSTem:COMMunicate:GPIB[1][:SELF]:CONTroller[:ENABle] ON OFF 0 1 :SYSTem:COMMunicate:GPIB[1][:SELF]:CONTroller[:ENABle]?
Example	:SYST:COMM:GPIB:CONT ON Will set GPIB port to Controller
Notes	When the instrument becomes the Controller bit 0 in the Standard Event Status Register is set (and when the instrument relinquishes Controller capability bit 0 is cleared in the Standard Event Status Register).
Preset	This is unaffected by Preset but is set to OFF on a "Restore System Defaults->Misc"
State Saved	No
Range	Disabled Enabled
Initial S/W Revision	A.02.00

Disabled

Disables the GPIB Controller capability, this is the default (or normal) setting.

Key Path	System, I/O Config, GPIB, GPIB Controller
Example	:SYST:COMM:GPIB:CONT OFF Will set GPIB port to Device
Initial S/W Revision	A.02.00

Enabled

Enables the GPIB Controller capability.

Key Path	System, I/O Config, GPIB, GPIB Controller
Example	:SYST:COMM:GPIB:CONT ON Will set GPIB port to Controller
Initial S/W Revision	A.02.00

SCPI LAN

Activates a menu for identifying and changing the SCPI over a LAN configuration. There are a number of different ways to send SCPI remote commands to the instrument over LAN. It can be a problem to have multiple users simultaneously accessing the instrument over the LAN. These keys limit that somewhat by disabling the telnet, socket, and/or SICL capability.

Key Path	System, I/O Config
Initial S/W Revision	Prior to A.02.00

SCPI Telnet

Turns the SCPI LAN telnet capability On or Off allowing you to limit SCPI access over LAN through telnet.

Key Path	System, I/O Config, SCPI LAN
Mode	All
Remote Command	:SYSTem:COMMunicate:LAN:SCPI:TELNet:ENABle OFF ON 0 1 :SYSTem:COMMunicate:LAN:SCPI:TELNet:ENABle?
Example	:SYST:COMM:LAN:SCPI:TELN:ENAB OFF
Preset	This is unaffected by Preset but is set to ON with a “Restore System Defaults->Misc”
State Saved	No
Range	On Off
Initial S/W Revision	Prior to A.02.00

SCPI Socket

Turns the capability of establishing Socket LAN sessions On or Off. This allows you to limit SCPI access over LAN through socket sessions.

Key Path	System, I/O Config, SCPI LAN
Mode	All
Remote Command	:SYSTem:COMMunicate:LAN:SCPI:SOCKet:ENABle OFF ON 0 1 :SYSTem:COMMunicate:LAN:SCPI:SOCKet:ENABle?
Example	:SYST:COMM:LAN:SCPI:SOCK:ENAB OFF
Preset	This is unaffected by a Preset but is set to ON with a “Restore System Defaults->Misc”
State Saved	No
Range	On Off
Initial S/W Revision	Prior to A.02.00

SICL Server

Turns the SICL server capability On or Off, enabling you to limit SCPI access over LAN through the SICL server. (SICL IEEE 488.2 protocol.)

Parameter	Description	Setting
Maximum Connections	The maximum number of connections that can be accessed simultaneously	5
Instrument Name	The name (same as the remote SICL address) of your analyzer	inst0
Instrument Logical Unit	The unique integer assigned to your analyzer when using SICL LAN	8
Emulated GPIB Name	The name (same as the remote SICL address) of the device used when communicating with your analyzer	gpib7

Emulated GPIB Logical Unit	The unique integer assigned to your device when it is being controlled using SICL LAN	8
Emulated GPIB Address	The emulated GPIB address assigned to your transmitter tester when it is a SICL server (the same as your GPIB address)	18

Key Path	System, I/O Config, SCPI LAN
Mode	All
Remote Command	:SYSTem:COMMunicate:LAN:SCPI:SICL:ENABle OFF ON 0 1 :SYSTem:COMMunicate:LAN:SCPI:SICL:ENABle?
Example	:SYST:COMM:LAN:SCPI:SICL:ENAB OFF
Preset	This is unaffected by Preset, but is set to ON with a "Restore System Defaults->Misc"
State Saved	No
Range	On Off
Initial S/W Revision	Prior to A.02.00

HiSLIP Server

Turns the HiSLIP server capability On or Off, enabling you to limit SCPI access over LAN through the HiSLIP server.

HiSLIP stands for High Speed LAN Instrument Protocol and is part of the IVI-6.1 specification.

Here is an example of a VISA connection string used to connect to the HiSLIP Server on an X-Series Spectrum Analyzer:

```
TCPIP0::a-n9030a-93016::hislip0::INSTR
```

In the example above, hislip0 is the HiSLIP device name that VISA users must include in their HiSLIP VISA Address strings. Your HiSLIP device name may be different depending on your VISA settings.

Key Path	System, I/O Config, SCPI LAN
Mode	All
Remote Command	:SYSTem:COMMunicate:LAN:SCPI:HISLip:ENABle OFF ON 0 1 :SYSTem:COMMunicate:LAN:SCPI:HISLip:ENABle?
Example	:SYST:COMM:LAN:SCPI:HISL:ENAB OFF
Preset	This is unaffected by Preset, but is set to ON with a "Restore System Defaults->Misc"
State Saved	No
Range	On Off
Initial S/W Revision	A.11.00

SCPI Socket Control Port (Remote Command Only)

Returns the TCP/IP port number of the control socket associated with the SCPI socket session. This query enables you to obtain the unique port number to open when a device clear is to be sent to the instrument. Every time a connection is made to the SCPI socket, the instrument creates a peer control socket. The port number for this socket is random. The user must use this command to obtain the port number of the control socket. To force a device clear on this socket, open the port and send the string "DCL" to the instrument.

If this SCPI command is sent to a non SCPI Socket interface, then 0 is returned.

Mode	All
Remote Command	:SYSTem:COMMunicate:LAN:SCPI:SOCKet:CONTRol?
Example	:SYST:COMM:LAN:SCPI:SOCK:CONT?
Preset	This is unaffected by Preset or "Restore System Defaults->Misc".
State Saved	No
Range	0 to 65534
Min	0
Max	65534
Backwards Compatibility SCPI	SYSTem:COMMunicate:TCPip:CONTRol?
Initial S/W Revision	Prior to A.02.00

Reset Web Password

The embedded web server contains certain capabilities which are password protected; modifying the LAN configuration of the instrument, and access to web pages that can change the settings of the instrument. The default password for software versions less than A.14.49 is 'agilent' (without the quotes), for software versions greater than A.14.50 the password is 'measure4u' (without the quotes). The control provided here is the means to set the web password as the user desires, or to reset the password to the factory default.

Selecting Reset web password brings up a control for resetting the password as the user desires, or to the factory default. An external keyboard is required to change the password from the factory default. The control is:

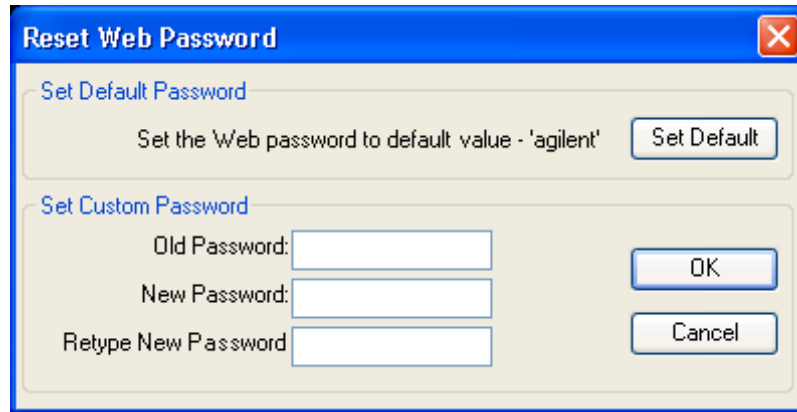

If this control is entered without an external keyboard or mouse connected, you can cancel the control by pressing the Cancel (ESC) front-panel key.

Key Path	System, I/O Config
Mode	All
Initial S/W Revision	Prior to A.02.00

LXI

Opens a menu that allows you to access the various LXI configuration properties.

Key Path	System, I/O Config
Initial S/W Revision	Prior to A.02.00

LAN Reset

Resets the LAN connection.

Key Path	System, I/O Config, LXI
Initial S/W Revision	Prior to A.02.00

Device Identification (Remote Command Only)

Enabling the LXI device identification will place the LXI Status Indicator to the 'Identify' state. Disabling the LXI device identification will place the LXI Status Indicator to the 'No Fault' state. The LXI Status indicator is in the upper left region of the instrument's graphical user interface (.

Mode	All
Remote Command	:LXI:IDENtify[:STATE] OFF ON 0 1 :LXI:IDENtify[:STATE]?
Example	:LXI:IDEN ON
Preset	Not part of Preset, but reset to OFF on Restore System Defaults All
State Saved	No

Range	On Off
Initial S/W Revision	A.12.50

System IDN Response

This key allows you to specify a response to the *IDN? query, or to return the analyzer to the Factory response if you have changed it.

To choose the factory-set response, press the **Factory** key.

To specify your own response, press the **User** key, and enter your desired response.

If your test software is expecting the response to indicate Agilent Technologies as the Manufacturer, you can conveniently configure the response by pressing the Agilent key.

Key Path	System, I/O Config
Mode	All
Remote Command	:SYSTem:IDN:CONFigure FACTory AGILent USER :SYSTem:IDN:CONFigure?
Notes	<ul style="list-style-type: none"> - This affects the response given in all Modes of the Analyzer, unless the current Mode has also specified a custom response, in which case the current Mode's custom IDN response takes precedence over the System's, but only while that Mode is the current Mode.. - It survives shutdown and restart of the software and therefore survives a power cycle
Preset	This is unaffected by Preset but is set to Factory on a "Restore System Defaults->Misc"
State Saved	No
Initial S/W Revision	A.06.00
Modified at S/W Revision	x.14.50

Factory

This key selects the factory setting, for example:

"Agilent Technologies,N9020A,MY00012345,A.05.01"

where the fields are manufacturer, model number, serial number, firmware revision.

Key Path	System, I/O Config, IDN Response
Example	:SYST:IDN:CONF FACT
Initial S/W Revision	A.06.0

User

This key allows you to specify your own response to the *IDN? query. You may enter your desired response with the Alpha Editor or a plugin PC keyboard.

When you press this key, the active function becomes the current User string with the cursor at the end. This makes it easy to edit the existing string.

If you enter a null string (for example, by clearing the User String while editing and then pressing **Done**) the analyzer automatically reverts to the Factory setting.

Key Path	System, I/O Config, IDN Response
Example	:SYST:IDN:CONF USER
Initial S/W Revision	A.06.00

SYSTem:IDN Response setting (Remote command)

This SCPI command is used to set or clear the User SYSTem:IDN response.

Remote Command	:SYSTem:IDN <string> :SYSTem:IDN?
Notes	<ul style="list-style-type: none"> - The format of the <string> must be four fields each separated by a comma, example: :SYST:IDN "XYZ Corp,Model 12,012345,A.01.01" - The four fields are <manufacturer>, <model number>, <serial number>, <firmware revision>. Thus, the text within a field cannot contain a comma. - This affects the response given in all Modes of the Analyzer, unless the current Mode has also specified a custom response, in which case the current Mode's custom IDN response takes precedence over the System's, but only while that Mode is the current Mode.. - It survives shutdown and restart of the software and therefore survives a power cycle - Null string as parameter restores the Factory setting, example: :SYST:IDN ""
Preset	This is unaffected by Preset but is set to the original factory setting on a "Restore System Defaults->Misc"
Initial S/W Revision	A.06.00

SYSTem:PERSONa:DEFault

This command will reset the *IDN response to the instrument default.

Remote Command	SYSTem:PERSONa:DEFault SYSTem:PERSONa:DEFault?
Notes	<p>The query SYST:PERS:DEF? returns the default value of *IDN? even if the current setting of *IDN? is the non-default value. The return value of SYST:PERS:DEF? is a <string>.</p> <p>SYST:PERS:DEF is equivalent to: SYSTem:IDN "" SYSTem:IDN:CONF DEF</p>
Initial S/W Revision	x.17.00

SYSTem:PERSONa:MANUFACTURer

This command will set the Manufacturer field of the *IDN? response. The Manufacturer field is the first field of the *IDN? response.

Remote Command	SYSTem:PERSONa:MANUFACTURer <string> SYSTem:PERSONa:MANUFACTURer?
Notes	When setting the manufacturer field, the current IDN response string is modified to replace the manufacturer field with the string specified by the command. If the resulting IDN response matches one of the predefined responses (SYSTem:IDN:CONFigure FACT AGIL), then the SYSTem:IDN:CONFigure is set to the corresponding value. If the IDN response with the new manufacturer field is not one of the predefined values, then SYSTem:IDN:CONFigure will be set to USER and SYSTem:IDN will be set to the new IDN response string. The query SYST:PERS:MAN? returns the current value of the *IDN? Manufacturer field.
Initial S/W Revision	x.17.00

SYSTem:PERSONa:MANUFACTURer:DEFault

This command will reset the Manufacturer field of the *IDN? response to the default value.

Remote Command	SYSTem:PERSONa:MANUFACTURer:DEFault SYSTem:PERSONa:MANUFACTURer:DEFault?
Notes	The query SYST:PERS:MAN:DEF? returns the default Manufacturer Field value of *IDN? even if the current setting of *IDN? is the non-default value. The return value of SYST:PERS:MAN:DEF? is a <string>.
Initial S/W Revision	x.17.00

SYSTem:PERSONa:MODEl

This command will set the Model field of the *IDN? response. The Model field is the second field of the *IDN? response.

Remote Command	SYSTem:PERSONa:MODEl <string> SYSTem:PERSONa:MODEl?
Notes	When setting the model field, the current IDN response string is modified to replace the model field with the string specified by the command. If the resulting IDN response matches one of the predefined responses (SYSTem:IDN:CONFigure FACT AGIL), then the SYSTem:IDN:CONFigure is set to the corresponding value. If the IDN response with the new model field is not one of the predefined values, then SYSTem:IDN:CONFigure will be set to USER and SYSTem:IDN will be set to the new IDN response string. The query SYST:PERS:MOD? returns the current value of the *IDN? Model field.
Initial S/W Revision	x.17.00

SYSTem:PERSONa:MODEl:DEFault

This command will reset the Model field of the *IDN? response to the default value.

Remote Command	SYSTem:PERSONa:MODEl:DEFault
-----------------------	------------------------------

	SYSTem:PERSonA:MODe1:DEFault?
Notes	The query SYST:PERS:MOD:DEF? returns the default Model Field value of *IDN? even if the current setting of *IDN? is the non-default value. The return value of SYST:PERS:MOD:DEF? is a <string>.
Initial S/W Revision	x.17.00

Query USB Connection (Remote Command Only)

Enables you to determine the speed of the USB connection.

Mode	All
Remote Command	:SYSTem:COMMunicate:USB:CONNecTion?
Example	:SYST:COMM:USB:CONN?
Notes	NONE – Indicates no USB connection has been made. LSPeed – Indicates a USB low speed connection (1.5 Mbps). This is reserved for future use, the T+M488 protocol is not supported on low speed connections. HSPeed – Indicates that a USB high speed connection (480 Mbps) has been negotiated. FSPeed – Indicates that a USB full speed connection (12 Mbps) has been negotiated.
State Saved	No
Range	NONE LSPeed HSPeed FSPeed
Initial S/W Revision	Prior to A.02.00

USB Connection Status (Remote Command Only)

Enables you to determine the current status of the USB connection.

Mode	All
Remote Command	:SYSTem:COMMunicate:USB:STATus?
Example	:SYST:COMM:USB:STAT?
Notes	SUSPended – Indicates that the USB bus is currently in its suspended state. The bus is in the suspended state when: <ul style="list-style-type: none"> – The bus is not connected to any controller – The controller is currently powered off – The controller has explicitly placed the USB device into the suspended state. When in the suspended state, no USB activity, including start of frame packets are received. ACTive – Indicates that the USB device is in the active state. When the device is in the active state, it is receiving periodic start of frames but it isn't necessarily receiving or transmitting data.
State Saved	No
Range	SUSPended ACTive
Initial S/W Revision	Prior to A.02.00

USB Packet Count (Remote Command Only)

Enables you to determine the number of packets received and transmitted on the USB bus.

Mode	All
Remote Command	:SYSTem:COMMunicate:USB:PACKets?
Example	:SYST:COMM:USB:PACK?
Notes	Two integers are returned. The first is the number of packets received since application invocation, the second is the number of packets transmitted since application invocation. If no packets have been received or transmitted the response is 0,0. The packet count is initialized to 0,0 when the instrument application is started.
State Saved	No
Initial S/W Revision	Prior to A.02.00

Lock Remote I/O Session (Remote Command only)

You can lock the SCPI control of the instrument to the I/O Interface and Session by performing a SYSTem:LOCK:REQuest? Query. This permits cooperative sharing of the instrument between multiple computers, or multiple sessions from the same computer.

NOTE

Use of cooperative sharing (locking) must take into account the properties of an interface, interfaces are either single session or multiple session:

Interface	Single Session	Multiple Session
GPIB	✓	
USB-488	✓	
LAN VXI-11 (SICL)	✓	
LAN Socket		✓
LAN HiSLIP		✓
LAN Telnet		✓

NOTE

It is inappropriate to control the instrument from multiple computers (or multiple processes or threads of a single computer) when using single session interfaces. In particular, care must be taken when using LAN VXI-11 (SICL) interface that only a single computer (or single process or single thread) is controlling the instrument; if multiple computers are controlling the instrument responses may not result in expected operation.

It is not recommend to use VXI-11 with SCPI locking as multiple clients can simultaneously connect to the instrument. If VXI-11 is required then VISA locking must be used in addition to SCPI locking.

The recommended interface is LAN HiSLIP. Since HiSLIP is a multiple session interface, the controlling computer can send lock requests from multiple applications (or multiple threads of a single application) to permit cooperative sharing of the instrument.

Remote Command	SYSTem:LOCK:REQuest?
Example	SYST:LOCK:REQ?
Notes	<p>The command returns a 1 if the lock request is granted, 0 is returned if the request is denied. Single Session interfaces will always return 1 once the same interface has already received a lock request.</p> <p>Lock requests on an individual interface and session can be nested and each request will increase an internal lock count by 1. For every granted request, you will need to perform a SYSTem:LOCK:RELease to decrement the internal lock count to fully relinquish the lock.</p> <p>When the instrument is locked bit 0 is set in the Operation Instrument status register.</p> <p>Disconnecting the individual interface and session will release the lock if the lock is granted to the interface and session.</p> <p>A Device Clear over any interface and session will release the lock, regardless of the interface and session which obtained the lock.</p> <p>The following queries are permitted over any interface and session even if an interface has the instrument locked:</p> <ul style="list-style-type: none"> *IDN? *OPT? *STB? *ESR? :SYSTem:DATE? :SYSTem:TIME? :SYSTem:PON:TIME? <p>Queries in the :STATus subsystem</p> <p>Queries in the :SYSTem:ERRor subsystem</p> <p>Queries in the :SYSTem:LKEY subsystem</p> <p>Queries in the :SYSTem:LOCK subsystem</p> <p>Queries in the :SYSTem:METRics subsystem</p> <p>Queries in the :SYSTem:MODule subsystem</p> <p>All other commands and queries will result in the error: -203, "Command protected; Instrument locked by another I/O session"</p>
State Saved	Not part of Save/Recall
Initial S/W Revision	x.16.10

Unlock Remote I/O Session (Remote Command only)

You can unlock the SCPI control of an I/O Interface and Session performing a SYSTem:LOCK:RELease command. Lock requests on an individual interface and

session can be nested and each request will increase an internal lock count by 1. For every granted request, you will need to perform a release. The lock is not relinquished until the internal lock count is at 0.

Remote Command	SYSTem:LOCK:RELease
Example	SYST:LOCK:REL
Notes	When the instrument is unlocked bit 0 is cleared in the Operation Instrument status register.
Initial S/W Revision	x.16.10

Remote I/O Session Lock Name (Remote Command only)

You can determine the I/O Interface and Session name of the currently running program with the query SYSTem:LOCK:NAME?.

Remote Command	SYSTem:LOCK:NAME?
Example	SYST:LOCK:NAME?
Notes	The information returned is a string of the format: “<I/O Interface>[/<IP address>/<Session ID>]” Where IP address and Session ID are only provided for interfaces that provide multiple sessions. Single Session interfaces (GPIB, USB-488, and LAN VXI-11) only list interface name. The Session ID is an internally generated identifier, it is not guaranteed to be consistent across instrument software versions (the identifier is free to change when the software of the instrument is updated). The absolute value of the Session ID is not significant, the identifier will be consistent for a given software version and can be relied upon for lock owner logic comparisons.
Initial S/W Revision	x.16.10

Remote I/O Session Lock Owner (Remote Command only)

You can determine which I/O Interface and Session has the SCPI locked with the query SYSTem:LOCK:OWNeR?. If no interface and session has the SCPI locked “NONE” is returned.

Remote Command	SYSTem:LOCK:OWNeR?
Example	SYST:LOCK:OWN?
Notes	The information returned is a string of the format: “<I/O Interface>[/<IP address>/<Session ID>]” Where IP address and Session ID are only provided for interfaces that provide multiple sessions. Single Session interfaces (GPIB, USB-488, and LAN VXI-11) only list interface name. The Session ID is an internally generated identifier, it is not guaranteed to be consistent across instrument software versions (the identifier is free to change when the software of the instrument is updated). The absolute value of the Session ID is not significant, the identifier will be consistent for a given software version and can be relied upon for lock owner logic comparisons. If no interface and session have the SCPI locked the return value is “NONE”.
Initial S/W Revision	x.16.10

Restore Defaults

Provides incremental initialization of the system setting groups along with supporting a comprehensive reset of the entire instrument back to a factory default state. The menu selections are the groups of system settings and when one is selected, that particular group of system settings is reset back to their default values.

Key Path	System
Mode	All
Remote Command	:SYSTem:DEFauLt [ALL] ALIGn INPut MISC MODes PON
Example	SYST:DEF
State Saved	No
Initial S/W Revision	Prior to A.02.00

Restore Input/Output Defaults

Causes the group of settings and data associated with Input/Output front-panel key to be a reset to their default values. This level of Restore System Defaults does not affect any other system settings, mode settings and does not cause a mode switch.

Confirmation is required to restore the Input/Output setting. The confirmation dialog is:

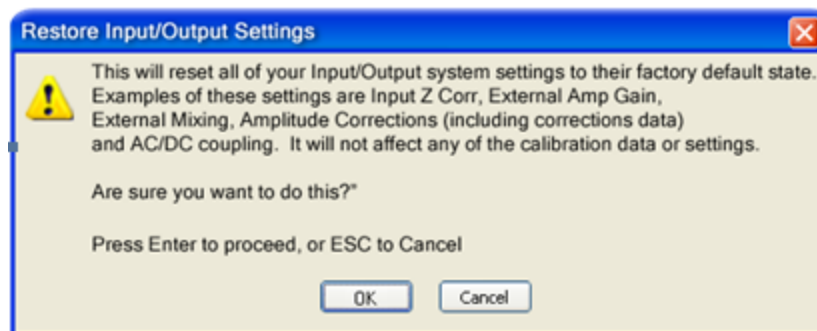

Key Path	System, Restore System Defaults
Example	:SYST:DEF INP
Initial S/W Revision	Prior to A.02.00

Restore Power On Defaults

This selection causes the Power On settings to be a reset to their default value. This level of Restore System Defaults does not affect any other system settings, mode settings and does not cause a mode switch. The Power On settings and their default values are Power On Type reset to Mode and Input/Output Defaults and Power On Application reset to whatever the factory set as its default value.

Confirmation is required to restore the factory default values. The confirmation dialog is:

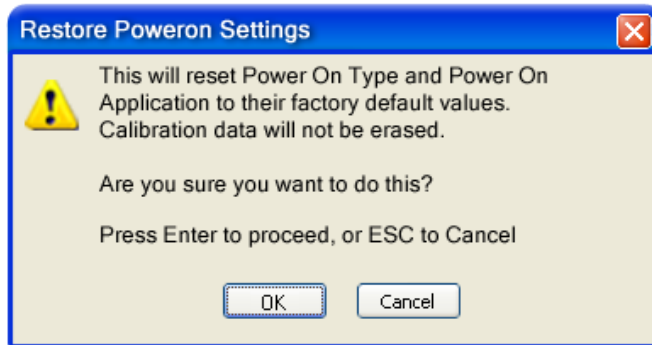

Key Path	System, Restore System Defaults
Example	:SYST:DEF PON
Initial S/W Revision	Prior to A.02.00

Restore Align Defaults

This selection causes the Alignment system settings to be a reset to their default values. This does not affect any Alignment data stored in the system. This level of Restore System Defaults does not affect any other system settings, mode settings and does not cause a mode switch.

After performing this function, it may impact the auto-alignment time of the instrument until a new alignment baseline has been established.

Confirmation is required to restore the factory default values. The confirmation dialog is:

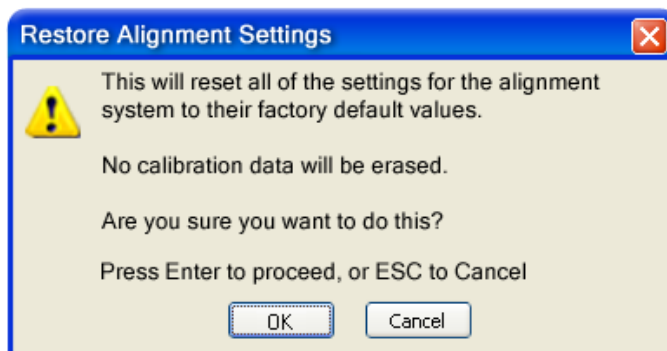

Key Path	System, Restore System Defaults
Example	:SYST:DEF ALIG
Initial S/W Revision	Prior to A.02.00

Restore Misc Defaults

This selection causes miscellaneous system settings to be reset to their default values. With this reset, you lose the GPIB address and it is reset to 18, so this should be used with caution. This level of Restore System Defaults does not affect any other

system settings, mode settings and does not cause a mode switch. This miscellaneous group contains the rest of the settings that have not been part of the other Restore System Defaults groups. The following table is a complete list of settings associated with this group:

Miscellaneous Setting	Default Value
Verbose SCPI	Off
The SYST:PRES:TYPE	MODE
Auto File Name Number	000
Save Type	State
State Save To	Register 1
Screen Save To	SCREEN000.png
DISP:ENABLE	ON
Full Screen	Off
SCPI Telnet	ON
SCPI Socket	ON
SICL Server	ON
Softkey Language	English
System Annotation	ON
Display Theme	TDColor
System IDN Response	Factory result of *IDN?
System IDN Response selection	Factory
Display Intensity	100
Display Backlight	ON
GPIB Address	18

Confirmation is required to restore the factory default values. The confirmation dialog is:

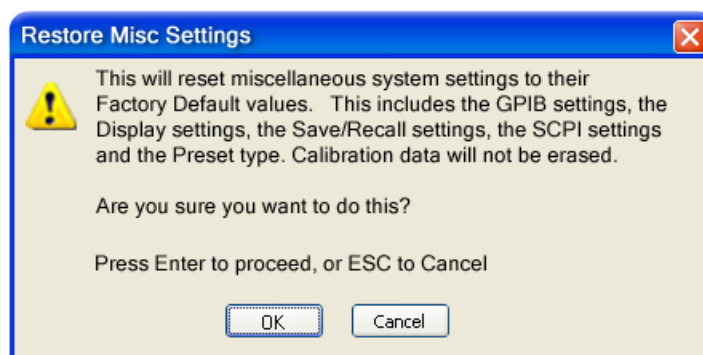

Key Path

System, Restore System Defaults

Example	:SYST:DEF MISC
Initial S/W Revision	Prior to A.02.00
Modified at S/W Revision	x.14.50

Restore Mode Defaults (All Modes)

This selection resets all of the modes in the instrument back to their default state just as a Restore Mode Defaults does and it switches the instrument to the power-on mode and causes the default measurement for the power-on mode to be active. This level of Restore System Defaults does not affect any system settings, but it does affect the state of all modes and does cause a mode switch unless the instrument was already in the power-on mode.

Confirmation is required to restore the factory default values. The confirmation dialog is:

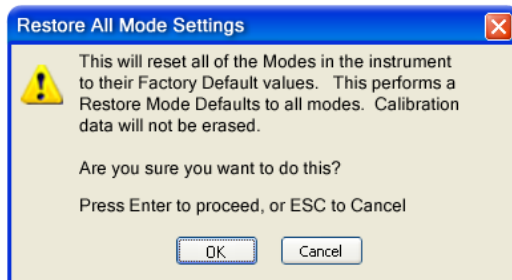

Key Path	System, Restore System Defaults
Example	:SYST:DEF MOD
Notes	RLC, SCPI LC, VSA, IDEN and WIMAXFIXED modes do not support this selection. These modes require individual Mode Presets.
Couplings	An All Mode will cause the currently running measurement to be aborted, mode switch to the power-on mode and activate the default measurement for the power-on mode.. It gets the mode to a consistent state with all of the default couplings set.
Initial S/W Revision	Prior to A.02.00

All

This performs a comprehensive reset of ALL analyzer settings to their factory default values. It resets all of the system setting groups, causes a Restore Mode Defaults for all modes in the instrument, and switches back to the power-on mode. It does not affect the User Preset file or any user saved files.

Confirmation is required to restore the factory default values. The confirmation dialog is:

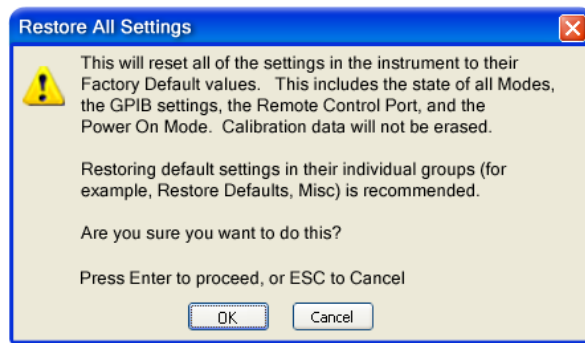
**NOTE**

If you are using an Keysight USB External Mixer, then you will need to perform a Refresh USB Mixer Connection after Restoring All Defaults.

Key Path	System, Restore System Defaults
Example	:SYST:DEF ALL
Notes	If using Keysight USB External Mixer, perform a Refresh USB Mixer Connection (SCPI command :MIX:BAND USB) following a Restore All Defaults.
Couplings	An All will cause the currently running measurement to be aborted and get all modes to a consistent state, so it is unnecessary to couple any settings.
Initial S/W Revision	Prior to A.02.00
Modified at S/W Revision	A.14.00

Control Panel...

Opens the Windows Control Panel. The Control Panel is used to configure certain elements of Windows that are not configured through the hardkey/softkey System menus.

NOTE

This feature is not available if option SF1 is installed.

The Control Panel is a separate Windows application, so to return to the analyzer once you are in the Control Panel, you may either:

Exit the Control Panel by clicking on the red X in the upper right hand corner, with a mouse

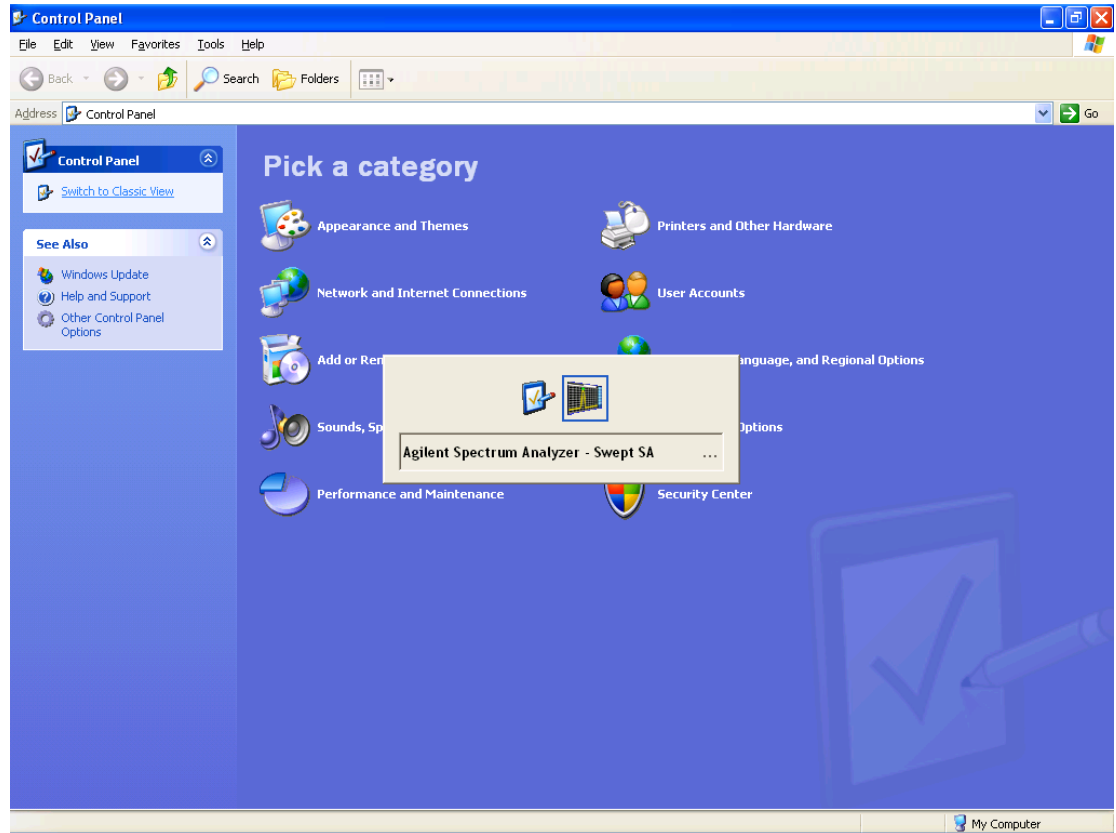

Or use Alt-Tab: press and hold the Alt  key and press and release the Tab key until the Analyzer logo is showing in the window in the center of the screen, as above, then release the Alt key.

Key Path	System
Notes	No remote command for this key.
Initial S/W Revision	Prior to A.02.00

Fixed/Transportable Licensing ...

Opens the license explorer for fixed and transportable license types.

NOTE

This feature is not available if option SF1 is installed.

For Help on this key, select Help in the menu bar at the top of the license explorer window.

Key Path	System
Notes	No equivalent remote command for this key.
Backwards Compatibility Notes	In ESA the SCPI command for displaying the Show Licenses screen is: :SYSTEM:CONFigure:LKEY:STATe OFF ON 0 1:SYSTEM:CONFigure:LKEY:STATe? There are no equivalent SCPI commands in the X-Series for displaying the License Explorer.
Initial S/W Revision	Prior to A.02.00

Remote Command	:SYSTem:LKEY <"OptionInfo">, <"LicenseInfo">
Example	SYST:LKEY "N9073A-1FP", "027253AD27F83CDA5673A9BA5F427FDA5E4F25AEB1017638211AC9F60D9C639FE539735909C551DE0A91"
Notes	The <"OptionInfo"> contains the feature and the version. You must specify the feature but can omit the version. If you omit the version, the system regards it as the latest one, since the system knows which version is supported for each feature. The <"LicenseInfo"> contains the signature, the expiration date, and serial number for transport if transportable. You must specify the signature, but you can omit the other information. If you omit the expiration date, the system regards it as permanent. If you omit the serial number, the system regards it as non-transportable. As a result, this supports reverse compatibility.
Initial S/W Revision	Prior to A.02.00

Remote Command	:SYSTem:LKEY:DELeTe <"OptionInfo">,<"LicenseInfo">
Example	SYST:LKEY:DEL 'N9073A-1FP', "027253AD27F83CDA5673A9BA5F427FDA5E4F25AEB1017638211AC9F60D9C639FE539735909C551DE0A91"
Notes	The <"OptionInfo"> contains the feature and the version. You must specify the feature but can omit the version. If you omit the version, the system regards it as the latest one, if more than one version is installed. The <"LicenseInfo"> contains the signature, the expiration date, and whether or not be transportable. You must specify the signature, but you can omit the other information. If you omit the expiration date, the system regards it as permanent. If you omit the transportability, the system regards it as non-transportable. As a result, this supports reverse compatibility.
Initial S/W Revision	Prior to A.02.00

Remote Command	:SYSTem:LKEY:LIST?
Notes	Return Value: An <arbitrary block data> of all the installed instrument licenses. The format of each license is as follows. <Feature>,<Version>,<Signature>,<Expiration Date>,<Serial Number for Transport> Return Value Example: #3136 N9073A-1FP,1.000,B043920A51CA N9060A-2FP,1.000,4D1D1164BE64 N9020A-508,1.000,389BC042F920 N9073A-1F1,1.000,5D71E9BA814C,13-aug-2005 <arbitrary block data> is: #NMMM<data>

	Where: N is the number of digits that describes the number of MMM characters. For example if the data was 55 bytes, N would be 2. MMM would be the ASCII representation of the number of bytes. In the previous example, N would be 55. <data> ASCII contents of the data
Initial S/W Revision	Prior to A.02.00

Remote Command	:SYSTem:LKEY? <"OptionInfo">
Example	SYST:LKEY? "N9073A-1FP"
Notes	The <"OptionInfo"> contains the feature and the version. You must specify the feature but can omit the version. If you omit the version, the system regards it as the latest one. Return Value: <"LicenseInfo"> if the license is valid, null otherwise. <"LicenseInfo"> contains the signature, the expiration date, and serial number if transportable. Return Value Example: "B043920A51CA"
Initial S/W Revision	Prior to A.02.00

Remote Command	:SYSTem:HID?
Notes	Return value is the host ID as a string
Initial S/W Revision	Prior to A.02.00

Security

Accesses capabilities for operating the instrument in a security controlled environment.

Key Path	System
Initial S/W Revision	A.04.00

USB

The Windows operating system can be configured to disable write access to the USB ports for users who are in a secure environment where transferring data from the instrument is prohibited. This user interface is a convenient way for the customer to disable write access to USB.

Key Path	System, Security
Mode	All
Scope	Mode Global
Remote Command	:SYSTem:SECurity:USB:WPRotect[:ENABLE] ON OFF 0 1

	:SYSTem:SECurity:USB:WPRotect[:ENABLE]?
Example	:SYST:SEC:USB:WPR ON Will set USB ports to Read-only
Notes	When the USB ports are in Read-only mode then no data can be stored to USB, including the internal USB memory used for a back-up location for the calibration data.
Dependencies	This key is grayed-out unless the current user has administrator privileges.
Preset	This is unaffected by Preset or any Restore System Defaults. An Agilent Recovery will set the USB to write protect OFF
State Saved	No
Range	Read-Write Read only
Initial S/W Revision	A.04.00

Read-Write

Selection for allowing full read-write access to the USB ports.

Key Path	System, Security, USB
Example	:SYST:SEC:USB:WPR OFF Will set USB ports to Read-Write
Initial S/W Revision	A.04.00

Read only

Selection for disabling write access to the USB ports.

Key Path	System, Security, USB
Example	:SYST:SEC:USB:WPR ON Will set USB ports to Read only
Initial S/W Revision	A.04.00

Diagnostics

The Diagnostics key in the System menu gives you access to basic diagnostic capabilities of the instrument.

Key Path	System
Initial S/W Revision	Prior to A.02.00

Show Hardware Statistics

Provides a display of various hardware statistics. The statistics include the following:

- Mechanical relay cycles
- High and Low temperature extremes
- Elapsed time that the instrument has been powered-on (odometer)

The display should appear listing the statistics, product number, serial number, and firmware revision.

Hardware Statistical Information	
Agilent MXA Signal Analyzer	
Product Number: N9020A	
Serial Number: US00061145	
Instrument S/W Revision: A.12.00	
Revision Date: 7/11/2012 12:11:10 PM	
Component Name	Value
MechAtten #1 Count Total	457304
Calibrator Switch Cycles	105953
AC/DC Switch Cycles	114240
2 dB #1 Mechanical Atten Cycles	112655
2 dB #2 Mechanical Atten Cycles	124456
MechAtten #2 Count Total	472265
6 dB Mechanical Atten Cycles	115302
10 dB Mechanical Atten Cycles	93602
20 dB Mechanical Atten Cycles	144781
30 dB Mechanical Atten Cycles	118580
Low Noise Path Switch	45668
Preselector Bypass Cycles	31133
High temperature operating extreme	45.75
Low temperature operating extreme	-23.9375
Elapsed Time (On-Time)(hours)	134164

In some CXA models this field is called "Fixed Aten"

Some CXA models omit these fields

Only shown if LNP installed
Only shown if MPB installed

The CXA models in which the AC/DC Switch field is called Fixed Aten and that omit the mechanical attenuation fields are the N9000A-503/507 models.

Modular HWs only have time and temperature information in Show Hardware Statistics.

The data will be updated only when the Show Hardware Statistics menu key is pressed, it will not be updated while the screen is displayed.

The tabular data should be directly printable.

Key Path	System, Diagnostics
Mode	All
Notes	The values displayed on the screen are only updated upon entry to the screen and not updated while the screen is being displayed.
Initial S/W Revision	Prior to A.02.00

SCPI for Show Hardware Statistics (Remote Commands Only)

Each of the hardware statistic items can be queried via SCPI.

- "Query the Mechanical Relay Cycle Count" on page 519
- "Query the Operating Temperature Extremes" on page 519
- "Query the Elapsed Time since 1st power on" on page 520

Query the Mechanical Relay Cycle Count

Return the count of mechanical relay cycles.

For N9038A model, there are additional 2 Mechanical Relays which are <N9038A Input2>, <N9038A Bypass>.

Remote Command	:SYSTem:MRELay:COUNT?
Example	:SYST:MREL:COUN?
Notes	<p>Query Only</p> <p>The return value is a comma separated list of the individual counts for each mechanical relay.</p> <p>The position of the relays in the list is:</p> <p>“<Cal Signal>,<AC/DC>,<2dB #1 Atten>,<2dB #2 Atten>,<6dB Atten>,<10dB Atten>,<20dB Atten>,<30dB Atten>,<Fixed Atten>,<Low Noise Path Switch>,<Presel Bypass>,<N9038A Input2>,<N9038A Bypass>”</p> <p>Items in the list not pertaining to your particular hardware configuration will return as -999 for those items.</p>
Initial S/W Revision	Prior to A.02.00
Modified at S/W Revision	A.08.00

Query the Operating Temperature Extremes

Returns the low operating temperature extreme value. The value survives a power-cycle and is the temperature extreme encountered since the value was reset by the factory or service center.

Mode	All
Remote Command	:SYSTem:TEMPerature:LEXTreme?
Example	:SYST:TEMP:LEXT?
Notes	Value is in degrees Celsius at which the lowest operating temperature has been recorded since 1st power-up.
State Saved	No
Initial S/W Revision	Prior to A.02.00

Mode	All
Remote Command	:SYSTem:TEMPerature:HEXTreme?
Example	:SYST:TEMP:HEXT?
Notes	Value is in degrees Celsius at which the highest operating temperature has been recorded since 1st power-up.
State Saved	No
Initial S/W Revision	Prior to A.02.00

Query the Elapsed Time since 1st power on

Returns the elapsed on-time in minutes since 1st power-on.

Remote Command	:SYSTem:PON:ETIMe?
Example	:SYST:PON:ETIM?
Notes	Query Only
Initial S/W Revision	Prior to A.02.00

Advanced

Accesses advanced diagnostic capabilities performed in the factory or under instructions from repair procedures. This menu key is only visible when the logged-in user is "saservice".

NOTE

This feature is not available if option SF1 is installed.

The first access to the Advanced Diagnostic Menu after invoking the instrument application will require an authentication, which is to enter the Service Code. Subsequent accesses to the Advanced Diagnostic Menu are unimpeded. The Authentication dialog looks like:

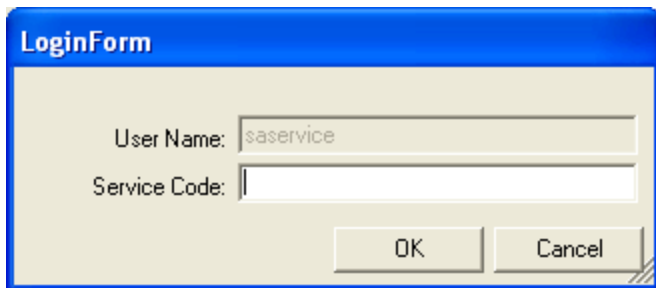

"OK" is the default key thus the Enter key is used to complete the entry. If invalid Service Code is entered authentication is not granted and you are provided the following dialog:



Key Path	System, Diagnostics
Notes	Password is required to access this menu.
Initial S/W Revision	Prior to A.02.00

IP Address	SYSTem:COMMunicate:LAN:ADDRes	:SYSTem:COMMunicate:LAN[:SELF]:IP
	<string>	<string>
	SYSTem:COMMunicate:LAN:ADDRes?	:SYSTem:COMMunicate:LAN[:SELF]:IP?
Gateway	SYSTem:COMMunicate:LAN:DGATeway	:SYSTem:COMMunicate:LAN
	<string>	[:SELF]:GATEway <string
	SYSTem:COMMunicate:LAN:DGATeway?	:SYSTem:COMMunicate:LAN
		[:SELF]:GATEway?
Subnet Mask	SYSTem:COMMunicate:LAN:SMASk	:SYSTem:COMMunicate:LAN
	<string>	[:SELF]:SUBNetmask <string>
	SYSTem:COMMunicate:LAN:SMASk?	:SYSTem:COMMunicate:LAN
		[:SELF]:SUBNetmask?

Service

Accesses capabilities performed in the factory or under instructions from repair procedures. This menu key is only visible when the logged-in user is “advanceduser” or “saservice”. The first access to the Service Menu after invoking the instrument application will require an authentication Service Code.

Key Path	System
Initial S/W Revision	Prior to A.02.00

Softkey Language

Accesses the selection of language displayed on the Softkeys and Softkey Menus. English is the default language. The selection of language is available when the instrument is licensed with a language option.

All Measurement Applications that share common softkeys will display the localized softkey.

The description on the key labels is bounded by the softkey size, any given language will have labels in that language which are shorter or longer than the equivalent label in English. Any localized text on the softkeys that does not fit the label size, will remain in English. Thus for any given menu, keys may be displayed in English and the selected language. Also, labels that are acronyms, engineering, or technology specific terms may remain in English.

All Application and Measurement names will remain in English.

All data in exported files will remain in English.

The Diagnostic and Service menus in the System Subsystem will remain in English.

The Windows operating system must remain in English. Changing the Region and Language settings in the Windows Control Panel is not supported.

External keyboards in English are supported. Localized external keyboards are not supported. When the language selected is not English, a message is presented to the user that any external keyboards must remain English.

Other aspects of the Graphical User Interface remain in the English language. The Remote User Interface, SCPI, remains in English.

Key Path	System
Mode	All
Remote Command	SYSTem:DISPlay:LANGuage ENGLISH RUSSian SYSTem:DISPlay:LANGuage?
Preset	This is unaffected by a Preset but is set to ENGLISH on a "Restore Misc Defaults" or "Restore System Defaults->All".
Readback	1-of-N selection
Initial S/W Revision	A.13.00

English

Displays English on the softkey labels.

Key Path	System, Language
Example	SYST:DISP:LANG ENGL
Readback	English
Initial S/W Revision	A.13.00

Russian

If option AKT is installed, Russian (**русский**) language is displayed on the softkey labels.

When the operator selects this language choice from the softkey, the following message is presented (the message is not presented if Russian is selected from SCPI):

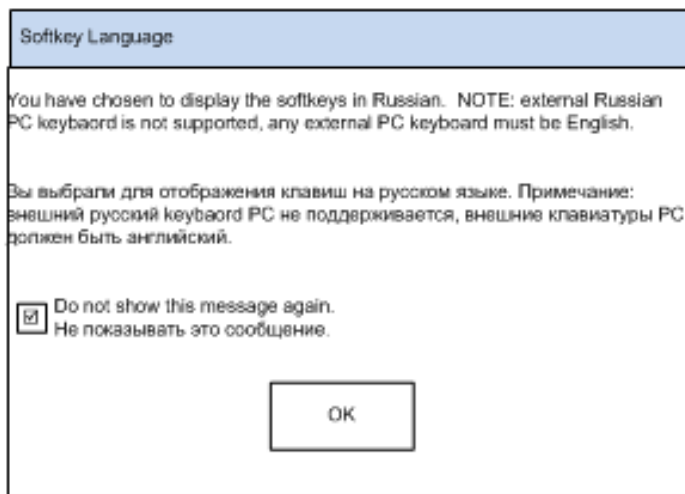

Key Path	System, Language
----------	-------------------------

Example	SYST:DISP:LANG RUSS
Readback	русский
Initial S/W Revision	A.13.00

Internet Explorer...

This key launches Microsoft Internet Explorer. A mouse and external keyboard are highly desired for using Internet Explorer. When Internet Explorer is running, close Internet Explorer to return focus to the Instrument Application (or use Alt-Tab).

NOTE

This feature is not available if option SF1 is installed.

Key Path	System
Mode	All
Notes	No equivalent remote command for this key.
Initial S/W Revision	A.05.01

System Remote Commands (Remote Commands Only)

The commands in this section have no front-panel key equivalent.

- "System Powerdown (Remote Command Only)" on page 523
- "System Log Off (Remote Command Only)" on page 524
- "List installed Options (Remote Command Only)" on page 524
- "Lock the Front-panel keys (Remote Command Only)" on page 524
- "Front Panel activity history (Remote Command only)" on page 525
- "SCPI activity history (Remote Command only)" on page 525
- "Instrument start time (Remote Command only)" on page 526
- "SCPI Version Query (Remote Command Only)" on page 526
- "Date (Remote Command Only)" on page 526
- "Time (Remote Command Only)" on page 527

Initial S/W Revision	Prior to A.02.00
----------------------	------------------

System Powerdown (Remote Command Only)

Remote Command	SYSTem:PDOWn [NORMa1 FORCe]
Notes	Shuts down the instrument in the normal way (NORMa1) or forced way (FORCe). In case there is another application with modified data pending for saving, the application prompt the user. The

system waits until the user responds in the normal mode. It will go off after 20 seconds of wait in the force mode and all data will be lost.

System Log Off (Remote Command Only)

This SCPI command provides a means to terminate all open Windows applications and log off the current user. This is equivalent to performing the Windows command “shutdown -l -f -t0”.

Remote Command	SYSTem:LOFF
Example	SYST:LOFF
Notes	Initiates an immediate log off of the current user. This exits the instrument application, thus any unsaved measurement result will be lost. You cannot use *WAI or *OPC? to synchronize operation. In addition to the instrument application, all other Windows programs will be terminated without the opportunity to save any work in progress. The instrument will require human interaction to perform a Log In to regain instrument operation.
Initial S/W Revision	A.14.50

List installed Options (Remote Command Only)

Lists the installed options that pertain to the instrument (signal analyzer). .

Mode	All
Remote Command	:SYSTem:OPTions?
Example	:SYST:OPT?
Notes	The return string is a comma separated list of the installed options. For example: “503,P03,PFR” :SYSTem:OPTions? and *OPT? are the same.
State Saved	No
Initial S/W Revision	Prior to A.02.00

Lock the Front-panel keys (Remote Command Only)

Disables the instrument keyboard to prevent local input when the instrument is controlled remotely. Annunciation showing a “K” for ‘Klock” (keyboard lock) alerts the local user that the keyboard is locked. Klock is similar to the GPIB Local Lockout function; namely that no front-panel keys are active with the exception of the Power Standby key. (The instrument is allowed to be turned-off if Klock is ON.) The Klock command is used in remote control situations where Local Lockout cannot be used.

Although primary intent of Klock is to lock-out the front panel, it will lock-out externally connected keyboards through USB. Klock has no effect on externally connected pointing devices (mice).

The front panel ‘Local’ key (Cancel/Esc) has no effect if Klock is ON.

Mode	All
Remote Command	:SYSTem:KLOCK OFF ON 0 1

	:SYSTem:KLOCK?
Example	:SYST:KLOC ON
Notes	Keyboard lock remains in effect until turned-off or the instrument is power-cycled
Preset	Initialized to OFF at startup, unaffected by Preset
State Saved	No
Initial S/W Revision	Prior to A.02.00

Front Panel activity history (Remote Command only)

Instrument front panel usage can be monitored with the query :SYSTem:METRics:FPANel?. The monitoring occurs for front panel Hardkey or Softkey operation (not mouse or touch operation on instruments with Multi-Touch User Interface). The information of the usage pertains to the activity since the instrument application was started; the information does not persist after the application is terminated, or the instrument has been rebooted.

To prevent the front panel from being placed into Remote the monitoring must occur via an I/O protocol such as LAN Socket, or the remote program performing the monitoring must explicitly place the instrument into Local after the query has been performed.

Remote Command	:SYSTem:METRics:FPANel?
Example	SYST:METR:FPAN?
Notes	The return value is a string with the format "YYYY-MM-DD<space>HH:MM:SS", in instrument local time. If no front panel activity has occurred since the instrument was booted (instrument application started), the return value will be the time the instrument application started. The instrument application start time can be obtained with the query SYSTem:METRics:STIME?
Initial S/W Revision	x.16.10

SCPI activity history (Remote Command only)

Instrument remote operation usage via SCPI can be monitored with the query :SYSTem:METRics:SCPI?. The monitoring occurs for SCPI control from any I/O channel (GPIB, USB, or LAN). The information of the usage pertains to the activity since the instrument application was started; the information does not persist after the application is terminated, or the instrument has been rebooted.

Remote Command	:SYSTem:METRics:SCPI?
Example	:SYST:METR:SCPI?
Notes	The return value is a string with the format "YYYY-MM-DD<space>HH:MM:SS", in instrument local time. The following commands are excluded from the history accounting: *IDN? *OPT? :SYSTem:DATE?

	:SYSTem:TIME?
	:SYSTem:PON:TIME?
	Queries in the :SYSTem:ERRor subsystem
	Queries in the :SYSTem:LKEY subsystem
	Queries in the :SYSTem:METRics subsystem
	Queries in the :SYSTem:MODule subsystem
	If no SCPI activity has occurred since the instrument was booted (instrument application started), the return value will be the time the instrument application started. The instrument application start time can be obtained with the query SYSTem:METRics:STIME?
Initial S/W Revision	x.16.10

Instrument start time (Remote Command only)

To determine if instrument activity has occurred the SCPI query :SYSTem:METRics:STIME? can be used to determine the instrument application start time.

Remote Command	:SYSTem:METRics:STIME?
Example	:SYST:METR:STIM?
Notes	The return value is a string with the format "YYYY-MM-DD<space>HH:MM:SS", in instrument local time.
Initial S/W Revision	x.16.10

List SCPI Commands (Remote Command Only)

Outputs a list of the valid SCPI commands for the currently selected Mode.

Remote Command	:SYSTem:HELP:HEADers?
Example	:SYST:HELP:HEAD?
Notes	The output is an IEEE Block format with each command separated with the New-Line character (hex 0x0A)
Initial S/W Revision	Prior to A.02.00

SCPI Version Query (Remote Command Only)

Returns the SCPI version number with which the instrument complies. The SCPI industry standard changes regularly. This command indicates the version used when the instrument SCPI commands were defined.

Remote Command	:SYSTem:VERSion?
Example	:SYST:VERS?
Initial S/W Revision	Prior to A.02.00

Date (Remote Command Only)

The recommended access to the Date, Time, and Time zone of the instrument is through the Windows native control (Control Panel or accessing the Task Bar). You

may also access this information remotely, as shown in this command and Time (below).

Sets or queries the date in the instrument.

Mode	All
Remote Command	:SYSTem:DATE "<year>,<month>,<day>" :SYSTem:DATE?
Example	:SYST:DATE "2006,05,26"
Notes	<year> is the four digit representation of year. (for example, 2006) <month> is the two digit representation of year. (for example. 01 to 12) <day> is the two digit representation of day. (for example, 01 to 28, 29, 30, or 31) depending on the month and year Unless the current account has Power User or Administrator privileges, an error will be generated by this command and no action will be taken.
Initial S/W Revision	Prior to A.02.00

Time (Remote Command Only)

Sets or queries the time in the instrument.

Mode	All
Remote Command	:SYSTem:TIME "<hour>,<minute>,<second>" :SYSTem:TIME?
Example	:SYST:TIME "13,05,26"
Notes	<hour> is the two digit representation of the hour in 24 hour format <minute> is the two digit representation of minute <second> is the two digit representation of second Unless the current account has Power User or Administrator privileges, an error will be generated by this command and no action will be taken.
Initial S/W Revision	Prior to A.02.00

7 Trigger Functions

Trigger

Accesses a menu of keys to control the selection of the trigger source and the setup of each of the trigger sources. The analyzer is designed to allow triggering from a number of different sources, for example, Free Run, Video, External, RF Burst, and so forth.

The TRIG:SOURCe command (below) will specify the trigger source for the currently selected input (RF or I/Q). If you change inputs, the new input remembers the trigger source it was last programmed to for the current measurement, and uses that trigger source. You can directly set the trigger source for each input using the TRIGger:RF:SOURce and TRIGger:IQ:SOURce commands (later in this section). When in External Mixing, the analyzer uses the RF trigger source.

Note the inclusion of the <measurement> parameter in the command below. Because each measurement remembers its own Trigger Source, the command must be qualified with the measurement name. Note that for the Swept SA measurement this is not the case; for backwards compatibility, no <measurement> parameter is used when setting the Trigger Source for the Swept SA measurement.

See ["Trigger Source Presets" on page 530](#)

See ["RF Trigger Source" on page 534](#)

See ["I/Q Trigger Source" on page 535](#)

See ["More Information" on page 536](#)

Key Path	Front-panel key
Remote Command	<pre>:TRIGger:<measurement>[:SEquence]:SOURce EXTerna11 EXTerna12 IMMediate LINE FRAMe RFBurst VIDeo IF ALARm LAN IQMag IDEMod QDEMod IINPut QINPut AIQMag TV PRTChandet PRTFrame PXI INTerna1</pre> <pre>:TRIGger:<measurement>[:SEquence]:SOURce?</pre> <p>where <measurement> is the measurement for which you wish to set the Source (blank for the Swept SA measurement)</p>
Example	<pre>TRIG:ACP:SOUR EXT1</pre> <p>Selects the external 1 trigger input for the ACP measurement and the selected input</p> <pre>TRIG:SOUR VID</pre> <p>Selects video triggering for the Swept SA (SANAlyzer) measurement in the Spectrum Analyzer mode. For SAN, do not use the <measurement> keyword. Only send this form in the Spectrum Analyzer mode or you will get an Undefined Header error</p>
Notes	<p>Not all measurements have all the trigger sources available to them. Check the trigger source documentation for your specific measurement to see what sources are available.</p> <p>Not all trigger sources are available for each input. See the "RF Trigger Source" on page 534 and "I/Q Trigger Source" on page 535 commands for detailed information on which trigger sources are available for each input.</p> <p>Other trigger-related commands are found in the INITiate and ABORt SCPI command subsystems.</p> <p>*OPC should be used after requesting data. This will hold off any subsequent changes to the selected trigger source, until after the sweep is completed and the data is returned.</p>

	Available ranges and presets can vary from mode to mode.
Dependencies	In some models, there is no second External input. In these models, the External 2 key is blanked and the EXTernal2 parameter will generate a "Hardware missing; Not available for this model number" message. INTernal trigger is only available on the M9420A. It triggers on the internal source signal PRTChandet and PRTFrame are only available in the E7515A. PXI trigger is only supported in PXI (modular) instruments.
Preset	See table below
Status Bits/OPC dependencies	The Status Operation Register bit 5 "Waiting for Trigger" is set at the same time as the Sweeping or Measuring bit is set. It is cleared when the trigger actually occurs (that is, after the trigger event occurs and all the applicable trigger criteria have been met). A corresponding pop-up message ("Waiting for trigger") is generated if no trigger signal appears after approximately 2 sec. This message goes away when a trigger signal appears.
Backwards Compatibility SCPI	:TRIGger[:SEquence]:SOURCe EXTernal1 For backward compatibility, the parameter EXTernal is mapped to EXTernal1
Backwards Compatibility SCPI	[:SENSe]:<measurement>:TRIGger:SOURce This backwards compatibility alias command is provided for ESA/PSA compatibility This backwards compatibility command does not apply to the Swept SA measurement, for that just use :TRIGger:SOURCe This backwards compatibility command does not apply to the monitor spectrum, log plot and spot frequency measurements
Backwards Compatibility SCPI	[:SENSe]:<measurement>:TRIGger:SOURce IF In earlier instruments, the parameter IF was used by apps for the video trigger, so using the IF parameter selects VIDeo triggering. Sending IF in the command causes VID to be returned to a query.
Backwards Compatibility SCPI	[:SENSe]:ACPR:TRIGger:SOURce This backwards Compatibility SCPI command is provided to support the same functionality as [:SENSe]:ACPr:TRIGger:SOURce (PSA W-CDMA, PSA cdma2000 and PSA 1xEVDO) due to the fact that the ACPr node conflicts with the ACPower node.
Initial S/W Revision	Prior to A.02.00
Modified at S/W Revision	A.03.00

Trigger Source Presets

Here are the Trigger Source Presets for the various measurements:

Meas	Mode	Preset for RF	Preset for IQ	Notes
Swept SA	SA	IMM	IQ not supported	
CHP	SA, WCDMA, C2K, WIMAX	IMM	IQ not supported	

Meas	Mode	Preset for RF	Preset for IQ	Notes
	OFDMA, 1xEVDO, DVB-T/H, DTMB, LTE, LTETDD, CMMB, ISDB-T, Digital Cable TV, MSR			
OBW	SA, WCDMA, C2K, WIMAX OFDMA, TD-SCDMA, 1xEVDO, LTE, LTETDD, CMMB, ISDB-T, MSR	1xEVDO: EXT1 others: IMM	IQ not supported	For 1xEVDO mode, the trigger source is coupled with the gate state, as well as the gate source. When the trigger source changes to RFBurst, External1 or External2, the gate state is set to on, and the gate source is set identically with the trigger source. When the trigger source changes to IMMEDIATE, VIDEO, LINE, FRAME or IF, the gate state is set to off.
CCDF	SA, WCDMA, C2K, WIMAX OFDMA, TD-SCDMA, 1xEV-DO, DVB-T/H, DTMB, LTE, LTETDD, CMMB, ISDB-T, Digital Cable TV, MSR	WIMAX OFDMA: RFBurst LTETDD: BTS: External 1 MS: Periodic Timer TD-SCDMA and 1xEV-DO: BTS: External 1 MS: RFBurst SA, WCDMA, C2K, LTE, CMMB, ISDB-T, DVB-T/H, DTMB, Digital Cable TV, MSR: IMMEDIATE	TD-SCDMA and 1xEV-DO: BTS: External 1 MS: IQMag LTETDD: BTS: External 1 MS: Periodic Timer Others: IMM	For TD-SCDMA: Trigger source is coupled with radio device. When radio device changes to BTS, trigger source will be changed to EXTERNAL1. When radio device changes to MS, trigger source will be set as RFBurst for RF or IQ Mag for BBIQ. When TriggerSource is RFBurst or IQ Mag, Measure Interval is grayed out.
ACP	SA, WCDMA, C2K, WIMAX OFDMA, TD-SCDMA, 1xEVDO, DVB-T/H, DTMB, LTE, LTETDD, CMMB, ISDB-T,	IMM	IQ not supported	

Meas	Mode	Preset for RF	Preset for IQ	Notes
	Digital Cable TV, MSR			
Tx Power	SA, GSM, TD-SCDMA	SA, GSM: RFBurst TD-SCDMA: EXTERNAL	IMM	TD-SCDMA doesn't support the Line and Periodic Timer parameters. When the mode is TD-SCDMA, if the Radio Device is switched to BTS, the value will be changed to External 1 and if the Radio device is switched to MS, the value will be changed to RFBurst
SPUR	SA, WCDMA, C2K, WIMAX OFDMA, TD-SCDMA, 1xEV-DO, DVB-T/H, LTE, LTETDD, MSR	IMM	IQ not supported	
SEM	SA, WCDMA, C2K, WIMAX OFDMA, TD-SCDMA, 1xEVDO, DVB-T/H, DTMB, LTE, LTETDD, CMMB, ISDB-T, Digital Cable TV, MSR	1xEVDO(BTS): EXTERNAL1 All others: IMMEDIATE	IQ not supported	
CDP	WCDMA	IMM	IMM	
RHO	WCDMA	IMM	IMM	
PCON	WCDMA	IMM	IMM	
QPSK	WCDMA, C2K, 1xEVDO	All except CDMA1xEVDO: IMMEDIATE CDMA1xEVDO: EXT1	IMM	
MON	All except SA and BASIC	IMM	IQ not supported	
WAV		LTETDD: BTS: External 1 MS: Periodic Timer	LTETDD: BTS: External 1 MS:	

Meas	Mode	Preset for RF	Preset for IQ	Notes
		GSM/EDGE: RFBurst All others: IMMediate	Periodic Timer GSM/EDGE: IQMag All others: IMMediate	
PVT	WIMAXOFDMA	RFB	IMM	
EVM	WIMAXOFDMA, DVB-T/H, DTMB, LTE, LTETDD, CMMB, ISDB-T, Digital Cable TV	All but CMMB: IMM CMMB: Periodic Timer	All but CMMB: IMM CMMB: External 1	LTE, LTETDD supports Free Run, Video and External 1 only.
SPEC	BASIC	IMM	IMM	
LOG Plot	PN	IMM	IQ not supported	
Spot Freq	PN	IMM	IQ not supported	
GMSK PVT	EDGE/GSM	RFB	IMM	
GMSK PFER	EDGE/GSM	RFB	IQMag	
GMSK ORFS	EDGE/GSM	RF Burst	IQ not supported	
EDGE PVT	EDGE/GSM	RFB	IMM	
EDGE EVM	EDGE/GSM	RFB	IQMag	
EDGE ORFS	EDGE/GSM	Periodic Timer	IQ not supported	
Combined WCDMA	WCDMA	IMM	IQ not supported	
Combined GSM	EDGE/GSM	RFB	IQ not supported	
List Power Step	WCDMA, EDGE/GSM	IMM	IQ not supported	
Transmit On/Off Power	LTETDD	LTETDD: BTS: External 1 MS: Periodic Timer	LTETDD: BTS: External 1 MS: Periodic Timer	
Transmit Analysis	BLUETOOTH	RFB	IQ not supported	

Meas	Mode	Preset for RF	Preset for IQ	Notes
Adjacent Channel Power	BLUETOOTH	IMM	IQ not supported	
LE In-band Emissions	BLUETOOTH	IMM	IQ not supported	
EDR In-band Spurious Emissions	BLUETOOTH	Periodic Timer	IQ not supported	
Conformance EVM	LTE, LTETDD, MSR	IMM	IMM	

RF Trigger Source

The **RF Trigger Source** command selects the trigger to be used for the specified measurement when RF is the selected input. The RF trigger source can be queried and changed even while another input is selected, but it is inactive until RF becomes the selected input.

Note the inclusion of the <measurement> parameter in the command below. Because each measurement remembers its own Trigger Source, the command must be qualified with the measurement name. Note that for the Swept SA measurement this is not the case; for backwards compatibility, no <measurement> parameter is used when setting the Trigger Source for the Swept SA measurement.

Remote Command	<pre> :TRIGger:<measurement>[:SEquence]:RF:SOURce EXTerna1 EXTerna12 IMMediate LINE FRAMe RFBurst VIDEo IF ALARm LAN TV PRTChandet PRTFrame PXI INTerna1 :TRIGger:<measurement>[:SEquence]:RF:SOURce? </pre>
Example	<pre> TRIG:ACP:RF:SOUR EXT1 </pre> <p>Selects the external 1 trigger input for the ACP measurement and the RF input</p> <pre> TRIG:RF:SOUR VID </pre> <p>Selects video triggering for the SANalyzer measurement and the RF input. For SAN, do not use the <measurement> keyword.</p>
Notes	*OPC should be used after requesting data. This will hold off any subsequent changes to the selected trigger source, until after the sweep is completed and the data is returned.
Dependencies	<p>Presets and available ranges can vary from mode to mode.</p> <p>Not all measurements have all the trigger sources available to them. Check the trigger source documentation for your specific measurement to see what sources are available.</p> <p>Not all trigger sources are available for each input. For the RF Trigger Source, the following trigger sources are available:</p> <ul style="list-style-type: none"> - IMMEDIATE - free run triggering - VIDEO - triggers on the video signal level

-
- LINE - triggers on the power line signal
 - EXTERNAL1 (or EXTERNAL) - triggers on an externally connected trigger source marked "Trigger 1 In" on the rear panel
 - EXTERNAL2 - triggers on an externally connected trigger source marked "Trigger 2 In" on the front panel. In some models, there is no second External input. In these models, the External 2 key is blanked and the EXTERNAL2 parameter will generate a "Hardware missing; Not available for this model number" message
 - RFBURST - triggers on the bursted frame
 - FRAME - triggers on the periodic timer
 - IF (video) - same as video, for backwards compatibility only

INTERNAL trigger is only available on the M9420A. It triggers on the internal source signal PRTCHANDET and PRTFRAME are only available in the E7515A.
PXI trigger is only supported in PXI (modular) instruments.

Status Bits/OPC dependencies	The Status Operation Register bit 5 "Waiting for Trigger" is set at the same time as the Sweeping or Measuring bit is set. It is cleared when the trigger actually occurs (that is, after the trigger event occurs and all the applicable trigger criteria have been met). A corresponding pop-up message ("Waiting for trigger") is generated if no trigger signal appears after approximately 2 sec. This message goes away when a trigger signal appears.
Initial S/W Revision	Prior to A.02.00

I/Q Trigger Source

NOTE

This command is available only when Option BBA is installed.

This command selects the trigger to be used for the specified measurement when I/Q is the selected input. The I/Q trigger source can be queried and changed even while another input is selected, but it is inactive until I/Q becomes the selected input.

Remote Command	<code>:TRIGGER:<measurement>[:SEQUENCE]:IQ:SOURCE EXTERNAL1 EXTERNAL2 IMMEDIATE IQMAG IDEMOD QDEMOD IINPUT QINPUT AIQMAG</code> <code>:TRIGGER:<measurement>[:SEQUENCE]:IQ:SOURCE?</code>
-----------------------	--

Example	TRIG:WAVEFORM:SOUR IQM Selects I/Q magnitude triggering for the IQ Waveform measurement and the I/Q input
----------------	--

Notes	Not all measurements have all the trigger sources available to them. Check the trigger source documentation for your specific measurement to see what sources are available. Not all trigger sources are available for each input. For the I/Q Trigger Source , the following trigger sources are available:
-------	--

- IMMEDIATE - free run triggering
 - EXTERNAL1 (or EXTERNAL) - triggers on an externally connected trigger source on the rear panel
 - EXTERNAL2 - triggers on an externally connected trigger source on the front panel
-

-
- IQMag - triggers on the magnitude of the I/Q signal
 - IDEMod - triggers on the I/Q signal's demodulated I voltage
 - QDEMod - triggers on the I/Q signal's demodulated Q voltage
 - IINPut - triggers on the I channel's ADC voltage
 - QINPut - triggers on the Q channel's ADC voltage
 - AIQMag - triggers on the magnitude of the auxiliary receiver channel I/Q signal

*OPC should be used after requesting data. This will hold off any subsequent changes to the selected trigger source, until after the sweep is completed and the data is returned.

Available ranges, and from mode to mode presets can vary

Status Bits/OPC dependencies

The Status Operation Register bit 5 "Waiting for Trigger" is set at the same time as the Sweeping or Measuring bit is set. It is cleared when the trigger actually occurs (that is, after the trigger event occurs and all the applicable trigger criteria have been met). A corresponding pop-up message ("Waiting for trigger") is generated if no trigger signal appears after approximately 2 sec. This message goes away when a trigger signal appears.

Initial S/W Revision

Prior to A.02.00

More Information

The trigger menus let you select the trigger source and trigger settings for a sweep or measurement. In triggered operation (basically, any trigger source other than Free Run), the analyzer will begin a sweep or measurement only with the selected trigger conditions are met, generally when your trigger source signal meets the specified trigger level and polarity requirements. (In FFT measurements, the trigger controls when the data acquisition begins for FFT conversion.)

For each of the trigger sources, you may define a set of operational parameters or settings which will be applied when that source is selected as the current trigger source. Examples of these settings are Trigger Level, Trigger Delay, and Trigger Slope. You may apply different settings for each source; so, for example, you could have a Trigger Level of 1v for External 1 trigger and -10 dBm for Video trigger.

Once you have established the settings for a given trigger source, they generally will remain unchanged for that trigger source as you go from measurement to measurement within a Mode (although the settings do change as you go from Mode to Mode). Furthermore, the trigger settings within a Mode are the same for the **Trigger** menu, the **Gate Source** menu, and the **Sync Source** menu that is part of the **Periodic Timer Trigger Setup** menu. That is, if **Ext1** trigger level is set to 1v in the **Trigger** menu, it will appear as 1v in both the **Gate Source** and the **Sync Source** menus. For these reasons the trigger settings commands are not qualified with the measurement name, the way the trigger source commands are.

The settings setup menu can be accessed by pressing the key for the current trigger source a second time. For example, one press of Video selects the Video trigger as the source. The Video key becomes highlighted and the hollow arrow on the key

turns black. Now a second press of the key takes you into the Video Trigger Setup menu.

Trigger Setup Parameters:

The following examples show trigger setup parameters using an external trigger source.

Example 1 illustrates the trigger conditions with negative slope and no trigger occurs during trigger Holdoff time.

Example 2 illustrates the trigger conditions with positive slope, trigger delay, and auto trigger time.

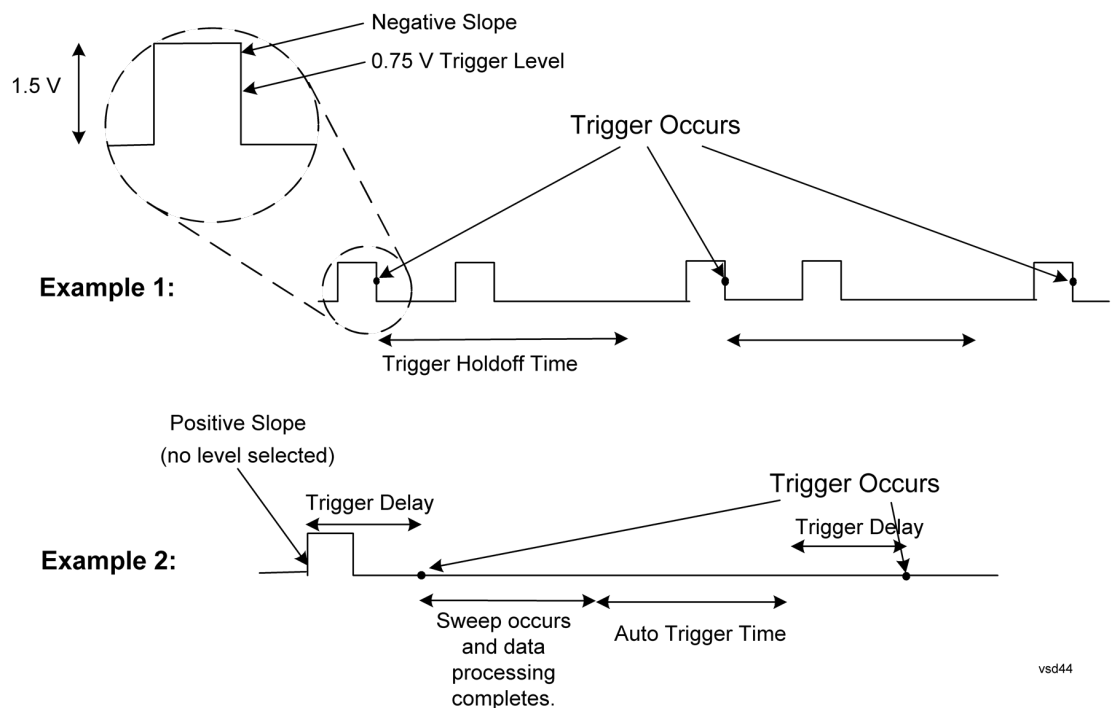

Free Run

Pressing this key, when it is not selected, selects free-run triggering. Free run triggering occurs immediately after the sweep/measurement is initiated.

Key Path	Trigger
Example	TRIG:SOUR IMM Swept SA measurement TRIG:<meas>:SOUR IMM Measurements other than Swept SA
State Saved	Saved in instrument state
Status Bits/OPC dependencies	The Status Operation Register bit 5 "Waiting for Trigger" is set at the same time as the Sweeping or Measuring bit is set. It is cleared when the trigger actually occurs (that is, after the trigger event occurs and all the applicable trigger criteria have been met). A corresponding pop-up message ("Waiting for trigger") is generated if no trigger signal appears after approximately 2 sec. This message goes away when a trigger signal appears.
Initial S/W Revision	Prior to A.02.00

Video (IF Envelope)

Pressing this key, when it is not selected, selects the video signal as the trigger. The Video trigger condition is met when the video signal (the filtered and detected version of the input signal, including both RBW and VBW filtering) crosses the video trigger level.

NOTE

When the detector selected for all active traces is the average detector, the video signal for triggering does not include any VBW filtering.

The video trigger level is shown as a labeled line on the display. The line is displayed as long as video is the selected trigger source.

Pressing this key, when it is already selected, accesses the video trigger setup functions.

Key Path	Trigger
Example	TRIG:SOUR VID Swept SA measurement TRIG:<meas>:SOUR VID Measurements other than Swept SA
Notes	Log Plot and Spot Frequency measurements do not support Video Trigger
Dependencies	Video trigger is allowed in average detector mode.
State Saved	Saved in instrument state
Status Bits/OPC dependencies	The Status Operation Register bit 5 "Waiting for Trigger" is set at the same time as the Sweeping or Measuring bit is set. It is cleared when the trigger actually occurs (that is, after the trigger event occurs and all the applicable trigger criteria have been met). A corresponding pop-up message ("Waiting for trigger") is generated if no trigger signal appears after approximately 2 sec. This message goes away when a trigger signal appears.
Backwards Compatibility Notes	In the past, the Average detector was not available when Video triggering was on, and consequently, functions that set the detector to average (such as Marker Noise or Band/Intvl Power) were not available when the video trigger was on. Similarly, Video triggering was not available when the detector was Average. In the X-Series, these restrictions are removed.
Initial S/W Revision	Prior to A.02.00

Trigger Level

Sets a level for the video signal trigger. When the video signal crosses this level, with the chosen slope, the trigger occurs. This level is displayed with a horizontal line only if **Video** is the selected trigger source.

Key Path	Trigger, Video
Remote Command	:TRIGger[:SEquence]:VIDeo:LEVe1 <amp1> :TRIGger[:SEquence]:VIDeo:LEVe1?
Example	TRIG:VID:LEV -40 dBm
Notes	When sweep type = FFT, the video trigger uses the amplitude envelope in a bandwidth wider than the FFT width as a trigger source. This might often be useful, but does not have the same relationship between the displayed trace and the trigger level as in swept triggering. Amplitude Corrections are not taken into account by the Video Trig Level. For example, if you

	<p>have given yourself effective gain with an amplitude correction factor, the Video Trigger will not fire until you have dropped the trigger line that far below the displayed signal level, rather than simply dropping it down to the displayed signal level.</p> <p>Note that other corrections, specifically External Gain and Ref Level Offset, modify the actual trace data as it is taken and therefore ARE taken into account by Trig Level.</p>
Couplings	This same level is used for the Video trigger source in the Trigger menu and for the Video selection in the Gate Source menu.
Preset	Set the Video Trigger Level -25 dBm on Preset. When the Video Trigger Level becomes the active function, if the value is off screen, set it to either the top or bottom of screen, depending on which direction off screen it was.
State Saved	Saved in instrument state
Min	-170 dBm
Max	+30 dBm
Default Unit	Depends on the current selected Y axis unit
Backwards Compatibility SCPI	:TRIGger[:SEquence]:IF:LEVe1 :TRIGger[:SEquence]:IF:LEVe1?
Backwards Compatibility Notes	This alias is provided for backward compatibility with VSA/PSA comms apps.
Initial S/W Revision	Prior to A.02.00

Trig Slope

Controls the trigger polarity. It is set positive to trigger on a rising edge and negative to trigger on a falling edge.

Key Path	Trigger, Video
Remote Command	:TRIGger[:SEquence]:VIDeo:SLOPe POSitive NEGative :TRIGger[:SEquence]:VIDeo:SLOPe?
Example	TRIG:VID:SLOP NEG
Preset	POSitive
State Saved	Saved in instrument state
Backwards Compatibility SCPI	:TRIGger[:SEquence]:IF:SLOPe NEGative POSitive :TRIGger[:SEquence]:IF:SLOPe?
Backwards Compatibility Notes	For backward compatibility with VSA/PSA comms apps The legacy :TRIGger[:SEquence]:SLOPe command affects the slopes for the VID, LINE, EXT1, EXT2, and RFB triggers.
Initial S/W Revision	Prior to A.02.00

Remote Command	:TRIGger[:SEquence]:SLOPe POSitive NEGative :TRIGger[:SEquence]:SLOPe?
Example	TRIG:SLOP NEG

Preset	POSitive
State Saved	Saved in instrument state
Backwards Compatibility Notes	In ESA/PSA, the Trigger Slope was global to all triggers. In the X-Series, the slope can be set individually for each Trigger Source. For backward compatibility, the global SLOPe command updates all instances of trigger slope (VID, LINE, EXT1, EXT2, TV, RFB). The query returns the trigger slope setting of the currently selected trigger source.
Initial S/W Revision	Prior to A.02.00

Trig Delay

Controls a time delay during that the analyzer will wait to begin a sweep after meeting the trigger criteria. You can use negative delay to pre-trigger the instrument in the time domain or FFT, but not in swept spans.

Key Path	Trigger, Video
Remote Command	:TRIGger[:SEquence]:VIDeo:DELAy <time> :TRIGger[:SEquence]:VIDeo:DELAy? :TRIGger[:SEquence]:VIDeo:DELAy:STATe OFF ON 0 1 :TRIGger[:SEquence]:VIDeo:DELAy:STATe?
Example	TRIG:VID:DEL:STAT ON TRIG:VID:DEL 100 ms
Notes	Video trigger delay may be set to negative values, in time domain, FFT and even swept. It makes intuitive sense in time domain and works well in FFT mode where the bandwidth of the filter before the video trigger is about 1.25 span. In swept spans, negative settings of Trig Delay are treated as a zero setting within the internal hardware and the advisory message "Neg. Trig Delay unavailable in Swept Mode, zero delay used." is generated when such a delay is set.
Preset	Off, 1 us
State Saved	Saved in instrument state
Min	-150 ms
Max	+500 ms
Default Unit	s
Backwards Compatibility Notes	! For backward compatibility with VSA/PSA comms apps :TRIGger[:SEquence]:IF:DELAy :TRIGger[:SEquence]:DELAy The legacy :TRIGger[:SEquence]:DELAy command affects the delay for the VID, LINE, EXT1, EXT2, and RFB triggers.
Initial S/W Revision	Prior to A.02.00

Remote Command	:TRIGger[:SEquence]:DELAy <time> :TRIGger[:SEquence]:DELAy? :TRIGger[:SEquence]:DELAy:STATe OFF ON 0 1
-----------------------	--

	:TRIGger[:SEquence]:DELay:STATe?
Example	TRIG:DEL 1 ms
Preset	1 us
State Saved	Saved in instrument state
Backwards Compatibility Notes	In ESA/PSA, the Trigger Delay was global to all triggers. In the X-Series, the delay can be set individually for each Trigger Source. For backward compatibility, the global DELay command updates all instances of trigger slope (VID, LINE, EXT1, EXT2) except TV and RFBurst. The query returns the trigger delay setting of the currently selected trigger source.
Initial S/W Revision	Prior to A.02.00

Remote Command	:TRIGger[:SEquence]:OFFSet <time> :TRIGger[:SEquence]:OFFSet? :TRIGger[:SEquence]:OFFSet:STATe OFF ON 0 1 :TRIGger[:SEquence]:OFFSet:STATe?
Example	TRIG:OFFS ON TRIG:OFFS -100 ms
Notes	These are ESA commands for trigger offset that allowed you to use a positive or negative delay when in zero span and in a Res BW \geq 1 kHz. For ESA compatibility, X-series analyzers keep track of this offset and adds it to the Trigger Delay for VIDeo, LINE, EXTernal1 or EXTernal2 whenever the value is sent to the hardware, if in Zero Span and RBW \geq 1 kHz.
Preset	Off, 0 s
State Saved	Saved in instrument state
Min	-11 s
Max	+11 s
Initial S/W Revision	Prior to A.02.00

X Axis Relative to Trigger

For triggers that support Trigger Delay it is beneficial that in time-domain displays (like Zero Span), X-axis values should be referenced to the Trigger point, that is, the zero value on the X Axis should be wherever the trigger point appears on the X Axis (including to the left or right of the X Axis). For negative trigger delays this means the zero point can actually appear on the X Axis.

Traditionally the zero point is at the left edge of the X Axis, and this behavior is retained for backwards compatibility, but if you turn on **X Axis Relative to Trigger**, the zero point moves to the trigger point and all X Axis values change to be relative to the trigger point.

When the **X Axis Relative to Trigger** switch is On, the trigger point on the X-axis will be marked with a vertical line and an annotation of "TRIG". Additionally, when the switch is On, values which are tied to the X-axis, such as trace data and markers, will have their X values adjusted to be referenced to the trigger point.

The switch is grayed out and Off unless the measurement is a time domain measurement; thus, in Swept SA it is grayed out unless in Zero Span.

Key Path	Trigger, Trigger
Remote Command	:TRIGger[:SEquence]:XRELative ON OFF 1 0 :TRIGger[:SEquence]:XRELative?
Example	TRIG:XREL ON
Notes	Although shown in all Trigger menus that have Trig Delay, the function is global to all of them and has the same value in all.
Dependencies	Grayed out unless in Zero Span. When grayed out, shows as Off. Non-forceful grayout, no error if SCPI sent while grayed out.
Preset	Off
State Saved	Saved in instrument state.
Initial S/W Revision	Prior to A.18.00
Control Type	Toggle

Line

Pressing this key, when it is not selected, selects the line signal as the trigger. A new sweep/measurement will start synchronized with the next cycle of the line voltage. Pressing this key, when it is already selected, access the line trigger setup menu.

Key Path	Trigger
Example	TRIG:SOUR LINE Swept SA measurement TRIG:<meas>:SOUR LINE Measurements other than Swept SA
Dependencies	Line trigger is not available when operating from a "dc power source", for example, when the instrument is powered from batteries.
State Saved	Saved in instrument state
Status Bits/OPC dependencies	The Status Operation Register bit 5 "Waiting for Trigger" is set at the same time as the Sweeping or Measuring bit is set. It is cleared when the trigger actually occurs (that is, after the trigger event occurs and all the applicable trigger criteria have been met). A corresponding pop-up message ("Waiting for trigger") is generated if no trigger signal appears after approximately 2 sec. This message goes away when a trigger signal appears.
Initial S/W Revision	Prior to A.02.00

Trig Slope

Controls the trigger polarity. It is set positive to trigger on a rising edge and negative to trigger on a falling edge.

Key Path	Trigger, Line
Remote Command	:TRIGger[:SEquence]:LINE:SLOPe POSitive NEGative :TRIGger[:SEquence]:LINE:SLOPe?
Example	TRIG:LINE:SLOP NEG

Preset	POSitive
State Saved	Saved in instrument state
Backwards Compatibility Notes	The legacy :TRIGger[:SEQuence]:SLOPe command affects the slopes for the VID, LINE, EXT1, EXT2, and RFB triggers.
Initial S/W Revision	Prior to A.02.00

Trig Delay

Controls a time delay during which the analyzer will wait to begin a sweep after meeting the trigger criteria. You can use negative delay to pre-trigger the instrument in time domain or FFT, but not in swept spans.

Key Path	Trigger, Line
Remote Command	:TRIGger[:SEQuence]:LINE:DELAy <time> :TRIGger[:SEQuence]:LINE:DELAy? :TRIGger[:SEQuence]:LINE:DELAy:STATe OFF ON 0 1 :TRIGger[:SEQuence]:LINE:DELAy:STATe?
Example	TRIG:LINE:DEL:STAT ON TRIG:LINE:DEL 100 ms
Notes	Video trigger delay may be set to negative values, in time domain, FFT and even swept. It makes intuitive sense in time domain and works well in FFT mode where the bandwidth of the filter before the video trigger is about 1.25 span. In swept spans, negative settings of Trig Delay are treated as a zero setting within the internal hardware and the advisory message "Neg. Trig Delay unavailable in Swept Mode, zero delay used." is generated when such a delay is set.
Preset	Off, 1.000 us
State Saved	Saved in instrument state
Min	-150 ms
Max	500 ms
Default Unit	S
Backwards Compatibility Notes	The legacy :TRIGger[:SEQuence]:DELAy command affects the delay for the VID, LINE, EXT1, EXT2, and RFB triggers. The legacy :TRIGger[:SEQuence]:OFFSet command is supported for the VIDEo, LINE, EXT1, and EXT2 triggers.
Initial S/W Revision	Prior to A.02.00

X Axis Relative to Trigger

For triggers that support Trigger Delay it is beneficial that in time-domain displays (like Zero Span), X-axis values should be referenced to the Trigger point, that is, the zero value on the X Axis should be wherever the trigger point appears on the X Axis (including to the left or right of the X Axis). For negative trigger delays this means the zero point can actually appear on the X Axis.

Traditionally the zero point is at the left edge of the X Axis, and this behavior is retained for backwards compatibility, but if you turn on **X Axis Relative to Trigger**, the

zero point moves to the trigger point and all X Axis values change to be relative to the trigger point.

When the **X Axis Relative to Trigger** switch is On, the trigger point on the X-axis will be marked with a vertical line and an annotation of "TRIG". Additionally, when the switch is On, values which are tied to the X-axis, such as trace data and markers, will have their X values adjusted to be referenced to the trigger point.

The switch is grayed out and Off unless the measurement is a time domain measurement; thus, in Swept SA it is grayed out unless in Zero Span.

Key Path	Trigger, Trigger
Remote Command	:TRIGger[:SEquence]:XRElative ON OFF 1 0 :TRIGger[:SEquence]:XRElative?
Example	TRIG:XREL ON
Notes	Although shown in all Trigger menus that have Trig Delay, the function is global to all of them and has the same value in all.
Dependencies	Grayed out unless in Zero Span. When grayed out, shows as Off. Non-forceful grayout, no error if SCPI sent while grayed out.
Preset	Off
State Saved	Saved in instrument state.
Initial S/W Revision	Prior to A.18.00
Control Type	Toggle

External 1

Pressing this key, when it is not selected, selects an external input signal as the trigger. A new sweep/measurement will start when the external trigger condition is met using the external 1 input connector on the rear panel.

Pressing this key, when it is already selected, accesses the external 1 trigger setup menu.

Key Path	Trigger
Example	TRIG:SOUR EXT1 Swept SA measurement TRIG:<meas>:SOUR EXT1 Measurements other than Swept SA
Dependencies	Grayed out if in use by Point Trigger in the Source Setup menu. Forced to Free Run if already selected and Point Trigger is set to External 1.
State Saved	Saved in instrument state
Status Bits/OPC dependencies	The Status Operation Register bit 5 "Waiting for Trigger" is set at the same time as the Sweeping or Measuring bit is set. It is cleared when the trigger actually occurs (that is, after the trigger event occurs and all the applicable trigger criteria have been met). A corresponding pop-up message ("Waiting for trigger") is generated if no trigger signal appears after approximately 2 sec. This message goes away when a trigger signal appears.
Initial S/W Revision	Prior to A.02.00

Trigger Level

Sets the value where the external 1 trigger input will trigger a new sweep/measurement.

Key Path	Trigger, External 1
Remote Command	:TRIGger[:SEquence]:EXTernal1:LEVel <level> :TRIGger[:SEquence]:EXTernal1:LEVel?
Example	TRIG:EXT1:LEV 0.4 V
Couplings	This same level is used for the Ext1 trigger source in the Trigger menu, for the Ext1 selection in the Periodic Timer sync source (in the Trigger menu and in the Gate Source menu), and also for the Ext1 selection in the Gate Source menu.
Preset	1.2 V
State Saved	Saved in instrument state
Min	-5 V
Max	5 V
Default Unit	V
Backwards Compatibility SCPI	:TRIGger[:SEquence]:EXTernal:LEVel For backward compatibility, the parameter EXTernal is mapped to EXTernal1
Backwards Compatibility SCPI	:TRIGger[:SEquence]:FRAME:EXTernal1:LEVel
Initial S/W Revision	Prior to A.02.00

Trig Slope

Controls the trigger polarity. It is set positive to trigger on a rising edge and negative to trigger on a falling edge.

Key Path	Trigger, External 1
Remote Command	:TRIGger[:SEquence]:EXTernal1:SLOPe POSitive NEGative :TRIGger[:SEquence]:EXTernal1:SLOPe?
Example	TRIG:EXT1:SLOP NEG
Couplings	This same slope is used in the Ext1 selection for the trigger source in the Trigger menu and for the period timer sync source (in the Trigger menu and in the Gate Source menu).
Preset	POSitive
State Saved	Saved in instrument state
Backwards Compatibility SCPI	:TRIGger[:SEquence]:EXTernal:SLOPe For backward compatibility, the parameter EXTernal is mapped to EXTernal1
Backwards Compatibility SCPI	:TRIGger[:SEquence]:FRAME:EXTernal1:SLOPe
Backwards Compatibility Notes	The legacy :TRIGger[:SEquence]:SLOPe command affects the slopes for the VID, LINE, EXT1, EXT2, and RFB triggers.
Initial S/W Revision	Prior to A.02.00

Trig Delay

Controls a time delay during which the analyzer will wait to begin a sweep after meeting the trigger criteria. You can use negative delay to pre-trigger the instrument in time domain or FFT, but not in swept spans.

Key Path	Trigger, External 1
Remote Command	:TRIGger[:SEquence]:EXTernal1:DELay <time> :TRIGger[:SEquence]:EXTernal1:DELay? :TRIGger[:SEquence]:EXTernal1:DELay:STATe OFF ON 0 1 :TRIGger[:SEquence]:EXTernal1:DELay:STATe?
Example	TRIG:EXT1:DEL:STAT ON TRIG:EXT1:DEL 100 ms
Notes	Video trigger delay may be set to negative values, in time domain, FFT and even swept. It makes intuitive sense in time domain and works well in FFT mode where the bandwidth of the filter before the video trigger is about 1.25 span. In swept spans, negative settings of Trig Delay are treated as a zero setting within the internal hardware and the advisory message "Neg. Trig Delay unavailable in Swept Mode, zero delay used." is generated when such a delay is set.
Preset	Off, 1.000 us
State Saved	Saved in instrument state
Min	-150 ms
Max	+500 ms
Default Unit	s
Backwards Compatibility SCPI	:TRIGger[:SEquence]:EXTernal1:DELay For backward compatibility, the parameter EXTernal is mapped to EXTernal1
Backwards Compatibility Notes	The legacy :TRIGger[:SEquence]:DELay command affects the delay for the VID, LINE, EXT1, EXT2, and RFB triggers. The legacy :TRIGger[:SEquence]:OFFSet command is supported for the VIDeo, LINE, EXT1, and EXT2 triggers.
Initial S/W Revision	Prior to A.02.00

X Axis Relative to Trigger

For triggers that support Trigger Delay it is beneficial that in time-domain displays (like Zero Span), X-axis values should be referenced to the Trigger point, that is, the zero value on the X Axis should be wherever the trigger point appears on the X Axis (including to the left or right of the X Axis). For negative trigger delays this means the zero point can actually appear on the X Axis.

Traditionally the zero point is at the left edge of the X Axis, and this behavior is retained for backwards compatibility, but if you turn on **X Axis Relative to Trigger**, the zero point moves to the trigger point and all X Axis values change to be relative to the trigger point.

When the **X Axis Relative to Trigger** switch is On, the trigger point on the X-axis will be marked with a vertical line and an annotation of "TRIG". Additionally, when the

switch is On, values which are tied to the X-axis, such as trace data and markers, will have their X values adjusted to be referenced to the trigger point.

The switch is grayed out and Off unless the measurement is a time domain measurement; thus, in Swept SA it is grayed out unless in Zero Span.

Key Path	Trigger, Trigger
Remote Command	:TRIGger[:SEquence]:XRELative ON OFF 1 0 :TRIGger[:SEquence]:XRELative?
Example	TRIG:XREL ON
Notes	Although shown in all Trigger menus that have Trig Delay, the function is global to all of them and has the same value in all.
Dependencies	Grayed out unless in Zero Span. When grayed out, shows as Off. Non-forceful grayout, no error if SCPI sent while grayed out.
Preset	Off
State Saved	Saved in instrument state.
Initial S/W Revision	Prior to A.18.00
Control Type	Toggle

Zero Span Delay Comp On/Off

In zero span, there is a natural delay in the signal path, which comes from the RBW filter. This is usually desirable, as it allows you to trigger on events and also see those events, because the signal is delayed from the trigger event. However, in some cases it is desirable to eliminate this delay, so that trigger events line up exactly with the zero time point in zero span. You can use the **Zero Span Delay Comp On/Off** feature to enable or disable zero span delay compensation.

Key Path	Trigger, External 1
Remote Command	:TRIGger[:SEquence]:EXTernal1:DELay:COMPensation OFF ON 0 1 :TRIGger[:SEquence]:EXTernal1:DELay:COMPensation?
Example	TRIG:EXT1:DEL:COMP ON
Dependencies	No effect except in zero-span, but not locked out in nonzero spans. Blanked in modes that do not support zero-span measurements. If the SCPI command is sent when the key is blanked, an error is returned: -221, "Settings conflict; Feature not supported for this measurement" In analyzers shipping N9060A, this feature requires N9060A-7FP.
Preset	OFF
State Saved	Saved in instrument state
Initial S/W Revision	A.11.00

External 2

Pressing this key, when it is not selected, selects an external input signal as the trigger. A new sweep/measurement will start when the external trigger condition is

met using the external 2 input connector. The external trigger 2 input connector is on the rear panel.

Pressing this key, when it is already selected, accesses the external 2 trigger setup menu.

Key Path	Trigger
Example	TRIG:SOUR EXT2 Swept SA measurement TRIG:<meas>:SOUR EXT2 Measurements other than Swept SA
Dependencies	In some models, there is no second External input. In these models, the External 2 key is blanked and the EXTernal2 parameter will generate a "Hardware missing; Not available for this model number" message. Grayed out if in use by Point Trigger in the Source Setup menu. Forced to Free Run if already selected and Point Trigger is set to External 2.
State Saved	Saved in instrument state
Status Bits/OPC dependencies	The Status Operation Register bit 5 "Waiting for Trigger" is set at the same time as the Sweeping or Measuring bit is set. It is cleared when the trigger actually occurs (that is, after the trigger event occurs and all the applicable trigger criteria have been met). A corresponding pop-up message ("Waiting for trigger") is generated if no trigger signal appears after approximately 2 sec. This message goes away when a trigger signal appears.
Initial S/W Revision	Prior to A.02.00
Modified at S/W Revision	A.03.00

Trigger Level

Sets the value where the external 2 trigger input will trigger a new sweep/measurement.

Key Path	Trigger, External 2
Remote Command	:TRIGger[:SEquence]:EXTernal2:LEVel :TRIGger[:SEquence]:EXTernal2:LEVel?
Example	TRIG:EXT2:LEV 1.1 V
Couplings	This same level is used for the Ext2 trigger source in the Trigger menu, for the Ext2 selection in the Periodic Timer sync source (in the Trigger menu and in the Gate Source menu), and also for the Ext2 selection in the Gate Source menu.
Preset	1.2 V
State Saved	Saved in instrument state
Min	-5 V
Max	5 V
Default Unit	V
Backwards Compatibility SCPI	:TRIGger[:SEquence]:FRAME:EXTernal2:LEVel
Initial S/W Revision	Prior to A.02.00

Trig Slope

Controls the trigger polarity. It is set positive to trigger on a rising edge and negative to trigger on a falling edge.

Key Path	Trigger, External 2
Remote Command	:TRIGger[:SEquence]:EXTerna12:SLOPe POSitive NEGative :TRIGger[:SEquence]:EXTerna12:SLOPe?
Example	TRIG:EXT2:SLOP NEG
Couplings	This same slope is used in the Ext2 selection for the trigger source in the Trigger menu and for the period timer sync source (in the Trigger menu and in the Gate Source menu).
Preset	POSitive
State Saved	Saved in instrument state
Backwards Compatibility SCPI	:TRIGger[:SEquence]:FRaME:EXTerna12:SLOPe
Backwards Compatibility Notes	The legacy :TRIGger[:SEquence]:SLOPe command affects the slopes for the VID, LINE, EXT1, EXT2, and RFB triggers.
Initial S/W Revision	Prior to A.02.00

Trig Delay

Controls a time delay during which the analyzer will wait to begin a sweep after meeting the trigger criteria. You can use negative delay to pre-trigger the instrument in time domain or FFT, but not in swept spans.

Key Path	Trigger, External 2
Remote Command	:TRIGger[:SEquence]:EXTerna12:DELay <time> :TRIGger[:SEquence]:EXTerna12:DELay? :TRIGger[:SEquence]:EXTerna12:DELay:STATe OFF ON 0 1 :TRIGger[:SEquence]:EXTerna12:DELay:STATe?
Example	TRIG:EXT2:DEL:STAT ON TRIG:EXT2:DEL 100 ms
Notes	Video trigger delay may be set to negative values, in time domain, FFT and even swept. It makes intuitive sense in time domain and works well in FFT mode where the bandwidth of the filter before the video trigger is about 1.25 span. In swept spans, negative settings of Trig Delay are treated as a zero setting within the internal hardware and the advisory message "Neg. Trig Delay unavailable in Swept Mode, zero delay used." is generated when such a delay is set.
Preset	Off, 1.000 us
State Saved	Saved in instrument state
Min	-150 ms
Max	500 ms
Default Unit	s
Backwards Compatibility Notes	The legacy :TRIGger[:SEquence]:DELay command affects the delay for the VID, LINE, EXT1, EXT2, and RFB triggers.

The legacy :TRIGger[:SEQuence]:OFFSet command is supported for the VIDEO, LINE, EXT1, and EXT2 triggers.

Initial S/W Revision Prior to A.02.00

X Axis Relative to Trigger

For triggers that support Trigger Delay it is beneficial that in time-domain displays (like Zero Span), X-axis values should be referenced to the Trigger point, that is, the zero value on the X Axis should be wherever the trigger point appears on the X Axis (including to the left or right of the X Axis). For negative trigger delays this means the zero point can actually appear on the X Axis.

Traditionally the zero point is at the left edge of the X Axis, and this behavior is retained for backwards compatibility, but if you turn on **X Axis Relative to Trigger**, the zero point moves to the trigger point and all X Axis values change to be relative to the trigger point.

When the **X Axis Relative to Trigger** switch is On, the trigger point on the X-axis will be marked with a vertical line and an annotation of "TRIG". Additionally, when the switch is On, values which are tied to the X-axis, such as trace data and markers, will have their X values adjusted to be referenced to the trigger point.

The switch is grayed out and Off unless the measurement is a time domain measurement; thus, in Swept SA it is grayed out unless in Zero Span.

Key Path	Trigger, Trigger
Remote Command	:TRIGger[:SEQuence]:XRELative ON OFF 1 0 :TRIGger[:SEQuence]:XRELative?
Example	TRIG:XREL ON
Notes	Although shown in all Trigger menus that have Trig Delay, the function is global to all of them and has the same value in all.
Dependencies	Grayed out unless in Zero Span. When grayed out, shows as Off. Non-forceful grayout, no error if SCPI sent while grayed out.
Preset	Off
State Saved	Saved in instrument state.
Initial S/W Revision	Prior to A.18.00
Control Type	Toggle

Zero Span Delay Comp On/Off

In zero span, there is a natural delay in the signal path, which comes from the RBW filter. This is usually desirable, as it allows you to trigger on events and also see those events, because the signal is delayed from the trigger event. However, in some cases it is desirable to eliminate this delay, so that trigger events line up exactly with the zero time point in zero span. You can use the **Zero Span Delay Comp On/Off** feature to enable or disable zero span delay compensation.

Key Path	Trigger, External 2
Remote Command	:TRIGger[:SEquence]:EXTernal2:DELay:COMPensation OFF ON 0 1 :TRIGger[:SEquence]:EXTernal2:DELay:COMPensation?
Example	TRIG:EXT2:DEL:COMP ON
Dependencies	No effect except in zero-span, but not locked out in nonzero spans. Blanked in modes that do not support zero-span measurements. If the SCPI command is sent when the key is blanked, an error is returned: -221, "Settings conflict; Feature not supported for this measurement" In analyzers shipping N9060A, this feature requires N9060A-7FP.
Preset	OFF
State Saved	Saved in instrument state
Initial S/W Revision	A.11.00

RF Burst

Pressing this key, when it is not selected, selects the RF Burst as the trigger. A new sweep/measurement will start when an RF burst envelope signal is identified from the signal at the RF Input connector. Pressing this key, when it is already selected, accesses the RF Burst trigger setup menu.

In some models, a variety of burst trigger circuitry is available, resulting in various available burst trigger bandwidths. The analyzer automatically chooses the appropriate trigger path based on the hardware configuration and other settings of the analyzer.

Key Path	Trigger
Example	TRIG:SOUR RFB Swept SA measurement TRIG:<meas>:SOUR RFB Measurements other than Swept SA
State Saved	Saved in instrument state
Status Bits/OPC dependencies	The Status Operation Register bit 5 "Waiting for Trigger" is set at the same time as the Sweeping or Measuring bit is set. It is cleared when the trigger actually occurs (that is, after the trigger event occurs and all the applicable trigger criteria have been met). A corresponding pop-up message ("Waiting for trigger") is generated if no trigger signal appears after approximately 2 sec. This message goes away when a trigger signal appears.
Backwards Compatibility Notes	The legacy command: :TRIGger[:SEquence]:RFBurst:FSElectivity[:STATE] OFF ON 0 1 is not supported in the X-Series, as the hardware to do Frequency Selective burst triggers does not exist in X-Series.
Initial S/W Revision	Prior to A.02.00
Modified at S/W Revision	A.04.00

Absolute Trigger Level

Sets the absolute trigger level for the RF burst envelope.

When using the External Mixing path, the Absolute Trigger Level is uncalibrated because the factory default was set to accommodate the expected IF levels for the RF path.

Key Path	Trigger, RF Burst
Scope	Meas Global
Remote Command	:TRIGger[:SEquence]:RFBurst:LEVel:ABSolute <ampl> :TRIGger[:SEquence]:RFBurst:LEVel:ABSolute?
Example	TRIG:RFB:LEV:ABS 10 dBm sets the trigger level of the RF burst envelope signal to the absolute level of 10 dBm
Notes	Sending this command does not switch the setting from relative to absolute; to switch it you need to send the :TRIGger[:SEquence]:RFBurst:LEVel:TYPE command, below. Amplitude Corrections are not taken into account by the Absolute Trigger Level. For example, if you have given yourself effective gain with an amplitude correction factor, the Absolute Trigger will not fire until you have set the trigger level that far below the displayed signal level, rather than simply to the displayed signal level. This is only true for Amplitude Corrections, not External Gain or Ref Level Offset functions. If mode is Bluetooth, the default value is -50 dBm.
Couplings	This same level is used for the RF Burst trigger source in the Trigger menu, for the RF Burst selection in the Periodic Timer sync source (in the Trigger menu and in the Gate Source menu), and also for the RF Burst selection in the Gate Source menu
Preset	-20 dBm
State Saved	Saved in instrument state
Min	-200 dBm
Max	100 dBm
Default Unit	depends on the current selected Y-Axis unit
Backwards Compatibility SCPI	:TRIGger[:SEquence]:FRAMe:RFBurst:LEVel:ABSolute
Initial S/W Revision	Prior to A.02.00
Modified at S/W Revision	A.04.00

Key Path	Trigger, RF Burst
Remote Command	:TRIGger[:SEquence]:RFBurst:LEVel:TYPE ABSolute RELative :TRIGger[:SEquence]:RFBurst:LEVel:TYPE?
Example	TRIG:RFB:LEV:TYPE REL sets the trigger level type of the RF burst trigger to Relative.
Preset	ABSolute
State Saved	Saved in instrument state
Initial S/W Revision	Prior to A.02.00
Modified at S/W Revision	A.04.00

Relative Trigger Level

Sets the relative trigger level for the RF burst envelope.

In some models, the relative burst trigger function is implemented in hardware. In other models, without the advanced triggering hardware required, the relative burst trigger function is implemented in software in some measurements, and is unavailable in other measurements.

When implemented in software, the relative RF Burst trigger function is implemented as follows:

5. The measurement starts with the absolute RF Burst trigger setting. If it cannot get a trigger with that level, auto trigger fires and the acquisition starts anyway. After the acquisition, the measurement searches for the peak in the acquired waveform and saves it.
6. Now, in the next cycle of the measurement, the measurement determines a new absolute RF Burst level based on the peak value from the first measurement and the Relative RF Burst Trigger Level (always 0 or negative dB) set by the user. The following formula is used:
7. absolute RF Burst level = peak level of the previous acquisition + relative RF Burst level
8. If the new absolute RF Burst level differs from the previous by more than 0.5 dB, the new level is sent to the hardware; otherwise it is not updated (to avoid slowing down the acquisition)

Steps 2 and 3 repeat for subsequent measurements.

Key Path	Trigger, RF Burst
Scope	Meas Global
Remote Command	:TRIGger[:SEquence]:RFBurst:LEVel:RELative <rel_amp1> :TRIGger[:SEquence]:RFBurst:LEVel:RELative?
Example	TRIG:RFB:LEV:REL -10 dB sets the trigger level of the RF burst envelope signal to the relative level of -10 dB
Notes	Sending this command does not switch the setting from absolute to relative; to switch it you need to send the :TRIGger[:SEquence]:RFBurst:LEVel:TYPE command, above. The relative trigger level is not available in some measurements. In those measurements the RELative parameter, and the :TRIGger[:SEquence]:RFBurst:LEVel:TYPE command (above), will generate an error if sent.
Dependencies	This key is grayed out and Absolute Trigger Level selected if the required hardware is not present in your analyzer and the current measurement does not support Relative triggering.
Preset	-6 dB GSM: -25 dB

State Saved	Saved in instrument state
Min	-45 dB
Max	0 dB
Default Unit	dB or dBc
Backwards Compatibility SCPI	:TRIGger[:SEquence]:RFBurst:LEVel This legacy command is aliased to :TRIGger[:SEquence]:RFBurst:LEVel:RELative because the PSA had ONLY relative burst triggering
Initial S/W Revision	Prior to A.02.00
Modified at S/W Revision	A.04.00

Trigger Slope

It is set positive to trigger on a rising edge and negative to trigger on a falling edge.

Key Path	Trigger, RF Burst
Remote Command	:TRIGger[:SEquence]:RFBurst:SLOPe POSitive NEGative :TRIGger[:SEquence]:RFBurst:SLOPe?
Example	TRIG:RFB:SLOP NEG
Couplings	This same slope is used in the RF Burst selection for the trigger source in the Trigger menu and for the period timer sync source (in the Trigger menu and in the Gate Source menu).
Preset	POSitive
State Saved	Saved in instrument state
Backwards Compatibility SCPI	:TRIGger[:SEquence]:FRAME:RFBurst:SLOPe
Backwards Compatibility Notes	The legacy :TRIGger[:SEquence]:SLOPe command affects the slopes for the VID, LINE, EXT1, EXT2, and RFB triggers.
Initial S/W Revision	Prior to A.02.00

Trig Delay

Controls a time delay during which the analyzer will wait to begin a sweep after meeting the trigger criteria. You can use negative delay to pre-trigger the instrument in time domain or FFT, but not in swept spans.

Key Path	Trigger, RF Burst
Remote Command	:TRIGger[:SEquence]:RFBurst:DELAy <time> :TRIGger[:SEquence]:RFBurst:DELAy? :TRIGger[:SEquence]:RFBurst:DELAy:STATe OFF ON 0 1 :TRIGger[:SEquence]:RFBurst:DELAy:STATe?
Example	TRIG:RFB:DEL:STAT ON TRIG:RFB:DEL 100 ms

Notes	Video trigger delay may be set to negative values, in time domain, FFT and even swept. It makes intuitive sense in time domain and works well in FFT mode where the bandwidth of the filter before the video trigger is about 1.25 span. In swept spans, negative settings of Trig Delay are treated as a zero setting within the internal hardware and the advisory message "Neg. Trig Delay unavailable in Swept Mode, zero delay used." is generated when such a delay is set.
Preset	Off, 1.000 us
State Saved	Saved in instrument state
Min	-150 ms
Max	500 ms
Default Unit	s
Backwards Compatibility Notes	The legacy :TRIGger[:SEQuence]:DELay command affects the delay for the VID, LINE, EXT1, EXT2, and RFB triggers.
Initial S/W Revision	Prior to A.02.00

X Axis Relative to Trigger

For triggers that support Trigger Delay it is beneficial that in time-domain displays (like Zero Span), X-axis values should be referenced to the Trigger point, that is, the zero value on the X Axis should be wherever the trigger point appears on the X Axis (including to the left or right of the X Axis). For negative trigger delays this means the zero point can actually appear on the X Axis.

Traditionally the zero point is at the left edge of the X Axis, and this behavior is retained for backwards compatibility, but if you turn on **X Axis Relative to Trigger**, the zero point moves to the trigger point and all X Axis values change to be relative to the trigger point.

When the **X Axis Relative to Trigger** switch is On, the trigger point on the X-axis will be marked with a vertical line and an annotation of "TRIG". Additionally, when the switch is On, values which are tied to the X-axis, such as trace data and markers, will have their X values adjusted to be referenced to the trigger point.

The switch is grayed out and Off unless the measurement is a time domain measurement; thus, in Swept SA it is grayed out unless in Zero Span.

Key Path	Trigger, Trigger
Remote Command	:TRIGger[:SEQuence]:XRELative ON OFF 1 0 :TRIGger[:SEQuence]:XRELative?
Example	TRIG:XREL ON
Notes	Although shown in all Trigger menus that have Trig Delay, the function is global to all of them and has the same value in all.
Dependencies	Grayed out unless in Zero Span. When grayed out, shows as Off. Non-forceful grayout, no error if SCPI sent while grayed out.
Preset	Off
State Saved	Saved in instrument state.
Initial S/W Revision	Prior to A.18.00
Control Type	Toggle

Zero Span Delay Comp On/Off

In zero span, there is a natural delay in the signal path, which comes from the RBW filter. This is usually desirable, as it allows you to trigger on events and also see those events, because the signal is delayed from the trigger event. However, in some cases it is desirable to eliminate this delay, so that trigger events line up exactly with the zero time point in zero span. You can use the **Zero Span Delay Comp On/Off** feature to enable or disable zero span delay compensation.

Key Path	Trigger, RF Burst
Remote Command	:TRIGger[:SEquence]:RFBurst:DElay:COMPensation OFF ON 0 1 :TRIGger[:SEquence]:RFBurst:DElay:COMPensation?
Example	TRIG:RFB:DEL:COMP ON
Dependencies	No effect except in zero-span, but not locked out in nonzero spans. Blanked in modes that do not support zero-span measurements. If the SCPI command is sent when the key is blanked, an error is returned: -221, "Settings conflict; Feature not supported for this measurement" In analyzers shipping N9060A, this feature requires N9060A-7FP.
Preset	OFF
State Saved	Saved in instrument state
Initial S/W Revision	A.11.00

Periodic Timer (Frame Trigger)

Pressing this key, when it is not selected, selects the internal periodic timer signal as the trigger. Triggering occurrences are set by the **Period** parameter, which is modified by the **Sync Source** and **Offset**. Pressing this key, when it is already selected, accesses the periodic timer trigger setup functions.

If you do not have a sync source selected (it is Off), then the internal timer will not be synchronized with any external timing events.

Key Path	Trigger
Example	TRIG:SOUR FRAM Swept SA measurement TRIG:<meas>:SOUR FRAM Measurements other than Swept SA
State Saved	Saved in instrument state
Readback	[Sync: <value of Sync Source>], for example, [Sync: External 1]
Status Bits/OPC dependencies	The Status Operation Register bit 5 "Waiting for Trigger" is set at the same time as the Sweeping or Measuring bit is set. It is cleared when the trigger actually occurs (that is, after the trigger event occurs and all the applicable trigger criteria have been met). A corresponding pop-up message ("Waiting for trigger") is generated if no trigger signal appears after approximately 2 sec. This message goes away when a trigger signal appears.
Initial S/W Revision	Prior to A.02.00

Periodic Timer Triggering:

This feature selects the internal periodic timer signal as the trigger. Trigger occurrences are set by the **Periodic Timer** parameter, which is modified by the **Sync Source** and **Offset**.

The figure below shows the action of the periodic timer trigger. Before reviewing the figure, we'll explain some uses for the periodic trigger.

A common application is measuring periodic burst RF signals for which a trigger signal is not easily available. For example, we might be measuring a TDMA radio which bursts every 20 ms. Let's assume that the 20 ms period is very consistent. Let's also assume that we do not have an external trigger source available that is synchronized with the period, and that the signal-to-noise ratio of the signal is not high enough to provide a clean RF burst trigger at all of the analysis frequencies. For example, we might want to measure spurious transmissions at an offset from the carrier that is larger than the bandwidth of the RF burst trigger. In this application, we can set the Periodic Timer to a 20.00 ms period and adjust the offset from that timer to position our trigger just where we want it. If we find that the 20.00 ms is not exactly right, we can adjust the period slightly to minimize the drift between the period timer and the signal to be measured.

A second way to use this feature would be to use **Sync Source** temporarily, instead of **Offset**. In this case, we might tune to the signal in a narrow span and use the RF Burst trigger to synchronize the periodic timer. Then we would turn the sync source off so that it would not miss-trigger. Miss-triggering can occur when we are tuned so far away from the RF burst trigger that it is no longer reliable.

A third example would be to synchronize to a signal that has a reference time element of much longer period than the period of interest. In some CDMA applications, it is useful to look at signals with a short periodicity, by synchronizing that periodicity to the "even-second clock" edge that happens every two seconds. Thus, we could connect the even-second clock trigger to Ext1 and use then Ext1 as the sync source for the periodic timer.

The figure below illustrates this third example. The top trace represents the even-second clock. It causes the periodic timer to synchronize with the leading edge shown. The analyzer trigger occurs at a time delayed by the accumulated offset from the period trigger event. The periodic timer continues to run, and triggers continue to occur, with a periodicity determined by the analyzer time base. The timer output (labeled "late event") will drift away from its ideal time due to imperfect matching between the time base of the signal being measured and the time base of the analyzer, and also because of imperfect setting of the period parameter. But the synchronization is restored on the next even-second clock event. ("Accumulated offset" is described in the in the **Offset** function section.)

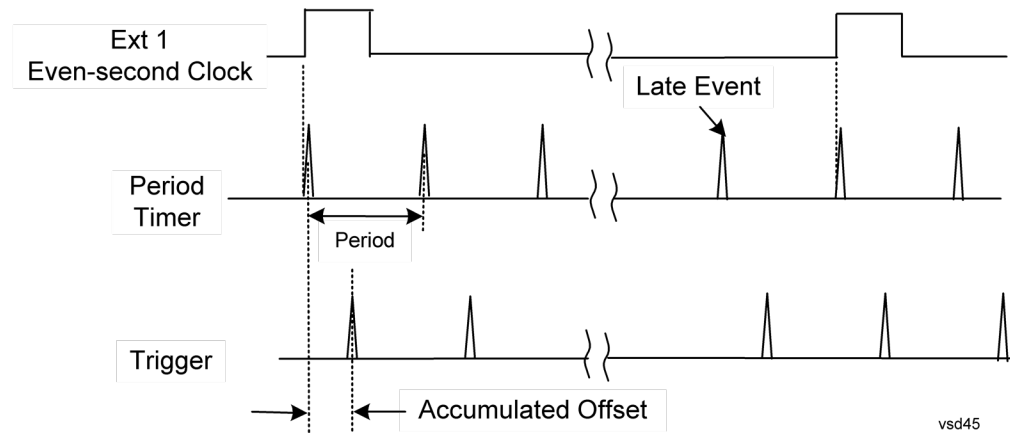

Period

Sets the period of the internal periodic timer clock. For digital communications signals, this is usually set to the frame period of your current input signal. In the case that sync source is not set to OFF, and the external sync source rate is changed for some reason, the periodic timer is synchronized at the every external synchronization pulse by resetting the internal state of the timer circuit.

Key Path	Trigger, Periodic Timer
Remote Command	:TRIGger[:SEquence]:FRAMe:PERiod <time> :TRIGger[:SEquence]:FRAMe:PERiod?
Example	TRIG:FRAM:PER 100 ms
Dependencies	The invalid data indicator turns on when the period is changed, until the next sweep/measurement completes.
Couplings	The same period is used in the Gate Source selection of the period timer.
Preset	20 ms GSM: 4.615383
State Saved	Saved in instrument state
Min	100.000 ns
Max	559.0000 ms
Default Unit	S
Initial S/W Revision	Prior to A.02.00

Offset

Adjusts the accumulated offset between the periodic timer events and the trigger event. Adjusting the accumulated offset is different than setting an offset, and requires explanation.

The periodic timer is usually not synchronized with any external events, so the timing of its output events has no absolute meaning. Since the timing relative to external events (RF signals) is important, you need to be able to adjust (offset) it. However, you have no direct way to see when the periodic timer events occur. All that you can

see is the trigger timing. When you want to adjust the trigger timing, you will be changing the internal offset between the periodic timer events and the trigger event. Because the absolute value of that internal offset is unknown, we will just call that the accumulated offset. Whenever the Offset parameter is changed, you are changing that accumulated offset. You can reset the displayed offset using Reset Offset Display. Changing the display does not change the value of the accumulated offset, and you can still make additional changes to accumulated offset.

To avoid ambiguity, we define that an increase in the "offset" parameter, either from the knob or the SCPI adjust command, serves to delay the timing of the trigger event.

Key Path	Trigger, Periodic Timer
Remote Command	<code>:TRIGger[:SEquence]:FRAMe:OFFSet <time></code> <code>:TRIGger[:SEquence]:FRAMe:OFFSet?</code>
Example	TRIG:FRAM:OFFS 1.2 ms
Notes	<p>The front panel interface (for example, the knob), and this command, adjust the accumulated offset, which is shown on the active function display. However, the actual amount sent to the hardware each time the offset is updated is the delta value, that is, the current accumulated offset value minus the previous accumulated offset value. Note that the accumulated offset value is essentially arbitrary; it represents the accumulated offset from the last time the offset was zeroed (with the Reset Offset Display key).</p> <p>Note that this command does not change the period of the trigger waveform. Note also that Offset is used only when the sync source is set to OFF, otherwise delay is used, see section "Trig Delay" on page 568.</p> <p>An increase in the "offset" parameter, either from the knob or the SCPI adjust command, serves to delay the timing of the trigger event.</p>
Notes	<p>When the SCPI command is sent the value shown on the key (and the Active Function, if this happens to be the active function) is updated with the new value. However, the actual amount sent to the hardware is the delta value, that is, the current accumulated offset value minus the previous accumulated offset value.</p> <p>The SCPI query simply returns the value currently showing on the key.</p>
Dependencies	The invalid data indicator turns on when the offset is changed, until the next sweep/measurement completes.
Couplings	The same offset is used in the Gate Source selection of the period timer.
Preset	0 s
State Saved	Saved in instrument state
Min	-10.000 s
Max	10.000 s
Default Unit	S
Initial S/W Revision	Prior to A.02.00

Offset Adjust (Remote Command Only)

This remote command does not work at all like the related front panel keys. This command lets you advance the phase of the frame trigger by the amount you specify.

It does not change the period of the trigger waveform. If the command is sent multiple times, it advances the phase of the frame trigger an additional amount each time it is sent. Negative numbers are permitted.

Remote Command	:TRIGger[:SEquence]:FRAMe:ADJust <time>
Example	TRIG:FRAM:ADJ 1.2 ms
Notes	Note also that Offset is used only when the sync source is set to OFF, otherwise delay is used, see section "Trig Delay" on page 568 An increase in the "offset" parameter, either from the knob or the SCPI adjust command, serves to delay the timing of the trigger event.
Notes	The front panel interface (for example, the knob) and the :TRIG:FRAM:OFFS command adjust the accumulated offset, which is shown on the active function display. However, the actual amount sent to the hardware is the delta value, that is, the current offset value minus the previous offset value. When the SCPI command is sent the value shown on the key (and the Active Function, if this happens to be the active function) is updated by increasing it (or decreasing it if the value sent is negative) by the amount specified in the SCPI command. This is a "command only" SCPI command, with no query.
Dependencies	The invalid data indicator turns on when the offset is changed, until the next sweep/measurement completes.
Couplings	The same offset is used in the Gate Source selection of the period timer.
Preset	0 s
State Saved	Saved in instrument state
Min	-10.000 s
Max	10.000 s
Default Unit	S
Initial S/W Revision	Prior to A.02.00

Reset Offset Display

Resets the value of the periodic trigger offset display setting to 0.0 seconds. The current displayed trigger location may include an offset value defined with the **Offset** key. Pressing this key redefines the currently displayed trigger location as the new trigger point that is 0.0 s offset. The **Offset** key can then be used to add offset relative to this new timing.

Key Path	Trigger, Periodic Timer
Remote Command	:TRIGger[:SEquence]:FRAMe:OFFSet:DISPlay:RESet
Example	TRIG:FRAM:OFFS:DISP:RES
Initial S/W Revision	Prior to A.02.00

Sync Source

Selects a signal source for you to synchronize your periodic timer trigger to, otherwise you are triggering at some arbitrary location in the frame. Synchronization reduces the precision requirements on the setting of the period.

For convenience you may adjust the level and slope of the selected sync source in a conditional branch setup menu accessed from the Sync Source menu. Note that these settings match those in the **Trigger** and **Gate Source** menus; that is, each trigger source has only one value of level and slope, regardless of which menu it is accessed from.

Key Path	Trigger, Periodic Timer
Remote Command	:TRIGger[:SEquence]:FRAMe:SYNC EXTerna11 EXTerna12 RFBurst PXI OFF :TRIGger[:SEquence]:FRAMe:SYNC?
Example	TRIG:FRAM:SYNC EXT2
Dependencies	In some models, there is no second External input. In these models, the External 2 key is blanked and the EXTerna12 parameter will generate a “Hardware missing; Not available for this model number” message. PXI trigger is only supported in PXI (modular) instruments.
Preset	Off GSM/EDGE, MSR,LTE,LTETDD: RFBurst
State Saved	Saved in instrument state
Readback	The current setting is read back to this key and it is also Readback to the previous Periodic Timer trigger key.
Backwards Compatibility SCPI	:TRIGger[:SEquence]:FRAMe:SYNC EXTerna1 For backward compatibility, the parameter EXTerna1 is mapped to EXTerna1
Initial S/W Revision	Prior to A.02.00
Modified at S/W Revision	A.03.00, A.14.00

Off

Turns off the sync source for your periodic trigger. With the sync source off, the timing will drift unless the signal source frequency is locked to the analyzer frequency reference.

Key Path	Trigger, Periodic Timer, Sync Source
Example	TRIG:FRAM:SYNC OFF
Readback	Off
Initial S/W Revision	Prior to A.02.00

External 1

Pressing this key, when it is not selected, selects an external input signal as the trigger. A new sweep/measurement will start when the external trigger condition is met using the external 1 input connector on the rear panel.

Pressing this key, when it is already selected, accesses the external 1 trigger setup menu.

Key Path	Trigger
Example	TRIG:SOUR EXT1 Swept SA measurement TRIG:<meas>:SOUR EXT1 Measurements other than Swept SA
Dependencies	Grayed out if in use by Point Trigger in the Source Setup menu. Forced to Free Run if already selected and Point Trigger is set to External 1.
State Saved	Saved in instrument state
Status Bits/OPC dependencies	The Status Operation Register bit 5 "Waiting for Trigger" is set at the same time as the Sweeping or Measuring bit is set. It is cleared when the trigger actually occurs (that is, after the trigger event occurs and all the applicable trigger criteria have been met). A corresponding pop-up message ("Waiting for trigger") is generated if no trigger signal appears after approximately 2 sec. This message goes away when a trigger signal appears.
Initial S/W Revision	Prior to A.02.00

Trigger Level

Sets the value where the external 1 trigger input will trigger a new sweep/measurement.

Key Path	Trigger, External 1
Remote Command	:TRIGger[:SEquence]:EXTernal1:LEVel <level> :TRIGger[:SEquence]:EXTernal1:LEVel?
Example	TRIG:EXT1:LEV 0.4 V
Couplings	This same level is used for the Ext1 trigger source in the Trigger menu, for the Ext1 selection in the Periodic Timer sync source (in the Trigger menu and in the Gate Source menu), and also for the Ext1 selection in the Gate Source menu.
Preset	1.2 V
State Saved	Saved in instrument state
Min	-5 V
Max	5 V
Default Unit	V
Backwards Compatibility SCPI	:TRIGger[:SEquence]:EXTernal:LEVel For backward compatibility, the parameter EXTernal is mapped to EXTernal1
Backwards Compatibility SCPI	:TRIGger[:SEquence]:FRAME:EXTernal1:LEVel
Initial S/W Revision	Prior to A.02.00

Trig Slope

Controls the trigger polarity. It is set positive to trigger on a rising edge and negative to trigger on a falling edge.

Key Path	Trigger, External 1
Remote Command	:TRIGger[:SEquence]:EXTernal1:SLOPe POSitive NEGative

	:TRIGger[:SEQuence]:EXTernal1:SLOPe?
Example	TRIG:EXT1:SLOP NEG
Couplings	This same slope is used in the Ext1 selection for the trigger source in the Trigger menu and for the period timer sync source (in the Trigger menu and in the Gate Source menu).
Preset	POSitive
State Saved	Saved in instrument state
Backwards Compatibility SCPI	:TRIGger[:SEQuence]:EXTernal:SLOPe For backward compatibility, the parameter EXTernal is mapped to EXTernal1
Backwards Compatibility SCPI	:TRIGger[:SEQuence]:FRAME:EXTernal1:SLOPe
Backwards Compatibility Notes	The legacy :TRIGger[:SEQuence]:SLOPe command affects the slopes for the VID, LINE, EXT1, EXT2, and RFB triggers.
Initial S/W Revision	Prior to A.02.00

External 2

Pressing this key, when it is not selected, selects an external input signal as the trigger. A new sweep/measurement will start when the external trigger condition is met using the external 2 input connector. The external trigger 2 input connector is on the rear panel.

Pressing this key, when it is already selected, accesses the external 2 trigger setup menu.

Key Path	Trigger
Example	TRIG:SOUR EXT2 Swept SA measurement TRIG:<meas>:SOUR EXT2 Measurements other than Swept SA
Dependencies	In some models, there is no second External input. In these models, the External 2 key is blanked and the EXTernal2 parameter will generate a "Hardware missing; Not available for this model number" message. Grayed out if in use by Point Trigger in the Source Setup menu. Forced to Free Run if already selected and Point Trigger is set to External 2.
State Saved	Saved in instrument state
Status Bits/OPC dependencies	The Status Operation Register bit 5 "Waiting for Trigger" is set at the same time as the Sweeping or Measuring bit is set. It is cleared when the trigger actually occurs (that is, after the trigger event occurs and all the applicable trigger criteria have been met). A corresponding pop-up message ("Waiting for trigger") is generated if no trigger signal appears after approximately 2 sec. This message goes away when a trigger signal appears.
Initial S/W Revision	Prior to A.02.00
Modified at S/W Revision	A.03.00

Trigger Level

Sets the value where the external 2 trigger input will trigger a new sweep/measurement.

Key Path	Trigger, External 2
Remote Command	:TRIGger[:SEquence]:EXTernal2:LEVel :TRIGger[:SEquence]:EXTernal2:LEVel?
Example	TRIG:EXT2:LEV 1.1 V
Couplings	This same level is used for the Ext2 trigger source in the Trigger menu, for the Ext2 selection in the Periodic Timer sync source (in the Trigger menu and in the Gate Source menu), and also for the Ext2 selection in the Gate Source menu.
Preset	1.2 V
State Saved	Saved in instrument state
Min	-5 V
Max	5 V
Default Unit	V
Backwards Compatibility SCPI	:TRIGger[:SEquence]:FRAME:EXTernal2:LEVel
Initial S/W Revision	Prior to A.02.00

Trig Slope

Controls the trigger polarity. It is set positive to trigger on a rising edge and negative to trigger on a falling edge.

Key Path	Trigger, External 2
Remote Command	:TRIGger[:SEquence]:EXTernal2:SLOPe POSitive NEGative :TRIGger[:SEquence]:EXTernal2:SLOPe?
Example	TRIG:EXT2:SLOP NEG
Couplings	This same slope is used in the Ext2 selection for the trigger source in the Trigger menu and for the period timer sync source (in the Trigger menu and in the Gate Source menu).
Preset	POSitive
State Saved	Saved in instrument state
Backwards Compatibility SCPI	:TRIGger[:SEquence]:FRAME:EXTernal2:SLOPe
Backwards Compatibility Notes	The legacy :TRIGger[:SEquence]:SLOPe command affects the slopes for the VID, LINE, EXT1, EXT2, and RFB triggers.
Initial S/W Revision	Prior to A.02.00

RF Burst

Pressing this key, when it is not selected, selects the RF Burst as the trigger. A new sweep/measurement will start when an RF burst envelope signal is identified from the signal at the RF Input connector. Pressing this key, when it is already selected, accesses the RF Burst trigger setup menu.

In some models, a variety of burst trigger circuitry is available, resulting in various available burst trigger bandwidths. The analyzer automatically chooses the

appropriate trigger path based on the hardware configuration and other settings of the analyzer.

Key Path	Trigger
Example	TRIG:SOUR RFB Swept SA measurement TRIG:<meas>:SOUR RFB Measurements other than Swept SA
State Saved	Saved in instrument state
Status Bits/OPC dependencies	The Status Operation Register bit 5 "Waiting for Trigger" is set at the same time as the Sweeping or Measuring bit is set. It is cleared when the trigger actually occurs (that is, after the trigger event occurs and all the applicable trigger criteria have been met). A corresponding pop-up message ("Waiting for trigger") is generated if no trigger signal appears after approximately 2 sec. This message goes away when a trigger signal appears.
Backwards Compatibility Notes	The legacy command: :TRIGger[:SEQuence]:RFBurst:FSElectivity[:STATe] OFF ON 0 1 is not supported in the X-Series, as the hardware to do Frequency Selective burst triggers does not exist in X-Series.
Initial S/W Revision	Prior to A.02.00
Modified at S/W Revision	A.04.00

Absolute Trigger Level

Sets the absolute trigger level for the RF burst envelope.

When using the External Mixing path, the Absolute Trigger Level is uncalibrated because the factory default was set to accommodate the expected IF levels for the RF path.

Key Path	Trigger, RF Burst
Scope	Meas Global
Remote Command	:TRIGger[:SEQuence]:RFBurst:LEVel:ABSolute <ampl> :TRIGger[:SEQuence]:RFBurst:LEVel:ABSolute?
Example	TRIG:RFB:LEV:ABS 10 dBm sets the trigger level of the RF burst envelope signal to the absolute level of 10 dBm
Notes	Sending this command does not switch the setting from relative to absolute; to switch it you need to send the :TRIGger[:SEQuence]:RFBurst:LEVel:TYPE command, below. Amplitude Corrections are not taken into account by the Absolute Trigger Level. For example, if you have given yourself effective gain with an amplitude correction factor, the Absolute Trigger will not fire until you have set the trigger level that far below the displayed signal level, rather than simply to the displayed signal level. This is only true for Amplitude Corrections, not External Gain or Ref Level Offset functions. If mode is Bluetooth, the default value is -50 dBm.
Couplings	This same level is used for the RF Burst trigger source in the Trigger menu, for the RF Burst selection in the Periodic Timer sync source (in the Trigger menu and in the Gate Source menu), and also for the RF Burst selection in the Gate Source menu
Preset	-20 dBm

State Saved	Saved in instrument state
Min	-200 dBm
Max	100 dBm
Default Unit	depends on the current selected Y-Axis unit
Backwards Compatibility SCPI	:TRIGger[:SEquence]:FRAMe:RFBurst:LEVel:ABSolute
Initial S/W Revision	Prior to A.02.00
Modified at S/W Revision	A.04.00

Key Path	Trigger, RF Burst
Remote Command	:TRIGger[:SEquence]:RFBurst:LEVel:TYPE ABSolute RELative :TRIGger[:SEquence]:RFBurst:LEVel:TYPE?
Example	TRIG:RFB:LEV:TYPE REL sets the trigger level type of the RF burst trigger to Relative.
Preset	ABSolute
State Saved	Saved in instrument state
Initial S/W Revision	Prior to A.02.00
Modified at S/W Revision	A.04.00

Relative Trigger Level

Sets the relative trigger level for the RF burst envelope.

In some models, the relative burst trigger function is implemented in hardware. In other models, without the advanced triggering hardware required, the relative burst trigger function is implemented in software in some measurements, and is unavailable in other measurements.

When implemented in software, the relative RF Burst trigger function is implemented as follows:

5. The measurement starts with the absolute RF Burst trigger setting. If it cannot get a trigger with that level, auto trigger fires and the acquisition starts anyway. After the acquisition, the measurement searches for the peak in the acquired waveform and saves it.
6. Now, in the next cycle of the measurement, the measurement determines a new absolute RF Burst level based on the peak value from the first measurement and the Relative RF Burst Trigger Level (always 0 or negative dB) set by the user. The following formula is used:

7. absolute RF Burst level = peak level of the previous acquisition + relative RF Burst level
8. If the new absolute RF Burst level differs from the previous by more than 0.5 dB, the new level is sent to the hardware; otherwise it is not updated (to avoid slowing down the acquisition)

Steps 2 and 3 repeat for subsequent measurements.

Key Path	Trigger, RF Burst
Scope	Meas Global
Remote Command	:TRIGger[:SEquence]:RFBurst:LEVel:RELative <rel_amp1> :TRIGger[:SEquence]:RFBurst:LEVel:RELative?
Example	TRIG:RFB:LEV:REL -10 dB sets the trigger level of the RF burst envelope signal to the relative level of -10 dB
Notes	Sending this command does not switch the setting from absolute to relative; to switch it you need to send the :TRIGger[:SEquence]:RFBurst:LEVel:TYPE command, above. The relative trigger level is not available in some measurements. In those measurements the RELative parameter, and the :TRIGger[:SEquence]:RFBurst:LEVel:TYPE command (above), will generate an error if sent.
Dependencies	This key is grayed out and Absolute Trigger Level selected if the required hardware is not present in your analyzer and the current measurement does not support Relative triggering.
Preset	-6 dB GSM: -25 dB
State Saved	Saved in instrument state
Min	-45 dB
Max	0 dB
Default Unit	dB or dBc
Backwards Compatibility SCPI	:TRIGger[:SEquence]:RFBurst:LEVel This legacy command is aliased to :TRIGger[:SEquence]:RFBurst:LEVel:RELative because the PSA had ONLY relative burst triggering
Initial S/W Revision	Prior to A.02.00
Modified at S/W Revision	A.04.00

Trigger Slope

It is set positive to trigger on a rising edge and negative to trigger on a falling edge.

Key Path	Trigger, RF Burst
Remote Command	:TRIGger[:SEquence]:RFBurst:SLOPe POSitive NEGative :TRIGger[:SEquence]:RFBurst:SLOPe?
Example	TRIG:RFB:SLOP NEG

Couplings	This same slope is used in the RF Burst selection for the trigger source in the Trigger menu and for the period timer sync source (in the Trigger menu and in the Gate Source menu).
Preset	POSitive
State Saved	Saved in instrument state
Backwards Compatibility SCPI	:TRIGger[:SEquence]:FRAME:RFBurst:SLOPe
Backwards Compatibility Notes	The legacy :TRIGger[:SEquence]:SLOPe command affects the slopes for the VID, LINE, EXT1, EXT2, and RFB triggers.
Initial S/W Revision	Prior to A.02.00

Zero Span Delay Comp On/Off

In zero span, there is a natural delay in the signal path, which comes from the RBW filter. This is usually desirable, as it allows you to trigger on events and also see those events, because the signal is delayed from the trigger event. However, in some cases it is desirable to eliminate this delay, so that trigger events line up exactly with the zero time point in zero span. You can use the **Zero Span Delay Comp On/Off** feature to enable or disable zero span delay compensation.

Key Path	Trigger, RF Burst
Remote Command	:TRIGger[:SEquence]:RFBurst:DELay:COMPensation OFF ON 0 1 :TRIGger[:SEquence]:RFBurst:DELay:COMPensation?
Example	TRIG:RFB:DEL:COMP ON
Dependencies	No effect except in zero-span, but not locked out in nonzero spans. Blanked in modes that do not support zero-span measurements. If the SCPI command is sent when the key is blanked, an error is returned: -221, "Settings conflict; Feature not supported for this measurement" In analyzers shipping N9060A, this feature requires N9060A-7FP.
Preset	OFF
State Saved	Saved in instrument state
Initial S/W Revision	A.11.00

Trig Delay

This setting delays the measurement timing relative to the Periodic Timer.

Key Path	Trigger, Periodic Timer
Remote Command	:TRIGger[:SEquence]:FRAME:DELay <time> :TRIGger[:SEquence]:FRAME:DELay? :TRIGger[:SEquence]:FRAME:DELay:STATE OFF ON 0 1 :TRIGger[:SEquence]:FRAME:DELay:STATE?
Notes	Note that delay is used when the sync source is not set to OFF. If the sync source is set to OFF, offset is used.

Preset	Off, 1.000 us
State Saved	Saved in instrument state
Min	-150 ms
Max	+500 ms
Default Unit	s
Initial S/W Revision	Prior to A.02.00

X Axis Relative to Trigger

For triggers that support Trigger Delay it is beneficial that in time-domain displays (like Zero Span), X-axis values should be referenced to the Trigger point, that is, the zero value on the X Axis should be wherever the trigger point appears on the X Axis (including to the left or right of the X Axis). For negative trigger delays this means the zero point can actually appear on the X Axis.

Traditionally the zero point is at the left edge of the X Axis, and this behavior is retained for backwards compatibility, but if you turn on **X Axis Relative to Trigger**, the zero point moves to the trigger point and all X Axis values change to be relative to the trigger point.

When the **X Axis Relative to Trigger** switch is On, the trigger point on the X-axis will be marked with a vertical line and an annotation of “TRIG”. Additionally, when the switch is On, values which are tied to the X-axis, such as trace data and markers, will have their X values adjusted to be referenced to the trigger point.

The switch is grayed out and Off unless the measurement is a time domain measurement; thus, in Swept SA it is grayed out unless in Zero Span.

Key Path	Trigger, Trigger
Remote Command	:TRIGger[:SEquence]:XRElative ON OFF 1 0 :TRIGger[:SEquence]:XRElative?
Example	TRIG:XREL ON
Notes	Although shown in all Trigger menus that have Trig Delay, the function is global to all of them and has the same value in all.
Dependencies	Grayed out unless in Zero Span. When grayed out, shows as Off. Non-forceful grayout, no error if SCPI sent while grayed out.
Preset	Off
State Saved	Saved in instrument state.
Initial S/W Revision	Prior to A.18.00
Control Type	Toggle

Sync Holdoff

Sync Holdoff specifies the duration that the sync source signal must be kept false before the transition to true to be recognized as the sync timing. The periodic timer phase is aligned when the sync source signal becomes true, after the Holdoff time is satisfied.

A holdoff of 2 ms will work with most WiMAX signals, but there may be cases where the burst off duration is less than 1 ms and this value will need to be changed.

Key Path	Trigger, Periodic Timer
Remote Command	:TRIGger[:SEquence]:FRAMe:SYNC:HOLDoff <time> :TRIGger[:SEquence]:FRAMe:SYNC:HOLDoff? :TRIGger[:SEquence]:FRAMe:SYNC:HOLDoff:STATe OFF ON 0 1 :TRIGger[:SEquence]:FRAMe:SYNC:HOLDoff:STATe?
Preset	On, 1.000 ms
State Saved	Saved in instrument state
Min	0 ms
Max	+500 ms
Default Unit	s
Initial S/W Revision	Prior to A.02.00

Baseband I/Q

Pressing this key when it is not selected selects Baseband I/Q as the trigger. Pressing the key when it is already selected accesses the Baseband I/Q trigger type selection menu. The key is annotated to display which of the Baseband I/Q trigger types is currently selected.

Key Path	Trigger
State Saved	Saved in instrument state
Readback	The Baseband I/Q trigger source that becomes active when this key is selected is displayed. The possible values are "I/Q Mag", "I", "Q", "Input I", "Input Q", and "Aux I/Q Mag".
Initial S/W Revision	Prior to A.02.00

I/Q Mag

Pressing this key, when it is not selected, selects the I/Q magnitude signal as the trigger. The I/Q Magnitude trigger condition is met when the I/Q magnitude crosses the I/Q magnitude trigger level. The magnitude is measured at the output of the main I/Q digital receiver.

Key Path	Trigger, Baseband I/Q
Example	TRIG:<meas>:SOUR IQM
Readback Text	I/Q Mag
Initial S/W Revision	Prior to A.02.00

Trigger Level

Sets a level for the I/Q magnitude trigger. When the signal crosses this level, with the chosen slope, the trigger occurs. If the specific Measurement displays the signal

from the chosen sampling point a green line will be displayed to indicate the trigger level.

Key Path	Trigger, Baseband I/Q, I/Q Mag
Remote Command	:TRIGger[:SEquence]:IQMag:LEVEl <amp1 > :TRIGger[:SEquence]:IQMag:LEVEl?
Example	TRIG:IQM:LEV -30 dBm
Notes	The I/Q reference impedance is used for converting between power and voltage.
Preset	-25 dBm
State Saved	Saved in instrument state
Range	-200 dBm to 100 dBm
Min	-200 dBm
Max	100 dBm
Readback Text	<level> dBm
Initial S/W Revision	Prior to A.02.00

Trig Slope

Controls the trigger polarity. It is set positive to trigger on a rising edge and negative to trigger on a falling edge.

Key Path	Trigger, Baseband I/Q, I/Q Mag
Remote Command	:TRIGger[:SEquence]:IQMag:SLOPe POSitive NEGative :TRIGger[:SEquence]:IQMag:SLOPe?
Example	TRIG:IQM:SLOP POS
Preset	POSitive
State Saved	Saved in instrument state
Initial S/W Revision	Prior to A.02.00

Trig Delay

Controls a time delay during which the analyzer will wait to begin a sweep after meeting the trigger criteria. You can use negative delay to pre-trigger the instrument in time domain or FFT.

Key Path	Trigger, Baseband I/Q, I/Q Mag
Remote Command	:TRIGger[:SEquence]:IQMag:DELay <time> :TRIGger[:SEquence]:IQMag:DELay? :TRIGger[:SEquence]:IQMag:DELay:STATe OFF ON 0 1 :TRIGger[:SEquence]:IQMag:DELay:STATe?
Example	TRIG:IQM:DEL 10 ms TRIG:IQM:DEL:STAT ON
Preset	1 us

	OFF
State Saved	Saved in instrument state
Range	-2.5 s to +10 s
Min	-2.5 s
Max	+10 s
Initial S/W Revision	Prior to A.02.00

X Axis Relative to Trigger

For triggers that support Trigger Delay it is beneficial that in time-domain displays (like Zero Span), X-axis values should be referenced to the Trigger point, that is, the zero value on the X Axis should be wherever the trigger point appears on the X Axis (including to the left or right of the X Axis). For negative trigger delays this means the zero point can actually appear on the X Axis.

Traditionally the zero point is at the left edge of the X Axis, and this behavior is retained for backwards compatibility, but if you turn on **X Axis Relative to Trigger**, the zero point moves to the trigger point and all X Axis values change to be relative to the trigger point.

When the **X Axis Relative to Trigger** switch is On, the trigger point on the X-axis will be marked with a vertical line and an annotation of "TRIG". Additionally, when the switch is On, values which are tied to the X-axis, such as trace data and markers, will have their X values adjusted to be referenced to the trigger point.

The switch is grayed out and Off unless the measurement is a time domain measurement; thus, in Swept SA it is grayed out unless in Zero Span.

Key Path	Trigger, Trigger
Remote Command	:TRIGger[:SEquence]:XRELative ON OFF 1 0 :TRIGger[:SEquence]:XRELative?
Example	TRIG:XREL ON
Notes	Although shown in all Trigger menus that have Trig Delay, the function is global to all of them and has the same value in all.
Dependencies	Grayed out unless in Zero Span. When grayed out, shows as Off. Non-forceful grayout, no error if SCPI sent while grayed out.
Preset	Off
State Saved	Saved in instrument state.
Initial S/W Revision	Prior to A.18.00
Control Type	Toggle

I (Demodulated)

Pressing this key, when it is not selected, selects the main receiver's output I voltage as the trigger. The I (Demodulated) trigger condition is met when the I voltage crosses the I voltage trigger level.

Key Path	Trigger, Baseband I/Q
Example	TRIG:<meas>:SOUR IDEM
Readback Text	I
Initial S/W Revision	Prior to A.02.00

Trigger Level

Sets a level for the I (Demodulated) trigger. When the signal crosses this level, with the chosen slope, the trigger occurs. If the specific Measurement displays the signal from the chosen sampling point a green line will be displayed to indicate the trigger level.

Key Path	Trigger, Baseband I/Q, I (Demodulated)
Remote Command	:TRIGger[:SEquence]:IDEMod:LEVEl <voltage> :TRIGger[:SEquence]:IDEMod:LEVEl?
Example	TRIG:IDEM:LEV 0.5 V
Preset	0.25 V
State Saved	Saved in instrument state
Range	-1 to 1 V
Min	-1 V
Max	1 V
Readback Text	0.1 of displayed unit (V, mV, etc.)
Initial S/W Revision	Prior to A.02.00

Trig Slope

Controls the trigger polarity. It is set positive to trigger on a rising edge and negative to trigger on a falling edge.

Key Path	Trigger, Baseband I/Q, I (Demodulated)
Remote Command	:TRIGger[:SEquence]:IDEMod:SLOPe POSitive NEGative :TRIGger[:SEquence]:IDEMod:SLOPe?
Example	TRIG:IDEM:SLOP POS
Preset	POSitive
State Saved	Saved in instrument state
Initial S/W Revision	Prior to A.02.00

Trig Delay

Controls a time delay during which the analyzer will wait to begin a sweep after meeting the trigger criteria. You can use negative delay to pre-trigger the instrument in time domain or FFT.

Key Path	Trigger, Baseband I/Q, I (Demodulated)
Remote Command	:TRIGger[:SEquence]:IDEMod:DELay <time> :TRIGger[:SEquence]:IDEMod:DELay? :TRIGger[:SEquence]:IDEMod:DELay:STATe OFF ON 0 1 :TRIGger[:SEquence]:IDEMod:DELay:STATe?
Example	TRIG:IDEM:DEL 10 ms TRIG:IDEM:DEL:STAT ON
Preset	1 us OFF
State Saved	Saved in instrument state
Range	-2.5 s to +10 s
Min	-2.5 s
Max	+10 s
Initial S/W Revision	Prior to A.02.00

X Axis Relative to Trigger

For triggers that support Trigger Delay it is beneficial that in time-domain displays (like Zero Span), X-axis values should be referenced to the Trigger point, that is, the zero value on the X Axis should be wherever the trigger point appears on the X Axis (including to the left or right of the X Axis). For negative trigger delays this means the zero point can actually appear on the X Axis.

Traditionally the zero point is at the left edge of the X Axis, and this behavior is retained for backwards compatibility, but if you turn on **X Axis Relative to Trigger**, the zero point moves to the trigger point and all X Axis values change to be relative to the trigger point.

When the **X Axis Relative to Trigger** switch is On, the trigger point on the X-axis will be marked with a vertical line and an annotation of "TRIG". Additionally, when the switch is On, values which are tied to the X-axis, such as trace data and markers, will have their X values adjusted to be referenced to the trigger point.

The switch is grayed out and Off unless the measurement is a time domain measurement; thus, in Swept SA it is grayed out unless in Zero Span.

Key Path	Trigger, Trigger
Remote Command	:TRIGger[:SEquence]:XRELative ON OFF 1 0 :TRIGger[:SEquence]:XRELative?
Example	TRIG:XREL ON
Notes	Although shown in all Trigger menus that have Trig Delay, the function is global to all of them and has the same value in all.
Dependencies	Grayed out unless in Zero Span. When grayed out, shows as Off. Non-forceful grayout, no error if SCPI sent while grayed out.

Preset	Off
State Saved	Saved in instrument state.
Initial S/W Revision	Prior to A.18.00
Control Type	Toggle

Q (Demodulated)

Pressing this key, when it is not selected, selects the main receiver's output Q voltage as the trigger. The Q (Demodulated) trigger condition is met when the Q voltage crosses the Q voltage trigger level.

Key Path	Trigger, Baseband I/Q
Example	TRIG:<meas>:SOUR QDEM
Readback Text	Q
Initial S/W Revision	Prior to A.02.00

Trigger Level

Sets a level for the Q (Demodulated) trigger. When the signal crosses this level, with the chosen slope, the trigger occurs. If the specific Measurement displays the signal from the chosen sampling point a green line will be displayed to indicate the trigger level.

Key Path	Trigger, Baseband I/Q, Q (Demodulated)
Remote Command	:TRIGger[:SEquence]:QDEMod:LEVEl <voltage> :TRIGger[:SEquence]:QDEMod:LEVEl?
Example	TRIG:QDEM:LEV 0.5 V
Preset	0.25 V
State Saved	Saved in instrument state
Range	-1 to 1 V
Min	-1 V
Max	1 V
Readback Text	0.1 of displayed unit (V, mV, etc.)
Initial S/W Revision	Prior to A.02.00

Trig Slope

Controls the trigger polarity. It is set positive to trigger on a rising edge and negative to trigger on a falling edge.

Key Path	Trigger, Baseband I/Q, Q (Demodulated)
Remote Command	:TRIGger[:SEquence]:QDEMod:SLOPe POSitive NEGative :TRIGger[:SEquence]:QDEMod:SLOPe?
Example	TRIG:QDEM:SLOP POS

Preset	POSitive
State Saved	Saved in instrument state
Initial S/W Revision	Prior to A.02.00

Trig Delay

Controls a time delay during which the analyzer will wait to begin a sweep after meeting the trigger criteria. You can use negative delay to pre-trigger the instrument in time domain or FFT.

Key Path	Trigger, Baseband I/Q, Q (Demodulated)
Remote Command	:TRIGger[:SEquence]:QDEMod:DELay <time> :TRIGger[:SEquence]:QDEMod:DELay? :TRIGger[:SEquence]:QDEMod:DELay:STATe OFF ON 0 1 :TRIGger[:SEquence]:QDEMod:DELay:STATe?
Example	TRIG:QDEM:DEL 10 ms TRIG:QDEM:DEL:STAT ON
Preset	1 us OFF
State Saved	Saved in instrument state
Range	-2.5 s to +10 s
Min	-2.5 s
Max	+10 s
Initial S/W Revision	Prior to A.02.00

X Axis Relative to Trigger

For triggers that support Trigger Delay it is beneficial that in time-domain displays (like Zero Span), X-axis values should be referenced to the Trigger point, that is, the zero value on the X Axis should be wherever the trigger point appears on the X Axis (including to the left or right of the X Axis). For negative trigger delays this means the zero point can actually appear on the X Axis.

Traditionally the zero point is at the left edge of the X Axis, and this behavior is retained for backwards compatibility, but if you turn on **X Axis Relative to Trigger**, the zero point moves to the trigger point and all X Axis values change to be relative to the trigger point.

When the **X Axis Relative to Trigger** switch is On, the trigger point on the X-axis will be marked with a vertical line and an annotation of "TRIG". Additionally, when the switch is On, values which are tied to the X-axis, such as trace data and markers, will have their X values adjusted to be referenced to the trigger point.

The switch is grayed out and Off unless the measurement is a time domain measurement; thus, in Swept SA it is grayed out unless in Zero Span.

Key Path	Trigger, Trigger
Remote Command	:TRIGger[:SEquence]:XRELative ON OFF 1 0 :TRIGger[:SEquence]:XRELative?
Example	TRIG:XREL ON
Notes	Although shown in all Trigger menus that have Trig Delay, the function is global to all of them and has the same value in all.
Dependencies	Grayed out unless in Zero Span. When grayed out, shows as Off. Non-forceful grayout, no error if SCPI sent while grayed out.
Preset	Off
State Saved	Saved in instrument state.
Initial S/W Revision	Prior to A.18.00
Control Type	Toggle

Input I

Pressing this key, when it is not selected, selects the I channel's ADC voltage as the trigger. The Input I trigger condition is met when the voltage crosses the trigger level.

Key Path	Trigger, Baseband I/Q
Example	TRIG:<meas>:SOUR IINP
Readback Text	Input I
Initial S/W Revision	Prior to A.02.00

Trigger Level

Sets a level for the Input I trigger. When the signal crosses this level, with the chosen slope, the trigger occurs.

Key Path	Trigger, Baseband I/Q, Input I
Remote Command	:TRIGger[:SEquence]:IINPut:LEVel <voltage> :TRIGger[:SEquence]:IINPut:LEVel?
Example	TRIG:IINP:LEV 0.5 V
Preset	0.25 V
State Saved	Saved in instrument state
Range	-1 to 1 V
Min	-1 V
Max	1 V
Readback Text	0.1 of displayed unit (V, mV, etc.)
Initial S/W Revision	Prior to A.02.00

Trig Slope

Controls the trigger polarity. It is set positive to trigger on a rising edge and negative to trigger on a falling edge.

Key Path	Trigger, Baseband I/Q, Input I
Remote Command	:TRIGger[:SEQuence]:IINPut:SLOPe POSitive NEGative :TRIGger[:SEQuence]:IINPut:SLOPe?
Example	TRIG:IINP:SLOP POS
Preset	POSitive
State Saved	Saved in instrument state
Initial S/W Revision	Prior to A.02.00

Trig Delay

Controls a time delay during which the analyzer will wait to begin a sweep after meeting the trigger criteria. You can use negative delay to pre-trigger the instrument in time domain or FFT.

Key Path	Trigger, Baseband I/Q, Input I
Remote Command	:TRIGger[:SEQuence]:IINPut:DELay <time> :TRIGger[:SEQuence]:IINPut:DELay? :TRIGger[:SEQuence]:IINPut:DELay:STATe OFF ON 0 1 :TRIGger[:SEQuence]:IINPut:DELay:STATe?
Example	TRIG:IINP:DEL 10 ms TRIG:IINP:DEL:STAT ON
Preset	1 us OFF
State Saved	Saved in instrument state
Range	-2.5 s to +10 s
Min	-2.5 s
Max	+10 s
Initial S/W Revision	Prior to A.02.00

X Axis Relative to Trigger

For triggers that support Trigger Delay it is beneficial that in time-domain displays (like Zero Span), X-axis values should be referenced to the Trigger point, that is, the zero value on the X Axis should be wherever the trigger point appears on the X Axis (including to the left or right of the X Axis). For negative trigger delays this means the zero point can actually appear on the X Axis.

Traditionally the zero point is at the left edge of the X Axis, and this behavior is retained for backwards compatibility, but if you turn on **X Axis Relative to Trigger**, the

zero point moves to the trigger point and all X Axis values change to be relative to the trigger point.

When the **X Axis Relative to Trigger** switch is On, the trigger point on the X-axis will be marked with a vertical line and an annotation of "TRIG". Additionally, when the switch is On, values which are tied to the X-axis, such as trace data and markers, will have their X values adjusted to be referenced to the trigger point.

The switch is grayed out and Off unless the measurement is a time domain measurement; thus, in Swept SA it is grayed out unless in Zero Span.

Key Path	Trigger, Trigger
Remote Command	:TRIGger[:SEquence]:XRELative ON OFF 1 0 :TRIGger[:SEquence]:XRELative?
Example	TRIG:XREL ON
Notes	Although shown in all Trigger menus that have Trig Delay, the function is global to all of them and has the same value in all.
Dependencies	Grayed out unless in Zero Span. When grayed out, shows as Off. Non-forceful grayout, no error if SCPI sent while grayed out.
Preset	Off
State Saved	Saved in instrument state.
Initial S/W Revision	Prior to A.18.00
Control Type	Toggle

Input Q

Pressing this key, when it is not selected, selects the Q channel's ADC voltage as the trigger. The Input Q trigger condition is met when the voltage crosses the trigger level.

Key Path	Trigger, Baseband I/Q
Example	TRIG:<meas>:SOUR QINP
Readback Text	Input Q
Initial S/W Revision	Prior to A.02.00

Trigger Level

Sets a level for the Input Q trigger. When the signal crosses this level, with the chosen slope, the trigger occurs.

Key Path	Trigger, Baseband I/Q, Input Q
Remote Command	:TRIGger[:SEquence]:QINPut:LEVel <voltage> :TRIGger[:SEquence]:QINPut:LEVel?
Example	TRIG:QINP:LEV 0.5 V
Preset	0.25 V
State Saved	Saved in instrument state

Range	-1 to 1 V
Min	-1 V
Max	1 V
Readback Text	0.1 of displayed unit (V, mV, etc.)
Initial S/W Revision	Prior to A.02.00

Trig Slope

Controls the trigger polarity. It is set positive to trigger on a rising edge and negative to trigger on a falling edge.

Key Path	Trigger, Baseband I/Q, Input Q
Remote Command	:TRIGger[:SEquence]:QINPut:SLOPe POSitive NEGative :TRIGger[:SEquence]:QINPut:SLOPe?
Example	TRIG:QINP:SLOP POS
Preset	POSitive
State Saved	Saved in instrument state
Initial S/W Revision	Prior to A.02.00

Trig Delay

Controls a time delay during which the analyzer will wait to begin a sweep after meeting the trigger criteria. You can use negative delay to pre-trigger the instrument in time domain or FFT.

Key Path	Trigger, Baseband I/Q, Input Q
Remote Command	:TRIGger[:SEquence]:QINPut:DELay <time> :TRIGger[:SEquence]:QINPut:DELay? :TRIGger[:SEquence]:QINPut:DELay:STATe OFF ON 0 1 :TRIGger[:SEquence]:QINPut:DELay:STATe?
Example	TRIG:QINP:DEL 10 ms TRIG:QINP:DEL:STAT ON
Preset	1 us OFF
State Saved	Saved in instrument state
Range	-2.5 s to +10 s
Min	-2.5 s
Max	+10 s
Initial S/W Revision	Prior to A.02.00

X Axis Relative to Trigger

For triggers that support Trigger Delay it is beneficial that in time-domain displays (like Zero Span), X-axis values should be referenced to the Trigger point, that is, the zero value on the X Axis should be wherever the trigger point appears on the X Axis (including to the left or right of the X Axis). For negative trigger delays this means the zero point can actually appear on the X Axis.

Traditionally the zero point is at the left edge of the X Axis, and this behavior is retained for backwards compatibility, but if you turn on **X Axis Relative to Trigger**, the zero point moves to the trigger point and all X Axis values change to be relative to the trigger point.

When the **X Axis Relative to Trigger** switch is On, the trigger point on the X-axis will be marked with a vertical line and an annotation of "TRIG". Additionally, when the switch is On, values which are tied to the X-axis, such as trace data and markers, will have their X values adjusted to be referenced to the trigger point.

The switch is grayed out and Off unless the measurement is a time domain measurement; thus, in Swept SA it is grayed out unless in Zero Span.

Key Path	Trigger, Trigger
Remote Command	:TRIGger[:SEquence]:XRELative ON OFF 1 0 :TRIGger[:SEquence]:XRELative?
Example	TRIG:XREL ON
Notes	Although shown in all Trigger menus that have Trig Delay, the function is global to all of them and has the same value in all.
Dependencies	Grayed out unless in Zero Span. When grayed out, shows as Off. Non-forceful grayout, no error if SCPI sent while grayed out.
Preset	Off
State Saved	Saved in instrument state.
Initial S/W Revision	Prior to A.18.00
Control Type	Toggle

Auxiliary Channel I/Q Mag

Pressing this key, when it is not selected, selects the Auxiliary Channel I/Q magnitude signal as the trigger. The Auxiliary Channel I/Q Magnitude trigger condition is met when the auxiliary receiver's I/Q magnitude output crosses the Auxiliary I/Q magnitude trigger level.

Key Path	Trigger, Baseband I/Q
Example	TRIG:<meas>:SOUR AIQM
Readback Text	Aux I/Q Mag
Initial S/W Revision	Prior to A.02.00

Trigger Level

Sets a level for the I/Q magnitude trigger. When the signal crosses this level, with the chosen slope, the trigger occurs.

Key Path	Trigger, Baseband I/Q, Aux Channel I/Q Mag
Remote Command	:TRIGger[:SEquence]:AIQMag:LEVel <amp1 > :TRIGger[:SEquence]:AIQMag:LEVel?
Example	TRIG:AIQM:LEV -30 dBm
Notes	The I/Q reference impedance is used for converting between power and voltage.
Preset	-25 dBm
State Saved	Saved in instrument state
Range	-200 dBm to 100 dBm
Min	-200 dBm
Max	100 dBm
Readback Text	<level> dBm
Initial S/W Revision	Prior to A.02.00

Trig Slope

Controls the trigger polarity. It is set positive to trigger on a rising edge and negative to trigger on a falling edge.

Key Path	Trigger, Baseband I/Q, Aux Channel I/Q Mag
Remote Command	:TRIGger[:SEquence]:AIQMag:SLOPe POSitive NEGative :TRIGger[:SEquence]:AIQMag:SLOPe?
Example	TRIG:AIQM:SLOP POS
Preset	POSitive
State Saved	Saved in instrument state
Initial S/W Revision	Prior to A.02.00

Trig Delay

Controls a time delay during which the analyzer will wait to begin a sweep after meeting the trigger criteria. You can use negative delay to pre-trigger the instrument in time domain or FFT.

Key Path	Trigger, Baseband I/Q, Aux Channel I/Q Mag
Remote Command	:TRIGger[:SEquence]:AIQMag:DELay <time> :TRIGger[:SEquence]:AIQMag:DELay? :TRIGger[:SEquence]:AIQMag:DELay:STATe OFF ON 0 1 :TRIGger[:SEquence]:AIQMag:DELay:STATe?
Example	TRIG:AIQM:DEL 10 ms

	TRIG:AIQM:DEL:STAT ON
Preset	1 us OFF
State Saved	Saved in instrument state
Range	-2.5 s to +10 s
Min	-2.5 s
Max	+10 s
Initial S/W Revision	Prior to A.02.00

X Axis Relative to Trigger

For triggers that support Trigger Delay it is beneficial that in time-domain displays (like Zero Span), X-axis values should be referenced to the Trigger point, that is, the zero value on the X Axis should be wherever the trigger point appears on the X Axis (including to the left or right of the X Axis). For negative trigger delays this means the zero point can actually appear on the X Axis.

Traditionally the zero point is at the left edge of the X Axis, and this behavior is retained for backwards compatibility, but if you turn on **X Axis Relative to Trigger**, the zero point moves to the trigger point and all X Axis values change to be relative to the trigger point.

When the **X Axis Relative to Trigger** switch is On, the trigger point on the X-axis will be marked with a vertical line and an annotation of "TRIG". Additionally, when the switch is On, values which are tied to the X-axis, such as trace data and markers, will have their X values adjusted to be referenced to the trigger point.

The switch is grayed out and Off unless the measurement is a time domain measurement; thus, in Swept SA it is grayed out unless in Zero Span.

Key Path	Trigger, Trigger
Remote Command	:TRIGger[:SEquence]:XRELative ON OFF 1 0 :TRIGger[:SEquence]:XRELative?
Example	TRIG:XREL ON
Notes	Although shown in all Trigger menus that have Trig Delay, the function is global to all of them and has the same value in all.
Dependencies	Grayed out unless in Zero Span. When grayed out, shows as Off. Non-forceful grayout, no error if SCPI sent while grayed out.
Preset	Off
State Saved	Saved in instrument state.
Initial S/W Revision	Prior to A.18.00
Control Type	Toggle

Trigger Center Frequency

This key sets the center frequency to be used by the auxiliary receiver.

Key Path	Trigger, Baseband I/Q, Aux Channel I/Q Mag
Remote Command	:TRIGger[:SEquence]:AIQMag:CENTer <freq> :TRIGger[:SEquence]:AIQMag:CENTer?
Example	:TRIG:AIQM:CENT 10 MHz
Notes	Trigger CF + 1/2 Trigger BW < Max Trigger CF - 1/2 Trigger BW > Min
Preset	0 Hz
State Saved	Saved in instrument state
Range	-40 MHz to 40 MHz
Min	-40 MHz
Max	40 MHz
Initial S/W Revision	Prior to A.02.00

Trigger Bandwidth

This key sets the information bandwidth used by the auxiliary receiver for the Auxiliary Channel I/Q Magnitude trigger.

Key Path	Trigger, Baseband I/Q, Aux Channel I/Q Mag
Remote Command	:TRIGger[:SEquence]:AIQMag:BANDwidth <freq> :TRIGger[:SEquence]:AIQMag:BANDwidth?
Example	:TRIG:AIQM:BAND 8 MHz
Notes	The combined sample rate for the main and auxiliary receivers cannot exceed 100 MSa/sec. The bandwidth available to the Trigger BW is limited to what is available after the main receiver's bandwidth (Info BW, sometimes pre-FFT BW) is set. Because of this limitation, the Max is not always achievable. The combination of Trigger Center Freq and Trigger BW is also limited: Trigger CF + 1/2 Trigger BW < Max Trigger CF - 1/2 Trigger BW > Min
Preset	Bandwidth option dependent: No Opt: 10 MHz Opt B25: 25 MHz Opt S40: 40 MHz
State Saved	Saved in instrument state
Range	10 Hz to Maximum
Min	10 Hz
Max	Bandwidth option & I/Q input path dependent: No Opt, I or Q Only: 10 MHz, I+jQ: 20 MHz Opt B25, I or Q Only: 25 MHz, I+jQ: 50 MHz Opt S40, I or Q Only: 40 MHz, I+jQ: 80 MHz
Initial S/W Revision	Prior to A.02.00

TV

Pressing this key, when it is not selected, selects the TV input signal as the trigger. A new sweep/measurement will start synchronized with the next occurrence of the synchronizing pulse of the selected TV line number.

Pressing this key, when it is already selected, opens a menu of TV Trigger setup functions. The default active function in this menu is the TV line number on which you want to trigger.

The Frame and Field options enable you to determine how the fields of the TV picture signal will be affected by the trigger system. One complete TV image consists of one frame of 525 or 625 horizontal lines depending on the TV standard being used. Each frame is composed of two fields of interlacing lines, each consisting of 262 1/2 lines (or 312 1/2 lines). The fields are called Field One and Field Two. Field One is viewed as having 263 lines (or 313 lines) and Field Two is viewed as having 262 lines (or 312 lines).

For the 525 line NTSC video standard, we refer to TV lines as follows (these are the Field Modes):

Entire Frame, lines 1 to 525

Field One, lines 1 to 263

Field Two, lines 1 to 262 (note that this really refers to "actual" lines 264 to 525)

For the 625 line PAL and SECAM video standards, we refer to TV lines as follows:

Entire Frame, lines 1 to 625

Field One, lines 1 to 313

Field Two, lines 314 to 625

As the Field is changed, the appropriate value for Line is chosen to keep triggering on the same line as before, or if this is not possible, the corresponding line in the new Field. For example, suppose line 264 is selected while in the NTSC-M standard and the Entire Frame mode. This is the first line in Field Two. If Field Two is then selected, the Line number changes to Line 1, the same actual line in the TV signal. If Field One is then selected, the line number stays at 1, but now we are triggering in the first line in Field One. The only exception to this is if we are on the last line of Field One and change to Field Two. In this case, we go to the last line in Field Two.

Key Path	Trigger
Example	TRIG:SOUR TV Swept SA measurement TRIG:<meas>:SOUR TV Measurements other than Swept SA
Dependencies	This key only appears in Modes which support TV Trigger, otherwise the key is blanked. If the SCPI command is sent while the key is blanked, an error is returned.
Readback	This key displays the value read back from TV Line
Status Bits/OPC dependencies	The Status Operation Register bit 5 "Waiting for Trigger" is set at the same time as the Sweeping or Measuring bit is set. It is cleared when the trigger actually occurs (that is, after the trigger

event occurs and all the applicable trigger criteria have been met). A corresponding pop-up message ("Waiting for trigger") is generated if no trigger signal appears after approximately 2 sec. This message goes away when a trigger signal appears.

Initial S/W Revision Prior to A.02.00

TV Line

Selects the TV line number to trigger on. Line number range is dependent on the settings of the **Standard** and **Field** menus within the TV trigger setup functions. When the line number is incremented beyond the upper limit, the value will change to the lower limit and continue incrementing from there. When the line number is decremented below the lower limit, the value will change to the upper limit and continue decrementing from there.

Key Path	Trigger, TV
Remote Command	:TRIGger[:SEquence]:TV:LINE <integer> :TRIGger[:SEquence]:TV:LINE?
Example	TRIG:TV:LINE 20 TRIG:TV:LINE?
Notes	The range of the TV line number is dependent on the settings of the Standard and Field menus within the TV trigger setup functions.
Preset	17
State Saved	Saved in instrument state
Min	The minimum value is the minimum line, and rolls over to the maximum value. The minimum line number depends on which Field and standard are selected.
Max	The maximum value is the maximum line, and rolls over to the minimum value. The maximum line number depends on which Field and standard are selected.
Initial S/W Revision	Prior to A.02.00

Field

Accesses the menu to select the field.

Key Path	Trigger, TV
Remote Command	:TRIGger[:SEquence]:TV:FMODe ENTire ODD EVEN :TRIGger[:SEquence]:TV:FMODe?
Example	TRIG:TV:FMOD EVEN
Notes	ODD is Field 1 EVEN is Field 2
Dependencies	This command is available only when Option B7B (TV trigger) is installed.
Preset	ENTire
Readback	Displays the Readback value
Initial S/W Revision	Prior to A.02.00

Entire Frame

When you select Entire Frame it causes the selected line number to be viewed as an offset into the entire frame starting with line 1, the first line in Field One.

Key Path	Trigger, TV, Field
Example	TRIG:TV:FMOD ENT
Min	1, for all formats.
Max	525, for formats NTSC-M, NTSC-Japan, NTSC-4.43, PAL-M and PAL-60 625, for formats PAL-B, D, G, H, I, PAL-N, PAL-N Combin, and SECAM-L.
Readback	Entire Frame
Initial S/W Revision	Prior to A.02.00

Field One

When you select Field One it causes the selected line number to be viewed as an offset into the first field starting with Line 1, the first line in Field One.

Key Path	Trigger, TV, Field
Example	TRIG:TV:FMOD ODD
Min	Field 1 (ODD) The minimum line is 1
Max	Field 1 (ODD) Maximum line is 263 for formats NTSC-M, NTSC-Japan, NTSC-4.43, PAL-M and PAL-60 Maximum line is 313 for formats PAL-B, D, G, H, I, PAL-N, PAL-N Combin, and SECAM-L.
Readback	Field 1
Initial S/W Revision	Prior to A.02.00

Field Two

When you select Field Two it causes the selected line number to be viewed as an offset into the second field. If Line 1 is selected, it is the 264th line of the frame (NTSC-M, NTSC-Japan, NTSC-4.43, PAL-M, PAL-60) or the 314th line of the frame (PAL-B,D,G,H,I, PAL-N, PAL-N-Combin, SECAM-L).

Key Path	Trigger, TV, Field
Example	TRIG:TV:FMOD EVEN
Min	Field 2 (EVEN) The minimum line is 1
Max	Field 2 (EVEN) The maximum line 262 for formats NTSC-M, NTSC-Japan, NTSC-4.43, PAL-M and PAL-60 The maximum line is 312 for formats PAL-B, D, G, H, I, PAL-N, PAL-N Combin, and SECAM-L
Readback	Field 2
Initial S/W Revision	Prior to A.02.00

Standard

Accesses the Standard menu keys which select from the following TV standards: NTSC-M, NTSC-Japan, NTSC-4.43, PAL-M, PAL-B,D,G,H,I , PAL-N, PAL-N-Combin, PAL-60, SECAM-L.

As the TV standard is changed, the current line value is clipped as necessary to keep it valid for the chosen standard and field mode. For example, line 600 is selected in Entire Frame mode in PAL-N; if NTSC-M is selected, the line number is clipped to 525. Or, if line 313 is selected in Field 1 mode in PAL-N and NTSC-M is selected, the line number is clipped to 263. Changing back to the PAL-N standard will leave the line number at 263.

Key Path	Trigger, TV
Remote Command	:TRIGger[:SEquence]:TV:STANdard MNTSc JNTSc NTSC443 MPAL BPAL NPAL CPAL PAL60 LSEC :TRIGger[:SEquence]:TV:STANdard?
Example	TRIG:TV:STAN MPAL TRIG:TV:STAN?
Preset	MNTS
State Saved	Saved in instrument state
Readback	Displays Readback value
Initial S/W Revision	Prior to A.02.00

NTSC-M

Sets the TV standard to NTSC-M.

Key Path	Trigger, TV, Standard
Example	TRIG:TV:STAN MNTS
Readback	NTSC-M
Initial S/W Revision	Prior to A.02.00

NTSC-Japan

Sets the TV standard to NTSC-Japan.

Key Path	Trigger, TV, Standard
Example	TRIG:TV:STAN JNTS
Readback	NTSC-Japan
Initial S/W Revision	Prior to A.02.00

NTSC-4.43

Sets the TV standard to NTSC-4.43.

Key Path	Trigger, TV, Standard
Example	TRIG:TV:STAN NTSC443
Readback	NTSC-Japan
Initial S/W Revision	Prior to A.02.00

PAL-M

Sets the TV standard to **PAL-M**.

Key Path	Trigger, TV, Standard
Example	TRIG:TV:STAN MPAL
Readback	PAL-M
Initial S/W Revision	Prior to A.02.00

PAL-N

Sets the TV standard to **PAL-N**.

Key Path	Trigger, TV, Standard
Example	TRIG:TV:STAN NPAL
Readback	PAL-N
Initial S/W Revision	Prior to A.02.00

PAL-N-Combin

Sets the TV standard to **PAL-N-Combin**.

Key Path	Trigger, TV, Standard
Example	TRIG:TV:STAN CPAL
Readback	PAL-N-C
Initial S/W Revision	Prior to A.02.00

PAL-B,D,G,H,I

Sets the TV standard to **PAL-B,D,G,H,I**

Key Path	Trigger, TV, Standard
Example	TRIG:TV:STAN BPAL
Readback	PAL-B
Initial S/W Revision	Prior to A.02.00

PAL-60

Sets the TV standard to **PAL-60**.

Key Path	Trigger, TV, Standard
Example	TRIG:TV:STAN PAL60
Readback	PAL-N
Initial S/W Revision	Prior to A.02.00

SECAM-L

Sets the TV standard to **SECAM-L**.

Key Path	Trigger, TV, Standard
Example	TRIG:TV:STAN LSEC
Readback	SECAM-L
Initial S/W Revision	Prior to A.02.00

Auto/Holdoff

Opens up a menu that lets you adjust Auto Trigger and Trigger Holdoff parameters

Key Path	Trigger
Readback line	<p>Displays a summary of the Auto Trig and Holdoff settings, in square brackets</p> <p>First line: Auto Off or Auto On</p> <p>Second Line: "Hldf" followed by:</p> <ul style="list-style-type: none"> - If Holdoff is Off, readback Off - If Holdoff On and Type = Normal, readback value - If Holdoff On and Type = Above, readback value followed by AL - If Holdoff On and Type = Below, readback value followed by BL - If Holdoff Type selection is not supported by the current measurement, Holdoff Type is always Normal
Initial S/W Revision	A.02.00

Auto Trig

Sets the time that the analyzer will wait for the trigger conditions to be met. If they are not met after that much time, then the analyzer is triggered anyway.

Key Path	Trigger, Auto/Holdoff
Remote Command	<pre>:TRIGger[:SEquence]:ATRigger <time> :TRIGger[:SEquence]:ATRigger? :TRIGger[:SEquence]:ATRigger:STATe OFF ON 0 1 :TRIGger[:SEquence]:ATRigger:STATe?</pre>
Example	TRIG:ATR:STAT ON

	TRIG:ATR 100 ms
Notes	The "time that the analyzer will wait" starts when the analyzer is ready for a trigger, which may be hundreds of ms after the data acquisition for a sweep is done. The "time" ends when the trigger condition is satisfied, not when the delay ends.
Preset	Off, 100 ms
State Saved	Saved in instrument state
Min	1 ms
Max	100 s
Default Unit	s
Initial S/W Revision	Prior to A.02.00

Trig Holdoff

Sets the holdoff time between triggers. When the trigger condition is satisfied, the trigger occurs, the delay begins, and the holdoff time begins. New trigger conditions will be ignored until the holdoff time expires. For a free-running trigger, the holdoff value is the minimum time between triggers.

Key Path	Trigger, Auto/Holdoff
Remote Command	:TRIGger[:SEquence]:HOLDoff <time> :TRIGger[:SEquence]:HOLDoff? :TRIGger[:SEquence]:HOLDoff:STATE OFF ON 0 1 :TRIGger[:SEquence]:HOLDoff:STATE?
Example	TRIG:HOLD:STAT ON TRIG:HOLD 100 ms
Dependencies	Unavailable if the selected Input is BBIQ. If this is the case, the key is grayed out if it is pressed the informational message "Feature not supported for this Input" is displayed. If the SCPI command is sent, the error "Settings conflict; Feature not supported for this Input" is generated.
Preset	Off, 100 ms
State Saved	Saved in instrument state
Min	0 s
Max	0.5 s
Default Unit	s
Initial S/W Revision	Prior to A.02.00

Holdoff Type

Lets you set the Trigger Holdoff Type.

NOTE

Holdoff Type is not supported by all measurements. If the current measurement does not support it, this key will be blank and the Holdoff Type will be Normal. If the Holdoff Type SCPI is sent while in such a measurement, the SCPI will be accepted and the setting remembered, but it will have no effect until a measurement is in force that supports Holdoff Type.

Trigger Holdoff Type functionality:

NORMAL	This is the "oscilloscope" type of trigger holdoff, and is the setting when the Holdoff Type key does not appear. In this type of holdoff, no new trigger will be accepted until the holdoff interval has expired after the previous trigger.
ABOVE	If the trigger slope is positive, a trigger event is generated only if the signal characteristic of interest crosses the trigger threshold (with positive slope) and then remains above the threshold for at least the holdoff time. For negative slope, the trigger event is generated if the signal characteristic crosses the threshold (with negative slope) after having been above the threshold for at least the holdoff time. In either case, the trigger event is associated with the time the level was crossed.
BELOW	If the trigger slope is positive, a trigger event is generated only if the signal characteristic of interest crosses the trigger threshold (with positive slope) after having been below the threshold for at least the holdoff time. For negative slope, the trigger event is generated if the signal characteristic crosses the threshold (with negative slope) and then remains below the threshold for at least the holdoff time. In either case, the trigger event is associated with the time the level was crossed.

Key Path	Trigger, Auto/Holdoff
Remote Command	:TRIGger[:SEquence]:HOLDoff:TYPE NORMa1 ABOVe BELow :TRIGger[:SEquence]:HOLDoff:TYPE?
Example	TRIG:HOLD:TYPE NORM
Preset	All modes but GSM/EDGE: Normal GSM/EDGE: Below
State Saved	Saved in instrument state
Initial S/W Revision	A.02.00

8 Swept SA Measurement

The Swept SA measurement uses both swept and FFT analysis, and the frequency and time domains. For more details, see "[Swept SA Measurement Description](#)" on page 597.

Measurement Commands and their Results for Swept SA

The INIT and CONF syntax, as well as the data returned to a FETCh (and therefore a MEASure and READ) is described in this section.

Note that the data returned to a FETCh? (and therefore to a MEAS? and a READ?) uses the data setting specified by the FORMat:BORDER and FORMat:DATA commands and can return real or ASCII data. If the format is set to INT,32 it returns REAL,32 data.

For more measurement related commands, see the SENSE subsystem, and the ["Remote Measurement Functions" on page 3140](#).

NOTE

The INIT command works in a slightly different fashion in the Spectrogram view. In the other Views (Normal, Trace Zoom and

Zone Span), the following two commands perform exactly the same function:

:INITiate:REStart

:INITiate:IMMEDIATE

However, in the Spectrogram View, the command :INITiate:REStart works like the Restart key, and clears out the Spectrogram trace history. The command :INITiate:IMMEDIATE does not clear out the Spectrogram trace history but performs all other functions of performing a restart.

The table below lists the measurement commands and their responses for the SANalyzer measurement (note that the marker values are x, y pairs):

Command	N	Return Value
INITiate:SANalyzer	n/a	n/a
CONFigure?	n/a	long form name of current measurement, for example, "SANalyzer"
CONFigure:SANalyzer	n/a	n/a (selects SAN measurement with Meas Setup settings in preset state – same as Meas Preset)
CONFigure:SANalyzer:NDEFault	n/a	n/a (selects SAN measurement without affecting settings)
FETCh:SANalyzer[n]? MEASure:SANalyzer[n]? READ:SANalyzer[n]?	0	Returns the following comma-separated results: <ol style="list-style-type: none"> 1 if there is any margin or limit failure, otherwise 0 0 (future). 0 (future). 0 (future). N dB points result (not a number if off) Terminal average count (the Average Number as set in the UI)

	7. Number of points in the sweep
	8. 0 (future).
	9. 0 (future).
	10. 0 (future).
	11. Marker 1 value (x,y)
	12. Marker 2 value (x,y)
	13. Marker 3 value (x,y)
	14. Marker 4 value (x,y)
	15. Marker 5 value (x,y)
	16. Marker 6 value (x,y)
	17. Marker 7 value (x,y)
	18. Marker 8 value (x,y)
	19. Marker 9 value (x,y)
	20. Marker 10 value (x,y)
	21. Marker 11 value (x,y)
	22. Marker 12 value (x,y)
not specified or n=1	<p>This query returns Trace 1 data as a list of x,y pairs. The y-values are in the current Y Axis Unit of the analyzer. The x-axis values are the values of the trace, in the x-axis scale units of the trace (Hz for frequency domain traces, seconds for time domain traces).</p> <p>When querying trace data, it is best if the analyzer is not sweeping during the query. Therefore, it is good to be in Single Sweep, or Update=Off when querying trace data from the analyzer.</p>
2	Returns Trace 2 data as a series of x,y pairs
3	Returns Trace 3 data as a series of x,y pairs
4	Returns Trace 4 data as a series of x,y pairs
5	Returns Trace 5 data as a series of x,y pairs
6	Returns Trace 6 data as a series of x,y pairs
7	Returns Peak Table data as a series of x,y pairs. If the Delta to Limit column is on it returns it as a series of x,y,delta triplets. If a cell is showing

	---	it is returned as NaN. The data is returned in the current sort order as displayed in the Peak Table.
	8 & above	Future use

Swept SA Measurement Description

Swept Spectrum Analysis (Freq Domain): The analyzer sweeps the LO to generate a heterodyned IF signal that can be detected to analyze the signal content of a range of frequencies. The x-axis of the display is frequency, the Y Axis is amplitude.

Swept FFT Analysis (Freq Domain): In some cases there is an advantage to not actually sweeping the LO, but instead analyzing the signal by taking a time record and performing FFT analysis. This is what is done in swept FFT analysis, but the data is still presented as though it were a sweeping spectrum analyzer. The x-axis of the display is frequency, the Y Axis is amplitude.

Zero Span Analysis (Time Domain): In Zero Span analysis, the analyzer stops sweeping the LO, placing it at the center frequency, and then takes time data from the detector while stopped at that frequency. Because the LO is not moving, the frequency span is zero. The time data is presented left to right across the screen just like on an oscilloscope. The x-axis of the display is time, and the Y Axis is amplitude.

All of the tools such as markers, peak tables, limit lines, trace math, N dB points, and marker functions are available in Zero Span measurement analysis, although some work differently in the time and frequency domains.

Key Path	Meas
Initial S/W Revision	Prior to A.02.00

AMPTD Y Scale

The Amplitude front-panel key activates the Amplitude menu and selects Reference Level or Reference Value (depending on the measurement) as the active function.

Some features in the Amplitude menu apply to multiple measurements; others apply only to specific measurements. Keys that only apply to some measurements are blanked or grayed out in measurements that are not supported.

Key Path	Front-panel key
Initial S/W Revision	Prior to A.02.00

Reference Level

The Reference Level specifies the amplitude represented by the topmost graticule line.

Changing the reference level does not restart a measurement, because it is a display function only; instead it vertically ‘pans’ all displayed traces and markers to the new value. If a change to the reference level changes the attenuation value (e.g. through an auto coupling), then the measurement will be restarted.

See ["Amplitude Representations" on page 599](#)

Key Path	AMPTD Y Scale
Remote Command	:DISPlay:WINDow[1]:TRACe:Y[:SCALe]:RLEVe1 <real> :DISPlay:WINDow[1]:TRACe:Y[:SCALe]:RLEVe1?
Example	DISP:WIND:TRAC:Y:RLEV 20 dBm Sets the reference level to 20 dBm, which displays in the current Y axis unit. For example, if the Y axis unit is dBμV, then 126.99 dBμV will be displayed.
Couplings	If you reduce the attenuation, the analyzer may have to lower the reference level to keep it below its allowed maximum. This allowed maximum level is specified in the “Max” row, below, along with other variables which affect it. When you increase attenuation, the reference level does not change.
Preset	0 dBm
State Saved	Saved in instrument state
Min	RefLevelMin = -170 dBm + RefLevelOffset - ExtGain.
Max	The maximum Ref Level is typically: +30 dBm + RL Offset – External Gain (for MXA and PXA) +23 dBm + RL Offset – External Gain (for EXA and CXA) This maximum value is determined by the maximum power that can be safely applied to the input circuitry. The actual maximum value at any given time may be even less than this, depending on other values including Mech Atten, Int Preamp Gain, Swept IF Gain, FFT IF Gain, Max Mixer Level, and the total attenuation currently available. Note that the maximum reference level is unaffected by the input choice of external mixing.
Default Unit	Depends on the current selected Y axis unit

Backwards Compatibility Notes	<ol style="list-style-type: none"> 1. In PSA, there was a restriction on Ref Level Max which was that it could not exceed 0 dBm when the preamp was on. This restriction does not apply to X-Series. 2. Ref Level – Ref Level is a display function, not a measurement control function, so a change in the setting does not start a new sweep (unless attenuation changes). This behavior differs from that of legacy analyzers
Initial S/W Revision	Prior to A.02.00

Amplitude Representations

The following is an illustration of the reference level and Y Axis scales under various conditions:

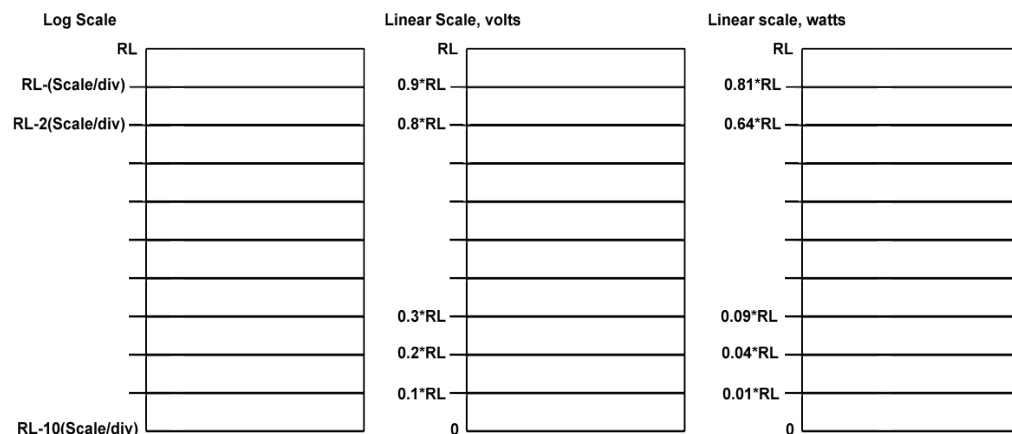

Attenuation

This menu controls the attenuator functions and interactions between the attenuation system components.

There are two attenuator configurations in the X-Series. One is a dual attenuator configuration consisting of a mechanical attenuator and an optional electronic attenuator. The other configuration uses a single attenuator with combined mechanical and electronic sections that controls all the attenuation functions. Different models in the X-Series come with different configurations.

See ["Dual Attenuator Configurations:" on page 600](#)

See ["Single Attenuator Configuration:" on page 600](#)

Most Attenuation settings are the same for all measurements – they do not change as you change measurements. Settings like these are called “Meas Global” and are unaffected by Meas Preset.

Key Path	AMPTD Y Scale
Scope	Meas Global
Dependencies	In measurements that support the I/Q inputs, this key is unavailable when I/Q is the selected

	input, and is replaced by the Range key in that case.
Readback Line	Contains a summary in [] brackets of the current total attenuation. See the descriptions of the , " (Mech) Atten " on page 3103, and "Enable Elec Atten" on page 3105 keys for more detail on the contributors to the total attenuation. Note that when "Pre-Adjust for Min Clip" is on, this value can change at the start of every measurement.
Initial S/W Revision	Prior to A.02.00
Modified at S/W Revision	A.03.00

Dual Attenuator Configurations:

Configuration 1: Mechanical attenuator + optional electronic attenuator

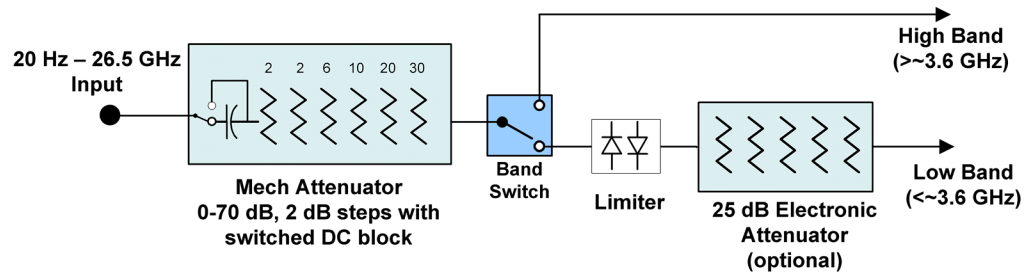

Configuration 2: Mechanical attenuator, no optional electronic attenuator

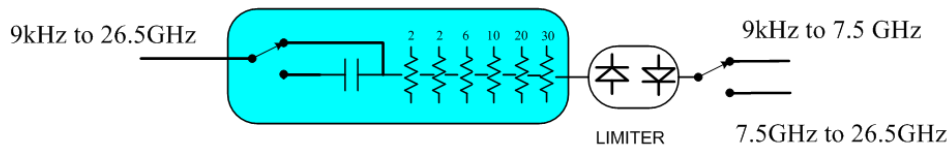

(note that Configuration 2 is not strictly speaking a dual-section attenuator, since there is no electronic section available. However, it behaves exactly like Configuration 1 without the Electronic Attenuator option EA3, therefore for the sake of this document it is grouped into the "Dual Attenuator" configuration)

Single Attenuator Configuration:

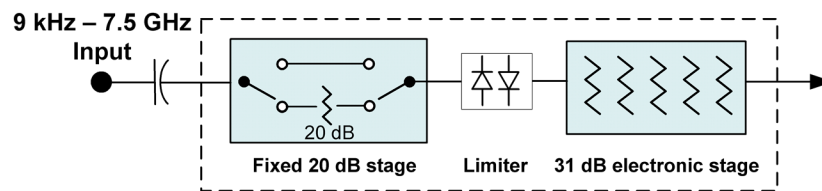

You can tell which attenuator configuration you have by pressing the Attenuation key, which (in most Modes) opens the Attenuation menu. If the first key in the Attenuation menu says **Mech Atten** you have the dual attenuator configuration. If the first key says **Atten** you have the single attenuator configuration.

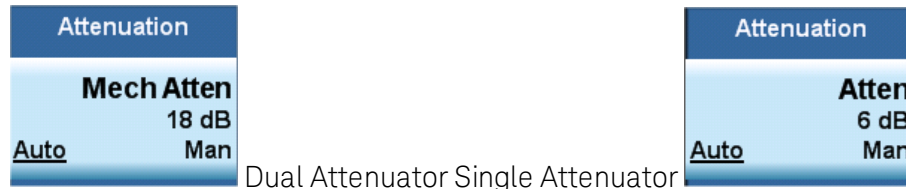

In the single attenuator configuration, you control the attenuation with a single control, as the fixed stage has only two states. In the dual attenuator configuration, both stages have significant range so you are given separate control of the mechanical and electronic attenuator stages.

When you have the dual attenuator configuration, you may still have only a single attenuator, because unless option EA3 (the Electronic Attenuator option) is available, and you purchase it, you will have only the mechanical attenuator.

(Mech) Atten

This key is labeled **Mech Atten** in dual attenuator models and **Atten** in single attenuator models. In the dual attenuator configuration, this key only affects the mechanical attenuator.

This key lets you modify the attenuation applied to the RF input signal path. This value is normally auto coupled to the Ref Level, the Internal Preamp Gain, any External Gain that is entered, and the Max Mixer Level, as described in the table below.

See ["Attenuator Configurations and Auto/Man" on page 602](#)

Key Path	AMPTD Y Scale, Attenuation
Remote Command	[:SENSE]:POWer[:RF]:ATTenuation <rel_amp1> [:SENSe]:POWer[:RF]:ATTenuation? [:SENSE]:POWer[:RF]:ATTenuation:AUTO OFF ON 0 1 [:SENSe]:POWer[:RF]:ATTenuation:AUTO?
Example	POW:ATT 20 Dual attenuator configuration: sets the mechanical attenuator to 20 dB Single attenuator mode: sets the main attenuation to 20 dB (see below for definition of "main" attenuation). If the attenuator was in Auto, it sets it to Manual.
Dependencies	Some measurements do not support the Auto setting of (Mech) Atten . In these measurements, the Auto/Man selection is not available, and the Auto/Man line on the key disappears. In dual attenuator configurations, when the electronic attenuator is enabled, the mechanical attenuator has no auto setting and the Auto/Man line on the key disappears. The state of Auto/Man is remembered and restored when the electronic attenuator is once again disabled. This is described in more detail in the "Enable Elec Atten" on page 3105 key description. See "Attenuator Configurations and Auto/Man" on page 602 for more information on the Auto/Man functionality of Attenuation.
Couplings	When (Mech) Atten is in Auto, it uses the following algorithm to determine a value: If the USB Preamp is connected to USB, use 0 dB.

	<p>Otherwise, $Atten = ReferenceLevel + PreAmpGain + ExternalGain - RefLevelOffset - MaxMixerLevel + IF\ Gain$.</p> <p>Limit this value to be between 6 dB and the Max value. No value below 6 dB can ever be chosen by Auto.</p> <p>The resulting value is rounded up to the largest value possible given the attenuation step setting. That is, 50.01 dB would change to 60 dB (for a 10 dB attenuation step).</p> <p>The “IF Gain” term in the equation above is either 0 dB or +10 dB, depending on the settings of FFT IF Gain, Swept IF Gain, max Ref Level and the Auto/Man setting of Mech Atten.</p> <p>In External Mixing and BBIQ, where the Attenuator is not in the signal path, the Attenuator setting changes as described above when (Mech) Atten is in Auto, but no changes are made to the actual attenuator hardware setting until the input is changed back to the RF Input.</p>
Preset	<p>The preset for Mech Attenuation is “Auto.”</p> <p>The Auto value of attenuation is: CXA, EXA, MXA and PXA: 10 dB</p>
State Saved	Saved in instrument state
Min	<p>0 dB</p> <p>The attenuation set by this key cannot be decreased below 6 dB with the knob or step keys. To get to a value below 6 dB it has to be directly entered from the keypad or via SCPI. This protects from adjusting the attenuation to a dangerously small value which can put the instrument at risk of damage to input circuitry. However, if the current mechanical attenuation is below 6 dB it can be increased with the knob and step keys, but not decreased.</p>
Max	<p>CXA N9000A-503/507: 50 dB CXA N9000A-513/526: 70dB EXA: 60 dB MXA and PXA: 70 dB</p> <p>In the single attenuator configuration, the total of ATT and EATT cannot exceed 50 dB, so if the EATT is set to 24 dB first, the main attenuation cannot be greater than 26 dB and will be reduced accordingly; if the main attenuator is set to 40 dB first, EATT cannot be greater than 10 dB.</p>
Initial S/W Revision	Prior to A.02.00
Modified at S/W Revision	A.03.00

Attenuator Configurations and Auto/Man

As described in the Attenuation key description, there are two distinct attenuator configurations available in the X-Series, the single attenuator and dual attenuator configurations. In dual attenuator configurations, we have the mechanical attenuation and the electronic attenuation, and the current total attenuation is the sum of the electronic + mechanical attenuation. In single attenuator configurations, we refer to the attenuation set using the **(Mech) Atten** key (or POW:ATT SCPI) as the “main” attenuation; and the attenuation that is set by the SCPI command POW:EATT as the “soft” attenuation (the POW:EATT command is honored even in the single attenuator configuration, for compatibility purposes). Then the current total attenuation is the sum of the main + soft attenuation. See the **Elec Atten** key description for more on “soft” attenuation.

In the dual attenuator configuration, when the electronic attenuator is enabled, there is no Auto/Man functionality for the mechanical attenuator, and the third line of the key label (the Auto/Man line) disappears:

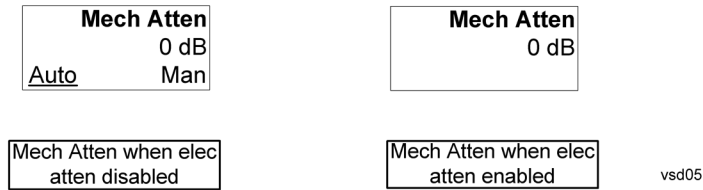

Enable Elec Atten

Enables the Electronic Attenuator.

The electronic attenuator offers finer steps than the mechanical attenuator, has no acoustical noise, is faster, and is less subject to wear. These advantages primarily aid in remote operation and are negligible for front panel use. See ["Using the Electronic Attenuator: Pros and Cons" on page 605](#) for a detailed discussion of the pros and cons of using the electronic attenuator.

For the single attenuator configuration, for SCPI backwards compatibility, the “soft” attenuation feature replaces the dual attenuator configuration’s electronic attenuator. All the same couplings and limitations apply. See ["Attenuator Configurations and Auto/Man" on page 3105](#)

See [Error! Reference source not found.](#)

Key Path	AMPTD Y Scale, Attenuation
Remote Command	[:SENSe] :POWer [:RF] :EATTenuation :STATe OFF ON 0 1 [:SENSe] :POWer [:RF] :EATTenuation :STATe ?
Example	POW:EATT:STAT ON
Dependencies	<p>This key only appears in Dual Attenuator models with an Electronic Attenuator installed. It does not appear in models with the Single Attenuator configuration, as in the single attenuator configuration there is no “electronic attenuator” there is only a single integrated attenuator (which has both a mechanical and electronic stage). However, in the single attenuator configuration, EATT SCPI commands are accepted for compatibility with other X-series instruments and set a “soft” attenuation as described in "Attenuator Configurations and Auto/Man" on page 3105.</p> <p>The electronic attenuator (and the “soft” attenuation function provided in single attenuator configurations) is unavailable above 3.6 GHz. Therefore, if the Stop Frequency of the analyzer is > 3.6 GHz then the Enable Elec Atten key will be OFF and grayed out.</p> <p>If the Internal Preamp is on, meaning it is set to Low Band or Full, the electronic attenuator (and the “soft” attenuation function provided in single attenuator configurations) is unavailable. In this case the Enable Elec Atten key will be OFF and grayed out.</p> <p>If either of the above is true, if the SCPI command is sent, an error indicating that the electronic attenuator is unavailable will be sent.</p> <p>If the electronic/soft Attenuator is enabled, then the Stop Freq of the analyzer is limited to 3.6 GHz and the Internal Preamp is unavailable.</p> <p>The SCPI-only “soft” electronic attenuation for the single-attenuator configuration is not</p>

	available in all measurements; in particular, it is not available in the Swept SA measurement.
Couplings	Enabling and disabling the Electronic Attenuator affects the setting of the Mechanical Attenuator (in dual attenuator configurations). This is described in more detail below this table.
Preset	OFF for Swept SA measurement; ON for all other measurements that support the electronic attenuator
State Saved	Saved in instrument state
Initial S/W Revision	Prior to A.02.00
Modified at S/W Revision	A.03.00

Mechanical Attenuator Transition Rules

When the Electronic Attenuator is enabled, the Mechanical Attenuator transitions to a state that has no Auto function. Below are the rules for transitioning the Mechanical Attenuator. NOTE that the information below ONLY applies to the dual attenuator configurations, and ONLY when the Electronic Attenuator is installed:

When the Electronic Attenuation is enabled from a disabled state:

- The Mechanical Attenuator is initialized to 10 dB (this is its optimal performance setting). You can then set it as desired with SCPI, numeric keypad, step keys, or knob, and it behaves as it normally would in manual mode
- The Auto/Man state of (Mech) Atten is saved
- The Auto/Man line on the (Mech) Atten key disappears and the auto rules are disabled
- The Electronic Attenuator is set to 10 dB less than the previous value of the Mechanical Attenuator, within the limitation that it must stay within the range of 0 to 24 dB of attenuation.

Examples in the dual attenuator configuration:

- Mech Atten at 20 dB. Elec Atten enabled, Mech Atten set to 10 dB, and Elec Atten set to 10 dB. New total attenuation equals the value before Elec Atten enabled.
- Mech Atten at 0 dB. Elec Atten enabled, Mech Atten set to 10 dB, and Elec Atten set to 0 dB. New total attenuation does not equal the value before Elec Atten enabled.
- Mech Atten at 40 dB. Elec Atten enabled, Mech Atten set to 10 dB, and Elec Atten set to 24 dB. New total attenuation does not equal the value before Elec Atten enabled.

When the Electronic Attenuation is disabled from an enabled state:

- The Elec Atten key is grayed out
- The Auto/Man state of (Mech) Atten is restored
- If now in Auto, (Mech) Atten recouples
- If now in Man, (Mech) Atten is set to the value of total attenuation that existed before the Elec Atten was disabled. The resulting value is rounded up to the smallest value possible given the (Mech) Atten Step setting - (That is, 57 dB changes to 58 dB when (Mech) Atten Step is 2 dB.)

Using the Electronic Attenuator: Pros and Cons

The electronic attenuator offers finer steps than the mechanical attenuator, has no acoustical noise, is faster, and is less subject to wear.

The “finer steps” advantage of the electronic attenuator is beneficial in optimizing the alignment of the analyzer dynamic range to the signal power in the front panel as well as remote use. Thus, you can achieve improved relative signal measurement accuracy. Compared to a mechanical attenuator with 2 dB steps, the 1 dB resolution of the electronic attenuator only gives better resolution when the odd-decibel steps are used. Those odd-decibel steps are less accurately calibrated than the even-decibel steps, so one tradeoff for this superior relative accuracy is reduced absolute amplitude accuracy.

Another disadvantage of the electronic attenuator is that the spectrum analyzer loses its “Auto” setting, making operation less convenient.

Also, the relationship between the dynamic range specifications (TOI, SHI, compression and noise) and instrument performance are less well-known with the electrical attenuator. With the mechanical attenuator, TOI, SHI and compression threshold levels increase dB-for-dB with increasing attenuation, and the noise floor does as well. With the electronic attenuator, there is an excess attenuation of about 1 to 3 dB between 0 and 3.6 GHz, making the effective TOI, SHI, and so forth, less well known. Excess attenuation is the actual attenuation relative to stated attenuation. Excess attenuation is accounted for in the analyzer calibration

Elec Atten

Controls the Electronic Attenuator in dual attenuator configurations. This key does not appear in single attenuator configurations, as the control of both the mechanical and electronic stages of the single attenuator is integrated into the single **Atten** key.

Key Path	AMPTD Y Scale, Attenuation
Remote Command	<code>[:SENSe] :POWer [:RF] :EATTenuation <rel_amp1></code> <code>[:SENSe] :POWer [:RF] :EATTenuation?</code>
Notes	Electronic Attenuation's specification is defined only when Mechanical Attenuation is 6 dB.

Dependencies	This key only appears in Dual Attenuator models with an Electronic Attenuator installed. It does not appear in models with the Single Attenuator configuration, as in the single attenuator configuration there is no "electronic attenuator" there is only a single integrated attenuator (which has both a mechanical and electronic stage). However, in the single attenuator configuration, EATT SCPI commands are accepted for compatibility with other X-series instruments and set a "soft" attenuation as described in "Attenuator Configurations and Auto/Man" on page 3105 . The "soft" attenuation is treated as an addition to the "main" attenuation value set by the Atten softkey or the POW:ATT SCPI command and affects the total attenuation displayed on the Attenuation key and the Meas Bar. When Enable Elec Atten is off or grayed out, the Elec Atten key is grayed out.
Preset	0 dB
State Saved	Saved in instrument state
Min	0 dB
Max	Dual attenuator configuration: 24 dB Single attenuator configuration: the total of ATT and EATT cannot exceed 50 dB, so if the EATT is set to 24 dB first, the main attenuation cannot be greater than 26 dB and will be reduced accordingly; if the main attenuator is set to 40 dB first, EATT cannot be greater than 10 dB
Initial S/W Revision	Prior to A.02.00
Modified at S/W Revision	A.03.00

Adjust Atten for Min Clip

Sets the combination of mechanical and electronic attenuation and gain based on the current measured signal level so that clipping will be at a minimum.

This is an "immediate action" function, that is, it executes once, when the key is pressed.

This key does not appear in measurements that do not support this functionality. The spectrum analyzer measurement, Swept SA, does not support this functionality.

Key Path	AMPTD Y Scale, Attenuation
Remote Command	[:SENSe]:POWer[:RF]:RANGe:OPTimize IMMEDIATE
Initial S/W Revision	Prior to A.02.00
Modified at S/W Revision	A.03.00

Pre-Adjust for Min Clip

If this function is on, it does the adjustment described under ["Adjust Atten for Min Clip" on page 3108](#) each time a measurement restarts. Therefore, in Continuous measurement mode, it only executes before the first measurement.

In dual attenuator models, you can set **Elec+Mech Atten**, in which case both attenuators participate in the autoranging, or **Elec Atten Only**, in which case the mechanical attenuator does not participate in the autoranging. This latter case results in less wear on the mechanical attenuator and is usually faster.

This key is grayed out in measurements that do not support this functionality. The spectrum analyzer measurement, Swept SA, does not support this functionality.

Key Path	AMPTD Y Scale, Attenuation
Remote Command	<code>[:SENSe] :POWer [:RF] :RANGe :OPTimize :ATTenuation OFF ELECTrical COMBined</code> <code>[:SENSe] :POWer [:RF] :RANGe :OPTimize :ATTenuation ?</code>
Notes	The SCPI parameter ELECTrical sets this function to On in single attenuator models. The SCPI parameter COMBined is mapped to ELECTrical in single attenuator models; if you send COMBined, it sets the function to On and returns ELEC to a query.
Dependencies	This key only appears in Dual Attenuator models with an Electronic Attenuator installed. In instruments with Dual Attenuator model, when Enable Elec Atten is off or grayed out, the Pre-Adjust for Min Clip key is grayed out.
Preset	OFF for Swept SA measurement; ON for all other measurements that support Pre-Adjust for Min Clip
State Saved	Saved in instrument state
Range	Dual attenuator models: Off Elec Atten Only Mech + Elec Atten Single attenuator models: Off On
Initial S/W Revision	Prior to A.02.00
Modified at S/W Revision	A.03.00

Remote Command	<code>[:SENSe] :POWer [:RF] :RANGe :AUTO ON OFF 1 0</code> <code>[:SENSe] :POWer [:RF] :RANGe :AUTO ?</code>
Notes	ON aliases to "Elec Atten Only" (:POW:RANG:OPT:ATT ELEC) OFF aliases to "Off" (:POW:RANG:OPT:ATT OFF) The query :POW:RANG:AUTO? returns true if :POW:RANG:OPT:ATT is not "Off"
Initial S/W Revision	Prior to A.02.00

Off

Turns **Pre-Adjust for Min Clip** off. This is the default setting.

This key is grayed out in measurements that do not support this functionality. The spectrum analyzer measurement, Swept SA, does not support this functionality.

Key Path	AMPTD Y Scale, Attenuation, Pre-Adjust for Min Clip
Example	<code>:POW:RANGe:OPT:ATT OFF</code>
Initial S/W Revision	Prior to A.02.00

Elec Atten Only

Selects only the electric attenuator to participate in auto ranging. This offers less wear on the mechanical attenuator and is usually faster.

This key is grayed out in measurements that do not support this functionality. The spectrum analyzer measurement, Swept SA, does not support this functionality.

Key Path	AMPTD Y Scale, Attenuation, Pre-Adjust for Min Clip
Example	:POW:RANGe:OPT:ATT ELEC
Initial S/W Revision	Prior to A.02.00

Mech + Elec Atten

In dual attenuator models, this selects both attenuators participate in the autoranging.

This key is grayed out in measurements that do not support this functionality. The spectrum analyzer measurement, Swept SA, does not support this functionality.

Key Path	AMPTD Y Scale, Attenuation, Pre-Adjust for Min Clip
Example	:POW:RANGe:OPT:ATT COMB
Initial S/W Revision	Prior to A.02.00

(Mech) Atten Step

This controls the step size used when making adjustments to the input attenuation.

This key is labeled **Mech Atten Step** in dual attenuator models and **Atten Step** in single attenuator models. In the dual attenuator configuration, this key only affects the step size of the mechanical attenuator.

Key Path	AMPTD Y Scale, Attenuation
Remote Command	[:SENSe] :POWer [:RF] :ATTenuation :STEP [:INCRement] 10 dB 2 dB [:SENSe] :POWer [:RF] :ATTenuation :STEP [:INCRement] ?
Example	POW:ATT:STEP 2
Notes	Note this feature works like a 1-N choice from the front panel, but it takes a specific value (in dB) when used remotely. The only valid values are 2 and 10.
Dependencies	Blanked in CXA and EXA if option FSA (2 dB steps) is not present. If blanked, attempts to set it via SCPI will yield an error.
Couplings	When the attenuation step size changes, the current mechanical attenuation value is adjusted (if necessary) to be quantized to the new step size. That is, if step is set to 10 dB, mech atten is increased if necessary so it is a multiple of 10 dB
Preset	PXA and MXA: 2 dB EXA and CXA: 10 dB (2 dB with option FSA)
State Saved	Saved in instrument state
Initial S/W Revision	Prior to A.02.00

Modified at S/W Revision	A.03.00
-----------------------------	---------

Max Mixer Level

Controls the limitation on the Ref Level for a given attenuation setting, and therefore also interacts with the Auto rules for selecting the attenuation as a coupling from the reference level.

Key Path	AMPTD Y Scale, Attenuation
Remote Command	[:SENSe] :POWer [:RF] :MIXer :RANGe [:UPPer] <real> [:SENSe] :POWer [:RF] :MIXer :RANGe [:UPPer] ?
Example	POW:MIX:RANG -15 dBm
Preset	-10 dBm
State Saved	Saved in instrument state
Min	-50 dBm
Max	0 dBm
Default Unit	Depends on the current selected Y axis unit, see Swept SA discussion of Y Axis Unit
Initial S/W Revision	Prior to A.02.00

Max Mixer Lvl Rules

This function is available only in the Swept SA measurement of the SA Mode, and in all measurements of the RTSA Mode.

The **Max Mixer Level Rules** key allows you to optimize the Max Mixer Level setting for certain kinds of measurements.

- **Normal** – Normal is the historical, and thus backwards compatible, setting range (–50 to 0 dBm) and default setting (–10 dBm). The instrument has been designed so that, at the default setting, any signal below the reference level is extremely unlikely to cause ADC overloads. At this mixer level the scale fidelity will be within specifications, thus compression will be negligible.
- **TOI** – Choosing the setting “TOI-limited dynamic range” allows a range of settings of the Max Mixer Level, –50 to –10 dBm, that can be optimum for measurements limited by the analyzer third-order dynamic range. The default setting, –25 dBm, is commonly appropriate but RBW affects this. A good setting for Max Mixer Level would be higher than the optimum mixer level by half of the attenuator step size.
- **Compression** – Choosing the setting “Compression-limited dynamic range” allows a range of settings of the Max Mixer Level, –10 to +10 dBm or more, that can be optimum for measurements limited by the tradeoffs between analyzer accuracy due to compression, and dynamic range due to the noise floor. The

default setting, -3 dBm, is commonly appropriate, representing mixer drive levels that cause 1 dB or less compression at most carrier frequencies. Typical measurements that would be optimized by this setting are the measurement of low sideband levels, including nulls, in angle-modulated signals (FM and PM). Also pulsed-RF measurements, including finding nulls to estimate pulse width, which are often best done with significant overdrive (compression) of the front end.

Setting Name (readback)	Setting Name (verbose)	Max Mixer Level Preset Value, dBm	Max Mixer Level minimum value, dBm	Max Mixer Level maximum value, dBm
Normal	Normal – balance TOI, noise and compression	-10	-50	0
TOI	TOI-limited dynamic range	-25	-50	-10
Compression	Compression-limited dynamic range	-3	-10	+30

Key Path	AMPTD Y Scale, Attenuation
Remote Command	[:SENSe]:POWer[:RF]:MIXer:RULEs NORMal TOI COMPression [:SENSe]:POWer[:RF]:MIXer:RULEs?
Example	POW:MIX:RULE:COMP
Preset	NORM
Initial S/W Revision	A.19.00

Range

This key is only available when I/Q is the selected input. It replaces the Attenuation key in that case.

Each input channel (I and Q) has four internal gain ranges. The maximum allowed voltage in each gain range is slightly more than the nominal value, so the break point between ranges is a couple of millivolts higher than the nominal (setting a peak voltage of 0.502 mV will still map to the 0.5 V Peak range).

Gain Setting	Volts RMS	Volts Peak	Volts Peak - Peak	dBm (50Ω)	Break Point
0 dB	0.7071	1.0	2.0	10	n/a
6 dB	0.3536	0.5	1.0	4	0.502 V Peak
12 dB	0.1768	0.25	0.5	-2	0.252 V

18 dB	0.0884	0.125	0.25	-8	Peak 0.127 V Peak
-------	--------	-------	------	----	-------------------------

Key Path	AMPTD Y Scale
Notes	Visible only when the selected input is I/Q.
State Saved	No
Readback Text	When Range is Auto, "[Auto]" When Range is Man and I & Q are the same, "[<range value>]" When Range is Man and I & Q are different: "I: <I range value> Q: <Q range value>]" See I Range and Q Range for the <range value> enumeration definition.
Initial S/W Revision	Prior to A.02.00

Range Auto/Man

The Auto setting for Range causes the range to be set based on the Y Scale settings. When Range is "Auto", the I & Q Range are set based on the top of the Y Scale when the Y scale is in dB units (for example, power), or to the max(abs(top), abs(bottom)) when the Y scale reference is not at the top of the screen.

Not all measurements support Range Auto/Man. If Auto is not supported in the current measurement, this key is grayed out and shows "Man" and MAN is returned to a SCPI query, but this does NOT change the Auto/Man setting for Range. When you go to a measurement that supports Auto, it goes back to Auto if it was previously in Auto mode.

Key Path	AMPTD Y Scale, Range
Scope	Meas Global
Remote Command	[:SENSe] :VOLTage:IQ:RANGe:AUTO OFF ON 0 1 [:SENSe] :VOLTage:IQ:RANGe:AUTO?
Example	Put the I Range and Q Range in manual. VOLT:IQ:RANG:AUTO OFF
Dependencies	If Auto is not supported, sending the SCPI command will generate an error.
Couplings	When in Auto, both I Range and Q Range are set to the same value, computed as follows: Maximum absolute value is computed for the Y Scale. The top and bottom of the graph are computed based on Ref Value, Scale/Div, and Ref Position. Formula: YMax = max(abs(top), abs(bottom)). The I Range and Q Range are then set to YMax.
Preset	ON

State Saved	Saved in instrument state
Range	Auto Man
Initial S/W Revision	Prior to A.02.00
Remote Command	[:SENSe] :POWer :IQ :RANGe :AUTO OFF ON 0 1 [:SENSe] :POWer :IQ :RANGe :AUTO ?
Example	Put the I Range and Q Range in manual. POW:IQ:RANG:AUTO OFF
Notes	The POW:IQ:RANG:AUTO is an alternate form of the VOLT:IQ:RANG:AUTO command. This is to maintain consistency with I Range and Q Range, which support both the POWER and VOLTage forms of the command.
Preset	ON
Range	Auto Man
Initial S/W Revision	Prior to A.02.00

I Range

This is the internal gain range for the I channel when Input Path is I Only or I and I/Q, and it is used for both the I and Q channels when the Input Path is I+jQ. See "[I/Q Gain Ranges](#)" on page 615.

Key Path	AMPTD Y Scale, Range
Remote Command	[:SENSe] :VOLTage :IQ [:I] :RANGe [:UPPer] <voltage> [:SENSe] :VOLTage :IQ [:I] :RANGe [:UPPer] ?
Example	Set the I Range to 0.5 V Peak VOLT:IQ:RANG 0.5 V
Notes	The numeric entries are mapped to the smallest gain range whose break point is greater than or equal to the value, or 1 V Peak if the value is greater than 1 V.
Couplings	When Q Same as I is On, the I Range value will be copied to the Q Range. Changing the value will also set Range = Man.
Preset	1 V Peak
State Saved	Saved in instrument state
Range	1 V Peak 0.5 V Peak 0.25 V Peak 0.125 V Peak
Min	0.125 V
Max	1 V
Initial S/W Revision	Prior to A.02.00
Remote Command	[:SENSe] :POWer :IQ [:I] :RANGe [:UPPer] <amp1> [:SENSe] :POWer :IQ [:I] :RANGe [:UPPer] ?

Example	Set the I Range to 0.5 V Peak when Reference Z is 50Ω, and to 1.0 V Peak when Reference Z is 75Ω. POW:IQ:RANG 4 dBm
Notes	The POWER form of the command is provided for convenience. It maps to the same underlying gain range parameter as the VOLTage form of the command. The Reference Z (not the I channel Input Z) is used to convert the power to peak voltage, which is then used to set the I Range as with the VOLTage form of the command. The power values of the 4 range states (1V Peak, 0.5V Peak, 0.25V Peak, and 0.125V Peak) will vary with Reference Z. Here are some examples: 50Ω: 10, 4, -2, -8 75Ω: 8.2, 2.2, -3.8, -9.8 600Ω: -0.8, -6.8, -12.8, -18.9
Preset	10.0 dBm
Range	-20 dBm to 10 dBm
Min	-20 dBm
Max	10 dBm
Initial S/W Revision	Prior to A.02.00

Q Range

Accesses the Q Range menu.

Key Path	AMPTD Y Scale, Range
Readback Text	Q Same as I 1 V Peak 0.5 V Peak 0.25 V Peak 0.125 V Peak When Q Same as I is On, the readback is "Q Same as I", otherwise it is the Q Range value.
Initial S/W Revision	Prior to A.02.00

Q Same as I

Many, but not all, usages require the I and Q channels to have an identical setup. To simplify channel setup, the Q Same as I will cause the Q channel range to be mirrored from the I channel. That way you only need to set up one channel (the I channel). The I channel values are copied to the Q channel, so at the time Q Same as I is Off, the I and Q channel setups will be identical.

Key Path	AMPTD Y Scale, Range, Q Range
Remote Command	[:SENSE] :VOLTage POWER : IQ : MIRRored OFF ON 0 1 [:SENSE] :VOLTage POWER : IQ : MIRRored ?
Example	Turn off the mirroring of I Range to Q Range. VOLT:IQ:MIRR OFF POW:IQ:MIRR OFF
Couplings	When On, the I Range value is mirrored (copied) to the Q Range.
Preset	On

State Saved	Saved in instrument state.
Range	On Off
Readback Text	"Q Same as I" when On, otherwise none.
Initial S/W Revision	Prior to A.02.00

Q Range Value

This is the internal gain range for the Q channel. See "[I/Q Gain Ranges](#)" on page 615. The Q Range only applies to Input Path Q Only and Ind I/Q. For input I+jQ the I Range determines both I and Q channel range settings.

Key Path	AMPTD Y Scale, Range
Remote Command	[:SENSE] :VOLTage:IQ:Q:RANGe[:UPPer] <voltage> [:SENSe] :VOLTage:IQ:Q:RANGe[:UPPer] ?
Example	Set the Q Range to 0.5 V Peak VOLT:IQ:Q:RANG 0.5 V
Notes	The numeric entries are mapped to the smallest gain range whose break point is greater than or equal to the value, or 1 V Peak if the value is greater than 1 V. The Q Range is only used for Input Path Q Only and Ind I/Q. For input I+jQ the I Range determines both I and Q channel range settings.
Couplings	When Q Same as I is On, the I Range value will be copied to the Q Range and the range value keys are disabled. Changing the value will also set Range = Man.
Preset	1 V Peak
State Saved	Saved in instrument state
Range	1 V Peak 0.5 V Peak 0.25 V Peak 0.125 V Peak
Min	0.125 V
Max	1 V
Initial S/W Revision	Prior to A.02.00

Remote Command	[:SENSE] :POWer:IQ:Q:RANGe[:UPPer] <amp1> [:SENSe] :POWer:IQ:Q:RANGe[:UPPer] ?
Example	Will set the Q Range to 0.5 V Peak when Reference Z is 50 Ω , and to 1.0 V Peak when Reference Z is 75 Ω . POW:IQ:Q:RANG 4 dBm
Notes	The POWer form of the command is provided for convenience. It maps to the same underlying gain range parameter as the VOLTage form of the command. The Reference Z (not the Q channel Input Z) is used to convert the power to peak voltage, which is then used to set the Q Range as with the VOLTage form of the command. The power values of the 4 range states (1V Peak, 0.5V Peak, 0.25V Peak, and 0.125V Peak) will vary with Reference Z. Here are some examples: 50 Ω : 10, 4, -2, -8

	75 Ω : 8.2, 2.2, -3.8, -9.8 600 Ω : -0.8, -6.8, -12.8, -18.9
Preset	10.0 dBm
Range	-20 dBm to 10 dBm
Min	-20 dBm
Max	10 dBm
Initial S/W Revision	Prior to A.02.00

I/Q Gain Ranges

See the following sections:

- "1 V Peak" on page 615
- "0.5 V Peak" on page 615
- "0.25 V Peak" on page 615
- "0.125 V Peak" on page 615

1 V Peak

Set the channel gain state to 1 Volt Peak.

Key Path	AMPTD Y Scale, I Range Q Range
Initial S/W Revision	Prior to A.02.00

0.5 V Peak

Set the channel gain state to 0.5 Volt Peak.

Key Path	AMPTD Y Scale, I Range Q Range
Initial S/W Revision	Prior to A.02.00

0.25 V Peak

Set the channel gain state to 0.25 Volt Peak.

Key Path	AMPTD Y Scale, I Range Q Range
Initial S/W Revision	Prior to A.02.00

0.125 V Peak

Set the channel gain state to 0.125 Volt Peak.

Key Path	AMPTD Y Scale, I Range Q Range
Initial S/W Revision	Prior to A.02.00

Scale / Div

Sets the units per vertical graticule division on the display. This function is only available when Scale Type (Log) is selected and the vertical scale is power. When Scale Type (Lin) is selected, Scale/Div is grayed out.

Key Path	AMPTD Y Scale
Remote Command	:DISPlay:WINDow[1]:TRACe:Y[:SCALe]:PDIVision <rel_amp1> :DISPlay:WINDow[1]:TRACe:Y[:SCALe]:PDIVision?
Example	DISP:WIND:TRAC:Y:PDIV 5 DB
Dependencies	Scale/Div is grayed out in linear Y scale. Sending the equivalent SCPI command does change the Scale/Div, though it has no affect while in Lin.
Preset	10.00 dB / Div
State Saved	Saved in instrument state
Min	0.10 dB
Max	20 dB
Initial S/W Revision	Prior to A.02.00

Scale Type

Chooses a linear or logarithmic vertical scale for the display and for remote data readout.

When Scale Type (Log) is selected, the vertical graticule divisions are scaled in logarithmic units. The top line of the graticule is the Reference Level and uses the scaling per division Scale/Div to assign values to the other locations on the graticule.

When Scale Type (Lin) is selected, the vertical graticule divisions are linearly scaled with the reference level value at the top of the display and zero volts at the bottom. Each vertical division of the graticule represents one-tenth of the Reference Level.

NOTE

The Y Axis Unit used for each type of display is set by pressing Y Axis Unit. The analyzer remembers separate Y Axis Unit settings for both Log and Lin.

Key Path	AMPTD Y Scale
Remote Command	:DISPlay:WINDow[1]:TRACe:Y[:SCALe]:SPACing LINear LOGarithmic :DISPlay:WINDow[1]:TRACe:Y[:SCALe]:SPACing?
Example	DISP:WIND:TRAC:Y:SPAC LOG DISP:WIND:TRAC:Y:SPAC?
Dependencies	If Normalize is on, Scale Type forced to Log and is grayed out.
Couplings	Changing the Scale Type always sets the Y Axis unit to the last unit specified for the current amplitude scale. In other words, we restore the Y Axis unit setting appropriate per log/lin.
Preset	LOG
State Saved	Saved in instrument state
Initial S/W Revision	Prior to A.02.00

Presel Center

When this key is pressed, the centering of the preselector filter is adjusted to optimize the amplitude accuracy at the frequency of the selected marker. If the selected marker is not on when Presel Center is pressed, the analyzer will turn on the selected marker, perform a peak search, and then perform centering on the marker's center frequency. If the selected marker is already on and between the start and stop frequencies of the analyzer, the analyzer performs the preselector calibration on that marker's frequency. If the selected marker is already on, but outside the frequency range between Start Freq and Stop Freq, the analyzer will first perform a peak search, and then perform centering on the marker's center frequency.

The value displayed on the **Presel Adjust** key will change to reflect the new preselector tuning (see **Presel Adjust**).

A number of considerations should be observed to ensure proper operation. See ["Proper Preselector Operation" on page 618](#).

Key Path	AMPTD Y Scale
Remote Command	[:SENSe] :POWer [:RF] :PCENter
Example	POW:PCEN
Notes	Note that the rules outlined above under the key description apply for the remote command as well as the key. The result of the command is dependent on marker position, and so forth. Any message shown by the key press is also shown in response to the remote command.
Dependencies	<ul style="list-style-type: none"> - Grayed out if the microwave preselector is off.) - If the selected marker's frequency is below Band 1, advisory message 0.5001 is generated and no action is taken. - Grayed out if entirely in Band 0. - Blank in models that do not include a preselector, such as option 503. If the SCPI is sent in these instruments, it is accepted without error, and the query always returns 0. - Grayed out in the Spectrogram View.
Couplings	<p>The active marker position determines where the centering will be attempted.</p> <p>If the analyzer is in a measurement such as averaging when centering is initiated, the act of centering the preselector will restart averaging but the first average trace will not be taken until the centering is completed.</p>
Status Bits/OPC dependencies	<p>When centering the preselector, *OPC will not return true until the process is complete and a subsequent measurement has completed, nor will results be returned to a READ or MEASure command.</p> <p>The Measuring bit should remain set while this command is operating and should not go false until the subsequent sweep/measurement has completed.</p>
Initial S/W Revision	Prior to A.02.00
Modified at S/W Revision	A.03.00

Proper Preselector Operation

A number of considerations should be observed to ensure proper operation:

3. If the selected marker is off, the analyzer will turn on a marker, perform a peak search, and adjust the preselector using the selected marker's frequency. It uses the "highest peak" peak search method unqualified by threshold or excursion, so that there is no chance of a 'no peak found' error. It continues with that peak, even if it is the peak of just noise. Therefore, for this operation to work properly, there should be a signal on screen in a preselected range for the peak search to find.
4. If the selected marker is already on, the analyzer will attempt the centering at that marker's frequency. There is no preselector for signals below about 3.6 GHz, therefore if the marker is on a signal below 3.6 GHz, no centering will be attempted and an advisory message generated
5. In some models, the preselector can be bypassed. If it is bypassed, no centering will be attempted in that range and a message will be generated.

Preselector Adjust

Allows you to manually adjust the preselector filter frequency to optimize its response to the signal of interest. This function is only available when "[Presel Center](#)" on page 3111 is available.

For general purpose signal analysis, using Presel Center is recommended. Centering the filter minimizes the impact of long-term preselector drift. Presel Adjust can be used instead to manually optimize the preselector. One application of manual optimization would be to peak the preselector response, which both optimizes the signal-to-noise ratio and minimizes amplitude variations due to small (short-term) preselector drifting.

Key Path	AMPTD Y Scale
Scope	Meas Global
Remote Command	<code>[:SENSe]:POWer[:RF]:PADJust <freq></code> <code>[:SENSe]:POWer[:RF]:PADJust?</code>
Example	POW:PADJ 100KHz POW:PADJ?
Notes	The value on the key reads out to 0.1 MHz resolution.
Dependencies	<ul style="list-style-type: none"> - Grayed out if microwave preselector is off.) - Grayed out if entirely in Band 0. - Blank in models that do not include a preselector, such as option 503. If the SCPI is sent in these instruments, it is accepted without error, and the query always returns 0.

– Grayed out in the Spectrogram View.

Preset	0 MHz
State Saved	The Presel Adjust value set by Presel Center , or by manually adjusting Presel Adjust , is not saved in instrument state, and does not survive a Preset or power cycle.
Min	-500 MHz
Max	500 MHz
Default Unit	Hz
Backwards Compatibility SCPI	<code>[:SENSe] :POWer [:RF] :MW :PADJust</code> <code>[:SENSe] :POWer [:RF] :MMW :PADJust</code> PSA had multiple preselectors, but the X-Series has only one. These commands simply alias to <code>[:SENSe] :POWer [:RF] :PADJust</code>
Initial S/W Revision	Prior to A.02.00
Modified at S/W Revision	A.03.00

Remote Command	<code>[:SENSe] :POWer [:RF] :PADJust :PRESelector MWAVE MMWave EXTERNAL</code> <code>[:SENSe] :POWer [:RF] :PADJust :PRESelector?</code>
Notes	PSA had multiple preselectors, and you could select which preselector to adjust. Since the X-Series has only one mm/uW preselector, the preselector selection softkey is no longer available. However, to provide backward compatibility, we accept the legacy remote commands. The command form has no effect, the query always returns MWAVE
Initial S/W Revision	Prior to A.02.00

Y Axis Unit

Displays the menu keys that enable you to change the vertical (Y) axis amplitude unit. The analyzer retains the entered Y Axis Unit separately for both Log and Lin amplitude scale types. For example, if Scale Type has been set to Log, and you set Y Axis Unit to dBm, pressing Scale Type (Log) sets the Y Axis Unit to dBm. If Scale Type has been set to Lin and you set Y Axis Unit to V, pressing Scale Type (Lin) sets the Y Axis Unit to V. Pressing Scale Type (Log) again sets the Y axis unit back to dBm.

NOTE

The units of current (A, dBmA, dBuA) are calculated based on 50 ohms input impedance.

All four of the EMI units (dB μ A/m, dB μ V/m, dBG, dBpT) are treated by the instrument exactly as though they were dBuV. The user must load an appropriate correction factor using Amplitude Corrections for accurate and meaningful results.

If a SCPI command is sent to the analyzer that uses one of the EMI units as a terminator, the analyzer treats it as though DBUV had been sent as the terminator.

Key Path	AMPTD Y Scale
----------	---------------

Mode	SA
Scope	Meas Global
Remote Command	:UNIT:POWer DBM DBMV DBMA V W A DBUV DBUA DBPW DBUVM DBUAM DBPT DBG :UNIT:POWer?
Example	UNIT:POW dBmV UNIT:POW?
Notes	The Y axis unit has either logarithmic or linear characteristics. The set of units that is logarithmic consists of dBm, dBmV, dBmA, dBμV, dBμA, dBμV/m, dBμA/m, dBpT, and dBG. The set of units that are linear consists of V, W, and A. The chosen unit will determine how the reference level and all the amplitude-related outputs like trace data, marker data, etc. read out.
Notes	The settings of Y Axis Unit and Scale Type, affect how the data is read over the remote interface. When using the remote interface no unit is returned, so you must know what the Y axis unit is to interpret the results: Example 1, set the following: Scale Type (Log) Y Axis Unit, dBm Scale/Div, 1 dB Ref Level, 10 dBm This sets the top line to 10 dBm with each vertical division representing 1 dB. Thus, if a point on trace 1 is on the fifth graticule line from the top, it represents 5 dBm and will read out remotely as 5. Example 2, set the following: Scale Type (Lin) Y Axis Unit, Volts Ref Level, 100 mV (10 mV/div) This sets the top line to 100 mV and the bottom line to 0 V, so each vertical division represents 10 mV. Thus, if a point on trace 1 is on the fifth graticule line from the top, it represents 50 mV and will read out remotely as 50.
Dependencies	If an amplitude correction with an Antenna Unit other than None is applied and enabled, then that antenna unit is forced and the key with that unit is the only Y Axis Unit available. All other Y Axis Unit keys are grayed out. If an amplitude correction with an Antenna Unit other than None is applied and enabled, and you then turn off that correction or set Apply Corrections to No , the Y Axis Unit that existed before the Antenna Unit was applied is restored.
Couplings	The analyzer retains the entered Y Axis Unit separately for both Log and Lin amplitude scale types
Preset	dBm for log scale, V for linear. The true 'preset' value is dBm, since at preset the Y Scale type is set to logarithmic.
State Saved	Saved in instrument state
Readback line	1-of-N selection
Initial S/W Revision	Prior to A.02.00
Modified at S/W Revision	A.02.00, A.04.00, A.11.00

dBm

Sets the amplitude unit for the selected amplitude scale (log/lin) to dBm.

Key Path	AMPTD Y Scale, Y Axis Unit
Example	UNIT:POW DBM
Dependencies	Grayed out if an Amplitude Correction with an Antenna Unit is ON.
Readback	dBm
Initial S/W Revision	Prior to A.02.00
Modified at S/W Revision	A.02.00

dBmV

Sets the amplitude unit for the selected amplitude scale (log/lin) to dBmV.

Key Path	AMPTD Y Scale, Y Axis Unit
Example	UNIT:POW DBMV
Dependencies	Grayed out if an Amplitude Correction with an Antenna Unit is ON.
Readback	dBmV
Initial S/W Revision	Prior to A.02.00
Modified at S/W Revision	A.02.00

dBmA

Sets the amplitude unit for the selected amplitude scale (log/lin) to dBmA.

Key Path	AMPTD Y Scale, Y Axis Unit
Example	UNIT:POW DBMA
Dependencies	Grayed out if an Amplitude Correction with an Antenna Unit is ON.
Readback	dBmA
Initial S/W Revision	Prior to A.02.00
Modified at S/W Revision	A.02.00

W

Sets the amplitude unit for the selected amplitude scale (log/lin) to watt.

Key Path	AMPTD Y Scale, Y Axis Unit
Example	UNIT:POW W
Dependencies	Grayed out if an Amplitude Correction with an Antenna Unit is ON.
Readback	W

Initial S/W Revision	Prior to A.02.00
Modified at S/W Revision	A.02.00

V

Sets the amplitude unit for the selected amplitude scale (log/lin) to volt.

Key Path	AMPTD Y Scale, Y Axis Unit
Example	UNIT:POW V
Dependencies	Grayed out if an Amplitude Correction with an Antenna Unit is ON.
Readback	V
Initial S/W Revision	Prior to A.02.00
Modified at S/W Revision	A.02.00

A

Sets the amplitude unit for the selected amplitude scale (log/lin) to Ampere.

Key Path	AMPTD Y Scale, Y Axis Unit
Example	UNIT:POW A
Dependencies	Grayed out if an Amplitude Correction with an Antenna Unit is ON.
Readback	A
Initial S/W Revision	Prior to A.02.00
Modified at S/W Revision	A.02.00

dB μ V

Sets the amplitude unit for the selected amplitude scale (log/lin) to dB μ V.

Key Path	AMPTD Y Scale, Y Axis Unit
Example	UNIT:POW DBUV
Dependencies	Grayed out if an Amplitude Correction with an Antenna Unit is ON.
Readback	dB μ V
Initial S/W Revision	Prior to A.02.00
Modified at S/W Revision	A.02.00

dB μ A

Sets the amplitude unit for the selected amplitude scale (log/lin) to dB μ A.

NOTE

The unit dBuA can also appear as an Antenna Unit. This will be used by customers using current probes, because current probes are often supplied with conversion tables that provide the transducer factors. When dBuA is used as an Antenna Unit the normal conversion from power to amps for dBuA (based on the analyzer input impedance) is not done, but instead the conversion is based solely on the Correction that contains the transducer factors. This is what distinguishes dBuA as a normal unit from dBuA as an antenna unit. When querying the Y-Axis unit, you can query the Antenna Unit to distinguish between regular dBuA and the dBuA antenna unit. If :CORR:CSET:ANT? returns NOC (for No Conversion), you are using a normal Y Axis dBuA. If it returns UA you are using an Antenna Unit dBuA.

Key Path	AMPTD Y Scale, Y Axis Unit
Example	UNIT:POW DBUA
Dependencies	Grayed out if an Amplitude Correction with an Antenna Unit is ON.
Readback	dB μ A
Initial S/W Revision	Prior to A.02.00
Modified at S/W Revision	A.02.00

Antenna Unit

When a Correction is turned on that uses an Antenna Unit, the Y Axis Unit changes to that Antenna Unit. All of the keys in the Y-Axis Unit menu are then greyed out, except the Antenna Unit key. The unit being used is shown on this key and is shown as selected in the submenu.

Key Path	AMPTD Y Scale, Y Axis Unit
Dependencies	Grayed out if no Amplitude Correction with an Antenna Unit is on.
Readback line	Currently selected unit
Initial S/W Revision	A.11.00

dB μ V/m

Sets the amplitude unit for the selected amplitude scale (log/lin) to dB μ V/m. This is an antenna unit, and this key is grayed out unless a Correction with this Antenna Unit selected is ON. If this is the case, all of the other Antenna Units are grayed out.

Key Path	AMPTD Y Scale, Y Axis Unit, Antenna Unit
Example	UNIT:POW DBUVM
Dependencies	Grayed out if no Amplitude Correction with an Antenna Unit is on.
Readback	dB μ V/m
Initial S/W Revision	A.02.00

dB μ A/m

Sets the amplitude unit for the selected amplitude scale (log/lin) to dB μ A/m. This is an antenna unit, and this key is grayed out unless a Correction with this Antenna Unit selected is ON. If this is the case, all of the other Antenna Units are grayed out.

Key Path	AMPTD Y Scale, Y Axis Unit, Antenna Unit
Example	UNIT:POW DBUAM
Dependencies	Grayed out if no Amplitude Correction with an Antenna Unit is on.
Readback	dB μ A/m
Initial S/W Revision	A.02.00

dB μ A

Sets the amplitude unit for the selected amplitude scale (log/lin) to dB μ A. This is an antenna unit, and this key is grayed out unless a Correction with this Antenna Unit selected is ON. If this is the case, all of the other Antenna Units are grayed out.

Key Path	AMPTD Y Scale, Y Axis Unit, Antenna Unit
Example	UNIT:POW DBUAM
Dependencies	Grayed out if no Amplitude Correction with an Antenna Unit is on.
Readback	dB μ A
Initial S/W Revision	A.11.00

dBpT

Sets the amplitude unit for the selected amplitude scale (log/lin) to dBpT. This is an antenna unit, and this key is grayed out unless a Correction with this Antenna Unit selected is ON. If this is the case, all of the other Antenna Units are grayed out.

Key Path	AMPTD Y Scale, Y Axis Unit, Antenna Unit
Example	UNIT:POW DBPT
Dependencies	Grayed out if no Amplitude Correction with an Antenna Unit is on.
Readback	dBpT
Initial S/W Revision	A.02.00

DBG

Sets the amplitude unit for the selected amplitude scale (log/lin) to DBG. This is an antenna unit, and this key is grayed out unless a Correction with this Antenna Unit selected is ON. If this is the case, all of the other Antenna Units are grayed out.

Key Path	AMPTD Y Scale, Y Axis Unit, Antenna Unit
Example	UNIT:POW DBG
Dependencies	Grayed out if no Amplitude Correction with an Antenna Unit is on.
Readback	DBG
Initial S/W Revision	A.02.00

None

This is selected if no Antenna Unit is currently on, however you cannot actually set this value, since it is always grayed out. The key is included simply to provide an indication on the Readback line of the Antenna Unit key when there is no Antenna Unit selected.

Key Path	AMPTD Y Scale, Y Axis Unit, Antenna Unit
Readback	"None"
Initial S/W Revision	A.11.00

Reference Level Offset

Adds an offset value to the displayed reference level. The reference level is the absolute amplitude represented by the top graticule line on the display.

See ["More Information" on page 625](#)

Key Path	AMPTD Y Scale
Mode	SA
Scope	Meas Global
Remote Command	:DISP:WINDow[1]:TRACe:Y[:SCALe]:RLEVel:OFFSet <rel_amp1> :DISP:WINDow[1]:TRACe:Y[:SCALe]:RLEVel:OFFSet?
Example	DISP:WIND:TRAC:Y:RLEV:OFFS 12.7 Sets the Ref Level Offset to 12.7 dB. The only valid suffix is dB. If no suffix is sent, dB will be assumed.
Preset	0 dBm
State Saved	Saved in instrument state
Min	The range for Ref Lvl Offset is variable. It is limited to values that keep the reference level within the range of -327.6 dB to 327.6 dB.
Max	327.6 dB
Backwards Compatibility Notes	6. In pre-X-Series instruments, Ref Level Offset could not be adjusted by the knob or step keys. That is no longer the case. 7. In ESA and PSA, Ref Level Offset was applied to the data as it was acquired; thus if the Offset changed the new offset was not applied until new trace data was taken. In X-Series, the offset is applied as the data is displayed/queried, so if you change the offset, it will change the data immediately.
Initial S/W Revision	Prior to A.02.00
Modified at S/W Revision	A.04.00

More Information

Offsets are used when gain or loss occurs between a device under test and the analyzer input. Thus, the signal level measured by the analyzer may be thought of

as the level at the input of an external amplitude conversion device. Entering an offset does not affect the trace position or attenuation value, just the value of the top line of the display and the values represented by the trace data. Thus, the values of exported trace data, queried trace data, marker amplitudes, trace data used in calculations such as N dB points, trace math, peak threshold, and so forth, are all affected by Ref Level Offset.

NOTE

Changing the offset causes the analyzer to immediately stop the current sweep and prepare to begin a new sweep, but the data will not change until the trace data updates, because the offset is applied to the data as it is taken. If a trace is exported with a nonzero Ref Level Offset, the exported data will contain the trace data with the offset applied.

The maximum reference level available is dependent on the reference level offset. That is, Ref Level - Ref Level Offset must be in the range -170 to +30 dBm. For example, the reference level value range can be initially set to values from -170 dBm to 30 dBm with no reference level offset. If the reference level is first set to -20 dBm, then the reference level offset can be set to values of -150 to +50 dB.

If the reference level offset is first set to -30 dB, then the reference level can be set to values of -200 dBm to 0 dBm. In this case, the reference level is “clamped” at 0 dBm because the maximum limit of +30 dBm is reached with a reference level setting of 0 dBm with an offset of -30 dB. If instead, the reference level offset is first set to 30 dB, then the reference level can be set to values of -140 to +60 dBm.

μW Path Control

The **μW Path Control** functions include the **μW Preselector Bypass** (Option MPB) and **Low Noise Path** (Option LNP) controls in the High Band path circuits.

When the μW Preselector is bypassed, the user has better flatness, but will be subject to spurs from out of band interfering signals. When the Low Noise Path is enabled, the analyzer automatically switches around certain circuitry in the high frequency bands which can contribute to noise, when it is appropriate based on other analyzer settings.

For most applications, the preset state is Standard Path, which gives the best remote-control throughput, minimizes acoustic noise from switching and minimizes the risk of wear out in the hardware switches. For applications that utilize the wideband IF paths, the preset state is the μW Preselector Bypass path, if option MPB is present. This is because, when using a wideband IF such as the 140 MHz IF, the μW Preselector’s bandwidth can be narrower than the available IF bandwidth, causing degraded amplitude flatness and phase linearity, so it is desirable to bypass the preselector in the default case.

Users may choose Low Noise Path Enable. It gives a lower noise floor, especially in the 21-26.5 GHz region, though without improving many measures of dynamic range, and without giving the best possible noise floor. The preamp, if purchased and used, gives better noise floor than does the Low Noise Path, however its compression threshold and third-order intercept are much poorer than that of the non-preamp Low Noise Path. There are some applications, typically for signals around -30 dBm, for which the third-order dynamic range of the standard path is

good enough, but the noise floor is not low enough even with 0 dB input attenuation. When the third-order dynamic range of the preamp path is too little and the noise floor of the standard path is too high, the Low Noise Path can provide the best dynamic range.

Key Path	AMPTD Y Scale
Mode	SA, BASIC, PNOISE, VSA , LTE, LTETDD
Scope	Meas Global
Remote Command	[:SENSe] :POWer [:RF] :MW:PATH STD LNPath MPBypass FULL [:SENSe] :POWer [:RF] :MW:PATH?
Example	:POW:MW:PATH LNP Enables the Low Noise path
Notes	If a Presel Center is performed, the analyzer will momentarily switch to the Standard Path, regardless of the setting of μW Path Control The DC Block will always be switched in when the low noise path is switched in, to protect succeeding circuitry from DC. Note that this does not mean “when the low noise path is enabled” but when, based on the Low Noise Path rules, the path is actually switched in. This can happen when the selection is Low Noise Path Enable . In the case where the DC Block is switched in the analyzer is now AC coupled. However, if the user has selected DC coupling, the UI will still behave as though it were DC coupled, including all annunciation, warnings, status bits, and responses to SCPI queries. This is because, based on other settings, the analyzer could switch out the low noise path at any time and hence go back to being DC coupled. Alignment switching ignores the settings in this menu, and restores them when finished.
Dependencies	Unavailable in BBIQ and External Mixing
Preset	All modes other than IQ Analyzer mode and VXA: STD IQ Analyzer, VXA and WLAN mode: MPB option present and licensed: MPB MPB option not present and licensed: STD
State Saved	Save in instrument state
Readback	Value selected in the submenu
Initial S/W Revision	A.04.00
Modified at S/W Revision	A.10.00

Standard Path

This path gives the best remote-control throughput, minimizes acoustic noise from switching and minimizes the risk of wear in the hardware switches, particularly in remote test scenarios where both low band and high band setups will follow in rapid succession.

In this path, the bypass of the low band/high band switch and microwave preamp is never activated, which can cause some noise degradation but preserves the life of the bypass switch.

Key Path	AMPTD Y Scale, μW Path Control
----------	---------------------------------------

Example	:POW:MW:PATH STD
Readback Text	Standard Path
Initial S/W Revision	A.04.00

Low Noise Path Enable

You may choose Low Noise Path Enable, which gives a lower noise floor under some circumstances, particularly when operating in the 21–26.5 GHz region. With the Low Noise Path enabled, the low band/high band switch and microwave preamp are bypassed whenever all of the following are true:

- The analyzer is not in the Low Band, meaning:
- the start frequency is above 3.5 GHz and
- the stop frequency is above 3.6 GHz.
- the internal preamp is not installed or (if installed) is set to **Off** or **Low Band**

Note that this means that, when any part of a sweep is done in Low Band, the Low Noise Path is not used, whether or not the **Low Noise Path Enable** is selected in the user interface. Also, if the preamp is turned on, the Low Noise Path is not used, whether or not the **Low Noise Path Enable** is selected in the user interface. The only time the Low Noise Path is used is when **Low Noise Path Enable** is selected, the sweep is completely in High Band (> 3.6 GHz) and no preamp is in use.

See "[More Information](#)" on page 628

Key Path	AMPTD Y Scale, μW Path Control
Measurement	Swept SA
Example	:POW:MW:PATH LNP
Notes	For measurements that use IQ acquisition, the low noise path is used when the Center Frequency is in High Band (> 3.6 GHz) and no preamp is in use. In other words, the rules above are modified to use only the center frequency to qualify which path to switch in. This is not the case for FFT's in the Swept SA measurement; they use the same rules as swept measurements.
Dependencies	Key is blanked if current mode does not support it. Key is grayed out if mode supports it but current measurement does not support it. Unless Option LNP is present and licensed, key is blank and if SCPI command sent, error -241, "Hardware missing; Option not installed" is generated.
Readback Text	Low Noise Path Enable
Initial S/W Revision	A.04.00

More Information

The user should understand that the Low Noise Path, while giving improved DANL, has the disadvantage of decreased TOI performance and decreased gain

compression performance relative to the standard path.

The user should also understand that the bypass switch is a mechanical switch and has finite life, so if the **Low Noise Path** is enabled, it is possible to cause frequent cycling of this switch by frequently changing analyzer settings such that the above conditions hold true only some of the time. A user making tests of this nature should consider opting for the **Standard Path**, which will never throw the bypass switch, at the expense of some degraded noise performance.

The low noise path is useful for situations where the signal level is so low that the analyzer performance is dominated by noise even with 0 dB attenuation, but still high enough that the preamp option would have excessive third-order intermodulation or compression. The preamp, if purchased and used, gives better noise floor than does the “Low Noise Path.” However, its compression threshold and third-order intercept are much poorer than that of the non-preamp path. There are some applications, typically for signals around -30 dBm, for which the third-order dynamic range of the standard path is good enough, but the noise floor is not low enough even with 0 dB input attenuation. When the third-order dynamic range of the preamp path is too little and the noise floor of the standard path is too high, the Low Noise Path can provide the best dynamic range

The graph below illustrates the concept. It shows, in red, the performance of an analyzer at different attenuation settings, both with the preamp on and off, in a measurement that is affected by both analyzer noise and analyzer TOI. The green shows the best available dynamic range, offset by 0.5 dB for clarity. The blue shows how the best available dynamic range improves for moderate signal levels with the low noise path switched in. In this illustration, the preamp improves the noise floor by 15 dB while degrading the third-order intercept by 30 dB, and the low noise path reduces loss by 8 dB. The attenuator step size is 2 dB.

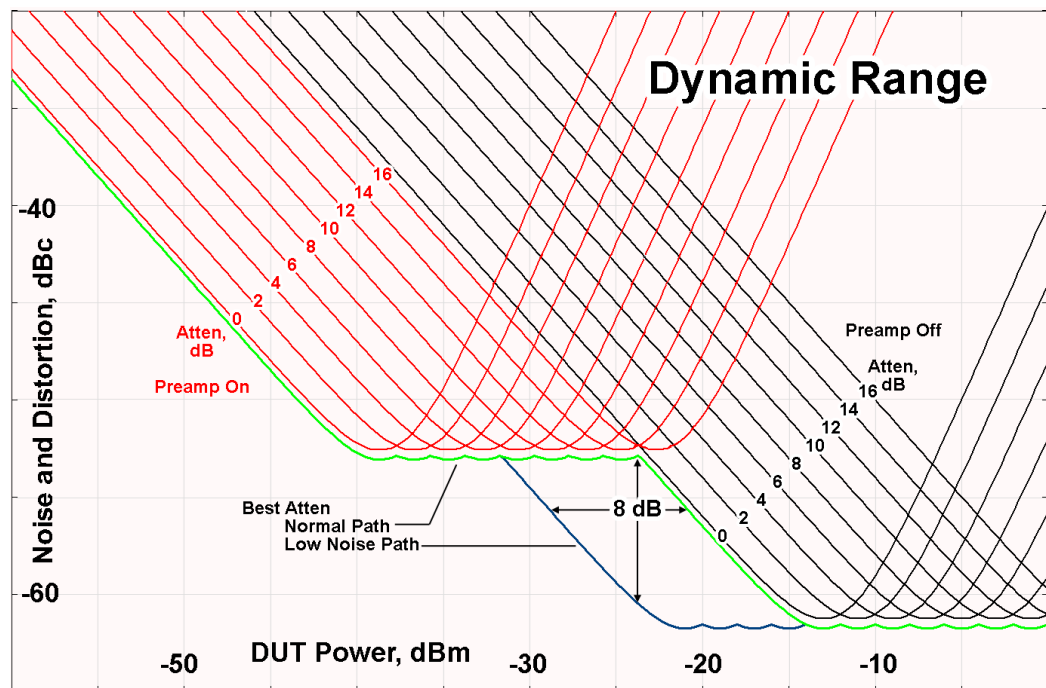

There are other times where selecting the low noise path improves performance, too. Compression-limited measurements such as finding the nulls in a pulsed-RF spectrum can profit from the low noise path in a way similar to the TOI-limited measurement illustrated. Accuracy can be improved when the low noise path allows the optimum attenuation to increase from a small amount like 0, 2 or 4 dB to a larger amount, giving better return loss at the analyzer input. Harmonic measurements, such as second and third harmonic levels, are much improved using the low noise path because of the superiority of that path for harmonic (though not intermodulation) distortion performance.

μW Preselector Bypass

This key toggles the preselector bypass switch for band 1 and higher. When the microwave preselector is on, the signal path is preselected. When the microwave preselector is off, the signal path is not preselected. The preselected path is the normal path for the analyzer.

The preselector is a tunable bandpass filter which prevents signals away from the frequency of interest from combining in the mixer to generate in-band spurious signals (images). The consequences of using a preselector filter are its limited bandwidth, the amplitude and phase ripple in its passband, and any amplitude and phase instability due to center frequency drift.

Option MPB or pre-selector bypass provides an unpreselected input mixer path for certain X-Series signal analyzers with frequency ranges above 3.6 GHz. This signal path allows a wider bandwidth and less amplitude variability, which is an advantage when doing modulation analysis and broadband signal analysis. The disadvantage is that, without the preselector, image signals will be displayed. Another disadvantage of bypassing the preselector is increased LO emission levels at the front panel input port.

Image responses are separated from the real signal by twice the 1st IF. For IF Paths of 10 MHz and 25 MHz, the 1st IF is 322.5 MHz, so the image response and the real signal will be separated by 645 MHz. The 1st IF will be different for other IF Path settings. When viewing a real signal and its corresponding image response in internal mixing, the image response will be to the left of the real signal.

Also, the image response and the real signal typically have the same amplitude and exhibit the same shape factor.

However, if Option FS1, Fast Sweep Capability, is enabled, the image response in the Swept SA measurement will appear lower in amplitude and have a much wider shape factor compared to the real signal.

Key Path	AMPTD Y Scale, μW Path Control
Example	:POW:MW:PATH MPB
Dependencies	Key is blanked if current mode does not support it. Key is grayed out if mode supports it but current measurement does not support it. Key is blank unless Option MPB is present and licensed. If SCPI command sent when MPB not present, error -241, "Hardware missing; Option not installed" is generated.

Readback Text	μ W Preselector Bypass
Initial S/W Revision	A.04.00
Remote Command	<code>[:SENSe]:POWer[:RF]:MW:PRESelector[:STATe] ON OFF 0 1</code> <code>[:SENSe]:POWer[:RF]:MW:PRESelector[:STATe]?</code>
Example	<code>:POW:MW:PRES OFF</code> Bypasses the microwave preselector
Notes	The ON parameter sets the STD path (:POW:MW:PATH STD) The OFF parameter sets path MPB (:POW:MW:PATH MPB)
Preset	ON

Internal Preamp

Accesses a menu of keys that control the internal preamps. Turning on the preamp gives a better noise figure, but a poorer TOI to noise floor dynamic range. You can optimize this setting for your particular measurement.

The instrument takes the preamp gain into account as it sweeps. If you sweep outside of the range of the preamp the instrument will also account for that. The displayed result will always reflect the correct gain.

For some measurements, when the preamp is on and any part of the displayed frequency range is below the lowest frequency for which the preamp has specifications, a warning condition message appears in the status line. For example ,for a preamp with a 9 kHz lowest specified frequency: "Preamp: Accy unspec'd below 9 kHz".

Key Path	AMPTD Y Scale
Scope	Meas Global
Remote Command	<code>[:SENSe]:POWer[:RF]:GAIN[:STATe] OFF ON 0 1</code> <code>[:SENSe]:POWer[:RF]:GAIN[:STATe]?</code>
Dependencies	Preamp is not available on all hardware platforms. If the preamp is not present or is unlicensed, the key is not shown. The preamp is not available when the electronic/soft attenuator is enabled.
Couplings	The act of connecting the U7227A USB Preamplifier to one of the analyzer's USB ports will cause the Internal Preamp to be switched on. When this happens an informational message will be generated: "Internal Preamp turned on for optimal operation with USB Preamp." Note that if the Internal Preamp was already on, there will be no change to the setting, but if it was Off it will be switched On, to Full Range. Note that this same action occurs when the SA mode is selected while the USB Preamp is connected to one of the analyzer's USB ports, if it is the first time that the SA mode has run since powerup, or if the last time the SA mode was running the USB Preamp was NOT connected. Subsequently disconnecting the USB Preamp from USB does not change the Internal Preamp setting nor restore the previous setting.

Preset	OFF
State Saved	Saved in instrument state
Initial S/W Revision	Prior to A.02.00
Modified at S/W Revision	A.14.00

Key Path	AMPTD Y Scale, Internal Preamp
Scope	Meas Global
Remote Command	<code>[:SENSe] :POWer [:RF] :GAIN :BAND LOW FULL</code> <code>[:SENSe] :POWer [:RF] :GAIN :BAND ?</code>
Dependencies	Preamp is not available on all hardware platforms. If the preamp is not present or is unlicensed, the key is not shown. If a POW:GAIN:BAND FULL command is sent when a low band preamp is available, the preamp band parameter is to LOW instead of FULL, and an "Option not installed" message is generated.
Preset	LOW
State Saved	Saved in instrument state
Initial S/W Revision	Prior to A.02.00

Off

Turns the internal preamp off

Key Path	AMPTD Y Scale, Internal Preamp
Example	<code>:POW:GAIN OFF</code>
Readback	Off
Initial S/W Revision	Prior to A.02.00

Low Band

Sets the internal preamp to use only the low band.

The frequency range of the installed (optional) low-band preamp is displayed in square brackets on the **Low Band** key label.

Key Path	AMPTD Y Scale, Internal Preamp
Example	<code>:POW:GAIN ON</code> <code>:POW:GAIN:BAND LOW</code>
Readback	Low Band
Initial S/W Revision	Prior to A.02.00

Full Range

Sets the internal preamp to use its full range. The low band (0-3.6 GHz or 0-3GHz, depending on the model) is supplied by the low band preamp and the frequencies

above low band are supplied by the high band preamp.

The frequency range of the installed (optional) preamp is displayed in square brackets on the **Full Range** key label. If the high band option is not installed the Full Range key does not appear.

Key Path	AMPTD Y Scale, Internal Preamp
Example	:POW:GAIN ON :POW:GAIN:BAND FULL
Readback	Full Range
Initial S/W Revision	Prior to A.02.00

Auto Couple

The Auto Couple feature provides a quick and convenient way to automatically couple multiple instrument settings. This helps ensure accurate measurements and optimum dynamic range. When the Auto Couple feature is activated, either from the front panel or remotely, all parameters of the current measurement that have an Auto/Manual mode are set to Auto mode and all measurement settings dependent on (or coupled to) the Auto/Man parameters are automatically adjusted for optimal performance.

However, the Auto Couple keyactions are confined to the current measurement only. It does not affect other measurements in the mode, and it does not affect markers, marker functions, or trace or display attributes.

See "[More Information](#)" on page 634

Key Path	Front-panel key
Remote Command	:COUPle ALL NONE
Example	:COUP ALL
Notes	:COUPle ALL puts all Auto/Man parameters in Auto mode (equivalent to pressing the Auto Couple key). :COUPLE NONE puts all Auto/Man parameters in manual mode. It decouples all the coupled instrument parameters and is not recommended for making measurements.
Initial S/W Revision	Prior to A.02.00

More Information

There are two types of functions that have Auto/Manual modes.

Auto/Man Active Function keys

An Auto/Man toggle key controls the binary state associated with an instrument parameter by toggling between **Auto** (where the parameter is automatically coupled to the other parameters it is dependent upon) and **Man** (where the parameter is controlled independent of the other parameters), as well as making the parameter the active function. The current mode is indicated on the softkey with either **Auto** or **Man** underlined as illustrated below.

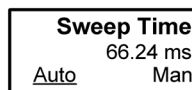

vsd07

Auto/Man 1-of-N keys

An Auto/Man 1-of-N key allows you to manually pick from a list of parameter values, or place the function in Auto, in which case the value is automatically selected (and indicated).

- If in Auto, Auto is underlined on the calling key.

- If in manual operation, manual is indicated on the calling key, but note that the calling key simply opens the menu and does **not** actually toggle the function.

BW

The BW key opens the bandwidth menu, which contains keys to control the Resolution Bandwidth and Video Bandwidth functions of the instrument.

The Resolution BW functions control filter bandwidth and filter type. There are two filter types, Gaussian and Flattop. The Gaussian filters have a response curve that is parabolic on a log scale. The Flattop filter shape is a close approximation of a rectangular filter.

NOTE

The AVERAGE functions, which appeared in the BW menu in earlier analyzers, can now be found in the Trace menu and the Meas Setup menu. In the Trace menu, you may turn Trace Averaging on or off for the desired traces (rather than globally as in the past); and in the Meas Setup menu you may configure Averaging, by setting the Average Number and the Average Type.

Key Path	Front-panel key
Backwards Compatibility Notes	<p>In previous analyzers, the BW hardkey was labeled “BW/Avg” and included menu keys to control the averaging behavior of the instrument, which was global.</p> <p>In the X-Series, averaging is performed on a trace-by-trace basis, with a corresponding impact on the SCPI functions. A backwards compatibility command (<code>[:SENSe]:AVERAge[:STATe]</code>) is provided to preserve the old global behavior. See the Trace/Det section for details.</p> <p>The control for the Average number is now found in the Meas Setup menu. See the Meas Setup section for details.</p>
Initial S/W Revision	Prior to A.02.00

Res BW

Activates the resolution bandwidth active function, which allows you to manually set the resolution bandwidth (RBW) of the analyzer. Normally, **Res BW** (Auto) selects automatic coupling of the Res BW to Span using the ratio set by the Span:3 dB RBW key. To decouple the resolution bandwidth, press Res BW until Man is underlined, or simply enter a different value for **Res BW**.

See ["More Information" on page 637](#)

Key Path	BW
Remote Command	<pre>[:SENSe]:BANDwidth BWIDth[:RESolution] <freq> [:SENSe]:BANDwidth BWIDth[:RESolution]? [:SENSe]:BANDwidth BWIDth[:RESolution]:AUTO OFF ON 0 1 [:SENSe]:BANDwidth BWIDth[:RESolution]:AUTO?</pre>
Example	<pre>BAND 1 KHZ BAND? BWID:AUTO ON BWID:AUTO?</pre>
Notes	For numeric entries, all RBW Types choose the nearest (arithmetically, on a linear scale, rounding

	up) available RBW to the value entered. The setting and querying of values depends on the current bandwidth type.
Dependencies	When in Zero Span with no EMI Standard selected, there is no Auto setting for Res BW. The Auto/Man line on the Res BW softkey disappears in this case, and if the SCPI command [:SENSe]:BWID[:RESolution]:AUTO ON is sent, it generates a message. While using the Tracking Generator, you must make sure the Start Frequency is high enough to avoid capturing LO feedthrough in the trace. How high you must make the Start Frequency to avoid this will depend on the RBW you have set. The analyzer displays a condition warning message if the Start Frequency falls below roughly 2.5 times the current RBW. The warning is "Source Uncal;adj Start Freq RBW Points". When you see this warning, you should increase the Start Freq, narrow the RBW, or increase the number of Sweep Points. For M9290A, if the requested setting of Res BW is less than 100KHz in Tracking Source mode, a condition warning message is generated. The warning is 301, "Meas Uncal".
Couplings	Res BW is normally coupled to Span; if Res BW is set to Auto, as the Span decreases, so will the Res BW. Normally, in Zero Span, this coupling is turned off and Res BW has no Auto setting. When a CISPR or MIL EMI Standard is in use, the Res BW is coupled to Center Frequency and not to Span, and this is true even in Zero Span. Sweep time is coupled to RBW when in a non-zero span. If Sweep Time is set to Auto, then the sweep time is changed as the RBW changes, to maintain amplitude calibration. Video bandwidth (VBW) is normally coupled to RBW. If VBW is set to Auto, then the VBW is changed as the RBW changes, to maintain the ratio set by VBW:3 dB RBW. See the " VBW:3dB RBW " on page 640 " VBW:3dB RBW " on page 640 key description.
Preset	3 MHz ON
State Saved	Saved in instrument state
Min	1 Hz
Max	8 MHz is the max equivalent -3 dB RBW, which means that the named RBW (the one shown on the key etc.) can actually exceed 8 MHz if using a filter other than -3 dB Gaussian
Default Unit	Hz
Backwards Compatibility Notes	For backwards compatibility this command obeys both the BANDwidth and BWIDth forms. For ESA, the maximum Res BW was 5 MHz; on X-Series it is 8 MHz.
Initial S/W Revision	Prior to A.02.00

More Information

When the **Res BW** is manually selected, it may be returned to the coupled state by pressing the **Res BW** key until **Auto** is underlined. This may also be done by pressing Auto Couple or by performing a **Preset**.

When **Res BW** is set to **Auto**, the bandwidth selected depends on the Filter Type (see "Filter Type" below).

Only certain discrete resolution bandwidths are available. The available bandwidths are dependent on the **Filter Type** or the **EMC Standard**. If an unavailable bandwidth is entered with the numeric keypad, the closest available bandwidth is selected.

The zero-span case deserves some mention, because RBW is coupled to Span when in a swept (non-zero) span and in zero span there is normally no meaningful RBW coupling in Zero Span. However, when a MIL or CISPR EMC Standard is selected, there is a meaningful coupling for RBW in Zero Span – in fact, it is coupled to Center Frequency, in order to make measurements according to the EMI specifications.

The annotation under RBW in the bottom left of the screen shows the type of filter or bandwidth that is being used. The following examples illustrate this:

-3 dB (Normal) filter BW:	Res BW 300 Hz
-6 dB filter BW:	Res BW (-6 dB) 422 Hz
Noise filter BW:	Res BW (Noise) 317 Hz
Impulse filter BW:	Res BW (Impulse) 444 Hz
CISPR filter BW :	Res BW (CISPR) 200 Hz
MIL filter BW:	Res BW (MIL) 1 kHz
Flattop filter type:	Res BW (Flattop) 300 Hz

Video BW

Lets you change the analyzer post-detection filter (VBW or “video bandwidth”) from 1 Hz to 8 MHz in approximately 10% steps. In addition, a wide-open video filter bandwidth may be chosen by selecting 50 MHz. The VBW is annotated at the bottom of the display, in the center.

NOTE

An * is displayed next to the VBW annotation when certain detector types (Average, EMI Average, Quasi Peak, and RMS Average) are in use. This is because the VBW filter is out of the circuit for these detectors and does not affect any traces which use them. If there is any active trace using one of these detectors the * is displayed. See ["Annotation Examples" on page 639](#).

Normally, Video BW (Auto) selects automatic coupling of the Video BW filter to the resolution bandwidth filter using the ratio set by the VBW:3 dB RBW key. To decouple the video bandwidth, press Video BW until Man is underlined, or simply enter a new value.

When the **Video BW** is manually selected, it may be returned to the coupled state by pressing the **Video BW** key until **Auto** is underlined. This may also be done by pressing Auto Couple or by performing a **Preset**.

Key Path	BW
Remote Command	[:SENSe] :BANDwidth BWIDth :VIDeo <freq> [:SENSe] :BANDwidth BWIDth :VIDeo?

	<code>[:SENSe]:BANDwidth BWIDth:VIDeo:AUTO OFF ON 0 1</code>
	<code>[:SENSe]:BANDwidth BWIDth:VIDeo:AUTO?</code>
Example	BAND:VID 1 KHZ BAND:VID? BWID:VID:AUTO ON BWID:VID:AUTO?
Notes	For numeric entries, the analyzer chooses the nearest (arithmetically, on a linear scale, rounding up) available VBW to the value entered. The 50 MHz VBW is defined to mean “wide open”. The values shown in this table reflect the conditions after a Mode Preset.
Dependencies	Sometimes the displayed Video BW is not actually used to process the trace data: <ul style="list-style-type: none"> - When the Average Detector is selected and Sweep Type is set to Swept, the video bandwidth filter cannot be used, because it uses the same hardware as the Average Detector. - When the Quasi-Peak, EMI Average or RMS Average detector is selected the VBW is implemented by the digital IF as part of the detector <p>When this is the case, the VBW still acts to change the Sweep Time, if Sweep Time is in Auto, and still affects the data on other traces for which this is not the case.</p>
Preset	3 MHz ON
State Saved	Saved in instrument state
Min	1 Hz
Max	50 MHz
Default Unit	Hz
Backwards Compatibility Notes	For backwards compatibility this command obeys both the BANDwidth and BWIDth forms.
Initial S/W Revision	Prior to A.02.00
Modified at S/W Revision	A.02.00

Annotation Examples

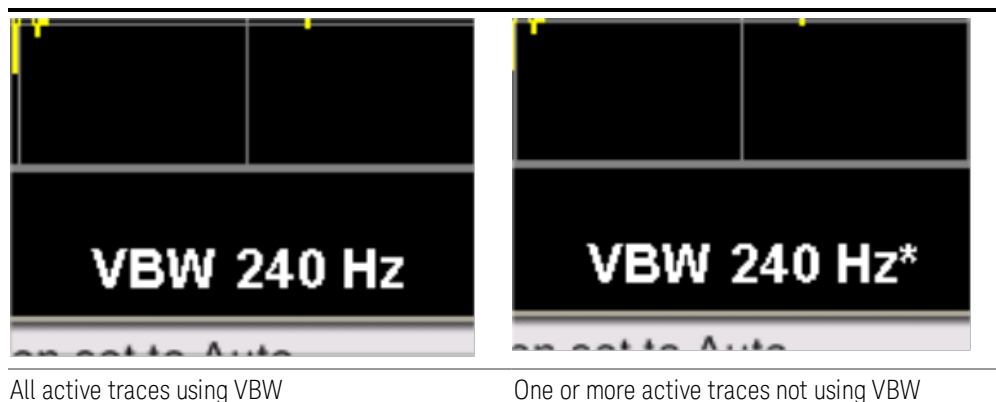

VBW:3dB RBW

Selects the ratio between the video bandwidth and the equivalent 3 dB resolution bandwidth to be used for setting VBW when VBW is in Auto.

VBW:3dB RBW (Auto) selects automatic coupling of the VBW:3 dB RBW ratio to **Detector** using the rules described below in "Auto Rules" on page 640. To decouple the ratio, press VBW:3 dB RBW until Man is underlined, or simply enter a new value.

When the VBW:3dB RBW is manually selected, it may be returned to the coupled state by pressing the VBW:3 dB RBW key until **Auto** is underlined. This may also be done by pressing Auto Couple or by performing a **Preset**.

Key Path	BW
Remote Command	[:SENSe]:BANDwidth BWIDth:VIDeo:RATio <real> [:SENSe]:BANDwidth BWIDth:VIDeo:RATio? [:SENSe]:BANDwidth BWIDth:VIDeo:RATio:AUTO OFF ON 0 1 [:SENSe]:BANDwidth BWIDth:VIDeo:RATio:AUTO?
Example	BAND:VID:RAT 2 BAND:VID:RAT? BAND:VID:RAT:AUTO 0 BAND:VID:RAT:AUTO?
Notes	The values shown in this table reflect the conditions after a Mode Preset.
Couplings	See "Coupling Auto Rules"
Preset	1 ON
State Saved	Saved in instrument state
Min	0.00001
Max	3000000
Backwards Compatibility Notes	For backwards compatibility this command obeys both the BANDwidth and BWIDth forms.
Initial S/W Revision	Prior to A.02.00
Modified at S/W Revision	A.02.00

Auto Rules

The Auto Rules for the **VBW:3dB RBW** function follow.

First, if Source Mode is set to "Tracking": Use 1.0

Otherwise, we go through the following list of detector numbers and find the lowest numbered detector being used on any active traces (traces for which Update is On):

1. Peak
2. Normal

3. Average
4. Sample
5. Negative Peak
6. EMI Average
7. Quasi Peak
8. RMS Average

Use that detector to pick the ratio based on the following criteria:

23. If the detector is Peak and the EMC Standard is set to either CISPR or MIL, use 10.0 (we use wide VBWs to capture peak levels accurately).
24. Otherwise, if the detector is **Negative Peak**, use 1.0 (in the Negative Peak case, there are no known significant use models so we use a medium ratio).
25. Otherwise, if the detector is **Normal**, use 1.0.
26. Otherwise, if the detector is **Average**, and the span is nonzero, use 0.1. The use of a small ratio in Average detection is desirable because of its effect on the sweep time equations. The VBW filter is not actually in-circuit when the average detector is on. If the detector is Average, and the span is zero, use 10.0, which gives optimal behavior for Interval Markers in zero span.
27. Otherwise, if the detector is EMI Average, Quasi Peak or RMS Average, use 10.0. In fact this is a “don’t care” since no VBW is used for these detectors, as noted under “Dependencies” for the VBW key
28. Otherwise, the detector is simply **Peak** or **Sample**. These two detectors can use the same rules. In these cases, if any active trace is in max hold or min hold, use 10.0, because Max and Min Hold operations will usually be intended to capture peaks and pits without smoothing from the VBW filter; otherwise, use 1.0 as a compromise, because you have not set the analyzer in a way that implies that you are measuring noise, pulsed-RF or CW signals, and for backward compatibility with earlier analyzers.

Note that because the above couplings depend on which traces are active, they are re-examined whenever any trace goes active or inactive, except when this leaves no traces active. Transitioning to the state where no traces are active should not affect the couplings; in that way, the annotation will always reflect the state of the last trace which was active.

Span:3dB RBW

Selects the ratio between span and resolution bandwidth.

Normally, Span:3dB RBW (Auto) selects a Span:3 dB RBW ratio of 106:1. If you manually enter the ratio, Man will become underlined, which enables you to manually select ratios more suitable for certain measurements.

When the Span:3dB RBW is manually selected, it may be returned to the coupled state by pressing the Span:3dB RBW key until **Auto** is underlined. This may also be done by pressing Auto Couple or by performing a **Preset**.

Key Path	BW
Remote Command	[:SENSe] :FREQuency :SPAN :BANDwidth [:RESolution] :RATio <integer> [:SENSe] :FREQuency :SPAN :BANDwidth [:RESolution] :RATio? [:SENSe] :FREQuency :SPAN :BANDwidth [:RESolution] :RATio :AUTO OFF ON 0 1 [:SENSe] :FREQuency :SPAN :BANDwidth [:RESolution] :RATio :AUTO?
Example	FREQ:SPAN:BAND:RAT 200 sets a ratio of 200:1, and turns off the auto coupling. FREQ:SPAN:BAND:RAT:AUTO ON FREQ:SPAN:BAND:RAT?
Notes	The values shown in this table reflect the conditions after a Mode Preset.
Dependencies	Grayed out when the EMC Standard is set to CISPR or MIL, since RBW is coupled to Center Frequency rather than Span in this case. If the grayed out key is pressed, an advisory message is generated. If the equivalent SCPI command is sent, the command is acted upon, but it doesn't affect the current measurement.
Preset	106 ON
State Saved	Saved in instrument state
Min	2
Max	10000
Initial S/W Revision	Prior to A.02.00

RBW Control

Selects the type/shape for the resolution bandwidth filters. Historically, the Res BW filters in Agilent spectrum analyzers were Gaussian filters, specified using the -3 dB bandwidth of the filter. That is, a 10 MHz Res BW filter was a Gaussian shape with its -3 dB points 10 MHz apart. In the X-Series you can, using the **Filter BW** key, specify bandwidths other than the -3 dB bandwidth (-6 dB, Noise, Impulse) for the width of the Gaussian filters. Furthermore, the **Filter BW** menu lets you choose between a Gaussian and Flat Top filter shape, for varying measurement conditions.

Key Path	BW
Dependencies	The RBW Control key is grayed out if the EMC Standard is set to CISPR or MIL . In this case the Filter Type is always Gaussian; the Filter BW is chosen as appropriate for the filter and the standard.
Readback line	[<filter type>] or, if Filter Type is Gaussian, [Gaussian,<filter BW>]
Initial S/W Revision	Prior to A.02.00

Modified at S/W Revision	A.02.00
-----------------------------	---------

Filter Type

Besides the familiar Gaussian filter shape, there are certain special filter types, such as Flat Top, that are desirable under certain conditions. The **Filter Type** menu gives you control over these types.

See "[More Information](#)" on page 643

Key Path	BW, RBW Control
Remote Command	[:SENSe] :BANDwidth BWIDth :SHAPE GAUSSian FLATtop [:SENSe] :BANDwidth BWIDth :SHAPE?
Example	BAND:SHAP GAUS
Notes	GAUSSian = Gaussian FLATtop = Flattop
Dependencies	When EMC Standard is set to CISPR or MIL , the Filter Type is always Gaussian. Any attempt to set it to Flattop will give an error.
Preset	Auto Couple chooses the preset value
State Saved	Saved in instrument state
Readback line	1-of-N selection
Initial S/W Revision	Prior to A.02.00
Modified at S/W Revision	A.02.00

More Information

Gaussian filters

When the Gaussian filter type is chosen, a set of 160 RBW filters are available whose shape is approximately Gaussian. The actual bandwidths used to realize the X-Series' Gaussian filters are chosen to come as close as possible to a 24 step per decade series, within the limitations of the digital IF.

For Gaussian filters, the annotation at the bottom of the screen shows the filter bandwidth type (unless it is Normal). This will be shown parenthetically between the words "Res BW" and the value, for example

Res BW 10.0 Hz	(Normal bandwidth)
Res BW (Impulse) 14.8 Hz	(Impulse bandwidth)

Flattop filters

When the Flattop filter type is chosen, a new set of 134 RBW hardware settings are available. These settings realize filters that are approximately rectangular in shape.

When this shape is chosen the filter bandwidth options are irrelevant and therefore unavailable.

The annotation at the bottom of the screen will show that the Flattop shape is being used, for example:

Res BW (Flattop) 10 Hz

Gaussian

Selects the Gaussian filter type. There are 160 of these RBWs. They are arranged in a 24-per-decade sequence from 1 Hz through 3 MHz, plus the 4, 5, 6 and 8 MHz settings.

Key Path	BW, RBW Control, Filter Type
Example	BAND:SHAP GAUS
Notes	Parameter is GAUSSian. See remote command in section "Filter Type" on page 643 .
Readback	Gaussian
Initial S/W Revision	Prior to A.02.00

Flattop

Selects the flat top filter type

Key Path	BW, RBW Control, Filter Type
Example	BAND:SHAP FLAT
Readback	Flattop
Initial S/W Revision	Prior to A.02.00

Filter BW

When using the Gaussian filters for certain types of applications it can be useful to be able to specify the filter width using points other than the -3 dB points. The Filter BW function allows you to pick the filter based on its -3 dB (Normal) bandwidth, its -6 dB bandwidth, its Noise bandwidth, or its Impulse bandwidth. Note that in all four cases the -3 dB bandwidth is the same. The filter does not change, but the way you specify it changes.

See ["More Information" on page 645](#)

Key Path	BW, RBW Control
Remote Command	[:SENSe]:BANDwidth BWIDth:TYPE DB3 DB6 IMPulse NOISe [:SENSe]:BANDwidth BWIDth:TYPE?
Example	BAND:TYPE NOIS
Notes	DB3 = -3 dB (Normal) DB6 = -6 dB IMPulse = Impulse NOISe = Noise

Dependencies	<p>Grayed out if the Flattop filter type is selected.</p> <p>When EMC Standard is set to CISPR or MIL, the Filter BW key is greyed out and the readback annotation on the key is blanked. This is because the Filter BW is chosen as appropriate for the filter and the standard and not selected by this key. Any attempt to set it otherwise will give an error.</p>
Preset	Auto Couple chooses the preset value
State Saved	Saved in instrument state
Readback line	1-of-N selection
Initial S/W Revision	Prior to A.02.00
Modified at S/W Revision	A.02.00

More Information

The analyzer provides four ways of specifying the bandwidth of a Gaussian filter:

1. The -3 dB bandwidth of the filter
2. The -6 dB bandwidth of the filter
3. The equivalent Noise bandwidth of the filter, which is defined as the bandwidth of a rectangular filter with the same peak gain which would pass the same power for noise signals.
4. The equivalent Impulse bandwidth of the filter, which is defined as the bandwidth of a rectangular filter with the same peak gain which would pass the same power for impulsive (narrow pulsed) signals.

The figure below shows the relationships of the various filter bandwidths for filters with the X-Series' shape factor (shape factor is defined as the ratio of the -60 dB bandwidth to the -3 dB bandwidth):

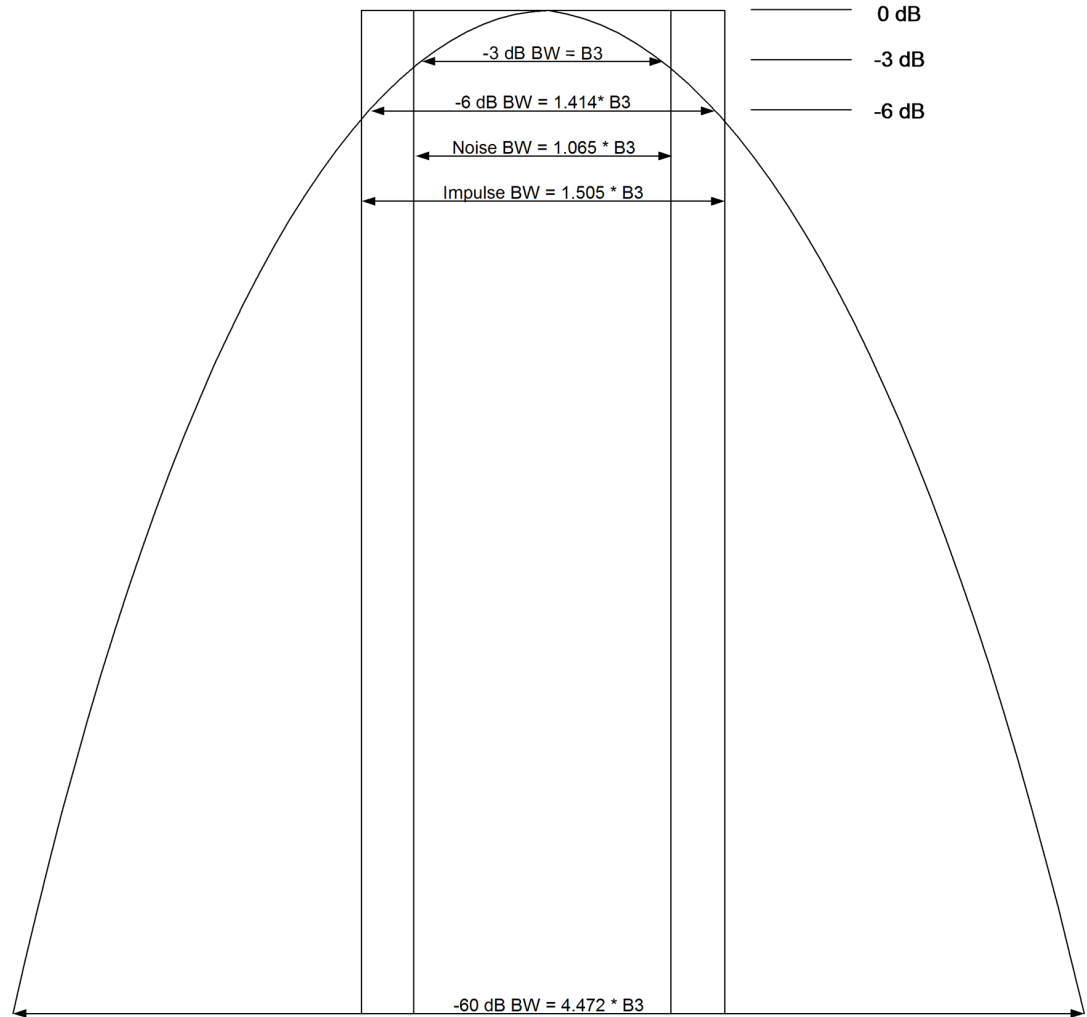

The **Filter Type** menu lets you choose the filter bandwidth (–3 dB, –6 dB, Noise or Impulse) that will be used when specifying the width of the filter. Note that for a given Gaussian filter, changing the filter bandwidth specification does not affect the filter width at all but only the means of specifying it. For example, the filter whose –3 dB bandwidth is 1.0 kHz is the same as the filter whose –6 dB bandwidth is 1.41 kHz, whose Noise bandwidth is 1.06 kHz, and whose Impulse bandwidth is 1.48 kHz. As you cycle through these various filter bandwidths the filter does not change, but the way the filter is annotated and the value which appears in the active function area and on the softkey does.

–3 dB (Normal)

Selects the normal Gaussian-shaped bandwidths that are defined by their –3 dB bandwidths.

Key Path	BW, RBW Control, Filter BW
Example	BAND:TYPE DB3
Readback	–3 dB
Initial S/W Revision	Prior to A.02.00

-6 dB

Selects the filter bandwidths where the bandwidth is defined at the -6 dB points. This uses the normal RBW filters, but the value displayed on the key, active function line and screen annotation changes to reflect the -6 dB bandwidth instead of the -3 dB bandwidth.

Key Path	BW, RBW Control, Filter BW
Example	BAND:TYPE DB6
Readback	-6 dB
Initial S/W Revision	Prior to A.02.00

Noise

Selects the noise filter bandwidths. This uses the normal RBW filters, but the value displayed on the key, active function line and screen annotation changes to reflect the equivalent noise bandwidth, instead of the -3 dB bandwidth.

Key Path	BW, RBW Control, Filter BW
Example	BAND:TYPE NOIS
Readback	Noise
Initial S/W Revision	Prior to A.02.00

Impulse

Selects the impulse bandwidths. This uses the normal RBW filters, but the value displayed on the key, active function line and screen annotation changes to reflect the equivalent impulse bandwidth instead of the -3 dB bandwidth.

Key Path	BW, RBW Control, Filter BW
Example	BAND:TYPE IMP
Readback	Impulse
Initial S/W Revision	Prior to A.02.00

Wide Bandwidths

The Wide Bandwidths key lets you access a set of Resolution Bandwidths that are wider than the standard RBW's. These wide bandwidths only appear in the Swept SA measurement. The Wide Bandwidths key is only available when Span is set to Zero Span, otherwise the key is grayed out.

When Wide Bandwidths are On:

- The minimum RBW is 10 MHz. The Wide Bandwidths selection must be Off to select RBWs 8 MHz or narrower.
- A channel filter shape is used that is nearly square (shape factor 1.2:1), rather than Gaussian or Flattop, and the RBW Filter Type control is grayed

out and displays “Channel”.

- The RBW Filter BW control is grayed out and shows “–3 dB”.
- No VBW filter is used, so VBW averaging is not available. Since VBW averaging is not available, the VBW annotation has the * symbol added (meaning no video averaging). When no VBW averaging is available, this is equivalent to having a VBW setting that is greater than RBW.
- Only the Peak detector is available, all other detectors are grayed out
- Gate is not available
- TV Trigger is not available

The instrument independently remembers the RBW settings for when Wide Bandwidths are set to Off and when Wide bandwidths are set to On. For example, if an RBW of 300 kHz was set before Wide Bandwidths was turned on, then the instrument will go back to an RBW of 300 kHz when Wide bandwidths is turned off.

As with the standard set of RBW’s, there is a set of specific RBW’s available when Wide Bandwidths is set to On. Here is the list:

- Wideband IF’s with information bandwidth less than 160 MHz : 10 MHz, 15 MHz, 20 MHz, 25 MHz, 30 MHz, 40 MHz, 50 MHz, 60 MHz, 70 MHz
- Wideband IF’s with 160 MHz information bandwidth: add 80 MHz, 100 MHz and 133 MHz RBW’s.
- Wideband IF’s with information bandwidth of 255 MHz or 510 MHz: add 150 MHz, 200 MHz and 212 MHz RBW’s.

Key Path	BW
Remote Command	[:SENSe] :BANDwidth BWIDth [:RESolution] :WIDE ON OFF 0 1 [:SENSe] :BANDwidth BWIDth [:RESolution] :WIDE ?
Example	BAND:WIDE ON BAND:WIDE ?
Dependencies	Only appears if at least one of options B85, B1A, B1X, B1Y, B2X, B5X is installed. Only appears if option RBE is installed. Only appears in the Swept SA measurement. Grayed out unless in Zero Span.
Preset	Off
State Saved	Saved in instrument state
Initial S/W Revision	A.17.00

Cont (Continuous Measurement/Sweep)

Sets the analyzer for Continuous measurement operation. The single/continuous state is Meas Global so the setting will affect all measurements. If you are Paused, pressing **Cont** does a Resume.

Key Path	Front-panel key
Remote Command	:INITiate:CONTinuous OFF ON 0 1 :INITiate:CONTinuous?
Example	:INIT:CONT 0 puts analyzer in Single measurement operation. :INIT:CONT 1 puts analyzer in Continuous measurement operation
Preset	ON (Note that SYST:PRESet sets INIT:CONT to ON but *RST sets INIT:CONT to OFF)
State Saved	Saved in instrument state
Backwards Compatibility Notes	For Spectrum Analysis mode in ESA and PSA, there is no Cont hardkey, instead there is a Sweep Single/Cont key. In these analyzers, switching the Sweep Single/Cont key from Single to Cont restarts averages (displayed average count reset to 1), but does not restart Max Hold and Min Hold . The X-Series has Single and Cont keys in place of the SweepSingleCont key. In the X-Series, if in single measurement, the Cont key (and INIT:CONT ON) switches to continuous measurement, but never restarts a measurement and never resets a sweep.
Initial S/W Revision	Prior to A.02.00

In Swept SA Measurement (Spectrum Analysis Mode):

The analyzer takes repetitive sweeps, averages, measurements, etc., when in Continuous mode. When the average count reaches the Average/Hold Number the count stops incrementing, but the analyzer keeps sweeping. See the Trace/Detector section for the averaging formula used both before and after the Average/Hold Number is reached. The trigger condition must be met prior to each sweep. The type of trace processing for multiple sweeps, is set under the Trace/Detector key, with choices of **Trace Average**, **Max Hold**, or **Min Hold**.

In Other Measurements/Modes:

With **Avg/Hold Num** (in the **Meas Setup** menu) set to **Off** or set to **On** with a value of 1, a sweep is taken after the trigger condition is met; and the analyzer continues to take new sweeps after the current sweep has completed and the trigger condition is again met. However, with **Avg/Hold Num** set to On with a value >1, multiple sweeps (data acquisitions) are taken for the measurement. The trigger condition must be met prior to each sweep. The sweep is not stopped when the average count k equals the number N set for Avg/Hold Num is reached, but the number k stops incrementing. A measurement average usually applies to all traces, marker results, and numeric results. But sometimes it only applies to the numeric results.

8 Swept SA Measurement

Cont (Continuous Measurement/Sweep)

If the analyzer is in Single measurement, pressing the **Cont** key does not change k and does not cause the sweep to be reset; the only action is to put the analyzer into Continuous measurement operation.

If it is already in continuous sweep:

the INIT:CONT 1 command has no effect

the INIT:CONT 0 command will place the analyzer in Single Sweep but will have no effect on the current sequence until $k = N$, at which point the current sequence will stop and the instrument will go to the idle state.

File

See "File" on page 426

FREQ Channel

Accesses a menu of keys that allow you to control the Frequency and Channel parameters of the instrument.

Some features in the Frequency menu are the same for all measurements – they do not change as you change measurements. Settings like these are called “Meas Global” and are unaffected by Meas Preset. For example, the Center Freq setting is the same for all measurements – it does not change as you change measurements.

Key Path	Front-panel key
Initial S/W Revision	Prior to A.02.00

Auto Tune

Auto Tune appears as the top key in the Frequency menu in the Normal and Spectrogram views of the Spectrum Analyzer Mode.

Auto Tune is an immediate action key. When it is pressed, it causes the analyzer to change Center Frequency to the strongest signal in the tunable span of the analyzer, excluding the LO. It is designed to quickly get you to the most likely signal (s) of interest, with no signal analysis knowledge required. As such, there are no configurable parameters for this feature. There are only pre-selected values that work in most real world situations.

Auto Tune performs a Preset as part of its function, so it always returns you to the Normal View and a preset state, although it does leave the AC/DC coupling and Single/Cont state unaffected.

NOTE

You may see a slight pause before the signal of interest is presented at midscreen.

Key Path	FREQ Channel
Remote Command	[:SENSe] :FREQuency:TUNE:IMMediate
Dependencies	Auto Tune is not available (grayed out) when Source Mode=Tracking.
Initial S/W Revision	Prior to A.02.00

Zoom Center

Zoom Center appears as the top key in the Frequency menu in the Trace Zoom View of the Spectrum Analyzer Mode.

Zoom Center allows you to change the frequency of the zoom region, and hence of the lower window, without changing the Zoom Span.

The **Zoom Center** value is displayed in the lower left corner of the zoom window (below the graticule) when the frequency entry mode is Center/Span (pressing Center Freq or Span sets the frequency entry mode to Center/Span). When the frequency entry mode is Start/Stop, **Zoom Start** is displayed in this lower left annotation position (pressing Start Freq or Stop Freq sets the frequency entry mode to Start/Stop).

Key Path	FREQ Channel
Remote Command	[:SENSe] :FREQuency :TZOom :CENTer <frequency> [:SENSe] :FREQuency :TZOom CENTer?
Example	FREQ:TZO:CENT 20 MHz
Dependencies	Only appears in the Trace Zoom View of the Swept SA measurement. If the SCPI command is sent in other Views, an error is reported. Grayed out in Zero Span. If the SCPI command is sent in Zero Span, an error is reported.
Couplings	The center frequency for the lower window is limited by the start and stop frequencies in the upper window. You cannot move the zoom region out of the upper window, nor does changing the Zoom Center frequency ever change the Zoom Span. When Zoom Center increases or decreases to a value that causes the zoom region to touch an edge of the top window, the Zoom Center is clipped at that value. If the analyzer Start and/or Stop frequencies change such that the Zoom Region is no longer between them, the Zoom Region is moved to the far left or right of the top window as appropriate. Affected by Freq Offset exactly the same as is Center Frequency.
Preset	On entry to Trace Zoom, the Zoom Center frequency is the same as the analyzer Center Frequency. So if you do a Mode Preset and then immediately go into Trace Zoom, Zoom Center matches the Preset values listed in the table under the Center Freq key description.
State Saved	Saved in instrument state
Min	Start Frequency of top window
Max	The maximum Zoom Center frequency is the same as the maximum analyzer Center Frequency, which is basically the instrument maximum frequency - 5 Hz. See the table under the Center Freq key description.
Default Unit	Hz
Initial S/W Revision	A.07.01
Modified at S/W Revision	A.18.00 (zero span grayout)

Zone Center

Zone Center appears as the top key in the Frequency menu in the Trace Zoom View of the Spectrum Analyzer Mode.

Zone center allows you to change the frequency of the zone without changing the zone span. As the zone center is changed, the center frequency of the lower window is changed. Note that the lower window will not be updated to reflect the change unless it is selected as the active window.

The center frequency for the lower window is not limited by the selected start and stop frequencies in the upper window. However, if the frequency span of the lower window is at all outside of the span for the upper window, an orange arrow pointing left or right will be displayed at the left or right edge of the top window.

Key Path	FREQ Channel
Remote Command	[:SENSe] :FREQuency :ZSPan :CENTer <frequency>

	[:SENSe] :FREQuency :ZSPan :CENTer?
Example	:FREQ:ZSP:CENT 20 MHz
Notes	Min and Max values depend on the Hardware Options (5xx)
Dependencies	Only appears in the Zone Span View of the Swept SA measurement. If the SCPI command is sent in other Views, an error is generated.
Couplings	Center Frequency of lower window changes so that it is always the same as Zone Center, and vice-versa Affected by Freq Offset exactly the same as is Center Frequency.
Preset	On entry to Zone Span, the Zone Center frequency is the same as the analyzer Center Frequency. So if you do a Mode Preset and then immediately go into Zone Span, Zone Center matches the Preset values listed in the table under the Center Freq key description.
State Saved	Saved in instrument state
Min	Hardware dependent; Zone Span dependent. Zone Center cannot go so low as to force Zone Left to be <0.
Max	The maximum Zone Center frequency is the same as the maximum analyzer Center Frequency, which is basically the instrument maximum frequency - 5 Hz. See the table under the Center Freq key description.
Default Unit	Hz
Status Bits/OPC dependencies	Non-overlapped
Initial S/W Revision	Prior to A.02.00

Center Freq

Sets the frequency that corresponds to the horizontal center of the graticule (when frequency Scale Type is set to linear). While adjusting the Center Frequency the Span is held constant, which means that both Start Frequency and Stop Frequency will change.

Pressing Center Freq also sets the frequency entry mode to Center/Span. In Center/Span mode, the center frequency and span values are displayed below the graticule, and the default active function in the Frequency menu is **Center Freq**.

The center frequency setting is the same for all measurements within a mode, that is, it is Meas Global. Some modes are also able to share a Mode Global center frequency value. If this is the case, the Mode will have a **Global Settings** key in its **Mode Setup** menu.

The **Center Freq** function sets (and queries) the Center Frequency for the currently selected input. If your analyzer has multiple inputs, and you select another input, the Center Freq changes to the value for that input. SCPI commands are available to directly set the Center Freq for a specific input.

Center Freq is remembered as you go from input to input. Thus you can set a Center Freq of 10 GHz with the RF Input selected, change to BBIQ and set a Center Freq of 20 MHz, then switch to External Mixing and set a Center Freq of 60 GHz, and when you go back to the RF Input the Center Freq will go back to 10 GHz; back to BBIQ and it is 20 MHz; back to External Mixing and it is 60 GHz.

See ["RF Center Freq" on page 658](#)

See [Ext Mix Center Freq](#)

See ["I/Q Center Freq" on page 659](#)

See ["Center Frequency Presets" on page 656](#)

Key Path	FREQ Channel
Scope	Meas Global
Remote Command	[:SENSe] :FREQuency:CENTer <freq> [:SENSe] :FREQuency:CENTer?
Example	FREQ:CENT 50 MHz FREQ:CENT UP changes the center frequency to 150 MHz if you use FREQ:CENT:STEP 100 MHz to set the center frequency step size to 100 MHz FREQ:CENT?
Notes	This command sets either the RF or I/Q Center Frequency depending on the selected input. For RF input it is equivalent to FREQ:RF:CENT For I/Q input it is equivalent to FREQ:IQ:CENT Preset and Max values are dependent on Hardware Options (5xx) If no terminator (e.g. MHz) is sent the terminator Hz is used. If a terminator with unit other than Frequency is used, an invalid suffix error message is generated.
Dependencies	The Center Frequency can be limited by Start or Stop Freq limits, if the Span is so large that Start or Stop reach their limit.
Couplings	When operating in "swept span", any value of the Center Frequency or Span that is within the frequency range of the analyzer is allowed when the value is being set through the front panel numeric key pad or the SCPI command. The other parameter is forced to a different value if needed, to keep the Start and the Stop Frequencies within the analyzer's frequency range
Preset	Depends on instrument maximum frequency, mode, measurement, and selected input. See "Center Frequency Presets" on page 656 and "RF Center Freq" on page 658 and Ext Mix Center Freq and "I/Q Center Freq" on page 659 .
State Saved	Saved in instrument state
Min	Depends on instrument maximum frequency, mode, measurement, and selected input.. See "Center Frequency Presets" on page 656 and "RF Center Freq" on page 658 and "I/Q Center Freq" on page 659 .
Max	Depends on instrument maximum frequency, mode, measurement, and selected input.. See "Center Frequency Presets" on page 656 and "RF Center Freq" on page 658 and "I/Q Center Freq" on page 659 .
Default Unit	Hz
Status Bits/OPC Dependencies	Non-overlapped
Initial S/W Revision	Prior to A.02.00

Center Frequency Presets

The following table provides the Center Frequency Presets for the Spectrum Analyzer mode, and the Max Freq, for the various frequency options:

Freq Option	CF after Mode Preset	Stop Freq after Mode Preset	Max Freq (can't tune above)	
503 (all but N9000A)		1.805 GHz	3.6 GHz	3.7 GHz
503 (N9000A)		1.505 GHz	3.0 GHz	3.08 GHz
504 (M9420A)		1 GHz	3.8GHz	3.88 GHz
506 (M9420A)		1 GHz	6.0GHz	6.08 GHz
507 (all but N9000A)		3.505 GHz	7.0 GHz	7.1 GHz
507 (N9000A)		3.755 GHz	7.5 GHz	7.58 GHz
508 (all but N9038A)		1.805 GHz	3.6 GHz	8.5 GHz
508 (N9038A)		4.205 GHz	8.4 GHz	8.5 GHz
513		6.805 GHz	13.6 GHz	13.8 GHz
526 (all but N9000A and N9038A)		13.255 GHz	26.5 GHz	27.0 GHz
526 (N9000A)		13.255 GHz	26.5 GHz	26.55 GHz
526 (N9038A)		1.805 GHz	3.6 GHz	27.0 GHz
532	16.005 GHz		32.0 GHz	32.5 GHz
543	21.505 GHz		43.0 GHz	TBD
544	22.005 GHz		44.0 GHz	44.5 GHz
550	25.005 GHz		50.0 GHz	51 GHz

Input 2:

Model	CF after Mode Preset	Stop Freq after Mode Preset	Max Freq (can't tune above)
N9000A opt C75	0.7505GHz	1.5 GHz	1.58 GHz
N9038A	505 MHz	1 GHz	1.000025 GHz

Tracking Generator Frequency Limits (N9000A only):

Tracking Generator Option	Min Freq (clips to this freq when turn TG on and can't tune below while TG on)	If above this Freq, Stop Freq clipped to this Freq when TG turned on	Max Freq (can't tune above) while TG on
T03	9 kHz	3.0 GHz	3.08 GHz
T06	9 kHz	6.0 GHz	6.05 GHz

Tracking Generator Frequency Limits(M9290A only):

Tracking Generator Option	Min Freq (clips to this freq when turn TG on and can't tune below while TG on)	If above this Freq, Stop Freq clipped to this Freq when TG turned on	Max Freq (can't tune above) while TG on
T03	2 MHz	3.08 GHz	3.08 GHz
T07	2 MHz	7.575 GHz	7.575 GHz
T13	2 MHz	13.8 GHz	13.8 GHz
T26	2 MHz	26.55 GHz	26.55 GHz

The following table shows the Center Frequency Presets for modes other than Spectrum Analyzer:

Mode	CF Preset for RF
WCDMA	1 GHz
WIMAXOFDMA,	1 GHz
BASIC	1 GHz
ADEMOD	1 GHz
VSA	1 GHz

Mode	CF Preset for RF
TDSCDMA	1 GHz
PNOISE	1 GHz
LTE	1 GHz
LTETDD	1 GHz
MSR	1 GHz
GSM	935.2 MHz
NFIGURE	1.505 GHz

RF Center Freq

SCPI command for specifying the RF Center Frequency. This command will set the Center Frequency to be used when the RF input is selected, even if the RF input is not the input that is selected at the time the command is sent. Note that the **Center Freq** function in the **Frequency** menu on the front panel always applies to the currently selected input.

Scope	Meas Global
Remote Command	[:SENSe] :FREQuency :RF :CENTer <freq> [:SENSe] :FREQuency :RF :CENTer ?
Example	FREQ:RF:CENT 30 MHz
Notes	This command is the same in all modes, but the parameter is Measurement Global. So the value is independent in each mode and common across all the measurements in the mode.
Dependencies	If the electronic/soft attenuator is enabled, any attempt to set Center Frequency such that the Stop Frequency would be >3.6 GHz fails and results in an advisory message. If the equivalent SCPI command is sent, this same message is generated as part of a "-221, Settings conflict" warning. If Source Mode is set to Tracking, and the Max or Min Center Freq is therefore limited by the limits of the source, a warning message is generated, "Data out of range;clipped to source max/min" if these limits are exceeded. Note that for an external source, these limits can be affected by the settings of Source Numerator, Source Denominator and Power Sweep.
Preset	See table above
State Saved	Saved in instrument state.
Min	-79.999995 MHz, unless Source Mode is set to Tracking, in which case it is limited by the minimum frequency of the Source
Max	See table above. Basically instrument maximum frequency - 5 Hz. Note that, if the Source Mode is set to Tracking, the effective instrument maximum frequency may be limited by the source maximum frequency. If the knob or step keys are being used, also depends on the value of the other three interdependent parameters Span, Start Frequency and Stop Frequency
Initial S/W Revision	Prior to A.02.00
Modified at S/W Revision	A.03.00

Ext Mix Center Freq

SCPI command for specifying the External Mixer Center Frequency. This command will set the Center Frequency to be used when the External Mixer is selected, even if the External Mixer input is not the input which is selected at the time the command is sent. Note that the **Center Freq** function in the **Frequency** menu on the front panel always applies to the currently selected input.

Scope	Meas Global
Remote Command	[:SENSe] :FREQuency:EMIXer:CENTer <freq> [:SENSe] :FREQuency:EMIXer:CENTer?
Example	:FREQ:EMIX:CENt 60 GHz :FREQ:EMIX:CENt?
Notes	This command is the same in all modes, but the parameter is Measurement Global. So the value is independent in each mode and common across all the measurements in the mode.
Couplings	When returning to External Mixing after having been switched to one of the other inputs (e.g., RF), you will come back into the settings that you had when you left External Mixing. So you will come back to the band you were in with the Center Frequency that you had. However, Span is not an input-dependent parameter, therefore you will bring the span over from the other input. Therefore, the analyzer comes back with the span from the previous input, limited as necessary by the current mixer setup.
Preset	When a Mode Preset is performed while in External Mixing, the Start frequency of the current Mode is set to the nominal Min Freq of the lowest harmonic range in the Harmonic Table for the current mixer setup. Similarly, the Stop frequency of the current Mode is set to the nominal Max Freq of the highest harmonic range in the Harmonic Table. The Center Freq thus presets to the point arithmetically equidistant from these two frequencies. If the current measurement has a limited Span available to it, and cannot achieve the Span shown in the table (Span=Stop Freq – Start Freq), the analyzer uses the maximum Span the measurement allows, and still sets the Center Freq to the midpoint of the Start and Stop Freq values in the Harmonic Table. When Restore Input/Output Defaults is performed, the mixer presets to the 11970A, whose Start and Stop frequencies are 26.5 and 40 GHz respectively. The center of these two frequencies is 33.25 GHz. Therefore, after a Restore Input/Output Defaults, if you go into External Mixing and do a Mode Preset while in the Spectrum Analyzer Mode, the resulting Center Freq is 33.25 GHz.
State Saved	Saved in instrument state.
Min	The minimum frequency in the currently selected mixer band + 5 Hz
Max	The maximum frequency in the currently selected mixer band - 5 Hz If the knob or step keys are being used, also depends on the value of the other three interdependent parameters Span, Start Frequency and Stop Frequency
Initial S/W Revision	A.08.01

I/Q Center Freq

SCPI command for specifying the I/Q Center Frequency. This command will set the Center Frequency to be used when the I/Q input is selected, even if the I/Q input is not the input which is selected at the time the command is sent. Note that the

Center Freq function in the **Frequency** menu on the front panel always applies to the currently selected input.

Scope	Meas Global
Remote Command	[:SENSe] :FREQuency :IQ:CENTer <freq> [:SENSe] :FREQuency :IQ:CENTer?
Example	FREQ:IQ:CENT: 30 MHz
Notes	This command is the same in all modes, but the parameter is Measurement Global. So the value is independent in each mode and common across all the measurements in the mode.
Preset	0 Hz
State Saved	Saved in instrument state.
Min	-40.049995 MHz
Max	40.049995 MHz
Initial S/W Revision	Prior to A.02.00

Start Freq

Sets the frequency at the left side of the graticule. While adjusting the start frequency, the stop frequency is held constant, which means that both the center frequency and span will change.

Start Freq also sets the frequency entry mode to Start or Stop. In Start or Stop mode, the start frequency and stop frequency values are displayed below the graticule, and the default active function in the Frequency menu is **Start Freq**.

Key Path	FREQ Channel
Remote Command	[:SENSe] :FREQuency :STARt <freq> [:SENSe] :FREQuency :STARt?
Example	FREQ:STAR 200 MHz FREQ:STAR?
Notes	Max values depends on Hardware Options (5xx)
Dependencies	By direct entry: You cannot set Start frequency > Stop frequency. You cannot set Start frequency = Stop frequency. You cannot select zero span by setting Start = Stop. You cannot set Start Frequency to a value that would create a span of less than 10 Hz. If you try to do any of these, Stop Frequency will change to maintain a minimum value of 10 Hz for the difference between Start and Stop. With the knob or step keys: Cannot increment Start Freq to a value greater than Stop Freq – 10 Hz. If already in zero span, cannot increment at all, and the first decrement will be forced to at least 10 Hz. The Start Frequency can be limited by Span limits, if the Stop Frequency is below its preset value. If the electronic/soft attenuator is enabled, any attempt to set the Start Frequency such that the Stop Frequency would be >3.6 GHz fails and results in an advisory message. If the equivalent SCPI command is sent, this same message is generated as part of a “-221, Settings conflict” warning. If Source Mode is set to Tracking, and the Max or Min Start Freq is therefore limited by the limits of the source, a warning message is generated, “Data out of range;clipped to source max/min” if

	these limits are exceeded. Note that for an external source, these limits can be affected by the settings of Source Numerator, Source Denominator and Power Sweep.
Couplings	<p>In the Spectrum Analyzer, the four parameters Center Freq, Start Freq, Stop Freq and Span are interdependent, as changing one necessarily affects one or more of the others. The couplings between Center Freq and Span are detailed under the key descriptions for those keys. These couplings also affect Start Freq and Stop Freq.</p> <p>You cannot set Start frequency = Stop frequency. You cannot select zero span by setting Start = Stop. The instrument will alter the value of the last setting to maintain a minimum value of 10 Hz for the difference between Start and Stop.</p>
Preset	<p>Start Freq does not preset. On Mode Preset, Span & CF preset, and Start Freq is derived. On a Meas Preset only Span presets, CF does not, so Start Freq will vary depending on CF.</p> <p>When a Mode Preset is performed while in External Mixing, the Start frequency of the current Mode is set to the nominal Min Freq of the lowest harmonic range in the Harmonic Table for the current mixer setup.</p> <p>If the current measurement has a limited Span available to it, and cannot achieve the Span shown in the table (Span=Stop Freq – Start Freq), the analyzer uses the maximum Span the measurement allows, and sets the Center Freq to the midpoint of the Start and Stop Freq values in the Harmonic Table. Thus, in this case, the Start Freq will preset to a frequency below the preset Center Freq by $\frac{1}{2}$ of the maximum Span.</p> <p>When Restore Input/Output Defaults is performed, the mixer presets to the 11970A, whose Start frequency is 26.5 GHz.</p> <p>Therefore, after a Restore Input/Output Defaults, if you go into External Mixing and do a Mode Preset while in the Spectrum Analyzer Mode, the resulting Start Freq is 26.5 GHz.</p>
State Saved	Saved in instrument state
Min	<p>-80 MHz, unless Source Mode is set to Tracking, in which case it is limited by the minimum frequency of the Source</p> <p>If the knob or step keys are being used, depends on the value of the other three interdependent parameters</p> <p>While in External Mixing, the minimum Start Freq you can set is determined by the external mixing parameters. It will be close to the minimum LO frequency (3.8 GHz if undoubled, 8.6 GHz if doubled) times the harmonic number, for the lowest harmonic range in the Harmonic Table for the current mixer setup. It can be queried with the SCPI command :FREQ:START? MIN.</p>
Max	<p>Depends on the instrument maximum frequency – 10 Hz. Note that, if the Source Mode is set to Tracking, the effective instrument maximum frequency may be limited by the source maximum frequency.</p> <p>If the knob or step keys are being used, it depends on the value of the other three interdependent parameters.</p> <p>While in External Mixing, the maximum Start Freq you can set is determined by the external mixing parameters. It will be close to the maximum LO frequency (7 GHz if undoubled, 14 GHz if doubled) times the harmonic number, for the highest harmonic range in the Harmonic Table for the current mixer setup. It can be queried with the SCPI command :FREQ:START? MAX.</p>
Default Unit	Hz
Status Bits/OPC dependencies	Non-overlapped
Initial S/W Revision	Prior to A.02.00

Modified at S/W	A.03.00
Revision	

Stop Freq

Sets the frequency at the right side of the graticule. While adjusting the stop Frequency, the start frequency is held constant, which means that both the center frequency and span will change.

Stop Freq also sets the frequency entry mode to Start or Stop. In Start or Stop mode, the start frequency and stop frequency values are displayed below the graticule, and the default active function in the Frequency menu is **Start Freq**.

Key Path	FREQ Channel
Remote Command	[:SENSe] :FREQuency :STOP <freq> [:SENSe] :FREQuency :STOP?
Example	FREQ:STOP 220 MHz FREQ:STOP?
Notes	Preset and Max values are dependent on Hardware Options (5xx)
Dependencies	<p>By direct entry:</p> <p>You cannot set the Stop frequency < Start frequency. You cannot set Start frequency = Stop frequency. You cannot select zero span by setting Start = Stop. You cannot set Stop Frequency to a value that would create a span of less than 10 Hz. If you try to do any of these, Start Frequency will change to maintain a minimum value of 10 Hz for the difference between Start and Stop.</p> <p>With the knob or step keys:</p> <p>Cannot decrement Stop Freq to a value less than Start Freq + 10 Hz. If already in zero span, cannot decrement at all, and the first increment will be forced to at least 10 Hz.</p> <p>The Stop Frequency can be limited by Span limits, if the Start Frequency is above its preset value. If the electronic/soft attenuator is enabled, any attempt to set the Stop Frequency >3.6 GHz fails and results in an advisory message. If the equivalent SCPI command is sent, this same message is generated as part of a "-221, Settings conflict" warning.</p> <p>If Source Mode is set to Tracking, and the Max or Min Stop Freq is therefore limited by the limits of the source, a warning message is generated, "Data out of range;clipped to source max/min" if these limits are exceeded. Note that for an external source, these limits can be affected by the settings of Source Numerator, Source Denominator and Power Sweep.</p>
Couplings	<p>In the Spectrum Analyzer, the four parameters Center Freq, Start Freq, Stop Freq and Span are interdependent, as changing one necessarily affects one or more of the others. The couplings between Center Freq and Span are detailed under the key descriptions for those keys. These couplings also affect Start Freq and Stop Freq.</p> <p>You cannot set Start frequency = Stop frequency. You cannot select zero span by setting Start = Stop. The instrument will alter the value of the last setting to maintain a minimum value of 10 Hz for the difference between Start and Stop.</p>
Preset	<p>On Mode Preset, Span & CF preset, and Stop Freq is derived. See "Center Frequency Presets" on page 2932 for a table which shows the Stop Freq after Preset for various model and option numbers).</p> <p>On a Meas Preset only Span presets, CF does not, so Stop Freq will vary depending on CF.</p>

	<p>When a Mode Preset is performed while in External Mixing, the Stop frequency of the current Mode is set to the nominal Max Freq of the highest harmonic range in the Harmonic Table for the current mixer setup.</p> <p>If the current measurement has a limited Span available to it, and cannot achieve the Span shown in the table (Span=Stop Freq – Start Freq), the analyzer uses the maximum Span the measurement allows, and sets the Center Freq to the midpoint of the Start and Stop Freq values in the Harmonic Table. Thus, in this case, the Stop Freq will preset to a frequency above the preset Center Freq by ½ of the maximum Span.</p> <p>When Restore Input/Output Defaults is performed, the mixer presets to the 11970A, whose Stop frequency is 40 GHz.</p> <p>Therefore, after a Restore Input/Output Defaults, if you go into External Mixing and do a Mode Preset while in the Spectrum Analyzer Mode, the resulting Stop Freq is 40 GHz.</p>
State Saved	Saved in instrument state
Min	<p>-79.999999999 MHz, unless Source Mode is set to Tracking, in which case it is limited by the minimum frequency of the Source</p> <p>If the knob or step keys are being used, depends on the value of the other three interdependent parameters</p> <p>While in External Mixing, the minimum Stop Freq you can set is determined by the external mixing parameters. It will be close to the minimum LO frequency (3.8 GHz if undoubled, 8.6 GHz if doubled) times the harmonic number, for the lowest harmonic range in the Harmonic Table for the current mixer setup. It can be queried with the SCPI command :FREQ:STOP? MIN.</p>
Max	<p>Depends on instrument maximum frequency. Note that, if the Source Mode is set to Tracking, the effective instrument maximum frequency may be limited by the source maximum frequency.</p> <p>If the knob or step keys are being used, depends on the value of the other three interdependent parameters.</p> <p>While in External Mixing, the maximum Stop Freq you can set is determined by the external mixing parameters. It will be close to the maximum LO frequency (7 GHz if undoubled, 14 GHz if doubled) times the harmonic number, for the highest harmonic range in the Harmonic Table for the current mixer setup. It can be queried with the SCPI command :FREQ:STOP? MAX.</p>
Default Unit	Hz
Status Bits/OPC dependencies	Non-overlapped
Initial S/W Revision	Prior to A.02.00
Modified at S/W Revision	A.03.00

CF Step

Changes the step size for the center frequency and start and stop frequency functions. Once a step size has been selected and the center frequency function is active, the step keys (and the UP/DOWN parameters for Center Frequency from remote commands) change the center frequency by the step-size value. The step size function is useful for finding harmonics and sidebands beyond the current frequency span of the analyzer.

Note that the start and stop frequencies also step by the CF Step value.

Key Path	FREQ Channel
Remote Command	[:SENSe] :FREQuency :CENTer :STEP [:INCRement] <freq> [:SENSe] :FREQuency :CENTer :STEP [:INCRement] ? [:SENSe] :FREQuency :CENTer :STEP :AUTO OFF ON 0 1 [:SENSe] :FREQuency :CENTer :STEP :AUTO ?
Example	FREQ:CENT:STEP:AUTO ON FREQ:CENT:STEP 500 MHz FREQ:CENT UP increases the current center frequency value by 500 MHz FREQ:CENT:STEP? FREQ:CENT:STEP:AUTO?
Notes	Preset and Max values are depending on Hardware Options (503, 507, 508, 513, 526)
Notes	Preset and Max values are dependent on Hardware Options (5xx)
Dependencies	Freq Offset is not available in External Mixing. In this case the Freq Offset key is grayed out and shows a value of zero. It will once again be available, and show the previously set value, when you return to the RF Input.
Dependencies	Span, RBW, Center frequency If the electronic/soft attenuator is enabled, any attempt to change the value of the center frequency >3.6 GHz by pressing the Up-arrow key, fails and results in an advisory message. If the equivalent SCPI command is sent, this same message is generated as part of a “-221, Settings conflict” warning.
Couplings	When auto-coupled in a non-zero span, the center frequency step size is set to 10% of the span. When auto-coupled in zero span, the center frequency step size is set to the equivalent -3 dB RBW value.
Preset	Auto ADEMOD: 1 MHz ON
State Saved	Saved in instrument state
Min	– (the maximum frequency of the instrument). That is, 27 GHz max freq instrument has a CF step range of +/- 27 GHz. Note that this is the maximum frequency given the current settings of the instrument, so in External Mixing, for example, it is the maximum frequency of the current mixer band.
Max	The maximum frequency of the instrument. That is, 27 GHz max freq instrument has a CF step range of +/- 27 GHz. Note that this is the maximum frequency given the current settings of the instrument, so in External Mixing, for example, it is the maximum frequency of the current mixer band.
Default Unit	Hz
Status Bits/OPC dependencies	non-overlapped
Initial S/W Revision	Prior to A.02.00
Modified at S/W Revision	A.03.00

Freq Offset

Enables you to set a frequency offset value to account for frequency conversions outside of the analyzer. This value is added to the display readout of the marker frequency, center frequency, start frequency, stop frequency, and all other absolute frequency settings in the analyzer including frequency count. When a frequency offset is entered, the value appears below the center of the graticule. To eliminate an offset, perform a Mode Preset or set the frequency offset to 0 Hz.

See ["More Information" on page 665](#).

Key Path	FREQ Channel
Scope	Meas Global
Remote Command	[:SENSe] :FREQuency:OFFSet <freq> [:SENSe] :FREQuency:OFFSet?
Example	FREQ:OFFS 10 MHz
Notes	Preset and Max values are dependent on Hardware Options (503, 507, 508, 513, 526)
Dependencies	Freq Offset is not available in External Mixing. In this case the Freq Offset key is grayed out and shows a value of zero. However, the value of CF Offset that was set for the RF Input is retained and restored when the user switches back to the RF Input.
Preset	See "Center Frequency Presets" on page 2932
State Saved	Saved in instrument state
Min	-500 GHz
Max	500 GHz
Default Unit	Hz
Status Bits/OPC dependencies	Non-overlapped
Backwards Compatibility SCPI	DISPlay:WINDow[1]:TRACe:X[:SCALE]:OFFSet The DISPlay version of the command is in the instrument for compatibility across platforms and is not recommended for new development.
Backwards Compatibility Notes	<ol style="list-style-type: none"> 1. In pre-X-Series instruments, Frequency Offset could not be adjusted by the knob or step keys. That is no longer the case. 2. Some previous spectrum analyzers did not adjust frequency counter results for the Frequency Offset. The X-Series does adjust the frequency counter for the offset.
Initial S/W Revision	Prior to A.02.00
Modified at S/W Revision	A.04.00, A.08.50

More Information

This command does not affect any bandwidths or the settings of relative frequency parameters such as delta markers or span. It does not affect the current hardware settings of the analyzer, but only the displayed frequency values. Entering an offset does not affect the trace position or display, just the value of the start and stop

frequency and the values represented by the trace data. The frequency values of exported trace data, queried trace data, markers, trace data used in calculations such as N dB points, trace math, etc., are all affected by Freq Offset. Changing the offset, even on a trace that is not updating will immediately change all of the above, without taking new data.

NOTE

If a trace is exported with a nonzero Freq Offset, the exported data will contain the trace data with the offset applied. Therefore, if that trace were to be imported back into the analyzer, you would want Freq Offset to be 0, or the offset would be applied again to data which is already offset. No such care need be taken when saving a State+Trace file because the data and state are saved together.

Scale Type Log/Lin

Selects either linear or logarithmic scaling for the frequency axis.

The scaling can be changed at any time and determines only how the data is displayed. It has no impact on the actual sweep or measurement of trace data (with the exception that the detector auto-rules never select the Normal detector while in Log Scale Type). Changing the scaling does not restart the sweep (unless the detector changes) and has no impact on the number of sweep points. The scaling can be changed while traces are in View and they will scale appropriately. Markers stay at their set frequency, so they may move on the display.

Note that the actual trace data does not change as you go between Log and Linear Scale Type. Trace data saved while the display is in log will look identical to trace data saved while the display is in linear. When recalling trace data, the current value of Scale Type is used to display the data. (Trace +State files will recall with whatever Scale Type setting was in effect when they were saved, since the State is saved with them).

This function has no effect on the zero span display, although it is available while in zero span.

See **"More Information" on page 667**

Key Path	Frequency
Scope	Meas Local
Measurement	Swept SA
Remote Command	:DISPlay:WINDow[1]:TRACe:X[:SCALe]:SPACing LINear LOGarithmic :DISPlay:WINDow[1]:TRACe:X[:SCALe]:SPACing?
Example	DISP:WIND:TRAC:X:SPAC LOG
Dependencies	Has no effect in Zero Span, but if changed while in Zero Span then it will be changed on returning to nonzero span. The Normal detector will never be selected by the detector auto-rules while in Log, the rules select Sample if Normal would have been selected.
Couplings	In Linear the Frequency controls and notation at the bottom of the screen default to Center/Span. In Log they default to Start/Stop. When switching from Linear to Log, the notation at the bottom of the screen changes to Start/Stop, and if the active function was one of the frequency controls

	(Center Freq, Start Freq, Stop Freq, or Span), it changes to Start Freq. When switching from Log to Linear, the notation at the bottom of the screen changes to Center/Span, and if the active function was one of the frequency controls (Center Freq, Start Freq, Stop Freq, or Span), it changes to Center Freq. When switching to Log, if the Start Frequency is 0 Hz it is changed to 10 Hz.
Preset	LIN
State Saved	Saved in Instrument State
Backwards Compatibility SCPI	[:SENSe] :SWEep :SPACing LINear LOGarithmic
Backwards Compatibility Notes	Unlike the similar feature in the ESA-Series and E7400 series analyzer, this function has no impact on the way data is gathered or stored in the analyzer (other than the change to detector auto-coupling), it is simply a scaling function that determines how the data will be displayed. Therefore trace data saved or queried while in log will generate exactly the same files as when in linear (assuming the same detector is used); this is not the case in the legacy analyzers. Nor is the number of sweep points affected in any way by this function, as it was in the legacy analyzers.
Initial S/W Revision	Prior to A.17.00

More Information

The log graticule is drawn to optimize the display based on the range of frequencies being shown. The center frequency is marked with a small triangle at the top and bottom of the display, regardless of whether the scaling is log or linear.

Center Freq mark in Linear Scale Type is in the center of the display:

8 Swept SA Measurement
FREQ Channel

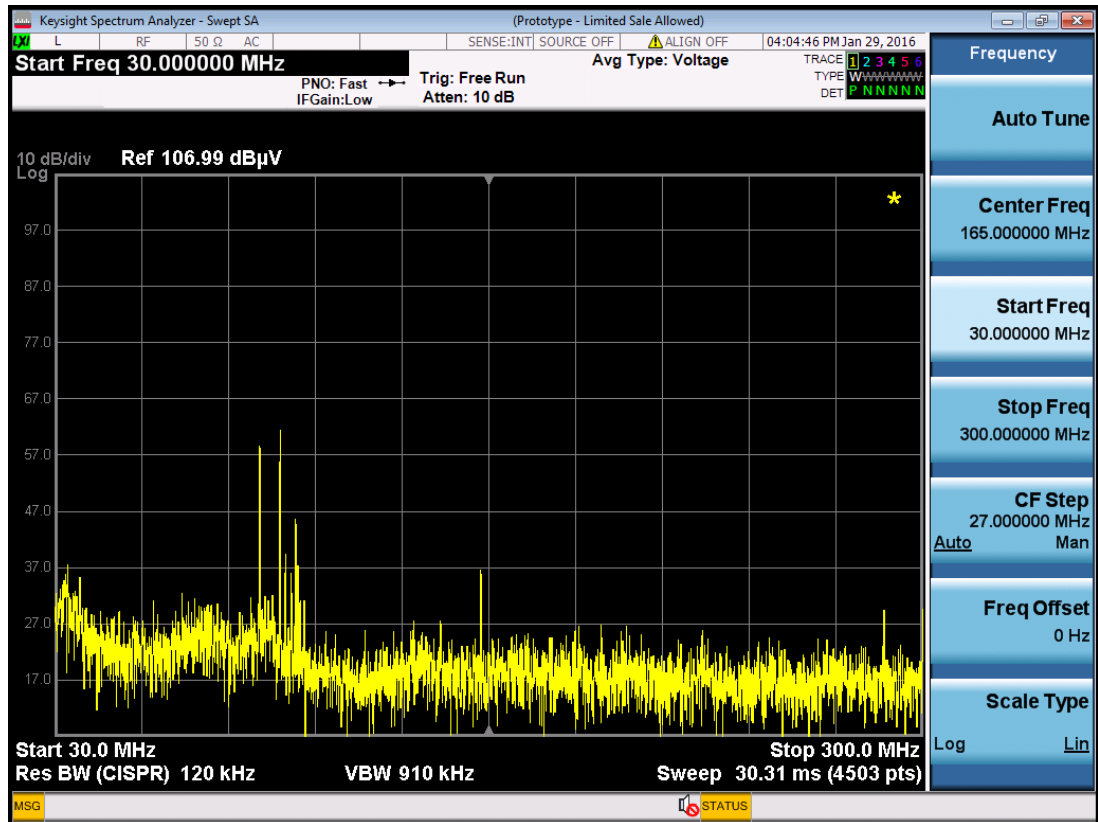

Center Freq mark in Log Scale Type is to the right of center:

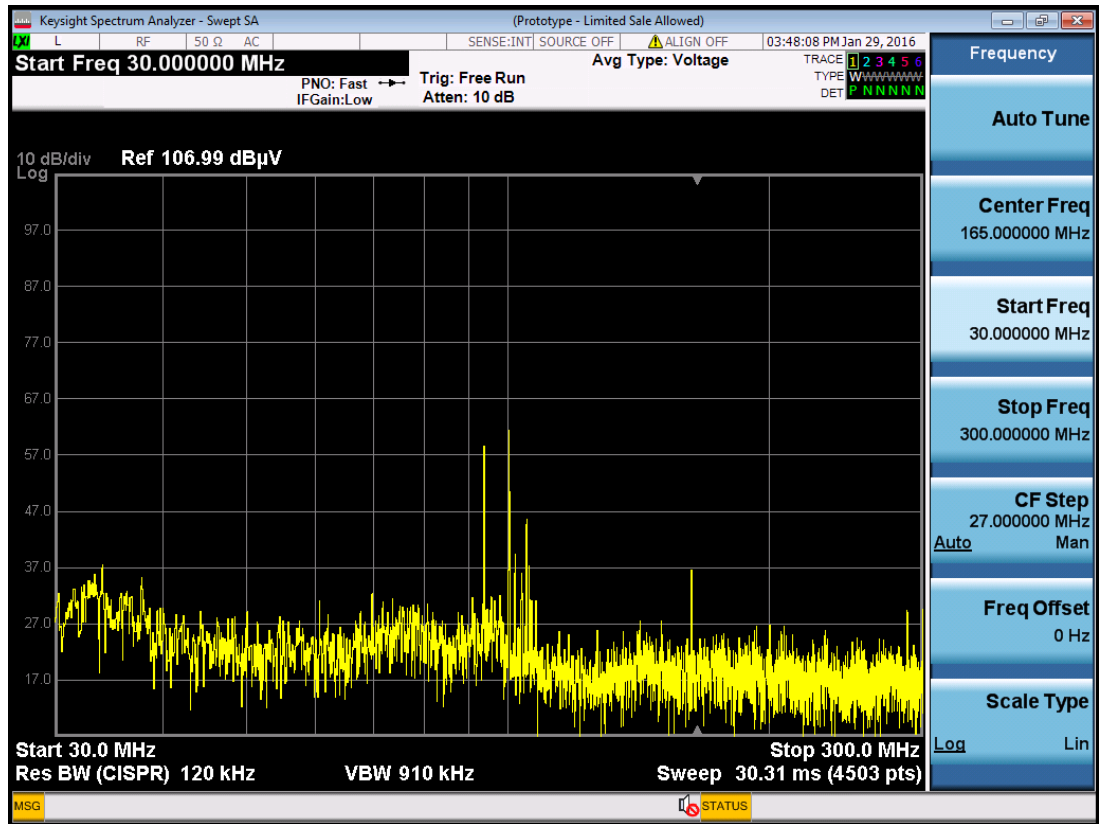

Input/Output

See ["Input/Output" on page 241](#)

Marker

The Marker key accesses the Marker menu. A marker can be placed on a trace to allow the value of the trace at the marker point to be determined precisely. The functions in this menu include a 1-of-N selection of the control mode Normal, Delta, Fixed, or Off for the selected marker.

The fundamental marker operation involves setting a Marker's X-Axis value and then reading the marker's Y-Axis value. From the front panel you do this using the Marker menu and the green marker readout in the upper right corner of the display.

Programmatically, to set the Marker's X-Axis value use the `:CALCulate:MARKer [1]|2|3|4|5|6|7|8|9|10|11|12:X <freq|time>` command. To query the Marker's Y-Axis value, use the `:CALCulate:MARKer [1]|2|3|4|5|6|7|8|9|10|11|12:Y?` query. See ["Setting/Querying the Marker X Axis Value" on page 672](#) and ["Setting/Querying the Marker Y Axis Value" on page 674](#) for information on these functions.

When Marker is pressed, if the selected marker is Off, pressing Marker sets it to Normal and places it at the center of the screen on the trace determined by the Marker Trace rules. If the selected marker is already On it will remain at the frequency/time and amplitude to which it is already set, even if this means it will be offscreen.

NOTE

Markers can be on and not be visible because they are offscreen. This may occur if you set a marker to a frequency outside of the current settings of the Start and Stop frequencies, or in Spectrogram View, you place a marker on a Display Trace other than 0. To move the marker on to the display, press Peak Search.

Markers may also be used in pairs to read the difference (or delta) between two data points. They can be used in Marker Functions to do advanced data processing, or to specify operating points in functions like Signal Track and N dB Points.

The command in the table below selects the marker and sets the marker control mode as described under **Normal**, **Delta**, **Fixed** and **Off**, below. All interactions and dependencies detailed under the key description are enforced when the remote command is sent.

- See ["Marker Control Mode" on page 672](#).
- See ["Setting/Querying the Marker X Axis Value" on page 672](#).
- See ["Setting the Marker X Position in Trace Points" on page 673](#).
- See ["Setting/Querying the Marker Y Axis Value" on page 674](#).
- See ["Marker Backwards Compatibility" on page 675](#)

Key Path	Front-panel key
Remote Command	<code>:CALCulate:MARKer[1] 2 ... 12:MODE POSition DELta FIXed OFF</code> <code>:CALCulate:MARKer[1] 2 ... 12:MODE?</code>

Preset	OFF (all markers)
State Saved	The marker control mode is saved in instrument state
Backwards Compatibility SCPI	:CALCulate:MARKer[1] 2 ... 12:MODE SPAN BAND To support band function backwards compatibility, both of these legacy parameters are accepted and aliased to POSition. They are never returned to a query. See " Band Function Backwards Compatibility " on page 695 for more information.
Initial S/W Revision	Prior to A.02.00

Marker Control Mode

There are four control modes for markers:

Normal (POSition) – A marker that can be moved to any point on the X Axis by specifying its X Axis value, and whose absolute Y Axis value is then the value of the trace point at that X Axis value.

Delta (DELTA) – A marker that can be moved to any point on the X Axis by specifying its X Axis offset from a reference marker, and whose absolute Y Axis value is then the value of the trace point at that X Axis value.

Fixed (FIXed) – A marker whose X Axis and Y Axis values may be directly or indirectly specified by you, but whose Y Axis value remains fixed, once specified, and does not follow the trace. Fixed markers are useful as reference markers for Delta markers, as operands in a Peak Search operation, and as arbitrary reference points settable by you. These markers are represented on the display by an “X” rather than a diamond.

Off (OFF) – A marker which is not in use.

In the Swept SA measurement, the Preset control mode is **Off** for all markers.

Setting/Querying the Marker X Axis Value

The command below sets the marker X Axis value in the current marker X Axis Scale unit. In each case the marker that is addressed becomes the selected marker. It has no effect (other than to cause the marker to become selected) if the control mode is **Off**, but it is the SCPI equivalent of entering an X value if the control mode is **Normal**, **Delta**, or **Fixed**.

Remote Command	:CALCulate:MARKer[1] 2 ... 12:X <freq time> :CALCulate:MARKer[1] 2 ... 12:X?
Notes	If no suffix is sent it will use the fundamental units for the current marker X Axis Scale. If a suffix is sent that does not match the current marker X Axis Scale unit, an invalid suffix message will be generated. If the specified marker is Fixed and a Marker Function is on, a message is generated. If the key is pressed, an advisory message is generated. If the equivalent SCPI command is sent, this same message is generated as part of a “-221, Settings conflict” warning. The query returns the marker’s absolute X Axis value if the control mode is Normal or Fixed . It returns the offset from the marker’s reference marker if the control mode is Delta . The query is returned in the fundamental units for the current marker X Axis scale: Hz for Frequency and

	Inverse Time , seconds for Period and Time . If the marker is Off the response is not a number.
Preset	After a preset, if X is queried with no value sent first, the center of screen value will be returned. This will depend on the frequency range of the instrument. 13.255 GHz is correct for the 26 GHz instruments only (Option 526).
Min	$-\infty$ (minus infinity)
Max	$+\infty$ (plus infinity). Unlike legacy analyzers, where the markers were forced to be on screen, X-Series marker values are not limited and do not clip
Default Unit	determined by X Axis Scale
Backwards Compatibility SCPI	:CALCulate:MARKer[1] 2 ... 4:X:CENTer This alias is provided for compatibility with the Band Power function in PSA and ESA. See details in the "Marker Function" section under " Band Function Backwards Compatibility " on page 695
Backwards Compatibility Notes	In earlier Agilent analyzers, markers were position markers, which means that Normal and Delta markers stayed at the same screen position when X Axis parameters were changed. In the X-Series, markers are value markers, which means that when the analyzer's X Axis settings are changed, the marker's X Axis value in fundamental X Axis units remains unchanged. See " Marker Backwards Compatibility " on page 675 for a full discussion of this change.
Initial S/W Revision	Prior to A.02.00

Setting the Marker X Position in Trace Points

The command below sets the marker X position in trace points. It has no effect if the marker control mode is **Off**. But it is the SCPI equivalent of entering a value if the control mode is **Normal** or **Delta** or **Fixed** – except the setting is in trace points rather than X Axis Scale units.

NOTE

The entered value in Trace Points is immediately translated into the current X Axis Scale units for setting the value of the marker. The marker's value in X Axis Scale Units, NOT trace points, will be preserved if a change is made to the X Axis scale settings. Thus, if you use this command to place a marker on bucket 500, which happens at that time to correspond to 13 GHz, and then you change the Start Frequency so that bucket 500 is no longer 13 GHz, the marker will stay at 13 GHz, NOT at bucket 500! This is important to realize as it differs from the behavior of past Agilent analyzers.

Remote Command	:CALCulate:MARKer[1] 2 ... 12:X:POStion <real> :CALCulate:MARKer[1] 2 ... 12:X:POStion?
Notes	If the specified marker is Fixed and a Marker Function is on, a message is generated. If the key is pressed, an advisory message is generated. If the equivalent SCPI command is sent, this same message is generated as part of a "-221, Settings conflict" warning. The query returns the marker's absolute X Axis value in trace points if the control mode is Normal or Fixed . It returns the offset from the marker's reference marker in trace points if the control mode is Delta . The value is returned as a real number, not an integer, corresponding to the translation from X Axis Scale units to trace points
Preset	After a preset, if X is queried with no value sent first, the center of screen value will be returned. So if per default, the number of Trace points is 1001, the center value will be 500.

Min	0
Max	Number of trace points – 1
Default Unit	unitless
Backwards Compatibility SCPI	:CALCulate:MARKer[1] 2 ... 4:X:POSition:CENTer This alias is provided for compatibility with the Band Power function in PSA and ESA. See details in the “Marker Function” section under "Band Function Backwards Compatibility" on page 695
Initial S/W Revision	Prior to A.02.00

Setting/Querying the Marker Y Axis Value

The fundamental item of marker data accessed by users is the marker’s Y-Axis value. The query below is used to select the marker and read the marker’s Y-Axis value.

In the command form, it selects the marker and sets the marker Y Axis value; the default unit is the current Y Axis unit. The command form has no effect (other than selecting the marker) unless the marker control mode is **Fixed**.

Remote Command	:CALCulate:MARKer[1] 2 ... 12:Y <real> :CALCulate:MARKer[1] 2 ... 12:Y?
Example	CALC:MARK2:MODE POS turns on marker 2 as a normal marker. CALC:MARK2:X 20 GHZ moves marker 2 to 20 GHz if X Axis Scale is Frequency. If X Axis Scale is Time, an Invalid Suffix error is generated.
Notes	The command :CALCulate:MARKer[1] 2 3 4 5 6 7 8 9 10 11 12:Y? returns the marker Y-axis result, if the control mode is Normal , Fixed or Delta . If the marker is Off the response is 9.91e37 (“not a number”). If no suffix is sent it will use the current Y Axis unit. If a suffix is sent that does not have units of absolute amplitude, an invalid suffix error will be generated. If a marker function is on for the specified marker, a Settings Conflict message is generated.
Preset	Trace value at center of screen. There is no way to predict what this will be after a preset.
Min	–∞ (minus infinity)
Max	+∞ (plus infinity)
Backwards Compatibility Notes	As a result of the change from position markers to value markers (see below), markers can be at a frequency which is offscreen, whereas in the past, they were clipped to the screen edges and hence were never offscreen. In the past, since markers could never be offscreen they always returned a valid result. In the X-Series, markers which are offscreen return not a number as a result; hence the potential now exists for not a number to be returned for a marker Y-Axis query. Also, in some previous analyzers linear ratios read out on the display in %. In the X-Series they display as dimensionless quantities. E.g., a quantity which used to display as 52% now displays as .52. The SCPI behavior is unaffected as it has always read out the ratio rather than the percentage.
Initial S/W Revision	Prior to A.02.00

Querying the Marker Z Axis Value

The command below queries the marker Z Axis value in the Spectrogram View only. The Z Axis value of a marker represents the time value of the marker (see

“Representation of Time” under the Spectrogram View description). In each case the marker that is addressed becomes the selected marker.

Remote Command	<code>:CALCulate:MARKer[1] 2 ... 12:Z?</code>
Notes	The query returns the marker's absolute Z Axis value if the control mode is Normal or Fixed . It returns the offset from the marker's reference marker if the control mode is Delta . For Spectrogram, the Z Axis value represents the amount of time transpired since the start of the recording of traces.
Preset	9.91E+37
Min	-Infinity
Max	+Infinity

Setting or Querying the Marker Z Position

The command below sets the Marker Z position in the Spectrogram View only. Setting the Z Position sets which of the 300 traces in the Spectrogram the selected marker will appear on. In each case the marker that is addressed becomes the selected marker. It has no effect (other than to cause the marker to become selected) if the control mode is **Off**, but it is the SCPI equivalent of making a Marker Z entry if the control mode is **Normal**, **Delta**, or **Fixed**.

Remote Command	<code>:CALCulate:MARKer[1] 2 ... 12:Z:POsition <integer></code> <code>:CALCulate:MARKer[1] 2 ... 12:Z:POsition?</code>
Notes	The command sets or queries the Z Axis position. In the Spectrogram View, this value correlates to be one of the 300 stored traces. Each Z Axis position represents a different stored trace.
Preset	0
Min	0
Max	Number of traces stored is limited to 300.
Default Unit	unitless

Marker Backwards Compatibility

In earlier Agilent analyzers, markers were position markers, which means that Normal and Delta markers stayed at the same screen position when X Axis parameters were changed. So a marker at center screen stayed at center screen even if Center Frequency was changed (which means that the marker's frequency changed). In the X-Series, markers are value markers, which means that when the analyzer's X Axis settings are changed, the marker's X Axis value in fundamental X Axis units remains unchanged. For example, if you put a marker at a particular frequency, it will stay at that frequency regardless of whether or not you change the Center Frequency of the analyzer, even if that means that the marker ends up offscreen.

While this change resulted in an overall higher level of usability of the marker system, there are some use cases where the user depends on the marker staying at the center of the screen. The most common one is where the user turns on a marker at center screen and uses it to measure the trace amplitude at the center frequency

or at a series of center frequencies, without the need to ever move the marker. In the X-Series, to mimic the legacy behavior for this use case, the user must turn the marker off and then back on after changing the center frequency of the analyzer. This causes the marker to reappear in the center of the screen.

Also as a result of the change from position markers to value markers, markers can be at a frequency which is offscreen, whereas in the past, they were clipped to the screen edges and hence were never offscreen. Users who depended on this clipping behavior to force markers to the edges of the screen will have to rewrite their code. Furthermore, since markers could never be offscreen they always returned a valid result. In the X-Series, markers which are offscreen return not a number as a result; hence the potential now exists for not a number to be returned for a marker query.

Select Marker

Specifies the selected marker. The term “selected marker” is used throughout this document to specify which marker will be affected by the functions.

Key Path	Marker
Notes	The selected marker is remembered even when not in the Marker menu and is used if a Search is done or a Band Function is turned on or for Signal Track or Continuous Peak.
Preset	Marker 1
State Saved	The number of the selected marker is saved in instrument state.
Initial S/W Revision	Prior to A.02.00

Normal

Sets the control mode for the selected marker to **Normal** and turns on the active function for setting its value. If the selected marker was **Off**, it is placed at the center of the screen on the trace specified by the marker’s Trace attribute.

A Normal mode (POsition type) marker can be moved to any point on the X Axis by specifying its X Axis value. Its absolute Y Axis value is then the value of the trace point at that X Axis value.

Key Path	Marker
Example	:CALC:MARK:MODE POS sets Marker 1 to Normal.
Notes	See the description under the “ Marker” key.
Couplings	The marker addressed by this command becomes the selected marker on the front panel.
State Saved	The marker control mode (Normal, Delta, Fixed, Off) and X Axis value are saved in instrument state.
Backwards Compatibility SCPI	:CALCulate:MARKer[1] 2 ... 12:STATe ON 1 Setting a marker which is OFF to ON or 1 selects the marker, puts it in Normal mode and places it at the center of the screen. Setting a marker which is not OFF to ON has no effect (does not change its control mode). Example: CALC:MARK2:STAT ON sets Marker 2 to Normal if it was off; otherwise it does nothing. The response to the query will be ON unless the marker is OFF.
Initial S/W Revision	Prior to A.02.00

Remote Command	:CALCulate:MARKer[1] 2 ... 12:STATe OFF ON 0 1 :CALCulate:MARKer[1] 2 ... 12:STATe?
Preset	OFF
Initial S/W Revision	Prior to A.02.00

Delta

Sets the control mode for the selected marker to Delta and turns on the active function for setting its delta value. If the selected marker was **Off**, it is placed at the center of the screen on the trace specified by the marker's Trace attribute.

In Delta mode the marker result shows the relative result between the selected (Delta) marker and its reference marker. A delta marker can be moved to any point on the X Axis by specifying its X Axis offset from a reference marker. Its absolute Y Axis value is then the value of the trace point at that X Axis value.

Key Path	Marker
Example	:CALC:MARK:MODE DELT sets marker 1 to Delta.
Notes	See the description under the "Marker" key.
State Saved	The marker control mode (Normal, Delta, Fixed, Off) and X Axis value are saved in instrument state
Backwards Compatibility Notes	Previously, pressing Delta (or sending the CALC:MARK:MODE:DELTa command) always moved the reference marker to the delta marker. Now it only does so if the marker was already a delta marker.
Initial S/W Revision	Prior to A.02.00

Fixed

Sets the control mode for the selected marker to Fixed. A fixed marker is fixed in the sense that it stays where you place it. It can be directly moved in both X and Y. It can be moved with a Peak Search. It can also be indirectly moved by re-zeroing the delta if it is a relative marker. If it is moved, it again becomes fixed at the X Axis point it moved to and it has a Y-axis result that it took on when it moved there. If a Normal or Delta marker is changed to Fixed it becomes fixed at the X Axis point it was at, and with the Y-axis result it had when it was set to Fixed.

In Fixed mode the marker result shows:

- If no Marker Function is on, the absolute X Axis and Y axis value of the marker
- If a Marker Function is on, the X Axis value and the Y-axis function result the marker had when it became fixed.

See ["Fixed Marker X Axis Value" on page 678](#).

See ["Fixed Marker Y Axis Value" on page 678](#).

See [Fixed Marker Z Axis Value](#)

Fixed Marker X Axis Value

Key Path	Marker, Fixed
Example	:CALC:MARK:MODE FIX sets Marker 1 to Fixed.
Notes	See the description under the “Marker” key, above.
Dependencies	<ul style="list-style-type: none"> – You cannot directly set the X or Y value of a Fixed marker which has a marker function turned on. If an attempt is made to actually adjust it while a Marker Function is on, a warning message is generated. – You cannot directly set the Y value of a Fixed marker while Normalize is turned on. If an attempt is made to do so while Normalize is on, a warning message is generated.
State Saved	The marker control mode (Normal, Delta, Fixed, Off) and X and Y Axis values are saved in instrument state
Backwards Compatibility Notes	In legacy analyzers, only a Reference marker could be Fixed, and it was always Fixed. Additionally it could not be moved. In the X-Series, any marker can be set to Fixed and can be moved to any X or Y value.
Initial S/W Revision	Prior to A.02.00

Fixed Marker Y Axis Value

Key Path	Marker, Fixed
Example	:CALC:MARK:MODE FIX sets Marker 1 to Fixed.
Notes	See the description under the Marker key.
Dependencies	You cannot directly set the X or Y value of a Fixed marker which has a marker function turned on. If an attempt is made to actually adjust it while a Marker Function is on, a warning message is generated.
State Saved	The marker control mode (Normal, Delta, Fixed, Off) and X and Y Axis values are saved in instrument state
Default Unit	depends on the current selected Y axis unit
Initial S/W Revision	Prior to A.02.00

Fixed Marker Z Axis Value

The Marker Z position determines which of the 301 traces (0-300) the selected marker is on. It cannot be set above the maximum trace in the Spectrogram window and, unlike the Marker X position, will not move off screen in the Spectrogram Window if the storage size is smaller than the number of traces that can be viewed.

If Spectrogram is on, the marker result block has a third line displaying the time value of Marker Z. If the marker is a delta marker, the delta time value is displayed. Although the Z Marker position can be moved to trace 0, this is not recommended, as the current trace value is constantly being updated by new acquisitions and therefore the Z time value for trace 0 is not completely registered until the trace is completed.

Marker Z position is only available in the Spectrogram View

Key Path	Marker, Fixed
Example	:CALC:MARK2:MODE FIX sets Marker 2 to Fixed. :CALC:MARK2:Z:POS 150 puts Marker 2 on Trace 150
Dependencies	Only appears in the Spectrogram view, otherwise blanked
State Saved	The marker control mode (Normal, Delta, Fixed, Off) and X, Y and Z Axis values are saved in instrument state
Initial S/W Revision	A.07.01

Off

Turns off the selected marker.

In addition, Off removes the marker annunciation from the display, turns off any active function and any marker function, and resets the following properties to their default value:

- X Axis scale: Auto
- Band/Interval Span: 0
- Auto Trace: On

Off does not affect which marker is selected.

Key Path	Marker
Example	:CALC:MARK:MODE OFF sets Marker 1 to Off.
Notes	See the description under the “Marker” key.
State Saved	The marker control mode (Normal, Delta, Fixed, Off) is saved in instrument state
Backwards Compatibility SCPI	:CALCulate:MARKer[1] 2 ... 12:STATe OFF 0 The response to the query will be OFF unless the marker is ON.
Initial S/W Revision	Prior to A.02.00

Properties

Opens a menu used to set certain properties of the selected marker.

Key Path	Marker
Initial S/W Revision	Prior to A.02.00

Select Marker

Specifies the selected marker. The term “selected marker” is used throughout this document to specify which marker will be affected by the functions.

Key Path	Marker
Notes	The selected marker is remembered even when not in the Marker menu and is used if a Search is

	done or a Band Function is turned on or for Signal Track or Continuous Peak.
Preset	Marker 1
State Saved	The number of the selected marker is saved in instrument state.
Initial S/W Revision	Prior to A.02.00

Relative To

Selects the marker that the selected marker will be relative to (its reference marker).

Every marker has another marker to which it is relative. This marker is referred to as the “reference marker” for that marker. This attribute is set by the **Marker, Properties, Relative To** key. The marker must be a **Delta** marker to make this attribute relevant. If it is a **Delta** marker, the reference marker determines how the marker is controlled and how its value is displayed. A marker cannot be relative to itself.

Key Path	Marker, Properties
Remote Command	:CALCulate:MARKer[1] 2 ... 12:REFerence <integer> :CALCulate:MARKer[1] 2 ... 12:REFerence?
Example	CALC:MARK1:REF 2 sets the marker 1 reference marker to 2 and turns marker 1 on as a delta marker.
Notes	A marker cannot be relative to itself so that choice is grayed out. If the grayed out key is pressed, an advisory message is generated.
Notes	This command causes the marker specified with the subopcode to become selected. Range (for SCPI command): 1 to 12. If the range is exceeded the value is clipped.
Couplings	The act of specifying the selected marker’s reference marker makes the selected marker a Delta marker. If the reference marker is off it is turned on in Fixed mode at the delta marker location.
Preset	The preset default “Relative To” marker (reference marker) is the next higher numbered marker (current marker +1). For example, if marker 2 is selected, then it’s default reference marker is marker 3. The exception is marker 12, which has a default reference of marker 1. Set to the defaults by using Restore Mode Defaults . This is not reset by Marker Off, All Markers Off, or Preset .
State Saved	Saved in instrument state. Not affected by Marker Off and hence not affected by Preset or power cycle.
Min	1
Max	12
Status Bits/OPC dependencies	none Default (selected when Restore Mode Defaults is pressed): next higher numbered marker or 1 if marker 12.
Initial S/W Revision	Prior to A.02.00

Select Marker

Specifies the selected marker. The term “selected marker” is used throughout this document to specify which marker will be affected by the functions.

Key Path	Marker
Notes	The selected marker is remembered even when not in the Marker menu and is used if a Search is done or a Band Function is turned on or for Signal Track or Continuous Peak.
Preset	Marker 1
State Saved	The number of the selected marker is saved in instrument state.
Initial S/W Revision	Prior to A.02.00

X Axis Scale

Accesses a menu that enables you to affect how the X Axis information for the selected marker is displayed in the marker area (top-right of display) and the active function area of the display, and how the marker is controlled. The available settings for the X Axis Scale are Frequency, Period, Time, and Inverse Time.

See "[More Information](#)" on page 681.

Key Path	Marker, Properties
Remote Command	:CALCulate:MARKer[1] 2 ... 12:X:READout FREQuency TIME ITIME PERiod :CALCulate:MARKer[1] 2 ... 12:X:READout? :CALCulate:MARKer[1] 2 ... 12:X:READout:AUTO ON OFF 1 0 :CALCulate:MARKer[1] 2 ... 12:X:READout:AUTO?
Example	CALC:MARK3:X:READ TIME sets the marker 3 X Axis Scale to Time.
Notes	This command causes the specified marker to become selected.
Preset	AUTO Marker Preset (selected when a marker is turned Off): Auto (see below). In most measurements the Auto settings results in Frequency being the preset readout.
State Saved	Saved in instrument state
Backwards Compatibility Notes	The X Axis Scale of a marker (Readout in legacy analyzers) now has only one value, not one value for frequency domain and another value for time domain. The value changes (if in Auto) when the domain of the trace it is on changes. This means that the default behaviors are identical, but if the user changes the readout manually in swept and expects the default to remain in zero span, there may be some backwards compatibility problems. As an example, in the old instruments, if the user set Readout to Period in a swept span, and the instrument was set to zero span, the readout changed to Time, the default for Zero Span. Now, it will stay in Period even in Zero Span until the user changes it or sets it back to Auto. Additionally, all choices for X Axis Scale are now always allowed. In legacy analyzers the choices of X Axis Scale were restricted based on the domain the instrument was currently in. Since the new behavior is less restrictive this should not show up as a backwards compatibility issue.
Initial S/W Revision	Prior to A.02.00

More Information

The **X Axis Scale** of a marker is the scale of its X Axis value. This affects the units displayed in the Marker Result block and used to specify the marker's X Axis location.

The X Axis Scale is specified using the **Marker, Properties, X Axis Scale** key.

All markers in swept spans have both a time and frequency value. Which of these is used for the result display, and for positioning the marker, depends on the **X Axis Scale** setting. The **X Axis Scale** setting can be **Frequency** or **Time**, as well as the reciprocal of either (**Period** or **Inverse Time**). There is also an **Auto** setting - when in **Auto**, a marker's **X Axis Scale** changes whenever the domain of the trace, upon which it set, changes. All choices for **X Axis Scale** are allowed. Note that this behavior differs from the behavior in previous instruments: previously the instrument remembered a different **X Axis Scale** (formerly called **Readout**) for each domain, and the choices of **X Axis Scale** were restricted. These restrictions were based on the current domain of the instrument.

Auto

When in Auto, the X-Axis Scale is **Frequency** if the Marker Trace is a frequency domain trace, **Time** if the Marker Trace is a time domain trace. When in Auto, if the marker changes traces, or the domain of the trace the marker is on changes, the auto result is re-evaluated. If the X Axis Scale is chosen manually, that Scale is used regardless of the domain of the trace.

Key Path	Marker, Properties, X Axis Scale
Example	CALC:MARK2:X:READ:AUTO ON sets the marker 2 X-axis scaling to automatically select the most appropriate units.
Initial S/W Revision	Prior to A.02.00

Frequency

Sets the marker X Axis scale to Frequency, displaying the absolute frequency of a normal marker or the frequency of the delta marker relative to the reference marker. Frequency is the auto setting for frequency domain traces.

If Frequency is selected for a time domain trace, all of the points in the trace will show the same value. Attempting to use the knob or step keys to adjust the X Axis value of the marker or entering an X Axis value from the numeric keypad or remotely will have no effect but will generate no error.

Key Path	Marker, Properties, X Axis Scale
Example	CALC:MARK2:X:READ:FREQ sets the marker 2 X Axis scale to Frequency.
Notes	1-of-N readback is Frequency
State Saved	The X Axis Scale setting is saved in instrument state.
Initial S/W Revision	Prior to A.02.00

Period

Sets the marker X Axis scale to Period, displaying the reciprocal of the frequency of the marker, or the reciprocal of the frequency separation of the two markers in a delta-marker mode. The units are those of time (sec, msec, etc.). If the markers are at the same frequency in a delta marker mode, the result will be the reciprocal of 0,

which is infinitely large. The display will show “---” and a SCPI query will return infinity.

If Period is selected for a time domain trace, all of the points in the trace will show the same value. Attempting to use the knob or step keys to adjust the X Axis value of the marker or entering an X Axis value from the numeric keypad or remotely will have no effect but will generate no error.

Key Path	Marker, Properties, X Axis Scale
Example	CALC:MARK2:X:READ PER sets the marker 2 X Axis scale to Period.
Notes	1-of-N readback is Period
State Saved	The X Axis Scale setting is saved in instrument state.
Initial S/W Revision	Prior to A.02.00

Time

Sets the marker X Axis scale to Time, displaying the time interval between a normal marker and the start of a sweep or the time of the delta marker relative to the reference marker. Time is the auto setting for time domain traces. In a delta-marker mode it is the (sweep) time interval between the two markers.

Key Path	Marker, Properties, X Axis Scale
Example	CALC:MARK2:X:READ TIME sets the marker 2 X Axis Scale to Time..
Notes	1-of-N readback is Time
Couplings	Frequency domain traces taken in FFT mode have no valid time data. Therefore when Time is selected for markers on such traces, the X Axis value is taken as the appropriate percentage of the displayed sweep time, which is a calculated estimate.
State Saved	The X Axis Scale setting is saved in instrument state
Initial S/W Revision	Prior to A.02.00

Inverse Time

Sets the marker X Axis scale to Inverse Time, displaying the reciprocal time. It is useful in a delta mode to show the reciprocal of (sweep) time between two markers. This function is only meaningful when on a time domain trace and in the **Delta** control mode. If the markers are at the same X Axis value, the time between them is 0, so the reciprocal of sweep time is infinitely large. The display will show “---” and a SCPI query will return infinity.

Key Path	Marker, Properties, X Axis Scale
Example	:CALC:MARK2:X:READ ITIM sets the marker 2 X Axis scale to Inverse Time.
Notes	1-of-N readback is Inverse Time
Couplings	Frequency domain traces taken in FFT mode have no valid time data. Therefore when Inverse Time is selected for markers on such traces, the X Axis value is undefined, shows as “---” and returns not a number to a query.
State Saved	The X Axis Scale setting is saved in instrument state
Initial S/W Revision	Prior to A.02.00

Marker Trace

Selects the trace that you want your marker to be placed on. A marker is associated with one and only one trace. This trace is used to determine the placement, result, and X Axis Scale of the marker. All markers have an associated trace, even **Fixed** markers; it is from that trace that they determine their attributes and behaviors, and it is to that trace that they go when they become Normal or Delta markers.

- See "Auto Init On" on page 684.
- See "Auto Init Rules Flowchart" on page 685.
- See "Auto Init OFF" on page 685.

Key Path	Marker, Properties
Remote Command	:CALCulate:MARKer[1] 2 ... 12:TRACe 1 2 3 4 5 6 :CALCulate:MARKer[1] 2 ... 12:TRACe?
Example	CALC:MARK1:TRAC 2 places marker 1 on trace 2.
Notes	A marker may be placed on a blanked and/or inactive trace, even though the trace is not visible and/or updating. An application may register a trace name to be displayed on the key instead of a trace number.
Couplings	The state of Marker Trace is not affected by the Auto Couple key. If a Marker Trace is chosen manually, Auto Init goes to Off for that marker. Sending the remote command causes the addressed marker to become selected.
Preset	Presets on Preset or All Markers Off
State Saved	The Marker Trace and state of Auto Init for each marker is saved in instrument state.
Min	1
Max	6
Readback line	[TraceN, Auto Init] or [TraceN, Manual] where N is the trace number to which the marker is currently assigned.
Initial S/W Revision	Prior to A.02.00

Auto Init On

When **Auto Init** is true, the marker's trace attribute is re-determined automatically by the analyzer whenever the marker turns on (Normal, Delta or Fixed) from an Off state. (The trace attribute is also determined for all markers that are on, whenever **Auto Init** is turned on).

When the marker moves between traces the marker's X position in trace points is retained as it moves. For moving between active traces this generally means the x-axis value of the marker will not change. But for moving to or from an inactive trace, the x-axis value will take on that of the new trace at the bucket the marker was on the old trace (and is still on, on the new trace, since the bucket doesn't change).

Note this is true even if the marker is off screen. Thus, a marker that is at the center of the screen on the old trace stays at the center of the screen on the new trace. A marker that is off screen one whole screen to the left on the old trace remains off

screen one whole screen to the left on the new trace – even if this means it will be at negative time!

Marker Trace is set to 1, and Auto Init is set to On, on a Preset or All Markers Off.

Auto Init Rules Flowchart

The following flowchart depicts the Auto Init rules:

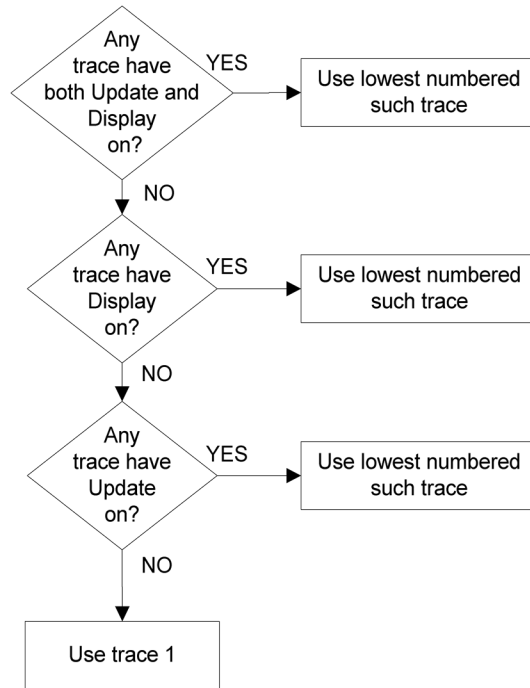

This flowchart makes it clear that putting all lower-numbered traces in View is the simplest way to specify which trace you want the markers to go to when they turn on. For example, if you want all Markers to go to trace 2 when they turn on, put trace 1 in View.

Auto Init OFF

This command associates the marker with the specified trace and turns Marker Trace, Auto Init OFF for that marker. If the marker is not **Off** it moves the marker from the trace it was on to the new trace. If the marker is **Off** it stays off but is now associated with the specified trace.

The query returns the number of the trace on which the marker is currently placed, even if that marker is in Auto mode.

Remote Command	:CALCulate:MARKer[1] 2 ... 12:TRACe:AUTO OFF ON 0 1 :CALCulate:MARKer[1] 2 ... 12:TRACe:AUTO?
Notes	Turning Marker Trace Auto Init off has no effect on the trace on which the marker is currently placed. The response to the query will be 0 if OFF, 1 if ON.

Couplings	The state of Auto Init is not affected by the Auto Couple key. Auto Init is set to True on a Preset or All Markers Off. If Auto Init is set to On for a marker and that marker is on, that marker's Marker Trace is immediately set according to the above flowchart. Sending the remote command causes the addressed marker to become selected.
Preset	ON
Backwards Compatibility Notes	The Marker Trace Auto function in legacy analyzers has been replaced by Marker Trace Auto Init, but the same SCPI command is used for the new function. This should work fine for most legacy users. See the sections on "Auto Init On" on page 684 , "Auto Init OFF" on page 685 and the "Auto Init Rules Flowchart" on page 685 for details. The new auto functionality causes markers to automatically go to the appropriate trace when the marker is first turned on. Users who counted on markers changing traces when a trace was put in or out of View will have to modify their code.
Initial S/W Revision	Prior to A.02.00

Lines

When on, displays a vertical line of graticule height and a horizontal line of graticule width, intersecting at the indicator point of the marker (that is, the center of the X or the bottom tip of the diamond). The lines are blue in color.

If the marker is off screen the lines should be extended from the marker so that they go thru the screen area if possible. This is really useful for off screen Fixed markers as it lets you see their amplitude even though they are off the X Axis.

Key Path	Marker, Properties
Remote Command	:CALCulate:MARKer[1] 2 ... 12:LINEs[:STATe] OFF ON 0 1 :CALCulate:MARKer[1] 2 ... 12:LINEs[:STATe]?
Example	:CALC:MARK2:LIN:ON turns Lines on for marker 2.
Couplings	Sending the remote command causes the addressed marker to become selected.
Preset	OFF
State Saved	Saved in instrument state
Initial S/W Revision	Prior to A.02.00

Marker Z

The Marker Z position determines which of the 301 traces (0-300) the selected marker is on. It cannot be set above the maximum trace in the Spectrogram window and, unlike the Marker X position, will not move off screen in the Spectrogram Window if the storage size is smaller than the number of traces that can be viewed.

If Spectrogram is on, the marker result block has a third line displaying the time value of Marker Z. If the marker is a delta marker, the delta time value is displayed. Although the Z Marker position can be moved to trace 0, this is not recommended, as the current trace value is constantly being updated by new acquisitions and therefore the Z time value for trace 0 is not completely registered until the trace is completed.

Key Path	Marker, Fixed
Example	:CALC:MARK3:Z:POS 100 puts Marker 3 on Trace 100
Dependencies	Only appears in the Spectrogram view, otherwise blanked
State Saved	The X, Y and Z Axis values are saved in instrument state
Initial S/W Revision	A.07.01

Marker Table

When set to On, the display is split into a measurement window and a marker data display window. For each marker which is on, information is displayed in the data display window, which includes the marker number, control mode, trace number, X axis scale, X axis value, and the Y-axis result. Additional information is shown for markers which have marker functions turned on.

Turning the Marker Table on turns the Peak Table off and vice versa.

Key Path	Marker
Remote Command	:CALCulate:MARKer:TABLE[:STATE] OFF ON 0 1 :CALCulate:MARKer:TABLE[:STATE]?
Example	CALC:MARK:TABL ON turns on the marker table.
Preset	OFF
State Saved	The on/off state of the Marker Table is saved in instrument state
Initial S/W Revision	Prior to A.02.00

Marker Count

Accesses the marker count menu.

Key Path	Marker
Readback line	[On] if count on for the selected marker, [Off] if it is off.
Initial S/W Revision	Prior to A.02.00

Counter

Turns the marker frequency counter on and off. The selected marker is counted, and if the selected marker is a delta marker and its reference marker is not fixed, the reference marker is counted as well.

- See ["Understanding the Marker Counter" on page 689](#).
- See ["Query Count Value" on page 688](#).

Key Path	Marker, Marker Count
Remote Command	:CALCulate:MARKer[1] 2 ... 12:FCOUNT[:STATE] OFF ON 0 1 :CALCulate:MARKer[1] 2 ... 12:FCOUNT[:STATE]?

Example	CALC:MARK2:FCO ON selects marker 2, turns it on, and turns on the counter CALC:MARK2:FCO:X? returns the counted frequency.
Notes	Fixed markers are not counted, but a Fixed marker will have a count stored in it if it is selected or is the reference marker for the selected marker. The count already in the marker is stored when the marker becomes fixed and if there is none or the marker moves (for example, Pk Search) it is counted and stored after the next sweep. If a Fixed marker has a count stored in it, that count will be displayed when the marker is selected, and used as the reference count when that marker is a reference marker. If a Fixed marker has a count stored in it, that count will be deleted if the marker X is adjusted. If a Fixed marker has a count stored in it, and a Search function is performed using the Fixed marker, while the counter is on, the count stored in the marker will be updated. If a Fixed marker has a count stored in it, and is a reference marker, and the reference is moved to a valid trace point by re-zeroing the delta (by pressing Delta again or sending the DELTA SCPI command), while the counter is on, the count stored in the marker will be updated.
Notes	This command causes the specified marker to become selected.
Dependencies	Marker Count is unavailable (grayed out and Off) if the Gate function is on.
Couplings	If the selected marker is Off when the counter is turned on, the selected marker is set to Normal and placed at center of screen on the trace determined by the Marker Trace rules. If a marker that is OFF is selected while the counter is on, the counter remains on, but since the marker is off, the count is undefined. In this case the analyzer will return not a number to a SCPI count query. The counter is turned OFF when the selected marker is turned OFF.
Preset	OFF
State Saved	The state of the counter (on/off) is saved in instrument state. In the case of Fixed markers, the count stored in the marker is saved in instrument state.
Backwards Compatibility Notes	In some legacy analyzers (e.g., the 8560 series) the FreqOffset value was applied to the Marker Count. In others (e.g., ESA and PSA) it was not. The X-Series follows the ESA/PSA model and does not apply Freq Offset to the Marker Count. In ESA and PSA the reference marker for Delta markers was always counted. In the X-Series the marker is counted for Normal and Delta markers; but for the reference marker, if it is a Fixed marker, we use the count stored in the Fixed marker. This enhanced capability may require a change to some users' code and/or test procedures.
Initial S/W Revision	Prior to A.02.00

Query Count Value

Queries the frequency count. The query returns the absolute count unless the specified marker is in Delta mode, then it returns the relative count. If the marker is off, or the marker is on but the counter is off, the analyzer will return not a number to a SCPI count query. A marker with no stored count, or a non-**Fixed** marker on a stored trace, will also return not a number to a SCPI count query. Note this result may simply mean that the first sweep after the counter turned on has not yet completed.

Remote Command	:CALCulate:MARKer[1] 2 ... 12:FCount:X?
-----------------------	---

Notes	This query does NOT cause the specified marker to become selected.
Initial S/W Revision	Prior to A.02.00

Understanding the Marker Counter

See ["Counting Off-screen Markers" on page 689](#).

See ["Delta Marker" on page 689](#).

See ["Fixed Markers" on page 690](#).

See ["More Information on "Counter"" on page 690](#).

Using the internal counter we can count the frequency of a marker, but we cannot count while we are actually sweeping. So, once we are done with a sweep, we move to the selected marker frequency and count that frequency. Then, if the marker is a Delta marker, the count is also taken for its reference marker. The count is actually performed by moving the LO to the frequency (or frequencies in the case of a delta marker) we wish to count. The count is executed on a marker by marker basis and no further count is taken until after the next sweep (even if the marker moves before another sweep has completed).

The Marker Count is taken by tuning the instrument to the frequency of the marker and counting the IF, with the instrument not sweeping. The count is adjusted for display by adding or subtracting it (as appropriate) from the LO frequency, so that you see a count that represents the signal frequency. This is true even if External Mixing is on. Since all this happens between sweeps, you never see the instrument retuning to do the counts.

If you wish to see the entered frequency of a counted marker it will appear in the active function area when that marker is selected (for Fixed markers, you have to press the Marker, Fixed key to select Fixed markers and then press it a second time to view or adjust the x or y marker values).

Counting Off-screen Markers

If the selected marker is off the X-axis the instrument can still be tuned to the marker (unless it is outside the current range of the instrument), so the count can still be displayed. This means you can see a count for an off-screen marker even though there may be no valid Y-value for the marker. If the marker frequency is outside the range of the instrument, the display will show three dashes in the count block (---), and not a number is returned to a SCPI count query.

Delta Marker

When a Delta Marker is selected while Marker Count is on:

1. If the reference marker is not a fixed marker, the display shows the difference between the count of the selected marker and the count of the reference marker

2. If the reference marker is a fixed marker and there is a count stored in the marker (because Marker Count was on when the marker became a fixed marker), the display shows the difference between the count at the marker and the count stored in the reference marker.

Marker Count works in zero span as well as in Swept SA. The instrument tunes to the frequency of the selected marker, which, for active zero span traces, is simply the center frequency of the analyzer.

Fixed Markers

Fixed markers have a count stored in them that is generally kept fixed and not updated. If a fixed marker is selected, or used as a reference, the signal at the marker frequency is not counted; rather the stored count is seen or used as the reference. The count is stored, if Count is on, when the marker becomes fixed or when, while fixed, the marker is moved by re-zeroing the reference (if it is the reference marker) or via a peak search (since both of these, by definition, use valid trace data). The count stored in a Fixed marker is lost if the counter is turned off, if the marker is moved to an inactive trace, or if the marker is moved by adjusting its x-value.

More Information on "Counter"

When the counter is on, the count (or the delta count) for the selected marker is displayed.

The invalid data indicator (*) will turn on until the completion of the first count.

Marker Count frequency readings are corrected using the **Freq Offset** function (in some previous analyzers, they were not). Note however that Marker Delta readings are not corrected, as any offset would be applied to both.

In zero span on active traces the counter continues to function, counting any signal near the center frequency of the analyzer.

NOTE

No signal farther from the marker frequency than the Res BW will be seen by the counter.

The above command turns on or off the frequency counter. If the specified marker number in the command is not the selected marker, it becomes the selected marker. If the specified marker number is not on, FCOunt ON sets it to Normal and places it at center of screen on the trace determined by the Marker Trace rules. Once the marker count is on, it is on for any selected marker, not just for the one used in the command. A 1 is returned to the state query only if marker count is on and the specified number is the selected marker. The invalid data indicator (*) will turn on until the completion of the first count but this does not keep a value from being returned.

Gate Time

Controls the length of time during which the frequency counter measures the signal frequency. Longer gate times allow for greater averaging of signals whose frequency

is “noisy”, though the measurement takes longer. If the gate time is an integer multiple of the length of a power-line cycle (20 ms for 50 Hz power, 16.67 ms for 60 Hz power), the counter rejects incidental modulation at the power line rate. The shortest gate time that rejects both 50 and 60 Hz modulation is 100 ms, which is the value chosen in Auto, or on Preset or when Auto Couple is pressed.

The start time of the Gate Time of the counter must be controlled by the same trigger parameters as controls the sweep. Thus, if the Trigger is not in Free Run, the counter gate must not start until after the trigger is received and delayed.

Key Path	Marker Function, Marker Count
Remote Command	:CALCulate:MARKer[1] 2 ... 12:FCOunt:GATetime <time> :CALCulate:MARKer[1] 2 ... 12:FCOunt:GATetime? :CALCulate:MARKer[1] 2 ... 12:FCOunt:GATetime:AUTO OFF ON 0 1 :CALCulate:MARKer[1] 2 ... 12:FCOunt:GATetime:AUTO?
Example	:CALC:MARK2:FCO:GAT 1e-2 sets the gate time for Marker 2 to $10^{(-2)}$ s = 10 ms.
Notes	When Auto Couple is pressed, Gate Time is set to 100 ms.
Notes	This command causes the specified marker to become selected.
Preset	100 ms ON
State Saved	Saved in instrument state.
Min	1 us
Max	500 ms
Initial S/W Revision	Prior to A.02.00

Remote Command	:CALCulate:MARKer[1] 2 ... 4:FCOunt:RESolution <freq> :CALCulate:MARKer[1] 2 ... 4:FCOunt:RESolution? :CALCulate:MARKer[1] 2 ... 4:FCOunt:RESolution:AUTO ON OFF 1 0 :CALCulate:MARKer[1] 2 ... 4:FCOunt:RESolution:AUTO?
Notes	This command is provided for ESA compatibility, which allowed the user to control the gate resolution, rather than the gate time. :CALCulate:MARKer[1] 2 3 4:FCOunt:RESolution <freq> Sets the gate time to 1/freq :CALCulate:MARKer[1] 2 3 4:FCOunt:RESolution? Returns 1/gate_time :CALCulate:MARKer[1] 2 3 4:FCOunt:RESolution:AUTO OFF ON 0 1 is accepted and ignored :CALCulate:MARKer[1] 2 3 4:FCOunt:RESolution:AUTO? Always returns 1 All of these commands cause the marker to become selected.
Preset	1Hz ON
Initial S/W Revision	Prior to A.02.00

Couple Markers

When this function is On, moving any marker causes an equal X Axis movement of every other marker which is not Fixed or Off. By “equal X Axis movement” we mean that we preserve the difference between each marker’s X Axis value (in the fundamental x-axis units of the trace that marker is on) and the X Axis value of the marker being moved (in the same fundamental x-axis units).

Note that Fixed markers do not couple. They stay where they were while all the other markers move. Of course, if a Fixed marker is being moved, all the non-fixed markers do move with it.

This may result in markers going off screen.

Key Path	Marker
Remote Command	:CALCulate:MARKer:COUple[:STATe] OFF ON 0 1 :CALCulate:MARKer:COUple[:STATe]?
Example	:CALC:MARK:COUP ON sets Couple Markers on.
Preset	Off, presets on Mode Preset and All Markers Off
State Saved	Saved in instrument state
Initial S/W Revision	Prior to A.02.00

All Markers Off

Turns off all markers. See Marker, "Off" on page 679.

Key Path	Marker
Remote Command	:CALCulate:MARKer:AOFF
Example	CALC:MARK:AOFF turns off all markers.
Couplings	Sets the selected marker to 1.
Preset	n/a.
Initial S/W Revision	Prior to A.02.00

Marker Function

The Marker Function key opens up a menu of softkeys that allow you to control the Marker Functions of the instrument. Marker Functions perform post-processing operations on marker data. Band Functions are Marker Functions that allow you to define a band of frequencies around the marker. The band defines the region of data used for the numerical calculations. These marker functions also allow you to perform mathematical calculations on trace and marker data and report the results of these calculations in place of the normal marker result.

NOTE

Unlike regular markers, marker function markers are not placed directly on the trace. They are placed at a location which is relative to the result of the function calculation.

- See ["More Information"](#) on page 693.
- See ["Fixed marker functions"](#) on page 694.
- See ["Interval Markers"](#) on page 694.

Key Path	Front-panel key
Remote Command	:CALCulate:MARKer[1] 2 ... 12:FUNCTION NOISE BPOwer BDENSITY OFF :CALCulate:MARKer[1] 2 ... 12:FUNCTION?
Notes	Sending this command selects the subopcoded marker The marker function result is queried in the same way as the Marker Result, as outlined in the Marker section, with the CALC:MARK:Y? command.
Dependencies	Fixed markers: It is not possible to change the Band Function for a Fixed marker; so all of the Band Function keys are grayed out for a Fixed marker. If a marker function was already on when the marker became Fixed, then the selected Band Function is shown but cannot be changed. Therefore, you cannot directly set the X or Y value of a Fixed marker that has a marker function turned on. To turn off the function, turn off the marker.
Preset	OFF
State Saved	The band function for each marker is saved in instrument state
Backwards Compatibility Notes	The introduction of adjustable-width Band Functions in the X-Series fundamentally changes the way Band Power markers are controlled. See the section entitled "Band Function Backwards Compatibility" on page 695 below for a complete discussion of programming Band Functions in a backwards compatible fashion.
Initial S/W Revision	Prior to A.02.00

More Information

The units to be used for displaying Marker Function results in Delta mode vary depending on what is the reference marker and what it is referenced to.

Marker Functions are different from Measurements, which automatically perform complex sequences of setup, data acquisition, and display operations in order to

measure specified signal characteristics. Marker Functions are specified for each individual marker and may be turned on individually for each marker.

The **Marker Fctn** menu controls which marker functions are turned on and allows you to adjust setup parameters for each function. The Marker Functions are **Marker Noise**, **Band/Interval Power**, and **Band/Interval Density**, only one of which can be on for a given marker.

If the selected marker is off, pressing Marker Fctn sets it to Normal and places it at the center of the display on the trace determined by the Marker Trace rules. However, if the selected marker was **Off**, **Marker Function Off** had to be the selected function, and it remains so even after the marker is thus turned on, although you may then change it.

Fixed marker functions

In the case of a fixed marker, it is not possible to turn on or change a band function. This is because a Fixed marker holds the value it had when it became fixed; the trace it was on may keep on changing, so the function value, which depends on trace data, could not be calculated on an ongoing basis.

It is possible to have a Marker Function on for a Fixed marker, in the case where a function was already on when the marker became Fixed. In this case the function value will be retained in the marker. It is also possible to have a Marker Function on for a Fixed marker in the case when the marker was off and was turned on as **Fixed** because **Delta** was pressed to create a reference marker - in which case the marker function, marker function width, Y Axis value and marker function result that the **Delta** marker had when **Delta** was pressed are copied into the Fixed marker. If **Delta** is pressed again, causing the fixed reference marker to move to the delta marker's position, the marker function, marker function width, Y Axis value and marker function result that the **Delta** marker had when **Delta** was pressed are again copied into the fixed reference marker.

If a Marker Function is on for a Fixed marker, the marker's reported value is derived by the function. Therefore you cannot directly set the X or Y value of a Fixed marker which has a marker function turned on. Indirect setting as detailed above or when a Peak Search is performed is allowed, as the Fixed marker is always placed on a trace and can derive its function value from the trace at the moment when it is placed.

Interval Markers

What is an interval marker? The band power marker computes the total power within a span in a nonzero span. The results computation must include the RBW. The interval power marker measures the average power across some time interval in zero span.

Interval Density is defined to be Interval Power divided by B_n . B_n is the noise bandwidth of the RBW filter, as noted and used within the Band Power computation.

Band Function Backwards Compatibility

To define the Band Power function, the ESA and PSA analyzers used Delta Marker functionality with two markers, for example, Marker 1 and its Reference Marker, as shown below:

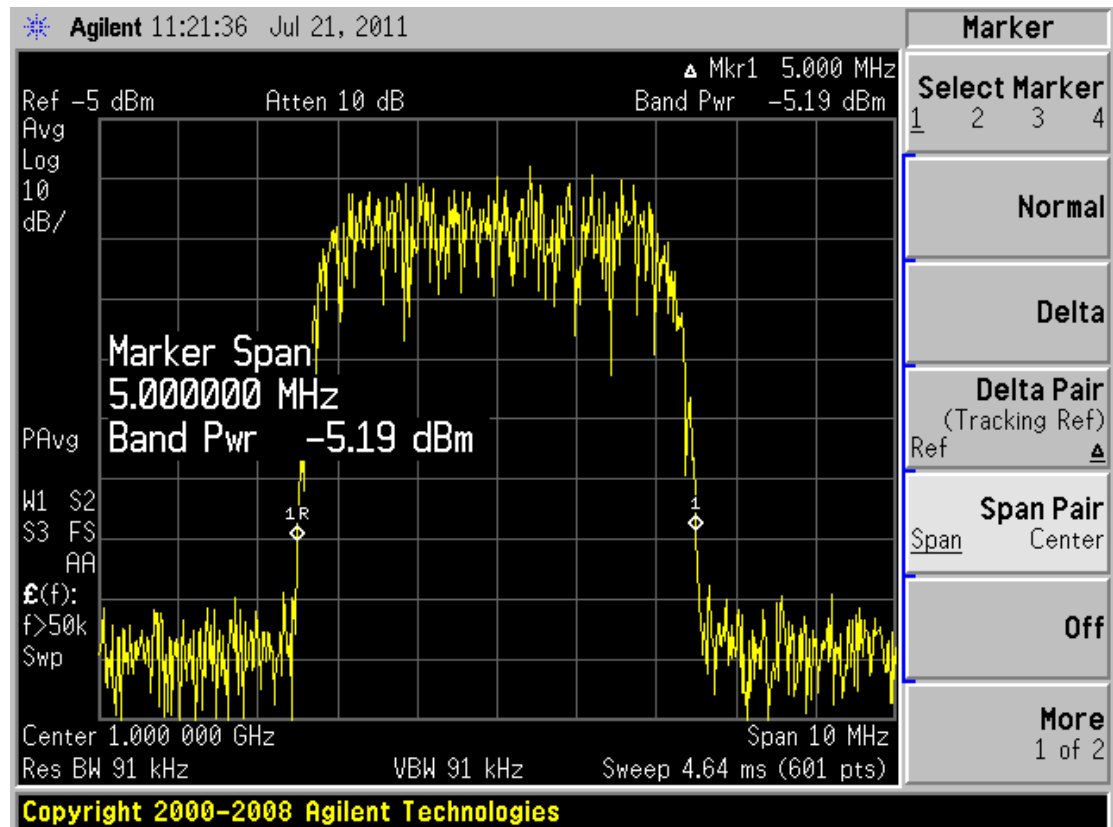

e

The marker modes known as Span Pair and Delta Pair (Band Pair in ESA) were used to set two markers for the primary purpose of defining the band of a Band Power function. The two markers were set by adjusting their span and centerpoint (Span Pair mode) or by adjusting their locations independently to directly define the Start and Stop edges of the band (Band Pair/Delta Pair modes).

In the X-Series, the introduction of adjustable-width Band Functions fundamentally changes the way Band Power markers are controlled, by using a single marker to completely define the function, as shown below:

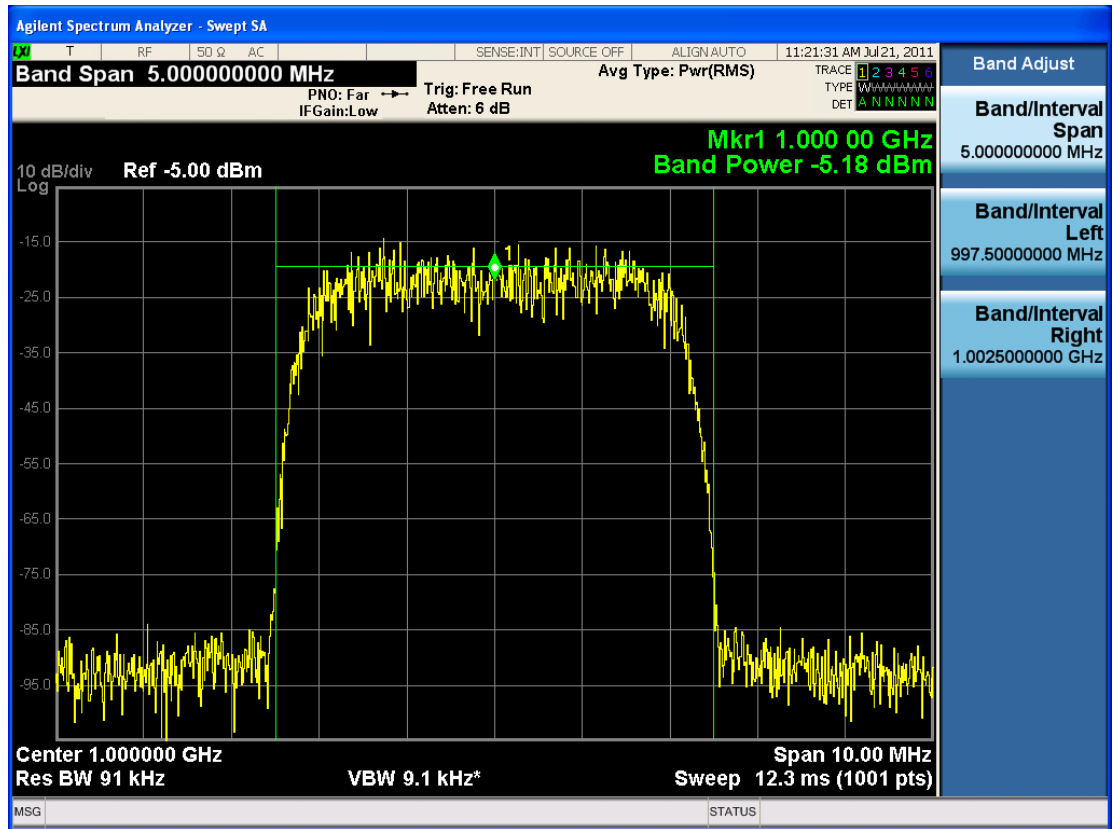

In the X-Series the marker itself has a width attribute, which you set using the Band Span function. The marker shows “wings” that define the edges of the band in which the Band Power is being measured. You only need one marker, not a pair of markers, to completely define a Band Power function (making it possible to do Delta Band Power, which PSA and ESA could not do).

Additional control functions of Band Left and Band Right are provided for the case when you need to precisely set the band edges. Note that the marker itself always remains centered in the band.

To map the old Span Pair and Band Pair/Delta Pair functions to the X-Series for code compatibility, aliases and compatibility commands were added. Since Span Pair and Band Pair/Delta Pair were primarily used for making band power measurements, the aliases are provided for setting the parameters of a Band Function. If the user was using the old commands for anything other than Band Power these aliases will likely not yield compatible results.

For example, some users took advantage of the fact that the Band Pair commands let you arbitrarily set the frequency (time) of a delta marker and its non-fixed reference marker. In these cases, which had nothing to do with band Power, the new commands will not be compatible. For these use cases the user must use two markers and position each using the CALC:MARK:X commands, since “marker pairs” do not exist anymore.

Note that all of the alias commands described below cause the specified marker to become selected.

Marker Mode compatibility

To setup Band Power measurements in the ESA and PSA, you had to send the :CALCulate:MARKer[1]|2|3|4:MODE POSition|DELTA|BAND|SPAN|OFF

command with either the BAND or SPAN parameter, in order to turn on the marker control modes that let you use a pair of delta markers as Band Power markers. In the X-Series this is no longer necessary, as there are no special marker modes for Band power. So when this command is sent with either a BAND or SPAN parameter it is aliased to simply turn on Normal markers. Thus:

Old command	Aliased to
:CALCulate:MARKer[1] 2 3 4:MODE:BAND	:CALCulate:MARKer[1] 2 3 4:MODE:POSition
:CALCulate:MARKer[1] 2 3 4:MODE:SPAN	:CALCulate:MARKer[1] 2 3 4:MODE:POSition

Span Pair Compatibility

In the past, the Span Pair function was used with a marker pair to set the band for Band Power. The following SCPI commands were used when performing this setup programmatically:

:CALCulate:MARKer[1]|2|3|4:X:CENTer <param>

:CALCulate:MARKer[1]|2|3|4:X:CENTer?

:CALCulate:MARKer[1]|2|3|4:X:SPAN <param>

:CALCulate:MARKer[1]|2|3|4:X:SPAN?

These commands are now aliased as follows to preserve the old functionality as much as possible:

Old command	Aliased to
:CALCulate:MARKer[1] 2 3 4:X:CENTer	:CALCulate:MARKer[1] 2 3 4:X
:CALCulate:MARKer[1] 2 3 4:X:SPAN	:CALCulate:MARKer[1] 2 3 4:FUNCTion:BAND:SPAN

Delta Pair/Band Pair functionality

Another way to set the marker pair for Band Power was with the Delta Pair function (Band Pair in ESA). The following SCPI commands were used when performing this setup programmatically:

:CALCulate:MARKer[1]|2|3|4:X:STARt <param>

:CALCulate:MARKer[1]|2|3|4:X:STARt?

:CALCulate:MARKer[1]|2|3|4:X:STOP <param>

:CALCulate:MARKer[1]|2|3|4:X:STOP?

These commands are now aliased as follows to preserve the old functionality as much as possible:

Old command	Aliased to
:CALCulate:MARKer [1] 2 3 4:X:START	:CALCulate:MARKer [1] 2 3 4:FUNCTion:BAND:LEFT
:CALCulate:MARKer [1] 2 3 4:X:STOP	:CALCulate:MARKer [1] 2 3 4:FUNCTion:BAND:RIGHT

Arbitrary Marker Pair functionality

Another use case was to use the START and STOP commands to arbitrarily set the frequency (time) of a delta marker and its reference marker without being in Band Power mode. This use case is not supported with a backwards compatibility command, but since in the X-Series you can arbitrarily set any marker's value and any reference marker's value, it is easy to fix this problem in code; but the user will have to change their code.

Old command	User must change to
:CALCulate:MARKer1:X:START <param>	:CALCulate:MARKer1:X <param> <param>
:CALCulate:MARKer1:X:STOP <param>	:CALCulate:MARKer2:X <param> <param>

(in the example marker 1 and marker 2 are used; in practice, use the reference marker number for the STOP marker number, which is usually marker number+1)

Band changes with analyzer settings

In the past, when a marker pair was used to set the width of the band for Band Power, the markers held their screen positions when analyzer frequency settings such as Span changed. The result of this was that as the Span changed, the frequency difference and hence the width of the band changed as well. In the X-Series, as a result of the change from position markers to value markers, the width of the band remains constant as frequency settings of the analyzer change.

Offscreen Markers

As a result of the change from position markers to value markers, markers can be at a frequency which is offscreen, whereas in the past, they were clipped to the screen edges and hence were never offscreen. Users who depended on this clipping behavior by setting Band Span to a high value in order to force Band Power markers to the left and right edges of the screen will have to rewrite their code.

Furthermore, since markers could never be offscreen, Band Power always returned a valid result. In the X-Series, if either edge of the Band is offscreen, Band Power returns not a number as a result.

Direct Marker Positioning

The following commands were used in ESA and PSA to directly set the marker to a specific trace point (“bucket”) position when they were being used in Span Pair and Delta Pair/Band Pair modes:

```
:CALCulate:MARKer[1]2|3|4:X:POSition:CENTer <param>
```

```
:CALCulate:MARKer[1]2|3|4:X:POSition:CENTer?
```

```
:CALCulate:MARKer[1]2|3|4:X:POSition:SPAN <param>
```

```
:CALCulate:MARKer[1]2|3|4:X:POSition:SPAN?
```

```
:CALCulate:MARKer[1]2|3|4:X:POSition:START <param>
```

```
:CALCulate:MARKer[1]2|3|4:X:POSition:START?
```

```
:CALCulate:MARKer[1]2|3|4:X:POSition:STOP <param>
```

```
:CALCulate:MARKer[1]2|3|4:X:POSition:STOP?
```

They are aliased very similarly to the non-position commands (above) however a translation to/from trace points (buckets) is also performed:

Old command	Aliased to
:CALCulate:MARKer [1]2 3 4:X:POSition:CENTer	:CALCulate:MARKer[1]2 3 4:X:POSition
:CALCulate:MARKer [1]2 3 4:X:POSition:SPAN	:CALCulate:MARKer [1]2 3 4:FUNC:BAND:SPAN
:CALCulate:MARKer [1]2 3 4:X:POSition:START	:CALCulate:MARKer [1]2 3 4:FUNC:BAND:LEFT
:CALCulate:MARKer [1]2 3 4:X:POSition:STOP	:CALCulate:MARKer [1]2 3 4:FUNC:BAND:RIGHT

In each case but the first (:X:POSition:CENTer), the analyzer first converts the specified value in trace points to the current X Axis Scale Units (e.g., frequency or time) of the trace upon which the marker resides. Then, that value is used in the alias command to set the desired value.

The query form of the command returns the marker function span in trace points (buckets) by translating back based on the X Axis Scale settings at the time the query is sent.

NOTE

The value in Trace Points is translated into the current X Axis Scale units for the purpose of setting the value of the marker. However, the marker's span value, LEFT value, or RIGHt value in X Axis Scale Units, NOT trace points, will be preserved if a change is made to the X Axis scale settings. For example, if you use this command to set a marker function span of 500 buckets, which happens at that time to correspond to 13 GHz, and then you change the analyzer's Start Frequency so that 500 buckets is no longer 13 GHz, the span will stay at 13 GHz, NOT at 500 buckets! This is important to realize as it differs from the legacy behavior.

The UP/DOWN parameters will increment/decrement by one bucket. For this the analyzer performs a conversion to buckets and back.

Select Marker

Specifies the selected marker. The term "selected marker" is used throughout this document to specify which marker will be affected by the functions.

Key Path	Marker
Notes	The selected marker is remembered even when not in the Marker menu and is used if a Search is done or a Band Function is turned on or for Signal Track or Continuous Peak.
Preset	Marker 1
State Saved	The number of the selected marker is saved in instrument state.
Initial S/W Revision	Prior to A.02.00

Marker Noise

Turns on the Marker Noise function for the selected marker, making it a noise marker. If the selected marker is off, it is turned on in **Normal** mode and located at the center of the screen.

When **Marker Noise** is selected while in the **Marker Function Off** state, the **Band Span** or **Interval Span** is initialized to 5% of the screen width.

When **Marker Noise** is on, the marker's Y Axis Result is the average noise level, normalized to a 1 Hz noise power bandwidth, in the band specified under the **Band Adjust** key.

- See "[More Information](#)" on page 701.
- See "[Off-trace Markers](#)" on page 701.

Key Path	Marker Function
Example	<p>CALC:MARK:FUNC NOIS turns on marker 1 as a noise marker.</p> <p>CALC:MARK:FUNC? returns the current marker function for the marker specified. In this case it returns the string: NOIS.</p> <p>CALC:MARK:Y? returns the y-axis value of the Marker Noise function for marker 1 (if Marker Noise is ON for marker 1). Note that the delta value when the Y axis unit is Watt is the square of the delta value when the Y axis unit is Volt. For example, when the percent ratio with Y axis unit in Volt is 0.2, the percent ratio with Y axis unit in Watt will be $0.22 = 0.04$. When you read the value out remotely you have to know whether your Y Axis Unit is log (dB), linear (V or A), or power (W).</p>

Notes	See the description under the " Marker Function " on page 693" key.
Dependencies	Fixed markers: It is not possible to change the Band Function for a Fixed marker; so all of the Band Function keys are grayed out for a Fixed marker.
Couplings	Average detector and Power Averaging auto selected when Marker Noise on If the selected (specified) marker is off, selecting Marker Noise via front panel or SCPI will turn the marker on.
Initial S/W Revision	Prior to A.02.00

More Information

To guarantee accurate data for noise-like signals, a correction for equivalent noise bandwidth is made by the analyzer. The **Marker Noise** function accuracy is best when the detector is set to Average or Sample, because neither of these detectors will peak-bias the noise. The tradeoff between sweep time and variance of the result is best when Average Type is set to Power Averaging. Therefore, Auto coupling chooses the Average detector and Power Averaging when Marker Noise is on. Though the Marker Noise function works with all settings of detector and Average Type, using the positive or negative peak detector gives less accurate measurement results.

Off-trace Markers

If a **Normal** or **Delta** noise marker is so near to the left or right edge of the trace that some of the band is off the trace, then it uses only that subset of the Band Width that is on-trace. If the marker itself is off-trace, its value becomes undefined.

Neither band/interval power nor band/interval density markers are defined if any part of the band is off-trace (unless they are Fixed with a stored function value in them), except that when the edges of the bandwidth are trivially off-screen, due to mathematical limitations in the analyzer or in the controlling computer, the result will still be considered valid.

Band/Interval Power

Turns on the Band/Interval Power function for the selected marker. If the selected marker is off it is turned on in **Normal** marker and located at the center of the screen.

When **Band/Interval Power** is selected while in the **Marker Function Off** state, the **Band Span** or **Interval Span** is initialized to 5% of the screen width.

If the detector mode for the detector on the marker's trace is set to Auto, the average detector is selected. If the Average type is set to Auto, Power Averaging is selected. Other choices for the detector or Average type will usually cause measurement inaccuracy.

Key Path	Marker Function
Example	CALC:MARK:FUNC BPOW turns on marker 1 as a band power marker. CALC:MARK2:FUNC? returns the current setting of marker function for marker 2. In this case it returns the string: BPOW.

	CALC:MARK:Y? returns the y-axis value of the Band Power function for marker 1. Note that the delta value when the Y axis unit is Watt is the square of the delta value when the Y axis unit is Volt. For example, when the percent ratio with Y axis unit in Volt is 0.2, the percent ratio with Y axis unit in Watt will be $0.22 = 0.04$. When you read the value out remotely you have to know whether your Y Axis Unit is log (dB), linear (V or A), or power (W).
Notes	See the description under the "Marker Function" on page 693 key, above.
Dependencies	Fixed markers: It is not possible to change the Band Function for a Fixed marker, so all of the Band Function keys are grayed out for a Fixed marker.
Couplings	If the detector mode for the detector on the marker's trace is set to Auto, the average detector is selected. If the Average type is set to Auto, Power Averaging is selected. If the selected (specified) marker is off, selecting Band Power via the front panel or SCPI will turn the marker on.
Initial S/W Revision	Prior to A.02.00

Band/Interval Density

Turns on the Band/Interval Density function for the selected marker. If the selected marker is off it is turned on in **Normal** marker mode and located at the center of the screen.

When **Band/Interval Density** is selected while in the **Marker Function Off** state, the **Band Span** or **Interval Span** is initialized to 5% of the screen width.

- See ["More Information" on page 703](#).
- See ["What is band/interval density?" on page 703](#)

Key Path	Marker Function
Example	CALC:MARK:FUNC BDEN turns on marker 1 as a band density marker. CALC:MARK:FUNC? returns the current setting of band function for the marker specified. In this case it returns the string: BDEN. CALC:MARK:Y? returns the y-axis value of the Band Density function for marker 1. Note that the delta value when the Y axis unit is Watt is the square of the delta value when the Y axis unit is Volt. For example, when the percent ratio with Y axis unit in Volt is 0.2, the percent ratio with Y axis unit in Watt will be $0.22 = 0.04$. When you read the value out remotely you have to know whether your Y Axis Unit is log (dB), linear (V or A), or power (W).
Notes	The zero-width case is treated as one bucket wide although it shows a width of 0. When the trace the marker is on crosses domains, the width crosses domains as well, to remain the same percentage of the trace.
Notes	See the description under the "Marker Function" on page 693 key.
Dependencies	Fixed markers: It is not possible to change the Band Function for a Fixed marker, so all of the Band Function keys are grayed out for a Fixed marker.
Couplings	If the detector mode for the detector on the marker's trace is set to Auto, the average detector is selected. If the Average type is set to Auto, Power Averaging is selected. If the selected (specified) marker is off, selecting Band Density via front panel or SCPI will turn the marker on.

State Saved	n/a.
Initial S/W Revision	Prior to A.02.00

More Information

It may seem like the band density marker function is exactly like a function of a noise marker with variable width. But they are somewhat different. The Noise markers assume that the signal to be measured is noise-like. Based on this assumption, we can actually make reasonable measurements under very nonideal conditions: any detector may be used, any averaging type, any VBW. In contrast, the Band Power and Band Density markers make no assumption about the statistics of the signal.

If the detector mode for the detector on the marker's trace is set to Auto, the average detector is selected. If the Average type is set to Auto, Power Averaging is selected. Other choices for the detector or Average type will usually cause measurement inaccuracy.

What is band/interval density?

On frequency domain traces, the average density across a band is the total band power divided by the bandwidth over which it is measured.

On time domain traces, interval density is the average power in the interval divided by the noise bandwidth of the RBW of the trace.

Marker Function Off

Turns off band functions for the selected marker.

Key Path	Marker Function
Example	:CALC:MARK:FUNC OFF turns off marker functions for marker 1
Notes	See the description under the " Marker " on page 671 key, above.
Dependencies	Fixed markers: It is not possible to change the Band Function for a Fixed marker, so all of the Band Function keys are grayed out for a Fixed marker, including Off
Couplings	Turning off the marker function has no effect on the band span nor does it turn the marker off.
Initial S/W Revision	Prior to A.02.00

Band Adjust

Opens a menu that lets you set the width or left or right edges of the band.

It is legal to change the width of the band even if there is no marker function on. Generally this can only happen by sending the SCPI command since access to the menu is restricted if no marker function is on.

Key Path	Marker Function
Dependencies	If the marker is Fixed, Band Adjust is grayed out. If the marker function is Off, Band Adjust is grayed out.

Couplings	If any of the Band Adjust functions are the active function, the wings and arms of the selected marker display in green; otherwise they display in white.
Backwards Compatibility Notes	If any of the band adjust SCPI commands (including the legacy compatibility commands documented under " Band Function Backwards Compatibility " on page 695) are sent while the marker function is off, they will be accepted and the value stored. If sent while the marker is off, they will be accepted and ignored.
Initial S/W Revision	Prior to A.02.00

Band/Interval Span

Sets the width of the span for the selected marker.

It is legal to change the width of the band even if there is no marker function on. Generally this can only happen by sending the SCPI command since access to the menu is restricted if no marker function is on.

In the table below, $\text{sweep_width} = \max(1, \text{sweep_points} - 1)$ and sweep_points is the number of sweep points, set in the **Sweep** menu.

Key Path	Marker Function, Band Adjust
Remote Command	:CALCulate:MARKer[1] 2 ... 12:FUNCtion:BAND:SPAN <freq> :CALCulate:MARKer[1] 2 ... 12:FUNCtion:BAND:SPAN?
Example	:CALC:MARK12:FUNC:BAND:SPAN 20 MHz sets the band span of marker 12 to 20 MHz :CALC:MARK:FUNC:BAND:SPAN? queries the band span of Marker 1
Notes	Units are those of the trace's domain, Hz for frequency domain, s for time domain.
Notes	Sending this command selects the subopcoded marker The unit of the parameter must match the current domain of the trace the selected marker is on, or an invalid suffix error will be generated. If no unit is sent the fundamental unit for the trace domain will be used (Hz for freq domain traces, s for time domain traces). Note that all the values provided in this table are only valid for frequency domain traces. If the current domain of the trace is time domain, values and unit will be different. In frequency domain, the Preset value is dependent on the frequency range of the instrument. The default value 1.3245 GHz is appropriate only if the instrument is a 26.5 GHz instrument (Option 526). In a 26.5 GHz Instrument, the default span is 26.49 GHz, so 5% of the span corresponds to 1.3245 GHz.
Couplings	Changing the Band/Interval Span necessarily changes the Band/Interval Left and Band/Interval Right values Band/Interval Span is set to 0 when the marker is turned off Band/Interval Span is set to 5% of span when any marker function is turned on if and only if it is zero at that time
Preset	If 0, set to 5% of span, when a marker function is turned on
State Saved	Saved in instrument state
Min	0 Hz
Max	Infinity. Unlike legacy analyzers, where the markers were forced to be on screen, X-Series marker values are not limited and do not clip
Backwards Compatibility SCPI	:CALCulate:MARKer[1] 2 ... 4:X:SPAN See " Band Function Backwards Compatibility " on page 695

Initial S/W Revision	Prior to A.02.00
Remote Command	:CALCulate:MARKer[1] 2 ... 4:X:POSition:SPAN <param> :CALCulate:MARKer[1] 2 ... 4:X:POSition:SPAN?
Preset	50
Backwards Compatibility Notes	The old command, :CALCulate:MARKer[n]:X:POSition:SPAN <param> was used to set the span between a delta marker and its reference marker in trace points (buckets) in Span Pair mode. There is no new command for setting the span of a Band Function in trace points. So, when this command is received, the analyzer first converts the specified span in trace points to the current X Axis Scale Units (e.g., frequency or time) of the trace upon which the marker resides. Then, that value is sent to the :CALC:MARKer[n]:FUNction:BAND:SPAN <param> command to set the span of the marker's Band Function. The query form of the command will return the marker function span in trace points (buckets) by translating back based on the X Axis Scale settings at the time the query is sent. ! See " Band Function Backwards Compatibility " on page 695 for more information
Initial S/W Revision	Prior to A.02.00

Band/Interval Left

Sets the left edge frequency or time for the band of the selected marker. The right edge is unaffected.

It is legal to change the width of the band even if there is no marker function on. Generally this can only happen by sending the SCPI command since access to the menu is restricted if no marker function is on.

In the table below, sweep_width = max(1, sweep_points-1) and sweep_points is the number of sweep points, set in the **Sweep** menu.

Key Path	Marker Function, Band Adjust
Remote Command	:CALCulate:MARKer[1] 2 ... 12:FUNction:BAND:LEFT <freq> :CALCulate:MARKer[1] 2 ... 12:FUNction:BAND:LEFT?
Example	:CALC:MARK12:FUNC:BAND:LEFT 20 GHz sets the left edge of the band span of marker 12 to 20 GHz :CALC:MARK:FUNC:BAND:LEFT? queries the band span of Marker 1
Notes	Units are those of the trace's domain, Hz for frequency domain, s for time domain. When the left edge is moved, the right edge stays anchored; thus, the marker's frequency will change.
Notes	Sending this command selects the subopcoded marker The unit of the parameter must match the current domain of the trace the selected marker is on, or an invalid suffix error will be generated. If no unit is sent the fundamental unit for the trace domain will be used (Hz for freq domain traces, s for time domain traces). Note that all the values provided in this table are only valid for frequency domain traces. If the

	current domain of the trace is time domain, values and unit will be different. In frequency domain, the Preset value is dependent on the frequency range of the instrument. The default value 1.3245 GHz is appropriate only if the instrument is a 26.5 GHz instrument (Option 526). In a 26.5 GHz Instrument, the default span is 26.49 GHz, so 5% of the span corresponds to 1.3245 GHz.
Couplings	Changing the Band/Interval Left necessarily changes the Band/Interval Span and Band/Interval Center values. Band/Interval Span is set to 0 when the marker is turned off so that means Band/Interval Left is set to the center value at this time. Band/Interval Span is set to 5% of span when any marker function is turned on if and only if it is zero at that time.
Preset	If 0, Band/Interval Span is set to 5% of span, when a marker function is turned on, which affects Band/Interval Left.
State Saved	Saved in instrument state
Min	0 Hz
Max	Infinity. Unlike legacy analyzers, where the markers were forced to be on screen, X-Series marker values are not limited and do not clip
Backwards Compatibility SCPI	:CALCulate:MARKer[1] 2 ... 4:X:START See "Band Function Backwards Compatibility" on page 695
Initial S/W Revision	Prior to A.02.00

Remote Command	:CALCulate:MARKer[1] 2 ... 4:X:POSITION:START <integer> :CALCulate:MARKer[1] 2 ... 4:X:POSITION:START?
Preset	0
Backwards Compatibility SCPI	The legacy command, :CALCulate:MARKer[n]:X:POSITION:START <param> was used to control the Reference marker in trace points (buckets) in Band Pair/Delta Pair mode. There is no new command for setting the start of a Band Function in trace points. So, when this command is received, the analyzer first converts the specified span in trace points to the current X Axis Scale Units (e.g., frequency or time) of the trace upon which the marker resides. :CALC:MARKer[n]:FUNCTION:BAND:LEFT <param> command to set the start of the marker's Band Function. The query form of the command will return the marker function LEFT value in trace points (buckets) by translating back based on the current X Axis Scale settings at the time the query is sent. See "Band Function Backwards Compatibility" on page 695 for more information
Initial S/W Revision	Prior to A.02.00

Band/Interval Right

Sets the right edge frequency or time for the band of the selected marker. The left edge is unaffected

In the table below, $\text{sweep_width} = \max(1, \text{sweep_points} - 1)$ and sweep_points is the number of sweep points, set in the **Sweep** menu.

It is legal to change the width of the band even if there is no marker function on. Generally this can only happen by sending the SCPI command since access to the menu is restricted if no marker function is on.

Key Path	Marker Function, Band Adjust
Remote Command	:CALCulate:MARKer[1] 2 ... 12:FUNction:BAND:RIGHT <freq> :CALCulate:MARKer[1] 2 ... 12:FUNction:BAND:RIGHT?
Example	:CALC:MARK12:FUNC:BAND:RIGHT 20 GHz sets the right edge of the band span of marker 12 to 20 GHz :CALC:MARK:FUNC:BAND:RIGHT? queries the band span of Marker 1
Notes	Units are those of the trace's domain, Hz for frequency domain, s for time domain. When the right edge is moved, the left edge stays anchored; thus, the marker's frequency will change.
Notes	Sending this command selects the subopcoded marker The unit of the parameter must match the current domain of the trace the selected marker is on, or an invalid suffix error will be generated. If no unit is sent the fundamental unit for the trace domain will be used (Hz for freq domain traces, s for time domain traces). Note that all the values provided in this table are only valid for frequency domain traces. If the current domain of the trace is time domain, values and unit will be different. In frequency domain, the Preset value is dependent on the frequency range of the instrument. The default value 1.3245 GHz is appropriate only if the instrument is a 26.5 GHz instrument (Option 526). In a 26.5 GHz Instrument, the default span is 26.49 GHz, so 5% of the span corresponds to 1.3245 GHz.
Couplings	Changing the Band/Interval Right necessarily changes the Band/Interval Span and Band/Interval Center values Band/Interval Span is set to 5% of span when any marker function is turned on if and only if it is zero at that time
Preset	If 0, Band/Interval Span is set to 5% of span, when a marker function is turned on, which affects Band/Interval Right
State Saved	Saved in instrument state
Min	0 Hz
Max	Infinity. Unlike legacy analyzers, where the markers were forced to be on screen, X-Series marker values are not limited and do not clip
Backwards Compatibility SCPI	:CALCulate:MARKer[1] 2 ... 4:X:STOP See " Band Function Backwards Compatibility " on page 695
Initial S/W Revision	Prior to A.02.00
Remote Command	:CALCulate:MARKer[1] 2 ... 4:X:POSition:STOP <integer> :CALCulate:MARKer[1] 2 ... 4:X:POSition:STOP?
Preset	1000, the actual value is dependent on the selected number of sweep points.
Backwards Compatibility SCPI	The legacy command, :CALCulate:MARKer[n]:X:POSition:STOP <param> was used to control the Delta marker in trace points (buckets) in Band Pair/Delta Pair mode. There is no new command for setting the stop of a Band Function in trace points. So, when this

command is received, the analyzer first converts the specified span in trace points to the current X Axis Scale Units (e.g., frequency or time) of the trace upon which the marker resides. Then, that value is sent to the

:CALC:MARKer[n]:FUNction:BAND:RIGHT <param>

command to set the stop of the marker's Band Function.

The query form of the command will return the marker function RIGHT value in trace points (buckets) by translating back based on the current X Axis Scale settings at the time the query is sent.

See "[Band Function Backwards Compatibility](#)" on page 695 for more information

Initial S/W Revision Prior to A.02.00

Band Span Auto/Man

Determines whether the Band Span for Marker Noise will track the analyzer's Span.

Band Span is initialized as specified above, under Band/Interval Span. Subsequently, if the analyzer's Span is changed, the effect on Band Span depends on the Auto/Man setting of Band Span:

- If in Auto, then whenever the Span changes, the Band Span for Marker Noise is changed to 5% of the new Span.
- If in Man, the Band Span does not change when the Span is changed.

The Band Span is set to 5% regardless of whether or not this would place part of the Band offscreen. The Marker Noise function is well able to function with part of the band offscreen.

This function only affects Marker Noise. The key only appears when Marker Noise is the Marker Function for the selected marker.

Note that, if in Zero Span, "Span" should be replaced by "Sweep Time" and "Band Span" should be replaced by "Band Interval", in the above specification and in the table below:

Key Path	Marker Function, Band Adjust
Remote Command	:CALCulate:MARKer[1] 2 ... 12:FUNction:BAND:SPAN:AUTO ON OFF :CALCulate:MARKer[1] 2 ... 12:FUNction:BAND:SPAN:AUTO?
Example	:CALC:MARK12:FUNC:BAND:SPAN:AUTO ON sets the band span of marker 12 to Auto :CALC:MARK:FUNC:BAND:SPAN:AUTO? queries the auto band span state of Marker 1
Dependencies	This only appears when the Marker Function for the selected marker is Marker Noise. If the SCPI command is sent to a marker that does not have Marker Noise selected, it is honored but of course, the user will not see any indication of this.
Couplings	When Auto Band Span is turned on, it immediately adjusts the band span to 5% of the Span. If the Band Span is changed, either by the Band/Interval Span key, the Band/Interval Left key, or the Band/Interval Right key, or the equivalent SCPI commands, this function is set to Man. This function is set to Auto on Preset and when the Auto Couple key is pressed. This function is set to Auto when Marker Noise is turned on, if the value of Band/Interval Span is

	0. Note that this test must be performed before Band/Interval Span is initialized, because Band/Interval Span is initialized to 5% if Band/Interval Span is 0 when the marker function is turned on. Sending this command selects the subopcoded marker.
Preset	Auto
State Saved	Saved in instrument state
Backwards Compatibility Notes	In legacy analyzers, the Noise Marker had a width that was always equal to 5% of the span. But in the X-Series it is possible for the user to change the span of the Marker Noise band using the Band Adjust function. To preserve the legacy behavior, the Band Span Auto/Man function is provided. When it is in Auto, which it is by default, the Marker Noise band is always held at 5% of Span, even if the Span changes. When the user adjusts the Marker Noise Band Span, Band Span Auto/Man is set to Manual. So the legacy behavior is preserved, but now the user can set the Marker Noise Span as well and that setting will be preserved when Span is changed.
Initial S/W Revision	Prior to A.02.00

Measure at Marker

This key and all the keys in this menu only appear with the N6141A or W6141A application or when Option EMC is installed and licensed.

Key Path	Marker Function
Dependencies	The Measure at Marker menu is not available in Spectrogram.
Initial S/W Revision	A.02.00

Measure at Marker

When this key is pressed, the analyzer executes one Measure at Marker function and then returns. Measure at Marker goes to the frequency of the selected marker and takes a reading with each of the three detectors selected in the Detectors menu, using the dwell times specified there, then displays the readings in a window on the display, using the current Y-Axis Unit.

When the Measure at Marker is complete, the analyzer restores all settings to their pre-Measure-at-Marker values and normal sweeps resume.

Key Path	Marker Function, Measure at Marker
Remote Command	:CALCulate:MARKer[1] 2 ... 12:FUNCtion:MAMarker?
Example	:CALC:MARK2:FUNC:MAM? Performs a Measure at Marker function at Marker 2's current frequency and, when completed, returns the results of the measure at marker window in a query
Notes	This query command returns comma separated values for the 3 specified detectors and the frequency value of the marker. If a Detector is off or if no measurement has yet completed, -999.0 will be returned. This can happen, for example, if you are operating with too large a value of (span/sweep points) and the Measure at Marker function does not execute but instead puts up the advisory message, "Span per point too large, narrow span or increase RBW or number of points" (see below).

	<p>The size of the return data array is fixed at 4. The elements are:</p> <ol style="list-style-type: none"> 1. Detector 1 value (if off, -999.0 for backwards compatibility) 2. Detector 2 value (if off, -999.0 for backwards compatibility) 3. Detector 3 value (if off, -999.0 for backwards compatibility) 4. Frequency of Marker <p>If a sweep is in process when this function executes it aborts, and restarts after the function is complete.</p>
Dependencies	If BW & Avg Type is in an Autocoupled state, the (up to three) measurements taken by Measure at Marker are taken with Auto Coupled settings for the functions in the BW menu, even if those functions are in manual.
Couplings	If the specified Marker is not on, the analyzer turns it on at the center of the screen and does a peak search before performing the function.
Status Bits/OPC dependencies	OPC goes true when the measurement is complete
Backwards Compatibility SCPI	<p>:MEASure:EMI:MARKer[1] 2 . . . 12?</p> <p>This command is included for compatibility with the E7400 and PSA option 239 . Performs a Measure at Marker function at the specified marker's current frequency and returns the results.</p>
Initial S/W Revision	A.02.00

Measure at Marker presents its information in a separate window that normally appears in the upper right of the display, but it can be repositioned to the upper left.

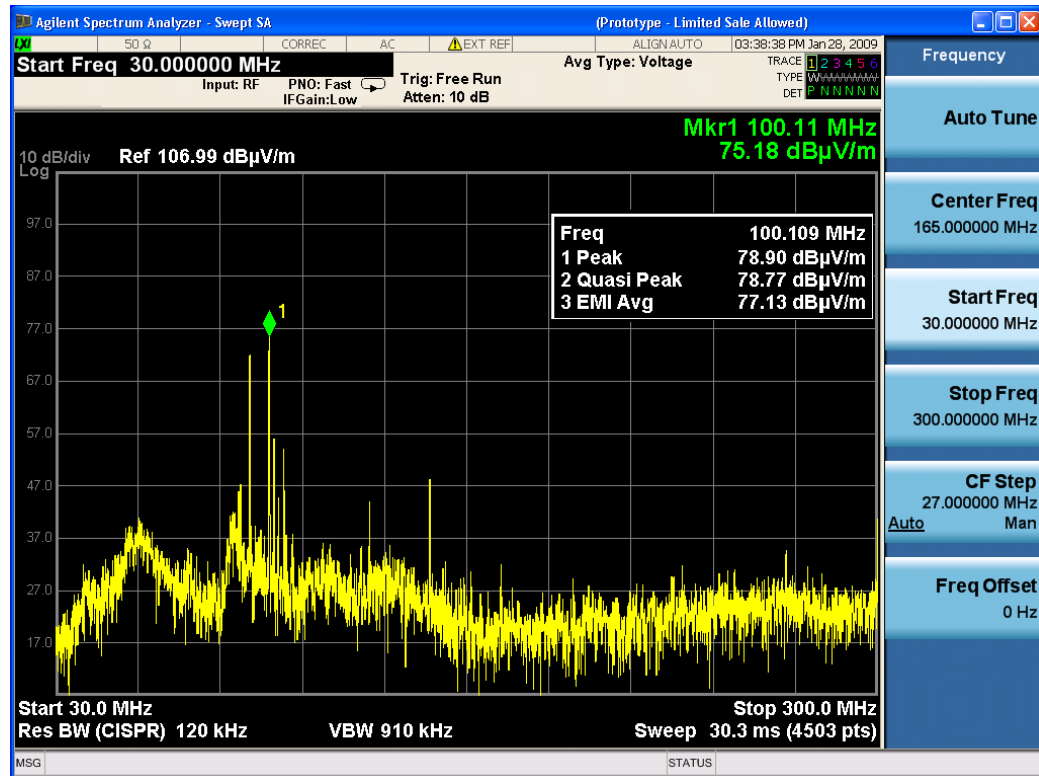

The Measure at Marker box shows the detector name for the selected detectors and “Off” for those not selected. The names used are:

Name	Detector
Normal	Normal
Peak	Peak
Sample	Sample
Neg Peak	Negative Peak
RMS	Average detector with Power Average (RMS)
Log Avg	Average detector with Log-Pwr Average
VoltageAvg	Average detector with Voltage Average
Quasi Peak	Quasi Peak
EMI Avg	EMI Average
RMS Avg	RMS Average

The marker frequency is shown in the “Freq” field. The measured value is shown for all detectors except those that are “Off.” For these, --- is displayed. The current Y-Axis unit is used, and the precision that is used for the detector value displays is exactly the same as for the Marker. The precision used for the Frequency display is six significant digits.

The sequence of steps in the measurement is as follows:

- Any sweep in progress is aborted.
- If in Zero Span, the Center Frequency is used as the frequency at which to take the reading, since in Zero Span, all markers are by definition at the Center Frequency
- If not in Zero Span:
 - If the selected marker is Off, it is first turned on in the center of the screen and a peak search performed.
 - If the selected marker is on, but offscreen, it is first moved to the center of the screen and a peak search performed. .
 - A frequency “zoom” function is performed to determine the frequency of the selected marker to the required precision. If you are operating with too large a value of (span/sweep points) then the Measure at Marker window will not display, but instead an advisory message, “Span per point too large, narrow span or increase RBW or number of points”. This means you have chosen a combination of RBW, span and sweep points that makes each trace point much wider than the RBW, so that the trace point in which the signal appears is an inadequately precise

measure of its frequency—for example, with a 30 MHz to 1000 MHz span, 601 trace points and 120 kHz RBW, each trace point is 13 times as wide as the RBW. In this case, a SCPI query of the results will yield –999 dBm for each detector.

- If the zoom is successful, the analyzer goes to zero span at this frequency.
- Each detector is then read in successive single-point zero span sweeps, using a sweep time equal to the specified dwell time. The value displayed by Measure at Marker represents the maximum value output by the detector during the dwell time. Autocoupled bandwidth and average type settings are used for each detector unless the **BW & Avg Type** key is set to **As Set**, in which case the current bandwidth and average type settings are used.
- Each result is then displayed in the measure at marker window as it becomes available.
- The analyzer returns to its pre-Measure at Marker span and settings after executing a Measure at Marker function, including Bandwidth, Avg Type, and EMC Std – regardless of the setting of **BW & Avg Type**.
- Finally, if the sweep had to be aborted, the aborted sweep is restarted.

While the function is executing, all the fields except Freq show “---” for their values until the measurement is complete for that detector. As each detector is read, an informational message is displayed in the status line, for example:

Measuring with detector 1 (Peak) with RBW=120 kHz

After the last detector, the status line is cleared.

Meas at Marker Window

This key opens a menu which controls the Measure at Marker window.

Key Path	Marker Function, Measure at Marker
Readback	In square brackets, the state of the window then the window position, separated by commas, as [On, Left]
Initial S/W Revision	A.02.00

Window

This key turns the Measure at Marker window on and off. It turns on automatically when Measure at Marker is initiated and turns off on a Preset. If the Window is turned on without a Measure at Marker result, “---” is displayed for each result for which the detector is not “Off”.

Key Path	Marker Function, Measure at Marker, Meas at Marker Window
Remote Command	:DISP:WIND:MA:Marker[:STATe] ON OFF 1 0 :DISP:WIND:MA:Marker[:STATe]?
Example	:DISP:WIND:MA ON
Couplings	The window turns on automatically when Measure at Marker is initiated and turns off on a Preset.
Preset	Off
State Saved	Saved in instrument state
Readback Text	On Off
Initial S/W Revision	A.02.00

Position

This key controls the placement of the Measure at Marker window on the display.

Key Path	Marker Function, Measure at Marker, Meas at Marker Window
Remote Command	:DISP:WIND:MA:Marker:POSition LEFT RIGHT :DISP:WIND:MA:Marker:POSition?
Example	:DISP:WIND:MA:POS RIGH
Preset	Right
State Saved	Saved in instrument state
Readback Text	Left Right
Initial S/W Revision	A.02.00

Detectors

This key opens up a menu that allows you to configure the detectors to be used for the Measure at Marker reading. Any of the analyzer's detectors can be used for each of the three detectors, or any of the three can be turned off. The dwell time for each detector is also settable.

When performing a Meas at Marker, the dwell time settings that you select will depend on the characteristics of the emission you are measuring. The default dwell time (200 ms) should work well for typical EUT emissions, but sometimes you will encounter emissions for which the defaults are not optimal. This is especially the case for emissions that vary slowly over time or have a slow repetition rate. By lengthening the dwell times you can increase the likelihood of accurately measuring these low repetition rate signals.

When Measure at Marker is activated, the receiver makes a zero span measurement for each of the (up to) three detectors selected, using the Dwell Time set for each detector. If the signal's repetition period is greater than 200 ms (the default setting), the dwell time should be increased to capture at least two and preferably more repetitions of the signal. Additionally, if you do not need or do not wish to use a detector to make a measurement, that specific detector may be turned off.

If the Measure at Marker window is being displayed, and one of the detectors is changed, any value being displayed for that detector changes to “---” until the next successful reading from that detector.

Key Path	Marker Function, Measure at Marker,
Remote Command	:CALCulate:MAMarker:DETECTOR[1] 2 3 OFF NORMal AVERage POSitive SAMPlE NEGative QPEak EAVERage RAVERage :CALCulate:MAMarker:DETECTOR[1] 2 3?
Example	:CALC:MAM:DET2 QPE Sets the detector for measure at marker detector 2 to Quasi peak :CALC:MAM:DET OFF Sets the detector for measure at marker detector 1 to Off
State Saved	Saved in instrument state
Initial S/W Revision	A.02.00

Key Path	Marker Function, Measure at Marker,
Remote Command	:CALCulate:MAMarker:DETECTOR[1] 2 3:DWELL <dwel1 time> :CALCulate:MAMarker:DETECTOR[1] 2 3:DWELL?
Example	:CALC:MAM:DET2:DWEL 500 ms Sets the detector for measure at marker detector 2 to dwell for 500 ms
State Saved	Saved in instrument state
Backwards Compatibility SCPI	[:SENSe] :EMI :MEASure :DETECTOR :DWELL <dwel1 time> This command is included for compatibility with the E7400 and PSA option 239 . Sets all of the detectors' dwell times to the specified amount
Initial S/W Revision	A.02.00

Detector 1

This menu lets you select the detector to be used for Detector 1, or turn Detector 1 off. This is a 1-of-N menu that shows the normal list of detectors, but with the “Auto” key replaced by “Off”.

Key Path	Marker Function, Measure at Marker, Detectors
Remote Command	See "Detectors" on page 713 .
Example	:CALC:MAM:DET QPE Sets the detector for measure at marker detector 1 to Quasi peak :CALC:MAM:DET OFF Sets the detector for measure at marker detector 1 to Off
Preset	Peak
State Saved	Saved in instrument state
Readback Text	Detector name
Initial S/W Revision	A.02.00

Detector 2

This menu lets you select the detector to be used for Detector 2, or turn Detector 2 off. This is a 1-of-N menu that shows the normal list of detectors, but with the “Auto” key replaced by “Off”.

Key Path	Marker Function, Measure at Marker, Detectors
Remote Command	See " Detectors " on page 713.
Example	:CALC:MAM:DET2 QPE Sets the detector for measure at marker detector 2 to Quasi peak :CALC:MAM:DET2 OFF Sets the detector for measure at marker detector 2 to Off
Preset	Quasi Peak
State Saved	Saved in instrument state
Readback Text	Detector name
Backwards Compatibility SCPI	[:SENSE] :EMI :MEASure :DETECTOR :QPEAK [:STATE] OFF ON 0 1 This command is included for compatibility with the E7400 and PSA option 239 . If sent with On as a parameter, sets detector 2 to Quasi Peak. If sent with Off as a parameter, sets detector 2 to Off
Initial S/W Revision	A.02.00

Detector 3

This menu lets you select the detector to be used for Detector 3, or turn Detector 3 off. This is a 1-of-N menu that shows the normal list of detectors, but with the “Auto” key replaced by “Off”.

Key Path	Marker Function, Measure at Marker, Detectors
Remote Command	See " Detectors " on page 713.
Example	:CALC:MAM:DET3 QPE Sets the detector for measure at marker detector 1 to Quasi peak :CALC:MAM:DET3 OFF Sets the detector for measure at marker detector 1 to Off
Preset	EMI Average
State Saved	Saved in instrument state
Readback Text	Detector name
Backwards Compatibility SCPI	[:SENSE] :EMI :MEASure :DETECTOR :AVERAGE [:STATE] OFF ON 0 1 This command is included for compatibility with the E7400 and PSA option 239 . If sent with On as a parameter, sets detector 3 to EMI Average. If sent with Off as a parameter, sets detector 3 to Off
Initial S/W Revision	A.02.00

Detector 1 Dwell Time

This is the time specified by the user to dwell while taking the measurement for detector 1. The minimum allowed dwell time is based on the current detector. If “Off” is selected for detector 1, this key is grayed out and shows 200 ms.

Key Path	Marker Function, Measure at Marker, Detectors
Remote Command	See "Detectors" on page 713 .
Example	:CALC:MAM:DET:DWEL 400 ms Sets the dwell time for detector 1 to 400 ms
Preset	200 ms
State Saved	Saved in instrument state
Min	1 ms
Max	60 s
Default Unit	s
Initial S/W Revision	A.02.00

Detector 2 Dwell Time

This is the time specified by the user to dwell while taking the measurement for detector 2. The minimum allowed dwell time is based on the current detector. If “Off” is selected for detector 2, this key is grayed out and shows 200 ms.

Key Path	Marker Function, Measure at Marker, Detectors
Remote Command	See "Detectors" on page 713 .
Example	:CALC:MAM:DET2:DWEL 400 ms Sets the dwell time for detector 2 to 400 ms
Preset	200 ms
State Saved	Saved in instrument state
Min	1 ms
Max	60 s
Default Unit	s
Initial S/W Revision	A.02.00

Detector 3 Dwell Time

This is the time specified by the user to dwell while taking the measurement for detector 3. The minimum allowed dwell time is based on the current detector. If “Off” is selected for detector 3, this key is grayed out and shows 200 ms.

Key Path	Marker Function, Measure at Marker, Detectors
Remote Command	See "Detectors" on page 713 .
Example	:CALC:MAM:DET3:DWEL 400 ms Sets the dwell time for detector 1 to 400 ms

Preset	200 ms
State Saved	Saved in instrument state
Min	1 ms
Max	60 s
Default Unit	s
Initial S/W Revision	A.02.00

BW & Avg Type

This key controls the type of bandwidth and average type coupling used in Measure at Marker.

If set to “Autocoupled”, then the RBW and Average Type are selected by the instrument during the Measure at Marker function, according to the normal Autocouple rules, regardless of whether RBW and Average Type are currently in Auto. If set to “As Set”, then the current value for RBW and Average Type are used (which could also be “Auto”).

Here are the details of the two modes:

If **BW & Avg Type** is set to **Autocoupled**, **Measure at Marker** behaves as follows:

1. The **EMC Std** changes to CISPR if any of the CISPR detectors (EMI Avg, RMS Avg, QPD) becomes selected; for all other detectors, the value of **EMC Std** that existed before Measure at Marker is used.
2. **RBW** autocouples throughout Measure at Marker, even if **RBW** is set to **Manual**. The autocouple rules are based on whatever the instantaneous setting of EMC Std, Span, and Center Freq are.

If **BW & Avg Type** is set to **As Set**, **Measure at Marker** behaves as follows:

1. The **EMC Std** never changes; so if it is set to **None** it stays at **None** throughout, even if one of the CISPR detectors is selected.
2. If **RBW** is set to **Auto**, then **RBW** autocouples throughout Measure at Marker. The autocouple rules are based on whatever the setting of EMC Std, Span, and Center Freq are.
3. If **RBW** is set to **Manual**, the RBW never changes at all throughout Measure at Marker, it stays at the value to which it was set before Measure at Marker began.

The analyzer returns to its pre-Measure at Marker span and settings after executing a Measure at Marker function, including Bandwidth, Avg Type, and EMC Std.

It is important to note that, when RBW is coupled to Frequency, as it is when **EMC Std** is anything but “None”, for all EMI measurements, the frequency it is coupled to for Measure at Marker is the MARKER frequency, not the Center Frequency.

Key Path	Marker Function, Measure at Marker
Remote Command	:CALCulate:MAMarker:COUPling ON OFF 1 0 :CALCulate:MAMarker:COUPling?
Example	:CALC:MAM:COUP ON
Preset	Autocoupled
State Saved	Saved in instrument state
Readback Text	Autocoupled As Set
Initial S/W Revision	A.02.00

Center Presel On/Off

This key controls the automatic centering of the preselector for the Measure at Marker function.

When Center Presel is On, the first step in performing the Measure at Marker function is to perform a Presel Center. This is not performed if the microwave preselector is off, or the selected marker's frequency is below Band 1. If the function is not performed, no message is generated.

Key Path	Marker Function, Measure at Marker
Remote Command	:CALCulate:MAMarker:PCENTER ON OFF 1 0 :CALCulate:MAMarker:PCENTER?
Example	:CALC:MAM:PCEN ON
Dependencies	Blank in models that do not include a preselector, such as option 503. If the SCPI is sent in these instruments, it is accepted without error, and the query always returns 0.
Preset	On
Backwards Compatibility SCPI	[:SENSe] :EMI :MEASure :PCENTER [:STATe] OFF ON 0 1 [:SENSe] :EMI :MEASure :PCENTER [:STATe] ? This command is included for compatibility with the E7400 and PSA option 239 .
Initial S/W Revision	A.02.00

Marker To

The Marker -> key accesses menu keys that can copy the current marker value into other instrument parameters (for example, Center Freq). The currently selected marker is made the active function on entry to this menu (if the currently selected marker is not on when you press this front panel key, it will be turned on at the center of the screen as a normal type marker and then made the active function).

The **Marker ->** (or Marker To) feature is used to quickly assign a marker's x- or y-axis value to another parameter. For example, if a marker's x-axis value is 500 MHz and y-axis value is -20 dBm, pressing **Mkr -> CF** would assign 500 MHz to **Center Freq** and pressing **Mkr -> Ref Lvl** would assign -20 dBm to **Ref Level**.

Key Path	Front-panel key
Notes	All Marker To functions executed from the front panel use the selected marker's values, while all Marker To remote commands specify in the command which marker's value to use. Consistent with other remote marker commands, sending a Marker To remote command will never change which marker is selected.
Initial S/W Revision	Prior to A.02.00

Mkr->CF

Sets the center frequency of the analyzer to the frequency of the selected marker. The marker stays at this frequency, so it moves to the center of the display. In delta marker mode, this function sets the center frequency to the x-axis value of the delta marker. When the frequency scale is in log mode, the center frequency is not at the center of the display.

If the currently selected marker is not on when this key is pressed, it will be turned on at the center of the screen as a normal type marker.

Key Path	Marker ->
Remote Command	:CALCulate:MARKer[1] 2 ... 12[:SET]:CENTER
Example	CALC:MARK2:CENT sets the CF of the analyzer to the value of marker 2.
Notes	Sending this command selects the subopcoded marker If specified marker is off, this command will turn it on at the center of the screen as a normal type marker.
Dependencies	This function is not available (key is grayed out) when x-axis is the time domain
Couplings	All the usual couplings associated with setting Center Frequency apply (see " FREQ Channel " on page 2613 .)
Initial S/W Revision	Prior to A.02.00

Mkr->CF Step

Sets the center frequency (CF) step size of the analyzer to the marker frequency, or in a delta-marker mode, to the frequency difference between the delta and reference markers.

If the currently selected marker is not on when this key is pressed, it will be turned on at the center of the screen as a normal type marker.

Key Path	Marker ->
Remote Command	:CALCulate:MARKer[1] 2 ... 12[:SET]:STEP
Example	CALC:MARK1:STEP sets the CF step to the value (or delta value) of marker 1.
Notes	Sending this command selects the subopcoded marker If specified marker is off, this command will turn it on at the center of the screen as a normal type marker.
Dependencies	This function is not available (key is grayed out) when x-axis is the time domain
Couplings	All the usual couplings associated with setting CF Step apply (see "FREQ Channel" on page 2613).
Initial S/W Revision	Prior to A.02.00

Mkr->Start

Changes the start frequency to the frequency of the selected marker. The marker stays at this frequency, so it moves to the left edge of the display. In delta marker mode, this function sets the start frequency to the x-axis value of the delta marker.

If the currently selected marker is not on when this key is pressed, it will be turned on at the center of the screen as a normal type marker.

Key Path	Marker ->
Remote Command	:CALCulate:MARKer[1] 2 ... 12[:SET]:START
Example	CALC:MARK1:STAR sets the start frequency to the value (or delta value) of marker 1.
Notes	Sending this command selects the subopcoded marker If specified marker is off, this command will turn it on at the center of the screen as a normal type marker.
Dependencies	This function is not available (key is grayed out) when x-axis is the time domain
Couplings	All the usual couplings associated with setting Start Frequency apply (see "FREQ Channel" on page 2613).
Initial S/W Revision	Prior to A.02.00

Mkr->Stop

Changes the stop frequency to the frequency of the selected marker. The marker stays at this frequency, so it moves to the right edge of the display. In delta marker mode, this function sets the stop frequency to the x-axis value of the delta marker.

If the currently selected marker is not on when this key is pressed, it will be turned on at the center of the screen as a normal type marker.

Key Path	Marker ->
Remote Command	:CALCulate:MARKer[1] 2 ... 12[:SET]:STOP
Example	CALC:MARK3:STOP sets the stop frequency to the value (or delta value) of marker 3.

Notes	Sending this command selects the subopcoded marker If specified marker is off, this command will turn it on at the center of the screen as a normal type marker.
Dependencies	This function is not available (key is grayed out) when x-axis is the time domain
Couplings	All the usual couplings associated with setting Stop Frequency apply (see "FREQ Channel" on page 2613).
Initial S/W Revision	Prior to A.02.00

Mkr->Ref Lvl

Sets the reference level to the amplitude value of the selected marker, moving the marked point to the reference level (top line of the graticule). The marker's mode (Normal, Delta, Fixed) doesn't matter in this case. For example, given a delta marker, if the delta marker is the selected marker, its amplitude is applied to the reference level. If the reference marker is selected, its amplitude is applied to the reference level.

If the currently selected marker is not on when this key is pressed, it will be turned on at the center of the screen as a normal type marker, and its amplitude applied to the reference level.

Key Path	Marker ->
Remote Command	:CALCulate:MARKer[1] 2 ... 12[:SET]:RLeve1
Example	CALC:MARK2:RLEV sets the reference level of the analyzer to the amplitude of marker 2.
Notes	Sending this command selects the subopcoded marker If specified marker is off, this command will turn it on at the center of the screen as a normal type marker.
Couplings	All the usual couplings associated with setting Reference Level apply.
Backwards Compatibility Notes	Mkr-> RefLvl behavior for a delta marker is slightly different from earlier models. ESA would calculate the delta amplitude (difference between reference marker and delta marker in dB) and assign that value to the reference level (in dBm). PSA would just assign the delta marker's amplitude to the reference level, ignoring the reference marker altogether. The X-Series products allow the user to select either the reference or the delta marker individually. It is the selected marker's amplitude that will be applied to the reference level.
Initial S/W Revision	Prior to A.02.00

Mkr Δ ->CF

Sets the center frequency to the frequency difference between the selected marker and its reference marker. The marker is then changed to a Normal marker and placed at the center of span.

Key Path	Marker ->
Remote Command	:CALCulate:MARKer[1] 2 ... 12[:SET]:DELTA:CENTer
Example	CALC:MARK2:CENT sets the CF of the analyzer to the value of marker 2.

Notes	Sending this command selects the subcoded marker
Dependencies	This function is only available when the selected marker is a delta marker. Otherwise the key is grayed out. In addition, this function is not available when x-axis is the time domain
Initial S/W Revision	Prior to A.02.00

Mkr Δ ->Span

Sets the start and stop frequencies to the values of the delta markers. That is, it moves the lower of the two marker frequencies to the start frequency and the higher of the two marker frequencies to the stop frequency. The marker mode is unchanged and the two markers (delta and reference) end up on opposite edges of the display.

Key Path	Marker ->
Remote Command	:CALCulate:MARKer[1] 2 ... 12[:SET]:DELTA:SPAN
Example	CALC:MARK2:DELT:SPAN sets the start and stop frequencies to the values of marker 2 and its reference marker.
Notes	Sending this command selects the subcoded marker
Dependencies	This function is only available when the selected marker is a delta marker. Otherwise the key is grayed out. In addition, this function is not available when x-axis is the time domain
Couplings	All the usual couplings associated with setting Span apply (see " SPAN X Scale " on page 919).
Backwards Compatibility SCPI	:CALCulate:MARKer[1] 2 ... 12[:SET]:SPAN
Backwards Compatibility Notes	In earlier ESA and PSA products, Mkr Δ ->Span would adjust the span and change the delta marker to a normal marker placing it at the center of screen. In all the X-Series products, this is no longer true. The markers will remain in delta mode and the delta and reference marker will end up on opposite edges of the display.
Initial S/W Revision	Prior to A.02.00

Mkr -> Zoom Center

Only appears in the Trace Zoom View of the Swept SA measurement.

Moves the zoom region so that it is centered at the selected marker in the top window. The **Zoom Span** is not changed, except as necessary to keep the entire Zoom Region between the top window Start and Stop frequencies. The center frequency of the lower window changes to reflect the new zoom center frequency.

If the marker frequency is entirely outside the current analyzer (top window) Start and Stop frequencies, a Mkr->CF function is first performed. (Note that if this Mkr->CF causes the Zoom Region to be outside the new Start and Stop frequencies, the Zoom Region is re-initialized to the new analyzer Center Freq with a span of 10% of the analyzer Span). After the Mkr->CF is performed, the Mkr->Zoom Center is performed.

Key Path	Marker ->
----------	---------------------

Remote Command	<code>:CALCulate:MARKer[1] 2 ... 12[:SET]:TZoom:CENTer</code>
Example	CALC:MARK2:TZO:CENT sets the Zoom CF to the value of marker 2.
Notes	Sending this command selects the subopcoded marker If specified marker is off, this command will first turn it on at the center of the screen as a normal type marker. Then the Mkr->Zoom Center function is performed.
Dependencies	Only appears in the Trace Zoom View of the Swept SA measurement. If the SCPI command is sent in other Views, gives an error.
Initial S/W Revision	A.07.01

Mkr -> Zone Center

Moves the zone so that it is centered at the selected marker in the top window. The zone span is not changed. The center frequency of the lower window changes to reflect the new zone center frequency. The lower window will not be updated until it is made active.

Key Path	Marker ->
Remote Command	<code>:CALCulate:MARKer[1] 2 ... 12[:SET]:ZSPan:CENTer</code>
Example	:CALC:MARK2:ZSP:CENT sets the Zone CF to the value of marker 2.
Notes	Sending this command selects the subopcoded marker If specified marker is off, this command will first turn it on at the center of the screen as a normal type marker. Then the Mkr->Zone Center function is performed.
Dependencies	Only appears in the Zone Span View of the Swept SA measurement. If the SCPI command is sent in other Views, gives an error. In addition, this function is not available when the bottom window is in Zero Span.
Initial S/W Revision	A.07.01

Meas

The information in this section is common to all measurements. For key and remote command information for a specific measurement, refer to the section that describes the measurement of interest.

Measurements available under the Meas key are specific to the current Mode.

When viewing Help for measurements, note the following:

NOTE

Operation for some keys differs between measurements. The information displayed in Help pertains to the current measurement. To see how a key operates in a different measurement, exit Help (press the Cancel Esc key), select the measurement, then reenter Help (press the Help key) and press that key.

Key Path	Front-panel key
Initial S/W Revision	Prior to A.02.00

Remote Measurement Functions

This section contains the following topics:

["Measurement Group of Commands" on page 3141](#)

["Current Measurement Query \(Remote Command Only\)" on page 3144](#)

["Limit Test Current Results \(Remote Command Only\)" on page 3144](#)

["Data Query \(Remote Command Only\)" on page 3144](#)

["Calculate/Compress Trace Data Query \(Remote Command Only\)" on page 3144](#)

["Calculate Peaks of Trace Data \(Remote Command Only\)" on page 3150](#)

["Hardware-Accelerated Fast Power Measurement \(Remote Command Only\)" on page 3151](#)

["Format Data: Numeric Data \(Remote Command Only\)" on page 3165](#)

["Format Data: Byte Order \(Remote Command Only\)" on page 3166](#)

Initial S/W Revision	Prior to A.02.00
----------------------	------------------

Measurement Group of Commands

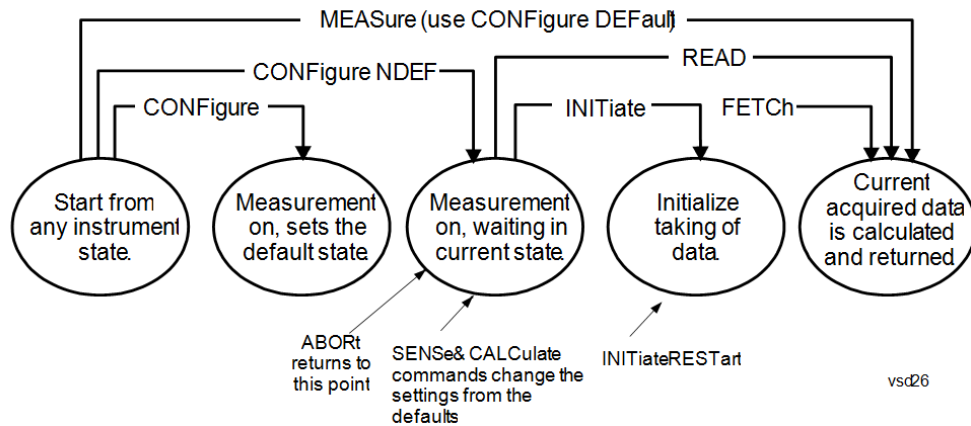

Measure Commands:

```
:MEASure:<measurement>[n]?
```

This is a fast single-command way to make a measurement using the factory default instrument settings. These are the settings and units that conform to the Mode Setup settings (e.g. radio standard) that you have currently selected.

- Stops the current measurement (if any) and sets up the instrument for the specified measurement using the factory defaults
- Initiates the data acquisition for the measurement
- Blocks other SCPI communication, waiting until the measurement is complete before returning results.
- If the function does averaging, it is turned on and the number of averages is set to 10.
- After the data is valid it returns the scalar results, or the trace data, for the specified measurement. The type of data returned may be defined by an [n] value that is sent with the command.
- The scalar measurement results will be returned if the optional [n] value is not included, or is set to 1. If the [n] value is set to a value other than 1, the selected trace data results will be returned. See each command for details of what types of scalar results or trace data results are available.
- ASCII is the default format for the data output. (Older versions of Spectrum Analysis and Phase Noise mode measurements only use ASCII.) The binary data formats should be used for handling large blocks of data since they are smaller and faster than the ASCII format. Refer to the FORMat:DATA command for more information.

If you need to change some of the measurement parameters from the factory default settings you can set up the measurement with the CONFigure command. Use the commands in the SENSe:<measurement> and CALCulate:<measurement> subsystems to change the settings. Then you can use the READ? command to initiate the measurement and query the results.

If you need to repeatedly make a given measurement with settings other than the factory defaults, you can use the commands in the SENSE:<measurement> and CALCulate:<measurement> subsystems to set up the measurement. Then use the READ? command to initiate the measurement and query results.

Measurement settings persist if you initiate a different measurement and then return to a previous one. Use READ:<measurement>? if you want to use those persistent settings. If you want to go back to the default settings, use MEASure:<measurement>?.

Configure Commands:

:CONFigure:<measurement>

This command stops the current measurement (if any) and sets up the instrument for the specified measurement using the factory default instrument settings. It does not initiate the taking of measurement data unless INIT:CONTinuous is ON. If you change any measurement settings after using the CONFigure command, the READ command can be used to initiate a measurement without changing the settings back to their defaults.

In the Swept SA measurement in Spectrum Analyzer mode the CONFigure command also turns the averaging function on and sets the number of averages to 10 for all measurements.

:CONFigure: <measurement>: NDEFault stops the current measurement and changes to the specified measurement. It does not change the settings to the defaults. It does not initiate the taking of measurement data unless INIT:CONTinuous is ON.

The CONFigure? query returns the current measurement name.

The CONFigure:CATalog? query returns a quoted string of all licensed measurement names in the current mode. For example, "SAN, CHP, OBW, ACP, PST, TXP, SPUR, SEM, LIST".

Fetch Commands:

:FETCh:<measurement>[n]?

This command puts selected data from the most recent measurement into the output buffer. Use FETCh if you have already made a good measurement and you want to return several types of data (different [n] values, for example, both scalars and trace data) from a single measurement. FETCh saves you the time of re-making the measurement. You can only FETCh results from the measurement that is currently active, it will not change to a different measurement. An error message is reported if a measurement other than the current one is specified.

If you need to get new measurement data, use the READ command, which is equivalent to an INITiate followed by a FETCh.

The scalar measurement results will be returned if the optional [n] value is not included, or is set to 1. If the [n] value is set to a value other than 1, the selected trace data results will be returned. See each command for details of what types of scalar results or trace data results are available. The binary data formats should be used for handling large blocks of data since they are smaller and transfer faster than the ASCII format. (FORMat:DATA)

FETCh may be used to return results other than those specified with the original READ or MEASure command that you sent.

INITiate Commands:

:INITiate:<measurement>

This command is not available for measurements in all the instrument modes:

- Initiates a trigger cycle for the specified measurement, but does not output any data. You must then use the FETCh<meas> command to return data. If a

measurement other than the current one is specified, the instrument will switch to that measurement and then initiate it.

- For example, suppose you have previously initiated the ACP measurement, but now you are running the channel power measurement. If you send INIT:ACP? it will change from channel power to ACP and will initiate an ACP measurement.
- Does not change any of the measurement settings. For example, if you have previously started the ACP measurement and you send INIT:ACP? it will initiate a new ACP measurement using the same instrument settings as the last time ACP was run.
- If your selected measurement is currently active (in the idle state) it triggers the measurement, assuming the trigger conditions are met. Then it completes one trigger cycle. Depending upon the measurement and the number of averages, there may be multiple data acquisitions, with multiple trigger events, for one full trigger cycle. It also holds off additional commands on GPIB until the acquisition is complete.

READ Commands:

:READ:<measurement>[n]?

- Does not preset the measurement to the factory default settings. For example, if you have previously initiated the ACP measurement and you send READ:ACP? it will initiate a new measurement using the same instrument settings.
 - Initiates the measurement and puts valid data into the output buffer. If a measurement other than the current one is specified, the instrument will switch to that measurement before it initiates the measurement and returns results.
 - For example, suppose you have previously initiated the ACP measurement, but now you are running the channel power measurement. Then you send READ:ACP? It will change from channel power back to ACP and, using the previous ACP settings, will initiate the measurement and return results.
 - Blocks other SCPI communication, waiting until the measurement is complete before returning the results
 - If the optional [n] value is not included, or is set to 1, the scalar measurement results will be returned. If the [n] value is set to a value other than 1, the selected trace data results will be returned. See each command for details of what types of scalar results or trace data results are available. The binary data formats should be used when handling large blocks of data since they are smaller and faster than the ASCII format. (FORMat:DATA)
-

Current Measurement Query (Remote Command Only)

This command returns the name of the measurement that is currently running.

Remote Command	:CONFiGure?
Example	CONF?
Initial S/W Revision	Prior to A.02.00

Limit Test Current Results (Remote Command Only)

Queries the status of the current measurement limit testing. It returns a 0 if the measured results pass when compared with the current limits. It returns a 1 if the measured results fail any limit tests.

Remote Command	:CALCuLate:CLIMits:FAIL?
Example	CALC:CLIM:FAIL? queries the current measurement to see if it fails the defined limits. Returns a 0 or 1: 0 it passes, 1 it fails.
Initial S/W Revision	Prior to A.02.00

Data Query (Remote Command Only)

Returns the designated measurement data for the currently selected measurement and subopcode.

n = any valid subopcode for the current measurement. See the measurement command results table for your current measurement, for information about what data is returned for the subopcodes.

This command uses the data setting specified by the FORMat:BORDER and FORMat:DATA commands and can return real or ASCII data. (See the format command descriptions under Input/Output in the Analyzer Setup section.)

Remote Command	:CALCuLate:DATA[n]?
Notes	The return trace depends on the measurement. In CALCulate:<meas>:DATA[n], n is any valid subopcode for the current measurement. It returns the same data as the FETCh:<measurement>? query where <measurement> is the current measurement.
Initial S/W Revision	Prior to A.02.00

Calculate/Compress Trace Data Query (Remote Command Only)

Returns compressed data for the currently selected measurement and sub-opcode [n].

n = any valid sub-opcode for that measurement. See the MEASure:<measurement>? command description of your specific measurement for information on the data that can be returned.

The data is returned in the current Y Axis Unit of the analyzer. The command is used with a sub-opcode <n> (default=1) to specify the trace. With trace queries, it is best if the analyzer is not sweeping during the query. Therefore, it is generally advisable to be in Single Sweep, or Update=Off.

This command is used to compress or decimate a long trace to extract and return only the desired data. A typical example would be to acquire N frames of GSM data and return the mean power of the first burst in each frame. The command can also be used to identify the best curve fit for the data.

Remote Command	:CALCulate:DATA<n>:COMPRESS? BLOCK CFIT MAXimum MINimum MEAN DMEan RMS RMSCubed SAMPLE SDEVIation PPHase [,<soffset> [,<length>[,<roffset>[,<rlimit>]]]]
Example	To query the mean power of a set of GSM bursts: Supply a signal that is a set of GSM bursts. Select the IQ Waveform measurement (in IQ Analyzer Mode). Set the sweep time to acquire at least one burst. Set the triggers such that acquisition happens at a known position relative to a burst. Then query the mean burst levels using, CALC:DATA2:COMP? MEAN, 24e-6, 526e-6 (These parameter values correspond to GSM signals, where 526e-6 is the length of the burst in the slot and you just want 1 burst.)
Notes	The command supports 5 parameters. Note that the last 4 (<soffset>, <length>, <roffset>, <rlimit>) are optional. But these optional parameters must be entered in the specified order. For example, if you want to specify <length>, then you must also specify <soffset>. See details below for a definition of each of these parameters. This command uses the data in the format specified by FORMat:DATA, returning either binary or ASCII data.
Initial S/W Revision	Prior to A.02.00

- BLOCK or block data - returns all the data points from the region of the trace data that you specify. For example, it could be used to return the data points of an input signal over several timeslots, excluding the portions of the trace data that you do not want. (This is x,y pairs for trace data and I,Q pairs for complex data.)
- CFIT or curve fit - applies curve fitting routines to the data. <soffset> and <length> are required to define the data that you want. <roffset> is an optional parameter for the desired order of the curve equation. The query will return the following values: the x-offset (in seconds) and the curve coefficients ((order + 1) values).

MIN, MAX, MEAN, DME, RMS, RMSC, SAMP, SDEV and PPH return one data value for each specified region (or <length>) of trace data, for as many regions as possible until you run out of trace data (using <roffset> to specify regions). Or they return the number of regions you specify (using <rlimit>) ignoring any data beyond that.

- MINimum - returns the minimum data point (y value) for the specified region (s) of trace data. For I/Q trace data, the minimum magnitude of the I/Q pairs is returned.
- MAXimum - returns the maximum data point (y value) for the specified region(s) of trace data. For I/Q trace data, the maximum magnitude of the I/Q pairs is returned.
- MEAN - returns a single value that is the arithmetic mean of the data point values (in dB/ dBm) for the specified region(s) of trace data. For I/Q trace data, the mean of the magnitudes of the I/Q pairs is returned. See the following equations.

NOTE

If the original trace data is in dB, this function returns the arithmetic mean of those log values, not log of the mean power which is a more useful value. The mean of the log is the better measurement technique when measuring CW signals in the presence of noise. The mean of the power, expressed in dB, is useful in power measurements such as Channel Power. To achieve the mean of the power, use the RMS option.

Equation 1

Mean Value of Data Points for Specified Region(s)

$$MEAN = \frac{1}{n} \sum_{X_i \in \text{region}(s)} X_i$$

where X_i is a data point value, and n is the number of data points in the specified region(s).

Equation 2

Mean Value of I/Q Data Pairs for Specified Region(s)

$$MEAN = \frac{1}{n} \sum_{X_i \in \text{region}(s)} |X_i|$$

where $|X_i|$ is the magnitude of an I/Q pair, and n is the number of I/Q pairs in the specified region(s).

- DMEan - returns a single value that is the mean power (in dB/ dBm) of the data point values for the specified region(s) of trace data. See the following

equation:

Equation 3

DMEan Value of Data Points for Specified Region(s)

$$\text{DME} = 10 \times \log_{10} \left(\frac{1}{n} \sum_{X_i \in \text{region}(s)} 10^{\frac{X_i}{10}} \right)$$

- RMS - returns a single value that is the average power on a root-mean-squared voltage scale (arithmetic rms) of the data point values for the specified region(s) of trace data. See the following equation.

NOTE

For I/Q trace data, the rms of the magnitudes of the I/Q pairs is returned. See the following equation.

This function is very useful for I/Q trace data. However, if the original trace data is in dB, this function returns the rms of the log values which is not usually needed.

Equation 4

RMS Value of Data Points for Specified Region(s)

$$\text{RMS} = \sqrt{\frac{1}{n} \sum_{X_i \in \text{region}(s)} X_i^2}$$

where X_i is a data point value, and n is the number of data points in the specified region(s).

Equation 5

RMS Value of I/Q Data Pairs for Specified Region(s)

$$\text{RMS} = \sqrt{\frac{1}{n} \sum_{X_i \in \text{region}(s)} X_i X_i^*}$$

where X_i is the complex value representation of an I/Q pair, X_i^* its conjugate complex number, and n is the number of I/Q pairs in the specified region(s).

Once you have the rms value for a region of trace data (linear or I/Q), you may want to calculate the mean power. You must convert this rms value (peak volts) to power in dBm:

$$10 \times \log[10 \times (\text{rms value})^2]$$

- SAMPlE - returns the first data value (x,y pair) for the specified region(s) of trace data. For I/Q trace data, the first I/Q pair is returned.
- SDEViation - returns a single value that is the arithmetic standard deviation for the data point values for the specified region(s) of trace data. See the following equation.
- For I/Q trace data, the standard deviation of the magnitudes of the I/Q pairs is returned. See the following equation.

Equation 6

Standard Deviation of Data Point Values for Specified Region(s)

$$SDEV = \sqrt{\frac{1}{n} \sum_{X_i \in \text{region}(s)} (X_i - \bar{X})^2}$$

where X_i is a data point value, \bar{X} is the arithmetic mean of the data point values for the specified region(s), and n is the number of data points in the specified region(s).

$$SDEV = \sqrt{\frac{1}{n} \sum_{X_i \in \text{region}(s)} (|X_i| - \bar{X})^2}$$

where $|X_i|$ is the magnitude of an I/Q pair, \bar{X} is the mean of the magnitudes for the specified region(s), and n is the number of data points in the specified region(s).

- PPHase - returns the x,y pairs of both rms power (dBm) and arithmetic mean phase (radian) for every specified region and frequency offset (Hz). The number of pairs is defined by the specified number of regions. This parameter can be used for I/Q vector (n=0) in Waveform (time domain) measurement and all parameters are specified by data point in PPHase.

The rms power of the specified region may be expressed as:

$$\text{Power} = 10 \times \log [10 \times (\text{RMS I/Q value})] + 10.$$

The RMS I/Q value (peak volts) is:

$$\sqrt{\frac{1}{n} \sum_{X_i \in \text{region}} X_i X_i^*}$$

where X_i is the complex value representation of an I/Q pair, X_i^* its conjugate complex number, and n is the number of I/Q pairs in the specified region.

The arithmetic mean phase of the specified region may be expressed as:

$$\frac{1}{n} \sum_{Y_i \in \text{region}} Y_i$$

where Y_i is the unwrapped phase of I/Q pair with applying frequency correction and n is the number of I/Q pairs in the specified region.

The frequency correction is made by the frequency offset calculated by the arithmetic mean of every specified region's frequency offset. Each frequency offset is calculated by the least square method against the unwrapped phase of I/Q pair.

Sample Trace Data - Constant Envelope

(See below for explanation of variables.)

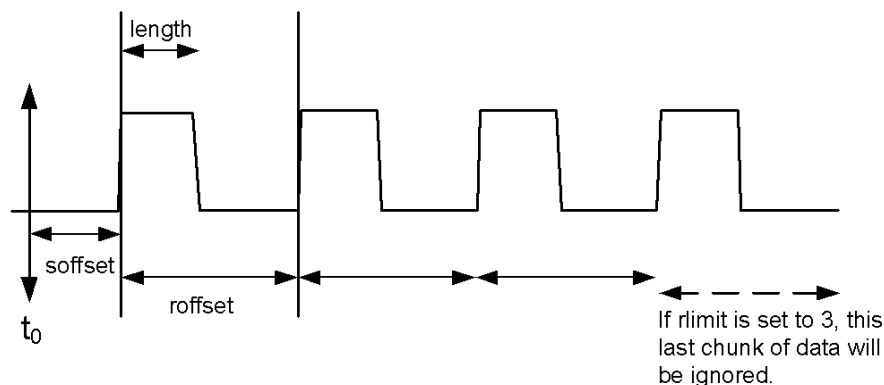

Sample Trace Data - Not Constant Envelope

(See below for explanation of variables.)

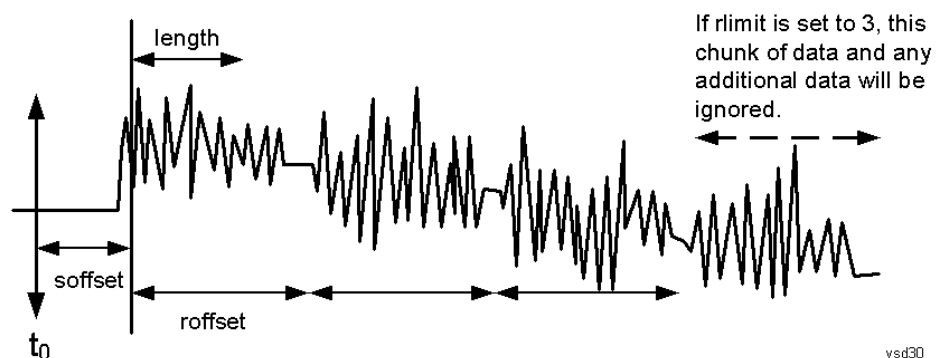

<soffset> - start offset is an optional real number. (It is in seconds for time-domain traces, and is a dimensionless index 0 to Npoints - 1, for frequency-domain traces). It specifies the amount of data at the beginning of the trace that will be ignored before the decimation process starts. It is the time or frequency change from the start of the trace to the point where you want to start using the data. The default value is zero.

<length> - is an optional real number. (It is in seconds for time-domain traces, and is a dimensionless index 0 to Npoints - 1, for frequency-domain traces). It defines how much data will be compressed into one value. This parameter has a default value equal to the current trace length.

<roffset> - repeat offset is an optional real number. (It is in seconds for time-domain traces, and is a dimensionless index 0 to Npoints - 1, for frequency-domain traces). It defines the beginning of the next field of trace elements to be compressed. This is relative to the beginning of the previous field. This parameter has a default value equal to the <length> variable. Note that this parameter is used for a completely different purpose when curve fitting (see CFIT above).

<rlimit> - repeat limit is an optional integer. It specifies the number of data items that you want returned. It will ignore any additional items beyond that number. You can use the Start offset and the Repeat limit to pick out exactly what part of the data you want to use. The default value is all the data.

Calculate Peaks of Trace Data (Remote Command Only)

Returns a list of all the peaks for the currently selected measurement and sub-opcode [n]. The peaks must meet the requirements of the peak threshold and excursion values.

n = any valid sub-opcode for the current measurement. See the MEASure:<measurement> command description of your specific measurement for information on the data that can be returned.

The command can only be used with specific sub-opcodes with measurement results that are trace data. Both real and complex traces can be searched, but complex traces are converted to magnitude in dBm. In many measurements the sub-opcode n=0, is the raw trace data which cannot be searched for peaks. And Sub-opcode n=1, is often calculated results values which also cannot be searched for peaks.

This command uses the data setting specified by the FORMat:BORDER and FORMat:DATA commands and can return real or ASCII data. If the format is set to INT,32, it returns REAL,32 data.

The command has four types of parameters:

- Threshold (in dBm)
- Excursion (in dB)
- Sorting order (amplitude, frequency, time)
- Optional in some measurements: Display line use (all, > display line, < display line)

Remote Command

For Swept SA measurement:

```
:CALCulate:DATA[1]|2|...|6:PEAKS? <threshold>,<excursion>[,AMPLitude  
| FREQuency | TIME[,ALL | GTDLine | LTDLine]]
```

For most other measurements:

	<code>:CALCulate:DATA[1] 2 ... 6:PEAKs? <threshold>,<excursion>[,AMPLitude FREQUENCY TIME]</code>
Example	<p>Example for Swept SA measurement in Spectrum Analyzer Mode:</p> <p>CALC:DATA4:PEAK? -40, 10, FREQ, GTDL This will identify the peaks of trace 4 that are above -40 dBm, with excursions of at least 10 dB. The peaks are returned in order of increasing frequency, starting with the lowest frequency. Only the peaks that are above the display line are returned.</p> <p>Query Results 1:</p> <p>With FORMat:DATA REAL, 32 selected, it returns a list of floating-point numbers. The first value in the list is the number of peak points that are in the following list. A peak point consists of two values: a peak amplitude followed by its corresponding frequency (or time).</p> <p>If no peaks are found the peak list will consist of only the number of peaks, (0).</p>
Notes	<p><n> - is the trace that will be used</p> <p><threshold> - is the level below which trace data peaks are ignored. Note that the threshold value is required and is always used as a peak criterion. To effectively disable the threshold criterion for this command, provide a substantially low threshold value such as -200 dBm. Also note that the threshold value used in this command is independent of and has no effect on the threshold value stored under the Peak Criteria menu.</p> <p><excursion> - is the minimum amplitude variation (rise and fall) required for a signal to be identified as peak. Note that the excursion value is required and is always used as a peak criterion. To effectively disable the excursion criterion for this command, provide the minimum value of 0.0 dB. Also note that the excursion value used in this command is independent of and has no effect on the excursion value stored under the Peak Criteria menu.</p> <p>Values must be provided for threshold and excursion. The sorting and display line parameters are optional (defaults are AMPLitude and ALL).</p> <p>Note that there is always a Y-axis value for the display line, regardless of whether the display line state is on or off. It is the current Y-axis value of the display line which is used by this command to determine whether a peak should be reported</p> <p>Sorting order:</p> <p>AMPLitude - lists the peaks in order of descending amplitude, with the highest peak first (default if optional parameter not sent)</p> <p>FREQUENCY - lists the peaks in order of occurrence, left to right across the x-axis.</p> <p>TIME - lists the peaks in order of occurrence, left to right across the x-axis.</p> <p>Peaks vs. Display Line:</p> <p>ALL - lists all of the peaks found (default if optional parameter not sent).</p> <p>GTDLLine (greater than display line) - lists all of the peaks found above the display line.</p> <p>LTDLine (less than display line) - lists all of the peaks found below the display line.</p>
Initial S/W Revision	Prior to A.02.00

Hardware-Accelerated Fast Power Measurement (Remote Command Only)

The Fast Power option (FP2) enables very fast channel power measurements for instruments with the prerequisite hardware (DP2 and/or B40). It accomplishes this by performing real-time overlapped FFTs at the hardware layer, using software for basic post-processing before returning the result to the user. The upshot of this

approach is improved throughput for user applications that require many sequential power measurements.

The analysis bandwidth of FP2 is limited by the licenses in the instrument, but its maximum overall analysis bandwidth per acquisition is 40 MHz.

FP2 is remote-only, which means the instrument does not switch to any particular mode or measurement. FP2 commands can be sent while another application is in use on the front panel.

Each Fast Power measurement can be predefined using an array index, and up to 1,000 measurements can be stored. In the following documentation, instances of [1,2,...,999] can be substituted with a particular measurement index, e.g. CALC:FPOW:POW1?, CALC:FPOW:POW2?, CALC:FPOW:POW134?. In this way, power measurements can be defined one time in a batch, and then executed multiple times without having to redefine them, similar to “list mode” on other measurements.

In addition to basic channel power measurements, there are a number of other measurement “functions” for each channel, including peak power, peak frequency, and power spectral density. See the Function parameter for more information.

Reset Fast Power Measurement (Remote Command Only)

Resets the measurement configuration to the defaults.

Mode	All
Remote Command	:CALCulate:FPOWer:POWer[1,2,...,999]:RESet
Example	:CALC:FPOW:POW1:RES
Notes	Option FP2 is required.
Initial S/W Revision	A.14.00

Define Fast Power Measurement (Remote Command Only)

Fast Power acquisitions are configured using the DEFine command. This command accepts a comma-delimited string of configuration parameters and their appropriate values, which are all specified in the subsection below.

Mode	All
Remote Command	:CALCulate:FPOWer:POWer[1,2,...,999]:DEFine "configuration string"
Example	:CALC:FPOW:POW1:DEF "CenterFrequency=2e9, AcquisitionTime=0.005"
Notes	See below for a list of measurement variables that can be defined in the configuration string.
Initial S/W Revision	A.14.00

Acquisition Time

Example	CALC:FPOW:POW1:DEF "AcquisitionTime=0.002"
Notes	The acquisition time parameter sets the time in which the entire spectrum is measured. An increase in the acquisition time yields an improvement in measurement repeatability.
Preset	0.001 s
Range	0 s to 1 s
Default Unit	Time (s)
Initial S/W Revision	A.14.00

Center Frequency

Example	CALC:FPOW:POW1:DEF "CenterFrequency=2e9"
Notes	The center frequency parameter sets the frequency in which the measurement is centered around. The OffsetFrequency parameter is calculated relative to the center frequency.
Preset	1 GHz
Range	0 Hz to maximum instrument frequency
Default Unit	Frequency (Hz)
Initial S/W Revision	A.14.00

DC Coupled

Example	CALC:FPOW:POW1:DEF "DCCoupled=True"
Notes	The DC coupled parameter allows the user to specify whether the DC blocking capacitor is utilized. Set parameter to true when measuring frequencies below 10 MHz.
Preset	False
Range	True (DC Coupled) or False (AC Coupled)
Default Unit	Boolean
Initial S/W Revision	A.14.00

DetectorType

Example	CALC:FPOW:POW1:DEF "DetectorType=Peak"
Notes	Option FP2 is required. The detector type parameter allows the user to choose whether a RMS average or peak value is used during the measurement.
Preset	RmsAverage
Range	RmsAverage, Peak
Initial S/W Revision	A.14.00

Do Noise Correction

Example	CALC:FPOW:POW1:DEF "DoNoiseCorrection=True"
Notes	<p>When noise correction is enabled, the linear noise power contributed by the analyzer is subtracted from all measurements. This effectively lowers the noise floor of the analyzer.</p> <p>When noise correction is enabled, the first measurement for a given set of input parameters will take extra time. This is because the analyzer takes an extra acquisition with the RF input disconnected from the analyzer's front end to measure the noise of just the analyzer. The measured noise floor is stored in a cache so the noise acquisition will occur only once for the same state settings. In other words, if noise correction was turned on and the analyzer made an acquisition at frequency A, then frequency B, and back again to frequency A, the hidden initial noise floor acquisition would only occur for the first acquisition at frequency A and the cached noise floor would be used the second time frequency A was measured.</p>
Preset	False
Range	True (enable noise correction) or False (disable noise correction)
Default Unit	Boolean
Initial S/W Revision	A.14.00

Do Spur Suppression

Example	CALC:FPOW:POW1:DEF "DoSpurSuppression=True"
Notes	<p>When measuring very low level signals, or when large out-of-band inputs are input into the analyzer, sometimes unwanted spurs and residuals can appear in the measured spectrum. Spur suppression is a method to help minimize the levels of these internally generated spurs and residuals.</p> <p>When spur suppression is enabled, the analyzer will automatically take two acquisitions using two different internal analog LO frequencies. The FFT spectrums from both acquisitions are combined by taking the minimum power between both traces on a per FFT bin basis. External signals will have the same amplitude for both traces and therefore will return the expected amplitudes. However, low level spurs and residuals generated internally to the analyzer tend to move to different FFT bins depending on the internal analog LO frequency used, and therefore tend to be suppressed using this spur suppression method.</p> <p>Because two acquisitions, rather than a single acquisition, are made when spur suppression is enabled, the measurement time will always be slower when spur suppression is enabled.</p>
Preset	False
Range	True (enable spur suppression) or False (disable spur suppression)
Default Unit	Boolean
Initial S/W Revision	A.14.00

Electronic Attenuator Bypass

Example	CALC:FPOW:POW1:DEF "ElecAttBypass =False"
---------	---

Notes	The electronic attenuation bypass parameter allows the user to either utilize or bypass the electronic attenuator. The electronic attenuator is only available for frequencies up to 3.6 GHz. Set parameter to true when using frequencies above 3.6 GHz and set the parameter to false when using the preamp.
Preset	True
Range	True (bypass electronic attenuator) or False (use electronic attenuator)
Default Unit	Boolean
Initial S/W Revision	A.14.00

Electronic Attenuation

Example	CALC:FPOW:POW1:DEF "ElecAttenuation=10"
Notes	Option EA3 is required. The electronic attenuation value parameter sets the amount of electrical attenuation from 0 to 24 dB (1 dB steps). Set "ElecAttBypass=False" to make sure the electronic attenuator path is enabled.
Preset	0 dB
Range	0 – 24 dB (1 dB steps)
Default Unit	dB
Initial S/W Revision	A.14.00

IF Gain

Example	CALC:FPOW:POW1:DEF "IFGain=10"
Notes	The IF gain parameter allows the user to specify the gain at the IF stage anywhere from -6 to 16 dB (1 dB steps). This is an advanced feature, and for most cases this should remain at its default value of 0 dB.
Preset	0 dB
Range	-6 – 16 dB (1 dB steps)
Default Unit	dB
Initial S/W Revision	A.14.00

IF Type

Example	CALC:FPOW:POW1:DEF "IFType=B25M"
Notes	The IF type parameter allows the user to select between different IF paths. For example, if the signal is less than 25 MHz wide, then the user can select the B25M path to take advantage of additional filtering on this analog IF path.

Preset	B40M
Range	B10M, B25M, B40M
Initial S/W Revision	A.14.00

Include Power Spectrum

Example	CALC:FPOW:POW1:DEF "IncludePowerSpectrum=True"
Notes	The power spectrum parameter allows the user to read data on the entire spectrum for diagnostic purposes. It is not recommended for production use. See CALC:FPOW:POW[n]:READ2? for details on the binary format of the response.
Preset	False
Range	True (return both channel power and full power spectrum) or False (returns only channel power)
Default Unit	Boolean
Initial S/W Revision	A.14.00

Mechanical Attenuation

Example	CALC:FPOW:POW1:DEF "MechAttenuation=10"
Notes	The mechanical attenuation value parameter sets the amount of mechanical attenuation anywhere from 0 to 70 dB (2 dB steps).
Preset	0 dB
Range	0 – 70 dB (2 dB steps)
Default Unit	dB
Initial S/W Revision	A.14.00

Preamp Mode

Example	CALC:FPOW:POW1:DEF "PreAmpMode=Low"
Notes	The license for the appropriate preamp is required. The preamp mode parameter specifies whether the preamps are being utilized. Low allows any preamps up to 3.6 GHz, and Full allows all licensed preamps. Set "ElecAttBypass=True" in order to utilize any preamps.
Preset	Off
Range	Off, Low, Full
Initial S/W Revision	A.14.00

Resolution Bandwidth Mode

Example	CALC:FPOW:POW1:DEF "PreAmpMode=Low"
Notes	The resolution bandwidth mode parameter allows the user to choose whether the RBW filter is automatically or manually set. The BestSpeed value minimizes measurement time, while the Narrowest value minimizes RBW size (minimum of two FFT bins per RBW). To manually specify an RBW, set this parameter to Explicit, and set the ResolutionBW parameter to the desired value.
Preset	BestSpeed
Range	BestSpeed, Narrowest, Explicit
Initial S/W Revision	A.14.00

Resolution Bandwidth

Example	CALC:FPOW:POW1:DEF "ResolutionBW=25e3"
Notes	The resolution bandwidth parameter sets the 3-dB bandwidth of the RBW filter. The ResolutionBWMode parameter must be set to Explicit in order to manually set the RBW.
Preset	0 Hz
Default Unit	Hz
Initial S/W Revision	A.14.00

Trigger Delay

Example	CALC:FPOW:POW1:DEF "TriggerDelay=0.025"
Notes	The trigger delay parameter sets the time after an external trigger is detected until the measurement is performed.
Preset	0 s
Range	0 – 1 s
Default Unit	Seconds
Initial S/W Revision	A.14.00

Trigger Level

Example	CALC:FPOW:POW1:DEF "TriggerLevel=2"
Notes	The trigger level parameter sets the voltage value at which an external trigger is detected.
Preset	1.2 V
Range	-5 to 5 V
Default Unit	Volts
Initial S/W Revision	A.14.00

Trigger Slope

Example	CALC:FPOW:POW1:DEF "TriggerSlope=Negative"
Notes	The trigger slope parameter indicates the direction of the edge trigger voltage for detection.
Preset	Positive
Range	Positive, Negative
Initial S/W Revision	A.14.00

Trigger Source

Example	CALC:FPOW:POW1:DEF "TriggerSource=Ext1"
Notes	The trigger source parameter allows the user to choose between measurement's triggering freely or controlled by an external input. Ext1 and Ext2 correspond to Trigger 1 In and Trigger 2 In, respectively.
Preset	Free
Range	Free, Ext1, Ext2
Initial S/W Revision	A.14.00

Trigger Timeout

Example	CALC:FPOW:POW1:DEF "TriggerTimeout=0.1"
Notes	The trigger timeout parameter sets the time in which the analyzer will wait for a trigger before automatically performing the measurement.
Preset	1 s
Range	0 – 1 s
Default Unit	Seconds
Initial S/W Revision	A.14.00

Signal Input

Example	CALC:FPOW:POW1:DEF "SignalInput=Fp50MHzCW"
Notes	The signal input parameter allows the user to select between using the main RF input or the internal analyzer reference CW signal of 50 MHz.
Preset	FpMainRf
Range	FpMainRf, Fp50MHzCW
Initial S/W Revision	A.14.00

Use Preselector

Example	CALC:FPOW:POW1:DEF "UsePreSelector=True"
Notes	The preselector parameter allows the user to either utilize or bypass the front end tunable filter at frequencies above 3.6 GHz. For frequencies below 3.6 GHz, the preselector is automatically bypassed, so you do not need to set this parameter to False in those cases.
Preset	False
Range	True (use preselector above 3.6 GHz), or False (preselector bypassed)
Default Unit	Boolean
Initial S/W Revision	A.14.00

Channel Bandwidth Array

Example	CALC:FPOW:POW1:DEF "Bandwidth=[3.84e6, 5e6, 3.84e6]"
Notes	The bandwidth parameter array defines the bandwidth of each channel that will be measured. All array parameters should have the same number of elements. Alternatively, if all the elements are the same value, a single number with no square brackets can be used to define the parameter.
Preset	[1e6]
Range	0 to 40 MHz
Default Unit	Hz
Initial S/W Revision	A.14.00

Channel Filter Type Array

Example	CALC:FPOW:POW1:DEF "FilterType=[RRC, IBW, RRC]"
Notes	The filter type parameter allows the user to choose between an integration bandwidth (IBW) filter or a root-raised-cosine (RRC) filter. The integration bandwidth filter weighs all frequencies within the bandwidth equally. The root-raised-cosine filter has an associated shape parameter, defined by the FilterAlpha parameter. All array parameters should have the same number of elements. Alternatively, if all the elements are the same value, a single value with no square brackets can be used to define the parameter.
Preset	[IBW]
Range	IBW, RRC
Initial S/W Revision	A.14.00

Channel Filter Alpha Array

Example	CALC:FPOW:POW1:DEF "FilterAlpha=[0.5, 0.0, 0.5]"
Notes	The filter alpha parameter allows the user to adjust the alpha value associated with the root-

	raised-cosine (RRC) filter type. Set FilterType to RRC in order to utilize this parameter. All array parameters should have the same number of elements. Alternatively, if all the elements are the same value, a single number with no square brackets can be used to define the parameter.
Preset	[0.22]
Range	0.0 – 1.0
Initial S/W Revision	A.14.00

Channel Measurement Function Array

Example	CALC:FPOW:POW1:DEF "Function=[BandPower, PeakPower, BandPower]"
Notes	This parameter array defines what measurement is being made for each individually-specified channel: BandPower: Total power within the specified bandwidth of the channel (dBm) BandDensity: Total power density within the specified bandwidth of the channel (dBm/Hz) PeakPower: The peak power value within the specified bandwidth of the channel (dBm) PeakFrequency: The frequency which corresponds to the peak power value within the specified bandwidth of the channel. This frequency is relative to the center frequency (Hz) XdBBandwidth: The half power (-3.01 dB) bandwidth of the highest amplitude signal that resides within the channel (Hz), dB is configurable using XdBBandwidth parameter OccupiedBandwidth: The bandwidth at which 99% of the total power resides within the channel (Hz), percentage configurable using OccupiedBandwidthPercent parameter All array parameters should have the same number of elements. Alternatively, if all the elements are the same value, a single value with no square brackets can be used to define the parameter.
Preset	[BandPower]
Range	BandPower, BandDensity, PeakPower, PeakFrequency, XdBBandwidth, OccupiedBandwidth
Initial S/W Revision	A.14.00

Channel Offset Frequency Array

Example	CALC:FPOW:POW1:DEF "OffsetFrequency=[-5e6, 0, 5e6]"
Notes	The offset frequency parameter array defines the difference between the center frequency to the center frequency of each channel. All array parameters should have the same number of elements.
Preset	[0]
Range	0 to 20 MHz
Default Unit	Hz
Initial S/W Revision	A.14.00

Channel Occupied Bandwidth Percent Array

Example	CALC:FPOW:POW1:DEF "OccupiedBandwidthPercent =[0.95, 0.95, 0.95]"
Notes	This parameter only applies for channels whose Function is set to OccupiedBandwidth. The occupied bandwidth percent parameter specifies the percent of total power in these channels. The valid range for this parameter is 0.0 to 1.0, where 1.0 represents 100%. The default for this parameter is 0.99, which will return the bandwidth that contains 99% of the total channel power.
Preset	[0.99]
Range	0 – 1.0
Initial S/W Revision	A.14.00

Channel x-dB Bandwidth Array

Example	CALC:FPOW:POW1:DEF "XdBBandwidth =[-6.02, -3.01, -1.0]"
Notes	This parameter only applies for channels whose Function is set to XdBBandwidth. The X dB bandwidth parameter is used to specify the power relative to the peak channel power over which the bandwidth is calculated. The parameter value must be a negative number.
Preset	[-3.01]
Range	-200 to 0 dB
Default Unit	dB
Initial S/W Revision	A.14.00

Define Fast Power Measurement Query (Remote Command Only)

The DEFine? command is used to retrieve a list of all defined parameters in an ASCII string format

```

M All
o
d
e
R :CALCulate:FPOWer:POWer[1,2,...,999]:DEFine?
e
m
o
t
e
C
o
m
m
a
n

```

d

E :CALC:FPOW:POW1:DEF?

**x
a
m
p
l
e**

N This command query is used to retrieve a list of all defined parameters in an ASCII format.

O The following is an example of the returned results:

t "DCCoupled=False,ElecAttBypass=True,ElecAttenuation=0,IFGain=0,MechAttenuation=0,PreAmpMode=Off,PreSelectorOf
e fset=0,UsePreSelector=False,ExternalReferenceFrequency=10000000,FrequencyReferenceSource=AutoExternalFrequenc
s yReference,IFType=B40M,LOMode=SLW,SignalInput=FpMainRf,AcquisitionTime=0.001,CenterFrequency=1000000000,Re
solutionBW=0,ResolutionBWMode=BestSpeed,DetectorType=RmsAverage,Bandwidth=[1000000],OffsetFrequency=
[0],Function=[BandPower],FilterType=[BW],FilterAlpha=[0.22],OccupiedBandwidthPercent=[0.99],XdBBandwidth=[-
3.01],DoNoiseCorrection=False,DoSpurSuppression=False,MeasurementMethod=HardwareFFT,IncludePowerSpectrum=F
alse,TriggerDelay=0,TriggerLevel=1.2,TriggerSlope=Positive,TriggerSource=Free,TriggerTimeout=1"

I A.14.00

**n
i
t
i
a
l**

**S
/
W**

**R
e
v
i
s
i
o
n**

Configure Fast Power Measurement (Remote Command Only)

The configure command begins hardware setup and returns immediately, with no acquisition made. This can be used in parallel with other hardware operations to effectively hide the hardware setup time.

Mode	All
Remote Command	:CALCulate:FPOWer:POWer[1,2,...,999]:CONFigure
Example	:CALC:FPOW:POW1:CONF

Notes	Option FP2 is required.
Initial S/W Revision	A.14.00

Initiate Fast Power Measurement (Remote Command Only)

The INITiate command begins an acquisition and returns immediately. The results of the measurement can be retrieved using FETCh.

Mode	All
Remote Command	:CALCulate:FPOWer:POWer[1,2,...,999]:INITiate
Example	:CALC:FPOW:POW1:INIT
Notes	Option FP2 is required.
Initial S/W Revision	A.14.00

Fetch Fast Power Measurement (Remote Command Only)

The FETCh command query is used to retrieve the results of an acquisition initiated by the INIT command. The returned results are in ASCII string format. The string begins and ends with quotation marks.

Mode	All
Remote Command	:CALCulate:FPOWer:POWer[1,2,...,999]:FETCh?
Example	:CALC:FPOW:POW1:FETC?
Notes	Option FP2 is required. Returns m comma-separated ASCII values, where m corresponds to the number of bandwidths defined. 1. Declared function return in the 1st specified channel 2. Declared function return in the 2nd specified channel ... m. Declared function return in the last specified channel The INIT and FETC? command sequence performs the same functionality of a single CALC:FPOW:POW[n]? query. Units of the returned values are dependent on the Function parameter for each channel.
Initial S/W Revision	A.14.00

Execute Fast Power Measurement (Remote Command Only)

This command query is used as shorthand for an INIT command immediately followed by a FETC? command. The returned results are in ASCII string format. The string begins and ends with quotation marks.

Mode	All
Remote Command	:CALCulate:FPOWer:POWer[1,2,...,999]?
Example	:CALC:FPOW:POW1?
Notes	Option FP2 is required. See notes for Fast Power Fetch for return format.
Initial S/W Revision	A.14.00

Binary Read Fast Power Measurement (Remote Command Only)

This command query is used as shorthand for an INIT command immediately followed by a FETC? command. The returned results are in a binary format.

Mode	All
Remote Command	:CALCulate:FPOWer:POWer[1,2,...,999]:READ? :CALCulate:FPOWer:POWer[1,2,...,999]:READ1?
Example	:CALC:FPOW:POW1:READ? :CALC:FPOW:POW1:READ1?
Notes	Option FP2 is required. Returns m 4 byte floating point binary values (Little-Endian), where m corresponds to the number of bandwidths defined.
Initial S/W Revision	A.14.00

Diagnostic Binary Read Fast Power Measurement (Remote Command Only)

This command query is used as shorthand for an INIT command immediately followed by a FETC? command. The returned results are in a binary format. This command is used primarily for diagnostic purposes to test for ADC overloads and to visibly inspect the spectrum.

Mode	All
Remote Command	:CALCulate:FPOWer:POWer[1,2,...,999]:READ2?
Example	:CALC:FPOW:POW1:READ2?
Notes	Option FP2 is required. <div style="display: flex; align-items: flex-start; margin-top: 10px;"> <div style="background-color: #cccccc; padding: 2px 5px; margin-right: 10px;">NOTE</div> <div> <p>Spectrum data is only returned if the IncludePowerSpectrum parameter is set to True. If IncludePowerSpectrum is False, the number of spectrum points will be zero (0).</p> <p>Units of the returned values are dependent on the Function parameter per channel (e.g. dBm for BandPower, Hz for PeakFrequency). Returns binary data (Little-Endian) that contains information on m amount of channels, along with ADC over range and full spectrum data.</p> </div> </div>

The following is the binary format of the response.

Bandwidth Return Value

1. Number of channels specified, m [4 byte int]
2. Declared function result for the 1st specified channel [4 byte float]
3. Declared function result for the 2nd specified channel [4 byte float]
- ...
- (m + 1). Declared function result for the last (mth) specified channel [4 byte float]

ADC Over Range

1. ADC over-range occurred (1: true, 0: false) [2 byte short]

Spectrum Data

1. Number of points in the spectrum data, k [4 byte int]
 2. Start frequency of spectrum data (Hz) [8 byte double]
 3. Step frequency of spectrum data (Hz) [8 byte double]
 4. FFT bin at 1st point (dBm) [4 byte float]
 5. FFT bin at 2nd point (dBm) [4 byte float]
 - ...
 - (k + 3). FFT bin at last (kth) point (dBm) [4 byte float]
-

Initial S/W Revision A.14.00

Format Data: Numeric Data (Remote Command Only)

This command specifies the format of the trace data input and output. It specifies the formats used for trace data during data transfer across any remote port. It affects only the data format for setting and querying trace data for the :TRACe[:DATA], TRACe[:DATA]?, :CALCulate:DATA[n]? and FETCh:SANalyzer[n]? commands and queries.

Remote Command	:FORMat[:TRACe][:DATA] ASCii INTEger,32 REAL,32 REAL,64 :FORMat[:TRACe][:DATA]?
-----------------------	---

Notes The query response is:

ASCii: ASC,8

REAL,32: REAL,32

REAL,64: REAL,64

INTEger,32: INT,32

When the numeric data format is REAL or ASCii, data is output in the current Y Axis unit. When the data format is INTEger, data is output in units of m dBm (.001 dBm).

The INT,32 format returns binary 32-bit integer values in internal units (m dBm), in a definite length block.

Dependencies	Sending a data format spec with an invalid number (for example, INT,48) generates no error. The analyzer simply uses the default (8 for ASCii, 32 for INTEger, 32 for REAL).
--------------	--

Sending data to the analyzer which does not conform to the current FORMat specified, results in an error. Sending ASCII data when a definite block is expected generates message -161 "Invalid

	Block Data" and sending a definite block when ASCII data is expected generates message -121 "Invalid Character in Number".
Preset	AScii
Backwards Compatibility Notes	Note that the INT,32 format is only applicable to the command, TRACe:DATA. This preserves backwards compatibility for the Swept SA measurement. For all other commands/queries which honor FORMat:DATA, if INT,32 is sent the analyzer will behave as though it were set to REAL,32.
Initial S/W Revision	Prior to A.02.00

The specs for each output type follow:

AScii - Amplitude values are in ASCII, in the current Y Axis Unit, one ASCII character per digit, values separated by commas, each value in the form:

SX.YYYYYEsZZ

Where:

S = sign (+ or -)

X = one digit to left of decimal point

Y = 5 digits to right of decimal point

E = E, exponent header

s = sign of exponent (+ or -)

ZZ = two digit exponent

REAL,32 - Binary 32-bit real values in the current Y Axis Unit, in a definite length block.

REAL,64 - Binary 64-bit real values in the current Y Axis Unit, in a definite length block.

Format Data: Byte Order (Remote Command Only)

This command selects the binary data byte order for data transfer and other queries. It controls whether binary data is transferred in normal or swapped mode. This command affects only the byte order for setting and querying trace data for the :TRACe[:DATA], TRACe[:DATA]? , :CALCulate:DATA[n]? and FETCh:SANalyzer[n]? commands and queries.

By definition any command that says it uses FORMat:DATA uses any format supported by FORMat:DATA.

The NORMal order is a byte sequence that begins with the most significant byte (MSB) first, and ends with the least significant byte (LSB) last in the sequence: 1|2|3|4. SWAPped order is when the byte sequence begins with the LSB first, and ends with the MSB last in the sequence: 4|3|2|1.

Remote Command :FORMat:BORDER NORMa1 | SWAPped

	:FORMat:BORDER?
Preset	NORMal
Initial S/W Revision	Prior to A.02.00

Meas Setup

The Meas Setup key opens a menu of softkeys that allow you to control the most important parameters for the current measurement.

NOTE

In the Meas Setup menu you may configure Averaging, by setting the Average Number and the Average Type.

Key Path	Front-panel key
Initial S/W Revision	Prior to A.02.00

Average/Hold Number

Sets the terminal count number N for **Average**, **Max Hold** and **Min Hold** trace types. This number is an integral part of how the average trace is calculated. Basically, increasing N results in a smoother average trace.

- See ["More Information" on page 752](#).
- See ["AVER:CLE command" on page 753](#).

Key Path	Meas Setup
Remote Command	[:SENSe] :AVERAge :COUNT <integer> [:SENSe] :AVERAge :COUNT ?
Couplings	Restarting any of these functions (Average , Max Hold or Min Hold) restarts all of them, as there is only one count.
Preset	100
State Saved	Saved in instrument state
Min	1
Max	10000
Status Bits/OPC dependencies	See "Sweep/Control" on page 927 for a discussion of the Sweeping, Measuring, Settling and OPC bits, and the Hi Sweep line. All are affected when a sequence is reset.
Backwards Compatibility Notes	In the past, when changing the Average Count (now Average/Hold Number), you had to re-start the trace at the beginning of a sweep to ensure valid average data. Now, the system will ensure valid results when changing the count limit.
Initial S/W Revision	Prior to A.02.00

More Information

When in **Single**, the sweep stops when N is reached. You can add more sweeps by increasing the Average/Hold Number. For example, if you want to add one more Average, or one more trace to Max Hold or Min Hold, simply increment this number by one, which you can do by pressing the Up key while Average/Hold Number is the active function.

In **Cont** (continuous), averaging and holding continues even after N is reached. Therefore, using doing trace holding in **Cont**, the value of N is irrelevant. But for averaging, each new sweep is exponentially averaged in with a weighting equal to N.

For details of how the average trace is calculated and how this depends on the **Average/Hold Number**, see "[Average Type](#)" on page 753, below. For details on how the various control functions in the instrument start and restart averaging, see "[Average Type](#)" on page 753.

The Average/Hold Number is not affected by Auto Couple.

AVER:CLE command

The AVER:CLE command (below) resets the average/hold count and does an INIT:IMM, which begins another set of sweeps when trigger conditions are satisfied. It only does this if an active trace is in Average or Hold type.

Remote Command	[:SENSe] :AVERage :CLEar
Example	AVER:COUN 100 AVER:CLE sets the current count (k and K) to 1 and restarts the averaging process.
Notes	When the instrument receives this command it performs an INIT:IMM, if and only if there is an active trace in Max Hold, Min Hold, or Average type.
Default Unit	Enter
Initial S/W Revision	Prior to A.02.00

Average Type

Lets you control the way averaging is done by choosing one of the following averaging scales: log-power (video), power (RMS), or voltage averaging. Also lets you choose Auto Average Type (default).

When performing Trace Averaging, , the equation that is used to calculate the averaged trace depends on the average type. See the descriptions for the keys which select each Average Type ("[Log-Pwr Avg \(Video\)](#)" on page 755, "[Pwr Avg \(RMS\)](#)" on page 756, or "[Voltage Avg](#)" on page 756) for details on these equations.

See "[More Information](#)" on page 754.

Key Path	Meas Setup
Remote Command	[:SENSe] :AVERage :TYPE :AUTO OFF ON 0 1 [:SENSe] :AVERage :TYPE :AUTO?
Preset	ON
State Saved	Saved in Instrument State
Readback line	1-of-N selection as Log-Pwr (Video) for Log-Pwr (Video) Avg Pwr (RMS) for Power Avg Voltage for Voltage
Initial S/W Revision	Prior to A.02.00

Remote Command	[:SENSe] :AVERAge:TYPE RMS LOG SCALar [:SENSe] :AVERAge:TYPE ?
Notes	Parameters map to avg types as: RMS = Pwr (RMS) Avg LOG = Log-Pwr (Video) Avg SCALar = Voltage Avg
Preset	LOG
Backwards Compatibility Notes	The following legacy parameters to the [:SENSe]:AVERAge:TYPE command are aliased as shown: LINear aliased to SCALar, sets Scalar averaging VOLTage aliased to SCALar, sets Scalar averaging VIDeo aliased to LOG, sets Log-Power averaging LPOWer aliased to LOG, sets Log-Power averaging POWer aliased to RMS , sets RMS averaging
Initial S/W Revision	Prior to A.02.00

More Information

When you select log-power averaging, the measurement results are the average of the signal level in logarithmic units (decibels). When you select power average (RMS), all measured results are converted into power units before averaging and filtering operations, and converted back to decibels for displaying. Remember: there can be significant differences between the average of the log of power and the log of the average power.

These are the averaging processes within a spectrum analyzer and all of them are affected by this setting:

1. Trace averaging (see "[Trace/Detector on page 986](#)") averages signal amplitudes on a trace-to-trace basis. The average type applies to all traces in Trace Average (it is not set on a trace-by-trace basis).
2. Average detector (see "[Trace/Detector on page 986](#)") averages signal amplitudes during the time or frequency interval represented by a particular measurement point.
3. Noise Marker (see "[Marker Function on page 693](#)") averages signal amplitudes across measurement points to reduce variations for noisy signals.
4. VBW filtering (see "[BW on page 636](#)") adds video filtering which is a form of averaging of the video signal.

When **Auto** is selected, the analyzer chooses the type of averaging (see below). When one of the average types is selected manually, the analyzer uses that type regardless of other analyzer settings, and shows Man on the **Average Type** softkey.

Auto

Chooses the optimum type of averaging for the current instrument measurement settings.

Key Path	Meas setup, Average Type
Example	AVER:TYPE:AUTO ON
Notes	See Average Type , above
Couplings	Here are the auto-select rules for Average Type : Auto selects VoltageAveraging if the Detector for any active trace is EMI Average or QPD or RMS Average ; otherwise it selects Power (RMS) Averaging if a Marker Function (Marker Noise, Band/Intvl Power) is on, or Detector is set to Man and Average ; otherwise if Amplitude, Scale Type is set to Lin it selects Voltage Averaging; otherwise, if the EMC Standard is set to CISPR, it selects Voltage; otherwise Auto selects Log-Power Average. Note that these rules are only applied to active traces. Traces which are not updating do not impact the auto-selection of Average Type.
State Saved	Saved in instrument state
Readback	The type auto-selected is displayed in the readback line on the Average Type key
Initial S/W Revision	Prior to A.02.00

Log-Pwr Avg (Video)

Selects the logarithmic (decibel) scale for all filtering and averaging processes. This scale is sometimes called “Video” because it is the most common display and analysis scale for the video signal within a spectrum analyzer. This scale is excellent for finding CW signals near noise, but its response to noise-like signals is 2.506 dB lower than the average power of those noise signals. This is compensated for in the Marker Noise function.

The equation for trace averaging on the log-pwr scale is shown below, where K is the number of averages accumulated. (In continuous sweep mode, once K has reached the Average/Hold Number, K stays at that value, providing a continuous running average.)

$$\text{New avg} = ((K-1)\text{Old avg} + \text{New data})/K$$

Assumes all values in decibel scale.

Key Path	Meas setup, Average Type
Example	AVER:TYPE LOG
Notes	See “ Average Type ” on page 753”
Couplings	See “ Auto ” on page 755”
Readback	Log-Pwr (Video)
Initial S/W Revision	Prior to A.02.00

Pwr Avg (RMS)

In this average type, all filtering and averaging processes work on the power (the square of the magnitude) of the signal, instead of its log or envelope voltage. This scale is best for measuring the true time average power of complex signals. This scale is sometimes called RMS because the resulting voltage is proportional to the square root of the mean of the square of the voltage.

In the equation for averaging on this scale (below), K is the number of averages accumulated. (In continuous sweep mode, once K has reached the Average/Hold Number, K stays at that value, providing a running average.)

$$\text{New avg} = 10 \log \left(\frac{1}{K} \left((K-1) \left(\frac{100 \text{Old avg}}{10} \right) + 10 \text{New data} / 10 \right) \right)$$

Equation assumes all values are in the decibel scale.

Key Path	Meas setup, Average Type
Example	AVER:TYPE RMS
Notes	See "Average Type" on page 753
Couplings	See "Auto" on page 755
Readback	Pwr (RMS)
Initial S/W Revision	Prior to A.02.00

Voltage Avg

In this Average type, all filtering and averaging processes work on the voltage of the envelope of the signal. This scale is good for observing rise and fall behavior of AM or pulse-modulated signals such as radar and TDMA transmitters, but its response to noise-like signals is 1.049 dB lower than the average power of those noise signals. This is compensated for in the **Marker Noise** function.

In the equation for averaging on this scale (below), K is the number of averages accumulated. (In continuous sweep mode, once K has reached the Average/Hold Number, K stays at that value.)

$$\text{New avg} = 20 \log \left(\frac{1}{K} \left((K-1) \left(\frac{100 \text{Old avg}}{20} \right) + 10 \text{New data} / 20 \right) \right)$$

Equation assumes all values are in the decibel scale.

Key Path	Meas setup, Average Type
Example	AVER:TYPE SCAL
Notes	See "Average Type" on page 753
Couplings	See "Auto" on page 755
Readback	Pwr (RMS)
Initial S/W Revision	Prior to A.02.00

Limits

The limits key opens a menu of softkeys to control the limits for the current measurement. Limits arrays can be entered by the user, sent over SCPI, or loaded from a file.

Key Path	Meas Setup
Dependencies	This key will only appear if you have the proper option installed in your instrument.
Preset	Limits are turned off by a Preset, but the Limits arrays (data) are only reset (deleted) by Restore Mode Defaults. They survive shutdown and restarting of the analyzer application, which means they will survive a power cycle.
Initial S/W Revision	A.02.00

Select Limit

Specifies the selected limit. The term “selected limit” is used throughout this document to specify which limit will be affected by the functions.

Key Path	Meas Setup, Limits
Notes	The selected limit is remembered even when not in the Limit Menu.
Preset	Limit 1, not affected by Mode Preset, preset by Restore Mode Defaults.
State Saved	Saved in instrument state.
Initial S/W Revision	A.02.00

Limit

Selects whether the limit and margin are displayed. If Test Limits is on, this also determines whether the test trace (see ["Test Trace" on page 759](#)) will be tested against the limit. If **Limit On/Off** is **On**, the following occurs:

- The limit line is displayed, in the same color as the limited trace, but paler. Portions of traces which fail the limits will be displayed in red.
- The margin line is displayed if Margin is on and the Margin Value is non-zero (see ["Margin" on page 764](#)). The margin line is displayed in the same color as the limit line, but paler still and dashed. Portions of traces which pass the limits but fail the margin will be displayed in amber.
- The trace is tested for the purpose of the “Trace Pass/Fail” indication in the graticule if, in addition to **Limit On/Off** being **On**, the trace is displayed and **Test Limits (All Limits)** is on (see ["Test Limits" on page 769](#)). If the trace is not tested, no report of the trace passing or failing is seen on the graticule. Note that the SCPI queries of Limit Pass/Fail are independent of these conditions; the test is always performed when queried over SCPI.

The PASS/FAIL box in the corner of the Meas Bar is only displayed if there is at least one “Trace Pass/Fail” indication displayed in the graticule.

Note that the red and amber coloring of traces which fail the limits and/or margins only applies to traces whose X-axis corresponds to the current analyzer X-axis. Traces which are not updating (in View, for example) will not change color if the analyzer X-axis settings (e.g., start and stop frequency) do not match those of the trace, for example if they have been changed since the trace stopped updating. In this case, the Invalid Data indicator (*) will appear in the upper right hand corner.

When the limits are frequency limits but the trace is a zero-span trace, the limit trace is drawn at the limit amplitude of the center frequency. When the limits are time limits but the trace is a frequency domain trace, the limit trace is drawn according to the current time axis, with the left of the screen being 0 and the right being equal to sweep time.

Key Path	Meas Setup, Limits
Remote Command	:CALCulate:LLINe[1] 2 ... 6:DISPlay OFF ON 0 1 :CALCulate:LLINe[1] 2 ... 6:DISPlay?
Example	:CALC:LLIN2:DISP ON turns on the display for limit line 2.
Dependencies	This command will generate an "Option not available" error message unless you have the proper option installed in your instrument.
Couplings	Limit display ON selects the limit. Testing is done on all displayed limits if Test Limits (All Limits) is ON. Entering the limit menu from the GUI turns on the selected limit.
Preset	OFF
State Saved	Saved in instrument state.
Backwards Compatibility SCPI	:CALCulate:LLINe[1] 2:STATe OFF ON 0 1 In the past you had to send the DISP command as well as the STATe command in order to get a limit on and testing. Now, the DISP command is sufficient, but we accept the state command and map it to DISP
Initial S/W Revision	A.02.00

Properties

Accesses a menu which lets you set the properties of the selected limit.

Key Path	Meas Setup, Limits
Initial S/W Revision	A.02.00

Select Limit

Specifies the selected limit. The term "selected limit" is used throughout this document to specify which limit will be affected by the functions.

Key Path	Meas Setup, Limits, Properties
Notes	The selected limit is remembered even when not in the Limit Menu.
Preset	Limit 1, not affected by Mode Preset, preset by Restore Mode Defaults.
State Saved	Saved in instrument state.
Initial S/W Revision	A.02.00

Test Trace

Selects the trace you want the limit to test. A limit is applied to one and only one trace; each trace can have both an upper and a lower limit. When executing Limit Test, the limit is applied only to the specified trace.

A trace can have multiple limit lines simultaneously; in that case, only one upper and one lower limit line will affect the color of the trace. Other limit lines will be displayed, and will affect the pass/fail status, but the trace will not turn red if it crosses a secondary limit line.

Key Path	Meas Setup, Limits, Properties
Remote Command	:CALCulate:LLINe[1] 2 ... 6:TRACe 1 2 3 4 5 6 :CALCulate:LLINe[1] 2 ... 6:TRACe?
Example	:CALC:LLIN3:TRAC 2 applies limit 3 to trace 2.
Notes	When the trace display is off, the trace is not tested. The trace is tested only when the trace display is on and Test Limits (see "Test Limits" on page 769) is on.
Couplings	This matters when testing a trace or limit line for failure, via :CALC:LLIN3:FAIL? or :CALC:TRAC2:FAIL?
Preset	Limits 1 and 2 preset to 1, Limits 3 and 4 preset to 2, Limits 5 and 6 preset to 3 Not affected by Mode Preset, preset by Restore Mode Defaults.
State Saved	Saved in instrument state.
Min	1
Max	6
Readback	Trace 1 2 3 4 5 6
Initial S/W Revision	A.02.00

Type

Selects whether the limit you are editing is an upper or lower limit. An upper limit fails if the trace exceeds the limit. A lower limit fails if the trace falls below the limit.

Key Path	Meas Setup, Limits, Properties
Remote Command	:CALCulate:LLINe[1] 2 ... 6:TYPE UPPer LOWer :CALCulate:LLINe[1] 2 ... 6:TYPE?
Example	:CALC:LLIN2:TYPE LOW sets limit line 2 to act as a lower limit.
Couplings	If a margin has already been set for this limit line, and this key is used to change the limit type, then the margin value will reverse sign.
Preset	Upper for Line 1, 3, and 5; Lower for Line 2, 4, 6. Not affected by Mode Preset, preset by Restore Mode Defaults.
State Saved	Saved in instrument state.
Initial S/W Revision	A.02.00

Interpolation

Accesses a menu which lets you set the frequency and amplitude interpolation of the selected limit.

Key Path	Meas Setup, Limits, Properties
Readback	[Lin Log Frequency, Lin Log Amplitude]
Initial S/W Revision	A.02.00

Frequency Interpolation

This key is grayed out if Time is the selected X Axis Units. Sets the interpolation between frequency points, allowing you to determine how limit trace values are computed between points in a limit table. The available interpolation modes are linear and logarithmic. If frequency interpolation is logarithmic (Log), frequency values between limit points are computed by first taking the logarithm of both the table values and the intermediate value. A linear interpolation is then performed in this logarithmic frequency space. An exactly analogous manipulation is done for logarithmic amplitude interpolation.

Note that the native representation of amplitude is in dB.

For linear amplitude interpolation and linear frequency interpolation, the interpolation is computed as:

$$y = 20 \log\left(\frac{10^{\frac{y_{i+1}}{20}} - 10^{\frac{y_i}{20}}}{f_{i+1} - f_i} (f - f_i) + 10^{\frac{y_i}{20}}\right)$$

For linear amplitude interpolation and log frequency interpolation, the interpolation is computed as:

$$y = 20 \log\left(\frac{10^{\frac{y_{i+1}}{20}} - 10^{\frac{y_i}{20}}}{\log f_{i+1} - \log f_i} (\log f - \log f_i) + 10^{\frac{y_i}{20}}\right)$$

For log amplitude interpolation and linear frequency interpolation, the interpolation is computed as:

$$y = \frac{y_{i+1} - y_i}{f_{i+1} - f_i} (f - f_i) + y_i$$

For log amplitude interpolation and log frequency interpolation, the interpolation is computed as:

$$y = \frac{y_{i+1} - y_i}{\log f_{i+1} - \log f_i} (\log f - \log f_i) + y_i$$

NOTE

Interpolation modes determine how limit values are computed between points in the limit table. The appearance of a limit trace is also affected by the amplitude scale, which may be linear or logarithmic.

Key Path	Meas Setup, Limits, Properties, Interpolation
Remote Command	:CALCulate:LLINE[1] 2 ... 6:CONTROL:INTERpolate:TYPE LOGarithmic LINear :CALCulate:LLINE[1] 2 ... 6:CONTROL:INTERpolate:TYPE?
Example	:CALC:LLIN:CONT:INT:TYPE LIN sets limit line 1 frequency interpolation to linear.
Preset	Linear, not affected by Mode Preset, preset by Restore Mode Defaults.
State Saved	Saved in instrument state.
Initial S/W Revision	A.02.00

Amplitude Interpolation

Sets the interpolation to linear or logarithmic for the specified limiting points set, allowing you to determine how limit trace values are computed between points in a limit table. See Frequency Interpolation for the equations used to calculate limit values between points.

Key Path	Meas Setup, Limits, Properties, Interpolation
Remote Command	:CALCulate:LLINE[1] 2 ... 6:AMPLitude:INTERpolate:TYPE LOGarithmic LINear :CALCulate:LLINE[1] 2 ... 6:AMPLitude:INTERpolate:TYPE?
Example	:CALC:LLIN:AMPL:INT:TYPE LIN sets limit line 1 amplitude interpolation to linear.
Preset	Logarithmic, not affected by Mode Preset, preset by Restore Mode Defaults.
State Saved	Saved in instrument state.
Initial S/W Revision	A.02.00

Fixed / Relative

Opens a menu which will allow you to specify that the selected limit is relative to either Center Frequency or Reference level.

Key Path	Meas Setup, Limits, Properties
Readback	Fixed Rel to CF Rel to RL Rel to CF + RL (square brackets)
Backwards Compatibility Notes	You can now set relative amplitude and relative frequency independently for each limit line. :CALC:LLIN:CMOD REL makes all limit lines relative to the center frequency and reference level. :CALC:LLIN:CMOD? returns 1 if Limit Line 1 is set Relative to CF, and returns 0 otherwise.
Initial S/W Revision	A.02.00

Relative to CF

Chooses whether the limit line frequency points are coupled to the instrument center frequency, and whether the frequency points are expressed as an offset from the instrument center frequency. If the limit lines are specified with time, this has no effect. The limit table must in this case support negative frequencies.

For example, assume you have a frequency limit line, and the analyzer center frequency is at 1 GHz. If Relative to CF is “Off”, entering a limit line segment with a

frequency coordinate of 300 MHz displays the limit line segment at 300 MHz, and the limit line segment will not change frequency if the center frequency changes. If Relative to CF is “On”, entering a limit line segment with a frequency coordinate of 300 MHz displays the limit line segment at CF + 300 MHz, or 1.3 GHz. Furthermore, if the center frequency changes to 2 GHz, the limit line segment will be displayed at CF + 300 MHz, or 2.3 GHz.

It is possible to change this setting after a limit line has been entered. When changing from On to Off or vice-versa, the frequency values in the limit line table change so that the limit line remains in the same position for the current frequency settings of the analyzer.

Pressing this button makes Center Frequency the active function.

Key Path	Meas Setup, Limits, Properties, Fixed/Relative
Remote Command	:CALCulate:LLINe[1] 2 ... 6:FREQuency:CMODE:RELative ON OFF 1 0 :CALCulate:LLINe[1] 2 ... 6:FREQuency:CMODE:RELative?
Example	:CALC:LLIN:FREQ:CMOD:REL ON makes limit line 1 relative to the center frequency.
Notes	If the Trace Domain is changed to Time (:CALCulate:LLINe:CONTRol:DOMain TIME), the command : :CALCulate:LLINe[1] 2 3 4 5 6:FREQuency:CMODE:RELative ON OFF 1 0 will have no effect.
Couplings	Pressing this button makes Center Frequency the active function.
Preset	Off, not affected by Mode Preset, preset by Restore Mode Defaults.
State Saved	Saved in instrument state.
Initial S/W Revision	A.02.00

Relative to RL

Chooses whether the limit line amplitude points are coupled to the instrument reference level, and whether the amplitude points are expressed as an offset from the instrument reference level.

For example, assume you have a limit line, and the reference level at -10 dBm. If Relative to RL is “Off”, entering a limit line segment with an amplitude coordinate of -20 dB displays the limit line segment at -20 dBm, and the limit line segment will not change amplitude if the reference level amplitude changes. If Relative to RL is “On”, entering a limit line segment with an amplitude coordinate of -20 dB displays the limit line segment at RL - 20 dB, or -30 dBm. Furthermore, if the reference level amplitude changes to -30 dBm, the limit line segment will be displayed at RL - 20 dB, or -50 dBm.

It is possible to change this setting after a limit line has been entered. When changing from On to Off or vice-versa, the amplitude values in the limit line table change so that the limit line remains in the same position for the current reference level settings of the analyzer.

Key Path	Meas Setup, Limits, Properties, Fixed/Relative
Remote Command	:CALCulate:LLINe[1] 2 ... 6:AMPLitude:CMODE:RELative ON OFF 1 0

	:CALCulate:LLINE[1] 2 ... 6:AMPLitude:CMODE:RELative?
Example	:CALC:LLIN:AMPL:CMOD:REL ON makes limit line 1 relative to the reference level amplitude.
Couplings	Pressing this button makes Reference level the active function.
Preset	Off, not affected by Mode Preset, preset by Restore Mode Defaults.
State Saved	Saved in instrument state.
Initial S/W Revision	A.02.00

Description

Provides a description of up to 60 characters by which the operator can easily identify the limit. Will be stored in the exported file. Can be displayed in the active function area by selecting as the active function, if desired to be in a screen dump.

Key Path	Meas Setup, Limits, Properties
Remote Command	:CALCulate:LLINE[1] 2 ... 6:DESCription "Description" :CALCulate:LLINE[1] 2 ... 6:DESCription?
Example	:CALC:LLIN:DESC "European Emissions"
Dependencies	60 characters max
Preset	"" (null String), not affected by Mode Preset, preset by Restore Mode Defaults.
State Saved	Saved in instrument state.
Readback	As much of the description will fit on one line of the key, followed by "..." if some of the description will not fit on one line of the key.
Initial S/W Revision	A.02.00

Comment

Sets an ASCII comment field, which will be stored in an exported file. Can be displayed in the active function area by selecting as the active function, if desired to be in a screen capture. The Limits .csv file supports this field.

Key Path	Meas Setup, Limits, Properties
Remote Command	:CALCulate:LLINE[1] 2 ... 6:COMMeNT "text" :CALCulate:LLINE[1] 2 ... 6:COMMeNT?
Example	:CALC:LLIN1:COMM "this is a comment"
Dependencies	60 characters max
Preset	"" (null String), not affected by Mode Preset, preset by Restore Mode Defaults.
State Saved	Saved in instrument state.
Readback	As much of the description will fit on one line of the key, followed by "..." if some of the description will not fit on one line of the key.
Initial S/W Revision	A.02.00

Margin

Selects a margin for this limit, which will cause a trace to Fail Margin when the trace is between the limit line and the margin line. Portions of the traces which pass the limit but fail the margin will be displayed in an amber color.

A margin is always specified in dB relative to a limit – an upper limit will always have a negative margin, and a lower limit will always have a positive margin. If a value is entered with the incorrect sign, the system will automatically take the negative of the entered value.

If the limit type is switched from lower to upper while margin is present, the margin will reverse sign.

When the Margin is selected, it may be turned off by pressing the Margin key until Off is underlined. This may also be done by performing a preset. Margin is the default active function whenever the margin is on, and it is not the active function whenever the margin is off.

The margin lines are displayed in the same color as limit lines, but paler. . If the limited trace is blanked then the limit line and the margin line will be blanked as well.

Key Path	Meas Setup, Limits
Remote Command	:CALCulate:LLINE[1] 2 ... 6:MARGin <rel_amp1> :CALCulate:LLINE[1] 2 ... 6:MARGin? :CALCulate:LLINE[1] 2 ... 6:MARGin:STATe OFF ON 0 1 :CALCulate:LLINE[1] 2 ... 6:MARGin:STATe?
Example	:CALC:LLIN1:MARG -2dB sets limit line 1's margin to -2 dB (Limit Line 1 is by default an upper limit). :CALC:LLIN2:MARG 1dB sets limit line 2's margin to 1 dB (Limit Line 2 is by default a lower limit). :CALC:LLIN2:MARG:STAT OFF Iturns off the margin for limit line 2 and removes any tests associated with that margin line.
Notes	The queries "Limit Line Fail?" (:CALCulate:LLINE[1] 2 3 4 5 6:FAIL?) and "Trace Fail?" (:CALCulate:TRACe[1] 2 3 4 5 6:FAIL?) will return 1 if the margin fails.
Couplings	This will affect :CALC:LLIN3:FAIL or :CALC:TRAC2:FAIL?
Preset	Not affected by Mode Preset, set to 0 dB for all Limits by Restore Mode Defaults.
State Saved	Saved in instrument state.
Min	-40 dB (Upper); 0 dB (Lower)
Max	0 dB (Upper); 40 dB (Lower);
Default Unit	dB
Initial S/W Revision	A.02.00

Edit

Opens the Table Editor for the selected limit line.

When entering the menu, the editor window (with the limit table) turns on, the selected Limit is turned **On** and the amplitude scale is set to **Log**. The display of the

trace to which the selected limit applies is turned on (thus, traces in Blank are set to View and traces in Background are set to On). Turning on the Limit means it's display will be on, and it's testing mode will be on as well. You should turn off any other limits that are on if they interfere with the editing of the selected limit.

NOTE

The table editor will only operate properly if the analyzer is sweeping, because its updates are tied to the sweep system. Thus, you should not try to use the editor in single sweep, and it will be sluggish during compute-intensive operations like narrow-span FFT sweeps.

When exiting the edit menu (by using the Return key or by pressing an instrument front panel key), the editor window turns off, however the Limit is still on and displayed, and the amplitude scale remains **Log**.

Limits are turned off by a Preset, but the Limits arrays (data) are only reset (deleted) by Restore Mode Defaults. They survive shutdown and restarting of the analyzer application, which means they will survive a power cycle.

Key Path	Meas Setup, Limits
Couplings	A remote user can enter or access limit line data via :CALCulate:LLINe[1]]2]3]4]5]6:DATA
Initial S/W Revision	A.02.00

Navigate

Lets you move through the table to edit the desired point

Key Path	Meas Setup, Limits, Edit
Notes	There is no value readback on the key
Min	1
Max	2000
Initial S/W Revision	A.02.00

Frequency

Lets you edit the frequency of the current row.

Key Path	Meas Setup, Limits, Edit
Notes	There is no value readback on the key
Min	0
Max	1 THz
Initial S/W Revision	A.02.00

Amplitude

Lets you edit the Amplitude of the current row.

Key Path	Meas Setup, Limits, Edit
Notes	There is no value readback on the key
Min	-1000 dBm
Max	1000 dBm
Initial S/W Revision	A.02.00

Insert Point Below

Pressing this key inserts a point below the current point. The new point is a copy of the current point. And becomes the current point The new point is not yet entered into the underlying table, and the data in the row is displayed in light gray.

Key Path	Meas Setup, Limits, Edit
Initial S/W Revision	A.02.00

Delete Point

This is an immediate action key. It will immediately delete the currently-selected point, whether or not that point is being edited, and select Navigate. The point following the currently-selected point (or the point preceding if there is none) will be selected.

Key Path	Meas Setup, Limits, Edit
Initial S/W Revision	A.02.00

Copy from Limit

Copies an existing limit into the current limit, including all secondary parameters (Description, Associated Trace, Type, Margin, Interpolation, Relative to CF/RL).

Key Path	Meas Setup, Limits, Edit
Remote Command	:CALCulate:LLINE[1] 2 ... 6:COPY LLINE1 LLINE2 LLINE3 LLINE4 LLINE5 LLINE6
Example	:CALC:LLINE2:COPY LLINE1 copies the data from line 1 into line 2.
Notes	Auto return to the Edit menu.
Initial S/W Revision	A.02.00

Build from Trace

Builds a limit using an existing trace. This command will overwrite all data in the limit. Since a straight copy would typically have hundreds or thousands of segments, the data will be approximated to better represent a limit line; small excursions whose width is less than 10 trace buckets will sometimes not be captured. Secondary parameters which are not associated with traces (Description, Associated Trace, Type, Margin, Interpolation, Relative to CF/RL) will be unchanged.

When taking a trace in order to build a limit, it will often work well to take the trace with a resolution bandwidth wider than the expected measurement, a video

bandwidth lower than the expected measurement, and with the detector set to Max Hold or Min Hold.

Note that an upper limit will be built above the trace, while a lower limit will be built below the trace. If the trace is constant, the limit should pass after being built.

Key Path	Meas Setup, Limits, Edit
Remote Command	:CALCulate:LLINe[1] 2 ... 6:BUILd TRACE1 TRACE2 TRACE3 TRACE4 TRACE5 TRACE6
Example	:CALC:LLIN2:BUIL TRACE1 builds limit line 2 based on the data in trace 1. This will overwrite the data in the table editor.
Notes	Auto return to Edit menu.
Initial S/W Revision	A.02.00

Offset

Enters a menu which allows you to offset the limit trace by a specified frequency, time, or amplitude. The offsets will be immediately applied to the limit trace for display and failure calculation; the offset can also be applied to the points in the limit line.

Key Path	Meas Setup, Limits, Edit
Initial S/W Revision	A.02.00

X Offset

Offsets the limit trace by some specified frequency (for Frequency-based limit lines) or a time (for time-based limit lines).

Key Path	Meas Setup, Limits, Edit, Offset
Remote Command	:CALCulate:LLINe[1] 2 ... 6:OFFSet:X <value> :CALCulate:LLINe[1] 2 ... 6:OFFSet:X? <value> = <freq> if Limit X-Axis Unit is Frequency, <value> = <time> if Limit X-Axis Unit is Time
Example	:CALC:LLIN:OFFS:X -50MHZ sets the X axis offset to -50 MHz. :CALC:LLIN:OFFS:UPD will apply the X axis offset to all points in the limit line, then reset the X axis offset to zero.
Preset	0 Hz if Limit X-Axis Unit is Frequency 0 S if Limit X-Axis Unit is Time
State Saved	Saved in instrument state, survives Preset
Min	-500 GHz
Max	500 GHz
Default Unit	Determined by X axis scale.
Initial S/W Revision	A.02.00

Y Offset

Offsets all segments in the limit line by some specified amplitude.

Key Path	Meas Setup, Limits, Edit, Offset
Remote Command	:CALCulate:LLINE[1] 2 ... 6:OFFSet:Y <rel amp1> :CALCulate:LLINE[1] 2 ... 6:OFFSet:Y?
Example	:CALC:LLIN:OFFS:Y -3 dB sets the Y axis offset to -3 dB. :CALC:LLIN:OFFSet:UPD will apply the Y axis offset to all points in the limit line, then reset the Y axis offset to zero.
Preset	0 dB
State Saved	Saved in instrument state.
Min	-Infinity
Max	+Infinity
Default Unit	dB
Initial S/W Revision	A.02.00

Apply Offsets to Limit Table

Adds the X and Y offsets to each point in the limit table, then resets the X and Y offset values to zero. This has no effect on the position of the limit trace.

For example, if the X offset is -10 MHz and the Y offset is 1 dB, the values in the limit table will be updated as follows: 10 MHz will be subtracted from each X value, 1 dB will be added to each Y value. The offset values will then be reset to zero. The limit trace will not be moved and the limit table will be updated to accurately reflect the currently-displayed limit trace.

Key Path	Meas Setup, Limits, Edit, Offset
Remote Command	:CALCulate:LLINE[1] 2 ... 6:OFFSet:UPDate
Example	:CALC:LLIN:OFFS:UPD sets updates the limit table to reflect the X and Y offsets, then resets the offsets to zero.
State Saved	No state
Initial S/W Revision	A.02.00

Scale X Axis

Matches the X Axis to the selected Limit, as well as possible.

For frequency limits and a frequency-domain X-axis, sets the Start and Stop Frequency to contain the minimum and maximum Frequency of the selected Limit. The range between Start Frequency and Stop Frequency is 12.5% above the range between the minimum and maximum Frequency so that span exceeds this range by one graticule division on either side.

For time limits and a time-domain X-axis, sets the sweep time to match the maximum Time of the selected Limit.

If the domain of the selected limit does not match the domain of the X Axis, no action is taken. Standard clipping rules apply, if the value in the table is outside the allowable range for the X axis.

Key Path	Meas Setup, Limits, Edit
Dependencies	If either the first or last point in the array is outside the frequency range of the current input, an error message is generated: “-221. Settings conflict; Start or Stop Freq out of range for current input settings”
Initial S/W Revision	A.02.00

Delete Limit

Deletes the currently selected limit line. Pressing Delete Limit purges the data from the limit line tables.

Limit data – including secondary parameters such as description, margin value, etc. – will be cleared and returned to factory preset settings.

When this key is pressed a prompt is placed on the screen that says “Please press Enter or OK key to delete limit. Press ESC or Cancel to close this dialog.” The deletion is only performed if you press OK or Enter; if so, after the deletion, the informational message “Limit deleted” appears in the MSG line.

Key Path	Meas Setup, Limits
Remote Command	:CALCulate:LLINe[1] 2 ... 6:DELeTe
Example	:CALC:LLIN2:DEL deletes all data for limit line 2.
Initial S/W Revision	A.02.00

Test Limits

Selects whether displayed traces are tested against displayed limits (i.e. those for which Limit On/Off is set to On).

For each displayed trace for which a Limit is turned on, a message will be displayed in the upper-left corner of the graticule to notify whether the trace passes or fails the limits.

If the trace is at or within the bounds of all applicable limits and margins, the text “Trace x Pass” will be displayed in green, where x is the trace number. A separate line is used for each reported trace.

If the trace is at or within the bounds of all applicable limits, but outside the bounds of some applicable margin, the text “Trace x Fail Margin” will be displayed in amber, where x is the trace number. A separate line is used for each reported trace.

If the trace is outside the bounds of some applicable limits, the text “Trace x Fail” will be displayed in red, where x is the trace number. A separate line is used for each reported trace.

If the trace has no enabled limits, or the trace itself is not displayed, no message is displayed for that trace.

The PASS/FAIL box in the corner of the Meas Bar is only displayed if there is at least one “Trace Pass/Fail” indication displayed in the graticule.

If two amplitude values are entered for the same frequency, a single vertical line is the result. In this case, if an upper line is chosen, the lesser amplitude is tested. If a lower line is chosen, the greater amplitude is tested.

This command only affects the display, and has no impact on remote behavior. Limit queries over SCPI test the trace against the limit regardless of whether the trace or the limit is turned on (exception: the query :CALCulate:TRACe[1]|2|3|4|5|6:FAIL? tests only the limits that are turned on for that trace).

Key Path	Meas Setup, Limits
Remote Command	:CALCulate:LLINe:TEST OFF ON 0 1 :CALCulate:LLINe:TEST?
Example	:CALC:LLIN:TEST ON turns on testing, and displays the results in the upper left corner.
Preset	On, not affected by Mode Preset, preset by Restore Mode Defaults.
State Saved	Saved in instrument state.
Initial S/W Revision	A.02.00

X-Axis Unit

Selects how the limit-line segments are defined. Pressing X Axis Unit selects whether the limit lines will be entered using frequency (Freq) or sweep time (Time) to define the segments. They can be specified as a table of limit-line segments of amplitude versus frequency, or of amplitude versus time.. When the X-Axis Unit is set to Time, a time value of zero corresponds to the start of the sweep, which is at the left edge of the graticule, and the column and softkey in the Limit Table Editor will read Time instead of Frequency

Switching the limit-line definition between Freq and Time will erase all of the current limit lines. When you do this from the front panel, a warning dialog will pop up letting you know that you are about to erase all the limit lines, and prompting you to hit "OK" if you are sure:

Changing the X Axis Unit will erase all your limit lines. Are you sure you want to do this? Press **Enter** or **OK** to proceed, or **Cancel(Esc)** to cancel.

Key Path	Meas Setup, Limits
Remote Command	:CALCulate:LLINe:CONTRol:DOMain FREQuency TIME :CALCulate:LLINe:CONTRol:DOMain?
Example	:CALC:LLIN:CONT:DOM FREQ deletes all currently existing limit lines, then sets all limit lines to be specified in terms of frequency.
Couplings	This affects all limit lines simultaneously, and resets all limit line data except the .wav file and email address stored in the Actions.
Preset	Freq, not affected by Mode Preset, preset by Restore Mode Defaults.
State Saved	Saved in instrument state.
Initial S/W Revision	A.02.00

Delete All Limits

Deletes all limit lines. Pressing Delete All Limits purges the data from all limit line tables.

All limit data will be cleared and returned to factory preset settings.

When this key is pressed a prompt is placed on the screen that says "Please press Enter or OK key to delete all limits. Press ESC or Cancel to close this dialog." The deletion is only performed if you press OK or Enter; if so, after the deletion, the informational message "All Limits deleted" appears in the MSG line.

Key Path	Meas Setup, Limits
Remote Command	:CALCulate:LLINe:ALL:DElete
Example	:CALC:LLIN:ALL:DEL deletes all data for all limit lines.
Initial S/W Revision	A.02.00

Limit Line Data (Remote Command Only)

Defines the limit line values, and destroys all existing data. Up to 200 points may be defined for each limit using the following parameters.

<x>Frequency or time values as specified by :Calculate:LLINe:CONTRol:DOMain. Units are not sent in the command but are taken to be fundamental units (Hz or seconds).

Range: -30 Gs to +30 Gs for time limits, -3 kHz to +350 GHz for frequency limits.

<ampl>Amplitude units are not sent in the command but are taken to be the current Y Axis Unit. Up to two amplitude values can be provided for each x-axis value, by repeating <x-axis> in the data list.

Range: -1000 dBm to +1000 dBm

<connect> connect values are either "0" or "1." A "1" means this point will be connected to the previously defined point to define the limit line. A "0" means that it is a point of discontinuity and is not connected to the preceding point. The connect value is ignored for the first point.

Remote Command	:CALCulate:LLINe[1] 2 ... 6:DATA <x>,<ampl>,<connect> {,<x>,<ampl>,<connect>} :CALCulate:LLINe[1] 2 ... 6:DATA?
Example	:CALC:LLIN3:DATA 1E9,-20,0,2E9,-20,1,2E9,-10,1,3E9,-10,1 describes a stair-stepped limit line.
Preset	Limit line data is cleared by Restore Mode Defaults. However, it survives shutdown/restart of the analyzer application (including power cycle)
State Saved	Saved in instrument state
Backwards Compatibility Notes	In the past it was possible to query the limit trace as though it were a normal trace. The query of the limit trace is not supported in the X-series.

Initial S/W Revision A.02.00

Merge Limit Line Data (Remote Command Only)

Adds the points with the specified values to the current limit line, allowing you to merge limit line data. Up to two amplitude values are allowed for each X value. If more than 200 points are entered to be merged, the first 200 points are merged, then an error message 'too many DATA entries' is reported.

<x>Frequency or time values as specified by :CALCulate:LLINe:CONTRol:DOMain. Units are not sent in the command but are taken to be fundamental units (Hz or seconds).

Range: -30 Gs to +30 Gs for time limits, -3 kHz to +350 GHz for frequency limits.

<ampl>Amplitude units are not sent in the command but are taken to be the current Y Axis Unit. Up to two amplitude values can be provided for each x-axis value, by repeating <x-axis> in the data list.

Range: -1000 dBm to +1000 dBm

<connect> connect values are either "0" or "1." A "1" means this point will be connected to the previously defined point to define the limit line. A "0" means that it is a point of discontinuity and is not connected to the preceding point. The connect value is ignored for the first point.

Remote Command	<code>:CALCulate:LLINe[1] 2 ... 6:DATA:MERGe <x-axis>,<ampl>,<connect> {,<x-axis>,<ampl>,<connect>}</code>
-----------------------	--

Example	<code>:CALC:LLIN1:DATA:MERG 1000000000, -20, 0, 2000000000, -30, 1</code> merges the 10GHz segment and the 20GHz segment into limit line 1. Note that the 20GHz segment will be connected to the next lower point, which may or may not be the 10GHz point.
----------------	--

Notes	This SCPI command is supported for Backwards Compatibility. Although PSA had a limit of 200 points, it is acceptable to increase that limit.
-------	---

Preset	Fixed
--------	-------

Initial S/W Revision	A.02.00
----------------------	---------

Limit Line Fail? (Remote Command Only)

Tests a limit line against its associated trace. Returns a 0 if the trace is within the limit and margin, a 1 if the trace exceeds either the limit or the margin.

Note that this command only tests one limit line – other limit lines are not tested when executing this command. To see whether a trace passed all limits, use :CALCulate:TRACe:FAIL?.

Note this command performs the test regardless of whether the trace or the limit is turned on the display.

Remote Command	<code>:CALCulate:LLINe[1] 2 ... 6:FAIL?</code>
-----------------------	--

Example	<code>:CALC:LLIN:FAIL?</code> returns a zero if limit line 1's associated trace has no failure, 1 if there is a margin or limit failure.
----------------	---

Initial S/W Revision A.02.00

Limit Line Control (Remote Command Only, SCPI standard conformance)

Defines a list of limit line control (frequency or time) values for a given limit line. Up to 2000 points may be defined for each limit using the following parameters.

<x>Frequency or time values as specified by :CALCulate:LLINE:CONTROL:DOMAIN. Units default to Hz (for frequency) and seconds (for time).

Range: -30 Gs to +30 Gs for time limits, -3 kHz to +1200 GHz for frequency limits.

Note that X values may be repeated if a vertical step in the limit line is desired.

The points query returns the number of points in the control. It should match the number of points in the amplitude, that is, the number of values for the CONTROL axis and for the corresponding UPPER and/or LOWER limit lines must be identical. If one array is larger than the other, the limit trace is built using only as much data as is contained in the smaller array.

An empty array returns not a number (9.91e+37 to a data query), 0 to a POINTs query.

Remote Command	:CALCulate:LIMit[1] 2 ... 6:CONTROL[:DATA] <x>, <x>, ... :CALCulate:LIMit[1] 2 ... 6:CONTROL[:DATA]?
Example	:CALC:LIM:CONT 1GHz,2GHz,2GHz,3GHz describes the X values of a stair-stepped limit line.
Preset	Limit line data is cleared by Restore Mode Defaults.
State Saved	Saved in instrument state
Initial S/W Revision	A.02.00

Remote Command	:CALCulate:LIMit[1] 2 ... 6:CONTROL:POINTs?
Example	:CALC:LIM:CONT:POIN? returns the number of points in the limit line.
Preset	Limit line data is cleared by Restore Mode Defaults.
State Saved	Saved in instrument state.
Initial S/W Revision	A.02.00

Limit Line Upper / Lower (Remote Command Only, SCPI standard conformance)

Defines a list of amplitude values for a given limit line. Changing the number of elements in the list spectrum will automatically turn the limit line off. Using the "UPP" syntax defines an upper limit line, using the "LOW" syntax defines a lower limit line. Note that a line may not be simultaneously both upper and lower; the type of

the limit line will automatically be changed as appropriate. Up to 200 points may be defined for each limit using the following parameters.

<ampl>Amplitude units are not sent in the command but are taken to be the current Y Axis Unit.

Range: -200 dBm to +100 dBm

The points query returns the number of points in the amplitude list. It should match the number of points in the control, that is, the number of values for the CONTROL axis and for the corresponding UPPER and/or LOWER limit lines must be identical. If one array is larger than the other, the limit trace is built using only as much data as is contained in the smaller array.

An empty array returns the system error message “list is empty” to a data query, 0 to a POINTs query.

Remote Command	:CALCulate:LIMit[1] 2 ... 6:UPPer[:DATA] <ampl>, <ampl>, ... :CALCulate:LIMit[1] 2 ... 6:UPPer[:DATA]?
Example	:CALC:LIM:UPP -10, -10, -20, -20 describes the amplitude values of an upper limit line
Preset	Limit line data is cleared by Restore Mode Defaults.
State Saved	Saved in instrument state
Initial S/W Revision	A.02.00

Remote Command	:CALCulate:LIMit[1] 2 ... 6:UPPer:POINTs?
Example	:CALC:LIM:UPP:POIN? returns the number of points in the upper limit line.
Preset	Upper Limit line data/points is cleared by Restore Mode Defaults.
State Saved	Saved in instrument state
Initial S/W Revision	A.02.00

Remote Command	:CALCulate:LIMit[1] 2 ... 6:LOWer[:DATA] <ampl>, ... :CALCulate:LIMit[1] 2 ... 6:LOWer[:DATA]?
Example	:CALC:LIM:LOW -10, -10, -20, -20 describes the amplitude values of an lower limit line
Preset	Limit line data is cleared by Restore Mode Defaults.
State Saved	Saved in instrument state
Initial S/W Revision	A.02.00

Remote Command	:CALCulate:LIMit[1] 2 ... 6:LOWer:POINTs?
Example	:CALC:LIM:UPP:POIN?

	returns the number of points in the lower limit line.
Preset	Limit line data/points is cleared by Restore Mode Defaults.
State Saved	Saved in instrument state
Initial S/W Revision	A.02.00

Limit Fail? (Remote Command Only, SCPI standard conformance)

Tests a limit line against its associated trace. Returns a 0 if the trace is within the limit and margin, a 1 if the trace exceeds either the limit or the margin. This command is identical to “:CALC:LLIN:FAIL?”

Note that this command only tests one limit line – other limit lines are not tested when executing this command. To see whether a trace passed all limits, use :CALCulate:TRACe:FAIL?.

Note this command performs the test regardless of whether the trace or the limit is turned on the display.

Remote Command	:CALCulate:LIMit[1] 2 ... 6:FAIL?
Example	:CALC:LIM:FAIL? returns a zero if limit line 1's associated trace has no failure, 1 if there is a margin or limit failure.
Couplings	This command is identical to :CALC:LLIN:FAIL?
Initial S/W Revision	A.02.00

Limit Clear (Remote Command Only, SCPI standard conformance)

Clears a limit line, and all associated data. This command is identical to “:CALC:LLIN:DEL”

Remote Command	:CALCulate:LIMit[1] 2 ... 6:CLEar
Example	:CALC:LIM2:CLE deletes all data for limit line 2.
Couplings	This command is identical to :CALC:LLIN:DEL
Initial S/W Revision	A.02.00

Trace Fail? (Remote Command Only)

Tests a trace against all associated limit lines. Returns a 0 if the trace is within all limits and margins, a 1 if the trace exceed either the limit or the margin. If no limits apply to the selected trace, this will automatically return a 0.

Only applies to limits that are turned on, if a Limit is off it will not be tested. If a Trace is not displaying it will still be tested, and if **Test Limits (All Limits)** is off the Trace will still be tested.

This command ignores limit lines that are assigned to other traces.

Remote Command	:CALCulate:TRACe[1] 2 ... 6:FAIL?
Example	:CALC:TRAC3:FAIL? returns a zero if there is no failure, 1 if the trace exceeds either the limit or the margin.
Initial S/W Revision	A.02.00

Fixed / Relative Limit (Remote Command Only)

This command sets both Relative to CF and Relative to RL simultaneously for all limits. If queried, it returns whether Limit Line 1 is set Relative to CF, and ignores all other fixed/relative data.

Remote Command	:CALCulate:LLINe:CMODe FIXed RELative :CALCulate:LLINe:CMODe?
Example	:CALC:LLIN:CMOD REL makes all limit lines relative to the center frequency and reference level.
Notes	This SCPI command is supported for Backwards Compatibility. PSA offers only the following softkey, which is generic to all limit lines: Limits Fixed / Rel. On the X-Series, this functionality is provided by a softkey which is specific to each limit line, and which provides a sub-menu with 2 softkeys (Relative to CF / Relative to RL). In order to be consistent with the implementation of the following new commands: :CALCulate:LLINe[1] 2 3 4 5 6:FREQuency:CMODe:RELative ON OFF 1 0 :CALCulate:LLINe[1] 2 3 4 5 6:FREQuency:CMODe:RELative? and :CALCulate:LLINe[1] 2 3 4 5 6:AMPLitude:CMODe:RELative ON OFF 1 0 :CALCulate:LLINe[1] 2 3 4 5 6:AMPLitude:CMODe:RELative? The :CALCulate:LLINe:CMODe? Query will returns 1 if Limit Line 1 is set Relative to CF, and returns 0 otherwise.
Preset	Fixed
Initial S/W Revision	A.02.00

N dB Points

Turns N dB points on and off and allows you to set the N dB value. N dB uses the selected marker. If the selected marker is not on when N dB is turned on, the selected marker turns on, as a Normal marker, at center screen, and is used by N dB.

See ["N dB Points Results Queries" on page 777](#).

See ["More Information" on page 778](#).

Key Path	Meas Setup
Remote Command	:CALCulate:BWIDth BANDwidth:NDB <rel_amp1> :CALCulate:BWIDth BANDwidth:NDB? :CALCulate:BWIDth BANDwidth[:STATe] OFF ON 0 1 :CALCulate:BWIDth BANDwidth[:STATe]?

Notes	If the selected marker is turned Off it turns off N dB Points. N DB Points is unaffected by Auto Couple
Preset	Off, -3.01 dB OFF
Preset	Off, -3.01 dB OFF
State Saved	The on/off status and the offset value are both saved in instrument state.
Min	-140 dB
Max	-0.01 dB
Backwards Compatibility Notes	In ESA, N dB points paid attention to the peak excursion and peak threshold set in the Search Criteria menu under Peak Search. This is not the case in the X-Series. In ESA, an invalid N dB reading was indicated, both onscreen and remotely, with a value of -100. In the X-Series it is indicated on screen by --- but remotely still by -100 Hz
Initial S/W Revision	Prior to A.02.00

N dB Points Results Queries

You can query the width of the N dB band as well as the right and left edges of the band. For example, for the signal shown below, the marker is at 100 MHz and each graticule division represents 200 kHz. The N dB value is -14.7 dB and this makes the width of the NdB band 400 kHz. The frequencies at the left and right edge of the N dB band are as shown, 99.8 MHz and 100.2 MHz:

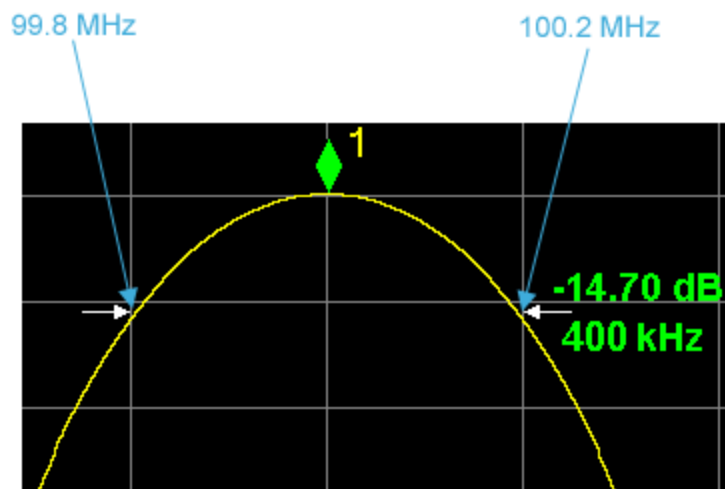

The following queries return the following values:

CALC:BAND:RES? 400 kHz

CALC:BAND:RLEF? 99.8 MHz

CALC:BAND:RRIG? 100.2 MHz

Remote Command	:CALCulate:BWIDth BANDwidth:RESult?
Example	:CALC:MARK:AOff Set selected marker to 1 :CALC:MARK:MAX Put marker 1 on peak :CALC:BWID ON Turn on N dB for the selected marker (1) :CALC:BWID:NDB-3.01 Set the offset to -3.01 dB :CALC:BWID:RES? Query the result
Notes	-100 returned if invalid reading
Initial S/W Revision	Prior to A.02.00

Remote Command	:CALCulate:BWIDth BANDwidth:RLEFt?
Example	:CALC:BWID:RLEF? Return the leftmost X Axis value for the N dB band
Notes	-100 returned if invalid reading
Initial S/W Revision	Prior to A.17.00

Remote Command	:CALCulate:BWIDth BANDwidth:RRIGht?
Example	:CALC:BWID:RRIG? Return the rightmost X Axis value for the N dB band
Notes	-100 returned if invalid reading
Initial S/W Revision	Prior to A.17.00

More Information

A marker should be placed on the peak of interest before turning on N dB points. The N dB points function looks for the two points on the marker's trace closest to the marker's X Axis value that are N dB below the marker's amplitude, one above and the other below the marker's X Axis value. (That is, one point is to the right and one is to the left of the selected marker.) The selected N dB value is called the offset. The function reports the frequency difference (for frequency domain traces) or time difference (for time domain traces) between those two points.

Each point is identified by a horizontal arrow pointing towards the marker, next to the trace. The arrows used by the N dB Points function will be as shown in the figure below (where each square represents one pixel). They point in, horizontally, at the trace below a peak, on either side of its skirts. There is one pixel between the arrow and the trace

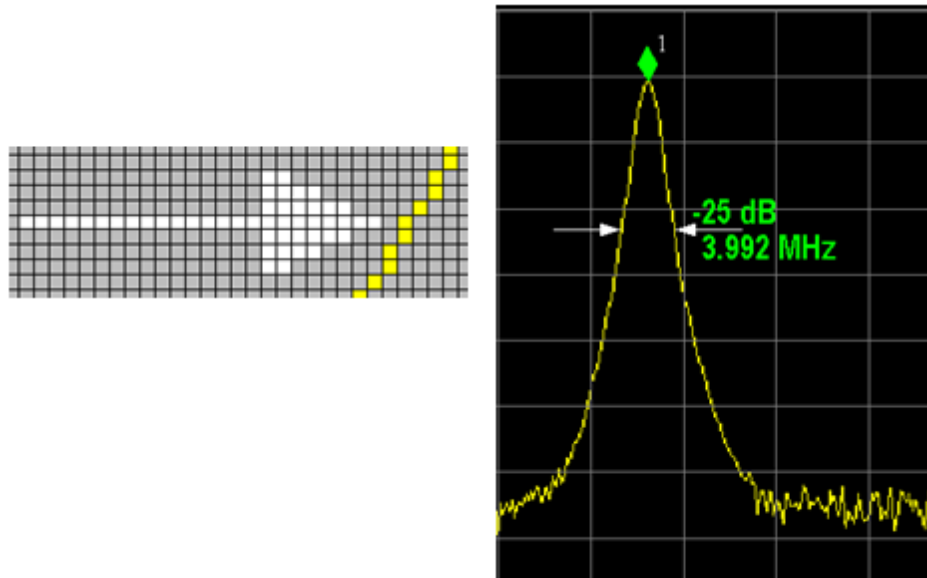

N dB Points can be used to measure the bandwidth of a signal; it is commonly used in conjunction with a tracking generator to measure filter bandwidths.

In one of the common use cases, the marker is placed on a peak, and the arrows are displayed N dB down the skirt from the marker on either side of the peak. The N dB value and the frequency difference between the two arrows is displayed around the arrow as shown in the figure above. Normally this displays on the right arrow, but if this would place any part of the text offscreen to the right then it displays on the left arrow.

If the analyzer is unable to find data that is N dB below the marker on either side of the marker, the arrows are displayed at the indicator point of the marker, no value (--) will be displayed as the result and -100 Hz returned remotely (see figure below):



Some sample N dB scenarios are shown below to illustrate how the function works in various cases. In each case, the two-headed blue arrow represents N dB of amplitude.

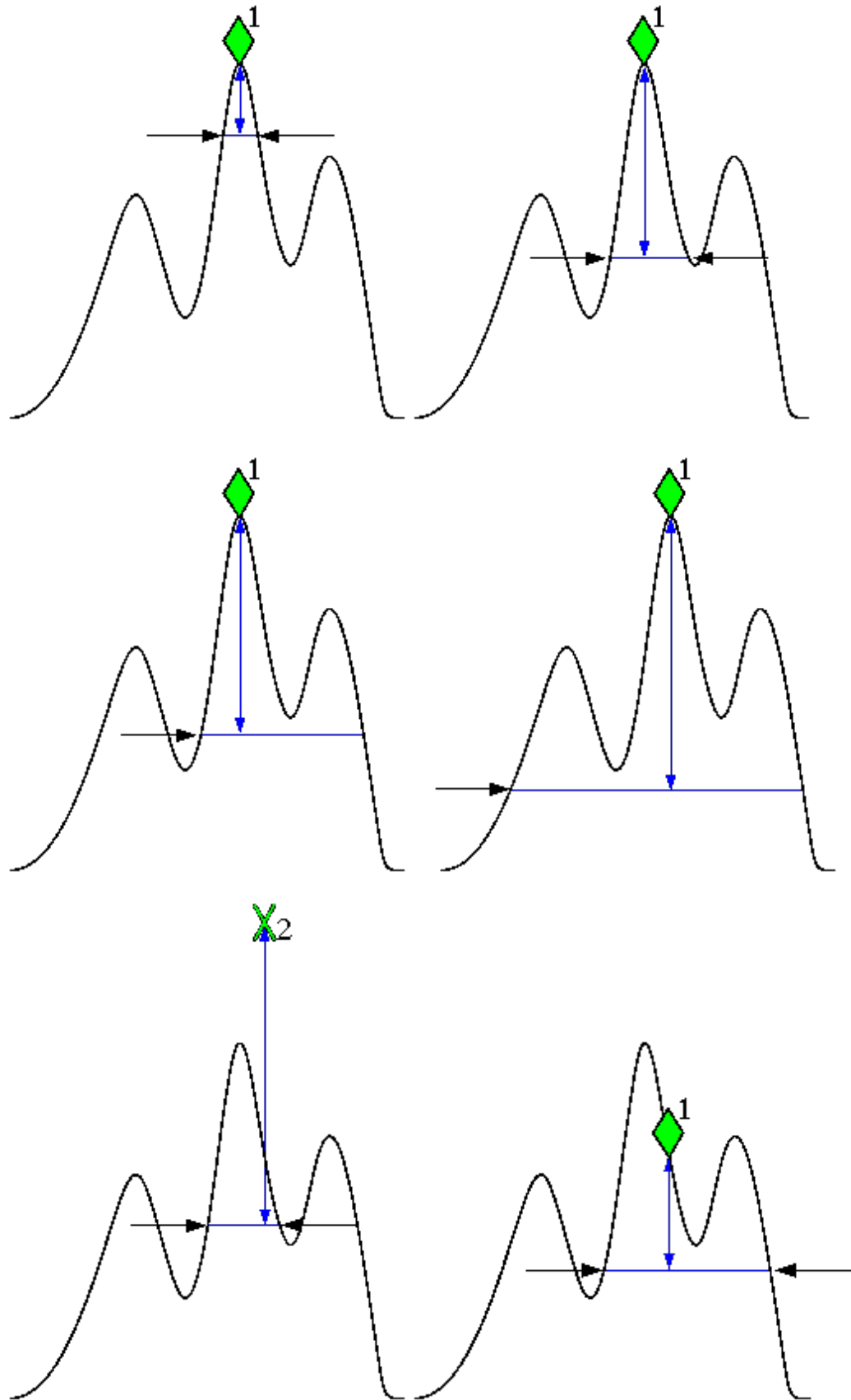

PhNoise Opt

Selects the LO (local oscillator) phase noise behavior for various desired operating conditions.

See ["More Information" on page 783](#)

Path	Meas Setup
Remote Command	[:SENSe] :FREQuency:SYNThesis [:STATe] 1 2 3 4 5 [:SENSe] :FREQuency:SYNThesis [:STATe] ?
Example	FREQ:SYNT 2 selects optimization for best wide offset phase noise
Range	All but EP0: Best Close-In Best Wide-Offset Fast Tuning EP0: Best Close-In Best Wide-Offset Fast Tuning Balanced Best Spurs
Range (Long Form)	No EPx option: Best Close-In Φ Noise [offset < 20 kHz] Best Wide-Offset Φ Noise [offset > 30 kHz] Fast Tuning [same as Close-in] EP0: Best Close-In Φ Noise [offset < 600 kHz] Balance Noise & Spurs [offset < 600 kHz] Best Spurs [offset < 600 kHz] Best Wide-Offset Φ Noise [offset > 800 kHz] Fast Tuning EP1: Best Close-In Φ Noise [offset < 140 kHz] Best Wide-Offset Φ Noise [offset > 160 kHz] Fast Tuning [single loop] EP2 & EP3: Best Close-In Φ Noise [offset < 70 kHz]

	<p>Best Wide-Offset Φ Noise [offset > 100 kHz] Fast Tuning [medium loop bw] EP4: Best Close-In Φ Noise [offset < 90 kHz] Best Wide-Offset Φ Noise [offset > 130 kHz] Fast Tuning [same as Close-in]</p>
Notes	<p>Parameter:</p> <p>1: In instruments with EPO, balances close-in phase noise with spur avoidance. In instruments without EPO optimizes phase noise for small frequency offsets from the carrier.</p> <p>2: optimizes phase noise for wide frequency offsets from the carrier.</p> <p>3: optimizes LO for tuning speed</p> <p>4: In instruments with EPO, balances close-in phase noise with spur avoidance. In instruments without EPO this setting is accepted but no action taken.</p> <p>5: In instruments with EPO, emphasizes spur avoidance with close-in phase noise performance. In instruments without EPO this setting is accepted but no action taken.</p> <p>The actual behavior varies somewhat depending on model number and option; you always get fast tuning by choosing #3, but in some models, the “Fast Tuning” choice is identical to the “Best Close-In” choice. Specifically:</p> <ul style="list-style-type: none"> – Models with option EPO (for example UXA), have a two stage local oscillator, which switches to a single loop for fast tuning – Models with option EP1 (for example PXA), have a two-loop local oscillator, which switches to a single loop for fast tuning – Models with option EP2 (available, for example, for MXA), use a different loop bandwidth for the fast-tuning choice, which is a compromise between tuning speed and phase noise, giving good tuning speed at all offsets, although not as good as for Close-In; this is useful when you have to look across a wide range of spans – In all other cases, Fast Tuning is the same as Best Close-In.
Dependencies	Does not appear in all models. The key is blank in those models, but the SCPI command is accepted for compatibility (although no action is taken).
Preset	Because this function is in Auto after preset, and because Span after preset > 314.16 kHz (see Auto rules, next section) the state of this function after Preset will be 2
Initial S/W Revision	Prior to A.02.00
Modified at S/W Revision	A.15.00

Path	Meas Setup, PhNoise Opt
Remote Command	[:SENSe] :FREQuency:SYNTHeSis:AUTO[:STATe] OFF ON 0 1 [:SENSe] :FREQuency:SYNTHeSis:AUTO[:STATe] ?
Example	FREQ:SYNT:AUTO ON
Preset	ON
State Saved	Saved in instrument state.
Initial S/W Revision	Prior to A.02.00

More Information

The Phase Noise Optimization control lets you optimize the setup and behavior of the Local Oscillator (LO) depending on your specific measurement conditions. You may wish to trade off noise and speed, for example, to make a measurement faster without regard to noise or with optimum noise characteristics without regard to speed.

Here is detail about the various settings you can choose:

- ["Auto " on page 783](#)
- ["Best Close-in \$\Phi\$ Noise" on page 783](#)
- ["Best Wide-offset \$\Phi\$ Noise" on page 784](#)
- ["Fast Tuning" on page 784](#)
- ["Balance Noise and Spurs " on page 784](#)
- ["Best Spurs " on page 784](#)
- ["Phase Noise Optimization Auto Rules" on page 785](#)

Auto

SCPI Example	FREQ:SYNT:AUTO ON
--------------	-------------------

Selects the LO (local oscillator) phase noise behavior to optimize dynamic range and speed for various instrument operating conditions. See ["Phase Noise Optimization Auto Rules" on page 785](#) for details on the Auto rules.

Best Close-in Φ Noise

SCPI Example	FREQ:SYNT 1
--------------	-------------

The LO phase noise is optimized for smaller offsets from the carrier, at the expense of phase noise farther out.

The actual frequency offset within which noise is optimized is shown with in square brackets, as this can vary depending on the hardware set in use. For example, in some analyzers this annotation appears as [offset <20 kHz]

In instruments with Option EP0, the LO is configured for the best possible phase noise at offsets up to 600 kHz from the carrier, regardless of spurious products that occur with some center frequencies.

Balance Noise and Spurs

SCPI Example FREQ:SYNT 4

In instruments with EP0, the LO is configured for the best possible phase noise at offsets up to 600 kHz from the carrier whenever there are no significant spurs within the span observed with an on-screen carrier. When there will be such a spur, the LO is reconfigured in a way that allows the phase noise to increase by 7 dB mostly within ± 1 octave around 400 kHz offset. The spurs will always be below -70 dBc.

Best Spurs

SCPI Example FREQ:SYNT 5

In instruments with EP0, the LO is configured for better phase noise than the “Wide-Offset” case close to the carrier, but the configuration has 11 dB worse phase noise than the “Best Close-In” case mostly within ± 1 octave around 300 kHz offset. Spurs are even lower than in the “Balance Noise and Spurs” case at better than -90 dBc, whether or not the carrier is on-screen.

This setting is never selected when Phase Noise Optimization is in Auto, you must select it manually.

Best Wide-offset Φ Noise

SCPI Example FREQ:SYNT 2

The LO phase noise is optimized for wider offsets from the carrier. Optimization is especially improved for offsets from 70 kHz to 300 kHz. Closer offsets are compromised and the throughput of measurements (especially remote measurements where the center frequency is changing rapidly), is reduced.

The actual frequency offset beyond which noise is optimized is shown with in square brackets, as this can vary depending on the hardware set in use. For example, in some analyzers this annotation appears as [offset >30 kHz]

In instruments with Option EP0, the LO is configured for the best possible phase noise at offsets up to 600 kHz from the carrier whenever there are no significant spurs within the span observed with an on-screen carrier. When there will be such a spur, the LO is reconfigured in a way that allows the phase noise to increase by 7 dB mostly within ± 1 octave around 400 kHz offset. The spurs will always be below -70 dBc.

Fast Tuning

SCPI Example FREQ:SYNT 3

In this mode, the LO behavior compromises phase noise at many offsets from the carrier in order to allow rapid measurement throughput when changing the center

frequency or span. The term “fast tuning” refers to the time it takes to move the local oscillator to the start frequency and begin a sweep; this setting does not impact the actual sweep time in any way.

In instruments with EP1, the LO behavior compromises phase noise at offsets below 4 MHz in order to improve measurement throughput. The throughput is especially affected when moving the LO more than 2.5 MHz and up to 10 MHz from the stop frequency to the next start frequency.

In instruments with Option EP0, this is the same configuration as the Best Spurs configuration. It is available with this “Fast Tuning” label to inform the user, and to make the user interface more consistent with other X-Series analyzer family members.

(In models whose hardware does not provide for a fast tuning option, the settings for Best Close-in Φ Noise are used if Fast Tuning is selected. This gives the fastest possible tuning for that hardware set.)

Phase Noise Optimization Auto Rules

The X-Series has several grades of LO that offer different configurations when in the Auto Mode.

- "Models with Option EP0" on page 785 (available in UXA)
- "Models with Option EP1" on page 786 (available in PXA)
- "Models with Option EP2" on page 786 (available, for example, in MXA for excellent phase noise)
- "Models with Option EP4" on page 786 (available in CXA for improved phase noise)
- "All other Models" on page 787

Models with Option EP0

Auto will choose:

Balanced Noise and Spurs whenever:

Center frequency is < 699.9 kHz

Otherwise, Auto will choose Fast Tuning whenever:

Span > 114.1 MHz, or when

RBW > 800 kHz

Otherwise, Auto will choose Best Wide-offset Φ Noise whenever:

RBW > 290 kHz, or when

Span > 4.2 MHz

Otherwise, Auto will choose Balanced Noise and Spurs.

The RBW to be used in the calculations above is the equivalent -3 dB bandwidth of the current RBW filter.

These rules apply whether in swept spans, zero span, or FFT spans.

Models with Option EP1

Auto will choose:

Fast Tuning whenever:

Span > 44.44 MHz, or when

RBW > 1.9 MHz, or if

Source Mode is set to "Tracking"

otherwise Auto will choose Best Close in Phase Noise whenever:

Center frequency is < 195 kHz, or when

CF ≥ 1 MHz and Span ≤ 1.3 MHz and RBW ≤ 75 kHz

otherwise, Auto will choose Best Wide-offset Phase Noise

The RBW to be used in the calculations above is the equivalent -3 dB bandwidth of the current RBW filter.

These rules apply whether in swept spans, zero span, or FFT spans.

Models with Option EP2

Auto will choose:

Best Close-in Φ Noise whenever:

CF < 130 kHz, or when

CF > 12 MHz and Span < 495 kHz and RBW < 40 kHz

Otherwise, Auto will choose Fast Tuning whenever:

Span > 22 MHz, or when

RBW > 400 kHz, or when

CF ≤ 12 MHz and Span < 495 kHz and RBW < 23 kHz

Otherwise, Auto will choose Best Wide-offset Φ Noise.

The RBW to be used in the calculations above is the equivalent -3 dB bandwidth of the current RBW filter.

These rules apply whether in swept spans, zero span, or FFT spans.

Models with Option EP4

Auto will choose:

Fast Tuning whenever:

Span > 101 MHz or when

RBW > 1.15 MHz or if

Source Mode is set to “Tracking”

otherwise, Auto will choose Best Close in Phase Noise whenever:

CF is < 109 kHz or when

CF >= 4.95 MHz and Span <= 666 kHz and RBW < 28 kHz

Otherwise, Auto will choose Best Wide-offset Φ Noise.

The RBW to be used in the calculations above is the equivalent -3 dB bandwidth of the current RBW filter.

These rules apply whether in swept spans, zero span, or FFT spans.

All other Models

Auto will choose:

Fast Tuning whenever:

Span > 12.34 MHz, or when

RBW > 250 kHz, or if

Source Mode is set to “Tracking”

Otherwise, Auto will choose Best Close in Phase Noise whenever:

Center frequency is < 25 kHz, or when

CF >= 1 MHz and Span <= 141.4 kHz and RBW <= 5 kHz

Otherwise, Auto will choose Best Wide-offset Phase Noise

Note that in these models, the hardware does not actually provide for an extra-fast tuning option, so the settings for Fast Tuning are actually the same as Best Close-in, but the rules are implemented this way so that the user who doesn't care about phase noise but does care about tuning speed doesn't have to remember which of the other two settings gives faster tuning.

The RBW to be used in the calculations above is the equivalent -3 dB bandwidth of the current RBW filter.

These rules apply whether in swept spans, zero span, or FFT spans.

ADC Dither

Accesses the menu to control the ADC Dither function. The dither function enhances linearity for low level signals at the expense of reduced clipping-to-noise ratio. The reduced clipping-to-noise ratio results in higher noise, because we work to ensure that the clipping level of the ADC relative to the front terminals remains unchanged with the introduction of dither, and this results in reduced ADC dynamic range. So

making measurements with ADC dither gives you better amplitude linearity, but turning ADC dither off gives you a lower noise floor (better sensitivity).

With dither on, the third-order distortions are usually invisible for mixer levels below -35 dBm. With dither off, these distortions can be visible, with typical power levels of -110 dBm referred to the mixer. Detection nonlinearity can reach 1 dB for dither off at mixer levels around -70 dBm and lower, while the specified nonlinearity is many times smaller with dither on.

When ADC Dither is on, the linearity of low-level signals is improved. The enhanced linearity is mostly improved scale fidelity. The linearity improvements of dither are most significant for RBWs of 3.9 kHz and less in swept mode, and FFT widths of 4 kHz and less in FFT mode.

The increased noise due to turning dither on is most significant in low band (0 to 3.6 GHz) with IF Gain set to Low, where it can be about 0.2 dB.

Key Path	Meas Setup
Remote Command	<code>[:SENSe] :ADC :DITHer [:STATe] OFF ON HIGH</code> <code>[:SENSe] :ADC :DITHer [:STATe] ?</code>
Example	ADC:DITH:HIGH Sets the ADC dither setting to High ADC:DITH ON Sets the ADC dither setting to Medium In older instruments the "Medium" key was labeled "On" and the SCPI for this setting is NOT changing.
Dependencies	In some models, the "High" parameter is not available. In some instruments, the HIGH parameter is honored and the HIGH state set, and returned to a query, but the Medium dither level is actually used.
Preset	AUTO
Backwards Compatibility SCPI	The old command <code>[:SENSe] :ADC :DITHer AUTO</code> is aliased to <code>[:SENSe] :ADC :DITHer :AUTO [:STATe] ON</code> ; because of this, the <code>[:SENSe] :ADC :DITHer</code> function cannot be a true Boolean, so the query, <code>[:SENSe] :ADC :DITHer ?</code> returns OFF or ON (not 1 or 0 like a true Boolean)
Initial S/W Revision	Prior to A.02.00
Modified at S/W Revision	A.02.00

Auto

Sets the ADC dither to automatic. The analyzer then chooses the dither level according to which is most likely to be the best selection, based on other settings within the digital IF.

When in Auto, the analyzer sets the dither to Medium whenever the effective IF Gain is Low by this definition of IF Gain = Low:

- When Sweep Type = Swept, IF Gain = Low whenever Swept IF Gain is set to Low Gain, whether by autocoupling or manual selection.

- When Sweep Type = FFT, IF Gain = Low whenever FFT IF Gain is set to "Low Gain," which cannot happen by autocoupling.

Whenever the IF Gain is not low by this definition, Auto sets the dither to Off.

Key Path	Meas Setup, ADC Dither
Remote Command	[:SENSe]:ADC:DITHer:AUTO[:STATe] OFF ON 0 1 [:SENSe]:ADC:DITHer:AUTO[:STATe]?
Example	ADC:DITH:AUTO ON
Preset	ON
State Saved	Saved in instrument state
Readback	The "Auto" is underlined, and the readback value is whatever setting is auto-selected
Initial S/W Revision	Prior to A.02.00

Medium (Log Accy)

The Medium setting of ADC Dither (known as "On" in earlier versions of the instrument software) improves the linearity of low-level signals at the expense of some noise degradation.

Key Path	Meas setup, ADC Dither
Example	ADC:DITH:ON
Readback	If manually selected, the readback is Medium, with the "Man" underlined
Initial S/W Revision	Prior to A.02.00
Modified at S/W Revision	A.02.00

Off (Best Noise)

When ADC Dither is Off, the instrument noise floor is improved, because without the need to make room for the dither, you get a lower noise floor and better sensitivity.

Key Path	Meas setup, ADC Dither
Example	ADC:DITH:OFF
Readback	If manually selected, the readback is Off, with the "Man" underlined.
Initial S/W Revision	Prior to A.02.00

Swept IF Gain

To take full advantage of the RF dynamic range of the analyzer, there is an added switched IF amplifier with approximately 10 dB of gain. When you can turn it on without overloading the analyzer, the dynamic range is always better with it on than off. The **Swept IF Gain** key can be used to set the IF Gain function to Auto, or to High Gain (the extra 10 dB), or to Low Gain. These settings affect sensitivity and IF overloads.

This function is only active when in Swept sweeps. In FFT sweeps, the FFT IF Gain function is used instead.

Key Path	Meas Setup
Remote Command	[:SENSe]:IF:GAIN:SWEpt[:STATe] OFF ON 0 1 [:SENSe]:IF:GAIN:SWEpt[:STATe]?
Example	IF:GAIN:SWEP ON
Notes	where ON = high gain OFF = low gain
Dependencies	The IF Gain keys (FFT IF Gain and Swept IF Gain) have no effect when the U7227A USB Preamplifier is connected. This is not annotated or reflected on any softkey; there are no keys grayed out nor any SCPI locked out. The analyzer simply behaves as though both FFT IF Gain and Swept IF Gain are set to Low regardless of the setting on the keys.
Couplings	The 'auto' rules for Swept IF Gain depend on attenuation, preamp state, start and stop frequency and the setting of FFT IF Gain. Set the Swept IF Gain to High (On) when the total input attenuation is 0 dB, the preamp is off, the start frequency is 10 MHz or more, and the FFT IF Gain is autocoupled, or manually set to Autorange, or manually set to High. Also set the Swept IF Gain to High (On) when the total input attenuation is 2 dB or less, the preamp is on, the start frequency is 10 MHz or more, and the stop frequency is 3.6 GHz or less and the FFT IF Gain is autocoupled, or manually set to Autorange, or manually set to High. Under all other circumstances, set the Swept IF Gain to Low (Off). If the sweep type is Swept, the start frequency of the instrument is less than 10 MHz, and you put Swept IF Gain in Manual On, a warning condition is generated and remains in effect as long as this condition exists. The warning message is about a possible IF overload. As with most parameters with an AUTO state, AUTO COUPLE sets it to Auto, and setting any specific value (for example on or off) will set the AUTO state to false.
Preset	Auto after a Preset which yields Off unless the Preamp is on. Auto and Off after Meas Preset.
State Saved	Saved in instrument state.
Readback Line	High Gain or Low Gain
Initial S/W Revision	Prior to A.02.00

Auto

Activates the auto rules for Swept IF Gain

Key Path	Meas setup
Remote Command	[:SENSe]:IF:GAIN:SWEpt:AUTO[:STATe] OFF ON 0 1 [:SENSe]:IF:GAIN:SWEpt:AUTO[:STATe]?
Example	IF:GAIN:SWEP:AUTO ON
Preset	ON
Initial S/W Revision	Prior to A.02.00

Low Gain (Best for Large Signals)

Forces Swept IF Gain to be off.

Key Path	Meas setup, ADC Ranging
Example	IF:GAIN:SWEP OFF
State Saved	Saved in instrument state.
Readback	Low Gain
Initial S/W Revision	Prior to A.02.00

High Gain (Best Noise Level)

Forces Swept IF Gain to be on.

Key Path	Meas setup, ADC Ranging
Example	IF:GAIN:SWEP ON
Dependencies	The High setting for Swept IF Gain is grayed out when FFT IF Gain is manually set to Low (not when Low is chosen by the auto-rules).
State Saved	Saved in instrument state.
Readback	High Gain
Initial S/W Revision	Prior to A.02.00

FFT IF Gain

Accesses the keys to set the ranging in the digital IF when doing FFT sweeps. When in Autorange mode, the IF checks its range once for every FFT chunk, to provide the best signal to noise ratio. You can specify the range for the best FFT speed, and optimize for noise or for large signals.

When the sweep type is FFT and this function is in Autorange, the IF Gain is set ON initially for each chunk of data. The data is then acquired. If the IF overloads, then the IF Gain is set OFF and the data is re-acquired. Because of this operation, the Auto setting uses more measurement time as the instrument checks/resets its range. You can get faster measurement speed by forcing the range to either the high or low gain setting. But you must know that your measurement conditions will not overload the IF (in the high gain range) and that your signals are well above the noise floor (for the low gain range), and that the signals are not changing.

Key Path	Meas Setup
Remote Command	[:SENSe] : IF : GAIN : FFT [: STATE] AUTOrange LOW HIGH [: SENSe] : IF : GAIN : FFT [: STATE] ?
Dependencies	The IF Gain keys (FFT IF Gain and Swept IF Gain) have no effect when the U7227A USB Preamplifier is connected. This is not annotated or reflected on any softkey; there are no keys grayed out nor any SCPI locked out. The analyzer simply behaves as though both FFT IF Gain and Swept IF Gain are set to Low regardless of the setting on the keys.
Couplings	As with most parameters with an AUTO state, AUTO COUPLE sets it to Auto, which then picks AUTOrange, and setting any specific value (AUTOrange, LOW or HIGH) will set the AUTO state to false.

Preset	AUTOrange
State Saved	Saved in instrument state.
Readback Line	Autorange, High Gain or Low Gain
Initial S/W Revision	Prior to A.02.00

Auto

Allows the instrument to pick the FFT IF Gain method as appropriate. This “Auto” state is set by the Auto Couple key, and it puts it in Autorange.

Key Path	Meas Setup
Remote Command	[:SENSe] : IF : GAIN : FFT : AUTO [: STATE] OFF ON 0 1 [:SENSe] : IF : GAIN : FFT : AUTO [: STATE] ?
Example	IF:GAIN:FFT:AUTO ON
Preset	ON
State Saved	Saved in instrument state.
Backwards Compatibility SCPI	DISP lay : WIND ow [1] : TRAC e : Y [: SCAL e] : LOG : RANG e : AUTO Included for ESA compatibility
Backwards Compatibility SCPI	[:SENSe] : ADC : RANG e AUTO NONE Included for PSA compatibility. Accepted without error but ignored; the query is ignored as well
Initial S/W Revision	Prior to A.02.00

Autorange (Slower – Follows Signals)

Turns the ADC ranging to automatic which provides the best signal to noise ratio. Autorange is usually preferred over the manual range choices.

Key Path	Meas setup, FFT IF Gain
Example	IF:GAIN:FFT AUTOrange
State Saved	Saved in instrument state.
Readback	Autorange
Initial S/W Revision	Prior to A.02.00

Low Gain (Best for Large Signals)

Forces FFT IF Gain to be off.

Key Path	Meas Setup, FFT IF Gain
Example	IF:GAIN:FFT LOW
State Saved	Saved in instrument state.
Readback	Low Gain
Initial S/W Revision	Prior to A.02.00

High Gain (Best Noise Level)

Forces FFT IF Gain to be on.

Key Path	Meas S0etup, FFT IF Gain
Example	IF:GAIN:FFT HIGH
Dependencies	The High setting for FFT IF Gain is grayed out when Swept IF Gain is manually set to Low (not when Low is chosen by the auto-rules).
State Saved	Saved in instrument state.
Readback	High Gain
Initial S/W Revision	Prior to A.02.00

Analog Demod Tune & Listen

The Analog Demod Tune & Listen key opens the Analog Demod menu which contains keys to turn the demod function on and off and select modulation type. This key only appears if the N9063A Analog Demod mode, the N6141A or W6141A application, or Option EMC is installed and licensed.

When the function is on (set to AM, FM, or Φ M), the demodulated signal is fed to the analyzer's speaker. Muting and volume control functions are done through the standard Windows speaker volume control interface.

Key Path	Meas Setup
Remote Command	[:SENSe] :DEMod AM FM PM OFF [:SENSe] :DEMod?
Example	DEM AM turns amplitude demodulation function ON
Dependencies	When Tune & Listen is turned on, all active traces are forced to use the same detector. CISPR detectors (QPD, EMI Avg, RMS Avg) and Tune & Listen are mutually exclusive. No sound output will be heard if one of these detectors is selected.
Preset	OFF
State Saved	Saved in instrument state.
Backwards Compatibility Notes	In ESA, the command [:SENSe]: DEMod AM FM would select the demodulation type but would not activate it (turn it on). In X-Series this command will both select and activate demodulation. The X-Series implementation of Demod Tune and Listen does not include Squelch Control as was supported in ESA. The speaker control for Tune and Listen for X-Series is done with the volume up/down and mute hardkeys on the front panel and is handled by the Windows operating system. There is no software speaker on/off control as was supported in ESA.
Initial S/W Revision	Prior to A.02.00
Modified at S/W Revision	A.02.00

AM

Pressing this key, when it is not selected, selects and activates the AM demodulation function. Pressing it a second time branches to the AM Demod menu where AM demodulation settings can be adjusted.

Key Path	Meas Setup, Analog Demod Tune&Listen
Example	DEM AM
State Saved	Saved in instrument state.
Backwards Compatibility SCPI	[:SENSe] :DEMod :STATe ON 1 Sending DEM:STAT ON will have the same effect as sending DEM:AM, turning AM Demod on.
Initial S/W Revision	Prior to A.02.00

Channel BW (AM Demod)

Sets the RBW setting used by the hardware during the demodulation period in nonzero spans. Note that this is a separate parameter only for the demodulation function and does not affect the RBW setting in the BW menu which is used during the normal sweep. The flat top filter type must be used during the demodulation period. A 5 kHz Video Bandwidth filter is used.

In Zero Span, the instrument's RBW & VBW filters are used for the demodulation; thus, the Channel BW (and RBW filter type) will match those of the instrument. This allows gap-free listening. The Channel BW key is grayed out and the value displayed on the key matches the current RBW of the instrument. Upon leaving zero span, the non-zero-span setting of Channel BW is restored as well as the flattop filter type.

Key Path	Meas Setup, Analog Demod Tune&Listen, AM
Remote Command	[:SENSe] :DEMod :AM :BANDwidth :CHANnel <freq> [:SENSe] :DEMod :AM :BANDwidth :CHANnel ?
Example	DEM:AM:BAND:CHAN 200 kHz
Notes	This key/command is grayed out in zero span.
Dependencies	Unavailable in zero span.
Couplings	In zero span only, the value is set equal to the instrument's current RBW value and it displays that value on the softkey, but the softkey is grayed out.
Preset	30 kHz
State Saved	Saved in instrument state.
Min	390 Hz
Max	8 MHz
Default Unit	Hz
Initial S/W Revision	Prior to A.02.00

FM

Pressing this key, when it is not selected, selects and activates the FM demodulation function. Pressing it a second time branches to the FM Demod menu where FM

demodulation settings can be adjusted.

Key Path	Meas Setup, Analog Demod Tune&Listen
Example	DEM FM
State Saved	Saved in instrument state.
Initial S/W Revision	Prior to A.02.00

Channel BW (FM Demod)

Sets the RBW setting used by the hardware during the demodulation period in nonzero spans. Note that this is a separate parameter only for the demodulation function and does not affect the RBW setting in the BW menu which is used during the normal sweep. The flat top filter type must be used during the demodulation period. A 5 kHz Video Bandwidth filter is used.

In Zero Span, the instrument's RBW & VBW filters are used for the demodulation; thus, the Channel BW (and RBW filter type) will match those of the instrument. This allows gap-free listening. The Channel BW key is grayed out and the value displayed on the key matches the current RBW of the instrument. Upon leaving zero span, the previous setting of Channel BW and the flattop filter type are restored.

Key Path	Meas Setup, Analog Demod Tune&Listen, FM
Remote Command	[:SENSe] :DEMod:FM:BA NDwidth:CHANnel <freq> [:SENSe] :DEMod:FM:BA NDwidth:CHANnel?
Example	DEM:FM:BA ND:CHAN 200 MHz
Notes	This key / command is grayed out in zero span
Dependencies	Unavailable in zero span.
Couplings	In zero span only, the value is set equal to the instrument's current RBW value and it displays that value on the softkey, but the softkey is grayed out.
Preset	150 kHz
State Saved	Saved in instrument state.
Min	390 Hz
Max	8 MHz
Default Unit	Hz
Initial S/W Revision	Prior to A.02.00

De-emphasis (FM Demod only)

The De-emphasis setting controls a single-pole filter (6 dB/octave roll off), usually to counter intentional pre-emphasis in the transmitter. When De-emphasis state is OFF the hardware digital filter is bypassed, otherwise the setting is applied

The De-emphasis softkey is only available when FM is the demod selected. It is grayed out for AM and PM.

Key Path	Meas Setup, Analog Demod Tune & Listen, FM
Remote Command	[:SENSe]:DEMod:FM:DEEMphasis OFF US25 US50 US75 US750 [:SENSe]:DEMod:FM:DEEMphasis?
Example	DEM:FM:DEEM US75 DEM:FM:DEEM?
Dependencies	Only available in FM. Grayed out for AM and PM.
Preset	US75 (recommended for US commercial FM 75 μ s pre-emphasis)
State Saved	Saved in instrument state.
Readback line	1-of-N selection
Initial S/W Revision	Prior to A.02.00

Φ M

Pressing this key, when it is not selected, selects and activates the Φ M demodulation function. Pressing it a second time branches to the Φ M Demod menu where Φ M demodulation settings can be adjusted.

Key Path	Meas Setup, Analog Demod Tune&Listen
Example	DEM PM
State Saved	Saved in instrument state.
Initial S/W Revision	Prior to A.02.00

Channel BW (Φ M Demod)

Sets the RBW setting used by the hardware during the demodulation period in nonzero spans. Note that this is a separate parameter only for the demodulation function and does not affect the RBW setting in the BW menu which is used during the normal sweep. The flat top filter type must be used during the demodulation period. A 5 kHz Video Bandwidth filter is used.

In Zero Span, the instrument's RBW & VBW filters are used for the demodulation; thus, the Channel BW (and RBW filter type) will match those of the instrument. This allows gap-free listening. The Channel BW key is grayed out and the value displayed on the key matches the current RBW of the instrument. Upon leaving zero span, the previous setting of Channel BW and the flattop filter type are restored.

Key Path	Meas Setup, Analog Demod Tune&Listen, Φ M
Remote Command	[:SENSe]:DEMod:PM:BANDwidth:CHANnel <freq> [:SENSe]:DEMod:PM:BANDwidth:CHANnel?
Example	DEM:PM:BAND:CHAN 200 MHz
Notes	This key / command is grayed out in zero span
Dependencies	Unavailable in zero span.
Couplings	In zero span only, the value is set equal to the instrument's current RBW value and it displays that value on the softkey, but the softkey is grayed out.

Preset	100 kHz
State Saved	Saved in instrument state.
Min	390 Hz
Max	8 MHz
Default Unit	Hz
Initial S/W Revision	Prior to A.02.00

Off

Pressing this key, turns the demodulation function off.

Key Path	Meas Setup, Analog Demod Tune&Listen
Example	DEM OFF turns the demodulation function OFF
State Saved	Saved in instrument state.
Backwards Compatibility SCPI	[:SENSe] :DEMod :STATe OFF 0
Initial S/W Revision	Prior to A.02.00

Demod Time

Sets the amount of time the instrument demodulates the signal after each sweep. The demodulated signal can be heard through the speaker during demodulation. In zero span, demodulation can be performed continuously, making this parameter not applicable, hence it is grayed out in zero span.

Key Path	Meas Setup, Analog Demod Tune&Listen
Remote Command	[:SENSe] :DEMod :TIME <time> [:SENSe] :DEMod :TIME ?
Example	DEM:TIME 500 ms DEM:TIME?
Notes	This key / command is grayed out in zero span
Dependencies	Unavailable in zero span.
Preset	500 ms
State Saved	Saved in instrument state.
Min	2 ms
Max	100 s
Initial S/W Revision	Prior to A.02.00

Demod State (Remote Command Only)

Sets or queries the state of the Analog Demod Tune and Listen function. Setting the state to ON with this command will select AM demodulation by default and activate

it (turn it on).

The response to the query is determined by the current setting of [:SENSE]:DEMod AM|FM|PM|OFF. The response will be 1 if AM, FM, PM are selected, or 0 if OFF is selected..

Remote Command	<code>[:SENSe]:DEMod:STATe OFF ON 0 1</code> <code>[:SENSe]:DEMod:STATe?</code>
Preset	OFF
Initial S/W Revision	Prior to A.02.00

Noise Source

This menu allows you to turn the noise source power on or off when making manual noise figure measurements.

See "[More Information](#)" on page 798.

Key Path	Meas Setup
Remote Command	<code>:SOURce:NOISe:TYPE NORMal SNS</code> <code>:SOURce:NOISe:TYPE?</code>
Example	SOUR:NOIS:TYPE NORM
Couplings	If no SNS is connected, this parameter will be set to "Normal" When Type is set to "SNS" and the SNS is disconnected, this parameter gets bumped to "Normal" When an SNS is not connected, the SNS type will be grayed (disabled).
Preset	Normal
State Saved	Saved in instrument state.
Range	Normal SNS
Backwards Compatibility Notes	In previous Noise Figure analysis applications, this command could optionally be preceded with the :SENSe keyword. The optional :SENSe keyword is no longer supported.
Initial S/W Revision	Prior to A.02.00

More Information

There are several types of noise sources:

- 346/7 Series
- N4000 series Smart Noise Source (SNS)
- USB Noise Source (connects via USB rather than via the Noise Source connector on the rear panel)

This menu allows the user to control any of these.

When an SNS is connected the user can then select it from the "Type" 1-of-N, allowing the State parameter to then control the SNS. The "Normal" source is controlled by a BNC connector that supplies 28V. If SNS is NOT connected then the

“state” parameter controls the “Normal” noise source 28V BNC port. If both are connected the “Type” parameter will determine which source the “State” parameter will control. Two sources can never be controlled together. The “SNS attached” SCPI query detailed below can be used remotely to determine if an SNS is connected. SNS functionality is limited to turning on and off only. The SNS ENR data and temperature cannot be queried, unless the Noise Figure application is installed. The SNS ENR data is issued in printed form when an SNS is purchased or can be read from the analyzer’s Noise Figure application if installed, or other Keysight noise figure instruments that support the SNS (NFA and ESA with option 219).

Only one SNS is supported at a time. To switch to a different SNS (a USB SNS or a N4000 series SNS), disconnect the one that is no longer being used prior to connecting a new one.

When first entering the Swept SA measurement the “State” will be set to OFF and the 28v BNC drive and SNS turned off to ensure the two are in sync. When the Swept SA measurement is exited, the “State” parameter will be set to OFF and the 28v BNC and SNS drive turned off.

For making manual noise figure measurements the following setup is recommended:

- Set the SPAN to Zero
- Set attenuation to 0 dB
- Set the PRE-AMP ON
- Set the RBW to 4MHz
- Set the Detector to AVERAGE
- Set the sweep time to 16ms - sets the variance correctly for good results.
- Set a Band/Interval Power Marker function and set the interval over the full width of trace i.e. Left to 0s and Right to 16ms

State

This key turns the Noise Source on and off.

Key Path	Meas Setup
Remote Command	:SOURce:NOISe[:STATe] ON OFF 1 0 :SOURce:NOISe[:STATe]?
Example	SOUR:NOIS OFF
Couplings	If an SNS is connected, and the Type is set to SNS, this parameter turns the SNS on and off. When an SNS is not connected this parameter turns the BNC 28V output on and off. When the SA mode is first entered this parameter is set to OFF and the 28v drive turned OFF. When the SA mode is exited this parameter is set to OFF and the 28v drive turned OFF.
Preset	OFF

State Saved	Saved in instrument state.
Backwards Compatibility Notes	In previous Noise Figure analysis applications, this command could optionally be preceded with the :SENSe keyword. The optional :SENSe keyword is no longer supported.
Initial S/W Revision	Prior to A.02.00

SNS Attached (Remote Command Only)

If an Smart Noise Source (SNS) is present this command will return 1 otherwise it will return 0.

Remote Command	:SOURce:NOISe:SNS:ATTached?
Example	SOUR:NOIS:SNS:ATT?
Preset	OFF
State Saved	No
Backwards Compatibility Notes	In previous Noise Figure analysis applications, this command could optionally be preceded with the :SENSe keyword. The optional :SENSe keyword is no longer supported.
Initial S/W Revision	Prior to A.02.00

ACP Enhanced Dynamic Range On/Off

The ACP Enhanced Dynamic Range function causes a 300 kHz SAW filter (also called the “ACP Filter”) to be switched into the signal path to allow third-order critical measurements, such as ACP measurements, to be made with improved dynamic range when the spectrum is substantially wider than 300 kHz. When ACP Enhanced Dynamic Range is on:

1. When $RBW \leq 300$ kHz, the “ACP filter” is switched in. This means that the RBW shape is affected, but not excessively.
2. When $RBW > 300$ kHz, ACP Enhanced Dynamic Range causes no changes in the signal path.

NOTE

This function should be used only under specific measurement scenarios, such as ratio measurements of intermodulation, to avoid adding other measurement inaccuracies, such as Frequency Readout Accuracy, RBW amplitude accuracy, power bandwidth accuracy and absolute amplitude accuracy.

Key Path	Meas Setup
Remote Command	[:SENSe] : IF : EDRange ON OFF 1 0 [:SENSe] : IF : EDRange ?
Example	IF:EDR ON
Preset	OFF
State Saved	Saved in instrument state.
Initial S/W Revision	Windows XP models: A.14.14

Windows 7 models: A.16.00

Meas Preset

This key returns the Meas Local variables in the Swept SA measurement to their preset values. This is the same as sending the SCPI command CONF:SAN.

The only exception is Limits On/Off, which is a persistent Meas Local variable. It will be set to Off by a Mode Preset but not by Meas Preset.

Key Path	Meas Setup
Initial S/W Revision	Prior to A.02.00

Mode

See "[Mode](#)" on page 353

Mode Preset

Returns the active mode to a known state.

Mode Preset does the following for the currently active mode:

- Aborts the currently running measurement.
- Brings up the default menu for the mode, with no active function.
- Sets measurement Global settings to their preset values for the active mode only.
- Activates the default measurement.
- Brings up the default menu for the mode.
- Clears the input and output buffers.
- Sets Status Byte to 0.

Mode Preset does not:

- Cause a mode switch
- Affect mode persistent settings
- Affect system settings
- See "[How-To Preset](#)" on page 804 for more information.

Key Path	Front-panel key
Remote Command	:SYSTem:PRESet
Example	:SYST:PRES
Notes	<p>*RST is preferred over :SYST:PRES for remote operation. *RST does a Mode Preset, as done by the :SYST:PRES command, and it sets the measurement mode to Single measurement rather than Continuous for optimal remote control throughput.</p> <p>Clears all pending OPC bits. The Status Byte is set to 0.</p>
Couplings	A Mode Preset aborts the currently running measurement, activates the default measurement, and gets the mode to a consistent state with all of the default couplings set.
Backwards Compatibility Notes	<p>In the X-Series, the legacy "Factory Preset" has been replaced with Mode Preset, which only presets the currently active mode, not the entire instrument. In the X-Series, the way to preset the entire instrument is by using System, Restore System Defaults All, which behaves essentially the same way as restore System Defaults does on ESA and PSA.</p> <p>There is also no "Preset Type" as there is on the PSA. There is a green Mode Preset front-panel key that does a Mode Preset and a white-with-green-letters User Preset front-panel key that does a User Preset. The old PRESet:TYPE command is ignored (without generating an error), and SYST:PRES without a parameter does a Mode Preset, which should cover most backward code compatibility issues.</p>

The settings and correction data under the Input/Output front-panel key (examples: Input Z Corr, Ext Amp Gain, etc.) are no longer part of any Mode, so they will not be preset by a Mode Preset. They are preset using Restore Input/Output Defaults, Restore System Defaults All. Note that because User Preset does a Recall State, and all of these settings are saved in State, they ARE recalled when using User Preset.

Initial S/W Revision Prior to A.02.00

How-To Preset

The table below shows all possible presets, their corresponding SCPI commands and front-panel access (key paths). Instrument settings depend on the current measurement context. Some settings are local to the current measurement, some are global (common) across all the measurements in the current mode, and some are global to all the available modes. In a similar way, restoring the settings to their preset state can be done within the different contexts.

Auto Couple - is a measurement local key. It sets all Auto/Man parameter couplings in the measurement to Auto. Any Auto/Man selection that is local to other measurements in the mode will not be affected.

Meas Preset - is a measurement local key. Meas Preset resets all the variables local to the current measurement except the persistent ones.

Mode Preset - resets all the current mode's measurement local and measurement global variables except the persistent ones.

Restore Mode Defaults - resets ALL the Mode variables (and all the Meas global and Meas local variables), including the persistent ones.

Type Of Preset	SCPI Command	Front Panel Access
Auto Couple	:COUPle ALL	Auto Couple front-panel key
Meas Preset	:CONFigure:<Measurement>	Meas Setup Menu
Mode Preset	:SYSTem:PRESet	Mode Preset (green key)
Restore Mode Defaults	:INSTrument:DEFault	Mode Setup Menu
Restore All Mode Defaults	:SYSTem:DEFault MODes	System Menu; Restore System Default Menu
*RST	*RST	not possible (Mode Preset with Single)
Restore Input/Output Defaults	:SYSTem:DEFault INPUt	System Menu; Restore System Default Menu
Restore Power On Defaults	:SYSTem:DEFault PON	System Menu; Restore System Default Menu
Restore Alignment Defaults	:SYSTem:DEFault ALIGN	System Menu; Restore System Default Menu
Restore Miscellaneous Defaults	:SYSTem:DEFault MISC	System Menu; Restore System Default Menu

Restore All System Defaults	:SYSTem:DEFault [ALL] :SYSTem:PRESet:PERsistent	System Menu; Restore System Default Menu
User Preset	:SYSTem:PRESet:USER	User Preset Menu
User Preset All Modes	:SYSTem:PRESet:USER:ALL	User Preset Menu
Power On Mode Preset	:SYSTem:PON:TYPE MODE	System Menu
Power On User Preset	:SYSTem:PON:TYPE USER	System Menu
Power On Last State	:SYSTem:PON:TYPE LAST	System Menu

Mode Setup

See ["Mode Setup" on page 388](#)

Peak Search

Pressing the Peak Search key displays the Peak Search menu and places the selected marker on the trace point with the maximum y-axis value for that marker's trace. The Peak Search features allow you to define specific search criteria to determine which signals can be considered peaks, excluding unwanted signals from the search.

NOTE

For all Peak Search functions, if you are in the Trace Zoom View of the Swept SA measurement, and the bottom window is selected, the search function will operate **ONLY** within that window. This allows you to perform a Peak Search over a specified, limited frequency range, while still viewing the larger frequency range in the top window.

See "[More Information](#)" on page 807.

Key Path	Front-panel key
Remote Command	:CALCulate:MARKer[1] 2 ... 12:MAXimum
Example	CALC:MARK2:MAX performs a peak search using marker 2. CALC:MARK2:Y? queries the marker amplitude (Y-axis) value for marker 2. CALC:MARK2:X? queries the marker frequency or time (X-axis) value for marker 2. SYST:ERR? can be used to query the errors to determine if a peak is found. The message "No peak found" will be returned after an unsuccessful search.
Notes	Sending this command selects the subopcoded marker.
Initial S/W Revision	Prior to A.02.00

More Information

The behavior of a Peak Search is dependent on settings under the Peak Criteria softkey on the second page of the menu. If **Same as "Next Peak" Criteria** is selected, and either **Pk Excursion** or **Pk Threshold** are on, a signal must meet those criteria to be considered a peak. If no valid peak is found, a "No peak found" message is generated and the marker is not moved. When **Highest Peak** is on, or both **Pk Excursion** and **Pk Threshold** are off, the marker is always placed at the point on the trace with the maximum y-axis value, even if that point is on the very edge of the trace (exception: negative frequencies and signals close to the LO are not searched at all).

Pressing Peak Search with the selected marker off causes the selected marker to be set to **Normal** at the center of the screen, then a peak search is immediately performed.

Pressing the front panel Peak Search key always does a peak search. Occasionally, you may need to get to the Peak Search menu key functions without doing a peak search. You can do this by first accessing the Peak Search menu. Then go to the other menus that you need to access. Finally, you can get back to the Peak Search key menu by using the front panel Return key and pressing it as many times as

required to navigate back through the previously accessed menus until you get back to the Peak Search menu.

Next Peak

Pressing Next Peak moves the selected marker to the peak that has the next highest amplitude less than the marker's current value. Only peaks which meet all enabled peak criteria are considered. If there is no valid peak lower than the current marker position, a "No peak found" message is generated and the marker is not moved.

If the selected marker was off, then it is turned on as a normal marker and a peak search is performed.

Key Path	Peak Search
Remote Command	:CALCulate:MARKer[1] 2 ... 12:MAXimum:NEXT
Example	CALC:MARK2:MAX:NEXT Selects marker 2 and moves it to the peak that is closest in amplitude to the current peak, but the next lower value.
Notes	Sending this command selects the subopcoded marker.
State Saved	Not part of saved state.
Initial S/W Revision	Prior to A.02.00

Next Pk Right

Pressing Next Pk Right moves the selected marker to the nearest peak right of the current marker that meets all enabled peak criteria. If there is no valid peak to the right of the current marker position, a "No peak found" message is generated and the marker is not moved.

If the selected marker was off, then it is turned on as a normal marker and a peak search is performed.

Key Path	Peak Search
Remote Command	:CALCulate:MARKer[1] 2 ... 12:MAXimum:RIGHT
Example	CALC:MARK2:MAX:RIGH Selects marker 2 and moves it to the next peak to the right of the current marker position.
Notes	Sending this command selects the subopcoded marker.
State Saved	Not part of saved state.
Initial S/W Revision	Prior to A.02.00

Next Pk Left

Pressing Next Pk Left moves the selected marker to the nearest peak left of the current marker that meets all enabled peak criteria. If there is no valid peak to the left of the current marker position, a "No peak found" message is generated and the marker is not moved.

If the selected marker was off, then it is turned on as a normal marker and a peak search is performed.

Key Path	Peak Search
Remote Command	:CALCulate:MARKer[1] 2 ... 12:MAXimum:LEFT
Example	CALC:MARK2:MAX:LEFT selects marker 2 and moves it to the next peak to the left of the current marker position.
State Saved	Not part of saved state.
Initial S/W Revision	Prior to A.02.00

Marker Delta

Performs the same function as the Delta 1-of-N selection key in the Marker menu. Basically this sets the control mode for the selected marker to Delta mode. See the Section ["Marker" on page 671](#) for the complete description of this function. The key is duplicated here in the Peak Search Menu to allow you to conveniently perform a peak search and change the marker's control mode to Delta without having to access two separate menus.

Key Path	Peak Search or Marker
Notes	Whenever the selected marker is in Delta mode and you are in the Peak Search menu, the Marker Delta key should be highlighted and the active function for setting its delta value turned on.
Initial S/W Revision	Prior to A.02.00

Mkr->CF

Assigns the selected marker's frequency to the Center Frequency setting. See the Section ["Marker To" on page 719](#) for the description of this function. The key is duplicated here in the Peak Search Menu to allow you to conveniently perform a peak search and marker to CF without having to access two separate menus.

Key Path	Peak Search or Marker ->
Dependencies	Same as specified under Marker To
Initial S/W Revision	Prior to A.02.00

Mkr->Ref Lvl

Assigns the selected marker's level to the Reference Level setting. See the Section ["Marker To" on page 719](#) for the description of this function. The key is duplicated here in the Peak Search Menu to allow you to conveniently perform a peak search and marker to RL without having to access two separate menus.

Key Path	Peak Search or Marker ->
Dependencies	Same as specified under Marker To
Initial S/W Revision	Prior to A.02.00

Peak Criteria

Pressing this key opens the Peak Criteria menu and allows you to adjust the Pk Threshold and Pk Excursion parameters used for peak search functions.

For a signal to be identified as a peak it must meet certain criteria. Signals in the negative frequency range and signals very close to 0 Hz are ignored. If either the peak excursion or peak threshold functions are on, then the signal must satisfy those criteria before being identified as a peak.

When peak excursion and peak threshold are both off:

- **Peak Search, Continuous Peak Search, and maximum part of Pk-Pk Search** will search the trace for the point with the highest y-axis value which does not violate the LO feedthrough rules. A rising and falling slope are not required for these three peak search functions.
- The remaining search functions **Next Peak, Next Pk Right**, etc. will only consider trace points which have a rising and falling slope on the left and right respectively.

Key Path	Peak Search
Backwards Compatibility Notes	In the ESA, this menu was called Search Criteria; in the PSA, it was called Search Param. The menu structure in X-Series is different (for clarity) but the functionality is essentially the same. Basically, the Peak Excursion and Peak Threshold keys appeared at the top level of this menu in the PSA/ESA, whereas in the X-Series they are one level down under “Next Peak” Criteria
Initial S/W Revision	Prior to A.02.00

“Peak Search” Criteria

This menu lets you decide what kind of search you want to do when the Peak Search key is pressed (or the equivalent SCPI command sent).

Note that there are two “types” of peak search functions. One type is the “Peak Search” type, the other type is the “Next Peak” type. “Next Peak” searches (for example, Next Peak, Next Pk Left, Next Pk Right) are always checked using the Excursion and Threshold criteria as long as these criteria are On. The “Peak Search” type of search, simply finds the highest point on the trace. However you can change the “Peak Search” type of search so that it also uses the Excursion and Threshold criteria. This allows you to find the Maximum point on the trace that also obeys the Excursion and/or Threshold criteria.

When **Highest Peak** is selected, pressing **Peak Search** simply finds the highest peak on the marker’s trace. If **Same as “Next Peak” Criteria** is selected, then the search is also forced to consider the Excursion and Threshold found under the “**Next Peak**” **Criteria** menu.

Key Path	Peak Search, Peak Criteria
Remote Command	:CALCulate:MARKer:PEAK:SEARch:MODE MAXimum PARAmeter

:CALCulate:MARKer:PEAK:SEARch:MODE?	
Notes	MAXimum corresponds to the Highest Peak setting PARameter corresponds to the Same as “Next Peak” Criteria setting
Preset	MAXimum
State Saved	Saved in instrument state.
Readback line	Current state
Backwards Compatibility Notes	The submenu called “Peak Search” Criteria in the X-Series was called Peak Search Type in the ESA, and in the PSA was not a submenu but a single called Peak Search with a toggle between Param and Max. Nonetheless, the functionality and SCPI commands are identical in all three, only the structure of the user interface is different
Initial S/W Revision	Prior to A.02.00

Highest Peak

When this key is selected, pressing the Peak Search key or issuing the equivalent SCPI command finds the maximum point on the trace, subject to the peak-search qualifications. This also affects the Peak Search half of Pk-Pk search and the Continuous Peak Search.

Key Path	Peak Search, Peak Criteria, “Peak Search” Criteria
Example	CALC:MARK:PEAK:SEAR:MODE MAX
Readback	Highest Peak
Initial S/W Revision	Prior to A.02.00

Same as “Next Peak” Criteria

When this key is selected, pressing the Peak Search key or issuing the equivalent SCPI command finds the maximum point on the trace, but subject to the Excursion and Threshold set under the Next Peak Criteria menu. The search is, of course, also subject to the peak-search qualifications. This also affects the Peak Search half of Pk-Pk search and the Continuous Peak Search.

Key Path	Peak Search, Peak Criteria, “Peak Search” Criteria
Example	CALC:MARK:PEAK:SEAR:MODE PAR
Readback	Use Excurs & Thr
Initial S/W Revision	Prior to A.02.00

“Next Peak” Criteria

This key opens up a menu which allows you to independently set the Peak Excursion and Peak Threshold and turn them on and off.

Key Path	Peak Search, Peak Criteria
Backwards	In the X-Series, you can enable Pk Excursion and Pk Threshold independently, but they default to

Compatibility Notes	“both on”. Since “both on” is always the case in ESA and PSA, this difference should not cause code compatibility problems.
Initial S/W Revision	Prior to A.02.00

Pk Excursion

Turns the peak excursion requirement on/off and sets the excursion value. The value defines the minimum amplitude variation (rise and fall) required for a signal to be identified as peak. For example, if a value of

6 dB is selected, peak search functions like the marker Next Pk Right function move only to peaks that rise and fall 6 dB or more.

When both Pk Excursion and Pk Threshold are on, a signal must rise above the Pk Threshold value by at least the **Peak Excursion** value and then fall back from its local maximum by at least the **Peak Excursion** value to be considered a peak.

NOTE

In the event that a sequence of trace points with precisely the same values represents the maximum, the leftmost point is found.

If a signal comes onto the screen falling and falls all the way to the threshold without ever rising, it is considered a peak at the far left edge of the display. Similarly, if a signal rises from the threshold and leaves the screen without ever falling, it is considered a peak at the far right edge of the display.

See ["More Information" on page 813](#).

Key Path	Peak Search, Peak Criteria, “Next Peak” Criteria
Remote Command	:CALCulate:MARKer:PEAK:EXCursion <rel_amp1> :CALCulate:MARKer:PEAK:EXCursion? :CALCulate:MARKer:PEAK:EXCursion:STATE OFF ON 0 1 :CALCulate:MARKer:PEAK:EXCursion:STATE?
Example	:CALC:MARK:PEAK:EXC:STAT ON :CALC:MARK:PEAK:EXC 30 DB sets the minimum peak excursion requirement to 30 dB
Dependencies	Available only when Y axis unit is amplitude units, otherwise grayed out.
Couplings	Whenever you adjust the value of Pk Excursion (with the knob, step keys, or by completing a numeric entry), and Peak Threshold is turned ON, the Peak Threshold Line and the Peak Excursion Region are displayed.
Preset	6.0 dB ON
Preset	6.0 dB ON
State Saved	Saved in instrument state
Min	0.0 dB
Max	100.0 dB
Initial S/W Revision	Prior to A.02.00

More Information

If two signals are very close together and the peak excursion and threshold criteria are met at the outside edges of the combined signals, this function finds the highest of these two signals as a peak (or next peak). However, if a signal appears near the edge of the screen such that the full extent of either the rising or falling edge cannot be determined, and the portion that is on screen does not meet the excursion criteria, then the signal cannot be identified as a peak.

When measuring signals near the noise floor, you can reduce the excursion value even further to make these signals recognizable. To prevent the marker from identifying noise as signals, reduce the noise floor variations to a value less than the peak-excursion value by reducing the video bandwidth or by using trace averaging.

Pk Threshold

Turns the peak threshold requirement on/off and sets the threshold value. The peak threshold value defines the minimum signal level (or min threshold) that the peak identification algorithm uses to recognize a peak.

When both Pk Excursion and Pk Threshold are on, a signal must rise above the Pk Threshold value by at least the **Peak Excursion** value and then fall back from its local maximum by at least the **Peak Excursion** value to be considered a peak.

For example, if a threshold value of -90 dBm is selected, the peak search algorithm will only consider signals with amplitude greater than the -90 dBm threshold. If a threshold value of -90 dBm is selected, and **Peak Excursion** is **On** and set to 6 dB, the peak search algorithm will only consider signals with amplitude greater than the -90 dBm threshold which rise 6 dB above the threshold and then fall back to the threshold.

NOTE

If a signal comes onto the screen falling and falls all the way to the threshold without ever rising, it is considered a peak at the far left edge of the display. Similarly, if a signal rises from the threshold and leaves the screen without ever falling, it is considered a peak at the far right edge of the display.

Key Path	Peak Search, Peak Criteria, "Next Peak Criteria"
Remote Command	:CALCulate:MARKer:PEAK:THReshold <amp;lt;1> :CALCulate:MARKer:PEAK:THReshold? :CALCulate:MARKer:PEAK:THReshold:STATe OFF ON 0 1 :CALCulate:MARKer:PEAK:THReshold:STATe?
Example	CALC:MARK:PEAK:THR:STAT ON turns on the threshold criterion. CALC:MARK:PEAK:THR -60 dBm sets the threshold to -60 dBm.
Dependencies	When Ref Level Offset changes, Peak Threshold must change by the same amount.
Preset	-90.0 dBm ON
State Saved	Saved in instrument state.
Min	The current displayed Ref Level $- 200$ dB. The current displayed Ref Level is the current Ref

	Level, offset by the Ref Level Offset.
Max	The current displayed Ref Level. This means the current Ref Level, offset by the Ref Level Offset.
Default Unit	depends on the current selected Y axis unit
Initial S/W Revision	Prior to A.02.00

Pk Threshold Line

Turns the peak threshold line on or off. Preset state is off. No equivalent SCPI command.

See ["More Information" on page 814](#).

Key Path	Peak Search, Peak Criteria, "Next Peak" Criteria
Initial S/W Revision	Prior to A.02.00

More Information

The Peak Threshold line is green and has the value of the peak threshold (for example, "-20.3 dBm") written above its right side, above the line itself. If Peak Excursion is ON it shows on the left side as a region above the Peak Threshold line. As with all such lines (Display Line, Trigger Level line, etc.) it is drawn on top of all traces.

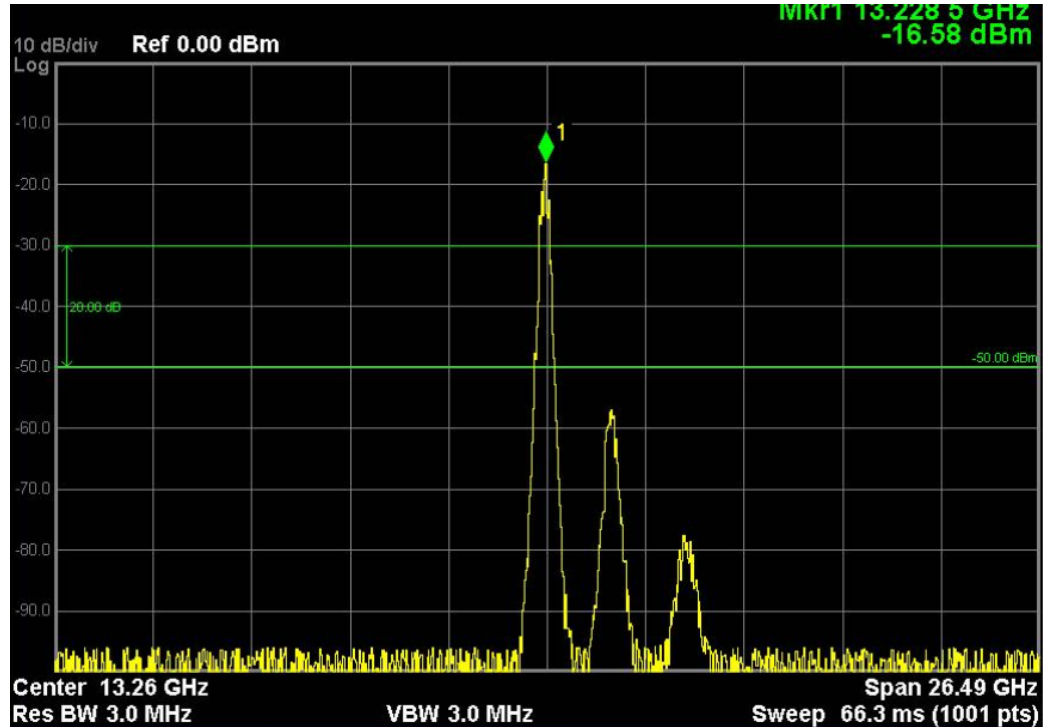

This function is automatically set to ON (thus turning on the Peak Threshold line) whenever the value of Peak Threshold or Peak Excursion becomes the active function, unless Peak Threshold is OFF. It is automatically set to OFF whenever Peak Threshold is set to OFF. Manually turning it ON automatically turns on Pk Threshold.

The Peak Excursion part is on whenever the Pk Threshold part is on, unless Peak Excursion is OFF.

Peak Table

Opens the Peak Table menu.

The Peak Table provides a displayed list of up to 20 signal peaks from the selected trace. If more than one trace window is displayed, the selected trace in the selected window is used. If there are more than 20 signals which meet the peak search criteria, only the 20 highest peaks are listed.

The Peak Table is updated after each sweep. The list of peaks in the Peak Table can be ordered either by ascending frequency or by descending amplitude. In either case, the entire trace is first evaluated and the 20 highest peaks are selected for inclusion in the list. After the peaks are selected, they are then sorted and displayed according to the Peak Sort setting.

Key Path	Peak Search
Initial S/W Revision	Prior to A.02.00

Peak Table On/Off

Turns Peak Table on/off. When turned on, the display is split into a measurement window and a peak table display window.

Turning the Peak Table on turns the Marker Table off and vice versa.

Key Path	Peak Search, Peak Table
Remote Command	:CALCulate:MARKer:PEAK:TABLE:STATE OFF ON 0 1 :CALCulate:MARKer:PEAK:TABLE:STATE?
Example	CALC:MARK:PEAK:TABL:STAT ON Turns on and displays the peak table.
Dependencies	When the Peak Table turns on, if Peak Threshold is On then it becomes the active function.
Preset	OFF
State Saved	Saved in instrument state.
Initial S/W Revision	Prior to A.02.00

Peak Sort

Sets the peak table sorting routine to list the peaks in order of descending amplitude, ascending frequency or descending “Delta to Limit” value. The remote command can also be used to sort the peaks found using the :CALCulate:DATA:PEAKs command.

Key Path	Peak Search, Peak Table
Remote Command	:CALCulate:MARKer:PEAK:SORT FREquency AMPLitude DELTA :CALCulate:MARKer:PEAK:SORT?
Example	CALC:MARK:PEAK:SORT AMPL Sets sorting routine to list peaks in order of descending

	amplitude. CALC:MARK:PEAK:SORT?
Preset	AMPLitude
State Saved	Saved in instrument state.
Backwards Compatibility SCPI	:TRACe:MATH:PEAK:SORT for ESA backward compatibility.
Backwards Compatibility Notes	In the ESA, when Peak Sort was set to ascending frequency, the Peak Table search algorithm would search left to right, including every peak which met the search criteria until the table was full, even if that meant only part of the trace was searched. In the X-Series, the sort is done correctly, sorting the top 20 peaks by ascending frequency.
Initial S/W Revision	Prior to A.02.00
Modified at S/W Revision	A.18.00

Peak Readout

Shows up to twenty signal peaks as defined by the setting:

All (ALL) - lists all the peaks defined by the peak criteria, in the current sort setting.

Above Display Line (GTDLine) - lists the peaks that are greater than the defined display line, and that meet the peak criteria. They are listed in the current sort order.

Below Display Line (LTDLine) - lists the peaks that are less than the defined display line, and that meet the peak criteria. They are listed in the current sort order.

If the peak threshold is defined and turned on, then the peaks must meet this peak criteria in addition to the display line requirements.

See "[More Information](#)" on page 817.

Key Path	Peak Search, Peak Table
Remote Command	:CALCulate:MARKer:PEAK:TABLE:READout ALL GTDLine LTDLine :CALCulate:MARKer:PEAK:TABLE:READout?
Example	CALC:MARK:PEAK:TABL:READ GTDL
Dependencies	Turning Display Line off forces Readout to ALL
Preset	All
Preset	All
State Saved	Saved in instrument state.
Readback line	1-of-N selection
Backwards Compatibility Notes	In ESA the display line does not have to be on for a peak to be qualified "above display line" or "below display line." In X-Series the display line has to be on to be used to exclude peaks.
Initial S/W Revision	Prior to A.02.00

More Information

If the Display Line (see the Section “View/Display”) is turned on, the Peak Table can be selected to include all peaks, only those above the Display Line, or only those below the Display Line. See Figures 1–2 and 1–3 to understand what happens if both Display Line and Pk Threshold are turned on.

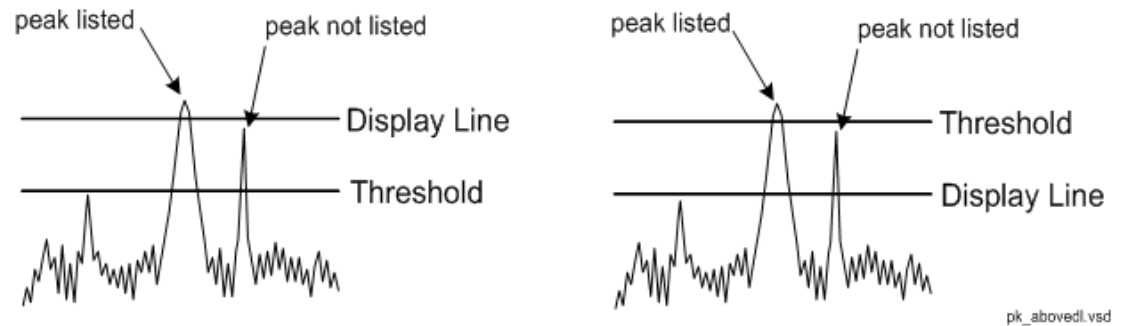

Figure 1- 2 Above Display Line Peak Identification

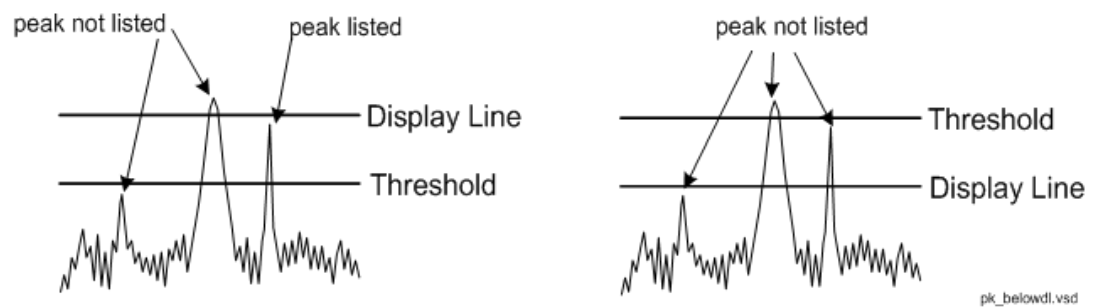

Figure 1- 3 Below Display Line Peak Identification

All

Sets the peak table to display the 20 highest peaks in the order specified by the current Peak Sort setting. If the Peak Criteria are turned on, then only peaks that meet the defined Pk Excursion and Pk Threshold values will be found.

Key Path	Peak Search, Peak Table, Peak Readout
Example	CALC:MARK:PEAK:TABL:READ ALL
Notes	Auto return after pressed
Readback	All
Initial S/W Revision	Prior to A.02.00

Above Display Line

Sets the peak table to display only the 20 highest peaks above the display line in the order specified by the current Sort setting. If the Peak Criteria are turned on, then only peaks that meet the defined criteria will be found. If the display line is not already on, it is turned on (it has to be on or it cannot be used to exclude peaks).

Key Path	Peak Search, Peak Table, Peak Readout
Example	CALC:MARK:PEAK:TABL:READ GTDL
Notes	Auto return after pressed
Dependencies	When Above Display Line is selected, Display Line is turned on and becomes the active function.
Readback	Above DL
Initial S/W Revision	Prior to A.02.00

Below Display Line

Sets the peak table to display only the 20 highest peaks below the display line as defined by the peak in the order specified by the current Sort setting. If the Peak Criteria are turned on, then only peaks that meet the defined criteria will be found. If the display line is not already on, it is turned on (it has to be on or it cannot be used to exclude peaks).

Key Path	Peak Search, Peak Table, Peak Readout
Example	CALC:MARK:PEAK:TABL:READ LTDL
Notes	Auto return after pressed
Dependencies	When Below Display Line is selected, Display Line is turned on and becomes the active function.
Readback	Below DL
Initial S/W Revision	Prior to A.02.00

Δ to Limit On/Off

Turns the Δ to Limit column on and off in the Peak Table.

When on, this column shows the difference between each peak and the specified Limit.

The Limit to use for this column is specified using the Delta to Limit Line key.

Key Path	Peak Search, Peak Table
Remote Command	:CALCulate:MARKer:PEAK:TABLE:DTLimit LLINE1 LLINE2 LLINE3 LLINE4 LLINE5 LLINE6 :CALCulate:MARKer:PEAK:TABLE:DTLimit? :CALCulate:MARKer:PEAK:TABLE:DTLimit:STATE ON OFF :CALCulate:MARKer:PEAK:TABLE:DTLimit:STATE?
Example	CALC:MARK:PEAK:TABL:DTL:STAT ON CALC:MARK:PEAK:TABL:DTL LLINE1
Preset	LLINE1

	OFF
Initial S/W Revision	A.18.00
Control Type	Toggle
Control Name	Δ to Limit

Δ to Limit Line

Selects the Limit to be used for the Δ to Limit column in the Peak Table.

(For the SCPI command, see Δ to Limit On/Off)

Key Path	Peak Search, Peak Table
Example	CALC:MARK:PEAK:TABL:DTL:STAT ON
Initial S/W Revision	A.18.00
Control Type	1 of N
Control Name	Δ to Limit Line

Continuous Peak Search

Turns Continuous Peak Search on or off. When Continuous Peak Search is on, a peak search is automatically performed for the selected marker after each sweep. The rules for finding the peak are exactly the same as for **Peak Search**, including the use of the peak criteria rules. If no valid peak is found, a “No peak found” message is generated after each sweep.

See ["More Information" on page 820](#).

Key Path	Peak Search
Remote Command	:CALCulate:MARKer[1] 2 ... 12:CPSearch[:STATe] ON OFF 1 0 :CALCulate:MARKer[1] 2 ... 12:CPSearch[:STATe]?
Example	CALC:MARK:CPS ON Turns on Continuous Peak Search.
Notes	Sending this command selects the subopcoded marker
Couplings	The Continuous Peak Search key is grayed out when the selected marker is a Fixed marker. Also, if Continuous Peak Search is on and the selected marker becomes a fixed marker, then Continuous Peak Search is turned off and the key grayed out. Signal Track and Continuous Peak Search are mutually exclusive so if Signal Track is on, Continuous Peak Search will be grayed out and vice versa.
Preset	Mode Preset
State Saved	Saved in instrument state.
Status Bits/OPC dependencies	The Measuring bit should remain set while this command is operating and should not go false until the marker position has been updated.
Backwards Compatibility Notes	In ESA and PSA, the Continuous Pk function would only consider a peak within a small window relative to the marker's previous position, and thus was designed to track a signal drifting in frequency but with similar amplitude. The new Continuous Peak Search function simply performs a Peak Search operation after each sweep with no regard for the marker's previous position.

Because of this difference, the SCPI commands for the old command (CPEak) is not accepted by the X-Series.

Also in ESA and PSA, Continuous Pk was grayed out when span equaled zero. The new Continuous Peak Search function will be available within zero span.

Also in ESA and PSA, turning Continuous Pk on would not automatically execute a peak search. A peak search would not be performed until the end of the next sweep. The new Continuous Peak Search function will perform a peak search when it is turned on, without waiting for the next sweep to complete.

Initial S/W Revision

Prior to A.02.00

More Information

When Continuous Peak Search is turned on a peak search is immediately performed and then is repeated after each sweep. If Continuous Peak Search is turned on with the selected marker off, the selected marker is set to **Normal** at the center of the screen, and then a peak search is immediately performed and subsequently repeated after each sweep.

When in Continuous Peak Search, *OPC will not return true, nor will READ or MEASure return any data, until the sweep is complete and the marker has been re-peaked. Note further that if the analyzer is in a measurement such as averaging, and Continuous Peak Search is on, the entire measurement will be allowed to complete (i.e., all the averages taken up to the average number) before the repeak takes place, and only THEN will *OPC go true and READ or MEASure return data.

Note that this function is not the “Continuous Peak” function found in some other instruments. That function was designed to track the signal; this function simply does a Peak Search after each sweep.

When Continuous Peak Search is turned on for a marker, a little “hat” is placed above the marker.



Pk-Pk Search

Finds and displays the amplitude and frequency (or time, if in zero span) differences between the highest and lowest y-axis value. It places the selected marker on the minimum value on its selected trace. And it places that marker's reference marker on the peak of its selected trace. This function turns on the reference marker and sets its mode to **Fixed** if it is not already on. (These markers may be on two different traces.)

The rules for finding the maximum peak are exactly the same as for **Peak Search**, including the use of the peak criteria rules. However, the minimum trace value is not required to meet any criteria other than being the minimum y-axis value in the trace.

If the selected marker is off, a delta type marker is turned on and the peak-to-peak search is done. If the selected marker is on, but it is not a delta marker, then it is changed to delta which turns on the reference marker if needed, and then it performs the peak-to-peak function.

Key Path	Peak Search
Remote Command	:CALCulate:MARKer[1] 2 ... 12:PTPeak
Example	CALC:MARK:PTP CALC:MARK:Y? queries the delta amplitude value for marker 1.
Notes	Turns on the Marker Δ active function.
Notes	Sending this command selects the subopcoded marker.
Dependencies	Pk-Pk Search is grayed out when Coupled Markers is on.
Couplings	The selected marker becomes a delta marker if not already in delta mode.
State Saved	Not part of saved state.
Initial S/W Revision	Prior to A.02.00

Min Search

Moves the selected marker to the minimum y-axis value on the current trace. Minimum (negative) peak searches do not have to meet the peak search criteria. It just looks for the lowest y-axis value. If the selected marker is Off, it is turned on before the minimum search is performed.

Key Path	Peak Search
Remote Command	:CALCulate:MARKer[1] 2 ... 12:MINimum
Example	CALC:MARK:MIN Selects marker 1 and moves it to the minimum amplitude value.
Notes	Sending this command selects the subopcoded marker.
State Saved	Not part of saved state.
Initial S/W Revision	Prior to A.02.00

Peak Search All Traces

In the Spectrogram View, when the Peak Search All Traces key is pressed, a Peak Search is executed that finds the highest point on ALL of the drawn traces in the Spectrogram window. The marker moves there and the Display Trace changes to the trace on which the peak was found.

This function obeys the Peak Criteria in the same way as the normal Peak Search function does.

Remote Command	<code>:CALCulate:MARKer[1 2 ... 12:MAXimum:ALL</code>
Example	CALC:MARK2:MAX:ALL SYST:ERR? can be used to query the errors to determine if a peak is found. The message "No peak found" will be returned after an unsuccessful search.
Notes	Sending this command selects the subopcoded marker.
Dependencies	Only appears in the Spectrogram View. If sent outside of Spectrogram, generates an error
Initial S/W Revision	A.10.01

Peak Data Query (RemoteCommand Only)

This command works the same way in this and many other measurements. For details about this key, see Calculate Peaks of Trace Data (Remote Command Only)@29982.

Query the Signal Peaks (Remote Command Only)

Provided for backwards compatibility with ESA and PSA. It is recommended that you use CALC:DATA:PEAK instead.

Outputs the signal peaks by frequency or by amplitude. This command uses only Trace 1 data. The sort mode is determined by the command :TRACe:MATH:PEAK:SORT. The commands :CALCulate:MARKer:PEAK:EXCursion and :CALCulate:MARKer:PEAK:THReshold are used to determine what is a signal peak. To get the number of signals found meeting the specified limits, use the query :TRACe:MATH:PEAK:POINTs?

Remote Command	<code>:TRACe:MATH:PEAK[:DATA]?</code>
Example	TRAC:MATH:PEAK? Will identify the peaks of trace 1 that are above the Peak Threshold (if Threshold is ON) and have an excursion above the Peak Excursion (if Excursion is ON).
Initial S/W Revision	Prior to A.02.00

Query Number of Peaks Found (Remote Command Only)

Provided for backwards compatibility with ESA and PSA. It is recommended that you use CALC:DATA:PEAK instead.

Outputs the number of signal peaks identified. The amplitude of the peaks can then be queried with :TRACe:MATH:PEAK:DATA? This command uses only Trace 1 data.

Remote Command	:TRACe:MATH:PEAK:POINts?
Example	TRAC:MATH:PEAK:POINts? Will identify the number of peaks of trace 1 that are above the Peak Threshold (if Threshold is ON) and have an excursion above the Peak Excursion (if Excursion is ON).
Initial S/W Revision	Prior to A.02.00

Print

See "Print " on page 430

Quick Save

The Quick Save front-panel key repeats the most recent save that was performed from the Save menu, with the following exceptions:

- Register saves are not remembered as Saves for the purpose of the Quick Save function
- If the current measurement does not support the last non-register save that was performed, an informational message is generated, “File type not supported for this measurement”

Quick Save repeats the last type of qualified save (that is, a save qualified by the above criteria) in the last save directory by creating a unique filename using the Auto File Naming algorithm described below.

If Quick Save is pressed after startup and before any qualified Save has been performed, the Quick Save function performs a Screen Image save using the current settings for Screen Image saves (current theme, current directory), which then becomes the “last save” for the purpose of subsequent Quick Saves.

The Auto File Naming feature automatically generates a file name for use when saving a file. The filename consists of a prefix and suffix separated by a dot, as is standard for the Windows® file system. A default prefix exists for each of the available file types:

Type	Default Prefix	Menu
State	State_	(Save/Recall)
Trace + State	State_	(Save/Recall)
Screen	Screen_	(Save/Recall)
Amplitude Corrections	Ampcor_	(Import/Export)
Traces	Trace_	(Import/Export)
Limit Lines	LLine_	(Import/Export)
Measurement Result	MeasR_	(Import/Export)
Capture Buffer	CapBuf_	(Import/Export)

A four digit number is appended to the prefix to create a unique file name. The numbering sequence starts at 0000 within each Mode for each file type and updates incrementally to 9999, then wraps to 0000 again. It remembers where it was through a Mode Preset and when leaving and returning to the Mode. It is reset by Restore Misc Defaults and Restore System Defaults and subsequent running of the instrument application. So, for example, the first auto file name generated for State files is State_0000.state. The next is State_0001, and so forth.

One of the key features of Auto File Name is that we guarantee that the Auto File Name will never conflict with an existing file. The algorithm looks for the next available number. If it gets to 9999, then it looks for holes. If it find no holes, that is no more numbers are available, it gives an error.

For example, if when we get to State_0010.state there is already a State_0010.state file in the current directory, it advances the counter to State_0011.state to ensure that no conflict will exist (and then it verifies that State_0011.state also does not exist in the current directory and advances again if it does, and so forth).

If you enter a file name for a given file type, then the prefix becomes the filename you entered instead of the default prefix, followed by an underscore. The last four letters (the suffix) are the 4-digit number.

For example, if you save a measurement results file as "fred.csv", then the next auto file name chosen for a measurement results save will be fred_0000.csv.

NOTE

Although 0000 is used in the example above, the number that is used is actually the current number in the Meas Results sequence, that is, the number that would have been used if you had not entered your own file name.

If the filename you entered ends with _dddd, where d=any number, making it look just like an auto file name, then the next auto file name picks up where you left off with the suffix being dddd + 1.

Key Path	Front-panel key
Notes	No remote command for this key specifically.
Initial S/W Revision	Prior to A.02.00

Recall

The **Recall** menu lets you choose what you want to recall, and where you want to recall it from. Among the types of files you can recall are **States and Traces**. In addition, an **Import (Data)** option lets you recall a number of data types stored in CSV files (as used by Excel and other spreadsheet programs).

The default paths for Recall are data type dependent and are the same as for the Save key.

Key Path	Front-panel key
Notes	<p>No remote command for this key specifically, but the :MMEM:LOAD command is available for specific file types. An example is :MMEM:LOAD:STATe <filename>.</p> <p>If you try to recall a State file for a mode that is not licensed or not available in the instrument, an error message will occur and the state will not change.</p>
Backwards Compatibility Notes	<p>In legacy analyzers, it was possible to load a state without affecting the trace data, limit lines or correction data. Similarly (since User Preset is actually loading a state), it was possible to do a User Preset without affecting the trace data, limit lines or correction data.</p> <p>In the X-Series, "state" always includes all of this data; so whenever state is loaded, all of the traces, limit lines and corrections are affected. Although this differs from previous behavior, it is desirable behavior, and should not cause adverse issues for users.</p>
Backwards Compatibility Notes	<p>Recall for the X-Series supports backward compatibility in the sense that you can recall a state file from any X-Series model number and any version of X-Series software. This is only possible if part of the recalling process goes through a limiting step after recalling the mode settings, at least for settings that may vary with version number, model number, option and license differences. If you try to recall a state file onto an instrument with less capability than what was available on the instrument during the save, the recall will ignore the state it doesn't support and it will limit the recalled setting to what it allows.</p> <p>Example: if the saved state includes preamp ON, but the recalling instrument does not have a preamp; the preamp is limited to OFF. Conversely, if you save a state without a preamp, the preamp is OFF in the state file. When this saved file is recalled on an instrument with a licensed preamp, the preamp is changed to OFF. Another example is if the saved state has center frequency set to 20 GHz, but the instrument recalling the saved state is a different model and only supports 13.5 GHz. In this case, the center frequency is limited along with any other frequency based settings. Since the center frequency can't be preserved in this case, the recall limiting tries to at least preserve span to keep the measurement setup as intact as possible.</p> <p>It may be appropriate to issue a warning if the state is limited on the recall; warnings do not go out to SCPI so this would only affect the manual user.</p> <p>Note that there is no state file compatibility outside of the X-Series. For example, you cannot recall a state file from ESA or PSA.</p>
Initial S/W Revision	Prior to A.02.00

State

The **Recall State** menu lets you choose a register or file from which to recall the state.

The content of a state file includes all of the settings and data required to return the analyzer as closely as possible to the Mode it was in, with the exact settings that were in place, when the save occurred. The Mode settings in each state file include the settings that are affected by Mode Preset, as well as the additional settings affected by Restore Mode Defaults; all of the Mode's settings. In addition, all of the settings of the **Input/Output** system are included, even though they are outside of the Mode's state, because they are needed to restore the complete setup. Persistent System settings (for example, GPIB address) are not affected by either a Mode Preset or Restore Mode Defaults, nor are they included in a saved State file.

Since each state file is only for one Mode, the settings for other Modes are unaffected when it is loaded. **Recall State** will cause a mode switch if the state being recalled is not from the current active mode.

After the recall completes, the message "File <filename> recalled" or "Recalled State Register <register number>" is displayed.

For rapid recalls, the State menu lists 16 registers that you can choose from to recall. Pressing a Register key initiates the recall. You can also select a file from which to recall.

The default path for all State Files is:

My Documents\<<mode name>\state

where <mode name> is the parameter used to select the mode with the INST:SEL command (for example, SA for the Spectrum Analyzer).

See "[More Information](#)" on page 829.

Key Path	Recall
Mode	All
Remote Command	:MMEMory:LOAD:STATe <filename>
Example	:MMEM:LOAD:STAT "myState.state" This recalls the file myState.state on the default path
Example	MMEM:LOAD:STAT "MyStateFile.state" This loads the state file data (on the default file directory path) into the instrument state.
Notes	When you pick a file to recall, the analyzer first verifies that the file is recallable in the current instrument by checking the software version and model number of the instrument. If everything matches, a full recall proceeds by aborting the currently running measurement, clearing any pending operations, and then loading the State from the saved state file. You can open state files from any mode, so recalling a State file switches to the mode that was active when the save occurred. After switching to the mode of the saved state file, mode settings and data (if any for the mode) are loaded with values from the saved file. The saved measurement of the mode becomes the newly active measurement and the data relevant to the measurement (if there is any) is recalled. <ul style="list-style-type: none"> - If there is a mismatch between file version or model number or instrument version or model number, the recall function tries to recall as much as possible and returns a warning message. It may limit settings that differ based on model number, licensing or version number.

After recalling the state, the Recall State function does the following:

- Makes the saved measurement for the mode the active measurement.
- Clears the input and output buffers.
- Status Byte is set to 0.
- Executes a *CLS

If the file specified is empty an error is generated. If the specified file does not exist, another error is generated. If there is a mismatch between the file and the proper file type, an error is generated. If there is a mismatch between file version or model number or instrument version or model number, a warning is displayed. Then it returns to the State menu and File Open dialog goes away.

After the Recall, the analyzer exits the Recall menu and returns to the previous menu.

**Backwards
Compatibility SCPI**

:MMEMory:LOAD:STATE 1,<filename>

For backwards compatibility, the above syntax is supported. The "1" is simply ignored.

Initial S/W Revision

Prior to A.02.00

More Information

In measurements that support saving Traces, for example, Swept SA, the Trace data is saved along with the State in the State file. When recalling the State, the Trace data is recalled as well. Traces are recalled exactly as they were stored, including the writing mode and update and display modes. If a Trace was updating and visible when the State was saved, it will come back updating and visible, and its data will be rewritten right away. When you use State to save and recall traces, any trace whose data must be preserved should be placed in View or Blank mode before saving.

The following table describes the Trace Save and Recall possibilities:

You want to recall state and one trace's data, leaving other traces unaffected.	Save Trace+State from 1 trace. Make sure that no other traces are updating (they should all be in View or Blank mode) when the save is performed.	On Recall, specify the trace you want to load the one trace's data into. This trace will load in View. All other traces' data will be unaffected, although their trace mode will be as it was when the state save was performed.
You want to recall all traces	Save Trace+State from ALL traces.	On Recall, all traces will come back in View (or Blank if they were in Blank or Background when saved)
You want all traces to load exactly as they were when saved.	Save State	On recall, all traces' mode and data will be exactly as they were when saved. Any traces that were updating will have their data immediately overwritten.

From File...

When you press “From File”, the analyzer brings up a Windows dialog and a menu entitled “File Open.” This menu allows you to navigate to the various fields in the Windows dialog without using a keyboard or mouse. The **Tab** and **Arrow** keys can also be used for dialog navigation.

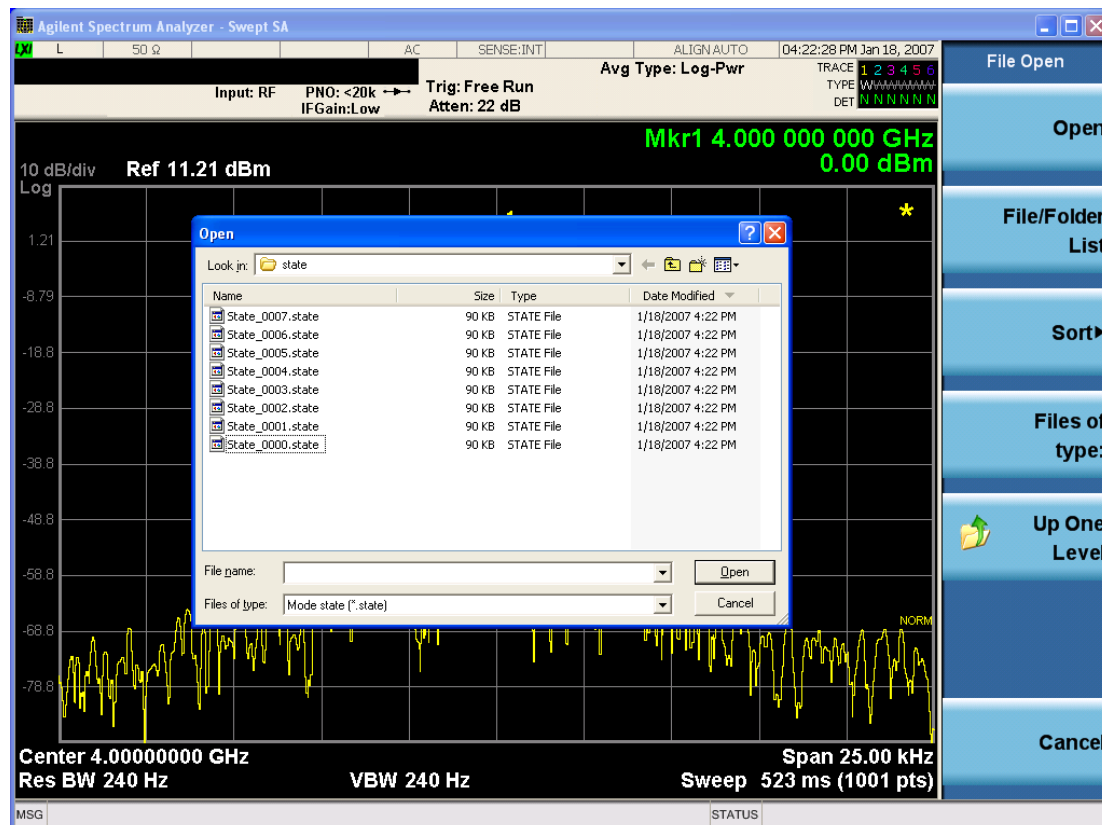

Listed below are the functions of the various fields in the dialog, and the corresponding softkeys:

Open

Performs the recall of the specified file. While the recall is being performed, the floppy icon appears briefly in the Meas bar.

File/Folder List

Enables you to navigate to the center of the dialog that contains the list of files and folders. Once here you can get information about the file and use the tab keys to navigate to the other fields in the dialog, such as Look In.

Look In

The **Look In** field shows the path from which the file will be recalled and allows you to change the path using the up and down arrow keys to navigate to other paths; the Enter key to open a directory; and the Backspace key to go back one directory. The **Look In** field first uses the last path from the Save As dialog **Save In:** path for that

same file type. There is no softkey for directly navigating to the Look In field, but you can use the left tab to get here from the File/Folder List.

User specified paths are remembered when you leave and return to a Mode and are reset back to the default using **Restore Mode Defaults**.

Sort

Accesses a menu that enables you to sort the files within the File Open dialog. Only one sorting type can be selected at a time and the sorting happens immediately. The sorting types are **By Date**, **By Name**, **By extension**, and **By Size**.

Files of Type

This field shows the file suffix for the type of file you have selected to recall. For example, if you navigated here while recalling State, "Mode state (*.state)" is in the field. If you navigated here while recalling Trace, "Mode state (*.trace)" is in the field. If you navigated here while importing a trace data file, "Trace Data (*.csv)" is in the field. For some file types, there is more than one choice in the dropdown menu, which you can select by using the up and down arrow keys and Enter.

Up One Level

This key corresponds to the icon of a folder with the up arrow that is in the tool bar of the dialog. When pressed, it causes the file and folder list to navigate up one level in the directory structure. The Backspace key does the same thing.

Cancel

This key corresponds to the **Cancel** selection in the dialog. It causes the current **Open** request to be cancelled. The ESC key does the same thing.

Key Path	Recall, State
Notes	Brings up the Open dialog for recalling a State Save Type
Initial S/W Revision	Prior to A.02.00

Edit Register Names

You may enter a custom name on any of the Register keys, to help you remember what you are using that state to save. To do this, press the **Edit Register Names** key, choose the register whose name you wish to edit, and then enter the desired label using the Alpha Editor or an external PC keyboard.

The maximum number of characters that can be added is 30. In most cases, 30 characters will fit on two lines of the key.

For more information and the SCPI command, see Edit Register Names under the **Save, State** function.

Key Path	Recall, State
Mode	All
Dependencies	N9060A-7FP or N9060B-2FP license required to edit the register names. When the feature is not

	licensed, sending the SCPI command generates an error, -221, "Settings conflict;Option not available"
Initial S/W Revision	A.11.00

Register 1 thru Register 16

Selecting any one of these register keys causes the State of the mode from the specified Register to be recalled. Each of the register keys annotates whether it is empty or at what date and time it was last modified. In addition, you can use the **Edit Register Names** key under **Save, State** to enter custom names for each register.

Registers are shared by all modes, so recalling from any one of the registers will cause a mode switch to the mode that was active when the save to the Register occurred.

Although these 16 registers are the only registers available from the front panel, there are 128 state registers available in the instrument. Registers 17-128 are only available from the SCPI interface, using the *RCL command.

After the recall completes, the message "Register <register number> recalled" appears in the message bar. If you are in the Spectrum Analyzer Mode, and you are recalling a register that was saved in the Spectrum Analyzer Mode, then after the recall, you will still be in the Recall Register menu. If the Recall causes you to switch modes, then after the Recall, you will be in the Frequency menu.

If a requested register is empty an error is generated.

Key Path	Recall, State
Example	*RCL 1
Range	1-16 from front panel, 1-128 from SCPI
Readback	Date and time with seconds resolution are displayed on the key OR A custom name of up to 30 characters entered using the Save, State,Edit Register Names key OR “(empty)” if no prior save operation has been performed to this register.
Initial S/W Revision	Prior to A.02.00
Modified at S/W Revision	Prior to A.11.00

Register 1 thru Register 16

Selecting any one of these register keys causes the State of the mode from the specified Register to be recalled. Each of the register keys annotates whether it is empty or at what date and time it was last modified. In addition, you can use the **Edit Register Names** key under **Save, State** to enter custom names for each register.

Registers are shared by all modes, so recalling from any one of the registers will cause a mode switch to the mode that was active when the save to the Register occurred.

Although these 16 registers are the only registers available from the front panel, there are 128 state registers available in the instrument. Registers 17-128 are only available from the SCPI interface, using the *RCL command.

After the recall completes, the message "Register <register number> recalled" appears in the message bar. If you are in the Spectrum Analyzer Mode, and you are recalling a register that was saved in the Spectrum Analyzer Mode, then after the recall, you will still be in the Recall Register menu. If the Recall causes you to switch modes, then after the Recall, you will be in the Frequency menu.

If a requested register is empty an error is generated.

Key Path	Recall, State
Example	*RCL 1
Range	1-16 from front panel, 1-128 from SCPI
Readback	Date and time with seconds resolution are displayed on the key OR A custom name of up to 30 characters entered using the Save, State, Edit Register Names key OR “(empty)” if no prior save operation has been performed to this register.
Initial S/W Revision	Prior to A.02.00
Modified at S/W Revision	Prior to A.11.00

Trace (+State)

The Recall Trace (+State) menu lets you choose a register or file from which to recall the Trace+State state file.

A saved state contains all of the settings and data required to return the analyzer as closely as possible to the exact setup it had when the save occurred. This includes the Input/Output settings, even though they are outside of the Mode's state, because they are needed to restore the complete setup. A Trace+State file also includes trace data from one trace or all traces, which will load in View mode when the Trace+State file is recalled. Recall Trace (+State) will also cause a mode switch if the state being recalled is not for the current active mode.

After the recall completes, the message "File <filename> recalled" or "Recalled Trace Register <register number>" is displayed.

For rapid recalls, the Trace (+State) menu lists 5 registers to choose from to recall. Pressing a Register key initiates the recall. You can also select a file from which to recall.

The default path for all State Files including .trace files is:

My Documents\<<mode name>\state

where <mode name> is the parameter used to select the mode with the INST:SEL command (for example, SA for the Spectrum Analyzer).

Key Path	Recall
Mode	SA
Remote Command	:MMEMory:LOAD:TRACe TRACE1 TRACE2 TRACE3 TRACE4 TRACE5 TRACE6,<filename> :MMEMory:LOAD:TRACe:REGister TRACE1 TRACE2 TRACE3 TRACE4 TRACE5 TRACE6,<integer>
Example	MMEM:LOAD:TRAC TRACE2, "MyTraceFile.trace" This loads the trace file data (on the default file directory path) into the specified trace; if it is a "single trace" save file, that trace is loaded to trace 2, and is set to be not updating. :MMEM:LOAD:TRAC:REG TRACE1,2 restores the trace data in register 2 to Trace 1
Notes	When you perform the recall, the recalling Trace function must first verify the file is recallable in this instrument by checking instrument software version and model number, since it includes State. If everything matches, a full recall proceeds by aborting the currently running measurement, and loading the state from the saved state file to as close as possible to the context in which the save occurred. You can open .trace files from any mode that supports them, so recalling a Trace file switches to the mode that was active when the save occurred. After switching to the mode of the saved state file, mode settings and data (if any for the mode) are loaded with values from the saved file and the saved measurement of the mode becomes the newly active measurement, and the data relevant to the measurement (if there is any) is recalled. Once the state is loaded, the trace data must be loaded. The internal flags are consulted to see which trace to load and the "To Trace" setting to see where to load it. Trace data is always loaded with the specified trace set to View, so that the data is visible and not updating (so as not to erase the recalled data). If the file is an "all trace" file, all traces are loaded with the saved data (to the original trace the data was saved from) and set to View. Traces whose data is not loaded are restored to the update state that existed when they were saved. After the Recall the analyzer exits the Recall menu and returns to the previous menu. Some modes and measurements do not have available all 6 traces. Phase Noise mode command, for example, is: MMEMory:LOAD:TRACe TRACE1 TRACE2 TRACE3,<filename> Some modes and measurements have more than 6 traces available. The Realtime SA mode command, for example, is: MMEMory:STORe:TRACe TRACE1 TRACE2 TRACE3 TRACE4 TRACE5 TRACE6 TRACE7 TRACE8 TRACE9 TRACE10 TRACE11 TRACE12 ALL,<filename>
Initial S/W Revision	Prior to A.02.00

To Trace

These menu selections let you choose the Trace where the recalled saved trace will go. Not all modes have the full 6 traces available. The default is the currently selected trace, selected in this menu or in the Trace/Detector, Export Data, Import Data, or Save Trace menus, except if you have chosen All, then it remains chosen until you specifically change it to a single trace.

If the .trace file is an "all trace" file, "To Trace" is ignored and the traces each go back to the trace from which they were saved.

Once selected, the key returns back to the Recall Trace menu and the selected Trace number is annotated on the key. Now you have selected exactly where the

trace needs to be recalled. To trigger a recall of the selected Trace, you must select the **Open** key in the Recall Trace menu.

When you select a trace, it makes that trace the current trace, so it displays on top of all of the other traces.

Key Path	Save, Data, Trace
Mode	SA
Initial S/W Revision	Prior to A.02.00

Register 1 thru Register 16

Selecting any one of these register keys causes the State of the mode from the specified Register to be recalled. Each of the register keys annotates whether it is empty or at what date and time it was last modified. In addition, you can use the **Edit Register Names** key under **Save, State** to enter custom names for each register.

Registers are shared by all modes, so recalling from any one of the registers will cause a mode switch to the mode that was active when the save to the Register occurred.

Although these 16 registers are the only registers available from the front panel, there are 128 state registers available in the instrument. Registers 17-128 are only available from the SCPI interface, using the *RCL command.

After the recall completes, the message "Register <register number> recalled" appears in the message bar. If you are in the Spectrum Analyzer Mode, and you are recalling a register that was saved in the Spectrum Analyzer Mode, then after the recall, you will still be in the Recall Register menu. If the Recall causes you to switch modes, then after the Recall, you will be in the Frequency menu.

If a requested register is empty an error is generated.

Key Path	Recall, State
Example	*RCL 1
Range	1-16 from front panel, 1-128 from SCPI
Readback	Date and time with seconds resolution are displayed on the key OR A custom name of up to 30 characters entered using the Save, State, Edit Register Names key OR “(empty)” if no prior save operation has been performed to this register.
Initial S/W Revision	Prior to A.02.00
Modified at S/W Revision	Prior to A.11.00

From File...

When you press “From File”, the analyzer brings up a Windows dialog and a menu entitled “**File Open.**” This menu allows you to navigate to the various fields in the

Windows dialog without using a keyboard or mouse. The **Tab** and **Arrow** keys can also be used for dialog navigation.

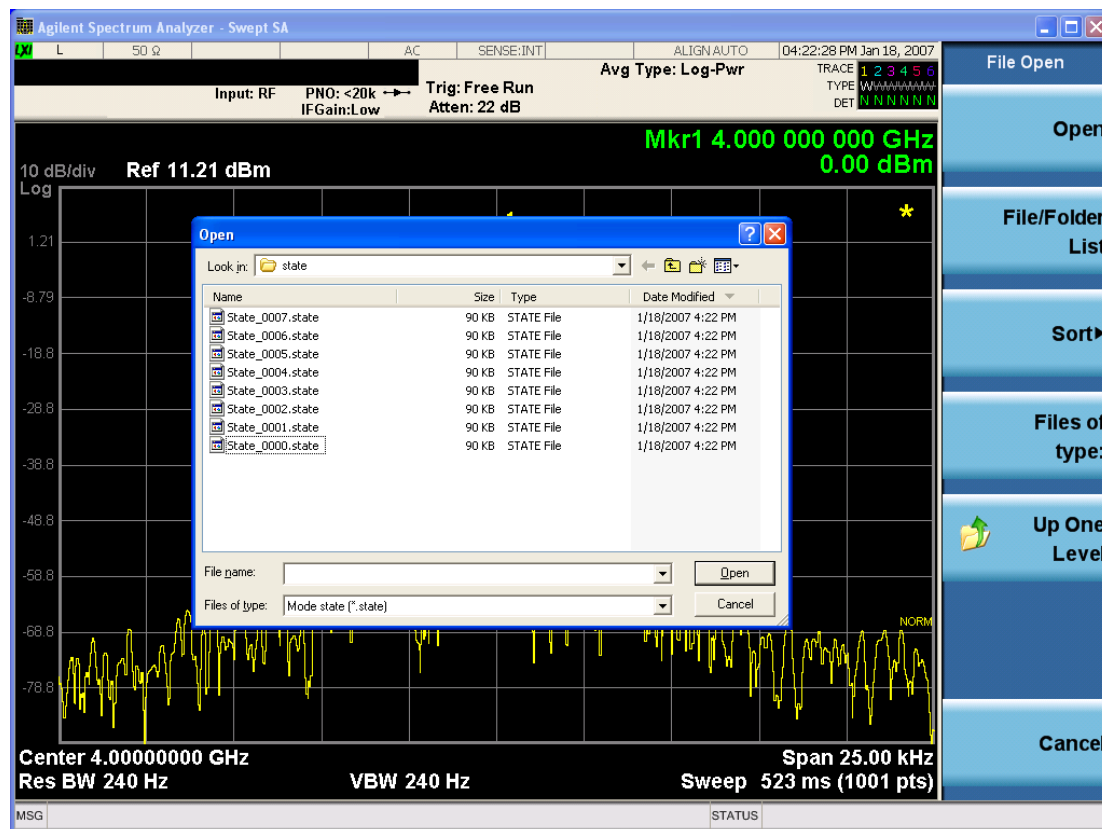

Listed below are the functions of the various fields in the dialog, and the corresponding softkeys:

Open

Performs the recall of the specified file. While the recall is being performed, the floppy icon appears briefly in the Meas bar.

File/Folder List

Enables you to navigate to the center of the dialog that contains the list of files and folders. Once here you can get information about the file and use the tab keys to navigate to the other fields in the dialog, such as Look In.

Look In

The **Look In** field shows the path from which the file will be recalled and allows you to change the path using the up and down arrow keys to navigate to other paths; the Enter key to open a directory; and the Backspace key to go back one directory. The **Look In** field first uses the last path from the Save As dialog **Save In**: path for that same file type. There is no softkey for directly navigating to the Look In field, but you can use the left tab to get here from the File/Folder List.

User specified paths are remembered when you leave and return to a Mode and are reset back to the default using **Restore Mode Defaults**.

Sort

Accesses a menu that enables you to sort the files within the File Open dialog. Only one sorting type can be selected at a time and the sorting happens immediately. The sorting types are **By Date**, **By Name**, **By extension**, and **By Size**.

Files of Type

This field shows the file suffix for the type of file you have selected to recall. For example, if you navigated here while recalling State, "Mode state (*.state)" is in the field. If you navigated here while recalling Trace, "Mode state (*.trace)" is in the field. If you navigated here while importing a trace data file, "Trace Data (*.csv)" is in the field. For some file types, there is more than one choice in the dropdown menu, which you can select by using the up and down arrow keys and Enter.

Up One Level

This key corresponds to the icon of a folder with the up arrow that is in the tool bar of the dialog. When pressed, it causes the file and folder list to navigate up one level in the directory structure. The Backspace key does the same thing.

Cancel

This key corresponds to the **Cancel** selection in the dialog. It causes the current **Open** request to be cancelled. The ESC key does the same thing.

Key Path	Recall, State
Notes	Brings up the Open dialog for recalling a State Save Type
Initial S/W Revision	Prior to A.02.00

Data (Import)

Importing a data file loads data that was previously saved from the current measurement or from other measurements and/or modes that produce compatible data files. The Import Menu only contains Data Types that are supported by the current measurement.

Since the commonly exported data files are in .csv format, the data can be edited by the user prior to importing. This allows you to export a data file, manipulate the data in Excel (the most common PC Application for manipulating .csv files) and then import it.

Importing Data loads measurement data from the specified file into the specified or default destination, depending on the data type selected. Selecting an Import Data menu key will not actually cause the importing to occur, since the analyzer still needs to know from where to get the data. Pressing the Open key in this menu brings up the Open dialog and Open menu that provides you with the options from where to recall the data. Once a filename has been selected or entered in the Open menu, the recall occurs as soon as the Open button is pressed.

Key Path	Recall
----------	---------------

Mode	All
Notes	The menu is built from whatever data types are available for the mode. Some keys will be missing completely, so the key locations in the sub-menu will vary. No SCPI command directly controls the Data Type that this key controls. The Data Type is included in the MMEM:LOAD commands.
Dependencies	If a file type is not used by a certain measurement, it is grayed out for that measurement. The key for a file type will not show at all if there are no measurements in the Mode that support it.
Preset	Is not affected by Preset or shutdown, but is reset during Restore Mode Defaults
Readback	The data type that is currently selected
Initial S/W Revision	Prior to A.02.00

Amplitude Correction

This key selects the Amplitude Corrections as the data type to be imported. When pressed a second time, it brings up the Select Menu, which lets you select the Correction into which the data will be imported.

Amplitude Corrections are fully discussed in the documentation of the Input/Output key, under the Corrections key.

A set of preloaded Corrections files can be found in the directory

/My Documents/ EMC Limits and Ampcor.

When the Amplitude Correction is an Antenna correction and the Antenna Unit in the file is not **None**, the Y Axis Unit setting will change to match the Antenna Unit in the file.

Key Path	Recall
Mode	SA EDGE GSM PN
Remote Command	:MMEMory:LOAD:CORRection 1 2 3 4 5 6 7 8, <filename>
Example	:MMEM:LOAD:CORR 2, "myAmpcor.csv" recalls the Amplitude Correction data from the file myAmpcor.csv in the current directory to the 2nd Amplitude Correction table, and turns on Correction 2. The default path is D:\Users\Instrument\My Documents\amplitudeCorrections\
Dependencies	Only the first correction array (Correction 1) supports antenna units. This means that a correction file with an Antenna Unit can only be loaded into the Corrections 1 register. Consequently only for Correction 1 does the dropdown in the Recall dialog include.ant, and if an attempt is made to load a correction file into any other Correction register which DOES contain an antenna unit, a Mass Storage error is generated. Corrections are not supported by all Measurements. If in a Mode in which some Measurements support it, this key will be grayed out in measurements that do not. The key will not show at all if no measurements in the Mode support it. Errors are reported if the file is empty or missing, or if the file type does not match, or if there is a mismatch between the file type and the destination data type. If any of these occur during manual operation, the analyzer returns to the Import Data menu and the File Open dialog goes away. This key does not appear unless you have the proper option installed in your instrument.

	This command will generate an “Option not available” error unless you have the proper option installed in your instrument.
Couplings	When a correction file is loaded from mass storage, it is automatically turned on (Correction ON) and ApplyCorrections is set to On. This allows you to see its effect, thus confirming the load.
Readback	selected Correction
Backwards Compatibility SCPI	:MMEMory:LOAD:CORRection ANTenna CABLe OTHer USER, <filename> For backwards compatibility, ANTenna maps to 1, CABLe maps to 2, OTHer maps to 3 and USER maps to 4
Initial S/W Revision	A.02.00

Amplitude Correction

These keys let you select which Correction to import the data into. Once selected, the key returns back to the Import Data menu and the selected Correction number is annotated on the key. The next step is to select the Open key in the Import Data menu.

Antenna corrections are a particular kind of Amplitude Corrections – they are distinguished in the corrections file by having the Antenna Unit set to a value other than None. Only Correction 1 supports Antenna Units.

Key Path	Recall, Data, Amplitude Correction
Notes	auto return
Dependencies	Only Correction 1 may be used to load a Correction that contains an Antenna Unit other than None
Preset	Not part of Preset, but is reset to Correction 1 by Restore Input/Output Defaults; survives shutdown.
State Saved	The current Correction number is saved in instrument state
Initial S/W Revision	A.02.00

Trace

This key selects Trace as the data type to be imported. When pressed a second time, it brings up the Trace Menu, which lets you select the Trace into which the data will be imported.

The trace file contains “meta” data which describes the state of the analyzer when the trace was exported (see ["Trace File Contents" on page 3216](#)). If the meta data in the file does not match the current SA state, the “invalid data indicator” (*) is displayed.

Key Path	Recall, Data
----------	---------------------

Remote Command	:MMEMory:LOAD:TRACe:DATA TRACE1 TRACE2 TRACE3 TRACE4 TRACE5 TRACE6,<filename>
Example	:MMEM:LOAD:TRAC DATA TRACE2, "myTrace2.csv" Imports the 2nd trace from the file myTrace2.csv in the current path. The default path is My Documents\SA\data\traces
Dependencies	For SA measurements, a trace cannot be recalled from a trace file that was exported with ALL traces selected. A trace cannot be imported if the number of trace points in the file do not match the number of sweep points currently set for the measurement. If this happens, an error message is generated. Errors are reported if the file is empty or missing, or if the file type does not match, or if there is a mismatch between the file type and the destination data type. If any error occurs while trying to load a file manually (as opposed to during remote operation), the analyzer returns to the Import Data menu and the File Open dialog goes away.
Couplings	When a trace is imported, Trace Update is always turned OFF for that trace and Trace Display is always turned ON.
Readback	Selected Trace
Status Bits/OPC dependencies	Sequential - aborts the current measurement.
Initial S/W Revision	Prior to A.02.00

Select Trace

These keys let you pick the Trace into which to import the data; either 1, 2, 3, 4, 5 or 6. The default is the currently selected trace, selected in this menu or in the Trace/Det, Export Data, Recall Trace, or Save Trace menus; except if you have chosen **All** then **All** remains chosen until you specifically change it to a single trace.

Once selected, the key returns back to the Import Data menu and the selected Trace number is annotated on the key. The next step is to select the Open key in the Import Data menu.

Key Path	Recall, Data, Trace
Notes	Auto return
Couplings	When you select the trace into which to import the data, it makes that trace the current trace, so it displays on top of all of the other traces.
Preset	Not part of Preset, but is reset to TRACE1 by Restore Mode Defaults; survives shutdown
State Saved	The current trace number is saved in State
Initial S/W Revision	Prior to A.02.00

Limit

This key selects Limit Lines as the data type to be imported. When pressed a second time, it brings up the Limits Menu, which lets you select into which Limit the data will be imported.

A set of preloaded Limits files can be found in the directory
/My Documents/ EMC Limits and Ampcor.

Under this directory, the directory called Limits (Legacy Naming) contains a set of legacy limits, generally the same files that were supplied with older Agilent EMC analyzers, that use the legacy suffix .lim, and the old 8-character file names. In the directory called Limits, the same files can be found, with the same suffix, but with longer, more descriptive filenames.

Key Path	Recall, Data
Remote Command	:MMEMory:LOAD:LIMit LLINE1 LLINE2,<filename>
Example	:MMEM:LOAD:LIM LLINE2, "myLimitLine2.csv" Imports the 2nd Limit Line from the file myLimitLine2.csv in the current path. The default path is My Documents\SA\data\limits
Dependencies	Errors are reported if the file is empty or missing, or if the file type does not match, or if there is a mismatch between the file type and the destination data type. If any of these occur during manual operation, the analyzer returns to the Import Data menu and the File Open dialog goes away. This key will only appear if you have the proper option installed in your instrument.
Couplings	When a limit line is loaded from mass storage, it is automatically turned on. This allows the user to see it, thus confirming the load. The Margin settings will match those when the limit was saved The instrument cannot mix Limits domains (X Axis Unit must be Frequency or Time for both Limits). So when a Limits file is loaded, the analyzer will set the Limits domain (X Axis Unit) to match that of the file. If this changes the Limits domain from what it was before the file was loaded, all Limits data in all Limits sets will be erased before the data loads. If this operation is over the remote interface there will be no warning if this occurs, so care should be taken to know the domain of the file you are loading.
Readback	Selected Limit Line
Status Bits/OPC dependencies	Sequential - aborts the current measurement
Initial S/W Revision	A.02.00

Limit Selection

These keys let you pick which Limit Line to import the data into; either 1, 2, 3, 4, 5 or 6. The default is the currently selected limit. Once selected, the key returns back to the Import Data menu and the selected Limit Line number is annotated on the key. Now you have selected exactly what needs to be imported. In order to trigger an import of the selected Limit Line, you must select the Open key in the Import Data menu.

An example of using this menu is: If you select 2 and continue to the File Open menu, Limit Line 2 will be imported from the file selected or entered in File Name option in the File Open dialog.

Key Path	Recall, Data, Limit Line
Notes	Auto return
Preset	Not part of Preset, but is reset to LLINE1 by Restore Mode Defaults; survives a shutdown.
State Saved	The selected limit number is saved in instrument state
Initial S/W Revision	A.02.00

Open...

When you press “Open”, the analyzer brings up a Windows dialog and a menu entitled “**File Open.**” This menu allows you to navigate to the various fields in the Windows dialog without using a keyboard or mouse. The **Tab** and **Arrow** keys can also be used for dialog navigation.

See "[From File...](#)" on page 3210 in **Recall, State**, for a full description of this dialog and menu.

Key Path	Recall, Data
Notes	The key location is mode-dependent and will vary. Brings up Open dialog for recalling a <mode specific> Save Type
Initial S/W Revision	Prior to A.02.00

Restart

The Restart function restarts the current sweep, or measurement, or set of averaged/hold sweeps or measurements. If you are Paused, pressing Restart does a Resume.

The Restart function is accessed in several ways:

- Pressing the Restart key
- Sending the remote command INIT:IMMEDIATE
- Sending the remote command INIT:RESTART

See ["More Information" on page 843](#)

Key Path	Front-panel key
Remote Command	:INITiate[:IMMEDIATE] :INITiate:RESTART
Example	:INIT:IMM :INIT:REST
Notes	:INITiate:RESTART and :INITiate:IMMEDIATE perform exactly the same function.
Couplings	Resets average/hold count k. For the first sweep overwrites all active (update=on) traces with new current data. For application modes, it resets other parameters as required by the measurement.
Status Bits/OPC dependencies	This is an Overlapped command. The STATus:OPERation register bits 0 through 8 are cleared. The STATus:QUESTionable register bit 9 (INTEgrity sum) is cleared. The SWEEPING bit is set. The MEASURING bit is set.
Backwards Compatibility Notes	For Spectrum Analysis mode in ESA and PSA, the Restart hardkey and the INITiate:RESTART command restart trace averages (displayed average count reset to 1) for a trace in Clear Write , but did not restart Max Hold and Min Hold . In the X-Series, the Restart hardkey and the INITiate:RESTART command restart not only Trace Average , but MaxHold and MinHold traces as well. For wireless comms modes in ESA and PSA, the Restart hardkey and the INITiate:RESTART command restart every measurement, which includes all traces and numeric results. There is no change to this operation.
Initial S/W Revision	Prior to A.02.00

More Information

The **Restart** function first aborts the current sweep/measurement as quickly as possible. It then resets the sweep and trigger systems, sets up the measurement

and initiates a new data measurement sequence with a new data acquisition (sweep) taken once the trigger condition is met.

If the analyzer is in the process of aligning when **Restart** is executed, the alignment finishes before the restart function is performed.

Even when set for Single operation, multiple sweeps may be taken when Restart is pressed (for example, when averaging/holding is on). Thus when we say that **Restart** "restarts a measurement," we may mean:

- It restarts the current sweep
- It restarts the current measurement
- It restarts the current set of sweeps if any trace is in Trace Average, Max Hold or Min Hold
- It restarts the current set of measurements if Averaging, or Max Hold, or Min Hold is on for the measurement
- depending on the current settings.

With **Average/Hold Number** (in **Meas Setup** menu) set to 1, or Averaging off, or no trace in Trace Average or Hold, a single sweep is equivalent to a single measurement. A single sweep is taken after the trigger condition is met; and the analyzer stops sweeping once that sweep has completed. However, with **Average/Hold Number** > 1 and at least one trace set to **Trace Average**, **Max Hold**, or **Min Hold (SA Measurement)** or **Averaging on (most other measurements)**, multiple sweeps/data acquisitions are taken for a single measurement. The trigger condition must be met prior to each sweep. The sweep is stopped when the average count k equals the number N set for **Average/Hold Number**. A measurement average usually applies to all traces, marker results, and numeric results; but sometimes it only applies to the numeric results.

Once the full set of sweeps has been taken, the analyzer will go to idle state. To take one more sweep without resetting the average count, increment the average count by 1, by pressing the step up key while **Average/Hold Number** is the active function, or sending the remote command `CALC:AVER:TCON UP`.

Save

The **Save** menu lets you choose what you want to save and where you want to save it. Among the types of files you can save are **States**, **Traces**, and **Screen Images**. In addition, an **Export (Data)** option lets you save a number of data types as CSV files for easy import into Excel and other spreadsheet programs.

Key Path	Front-panel key
Mode	All
Notes	No remote command for this key specifically, but the :MMEM:STORe command is available for specific file types. An example is :MMEM:STOR:STATe <filename>.
Initial S/W Revision	Prior to A.02.00

State

The Save State menu lets you choose a register or file for saving the state.

The content of a state file includes all of the settings and data required to return the analyzer as closely as possible to the Mode it was in, with the exact settings which were in place, when the save occurred. The Mode settings in each state file include the settings that are affected by Mode Preset, as well as the additional settings affected by Restore Mode Defaults; all of the Mode's settings. In addition, all of the settings of the **Input/Output** system are included, even though they are outside of the Mode's state, because they are needed to restore the complete setup. Persistent **System** settings (for example, Verbose SCPI) are not affected by either Mode Preset or Restore Mode Defaults, nor are they included in a saved State file.

After the save completes, the message "File <filename> saved" or "State Register <register number> saved" is displayed.

For rapid saving, the State menu lists 16 registers to save to. Pressing a Register key initiates the save. You can also select a file to save to.

The default path for all State Files is:

My Documents\<<mode name>\state

where <mode name> is the parameter used to select the mode with the INST:SEL command (for example, SA for the Spectrum Analyzer).

Key Path	Save
Mode	All
Remote Command	:MMEMory:STORe:STATe <filename>
Example	MMEM:STOR:STATe "MyStateFile.state" This stores the current instrument state data in the file MyStateFile.state in the default directory.
Notes	Both single and double quotes are supported for any filename parameter over remote. After saving to a register, that register's menu key is updated with the date the time, unless a

	custom label has been entered for that key. After saving to a register, you remain in the Save State menu, so that you can see the Register key update. After saving to a file, the analyzer automatically returns to the previous menu and any Save As dialog goes away.
Backwards Compatibility SCPI	:MMEMory:STORe:STATe 1,<filename> For backwards compatibility, the above syntax is supported. The "1" is simply ignored. The command is sequential.
Initial S/W Revision	Prior to A.02.00

To File . . .

When you press "To File", the analyzer brings up a Windows dialog and a menu entitled "**Save As.**" This menu allows you to navigate to the various fields in the Windows dialog without using a keyboard or mouse. The **Tab** and **Arrow** keys can also be used for dialog navigation.

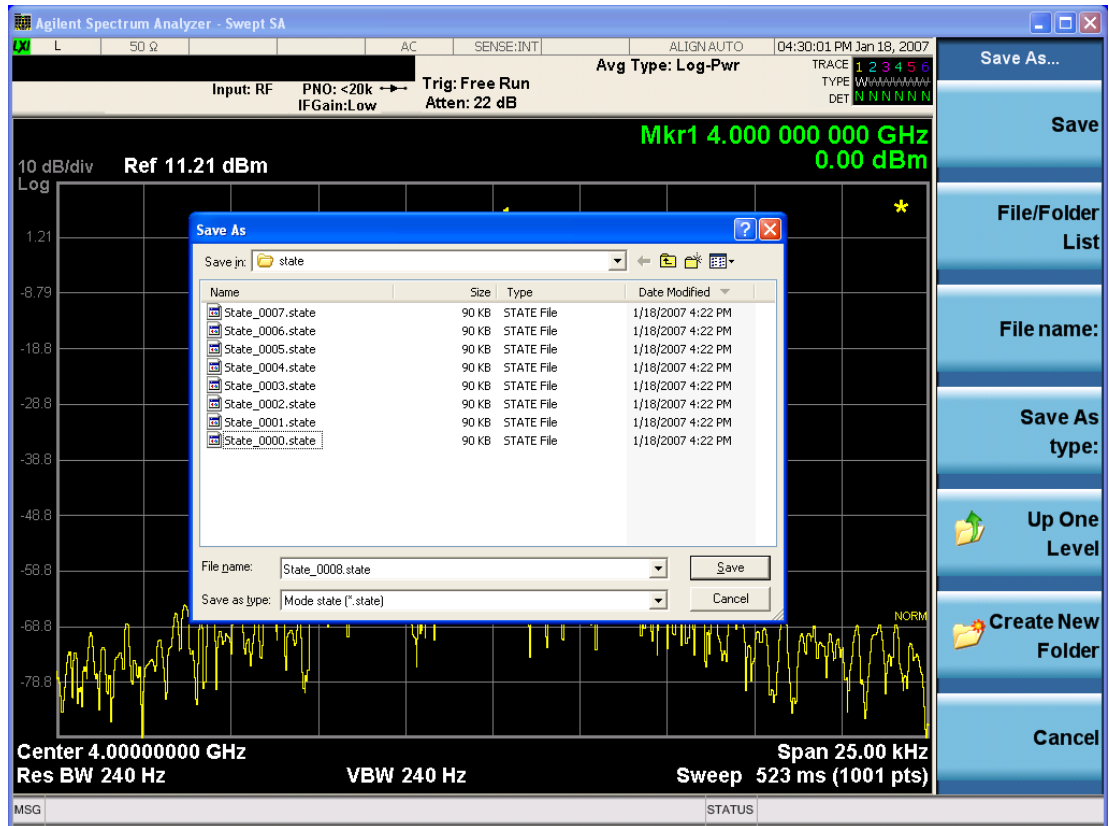

The Listed below are the functions of the various fields in the dialog, and the

corresponding softkeys:

Save

Performs the save to the specified file of the selected type. If the file already exists, a dialog will appear that allows you to replace the existing file by selecting **OK**, or you can Cancel the request. If you select OK, the file will be overwritten. Using the C: drive is strongly discouraged, since it runs the risk of being overwritten during an instrument software upgrade.

While the save is being performed, the floppy icon appears briefly in the Meas bar.

File/Folder List

Enables you to navigate to the center of the dialog that contains the list of files and folders. Once here you can get information about the file and use the tab keys to navigate to the other fields in the dialog, such as Save In.

Save In

The Save In field shows the path to which the file will be saved and allows you to change the path using the up and down arrow keys to navigate to other paths; the Enter key to open a directory; and the Backspace key to go back one directory. The **Save In field** defaults to the default path for this type of file and remembers the last path you used to save this type of file. There is no softkey for directly navigating to the Save In field but you can use left tab to get here from the File/Folder List.

User specified paths are remembered when you leave and return to a Mode and are reset back to the default using **Restore Mode Defaults**.

File Name

The **File Name** field is initially loaded with an automatically generated filename specific to the appropriate Save Type. The automatically generated filename is guaranteed not to conflict with any filename currently in the directory. You may replace or modify this filename using the File Name key. See the ["Quick Save " on page 3181](#) documentation for more on the automatic file naming algorithm.

When you press the **File Name** key the analyzer displays the Alpha Editor. Use the knob to choose the letter to add and the front-panel Enter key to add the letter to the file name. The BK character moves you back and the FW character moves you forward in the filename. The Select key on the front panel generates a space character. When you are done entering the filename press the **Done** softkey. This returns back to the **File Open** dialog and menu, but does not cause the save to occur.

Save As Type

This field shows the file suffix for the type of file you have selected to save. For example, if you navigated here while saving State, "Mode state (*.state)" is in the field. If you navigated here from saving Trace, ""Mode state (*.trace)" is in the field. If you navigated here while exporting a trace data file, "Trace Data (*.csv)" is in the field. For some file types, there is more than one choice in the dropdown, which you can select by using the up and down arrow keys and Enter.

Up One Level

This key corresponds to the icon of a folder with the up arrow that is in the tool bar of the dialog. When pressed, it causes the file and folder list to navigate up one level in the directory structure. The Backspace key does the same thing.

Create New Folder

This key corresponds to the icon of a folder with the "*" that is in the tool bar of the dialog. When pressed, a new folder is created in the current directory with the name **New Folder** and you can enter a new folder name using the Alpha Editor.

Cancel

This key corresponds to the **Cancel** selection in the dialog. It causes the current **Save As** request to be cancelled. The ESC key does the same thing.

Key Path	Save, State
Mode	All
Notes	Brings up Save As dialog for saving a State Save Type
Initial S/W Revision	Prior to A.02.00

Edit Register Names

You may enter a custom name on any of the Register keys, to help you remember what you are using that state to save. To do this, press the **Edit Register Names** key, choose the register whose name you wish to edit, and then enter the desired label using the Alpha Editor or an external PC keyboard.

The maximum number of characters that can be added is 30. In most cases, 30 characters will fit on two lines of the key.

See ["More Information" on page 850](#)

Key Path	Save, State
Mode	All
Remote Command	:MMEMory:REGiSTER:STATe:LABeL <reg number>,"label" :MMEMory:REGiSTER:STATe:LABeL? <reg number>
Example	:MMEM:REG:STAT:LAB 1,"my label"
Notes	<reg number> is an integer from 1 to 16. If the SCPI specifies an invalid register number an error message is generated, -222,"Data out of range;Invalid register label number" "label" is a string from 0 to 30 characters in length. If a label exceeds 30 characters, an error message is generated, -150,"String data error;Label clipped to 30 characters" "label" of length 0 erases the custom label and restores the default (time and date) label. E.g.: :MMEM:REG:STAT:LAB 1,""
Dependencies	N9060A-7FP or N9060B-2FP license required to edit the register names. When the feature is not licensed, sending this command generates an error, -221,"Settings conflict;Option not available"
Preset	The names are unaffected by Preset or power cycle but are set to the default label (time and date) on a "Restore System Defaults->Misc"
Initial S/W Revision	A.11.00

More Information

When you edit one of the register names, the time and date field will be replaced by the custom name.

If you delete all the characters in the custom name, it restores the default (time and date).

The register names are stored within the state files, but they are not part of the instrument state; that is, once you have edited a register name, loading a new state will not change that register name. Another consequence of this is that the names will be persistent through a power cycle. Also, if a named state file is transferred to another analyzer, it will bring its custom name along with it.

If you try to edit the name of an empty register, the analyzer will first save the state to have a file to put the name in. If you load a named state file into an analyzer with older firmware it will ignore the metadata.

The *SAV and *RCL commands will not be affected by the custom register names, nor will the MMEM commands.

Register 1 thru Register 16

Selecting any one of these register menu keys causes the State of the currently active mode to be saved to the specified Register. The registers are provided for rapid saving and recalling, since you do not need to specify a filename or navigate to a file. Each of the register menu keys annotates whether it is empty or at what date and time it was last modified. In addition, you can use the **Edit Register Names** key to enter custom names for each register.

Although these 16 registers are the only registers available from the front panel, there are 128 state registers available in the instrument. Registers 17-128 are only available from the SCPI interface, using the *SAV command.

There is one set of 128 state registers in the instrument, not one set for each Mode. When a state is saved, the Mode it was saved from is saved with it; then when it is recalled, the instrument switches to that Mode.

After the save completes, the corresponding register menu key annotation is updated with the date and time and the message "Register <register number> saved" is displayed.

Key Path	Save, State
Mode	All
Example	*SAV 1
Range	1-16 from front panel, 1-128 from SCPI
Readback	Date and time with seconds resolution are displayed on the key OR A custom name of up to 30 characters entered using the Edit Register Names key OR “(empty)” if no prior save operation has been performed to this register.

Initial S/W Revision	Prior to A.02.00
Modified at S/W Revision	A.11.00

Register 1 thru Register 16

Selecting any one of these register menu keys causes the State of the currently active mode to be saved to the specified Register. The registers are provided for rapid saving and recalling, since you do not need to specify a filename or navigate to a file. Each of the register menu keys annotates whether it is empty or at what date and time it was last modified. In addition, you can use the **Edit Register Names** key to enter custom names for each register.

Although these 16 registers are the only registers available from the front panel, there are 128 state registers available in the instrument. Registers 17-128 are only available from the SCPI interface, using the *SAV command.

There is one set of 128 state registers in the instrument, not one set for each Mode. When a state is saved, the Mode it was saved from is saved with it; then when it is recalled, the instrument switches to that Mode.

After the save completes, the corresponding register menu key annotation is updated with the date and time and the message "Register <register number> saved" is displayed.

Key Path	Save, State
Mode	All
Example	*SAV 1
Range	1-16 from front panel, 1-128 from SCPI
Readback	Date and time with seconds resolution are displayed on the key OR A custom name of up to 30 characters entered using the Edit Register Names key OR “(empty)” if no prior save operation has been performed to this register.
Initial S/W Revision	Prior to A.02.00
Modified at S/W Revision	A.11.00

Mass Storage Catalog (Remote Command Only)

Key path	SCPI Only
Remote Command	:MMEMory:CATalog? [<directory_name>]
Notes	The string must be a valid logical path. Queries disk usage information (drive capacity, free space available) and obtains a list of files and directories in a specified directory in the following format: <numeric_value>,<numeric_value>,{<file_entry>}

It returns two numeric parameters and as many strings as there are files and directories. The first parameter indicates the total amount of storage currently used in bytes. The second parameter indicates the total amount of storage available, also in bytes. The <file_entry> is a string. Each <file_entry> indicates the name, type, and size of one file in the directory list:

<file_name>,<file_type>,<file_size>

As the windows file system has an extension that indicates file type, <file_type> is always empty. <file_size> provides the size of the file in bytes. For directories, <file_entry> is surrounded by square brackets and both <file_type> and <file_size> are empty

Initial S/W Revision Prior to A.02.00

Mass Storage Change Directory (Remote Command Only)

Key path SCPI Only

Remote Command :MMEMory:CDIRectory [<directory_name>]
 :MMEMory:CDIRectory?

Notes The string must be a valid logical path.

Changes the default directory for a mass memory file system. The <directory_name> parameter is a string. If no parameter is specified, the directory is set to the *RST value.

At *RST, this value is set to the default user data storage area, that is defined as System.Environment.SpecialFolder.Personal.

Query returns full path of the default directory.

Initial S/W Revision Prior to A.02.00

Mass Storage Copy (Remote Command Only)

Key path SCPI Only

Remote Command :MMEMory:COpy <string>,<string>[,<string>,<string>]

Notes The string must be a valid logical path.

Copies an existing file to a new file or an existing directory to a new directory.

Two forms of parameters are allowed. The first form has two parameters. In this form, the first parameter specifies the source, and the second parameter specifies the destination.

The second form has four parameters. In this form, the first and third parameters specify the source. The second and fourth parameters specify the directories. The first pair of parameters specifies the source. The second pair specifies the destination. An error is generated if the source doesn't exist or the destination file already exists.

This command will generate an "access denied" error if the destination is a restricted folder (e.g., C:\Windows) and the current user does not have Power User or Administrator privileges.

Mass Storage Device Copy (Remote Command Only)

This command transfers data to/from a file and a peripheral device.

Key path SCPI Only

Remote Command :MMEMory:COpy:DEvice <source_string>,<dest_string>

Notes The strings must be a valid logical path or a valid device keyword. If the dest_string is a device

keyword, the data is copied from the source file to the device. If the source_string is a device keyword, the data is copied to the source file from the device.

Valid device keywords are:

SNS (smart noise source)

An error is generated if the file or device is not found.

Mass Storage Delete (Remote Command Only)

Key path	SCPI Only
Remote Command	:MMEMory:DELeTe <file_name>[,<directory_name>]
Notes	The string must be a valid logical path. Removes a file from the specified directory. The <file_name> parameter specifies the file name to be removed. This command will generate an “access denied” error if the file is in a restricted folder (e.g., C:\Windows) and the current user does not have Power User or Administrator privileges.
Initial S/W Revision	Prior to A.02.00

Mass Storage Data (Remote Command Only)

Creates a file containing the specified data OR queries the data from an existing file.

Key path	SCPI Only
Remote Command	:MMEMory:DATA <file_name>, <data> :MMEMory:DATA? <file_name>
Notes	The string must be a valid logical path. The command form is MMEMory:DATA <file_name>,<data>. It loads <data> into the file <file_name>. <data> is in 488.2 block format. <file_name> is string data. The query form is MMEMory:DATA? <file_name> with the response being the associated <data> in block format.
Initial S/W Revision	Prior to A.02.00

Mass Storage Make Directory (Remote Command Only)

Key path	SCPI Only
Remote Command	:MMEMory:MDIRectory <directory_name>
Notes	The string must be a valid logical path. Creates a new directory. The <directory_name> parameter specifies the name to be created. This command will generate an “access denied” error if the new directory would be in a restricted folder (e.g., C:\Windows) and the current user does not have Power User or Administrator privileges.
Initial S/W Revision	Prior to A.02.00

Mass Storage Move (Remote Command Only)

Key path	SCPI Only
Remote Command	:MMEMory:MOVE <string>,<string>[,<string>,<string>]
Notes	<p>The string must be a valid logical path.</p> <p>Moves an existing file to a new file or an existing directory to a new directory.</p> <p>Two forms of parameters are allowed. The first form has two parameters. In this form, the first parameter specifies the source, and the second parameter specifies the destination.</p> <p>The second form has four parameters. In this form, the first and third parameters specify the source. The second and fourth parameters specify the directories. The first pair of parameters specifies the source. The second pair specifies the destination. An error is generated if the source doesn't exist or the destination file already exists.</p> <p>This command will generate an "access denied" error if the destination is a restricted folder (e.g., C:\Windows) and the current user does not have Power User or Administrator privileges.</p>
Initial S/W Revision	Prior to A.02.00

Mass Storage Remove Directory (Remote Command Only)

Key path	SCPI Only
Remote Command	:MMEMory:RDIREctory <directory_name>
Notes	<p>The string must be a valid logical path.</p> <p>Removes a directory. The <directory_name> parameter specifies the directory name to be removed. All files and directories under the specified directory shall also be removed.</p> <p>This command will generate an "access denied" error if the folder is a restricted folder (e.g., C:\Windows) or is in a restricted folder and the current user does not have Power User or Administrator privileges.</p>
Initial S/W Revision	Prior to A.02.00

Trace (+State)

The **Save Trace (+State)** menu lets you choose a register or file specifying where to save the Trace+State state file.

A saved state contains all of the settings and data required to return the analyzer as closely as possible to the exact setup it had when the save occurred. This includes the Input/Output settings, even though they are outside of the Mode's state, because they are needed to restore the complete setup. A Trace+State file also includes trace data from one trace or all traces, which will load in View mode when the Trace+State file is recalled.

After the save completes, the message "File <filename> saved" or "Trace Register <register number> saved" is displayed.

For rapid saves, the Trace (+State) menu lists 5 registers to save to. Pressing a Register key initiates the save. You can also select a file to save to.

The default path for all State Files including .trace files is:

My Documents\<<mode name>\state

where <mode name> is the parameter used to select the mode with the INST:SEL command (for example, Basic for the IQAnalyzer).

This key is grayed out for measurements that do not support trace saves. It is blanked for modes that do not support trace saves. Saving **Trace** is identical to saving State except a .trace extension is used on the file instead of .state, and internal flags are set in the file indicating which trace was saved. You may select to save one trace or ALL traces.

Key Path	Save
Mode	SA
Remote Command	:MMEMory:STORe:TRACe TRACE1 TRACE2 TRACE3 TRACE4 TRACE5 TRACE6 ALL,<filename> :MMEMory:STORe:TRACe:REGister TRACE1 TRACE2 TRACE3 TRACE4 TRACE5 TRACE6 ALL,<integer>
Example	:MMEM:STOR:TRAC TRACE1, "myState.trace" saves the file myState.trace on the default path and flags it as a "single trace" file with Trace 1 as the single trace (even though all of the traces are in fact stored). :MMEM:STOR:TRAC ALL, "myState.trace" saves the file myState.trace on the default path and flags it as an "all traces" file :MMEM:STOR:TRAC:REG TRACE1, 2 stores trace 1 data in trace register 2
Notes	This command actually performs a save state, which in the Swept SA measurement includes the trace data. However it flags it (in the file) as a "save trace" file of the specified trace (or all traces). Some modes and measurements do not have available all 6 traces. The Phase Noise mode command, for example, is: MMEMory:STORe:TRACe TRACE1 TRACE2 TRACE3 ALL,<filename> Some modes and measurements have more than 6 traces available. The Realtime SA mode command, for example, is: MMEMory:STORe:TRACe TRACE1 TRACE2 TRACE3 TRACE4 TRACE5 TRACE6 TRACE7 TRACE8 TRACE9 TRACE10 TRACE11 TRACE12 ALL,<filename> The range for the register parameter is 1-5 When you initiate a save, if the file already exists, a dialog will appear that allows you to replace the existing file by selecting OK or you can Cancel the request. If you select OK, the file will be overwritten. Using the C: drive is strongly discouraged, since it runs the risk of being overwritten during an instrument software upgrade. Both single and double quotes are supported for any filename parameter over remote. After saving to a register, that register's menu key is updated with the date and time of the save. After saving to a register, you remain in the Save Trace menu, so that you can see the Register key update. After saving to a file, the analyzer automatically returns to the previous menu and any Save As dialog goes away.
Initial S/W Revision	Prior to A.02.00

Register 1 thru Register 16

Selecting any one of these register menu keys causes the State of the currently active mode to be saved to the specified Register. The registers are provided for rapid saving and recalling, since you do not need to specify a filename or navigate to a file. Each of the register menu keys annotates whether it is empty or at what date

and time it was last modified. In addition, you can use the **Edit Register Names** key to enter custom names for each register.

Although these 16 registers are the only registers available from the front panel, there are 128 state registers available in the instrument. Registers 17-128 are only available from the SCPI interface, using the *SAV command.

There is one set of 128 state registers in the instrument, not one set for each Mode. When a state is saved, the Mode it was saved from is saved with it; then when it is recalled, the instrument switches to that Mode.

After the save completes, the corresponding register menu key annotation is updated with the date and time and the message "Register <register number> saved" is displayed.

Key Path	Save, State
Mode	All
Example	*SAV 1
Range	1-16 from front panel, 1-128 from SCPI
Readback	Date and time with seconds resolution are displayed on the key OR A custom name of up to 30 characters entered using the Edit Register Names key OR “(empty)” if no prior save operation has been performed to this register.
Initial S/W Revision	Prior to A.02.00
Modified at S/W Revision	A.11.00

From Trace

Accesses a menu that enables you to select the trace to be saved. Once a trace is selected, the key returns to the Save Trace menu and the selected trace number is annotated on the key. The default is the currently selected trace, selected in this menu or in the Trace/Det, Export Data, Import Data or Recall Trace menus, except if you have chosen All then it remains chosen until you specifically change it to a single trace. To save the Trace you must select the **Save As** key in the Save Trace menu.

When you select a trace, it makes that trace the current trace, so it displays on top of all of the other traces.

Key Path	Save, Trace + State
Mode	SA
Initial S/W Revision	Prior to A.02.00

From File...

When you press “From File”, the analyzer brings up a Windows dialog and a menu entitled “**File Open.**” This menu allows you to navigate to the various fields in the

Windows dialog without using a keyboard or mouse. The **Tab** and **Arrow** keys can also be used for dialog navigation.

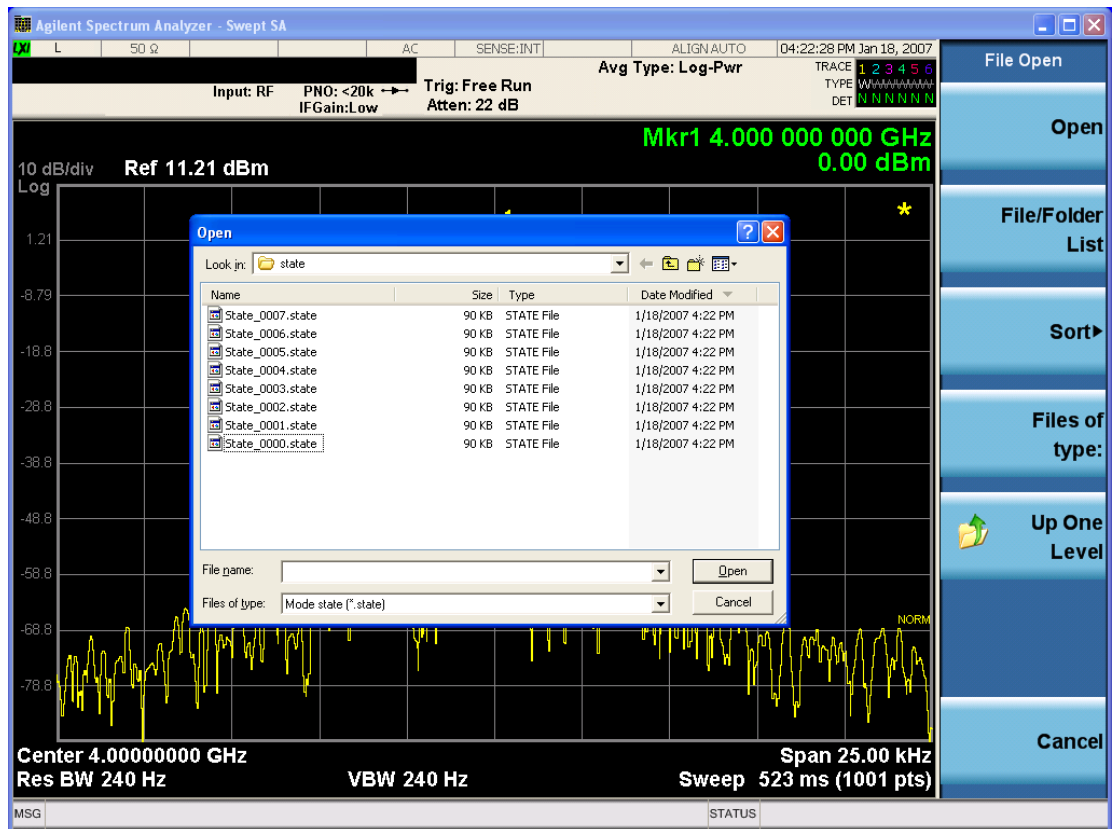

Listed below are the functions of the various fields in the dialog, and the corresponding softkeys:

Open

Performs the recall of the specified file. While the recall is being performed, the floppy icon appears briefly in the Meas bar.

File/Folder List

Enables you to navigate to the center of the dialog that contains the list of files and folders. Once here you can get information about the file and use the tab keys to navigate to the other fields in the dialog, such as Look In.

Look In

The **Look In** field shows the path from which the file will be recalled and allows you to change the path using the up and down arrow keys to navigate to other paths; the Enter key to open a directory; and the Backspace key to go back one directory. The **Look In** field first uses the last path from the Save As dialog **Save In:** path for that same file type. There is no softkey for directly navigating to the Look In field, but you can use the left tab to get here from the File/Folder List.

User specified paths are remembered when you leave and return to a Mode and are reset back to the default using **Restore Mode Defaults**.

Sort

Accesses a menu that enables you to sort the files within the File Open dialog. Only one sorting type can be selected at a time and the sorting happens immediately. The sorting types are **By Date**, **By Name**, **By extension**, and **By Size**.

Files of Type

This field shows the file suffix for the type of file you have selected to recall. For example, if you navigated here while recalling State, "Mode state (*.state)" is in the field. If you navigated here while recalling Trace, "Mode state (*.trace)" is in the field. If you navigated here while importing a trace data file, "Trace Data (*.csv)" is in the field. For some file types, there is more than one choice in the dropdown menu, which you can select by using the up and down arrow keys and Enter.

Up One Level

This key corresponds to the icon of a folder with the up arrow that is in the tool bar of the dialog. When pressed, it causes the file and folder list to navigate up one level in the directory structure. The Backspace key does the same thing.

Cancel

This key corresponds to the **Cancel** selection in the dialog. It causes the current **Open** request to be cancelled. The ESC key does the same thing.

Key Path	Recall, State
Notes	Brings up the Open dialog for recalling a State Save Type
Initial S/W Revision	Prior to A.02.00

Data (Export)

Exporting a data file stores data from the current measurement to mass storage files. The Export Menu only contains data types that are supported by the current measurement.

Since the commonly exported data files are in .csv format, the data can be edited by you prior to importing. This allows you to export a data file, manipulate the data in Excel (the most common PC Application for manipulating .csv files) and then import it.

Selecting an Export Data menu key will not actually cause the exporting to occur, since the analyzer still needs to know where you wish to save the data. Pressing the Save As key in this menu brings up the Save As dialog and Save As menu that allows you to specify the destination file and directory. Once a filename has been selected or entered in the Open menu, the export will occur as soon as the Save key is pressed.

Key Path	Save
----------	-------------

Mode	All
Notes	The menu is built from whatever data types are available for the mode. So the key locations in the sub menu will vary. No SCPI command directly controls the Data Type that this key controls. The Data Type is included in the MMEM:STORe commands.
Dependencies	If a file type is not used by a certain measurement, that type is grayed out for that measurement. The key for a file type will not show at all if there are no measurements in the Mode that support it.
Preset	Is not affected by a Preset or shutdown, but is reset during Restore Mode Defaults
Readback	The data type that is currently selected
Initial S/W Revision	Prior to A.02.00

Amplitude Correction

Pressing this key selects **Amplitude Corrections** as the data type to be exported. Pressing this key again brings up the Select Menu, which allows the user to select which **Amplitude Correction** to save.

Amplitude Corrections are fully discussed in the documentation of the Input/Output key, under the Corrections softkey.

See "[Correction Data File](#)" on page 860

Key Path	Save
Remote Command	:MMEMory:STORe:CORRection 1 2 3 4 5 6, <filename>
Example	:MMEM:STOR:CORR 2 "myAmpcor.csv" saves Correction 2 to the file myAmpcor.csv on the current path. The default path is My Documents\amplitudeCorrections.
Notes	If the save is initiated via SCPI, and the file already exists, the file will be overwritten. Using the C: drive is strongly discouraged, since it runs the risk of being overwritten during an instrument software upgrade. Both single and double quotes are supported for any filename parameter over SCPI.
Dependencies	Corrections are not supported by all Measurements. If in a Mode in which some Measurements support it, this key will be grayed out in measurements that do not. The key will not show at all if no measurements in the Mode support it. This key will not appear unless you have the proper option installed in your instrument.
Readback	Selected Correction
Backwards Compatibility SCPI	:MMEMory:STORe:CORRection ANTenna CABLe OTHer USER, <filename> For backwards compatibility, ANTenna maps to 1, CABLe maps to 2, OTHer maps to 3 and USER maps to 4
Initial S/W Revision	A.02.00

Correction Data File

A Corrections Data File contains a copy of one of the analyzer correction tables. Corrections provide a way to adjust the trace display for predetermined gain curves (such as for cable loss).

Corrections files are text files in .csv (comma separated values) form, to make them importable into Excel or other spreadsheet programs. The format for Corrections files is as follows.

Line #	Type of field	Example	Notes
1	File type, must be "Amplitude Correction"	Amplitude Correction	May not be omitted
2	File Description (in quotes)	"Correction Factors for 11966E"	60 characters max; may be empty but may not be omitted. If exceeds 60 characters, error -233 Too much data reported
3	Comment (in quotes)	"Class B Radiated"	60 characters max; may be empty but may not be omitted. . If exceeds 60 characters, error -233 Too much data reported
4	Instrument Version, Model #	A.02.06,N9020A	May be empty but may not be omitted
5	Option List, File Format Version	K03 LFE EXM ,01	May be empty but may not be omitted
6	Freq Unit to be used for all frequency values in the file	Frequency Unit,MHz	assumed to be Hz if omitted
7	Antenna Unit	Antenna Unit,None	If omitted leaves the Antenna unit unchanged. The amplitude unit in the Antenna Unit field is a conversion factor that is used to adjust the Y Axis Units of the current mode, if the mode supports Antenna Units. For more details on antenna correction data, refer to the Input/Output,Corrections key description. Allowable values: dBuv/m, dBuA/m, dBG, dBpT, None
8	Freq Interpolation	Frequency Interpolation,Linear	if omitted leaves the Freq Interpolation unchanged. Allowable values: Linear, Logarithmic
9	Bias value in mA	Bias,0.00	If omitted leaves the Bias value

Line #	Type of field	Example	Notes
			unchanged (added as of A.08.50)
10	Bias State	Bias State,On	If omitted leaves the Bias State unchanged. Allowable values: On, Off (added as of A.08.50)
11	Overlap, two values, Freq1 and Freq2, separated by commas.	Overlap,33500,40000	Uses Freq Unit from line 6. Thus, in this example Freq1=33.5 GHz, Freq2= 40.0 GHz (see note below). If omitted leaves the overlap unchanged (added as of A.08.50)
12	DATA marker	DATA	Corrections data begins in the next line

Lines 2 through 5 can be empty but must appear in the file. Lines 6 through 11 are optional, the lines can be left out of the file altogether.

The Overlap row and the two Bias rows apply only to external mixing. Both are read-only, they are never written by the analyzer. The only way to insert or modify these rows is to edit the file with a text editor or a spreadsheet editor. These rows are intended for use by mixer manufacturers, as they allow the manufacturer to insert data about how the mixer corrections were generated and how they should be applied. The Bias rows allow you to specify whether to turn Bias on or off when the Correction is turned on and to specify a Bias value (turning off the Correction does not change the Bias, but turning it back on again sets it to the value specified in the file). The Overlap row allows you to specify an overlap region in which two different corrections may be applied. It is expected that in the corrections data itself, there will be TWO corrections values exactly at Max Freq, otherwise Overlap is ignored. The way the overlap is processed is as follows: if at any given time the current analyzer Start Freq is greater than Freq 1 and lower than Freq 2, and the current Stop Freq is greater than Freq 2, extend the first correction point at or above Freq 2 down to Freq 1, rather than using the correction data between Freq1 and Freq2.

The Antenna Unit row can only be used in Correction register 1, because there can only be one setting for Antenna Unit at any given time. If a Correction whose Antenna Unit is set to anything but None is loaded into any Correction register but 1, an error is generated (Mass storage error; Can only load an Antenna Unit into Correction 1). When a correction file is saved from any Correction register but 1, Antenna Unit is always written as None.

Similarly, the Bias rows can only be used in Correction register 1, because there can only be one setting for Bias at any given time. If a Correction file with a Bias or Bias State row is loaded into any Correction register but 1, an error is generated: Mass storage error; Can only load Bias Settings into Correction 1

The data follows the DATA row, as comma separated X, Y pairs; one pair per line.

For example, suppose you have an Antenna to correct for on an N9020A version A.02.06 and the correction data is:

- 0 dB at 200 MHz
- 17 dB at 210 MHz
- 14.8 dB at 225 MHz

Then the file will look like:

- Amplitude Correction
- "Correction Factors for 11966E"
- "Class B Radiated"
- A.02.06,N9020A
- P13 EA3 UK6,01
- Frequency Unit,MHz
- Antenna Unit,dBuV/m
- Frequency Interpolation,Linear
- DATA
- 200.000000,0.00
- 210.000000,17.00
- 225.000000,14.80

The choices for the 1 of N fields in the metadata are as follows:

- Frequency Unit: Hz, kHz, MHz, GHz
- Antenna Unit: dBuv/m, dBuA/m, dBG, dBpT, None
- Frequency Interpolation: Logarithmic, Linear

Amplitude Correction

These keys let you choose which Correction to save. Once selected, the key returns back to the Export Data menu and the selected Correction number is annotated on the key.

The next step in the Save process is to select the Save As key in the Export Data menu.

Key Path	Save, Data, Amplitude Correction
Preset	Not part of a Preset, but is reset to Correction 1 by Restore Input/Output Defaults. Survives a shutdown.
Readback	1
Initial S/W Revision	A.02.00

Trace

Pressing this key selects Traces as the data type to be exported. Pressing this key when it is already selected brings up the Trace Menu, which allows you to select which Trace to save.

The trace file contains “meta” data which describes the current state of the analyzer. The metadata is detailed in ["Trace File Contents" on page 863](#) below.

Key Path	Save, Data
Remote Command	<code>:MMEMory:STORe:TRACe:DATA TRACE1 TRACE2 TRACE3 TRACE4 TRACE5 TRACE6 ALL,<filename></code>
Example	:MMEM:STOR:TRAC:DATA TRACE2, "myTrace2.csv" Exports the 2nd trace to the file myTrace2.csv in the current path. The default path is My Documents\SA\data\traces
Notes	If the save is initiated via SCPI, and the file already exists, the file will be overwritten. Using the C: drive is strongly discouraged, since it runs the risk of being overwritten during an instrument software upgrade. Both single and double quotes are supported for any filename parameter over SCPI.
Dependencies	For SA measurements, traces cannot be recalled from a trace file that was saved with ALL traces selected.
Couplings	When you select which trace to save, it makes that trace the current trace, so it displays on top of all of the other traces.
Readback	selected Trace
Status Bits/OPC dependencies	Sequential - waits for previous measurement to complete
Initial S/W Revision	Prior to A.02.00

Trace File Contents

A Trace Data File contains the data for one trace.

Metadata: Trace Specific

Besides the trace data, there is metadata describing the context by which the trace was produced. Some of the metadata is trace specific:

- Trace Type
- Detector

- Trace math (function, operand1, operand2, offset, reference)
- Trace name/number

When importing a trace, the detector and/or trace math function specified in the metadata is imported with the trace, so that the annotation correctly shows the detector and/or math type that was used to generate the data

Metadata: Display Specific

There is also some display-related metadata:

- Ref Level Offset
- External Gain
- X-Axis Unit
- Y-Axis Unit

Metadata: Measurement Related

The rest of the metadata is measurement specific and reflects the state of the measurement the last time the trace was updated. These are the “measurement-related instrument settings” which, if changed, cause a measurement restart.

- Number of Points
- Sweep Time
- Start Frequency
- Stop Frequency
- Average Count (actual; not the limit for the instrument)
- Average Type
- RBW
- RBW Filter Type
- RBW Filter BW Type
- VBW
- Sweep Type (FFT vs. Swept)
- Log/Lin X Scale (sometimes called Log Sweep)
- Preamp (on/off, band)
- Trigger (source, level, slope, delay)

- Phase Noise optimization setting
- Swept IF Gain
- FFT IF Gain
- AC/DC setting (RF Coupling)
- FFT Width
- External Reference setting
- Input (which input is in use)
- RF calibrator on/off
- Attenuation

Because any inactive trace can have a value that does not match the rest of the measurement, when performing a Save the metadata for each trace is pulled from the individual trace, not from the measurement.

A revision number is also included in the trace database, to allow for future changes.

The choices for the various 1 of N and binary fields are as follows:

- Average Type: Power(RMS), Voltage, LogPower(Video)
- RBW Filter Type: Flattop, EMI, Gaussian
- RBW Filter BW: 3dB, 6dB, Noise, Impulse
- Sweep Type: Swept, FFT
- PreAmp State: On, Off
- PreAmp Band: Low, Full
- Trigger Source: Free, RFBurst, Video, Line, Periodic, Ext1, Ext2, TV
- Trigger Slope: Positive, Negative
- Phase Noise Optimization: Fast, Narrow, Wide
- Swept IF Gain: Low, High
- FFT If Gain: Autorange, Low, High
- Input: RF, BBIQ
- RF Calibrator: 50M, 400G, Comb, Off
- Trace Type: ClearWrite, TraceAverage, MaxHold, MinHold

- Detector: Normal, Average, Peak, NegPeak, Sample
- Trace Math: Off, PowerDifference, PowerSum, LogOffset, LogDifference
- Y Axis Unit: dBm, dBmV, dBmA, W, V, A, dBuV, dBuA, dBuV/m, dBuA/m, dBuV, dBpT, dBG, dB

After the header, just before the trace data, a line with just the word DATA on it is inserted to flag the start of the trace data.

The following file example shows the first lines of a Trace 1 file with X Axis Unit = Hz and Y Axis Unit = dBuV, after importing into Excel (the second row contains the Title):

Trace	
"AS/NZS 1044; Conducted >1000 W, Motors, Average"	
A.01.00	E4410A
526 EA3 B25 P26 PFR	1
Segment	0
Number of Points	1001
Sweep Time	0.066266667
Start Frequency	18827440
Stop Frequency	24463718
Average Count	0
Average Type	Power(RMS)
RBW	51000
RBW Filter	Gaussian
RBW Filter BW	3dB
VBW	51000
Sweep Type	Swept
X Axis Scale	Lin
PreAmp State	Off
PreAmp Band	Low
Trigger Source	Video
Trigger Level	1.2
Trigger Slope	Positive
Trigger Delay	1.00E-06
Phase Noise Optimization	Fast
Swept IF Gain	Low
FFT IF Gain	Autorange

RF Coupling	AC
FFT Width	411900
Ext Ref	10000000
Input	RF
RF Calibrator	Off
Attenuation	10
Ref Level Offset	0
External Gain	0
Trace Type	ClearWrite
Detector	Normal
Trace Math	Off
Trace Math Oper1	Trace5
Trace Math Oper2	Trace6
Trace Math Offset	0
Trace Name	Trace1
X Axis Unit	Hz
Y Axis Unit	dBm
DATA	
1.6009301E+07	4.82047E+01
1.6018694E+07	4.69737E+01
1.6028087E+07	4.81207E+01
1.6037480E+07	4.72487E+01
1.6046873E+07	4.66437E+01
1.6056266E+07	4.66237E+01
1.6065659E+07	4.66967E+01
1.6075052E+07	4.77117E+01
1.6084445E+07	4.75787E+01
1.6093838E+07	4.83297E+01
1.6103231E+07	4.71327E+01
1.6112624E+07	4.78957E+01
1.6122017E+07	4.67507E+01
1.6131410E+07	4.81137E+01

Select Trace

These softkeys let you pick which Trace to save. Once selected, the key returns back to the Export Data menu and the selected trace name/number is annotated on the key. The default is the currently selected trace, selected in this menu or in the

Trace/Det, Import Data, Recall Trace or Save Trace menus, except if you have chosen **All** then **All** remains chosen until you specifically change it to a single trace.

The **All** selection saves all six traces in one .csv file with the x-axis data in the first column and the individual trace data in succeeding columns. The header data and x-axis data in this file reflect the current settings of the measurement. Note that any traces which are in View or Blank may have different x-axis data than the current measurement settings; but this different x-axis data will not be output to the file.

This menu is the same as the Select Trace menu under Trace. The trace selected on that menu appears selected here, and selecting a trace here causes the same trace to be selected on the Select Trace menu. (That is, there is only one "selected trace".)

The next step in the Save process is to select the Save As key in the Export Data menu.

Key Path	Save, Data, Trace
Notes	auto return
Couplings	When you select which trace to save, it makes that trace the current trace, so it displays on top of all of the other traces.
Preset	Not part of Preset, but is reset to TRACE1 by Restore Mode Defaults; survives shutdown
State Saved	The current trace number is saved in instrument state.
Initial S/W Revision	Prior to A.02.00

Limit

Pressing this key selects Limit Lines as the data type to be exported. Pressing the key a second time brings up the Limit Menu that allows you to select which **Limit Line** to save.

- See "[Limits File Contents](#)" on page 869.
- See "[.csv file format](#)" on page 869
- See "[.lim file format](#)" on page 870

Key Path	Save, Data
Remote Command	:MMEMory:STORe:LIMit LLINE1 LLINE2,<filename>
Example	:MMEM:STOR:LIM LLINE2, "myLimitLine2.csv" Saves the 2nd Limit Line to the file myLimitLine2.csv in the current path. The default path is My Documents\SA\data\limits
Notes	If the save is initiated via SCPI, and the file already exists, the file will be overwritten. Using the C: drive is strongly discouraged, since it runs the risk of being overwritten during an instrument software upgrade. Both single and double quotes are supported for any filename parameter over SCPI.
Dependencies	This key will only appear if you have the proper option installed in your instrument.
Preset	1; not part of Preset, but is reset by Restore Mode Defaults and survives power cycles
State Saved	The selected Limit number is saved in instrument state.

Readback	selected Limit Line
Status Bits/OPC dependencies	Sequential - waits for previous measurement to complete
Initial S/W Revision	A.02.00

Limits File Contents

Limits may be exported into a data file with a .csv extension. They may be imported from that data file; they may also be imported from a legacy limit file with a .lim extension. The .lim files meet the specification for limit files contained in the EMI measurement guide, HP E7415A.

.csv file format

Except for information in quotes, limit line files are not case sensitive. Information in bold is required verbatim; other text is example text, and italic text is commentary which should not be present in the file.

The first five lines are system-required header lines, and must be in the correct order.

Limit	<i>Data file type name</i>
"FCC Part 15"	<i>File Description</i>
"Class B Radiated"	<i>Comment</i>
A.01.00.R0001,N9020A	<i>Instrument Version, Model Number</i>
P13 EA3 UK6 ,01	<i>Option List, File Format Version</i>

The next few lines describe the parameters; on export they will be in the order shown, on import they can be in any order. If some parameters are missing, they will revert to the default.

Type, Upper	<i>Upper Lower</i>
X Axis Unit, MHz	<i>MHz S; other units should be converted; this also specifies the domain</i>
Amplitude Unit, dBm	<i>dBm V; all other units should be converted appropriately</i>
Frequency Interpolation, Linear	<i>Logarithmic Linear</i>
Amplitude Interpolation, Logarithmic	<i>Logarithmic Linear</i>
X Control, Fixed	<i>Fixed Relative; on input we consider only the first three characters</i>
Y Control, Fixed	<i>Fixed Relative; on input we consider only the first three characters</i>
Margin, 0	<i>Always in dB. A 0 margin is equivalent to margin off</i>
X Offset, 10	<i>Expressed in the X axis units</i>
Y Offset, 5	<i>Expressed in the Amplitude units</i>

The Amplitude Unit line in the limits file may contain an antenna factor unit, for example:

Amplitude Unit=dBuV/m

Antenna factor units are dBuV/m, dBuA/m, dBpT, and dBG. In this case, the unit is treated exactly as though it were dBuV, meaning that all of the limits are interpreted to have units of dBuV. The box does NOT change Y Axis Units when such a limit is loaded in.

The X axis unit also specifies the domain (time or frequency). It is not possible to have both time-domain lines and frequency-domain lines at the same time; if a time-

domain line is imported while the other lines are in the frequency domain (or vice-versa), all limit lines will be deleted prior to import.

If the sign of the margin is inappropriate for the limit type (for example a positive margin for an upper limit), the sign of the margin will be changed internally so that it is appropriate.

The remaining lines describe the data. Each line in the file represents an X-Y pair. The X values should be monotonically non-decreasing, although adjacent lines in the file can have the same X value as an aid to building a stair-stepped limit line. To specify a region over which there is no limit, use +1000 dBm for upper limits or -1000 dBm for lower limits.

The data region begins with the keyword DATA:

```
DATA
200.000000,-10.00
300.000000,-10.00
300.000000,-20.00
500.000000,-20.00
```

.lim file format

This is a legacy format which allows files saved from older analyzers to be loaded into the X-Series. Design of files in this format is not recommended.

Limit Selection

These keys let you pick which Limit Line to save. Once selected, the key returns back to the **Export Data** menu and the selected Limit Line number is annotated on the key.

The next step in the Save process is to select the Save As key in the Export Data menu.

Key Path	Save, Data, Limit Line
Notes	auto return
Preset	Not part of Preset, but is reset to LLINE1 by Restore Mode Defaults; survives shutdown
Initial S/W Revision	A.02.00

Measurement Results

Pressing this key selects Meas Results as the data type to be exported. Pressing the key a second time brings up the Meas Results menu, which allows you to select which **Meas Result** to save. In the Swept SA measurement, there are three types of Measurement Results files: Peak Table, Marker Table and Spectrogram.

- See ["Meas Results File Contents" on page 871](#).
- See ["Marker Table" on page 871](#).
- See ["Peak Table" on page 875](#).
- See ["Spectrogram" on page 878](#)

Remote Command	:MMEMory:STORe:RESuLts:MTABle PTABle SPEctrogram <filename>
Example	:MMEM:STOR:RES:MTAB "myResults.csv" Saves the results from the current marker table to the file myResults.csv in the current path. :MMEM:STOR:RES:PTAB "myResults.csv" Saves the results from the current peak table to the file myResults.csv in the current path. :MMEM:STOR:RES:SPEC "myResults.csv" Saves the results from the current Spectrogram display to the file myResults.csv in the current path. The default path is My Documents\SA\data\SAN\results
Notes	If the save is initiated via SCPI, and the file already exists, the file will be overwritten. Using the C: drive is strongly discouraged, since it runs the risk of being overwritten during an instrument software upgrade. Both single and double quotes are supported for any filename parameter over SCPI.
Dependencies	If a save of Marker Table results is requested and the Marker Table is not on, no file is saved and a message is generated If a save of Peak Table results is requested and the Peak Table is not on, no file is saved and a message is generated If a save of Spectrogram results is requested and the Spectrogram is not on, no file is saved and a message is generated. The Spectrogram choice only appears if option EDP is licensed.
Preset	Not part of Preset, but is reset to Peak Table by Restore Mode Defaults. Survives a shutdown.
Initial S/W Revision	Prior to A.02.00

Meas Results File Contents

All files are .csv files. The following section details the data in each file type.

Marker Table

This section discusses the Marker Table Meas Results file format.

Imagine that, at the point where a Marker Table Meas Result is requested, the following screen is showing:

8 Swept SA Measurement
Save

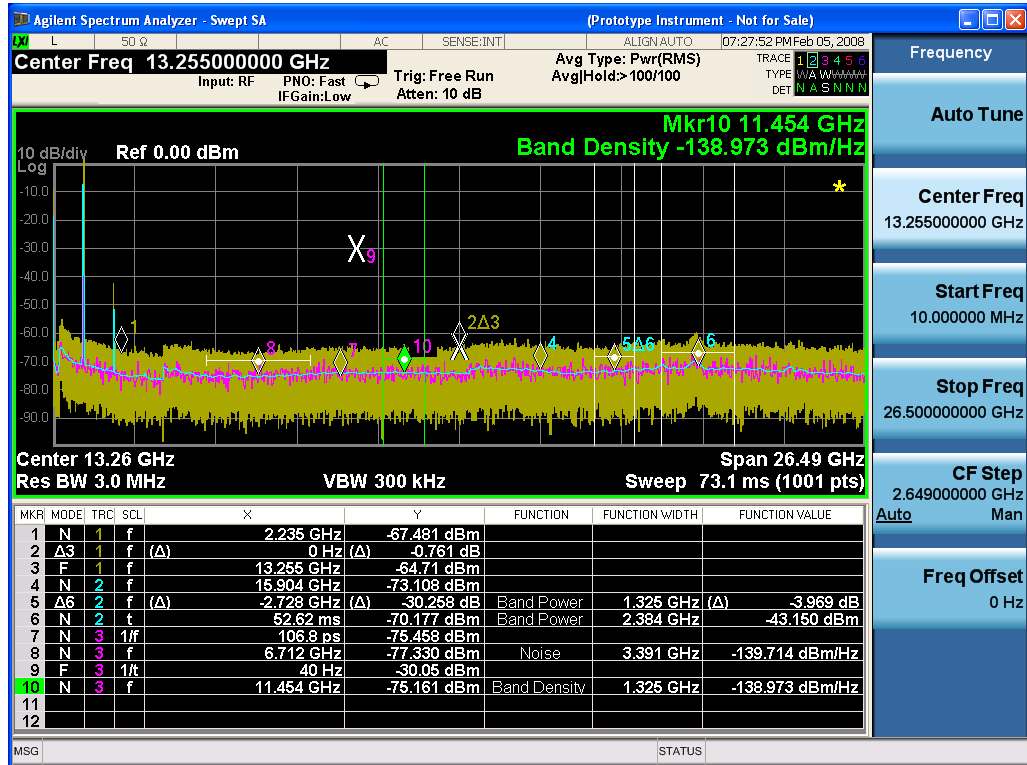

Then the Meas Results file, when opened, would show the following data:

Measurement	Result
Swept SA	
A.01.40_	N9020A
R0017	
526 B25	1
PFR P26	
EA3	
Result Type	Marker Table
Ref Level	0
Number of Points	1001
Sweep Time	0.06626667
Start Frequency	10000000
Stop Frequency	265000000
Average Count	0

Average Type	LogPower (Video)
RBW	3000000
RBW Filter	Gaussian
RBW Filter BW	3dB
VBW	3000000
Sweep Type	Swept
X Axis Scale	Lin
PreAmp State	Off
PreAmp Band	Low
Trigger Source	Free
Trigger Level	1.2
Trigger Slope	Positive
Trigger Delay	1.00E-06
Phase Noise Optimization	Fast
Swept If Gain	Low
FFT If Gain	Autorange
RF Coupling	AC
FFT Width	411900
Ext Ref	10000000
Input	RF
RF Calibrator	Off
Attenuation	10
Ref Level Offset	0

8 Swept SA Measurement
Save

External Gain	0								
X Axis Units	Hz								
Y Axis Units	dBm								
DATA									
MKR	MODE	T R C	SCL	X	Y	FUNC TION	FUNC TION WIDT H	FUNC TION VALU E	FUNC TION UNIT
1	Normal	1	Frequ ency	2.2350 E+09	- 67. 48 1	Off	0.0000 E+00	0	None
2	Delta3	1	Frequ ency	0.0000 E+00	- 0.7 61	Off	0.0000 E+00	0	None
3	Fixed	1	Frequ ency	1.3255 E+10	- 64. 71	Off	0.0000 E+00	0	None
4	Normal	2	Frequ ency	1.5904 E+10	- 73. 10 8	Off	0.0000 E+00	0	None
5	Delta7	2	Frequ ency	- 2.7280 E+09	- 30. 25 8	Band Power	1.3250 E+06	- 3.969	dB
6	Normal	2	Time	5.2620 E-02	- 70. 17 7	Band Power	2.3840 E+06	- 43.15	dBm
7	Normal	3	Perio d	1.0680 E-10	- 75. 45 8	Off	0.0000 E+00	0	None
8	Normal	3	Frequ ency	6.7120 E+09	- 77. 33	Noise	3.3910 E+06	- 139.7 14	dBm/ Hz
9	Fixed	3	Inver se Time	4.0000 E+01	- 30. 05	Off	0.0000 E+00	0	None
10	Normal	3	Frequ ency	1.1454 E+10	- 75. 16 1	Band Densi ty	1.3250 E+06	- 138.9 73	dBm/ Hz
11	Off	1	Frequ	0.0000	0	Off	0.0000	0	None

			ency	E+00			E+00		
12	Off	1	Frequ	0.0000	0	Off	0.0000	0	None
			ency	E+00			E+00		

The numbers appear in the file exactly as they appear onscreen. If it says 11.454 GHz onscreen, then in the file it is 11.454E+09.

The metadata header is very similar to the metadata used in the trace data .csv files. See ["Trace File Contents" on page 3216](#). The only new information concerns the 1-of-N fields in the marker table itself.

Peak Table

This section discusses the Peak Table Meas Results file format.

Imagine that, at the point where a Marker Table Meas Result is requested, the following screen is showing:

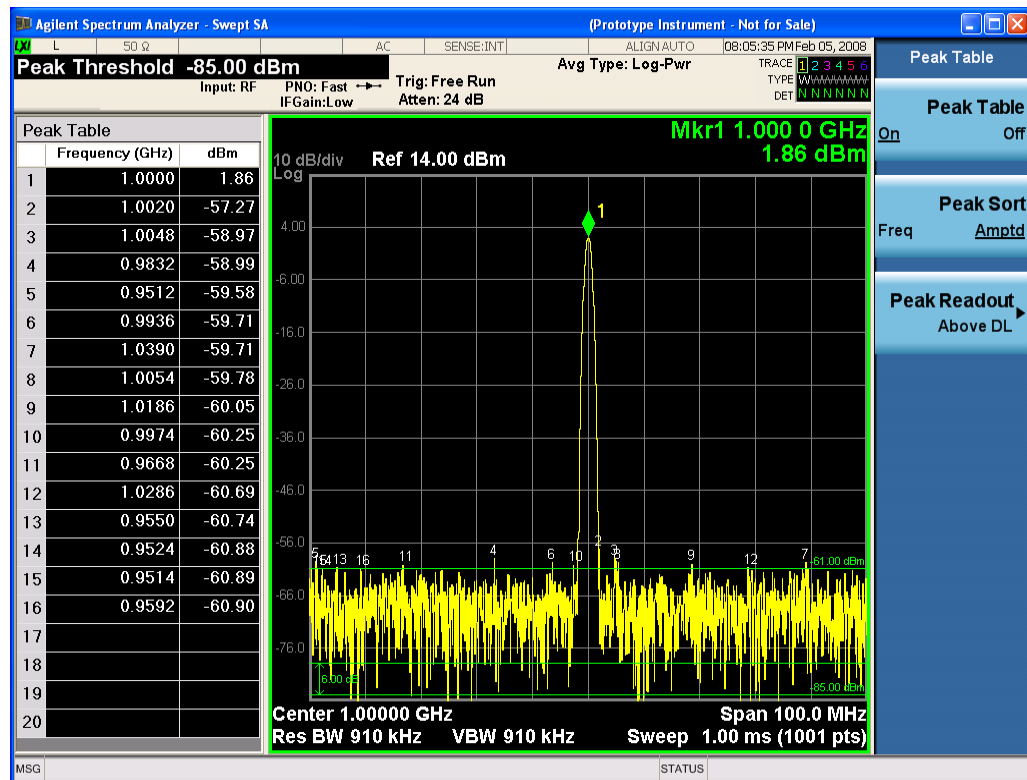

Then the Meas Results file, when opened, would show the header data (the same as for the Marker Table except that the Result Type is Peak Table) ending with a few fields of specific interest to Peak Table users:

- Peak Threshold
- Peak Threshold State (On|Off)

- Peak Excursion
- Peak Excursion State (On|Off)
- Display Line
- Peak Readout (All|AboveDL|BelowDL)
- Peak Sort (Freq|Amptd)

These fields are then followed by the data for the Peak Table itself.

Note that the label for the Frequency column changes to Time in 0 span.

Here is what the table for the above display looks like:

MeasurementResult	
Swept SA	
A.18.00	N9020A
526 B25 PFR P26 EA3	1
Result Type	Peak Table
Ref Level	0
Number of Points	1001
Sweep Time	0.066266667
Start Frequency	10000000
Stop Frequency	26500000000
Average Count	0
Average Type	LogPower (Video)
RBW	3000000
RBW Filter	Gaussian
RBW Filter BW	3dB
VBW	3000000
Sweep Type	Swept
X Axis Scale	Lin
PreAmp State	Off
PreAmp Band	Low
Trigger Source	Free
Trigger Level	1.2
Trigger Slope	Positive
Trigger Delay	1.00E-06
Phase Noise Optimization	Fast

Swept If Gain	Low		
FFT If Gain	Autorange		
RF Coupling	AC		
FFT Width	411900		
Ext Ref	10000000		
Input	RF		
RF Calibrator	Off		
Attenuation	10		
Ref Level Offset	0		
External Gain	0		
X Axis Units	Hz		
Y Axis Units	dBm		
Peak Threshold	-85		
Peak Threshold State	On		
Peak Excursion	6		
Peak Excursion State	On		
Display Line	-61		
Peak Readout	AboveDL		
Peak Sort	Amptd		
DATA			
Peak	Frequency	Amplitude	Delta to Limit
1	1.000009988E+09	-26.08	41.1
2	9.99989974E+08	-26.11	43.9
3	1.000019929E+09	-29.47	35.2
4	9.999799016E+08	-29.54	40.4
5	1.000030002E+09	-37.51	23.1
6	9.999699601E+08	-37.62	32.4
7	9.999999155E+08	-37.71	32.3
8	1.000039943E+09	-48.38	9.1

9	9.999598877E+08	-48.55	21.4
10	1.000049885E+09	-61.43	-8.1
11	9.999499461E+08	-61.66	8.3
12	1.000059957E+09	-76.53	- 26.1
13	9.999398738E+08	-77.01	-7.6
14			
15			
16			
17			
18			
19			
20			

Spectrogram

This section discusses the Spectrogram Results file format. The Spectrogram choice only appears if option EDP is licensed.

The Spectrogram results are the same as a Trace data export, except that instead of having just one trace's data, all 300 traces appear one after the other.

Each trace has its own data mark; the data for Spectrogram Trace 0 follows the row marked DATA, the data for Spectrogram Trace 1 follows the row marked DATA1, for Spectrogram Trace 2 follows the row marked DATA2, and so on.

Each DATA row has a timestamp in the second column (as of firmware revision A.11.01). So, for example, if Trace 0 had a relative start time of 1729.523 sec, then the first DATA row would look like this:

DATA,1729.523

And if Trace 13 had a relative start time of 100.45 sec, then the fourteenth data row would look like:

DATA13,100.453

To find the absolute time for the relative timestamps of each trace, the last row before the first DATA row gives the absolute start time of the Spectrogram, in the form YYYYMMDDHHMMSS

So, for example, if the absolute start time is 13:23:45:678 on January 30, 2012, this row would look like:

Start Time,20120130132345678

NOTE:

NOTE

The resolution of the absolute time stored is 1 ms, which matches up with the fact that the fastest sweep time is also 1 ms. However, there is no specification for the absolute accuracy of the clock in the analyzer, nor is there any facility provided to allow the user to set this time to any particular degree of accuracy.

Traces that have not yet been filled in the Spectrogram display are empty; there is no DATA header for them. The file ends after the last non-empty trace.

Imagine that, at the point where a Spectrogram Meas Result is requested, the following screen is showing:



For the purpose of this example, we have set the Average/Hold Number to 10, thus we have only traces 0 thru 10. The Spectrogram was started at 02:28:08:700 pm on April 25, 2012 (that is, 700 ms after 2:28:08 pm), although the screen dump itself shows a different time, as it was taken ten minutes after the Spectrogram data. Trace 0 is showing a start time of 5.30 seconds, meaning 5.3 seconds after the Spectrogram started (trace 10 has a start time of 0, as it was the first trace taken but has now rolled up into the tenth trace slot).

The Meas Results file, when opened, shows the header data and ten traces of trace data. Below is an extract from the result file for the above display. Note the start time of 20120425142808700 showing in the last row before the first DATA row, and the relative time of 5.299231048 showing in the first DATA row:

Result Type	Spectrogram
MeasResult	
Swept SA	
A.11.00.01	N9020A
503 508 513 526 ALL ALV B1C B1X B25 B2X B40 BAB BBA CR3 CRP DP2 DRD EA3 EDP EMC EP1 ERC ESC ESP EXM FSA HBA K03 LFE MPB P03 P08 P13 P26 PFR RTL RTS S40 SB1 SEC SM1 UK6 YAS YAV	1
Segment	0
Number of Points	1001
Sweep Time	0.523333333
Start Frequency	5999984415
Stop Frequency	6000009415
Average Count	0
Average Type	LogPower(Video)
RBW	240
RBW Filter	Gaussian
RBW Filter BW	3dB
VBW	240
Sweep Type	Swept
X Axis Scale	Lin
PreAmp State	Off
PreAmp Band	Low
Trigger Source	Free
Trigger Level	1.2
Trigger Slope	Positive
Trigger Delay	0
Phase Noise Optimization	Wide
Swept If Gain	Low
FFT If Gain	Autorange
RF Coupling	AC
FFT Width	411900
Ext Ref	10000000
Input	RF
RF Calibrator	Off

Result Type	Spectrogram
Attenuation	14
Ref Level Offset	0
External Gain	0
Trace Type	Clearwrite
Detector	Normal
Trace Math	Off
Trace Math Oper1	Trace5
Trace Math Oper2	Trace6
Trace Math Offset	0
Trace Name	Trace1
X Axis Units	Hz
Y Axis Units	dBm
Start Time	20120425142808700
DATA	5.299231048
5999984415	-76.34749519
5999984440	-77.28097006
5999984465	-75.32317869
5999984490	-73.64417681
5999984515	-72.67154604

o
o
o

6000009315	-77.94423277
6000009340	-79.51829697
6000009365	-78.46108961
6000009390	-78.46108957
6000009415	-76.59570596
DATA2	4.708697055
5999984415	-80.98197882
5999984440	-80.98197879
5999984465	-75.83142132
5999984490	-74.02712079
5999984515	-73.57213005

o
o

o

6000009315	-75.9183103
6000009340	-79.53787488
6000009365	-78.82602191
6000009390	-78.82602188
6000009415	-76.37486709
DATA10	0
5999984415	-75.56751112
5999984440	-75.76485645
5999984465	-76.67718717
5999984490	-78.79238489
5999984515	-83.72680212

o
o
o

6000009315	-71.3942461
6000009340	-72.28308332
6000009365	-73.92684489
6000009390	-75.45548832
6000009415	-75.17904815

Save As . . .

When you press “Save As”, the analyzer brings up a Windows dialog and a menu entitled “**Save As.**” This menu allows you to navigate to the various fields in the Windows dialog without using a keyboard or mouse. The **Tab** and **Arrow** keys can also be used for dialog navigation.

See "[To File . . .](#)" on page 3202 in **Save, State** for a full description of this dialog and menu.

The default path for saving files is:

For all of the Trace Data Files:

- My Documents\<<mode name>\data\traces

For all of the Limit Data Files:

- My Documents\<<mode name>\data\limits

For all of the Measurement Results Data Files:

- My Documents\<<mode name>\data\<<measurement name>\results

For all of the Capture Buffer Data Files:

- My Documents\<<mode name>\data\captureBuffer

Key Path	Save, Data
Mode	All
Notes	The key location is mode-dependent and will vary. Brings up the Save As dialog for saving a <mode specific> Save Type. The save is performed immediately and does not wait until the measurement is complete.
Initial S/W Revision	Prior to A.02.00

Screen Image

Pressing Screen Image accesses a menu of functions that enable you to specify a format and location for the saved screen image. It brings up a menu that allows you to specify the color scheme of the Screen Image (Themes) or navigate to the Save As dialog to perform the actual save.

Screen Image files contain an exact representation of the analyzer display. They cannot be loaded back onto the analyzer, but they can be loaded into your PC for use in many popular applications.

The image to be saved is actually captured when the **Save** front panel key is pressed, and kept in temporary storage to be used if you ask for a Screen Image save. When the Screen Image key is pressed, a "thumbnail" of the captured image is displayed, as shown below:

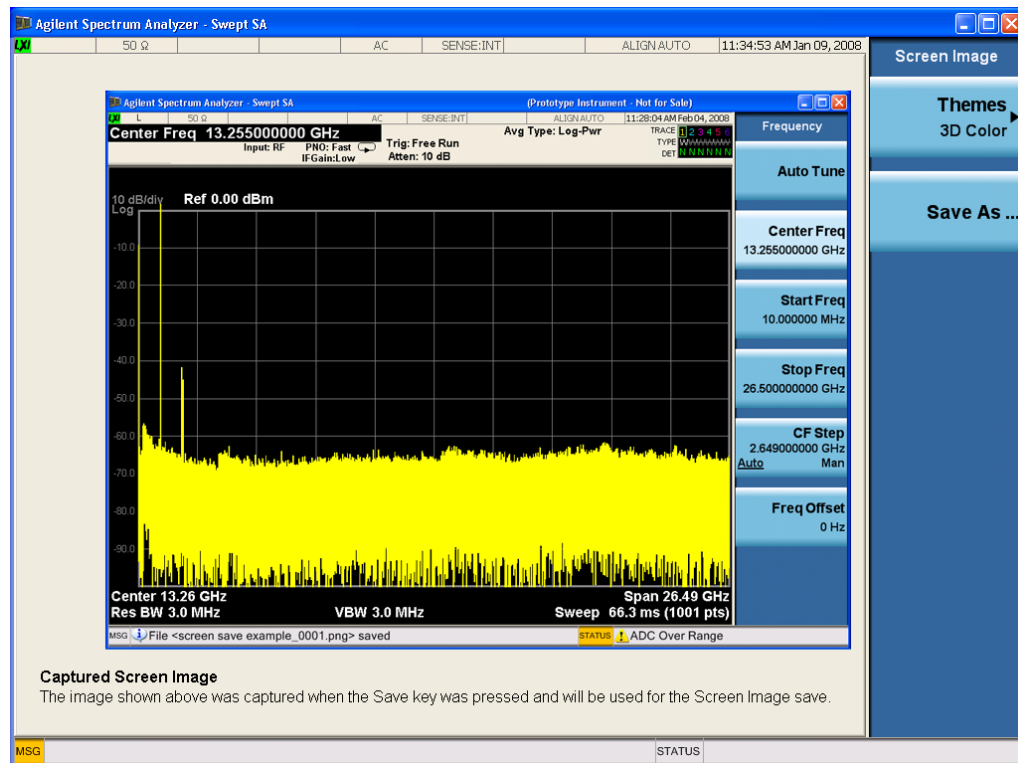

When you continue on into the **Save As** menu and complete the Screen Image save, the image depicted in the thumbnail is the one that gets saved, showing the menus that were on the screen before going into the **Save** menus. The save is performed immediately and does not wait until the measurement is complete.

After you have completed the save, the **Quick Save** front-panel key lets you quickly repeat the last save performed, using an auto-named file, with the current screen data.

NOTE

For versions previous to A.01.55, if you initiate a screen image save by navigating through the Save menus, the image that is saved will contain the Save menu softkeys, not the menus and the active function that were on the screen when you first pressed the Save front panel key.

Key Path	Save
Mode	All
Remote Command	:MMEMory:STORe:SCReen <filename>
Example	:MMEM:STOR:SCR "myScreen.png" This stores the current screen image in the file MyScreenFile.png in the default directory.
Backwards Compatibility SCPI	HCOPy:SDUMp:DATA? returns the screen image in a <DEFINITE LENGTH ARBITRARY RESPONSE DATA> element. The response data is IEEE Block format; the controlling computer can strip the header and store the result as a .png file.
Initial S/W Revision	Prior to A.02.00

Themes

Accesses a menu of functions that enable you to choose the theme to be used when saving the screen image.

The **Themes** option is the same as the **Themes** option under the **Display** and **Page Setup** dialogs. It allows you to choose between themes to be used when saving the screen image.

Key Path	Save, Screen Image
Remote Command	:MMEMory:STORe:SCReen:THEMe TDCoLor TDMonochrome FCOLor FMONochrome :MMEMory:STORe:SCReen:THEMe?
Example	:MMEM:STOR:SCR:THEM TDM
Preset	3D Color; Is not part of Preset, but is reset by Restore Misc Defaults or Restore System Defaults All and survives subsequent running of the modes.
Readback	3D Color 3D Mono Flat Color Flat Mono
Backwards Compatibility Notes	In ESA and PSA we offer the choice of "Reverse Bitmap" or "Reverse Metafile" when saving screen images. This is much like the "Flat Color" theme available in X-Series. Also, if you selected Reverse Bitmap AND a black & white screen image, that would be much like "Flat Monochrome". In other words, each of the X-Series themes has a similar screen image type in ESA/PSA. But they are not identical.
Initial S/W Revision	Prior to A.02.00

3D Color

Selects a standard color theme with each object filled, shaded and colored as designed.

Key Path	Save, Screen Image, Themes
Example	MMEM:STOR:SCR:THEM TDC
Readback	3D Color
Initial S/W Revision	Prior to A.02.00

3D Monochrome

Selects a format that is like 3D color but shades of gray are used instead of colors.

Key Path	Save, Screen Image, Themes
Example	MMEM:STOR:SCR:THEM TDM
Readback	3D Mono
Initial S/W Revision	Prior to A.02.00

Flat Color

Selects a format that is best when the screen is to be printed on an ink printer.

Key Path	Save, Screen Image, Themes
Example	MMEM:STOR:SCR:THEM FCOL
Readback	Flat Color
Initial S/W Revision	Prior to A.02.00

Flat Monochrome

Selects a format that is like Flat Color. But only black is used (no colors, not even gray), and no fill.

Key Path	Save, Screen Image, Themes
Example	MMEM:STOR:SCR:THEM FMON
Readback	Flat Mono
Initial S/W Revision	Prior to A.02.00

Save As...

When you press "Save As", the analyzer brings up a Windows dialog and a menu entitled "**Save As.**" This menu allows you to navigate to the various fields in the Windows dialog without using a keyboard or mouse. The **Tab** and **Arrow** keys can also be used for dialog navigation.

See "[To File . . .](#)" on page 3202 in **Save, State** for a full description of this dialog and menu.

The default path for Screen Images is

- My Documents\<<mode name>\screen.

where <mode name> is the parameter used to select the mode with the INST:SEL command (for example, SA for the Spectrum Analyzer).

Key Path	Save, Screen Image
Notes	Brings up Save As dialog for saving a Screen Image Save Type
Initial S/W Revision	Prior to A.02.00

Mass Storage Catalog (Remote Command Only)

Key path	SCPI Only
Remote Command	:MMEMory:CATalog? [<directory_name>]
Notes	<p>The string must be a valid logical path.</p> <p>Queries disk usage information (drive capacity, free space available) and obtains a list of files and directories in a specified directory in the following format:</p> <p><numeric_value>,<numeric_value>,{<file_entry>}</p> <p>It returns two numeric parameters and as many strings as there are files and directories. The first parameter indicates the total amount of storage currently used in bytes. The second parameter indicates the total amount of storage available, also in bytes. The <file_entry> is a string. Each <file_entry> indicates the name, type, and size of one file in the directory list:</p> <p><file_name>,<file_type>,<file_size></p> <p>As the windows file system has an extension that indicates file type, <file_type> is always empty. <file_size> provides the size of the file in bytes. For directories, <file_entry> is surrounded by square brackets and both <file_type> and <file_size> are empty</p>
Initial S/W Revision	Prior to A.02.00

Mass Storage Change Directory (Remote Command Only)

Key path	SCPI Only
Remote Command	:MMEMory:CDIRectory [<directory_name>] :MMEMory:CDIRectory?
Notes	<p>The string must be a valid logical path.</p> <p>Changes the default directory for a mass memory file system. The <directory_name> parameter is a string. If no parameter is specified, the directory is set to the *RST value.</p> <p>At *RST, this value is set to the default user data storage area, that is defined as System.Environment.SpecialFolder.Personal.</p> <p>Query returns full path of the default directory.</p>
Initial S/W Revision	Prior to A.02.00

Mass Storage Copy (Remote Command Only)

Key path	SCPI Only
----------	------------------

Remote Command	:MMEMory:COpy <string>,<string>[,<string>,<string>]
Notes	<p>The string must be a valid logical path.</p> <p>Copies an existing file to a new file or an existing directory to a new directory.</p> <p>Two forms of parameters are allowed. The first form has two parameters. In this form, the first parameter specifies the source, and the second parameter specifies the destination.</p> <p>The second form has four parameters. In this form, the first and third parameters specify the source. The second and fourth parameters specify the directories. The first pair of parameters specifies the source. The second pair specifies the destination. An error is generated if the source doesn't exist or the destination file already exists.</p> <p>This command will generate an "access denied" error if the destination is a restricted folder (e.g., C:\Windows) and the current user does not have Power User or Administrator privileges.</p>

Mass Storage Delete (Remote Command Only)

Key path	SCPI Only
Remote Command	:MMEMory:DELeTe <file_name>[,<directory_name>]
Notes	<p>The string must be a valid logical path.</p> <p>Removes a file from the specified directory. The <file_name> parameter specifies the file name to be removed. This command will generate an "access denied" error if the file is in a restricted folder (e.g., C:\Windows) and the current user does not have Power User or Administrator privileges.</p>
Initial S/W Revision	Prior to A.02.00

Mass Storage Device Copy (Remote Command Only)

This command transfers data to/from a file and a peripheral device.

Key path	SCPI Only
Remote Command	:MMEMory:COpy:DEvice <source_string>,<dest_string>
Notes	<p>The strings must be a valid logical path or a valid device keyword. If the dest_string is a device keyword, the data is copied from the source file to the device. If the source_string is a device keyword, the data is copied to the source file from the device.</p> <p>Valid device keywords are:</p> <p>SNS (smart noise source)</p> <p>An error is generated if the file or device is not found.</p>

Mass Storage Data (Remote Command Only)

Creates a file containing the specified data OR queries the data from an existing file.

Key path	SCPI Only
Remote Command	:MMEMory:DATA <file_name>, <data> :MMEMory:DATA? <file_name>
Notes	The string must be a valid logical path.

	<p>The command form is MMEemory:DATA <file_name>,<data>. It loads <data> into the file <file_name>. <data> is in 488.2 block format. <file_name> is string data.</p> <p>The query form is MMEemory:DATA? <file_name> with the response being the associated <data> in block format.</p>
Initial S/W Revision	Prior to A.02.00

Mass Storage Make Directory (Remote Command Only)

Key path	SCPI Only
Remote Command	:MMEemory:MDIRectory <directory_name>
Notes	<p>The string must be a valid logical path.</p> <p>Creates a new directory. The <directory_name> parameter specifies the name to be created.</p> <p>This command will generate an “access denied” error if the new directory would be in a restricted folder (e.g., C:\Windows) and the current user does not have Power User or Administrator privileges.</p>
Initial S/W Revision	Prior to A.02.00

Mass Storage Move (Remote Command Only)

Key path	SCPI Only
Remote Command	:MMEemory:MOVE <string>,<string>[,<string>,<string>]
Notes	<p>The string must be a valid logical path.</p> <p>Moves an existing file to a new file or an existing directory to a new directory.</p> <p>Two forms of parameters are allowed. The first form has two parameters. In this form, the first parameter specifies the source, and the second parameter specifies the destination.</p> <p>The second form has four parameters. In this form, the first and third parameters specify the source. The second and fourth parameters specify the directories. The first pair of parameters specifies the source. The second pair specifies the destination. An error is generated if the source doesn't exist or the destination file already exists.</p> <p>This command will generate an “access denied” error if the destination is a restricted folder (e.g., C:\Windows) and the current user does not have Power User or Administrator privileges.</p>
Initial S/W Revision	Prior to A.02.00

Mass Storage Remove Directory (Remote Command Only)

Key path	SCPI Only
Remote Command	:MMEemory:RDIRectory <directory_name>
Notes	<p>The string must be a valid logical path.</p> <p>Removes a directory. The <directory_name> parameter specifies the directory name to be removed. All files and directories under the specified directory shall also be removed.</p> <p>This command will generate an “access denied” error if the folder is a restricted folder (e.g., C:\Windows) or is in a restricted folder and the current user does not have Power User or Administrator privileges.</p>
Initial S/W Revision	Prior to A.02.00

Mass Storage Determine Removable Media (Remote Command Only)

This command is used to determine if any removable media devices are connected to the instrument. Primarily, these are USB memory devices plugged-in to the front panel or rear panel USB ports. On instruments with PC6 or PC7 CPU's, one SD card slot is available for removable media. The instrument's primary disk drive is not a removable media device.

Key Path	SCPI Only
Remote Command	:MMEMory:RMEDia:LIST?
Notes	<p>The return value is a string containing a list of partition identifiers that are removable media devices. Each identifier is separated by a comma. If no removable media is present, an empty string is returned.</p> <p>Examples:</p> <ul style="list-style-type: none"> - One removable device present results in a return string of "F:". - Two removable devices present results in a return string of "F:,G:". - No removable devices present results in a return string of "".
Initial S/W Revision	x.15.00

Mass Storage Determine Removable Media Label (Remote Command Only)

This command is used to set or query a removable media device's label.

Key Path	SCPI Only
Remote Command	:MMEMory:RMEDia:LABel <partition>,<string> :MMEMory:RMEDia:LABel? <partition>
Example	MMEM:RMED:LAB "F:","My Device"
Notes	<p>If the <partition> specified does not exist or is not a removable media device, the error -252,"Missing Media" is generated.</p> <p>Setting the removable media label requires Administrative privileges. If the currently logged in user does not have appropriate privileges the error "-221.9900,Settings conflict;Administrator privileges required" is generated.</p>
Initial S/W Revision	x.15.00

Mass Storage Determine Removable Media Write-protect status (Remote Command Only)

This command is used to query a removable media device's write-protect status.

Key Path	SCPI Only
----------	-----------

Remote Command	:MMEMory:RMEDia:WPRotect? <partition>
Example	MMEM:RMED:WPR? "F:"
Notes	The return value is 1 if the device is write-protected, or 0 if the device is write-enabled. If the <partition> specified does not exist or is not a removable media device the error - 252,"Missing Media" is generated.
Preset	The return value will be depending on SD card installed.
Initial S/W Revision	x.15.00

Mass Storage Determine Removable Media size (Remote Command Only)

This command is used to query a removable media device's total memory size (not available memory size).

Key Path	SCPI Only
Remote Command	:MMEMory:RMEDia:SIZE? <partition>
Example	MMEM:RMED:SIZE? "F:"
Notes	The return value is integer value in GBytes. Any device that is less than 1 GB returns 0 GB. If the <partition> specified does not exist or is not a removable media device, the error - 252,"Missing Media" is generated.
Initial S/W Revision	x.15.00

:SYSTem:SET (Remote Command Only)

Remote command that allows the user to obtain the state of the currently active mode in a form that can then be loaded back into the instrument quickly.

Remote Command	SYSTem:SET <instrument state in IEEE Block> SYSTem:SET?
Notes	SYST:SET? returns current instrument state of the active mode in IEEE Block data format. The state is in a machine readable format only. Sending the query returns the following format: <syst set preamble><state block data> Where: <syst set preamble> is the format: #NMMM N=number of digits that comprise MMM MMM=length in bytes of following data <state block data> is machine readable state data Example response: #42016<state data> The state is recalled by sending the SYST:SET? Response data to the instrument. From example above: SYST:SET #42016<state data>
Initial S/W Revision	x.17.00

Single (Single Measurement/Sweep)

Sets the analyzer for Single measurement operation. The single/continuous state is Meas Global, so the setting will affect all the measurements. If you are Paused, pressing **Single** does a Resume.

See "[More Information](#)" on page 891

Key Path	Front-panel key
Example	:INIT:CONT OFF
Notes	See Cont key description.
Backwards Compatibility Notes	For Spectrum Analysis mode in ESA and PSA, the Single hardkey and the INITiate:IMM switched from continuous measurement to single measurement and restarted sweeps and averages (displayed average count reset to 1), but did not restart Max Hold and Min Hold . In the X-Series, the Single hardkey and the INITiate:IMM command initiate a sweep/ measurement/ average sequence/hold sequence including MaxHold and MinHold . For Spectrum Analysis mode in ESA and PSA, the Single hardkey restarted the sweep regardless of whether or not you were in an active sweep or sweep sequence. In the X-Series, Restart does this but Single only restarts the sweep or sweep sequence if you are in the idle state. INIT[:IMM] in ESA & PSA Spectrum Analysis Mode does an implied ABORT. In some other PSA Modes, INIT[:IMM] is ignored if not in the idle state. . The X-Series follows the ESA/PSA SA Mode model, which may cause some Modes to have compatibility problems.
Initial S/W Revision	Prior to A.02.00

More Information

See "[Restart](#)" on page 3199 for details on the INIT:IMMEDIATE (Restart) function.

If you are already in single sweep, the INIT:CONT OFF command has no effect.

If you are already in Single Sweep, then pressing the **Single** key in the middle of a sweep does not restart the sweep or sequence. Similarly, pressing the **Single** key does not restart the sweep or sequence if the sweep is not in the idle state (for example, if you are taking a very slow sweep, or the analyzer is waiting for a trigger). Instead, it results in a message. "Already in Single, press Restart to initiate a new sweep or sequence". Even though pressing the **Single** key in the middle of a sweep does not restart the sweep, sending INIT:IMMEDIATE does reset it.

To take one more sweep without resetting the average count, increment the average count by 1, by pressing the step up key while **Average/Hold Number** is the active function, or sending the remote command CALC:AVER:TCON UP.

Source

The Source key accesses menus for controlling a Source in Tracking Source mode

Key Path	Front-panel key
Dependencies	Operation with a source requires a license. If the proper license is not installed, the following occurs: <ul style="list-style-type: none"> - When the Source key is pressed the user sees an informational message, "Option not installed" - If any SCPI command in the :SOURce subsystem is sent it generates a message, "Settings conflict;option not installed"
Initial S/W Revision	A.06.01

NOTE

Option T03 or T06 is required for the Tracking Generator function in CXA. Option T03, T07, T13 or T26 is required for the Tracking Generator function in CXA-m.

When using the CXA-m Tracking Generator, if the Source Frequency is in the frequency range of the below table, and the Source Amplitude is in the corresponding amplitude range of the below table, a warning status message is generated, +313 "Source Uncal". This is also true if Power Sweep is on and any amplitude in the Power Sweep (as calculated by Amplitude, Power Sweep, and Amptd Offset) is in that range.

CXA-m TG Un-calibrated Amplitude Range

Frequency Range	Amplitude Range
$2 \text{ MHz} \leq \text{frequency} < 10 \text{ GHz}$	$-40 \text{ dBm} \leq \text{amplitude} < -35 \text{ dBm}$
$10 \text{ GHz} \leq \text{frequency} < 20 \text{ GHz}$	$-40 \text{ dBm} \leq \text{amplitude} < -35 \text{ dBm}$ or $-5 \text{ dBm} < \text{amplitude} \leq 0 \text{ dBm}$
$20 \text{ GHz} \leq \text{frequency} \leq 26.55 \text{ GHz}$	$-12 \text{ dBm} < \text{amplitude} \leq 0 \text{ dBm}$

RF Output

Allows you to turn the source RF Power on or off.

NOTE

When the RF Output is turned on, the Source Mode is set to Tracking. See the Source Mode key description for special considerations concerning how to configure your N5172B or N5182B source for use with External Source Control.

Key Path	Source
Scope	Meas Global
Remote Command	:OUTPut[:EXTErnal] [:STATe] ON OFF 1 0 :OUTPut[:EXTErnal] [:STATe]?

Example	:OUTP ON :OUTP?
Dependencies	Grayed out in measurements that do not support a source. If you go to such a measurement the output will be forced to Off. Grayed out if there is no valid source selection, in this case go to the Select Source menu to choose, configure and/or verify your source When there is no available Source Mode (other than Off), due to other couplings, then the RF Output key is grayed out.
Couplings	When RF Output is turned On, Source Mode is set to Tracking When Source Mode is turned Off, RF Output is turned Off. When Source Mode is turned Off (or forced to Off by another coupling), RF Output is turned Off. Turning RF Output Off does not affect Source Mode or other settings.
Preset	OFF (on either a Mode Preset, a Source Preset, or Restore Input/Output Defaults)
State Saved	Part of the Input/Output system, which means it is Loaded and Saved with state.
Range	On Off
Initial S/W Revision	A.06.01
Modified at S/W Revision	A.10.01

Amplitude

Allows you to access the Amplitude sub-menu to control various amplitude parameters of the Source. The resolution of the Source amplitude parameters is coupled to match the minimum resolution of the source when the source is acquired. When the source is released, the amplitude parameter resolution reverts to default values.

Key Path	Source
Readback	In square brackets, the amplitude value from Amplitude key in the next menu level down
Initial S/W Revision	A.06.01

Amplitude

Allows you to adjust the power level of the selected source. Note that the actual amplitude is also affected by the Amplitude Offset and Power Sweep parameters.

Key Path	Source, Amplitude
Scope	Mode Global
Remote Command	:SOURce[:EXTernal]:POWer[:LEVel][:IMMediate][:AMPLitude] <amp1> :SOURce[:EXTernal]:POWer[:LEVel][:IMMediate][:AMPLitude]?
Example	:OUTP ON :SOUR:POW -10dBm
Dependencies	If the requested setting of Source Amplitude causes the calculated external source start or stop

	Amplitude to exceed the external source capability, a warning status message is generated, "Data out of Range; clipped to source max/min" The "Show Source Capabilities and Settings" menu can then be examined to check the source capabilities. This parameter test and clip is also performed at source acquisition.
Preset	-10.00 dBm (On Source Preset and Restore Input/Output Defaults) Not affected by Mode Preset
State Saved	Part of the Input/Output system, which means it is Loaded and Saved with state.
Min	The range of the amplitude parameter is dependent on the amplitude range of the source that is selected, and the settings of Amplitude Offset and Power Sweep.
Max	The range of the amplitude parameter is dependent on the amplitude range of the source that is selected, and the settings of Amplitude Offset and Power Sweep.
Backwards Compatibility SCPI	:SOURce:POWer:START <amp1> :SOURce:POWer:START? This alias is for the ESA tracking generator. It specifies the source output power level at the start of the power sweep, just as does :SOURce:POWer.
Initial S/W Revision	A.06.01
Modified at S/W Revision	A.10.01

Power Sweep

Allows you to set up a Power Sweep. Power Sweep is useful for measuring saturation behavior in a test device, such as a power amplifier.

Pressing the key sets the power-sweep function to On or Off. The value of the power-sweep range is displayed in the active function block, and can be adjusted, when set to On.

The source will sweep the power between the start power defined by the Amplitude function and the stop power = start power + power sweep value:

Source (start) amplitude = Amplitude – Amplitude Offset

Source (stop) amplitude = Amplitude – Amplitude Offset + Power Sweep

In Stepped Tracking, such as is used with an external source or the CXA-m TG, the analyzer controls the source with step sweep mode, which provides a linear progression from one selected frequency, amplitude, or both, to another, pausing at linearly spaced points (steps) along the sweep. The analyzer continues to sweep the specified frequency range when power sweep is on, although generally Power Sweep is performed in Zero Span.

With CXA options T03, T06, the hardware is capable of continuous power sweeps. This makes it possible to use the swept sweep time rules and should be employed for faster sweeps. Care should be taken to limit the sweep time you use as there are no sweep time couplings to Power Sweep settings. The recommended minimum sweep time depends on the RBW and power-sweep range. Start by computing $(1.28/\text{RBW}) * (\text{abs}(\text{startPower} - \text{stopPower}) / (5 \text{ dB}))$. The recommended minimum sweep time is the larger of this value and 50 ms.

Some external Sources have mechanical attenuators, which are not used in Power Sweep in order to save wear on the attenuators. To allow an acceptable range of Power Sweep without changing the mechanical attenuation, the Sources are put in a mode that allows the Source to handle a wide amplitude range without switching the attenuators. When the Power Sweep settings put the Source in an amplitude range that requires the mechanical attenuators, the analyzer displays a condition warning message:

Settings Alert;Src pwr ramp>ALC range

Key Path	Source, Amplitude
Mode	SA
Scope	Mode Global
Remote Command	:SOURce:POWer:SWEEp <rel_amp1> :SOURce:POWer:SWEEp? :SOURce:POWer:SWEEp:STATe ON OFF 1 0 :SOURce:POWer:SWEEp:STATe?
Example	:SOUR:POW -5 :SOUR:POW:SWE:STAT ON :SOUR:POW:SWE 10 Set source start power to - 5 dBm and stop power + 5dBm (-5 + 10).
Example	:SOUR:POW:SWE:STAT ON
Dependencies	If the requested setting of Power Sweep causes the calculated external source start or stop Amplitude to exceed the external source capability, a warning status message is generated, "Data out of Range; clipped to source max/min". The Show Source Capabilities and Settings menu can then be examined to check the source capabilities. This parameter test and clip is also performed at source acquisition.
Preset	This is unaffected by "Mode Preset" but is set to 0dB on a "Source Preset" or "Restore Input/Output Defaults".
State Saved	Part of the Input/Output system, which means it is Loaded and Saved with state.
Min	-500 dB
Max	+500 dB
Backwards Compatibility SCPI	:SOURce[:EXTErnal][:SWEEp]:POWer:SPAN <rel_amp1> :SOURce[:EXTErnal][:SWEEp]:POWer:SPAN? This alias is for the ESA tracking generator and PSA option 215. It specifies the range of power levels through which the source output will sweep just as does :SOURce:POWer:SWEEp.
Initial S/W Revision	A.06.01
Remote Command	:SOURce[:EXTErnal]:POWer:MODE FIXed SWEEp :SOURce[:EXTErnal]:POWer:MODE?
Notes	The ESA tracking generator and the PSA option 215 support this SCPI command. It sets the source output to be at a single amplitude (fixed) or to sweep through a range of power levels

	SOURce:POWer:MODE FIXed is equivalent to :SOURce:POWer:SWEEp:STATe OFF
	SOURce:POWer:MODE SWEEp is equivalent to :SOURce:POWer:SWEEp:STATe ON
Preset	This is unaffected by "Mode Preset" but is set to FIXed on a "Source Preset" or "Restore Input/Output Defaults".
Initial S/W Revision	A.06.01
Modified at S/W Revision	A.10.01

Amptd Offset

Offsets the displayed power of the source in the Amplitude parameter. Using the amplitude offset allows you to take into account any system losses or gains (for example, due to cable loss), thereby displaying the actual power delivered to the device under test. See the equations under the Source, Amplitude, Power Sweep key.

Key Path	Source, Amplitude
Mode	SA
Scope	Mode Global
Remote Command	:SOURce:CORRection:OFFSet <rel_ampl> :SOURce:CORRection:OFFSet?
Example	:SOUR:CORR:OFFS 5 Sets the displayed source offset power to 5 dB.
Dependencies	If the requested setting of Amptd Offset causes the calculated external source start or stop Amplitude to exceed the external source capability, a warning status message is generated, "Data out of Range; clipped to source max/min". The Show Source Capabilities and Settings menu can then be examined to check the source capabilities. This parameter test and clip is also performed at source acquisition.
Preset	This is unaffected by Mode Preset but is set to 0.00dBm on a Source Preset or Restore Input/Output Defaults.
State Saved	Part of the Input/Output system, which means it is Loaded and Saved with state.
Min	-1000 dB
Max	+1000 dB
Initial S/W Revision	A.06.01

Amptd Step Auto/Man

Allows you to set the step size associated with the Source Amplitude key. When auto-coupled, the step size is the current Scale/Div setting under the Amplitude hardkey (note that this is true even if the analyzer is currently in Linear amplitude scale).

Once a step size has been selected and the Source Amplitude function is active, the step keys (and the UP|DOWN parameters for Source Amplitude from remote commands) change the Source Amplitude by the step-size value.

You may change the step size manually by pressing Amptd Step and entering a value. The function (and the step size) will return to Auto when a Mode Preset or Auto Couple is performed.

Key Path	Source, Amplitude
Scope	Mode Global
Remote Command	:SOURce:POWer:STEP[:INCRement] <amp1> :SOURce:POWer:STEP[:INCRement]? :SOURce:POWer:STEP:AUTO OFF ON 0 1 :SOURce:POWer:STEP:AUTO?
Example	:SOUR:POW:STEP 0.1 Set amplitude step to 0.1 dB :SOUR:POW:STEP:AUTO ON
Couplings	In Auto, coupled to the size of one logarithmic vertical graticule division
Preset	Auto
State Saved	Part of the Input/Output system, which means it is Loaded and Saved with state.
Min	0.1 dB
Max	20 dB
Initial S/W Revision	A.06.01

Frequency

Allows a you to access the Frequency sub-menu. This menu lets you use a stepped tracking source for stimulus/response measurements for some added flexibility. Because with such a source, the source frequency does not need to track 1:1 with the analyzer LO frequency, it is possible to measure scalar harmonic and subharmonic responses of devices. For example, the second harmonic response is measured by stepping the analyzer and source so that the analyzer is always at twice the source frequency. In addition, the frequency offset capability allows the measurement of frequency conversion devices (like mixers).

In tracking mode, the source frequency tracks the analyzer frequency according to the source frequency equation:

$$\text{Source Frequency} = (\text{Analyzer Frequency} * \text{Multiplier Numerator} / \text{Multiplier Denominator}) + \text{Source Frequency Offset}$$

NOTE

Analyzer Frequency is the frequency to which the analyzer is set, which is the analyzer's displayed frequency, offset by any Freq Offset set under the Frequency hardkey. **Source Frequency Offset** is the value set under **Source, Frequency, Freq Offset**.

Key Path	Source
----------	---------------

Readback	none in Tracking Source mode
Initial S/W Revision	A.06.01

Multiplier Numerator

The multiplier numerator parameter offsets the source frequency from the analyzer frequency. The source frequency tracks the SA frequency according to the source frequency equation shown under the **Source, Frequency** key description.

The multiplier numerator must be restricted to operate within the range of the source minimum and maximum frequencies.

Key Path	Source, Frequency
Mode	SA
Scope	Mode Global
Remote Command	:SOURCE:FREQUENCY[:MULTIPLIER]:NUMERATOR <integer> :SOURCE:FREQUENCY[:MULTIPLIER]:NUMERATOR?
Example	:SOUR:FREQ:NUM 3 Sets the source frequency multiplier numerator to 3.
Dependencies	If the currently selected source does not support this capability (for example, an internal Tracking Generator which must track the LO), this key is forced to its Preset value and grayed out
Preset	This is unaffected by Mode Preset but is set to 1 on a Source Preset or Restore Input/Output Defaults.
State Saved	Part of the Input/Output system, which means it is Loaded and Saved with state.
Min	1
Max	1000
Initial S/W Revision	A.06.01

Multiplier Denominator

The multiplier denominator parameter offsets the source frequency from the analyzer frequency. The source frequency tracks the SA frequency according to the source frequency equation shown under the **Source, Frequency** key description.

The multiplier denominator must be restricted to operate within the range of the source minimum and maximum frequencies.

Key Path	Source, Frequency
Mode	SA
Scope	Mode Global
Remote Command	:SOURCE:FREQUENCY[:MULTIPLIER]:DENOMINATOR <integer> :SOURCE:FREQUENCY[:MULTIPLIER]:DENOMINATOR?
Example	:SOUR:FREQ:DEN 3 Sets the source frequency multiplier denominator to 3
Dependencies	If the currently selected source does not support this capability (for example, an internal Tracking

	Generator which must track the LO), this key is forced to its Preset value and grayed out
Preset	This is unaffected by Mode Preset but is set to 1 on a Source Preset or Restore Input/Output Defaults.
State Saved	Part of the Input/Output system, which means it is Loaded and Saved with state
Min	1
Max	1000
Initial S/W Revision	A.06.01

Source Sweep Reverse

Allows you to reverse the source sweep direction

Normally, the source will sweep from a lower frequency to a higher frequency. However, there are test scenarios in which the source sweep needs to be “reversed”. In this case, it sweeps from a higher frequency to a lower frequency. For example, when the DUT is a frequency converter and a measurement of the Lower Side Band characteristics is desired, a reverse sweep is employed. Reverse sweeps are supported for such scenarios, but two cautions are in order:

4. Reverse Sweep only reverses the direction of the source’s sweep, not the analyzer’s sweep. Unless you are actually using a device like a frequency converter and looking at the lower sideband, thus effectively reversing the direction of the source’s sweep, the source will be sweeping in the opposite direction from the analyzer, and it will not be possible track the desired device output frequency.
5. Any time you are using a frequency converter, care must be taken in setting up all of the sweep parameters, including analyzer start/stop frequency and source multiplier, to make sure that the analyzer’s sweep tracks the output of the converter device.

Key Path	Source, Frequency
Mode	SA
Scope	Mode Global
Remote Command	:SOURce:FREQuency:SSReverse:ON OFF 0 1 :SOURce:FREQuency:SSReverse?
Example	SOUR:FREQ:SSR:OFF SOUR:FREQ:SSR?
Notes	You must be in Spectrum Analyzer mode to use this command. Use INSTRument:SElect to set the mode.
Dependencies	If the currently selected source does not support this capability (for example, an internal Tracking Generator which must track the LO), this key is forced to its Preset value and grayed out
Preset	This is unaffected by Mode Preset but is set to OFF on a Source Preset or Restore Input/Output Defaults.

State Saved	Part of the Input/Output system, which means it is Loaded and Saved with state
Range	On Off
Initial S/W Revision	A.06.01

Freq Offset

The frequency offset parameter offsets the source frequency from the analyzer frequency. The source frequency tracks the SA frequency according to the equations under the **Source, Frequency** key.

Pressing the key sets the Freq Offset function to On or Off. The value of Freq Offset is displayed in the active function block, and can be adjusted, when set to On.

The frequency offset must be restricted to operate within the range of the source minimum and maximum frequencies.

Key Path	Source, Frequency
Mode	SA
Scope	Mode Global
Remote Command	:SOURce:FREQuency:OFFSet <freq> :SOURce:FREQuency:OFFSet? :SOURce:FREQuency:OFFSet:STATe ON OFF 1 0 :SOURce:FREQuency:OFFSet:STATe?
Example	:SOUR:FREQ:OFFS 10MHz Sets the source frequency offset to 10MHz.
Dependencies	If the currently selected source does not support this capability (for example, an internal Tracking Generator which must track the LO), this key is forced to its Preset value and grayed out
Preset	This is unaffected by Mode Preset but is set to 0.00Hz on a Source Preset or Restore Input/Output Defaults.
State Saved	Part of the Input/Output system, which means it is loaded and saved with state
Min	-500 GHz
Max	500 GHz
Backwards Compatibility SCPI	:SOURce:EXTernal:SWEEp:OFFSet:FREQuency <freq> :SOURce:EXTernal:SWEEp:OFFSet:FREQuency? The PSA option 215 supports this SCPI command. This command is equivalent to :SOURce:FREQuency:OFFSet
Initial S/W Revision	A.06.01
Modified at S/W Revision	A.10.01

Source Mode

Accesses the Source Mode softkey menu. This menu lets you select Tracking mode for the Source, and also allows you to set the Source Mode to OFF.

The Source Mode can be set to Tracking without the user setting it directly. There are several couplings that cause Source Mode to be automatically set to Tracking (detailed in the table below). One important coupling is that Source Mode is forced to Tracking when the RF Output is turned on if the measurement supports Tracking. Since Source Mode is set to Off on a Mode Preset, this means that you will rarely need to change the Source Mode setting directly.

NOTE

When the Source Mode is set to Tracking, the analyzer acquires control of the source. When this happens the source is told to save its state and then perform a preset. Usually both of these operations take very little time; however, on an N5172B or an N5182B, if many Source real-time apps are in use, both save and preset can take many seconds. If it takes longer than the analyzer expects to acquire control, you will see an error: “Source connection lost, check interface connection”. If you see this error, and you are using an N5172B or an N5182B, you can shorten the acquire time by presetting your MXG before attempting to use External Source Control.

Key Path	Source
Scope	Meas Global
Remote Command	:INSTrument:SOURce[:SElect] TRACKing OFF :INSTrument:SOURce[:SElect]?
Example	:INST:SOUR TRAC
Dependencies	<p>Grayed out if no Source is selected, in this case go to the Select Source menu to choose, configure and/or verify your source</p> <p>Grayed out and forced to Off if either BBIQ or External Mixing are selected</p> <p>Blanked in Modes that do not support a source</p> <p>Grayed out in Measurements that do not support a source</p> <p>Tracking is grayed out when Manual FFT is selected</p> <p>Tracking is grayed out when the RF Preselector is on (in models which support the RF Preselector).</p>
Couplings	<p>When RF Output is turned On, Source Mode is set to Tracking. When Source Mode is turned Off, RF Output is turned Off.</p> <p>Whenever you switch to an application (Mode) in which the Source Mode was previously set to Tracking, it is again set to Tracking. That is, the last setting of the Source Mode is remembered when you leave an application (Mode) and restored when you return</p> <p>Source Mode is forced to Tracking when the RF Output is turned on if the measurement supports Tracking</p> <p>If Source Mode is set to Tracking, then it is forced to Off when you select a measurement that does not support Tracking.</p> <p>If Source Mode is set to Tracking, then it is forced to Off when you turn on the RF Preselector (in models which support the RF Preselector).</p> <p>Whenever the Source Mode is set to Tracking, the analyzer acquires the Source. Similarly, the Source is released whenever the Source Mode is set to Off. This is true whether the Source Mode was set directly by you, was set indirectly through a coupling, if you switched to an application (Mode) that had previously been set to Tracking, or if you switched to an application (Mode) in which the Source Mode is not set to Tracking.</p>

For an external source, “acquiring the source” involves contacting the external instrument over the remote interface (which puts it into Remote) and taking control of it.

When you set the Source Mode to OFF, it releases the Source (and puts it into Local). For an external source, this means you are now free to operate the source for other purposes.

When the Source is acquired, its previous state is saved, and when it is released, that state is restored, so that you can acquire and then release the source and it will return to the state it was in before you acquired it.

Preset	OFF
State Saved	Saved in instrument state
Initial S/W Revision	A.06.01
Modified at S/W Revision	A.10.01

Select Source

The Select Source menu allows you to maintain a list of available external Sources, and choose the Source that you want to use from the list. It shows the currently selected source at the bottom of the screen.

While in the Select Source menu, you can see, and select from, a list of the currently available sources. The sources listed in this table are as follows:

- Any internal sources which are installed and licensed

NOTE

Only one internal source can be installed, displayed at address “INTERNAL”

- Any external sources which you have previously configured, whether or not they are currently connected, displayed with their VISA address

Note that only external sources that are supported by the Tracking Source Mode are displayed in the Available Source List. Here are the Keysight/Agilent sources currently supported:

Source	PXA	MXA	EXA	CXA	MXE (Presel off)
MXG N5181A	X	X	X	X	X
MXG N5182A	X	X	X	X	X
MXG N5183A	X	X	X		X
EXG N5171B	X	X	X	X	X
MXG N5181B	X	X	X	X	X
EXG	X	X	X	X	X

N5172B					
EXG	X	X	X	X	X
N5173B					
MXG	X	X	X	X	X
N5182B					
MXG	X	X	X	X	X
N5183B					
PSG	X	X	X		
E8257D					
PSG	X	X	X		
E8267D					

NOTE

For X-Series software versions earlier than A.10.01, option UNZ (Fast switching) was required on the MXG for some use cases. This is no longer the case, option ESC now works without MXG option UNZ for all use cases. (Note that you will get better performance if your MXG has option UNZ, because without option UNZ your sweep speeds will be noticeably slower.)

While in the Select Source menu and its submenus, detailed instructions are presented that tell you how to operate the Select Source functions. Basically they tell you to first use the up and down arrow keys to move the selection highlighted in the “Available Source List” to the source that you want to use. The list of available sources includes any sources that you have previously used (unless you have deleted them) and any found while in the “Add Source to List” menu.

When the source you want to use is highlighted, press “Select Highlighted Source” or “Enter”. The source you have selected shows up at the bottom of the screen as the “Current Source”. Press “Verify Current Source Connection” to make sure that the interface connection to the Source is still functional.

At any time you may use the “Add Source to List” or “Delete Highlighted Source” keys to find new sources or remove a source from the list of available sources.

Key Path	Source
Readback Text	Two lines of readback give the type information and serial number of the current source, in square brackets
Initial S/W Revision	A.06.01

Select Highlighted Source

You can navigate up and down in the list with the up and down arrow keys, and can select any entry by pressing the Select Highlighted Source key (or by double-clicking on the entry in the table with a mouse). The highlighted source becomes the Current Source and is prominently displayed at the bottom of the screen.

At any given time there is only one selected Source for the entire system; once a Source is selected, it becomes the Current Source and will be used by all applications that support Source Control.

For example, if no Source has yet been selected, the statement at the bottom of the screen would say

Current Source

None

If an N5182A connected via USB were the Current Source, the statement at the bottom of the screen might say:

Current Source

Agilent N5182A US00000258 at USB0::2931::7937::US00000258::0::INSTR

The SCPI command defined below allows the programmatic user to directly define the VISA address via a string parameter. The parameter is checked for proper syntax, the connection to the instrument is verified, and the source is added to the Available Source List if it verifies. If it does not verify or no source is found at that address, an error message is generated.

Normally the source selection activities should be performed only when the user changes the hardware connection configuration or activates/deactivates a source option license; shutdown and startup of the application will not cause source re-selection.

The Agilent IO Libraries Suite provides an “Agilent VISA Help” document that has a section that shows the proper syntax for valid VISA address strings, in the ViOpen function definition.

Key Path	Source, Select Source
Mode	SA
Remote Command	:SYSTem:COMMunicate:SOURce[1]:ADDRess <address string> :SYSTem:COMMunicate:SOURce[1]:ADDRess?
Example	Different examples for setting external source address :SYST:COMM:SOUR:ADDR "TCPIP0::MyHostName::INSTR" :SYST:COMM:SOUR:ADDR "TCPIP0::123.121.100.210::INSTR" :SYST:COMM:SOUR:ADDR "USB0::12212::32145::US1234567A::INSTR" :SYST:COMM:SOUR:ADDR "GPIB1::19::INSTR"
Notes	Empty string is allowed and means no source is defined or selected.
Remote Command Notes	The address string is the VISA address for external sources and "INTERNAL" for an internal source
Dependencies	Operation with a source requires a license. If the proper license is not installed, the SCPI command generates an error message, "Settings conflict;option not installed" If no supported source, or no source at all, is found at the specified address, the SCPI command generates an error message
Preset	The current source selection is unaffected by a Mode Preset and Source Preset but reverts to

	[None] on a Restore Input/Output Defaults. If an internal Tracking Generator is installed, then instead of None, the default selection will be INTERNAL.
State Saved	Selected Source is <ul style="list-style-type: none"> - Power On Persistent (survives power cycle) - Part of the Input/Output system, which means it is Loaded and Saved with state.
Readback	Two lines of readback give the type information and serial number of the current source on the Select Source key in the form [<source type>] [<serial number>] [None] shows in the type area and blank in the serial number area if a source has not been configured. [Internal TG] shows in type area and serial number in the serial number area if an internal Tracking Generator has been selected. For example: [MXG]/n, [US01020022]. This indicates an MXG of serial number US01020022.
Backwards Compatibility SCPI	:SYSTem:COMMunicate:LAN:SOURce[:EXTernal]:IP <address string> :SYSTem:COMMunicate:LAN:SOURce[:EXTernal]:IP? This command is provided for compatibility with PSA Option 215. The address string is reformatted for the X-Series. For example, if the customer sends :SYSTem:COMMunicate:LAN:SOURce:EXTernal:IP 146.208.172.111 The analyzer turns this into :SYSTem:COMMunicate:SOURce:ADDRess "TCPIP0::146.208.172.111::INSTR"
Initial S/W Revision	A.06.01
Modified at S/W Revision	A.10.01

Delete Highlighted Source

Deletes the highlighted source from the list of available sources. You will be prompted with a dialog box to make sure you REALLY want to do this. The prompt says "The highlighted source will be permanently deleted from the list. Are you sure you want to do this? Press Enter to proceed, or Cancel (ESC) to cancel."

Key Path	Source, Select Source
Initial S/W Revision	A.06.01

Add Source To List

This menu allows you to add to the list of available sources from various interfaces.

Key Path	Source, Select Source
Initial S/W Revision	A.06.01

USB

Sources on USB (once installed) can be added to the list by pressing “Add Installed USB Sources.” Any supported source found will be added to the list.

See ["Add Installed USB Sources" on page 3259](#) for information on connecting and installing USB devices.

Key Path	Source, Select Source, Add Source to List
Initial S/W Revision	A.06.01

Add Installed USB Sources

Press this key to add USB sources to the Available Source List. Note that this function will ONLY find sources that have previously been installed onto the USB. For information on how to install a USB source, see ["Installing a USB source" on page 907](#)

Key Path	Source, Select Source, Add Source to List, USB
Notes	If no installed USB device is found which is a supported source, an error message is generated
Initial S/W Revision	A.06.01

Installing a USB source

USB is the only interface which requires no runtime action by the user in the Select Source menu, but does require “installation” when a source is plugged in.

You start by connecting the USB source to the analyzer. You will get a series of messages indicating that the analyzer is installing required device software.

When the installation is complete, you will get a message to that effect. You can then use the “Add Installed USB Sources” function (above) to add the source to the list of sources in the Available Source List.

GPIB

Lets you add GPIB sources to the Available Source List.

For the GPIB interface to work properly, it must be configured as a Controller. You can find this setting in the System menu under System, I/O Config, GPIB. Set the GPIB Controller function to Enabled.

Note that you must also make sure that the GPIB interface is not set to “Ignore” in the Agilent Connection Expert. If it is set to **Ignore**, then even if the GPIB Controller is set to **Enabled**, it is not possible for the analyzer to find a GPIB connected source. See ["More Information" on page 907](#) .

Key Path	Source, Select Source, Add Source to List
Initial S/W Revision	A.06.01

More Information

If you suspect that the GPIB interface is not set to Ignore, run the Agilent Connection Expert (ACE). To run ACE, press Source, Select Source, Add Source to List, LAN, Run Connection Expert. Look for the GPIB branch on the interface tree:

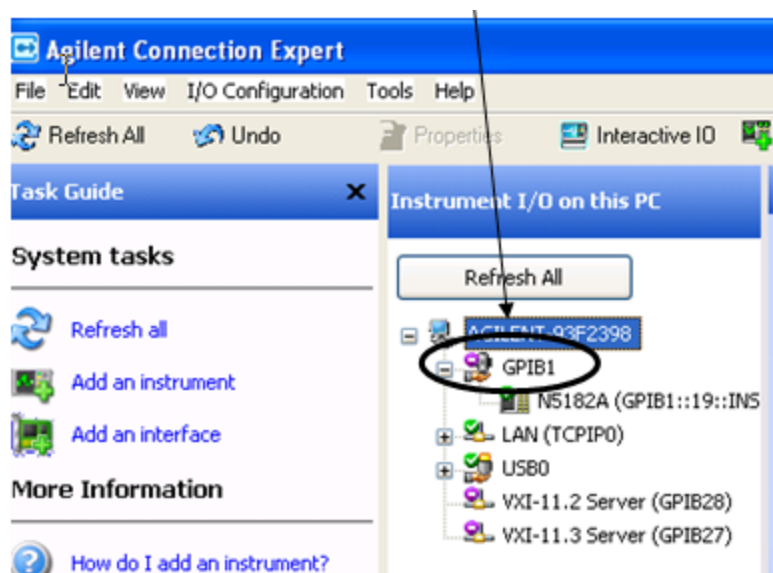

Right click on the GPIB branch (you will have to plug in a mouse to do this). You should see a dialog like the one below. If this dialog says **Stop Ignoring**, select **Stop Ignoring** and close ACE.

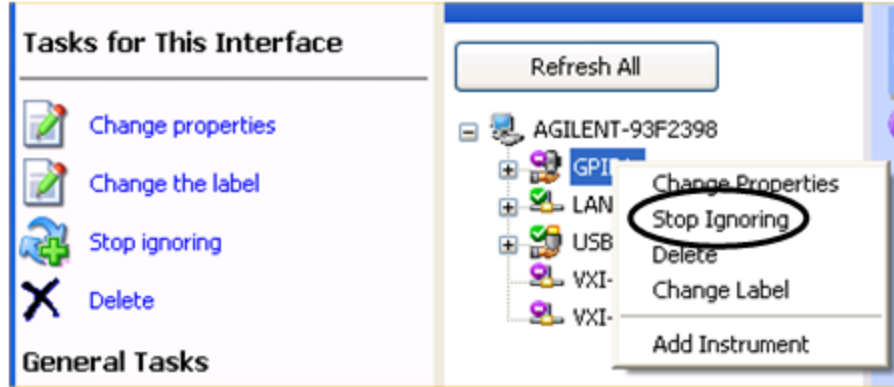

Scan & Add GPIB Sources

Sources on GPIB can be added by pressing **Scan & Add GPIB Sources**. Any supported source found will be added to the Available Source List.

NOTE

This will cause any older, non-SCPI compatible devices on your GPIB to generate error messages.

Key Path	Source, Select Source, Add Source to List, GPIB
Notes	If the GPIB controller mode is not enabled, an error message is generated If no GPIB device is found which is a supported source, an error message is generated
Initial S/W Revision	A.06.01

Enter GPIB Address

Opens a menu that lets you enter the GPIB address of the desired source directly.

NOTE

For this to work properly, the GPIB interface must be configured as GPIB1. This is the default state and should normally be the case. To see how to verify this, see "**More Information**" on page 909.

Key Path	Source, Select Source, Add Source to List, GPIB
Initial S/W Revision	A.06.01

More Information

If you suspect that the GPIB interface is not set to GPIB1, run the Agilent Connection Expert (ACE). To run ACE, press Source, Select Source, Add Source to List, LAN, Run Connection Expert. Look for the GPIB branch on the interface tree:

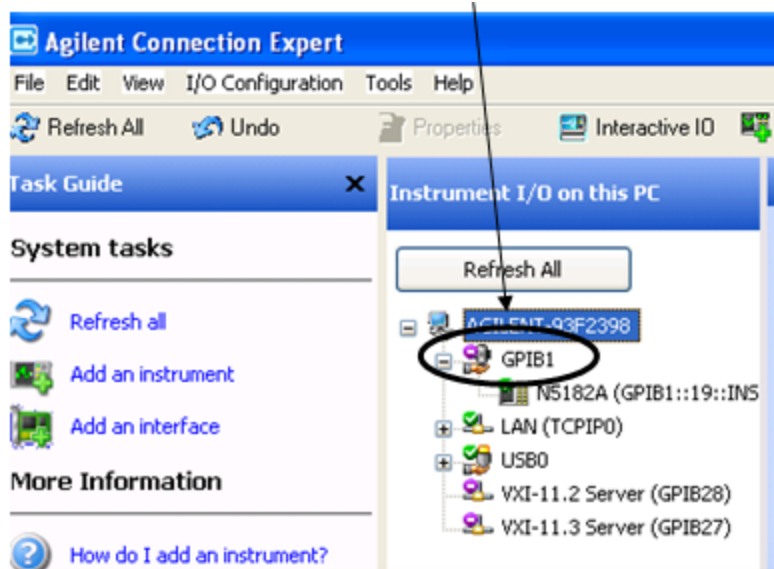

If this branch is not labeled **GPIB1**, right click on the GPIB branch (you will have to plug in a mouse to do this) and select **Change Properties**.

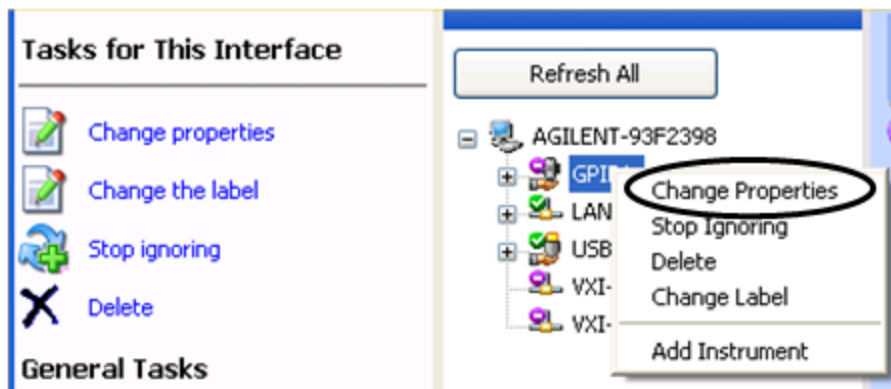

You should see a dialog like the one below. Click on the drop-down arrow under **VISA Interface ID**, select **GPIB1** and click **OK**

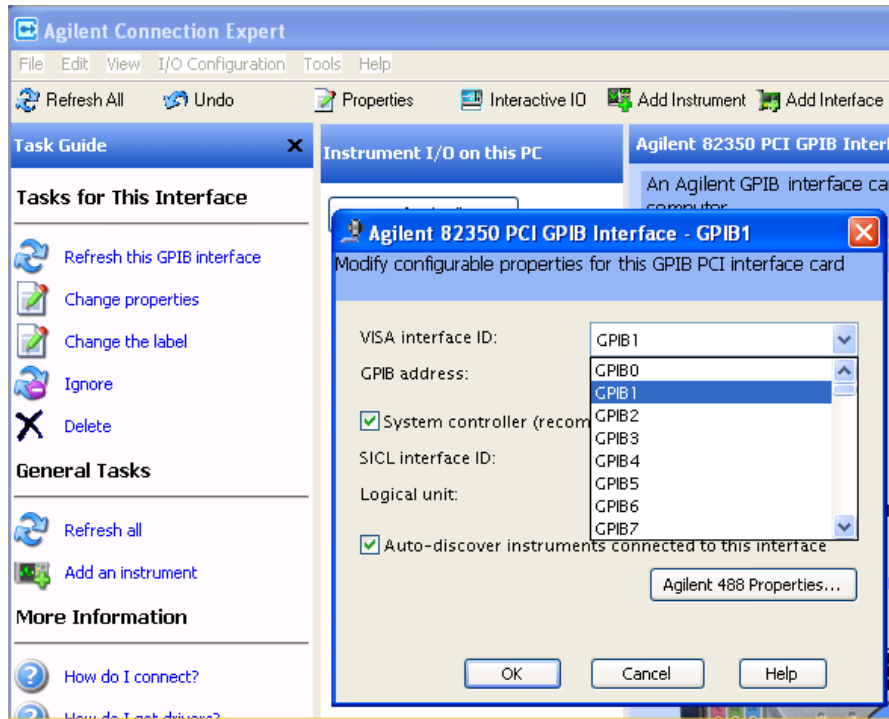

GPIB Address

Lets you enter the GPIB address. After you enter the address press **Add** to add the source at that address to the Available Source List.

Key Path	Source, Select Source, Add Source to List, GPIB, Enter GPIB Address
Preset	Unaffected by Mode Preset but set to 19 by "Restore Input/Output defaults"
State Saved	No
Min	0
Max	30
Initial S/W Revision	A.06.01

Add

Add the source at the entered GPIB address to the Available Source List. If a supported source is found at that address it will be added to the list.

Key Path	Source, Select Source, Add Source to List, GPIB, Enter GPIB Address
Notes	If GPIB controller mode is not enabled, an error message is generated If no supported source is found at the specified address, an error message is generated
Initial S/W Revision	A.06.01

LAN

The LAN cannot be scanned directly from the analyzer software, but you can import the list of currently configured devices from Agilent Connection Expert by pressing

“Add From Connection Expert List.” The Connection Expert list depends on which instruments have already been discovered by the Agilent Connection Expert application. Any connected, supported sources in that list will be added.

You can also enter the IP address and press “Add”. If a supported source is found at that address it will be added.

If you want to discover sources on the LAN, you can open Connection Expert by pressing the “Run Connection Expert...” softkey.

Key Path	Source, Select Source, Add Source to List
Initial S/W Revision	A.06.01

Enter LAN Address

Opens up a menu which lets you enter the IP address of the desired source directly.

Key Path	Source, Select Source, Add Source to List, LAN
Initial S/W Revision	A.06.01

IP Address

Lets you enter the IP address of the desired source. After you enter the address you should press “Add” to add the source at that address to the Available Source List.

Key Path	Source
Preset	Unaffected by Mode Preset but set to 0.0.0.0 by Restore Input/Output defaults
State Saved	No
Initial S/W Revision	A.06.01

Add

Adds the source at the entered IP address to the Available Source List. If a supported source is found at that address it will be added to the list.

Key Path	Source
Notes	If no supported source is found at the specified address, an error message is generated
Initial S/W Revision	A.06.01

Run Connection Expert...

Runs the Agilent Connection Expert so that you can scan the LAN for sources.

Key Path	Source, Select Source, Add Source to List, LAN
Initial S/W Revision	A.06.01

Add From Connection Expert List

You can import the list of currently configured devices from Agilent Connection Expert by pressing **Add From Connection Expert List**. The Connection Expert list depends on which instruments have already been discovered by the Agilent Connection Expert application. Any connected, supported sources in that list will be added.

Key Path	Source, Select Source, Add Source to List, LAN
Notes	If no supported source is found in the Connection Expert list, an error message is generated
Initial S/W Revision	A.06.01

Verify Current Source Connection

This key verifies the interface connection to the Current Source (it does NOT verify any signal connections!)

Until the selected source is verified, a statement appears at the bottom of the screen which says (in red):

This Source has not been verified. Press "Verify Source" to check the interface connection.

When you press this key, the connection is checked to the selected source. If all is well, the statement is changed to (in green):

This connection to this source has been verified.

If the verification fails, the statement at the bottom will change to (in red):

Verification of this source failed. Check the interface connection

The selected source is also verified whenever it is acquired. If a Source's connection has been verified by any means, then that Source is considered to have been verified until either the analyzer software is shut down or if, in attempting to use the Source, communication with it fails.

Key Path	Source, Select Source
Initial S/W Revision	A.06.01

Source Setup

This menu is used to set up miscellaneous source functions, including trigger settings. For more on triggering in Tracking Mode, see ["Tracking Setup Details" on page 913](#). For information on bypassing the Microwave Preselector, see ["Use of the YTF \(Microwave or mm Preselector\) with External Source Control" on page 914](#)

Key Path	Source
Mode	SA
Initial S/W Revision	A.06.01

Tracking Setup Details

When an external source is operating in Tracking Mode, operation can be greatly enhanced by using hardware triggers. Below is a typical connection diagram showing a hardware handshake using Trigger 1 inputs and outputs on the analyzer (trigger 2 in and out is also a valid connection).

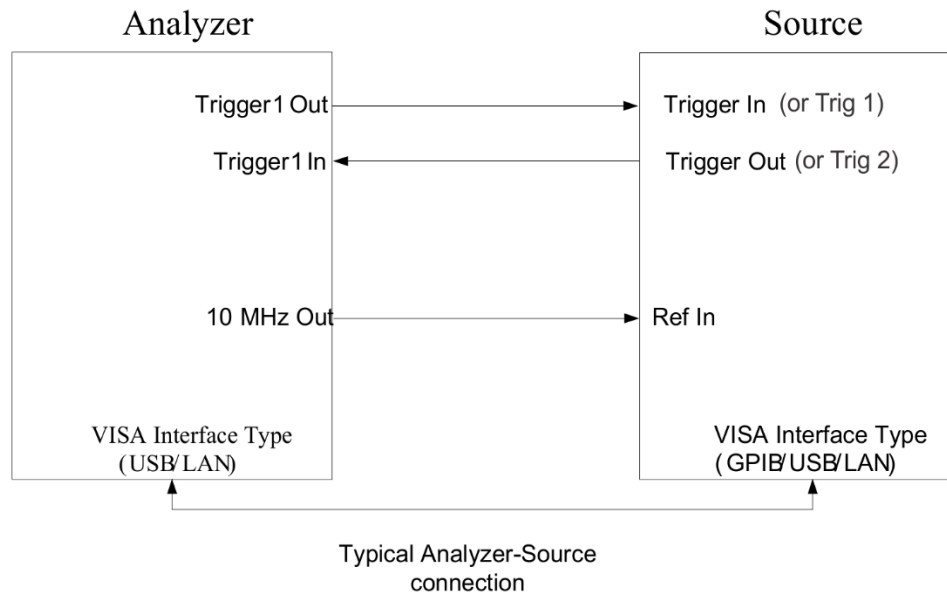

Analyzer Trigger 1 Out: Triggers the external source to step to next point in the frequency step/list.

Analyzer Trigger 1 In: Triggers the analyzer to make a measurement on this point

Source Trigger In (or “Trig 1” at default setting for N5181B/82B, N5183B MXG or N5171B/72B, N5173B EXG):

Triggers the source to step to the next point.

Source Trigger Out (or “Trig 2” at default setting for N5181B/82B, N5183B MXG or N5171B/72B, N5173B EXG): Indicates that the source has settled.

IO interface Connection: analyzer can connect to sources with its GPIB, USB or LAN interface.

Notes:

- Trigger sync connections are optional – synchronization can be done via remote commands if Bus Trigger is enabled in the Source Setup menu.
- Connection from the SA external frequency reference output to the source frequency reference input (10 MHz Out to Ref In) is not required, but may improve the measurement accuracy.

Use of the YTF (Microwave or mm Preselector) with External Source Control

In most stimulus/response measurements that utilize External Source Control, the source exactly tracks the tuned analyzer frequency. Consequently, preselection is not needed, and you can achieve greatly superior amplitude accuracy and repeatability by bypassing the YTF (Preselector) using the Microwave Preselector Bypass control in the Amplitude, μ W Path Control menu.

NOTE

This control is only available if option MPB is installed.

There are rare but important cases, however, where the source is tuned to a different frequency than the analyzer, using the Multiplier and Reverse controls in the Source, Frequency menu. For example, you might be tuning the source to $\frac{1}{2}$ of the analyzer frequency when looking at second harmonic distortion in a DUT. In these cases, it would be commonplace for there to be an undesired signal at the analyzer input that is at an image frequency that you will want to reject with the YTF.

Understanding these cases is important for proper operation of the Microwave Preselector with External Source Control, so that you only bypass it when it will improve accuracy but not hinder the measurement.

Point Trigger

Shows point trigger type selected and navigates to the Point Trigger menu.

The Point Trigger menu lists all analyzer point trigger types. The analyzer and source point trigger synchronization can be done using SCPI bus commands or by using external trigger output and input lines.

NOTE

For X-Series software versions earlier than A.10.01, hardware triggering was unavailable in stepped tracking at frequencies above 3.6 GHz, so above 3.6 GHz, software triggering was always used. This is no longer the case.

Key Path	Source, Source Setup
Mode	SA
Scope	Mode Global
Remote Command	:SOURce:TRIGger:TYPE BUS EXTernal[1] EXTernal2 :SOURce:TRIGger:TYPE?
Example	:SOUR:TRIG:TYPE EXT1 Selects analyzer external trigger 1 in and out for point trigger synchronization with selected source
Dependencies	If an internal Tracking Generator is selected, then this menu is unavailable, Additionally, the External 1 and External 2 Trigger keys on the Spectrum Analyzer are released from any grayout that may have been forced on them by the external source Point Trigger selection. In some models, there is no second External input. In these models, the External 2 key is blanked and the EXTernal2 parameter will generate a "Hardware missing; Not available for this model number" message.
Couplings	The source control point trigger selection can select external trigger 1 or 2 in for synchronized point triggering. This can conflict with the selection under the Trigger hardkey, if it has External 1 or 2 selected. If there is a conflict when the selection is made under the Point Trigger menu, the

	Trigger selection under the Trigger hardkey will be changed to Free Run.
Preset	This is unaffected by "Mode Preset" but is set to EXTERNAL1 on a "Source Preset" or "Restore Input/Output Defaults".
State Saved	Part of the Input/Output system, which means it is Loaded and Saved with state
Readback	1-of-N selection
Initial S/W Revision	A.06.01

SW Trigger

Analyzer and source point trigger synchronization is setup using the SCPI commands. Source is stepped via SCPI commands. Analyzer waits for source to settle by polling source.

Key Path	Source, Source Setup, Point Trigger
Mode	SA
Example	:SOUR:TRIG:TYPE BUS
Readback	SW Trigger
Initial S/W Revision	A.06.01

Ext Trigger 1

Analyzer and source point trigger synchronization is setup using the analyzer Trigger 1 Output and Trigger 1 Input. The Source is stepped via Trigger 1 Output. The Analyzer waits for source to settle via Trigger 1 Input.

Key Path	Source, Source Setup, Point Trigger
Mode	SA
Example	:SOUR:TRIG:TYP EXT1
Couplings	<p>With an acquired source, selecting this point trigger mode overrides existing external trigger 1 output level, slope, and delay, and external trigger 1 type and polarity.</p> <p>External trigger 1 input level = 1.20 V</p> <p>External trigger 1 input slope = Positive</p> <p>External trigger 1 input delay = Off</p> <p>External trigger 1 output type = Source Point Trigger</p> <p>External trigger 1 output polarity = Positive</p> <p>When this selection is made:</p> <ul style="list-style-type: none"> - The External 1 key in the Trigger menu (under the Trigger hardkey) is grayed out and, if External 1 was previously selected, it will be changed to Free Run. - Trig 1 Out selected under Output Config in the Input/Output menu will be changed to Source Point Trigger <p>If the user subsequently goes into the Trig 1 Out menu and selects a different Trigger Output, the Point Trigger will revert to SW Trigger.</p>

Readback	Ext Trigger 1
Initial S/W Revision	A.06.01

Ext Trigger 2

Analyzer and source point trigger synchronization is setup using the analyzer Trigger 2 Output and Trigger 2 Input. The Source is stepped via Trigger 2 Output. The Analyzer waits for source to settle via Trigger 2 Input.

Key Path	Source, Source Setup, Point Trigger
Mode	SA
Example	:SOUR:TRIG:TYP EXT2
Dependencies	This key is blanked out on CXA as there is only one trigger input
Couplings	<p>With an acquired source, selecting this point trigger mode overrides existing external trigger 2 output level, slope, and delay, and external trigger 2 type and polarity.</p> <p>External trigger 2 input level = 1.20 V</p> <p>External trigger 2 input slope = Positive</p> <p>External trigger 2 input delay = Off</p> <p>External trigger 2 output type = Source Point Trigger</p> <p>External trigger 2 output polarity = Positive</p> <p>When this selection is made:</p> <ul style="list-style-type: none"> - The External 2 key in the Trigger menu (under the Trigger hardkey) is grayed out and, if External 2 was previously selected, it will be changed to Free Run. - Trig 2 Out selected under Output Config in the Input/Output menu will be changed to Source Point Trigger - If the user subsequently goes into the Trig 2 Out menu and selects a different Trigger Output, the Point Trigger will revert to SW Trigger.
Readback	Ext Trigger 2
Initial S/W Revision	A.06.01

Show Source Capabilities & Settings

Shows the capabilities of the currently selected Source. The menu is useful for displaying source capabilities such as frequency and amplitude ranges. In addition, the results of the source control sweep algorithms can be viewed. This gives information of the source range required for a given analyzer sweep range. This can be used dynamically as a way of configuring the sweep settings.

Key Path	Source, Source Setup
Mode	SA
Dependencies	If no source is selected this key is grayed out.
Initial S/W Revision	A.06.01

Source Preset

The Source Preset key forces all the settings in the analyzer's Source State to their preset condition.

The Source State is the set of Source settings that is maintained and remembered by the analyzer for use in the Tracking Source Mode. The Source State variables are controlled and set in the menus under the Source front panel key. These settings include:

- RF Output Off
- Amplitude = - 10 dBm
- Amplitude Step = Auto
- Power Sweep = 0 dB
- Amplitude Offset = 0 dB
- Source Sweep Reverse = Off
- Multiplier Numerator = 1
- Multiplier Denominator = 1
- Freq Offset = 0 Hz
- Point trigger is set to "Ext1"

The Source State is saved along with the state of the current Mode when you save a State, and is recalled when that Mode State is recalled.

When the analyzer first starts up, a Source Preset is performed. In the Input/Output menu, Restore Input/Output Defaults will also perform a Source Preset.

A Mode Preset, from modes that support the External Source, will turn the RF Off but will **not** perform a Source Preset. By the same token, Source Preset does **not** perform a Mode Preset.

Source Preset does **not** change the Source Mode nor the selection of which physical source is being used, nor does it release the current source (the source remains under the control of the analyzer) nor exit the Source menu.

Key Path	Source
Mode	SA
Remote Command	:SOURce:PRESet
Example	:SOUR:PREs
Preset	Initiates a Source Preset
State Saved	No
Initial S/W Revision	A.06.01

Source Setting Query (Remote Command Only)

This query can be used to get certain settings from the Source when the Source Mode is set to Tracking. The returned values are all in ASCII.

Remote Command	<code>:SOURce:SETtings?</code>
Example	<code>:SOUR:SET?</code>
Notes	Returns a set of comma separated values as follows (no spaces): source max frequency,source min frequency,source frequency resolution,source max amplitude,source min amplitude,source amplitude resolution,source sweep max point,source start frequency,source stop frequency,source start amplitude,source stop amplitude
Initial S/W Revision	A.10.01

SPAN X Scale

Activates the Span function and displays a menu of span functions.

Key Path	Front-panel key
Initial S/W Revision	Prior to A.02.00

Span

Changes the displayed frequency range symmetrically about the center frequency. While adjusting the Span the Center Frequency is held constant, which means that both Start Frequency and Stop Frequency will change.

Span also sets the frequency entry mode to Center/Span. In Center/Span mode, the center frequency and span values are displayed below the graticule, and the default active function in the Frequency menu is **Center Freq.**

While discussing the Span function we make the distinction between “swept spans” and “zero span”. We use the term “swept spans” to mean spans other than zero; recognizing that, because of this terminology, the user can be in what we call a “swept span” even while performing an FFT “sweep”.

While in swept spans, setting the span to 0 Hz through SCPI or the front panel numeric key pad puts the analyzer into zero span. However, using the Step keys and the RPG in swept spans, the Span can only go as far down as 10 Hz and cannot be set to zero.

While in zero span, setting the Span to a non-zero value through SCPI or Front Panel puts the analyzer in swept spans.

If the Span is set to a value greater than the maximum allowable span of the instrument, an error message is generated indicating the data is out of range and was clipped to upper limit.

See ["Span Presets" on page 920](#)

Key Path	SPAN X Scale
Remote Command	[:SENSe] :FREQuency:SPAN <freq> [:SENSe] :FREQuency:SPAN?
Example	FREQ:SPAN 2GHz sets the span to 2GHz FREQ:SPAN 0 Hz Sets the span to 0 Hz and puts the instrument in Zero Span
Dependencies	If the electrical attenuator is enabled, any attempt to set Span such that the Stop Frequency would be >3.6 GHz results in an error. If Source Mode is set to Tracking, and the Span is therefore limited by the limits of the source, a warning message is generated, “Data out of range;clipped to source max/min” if these limits are exceeded. Note that for an external source, these limits can be affected by the settings of Source Numerator, Source Denominator and Power Sweep. In analyzers with an RF Preselector, such as MXE, you cannot sweep across the band break at 3.6 GHz while the RF Preselector is on in Continuous sweep, as there is a mechanical switch which

	bypasses the RF Preselector above 3.6 GHz. See the Stop Frequency key description for details of this limitation.
Couplings	Span affects RBW, sweep time, FFT & Sweep choice (including FFT Width, Phase Noise Optimization and ADC Dither auto couplings.) When operating in "swept span": <ul style="list-style-type: none"> - Any value of the Center Frequency or Span that is within the frequency range of the analyzer is allowed when the value is being set through the front panel numeric key pad or the SCPI command. The other parameter is forced to a different value if needed, to keep the Start and the Stop Frequencies within the analyzer's frequency range - When using the knob or the step up/down keys or the UP DOWN keywords in SCPI, the value that is being changed i.e. the Center Frequency or Span, is limited so that the other parameter is not forced to a new value - The Span cannot be set to Zero by setting Start Frequency = Stop Frequency. The value of the last setting will be changed to maintain a minimum value of 10 Hz for the difference between start and stop frequencies.
Preset	Depends on instrument maximum frequency, mode, measurement, and selected input. See " Span Presets " on page 920
State Saved	Saved in instrument state
Min	10 Hz unless entered directly, then 0 Hz is allowed, but nothing between 0 and 10 is ever allowed. In the Swept SA measurement, in Trace Zoom, Zero Span is not allowed, so the Span may not go below 10 Hz. In the Swept SA measurement, in Zone Span, Zero Span is not allowed in the top window, so the Span may not go below 10 Hz in the top window.
Max	Depends on instrument maximum frequency, mode, measurement, and selected input. See " Span Presets " on page 920 If the knob or step keys are being used, depends on the value of the other three interdependent parameters Center Frequency, Start Frequency, Stop Frequency Note that, if the Source Mode is set to Tracking, the effective instrument maximum Span may be limited by the source maximum frequency.
Default Unit	Hz
Status Bits/OPC dependencies	Overlapped if Signal Track is on (OPC shouldn't return or clear until the zooming has completed for the new span)
Initial S/W Revision	Prior to A.02.00

Span Presets

The following table provides the Span Presets for the Spectrum Analyzer mode, and the Max Span, for the various frequency options:

Freq Option	Span after Mode Preset	Max Span (can't set higher than this)
503 (all but N9000A)	3.59 GHz	3.7 GHz
503 (N9000A)	2.99 GHz	3.08 GHz
507 (all but N9000A)	6.99 GHz	7.1 GHz
507 (N9000A)	7.49 GHz	7.58 GHz
508 (all but N9038A)	8.39 GHz	8.5 GHz
508 (N9038A)	3.59 GHz	8.5 GHz
513	13.59 GHz	13.8 GHz
526 (all but N9000A and N9038A)	26.49 GHz	27.0 GHz
526 (N9038A)	3.59 GHz	27.0 GHz
526 (N9000A)	26.49 GHz	26.55 GHz
543	42.99 GHz	TBD
544	43.99 GHz	44.5 GHz
550	49.99 GHz	51 GHz

Input 2:

Model	Span after Mode Preset	Max Span (can't set higher than this)
N9000A opt C75	1.499 GHz	1.58 GHz
N9038A	1 GHz	1.000025 GHz

Note that if you are in External Mixing, the maximum Span will be equal to the Maximum Stop Frequency – Minimum Start Frequency for the currently selected mixer.

Full Span

Changes the frequency span of the analyzer to the Preset frequency span of the analyzer and sets the Frequency entry mode to Center/Span.

The span is dependent on the currently selected Input (see the Section “Input/Output”). For example, when using external mixing, it changes the frequency to the Preset frequency range specified for the selected external mixing band.

Pressing this key while in zero span puts the analyzer back in swept span.

Key Path	SPAN X Scale
Remote Command	[:SENSe] :FREQuency :SPAN :FULL
Example	FREQ:SPAN:FULL Sets the span to full frequency range of the analyzer
Notes	n /a
Couplings	Turns off signal tracking (span zoom). It does NOT turn off the markers, nor the current active function.
Backwards Compatibility Notes	In the past, the Full Span function turned off all markers. In the X-Series this is not the case.
Initial S/W Revision	Prior to A.02.00

Zero Span

Changes the displayed frequency span to 0 Hz. The horizontal axis changes to time rather than frequency. The amplitude displayed is the input signal level at the current center frequency. This is a time-domain mode that changes several measurement functions and couplings. The instrument behavior is similar to an oscilloscope with a frequency selective detector installed in front of the oscilloscope. See Application Note 150 for more information on how to use zero span.

You can enter Zero Span in several ways:

- Press the Zero Span key in Span
- Set Span=0 Hz
- Press last Span if the last span was 0

You cannot go to Zero Span by setting start freq = stop freq, or rolling span down with the RPG, that will limit you to 10 Hz

You can go back to Swept Span by setting Span to a nonzero value or pressing Last Span, assuming the last span was not also zero span.

Pressing Zero Span places the analyzer in Center/Span frequency entry mode.

The following table summarizes the differences between Zero Span and Swept Spans:

Zero Span	Swept Spans
X axis is time	X axis is frequency
There is no auto-RBW selection unless the EMC Standard is CISPR or MIL	RBW coupled to Span when RBW in auto
There is no auto sweep time	Sweep time coupled to RBW when sweep time in auto

Zero Span	Swept Spans
Interval Power calculated in Mkr Function	Band Power calculated in Mkr Function
Can only define time limits when in zero span	Can only define frequency limits when in swept SA
Marker Count counts at the center frequency	Marker Count counts at the marker frequency
CF Step Size set to RBW value	CF Step autocouples to 10% of Span
Some "Marker ->" commands not available.	Other "Marker ->" commands not available
Freq entry mode always Center/Span	Freq entry mode can be Center/Span or Start/Stop
N dB points reports a time difference.	N dB points reports a frequency difference.

Key Path	SPAN X Scale
Example	FREQ:SPAN 0 Hz Sets the span to zero, switches to Zero Span Sending FREQ:SPAN 1 MHz while in Zero Span, switches to Swept span
Notes	Setting the Span to 0 Hz will change to Zero Span and setting the span to a non-zero value will select a swept span
Notes	n /a
Dependencies	Zero Span key is unavailable (grayed out) if any of the following is true: In the Swept SA measurement, in Trace Zoom In the Swept SA measurement, in Zone Span, in the top window
Couplings	Pressing Zero Span key (switching to Zero Span): <ul style="list-style-type: none"> - Turns off signal track function (span zoom). - Turns off the auto-coupling of RBW and sweep time.
Initial S/W Revision	Prior to A.02.00

Last Span

Changes the displayed frequency span to the previous span setting. If it is pressed immediately after Signal Track is turned off, then the span setting returns to the span that was in effect before Signal Track was turned on.

If this key is pressed while in a nonzero span, and the previous value of span was 0, it will put the analyzer back in Zero Span. And if it is pressed while in zero span, it will set the analyzer back to its last nonzero span.

Pressing Last Span places the analyzer in Center/Span frequency entry mode.

Key Path	SPAN X Scale
Remote Command	[:SENSe] :FREQuency:SPAN:PREVIOUS

Example	FREQ:SPAN:PREV Sets the span to the previous value
Notes	n /a
Dependencies	If the electrical attenuator is enabled, any attempt to set Span such that the Stop Frequency would be >3.6 GHz results in an error.
Initial S/W Revision	Prior to A.02.00

Signal Track (Span Zoom)

When Marker 1 is placed on a signal and Signal Track is pressed, the marker remains on the signal while the analyzer retunes the center frequency to the marker frequency. The analyzer keeps the signal at the center of the display, as long as the amplitude of the signal does not change by more than +/-3 dB from one sweep to another. If Marker 1 is not in Normal or Delta, turning on Signal Track sets it to Normal, perform a peak search, and center the marker on the display.

See "[More Information](#)" on page 925.

Key Path	SPAN X Scale
Remote Command	:CALCulate:MARKer:TRCKing[:STATE] OFF ON 0 1 :CALCulate:MARKer:TRCKing[:STATE]?
Example	CALC:MARK:TRCK ON Turns on Signal Track using Marker 1. CALC:MARK:TRCK?
Dependencies	Signal Track is associated with Marker 1. When marker 1 is turned off or set to Fixed, signal track is turned off as well. Signal Track is not available (grayed out) when Source Mode=Tracking. Signal Track is not available (grayed out) when Signal ID = on. Signal Track and Continuous Pk cannot be used with each other. If one is on, the other is grayed out. Signal Track is grayed out if in Zero Span. But if Zero Span is entered while in Signal Track, Signal Track is turned off. Signal Track can only function properly if the trace Marker 1 is on is updating. Therefore if Signal Track is on and the trace Marker 1 is on is put into View, Signal Track is turned off and the Signal Track key grayed out. Whenever the trace Marker 1 is on is not updating, the Signal Track key is grayed out. Signal Track is only available in SA measurement . It should be grayed out in other Measurements in the Spectrum Analyzer mode.
Couplings	Signal Track can only function properly if the trace Marker 1 is on, is in Trace Update = Active. Therefore if the trace Marker 1 is on is in Update Off when Signal Track is turned on, it is changed to Update On. If the trace Marker 1 is on is set to Update Off while Signal Track is on, it turns off Signal Track.
Preset	OFF
State Saved	Saved in instrument state
Backwards Compatibility Notes	Signal Track is now in the Span menu. It was located in the Frequency menu in ESA and PSA, under its own hardkey in 859xA, under Marker Function (and called Marker Track) in 859xB/C/D/E. It was placed in Span in the X-Series because of the value that one of Signal

Track's features, Auto Zoom, provides when changing span (see below).

In ESA and PSA the Span Zoom key (in the Span menu) turned on Signal Track in order to let the user enter a new span with Auto Zoom on; by putting Signal Track into the Span menu we achieve the same functionality more clearly. Hence Span Zoom is eliminated as a separate function.

There never was a remote command for Span Zoom so there are no SCPI issues with this.

Signal Track now obeys the Excursion and Threshold criteria, allowing the user to control the search better; but this may cause low level signals that could previously be tracked to need the Excursion and Threshold adjusted.

Signal Track is now bound to only Marker 1, and cannot be enabled for any other marker.

ESA/PSA allowed a subopcode to specify the marker to use. In X-Series, no subopcode is allowed and the marker is always assumed to be marker 1.

Signal Track now turns off when it finds an unstable signal. In the past it kept searching which caused unpredictable results.

Initial S/W Revision

Prior to A.02.00

More Information

If marker 1 is off when Signal Track is turned on, marker 1 is turned on in the center of the screen and a peak search is performed. If marker 1 is already on, it stays on and is used where it is. If it is Fixed, it is set to Normal.

If you move the marker during Signal Track, a Mkr-> CF is performed and the signal track function starts over.

If the signal is lost, an attempt will be made to find it again and continue tracking. If there are other signals on screen that are near the same amplitude, one of them may be found instead since the algorithm is seeking a signal with amplitude similar to the amplitude of the original signal.

Signals near 0 Hz cannot be tracked effectively as they cannot be distinguished from the LO feed-through, which is excluded by intent from the search algorithm.

As a speed optimization, the center frequency is only changed if it differs from the marker position by 1% or more of the span.

If the analyzer is in Single Sweep and Signal Track is turned on, then nothing happens until a sweep is actually initiated (i.e. by an INIT:IMM or Single key press, and a trigger). Once the sweep is initiated, the entire set of sweeps necessary to complete a pass through the signal track algorithm ensues before the analyzer returns *OPC true, returns results to a READ or MEASure, or returns to the idle state.

If the span is changed while in Signal Track, either by you or because moving the instrument to the signal's frequency results in Span Limiting (as described under the Frequency key), an "auto-zoom" algorithm is executed to get to the new span without losing the signal. In "auto zoom", the span is reduced in stages, with a sweep between each stage. You will see this zooming occur as each sweep is performed, and the new span is set.

When auto-zooming, the set of steps necessary to achieve the target span is to be considered a "measurement," thus the entire process executes even if the analyzer is in single sweep. *OPC will not return true until the process is complete nor will

results be returned to a READ or MEASure command. Note further that if the analyzer is in a measurement such as averaging when this happens, the act of changing the span restarts averaging but the first average trace is the last trace of the auto zoom.

When you increase the span, we go directly to the new span. No zooming is required.

This function is intended to track signals with a frequency that is changing (drifting), and an amplitude that is not changing. It keeps tracking if you are in continuous-sweep mode. If in single-sweep mode, as described above, the analyzer only does one center frequency adjustment as necessary.

Sweep/Control

Accesses a menu that enables you to configure the Sweep and Control functions of the analyzer, such as Sweep Time and Gating.

Key Path	Front-panel key
Initial S/W Revision	Prior to A.02.00

Sweep Time

Controls the time the analyzer takes to sweep the current frequency span when the Sweep Type is Swept, and displays the equivalent Sweep Time when the Sweep Type is FFT.

When Sweep Time is in Auto, the analyzer computes a time which will give accurate measurements based on other settings of the analyzer, such as RBW and VBW.

NOTE

Significantly faster sweep times are available for the Swept SA measurement with Option FS1.

The Meas Uncal (measurement uncalibrated) warning is given in the Status Bar in the lower right corner of the screen when the manual sweep time entered is faster than the time computed by the analyzer's sweep time equations, that is, the Auto Sweep Time. The analyzer's computed sweep time will give accurate measurements; if you sweep faster than this your measurements may be inaccurate. A Meas Uncal condition may be corrected by returning the Sweep Time to Auto; by entering a longer Sweep Time; or by choosing a wider RBW and/or VBW.

On occasion other factors such as the Tracking Generator's maximum sweep rate, the YTF sweep rate (in high band) or the LO's capability (in low band) can cause a Meas Uncal condition. The most reliable way to correct it is to return the Sweep Time to Auto.

If the analyzer calculates that the Auto Sweep Time would be greater than 4000s (which is beyond its range), the warning message "Settings Alert;Sweep Rate Unavailable" is displayed. In this case increase the RBW or reduce the span.

If the analyzer's estimated sweep time in an FFT sweep is greater than 4000s, the warning message "Settings Alert;Span:RBW Ratio too big" is displayed. In this case reduce the span or increase the RBW and/or FFT Width.

When Sweep Type is FFT, you cannot control the sweep time, it is simply reported by the analyzer to give you an idea of how long the measurement is taking.

Note that although some overhead time is required by the analyzer to complete a sweep cycle, the sweep time reported when Sweep Type is Swept does not include the overhead time, just the time to sweep the LO over the current Span. When Sweep Type is FFT, however, the reported Sweep Time takes into account both the data acquisition time and the processing time, in order to report an equivalent Sweep Time for a meaningful comparison to the Swept case.

Because there is no “Auto Sweep Time” when in zero span, the Auto/Man line on this key disappears when in Zero Span. The Auto/Man line also disappears when in an FFT sweep. In this case the key is grayed out as shown below.



NOTE

When using a Tracking Source (**Source**, **Source Mode** set to “**Tracking**”), the sweep time shown includes an estimate of the source’s settling time. This estimate may contain inaccuracies, particularly when software triggering is used for the source. This can result in the reported sweep time being shorter than the actual sweep time.

Key Path	Sweep/Control
Remote Command	<pre>[:SENSe]:SWEep:TIME <time> [:SENSe]:SWEep:TIME? [:SENSe]:SWEep:TIME:AUTO OFF ON 0 1 [:SENSe]:SWEep:TIME:AUTO?</pre>
Example	<pre>SWE:TIME 500 ms SWE:TIME:AUTO OFF</pre>
Notes	The values shown in this table reflect the “swept spans” conditions which are the default settings after a preset. See “Couplings” for values in the zero span domain.
Dependencies	<p>The third line of the softkey (Auto/Man) disappears in Zero Span. The SCPI command SWEep:TIME:AUTO ON if sent in Zero Span generates an error message.</p> <p>Softkey grayed out and third line of the softkey (Auto/Man) disappears in FFT sweeps. Pressing the key or sending the SCPI for sweep time while the instrument is in FFT sweep generates a -221, “Settings Conflict;” error. F</p> <p>The SCPI command :SWEep:TIME:AUTO ON if sent in FFT sweeps generates an error.</p> <p>Grayed out while in Gate View, to avoid confusing those who want to set GATE VIEW Sweep Time.</p> <p>Key is grayed out in Measurements that do not support swept mode.</p> <p>Key is blanked in Modes that do not support swept mode.</p> <p>Set to Auto when Auto Couple is pressed or sent remotely</p>
Couplings	<p>Sweep Time is coupled primarily to Span and RBW. Center Frequency, VBW, and the number of sweep points also can have an effect. So changing these parameters may change the sweep time.</p> <p>The Sweep Time used upon entry to Zero Span is the same as the Sweep Time that was in effect before entering Zero Span. The Sweep Time can be changed while in Zero Span. Upon leaving Zero Span, the Auto/Man state of Sweep Time that existed before entering Zero Span is restored.</p> <p>If Sweep Time was in Auto before entering Zero Span, or if it is set to Auto while in zero span (which can happen via remote command or if Auto Couple is pressed) it returns to Auto and recouples when returning to non-zero spans.</p> <p>If Sweep Time was in Man before entering Zero Span, it returns to Man when returning to non-zero spans, and any changes to Sweep Time that were made while in Zero Span are retained in the non-zero span (except where constrained by minimum limits, which are different in and out of zero span).</p>
Preset	The preset Sweep Time value is hardware dependent since Sweep Time presets to “Auto”.

State Saved	Saved in instrument state
Min	In zero span: 1 μ s In swept spans: 1 ms In Stepped Tracking (as with option ESC): same as auto sweep time (In Swept Tracking, with Tracking Generator option T03 or T06, the minimum sweep time is 1 ms, but the Meas Uncal indicator is turned on for sweep times faster than 50 ms)
Max	In zero span: 6000 s In swept spans: 4000 s
Status Bits/OPC dependencies	Meas Uncal is Bit 0 in the STATus:QUESTionable:INTEgrity:UNCalibrated register
Initial S/W Revision	Prior to A.02.00

Sweep Setup

Lets you set the sweep functions that control features such as sweep type and time.

Key Path	Sweep/Control
Dependencies	The whole Sweep Setup menu is grayed out in Zero Span, however, the settings in the menus under Sweep Setup can be changed remotely with no error indication. Grayed out in measurements that do not support swept mode. Blanked in modes that do not support swept mode
Initial S/W Revision	Prior to A.02.00

Sweep Time Rules

Allows the choice of three distinct sets of sweep time rules. These are the rules that are used to set the sweep time when **Sweep Time** is in Auto mode. Note that these rules only apply when in the Swept **Sweep Type** (either manually or automatically chosen) and not when in FFT sweeps.

See "[More Information](#)" on page 930.

Key Path	Sweep/Control, Sweep Setup
Remote Command	[:SENSe] :SWEep:TIME:AUTO:RULEs NORMa1 ACCuracy SRESponse [:SENSe] :SWEep:TIME:AUTO:RULEs?
Example	SWE:TIME:AUTO:RUL ACC
Dependencies	In Zero Span, this key is irrelevant and cannot be accessed (because the whole Sweep Setup menu is grayed out in Zero Span), however its settings can be changed remotely with no error indication. Grayed out in FFT sweeps. Pressing the key while the instrument is in FFT sweep generates an advisory message. The SCPI is acted upon if sent, but has no effect other than to change the readout on the key, as long as the analyzer is in an FFT sweep.
Couplings	Set to Auto on Auto Couple
Preset	AUTO

State Saved	Saved in instrument state
Backwards Compatibility SCPI	:SWEep:TIME:AUTO:MODE SRESponse This legacy command is aliased to :SWEep:TIME:AUTO:RULEs SRESponse
Backwards Compatibility SCPI	:SWEep:TIME:AUTO:MODE SANalyzer This legacy command is aliased to :SWEep:TIME:AUTO:RULEs NORMAl
Backwards Compatibility SCPI	:SWEep:TIME:AUTO:MODE? This legacy query is aliased to :SWEep:TIME:RULEs?, so it will match for SRESponse but not for SANalyzer
Backwards Compatibility Notes	The old Auto Sweep Time command was the same [:SENSe]:SWEep:TIME:AUTO:RULEs NORMAl ACCuracy so it still works although it now has a third parameter (SRESponse). The old Sweep Coupling command was [:SENSe]:SWEep:TIME:AUTO:MODE SRESponse SANalyzer and it is aliased as below:
Initial S/W Revision	Prior to A.02.00

More Information

The first set of rules is called **SA – Normal**. **Sweep Time Rules** is set to **SA-Normal** on a **Preset** or **Auto Couple**. These rules give optimal sweep times at a loss of accuracy. Note that this means that in the Preset or Auto Coupled state, instrument amplitude accuracy specifications do not apply.

Setting **Sweep Time Rules** to **SA-Accuracy** will result in slower sweep times than **SA-Normal**, usually about three times as long, but with better amplitude accuracy for CW signals. The instrument absolute amplitude accuracy specifications only apply when **Sweep Time** is set to **Auto**, and **Sweep Time Rules** are set to **SA-Accuracy**. Additional amplitude errors which occur when Sweep Time Rules are set to SA-Normal are usually well under 0.1 dB with non-EMI detectors (though this is not guaranteed). With EMI detectors (Quasi Peak, EMI Average and RMS Average), the errors are usually well under 0.5 dB. For best accuracy when using EMI detectors, zero span is the preferred measurement technique; for the EMI detectors, zero span measurements will not fully agree with swept measurements except at extremely slow sweep rates (note that the meters in the N6141A are zero span measurements and therefore this statement also applies to the meters).

Because of the faster sweep times and still low errors, **SA-Normal** is the preferred setting of **Sweep Time Rules**.

The third set of sweep time rules is called **Stimulus/Response** and is automatically selected when an integrated source is turned on, such as a Tracking Generator or a synchronized external source. The sweep times for this set of rules are usually much faster for swept-response measurements. Stimulus-response auto-coupled sweep times are typically valid in stimulus-response measurements when the system's frequency span is less than 20 times the bandwidth of the device under test. You can select these rules manually (even if not making Stimulus-Response measurements) which will allow you to sweep faster before the "Meas Uncal" warning comes on, but you are then not protected from the over-sweep condition and may end up with

uncalibrated results. However, it is commonplace in measuring non-CW signals such as noise to be able to get excellent measurement accuracy at sweep rates higher than those required for CW signal accuracy, so this is a valid measurement technique.

Auto

Sets the analyzer to automatically choose the Sweep Time Rules for the measurement.

Key Path	Sweep/Control, Sweep Setup, Sweep Time Rules
Remote Command	[:SENSe] :SWEep : TIME : AUTO : RULEs : AUTO [: STATe] ON OFF 1 0 [:SENSe] :SWEep : TIME : AUTO : RULEs : AUTO [: STATe] ?
Example	:SWE:TIME:AUTO:RUL:AUTO ON
Couplings	Set on Preset or Auto Couple
Preset	ON
Initial S/W Revision	Prior to A.02.00

SA - Normal

Chooses Sweep Time Auto Rules for optimal speed and generally sufficient accuracy.

Key Path	Sweep/Control, Sweep Setup, Sweep Time Rules
Example	:SWE:TIME:AUTO:RUL NORM
Dependencies	Not available (grayed out) when Source Mode=Tracking.
Couplings	Automatically selected unless Source is on If directly selected, sets AUTO to Off
Readback	SA - Normal
Initial S/W Revision	Prior to A.02.00

SA - Accuracy

Chooses Sweep Time Auto Rules for specified absolute amplitude accuracy.

NOTE

For specified accuracy, do not allow sweep time to fall below 20 ms when in SA - Accuracy

Key Path	Sweep/Control, Sweep Setup, Sweep Time Rules
Example	:SWE:TIME:AUTO:RUL ACC
Dependencies	Not available (grayed out) when Source Mode=Tracking.
Couplings	If directly selected, sets AUTO to Off
Readback	SA - Accuracy
Initial S/W Revision	Prior to A.02.00

Stimulus/Response

The Stimulus-Response setting for sweep time rules provides different sweep time settings, for the case where the analyzer is sweeping in concert with a source. These modified rules take two forms:

1. Sweeping along with a swept source, which allows faster sweeps than the normal case because the RBW and VBW filters do not directly interact with the Span. We call this “Swept Tracking”
2. Sweeping along with a stepped source, which usually slows the sweep down because it is necessary to wait for the stepped source and the analyzer to settle at each point. We call this “Stepped Tracking”

The analyzer chooses one of these methods based on what kind of a source is connected or installed; it picks Swept Tracking if there is no source in use.

As always, when the X-series analyzer is in Auto Sweep Time, the sweep time is estimated and displayed in the Sweep/Control menu as well as in the annotation at the bottom of the displayed measurement; of course, since this can be dependent on variables outside the analyzer’s control, the actual sweep time may vary slightly from this estimate.

You can always choose a shorter sweep time to improve the measurement throughput, (with some potential unspecified accuracy reduction), but the Meas Uncal indicator will come on if the sweep time you set is less than the calculated Auto Sweep time. You can also select a longer sweep time, which can be useful (for example) for obtaining accurate insertion loss measurements on very narrowband filters. The number of measurement points can also be reduced to speed the measurement (at the expense of frequency resolution).

Key Path	Sweep/Control, Sweep Setup, Sweep Time Rules
Example	:SWE:TIME:AUTO:RUL SRES
Couplings	Automatically selected when the Source is on (Source Mode not set to OFF). If directly selected sets AUTO to Off
Readback	SR
Initial S/W Revision	Prior to A.02.00

Sweep Type

Chooses between the FFT and Sweep types of sweep.

Sweep Type refers to whether or not the instrument is in Swept or FFT analysis. When in Auto, the selection of sweep type is governed by two different sets of rules, depending on whether you want to optimize for dynamic range or for speed.

FFT “sweeps” should not be used when making EMI measurements; therefore, when a CISPR detector (Quasi Peak, EMI Average, RMS Average) is selected for any active trace (one for which Update is on), the FFT key in the Sweep Type menu is grayed out, and the Auto Rules only choose Swept. If Sweep Type is manually selected to be FFT, the CISPR detectors are all grayed out.

FFT sweeps will never be auto-selected when Screen Video, Log Video or Linear Video are the selected Analog Output.

Key Path	Sweep/Control, Sweep Setup
Remote Command	[:SENSe] :SWEep :TYPE FFT SWEep [:SENSe] :SWEep :TYPE ?
Dependencies	In Zero Span, this key is irrelevant and cannot be accessed (because the whole Sweep Setup menu is grayed out in Zero Span), however its settings can be changed remotely with no error indication. When Gate is on, Gate Method selection affects Sweep Type: Method FFT&Sweep menu FFT - Swept grayed out and rules choose FFT Video - FFT grayed out and rules choose Swept LO - FFT grayed out and rules choose Swept
Preset	AUTO
Backwards Compatibility SCPI	[:SENSe] :SWEep :TYPE AUTO sets sweep type Auto to On but the query will return either FFT or SWE depending on the auto setting. [:SENSe] :SWEep :TYPE SWP selects sweep type Swept but will return SWE on a query
Initial S/W Revision	Prior to A.02.00

Auto

When in Auto, the selection of sweep type is governed by two different sets of rules, depending on whether you want to optimize for dynamic range or for speed. These rules are chosen under the **Sweep Type Rules** key.

Key Path	Sweep/Control, Sweep Setup, Sweep Type
Remote Command	[:SENSe] :SWEep :TYPE :AUTO OFF ON 0 1 [:SENSe] :SWEep :TYPE :AUTO ?
Example	:SWE:TYPE:AUTO ON
Couplings	Pressing Auto Couple always sets Sweep Type to Auto. Swept is always chosen whenever any form of Signal ID is on, or the Source Mode is set to Tracking, or any EMI detector is selected, or the RF Preselector is ON.
Preset	ON
State Saved	Saved in instrument state
Initial S/W Revision	Prior to A.02.00

Swept

Manually selects swept analysis, so it cannot change automatically to FFT.

Key Path	Sweep/Control, Sweep Setup, Sweep Type
----------	---

Example	SWE:TYPE SWE
Dependencies	Grayed out while in Gated FFT (meaning Gate is ON and Gate Method is FFT). If this key is selected, the gate method Gated FFT is grayed out.
Couplings	This selection is chosen automatically if any of the CISPR detectors is chosen for any active trace, in which case the FFT Sweep Type selection is also grayed out.
State Saved	Saved in instrument state
Readback	Swept
Initial S/W Revision	Prior to A.02.00
Modified at S/W Revision	A.02.00

FFT

Manually selects FFT analysis, so it cannot change automatically to Swept.

Key Path	Sweep/Control, Sweep Setup, Sweep Type
Example	SWE:TYPE FFT
Dependencies	When a CISPR detector (Quasi Peak, EMI Average, RMS Average) is selected for any active trace, the FFT key is grayed out. When the RF Preselector is on, the FFT key is grayed out. When Source Mode is set to Tracking, Manual FFT is grayed out. When Signal ID is on, Manual FFT is grayed out. Grayed out while in Gated LO (meaning Gate is ON and Gate Method is LO). Grayed out while in Gated Video (meaning Gate is ON and Gate Method is Video).
State Saved	Saved in instrument state
Readback	FFT
Initial S/W Revision	Prior to A.02.00

Sweep Type Rules

Selects which set of rules will be used for automatically choosing the Sweep Type when Sweep Type is in Auto.

Key Path	Sweep/Control, Sweep Setup
Remote Command	[:SENSe] :SWEep:TYPE:AUTO:RULEs SPEed DRANge [:SENSe] :SWEep:TYPE:AUTO:RULEs?
Dependencies	In Zero Span, this key is irrelevant and cannot be accessed (because the whole Sweep Setup menu is grayed out in Zero Span), however its settings can be changed remotely with no error indication.
Preset	DRANge
State Saved	Saved in instrument state
Backwards Compatibility Notes	The legacy parameter DYNamicrange is unsupported
Initial S/W Revision	Prior to A.02.00

Auto

This selection is automatically chosen when Auto Couple is pressed. When in Auto, the Sweep Type Rules are set to Best Dynamic Range. It seems like a very simple Auto function but the use of this construct allows a consistent statement about what the Auto Couple key does.

Key Path	Sweep/Control, Sweep Setup, Sweep Type Rules
Remote Command	[:SENSe] :SWEep :TYPE :AUTO :RULEs :AUTO [:STATe] OFF ON 0 1 [:SENSe] :SWEep :TYPE :AUTO :RULEs :AUTO [:STATe] ?
Example	:SWE:TYPE:AUTO:RUL:AUTO ON
Couplings	Pressing Auto Couple always sets Sweep Type Rules to Auto.
Preset	ON
State Saved	Saved in instrument state
Initial S/W Revision	Prior to A.02.00

Best Dynamic Range

This selection tells the analyzer to choose between swept and FFT analysis with the primary goal of optimizing dynamic range. If the dynamic range is very close between swept and FFT, then it chooses the faster one. This auto selection also depends on RBW Type.

In determining the Swept or FFT setting, the auto rules use the following approach:

- If the RBW Filter Type is Gaussian use the RBW for the Normal Filter BW and if that RBW > 210 Hz, use swept; for RBW ≤ 210 Hz, use FFT
- If the RBW Filter Type is Flat Top, use the same algorithm but use 420 Hz instead of 210 Hz for the transition point between Swept and FFT
- If any of the CISPR detectors is chosen for any active trace, always use Swept.

Key Path	Sweep/Control, Sweep Setup, Sweep Type Rules
Example	SWE:TYPE:AUTO:RUL DRAN sets the auto rules to dynamic range.
Couplings	Directly selecting this setting sets AUTO to OFF.
Readback	Dynamic Range
Initial S/W Revision	Prior to A.02.00

Best Speed

This selection tells the analyzer to choose between FFT or swept analysis based on the fastest analyzer speed.

Key Path	Sweep/Control, Sweep Setup, Sweep Type Rules
----------	--

Example	SWE:TYPE:AUTO:RUL SPE sets the rules for the auto mode to speed
Couplings	Directly selecting this setting sets AUTO to OFF.
Readback	Speed.
Initial S/W Revision	Prior to A.02.00

FFT Width

This menu displays and controls the width of the FFT's performed while in FFT mode. The "FFT width" is the range of frequencies being looked at by the FFT, sometimes referred to as the "chunk width" -- it is not the resolution bandwidth used when performing the FFT.

It is important to understand that this function does not directly set the FFT width, it sets the limit on the FFT Width. The actual FFT width used is determined by several other factors including the Span you have set. Usually the instrument picks the optimal FFT Width based on the current setup; but on occasion you may wish to limit the FFT Width to be narrower than that which the instrument would have set.

NOTE

This function does not allow you to widen the FFT Width beyond that which the instrument might have set; it only allows you to narrow it. You might do this to improve the dynamic range of the measurement or eliminate nearby spurs from your measurement.

Note that the **FFT Width** setting will have no effect unless in an FFT sweep.

See "[More Information](#)" on page 937

Key Path	Sweep/Control, Sweep Setup
Remote Command	[:SENSe] :SWEEP:FFT:WIDTH <real> [:SENSe] :SWEEP:FFT:WIDTH?
Example	SWE:FFT:WIDT 167 kHz sets this function to "<167.4 kHz"
Notes	The parameter is in units of frequency. For values sent from SCPI, the analyzer chooses the smallest value that is at least as great as the requested value. Examples: Parameter 3.99 kHz is sent over SCPI. Analyzer chooses ≤4.01 kHz Parameter 4.02 kHz is sent over SCPI. Analyzer chooses ≤28.81 kHz Parameter 8 MHz is sent over SCPI. Analyzer chooses 10 MHz
Dependencies	In some models, the analog prefilters are not provided. In these models the FFT Width function is always in Auto . The FFT Width key is blanked in these models, and the SCPI commands are accepted without error but have no effect. In Zero Span, this key is irrelevant and cannot be accessed (because the whole Sweep Setup menu is grayed out in Zero Span). However, its settings can be changed remotely with no error indication.
Couplings	The FFT Width affects the ADC Dither function (see Meas Setup key) and the point at which the instrument switches from Swept to FFT acquisition.
Preset	The Preset is Auto, but Preset will also pick Best Dynamic Range and hence this function will be

	set to ~Maximum
State Saved	Saved in instrument state
Min	4.01 kHz
Max	The maximum available FFT width is dependent on the IF Bandwidth option. The maximum available width is: Option B10, 10 MHz; Option B25, 25 MHz, Option B40, 40 MHz, Option B2X, 255 MHz
Backwards Compatibility SCPI	[:SENSE] :SWEep:FFT:SPAN:RATio <integer> [:SENSE] :SWEep:FFT:SPAN:RATio? This is the legacy “FFTs per Span” command, because in the PSA, this is what you set rather than the FFT Width. The behavior of the analyzer when it receives this command is to compute the “intended segment width” by dividing the Span by the FFTs/Span parameter, then converting this intended width to an actual width by using the largest available FFT Width that is still less than the intended segment width. The “Span” used in this computation is whatever the Span is currently set to, whether a sweep has been taken at that Span or not.
Initial S/W Revision	Prior to A.02.00
Modified at S/W Revision	A.04.00

Key Path	Sweep/Control, Sweep Setup
Remote Command	[:SENSe] :SWEep:FFT:WIDTh:AUTO OFF ON 0 1 [:SENSe] :SWEep:FFT:WIDTh:AUTO?
Example	:SWE:FFT:WIDT:AUTO ON
Couplings	Pressing Auto Couple always sets FFT Width to Auto.
Preset	ON
State Saved	Saved in instrument state
Initial S/W Revision	Prior to A.02.00

More Information

An FFT measurement can only be performed over a limited span known as the “FFT segment”. Several segments may need to be combined to measure the entire span. For advanced FFT control in the X-Series, you have direct control over the segment width using the **FFT Width** control. Generally, in automatic operation, the X-Series sets the segment width to be as wide as possible, as this results in the fastest measurements.

However, in order to increase dynamic range, most X-series models provide a set of analog prefilters that precede the ADC. Unlike swept measurements, which pass the signal through a bandpass before the ADC, FFT measurements present the full

signal bandwidth to the ADC, making them more susceptible to overload, and requiring a lower signal level. The prefilters act to alleviate this phenomenon - they allow the signal level at the ADC to be higher while still avoiding an ADC overload, by eliminating signal power outside the bandwidth of interest, which in turn improves dynamic range.

Although narrowing the segment width can allow higher dynamic ranges some cases, this comes at the expense of losing some of the speed advantages of the FFT, because narrower segments require more acquisitions and proportionately more processing overhead.

However, the advantages of narrow segments can be significant. For example, in pulsed-RF measurements such as radar, it is often possible to make high dynamic range measurements with signal levels approaching the compression threshold of the analyzer in swept spans (well over 0 dBm), while resolving the spectral components to levels below the maximum IF drive level (about -8 dBm at the input mixer). But FFT processing experiences overloads at the maximum IF drive level even if the RBW is small enough that no single spectral component exceeds the maximum IF drive level. If you reduce the width of an FFT, an analog filter is placed before the ADC that is about 1.3 times as wide as the FFT segment width. This spreads out the pulsed RF in time and reduces the maximum signal level seen by the ADC. Therefore, the input attenuation can be reduced and the dynamic range increased without overloading the ADC.

Further improvement in dynamic range is possible by changing the **FFT IF Gain** (in the **Meas Setup** menu of many measurements). If the segments are reduced in width, **FFT IF Gain** can be set to High, improving dynamic range.

Depending on what IF Bandwidth option you have ordered, there can be up to three different IF paths available in FFT sweeps, as seen in the diagram below:

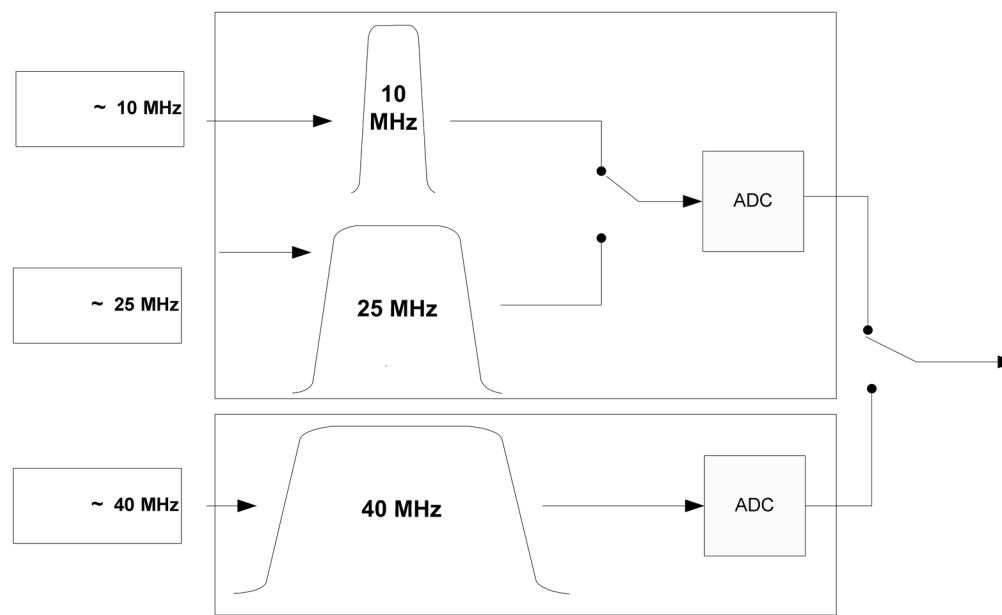

The 10 MHz path is always used for Swept sweeps. It is always used for FFT sweeps as well, unless the user specifies ~25 MHz in which case the 25 MHz path will be

used for FFT sweeps, or ~40 MHz, in which case the 40 MHz path will be used for FFT sweeps. Note that, although each of these keys picks the specified path, the analyzer may choose an FFT width less than the full IF width, in order to optimize speed, trading off acquisition time versus processing time.

If the 255 MHz IF (option B2X) is installed, it may also be used for FFT sweeps, but only if the user specifies ~255 MHz for the FFT Width.

Zoom Sweep Time

Controls the sweep time in the bottom window of the Trace Zoom View (the Zoomed Trace window).

Zoom Sweep Time works very much the way Sweep Time works, but it only affects the sweep time of the Zoomed Trace window, whereas Sweep Time affects the Sweep Time of the Spectrum (top) window in Trace Zoom. Because the ratio of the Zoom Sweep Time to the Sweep Time affects the width of the blue bar in the Spectrum window, adjusting Zoom Sweep Time changes the width of the blue bar.

Adjusting the Zoom Sweep Time has no impact on Sweep Time, hence it has no impact on any parameter that might be coupled to Sweep Time and no impact on the measurement. It only affects the portion of the upper trace which is visible in the bottom window.

Key Path	Sweep/Control
Remote Command	[:SENSe] :SWEep:TZOom:TIME <time> [:SENSe] :SWEep:TZO:TIME?
Example	SWE:TZO:TIME 500 ms
Dependencies	Only appears in the Trace Zoom View
Preset	10% of Sweep Time
State Saved	Saved in instrument state
Min	10% of minimum Sweep Time
Max	Maximum Sweep Time
Initial S/W Revision	A.18.00

Zoom Center

Zoom Center allows you to change the center of the zoom region, and hence of the lower window, without changing the Zoom Span, when you are in Zero Span.

The **Zoom Center** value is displayed in the lower left corner of the zoom window (below the graticule).

Key Path	Sweep/Control
Remote Command	[:SENSe] :FREQuency:TZOom:TIME:CENTer <time> [:SENSe] :FREQuency:TZOom:TIME:CENTer?
Example	FREQ:TZO:TIME:CENT 500 ms

Dependencies	Only appears in the Trace Zoom View Grayed out unless in Zero Span. If the SCPI command is sent when not in Zero Span, an error is reported.
Couplings	The center of the lower window is limited by the Sweep Time in the upper window. You cannot move the zoom region out of the upper window, nor does changing the Zoom Center ever change the Zoom Sweep Time. When Zoom Center increases or decreases to a value that causes the zoom region to touch an edge of the top window, the Zoom Center is clipped at that value.
Preset	50% of Sweep Time
State Saved	Saved in instrument state
Min	50% of Zoom Sweep Time
Max	Sweep Time - 50% of Zoom Sweep Time
Initial S/W Revision	A.18.00

Gate

Accesses a menu that enables you to control the gating function. The Gate functionality is used to view signals best viewed by qualifying them with other events.

Gate setup parameters are the same for all measurements – they do not change as you change measurements. Settings like these are called “Meas Global” and are unaffected by Meas Preset.

Note that Sweep Time autocoupling rules and annotation are changed by Gate being on.

Key Path	Sweep/Control
Scope	Meas Global
Readback	The state and method of Gate, as [Off, LO] or [On, Video]. Note that for measurements that only support gated LO, the method is nonetheless read back, but always as LO.
Initial S/W Revision	Prior to A.02.00

Gate On/Off

Turns the gate function on and off.

When the Gate Function is on, the selected Gate Method is used along with the gate settings and the signal at the gate source to control the sweep and video system with the gate signal. Not all measurements allow every type of Gate Methods.

When Gate is on, the annunciation in the measurement bar reflects that it is on and what method is used, as seen in the following "Gate: LO" annunciator graphic.

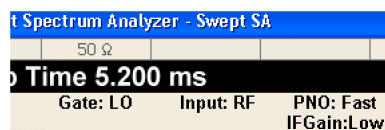

Key Path	Sweep/Control, Gate
Remote Command	[:SENSe] :SWEep :EGATe [:STATe] OFF ON 0 1 [:SENSe] :SWEep :EGATe [:STATe] ?
Example	SWE:EGAT ON SWE:EGAT?
Dependencies	<p>The function is unavailable (grayed out) and Off when:</p> <ul style="list-style-type: none"> - Gate Method is LO or Video and FFT Sweep Type is manually selected. - Gate Method is FFT and Swept Sweep Type is manually selected. - Marker Count is ON. <p>The following are unavailable whenever Gate is on:</p> <ul style="list-style-type: none"> - FFT under Sweep Type when Method=LO or Video or Swept under Sweep Type when Method=FFT <p style="text-align: center;">Marker Count</p> <p>While Gate is on, the Auto Rules for Sweep Type are modified so that the choice agrees with the Gate Method: i.e., FFT for Method = FFT and Swept for Method = LO or Video.</p> <p>The Gate softkey and all SCPI under the [:SENSe]:SWEep:EGATe SCPI node are grayed out when Source Mode is Tracking with an external source. This is because the Gate circuitry is used to sync the external source. If the Tracking Source is turned on, the Gate is turned off.</p> <p>When in the ACP measurement:</p> <ul style="list-style-type: none"> - When Meas Method is RBW or FAST, this function is unavailable and the key is grayed out. - Whenever Gate is on, Meas Method, RBW or FAST is unavailable and keys for those are grayed out. - When Gate is on, Offset Res BW and Offset Video BW are ignored (if you set these values) and the measurement works as if all Offset Res BW and all Offset Video BW are coupled with the Res BW and the Video BW under the BW menu. When Gate is on, the Offset BW key in the Offset/Limit menu is grayed out.
Preset	Off LTETDD: On
State Saved	Saved in instrument state
Range	On Off
Backwards Compatibility SCPI	[:SENSe]:SWEep:TIME:GATE[:STATe] ESA compatibility
Backwards Compatibility Notes	In ESA, Trig Delay (On) and Gate (On) could not be active at the same time.. This dependency does not exist in PSA or in the X-Series.
Initial S/W Revision	Prior to A.02.00

Gate View On/Off

Turning on Gate View in the Swept SA measurement provides a single-window gate view display..

Turning on Gate View in other measurements shows the split-screen Gate View. In these measurements, when the Gate View is on, the regular view of the current measurement traces and results are reduced vertically to about 70% of the regular height. The Zero Span window, showing the positions of the Gate, is shown between the Measurement Bar and the reduced measurement window. By reducing the height of the measurement window, some of the annotation on the Data Display may not fit and is not shown.

Key Path	Sweep/Control, Gate
Remote Command	[:SENSe] : SWEEp : EGATe : VIEW ON OFF 1 0 [:SENSe] : SWEEp : EGATe : VIEW?
Example	SWE:EGAT:VIEW ON turns on the gate view.
Dependencies	In the Swept SA measurement: In Gate View, the regular Sweep Time key is grayed out . When pressed, the grayed out key puts up the informational message "Use Gate View Sweep Time in the Gate menu." In the other measurements: When you turn Gate View on, the lower window takes on the current state of the instrument. Upon leaving Gate View, the instrument takes on the state of the lower window. When you turn Gate View on, the upper window Sweep Time is set to the gate view sweep time.
Couplings	These couplings apply to the Swept SA measurement: <ul style="list-style-type: none"> - When Gate View is turned on, the instrument is set to Zero Span. - Gate View automatically turns off whenever a Span other than Zero is selected. - Gate View automatically turns off if you press the Last Span key while in Gate View, and the instrument returns to the Span it was in before entering Gate View (even if that is Zero Span). - When Gate View is turned on, the sweep time used is the gate view sweep time. This is set according to the rules in section "Gate View Setup " on page 2809 - When Gate View is turned off, Sweep Time is set to the normal Swept SA measurement sweep time. - If Gate View is on and Gate is off, then turning on Gate turns off Gate View.
Preset	OFF
State Saved	Saved in instrument state
Range	On Off
Initial S/W Revision	Prior to A.02.00

A sample of the Gate View screen in the Swept SA measurement is shown in the following graphic :

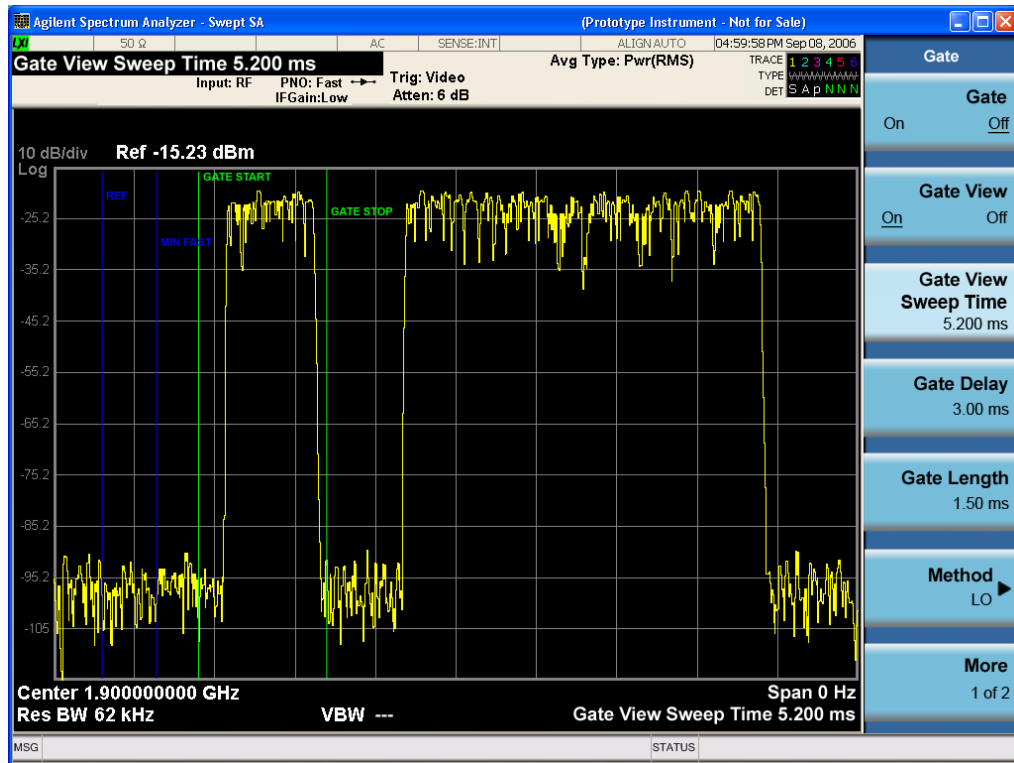

A sample of the Gate View screen in other measurements is shown in the following graphic. This example is for the ACP measurement:



Turning Gate View off returns the analyzer to the Normal measurement view.

In the Swept SA, the normal measurement view is the single-window Swept SA view. When returning to this view, the Swept SA measurement returns to the Span it was in before entering **Gate View** (even if that is Zero Span).

The **Gate View** window is triggered from the Gate Source, with zero trigger delay. Also, when updating the **Gate View** window, the Gate itself must not operate. So it is internally shut off while the gate view window is being updated. For the Swept SA measurement, this means that the Gate is internally shut off whenever the gate view window is displayed. The measurement bar and softkeys continue to show the Trigger source for the main sweep window and give no indication that the Gate is shut off or that the Gate View window is triggered from the Gate Source.

When in **Gate View**, vertical lines are displayed in the Gate View window as follows:

- Green lines are displayed at the gate edges as follows: in Edge Gate, a line is shown for Delay and one for the end of the Gate period, defined by Length. In Level Gate a line is shown only for Delay. You can adjust the position of the green lines by adjusting the gate length and the gate delay. These lines update in the Gate View window as the active function changes, even if the window is not being updated. In Gated LO and Gated Video, these lines are positioned relative to the delay reference line (not relative to 0 time). In Gated FFT, their location is relative to the left edge of the screen.
- A blue line is displayed showing the delay reference, that is, the reference point for the Gate Delay within the Zero Span window. The blue line represents where (in time) the effective location of the gate start would be if the gate were programmed to zero delay.
-
- The second blue line is labeled "MIN FAST" as shown in the figure above because it represents the minimum Gate Delay for fast Gated LO operation. This line is only displayed in Gated LO. You cannot scroll (knob) or decrement (down key) the Gate Delay to less than that represented by the position of this line, it can only be set below this position manually, although once there it can be moved freely with the knob while below the line.
- A yellow line in the Gated Video case only, is displayed at Blength, where Blength is the display point (bucket) length for the swept trace, which is given by the sweep time for that trace divided by number of Points - 1. So it is referenced to 0 time, not to the delay reference. This line is labeled NEXT PT (it is not shown in the figure above because the figure above is for Gated LO).
- The yellow line represents the edge of a display point (bucket). Normally in Gated Video, the bucket length must be selected so that it exceeds the off

time of the burst. There is another way to use the analyzer in Gated Video measurements, and that is to set the bucket width much shorter than the off time of the burst. Then use the Max Hold trace function to fill in "missing" buckets more slowly. This allows you to see some of the patterns of the Gated Video results earlier, though seeing a completely filled-in spectrum later.

Gate View Setup

Accesses a menu that enables you to setup parameters relevant to the Gate View

Key Path	Sweep/Control, Gate
Scope	Meas Global
Initial S/W Revision	A.10.00

Gate View Sweep Time

Controls the sweep time in the Gate View window. To provide an optimal view of the gate signal, the analyzer initializes Gate View Sweep Time based on the current settings of Gate Delay and Gate Length.

Key Path	Sweep/Control, Gate, Gate View Setup
Remote Command	<code>[:SENSe] :SWEep:EGATe:TIME <time></code> <code>[:SENSe] :SWEep:EGATe:TIME?</code>
Example	SWE:EGAT:TIME 500 ms
Dependencies	Gate View Sweep Time is initialized: <ul style="list-style-type: none"> - On Preset (after initializing delay and length). - Every time the Gate Method is set/changed. <p>Additionally, in the Swept SA measurement, whenever you do a Preset, or leave Gate View, the analyzer remembers the Gate Delay and Gate Length settings. Then, when returning to Gate View, if the current Gate Delay and/or Gate Length do not match the remembered values Gate View Sweep Time is re-initialized.</p>
Preset	519.3 μ s WiMAX OFDMA: 5 ms GSM/EDGE: 1 ms
State Saved	Saved in instrument state
Max	6000 s
Initial S/W Revision	Prior to A.02.00

Gate View Start Time

Controls the time at the left edge of the Gate View.

Key Path	Sweep/Control, Gate, Gate View Setup
Remote Command	[:SENSe]:SWEep:EGATe:VIEW:STARt <time> [:SENSe]:SWEep:EGATe:VIEW:STARt?
Example	SWE:EGAT:VIEW:STAR 10ms
Notes	Units of time are required or no units; otherwise an invalid suffix error message will be generated. See error -131.
Preset	0 ms
State Saved	Saved in instrument state
Min	0
Max	500 ms
Initial S/W Revision	A.10.00

Gate Delay

Controls the length of time from the time the gate condition goes True until the gate is turned on.

Key Path	Sweep/Control, Gate
Remote Command	[:SENSe]:SWEep:EGATe:DELay <time> [:SENSe]:SWEep:EGATe:DELay?
Example	SWE:EGAT:DELay 500ms SWE:EGAT:DELay?
Notes	Units of time are required or no units; otherwise an invalid suffix error message will be generated.
Preset	57.7 us WiMAX OFDMA: 71 us GSM/EDGE: 600 us WLAN: 500 us
State Saved	Saved in instrument state
Min	0.0 us
Max	100 s
Backwards Compatibility SCPI	[:SENSe]:SWEep:TIME:GATE:DELay ESA compatibility
Initial S/W Revision	Prior to A.02.00

Gate Length

Controls the length of time that the gate is on after it opens.

Key Path	Sweep/Control, Gate
Remote Command	[:SENSe]:SWEep:EGATe:LENGth <time> [:SENSe]:SWEep:EGATe:LENGth?

Example	SWE:EGAT:LENG 1 SWE:EGAT:LENG?
Notes	Units of time are required or no units; otherwise an invalid suffix error message will be generated.
Dependencies	Grayed out when Gate Method is set to FFT in which case the label changes to that shown below. <div style="border: 1px solid black; padding: 5px; display: inline-block;"> Gate Length (=1.83/RBW) 2.8 ms </div> <small>vsd 39-1</small> The key is also grayed out if Gate Control = Level.
Preset	461.6 us WiMAX OFDMA: 50 us GSM/EDGE: 200 us WLAN: 1.54 ms
State Saved	Saved in instrument state
Min	100 ns
Max	5 s
Backwards Compatibility SCPI	[:SENSe] :SWEep :TIME :GATE :LENGth ESA compatibility
Initial S/W Revision	Prior to A.02.00

Method

This lets you choose one of the three different types of gating.

Not all types of gating are available for all measurements.

Key Path	Sweep/Control, Gate
Remote Command	[:SENSe] :SWEep :EGATe :METHod LO VIDEo FFT [:SENSe] :SWEep :EGATe :METHod ?
Example	SWE:EGAT:METH FFT
Preset	LO
State Saved	Saved in instrument state
Initial S/W Revision	Prior to A.02.00

LO

When Gate is set to On, the LO sweeps whenever the gate conditions as specified in the Gate menu are satisfied by the signal at the Gate Source.

This form of gating is more sophisticated, and results in faster measurements. With Gated LO, the analyzer only sweeps while the gate conditions are satisfied. This means that a sweep could take place over several gate events. It would start when the gate signal goes true and stop when it goes false, and then continue when it

goes true again. But since the LO is sweeping as long as the gate conditions are satisfied, the sweep typically finishes much more quickly than with Gated Video.

When in zero span, there is no actual sweep performed. But data is only taken while the gate conditions are satisfied. So even though there is no sweep, the gate settings will impact when data is acquired.

Key Path	Sweep/Control, Gate, Method
Dependencies	Key is unavailable when Gate is On and FFT Sweep Type manually selected. When selected, Sweep Type is forced to Swept and the FFT key in Sweep Type is grayed out.
Readback	LO
Initial S/W Revision	Prior to A.02.00

Video

When Gate is set to On, the video signal is allowed to pass through whenever the gate conditions as specified in the Gate menu are satisfied by the signal at the Gate Source.

This form of gating may be thought of as a simple switch, which connects the signal to the input of the spectrum analyzer. When the gate conditions are satisfied, the switch is closed, and when the gate conditions are not satisfied, the switch is open. So we only look at the signal while the gate conditions are satisfied.

With this type of gating, you usually set the analyzer to sweep very slowly. In fact, a general rule is to sweep slowly enough that the gate is guaranteed to be closed at least once per data measurement interval (bucket). Then if the peak detector is used, each bucket will represent the peak signal as it looks with the gate closed.

Key Path	Sweep/Control, Gate, Method
Dependencies	Key is unavailable when Gate is On and FFT Sweep Type manually selected. When selected, Sweep Type is forced to Swept and the FFT key in Sweep Type is grayed out
Readback	Video
Initial S/W Revision	Prior to A.02.00

FFT

When Gate is set to On, an FFT is performed whenever the gate conditions as specified in the Gate menu are satisfied by the signal at the Gate Source. This is an FFT measurement which begins when the gate conditions are satisfied. Since the time period of an FFT is approximately $1.83/\text{RBW}$, you get a measurement that starts under predefined conditions and takes place over a predefined period. So, in essence, this is a gated measurement. You have limited control over the gate length but it works in FFT sweeps, which the other two methods do not.

Gated FFT cannot be done in zero span since the instrument is not sweeping. So in zero span the Gated LO method is used. Data is still only taken while the gate conditions are satisfied, so the gate settings do impact when data is acquired.

The Gate Length will be $1.83/\text{RBW}$.

This is a convenient way to make a triggered FFT measurement under control of an external gating signal.

Key Path	Sweep/Control, Gate
Dependencies	Key is unavailable when Gate is On and Swept Sweep Type is manually selected. When selected, Sweep Type is forced to FFT and the Swept key in Sweep Type is grayed out Key is unavailable when gate Control is set to Level. Forces Gate Length to 1.83/RBW
Readback	FFT
Initial S/W Revision	Prior to A.02.00

Gate Source

The menus under the **Gate Source** key are the same as those under the **Trigger key**, with the exception that neither **Free Run** nor **Video** are available as Gate Source selections. However, a different SCPI command is used to select the Gate Source (see table below) because you may independently set the Gate Source and the Trigger Source.

Any changes to the settings in the setup menus under each Gate Source selection key (for example: Trigger Level, Trigger Delay, etc.) also affect the corresponding settings under the Trigger menu keys. The SCPI commands used for these are the same for Trigger and Gate, since there is only one setting which affects both Gate and Trigger. Example: to set the Trigger Level for External 1 you use the command :TRIG:EXT1:LEV regardless of whether you are using External 1 as a Trigger Source or a Gate Source.

Key Path	Sweep/Control, Gate
Remote Command	[:SENSe] :SWEep :EGATe :SOURce EXTerna11 EXTerna12 LINE FRAME RFBurst TV PXI [:SENSe] :SWEep :EGATe :SOURce?
Dependencies	In some models, there is no second External input. In these models, the External 2 key is blanked and the EXTernal2 parameter will generate a "Hardware missing; Not available for this model number" error. PXI trigger is only supported in PXI (modular) instruments.
Preset	EXTernal 1 GSM/EDGE, MSR: FRAME LTETDD: EXTernal 1When Direction is Downlink, FRAME when Direction is Uplink.
Backwards Compatibility Notes	In ESA, there is a single Gate input port. In PSA, the Gate Source may be taken from one of two specified input ports. In the X-Series, any Trigger Source can be a Gate Source.
Initial S/W Revision	Prior to A.02.00
Modified at S/W Revision	A.03.00, A.14.00

Line

Pressing this key, when it is not selected, selects the line signal as the trigger. A new sweep/measurement will start synchronized with the next cycle of the line voltage. Pressing this key, when it is already selected, access the line trigger setup menu.

Key Path	Trigger
Example	TRIG:SOUR LINE Swept SA measurement TRIG:<meas>:SOUR LINE Measurements other than Swept SA
Dependencies	Line trigger is not available when operating from a "dc power source", for example, when the instrument is powered from batteries.
State Saved	Saved in instrument state
Status Bits/OPC dependencies	The Status Operation Register bit 5 "Waiting for Trigger" is set at the same time as the Sweeping or Measuring bit is set. It is cleared when the trigger actually occurs (that is, after the trigger event occurs and all the applicable trigger criteria have been met). A corresponding pop-up message ("Waiting for trigger") is generated if no trigger signal appears after approximately 2 sec. This message goes away when a trigger signal appears.
Initial S/W Revision	Prior to A.02.00

Trig Slope

Controls the trigger polarity. It is set positive to trigger on a rising edge and negative to trigger on a falling edge.

Key Path	Trigger, Line
Remote Command	:TRIGger[:SEQuence]:LINE:SLOPe POSitive NEGative :TRIGger[:SEQuence]:LINE:SLOPe?
Example	TRIG:LINE:SLOP NEG
Preset	POSitive
State Saved	Saved in instrument state
Backwards Compatibility Notes	The legacy :TRIGger[:SEQuence]:SLOPe command affects the slopes for the VID, LINE, EXT1, EXT2, and RFB triggers.
Initial S/W Revision	Prior to A.02.00

External 1

Pressing this key, when it is not selected, selects an external input signal as the trigger. A new sweep/measurement will start when the external trigger condition is met using the external 1 input connector on the rear panel.

Pressing this key, when it is already selected, accesses the external 1 trigger setup menu.

Key Path	Trigger
Example	TRIG:SOUR EXT1 Swept SA measurement TRIG:<meas>:SOUR EXT1 Measurements other than Swept SA
Dependencies	Grayed out if in use by Point Trigger in the Source Setup menu.

	Forced to Free Run if already selected and Point Trigger is set to External 1.
State Saved	Saved in instrument state
Status Bits/OPC dependencies	The Status Operation Register bit 5 "Waiting for Trigger" is set at the same time as the Sweeping or Measuring bit is set. It is cleared when the trigger actually occurs (that is, after the trigger event occurs and all the applicable trigger criteria have been met). A corresponding pop-up message ("Waiting for trigger") is generated if no trigger signal appears after approximately 2 sec. This message goes away when a trigger signal appears.
Initial S/W Revision	Prior to A.02.00

Trigger Level

Sets the value where the external 1 trigger input will trigger a new sweep/measurement.

Key Path	Trigger, External 1
Remote Command	:TRIGger[:SEquence]:EXTernal1:LEVEl <level> :TRIGger[:SEquence]:EXTernal1:LEVEl?
Example	TRIG:EXT1:LEV 0.4 V
Couplings	This same level is used for the Ext1 trigger source in the Trigger menu, for the Ext1 selection in the Periodic Timer sync source (in the Trigger menu and in the Gate Source menu), and also for the Ext1 selection in the Gate Source menu.
Preset	1.2 V
State Saved	Saved in instrument state
Min	-5 V
Max	5 V
Default Unit	V
Backwards Compatibility SCPI	:TRIGger[:SEquence]:EXTernal:LEVEl For backward compatibility, the parameter EXTernal is mapped to EXTernal1
Backwards Compatibility SCPI	:TRIGger[:SEquence]:FRAME:EXTernal1:LEVEl
Initial S/W Revision	Prior to A.02.00

Trig Slope

Controls the trigger polarity. It is set positive to trigger on a rising edge and negative to trigger on a falling edge.

Key Path	Trigger, External 1
Remote Command	:TRIGger[:SEquence]:EXTernal1:SLOPe POSitive NEGative :TRIGger[:SEquence]:EXTernal1:SLOPe?
Example	TRIG:EXT1:SLOP NEG
Couplings	This same slope is used in the Ext1 selection for the trigger source in the Trigger menu and for the period timer sync source (in the Trigger menu and in the Gate Source menu).

Preset	POSitive
State Saved	Saved in instrument state
Backwards Compatibility SCPI	:TRIGger[:SEQuence]:EXTernal:SLOPe For backward compatibility, the parameter EXTernal is mapped to EXTernal1
Backwards Compatibility SCPI	:TRIGger[:SEQuence]:FRAMe:EXTernal1:SLOPe
Backwards Compatibility Notes	The legacy :TRIGger[:SEQuence]:SLOPe command affects the slopes for the VID, LINE, EXT1, EXT2, and RFB triggers.
Initial S/W Revision	Prior to A.02.00

Zero Span Delay Comp On/Off

In zero span, there is a natural delay in the signal path, which comes from the RBW filter. This is usually desirable, as it allows you to trigger on events and also see those events, because the signal is delayed from the trigger event. However, in some cases it is desirable to eliminate this delay, so that trigger events line up exactly with the zero time point in zero span. You can use the **Zero Span Delay Comp On/Off** feature to enable or disable zero span delay compensation.

Key Path	Trigger, External 1
Remote Command	:TRIGger[:SEQuence]:EXTernal1:DELay:COMPensation OFF ON 0 1 :TRIGger[:SEQuence]:EXTernal1:DELay:COMPensation?
Example	TRIG:EXT1:DEL:COMP ON
Dependencies	No effect except in zero-span, but not locked out in nonzero spans. Blanked in modes that do not support zero-span measurements. If the SCPI command is sent when the key is blanked, an error is returned: -221, "Settings conflict; Feature not supported for this measurement" In analyzers shipping N9060A, this feature requires N9060A-7FP.
Preset	OFF
State Saved	Saved in instrument state
Initial S/W Revision	A.11.00

External 2

Pressing this key, when it is not selected, selects an external input signal as the trigger. A new sweep/measurement will start when the external trigger condition is met using the external 2 input connector. The external trigger 2 input connector is on the rear panel.

Pressing this key, when it is already selected, accesses the external 2 trigger setup menu.

Key Path	Trigger
Example	TRIG:SOUR EXT2 Swept SA measurement TRIG:<meas>:SOUR EXT2 Measurements other than Swept SA

Dependencies	In some models, there is no second External input. In these models, the External 2 key is blanked and the EXTernal2 parameter will generate a "Hardware missing; Not available for this model number" message. Grayed out if in use by Point Trigger in the Source Setup menu. Forced to Free Run if already selected and Point Trigger is set to External 2.
State Saved	Saved in instrument state
Status Bits/OPC dependencies	The Status Operation Register bit 5 "Waiting for Trigger" is set at the same time as the Sweeping or Measuring bit is set. It is cleared when the trigger actually occurs (that is, after the trigger event occurs and all the applicable trigger criteria have been met). A corresponding pop-up message ("Waiting for trigger") is generated if no trigger signal appears after approximately 2 sec. This message goes away when a trigger signal appears.
Initial S/W Revision	Prior to A.02.00
Modified at S/W Revision	A.03.00

Trigger Level

Sets the value where the external 2 trigger input will trigger a new sweep/measurement.

Key Path	Trigger, External 2
Remote Command	:TRIGger[:SEquence]:EXTernal2:LEVel :TRIGger[:SEquence]:EXTernal2:LEVel?
Example	TRIG:EXT2:LEV 1.1 V
Couplings	This same level is used for the Ext2 trigger source in the Trigger menu, for the Ext2 selection in the Periodic Timer sync source (in the Trigger menu and in the Gate Source menu), and also for the Ext2 selection in the Gate Source menu.
Preset	1.2 V
State Saved	Saved in instrument state
Min	-5 V
Max	5 V
Default Unit	V
Backwards Compatibility SCPI	:TRIGger[:SEquence]:FRAMe:EXTernal2:LEVel
Initial S/W Revision	Prior to A.02.00

Trig Slope

Controls the trigger polarity. It is set positive to trigger on a rising edge and negative to trigger on a falling edge.

Key Path	Trigger, External 2
Remote Command	:TRIGger[:SEquence]:EXTernal2:SLOPe POSitive NEGative :TRIGger[:SEquence]:EXTernal2:SLOPe?

Example	TRIG:EXT2:SLOP NEG
Couplings	This same slope is used in the Ext2 selection for the trigger source in the Trigger menu and for the period timer sync source (in the Trigger menu and in the Gate Source menu).
Preset	POSitive
State Saved	Saved in instrument state
Backwards Compatibility SCPI	:TRIGger[:SEQuence]:FRAMe:EXTerna12:SLOPe
Backwards Compatibility Notes	The legacy :TRIGger[:SEQuence]:SLOPe command affects the slopes for the VID, LINE, EXT1, EXT2, and RFB triggers.
Initial S/W Revision	Prior to A.02.00

Zero Span Delay Comp On/Off

In zero span, there is a natural delay in the signal path, which comes from the RBW filter. This is usually desirable, as it allows you to trigger on events and also see those events, because the signal is delayed from the trigger event. However, in some cases it is desirable to eliminate this delay, so that trigger events line up exactly with the zero time point in zero span. You can use the **Zero Span Delay Comp On/Off** feature to enable or disable zero span delay compensation.

Key Path	Trigger, External 2
Remote Command	:TRIGger[:SEQuence]:EXTerna12:DELay:COMPensation OFF ON 0 1 :TRIGger[:SEQuence]:EXTerna12:DELay:COMPensation?
Example	TRIG:EXT2:DEL:COMP ON
Dependencies	No effect except in zero-span, but not locked out in nonzero spans. Blanked in modes that do not support zero-span measurements. If the SCPI command is sent when the key is blanked, an error is returned: -221, "Settings conflict; Feature not supported for this measurement" In analyzers shipping N9060A, this feature requires N9060A-7FP.
Preset	OFF
State Saved	Saved in instrument state
Initial S/W Revision	A.11.00

RF Burst

Pressing this key, when it is not selected, selects the RF Burst as the trigger. A new sweep/measurement will start when an RF burst envelope signal is identified from the signal at the RF Input connector. Pressing this key, when it is already selected, accesses the RF Burst trigger setup menu.

In some models, a variety of burst trigger circuitry is available, resulting in various available burst trigger bandwidths. The analyzer automatically chooses the appropriate trigger path based on the hardware configuration and other settings of the analyzer.

Key Path	Trigger
Example	TRIG:SOUR RFB Swept SA measurement TRIG:<meas>:SOUR RFB Measurements other than Swept SA
State Saved	Saved in instrument state
Status Bits/OPC dependencies	The Status Operation Register bit 5 "Waiting for Trigger" is set at the same time as the Sweeping or Measuring bit is set. It is cleared when the trigger actually occurs (that is, after the trigger event occurs and all the applicable trigger criteria have been met). A corresponding pop-up message ("Waiting for trigger") is generated if no trigger signal appears after approximately 2 sec. This message goes away when a trigger signal appears.
Backwards Compatibility Notes	The legacy command: :TRIGger[:SEquence]:RFBurst:FSElectivity[:STATE] OFF ON 0 1 is not supported in the X-Series, as the hardware to do Frequency Selective burst triggers does not exist in X-Series.
Initial S/W Revision	Prior to A.02.00
Modified at S/W Revision	A.04.00

Absolute Trigger Level

Sets the absolute trigger level for the RF burst envelope.

When using the External Mixing path, the Absolute Trigger Level is uncalibrated because the factory default was set to accommodate the expected IF levels for the RF path.

Key Path	Trigger, RF Burst
Scope	Meas Global
Remote Command	:TRIGger[:SEquence]:RFBurst:LEVel:ABSolute <ampl> :TRIGger[:SEquence]:RFBurst:LEVel:ABSolute?
Example	TRIG:RFB:LEV:ABS 10 dBm sets the trigger level of the RF burst envelope signal to the absolute level of 10 dBm
Notes	Sending this command does not switch the setting from relative to absolute; to switch it you need to send the :TRIGger[:SEquence]:RFBurst:LEVel:TYPE command, below. Amplitude Corrections are not taken into account by the Absolute Trigger Level. For example, if you have given yourself effective gain with an amplitude correction factor, the Absolute Trigger will not fire until you have set the trigger level that far below the displayed signal level, rather than simply to the displayed signal level. This is only true for Amplitude Corrections, not External Gain or Ref Level Offset functions. If mode is Bluetooth, the default value is -50 dBm.
Couplings	This same level is used for the RF Burst trigger source in the Trigger menu, for the RF Burst selection in the Periodic Timer sync source (in the Trigger menu and in the Gate Source menu), and also for the RF Burst selection in the Gate Source menu
Preset	-20 dBm
State Saved	Saved in instrument state

Min	-200 dBm
Max	100 dBm
Default Unit	depends on the current selected Y-Axis unit
Backwards Compatibility SCPI	:TRIGger[:SEquence]:FRAMe:RFBurst:LEVel:ABSolute
Initial S/W Revision	Prior to A.02.00
Modified at S/W Revision	A.04.00

Key Path	Trigger, RF Burst
Remote Command	:TRIGger[:SEquence]:RFBurst:LEVel:TYPE ABSolute RELative :TRIGger[:SEquence]:RFBurst:LEVel:TYPE?
Example	TRIG:RFB:LEV:TYPE REL sets the trigger level type of the RF burst trigger to Relative.
Preset	ABSolute
State Saved	Saved in instrument state
Initial S/W Revision	Prior to A.02.00
Modified at S/W Revision	A.04.00

Relative Trigger Level

Sets the relative trigger level for the RF burst envelope.

In some models, the relative burst trigger function is implemented in hardware. In other models, without the advanced triggering hardware required, the relative burst trigger function is implemented in software in some measurements, and is unavailable in other measurements.

When implemented in software, the relative RF Burst trigger function is implemented as follows:

5. The measurement starts with the absolute RF Burst trigger setting. If it cannot get a trigger with that level, auto trigger fires and the acquisition starts anyway. After the acquisition, the measurement searches for the peak in the acquired waveform and saves it.
6. Now, in the next cycle of the measurement, the measurement determines a new absolute RF Burst level based on the peak value from the first measurement and the Relative RF Burst Trigger Level (always 0 or negative dB) set by the user. The following formula is used:
7. absolute RF Burst level = peak level of the previous acquisition + relative RF Burst level

8. If the new absolute RF Burst level differs from the previous by more than 0.5 dB, the new level is sent to the hardware; otherwise it is not updated (to avoid slowing down the acquisition)

Steps 2 and 3 repeat for subsequent measurements.

Key Path	Trigger, RF Burst
Scope	Meas Global
Remote Command	:TRIGger[:SEquence]:RFBurst:LEVel:RELative <rel_amp1> :TRIGger[:SEquence]:RFBurst:LEVel:RELative?
Example	TRIG:RFB:LEV:REL -10 dB sets the trigger level of the RF burst envelope signal to the relative level of -10 dB
Notes	Sending this command does not switch the setting from absolute to relative; to switch it you need to send the :TRIGger[:SEquence]:RFBurst:LEVel:TYPE command, above. The relative trigger level is not available in some measurements. In those measurements the RELative parameter, and the :TRIGger[:SEquence]:RFBurst:LEVel:TYPE command (above), will generate an error if sent.
Dependencies	This key is grayed out and Absolute Trigger Level selected if the required hardware is not present in your analyzer and the current measurement does not support Relative triggering.
Preset	-6 dB GSM: -25 dB
State Saved	Saved in instrument state
Min	-45 dB
Max	0 dB
Default Unit	dB or dBc
Backwards Compatibility SCPI	:TRIGger[:SEquence]:RFBurst:LEVel This legacy command is aliased to :TRIGger[:SEquence]:RFBurst:LEVel:RELative because the PSA had ONLY relative burst triggering
Initial S/W Revision	Prior to A.02.00
Modified at S/W Revision	A.04.00

Trigger Slope

It is set positive to trigger on a rising edge and negative to trigger on a falling edge.

Key Path	Trigger, RF Burst
Remote Command	:TRIGger[:SEquence]:RFBurst:SLOPe POSitive NEGative :TRIGger[:SEquence]:RFBurst:SLOPe?
Example	TRIG:RFB:SLOP NEG
Couplings	This same slope is used in the RF Burst selection for the trigger source in the Trigger menu and for the period timer sync source (in the Trigger menu and in the Gate Source menu).

Preset	POSitive
State Saved	Saved in instrument state
Backwards Compatibility SCPI	:TRIGger[:SEquence]:FRAMe:RFBurst:SLOPe
Backwards Compatibility Notes	The legacy :TRIGger[:SEquence]:SLOPe command affects the slopes for the VID, LINE, EXT1, EXT2, and RFB triggers.
Initial S/W Revision	Prior to A.02.00

Zero Span Delay Comp On/Off

In zero span, there is a natural delay in the signal path, which comes from the RBW filter. This is usually desirable, as it allows you to trigger on events and also see those events, because the signal is delayed from the trigger event. However, in some cases it is desirable to eliminate this delay, so that trigger events line up exactly with the zero time point in zero span. You can use the **Zero Span Delay Comp On/Off** feature to enable or disable zero span delay compensation.

Key Path	Trigger, RF Burst
Remote Command	:TRIGger[:SEquence]:RFBurst:DELay:COMPensation OFF ON 0 1 :TRIGger[:SEquence]:RFBurst:DELay:COMPensation?
Example	TRIG:RFB:DEL:COMP ON
Dependencies	No effect except in zero-span, but not locked out in nonzero spans. Blanked in modes that do not support zero-span measurements. If the SCPI command is sent when the key is blanked, an error is returned: -221, "Settings conflict; Feature not supported for this measurement" In analyzers shipping N9060A, this feature requires N9060A-7FP.
Preset	OFF
State Saved	Saved in instrument state
Initial S/W Revision	A.11.00

Periodic Timer (Frame Trigger)

Pressing this key, when it is not selected, selects the internal periodic timer signal as the trigger. Triggering occurrences are set by the **Period** parameter, which is modified by the **Sync Source** and **Offset**. Pressing this key, when it is already selected, accesses the periodic timer trigger setup functions.

If you do not have a sync source selected (it is Off), then the internal timer will not be synchronized with any external timing events.

Key Path	Trigger
Example	TRIG:SOUR FRAM Swept SA measurement TRIG:<meas>:SOUR FRAM Measurements other than Swept SA
State Saved	Saved in instrument state
Readback	[Sync: <value of Sync Source>], for example, [Sync: External 1]

Status Bits/OPC dependencies	The Status Operation Register bit 5 "Waiting for Trigger" is set at the same time as the Sweeping or Measuring bit is set. It is cleared when the trigger actually occurs (that is, after the trigger event occurs and all the applicable trigger criteria have been met). A corresponding pop-up message ("Waiting for trigger") is generated if no trigger signal appears after approximately 2 sec. This message goes away when a trigger signal appears.
Initial S/W Revision	Prior to A.02.00

Periodic Timer Triggering:

This feature selects the internal periodic timer signal as the trigger. Trigger occurrences are set by the **Periodic Timer** parameter, which is modified by the **Sync Source** and **Offset**.

The figure below shows the action of the periodic timer trigger. Before reviewing the figure, we'll explain some uses for the periodic trigger.

A common application is measuring periodic burst RF signals for which a trigger signal is not easily available. For example, we might be measuring a TDMA radio which bursts every 20 ms. Let's assume that the 20 ms period is very consistent. Let's also assume that we do not have an external trigger source available that is synchronized with the period, and that the signal-to-noise ratio of the signal is not high enough to provide a clean RF burst trigger at all of the analysis frequencies. For example, we might want to measure spurious transmissions at an offset from the carrier that is larger than the bandwidth of the RF burst trigger. In this application, we can set the Periodic Timer to a 20.00 ms period and adjust the offset from that timer to position our trigger just where we want it. If we find that the 20.00 ms is not exactly right, we can adjust the period slightly to minimize the drift between the period timer and the signal to be measured.

A second way to use this feature would be to use **Sync Source** temporarily, instead of **Offset**. In this case, we might tune to the signal in a narrow span and use the RF Burst trigger to synchronize the periodic timer. Then we would turn the sync source off so that it would not miss-trigger. Miss-triggering can occur when we are tuned so far away from the RF burst trigger that it is no longer reliable.

A third example would be to synchronize to a signal that has a reference time element of much longer period than the period of interest. In some CDMA applications, it is useful to look at signals with a short periodicity, by synchronizing that periodicity to the "even-second clock" edge that happens every two seconds. Thus, we could connect the even-second clock trigger to Ext1 and use then Ext1 as the sync source for the periodic timer.

The figure below illustrates this third example. The top trace represents the even-second clock. It causes the periodic timer to synchronize with the leading edge shown. The analyzer trigger occurs at a time delayed by the accumulated offset from the period trigger event. The periodic timer continues to run, and triggers continue to occur, with a periodicity determined by the analyzer time base. The timer output (labeled "late event") will drift away from its ideal time due to imperfect matching between the time base of the signal being measured and the time base of the analyzer, and also because of imperfect setting of the period parameter. But the

synchronization is restored on the next even-second clock event. ("Accumulated offset" is described in the in the **Offset** function section.)

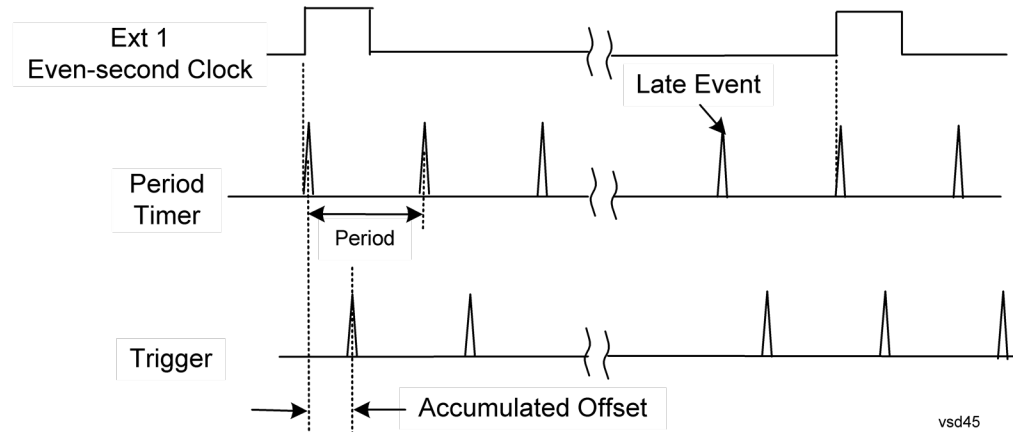

Period

Sets the period of the internal periodic timer clock. For digital communications signals, this is usually set to the frame period of your current input signal. In the case that sync source is not set to OFF, and the external sync source rate is changed for some reason, the periodic timer is synchronized at the every external synchronization pulse by resetting the internal state of the timer circuit.

Key Path	Trigger, Periodic Timer
Remote Command	:TRIGger[:SEquence]:FRAMe:PERiod <time> :TRIGger[:SEquence]:FRAMe:PERiod?
Example	TRIG:FRAM:PER 100 ms
Dependencies	The invalid data indicator turns on when the period is changed, until the next sweep/measurement completes.
Couplings	The same period is used in the Gate Source selection of the period timer.
Preset	20 ms GSM: 4.615383
State Saved	Saved in instrument state
Min	100.000 ns
Max	559.0000 ms
Default Unit	S
Initial S/W Revision	Prior to A.02.00

Offset

Adjusts the accumulated offset between the periodic timer events and the trigger event. Adjusting the accumulated offset is different than setting an offset, and requires explanation.

The periodic timer is usually not synchronized with any external events, so the timing of its output events has no absolute meaning. Since the timing relative to external

events (RF signals) is important, you need to be able to adjust (offset) it. However, you have no direct way to see when the periodic timer events occur. All that you can see is the trigger timing. When you want to adjust the trigger timing, you will be changing the internal offset between the periodic timer events and the trigger event. Because the absolute value of that internal offset is unknown, we will just call that the accumulated offset. Whenever the Offset parameter is changed, you are changing that accumulated offset. You can reset the displayed offset using Reset Offset Display. Changing the display does not change the value of the accumulated offset, and you can still make additional changes to accumulated offset.

To avoid ambiguity, we define that an increase in the "offset" parameter, either from the knob or the SCPI adjust command, serves to delay the timing of the trigger event.

Key Path	Trigger, Periodic Timer
Remote Command	:TRIGger[:SEquence]:FRAMe:OFFSet <time> :TRIGger[:SEquence]:FRAMe:OFFSet?
Example	TRIG:FRAM:OFFS 1.2 ms
Notes	<p>The front panel interface (for example, the knob), and this command, adjust the accumulated offset, which is shown on the active function display. However, the actual amount sent to the hardware each time the offset is updated is the delta value, that is, the current accumulated offset value minus the previous accumulated offset value. Note that the accumulated offset value is essentially arbitrary; it represents the accumulated offset from the last time the offset was zeroed (with the Reset Offset Display key).</p> <p>Note that this command does not change the period of the trigger waveform. Note also that Offset is used only when the sync source is set to OFF, otherwise delay is used, see section "Trig Delay" on page 568.</p> <p>An increase in the "offset" parameter, either from the knob or the SCPI adjust command, serves to delay the timing of the trigger event.</p>
Notes	<p>When the SCPI command is sent the value shown on the key (and the Active Function, if this happens to be the active function) is updated with the new value. However, the actual amount sent to the hardware is the delta value, that is, the current accumulated offset value minus the previous accumulated offset value.</p> <p>The SCPI query simply returns the value currently showing on the key.</p>
Dependencies	The invalid data indicator turns on when the offset is changed, until the next sweep/measurement completes.
Couplings	The same offset is used in the Gate Source selection of the period timer.
Preset	0 s
State Saved	Saved in instrument state
Min	-10.000 s
Max	10.000 s
Default Unit	S
Initial S/W Revision	Prior to A.02.00

Offset Adjust (Remote Command Only)

This remote command does not work at all like the related front panel keys. This command lets you advance the phase of the frame trigger by the amount you specify.

It does not change the period of the trigger waveform. If the command is sent multiple times, it advances the phase of the frame trigger an additional amount each time it is sent. Negative numbers are permitted.

Remote Command	<code>:TRIGger[:SEquence]:FRAMe:ADJust <time></code>
Example	TRIG:FRAM:ADJ 1.2 ms
Notes	Note also that Offset is used only when the sync source is set to OFF, otherwise delay is used, see section "Trig Delay" on page 568 An increase in the "offset" parameter, either from the knob or the SCPI adjust command, serves to delay the timing of the trigger event.
Notes	The front panel interface (for example, the knob) and the :TRIG:FRAM:OFFS command adjust the accumulated offset, which is shown on the active function display. However, the actual amount sent to the hardware is the delta value, that is, the current offset value minus the previous offset value. When the SCPI command is sent the value shown on the key (and the Active Function, if this happens to be the active function) is updated by increasing it (or decreasing it if the value sent is negative) by the amount specified in the SCPI command. This is a "command only" SCPI command, with no query.
Dependencies	The invalid data indicator turns on when the offset is changed, until the next sweep/measurement completes.
Couplings	The same offset is used in the Gate Source selection of the period timer.
Preset	0 s
State Saved	Saved in instrument state
Min	-10.000 s
Max	10.000 s
Default Unit	S
Initial S/W Revision	Prior to A.02.00

Reset Offset Display

Resets the value of the periodic trigger offset display setting to 0.0 seconds. The current displayed trigger location may include an offset value defined with the **Offset** key. Pressing this key redefines the currently displayed trigger location as the new trigger point that is 0.0 s offset. The **Offset** key can then be used to add offset relative to this new timing.

Key Path	Trigger, Periodic Timer
Remote Command	<code>:TRIGger[:SEquence]:FRAMe:OFFSet:DISPlay:RESet</code>
Example	TRIG:FRAM:OFFS:DISP:RES
Initial S/W Revision	Prior to A.02.00

Sync Source

Selects a signal source for you to synchronize your periodic timer trigger to, otherwise you are triggering at some arbitrary location in the frame. Synchronization reduces the precision requirements on the setting of the period.

For convenience you may adjust the level and slope of the selected sync source in a conditional branch setup menu accessed from the Sync Source menu. Note that these settings match those in the **Trigger** and **Gate Source** menus; that is, each trigger source has only one value of level and slope, regardless of which menu it is accessed from.

Key Path	Trigger, Periodic Timer
Remote Command	:TRIGger[:SEquence]:FRAMe:SYNC EXTerna11 EXTerna12 RFBurst PXI OFF :TRIGger[:SEquence]:FRAMe:SYNC?
Example	TRIG:FRAM:SYNC EXT2
Dependencies	In some models, there is no second External input. In these models, the External 2 key is blanked and the EXTerna12 parameter will generate a "Hardware missing; Not available for this model number" message. PXI trigger is only supported in PXI (modular) instruments.
Preset	Off GSM/EDGE, MSR,LTE,LTETDD: RFBurst
State Saved	Saved in instrument state
Readback	The current setting is read back to this key and it is also Readback to the previous Periodic Timer trigger key.
Backwards Compatibility SCPI	:TRIGger[:SEquence]:FRAMe:SYNC EXTerna1 For backward compatibility, the parameter EXTerna1 is mapped to EXTerna11
Initial S/W Revision	Prior to A.02.00
Modified at S/W Revision	A.03.00, A.14.00

Off

Turns off the sync source for your periodic trigger. With the sync source off, the timing will drift unless the signal source frequency is locked to the analyzer frequency reference.

Key Path	Trigger, Periodic Timer, Sync Source
Example	TRIG:FRAM:SYNC OFF
Readback	Off
Initial S/W Revision	Prior to A.02.00

External 1

Pressing this key, when it is not selected, selects an external input signal as the trigger. A new sweep/measurement will start when the external trigger condition is met using the external 1 input connector on the rear panel.

Pressing this key, when it is already selected, accesses the external 1 trigger setup menu.

Key Path	Trigger
Example	TRIG:SOUR EXT1 Swept SA measurement TRIG:<meas>:SOUR EXT1 Measurements other than Swept SA
Dependencies	Grayed out if in use by Point Trigger in the Source Setup menu. Forced to Free Run if already selected and Point Trigger is set to External 1.
State Saved	Saved in instrument state
Status Bits/OPC dependencies	The Status Operation Register bit 5 "Waiting for Trigger" is set at the same time as the Sweeping or Measuring bit is set. It is cleared when the trigger actually occurs (that is, after the trigger event occurs and all the applicable trigger criteria have been met). A corresponding pop-up message ("Waiting for trigger") is generated if no trigger signal appears after approximately 2 sec. This message goes away when a trigger signal appears.
Initial S/W Revision	Prior to A.02.00

Trigger Level

Sets the value where the external 1 trigger input will trigger a new sweep/measurement.

Key Path	Trigger, External 1
Remote Command	:TRIGger[:SEquence]:EXTernal1:LEVel <level> :TRIGger[:SEquence]:EXTernal1:LEVel?
Example	TRIG:EXT1:LEV 0.4 V
Couplings	This same level is used for the Ext1 trigger source in the Trigger menu, for the Ext1 selection in the Periodic Timer sync source (in the Trigger menu and in the Gate Source menu), and also for the Ext1 selection in the Gate Source menu.
Preset	1.2 V
State Saved	Saved in instrument state
Min	-5 V
Max	5 V
Default Unit	V
Backwards Compatibility SCPI	:TRIGger[:SEquence]:EXTernal:LEVel For backward compatibility, the parameter EXTernal is mapped to EXTernal1
Backwards Compatibility SCPI	:TRIGger[:SEquence]:FRAMe:EXTernal1:LEVel
Initial S/W Revision	Prior to A.02.00

Trig Slope

Controls the trigger polarity. It is set positive to trigger on a rising edge and negative to trigger on a falling edge.

Key Path	Trigger, External 1
Remote Command	:TRIGger[:SEquence]:EXTernal1:SLOPe POSitive NEGative :TRIGger[:SEquence]:EXTernal1:SLOPe?
Example	TRIG:EXT1:SLOP NEG
Couplings	This same slope is used in the Ext1 selection for the trigger source in the Trigger menu and for the period timer sync source (in the Trigger menu and in the Gate Source menu).
Preset	POSitive
State Saved	Saved in instrument state
Backwards Compatibility SCPI	:TRIGger[:SEquence]:EXTernal:SLOPe For backward compatibility, the parameter EXTernal is mapped to EXTernal1
Backwards Compatibility SCPI	:TRIGger[:SEquence]:FRAMe:EXTernal1:SLOPe
Backwards Compatibility Notes	The legacy :TRIGger[:SEquence]:SLOPe command affects the slopes for the VID, LINE, EXT1, EXT2, and RFB triggers.
Initial S/W Revision	Prior to A.02.00

External 2

Pressing this key, when it is not selected, selects an external input signal as the trigger. A new sweep/measurement will start when the external trigger condition is met using the external 2 input connector. The external trigger 2 input connector is on the rear panel.

Pressing this key, when it is already selected, accesses the external 2 trigger setup menu.

Key Path	Trigger
Example	TRIG:SOUR EXT2 Swept SA measurement TRIG:<meas>:SOUR EXT2 Measurements other than Swept SA
Dependencies	In some models, there is no second External input. In these models, the External 2 key is blanked and the EXTernal2 parameter will generate a "Hardware missing; Not available for this model number" message. Grayed out if in use by Point Trigger in the Source Setup menu. Forced to Free Run if already selected and Point Trigger is set to External 2.
State Saved	Saved in instrument state
Status Bits/OPC dependencies	The Status Operation Register bit 5 "Waiting for Trigger" is set at the same time as the Sweeping or Measuring bit is set. It is cleared when the trigger actually occurs (that is, after the trigger event occurs and all the applicable trigger criteria have been met). A corresponding pop-up message ("Waiting for trigger") is generated if no trigger signal appears after approximately 2 sec. This message goes away when a trigger signal appears.

Initial S/W Revision	Prior to A.02.00
Modified at S/W Revision	A.03.00

Trigger Level

Sets the value where the external 2 trigger input will trigger a new sweep/measurement.

Key Path	Trigger, External 2
Remote Command	:TRIGger[:SEquence]:EXTErnal2:LEVEl :TRIGger[:SEquence]:EXTErnal2:LEVEl?
Example	TRIG:EXT2:LEV 1.1 V
Couplings	This same level is used for the Ext2 trigger source in the Trigger menu, for the Ext2 selection in the Periodic Timer sync source (in the Trigger menu and in the Gate Source menu), and also for the Ext2 selection in the Gate Source menu.
Preset	1.2 V
State Saved	Saved in instrument state
Min	-5 V
Max	5 V
Default Unit	V
Backwards Compatibility SCPI	:TRIGger[:SEquence]:FRAME:EXTErnal2:LEVEl
Initial S/W Revision	Prior to A.02.00

Trig Slope

Controls the trigger polarity. It is set positive to trigger on a rising edge and negative to trigger on a falling edge.

Key Path	Trigger, External 2
Remote Command	:TRIGger[:SEquence]:EXTErnal2:SLOPe POSitive NEGative :TRIGger[:SEquence]:EXTErnal2:SLOPe?
Example	TRIG:EXT2:SLOP NEG
Couplings	This same slope is used in the Ext2 selection for the trigger source in the Trigger menu and for the period timer sync source (in the Trigger menu and in the Gate Source menu).
Preset	POSitive
State Saved	Saved in instrument state
Backwards Compatibility SCPI	:TRIGger[:SEquence]:FRAME:EXTErnal2:SLOPe
Backwards Compatibility Notes	The legacy :TRIGger[:SEquence]:SLOPe command affects the slopes for the VID, LINE, EXT1, EXT2, and RFB triggers.
Initial S/W Revision	Prior to A.02.00

RF Burst

Pressing this key, when it is not selected, selects the RF Burst as the trigger. A new sweep/measurement will start when an RF burst envelope signal is identified from the signal at the RF Input connector. Pressing this key, when it is already selected, accesses the RF Burst trigger setup menu.

In some models, a variety of burst trigger circuitry is available, resulting in various available burst trigger bandwidths. The analyzer automatically chooses the appropriate trigger path based on the hardware configuration and other settings of the analyzer.

Key Path	Trigger
Example	TRIG:SOUR RFB Swept SA measurement TRIG:<meas>:SOUR RFB Measurements other than Swept SA
State Saved	Saved in instrument state
Status Bits/OPC dependencies	The Status Operation Register bit 5 "Waiting for Trigger" is set at the same time as the Sweeping or Measuring bit is set. It is cleared when the trigger actually occurs (that is, after the trigger event occurs and all the applicable trigger criteria have been met). A corresponding pop-up message ("Waiting for trigger") is generated if no trigger signal appears after approximately 2 sec. This message goes away when a trigger signal appears.
Backwards Compatibility Notes	The legacy command: :TRIGger[:SEquence]:RFBurst:FSElectivity[:STATe] OFF ON 0 1 is not supported in the X-Series, as the hardware to do Frequency Selective burst triggers does not exist in X-Series.
Initial S/W Revision	Prior to A.02.00
Modified at S/W Revision	A.04.00

Absolute Trigger Level

Sets the absolute trigger level for the RF burst envelope.

When using the External Mixing path, the Absolute Trigger Level is uncalibrated because the factory default was set to accommodate the expected IF levels for the RF path.

Key Path	Trigger, RF Burst
Scope	Meas Global
Remote Command	:TRIGger[:SEquence]:RFBurst:LEVel:ABSolute <amp1> :TRIGger[:SEquence]:RFBurst:LEVel:ABSolute?
Example	TRIG:RFB:LEV:ABS 10 dBm sets the trigger level of the RF burst envelope signal to the absolute level of 10 dBm
Notes	Sending this command does not switch the setting from relative to absolute; to switch it you need to send the :TRIGger[:SEquence]:RFBurst:LEVel:TYPE command, below. Amplitude Corrections are not taken into account by the Absolute Trigger Level. For example, if

	<p>you have given yourself effective gain with an amplitude correction factor, the Absolute Trigger will not fire until you have set the trigger level that far below the displayed signal level, rather than simply to the displayed signal level. This is only true for Amplitude Corrections, not External Gain or Ref Level Offset functions.</p> <p>If mode is Bluetooth, the default value is -50 dBm.</p>
Couplings	This same level is used for the RF Burst trigger source in the Trigger menu, for the RF Burst selection in the Periodic Timer sync source (in the Trigger menu and in the Gate Source menu), and also for the RF Burst selection in the Gate Source menu
Preset	-20 dBm
State Saved	Saved in instrument state
Min	-200 dBm
Max	100 dBm
Default Unit	depends on the current selected Y-Axis unit
Backwards Compatibility SCPI	:TRIGger[:SEquence]:FRAMe:RFBurst:LEVel:ABSolute
Initial S/W Revision	Prior to A.02.00
Modified at S/W Revision	A.04.00

Key Path	Trigger, RF Burst
Remote Command	:TRIGger[:SEquence]:RFBurst:LEVel:TYPE ABSolute RELative :TRIGger[:SEquence]:RFBurst:LEVel:TYPE?
Example	TRIG:RFB:LEV:TYPE REL sets the trigger level type of the RF burst trigger to Relative.
Preset	ABSolute
State Saved	Saved in instrument state
Initial S/W Revision	Prior to A.02.00
Modified at S/W Revision	A.04.00

Relative Trigger Level

Sets the relative trigger level for the RF burst envelope.

In some models, the relative burst trigger function is implemented in hardware. In other models, without the advanced triggering hardware required, the relative burst trigger function is implemented in software in some measurements, and is unavailable in other measurements.

When implemented in software, the relative RF Burst trigger function is implemented as follows:

5. The measurement starts with the absolute RF Burst trigger setting. If it cannot get a trigger with that level, auto trigger fires and the acquisition starts anyway.

After the acquisition, the measurement searches for the peak in the acquired waveform and saves it.

6. Now, in the next cycle of the measurement, the measurement determines a new absolute RF Burst level based on the peak value from the first measurement and the Relative RF Burst Trigger Level (always 0 or negative dB) set by the user. The following formula is used:
7. absolute RF Burst level = peak level of the previous acquisition + relative RF Burst level
8. If the new absolute RF Burst level differs from the previous by more than 0.5 dB, the new level is sent to the hardware; otherwise it is not updated (to avoid slowing down the acquisition)

Steps 2 and 3 repeat for subsequent measurements.

Key Path	Trigger, RF Burst
Scope	Meas Global
Remote Command	:TRIGger[:SEquence]:RFBurst:LEVel:RELative <rel_amp1> :TRIGger[:SEquence]:RFBurst:LEVel:RELative?
Example	TRIG:RFB:LEV:REL -10 dB sets the trigger level of the RF burst envelope signal to the relative level of -10 dB
Notes	Sending this command does not switch the setting from absolute to relative; to switch it you need to send the :TRIGger[:SEquence]:RFBurst:LEVel:TYPE command, above. The relative trigger level is not available in some measurements. In those measurements the RELative parameter, and the :TRIGger[:SEquence]:RFBurst:LEVel:TYPE command (above), will generate an error if sent.
Dependencies	This key is grayed out and Absolute Trigger Level selected if the required hardware is not present in your analyzer and the current measurement does not support Relative triggering.
Preset	-6 dB GSM: -25 dB
State Saved	Saved in instrument state
Min	-45 dB
Max	0 dB
Default Unit	dB or dBc
Backwards Compatibility SCPI	:TRIGger[:SEquence]:RFBurst:LEVel This legacy command is aliased to :TRIGger[:SEquence]:RFBurst:LEVel:RELative because the PSA had ONLY relative burst triggering
Initial S/W Revision	Prior to A.02.00
Modified at S/W Revision	A.04.00

Trigger Slope

It is set positive to trigger on a rising edge and negative to trigger on a falling edge.

Key Path	Trigger, RF Burst
Remote Command	:TRIGger[:SEquence]:RFBurst:SLOPe POSitive NEGative :TRIGger[:SEquence]:RFBurst:SLOPe?
Example	TRIG:RFB:SLOP NEG
Couplings	This same slope is used in the RF Burst selection for the trigger source in the Trigger menu and for the period timer sync source (in the Trigger menu and in the Gate Source menu).
Preset	POSitive
State Saved	Saved in instrument state
Backwards Compatibility SCPI	:TRIGger[:SEquence]:FRAME:RFBurst:SLOPe
Backwards Compatibility Notes	The legacy :TRIGger[:SEquence]:SLOPe command affects the slopes for the VID, LINE, EXT1, EXT2, and RFB triggers.
Initial S/W Revision	Prior to A.02.00

Zero Span Delay Comp On/Off

In zero span, there is a natural delay in the signal path, which comes from the RBW filter. This is usually desirable, as it allows you to trigger on events and also see those events, because the signal is delayed from the trigger event. However, in some cases it is desirable to eliminate this delay, so that trigger events line up exactly with the zero time point in zero span. You can use the **Zero Span Delay Comp On/Off** feature to enable or disable zero span delay compensation.

Key Path	Trigger, RF Burst
Remote Command	:TRIGger[:SEquence]:RFBurst:DELAy:COMPensation OFF ON 0 1 :TRIGger[:SEquence]:RFBurst:DELAy:COMPensation?
Example	TRIG:RFB:DEL:COMP ON
Dependencies	No effect except in zero-span, but not locked out in nonzero spans. Blanked in modes that do not support zero-span measurements. If the SCPI command is sent when the key is blanked, an error is returned: -221, "Settings conflict; Feature not supported for this measurement" In analyzers shipping N9060A, this feature requires N9060A-7FP.
Preset	OFF
State Saved	Saved in instrument state
Initial S/W Revision	A.11.00

TV

Pressing this key, when it is not selected, selects the TV input signal as the trigger. A new sweep/measurement will start synchronized with the next occurrence of the synchronizing pulse of the selected TV line number.

Pressing this key, when it is already selected, opens a menu of TV Trigger setup functions. The default active function in this menu is the TV line number on which you want to trigger.

The Frame and Field options enable you to determine how the fields of the TV picture signal will be affected by the trigger system. One complete TV image consists of one frame of 525 or 625 horizontal lines depending on the TV standard being used. Each frame is composed of two fields of interlacing lines, each consisting of 262 1/2 lines (or 312 1/2 lines). The fields are called Field One and Field Two. Field One is viewed as having 263 lines (or 313 lines) and Field Two is viewed as having 262 lines (or 312 lines).

For the 525 line NTSC video standard, we refer to TV lines as follows (these are the Field Modes):

Entire Frame, lines 1 to 525

Field One, lines 1 to 263

Field Two, lines 1 to 262 (note that this really refers to "actual" lines 264 to 525)

For the 625 line PAL and SECAM video standards, we refer to TV lines as follows:

Entire Frame, lines 1 to 625

Field One, lines 1 to 313

Field Two, lines 314 to 625

As the Field is changed, the appropriate value for Line is chosen to keep triggering on the same line as before, or if this is not possible, the corresponding line in the new Field. For example, suppose line 264 is selected while in the NTSC-M standard and the Entire Frame mode. This is the first line in Field Two. If Field Two is then selected, the Line number changes to Line 1, the same actual line in the TV signal. If Field One is then selected, the line number stays at 1, but now we are triggering in the first line in Field One. The only exception to this is if we are on the last line of Field One and change to Field Two. In this case, we go to the last line in Field Two.

Key Path	Trigger
Example	TRIG:SOUR TV Swept SA measurement TRIG:<meas>:SOUR TV Measurements other than Swept SA
Dependencies	This key only appears in Modes which support TV Trigger, otherwise the key is blanked. If the SCPI command is sent while the key is blanked, an error is returned.
Readback	This key displays the value read back from TV Line
Status Bits/OPC dependencies	The Status Operation Register bit 5 "Waiting for Trigger" is set at the same time as the Sweeping or Measuring bit is set. It is cleared when the trigger actually occurs (that is, after the trigger event occurs and all the applicable trigger criteria have been met). A corresponding pop-up message ("Waiting for trigger") is generated if no trigger signal appears after approximately 2 sec. This message goes away when a trigger signal appears.
Initial S/W Revision	Prior to A.02.00

TV Line

Selects the TV line number to trigger on. Line number range is dependent on the settings of the **Standard** and **Field** menus within the TV trigger setup functions. When the line number is incremented beyond the upper limit, the value will change to the lower limit and continue incrementing from there. When the line number is decremented below the lower limit, the value will change to the upper limit and continue decrementing from there.

Key Path	Trigger, TV
Remote Command	:TRIGger[:SEquence]:TV:LINE <integer> :TRIGger[:SEquence]:TV:LINE?
Example	TRIG:TV:LINE 20 TRIG:TV:LINE?
Notes	The range of the TV line number is dependent on the settings of the Standard and Field menus within the TV trigger setup functions.
Preset	17
State Saved	Saved in instrument state
Min	The minimum value is the minimum line, and rolls over to the maximum value. The minimum line number depends on which Field and standard are selected.
Max	The maximum value is the maximum line, and rolls over to the minimum value. The maximum line number depends on which Field and standard are selected.
Initial S/W Revision	Prior to A.02.00

Field

Accesses the menu to select the field.

Key Path	Trigger, TV
Remote Command	:TRIGger[:SEquence]:TV:FMODe ENTire ODD EVEN :TRIGger[:SEquence]:TV:FMODe?
Example	TRIG:TV:FMOD EVEN
Notes	ODD is Field 1 EVEN is Field 2
Dependencies	This command is available only when Option B7B (TV trigger) is installed.
Preset	ENTire
Readback	Displays the Readback value
Initial S/W Revision	Prior to A.02.00

Entire Frame

When you select Entire Frame it causes the selected line number to be viewed as an offset into the entire frame starting with line 1, the first line in Field One.

Key Path	Trigger, TV, Field
----------	--------------------

Example	TRIG:TV:FMODE ENT
Min	1, for all formats.
Max	525, for formats NTSC-M, NTSC-Japan, NTSC-4.43, PAL-M and PAL-60 625, for formats PAL-B, D, G, H, I, PAL-N, PAL-N Combin, and SECAM-L.
Readback	Entire Frame
Initial S/W Revision	Prior to A.02.00

Field One

When you select Field One it causes the selected line number to be viewed as an offset into the first field starting with Line 1, the first line in Field One.

Key Path	Trigger, TV, Field
Example	TRIG:TV:FMODE ODD
Min	Field 1 (ODD) The minimum line is 1
Max	Field 1 (ODD) Maximum line is 263 for formats NTSC-M, NTSC-Japan, NTSC-4.43, PAL-M and PAL-60 Maximum line is 313 for formats PAL-B, D, G, H, I, PAL-N, PAL-N Combin, and SECAM-L.
Readback	Field 1
Initial S/W Revision	Prior to A.02.00

Field Two

When you select Field Two it causes the selected line number to be viewed as an offset into the second field. If Line 1 is selected, it is the 264th line of the frame (NTSC-M, NTSC-Japan, NTSC-4.43, PAL-M, PAL-60) or the 314th line of the frame (PAL-B,D,G,H,I, PAL-N, PAL-N-Combin, SECAM-L).

Key Path	Trigger, TV, Field
Example	TRIG:TV:FMODE EVEN
Min	Field 2 (EVEN) The minimum line is 1
Max	Field 2 (EVEN) The maximum line 262 for formats NTSC-M, NTSC-Japan, NTSC-4.43, PAL-M and PAL-60 The maximum line is 312 for formats PAL-B, D, G, H, I, PAL-N, PAL-N Combin, and SECAM-L
Readback	Field 2
Initial S/W Revision	Prior to A.02.00

Standard

Accesses the Standard menu keys which select from the following TV standards: NTSC-M, NTSC-Japan, NTSC-4.43, PAL-M, PAL-B,D,G,H,I, PAL-N, PAL-N-Combin, PAL-60, SECAM-L.

As the TV standard is changed, the current line value is clipped as necessary to keep it valid for the chosen standard and field mode. For example, line 600 is selected in Entire Frame mode in PAL-N; if NTSC-M is selected, the line number is clipped to 525. Or, if line 313 is selected in Field 1 mode in PAL-N and NTSC-M is selected, the line number is clipped to 263. Changing back to the PAL-N standard will leave the line number at 263.

Key Path	Trigger, TV
Remote Command	:TRIGger[:SEquence]:TV:STANdard MNTSc JNTSc NTSC443 MPAL BPAL NPAL CPAL PAL60 LSEC :TRIGger[:SEquence]:TV:STANdard?
Example	TRIG:TV:STAN MPAL TRIG:TV:STAN?
Preset	MNTS
State Saved	Saved in instrument state
Readback	Displays Readback value
Initial S/W Revision	Prior to A.02.00

NTSC-M

Sets the TV standard to NTSC-M.

Key Path	Trigger, TV, Standard
Example	TRIG:TV:STAN MNTS
Readback	NTSC-M
Initial S/W Revision	Prior to A.02.00

NTSC-Japan

Sets the TV standard to NTSC-Japan.

Key Path	Trigger, TV, Standard
Example	TRIG:TV:STAN JNTS
Readback	NTSC-Japan
Initial S/W Revision	Prior to A.02.00

NTSC-4.43

Sets the TV standard to NTSC-4.43.

Key Path	Trigger, TV, Standard
Example	TRIG:TV:STAN NTSC443
Readback	NTSC-Japan
Initial S/W Revision	Prior to A.02.00

PAL-M

Sets the TV standard to PAL-M.

Key Path	Trigger, TV, Standard
Example	TRIG:TV:STAN MPAL
Readback	PAL-M
Initial S/W Revision	Prior to A.02.00

PAL-N

Sets the TV standard to PAL-N.

Key Path	Trigger, TV, Standard
Example	TRIG:TV:STAN NPAL
Readback	PAL-N
Initial S/W Revision	Prior to A.02.00

PAL-N-Combin

Sets the TV standard to PAL-N-Combin.

Key Path	Trigger, TV, Standard
Example	TRIG:TV:STAN CPAL
Readback	PAL-N-C
Initial S/W Revision	Prior to A.02.00

PAL-B,D,G,H,I

Sets the TV standard to PAL-B,D,G,H,I

Key Path	Trigger, TV, Standard
Example	TRIG:TV:STAN BPAL
Readback	PAL-B
Initial S/W Revision	Prior to A.02.00

PAL-60

Sets the TV standard to PAL-60.

Key Path	Trigger, TV, Standard
Example	TRIG:TV:STAN PAL60
Readback	PAL-N
Initial S/W Revision	Prior to A.02.00

SECAM-L

Sets the TV standard to **SECAM-L**.

Key Path	Trigger, TV, Standard
Example	TRIG:TV:STAN LSEC
Readback	SECAM-L
Initial S/W Revision	Prior to A.02.00

Control Edge/Level

Sets the method of controlling the gating function from the gating signal.

Edge

In Edge triggering, the gate opens (after the Delay) on the selected edge (for example, positive) of the gate signal and closes on the alternate edge (for example, negative).

Level

In Level triggering, the gate opens (after the Delay) when the gate signal has achieved a certain level and stays open as long as that level is maintained.

Key Path	Sweep/Control, Gate
Remote Command	[:SENSe] :SWEep:EGATe:CONTRo1 EDGE LEVe1 [:SENSe] :SWEep:EGATe:CONTRo1?
Example	SWE:EGAT:CONT EDGE
Dependencies	If the Gate Method is FFT the Control key is grayed out and Edge is selected. If the Gate Source is TV, Frame or Line, the Control key is grayed out and Edge is selected.
Preset	EDGE
State Saved	Saved in instrument state
Backwards Compatibility SCPI	[:SENSe] :SWEep:TIME:GATE:TYPE ESA Compatibility
Initial S/W Revision	Prior to A.02.00

Gate Holdoff

Lets you increase or decrease the wait time after a gate event ends before the analyzer will respond to the next gate signal.

After any Gate event finishes, the analyzer must wait for the sweep system to settle before it can respond to another Gate signal. The analyzer calculates a "wait time," taking into account a number of factors, including RBW and Phase Noise Optimization settings. The goal is to achieve the same accuracy when gated as in ungated operation. The figure below illustrates this concept:

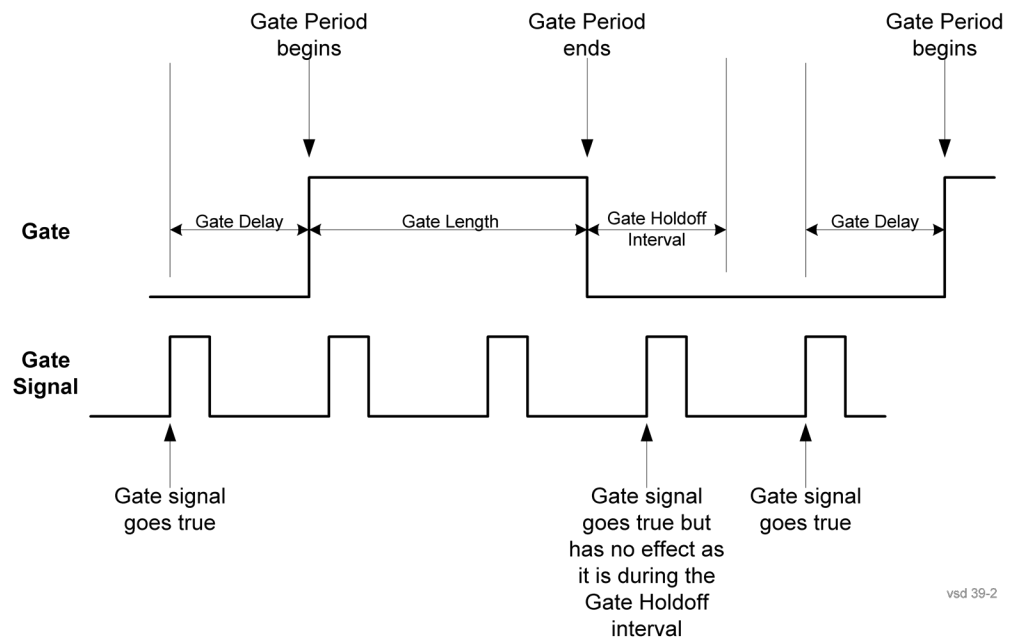

When Gate Holdoff is in Auto, the wait time calculated by the analyzer is used. When Gate Time is in Manual, the user may adjust the wait time, usually decreasing it in order to achieve greater speed, but at the risk of decreasing accuracy.

When the **Method** key is set to **Video** or **FFT**, the **Gate Holdoff** function has no effect.

In measurements that do not support Auto, the value shown when Auto is selected is “---” and the manually set holdoff is returned to a query.

Key Path	Sweep/Control, Gate
Remote Command	<pre>[:SENSe]:SWEep:EGATe:HOLDoff <time> [:SENSe]:SWEep:EGATe:HOLDoff? [:SENSe]:SWEep:EGATe:HOLDoff:AUTO OFF ON 0 1 [:SENSe]:SWEep:EGATe:HOLDoff:AUTO?</pre>
Example	<pre>SWE:EGAT:HOLD 0.0002 SWE:EGAT:HOLD? SWE:EGAT:HOLD:AUTO ON SWE:EGAT:HOLD:AUTO?</pre>
Couplings	<p>When Gate Holdoff is Auto, the Gate Holdoff key shows the value calculated by the analyzer for the wait time.</p> <p>Pressing the Gate Holdoff key while it is in Auto and not selected, causes the key to become selected and allows the user to adjust the value. If the value is adjusted, the setting changes to Man.</p> <p>Pressing the Gate Holdoff key, while it is in Auto and selected, does not change the value of Gate Holdoff, but causes the setting to change to Man. Now the user can adjust the value.</p> <p>Pressing the key while it is in Man and selected, cause the value to change back to Auto.</p> <p>Pressing the key while it is in Man and not selected, causes the key to become selected and</p>

	allows the user to adjust the value. When Method is set to Video or FFT , the Gate Holdoff function has no effect.
Preset	Auto Auto/On
State Saved	Saved in instrument state
Min	1 µsec
Max	1 sec
Initial S/W Revision	Prior to A.02.00

Gate Delay Compensation

This function allows you to select an RBW-dependent value by which to adjust the gate delay, to compensate for changes in the delay caused by RBW effects.

You can select between uncompensated operation and two types of compensation, **Delay Until RBW Settled** and **Compensate for RBW Group Delay**.

See "[More Information](#)" on page 979

Key Path	Sweep/Control, Gate
Scope	Meas Global
Remote Command	[:SENSe] :SWEep:EGATe:DELay:COMPensation:TYPE OFF SETTled GDELay [:SENSe] :SWEep:EGATe:DELay:COMPensation:TYPE?
Example	SWE:EGAT:DEL:COMP:TYPE SETT SWE:EGAT:DEL:COMP:TYPE?
Notes	Although this function is Meas Global, there are some measurements that do not support this function. In those measurements the operation will be Uncompensated. Going into one of those measurements will not change the Meas Global selection; it will simply display the grayed-out menu key with "Uncompensated" showing as the selection. This is a non-forceful grayout, so the SCPI command is still accepted. If Gate Delay Compensation is not supported at all within a particular mode, the key is not displayed, and if the SCPI command is sent while in a measurement within that mode, an "Undefined Header" message is generated. Measurements that do not support this function include: Swept SA
Preset	TD-SCDMA mode: Compensate for RBW Group Delay All other modes: Delay Until RBW Settled
State Saved	Saved in instrument state
Range	Uncompensated Delay Until RBW Settled Compensate for RBW Group Delay
Readback text	Uncompensated Settled Group Delay
Initial S/W Revision	Prior to A.02.00
Modified at S/W Revision	A.11.0

More Information

Selecting **Uncompensated** means that the actual gate delay is as you sets it.

Selecting **Delay Until RBW Settled** causes the gate delay to be increased above the user setting by an amount equal to $3.06/\text{RBW}$. This compensated delay causes the GATE START and GATE STOP lines on the display to move by the compensation amount, and the actual hardware gate delay to be increased by the same amount. All the other gate lines (for example, MIN FAST) are unaffected. If the RBW subsequently changes, the compensation is readjusted for the new RBW. The value shown on the **Gate Delay** key does NOT change.

Delay Until RBW Settled allows excellent measurements of gated signals, by allowing the IF to settle following any transient that affects the burst. Excellent measurements also require that the analysis region not extend into the region affected by the falling edge of the burst. Thus, excellent measurements can only be made over a width that declines with narrowing RBWs, which is achieved by decreasing the gate length below the user setting by an amount equal to $2.53/\text{RBW}$. Therefore, for general purpose compensation, you will still want to change the gate length with changes in RBW even if the gate delay is compensated. The compensated Gate Length is limited by the analyzer so that it will never go below 10% of the value shown on the Gate Length key, as otherwise the sweep times could get very long. Anytime the **Gate Length and RBW** values combine in such a way that this limiting takes place, a warning is displayed. For measurements which contain multiple sweeps with different RBW like SEM and SPUR, the smallest RBW is used for this limiting.

Selecting **Compensate for RBW Group Delay** causes the gate delay to be increased above the user setting by an amount equal to $1.81/\text{RBW}$. This compensated delay causes the GATE START, GATE STOP lines on the display to move by the compensation amount, and the actual hardware gate delay to be increased by the same amount. All the other gate lines (for example, MIN FAST) are unaffected. If the RBW subsequently changes, the compensation is readjusted for the new RBW. The value shown on the **Gate Delay** key does NOT change. **Compensate for RBW Group Delay** also includes gate length compensation; the gate length itself is adjusted as necessary to attempt to compensate for delay effects imposed by the RBW.

Compensate for RBW Group Delay is similar to **Delay Until RBW Settled**, but compensates for the group delay of the RBW filter, rather than the filter settling time. As the RBW gets narrow, this can allow the settling tail of the RBW to affect the beginning part of the gated measurement, and allow the beginning of the RBW settling transient to affect the end of the gated measurement. These two effects are symmetric because the RBW response is symmetric. Because the gate length is not automatically compensated, some users might find this compensation to be more intuitive than compensation for RBW settling.

Min Fast Position Query (Remote Command Only)

This command queries the position of the MIN FAST line, relative to the delay reference (REF) line. See section ["Gate View On/Off" on page 2806](#). If this query is sent while not in gate view, the MinFast calculation is performed based on the

current values of the appropriate parameters and the result is returned. Knowing this value lets you set an optimal gate delay value for the current measurement setup.

Remote Command	<code>[:SENSe] :SWEep:EGATe:MINFast?</code>
Example	<code>SWE:EGAT:MIN?</code>
Initial S/W Revision	Prior to A.02.00

Gate Preset (Remote Command Only)

Presets the time-gated spectrum analysis capability.

This command sets gate parameter values to the ESA preset values, as follows:

Gate trigger type = edge

Gate polarity = positive

Gate delay = 1 us

Gate length = 1 us

Remote Command	<code>[:SENSe] :SWEep:TIME:GATE:PRESet ESA Compatibility</code>
Initial S/W Revision	Prior to A.02.00

Gate Level (Remote Command Only)

Sets the gate input transition point level for the external TRIGGER inputs on the front and rear panel. This is a legacy command for PSA compatibility. It is simply an alias to the equivalent trigger level command.

Remote Command	<code>[:SENSe] :SWEep:EGATe:EXTernal[1] 2:LEVel <voltage></code> <code>[:SENSe] :SWEep:EGATe:EXTernal[1] 2:LEVel?</code>
Notes	This command is simply an alias to <code>:TRIGger[:SEQUence]:EXTernal[1] 2:LEVel</code>
Initial S/W Revision	Prior to A.02.00

Gate Polarity (Remote Command Only)

Sets the polarity for the gate signal. This setup is now done using the gate trigger's slope setting.

When Positive (Pos) is selected, a positive-going edge (Edge) or a high voltage (Level) will satisfy the gate condition, after the delay set with the Gate Delay key. When Negative (Neg) is selected, a negative-going edge (Edge) or a low voltage (Level) will satisfy the gate condition after the delay.

Remote Command	<code>[:SENSe] :SWEep:EGATe:POLarity NEGative POSitive</code> <code>[:SENSe] :SWEep:EGATe:POLarity?</code>
Example	<code>SWE:EGAT:POL NEG</code> <code>SWE:EGAT:POL?</code>

Preset	POSitive
State Saved	Saved in instrument state
Backwards Compatibility SCPI	[:SENSe]:SWEep:TIME:GATE:POLarity ESA compatibility
Initial S/W Revision	Prior to A.02.00

Remote Command	[:SENSe]:SWEep:TIME:GATE:LEVEl HIGH LOW [:SENSe]:SWEep:TIME:GATE:LEVEl? ESA compatibility
Preset	HIGH
Initial S/W Revision	Prior to A.02.00

Points

Sets the number of points taken per sweep, and displayed in the traces. The current value of points is displayed parenthetically, next to the sweep time in the lower-right corner of the display. Using more points provides greater resolution. Using fewer points compacts the data and decreases the time required to access a trace over the remote interface.

Increasing the number of points does not increase the sweep time; however, it can slightly impact the trace processing time and therefore the overall measurement speed. Decreasing the number of points does not decrease the sweep time, but it may speed up the measurement, depending on the other sweep settings (for example, in FFT sweeps). Fewer points will always speed up the I/O.

Due to minimum sweep rate limitations of the hardware, the minimum sweep time available to the user will increase above its normal value of 1 ms as the number of sweep points increases above 15001.

Changing the number of sweep points has several effects on the analyzer. The sweep time resolution will change. Trace data for all the traces will be cleared and, if Sweep is in Cont, a new trace taken. If any trace is in average or hold, the averaging starts over.

When in a split screen display each window may have its own value for points.

When sweep points is changed, an informational message is displayed, "Sweep points changed, all traces cleared."

Key Path	Sweep/Control
Remote Command	[:SENSe]:SWEep:POINts <integer> [:SENSe]:SWEep:POINts?
Example	SWE:POIN 5001 SWE:POIN?

Dependencies	<ul style="list-style-type: none"> - This function is not available when signal identification is set to On in External Mixing - Neither the knob nor the step keys can be used to change this value. If it is tried, a warning is given. - Clipped to 1001 whenever you are in the Spectrogram View in all models but MXE, clipped to 20001 whenever you are in the Spectrogram View in MXE - Grayed out in measurements that do not support swept. Forceful message -221.3200 - Blanked in modes that do not support Swept - Grayed out if Normalize is on; you can't change the number of sweep points with Normalize on, as it will erase the reference trace.
Couplings	<ul style="list-style-type: none"> - When Source Mode is set to Tracking, and Stepped Tracking is used (as with option ESC), 201 source steps are used to achieve optimal speed. The number of sweep points in the analyzer is then set to match the number of steps in the source. When Source Mode is set to Off, the previous number of points (the value that existed when Source Mode was Off previously) is restored, even if the user has changed the Points value while the Source Mode was set to Tracking. - Whenever the number of sweep points change: <ul style="list-style-type: none"> - All trace data is erased - Any traces with Update Off will also go to Display Off (like going from View to Blank in the older analyzers) - Sweep time is re-quantized - Any limit lines that are on will be updated - If averaging/hold is on, averaging/hold starts over
Preset	1001
State Saved	Saved in instrument state
Min	Normally the minimum is 1, but in Tracking Source Mode, the minimum value of Points is 101. If you go into Tracking Source Mode with fewer points than 101, it sets Points to 101.
Max	<p>100,001 when not in Tracking Source mode</p> <p>In Tracking Source mode:</p> <ul style="list-style-type: none"> - in Stepped Tracking (e.g., External Source), 1601 or the maximum number of points supported by the source, whichever is less - in Swept Tracking with the CXA TG, 10000 - in Stepped Tracking with the CXA-m TG, 16000
Backwards Compatibility Notes	<p>3. In ESA and PSA, Sweep Points was adjustable with the knob and step keys. This caused the sweep time to increase whenever Points was adjusted (either up or down), due to excessive application of the quantization rules. In the X-Series the value of Sweep Points must be entered manually, which avoids this anomaly</p>

	4. In ESA the preset value of Sweep Points is 401, in PSA it is 601. In X-Series it is 1001.
Initial S/W Revision	Prior to A.02.00
Modified at S/W Revision	A.11.00

Zoom Points

In the Trace Zoom View of the Swept SA measurement, the Points key changes to Zoom Points whenever the focus (thick green border) is on the bottom window. Zoom Points controls how many points are displayed in the Zoom Window and hence indirectly controls the Zoom Span.

Key Path	Sweep/Control
Remote Command	[:SENSe] :SWEep:TZOom:POINts <integer> [:SENSe] :SWEep:TZOom:POINts?
Example	SWE:TZO:POIN 5001
Dependencies	Only appears in the Trace Zoom View of the Swept SA measurement. If the SCPI command is sent in other Views, gives an error.
Couplings	Zoom Points is coupled to Zoom Span and Sweep Points; if Zoom Span changes, Zoom Points will change but Sweep Points will not; if Sweep Points changes, Zoom Points will change but Zoom Span will not. Zoom Span is directly coupled to Zoom Points; if Zoom Points changes, Zoom Span will change but Sweep Points will not.
Preset	On entry to Trace Zoom, 10% of the number of points in the upper window.
State Saved	Saved in instrument state
Min	1
Max	Number of points in top window
Initial S/W Revision	A.07.01

Abort (Remote Command Only)

This command is used to stop the current measurement. It aborts the current measurement as quickly as possible, resets the sweep and trigger systems, and puts the measurement into an "idle" state. If the analyzer is in the process of aligning when ABORT is sent, the alignment finishes before the abort function is performed. So ABORT does not abort an alignment.

If the analyzer is set for Continuous measurement, it sets up the measurement and initiates a new data measurement sequence with a new data acquisition (sweep) taken once the trigger condition is met.

If the analyzer is set for Single measurement, it remains in the "idle" state until an :INIT:IMM command is received.

Remote Command	:ABORt
-----------------------	--------

Example	:ABOR
Notes	<p>If :INITiate:CONTInuous is ON, then a new continuous measurement will start immediately; with sweep (data acquisition) occurring once the trigger condition has been met.</p> <p>If :INITiate:CONTInuous is OFF, then :INITiate:IMMediate is used to start a single measurement; with sweep (data acquisition) occurring once the trigger condition has been met.</p>
Dependencies	<p>For continuous measurement, ABORt is equivalent to the Restart key.</p> <p>Not all measurements support the abort command.</p>
Status Bits/OPC dependencies	<p>The STATus:OPERation register bits 0 through 8 are cleared.</p> <p>The STATus:QUESTionable register bit 9 (INTEgrity sum) is cleared.</p> <p>Since all the bits that feed into OPC are cleared by the ABORt, the ABORt will cause the *OPC query to return true.</p>
Initial S/W Revision	Prior to A.02.00

System

See "System" on page 431

Trace/Detector

The **Trace/Detector** menu lets you control the acquisition, display, storage, detection and manipulation of trace data for the six available traces. The first page of this menu contains a selection of the trace type (**Clear Write**, **Trace Average**, **Max Hold**, **Min Hold**) for the selected trace. Those choices are described here.

A trace is a series of data points, each having an x and a y value. The x value is frequency (or time, in zero span) and the y value is amplitude. Each data point is referred to as a trace point. In any given trace, trace point 0 is the first point, and trace point (sweep_points – 1) is the last. For example, in a 1001 point trace, the first point is 0 and the last is 1000. Another term sometimes used to describe traces is bucket. A bucket is the frequency span of a trace point, equal to the point spacing. For swept analysis, the y value in each bucket is measured while the analyzer is sweeping across the bucket. How it is measured depends on which detector is selected.

For more information see:

- ["Trace Update Indicator" on page 988](#)
- ["Trace Annunciator Panel" on page 989](#)
- ["Trace Annotation" on page 990](#)
- ["Trace Mode Backwards Compatibility" on page 988](#)

Key Path	Front-panel key
Remote Command	:TRACe[1] 2 ... 6:TYPE WRITe AVERAge MAXHoId MINHoId :TRACe[1] 2 ... 6:TYPE?
Notes	WRITe = Clear Write AVERAge = Trace Average MAXHoId = Maximum Hold MINHoId = Minimum Hold
Couplings	Sending a trace command does not cause the specified trace to become selected. Selecting a trace type (pressing any of the four keys or sending a TRAC:TYPE command) puts Update in On and Display in On , even if that trace type was already selected.
Preset	Write. During normal operation of the instrument (that is, other than at powerup), after a mode preset is performed, all active traces are cleared. This is so their domains and initial x values will match the current X Axis of the analyzer. Inactive traces are not cleared after a preset, so a trace which is in Update=On before a preset, and in Update=Off after the preset, will still have the data that it had before the preset.
State Saved	The type of each trace is saved in instrument state
Initial S/W Revision	Prior to A.02.00

Remote Command	<code>:TRACe[1] 2 ... 6:MODE WRITe MAXHold MINHold VIEW BLANK</code> <code>:TRACe[1] 2 ... 6:MODE?</code>
Notes	<p>The legacy TRACe:MODE command is retained for backwards compatibility. In conjunction with the legacy :AVERage command, it works as follows:</p> <ul style="list-style-type: none"> - :AVERage ON OFF sets/clears a variable which we will call average for the sake of this discussion. This variable is maintained by the analyzer solely for backwards compatibility. See the [:SENSe]:AVERage[:STATe] command description below. - :TRACe:MODE WRITe sets :TRACe:TYPE WRITe (Clear Write) unless average is true, in which case it sets it to :TRACe:TYPE AVERage. It also sets :TRACe:UPDate ON, :TRACe:DISPlay ON, for the selected trace. - :TRACe:MODE MAXHold sets :TRACe:TYPE MAXHold (Max Hold). It also sets :TRACe:UPDate ON, :TRACe:DISPlay ON, for the selected trace. - :TRACe:MODE MINHold sets :TRACe:TYPE MINHold (Min Hold). It also sets :TRACe:UPDate ON, :TRACe:DISPlay ON, for the selected trace. - :TRACe:MODE VIEW sets :TRACe:UPDate OFF, :TRACe:DISPlay ON, for the selected trace - :TRACe:MODE BLANK sets :TRACe:UPDate OFF, :TRACe:DISPlay OFF, for the selected trace <p>The query will return the same value as a :TRACe:TYPE? Query, meaning that if you set :TRACe:MODE:VIEW or :TRACe:MODE:BLANK, the query response will not be what you sent.</p>
Preset	WRITe
State Saved	The trace mode is an alias only
Backwards Compatibility Notes	The legacy command :TRACe[n]:MODE was formerly used to set the type or “writing mode” of the trace. At that time, View and Blank were writing modes. The new TRACe:TYPE command should be used in the future, but TRACe:MODE is retained to afford backwards compatibility.
Initial S/W Revision	Prior to A.02.00

Remote Command	<code>[:SENSe]:AVERage[:STATe] ON OFF 1 0</code> <code>[:SENSe]:AVERage[:STATe]?</code>
Preset	OFF
State Saved	The state of Average is saved in Instrument State for ghosting purposes
Backwards Compatibility Notes	<p>Previous to the X-Series, Averaging (also sometimes known as trace averaging) was global to all traces, that is, it was either on or off for all active traces. The legacy command <code>[:SENSe]:AVERage[:STATe] ON OFF 1 0</code> was used to turn averaging on and off. In the X-Series, Averaging is turned on and off on a per-trace basis, so it can be on for one trace</p>

and off for another.

For backwards compatibility, the old global Average State variable is retained solely as a legacy variable, turned on and off and queried by the legacy command **[:SENSe] :AVERAge [:STATe] OFF | ON | 0 | 1**. When Average is turned on, any trace in Clear Write will get put into Average. While Average is on, any trace put into Clear Write by the old TRAC:MODE command will instead get put into Average. When Average is turned off, any trace in Average will get put into Clear Write.

Initial S/W Revision	Prior to A.02.00
----------------------	------------------

Trace Mode Backwards Compatibility

In earlier analyzers, the Trace Modes were Clear/Write, Max Hold, Min Hold, View and Blank. Averaging was global to all traces and was controlled under the BW/Avg menu.

In the X-Series, trace averaging can be done on a per-trace basis. The Trace Modes (now called Types) are Clear/Write, Trace Average, Max Hold and Min Hold. View and Blank are set separately under the View/Blank key.

While this gives the user more flexibility it also gives rise to potential backwards compatibility problems. To mitigate these, the old Trace Mode command has been retained and a new command, Trace Type, has been added. What were formerly called trace modes are now called trace types. The **:TRACe:MODE** command is retained for backwards compatibility and the **:TRACe:TYPE**, **:TRACe:UPDate** and **:TRACe:DISPlay** commands introduced for ongoing use. The old Trace Modes are selected using TRAC:MODE, whose parameters are mapped into calls to TRACe:TYPE, TRACe:UPDate and TRACe:DISPlay, and the old global Averaging command **[:SENSe] :AVERAge [:STATe]** is provided for backwards compatibility. See these individual command descriptions for details.

Trace Update Indicator

Trace updates can take one of two forms:

1. The trace is updated in a single operation that affects all of the points in the trace at once. This happens, for example, in the case of very fast (< 200 ms) sweeps, single-chunk FFT's, and the initial math operation after a math function is set for a trace.
2. The trace is updated in a series of discrete steps, with measurement data being gathered between each step. This will be the case for slow sweeps, multi-chunk FFT's, etc.

In the first case, no update indicator is required. In the second case, however, a visual indicator exists on the trace where the new data is being written, a green "caret" or ^ symbol, which moves across the bottom of the graticule showing the current trace point.

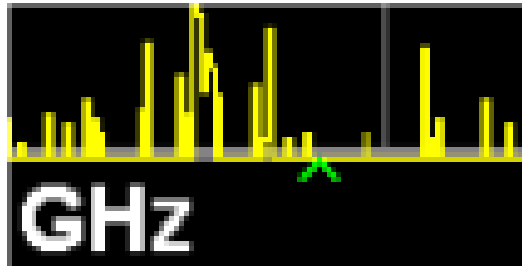

Trace Annunciator Panel

The trace annunciator panel appears on the right hand side of the Meas Bar. Here is an explanation of the fields in this panel:



On the line labeled “TRACE”, each trace number is shown, in the trace color. A green box is drawn around the currently selected trace

Below each trace number, on the line labeled “TYPE”, is a letter signifying the trace type for that trace number, where

W=Clear Write

A=Trace Average

M=Max Hold

m=Min Hold

If the letter is white it means the trace is being updated (**Update = On**); if the letter is dimmed, it means the trace is not being updated (**Update = Off**). A strikethrough (e.g., ~~W~~) indicates that the trace is blanked (**Display = Off**). Note that it is possible for a trace to be updating and blanked, which is useful if the trace is a trace math component.

The third line, labeled “DET”, shows the detector type for each trace, or, if trace math is on for that trace, it shows an “f” (for “math function”). It is not always possible to have a unique detector for each trace, but the analyzer hardware provides the maximum flexibility of detector selection in order to maintain the highest accuracy. The letters used for this readout are:

N=Normal

A=Average

P=peak

p=negative peak

S=Sample

Q=Quasi Peak

E=EMI Average

R=RMS Average

f=math function

If the DET letter is green it means the detector is in Auto; if it is white it means the detector has been manually selected.

Trace Annotation

When Trace Annotation (see View/Display menu) is On, each non-blanked trace is labeled on the trace with the detector used to take it, unless a trace math function is on for that trace, in which case it is labeled with the math function.

The detector labels are:

NORM =Normal

PEAK =Peak

SAMP =Sample

NPEAK =Negative Peak

RMS =Average detector with Power Average (RMS)

LG AVG =Average detector with Log-Pwr Average

VAVG =Average detector with Voltage Average

QPEAK =Quasi Peak

EMI AVG =EMI Average

RMS AVG =RMS Average

The trace math labels are:

PDIF =Power Difference

PSUM =Power Sum

LOFF =Log Offset

LDIF =Log Difference

Select Trace

Determines which trace the type control keys will affect. When you select a trace, it makes that trace the current trace, so it displays on top of all of the other traces.

Key Path	Trace/Detector
Dependencies	When Signal ID is on, Traces 3-6 are grayed out in Image Shift Mode.

Couplings	<ul style="list-style-type: none"> - In Image Suppress mode when you select a trace it becomes the active trace, and the formerly active trace goes into View - When you turn on Image Suppress, Update turns off for all traces except the selected trace
Preset	Trace 1
State Saved	The number of the selected trace is saved in Instrument State
Initial S/W Revision	Prior to A.02.00

Clear Write

In **Clear Write** type each trace update replaces the old data in the trace with new data. Pressing the **Clear Write** key for the selected trace, or sending the TRAC:TYPE WRIT command for the specified trace, sets the trace type to **Clear Write** and causes the trace to be cleared, even if you are already in Clear Write. Then a new sweep is initiated.

Because pressing **Clear Write** stops the current sweep and initiates a new one, **Trace Average**, **Max Hold** and **Min Hold** data may be interrupted in mid-sweep, and may not accurately reflect the displayed count. Therefore, when **Clear Write** is pressed for one trace, **Trace Average**, **Max Hold** and **Min Hold** must restart for all traces.

When in **Clear Write**, if a measurement-related instrument setting is changed, a new sweep is initiated but the trace is not cleared.

Key Path	Trace/Detector
Example	TRAC:TYPE WRIT
Notes	See "Trace/Detector" on page 986 .
Dependencies	When Signal ID is on, this key is grayed out for Traces 2-6 in Image Suppress mode and for Traces 3-6 in Image Shift Mode.
Couplings	Whenever you press Clear Write or send the equivalent SCPI command, Update is set to On and Display is set to On . Automatic detector selection and the VBW:RBW ratio auto rules both depend on the trace type selections
Preset	After a Preset, any trace that is in Clear Write is cleared (all trace points set to mintracevalue).
State Saved	The type for each trace is saved in Instrument State
Backwards Compatibility Notes	Previous to the X-Series, pressing Clear Write while already in Clear Write (or doing so remotely) had no effect. Now it will clear the trace and restart the sweep
Initial S/W Revision	Prior to A.02.00

Trace Average

In **Trace Average** type the analyzer maintains and displays an average trace, which represents the cumulative average on a point-by-point basis of the new trace data and previous averaged trace data. Details of the averaging calculations may be

found under "[Average/Hold Number](#)" on page 752 and "[Average Type](#)" on page 753 in the Meas Setup Section.

See "[Trace Averaging: More Information](#)" on page 992.

Key Path	Trace/Detector
Example	TRAC2:TYPE AVER
Notes	See " Trace/Detector " on page 986.
Dependencies	When Signal ID is on, this key is grayed out for Traces 2-6 in Image Suppress mode and for Traces 3-6 in Image Shift Mode.
Couplings	Affected by Average Type and Average/Hold Number Whenever you press Trace Average or send the equivalent SCPI command, Update is set to On and Display is set to On . Automatic detector selection and the VBW:RBW ratio auto rules both depend on the trace type selections.
Preset	After a Preset, any trace that is in Trace Average is cleared (all trace points set to mintracevalue).
State Saved	The type for each trace is saved in instrument state
Initial S/W Revision	Prior to A.02.00

Trace Averaging: More Information

Pressing the **Trace Average** key (for the selected trace), or sending the TRAC:TYPE AVER command (for the specified trace), sets the trace type to **Trace Average** and causes the average to be restarted.

When in **Trace Average**, if a measurement-related instrument setting is changed, the average restarts and a new sweep is initiated but the trace is not cleared.

Restarting the average means:

- The average/hold count k is set to 1, so that the next time the average trace is displayed it simply represents one trace of new data
- A new sweep is initiated.
- Once the new sweep starts, the trace is overwritten with current trace data as the first trace of the new average

Remember that restarting averaging also restarts **Max Hold** and **Min Hold**, as there is only one count for Trace Average and Hold.

Max Hold

In **Max Hold** type the analyzer maintains and displays a max hold trace, which represents the maximum data value on a point-by-point basis of the new trace data and previous trace data.

Pressing the **Max Hold** key for the selected trace, or sending the :TRAC:TYPE MAXH command for the specified trace, sets the trace type to **Max Hold**, causes the trace

to be cleared, and causes the **Max Hold** sequence to be (re)started, even if you are already in Max Hold.

When in **Max Hold**, if a measurement-related instrument setting is changed, the **Max Hold** sequence restarts and a new sweep is initiated but the trace is not cleared.

Restarting the **Max Hold** sequence means:

- The average/hold count k is set to 1, so that the next time the max hold trace is displayed it simply represents one trace of new data
- A new sweep is initiated.

Remember that restarting **Max Hold** also restarts averaging and **Min Hold**, as there is only one count for Trace Average and Hold.

Key Path	Trace/Detector
Example	TRAC4:TYPE MAXH
Notes	See "Trace/Detector" on page 986 .
Dependencies	<p>When Signal ID is on, this key is grayed out for Traces 2-6 in Image Suppress mode and for Traces 3-6 in Image Shift Mode.</p> <p>When the Average/Hold switch in the Mode Setup, Legacy Compatibility menu is in the "Legacy" position, the following is true for traces in Max Hold:</p> <ul style="list-style-type: none"> – They pay no attention to the Average/Hold number; "Single" for Max Hold causes one sweep only, so going to Single stops after the current sweep, and going to Cont starts you going again without clearing the accumulated result – They don't clear the Max Hold on a Restart or Single or INIT:IMM (changing a measurement parameter like frequency or bandwidth etc. would still restart the max hold).
Couplings	<p>Affected by Average Type and Average/Hold Number</p> <p>Whenever you press Max Hold or send the equivalent SCPI command, Update is set to On and Display is set to On.</p> <p>Automatic detector selection and the VBW:RBW ratio auto rules both depend on the trace type selections.</p>
Preset	After a Preset, any trace that is in Max Hold is cleared (all trace points set to mintracevalue).
State Saved	The type for each trace is saved in instrument state
Backwards Compatibility Notes	<p>In the X-Series, unlike earlier analyzers, Max Hold and Min Hold now obey the Average Number and counts up to a terminal value as Average always has.</p> <p>As the Average/Hold Number now affects Min Hold and Max Hold, the things that restart Averaging (e.g., the Restart key) now also restart Min Hold and Max Hold.</p> <p>As a result of these changes, users who used to restart averaging while retaining a running Max Hold will find that they need to rewrite their code, because the Max Hold will restart when the Average does.</p> <p>Also, previous to the X-Series,</p>

- pressing **Max Hold** while already in **Max Hold** (or doing so remotely) had no effect. Now it will clear the trace and restart the sweep and the Max Hold sequence..
- changing the vertical scale (Log/Lin or dB/div) of the display restarted **Max Hold** and **Min Hold**. This is no longer the case in the X-Series.

Initial S/W Revision	Prior to A.02.00
Modified at S/W Revision	A.11.00

Min Hold

In **Min Hold** type the analyzer maintains and displays a min hold trace, which represents the minimum data value on a point-point basis of the new trace data and previous trace data. Details of the count limiting behavior may be found under "[Average/Hold Number](#)" on page 752 in the Meas Setup Section.

Pressing the **Min Hold** key for the selected trace, or sending the TRAC:TYPE MINH command for the specified trace, sets the trace type to **Min Hold**, causes the trace to be cleared, and causes the **Min Hold** sequence to be (re)started, even if you are already in Min Hold.

When in **Min Hold**, if a measurement-related instrument setting is changed, the **Min Hold** sequence restarts and a new sweep is initiated but the trace is not cleared.

Restarting the **Min Hold** sequence means:

- The average/hold count k is set to 1, so that the next time the min hold trace is displayed it simply represents one trace of new data
- A new sweep is initiated.

Remember that restarting **Min Hold** also restarts **Max Hold** and averaging, as there is only one count for Trace Average and Hold.

Key Path	Trace/Detector
Example	TRAC3:TYPE MINH
Notes	See " Trace/Detector " on page 986".
Dependencies	<p>When Signal ID is on, this key is grayed out for Traces 2-6 in Image Suppress mode and for Traces 3-6 in Image Shift Mode.</p> <p>When the Average/Hold switch in the Mode Setup, Legacy Compatibility menu is in the "Legacy" position, the following is true for traces in Min Hold:</p> <ul style="list-style-type: none"> - They pay no attention to the Average/Hold number; "Single" for Min Hold causes one sweep only, so going to Single stops after the current sweep, and going to Cont starts you going again without clearing the accumulated result - They don't clear the Min Hold on a Restart or Single or INIT:IMM (changing a measurement parameter like frequency or bandwidth etc. would still restart the min hold).

Couplings	Affected by Average Type and Average/Hold Number . Whenever you press Min Hold or send the equivalent SCPI command, Update is set to On and Display is set to On . Automatic detector selection and the VBW:RBW ratio auto rules both depend on the trace type selections.
Preset	After a Preset, any trace that is in Min Hold is cleared (all trace points set to maxtracevalue).
State Saved	The type for each trace is saved in instrument state
Backwards Compatibility Notes	In the X-Series, unlike earlier analyzers, Max Hold and Min Hold now obey the Average Number and counts up to a terminal value as Average always has. As the Average/Hold Number now affects Min Hold and Max Hold , the things that restart Averaging (e.g., the Restart key) now also restart Min Hold and Max Hold . As a result of these changes, users who used to restart averaging while retaining a running Min Hold will find that they need to rewrite their code, because the Min Hold will restart when the Average does. Also, previous to the X-Series, <ul style="list-style-type: none"> – pressing Min Hold while already in Min Hold (or doing so remotely) had no effect. Now it will clear the trace and restart the sweep and the Min Hold sequence. – changing the vertical scale (Log/Lin or dB/div) of the display restarted Max Hold and Min Hold. This is no longer the case in the X-Series.
Initial S/W Revision	Prior to A.02.00
Modified at S/W Revision	A.11.00

View/Blank

This key lets you set the state of the two trace variables, Update and Display. The four choices available in this 1-of-N menu are:

- Trace On: Update and Display both On
- View: Update Off and Display On
- Blank: Update Off and Display Off
- Background: Update On, Display Off (this allows a trace to be blanked and continue to update “in the background”, which was not possible in the past)

A trace with Display Off is indicated by a strikethrough thru the type letter in the trace annotation panel in the Measurement bar. A trace with Update Off is indicated by dimming the type letter in the trace annotation panel in the Measurement bar. So in the example below, Traces 3, 4, 5 and 6 have Update Off and Traces 4 and 6 have Display Off.

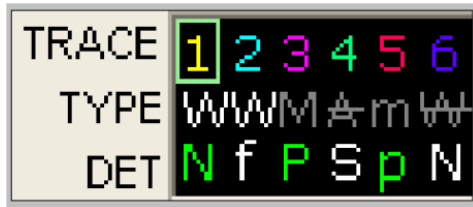

- See "Trace Update State On/Off" on page 996.
- See "Trace Display State On/Off" on page 997.
- See "More Information" on page 997.

Key Path	Trace/Detector
Notes	<p>The four states of this 1-of-N actually set two variables, Update and Display, to their four possible combinations:</p> <ul style="list-style-type: none"> - Trace On: Update and Display both On - View: Update Off and Display On - Blank: Update Off and Display Off - Background: Update On, Display Off <p>See tables below for detail on the SCPI to control these two variables.</p>
Dependencies	When Signal ID is on, this key is grayed out.
Couplings	<p>Selecting a trace type (Clear Write, Trace Average, Max Hold, Min Hold) for a trace (pressing the key or sending the equivalent SCPI command) puts the trace in Trace On (Update On and Display On), even if that trace type was already selected.</p> <p>Selecting a detector for a trace (pressing the key or sending a [:SENS]:DET:TRAC command) puts the trace in Trace On (Update On and Display On), even if that detector was already selected.</p> <p>Selecting a math mode other than Off for a trace (pressing the key or sending the equivalent SCPI command) puts the trace in Trace On (Update On and Display On), even if that math mode was already selected.</p> <p>Loading a trace from a file puts that trace in View regardless of the state it was in when it was saved; as does being the target of a Copy or a participant in an Exchange.</p>
Initial S/W Revision	Prior to A.02.00

Trace Update State On/Off

Key Path	Trace/Detector
Remote Command	:TRACe[1] 2 ... 6:UPDate[:STATe] ON OFF 0 1 :TRACe[1] 2 ... 6:UPDate[:STATe]?
Example	TRAC2:UPD 0 Makes trace 2 inactive (stops updating)
Couplings	Whenever you set Update to On for any trace, the Display is set to On for that trace.
Preset	1 0 0 0 0 0 (On for Trace 1; Off for 2-6)
State Saved	Saved in instrument state

Backwards Compatibility SCPI	:TRACe:MODE VIEW sets :TRACe:UPDate OFF, :TRACe:DISPlay ON, for the selected trace. In earlier analyzers, View and Blank were trace modes, set by TRACe:MODE command. In the X-Series, View and Blank are two of the states set by the :TRACe:UPDate and :TRACe:DISPlay commands. The TRACe:MODE VIEW command will yield its new equivalent, which is Update=Off, Display=On
Initial S/W Revision	Prior to A.02.00

Trace Display State On/Off

Key Path	Trace/Detector
Remote Command	:TRACe[1] 2 ... 6:DISPlay[:STATe] ON OFF 0 1 :TRACe[1] 2 ... 6:DISPlay[:STATe]?
Example	TRAC2:DISP,1 Makes trace 2 visible TRAC3:DISP,0 Blanks trace 3
Couplings	Whenever you set Update to On for any trace, the Display is set to On for that trace.
Preset	1 0 0 0 0 0 (On for Trace 1; Off for 2-6)
State Saved	Saved in instrument state
Backwards Compatibility SCPI	:TRACe:MODE BLANK sets :TRACe:UPDate OFF, :TRACe:DISPlay OFF, for the selected trace. In earlier analyzers, View and Blank were trace modes, set by TRACe:MODE command. In the X-Series, View and Blank are two of the states set by the :TRACe:UPDate and :TRACe:DISPlay commands. The TRACe:MODE BLANK command will yield its new equivalent, which is Update=Off, Display=Off
Initial S/W Revision	Prior to A.02.00

More Information

When a trace becomes inactive, the following things happen:

- Any update from the SENSE system (detectors) immediately stops (does not wait for end of sweep)
- the trace is displayed at half intensity (as long as it stays inactive)

Inactive traces display across the entire X Axis of the instrument. Their horizontal placement does not change even if X Axis settings subsequently are changed, although Y-axis settings will affect the vertical placement of data.

In most cases, inactive traces are static and unchanging; however, there are cases when an inactive trace will update, specifically:

- if data is written to that trace from remote
- if trace data is loaded from mass storage
- if the trace is the target of a Copy or participant in an Exchange
- if the trace is cleared using the Clear Trace function (below)

When a trace becomes active (Update=On), the trace is cleared, the average count is reset, and a new sweep is initiated.

Traces which are blanked (Display=off) do not display nor appear on printouts but are otherwise unaffected. They may be queried and markers may be placed on them.

Note that the action of putting a trace in Display=Off and/or Update=Off does not restart the sweep and does not restart Averaging or Hold functions for any traces.

Note also that whenever you set **Update** to **On** for any trace, **Display** is set to **On** for that trace.

Detector

Selects a detector. The detector selected is then applied to the selected trace.

For the SCPI UI, two commands are provided. One is a legacy command, which affects all traces. There is also a command which is new for the X-Series, which uses a subopcode to specify to which trace the specified detector is to be applied.

The three detectors on the second page of the Detector menu, Quasi Peak, EMI Average, and RMS Average, are referred to collectively as the “CISPR detectors” because their behaviors are specified by the CISPR 16–1–1 specification.

NOTE

The analyzer can typically provide 3 different detectors simultaneously. Occasionally the analyzer can only provide 2 simultaneous detectors, typically when the Average detector is selected. When one of the CISPR detectors is selected, it is only possible to have that one detector so all active traces change to that detector. It is never possible to have more than 3 simultaneous detectors.

See ["More Information" on page 1000](#)

Key Path	Trace/Detector
Remote Command	[:SENSe]:DETECTOR:TRACe[1] 2 ... 6 AVERage NEGative NORMal POSitive SAMPle QPEak EAverage RAverage [:SENSe]:DETECTOR:TRACe[1] 2 ... 6?
Example	DET:TRAC AVER -- Sets trace 1's detector to average DET:TRAC1 AVER -- Sets trace 1's detector to average DET:TRAC2 SAMP -- Sets trace 2's detector to sample
Notes	When a detector selection is made, the menu returns to the previous menu. Selecting any CISPR detector on any active trace sets the EMI Standard to CISPR.
Notes	The query returns a name that corresponds to the detector type as shown below, and indicates the setting for Trace 1. String ReturnedDefinition NORM =Normal AVER =Average / RMS POS =Positive peak SAMP =Sample NEG =Negative peak QPE =Quasi Peak

	EAV =EMI Average RAV =RMS Average
Dependencies	<p>When Tune & Listen is turned on, or Demod Audio is the selected Analog Output:</p> <ul style="list-style-type: none"> - all active traces are forced to use the same detector. - CISPR detectors (QPD, EMI Avg, RMS Avg) are unavailable <p>CISPR detectors are grayed out when you have manually selected FFT sweep. Conversely, if any CISPR detector is selected on an active trace, the auto rules for sweep type will never select FFT, and manual FFT selection will be grayed out.</p> <p>When Signal ID is on, the Detector key is grayed out for Traces 2-6 in Image Suppress mode and for Traces 3-6 in Image Shift Mode.</p> <p>If the grayed out key is pressed, an advisory message is generated. If the equivalent SCPI command is sent, this same message is generated as part of a “-221, Settings conflict” warning. It is never possible to have more than 3 simultaneous detectors, and sometimes fewer than three. If the analyzer has to enforce this limit a message is generated, “Detector n changed due to physical constraints” where “n” is the detector number.</p>
Couplings	<p>The auto detector rules depend upon marker type, averaging state and type, trace state writing mode, and trace active state.</p> <p>If the Avg Type is in Auto, and any of the CISPR detectors is selected on any active trace, the Voltage Averaging type is auto-selected.</p> <p>In Tracking Source mode, if a stepped source is used (for example, an external source using option ESC), the best detector is Average, as this gives optimal sensitivity. Therefore, when operating a source in Tracking Source mode, Auto selection is Average. All other detector selections are allowed, but in most cases the user will want to stick with the Auto selection, which gives optimal sensitivity.</p>
Preset	Preset returns all traces to “auto”, which will result in Normal (Rosenfell) detection for all traces.
State Saved	Saved in instrument state
Initial S/W Revision	Prior to A.02.00
Modified at S/W Revision	A.02.00
Remote Command	<pre>[:SENSe]:DETEctor[:FUNction] NORMal AVERage POSitive SAMPlE NEGative QPEak EAVERage EPOSitive MPOSitive RMS [:SENSe]:DETEctor[:FUNction]?</pre>
Example	<p>DET AVER Sets detector to average for all traces</p> <p>DET:FUNC? Returns trace 1's detector setting</p>
Notes	<p>This is a SCPI only legacy command to preserve the classic functionality wherein all traces are affected when a detector is selected (in the X-Series, the detector is set on a per-trace basis). The query returns a name that corresponds to the detector type as shown below, and indicates the setting for Trace 1.</p> <p>The RMS selection sets the detector type to AVERage and the Average Type to RMS. Therefore if RMS has been selected, the query will return the “AVER” string.</p>

	<p>The EPOS selection sets the detector type to Peak and the EMI Standard to CISPR. A query will then return POS</p> <p>The MPOS selection sets the detector type to Peak and the EMI Standard to MIL Impulse. A query will then return POS</p> <p>The RAV parameter is not included in the command because this is not a legacy detector; nonetheless, if it happens to be the detector on Trace 1 then RAV will be returned.</p> <p>String ReturnedDefinition</p> <p>NORM =Normal</p> <p>AVER =Average / RMS</p> <p>POS =Positive peak</p> <p>SAMP =Sample</p> <p>NEG =Negative peak</p> <p>QPE =Quasi Peak</p> <p>EAV =EMI Average</p> <p>RA =RMS Average</p>
Preset	NORMal
State Saved	Saved in instrument state
Backwards Compatibility Notes	<p>In ESA and E7400, selecting QPD or EMI Average sets the Amplitude Scale Type to Linear and performs an auto-ranging function resulting in the Reference Level being adjusted such that the highest level of the trace is near (but below) the Reference Level. Subsequent selection of Peak, Negative Peak, Sample, or Average (the 'non-EMI Detectors') will return the Reference Level and Amplitude Scale Type to their pre-EMI Detector values. The X-Series does not perform this scale and reference level change because the digital IF makes it unnecessary..</p> <p>The commands which select the CISPR detectors are not generally compatible with pre-PSA instruments, because the CISPR detectors are now part of the overall detector set, rather than a separate set. However, the basic behavior of coupling the resolution bandwidth to the selected detector is similar to the behavior of previous EMI analyzers, like the E4400B series.</p> <p>In the past, selecting Auto Couple All did not change the selected CISPR detector. Now, since the CISPR detectors are part of the full set of detectors, pressing Auto Couple All will switch from the selected CISPR detector to an auto coupled detector according to the Auto Detector rules in the Detector, Auto key description below.</p> <p>The following ESA/E7400 detector commands are no longer accepted: [:SENSe]:DETEctor[:FUNction]:EMI QPD AVERage OFF[:SENSe]:POWer-:QPGain[:STATe][:SENSe]:ARDT</p>
Initial S/W Revision	Prior to A.02.00
Modified at S/W Revision	A.02.00

More Information

The available detectors are:

- The Sample detector indicates the instantaneous level of the signal at the center of the bucket represented by each display point.

- The Normal detector determines the peak of CW-like signals, and it yields alternating maximums and minimums of noise-like signals. This is also referred to as Rosenfell detection.
- The Average detector determines the average of the signal within the bucket. The averaging method depends upon Average Type selection (voltage, power or log scales).
- The Peak detector determines the maximum of the signal within the bucket.
- The Negative Peak detector determines the minimum of the signal within the bucket.
- The Quasi-Peak detector is a fast-rise, slow-fall detector used in making CISPR compliant EMI measurements.
- The EMI-Average detector provides a standard means to “smooth” the signal while still providing compliance to CISPR pulse response standards. It displays the average value of the amplitude envelope, rather than the average value of sample-detected amplitude, and uses an advanced algorithm to realize a lowpass filter that conforms to the latest CISPR standard.
- The RMS Average detector is a frequency dependent RMS or Averaging filter, used in making CISPR compliant EMI measurements, which performs one averaging process (in the VBW hardware) on the "power" (a.k.a. RMS) scale, and another process on the voltage scale using a "meter movement simulator". This filter conforms to the 2007 revision of the CISPR 16-1-1 standard.

Because they may not find a spectral component's true peak, neither average nor sample detectors measure amplitudes of CW signals as accurately as peak or normal, but they do measure noise without the biases of peak detection.

When the Detector choice is Auto, the detector selected depends on marker functions, trace functions, average type, and the trace averaging function.

When you manually select a detector (instead of selecting Auto), that detector is used regardless of other analyzer settings.

Multiple Detectors

The analyzer always provides the requested detector on the specified trace. Depending on the detectors requested the analyzer can provide up to three different detectors simultaneously within the constraints of its digital processing algorithms. Some detectors utilize more resources; the Quasi-Peak detector, for example, utilizes most of the digital IF's resources, and the hardware in some analyzers is incapable of providing another detector when Quasi-Peak is on. If the limit of system

resources is exceeded, detectors on some existing traces may be forced to change. When this happens, they change to match the detector just requested, and a message is generated: “Detector <X> changed due to physical constraints”, where X might contain multiple values.

Example: User has traces 1, 2, and 3 with Peak, Average, and Negative Peak. User specifies QPD for trace 1. Traces 2 and 3 also change to QPD and we generate the message “Detector 2,3 changed due to physical constraints”. Now all three traces have the QPD.

Auto

This sets the detector for the currently selected trace to Auto. (For SCPI, the trace number is specified as a subopcode.) This will immediately apply the auto rules to determine a new detector value.

Key Path	Trace/Detector, Detector
Remote Command	[:SENSe]:DETECTOR:TRACe[1] 2 ... 6:AUTO ON OFF 1 0 [:SENSe]:DETECTOR:TRACe[1] 2 ... 6:AUTO?
Example	DET:TRACE2:AUTO ON Sets trace 2 detection to automatic.
Dependencies	The auto detector rules depend upon marker type, averaging state and type, trace state writing mode, and trace active state. _Auto_Rules_(couplings) When operating a source in Tracking Source mode, Auto selection is the Average detector. All other detector selections are allowed, but in most cases you will want to stick with Average, which gives optimal sensitivity.
Couplings	Selecting AUTO, whether by pressing the softkey or sending the equivalent SCPI command, will turn trace math to Off for the selected/specified trace.
Preset	Auto (On) for all detectors.
State Saved	Saved in instrument state
Initial S/W Revision	Prior to A.02.00

Remote Command	[:SENSe]:DETECTOR:AUTO ON OFF 1 0 [:SENSe]:DETECTOR:AUTO?
Example	DET:AUTO ON
Notes	SCPI only. Turns AUTO on or off for ALL detectors. This is a legacy command to preserve the classic functionality wherein all traces are affected when a detector is addressed
Notes	The query returns the Auto state of Trace 1.
Initial S/W Revision	Prior to A.02.00

Normal

This sets the detector for the current selected trace to Normal (Rosenfell).

When the signal is CW-like, it displays the peak-detected level in the interval (bucket) being displayed. If the signal is noise-like (within a bucket the signal both rose and fell), it alternates displaying the max/min values. That is, an even bucket

shows the peak (maximum) within a two-bucket wide interval centered on the even bucket. And an odd bucket will show the negative peak (minimum) within a two-bucket wide interval. For example, for an even bucket the two-bucket wide interval is a combination of one-half bucket to the left of the even bucket, the even bucket itself, and one-half bucket to the right of the even bucket, so the peak found will be displayed in the correct relative location on screen. The odd buckets are similar.

Key Path	Trace/Detector, Detector
Example	DET:TRAC3 NORM Sets the detector to normal for trace 3.
Dependencies	Selecting any detector (even the currently selected detector) for a given trace turns Update and Display on for that trace. Normal detector is grayed out when the X scale is Log.
Couplings	Selecting a specific detector type turns “Auto” to false for this trace (manual). Selecting a detector for a trace (pressing the key or sending a [:SENS]:DET:TRAC command) puts Update On and Display On for that trace, even if that detector was already selected. Note that the legacy command [:SENS]:DET[:FUNC] does NOT exhibit this behavior. Selecting a detector, whether by pressing the softkey or sending the equivalent SCPI command, will turn trace math to Off for the selected/specified trace.
Initial S/W Revision	Prior to A.02.00

Average (Log/RMS/V)

For each bucket (interval) in the trace, Average detection displays the average of the amplitude within the bucket using one of the following averaging methods:

- Log power (also known as video)
- Power (also known as RMS)
- Voltage envelope

To explicitly set the averaging method, use the **Meas Setup, Average Type** key. When you are using average detection with the Power method is equivalent to what is sometimes referred to as “RMS detection”. The detailed information about the different types of averaging is found in **Average Type** in the **Meas Setup** key menu.

Key Path	Trace/Detector, Detector
Example	DET:TRAC3 AVER Sets the detector to average for trace 3.
Notes	For the specific case of a customer wanting RMS detection, they need to set the averaging type to RMS, and also select average detection for the trace: AVER:TYPE RMS DET:TRAC AVER
Dependencies	Selecting any detector (even the currently selected detector) for a given trace turns Update and Display on for that trace.
Couplings	Selecting a specific detector type turns “Auto” to false for this trace (manual). Selecting a detector for a trace (pressing the key or sending a [:SENS]:DET:TRAC command) puts Update On and Display On for that trace, even if that detector was already selected. Note that

the legacy command [:SENS]:DET[:FUNC] does NOT exhibit this behavior.

Selecting a detector, whether by pressing the softkey or sending the equivalent SCPI command, will turn trace math to Off for the selected/specified trace.

The VBW filter is not used for this detector, so varying the VBW will have no effect for any traces for which this detector is selected (other than to slow down the sweep, because of the coupling to Sweep Time of VBW). If any traces are active for which VBW does not apply (traces with Average, EMI Average, RMS Average or Quasi Peak detectors), then an * displays after the VBW annotation on the front panel.

Use of the Average detector affects the VBW setting because of its effect on the VBW/RBW coupling.

Initial S/W Revision	Prior to A.02.00
----------------------	------------------

Peak

For each bucket (interval) in the trace, Peak detection displays the highest amplitude within the bucket.

Peak detection is used for CW measurements and some pulsed-RF measurements. For FFT analysis, the highest amplitude across the frequency width of a bucket is displayed, even if that peak amplitude falls between samples of the spectrum computed in the FFT process.

Key Path	Trace/Detector, Detector
----------	---------------------------------

Example	DET:TRAC2 POS Sets the detector to peak for trace 2.
----------------	--

Couplings	<p>Selecting a specific detector type turns “Auto” to false for this trace (manual).</p> <p>Selecting a detector for a trace (pressing the key or sending a [:SENS]:DET:TRAC command) puts Update On and DisplayOn for that trace, even if that detector was already selected. Note that the legacy command [:SENS]:DET[:FUNC] does NOT exhibit this behavior.</p> <p>Selecting a detector, whether by pressing the softkey or sending the equivalent SCPI command, will turn trace math to Off for the selected/specified trace.</p>
-----------	---

Initial S/W Revision	Prior to A.02.00
----------------------	------------------

Sample

The sample detector displays the instantaneous level of the signal at the center of the bucket (interval) represented by each trace point.

Sample detection is good for displaying noise or noise-like signals.

Sample detection is not the best for making amplitude measurements of CW-like signals for two reasons. First, the peak response to a signal can occur between samples. So unless the Span to RBW ratio is lower than usual, then the highest sample can be well below the peak signal amplitude. Second, for the high sweep rates normally used, the peak response of the RBW filters is up to -0.5 dB. This sweeping error is compensated when using the peak and normal detectors by changing the overall gain. But the gain is not changed when in the sample detector, because doing so would cause errors in the response to noise. Instead, the auto-couple rules for sweep time are modified to give slower sweeps.

Key Path	Trace/Detector, Detector
Example	DET:TRAC SAMP Selects the Sample detector for trace 1.
Couplings	<p>Selecting a specific detector type turns “Auto” to false for this trace (manual).</p> <p>Selecting a detector for a trace (pressing the key or sending a [:SENS]:DET:TRAC command) puts Update On and DisplayOn for that trace, even if that detector was already selected. Note that the legacy command [:SENS]:DET[:FUNC] does NOT exhibit this behavior.</p> <p>Selecting a detector, whether by pressing the softkey or sending the equivalent SCPI command, will turn trace math to Off for the selected/specified trace.</p>
Initial S/W Revision	Prior to A.02.00

Negative Peak

For each bucket (interval) in the trace, Negative Peak detection displays the lowest sample within the bucket. Negative peak detection is similar to peak detection, but selects the minimum video signal.

Key Path	Trace/Detector, Detector
Example	DET:TRAC2 NEG Selects the negative peak detector for trace 2.
Couplings	<p>Selecting a specific detector type turns “Auto” to false for this trace (manual).</p> <p>Selecting a detector for a trace (pressing the key or sending a [:SENS]:DET:TRAC command) puts Update On and DisplayOn for that trace, even if that detector was already selected. Note that the legacy command [:SENS]:DET[:FUNC] does NOT exhibit this behavior.</p> <p>Selecting a detector, whether by pressing the softkey or sending the equivalent SCPI command, will turn trace math to Off for the selected/specified trace.</p>
Initial S/W Revision	Prior to A.02.00

Quasi Peak

Only appears with the N6141A or W6141A application or Option EMC installed and licensed.

This is a fast-rise, slow-fall detector used in making CISPR compliant EMI measurements and defined by CISPR Publication 16-1-1. Quasi-peak detection displays a weighted, sample-detected amplitude using specific, charge, discharge, and meter time constants derived from the legacy behaviors of analog detectors and meters. It is used for EMI measurements to provide a specific and consistent response to EMI-like signals.

Note that CISPR standard operation is to perform the averaging associated with quasi peak detection on the voltage scale. You can manually set the Average Type to Log-Power or Power, but the results will no longer be CISPR compliant.

See ["More Information" on page 1006](#).

Key Path	Trace/Detector, Detector
Example	DET:TRAC3 QPE Selects the quasi-peak detector for trace 3.
Dependencies	Unavailable in manual FFT sweep.

	Unavailable when Tune & Listen is turned on, or Demod Audio is the selected Analog Output:
Couplings	<p>If the user selects this detector on any active trace, the EMI Standard will be set to CISPR. If any inactive trace with this detector selected goes active, the EMI Standard is set to CISPR.</p> <p>If the Avg Type is in Auto, and this detector is selected on any active trace, the Voltage Averaging type is auto-selected.</p> <p>The VBW filter is not used for this detector, so varying the VBW will have no effect for any traces for which this detector is selected (other than to slow down the sweep, because of the coupling to Sweep Time of VBW). If any traces are active for which VBW does not apply (traces with Average, EMI Average, RMS Average or Quasi Peak detectors), then an * displays after the VBW annotation on the front panel.</p> <p>Selecting a specific detector type turns the "Auto" on page 1002 (to false for this trace (manual).</p> <p>Selecting a detector for a trace (pressing the key or sending a [:SENS]:DET:TRAC command) puts Update On and DisplayOn for that trace, even if that detector was already selected. Note that the legacy command [:SENS]:DET[:FUNC] does NOT exhibit this behavior.</p> <p>Selecting a detector, whether by pressing the softkey or sending the equivalent SCPI command, will turn trace math to Off for the selected/specified trace.</p>
Initial S/W Revision	A.02.00

More Information

In the past, Quasi Peak and EMI Average measurements were often made on a linear display scale because those detectors only worked properly with signals on a linear (voltage) scale. The X-series analyzers are capable of making Quasi Peak and EMI Average detected measurements correctly on a log scale, due to the digital IF. This latter capability means that the user can observe detected EMI levels on a log scale, allowing a large visible dynamic range.

Also in the past, EMI analysis equipment would need to perform a ranging operation to set the reference level when one of these detectors was turned on, but the X-series analyzers do not – because of its digital IF, there is no need to set the reference level (range) to improve the accuracy nor to allow visibility of the detected level.

EMI Average

Only appears with the N6141A or W6141A application or Option EMC installed and licensed.

The EMI Average detector in Agilent's X-Series analyzers is so called to distinguish it from the Average detector, although EMI users typically refer to it simply as the "Average detector". The intent of this detector is to provide a standard means to "smooth" the signal while still providing compliance to CISPR pulse response standards.

Unlike the regular Average detector, which averages on a bucket-by-bucket basis using either a power, log-power or voltage scale (a bucket is the same as a trace point), the EMI Average detector displays the average value, on the voltage scale, of the overall amplitude envelope, independent of the trace bucket width. It is defined for EMI measurements by the CISPR 16-1-1 standard and, in the X-series, uses a

sophisticated algorithm to implement a lowpass filter that conforms to the latest CISPR standard.

Note that CISPR standard operation is to perform the envelope averaging on the voltage scale. You can manually set the Average Type to Log-Power or Power, but the results will no longer be CISPR compliant.

Key Path	Trace/Detector, Detector
Example	DET:TRAC3 EAV Selects the EMI average detector for trace 3.
Dependencies	Unavailable in manual FFT sweep. Unavailable when Tune & Listen is turned on, or Demod Audio is the selected Analog Output:
Couplings	<p>If the user selects this detector on any active trace, the EMI Standard will be set to CISPR. If any inactive trace with this detector selected goes active, the EMI Standard is set to CISPR.</p> <p>If the Avg Type is in Auto, and this detector is selected on any active trace, the Voltage Averaging type is auto-selected.</p> <p>The VBW filter is not used for this detector, so varying the VBW will have no effect for any traces for which this detector is selected (other than to slow down the sweep, because of the coupling to Sweep Time of VBW). If any traces are active for which VBW does not apply (traces with Average, EMI Average, RMS Average or Quasi Peak detectors), then an * displays after the VBW annotation on the front panel.</p> <p>Selecting a detector for a trace (pressing the key or sending a [:SENS]:DET:TRAC command) puts Update On and DisplayOn for that trace, even if that detector was already selected. Note that the legacy command [:SENS]:DET[:FUNC] does NOT exhibit this behavior.</p> <p>Selecting a detector, whether by pressing the softkey or sending the equivalent SCPI command, will turn trace math to Off for the selected/specified trace.</p>
Initial S/W Revision	A.02.00

RMS Average

Only appears with the N6141A or W6141A application or Option EMC installed and licensed.

This key selects the RMS Average detector, a frequency dependent RMS/Averaging filter, used in making CISPR compliant EMI measurements. This filter conforms to the 2007 revision of the CISPR 16-1-1 standard.

This detector does one averaging process (in the VBW hardware) on the "power" (a.k.a. RMS) scale and another process on the voltage scale using a "meter movement simulator" similar to the one used in the QPD filter.

Note that the user can manually set the Average Type to Log-Power or Power, but the results will no longer be CISPR compliant.

Key Path	Trace/Detector, Detector
Example	DET:TRAC3 RAV Selects the RMS Average detector for trace 3.
Notes	This key / command is grayed out when you have manually selected FFT sweep.
Dependencies	Unavailable in manual FFT sweep. Unavailable when Tune & Listen is turned on, or Demod Audio is the selected Analog Output:

Couplings	Selecting a detector for a trace (pressing the key or sending a [:SENS]:DET:TRAC command) puts Update On and DisplayOn for that trace, even if that detector was already selected. Note that the legacy command [:SENS]:DET[:FUNC] does NOT exhibit this behavior.
Couplings	<p>If the user selects this detector on any active trace, the EMI Standard will be set to CISPR. If any inactive trace with this detector selected goes active, the EMI Standard is set to CISPR.</p> <p>If the Avg Type is in Auto, and this detector is selected on any active trace, the Voltage Averaging type is auto-selected.</p> <p>The VBW filter is not used for this detector, so varying the VBW will have no effect for any traces for which this detector is selected (other than to slow down the sweep, because of the coupling to Sweep Time of VBW). If any traces are active for which VBW does not apply (traces with Average, EMI Average, RMS Average or Quasi Peak detectors), then an * displays after the VBW annotation on the front panel.</p> <p>Selecting a detector for a trace (pressing the key or sending a [:SENS]:DET:TRAC command) puts Update On and DisplayOn for that trace, even if that detector was already selected. Note that the legacy command [:SENS]:DET[:FUNC] does NOT exhibit this behavior.</p> <p>Selecting a detector, whether by pressing the softkey or sending the equivalent SCPI command, will turn trace math to Off for the selected/specified trace.</p>
Initial S/W Revision	A.02.00

Preset Detectors

The keys in this menu provide a quick way of setting a number of traces to convenient common detector settings. It is important to point out that these are not toggles or 'modes', and do not keep any detectors in a particular configuration. The effect is identical to just setting the traces' detectors individually. These are simply one-time settings that are quicker than making many individual changes.

Key Path	Trace/Detector, Detector
Dependencies	When Signal ID is on, this key is grayed out.
Preset	No interaction with preset
State Saved	Not saved in instrument state
Initial S/W Revision	Prior to A.02.00

All Traces Auto

This is designed to quickly return the selected set of detectors to the "preset" state, which is auto-selected.

Key Path	Trace/Detector, Detector, Preset Detectors
Couplings	Sets all traces' Detector Auto to true.
Initial S/W Revision	Prior to A.02.00

Peak / Average / NPeak

This is a setting for making a measurement of the average power and the signal envelope.

Key Path	Trace/Detector, Detector, Preset Detectors
Couplings	Trace 1: Set to peak detection, and Clear-Write. Trace 2: Set to average detection, and Clear-Write. Trace 3: Set to negative peak detection, and Clear-Write.
Initial S/W Revision	Prior to A.02.00

Peak / Sample / NPeak

This is a setting for making a measurement that displays a power sample and the signal envelope.

Key Path	Trace/Detector, Detector, Preset Detectors
Couplings	Trace 1: Set to peak detection, and Clear-Write. Trace 2: Set to sample detection, and Clear-Write. Trace 3: Set to negative peak detection, and Clear-Write.
Initial S/W Revision	Prior to A.02.00

Clear Trace

Clears the selected trace (from the front panel) or the specified trace (from SCPI). Does not affect the state of any function or variable in the instrument. Loads mintracevalue into all of the points in the selected trace, unless the trace is in Min Hold in which case it loads maxtracevalue. It does this even if Update=Off.

Key Path	Trace/Detector
Remote Command	:TRACe:CLEAr TRACE1 TRACE2 TRACE3 TRACE4 TRACE5 TRACE6
Example	TRAC:CLE TRACE1 Clears trace 1
Initial S/W Revision	Prior to A.02.00

Clear All Traces

Clears all traces. Does not affect the state of any function or variable in the instrument. Loads mintracevalue into all of the points all traces, except traces in Min Hold in which case it loads maxtracevalue. Does so even if Update=Off.

Key Path	Trace/Detector
Remote Command	:TRACe:CLEAr:ALL :TRACe:PRESet:ALL When Signal ID is on, this key is grayed out.
Example	TRAC:CLE:ALL Clears all traces
Initial S/W Revision	Prior to A.02.00

Math

This menu lets you turn on trace math functions. Trace math functions perform mathematical operations between traces and, in some cases, user-specified offsets. When in a trace math function, the indicated function is performed during the sweep with the math function used in place of a detector. The trace operands for the math function are set using the **Trace Operands** key.

See ["Math: More Information" on page 1011](#).

Key Path	Trace/Detector
Remote Command	:CALCulate:MATH TRACE1 TRACE2 TRACE3 TRACE4 TRACE5 TRACE6, PDIFference PSUM LOFFset LDIFference OFF, TRACE1 TRACE2 TRACE3 TRACE4 TRACE5 TRACE6, TRACE1 TRACE2 TRACE3 TRACE4 TRACE5 TRACE6, <real>, <real> :CALCulate:MATH? TRACE1 TRACE2 TRACE3 TRACE4 TRACE5 TRACE6
Notes	The lower level menu, which contains an embedded 1-of-N, does not auto-return when a selection is made.
Notes	<p>The Trace Math Function command has 6 main set of parameters:</p> <ul style="list-style-type: none"> - Set 1 defines the "result trace": TRACE1 TRACE2 TRACE3 TRACE4 TRACE5 TRACE6 -Set 2 defines the "function": PDIFference PSUM LOFFset LDIFference OFF - Set 3 is a "trace operand" (1): TRACE1 TRACE2 TRACE3 TRACE4 TRACE5 TRACE6 - Set 4 is a "trace operand" (2): TRACE1 TRACE2 TRACE3 TRACE4 TRACE5 TRACE6 - Set 5 defines the "Log Offset" (in dB). - Set 6 defines the "Log Difference Reference" (in dBm). <p>Note that the trace math mode is an enumeration; that is, when a math function is set for a trace it turns off any math function that is on for that trace and sets the new math function.</p> <p>The parameters sent in the command are reflected in the values in the softkey menu. There is no default for any parameter; all 6 parameters must be sent to satisfy the parser. Failure to specify a parameter will result in a missing parameter message.</p> <p>Note that for some of the math modes some of the parameters are not relevant. For those modes, the parameters are ignored, and sending ".,," is sufficient for those parameters.</p> <p>The query returns the math mode, the operand traces, the offset and the reference for the specified trace, all separated by commas. The return value of irrelevant parameters is undefined; empty fields (".,,") would be desirable.</p> <p>Remote command examples are included in each section below.</p>
Dependencies	<p>Trace Math is not available if Normalize is on.</p> <p>Trace Math is not available if Signal ID is on.</p> <p>None of the trace operands can be the destination trace. If any of the three trace math commands is sent with a destination trace number matching one of the operands a warning is generated and the function does not turn on.</p>
Couplings	Whenever a math function is turned on for a trace, that trace is set to Display=On and

	Update=On.
Preset	OFF, TRACE5, TRACE6, 0, 0 OFF, TRACE6, TRACE1, 0, 0 OFF, TRACE1, TRACE2, 0, 0 OFF, TRACE2, TRACE3, 0, 0 OFF, TRACE3, TRACE4, 0, 0 OFF, TRACE4, TRACE5, 0, 0
State Saved	The trace math function for each trace is saved in instrument state.
Status Bits/OPC dependencies	*OPC can be used to detect the completion of a sweep, which will also correspond to the completion of the math operation, since all math takes place during the sweep
Backwards Compatibility Notes	The legacy TRACE:MATH:ADD and TRACE:MATH:SUBtract commands have been eliminated.
Initial S/W Revision	Prior to A.02.00

Math: More Information

IMPORTANT: to generate a trace math result, you must take a sweep. The trace math engine, described below, operates in concert with the sweep engine in the analyzer. Until a sweep has been taken, even if the constituent traces are not in Update mode, no result is generated. Note that certain events can affect the trace in ways that affects all points at once. This can happen in any number of ways, including:

- A trace clear taking place
- A trace being loaded from the file system
- Trace data being sent in from the remote interface
- A copy or exchange of trace data

You should try to avoid these occurrences during a sweep, as they will tend to invalidate the math result being accumulated.

How trace math is processed:

Whenever a trace math function is turned on, or the parameters and/or operands of an existing trace math function are changed, the destination trace is cleared. After the trace is cleared, all x-axis values in the trace, and the domain of the trace, are set to match the X Axis settings of the first trace operand. When this is complete, a new sweep is initiated.

The process of acquiring data, processing it using the math and average/hold functions, and presenting it to the user as trace data, consists of several functional blocks, as shown below:

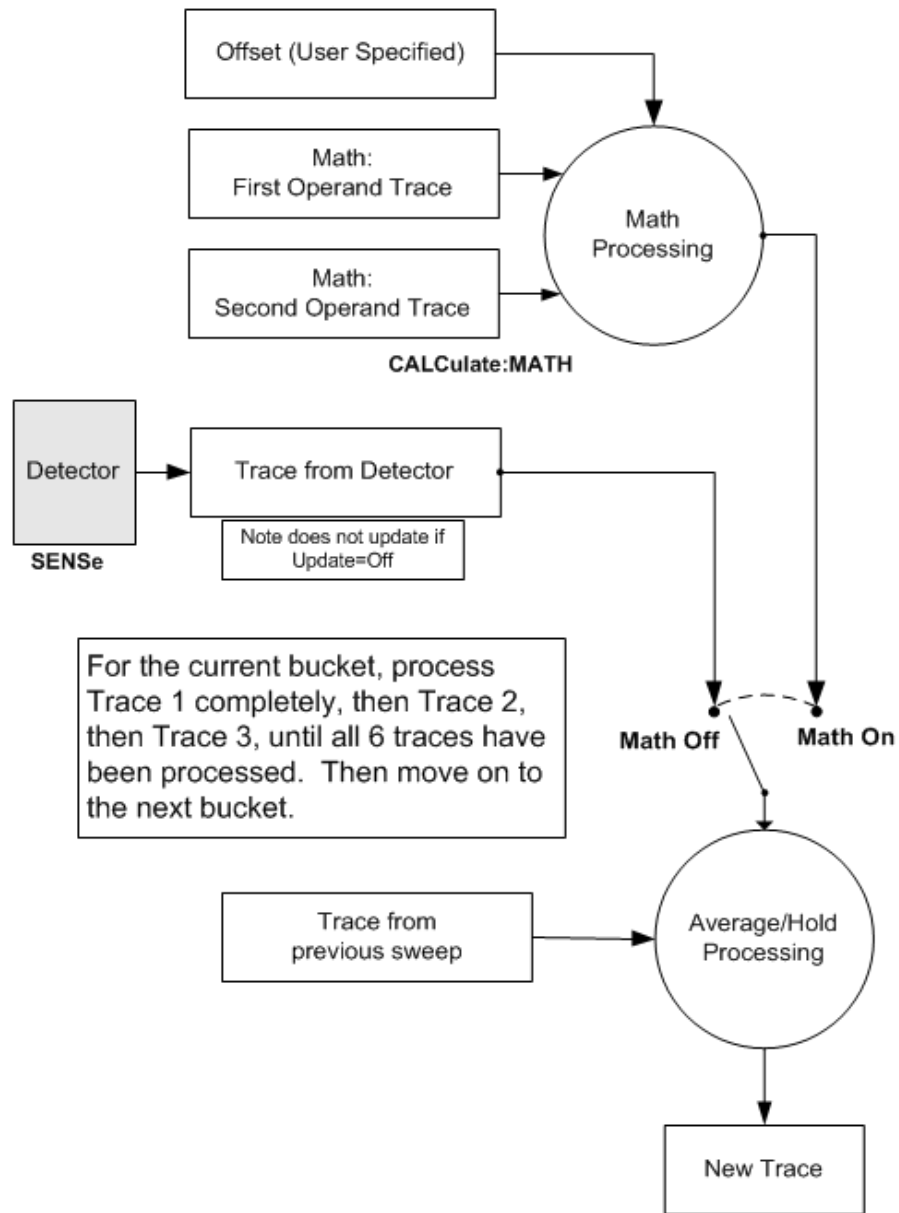

NOTE ABOUT OFFSETS: When either External Gain or Ref Level Offset is on, an offset is applied to the trace operands, and when Trace Math is on this offset is applied before any math processing is performed. Since the operands have already been offset the result trace should NOT be offset. Therefore when any Trace Math operation is performed, the sum of (External Gain - Ref Level Offset) is added to the result before it is stored in the result trace.

For each active trace, the current trace point is processed for Trace 1, then Trace 2, then Trace 3, etc. Trace data is taken from either the detector for that trace, or from the mathematical result of up to two other traces and an offset, depending on whether trace math is on or not. The resultant data is then fed to the Average/Hold processing block, where (if the trace type is Average, Max Hold, or Min Hold) it is

processed with previous trace data. The new trace data resulting from this process is then available for display, storage or remote output.

When the processing is complete for Trace 1, Trace 2 is processed, and so on until all six traces have been processed. This allows a downstream trace to use as one of its math components a fully processed upstream trace. In other words, if math is on for Trace 4, and its operand traces are Trace 2 and Trace 3, all detector, math, average and hold processing for traces 2 and 3 is complete before the math is performed for trace 4. When the current trace point is completed for all traces, the analyzer moves on to the next trace point.

Select Trace

Determines which trace the type control keys will affect. When you select a trace, it makes that trace the current trace, so it displays on top of all of the other traces.

Key Path	Trace/Detector
Dependencies	When Signal ID is on, Traces 3-6 are grayed out in Image Shift Mode.
Couplings	<ul style="list-style-type: none"> - In Image Suppress mode when you select a trace it becomes the active trace, and the formerly active trace goes into View - When you turn on Image Suppress, Update turns off for all traces except the selected trace
Preset	Trace 1
State Saved	The number of the selected trace is saved in Instrument State
Initial S/W Revision	Prior to A.02.00

Power Diff (Op1 – Op2)

Calculates a power difference between the **First Trace** operand and the **Second Trace** operand and puts the result in the destination trace.

During the sweep, the following formula is executed for each point in the trace operands, and the corresponding point is generated for the destination trace:

$$\text{DestinationTrace} = 10 \log(10(1/10)(\text{FirstTrace}) - 10(1/10)(\text{SecondTrace}))$$

The values of the trace points are assumed to be in a decibel scale, as they are internally stored.

If a point in FirstTrace is equal to maxtracevalue, the resultant point is also maxtracevalue.

Otherwise, if the result of the subtraction is less than or equal to 0, the resultant point is mintracevalue.

Key Path	Trace/Detector, Math
Example	:CALC:MATH TRACE1,PDIF,TRACE4,TRACE5,, Sets Trace 1 to Power Diff trace math function, and sets the First Trace operand (for Trace 1) to Trace 4 and the Second Trace operand (for Trace 1) to Trace 5.
Couplings	Selecting a math mode other than Off for a trace (pressing the key or sending the equivalent SCPI

	command) puts the trace in View (Update On and Display On), even if that math mode was already selected.
Initial S/W Revision	Prior to A.02.00

Power Sum (Op1 + Op2)

Calculates a power sum between the **First Trace** operand and the **Second Trace** operand and puts the result in the destination trace.

During the sweep, the following formula is executed for each point in the trace operands, and the corresponding point is generated for the destination trace.:

$$\text{DestinationTrace} = 10 \log(10(1/10)(\text{FirstTrace}) + 10(1/10)(\text{SecondTrace}))$$

The values of the trace points are assumed to be in a decibel scale, as they are internally stored.

If a point in either trace operand is equal to maxtracevalue, the resultant point is also maxtracevalue.

Key Path	Trace/Detector, Math
Example	:CALC:MATH TRACE1,PSUM,TRACE4,TRACE5,, Sets Trace 1 to Power Sum trace math function and sets the First Trace operand (for Trace 1) to Trace 4 and the Second Trace operand (for Trace 1) to Trace 5.
Couplings	Selecting a math mode other than Off for a trace (pressing the key or sending the equivalent SCPI command) puts the trace in View (Update On and Display On), even if that math mode was already selected.
Initial S/W Revision	Prior to A.02.00

Log Offset (Op1 + Offset)

Calculates a log offset from the **First Trace** operand and puts the result in the destination trace. This is like the B-DL function in some older analyzers. The offset is entered as the active function. Each destination trace has its own offset.

During the sweep, the following formula is executed for each point in the trace operand, and the corresponding point is generated for the destination trace.:

$$\text{DestinationTrace} = \text{FirstTrace} + \text{Offset}$$

The values of the trace points are assumed to be in dBm (as they are internally stored) and the offset is in dB.

If a point in the trace operand is equal to maxtracevalue, the resultant point is also maxtracevalue.

If a point in the trace operand is equal to mintracevalue, the resultant point is also mintracevalue.

Example: If offset is 25 dB, then our destination trace will be higher than the operand trace by 25 dB.

Note that the **Second Trace** operand is not used for this function.

Key Path	Trace/Detector, Math
Example	:CALC:MATH TRACE1,LOFF,TRACE4,,-6.00, Sets Trace 1 to Log Offset trace math function, sets the First Trace operand (for Trace 1) to Trace 4, leaves the Second Trace operand (for Trace 1) unchanged (it is irrelevant for this function) and sets the Log Offset (for Trace 1) to -6 dB.
Couplings	Selecting a math mode other than Off for a trace (pressing the key or sending the equivalent SCPI command) puts the trace in View (Update On and Display On), even if that math mode was already selected.
State Saved	The Log Offset value for each trace is saved in Instrument State
Min	-100 dB
Max	100 dB
Initial S/W Revision	Prior to A.02.00

Log Diff (Op1 – Op2 + Ref)

Offsets the difference between the **First Trace** operand and the **Second Trace** operand by a reference and puts the result in the destination trace. This is like the A-B+DL function in some older analyzers. The reference is entered as the active function. Each destination trace has its own reference.

During the sweep, the following formula is executed for each point in the trace operands, and the corresponding point is generated for the destination trace:

$$\text{DestinationTrace} = (\text{FirstTrace} - \text{SecondTrace}) + \text{Reference}$$

The values of the operand trace points are assumed to be in decibel units (as they are internally stored) and the reference is in dBm so the result is in dBm.

Example: If the first operand trace 1 is at 5 dBm, the second operand trace 2 is at -5 dBm, and the reference is -25 dBm, then the destination trace will be -15 dBm.

Example: If the first operand trace 1 is at 60 dBuV, the second operand trace 2 is at 50 dBuV, and the reference is 35 dBuV, then the destination trace will be 45 dBuV.

See "[More Information](#)" on page 1016.

Key Path	Trace/Detector, Math
Example	:CALC:MATH TRACE1, LDIF, TRACE4, TRACE5, , -6.00 Sets Trace 1 to Log Diff trace math function, sets the First Trace operand (for Trace 1) to Trace 4, sets the Second Trace operand (for Trace 1) to Trace 5, and sets the Log Difference reference for Trace 1 to -6 dBm.
Couplings	Selecting a math mode other than Off for a trace (pressing the key or sending the equivalent SCPI command) puts the trace in View (Update On and Display On), even if that math mode was already selected.
State Saved	The Log Difference reference value for each trace is saved in instrument state
Min	Same as reference level
Max	Same as reference level

Default Unit	depends on the current selected Y axis unit
Initial S/W Revision	Prior to A.02.00

More Information

If a point in FirstTrace is equal to maxtracevalue, the resultant point is also maxtracevalue.

If a point in FirstTrace is equal to mintracevalue, the resultant point is also mintracevalue.

If neither of the above is true for a given point, then:

- If that point in SecondTrace is equal to maxtracevalue, the resultant point is mintracevalue.
- If that point in SecondTrace is equal to mintracevalue, the resultant point is maxtracevalue.

Off

Turns off Trace Math.

Key Path	Trace/Detector, Math
Example	CALC:MATH TRACE1 OFF Turns off trace math for trace 1.
Notes	See Trace “Math”.
State Saved	The current trace math function is saved in Instrument State
Readback	Off
Initial S/W Revision	Prior to A.02.00

Trace Operands

Selects the trace operand(s) to be used for the trace math functions for the destination trace.

Key Path	Trace/Detector, Math
Notes	The operands of the trace math commands specify the trace operands. Since the operands are common to all math functions for a given trace, the most recently sent math function command sets the operands for each trace and are reflected on the trace operand keys.
Dependencies	The destination trace cannot be an operand.
Readback line	In square brackets, the First Trace operand, new line, and the second trace operand, as: [Op1=Trace 1, Op2=Trace2] where Trace 1 is operand 1 and Trace 2 is operand 2.
Initial S/W Revision	Prior to A.02.00

Operand 1

Selects the first trace operand to be used for the trace math functions for the destination trace.

Key Path	Trace/Detector, Math, Trace Operands
Dependencies	The First Trace cannot be the same as the destination trace. The destination trace number is gray on the key, and the underline skips that number when selecting the trace.
Preset	Trace number – 2 (wraps at 1). For example, for Trace 1, the First Trace presets to Trace 5; for Trace 6, it presets to Trace 4.
State Saved	The First Trace operand for each trace is stored in instrument state.
Readback	Trace <trace number>
Initial S/W Revision	Prior to A.02.00

Operand 2

Selects the second trace operand to be used for the trace math functions for the destination trace.

Key Path	Trace/Detector, Math, Trace Operands
Dependencies	The Second Trace cannot be the same as the destination trace. The destination trace number is gray on the key, and the underline skips that number when selecting the trace.
Preset	Trace number – 1 (wraps at 1). For example, for Trace 1, the Second Trace presets to Trace 6; for Trace 6, it presets to Trace 5.
State Saved	The Second Trace operand for each trace is stored in instrument state
Readback	Trace <trace number>
Initial S/W Revision	Prior to A.02.00

Copy/Exchange

This menu lets you copy any trace to any other trace, or exchange any trace with any other trace. The action is performed once, it is not an “every sweep” type of thing.

The X-Axis settings and domain of a trace go with it when it is copied or exchanged.

Key Path	Trace/Detector
Remote Command	:TRACe:COPIY TRACE1 TRACE2 TRACE3 TRACE4 TRACE5 TRACE6, TRACE1 TRACE2 TRACE3 TRACE4 TRACE5 TRACE6 :TRACe:COPIY?
Example	TRAC:COPIY TRACE1, TRACE3 Copies Trace 1 to Trace 3 and puts Trace 3 in Update=Off, Display=On
Notes	The TRACe:COPIY command is of the form: :TRACe:COPIY <source_trace>,<dest_trace>
Notes	In the case of a Copy , the destination trace is put in Update=Off, Display=On after the copy. In the case of an Exchange , both traces are put into Update=Off, Display=On after the exchange.

Dependencies	When Signal ID is on, this key is grayed out.
Preset	TRACE1, TRACE2
Backwards Compatibility Notes	The copy and exchange operations menu in ESA and PSA is replaced with the more general purpose Copy/Exchange menu. The remote commands are unaffected, as they were already general. The 2-DL->2 function in ESA and PSA (which was really a trace math function) has been eliminated, because its use case was very rare.. It actually subtracted the dB-equivalent of the dBm-expressed display line, regardless of the y axis unit. For example, if DL = +21.99 dBmV, it subtracted -25.00 dB (i.e. add +25.00 dB) to trace 2. New, more useful functions are provided in the new Trace, Math menu
Initial S/W Revision	Prior to A.02.00

Remote Command	:TRACe:EXCHange TRACE1 TRACE2 TRACE3 TRACE4 TRACE5 TRACE6, TRACE1 TRACE2 TRACE3 TRACE4 TRACE5 TRACE6 :TRACe:EXCHange?
Example	TRAC:EXCH TRACE1, TRACE2 Exchanges Trace 1 and Trace 2 and puts both traces in Update=Off, Display=On .
Notes	The TRACe:EXCHange command is of the form: ::TRACe:EXCHange <trace_1>,<trace_2>
Preset	TRACE1, TRACE2
Backwards Compatibility Notes	The copy and exchange operations menu in ESA and PSA is replaced with the more general purpose Copy/Exchange menu. The remote commands are unaffected, as they were already general.
Initial S/W Revision	Prior to A.02.00

From Trace

Selects the trace to be copied to or exchanged with the **To Trace**

Key Path	Trace/Detector, Copy/Exchange
Notes	See "Copy/Exchange".
Preset	1
Initial S/W Revision	Prior to A.02.00

To Trace

Selects the trace to be copied from or exchanged with the **From Trace**

Key Path	Trace/Detector, Copy/Exchange
Notes	See "Copy/Exchange".
Preset	2
Initial S/W Revision	Prior to A.02.00

Copy Now

Executes the Copy operation and puts the destination trace in **Update=Off, Display=On**.

Key Path	Trace/Detector, Copy/Exchange
Notes	See "Copy/Exchange".
Initial S/W Revision	Prior to A.02.00

Exchange Now

Executes the Exchange operation and puts both traces in **Update=Off, Display=On**.

Key Path	Trace/Detector, Copy/Exchange
Notes	See "Copy/Exchange".
Initial S/W Revision	Prior to A.02.00

Normalize

Displays menu keys that let you normalize trace data.

Key Path	Trace/Detector
Dependencies	When Signal ID is on, this key is grayed out.
Readback	[On] or [Off]
Initial S/W Revision	Prior to A.02.00

Normalize On/Off

Normalize (On) activates the normalize function. On each sweep, the normalized trace (Trace 3) is subtracted from Trace 1 and the result is added to the normalized reference level. This arithmetic assumes all values are in decibel units, so we are actually taking a ratio.

- See "[More Information](#)" on page 1020.
- See "[Normalize Block Diagram](#)" on page 1021.

Key Path	Trace/Detector, Normalize
Remote Command	:CALCulate:NTData[:STATe] OFF ON 0 1 :CALCulate:NTData[:STATe]?
Example	CALC:NTD ON CALC:NTD?
Dependencies	<ul style="list-style-type: none"> – If Normalize (On) is pressed before Store Ref (1→3), an error message is generated. Normalize remains off in this case. – Normalize is not available (grayed out) if any Trace Math function is on.

Couplings	When Normalize is turned on, Trace 1 is placed in Clear/Write with Update = On and Display = On.
Preset	OFF
State Saved	Saved in instrument state.
Initial S/W Revision	Prior to A.02.00

More Information

The normalize function is most useful for applying correction data to a trace while making a stimulus-response measurement with a tracking generator (or synchronized source). For example, connect the cables and a through line, in place of the device to be measured, between the tracking generator and the analyzer input. Notice that the frequency response is not perfectly flat, showing the response of the cables, as well as the flatness of both the tracking generator and the analyzer. Now press Store Ref (1 → 3), Normalize On. Notice that the displayed trace is now flat, or normalized. The position of the normalized trace can now be moved to a different position on the display by changing the normalized reference position. This may be useful if the device to be tested has positive gain, such as an amplifier. Now replace the through line with the device under test, and an accurate measurement of the gain or loss can be made.

The normalize function can also be used to perform a scalar reflection measurement (return loss). In this case a directional coupler or bridge is used to extract the reflected signal. In the simplest reflection measurement a Short is placed at the end of the cable and the result is stored to trace 3 (as before). When Normalize is turned on, the result is the calibrated return loss in dB. For a more accurate calibration, an Open and Short can be used. To do the Open/Short calibration, the Open/Short key at the bottom of the Normalize menu is pressed. This will initiate a guided calibration procedure which captures the reference trace. This is then stored to Trace 3, as before. When Normalize is turned on the corrected return loss is displayed.

Measurement Details

First the following calculation is performed:

$$\text{Trace 1} = (\text{Trace 1D} - \text{Normalized Trace})$$

Where:

Trace 1D is the measured value of trace 1, as it comes from the SENSE subsystem.

Normalized Trace is Trace 3, in which you have previously stored a reference trace

All values are in decibel units.

This Trace 1 contains the values that will be returned from a trace query, or if the marker is placed on the trace.

For example, let's say bucket 1 on Trace 1 is at 0 dBm, and bucket 1 on Trace 3 is at 10 dBm. The resultant bucket is at $0 \text{ dBm} - 10 \text{ dBm} = -10 \text{ dB}$ (just like with a delta marker).

You are also given the ability to define what (dB) value to use for Ref Level, and to define where on the screen the Ref Lvl line will appear using Normalized Reference Position. This flexibility in displaying the result allows a wide range of devices, including amplifiers, to be tested using Normalize.

In the example above, bucket 1 has the value of -10 dB. Let us assume you have set Norm Ref Lvl to 5 dB. Thus bucket 1 will display 1.5 divisions below the Reference Level line (assuming 10 dB per division).

The Reference Level line is normally the top line of the graticule. If Norm Ref Posn is set to 10, this is the case. If it is set to 9, it is the next line down. If it is set to 5, it is the middle line of the graticule. If set to 0 it is the bottom line.

So in the example above, if Norm Ref Posn is set to 9, then bucket 1 will display 2.5 divisions below the top line of the graticule.

None of the manipulations of Norm Ref Posn and Norm Ref Lvl affect the data in the trace.

As Normalize displays a ratio between two traces (a difference, in dB) the Y-Axis Unit while in Normalize is dB in Log Amplitude and dimensionless in Linear. The Y Axis Unit chosen in the Y Axis Unit menu is unaffected by Normalize. When you leave Normalize the Y Axis Unit returns to the value set in the Y Axis Unit menu. While in Normalize, all amplitude functions, such as Marker Y and the values in other traces, should be always in db unit, and so should the returned trace query results. In other words, both trace query result and marker Y become independent of the Y Axis Unit chosen in the Y Axis Unit menu when normalize is on.

(In Linear, the equivalent calculation is performed but it yields a dimensionless ratio, so the normalized ref level will be unitless, presetting to 1, just as in Log it presets to 0 dB).

Y Axis annotation is blanked while in Normalize. Any other traces on the display are plotted in dB, where the dB value used is equivalent to the dBm value of the trace. For example, if bucket 1 in trace 2 is at -40 dBm, that bucket is plotted at -40 dB. All traces use Norm Ref Lvl and Norm Ref Posn for positioning on the display. When Normalize exits, the normal Ref Lvl is restored. This normal Ref Level is unaffected by Normalize.

Normalize Block Diagram

A block diagram showing how Normalize works is presented below:

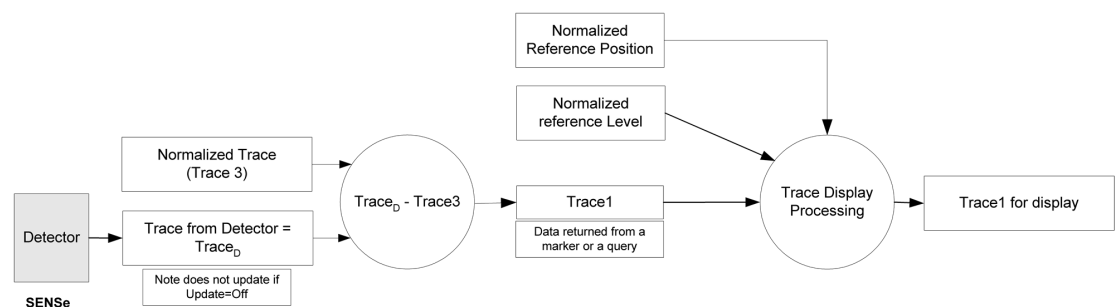

Store Ref (1 → 3)

Copies trace 1 into trace 3. Store Ref (1→ 3) must be pressed before pressing Normalize (On). Note that this puts Trace 3 in Update=Off (not updating) and Display=On (visible).

Key Path	Trace/Detector, Normalize
Notes	There is no remote command for this function, however the trace copy command can be used for this purpose.
Dependencies	If Normalize (On) is pressed before Store Ref (1→ 3), an error message is generated. Normalize remains off in this case.
Initial S/W Revision	Prior to A.02.00

Show Ref Trace (Trace 3)

Views or blanks the reference trace on the display. The reference trace is trace 3, so this is the same as setting Trace 3's "Display" attribute.

Key Path	Trace/Detector, Normalize
Example	TRAC3:DISP 1 Shows the reference trace.
Notes	Use the TRAC3:DISP command to show or blank the reference trace Trace 3 is always the reference trace by definition.
State Saved	Saved in instrument state.
Initial S/W Revision	Prior to A.02.00

Norm Ref Lvl

Sets the level (in dB) of the normalized reference.

Key Path	Trace/Detector, Normalize
Remote Command	:DISP:WINDow[1]:TRACe:Y[:SCALE]:NRLevel <rel_amp> :DISP:WINDow[1]:TRACe:Y[:SCALE]:NRLevel?
Example	DISP:WIND:TRAC:Y:NRL .10 dB DISP:WIND:TRAC:Y:NRL?
Preset	0 dB
State Saved	Saved in instrument state.
Min	-327.6 dB
Max	327.6 dB
Initial S/W Revision	Prior to A.02.00

Norm Ref Posn

Offsets the displayed trace without affecting the instrument gain or attenuation settings. This allows the displayed trace to be moved without decreasing measurement accuracy. The normalized reference position is indicated with a right

arrow on the left side of the display and a left arrow on the right side of the display, just inside the graticule. See picture below:

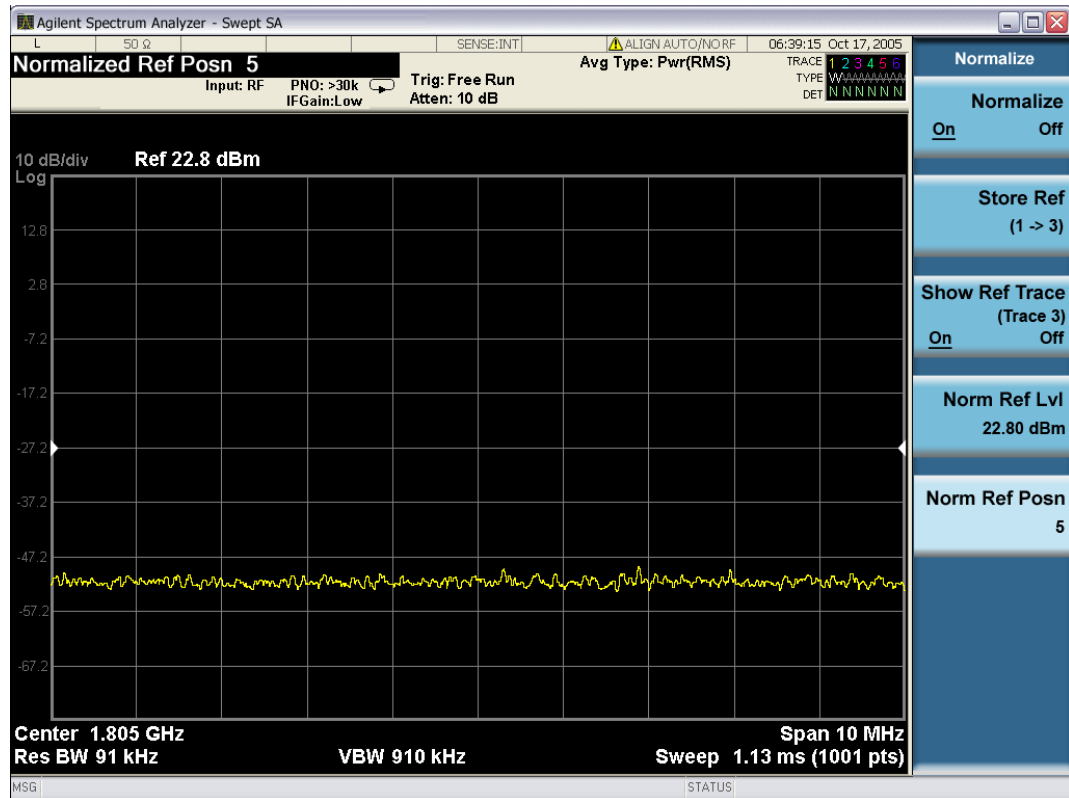

Key Path	Trace/Detector, Normalize
Remote Command	:DISP:WINDow[1]:TRACe:Y[:SCALE]:NRPosition <integer> :DISP:WINDow[1]:TRACe:Y[:SCALE]:NRPosition?
Example	DISP:WIND:TRAC:Y:NRP 5 DISP:WIND:TRAC:Y:NRP?
Notes	The top and bottom graticule lines correspond to 10 and 0, respectively.
Preset	10
State Saved	Saved in instrument state.
Min	0
Max	10
Initial S/W Revision	Prior to A.2.00

Open/Short Cal

Performs a guided open/short calibration, while providing step-by-step instructions to the user. This is the most accurate way to make the return loss measurement on the X-series analyzers. You are directed through a 1-Port coaxial open calibration, and a 1-Port coaxial short calibration. The result can then be saved to Trace 3. It is

used to perform calibrated scalar reflection measurements (return loss), using the Normalize function.

Key Path	Trace/Detector, Normalize
Mode	SA
Notes	Does not auto return
Dependencies	Key is grayed out unless Source Mode is Tracking, and control returns to the Normalize menu.
Initial S/W Revision	A.06.01

Open/Short Guided Cal

On pressing the Open/Short Cal softkey in the Normalize menu, the Open Calibration Form is displayed. The form shows a diagrammatic representation of how to connect the external source to the spectrum analyzer to perform the calibration. When the Continue button is pressed, the Open calibration sweep is taken and stored in internal memory, for use later in this cal process. If the Cancel button is pressed, the Open/Short Cal is cancelled and the Normalize menu is returned.

On completion of the Open Calibration, the Short Calibration Form is displayed. This form shows a diagrammatic representation of how to connect the external source to the spectrum analyzer to perform the Short calibration. When the Continue button is pressed, the Short calibration sweep is taken and stored in internal memory, for use later in this cal process. If the Cancel button is pressed, the Open/Short Cal is cancelled and the Normalize menu is returned.

On completion of the Short Calibration, the Open and Short calibration measurements are averaged (power). The picture with prompt is taken off the screen and a menu with “Done Cal” and “Cancel” is displayed. When you press “Done Cal” the resulting trace is stored to Trace 3. If the Cancel button is pressed, the Open/Short Cal is cancelled and the Normalize menu is returned.

The Open Short calibration is applied by taking the average of the Open and the Short trace. The average is a linear average point-by-point. You can further configure averaging on the traces (Open, Short, and final measurement). In this case, the value of the averaged Open and Short trace are linear averaged (by performing a point-by-point average of the two traces). Both the Open and the Short terminations should have approximately unity reflection. Taking the average gives the best estimate of a perfect reflector for a scalar return loss measurement. You should store the result in reference trace 3, for later application with the Normalize function.

Continue

This soft key paces the user through an open/short calibration.

Key Path	Trace/Detector, Normalize, Open/Short Cal
Mode	SA
Notes	Does not auto return
Couplings	Key is grayed out unless Source Mode is Tracking, and control returns to the Normalize menu.
Initial S/W Revision	A.06.01

Cancel

This soft key cancels an open/short calibration.

Key Path	Trace/Detector, Normalize, Open/Short Cal
Mode	SA
Notes	Does not auto return
Couplings	Key is grayed out unless Source Mode is Tracking, and control returns to the Normalize menu.
Initial S/W Revision	A.06.01

Send/Query Trace Data (Remote Command Only)

This command allows trace data to be sent to the analyzer or queried from the analyzer. The response to the query is a list of the amplitude points which comprise the requested trace in the current Y Axis Unit of the analyzer. The X Axis Unit is that of the destination trace (for send) or the source trace (for query).

- See ["Query Trace Data" on page 1025](#).
- See ["More Information" on page 1026](#).

Remote Command	:TRACe[:DATA] TRACE1 TRACE2 TRACE3 TRACE4 TRACE5 TRACE6, <data>
Notes	The TRACe[:DATA] command is of the form: :TRACe:DATA <trace>,<data> where <trace> can be one of the following parameters: TRACE1,TRACE2,TRACE3,TRACE4,TRACE5,TRACE6 and where <data> can be - ASCII data, which consists of a string of values separated by comma or - REAL or INT eger sent as a definite length block, with a header describing the data to follow.
Couplings	Sweep points will affect the amount of data The FORMat:DATA command describes the different types of data formats that can be used with trace data. Use the FORMat:BORDer command to set the byte order.
Initial S/W Revision	Prior to A.02.00

Query Trace Data

Remote Command	:TRACe[:DATA]? TRACE1 TRACE2 TRACE3 TRACE4 TRACE5 TRACE6
Example	TRAC TRACE1, -1, -2, -3, -4, -5 Sends five points to Trace 1. Assuming that FORMat:DATA is set to ASCII, Y Axis Unit is set to dBm, and sweep points is set to 5, this will result in Trace 1 consisting of the five points -1 dBm, -2 dBm, -3 dBm, -4 dBm, and -5 dBm. TRAC? TRACE2 Queries the analyzer for the contents of trace 2.
Backwards	In the X-Series, the legacy RAWTRACE,LLINE1,LLINE2 parameters for trace data query are no

Compatibility SCPI	longer available.
---------------------------	-------------------

Initial S/W Revision	Prior to A.02.00
----------------------	------------------

More Information

The format and byte-ordering of the sent or received data will be dependent on the **FORMat:DATA** and **FORMat:BORDER** commands. **ASCII** data consists of a string of comma separated values. **REAL** or **INTEger** data is sent as a definite length block, with a header describing the data to follow.

For example, a four point trace might look like this if in ASCII (**FORMat:DATA ASCII**):

```
-5.87350E+01, -5.89110E+01, -5.87205E+01, -5.12345E+01 <NL> <END>
```

and like this if in INTEger with 4 bytes per point (**FORMat:DATA INT, 32**):

```
#216<16 bytes of data> <NL> <END>
```

where the 2 in the #216 means “2 digits of numeric data to follow”, and the 16 is the 2 digits and means “16 binary bytes to follow” (this is the definite length block format).

Note that the data is terminated with <NL><END>. (For GPIB this is newline, or linefeed, followed by EOI set true. For LAN, this is newline only.)

The data format set by **FORMat:DATA** and **FORMat:BORDER** is used both for sending data to the instrument and receiving data from the instrument.

When sending data to the instrument, the data block must contain exactly the number of points currently specified in **Sweep, Points** or an error message will be generated and there will be no change to the target trace.

No units terminator (for example, dB or V) is used when sending data; the data is taken as being in the current Y Axis Unit of the analyzer.

When a trace is sent to the instrument, it immediately overwrites all of the data in the target trace. Consequently the trace should be inactive in order to achieve predictable results. If you send trace data while a trace is active, and particularly if a sweep or an **Average** or Max/Min Hold sequence is already in progress, you may end up with a trace which combines the data you sent with measurement data. Similarly, when querying trace data, it is best if the analyzer is not sweeping during the query.

Therefore, it is generally advisable to be in Single Sweep, or have the trace in View, when sending trace data to the analyzer or querying trace data from the analyzer.

Smooth Trace Data (Remote Command Only)

Included for ESA compatibility. Not recommended for new designs. Use the **CALCulate:DATA:COMPRESS** command instead.

Smooths the trace according to the number of points specified in **:TRACe:MATH:SMOoth:POINts**. There is no equivalent front panel function.

The purpose of this function is to perform a spatial video averaging, as compared to the temporal version supplied by the video-average command [:SENSe]:AVERAge:TYPE VIDEo. The functions of TRACe:MATH:SMOoth <trace> and [:SENSe]:AVERAge:TYPE VIDEo|POWEr are not interchangeable.

Remote Command	:TRACe:MATH:SMOoth TRACE1 TRACE2 TRACE3 TRACE4 TRACE5 TRACE6
Initial S/W Revision	Prior to A.02.00

Each point value is replaced with the average of the values of the selected number of points, with half of those points located on each side of any particular point (when possible). Refer to Figure 14-1 below. This figure illustrates a 401 point trace with a smoothing number of 31. Think of the trace points as “buckets” of data. To smooth (arbitrary) point 273, the analyzer averages buckets 258 through 288 and applies that value to point 273.

Increasing the number of points increases smoothing at the cost of decreasing resolution.

The amount of smoothing decreases at the end points. Because :TRACe:MATH:SMOoth <trace> averages values that occur before and after the data point in time, display irregularities can be caused at the start and stop frequencies. To avoid possible irregularities (signal distortion) at the ends of the trace, use small values for the smooth parameter.

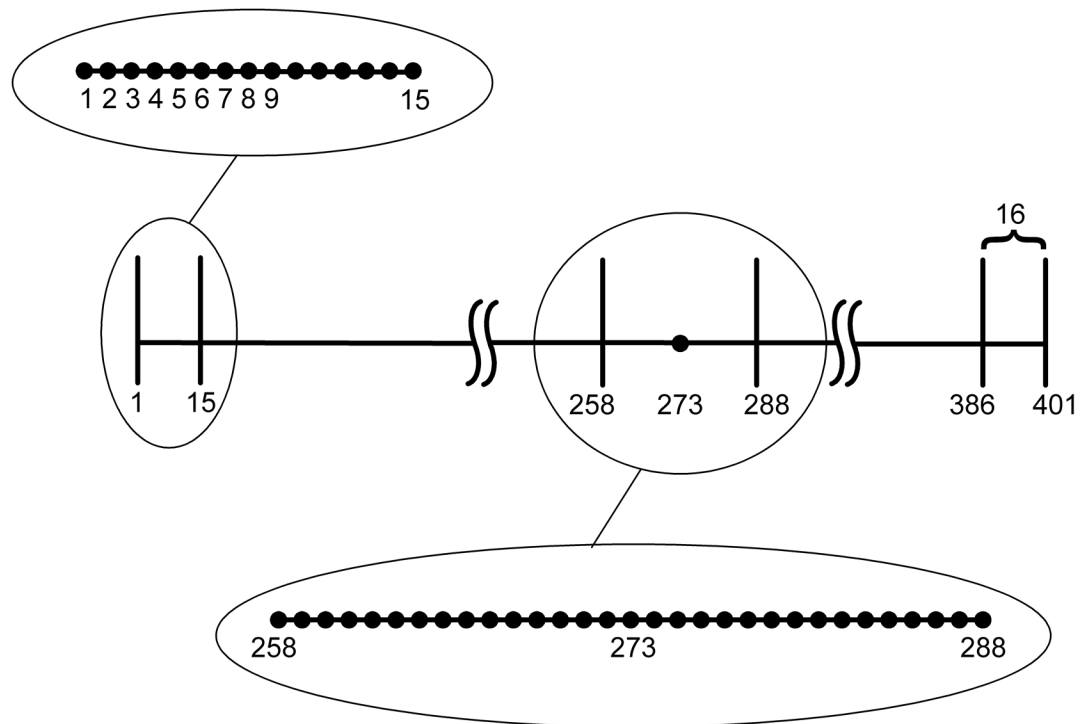

Figure 14- 1Smoothing With 401 Trace Points and 31 Smoothing Points

Refer to Figure 14-1 for a discussion of this end-point smoothing phenomena. With 31 smoothing points and a 401 point trace, point 16 will be the first point to have full 31-bucket smoothing. Likewise, point 386 will be the last point with full 31-bucket

smoothing. Under the conditions stated, points 2 through 15 will be smoothed as follows: Point 2 is derived from averaging buckets 1 through 3. Point 3 is derived from averaging buckets 1 through 5, Point 4 is derived from averaging buckets 1 through 7, and so forth until point 16 is reached. The quantity of buckets used for the smoothing running average increases at the rate of 2 buckets per point, from point 1 to point $([\text{smoothing number}+1]/2)$, at which time the full number of smoothing points is utilized. The same characteristic occurs at the completion of the trace, beginning at point 386, beyond which the number of averaging buckets begins to decrease until point 401 is reached.

By replacing the value of each point in a trace with the average of the values of a number of points centered about that point, any rapid variations in noise or signals are smoothed into more gradual variations. It thereby performs a function similar to reducing the video bandwidth without the corresponding changes in sweep time; as such, frequency resolution is decreased. Also, signal peaks are reduced with large smoothing values. This can cause the amplitude to appear to be less than its actual value.

Number of Points for Smoothing (Remote Command Only)

Included for ESA compatibility. Not recommended for new designs. (Will not be supported in future designs.) Use the CALCulate:DATA:COMPRESS command instead.

Specifies the number of points that will be smoothed. Increasing the number of points increases smoothing at the cost of decreasing resolution. If the number of points is an even number, then the number of points is increased by one. If the number of points is larger than the number of sweep points, then the number of sweep points is used, unless the number of sweep points is even, in which case the number of points will be the sweep points minus one. The number of points smoothed is always an odd number.

Remote Command	:TRACe:MATH:SMOoth:POINts <integer> :TRACe:MATH:SMOoth:POINts?
Example	TRAC:MATH:SMO:POIN 501
Notes	Only odd values allowed; if <integer> even, add 1 unless <integer> = number of sweep points, in which case subtract 1 Used with the TRACe:MATH:SMOoth command.
Preset	11
Min	3
Max	Number of sweep points
Initial S/W Revision	Prior to A.02.00

Mean Trace Data (Remote Command Only)

Included for ESA compatibility. Not recommended for new designs. Use the CALCulate:DATA:COMPRESS command instead.

Returns the mean of the amplitudes of the trace amplitude elements in measurement units.

Remote Command	:TRACe:MATH:MEAN? TRACE1 TRACE2 TRACE3 TRACE4 TRACE5 TRACE6
Example	TRAC:MATH:MEAN? TRACE2
Initial S/W Revision	Prior to A.02.00

Display Trace Time Query (Remote Command Only)

Can be used to determine the time that the current trace in the spectrogram started.

Remote Command	:TRACe:DISPlay:VIEW:SPECTrogram:TIME?
Example	:TRAC:DISP:VIEW:SPEC:TIME? Returns the start time of the Display Trace relative to the start time of the "live" trace (Spectrogram Trace 1)
Dependencies	Only available in the Spectrogram View of the Swept SA measurement. If the command is sent in any other View, an error is generated
Initial S/W Revision	A.07.01

Trigger

See ["Trigger" on page 529](#)

Free Run

See ["Free Run " on page 537](#)

Video

See ["Video \(IF Envelope\) " on page 538](#)

Trigger Level

See ["Trigger Level" on page 538](#)

Trig Slope

See ["Trig Slope" on page 539](#)

Trig Delay

See ["Trig Delay" on page 540](#)

X Axis Relative to Trigger

See ["X Axis Relative to Trigger" on page 583](#)

Line

See ["Line" on page 2814](#)

Trig Slope

See ["Trig Slope" on page 2814](#)

Trig Delay

See ["Trig Delay" on page 543](#)

X Axis Relative to Trigger

See ["X Axis Relative to Trigger" on page 583](#)

External 1

See ["External 1" on page 2828](#)

Trigger Level

See ["Trigger Level" on page 2828](#)

Trig Slope

See ["Trig Slope" on page 2829](#)

Trig Delay

See ["Trig Delay" on page 546](#)

X Axis Relative to Trigger

See ["X Axis Relative to Trigger" on page 583](#)

Zero Span Delay Comp

See ["Zero Span Delay Comp On/Off " on page 2816](#)

External 2

See ["External 2 " on page 2829](#)

Trigger Level

See ["Trigger Level" on page 2830](#)

Trig Slope

See ["Trig Slope" on page 2831](#)

Trig Delay

See ["Trig Delay " on page 549](#)

X Axis Relative to Trigger

See ["X Axis Relative to Trigger" on page 583](#)

Zero Span Delay Comp

See ["Zero Span Delay Comp On/Off" on page 2818](#)

RF Burst

See ["RF Burst" on page 2831](#)

Absolute Trigger

See ["Absolute Trigger Level" on page 2832](#)

Relative Trigger

See ["Relative Trigger Level" on page 2833](#)

Trig Slope

See ["Trigger Slope" on page 2834](#)

Trig Delay

See ["Trig Delay" on page 554](#)

X Axis Relative to Trigger

See ["X Axis Relative to Trigger" on page 583](#)

Zero Span Delay Comp

See ["Zero Span Delay Comp On/Off" on page 2834](#)

Periodic Timer

See ["Periodic Timer \(Frame Trigger\)" on page 2823](#)

Period

See ["Period" on page 2824](#)

Offset

See ["Offset" on page 2825](#)

Offset Adjust (Remote Command Only)

See ["Offset Adjust \(Remote Command Only\)" on page 2826](#)

Reset Offset Display

See ["Reset Offset Display" on page 2827](#)

Sync Source

See ["Sync Source" on page 2827](#)

Off

See ["Off" on page 2828](#)

External 1

See ["External 1" on page 2828](#)

Trigger Level

See ["Trigger Level" on page 2828](#)

Trig Slope

See ["Trig Slope" on page 2829](#)

External 2

See ["External 2 " on page 2829](#)

Trigger Level

See ["Trigger Level" on page 2830](#)

Trig Slope

See ["Trig Slope" on page 2831](#)

RF Burst

See ["RF Burst" on page 2831](#)

Absolute Trigger

See ["Absolute Trigger Level" on page 2832](#)

Relative Trigger

See ["Relative Trigger Level" on page 2833](#)

Trig Slope

See ["Trigger Slope" on page 2834](#)

Zero Span Delay Comp

See ["Zero Span Delay Comp On/Off" on page 2834](#)

Trig Delay

See ["Trig Delay" on page 568](#)

X Axis Relative to Trigger

See ["X Axis Relative to Trigger" on page 583](#)

Sync Holdoff

See ["Sync Holdoff" on page 1289](#)

Baseband I/Q

See ["Baseband I/Q " on page 570](#)

I/Q Mag

See ["I/Q Mag" on page 570](#)

Trigger Level

See ["Trigger Level" on page 570](#)

Trig Slope

See ["Trig Slope" on page 571](#)

Trig Delay

See ["Trig Delay" on page 571](#)

X Axis Relative to Trigger

See ["X Axis Relative to Trigger" on page 583](#)

I (Demodulated)

See ["I \(Demodulated\)" on page 572](#)

Trigger Level

See ["Trigger Level" on page 573](#)

Trig Slope

See ["Trig Slope" on page 573](#)

Trig Delay

See ["Trig Delay" on page 573](#)

X Axis Relative to Trigger

See ["X Axis Relative to Trigger" on page 583](#)

Q (Demodulated)

See ["Q \(Demodulated\)" on page 575](#)

Trigger Level

See ["Trigger Level" on page 575](#)

Trig Slope

See ["Trig Slope" on page 575](#)

Trig Delay

See ["Trig Delay" on page 576](#)

X Axis Relative to Trigger

See ["X Axis Relative to Trigger" on page 583](#)

Input I

See ["Input I" on page 577](#)

Trigger Level

See ["Trigger Level" on page 577](#)

Trig Slope

See ["Trig Slope" on page 578](#)

Trig Delay

See ["Trig Delay" on page 578](#)

X Axis Relative to Trigger

See ["X Axis Relative to Trigger" on page 583](#)

Input Q

See ["Input Q" on page 579](#)

Trigger Level

See ["Trigger Level" on page 579](#)

Trig Slope

See ["Trig Slope" on page 580](#)

Trig Delay

See ["Trig Delay" on page 580](#)

X Axis Relative to Trigger

See ["X Axis Relative to Trigger" on page 583](#)

Auxiliary Channel I/Q Mag

See ["Auxiliary Channel I/Q Mag" on page 581](#)

Trigger Level

See ["Trigger Level" on page 582](#)

Trig Slope

See ["Trig Slope" on page 582](#)

Trig Delay

See ["Trig Delay" on page 582](#)

X Axis Relative to Trigger

See ["X Axis Relative to Trigger" on page 583](#)

Trigger Center Frequency

See ["Trigger Center Frequency" on page 583](#)

Trigger Bandwidth

See ["Trigger Bandwidth" on page 584](#)

TV

See ["TV" on page 2835](#)

TV Line

See ["TV Line" on page 2836](#)

Field

See ["Field" on page 2836](#)

Entire Frame

See ["Entire Frame" on page 2837](#)

Field One

See ["Field One" on page 2837](#)

Field Two

See ["Field Two" on page 2837](#)

Standard

See ["Standard" on page 2838](#)

NTSC-M

See ["NTSC-M" on page 2838](#)

NTSC-Japan

See ["NTSC-Japan" on page 2839](#)

NTSC-4.43

See ["NTSC-4.43" on page 2839](#)

PAL-M

See ["PAL-M" on page 2839](#)

PAL-N

See ["PAL-N" on page 2839](#)

PAL-N Combin

See ["PAL-N-Combin" on page 2839](#)

PAL-B,D,G,H,I

See ["PAL-B,D,G,H,I" on page 2839](#)

PAL-60

See "PAL-60" on page 2840

SECAM-L

See "SECAM-L" on page 2840

Auto/Holdoff

See "Auto/Holdoff" on page 590

Auto Trig

See "Auto Trig" on page 590

Trig Holdoff

See "Trig Holdoff" on page 591

Holdoff Type

See "Holdoff Type" on page 591

User Preset

Accesses a menu that gives you the following three choices:

- **User Preset** – recalls a state previously saved using the Save User Preset function.
- **User Preset All Modes** – presets all of the modes in the analyzer
- **Save User Preset**– saves the current state for the current mode

Key Path	Front-panel key
Backwards Compatibility Notes	<p>User Preset is actually loading a state, and in legacy analyzers, it was possible to load a state without affecting the trace data, limit lines or correction data. Similarly it was possible to do a User Preset without affecting the trace data, limit lines or correction data.</p> <p>In the X-Series, “state” always includes all of this data; so whenever state is loaded, or User Preset is executed, all of the traces, limit lines and corrections are affected. Although this differs from previous behavior, it is desirable behavior, and should not cause adverse issues for users.</p> <p>On ESA and PSA, User Preset affected the entire instrument’s state. In the X-Series, User Preset only recalls the state for the active mode. There is a User Preset file for each mode. User Preset can never cause a mode switch as it can in legacy analyzers. If you want to recall all modes to their user preset file state, you will need to do a User Preset after mode switching into each mode.</p> <p>User Preset recalls mode state which can now include data like traces; whereas on ESA and PSA, User Preset did not affect data.</p>
Initial S/W Revision	Prior to A.02.00

User Preset

User Preset sets the state of the currently active mode back to the state that was previously saved for this mode using the Save User Preset menu key or the SCPI command, **SYST:PRES:USER:SAV**. **It not only recalls the** Mode Preset settings, but it also recalls all of the mode persistent settings, and the Input/Output system setting that existed at the time Save User Preset was executed.

If a Save User Preset has not been done at any time, User Preset recalls the default user preset file for the currently active mode. The default user preset files are created if, at power-on, a mode detects there is no user preset file. There will never be a scenario when there is no user preset file to restore. For each mode, the default user preset state is the same state that would be saved if a Save User Preset is performed in each mode right after doing a Restore Mode Default and after a Restore Input/Output Defaults.

The User Preset function does the following:

- Aborts the currently running measurement.
- Sets the mode State to the values defined by Save User Preset.

- Makes the saved measurement for the currently running mode the active measurement.
- Brings up the saved menu for the power-on mode.
- Clears the input and output buffers.
- Sets the Status Byte to 0.

Key Path	User Preset
Remote Command	:SYSTem:PRESet:USER
Example	:SYST:PRES:USER
Notes	:SYST:PRES:USER:SAVE is used to save the current state as the user preset state. Clears all pending OPC bits. The Status Byte is set to 0. Pressing the User Preset front-panel key while already in the User Preset menu will cause the User Preset to get executed
Couplings	A user preset will cause the currently running measurement to be aborted and cause the saved measurement to be active. Recalling a User Preset file has the same issues that recalling a Save State file has. Some settings may need to be limited and therefore re-coupled, since the capabilities of the mode may have changes when the User Preset file was last saved.
Initial S/W Revision	Prior to A.02.00

User Preset All Modes

Recalls all of the User Preset files for each mode, switches to the power-on mode, and activates the saved measurement from the power-on mode User Preset file.

NOTE

When the instrument is secured, all of the user preset files are converted back to their default user preset files.

The User Preset function does the following:

- Aborts the currently running measurement.
- Switches the Mode to the power-on mode.
- Restores the User Preset files for each mode.
- Makes the saved measurement for the power-on mode the active measurement.
- Brings up the saved menu for the power-on mode.
- Clears the input and output buffers.
- Sets the Status Byte to 0.

Key Path	User Preset
----------	--------------------

Remote Command	:SYSTem:PRESet:USER:ALL
Example	:SYST:PRES:USER:SAVE :SYST:PRES:USER:ALL
Notes	Clears all pending OPC bits. The Status Byte is set to 0. :SYST:PRES:USER:SAVE is used to save the current state as the user preset state.
Couplings	A user preset will cause the currently running measurement to be aborted, cause a mode switch to the power-on mode, and cause the saved measurement to be active in the power-on mode. Recalling a User Preset file has the same issues that recalling a Save State file has. Some settings may need to be limited and therefore re-coupled, since the capabilities of the mode may have changes when the User Preset file was last saved.
Initial S/W Revision	Prior to A.02.00

Save User Preset

Saves the currently active mode and its State. You can recall this User Preset file by pressing the User Preset menu key or sending the SYST:PRES:USER remote command. This same state is also saved by the Save State function.

Key Path	User Preset
Remote Command	:SYSTem:PRESet:USER:SAVE
Example	:SYST:PRES:USER:SAVE
Notes	:SYST:PRES:SAVE creates the same file as if the user requested a *SAV or a MMEM:STOR:STAT, except User Preset Save does not allow the user to specify the filename or the location of the file.
Initial S/W Revision	Prior to A.02.00

View/Display

The View/Display key opens the Display Menu (common to most measurements) and the View menu for the current measurement.

Some measurements have simple View menus, or even no View menu, others provide many different Views.

Views are different ways of looking at data, usually different ways of looking at the same data, often when the data represents a time record that is being digitally processed with an FFT and/or other digital signal processing algorithms.

Key Path	Front-panel key
Initial S/W Revision	Prior to A.02.00

Display

The Display menu is common to most measurements, and is used for configuring items on the display. Some Display menu settings apply to all the measurements in a mode, and some only to the current measurement. Those under the **System Display Settings** key apply to all measurements in all modes.

Key Path	Display
Key Path	View/Display
Initial S/W Revision	Prior to A.02.00

Annotation

Turns on and off various parts of the display annotation. The annotation is divided up into four categories:

13. Meas Bar: This is the measurement bar at the top of the screen. It does not include the settings panel or the Active Function. Turning off the Meas Bar turns off the settings panel and the Active Function. When the Meas Bar is off, the graticule area expands to fill the area formerly occupied by the Meas Bar.
14. Screen Annotation: this is the annotation and annunciation around the graticule, including any annotation on lines (such as the display line, the threshold line, etc.) This does NOT include the marker number or the N dB result. When off, the graticule expands to fill the entire graticule area.
15. Trace annotation: these are the labels on the traces, showing their detector (or their math mode).
16. Active Function annotation: this is the active function display in the meas bar, and all of the active function values displayed on softkeys.

See the figure below. Each type of annotation can be turned on and off individually.

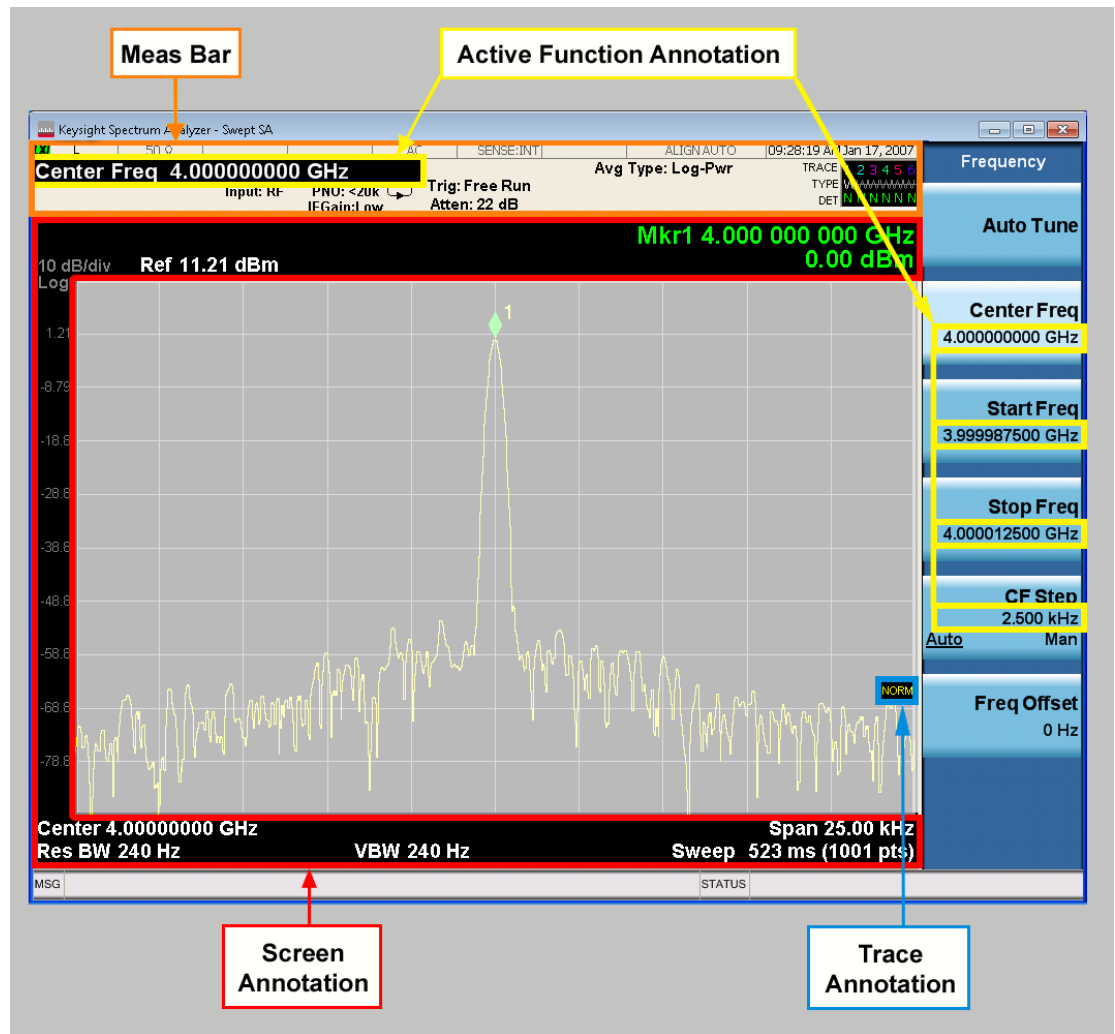

Key Path	View/Display, Display
Initial S/W Revision	Prior to A.02.00

Meas Bar On/Off

This function turns the Measurement Bar on and off, including the settings panel. When off, the graticule area expands to fill the area formerly occupied by the Measurement Bar.

Key Path	View/Display, Display, Annotation
Remote Command	:DISPlay:ANNOtation:MBAR[:STATe] OFF ON 0 1 :DISPlay:ANNOtation:MBAR[:STATe]?
Example	DISP:ANN:MBAR OFF
Dependencies	Grayed out and forced to OFF when System Display Settings, Annotation is set to Off.

Preset	On This should remain Off through a Preset when System DisplaySettings, Annotation is set to Off.
State Saved	Saved in instrument state.
Initial S/W Revision	Prior to A.02.00

Screen

This controls the display of the annunciation and annotation around the graticule, including any annotation on lines (such as the display line, the threshold line, etc.) and the y-axis annotation. This does NOT include marker annotation (or the N dB result). When off, the graticule expands to fill the entire graticule area, leaving only the 1.5% gap above the graticule as described in the Trace/Detector chapter.

Key Path	View/Display, Display, Annotation
Remote Command	:DISPlay:ANNotation:SCReen[:STATe] OFF ON 0 1 :DISPlay:ANNotation:SCReen[:STATe]?
Example	DISP:ANN:SCR OFF
Dependencies	Grayed-out and forced to OFF when System Display Settings, Annotation is set to Off.
Preset	On This should remain Off through a Preset when System DisplaySettings, Annotation is set to Off
State Saved	Saved in instrument state.
Initial S/W Revision	Prior to A.02.00

Trace

Turns on and off the labels on the traces, showing their detector (or their math mode) as described in the Trace/Detector section.

If trace math is being performed with a trace, then the trace math annotation will replace the detector annotation.

Key Path	View/Display, Display, Annotation
Remote Command	:DISPlay:ANNotation:TRACe[:STATe] ON OFF 1 0 :DISPlay:ANNotation:TRACe[:STATe]?
Example	DISP:ANN:TRAC OFF
Preset	Off
State Saved	Saved in instrument state.
Initial S/W Revision	Prior to A.02.00

Active Function Values On/Off

Turns on and off the active function display in the Meas Bar, and all of the active function values displayed on the softkeys.

Note that all of the softkeys that have active functions have these numeric values blanked when this function is on. This is a security feature..

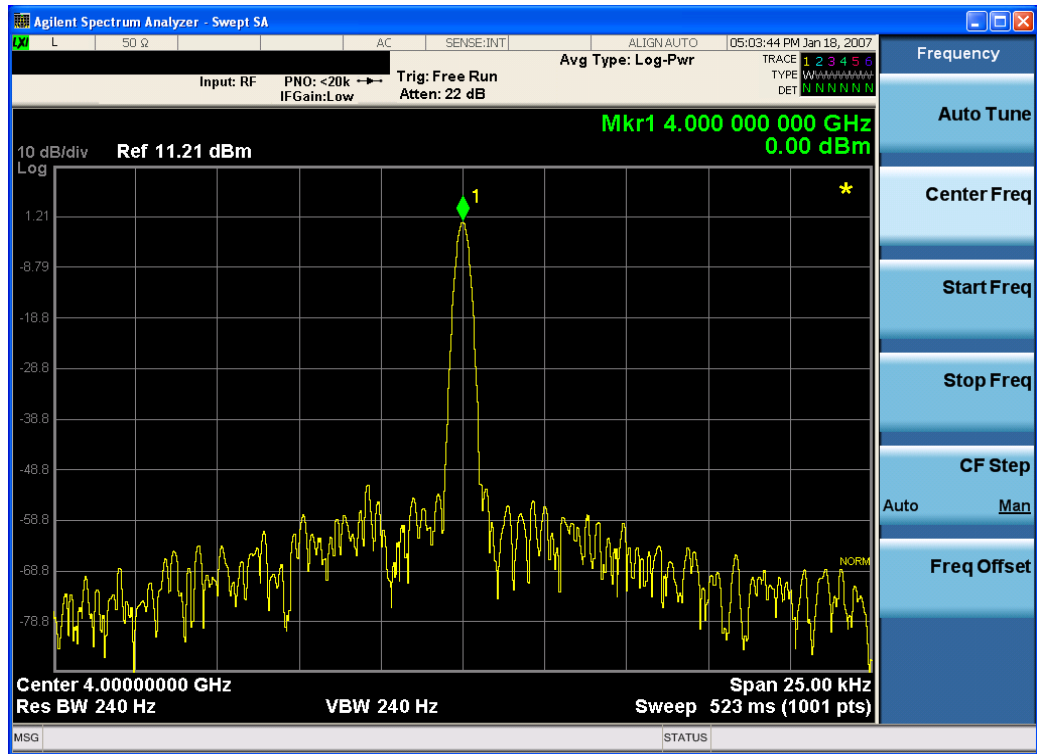

Key Path	View/Display, Display, Annotation
Remote Command	:DISP:ACTivEfunc[:STATe] ON OFF 1 0 :DISP:ACTivEfunc[:STATe]?
Example	DISP:ACT OFF
Dependencies	Grayed out and forced to OFF when System Display Settings, Annotation is set to Off.
Preset	On This should remain Off through a Preset when System DisplaySettings, Annotation is set to Off
State Saved	Saved in instrument state.
Initial S/W Revision	Prior to A.02.00

Frequency

This key turns on and off the absolute frequency annotation in the main display.

The affected annotations include Center frequency, Start/Stop frequency, Frequency Offset, Marker frequency. Any relative frequency annotation such as Span and Marker Delta are not affected.

The frequency annotations in any other associated display such as in Active Function, Softkey label, Limit Editor, Amp Corr Editor and Marker Table are not changed.

Frequency annotations that are not associated with the spectrum such as RBW, IBW, Sweep Time are excluded and they are shown regardless this selection.

This function is Measurement Local to the Swept SA measurement only so that the selection is only available in the measurement.

Key Path	View/Display, Display, Annotation
Remote Command	:DISPlay:ANNotation:FREQuency[:STATe] ON OFF 1 0 :DISPlay:ANNotation:FREQuency[:STATe]?
Example	DISP:ANN:FREQ OFF
Preset	On
State Saved	Saved in instrument state.
Initial S/W Revision	A.14.00

Title

Displays menu keys that enable you to change or clear a title on your display.

Key Path	View/Display, Display
Initial S/W Revision	Prior to A.02.00

Change Title

Writes a title into the "measurement name" field in the banner, for example, "Swept SA".

Press Change Title to enter a new title through the alpha editor. Press Enter or Return to complete the entry. Press ESC to cancel the entry and preserve your existing title.

The display title will replace the measurement name. It remains for this measurement until you press **Change Title** again, or you recall a state, or a Preset is performed. A title can also be cleared by pressing **Title**, **Clear Title**.

NOTE

Notice the inclusion of the <measurement> parameter in the command below. Because each measurement remembers the Display Title, the command must be qualified with the measurement name. For the Swept SA measurement this is not the case; no <measurement> parameter is used when changing the Display Title for the Swept SA measurement.

Key Path	View/Display, Display, Title
Mode	All
Remote Command	:DISPlay:<measurement>:ANNotation:TITLe:DATA <string> :DISPlay:<measurement>:ANNotation:TITLe:DATA?
Example	DISP:ANN:TITL:DATA "This Is My Title" This example is for the Swept SA measurement in the Spectrum Analyzer mode. The SANalyzer <measurement> name is not used. DISP:ACP:ANN:TITL:DATA "This Is My Title" This example is for Measurements other than Swept SA. Both set the title to: This Is My Title
Notes	Pressing this key cancels any active function. When a title is edited the previous title remains intact (it is not cleared) and the cursor goes at the end so that characters can be added or BKSP can be used to go back over previous characters.
Preset	No title (measurement name instead)
State Saved	Saved in instrument state.
Initial S/W Revision	Prior to A.02.00

Clear Title

Clears a title from the front-panel display. Once cleared, the title cannot be retrieved. After the title is cleared, the current Measurement Name replaces it in the title bar.

Key Path	View/Display, Display, Title
Example	The following commands clear the title and restore the measurement's original title: DISP:ANN:TITL:DATA "" This example is for the Swept SA measurement in the Spectrum Analyzer mode. The SANalyzer <measurement> name is not used. DISP:ACP:ANN:TITL:DATA "" This example is for ACP; in measurements other than Swept SA the measurement name is required.
Notes	Uses the :DISPlay:<measurement>:ANNotation:TITLe:DATA <string> command with an empty string (in the Swept SA, the <measurement> is omitted).
Preset	Performed on Preset.
Initial S/W Revision	Prior to A.02.00

Graticule

Pressing Graticule turns the display graticule On or Off. It also turns the graticule y-axis annotation on and off.

Key Path	View/Display, Display
Remote Command	:DISPlay:WINDow[1]:TRACe:GRATicule:GRID[:STATe] OFF ON 0 1 :DISPlay:WINDow[1]:TRACe:GRATicule:GRID[:STATe]?
Example	DISP:WIND:TRAC:GRAT:GRID OFF
Notes	The graticule is the set of horizontal and vertical lines that make up the grid/divisions for the x-axis and y-axis.
Preset	On
State Saved	Saved in instrument state
Initial S/W Revision	Prior to A.02.00

Display Line

This key allows you to control the Display Line, or for measurements which support multiple Display Lines, it allows you to control Display Line 1. See the key description for **Display Line 1|2|3|4** for detailed information and the SCPI command.

Key Path	View/Display, Display
Initial S/W Revision	Prior to A.02.00

Display Lines

This key appears in measurements which support multiple display lines, and opens up a menu which lets you control all the display lines.

Key Path	View/Display, Display
Initial S/W Revision	A.17.50

Select Display Line

This key allows you to select the display line currently being controlled by the **Display Line 1|2|3|4** key.

Key Path	View/Display, Display, Display Lines
Preset	1
Initial S/W Revision	A.17.50

Display Line 1|2|3|4

Activates an adjustable horizontal line that is used as a visual reference line. The line's vertical position corresponds to its amplitude value. The value of the display

line (for example, -20.3 dBm) appears right justified above the line itself on the right side of the display, marked “DL” for measurements that support only one Display Line, or marked “DL1” for Display Line 1, “DL2” for display line 2, etc.

In measurements which support multiple Display Lines, this key controls whichever Display Line has been selected by the **Select Display Line** key.

The display line can be adjusted using the step keys, knob, or numeric keypad. The unit of the Display Line is determined by the **Y axis unit** setting under **Amplitude**. If more than one window has a display line, the display line of the selected window is controlled.

If the display line is off the screen, it shows as a line at the top/bottom of the screen with an arrow pointing up or down. As with all such lines (Pk Thresh, Trigger Level, etc.) it is drawn on top of all traces.

The display line is unaffected by Auto Couple.

Key Path	View/Display, Display
Remote Command	:DISPlay:WINDow[1]:TRACe:Y:DLINe[1] 2 ... 4 <amp1> :DISPlay:WINDow[1]:TRACe:Y:DLINe[1] 2 ... 4? :DISPlay:WINDow[1]:TRACe:Y: DLINe[1] 2 ... 4:STATe OFF ON 0 1 :DISPlay:WINDow[1]:TRACe:Y: DLINe[1] 2 ... 4:STATe?
Example	DISP:WIND:TRAC:Y:DLIN:STAT ON Turns on Display Line; if multiple display lines, turns on Display Line 1 DISP:WIND:TRAC:Y:DLIN2 -32 dBm Adjust Display Line 2
Couplings	When a value is set for the display line, turn it On. When the Display Line goes from Off to On, if it is off screen, set it to either the top or bottom of screen, depending on which direction off screen it was. The Display Line's value does not change when it is turned off.
Preset	Display Line 1 selected, Off, and set to -25 dBm Off
State Saved	Saved in instrument state.
Min	-∞ (minus infinity) in current units
Max	+∞ (plus infinity) in current units
Default Unit	Depends on the current selected Y axis unit
Initial S/W Revision	Prior to A.02.00
Modified at S/W Revision	A.17.50

Select Freq Line

This key allows you to select the display line currently being controlled by the **Freq Line 1|2|3|4** key.

Key Path	View/Display, Display, Display Lines
Preset	1
Initial S/W Revision	A.17.50

Freq Line 1|2|3|4

Activates an adjustable vertical line that is used as a visual reference line. The line's horizontal position corresponds to its frequency value. The value of the frequency line (for example, 2.5 GHz) appears at the top of the display, to the right or left of the line justified as required for it to be on screen, marked "FL1" for Freq Line 1, "FL2" for Freq Line 2, etc.

This key controls whichever Freq Line has been selected by the **Select Freq Line** key.

The Freq Line can be adjusted using the step keys, knob, or numeric keypad. If more than one window has a Freq Line, the Freq Line of the selected window is controlled.

If the Freq Line is off the screen, it shows as a line at the left or right of the screen. As with all such lines (Pk Thresh, Trigger Level, etc.) it is drawn on top of all traces.

The Freq Line is unaffected by Auto Couple.

Control Path	Display, Meas Display
Control Type	Binary Active Function
Remote Command	:DISP:WIND:W[1]:TRAC:X:FLINE[1] 2 ... 4 <amp1> :DISP:WIND:W[1]:TRAC:X:FLINE[1] 2 ... 4? :DISP:WIND:W[1]:TRAC:X:FLINE[1] 2 ... 4:STATE OFF ON 0 1 :DISP:WIND:W[1]:TRAC:X:FLINE[1] 2 ... 4:STATE?
Example	DISP:WIND:TRAC:X:FLIN:STAT ON Turn Freq Line 1 on DISP:WIND:TRAC:X:FLIN3 1 GHz Set Freq line 3 to 1 GHz
Preset	Freq Line 1 selected, Off, and set to 1 GHz Off
Dependencies	Freq Lines only display in Swept Spans
Couplings	When a value is set for the Freq Line, turn it On, if in Zero Span. When the Freq Line goes from Off to On, if it is off screen, set it to either the left or right of screen, depending on which direction off screen it was. The Freq Line's value does not change when it is turned off.
State Saved	Saved in instrument state.
Initial S/W Revision	A.17.50

Select Time Line

This key allows you to select the display line currently being controlled by the **Time Line 1|2|3|4** key.

Key Path	View/Display, Display, Display Lines
Preset	1
Initial S/W Revision	A.17.50

Time Line 1|2|3|4

Activates an adjustable vertical line that is used as a visual reference line. The line's horizontal position corresponds to its time value. The value of the time line (for example, 1 ms) appears at the top of the display, to the right or left of the line justified as required for it to be on screen, marked "TL1" for Time Line 1, "TL2" for time line 2, etc.

This key controls whichever Time Line has been selected by the **Select Time Line** key.

The Time Line can be adjusted using the step keys, knob, or numeric keypad. If more than one window has a Time Line, the Time Line of the selected window is controlled.

If the Time Line is off the screen, it shows as a line at the left or right of the screen. As with all such lines (Pk Thresh, Trigger Level, etc.) it is drawn on top of all traces.

The Time Line is unaffected by Auto Couple.

Control Path	Display, Meas Display
Control Type	Numeric Toggle
Remote Command	<pre>:DISPlay:WINDow[1]:TRACe:X:TLINE[1] 2 ... 4 <amp;1> :DISPlay:WINDow[1]:TRACe:X:TLINE[1] 2 ... 4? :DISPlay:WINDow[1]:TRACe:X:TLINE[1] 2 ... 4:STATe OFF ON 0 1 :DISPlay:WINDow[1]:TRACe:X:TLINE[1] 2 ... 4:STATe?</pre>
Example	<pre>DISP:WIND:TRAC:X:TLIN:STAT ON Turn Time Line 1 on DISP:WIND:TRAC:X:TLIN3 1.2 ms Set Time Line 3 to 1.2 ms</pre>
Preset	Time Line 1 selected, Off, and set to 1 ms Off
Dependencies	Time Lines and this control only display in Zero Span
Couplings	<p>When a value is set for the Time Line, turn it On, if in Zero Span.</p> <p>When the Time Line goes from Off to On, if it is off screen, set it to either the left or right of screen, depending on which direction off screen it was.</p> <p>The Time Line's value does not change when it is turned off.</p>
State Saved	Saved in instrument state.
Initial S/W Revision	A.17.50

System Display Settings

These settings are "Mode Global" – they affect all modes and measurements and are reset only by **Restore Misc Defaults** or **Restore System Defaults** under System.

Key Path	View/Display, Display
Initial S/W Revision	Prior to A.02.00

Annotation Local Settings

This is a Mode Global override of the meas local annotation settings. When it is **All Off**, it forces **ScreenAnnotation, Meas Bar, Trace, and Active Function Values** settings to be **OFF** for all measurements in all modes. This provides the security based "annotation off" function of previous analyzers; hence it uses the legacy SCPI command.

When it is **All Off**, the **Screen, Meas Bar, Trace, and Active Function Values** keys under the **Display, Annotation** menu are grayed out and forced to **Off**. When **Local Settings** is selected, you are able to set the local annotation settings on a measurement by measurement basis.

Key Path	View/Display, Display, System Display Settings
Remote Command	:DISPlay:WINDow[1]:ANNotation[:ALL] OFF ON 0 1 :DISPlay:WINDow[1]:ANNotation[:ALL]?
Example	:DISP:WIND:ANN OFF
Preset	On (Set by Restore Misc Defaults)
State Saved	Not saved in instrument state.
Backwards Compatibility Notes	The WINDow parameter and optional subopcode is included for backwards compatibility but ignored – all windows are equally affected.
Initial S/W Revision	Prior to A.02.00

Themes

Accesses a menu of functions that enable you to choose the theme to be used when saving the screen image.

The **Themes** option is the same as the **Themes** option under the **Display** and **Page Setup** dialogs. It allows you to choose between themes to be used when saving the screen image.

Key Path	Save, Screen Image
Remote Command	:MMEMemory:STORe:SCReen:THEMe TDCoLor TDMonochrome FCOLor FMONochrome :MMEMemory:STORe:SCReen:THEMe?

Example	:MMEM:STOR:SCR:THEM TDM
Preset	3D Color; Is not part of Preset, but is reset by Restore Misc Defaults or Restore System Defaults All and survives subsequent running of the modes.
Readback	3D Color 3D Mono Flat Color Flat Mono
Backwards Compatibility Notes	In ESA and PSA we offer the choice of "Reverse Bitmap" or "Reverse Metafile" when saving screen images. This is much like the "Flat Color" theme available in X-Series. Also, if you selected Reverse Bitmap AND a black & white screen image, that would be much like "Flat Monochrome". In other words, each of the X-Series themes has a similar screen image type in ESA/PSA. But they are not identical.
Initial S/W Revision	Prior to A.02.00

3D Color

Selects a standard color theme with each object filled, shaded and colored as designed.

Key Path	Save, Screen Image, Themes
Example	MMEM:STOR:SCR:THEM TDC
Readback	3D Color
Initial S/W Revision	Prior to A.02.00

3D Monochrome

Selects a format that is like 3D color but shades of gray are used instead of colors.

Key Path	Save, Screen Image, Themes
Example	MMEM:STOR:SCR:THEM TDM
Readback	3D Mono
Initial S/W Revision	Prior to A.02.00

Flat Color

Selects a format that is best when the screen is to be printed on an ink printer.

Key Path	Save, Screen Image, Themes
Example	MMEM:STOR:SCR:THEM FCOL
Readback	Flat Color
Initial S/W Revision	Prior to A.02.00

Flat Monochrome

Selects a format that is like Flat Color. But only black is used (no colors, not even gray), and no fill.

Key Path	Save, Screen Image, Themes
----------	-----------------------------------

Example	MMEM:STOR:SCR:THEM FMON
Readback	Flat Mono
Initial S/W Revision	Prior to A.02.00

Backlight

Accesses the display backlight on/off keys. This setting may interact with settings under the Windows "Power" menu.

When the backlight is off, pressing ESC, TAB, SPACE, ENTER, UP, DOWN, LEFT, RIGHT, DEL, BKSP, CTRL, or ALT turns the backlight on without affecting the application. Pressing any other key will turn backlight on and could potentially perform the action as well.

Key Path	View/Display, Display, System Display Settings
Remote Command	:DISPlay:BACKlight ON OFF :DISPlay:BACKlight?
Preset	ON (Set by Restore Misc Defaults)
Initial S/W Revision	Prior to A.02.00

Backlight Intensity

An active function used to set the backlight intensity. It goes from 0 to 100 where 100 is full on and 0 is off. This value is independent of the values set under the Backlight on/off key.

Key Path	View/Display, Display, System Display Settings
Remote Command	:DISPlay:BACKlight:INTensity <integer> :DISPlay:BACKlight:INTensity?
Example	DISP:BACK:INT 50
Preset	100 (Set by Restore Misc Defaults)
Min	0
Max	100
Initial S/W Revision	Prior to A.02.00

Normal

Single window view of the frequency domain or zero span. This is the classic SA view. This is also the View into which the analyzer switches whenever you do anything that causes the frequency limits to change, for example:

- If you switch inputs (for example, if you switch from the RF Input to External Mixing)
- If, while in External Mixing, you edit the Harmonic Table
- If, while in External Mixing, the Mixer Preset changes (for example, if you change from A-band to V-band etc.)

Key Path	View/Display
Example	:DISP:VIEW NORM
Initial S/W Revision	A.07.01

Spectrogram

The Spectrogram View allows a quick look at a history of 300 traces. In the Spectrogram View, the display opens up a second window (the “spectrogram window”), in which trace history is displayed, below the main Swept SA display window (the “trace window”). Each horizontal line in the spectrogram display represents one historical trace. The data streams upwards from newest to oldest; the latest trace displays on the bottom and the oldest trace on the top.

Note that whenever you save state while in Spectrogram, and then recall the state, Spectrogram comes back with all the settings just as they were when you saved the state, but not including the Spectrogram data itself. If you want to save the Spectrogram data, you can Export it using Meas Results, and import it into a PC, although you cannot load it back into the analyzer.

See ["More Information" on page 1054](#).

Key Path	View/Display
Example	DISP:VIEW SPEC
Dependencies	Because Spectrogram is a split-screen View, no other split screen views are available in Spectrogram. These include Peak Table, Marker Table, and the Limit and Ampcor editors. The keys that access these functions are grayed out while in Spectrogram.
Initial S/W Revision	A.07.01

More Information

In the Spectrogram View, the spectrogram window shows a history of the last 300 traces, and the trace window shows the trace indicated by the **Display Trace** function in the View/Display menu. The **Display Trace** key determines which of the traces in the spectrogram (lower) window is currently being viewed in the trace (top) window. A white line across the spectrogram window shows the current position of the Display Trace. On entry to the Spectrogram view, Display Trace has a value of 0; which means it is set to the “live” trace.

The “live” trace does not appear in the Spectrogram window; Display Trace 1 is the bottommost trace in the spectrogram window. Every time a sweep completes, the

data from Display Trace 0 is put into Display Trace 1, and all the other traces “roll up.” Once the trace data has been written into the spectrogram, it is immutable.

Although all 6 traces can be used in the trace window, it is the data from the “live” Trace 1 that goes into Display Trace 0 and then into the spectrogram window. Thus, the spectrogram represents the history of Trace 1; traces 2-6, although available, are not written into the spectrogram. As you change the value of Display Trace, you see the historical data only in Trace 1; Traces 2-6 still represent live data.

The display can only hold 300 traces. The oldest trace is Display Trace 300, and it is always the topmost trace in the bottom window. (If the Spectrogram window has not yet filled with 300 traces, the oldest trace is the highest numbered trace that has data in it). The value of Display Trace is annunciated in the upper left hand corner of the bottom window, along with the start time of that trace.

Any variable change that restarts a sweep will clear out the spectrogram and start it over, unless you are in the idle state (single sweep or waiting for a trigger), in which case it will be cleared out when you start sweeping again. The Restart key will clear out all spectrogram traces and start over. The spectrogram display is also cleared on exit from the Spectrogram View, so every time you enter the Spectrogram View, the spectrogram window is empty.

The colors in the Spectrogram represent signal amplitude. The key to these colors is displayed next to the Y Axis in the upper window. By changing the Y Axis parameters you can change the scaling; that is, by changing the Ref Level or Scale/Div, the colors will get remapped to new Amplitude values. Note that this will not restart the Spectrogram unless the Attenuation changes.

As this is swept spectrum analysis, each horizontal line in the spectrogram represents a single trace, and the vertical axis represents time. The user might thus expect each line to slope upwards from left to right to more correctly represent the point in time at which each point in the trace was taken. However, the lines are horizontal, so the display represents each trace as representing a single time, which is in fact its start time. If this distinction is important to you, you should use FFT sweeps (with an FFT Width greater than your span, of course) to ensure that each trace point in a line better represents the same moment in time.

If Display Trace=0, the data for Trace 1 is written into the trace as the data is acquired, just as in Normal View. So you will see the data as it is acquired; for a slow sweep, for example, you will see the trace fill as the points are taken. For any other value of Display Trace, Trace 1 will appear static, as it represents an historical trace. As the traces roll up, the value of Display Trace does not change, so you will see a different trace in Trace 1 every time the live trace finishes. To freeze the spectrogram, put Trace 1 into View, or put the analyzer into Single sweep (note that unless the Average/Hold Number=1, putting the analyzer into Single will not freeze the Spectrogram until the number of traces specified by the Average/Hold Number have been taken).

When returning to the Normal View from the Spectrogram View, Trace 1 will hold whatever data was in Display Trace 0 on exit.

Note that since the spectrogram is intended to give a view of spectral behavior versus time, the Periodic Trigger, which generates triggers at known intervals, will give the most predictable and consistent starting times for the traces. Other triggers, like Free Run or External Triggers, may give non-linear or less predictable times. Similarly, turning Auto Align off will improve the regularity of the trace starting times.

While in Spectrogram View, all functions and settings work as normal, except as noted below.

- The **Single** key behaves differently than it does in **Normal** View. In the **Spectrogram** View, the **Single** key causes a specified number of traces to be read into the spectrogram from Trace 1, after which the acquisition stops. The number of traces to be read into the spectrogram is controlled with the “Average/Hold Number” key in the Meas Setup menu. For example, if you set the “Average/Hold Number” to 5, then every time you press Single, it will take 5 sweeps and put the 5 traces one by one into the Spectrogram; then it will stop sweeping. Note that you can set the “Average/Hold Number” to 1 to capture a single trace into the Spectrogram when the Single key is pressed, making the behavior similar to that of the Normal View
- In the Spectrogram View, Sweep Points are limited to a maximum of 1001 due to memory concerns. On entry to this View, if the number of points is greater than 1001, it is forced to 1001; therefore if the user had a larger number of points on entry to Spectrogram, all the traces from the Normal View will be cleared out.
- In the Spectrogram View, if Trace 1 is saved, exported or queried, the data that gets saved or returned is the data from the Display Trace in the spectrogram. All SCPI trace saves or queries for the other 5 traces return their data normally.
- Copy Trace is available in Spectrogram. If Trace 1 is the “from” trace, Copy Trace will copy the Display Trace to any other trace; remember that the Display Trace is one of up to 300 historical versions of Trace 1. So if the Display Trace is 150, then the 150th version of Trace 1 will get copied to the destination trace. Since the historical trace data is immutable, copying a trace to Trace 1 is not possible. The same is true for Exchange Trace; Trace 1 is not available to exchange
- Selecting or moving a marker which is turned on but not on the current Display Trace will NOT move the marker to the current Display Trace; it will select it, and/or move it, but it will stay on the Trace it is currently on.
- Turning on a marker which is turned off will turn it on in the center of the current Display Trace.

- When a Peak Search is performed, if the selected marker is turned on but is not on the current Display Trace, it is first moved to the center of the current Display Trace before performing the search.
- If Couple Markers is On, then moving a marker to a new Display Trace will cause all the coupled markers to move by the same number of traces.

Representation of Time

In the Spectrogram view, zero time is the point where the first trace started, meaning that each subsequent trace point is at a positive time that represents when that point was gathered, relative to the start point. Each trace is time stamped as it starts, and this time is remembered for each trace. As successive traces appear their start times get successively larger, relative to the start time of the oldest trace. If a marker is placed on the live trace and its readout is set to Time, the time of this marker will increment by about the sweep time for every new sweep. See the diagram below for a graphical representation of how this will appear to the user:

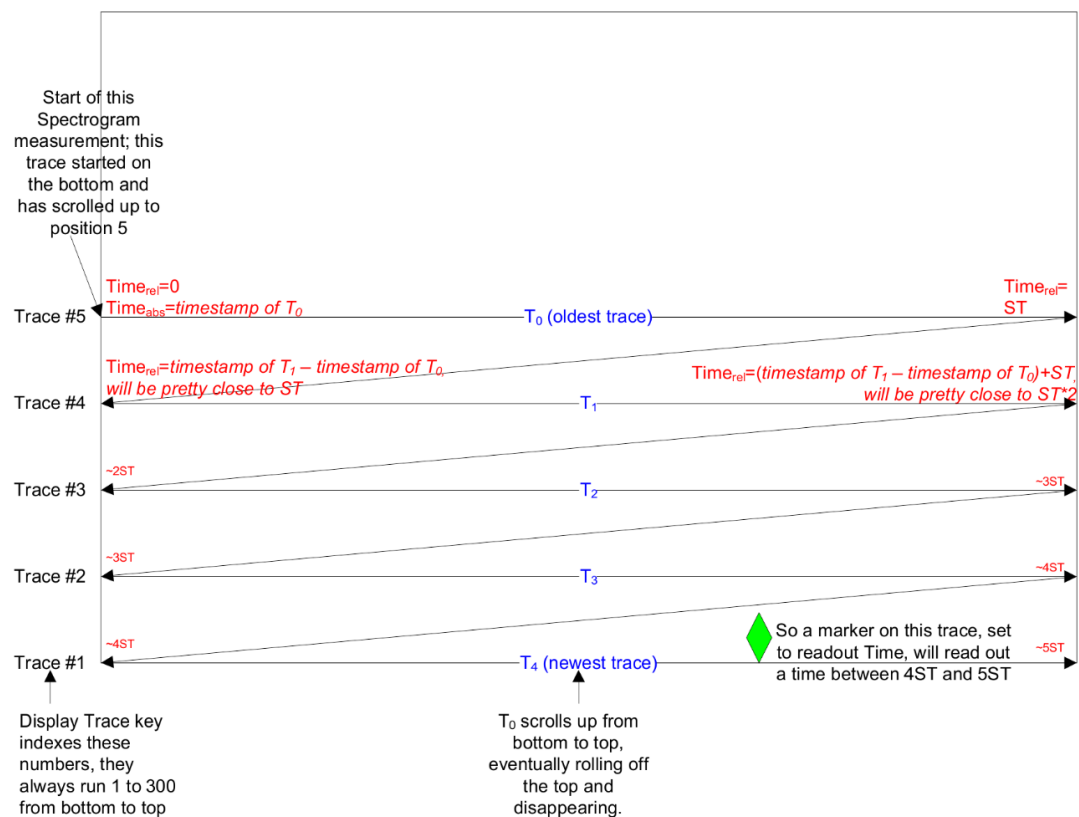

Each trace point has a time value; the value of the start time of the trace is accurately time stamped, but each point within the trace is the start value plus the proportion of sweep time represented by that position in the trace. This means the time value of the points within a trace will not be as accurate as the start point, which is actually the case even in the Normal View, when you use a Time readout for

Markers in the frequency domain. This problem is particularly acute with the Sweep Type set to FFT, since the calculated nominal FFT sweep time estimate can be off by a large percentage. Therefore, in FFT sweeps, to prevent overlaps of time on traces, and to make the Sweep Type of FFT consistent with Swept, the end time for each trace is calculated to yield a continuous functional Z axis time value for each position on the trace. Since any inaccuracies within each trace are therefore reconciled with the start of the next sweep, the user may consider the time values along a trace to be accurate enough for the purpose of making delta time measurements between traces.

The **:TRACe:DISPlay:VIEW:SPECTrogram:TIME?** Command can be used to determine the time that the current trace in the spectrogram started.

Markers

In the Spectrogram View, you can put Markers on any trace in the spectrogram window. To put a Marker on a particular trace in the spectrogram window, set the Display Trace to the trace upon which you want the marker, then position the marker as desired on Trace 1 in the trace window. When you turn a Marker on, or do any kind of Peak Search, if the Marker is a Trace 1 Marker, it will appear on the current Display Trace. Then when you move the Display Trace to other traces in the Spectrogram Window, the Marker will stay on the spectrogram trace it is on.

Markers are displayed in the Spectrogram Window as little crosses, with one bar sitting on the trace in question and the other bar perpendicular to it. The selected marker's cross is green; the others are white.

Example: Set Display Trace to spectrogram trace number 125. Turn on Marker 1. Marker 1 appears on Trace 1, which is spectrogram trace number 125. A green diamond appears on trace 1 in the trace window, and a little cross appears on spectrogram trace number 125 in the spectrogram window. Now set Display Trace to 200. The trace window now shows spectrogram trace number 200; Marker 1 disappears out of that window because it is still on spectrogram trace number 125. You can still see the little cross sitting on spectrogram trace number 125 in the spectrogram window.

The selected marker displays in the upper right corner of the top window display, as always. If a delta marker is referenced to a marker on another Spectrogram Trace, then when the Marker X-Axis Scale is time, you will see the delta which represents the Y-axis delta between the two markers, as always; but in this case the X-axis delta now includes the time between the two traces.

When you leave the Spectrogram View, all Trace 1 Markers that were not on Display Trace 0 are turned OFF.

Trace Zoom

In the Trace Zoom view, the screen is split into two windows. The top window is a normal spectrum analyzer window, and the bottom window ("Zoomed Trace") shows a "zoomed" representation of the traces in the top window. The data in both windows is identical, but the bottom window typically shows fewer data points, spread across the whole display, which allows you to see the data in those points

more clearly, particularly when the trace data in the top window is very dense (sweep points much greater than 1000).

The zoom region is indicated by a blue shading. In the top window, this indicates which subset of the data is zoomed in the bottom window. In Swept Span, you set the span of the bottom window using the Zoom Span control (in the Span menu) and you set the Center Frequency of the bottom window using the Zoom Center key (in the Frequency menu). In Zero Span, you set the width of the bottom window using the Zoom Sweep Time control and the center using the Zoom Center key (both in the Sweep menu).

It is important to emphasize that the data and state in the two windows is IDENTICAL. The Zoom Window is simply a close-up view of a region of the top windows' traces. Therefore all traces and markers are the same in both windows; and any state changes you make affect both windows.

You set the number of sweep points shown in the Zoom Window separately from the top window. Changing the number of points in the top window does not change the Zoom Span; hence the number of points in the bottom window will change by the same proportion as the change in the top window. Conversely, changing the number of points in the bottom window WILL change the Zoom Span and does NOT change the number of points in the top window, because the more points you show in the bottom window, the greater is the percentage of the top window which you are showing in the bottom.

Two functions in Trace Zoom depend on which window is selected (the selected window has a thick green border around it). When the Zoom Window (bottom window) is selected, the Points key in the Sweep/Control menu changes to Zoom Points and adjusts the number of points in the bottom window. Also, for all Peak Search functions, if the bottom window is selected the search function will operate ONLY within that window. This allows you to perform a Peak Search over a specified, limited frequency range, while still viewing the larger frequency range in the top window.

NOTE

If you have just switched to the Zoom Window via SCPI (using the :DISP:WIND function) you should wait at least one second before performing a Peak Search, to ensure that SCPI will direct the Peak Search command to the correct window.

When you are in Zero Span in Trace Zoom, both the top and bottom window are in Zero Span, but the bottom window will have a different sweep time reflecting how much it is zoomed. When you go between Swept Span and Zero Span (either direction), the blue bar in the top window remains fixed in position and size, and the number of points in the top window does not change. So on the Swept Span to Zero Span transition, this determines the number of points in the bottom window.

Key Path	View/Display
Example	DISP:VIEW TZ0
Dependencies	Because Trace Zoom is a split-screen View, no other split screen views are available in Trace Zoom. These include Peak Table, Marker Table, and the Limit and Ampcor editors. The keys that access these functions are grayed out while in Trace Zoom.

Initial S/W Revision	A.07.01
Modified at S/W Revision	A.18.01 (zero span support added)

Transition Rules

When you enter the Trace Zoom view, the top window of Trace Zoom takes on all of the traces, markers and settings that were present in the Normal View. The Zoom Center is the same as the analyzer Center Frequency, and the Zoom Span is 10 % of the analyzer Span. When you leave the Trace Zoom View, the top window traces and settings carry over to the next view.

When you enter the Trace Zoom view, the focus is always in the zoom window. To change the focus (switch between windows), press the Next Window key located below the display. The window which has the focus is distinguished by a green border.

Zone Span

In the Zone Span view, the screen is split into two windows. The top window is a normal spectrum analyzer window, and the bottom window (“Zone Window”) shows a window whose span represents a region (zone) within the top window. The data in the two windows represents two completely separate sweeps; each window sweeps ONLY when the focus (thick green border) is on that window. It is important to understand that the data in the window without the focus remains unchanged until the focus is moved to that window.

In the top window, the zone region is indicated by a light orange shading and solid orange boundary lines. The Zone Window is not shaded orange; this emphasizes the fact that, unlike Trace Zoom, the data in the Zone Window does not match the top window but is from a separate sweep. You can set the span of the Zone Window using the Zone Span key (in the Span menu) and you can set the Center Frequency of the Zoom Window using the Zone Center key (in the Frequency menu).

Note that in Zone Span, the Span of the top window cannot go below 10 Hz. The Zero Span key is grayed out when the top window is active. The Last Span key will do nothing if the last span was zero span. If, on entry to Zone Span, the Span is 0 Hz, the Span will revert to the last nonzero span. Also, if the Span of the top window is between 10 Hz and 100 Hz on transition, the Zone Span will initialize to 10 Hz, not 10% of Span.

Key Path	View/Display
Example	DISP:VIEW ZSP
Dependencies	Because Zone Span is a split-screen View, no other split screen views are available in Zone Span. These include Peak Table, Marker Table, and the Limit and Ampcor editors. The keys that access these functions are grayed out while in Zone Span. Also in the Zone Span View, Signal Track is not allowed and is grayed out
Backwards Compatibility SCPI	Zone Span is a View in the X-Series, whereas in the ESA it was under the Span menu. There were no remote commands associated with Zone Span in the past so there are no code compatibility

Notes	issues.
Initial S/W Revision	A.07.01

More Information

In Zone Span, the window with the focus (the selected window) is the window which updates. You can tell which window is selected because the selected window has a thick green border around it. When you enter the Zone Span view, the focus is always in the Zone Window, so it is the window which is updating. To change the focus (switch between windows), press the Next Window key located below the display. Single and Continuous settings apply, so if the analyzer is in Single, no sweep actually happens until it is initiated or you go to Continuous.

NOTE

The selected window is the window to which virtually all key presses and SCPI commands are directed. Most key functions like Center Frequency, Ref Level, etc., apply only to the selected window. Similarly, any traces which are exported or queried while in Zone Span will return the data from the currently active window. Because of this dependency, it is important to allow the SCPI system to synchronize after switching windows. Therefore, if you have just switched windows via SCPI (using the :DISP:WIND function) you should wait at least one second before sending any window-dependent command, to ensure that SCPI will direct the command to the correct window.

Transition Rules

When you enter the Zone Span view, the top window of Zone Span takes on all of the traces, markers and settings that were present in the Normal View. The Zone Center is the same as the analyzer Center Frequency, and the Zone Span is 10 % of the analyzer Span.

When you leave the Zone Span View, the current window traces and settings carry over to the next view. The traces from the other window will all now be gone. To mitigate this fact, we note that whenever you save state while in Zone Span, and then recall the state, Zone Span comes back just as it was when you saved the state, including all trace data and settings for both windows (of course, any traces that were updating when you did the save will load in an updating state, so their data will be erased after the first sweep). So if the data in both windows is important to preserve, make sure you put the traces in View and save the state before you exit.

9 Channel Power Measurement

The Channel Power measurement is used to find the total power present in a specified bandwidth. The power spectral density (the power in the signal normalized to 1 Hz) is also reported (In WLAN mode or WLAN radio standard in SA mode, the peak power spectral density for 1 MHz is reported).

This topic contains the following sections:

- ["Measurement Commands for Channel Power" on page 1063](#)
- ["Remote Command Results for Channel Power Measurement" on page 1064](#)

Measurement Commands for Channel Power

These commands are used to measure the total rms power in a specified integration bandwidth.

Use :INSTrument:SElect to set the mode.

:CONFIgure:CHPower

:CONFIgure:CHPower:NDEFault

:INITiate:CHPower

:FETCh:CHPower[n]?

:MEASure:CHPower[n]?

:READ:CHPower[n]?

:FETCh:CHPower:CHPower?

:MEASure:CHPower:CHPower?

:READ:CHPower:CHPower?

:FETCh:CHPower:DENSity?

:MEASure:CHPower:DENSity?

:READ:CHPower:DENSity

For more measurement related commands, see the SENSE subsystem, and the section ["Remote Measurement Functions" on page 3140](#).

Remote Command Results for Channel Power Measurement

For DVB-T/H and DTMB (CTTB) mode, see ["DVB-T/H and DTMB \(CTTB\) Mode Remote Command Results" on page 1065](#)

For ISDB-T and CMMB mode, see ["ISDB-T and CMMB mode Remote Command Results" on page 1067](#)

For MSR, see ["MSR Mode Remote Command Results" on page 1068](#)

For LTE-Advanced FDD/TDD, see ["LTE-Advanced FDD/TDD Mode Remote Command Results " on page 1069](#)

For WLAN, see ["Remote Command Results for WLAN Channel Power Measurement" on page 1070](#)

Command	Return Value
FETCh:CHPower[n]?	Refer to the table below.
MEASure:CHPower[n]?	
READ:CHPower[n]?	
FETCh:CHPower:CHPower?	Returns the Channel Power (dBm) (BW compatibility functionality)
MEASure:CHPower:CHPower?	
READ:CHPower:CHPower?	
FETCh:CHPower:DENSity?	Returns the Power Spectral Density (dBm/Hz) (BW compatibility functionality)
MEASure:CHPower:DENSity?	
READ:CHPower:DENSity?	

n	Results Returned
n=1 (or not specified)	Returns scalar results: <ol style="list-style-type: none"> 1. Channel Power is a floating point number representing the total channel power in the specified integration bandwidth. 2. PSD (Power Spectral Density) is the power in the specified unit bandwidth. The unit bandwidth is selected by the PSD Unit parameter in either dBm/Hz or dBm/MHz.
2	Returns floating point numbers that are the captured trace data of the power (in dBm/resolution BW) of the signal. The frequency span of the captured trace data is specified by the Span key.

DVB-T/H and DTMB (CTTB) Mode Remote Command Results

The following commands are available only for DVB-T/H and DTMB (CTTB) mode.

Condition	n	Results Returned
	n=1 (or not specified)	Returns scalar results: 1. Channel Power is a floating point number representing the total channel power in the specified integration bandwidth. 2. PSD (Power Spectral Density) is the power in the specified unit bandwidth. The unit bandwidth is selected by the PSD Unit parameter in either dBm/Hz or dBm/MHz.
	2	Returns floating point numbers that are the captured trace data of the power (in dBm/resolution BW) of the signal. The frequency span of the captured trace data is specified by the Span key.
Mode = DVB-T/H or Mode = DTMB (CTTB)	3	Returns 7 comma-separated scalar results, in the following order. 1. The shoulder attenuation result (dB) 2. Lower shoulder attenuation result (dB) 3. Upper shoulder attenuation result (dB) 4. Lower Offset - MAX shoulder point power (dBm) 5. Lower Offset - MAX shoulder point frequency (MHz) 6. Upper Offset - MAX shoulder point power (dBm) 7. Upper Offset - MAX shoulder point frequency (MHz) If the results are not available, -999.0 is returned. For example, if current view is RF spectrum or spectrum mask, -999.0 is returned.
Mode = DVB-T/H or Mode = DTMB (CTTB)	4	Returns floating point numbers that are the captured trace data of the power (in dBm/resolution BW) of the signal in the left graph of the shoulder attenuation view. If the results are not available, -999.0 is returned. For example, if current view is RF spectrum or spectrum mask, -999.0 is returned.
Mode = DVB-T/H or Mode = DTMB (CTTB)	5	Returns floating point numbers that are the captured trace data of the power (in dBm/resolution BW) of the signal in the right graph of the shoulder attenuation view. If the results are not available, -999.0 is returned. For example, if current view is RF spectrum or spectrum mask, -999.0 is returned.
Mode = DVB-T/H or Mode =	6	Returns floating point numbers that are the captured trace data of the power (in dBm/resolution BW) of the mask in the spectrum mask view. If the results are not available, -999.0 is returned.

DTMB (CTTB)		For example, if current view is RF spectrum or shoulder attenuation, -999.0 is returned.
Mode = DVB-T/H or Mode = DTMB (CTTB)	7	<p>Returns the failed point information in the following order:</p> <ol style="list-style-type: none"> 8. the 1st failed point frequency (MHz) 9. the 1st failed point absolute power (dBm) 10. the 1st failed point relative power (dB) 11. the 2nd failed point frequency (MHz) 12. the 2nd failed point absolute power (dBm) 13. the 2nd failed point relative power (dB) <p>...</p> <p>3*N-2. the (3*N-2)th failed point frequency (MHz)</p> <p>3*N-1. the (3*N-1)th failed point absolute power (dBm)</p> <p>3*N. the (3*N)th failed point relative power (dB)</p> <p>If the number of failed points is less than 20, it will show all of them (frequency, power and relative power), N<20;</p> <p>If the number of failed points is great than 20, the first ten failed points and the last ten failed points will be show, N=20.</p> <p>If the results are not available, -999.0 is returned.</p> <p>For example, if current view is RF spectrum or shoulder attenuation, -999.0 is returned.</p>

ISDB-T and CMMB mode Remote Command Results

The following commands are available only for ISDB-T and CMMB mode.

Condition	n	Results Returned
	n=1 (or not specified)	Returns scalar results: 14. Channel Power is a floating point number representing the total channel power in the specified integration bandwidth. 15. PSD (Power Spectral Density) is the power in the specified unit bandwidth. The unit bandwidth is selected by the PSD Unit parameter in either dBm/Hz or dBm/MHz.
	2	Returns floating point numbers that are the captured trace data of the power (in dBm/resolution BW) of the signal. The frequency span of the captured trace data is specified by the Span key.
Mode = ISDB-T or Mode = CMMB	3	Returns 7 comma-separated scalar results, in the following order. 16. The shoulder attenuation result (dB) 17. Lower shoulder attenuation result (dB) 18. Upper shoulder attenuation result (dB) 19. Lower Offset - MAX shoulder point power (dBm) 20. Lower Offset - MAX shoulder point frequency (MHz) 21. Upper Offset - MAX shoulder point power (dBm) 22. Upper Offset - MAX shoulder point frequency (MHz) If the results are not available, -999.0 is returned. For example, if current view is RF spectrum or spectrum mask, -999.0 is returned.
Mode = ISDB-T or Mode = CMMB	4	Returns floating point numbers that are the captured trace data of the power (in dBm/resolution BW) of the signal in the left window of the shoulder attenuation view. If the results are not available, -999.0 is returned. For example, if current view is RF spectrum or spectrum mask, -999.0 is returned.
Mode = ISDB-T or Mode = CMMB	5	Returns floating point numbers that are the captured trace data of the power (in dBm/resolution BW) of the signal in the right window of the shoulder attenuation view. If the results are not available, -999.0 is returned. For example, if current view is RF spectrum or spectrum mask, -999.0 is returned.

MSR Mode Remote Command Results

The following commands are available only for MSR mode.

Condition	n	Results Returned
	n=1 (or not specified)	Returns scalar results: 1. Channel Power is a floating point number representing the total channel power in the specified integration bandwidth. 2. PSD (Power Spectral Density) is the power in the specified unit bandwidth. The unit bandwidth is selected by the PSD Unit parameter in either dBm/Hz or dBm/MHz.
	2	Returns floating point numbers that are the captured trace data of the power (in dBm/resolution BW) of the signal. The frequency span of the captured trace data is specified by the Span key.
Mode = MSR	3	Returns [Carriers] comma-separated scalar results, in the following order. 1. Total Power of Carrier 1 (dBm) 2. Total Power of Carrier 2 (dBm) ... [Carriers]. Total Power of Carrier [Carriers] (dBm) If the result is not available, NaN (9.91E+37) is returned. Number of returned values might be changed in future releases.
Mode = MSR	4	Returns comma-separated scalar results, in the following order. 1. Total Power of LTE FDD carriers (dBm) 2. Total Power of W-CDMA carriers (dBm) 3. Total Power of GSM/EDGE carriers (dBm) 4. Total Power of cdma2000 carriers (dBm) 5. Total Power of 1xEV-DO carriers (dBm) ... The number of results is incremented by one when a new format is supported. If the result is not available, NaN (9.91E+37) is returned. Number of returned values will be changed in future releases if the number of supported radio format is increased.

LTE-Advanced FDD/TDD Mode Remote Command Results

The following commands are available only for LTE-Advanced FDD/TDD mode.

Condition	n	Results Returned
	n=1 (or not specified)	Returns scalar results: 1. Channel Power is a floating point number representing the total channel power in the specified integration bandwidth. 2. PSD (Power Spectral Density) is the power in the specified unit bandwidth. The unit bandwidth is selected by the PSD Unit parameter in either dBm/Hz or dBm/MHz.
	2	Returns floating point numbers that are the captured trace data of the power (in dBm/resolution BW) of the signal. The frequency span of the captured trace data is specified by the Span key.
Mode = LTEATDD/ LTEAFDD	3	Returns comma-separated scalar results, in the following order. 1. Total Power of Component Carrier 0 (dBm) 2. Total Power of Component Carrier 1 (dBm) 3. Total Power of Component Carrier 2 (dBm) 4. Total Power of Component Carrier 3 (dBm) 5. Total Power of Component Carrier 4 (dBm) If the result is not available, NaN (9.91E+37) is returned.
Mode = LTEATDD/ LTEAFDD	4	Returns comma-separated scalar results, in the following order. The unit bandwidth is selected by the PSD Unit parameter in either dBm/Hz or dBm/MHz. 1. Total Power Spectral Density of Component Carrier 0 (PSD Unit) 2. Total Power Spectral Density of Component Carrier 1 (PSD Unit) 3. Total Power Spectral Density of Component Carrier 2 (PSD Unit) 4. Total Power Spectral Density of Component Carrier 3 (PSD Unit) 5. Total Power Spectral Density of Component Carrier 4 (PSD Unit) If the result is not available, NaN (9.91E+37) is returned.

Remote Command Results for WLAN Channel Power Measurement

n	Results Returned
n=1 (or not specified)	<p>Returns scalar results:</p> <p>When the radio standard is NOT WLAN 802.11ac 80 + 80 MHz:</p> <ul style="list-style-type: none"> 23. Channel Power is a floating point number representing the total channel power in the specified integration bandwidth. 24. PSD (Power Spectral Density) is the power in the specified unit bandwidth. The unit bandwidth is selected by the PSD Unit parameter in either dBm/Hz or dBm/MHz. <p>When the radio standard is WLAN 802.11ac 80 + 80 MHz:</p> <ul style="list-style-type: none"> 25. Channel Power of the carrier of which the center frequency is indicated by Freq Segment 1 is a floating point number representing the total channel power of the first segment in the specified integration bandwidth. 26. PSD (Power Spectral Density) of the carrier of which the center frequency is indicated by Freq Segment 1 is the power in the specified unit bandwidth of the first segment. The unit bandwidth is selected by the PSD Unit parameter in either dBm/Hz or dBm/MHz. 27. Channel Power of the carrier of which the center frequency is indicated by Freq Segment 2 is a floating point number representing the total channel power of the second segment in the specified integration bandwidth. 28. PSD (Power Spectral Density) of the carrier of which the center frequency is indicated by Freq Segment 2 is the power in the specified unit bandwidth of the second segment. The unit bandwidth is selected by the PSD Unit parameter in either dBm/Hz or dBm/MHz.
2	Returns floating point numbers that are the captured trace data of the power (in dBm/resolution BW) of the signal. The frequency span of the captured trace data is specified by the Span key.

Key Path	Meas
Mode	SA, WCDMA, C2K, WIMAX OFDMA, 1xEVDO, DVB-T/H, DTMB (CTTB), ISDB-T, CMMB, LTE, LTE-TDD, Digital Cable TV, WLAN, MSR, LTEAFDD, LTEATDD
Initial S/W Revision	Prior to A.02.00
Modified at S/W Revision	A.03.00

AMPTD Y Scale

Accesses a menu of functions that enable you to set the vertical scale parameters. The parameter values are measurement independent, except all Attenuation values and the Internal Preamp selection, which are the same across all measurements.

Key Path	Front-panel key
Initial S/W Revision	Prior to A.02.00

Ref Value

Sets the value for the absolute power reference. However, since the Auto Scaling is defaulted to On, this value is automatically determined by the measurement result. When you set a value manually, Auto Scaling automatically changes to Off.

Key Path	AMPTD Y Scale
Mode	SA, WCDMA, C2K, WIMAX OFDMA, 1xEVDO, DVB-T/H, DTMB (CTTB), ISDB-T, CMMB, LTE, LTETDD, Digital Cable TV, WLAN, MSR, LTEAFDD, LTEATDD
Remote Command	:DISP:CHPower:VIEW[1]:WINDow[1]:TRACe:Y[:SCALE]:RLEVel <real> :DISP:CHPower:VIEW[1]:WINDow[1]:TRACe:Y[:SCALE]:RLEVel?
Example	DISP:CHP:VIEW:WIND:TRAC:Y:RLEV 10 dBm DISP:CHP:VIEW:WIND:TRAC:Y:RLEV?
Notes	You must be in the Spectrum Analysis mode, W-CDMA mode, cdma2000 mode, DVB-T/H mode, DTMB (CTTB) mode, ISDB-T mode, CMMB mode, Digital Cable TV mode, LTD mode, LTE TDD mode, WLAN mode, 1xEVDO mode, MSR, LTE-Advanced FDD/TDD mode or WIMAX OFDMA mode to use this command. Use :INSTrument:SElect to set the mode.
Couplings	When the Auto Scaling is On, this value is automatically determined by the measurement result. When you set a value manually, Auto Scaling automatically changes to Off.
Preset	10.00 dBm
State Saved	Saved in instrument state.
Min	-250.00 dBm
Max	250.00 dBm
Initial S/W Revision	Prior to A.02.00
Modified at S/W Revision	A.02.00, A.03.00

Attenuation

This menu controls the attenuator functions and interactions between the attenuation system components.

There are two attenuator configurations in the X-Series. One is a dual attenuator configuration consisting of a mechanical attenuator and an optional electronic attenuator. The other configuration uses a single attenuator with combined

mechanical and electronic sections that controls all the attenuation functions. Different models in the X-Series come with different configurations.

See ["Dual Attenuator Configurations:" on page 1072](#)

See ["Single Attenuator Configuration:" on page 1073](#)

Most Attenuation settings are the same for all measurements – they do not change as you change measurements. Settings like these are called “Meas Global” and are unaffected by Meas Preset.

Key Path	AMPTD Y Scale
Scope	Meas Global
Dependencies	In measurements that support the I/Q inputs, this key is unavailable when I/Q is the selected input, and is replaced by the Range key in that case.
Readback Line	Contains a summary in [] brackets of the current total attenuation. See the descriptions of the , " (Mech) Atten " on page 3103, and " Enable Elec Atten " on page 3105 keys for more detail on the contributors to the total attenuation. Note that when "Pre-Adjust for Min Clip" is on, this value can change at the start of every measurement.
Initial S/W Revision	Prior to A.02.00
Modified at S/W Revision	A.03.00

Dual Attenuator Configurations:

Configuration 1: Mechanical attenuator + optional electronic attenuator

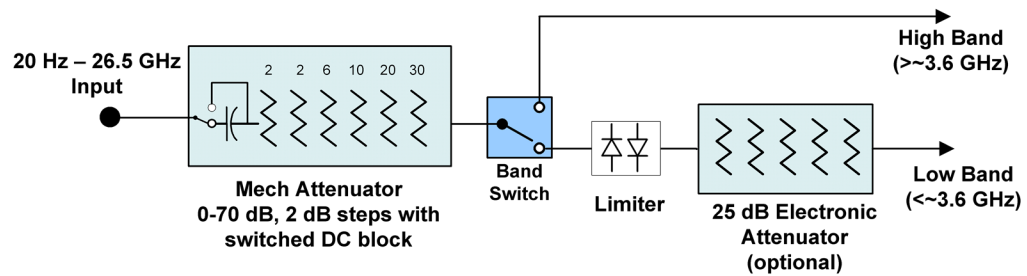

Configuration 2: Mechanical attenuator, no optional electronic attenuator

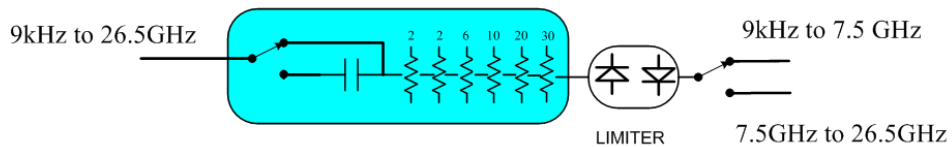

(note that Configuration 2 is not strictly speaking a dual-section attenuator, since there is no electronic section available. However, it behaves exactly like Configuration 1 without the Electronic Attenuator option EA3, therefore for the sake of this document it is grouped into the “Dual Attenuator” configuration)

Single Attenuator Configuration:

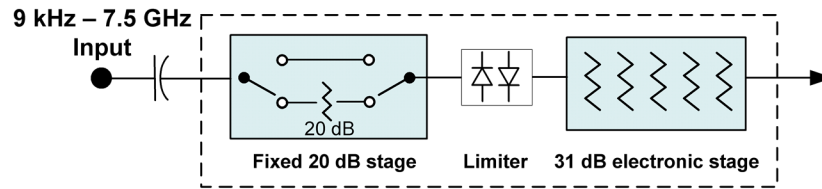

You can tell which attenuator configuration you have by pressing the Attenuation key, which (in most Modes) opens the Attenuation menu. If the first key in the Attenuation menu says **Mech Atten** you have the dual attenuator configuration. If the first key says **Atten** you have the single attenuator configuration.

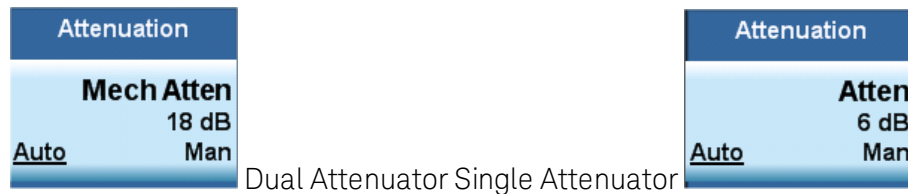

In the single attenuator configuration, you control the attenuation with a single control, as the fixed stage has only two states. In the dual attenuator configuration, both stages have significant range so you are given separate control of the mechanical and electronic attenuator stages.

When you have the dual attenuator configuration, you may still have only a single attenuator, because unless option EA3 (the Electronic Attenuator option) is available, and you purchase it, you will have only the mechanical attenuator.

(Mech) Atten

This key is labeled **Mech Atten** in dual attenuator models and **Atten** in single attenuator models. In the dual attenuator configuration, this key only affects the mechanical attenuator.

This key lets you modify the attenuation applied to the RF input signal path. This value is normally auto coupled to the Ref Level, the Internal Preamp Gain, any External Gain that is entered, and the Max Mixer Level, as described in the table below.

See "[Attenuator Configurations and Auto/Man](#)" on page 1075

Key Path	AMPTD Y Scale, Attenuation
Remote Command	[:SENSe]:POWer[:RF]:ATTenuation <rel_amp1> [:SENSe]:POWer[:RF]:ATTenuation? [:SENSe]:POWer[:RF]:ATTenuation:AUTO OFF ON 0 1 [:SENSe]:POWer[:RF]:ATTenuation:AUTO?
Example	POW:ATT 20 Dual attenuator configuration: sets the mechanical attenuator to 20 dB Single attenuator mode: sets the main attenuation to 20 dB (see below for definition of "main" attenuation).

	If the attenuator was in Auto, it sets it to Manual.
Dependencies	<p>Some measurements do not support the Auto setting of (Mech) Atten. In these measurements, the Auto/Man selection is not available, and the Auto/Man line on the key disappears.</p> <p>In dual attenuator configurations, when the electronic attenuator is enabled, the mechanical attenuator has no auto setting and the Auto/Man line on the key disappears. The state of Auto/Man is remembered and restored when the electronic attenuator is once again disabled. This is described in more detail in the "Enable Elec Atten" on page 3105 key description.</p> <p>See "Attenuator Configurations and Auto/Man" on page 1075 for more information on the Auto/Man functionality of Attenuation.</p>
Couplings	<p>When (Mech) Atten is in Auto, it uses the following algorithm to determine a value:</p> <p>If the USB Preamp is connected to USB, use 0 dB.</p> <p>Otherwise, $Atten = ReferenceLevel + PreAmpGain + ExternalGain - RefLevelOffset - MaxMixerLevel + IF\ Gain$.</p> <p>Limit this value to be between 6 dB and the Max value. No value below 6 dB can ever be chosen by Auto.</p> <p>The resulting value is rounded up to the largest value possible given the attenuation step setting. That is, 50.01 dB would change to 60 dB (for a 10 dB attenuation step).</p> <p>The "IF Gain" term in the equation above is either 0 dB or +10 dB, depending on the settings of FFT IF Gain, Swept IF Gain, max Ref Level and the Auto/Man setting of Mech Atten.</p> <p>In External Mixing and BBIQ, where the Attenuator is not in the signal path, the Attenuator setting changes as described above when (Mech) Atten is in Auto, but no changes are made to the actual attenuator hardware setting until the input is changed back to the RF Input.</p>
Preset	<p>The preset for Mech Attenuation is "Auto."</p> <p>The Auto value of attenuation is:</p> <p>CXA, EXA, MXA and PXA: 10 dB</p>
State Saved	Saved in instrument state
Min	<p>0 dB</p> <p>The attenuation set by this key cannot be decreased below 6 dB with the knob or step keys. To get to a value below 6 dB it has to be directly entered from the keypad or via SCPI. This protects from adjusting the attenuation to a dangerously small value which can put the instrument at risk of damage to input circuitry. However, if the current mechanical attenuation is below 6 dB it can be increased with the knob and step keys, but not decreased.</p>
Max	<p>CXA N9000A-503/507: 50 dB</p> <p>CXA N9000A-513/526: 70dB</p> <p>EXA: 60 dB</p> <p>MXA and PXA: 70 dB</p> <p>In the single attenuator configuration, the total of ATT and EATT cannot exceed 50 dB, so if the EATT is set to 24 dB first, the main attenuation cannot be greater than 26 dB and will be reduced accordingly; if the main attenuator is set to 40 dB first, EATT cannot be greater than 10 dB.</p>
Initial S/W Revision	Prior to A.02.00
Modified at S/W Revision	A.03.00

Attenuator Configurations and Auto/Man

As described in the Attenuation key description, there are two distinct attenuator configurations available in the X-Series, the single attenuator and dual attenuator configurations. In dual attenuator configurations, we have the mechanical attenuation and the electronic attenuation, and the current total attenuation is the sum of the electronic + mechanical attenuation. In single attenuator configurations, we refer to the attenuation set using the **(Mech) Atten** key (or POW:ATT SCPI) as the “main” attenuation; and the attenuation that is set by the SCPI command POW:EATT as the “soft” attenuation (the POW:EATT command is honored even in the single attenuator configuration, for compatibility purposes). Then the current total attenuation is the sum of the main + soft attenuation. See the **Elec Atten** key description for more on “soft” attenuation.

In the dual attenuator configuration, when the electronic attenuator is enabled, there is no Auto/Man functionality for the mechanical attenuator, and the third line of the key label (the Auto/Man line) disappears:

Mech Atten	0 dB
<u>Auto</u>	Man

Mech Atten	0 dB
-------------------	------

Mech Atten when elec atten disabled
--

Mech Atten when elec atten enabled

vsd05

Enable Elec Atten

Enables the Electronic Attenuator.

The electronic attenuator offers finer steps than the mechanical attenuator, has no acoustical noise, is faster, and is less subject to wear. These advantages primarily aid in remote operation and are negligible for front panel use. See ["Using the Electronic Attenuator: Pros and Cons" on page 1077](#) for a detailed discussion of the pros and cons of using the electronic attenuator.

For the single attenuator configuration, for SCPI backwards compatibility, the “soft” attenuation feature replaces the dual attenuator configuration’s electronic attenuator. All the same couplings and limitations apply. See ["Attenuator Configurations and Auto/Man" on page 3105](#)

See [Error! Reference source not found.](#)

Key Path	AMPTD Y Scale, Attenuation
Remote Command	[:SENSe] :POWer [:RF] :EATTenuation :STATe OFF ON 0 1 [:SENSe] :POWer [:RF] :EATTenuation :STATe ?
Example	POW:EATT:STAT ON
Dependencies	This key only appears in Dual Attenuator models with an Electronic Attenuator installed. It does not appear in models with the Single Attenuator configuration, as in the single attenuator configuration there is no “electronic attenuator” there is only a single integrated attenuator (which has both a mechanical and electronic stage). However, in the single attenuator configuration, EATT SCPI commands are accepted for compatibility with other X-series

instruments and set a “soft” attenuation as described in "[Attenuator Configurations and Auto/Man](#)" on page 3105.

The electronic attenuator (and the “soft” attenuation function provided in single attenuator configurations) is unavailable above 3.6 GHz. Therefore, if the Stop Frequency of the analyzer is > 3.6 GHz then the **Enable Elec Atten** key will be OFF and grayed out.

If the Internal Preamp is on, meaning it is set to Low Band or Full, the electronic attenuator (and the “soft” attenuation function provided in single attenuator configurations) is unavailable. In this case the **Enable Elec Atten** key will be OFF and grayed out.

If either of the above is true, if the SCPI command is sent, an error indicating that the electronic attenuator is unavailable will be sent.

If the electronic/soft Attenuator is enabled, then the Stop Freq of the analyzer is limited to 3.6 GHz and the Internal Preamp is unavailable.

The SCPI-only “soft” electronic attenuation for the single-attenuator configuration is not available in all measurements; in particular, it is not available in the Swept SA measurement.

Couplings	Enabling and disabling the Electronic Attenuator affects the setting of the Mechanical Attenuator (in dual attenuator configurations). This is described in more detail below this table.
Preset	OFF for Swept SA measurement; ON for all other measurements that support the electronic attenuator
State Saved	Saved in instrument state
Initial S/W Revision	Prior to A.02.00
Modified at S/W Revision	A.03.00

Mechanical Attenuator Transition Rules

When the Electronic Attenuator is enabled, the Mechanical Attenuator transitions to a state that has no Auto function. Below are the rules for transitioning the Mechanical Attenuator. NOTE that the information below ONLY applies to the dual attenuator configurations, and ONLY when the Electronic Attenuator is installed:

When the Electronic Attenuation is enabled from a disabled state:

- The Mechanical Attenuator is initialized to 10 dB (this is its optimal performance setting). You can then set it as desired with SCPI, numeric keypad, step keys, or knob, and it behaves as it normally would in manual mode
- The Auto/Man state of (Mech) Atten is saved
- The Auto/Man line on the (Mech) Atten key disappears and the auto rules are disabled
- The Electronic Attenuator is set to 10 dB less than the previous value of the Mechanical Attenuator, within the limitation that it must stay within the range of 0 to 24 dB of attenuation.

Examples in the dual attenuator configuration:

- Mech Atten at 20 dB. Elec Atten enabled, Mech Atten set to 10 dB, and Elec Atten set to 10 dB. New total attenuation equals the value before Elec Atten enabled.
- Mech Atten at 0 dB. Elec Atten enabled, Mech Atten set to 10 dB, and Elec Atten set to 0 dB. New total attenuation does not equal the value before Elec Atten enabled.
- Mech Atten at 40 dB. Elec Atten enabled, Mech Atten set to 10 dB, and Elec Atten set to 24 dB. New total attenuation does not equal the value before Elec Atten enabled.

When the Electronic Attenuation is disabled from an enabled state:

- The Elec Atten key is grayed out
- The Auto/Man state of (Mech) Atten is restored
- If now in Auto, (Mech) Atten recouples
- If now in Man, (Mech) Atten is set to the value of total attenuation that existed before the Elec Atten was disabled. The resulting value is rounded up to the smallest value possible given the (Mech) Atten Step setting - (That is, 57 dB changes to 58 dB when (Mech) Atten Step is 2 dB.)

Using the Electronic Attenuator: Pros and Cons

The electronic attenuator offers finer steps than the mechanical attenuator, has no acoustical noise, is faster, and is less subject to wear.

The “finer steps” advantage of the electronic attenuator is beneficial in optimizing the alignment of the analyzer dynamic range to the signal power in the front panel as well as remote use. Thus, you can achieve improved relative signal measurement accuracy. Compared to a mechanical attenuator with 2 dB steps, the 1 dB resolution of the electronic attenuator only gives better resolution when the odd-decibel steps are used. Those odd-decibel steps are less accurately calibrated than the even-decibel steps, so one tradeoff for this superior relative accuracy is reduced absolute amplitude accuracy.

Another disadvantage of the electronic attenuator is that the spectrum analyzer loses its “Auto” setting, making operation less convenient.

Also, the relationship between the dynamic range specifications (TOI, SHI, compression and noise) and instrument performance are less well-known with the electrical attenuator. With the mechanical attenuator, TOI, SHI and compression threshold levels increase dB-for-dB with increasing attenuation, and the noise floor does as well. With the electronic attenuator, there is an excess attenuation of about 1 to 3 dB between 0 and 3.6 GHz, making the effective TOI, SHI, and so forth, less

well known. Excess attenuation is the actual attenuation relative to stated attenuation. Excess attenuation is accounted for in the analyzer calibration

Elec Atten

Controls the Electronic Attenuator in dual attenuator configurations. This key does not appear in single attenuator configurations, as the control of both the mechanical and electronic stages of the single attenuator is integrated into the single **Atten** key.

Key Path	AMPTD Y Scale, Attenuation
Remote Command	[:SENSe]:POWer[:RF]:EATTenuation <rel_amp1> [:SENSe]:POWer[:RF]:EATTenuation?
Notes	Electronic Attenuation's specification is defined only when Mechanical Attenuation is 6 dB.
Dependencies	This key only appears in Dual Attenuator models with an Electronic Attenuator installed. It does not appear in models with the Single Attenuator configuration, as in the single attenuator configuration there is no "electronic attenuator" there is only a single integrated attenuator (which has both a mechanical and electronic stage). However, in the single attenuator configuration, EATT SCPI commands are accepted for compatibility with other X-series instruments and set a "soft" attenuation as described in " Attenuator Configurations and Auto/Man " on page 3105. The "soft" attenuation is treated as an addition to the "main" attenuation value set by the Atten softkey or the POW:ATT SCPI command and affects the total attenuation displayed on the Attenuation key and the Meas Bar. When Enable Elec Atten is off or grayed out, the Elec Atten key is grayed out.
Preset	0 dB
State Saved	Saved in instrument state
Min	0 dB
Max	Dual attenuator configuration: 24 dB Single attenuator configuration: the total of ATT and EATT cannot exceed 50 dB, so if the EATT is set to 24 dB first, the main attenuation cannot be greater than 26 dB and will be reduced accordingly; if the main attenuator is set to 40 dB first, EATT cannot be greater than 10 dB
Initial S/W Revision	Prior to A.02.00
Modified at S/W Revision	A.03.00

Adjust Atten for Min Clip

Sets the combination of mechanical and electronic attenuation and gain based on the current measured signal level so that clipping will be at a minimum.

This is an "immediate action" function, that is, it executes once, when the key is pressed.

This key does not appear in measurements that do not support this functionality. The spectrum analyzer measurement, Swept SA, does not support this functionality.

Key Path	AMPTD Y Scale, Attenuation
Remote Command	[:SENSe]:POWer[:RF]:RANGe:OPTimize IMMEDIATE

Initial S/W Revision	Prior to A.02.00
Modified at S/W Revision	A.03.00

Pre-Adjust for Min Clip

If this function is on, it does the adjustment described under "[Adjust Atten for Min Clip](#)" on page 3108 each time a measurement restarts. Therefore, in Continuous measurement mode, it only executes before the first measurement.

In dual attenuator models, you can set **Elec+Mech Atten**, in which case both attenuators participate in the autoranging, or **Elec Atten Only**, in which case the mechanical attenuator does not participate in the autoranging. This latter case results in less wear on the mechanical attenuator and is usually faster.

This key is grayed out in measurements that do not support this functionality. The spectrum analyzer measurement, Swept SA, does not support this functionality.

Key Path	AMPTD Y Scale, Attenuation
Remote Command	<code>[:SENSe]:POWer[:RF]:RANGe:OPTimize:ATTenuation OFF ELECtrical COMBined</code> <code>[:SENSe]:POWer[:RF]:RANGe:OPTimize:ATTenuation?</code>
Notes	The SCPI parameter ELECtrical sets this function to On in single attenuator models. The SCPI parameter COMBined is mapped to ELECtrical in single attenuator models; if you send COMBined, it sets the function to On and returns ELEC to a query.
Dependencies	This key only appears in Dual Attenuator models with an Electronic Attenuator installed. In instruments with Dual Attenuator model, when Enable Elec Atten is off or grayed out, the Pre-Adjust for Min Clip key is grayed out.
Preset	OFF for Swept SA measurement; ON for all other measurements that support Pre-Adjust for Min Clip
State Saved	Saved in instrument state
Range	Dual attenuator models: Off Elec Atten Only Mech + Elec Atten Single attenuator models: Off On
Initial S/W Revision	Prior to A.02.00
Modified at S/W Revision	A.03.00

Remote Command	<code>[:SENSe]:POWer[:RF]:RANGe:AUTO ON OFF 1 0</code> <code>[:SENSe]:POWer[:RF]:RANGe:AUTO?</code>
Notes	ON aliases to "Elec Atten Only" (:POW:RANG:OPT:ATT ELEC) OFF aliases to "Off" (:POW:RANG:OPT:ATT OFF) The query :POW:RANG:AUTO? returns true if :POW:RANG:OPT:ATT is not "Off"
Initial S/W Revision	Prior to A.02.00

Off

Turns **Pre-Adjust for Min Clip** off. This is the default setting.

This key is grayed out in measurements that do not support this functionality. The spectrum analyzer measurement, Swept SA, does not support this functionality.

Key Path	AMPTD Y Scale, Attenuation, Pre-Adjust for Min Clip
Example	:POW:RANGe:OPT:ATT OFF
Initial S/W Revision	Prior to A.02.00

Elec Atten Only

Selects only the electric attenuator to participate in auto ranging. This offers less wear on the mechanical attenuator and is usually faster.

This key is grayed out in measurements that do not support this functionality. The spectrum analyzer measurement, Swept SA, does not support this functionality.

Key Path	AMPTD Y Scale, Attenuation, Pre-Adjust for Min Clip
Example	:POW:RANGe:OPT:ATT ELEC
Initial S/W Revision	Prior to A.02.00

Mech + Elec Atten

In dual attenuator models, this selects both attenuators participate in the autoranging.

This key is grayed out in measurements that do not support this functionality. The spectrum analyzer measurement, Swept SA, does not support this functionality.

Key Path	AMPTD Y Scale, Attenuation, Pre-Adjust for Min Clip
Example	:POW:RANGe:OPT:ATT COMB
Initial S/W Revision	Prior to A.02.00

(Mech) Atten Step

This controls the step size used when making adjustments to the input attenuation.

This key is labeled **Mech Atten Step** in dual attenuator models and **Atten Step** in single attenuator models. In the dual attenuator configuration, this key only affects the step size of the mechanical attenuator.

Key Path	AMPTD Y Scale, Attenuation
Remote Command	[:SENSe] :POWer [:RF] :ATTenuation :STEP [:INCRement] 10 dB 2 dB [:SENSe] :POWer [:RF] :ATTenuation :STEP [:INCRement] ?
Example	POW:ATT:STEP 2
Notes	Note this feature works like a 1-N choice from the front panel, but it takes a specific value (in dB) when used remotely. The only valid values are 2 and 10.

Dependencies	Blanked in CXA and EXA if option FSA (2 dB steps) is not present. If blanked, attempts to set it via SCPI will yield an error.
Couplings	When the attenuation step size changes, the current mechanical attenuation value is adjusted (if necessary) to be quantized to the new step size. That is, if step is set to 10 dB, mech atten is increased if necessary so it is a multiple of 10 dB
Preset	PXA and MXA: 2 dB EXA and CXA: 10 dB (2 dB with option FSA)
State Saved	Saved in instrument state
Initial S/W Revision	Prior to A.02.00
Modified at S/W Revision	A.03.00

Scale/Div

Sets the units per division of the vertical scale in the logarithmic display. However, since the Auto Scaling is defaulted to On, this value is automatically determined by the measurement result. When you set a value manually, Auto Scaling automatically changes to Off.

Key Path	AMPTD Y Scale
Mode	SA, WCDMA, C2K, WIMAX OFDMA, 1xEVDO, DVB-T/H, DTMB (CTTB), ISDB-T, CMMB, LTE, LTETDD, Digital Cable TV, WLAN, MSR, LTEAFDD, LTEATDD
Remote Command	:DISPlay:CHPower:VIEW[1]:WINDow[1]:TRACe:Y[:SCALe]:PDIVision <rel_amp1> :DISPlay:CHPower:VIEW[1]:WINDow[1]:TRACe:Y[:SCALe]:PDIVision?
Example	DISP:CHP:VIEW:WIND:TRAC:Y:PDIV 2 DISP:CHP:VIEW:WIND:TRAC:Y:PDIV?
Notes	You must be in the Spectrum Analysis mode, W-CDMA mode, cdma2000 mode, DVB-T/H mode, DTMB (CTTB) mode, ISDB-T mode, CMMB mode, Digital Cable TV mode, LTE mode, LTE TDD mode, WLAN mode, 1xEVDO mode, MSR, LTE-Advanced FDD/TDD mode or WIMAX OFDMA mode to use this command. Use :INSTrument:SElect to set the mode.
Couplings	When the Auto Scaling is On, this value is automatically determined by the measurement result. When you set a value manually, Auto Scaling automatically changes to Off.
Preset	10.00 dB
State Saved	Saved in instrument state.
Min	0.10 dB
Max	20.00 dB
Initial S/W Revision	Prior to A.02.00
Modified at S/W Revision	A.02.00, A.03.00

Presel Center

When this key is pressed, the centering of the preselector filter is adjusted to optimize the amplitude accuracy at the frequency of the selected marker. If the selected marker is not on when Presel Center is pressed, the analyzer will turn on the selected marker, perform a peak search, and then perform centering on the marker's center frequency. If the selected marker is already on and between the start and stop frequencies of the analyzer, the analyzer performs the preselector calibration on that marker's frequency. If the selected marker is already on, but outside the frequency range between Start Freq and Stop Freq, the analyzer will first perform a peak search, and then perform centering on the marker's center frequency.

The value displayed on the **Presel Adjust** key will change to reflect the new preselector tuning (see **Presel Adjust**).

A number of considerations should be observed to ensure proper operation. See ["Proper Preselector Operation" on page 1083](#).

Key Path	AMPTD Y Scale
Remote Command	[:SENSe] :POWer [:RF] :PCENter
Example	POW:PCEN
Notes	Note that the rules outlined above under the key description apply for the remote command as well as the key. The result of the command is dependent on marker position, and so forth. Any message shown by the key press is also shown in response to the remote command.
Dependencies	<ul style="list-style-type: none"> - Grayed out if the microwave preselector is off.) - If the selected marker's frequency is below Band 1, advisory message 0.5001 is generated and no action is taken. - Grayed out if entirely in Band 0. - Blank in models that do not include a preselector, such as option 503. If the SCPI is sent in these instruments, it is accepted without error, and the query always returns 0. - Grayed out in the Spectrogram View.
Couplings	<p>The active marker position determines where the centering will be attempted.</p> <p>If the analyzer is in a measurement such as averaging when centering is initiated, the act of centering the preselector will restart averaging but the first average trace will not be taken until the centering is completed.</p>
Status Bits/OPC dependencies	<p>When centering the preselector, *OPC will not return true until the process is complete and a subsequent measurement has completed, nor will results be returned to a READ or MEASure command.</p> <p>The Measuring bit should remain set while this command is operating and should not go false until the subsequent sweep/measurement has completed.</p>
Initial S/W Revision	Prior to A.02.00
Modified at S/W Revision	A.03.00

Proper Preselector Operation

A number of considerations should be observed to ensure proper operation:

3. If the selected marker is off, the analyzer will turn on a marker, perform a peak search, and adjust the preselector using the selected marker's frequency. It uses the "highest peak" peak search method unqualified by threshold or excursion, so that there is no chance of a 'no peak found' error. It continues with that peak, even if it is the peak of just noise. Therefore, for this operation to work properly, there should be a signal on screen in a preselected range for the peak search to find.
4. If the selected marker is already on, the analyzer will attempt the centering at that marker's frequency. There is no preselector for signals below about 3.6 GHz, therefore if the marker is on a signal below 3.6 GHz, no centering will be attempted and an advisory message generated
5. In some models, the preselector can be bypassed. If it is bypassed, no centering will be attempted in that range and a message will be generated.

Preselector Adjust

Allows you to manually adjust the preselector filter frequency to optimize its response to the signal of interest. This function is only available when "[Presel Center](#)" on page 3111 is available.

For general purpose signal analysis, using Presel Center is recommended. Centering the filter minimizes the impact of long-term preselector drift. Presel Adjust can be used instead to manually optimize the preselector. One application of manual optimization would be to peak the preselector response, which both optimizes the signal-to-noise ratio and minimizes amplitude variations due to small (short-term) preselector drifting.

Key Path	AMPTD Y Scale
Scope	Meas Global
Remote Command	<code>[:SENSe]:POWer[:RF]:PADJust <freq></code> <code>[:SENSe]:POWer[:RF]:PADJust?</code>
Example	POW:PADJ 100KHz POW:PADJ?
Notes	The value on the key reads out to 0.1 MHz resolution.
Dependencies	<ul style="list-style-type: none"> - Grayed out if microwave preselector is off.) - Grayed out if entirely in Band 0. - Blank in models that do not include a preselector, such as option 503. If the SCPI is sent in these instruments, it is accepted without error, and the query always returns 0.

– Grayed out in the Spectrogram View.

Preset	0 MHz
State Saved	The Presel Adjust value set by Presel Center , or by manually adjusting Presel Adjust , is not saved in instrument state, and does not survive a Preset or power cycle.
Min	-500 MHz
Max	500 MHz
Default Unit	Hz
Backwards Compatibility SCPI	<code>[:SENSe] :POWer [:RF] :MW :PADJust</code> <code>[:SENSe] :POWer [:RF] :MMW :PADJust</code> PSA had multiple preselectors, but the X-Series has only one. These commands simply alias to <code>[:SENSe] :POWer [:RF] :PADJust</code>
Initial S/W Revision	Prior to A.02.00
Modified at S/W Revision	A.03.00

Remote Command	<code>[:SENSe] :POWer [:RF] :PADJust :PRESelector MWAVE MMWave EXTERNAL</code> <code>[:SENSe] :POWer [:RF] :PADJust :PRESelector?</code>
Notes	PSA had multiple preselectors, and you could select which preselector to adjust. Since the X-Series has only one mm/uW preselector, the preselector selection softkey is no longer available. However, to provide backward compatibility, we accept the legacy remote commands. The command form has no effect, the query always returns MWAVE
Initial S/W Revision	Prior to A.02.00

Y Axis Unit

Displays the menu keys that enable you to change the vertical (Y) axis amplitude unit. The analyzer retains the entered Y Axis Unit separately for both Log and Lin amplitude scale types. For example, if Scale Type has been set to Log, and you set Y Axis Unit to dBm, pressing Scale Type (Log) sets the Y Axis Unit to dBm. If Scale Type has been set to Lin and you set Y Axis Unit to V, pressing Scale Type (Lin) sets the Y Axis Unit to V. Pressing Scale Type (Log) again sets the Y axis unit back to dBm.

NOTE

The units of current (A, dBmA, dBuA) are calculated based on 50 ohms input impedance.

All four of the EMI units (dB μ A/m, dB μ V/m, dBG, dBpT) are treated by the instrument exactly as though they were dBuV. The user must load an appropriate correction factor using Amplitude Corrections for accurate and meaningful results.

If a SCPI command is sent to the analyzer that uses one of the EMI units as a terminator, the analyzer treats it as though DBUV had been sent as the terminator.

Key Path	AMPTD Y Scale
----------	---------------

Mode	SA
Scope	Meas Global
Remote Command	:UNIT:POWer DBM DBMV DBMA V W A DBUV DBUA DBPW DBUVM DBUAM DBPT DBG :UNIT:POWer?
Example	UNIT:POW dBmV UNIT:POW?
Notes	The Y axis unit has either logarithmic or linear characteristics. The set of units that is logarithmic consists of dBm, dBmV, dBmA, dBμV, dBμA, dBμV/m, dBμA/m, dBpT, and dBG. The set of units that are linear consists of V, W, and A. The chosen unit will determine how the reference level and all the amplitude-related outputs like trace data, marker data, etc. read out.
Notes	The settings of Y Axis Unit and Scale Type, affect how the data is read over the remote interface. When using the remote interface no unit is returned, so you must know what the Y axis unit is to interpret the results: Example 1, set the following: Scale Type (Log) Y Axis Unit, dBm Scale/Div, 1 dB Ref Level, 10 dBm This sets the top line to 10 dBm with each vertical division representing 1 dB. Thus, if a point on trace 1 is on the fifth graticule line from the top, it represents 5 dBm and will read out remotely as 5. Example 2, set the following: Scale Type (Lin) Y Axis Unit, Volts Ref Level, 100 mV (10 mV/div) This sets the top line to 100 mV and the bottom line to 0 V, so each vertical division represents 10 mV. Thus, if a point on trace 1 is on the fifth graticule line from the top, it represents 50 mV and will read out remotely as 50.
Dependencies	If an amplitude correction with an Antenna Unit other than None is applied and enabled, then that antenna unit is forced and the key with that unit is the only Y Axis Unit available. All other Y Axis Unit keys are grayed out. If an amplitude correction with an Antenna Unit other than None is applied and enabled, and you then turn off that correction or set Apply Corrections to No , the Y Axis Unit that existed before the Antenna Unit was applied is restored.
Couplings	The analyzer retains the entered Y Axis Unit separately for both Log and Lin amplitude scale types
Preset	dBm for log scale, V for linear. The true 'preset' value is dBm, since at preset the Y Scale type is set to logarithmic.
State Saved	Saved in instrument state
Readback line	1-of-N selection
Initial S/W Revision	Prior to A.02.00
Modified at S/W Revision	A.02.00, A.04.00, A.11.00

dBm

Sets the amplitude unit for the selected amplitude scale (log/lin) to dBm.

Key Path	AMPTD Y Scale, Y Axis Unit
Example	UNIT:POW DBM
Dependencies	Grayed out if an Amplitude Correction with an Antenna Unit is ON.
Readback	dBm
Initial S/W Revision	Prior to A.02.00
Modified at S/W Revision	A.02.00

dBmV

Sets the amplitude unit for the selected amplitude scale (log/lin) to dBmV.

Key Path	AMPTD Y Scale, Y Axis Unit
Example	UNIT:POW DBMV
Dependencies	Grayed out if an Amplitude Correction with an Antenna Unit is ON.
Readback	dBmV
Initial S/W Revision	Prior to A.02.00
Modified at S/W Revision	A.02.00

dBmA

Sets the amplitude unit for the selected amplitude scale (log/lin) to dBmA.

Key Path	AMPTD Y Scale, Y Axis Unit
Example	UNIT:POW DBMA
Dependencies	Grayed out if an Amplitude Correction with an Antenna Unit is ON.
Readback	dBmA
Initial S/W Revision	Prior to A.02.00
Modified at S/W Revision	A.02.00

W

Sets the amplitude unit for the selected amplitude scale (log/lin) to watt.

Key Path	AMPTD Y Scale, Y Axis Unit
Example	UNIT:POW W
Dependencies	Grayed out if an Amplitude Correction with an Antenna Unit is ON.
Readback	W

Initial S/W Revision	Prior to A.02.00
Modified at S/W Revision	A.02.00

V

Sets the amplitude unit for the selected amplitude scale (log/lin) to volt.

Key Path	AMPTD Y Scale, Y Axis Unit
Example	UNIT:POW V
Dependencies	Grayed out if an Amplitude Correction with an Antenna Unit is ON.
Readback	V
Initial S/W Revision	Prior to A.02.00
Modified at S/W Revision	A.02.00

A

Sets the amplitude unit for the selected amplitude scale (log/lin) to Ampere.

Key Path	AMPTD Y Scale, Y Axis Unit
Example	UNIT:POW A
Dependencies	Grayed out if an Amplitude Correction with an Antenna Unit is ON.
Readback	A
Initial S/W Revision	Prior to A.02.00
Modified at S/W Revision	A.02.00

dB μ V

Sets the amplitude unit for the selected amplitude scale (log/lin) to dB μ V.

Key Path	AMPTD Y Scale, Y Axis Unit
Example	UNIT:POW DBUV
Dependencies	Grayed out if an Amplitude Correction with an Antenna Unit is ON.
Readback	dB μ V
Initial S/W Revision	Prior to A.02.00
Modified at S/W Revision	A.02.00

dB μ A

Sets the amplitude unit for the selected amplitude scale (log/lin) to dB μ A.

NOTE

The unit dBuA can also appear as an Antenna Unit. This will be used by customers using current probes, because current probes are often supplied with conversion tables that provide the transducer factors. When dBuA is used as an Antenna Unit the normal conversion from power to amps for dBuA (based on the analyzer input impedance) is not done, but instead the conversion is based solely on the Correction that contains the transducer factors. This is what distinguishes dBuA as a normal unit from dBuA as an antenna unit. When querying the Y-Axis unit, you can query the Antenna Unit to distinguish between regular dBuA and the dBuA antenna unit. If :CORR:CSET:ANT? returns NOC (for No Conversion), you are using a normal Y Axis dBuA. If it returns UA you are using an Antenna Unit dBuA.

Key Path	AMPTD Y Scale, Y Axis Unit
Example	UNIT:POW DBUA
Dependencies	Grayed out if an Amplitude Correction with an Antenna Unit is ON.
Readback	dB μ A
Initial S/W Revision	Prior to A.02.00
Modified at S/W Revision	A.02.00

Antenna Unit

When a Correction is turned on that uses an Antenna Unit, the Y Axis Unit changes to that Antenna Unit. All of the keys in the Y-Axis Unit menu are then greyed out, except the Antenna Unit key. The unit being used is shown on this key and is shown as selected in the submenu.

Key Path	AMPTD Y Scale, Y Axis Unit
Dependencies	Grayed out if no Amplitude Correction with an Antenna Unit is on.
Readback line	Currently selected unit
Initial S/W Revision	A.11.00

dB μ V/m

Sets the amplitude unit for the selected amplitude scale (log/lin) to dB μ V/m. This is an antenna unit, and this key is grayed out unless a Correction with this Antenna Unit selected is ON. If this is the case, all of the other Antenna Units are grayed out.

Key Path	AMPTD Y Scale, Y Axis Unit, Antenna Unit
Example	UNIT:POW DBUVM
Dependencies	Grayed out if no Amplitude Correction with an Antenna Unit is on.
Readback	dB μ V/m
Initial S/W Revision	A.02.00

dB μ A/m

Sets the amplitude unit for the selected amplitude scale (log/lin) to dB μ A/m. This is an antenna unit, and this key is grayed out unless a Correction with this Antenna Unit selected is ON. If this is the case, all of the other Antenna Units are grayed out.

Key Path	AMPTD Y Scale, Y Axis Unit, Antenna Unit
Example	UNIT:POW DBUAM
Dependencies	Grayed out if no Amplitude Correction with an Antenna Unit is on.
Readback	dB μ A/m
Initial S/W Revision	A.02.00

dB μ A

Sets the amplitude unit for the selected amplitude scale (log/lin) to dB μ A. This is an antenna unit, and this key is grayed out unless a Correction with this Antenna Unit selected is ON. If this is the case, all of the other Antenna Units are grayed out.

Key Path	AMPTD Y Scale, Y Axis Unit, Antenna Unit
Example	UNIT:POW DBUAM
Dependencies	Grayed out if no Amplitude Correction with an Antenna Unit is on.
Readback	dB μ A
Initial S/W Revision	A.11.00

dBpT

Sets the amplitude unit for the selected amplitude scale (log/lin) to dBpT. This is an antenna unit, and this key is grayed out unless a Correction with this Antenna Unit selected is ON. If this is the case, all of the other Antenna Units are grayed out.

Key Path	AMPTD Y Scale, Y Axis Unit, Antenna Unit
Example	UNIT:POW DBPT
Dependencies	Grayed out if no Amplitude Correction with an Antenna Unit is on.
Readback	dBpT
Initial S/W Revision	A.02.00

dBG

Sets the amplitude unit for the selected amplitude scale (log/lin) to dBG. This is an antenna unit, and this key is grayed out unless a Correction with this Antenna Unit selected is ON. If this is the case, all of the other Antenna Units are grayed out.

Key Path	AMPTD Y Scale, Y Axis Unit, Antenna Unit
Example	UNIT:POW DBG
Dependencies	Grayed out if no Amplitude Correction with an Antenna Unit is on.
Readback	dBG
Initial S/W Revision	A.02.00

None

This is selected if no Antenna Unit is currently on, however you cannot actually set this value, since it is always grayed out. The key is included simply to provide an indication on the Readback line of the Antenna Unit key when there is no Antenna Unit selected.

Key Path	AMPTD Y Scale, Y Axis Unit, Antenna Unit
Readback	"None"
Initial S/W Revision	A.11.00

Reference Level Offset

Adds an offset value to the displayed reference level. The reference level is the absolute amplitude represented by the top graticule line on the display.

See ["More Information" on page 1090](#)

Key Path	AMPTD Y Scale
Mode	SA
Scope	Meas Global
Remote Command	:DISP:WINDow[1]:TRACe:Y[:SCALe]:RLEVel:OFFSet <rel_amp1> :DISP:WINDow[1]:TRACe:Y[:SCALe]:RLEVel:OFFSet?
Example	DISP:WIND:TRAC:Y:RLEV:OFFS 12.7 Sets the Ref Level Offset to 12.7 dB. The only valid suffix is dB. If no suffix is sent, dB will be assumed.
Preset	0 dBm
State Saved	Saved in instrument state
Min	The range for Ref Lvl Offset is variable. It is limited to values that keep the reference level within the range of -327.6 dB to 327.6 dB.
Max	327.6 dB
Backwards Compatibility Notes	<ol style="list-style-type: none"> 6. In pre-X-Series instruments, Ref Level Offset could not be adjusted by the knob or step keys. That is no longer the case. 7. In ESA and PSA, Ref Level Offset was applied to the data as it was acquired; thus if the Offset changed the new offset was not applied until new trace data was taken. In X-Series, the offset is applied as the data is displayed/queried, so if you change the offset, it will change the data immediately.
Initial S/W Revision	Prior to A.02.00
Modified at S/W Revision	A.04.00

More Information

Offsets are used when gain or loss occurs between a device under test and the analyzer input. Thus, the signal level measured by the analyzer may be thought of

as the level at the input of an external amplitude conversion device. Entering an offset does not affect the trace position or attenuation value, just the value of the top line of the display and the values represented by the trace data. Thus, the values of exported trace data, queried trace data, marker amplitudes, trace data used in calculations such as N dB points, trace math, peak threshold, and so forth, are all affected by Ref Level Offset.

NOTE

Changing the offset causes the analyzer to immediately stop the current sweep and prepare to begin a new sweep, but the data will not change until the trace data updates, because the offset is applied to the data as it is taken. If a trace is exported with a nonzero Ref Level Offset, the exported data will contain the trace data with the offset applied.

The maximum reference level available is dependent on the reference level offset. That is, Ref Level - Ref Level Offset must be in the range -170 to +30 dBm. For example, the reference level value range can be initially set to values from -170 dBm to 30 dBm with no reference level offset. If the reference level is first set to -20 dBm, then the reference level offset can be set to values of -150 to +50 dB.

If the reference level offset is first set to -30 dB, then the reference level can be set to values of -200 dBm to 0 dBm. In this case, the reference level is “clamped” at 0 dBm because the maximum limit of +30 dBm is reached with a reference level setting of 0 dBm with an offset of -30 dB. If instead, the reference level offset is first set to 30 dB, then the reference level can be set to values of -140 to +60 dBm.

μW Path Control

The **μW Path Control** functions include the **μW Preselector Bypass** (Option MPB) and **Low Noise Path** (Option LNP) controls in the High Band path circuits.

When the μW Preselector is bypassed, the user has better flatness, but will be subject to spurs from out of band interfering signals. When the Low Noise Path is enabled, the analyzer automatically switches around certain circuitry in the high frequency bands which can contribute to noise, when it is appropriate based on other analyzer settings.

For most applications, the preset state is Standard Path, which gives the best remote-control throughput, minimizes acoustic noise from switching and minimizes the risk of wear out in the hardware switches. For applications that utilize the wideband IF paths, the preset state is the μW Preselector Bypass path, if option MPB is present. This is because, when using a wideband IF such as the 140 MHz IF, the μW Preselector’s bandwidth can be narrower than the available IF bandwidth, causing degraded amplitude flatness and phase linearity, so it is desirable to bypass the preselector in the default case.

Users may choose Low Noise Path Enable. It gives a lower noise floor, especially in the 21-26.5 GHz region, though without improving many measures of dynamic range, and without giving the best possible noise floor. The preamp, if purchased and used, gives better noise floor than does the Low Noise Path, however its compression threshold and third-order intercept are much poorer than that of the non-preamp Low Noise Path. There are some applications, typically for signals around -30 dBm, for which the third-order dynamic range of the standard path is

good enough, but the noise floor is not low enough even with 0 dB input attenuation. When the third-order dynamic range of the preamp path is too little and the noise floor of the standard path is too high, the Low Noise Path can provide the best dynamic range.

Key Path	AMPTD Y Scale
Mode	SA, BASIC, PNOISE, VSA , LTE, LTETDD
Scope	Meas Global
Remote Command	[:SENSe] :POWer [:RF] :MW:PATH STD LNPath MPBypass FULL [:SENSe] :POWer [:RF] :MW:PATH?
Example	:POW:MW:PATH LNP Enables the Low Noise path
Notes	If a Presel Center is performed, the analyzer will momentarily switch to the Standard Path, regardless of the setting of μW Path Control The DC Block will always be switched in when the low noise path is switched in, to protect succeeding circuitry from DC. Note that this does not mean “when the low noise path is enabled” but when, based on the Low Noise Path rules, the path is actually switched in. This can happen when the selection is Low Noise Path Enable . In the case where the DC Block is switched in the analyzer is now AC coupled. However, if the user has selected DC coupling, the UI will still behave as though it were DC coupled, including all annunciation, warnings, status bits, and responses to SCPI queries. This is because, based on other settings, the analyzer could switch out the low noise path at any time and hence go back to being DC coupled. Alignment switching ignores the settings in this menu, and restores them when finished.
Dependencies	Unavailable in BBIQ and External Mixing
Preset	All modes other than IQ Analyzer mode and VXA: STD IQ Analyzer, VXA and WLAN mode: MPB option present and licensed: MPB MPB option not present and licensed: STD
State Saved	Save in instrument state
Readback	Value selected in the submenu
Initial S/W Revision	A.04.00
Modified at S/W Revision	A.10.00

Standard Path

This path gives the best remote-control throughput, minimizes acoustic noise from switching and minimizes the risk of wear in the hardware switches, particularly in remote test scenarios where both low band and high band setups will follow in rapid succession.

In this path, the bypass of the low band/high band switch and microwave preamp is never activated, which can cause some noise degradation but preserves the life of the bypass switch.

Key Path	AMPTD Y Scale, μW Path Control
----------	---------------------------------------

Example	:POW:MW:PATH STD
Readback Text	Standard Path
Initial S/W Revision	A.04.00

μW Preselector Bypass

This key toggles the preselector bypass switch for band 1 and higher. When the microwave preselector is on, the signal path is preselected. When the microwave preselector is off, the signal path is not preselected. The preselected path is the normal path for the analyzer.

The preselector is a tunable bandpass filter which prevents signals away from the frequency of interest from combining in the mixer to generate in-band spurious signals (images). The consequences of using a preselector filter are its limited bandwidth, the amplitude and phase ripple in its passband, and any amplitude and phase instability due to center frequency drift.

Option MPB or pre-selector bypass provides an unpreselected input mixer path for certain X-Series signal analyzers with frequency ranges above 3.6 GHz. This signal path allows a wider bandwidth and less amplitude variability, which is an advantage when doing modulation analysis and broadband signal analysis. The disadvantage is that, without the preselector, image signals will be displayed. Another disadvantage of bypassing the preselector is increased LO emission levels at the front panel input port.

Image responses are separated from the real signal by twice the 1st IF. For IF Paths of 10 MHz and 25 MHz, the 1st IF is 322.5 MHz, so the image response and the real signal will be separated by 645 MHz. The 1st IF will be different for other IF Path settings. When viewing a real signal and its corresponding image response in internal mixing, the image response will be to the left of the real signal.

Also, the image response and the real signal typically have the same amplitude and exhibit the same shape factor.

However, if Option FS1, Fast Sweep Capability, is enabled, the image response in the Swept SA measurement will appear lower in amplitude and have a much wider shape factor compared to the real signal.

Key Path	AMPTD Y Scale, μW Path Control
Example	:POW:MW:PATH MPB
Dependencies	Key is blanked if current mode does not support it. Key is grayed out if mode supports it but current measurement does not support it. Key is blank unless Option MPB is present and licensed. If SCPI command sent when MPB not present, error -241, "Hardware missing; Option not installed" is generated.
Readback Text	μW Preselector Bypass
Initial S/W Revision	A.04.00

Remote Command	<code>[:SENSe]:POWer[:RF]:MW:PRESelector[:STATe] ON OFF 0 1</code> <code>[:SENSe]:POWer[:RF]:MW:PRESelector[:STATe]?</code>
Example	<code>:POW:MW:PRES OFF</code> Bypasses the microwave preselector
Notes	The ON parameter sets the STD path (:POW:MW:PATH STD) The OFF parameter sets path MPB (:POW:MW:PATH MPB)
Preset	ON

Internal Preamp

Accesses a menu of keys that control the internal preamps. Turning on the preamp gives a better noise figure, but a poorer TOI to noise floor dynamic range. You can optimize this setting for your particular measurement.

The instrument takes the preamp gain into account as it sweeps. If you sweep outside of the range of the preamp the instrument will also account for that. The displayed result will always reflect the correct gain.

For some measurements, when the preamp is on and any part of the displayed frequency range is below the lowest frequency for which the preamp has specifications, a warning condition message appears in the status line. For example ,for a preamp with a 9 kHz lowest specified frequency: "Preamp: Accy unspec'd below 9 kHz".

Key Path	AMPTD Y Scale
Scope	Meas Global
Remote Command	<code>[:SENSe]:POWer[:RF]:GAIN[:STATe] OFF ON 0 1</code> <code>[:SENSe]:POWer[:RF]:GAIN[:STATe]?</code>
Dependencies	Preamp is not available on all hardware platforms. If the preamp is not present or is unlicensed, the key is not shown. The preamp is not available when the electronic/soft attenuator is enabled.
Couplings	The act of connecting the U7227A USB Preamplifier to one of the analyzer's USB ports will cause the Internal Preamp to be switched on. When this happens an informational message will be generated: "Internal Preamp turned on for optimal operation with USB Preamp." Note that if the Internal Preamp was already on, there will be no change to the setting, but if it was Off it will be switched On, to Full Range. Note that this same action occurs when the SA mode is selected while the USB Preamp is connected to one of the analyzer's USB ports, if it is the first time that the SA mode has run since powerup, or if the last time the SA mode was running the USB Preamp was NOT connected. Subsequently disconnecting the USB Preamp from USB does not change the Internal Preamp setting nor restore the previous setting.
Preset	OFF
State Saved	Saved in instrument state
Initial S/W Revision	Prior to A.02.00
Modified at S/W	A.14.00

Revision	
Key Path	AMPTD Y Scale, Internal Preamp
Scope	Meas Global
Remote Command	<code>[:SENSe] :POWer [:RF] :GAIN :BAND LOW FULL</code> <code>[:SENSe] :POWer [:RF] :GAIN :BAND ?</code>
Dependencies	Preamp is not available on all hardware platforms. If the preamp is not present or is unlicensed, the key is not shown. If a POW:GAIN:BAND FULL command is sent when a low band preamp is available, the preamp band parameter is to LOW instead of FULL, and an "Option not installed" message is generated.
Preset	LOW
State Saved	Saved in instrument state
Initial S/W Revision	Prior to A.02.00

Off

Turns the internal preamp off

Key Path	AMPTD Y Scale, Internal Preamp
Example	<code>:POW:GAIN OFF</code>
Readback	Off
Initial S/W Revision	Prior to A.02.00

Low Band

Sets the internal preamp to use only the low band.

The frequency range of the installed (optional) low-band preamp is displayed in square brackets on the **Low Band** key label.

Key Path	AMPTD Y Scale, Internal Preamp
Example	<code>:POW:GAIN ON</code> <code>:POW:GAIN:BAND LOW</code>
Readback	Low Band
Initial S/W Revision	Prior to A.02.00

Full Range

Sets the internal preamp to use its full range. The low band (0–3.6 GHz or 0–3GHz, depending on the model) is supplied by the low band preamp and the frequencies above low band are supplied by the high band preamp.

The frequency range of the installed (optional) preamp is displayed in square brackets on the **Full Range** key label. If the high band option is not installed the Full Range key does not appear.

Key Path	AMPTD Y Scale, Internal Preamp
Example	:POW:GAIN ON :POW:GAIN:BAND FULL
Readback	Full Range
Initial S/W Revision	Prior to A.02.00

Ref Position

Positions the reference level at the top, center, or bottom of the Y Scale display. Changing the reference position does not change the reference level value.

Key Path	AMPTD Y Scale
Mode	SA, WCDMA, C2K, WIMAX OFDMA, 1xEVDO, DVB-T/H, DTMB (CTTB), ISDB-T, CMMB, LTE, LTETDD, Digital Cable TV, WLAN, MSR, LTEAFDD, LTEATDD
Remote Command	:DISPlay:CHPower:VIEW[1]:WINDow[1]:TRACe:Y[:SCALe]:RPOStion TOP CENTER BOTTom :DISPlay:CHPower:VIEW[1]:WINDow[1]:TRACe:Y[:SCALe]:RPOStion?
Example	DISP:CHP:VIEW:WIND:TRAC:Y:RPOS CENT DISP:CHP:VIEW:WIND:TRAC:Y:RPOS?
Notes	You must be in the Spectrum Analysis mode, W-CDMA mode, cdma2000 mode, DVB-T/H mode, DTMB (CTTB) mode, ISDB-T mode, CMMB mode, Digital Cable TV mode, LTE mode, LTE TDD mode, WLAN mode, 1xEVDO mode, MSR, LTE-Advanced FDD/TDD mode or WIMAX OFDMA mode to use this command. Use :INSTrument:SElect to set the mode.
Preset	TOP
State Saved	Saved in instrument state.
Range	Top Ctr Bot
Initial S/W Revision	Prior to A.02.00
Modified at S/W Revision	A.02.00, A.03.00

Auto Scaling

Toggles the Auto Scaling function between On and Off.

Key Path	AMPTD Y Scale
Mode	SA, WCDMA, C2K, WIMAX OFDMA, 1xEVDO, DVB-T/H, DTMB (CTTB), ISDB-T, CMMB, LTE, LTETDD, Digital Cable TV, WLAN, MSR, LTEAFDD, LTEATDD
Remote Command	:DISPlay:CHPower:VIEW[1]:WINDow[1]:TRACe:Y[:SCALe]:COUPle 0 1 OFF ON :DISPlay:CHPower:VIEW[1]:WINDow[1]:TRACe:Y[:SCALe]:COUPle?
Example	DISP:CHP:VIEW:WIND:TRAC:Y:COUP OFF DISP:CHP:VIEW:WIND:TRAC:Y:COUP?
Couplings	When Auto Scaling is On, and the Restart front-panel key is pressed, this function automatically

	sets the scale per division to 10 dB and determines the reference values based on the measurement results. When you set a value to either Scale/Div or Ref Value manually, Auto Scaling automatically changes to Off.
Preset	1
State Saved	Saved in instrument state.
Range	On Off
Initial S/W Revision	Prior to A.02.00
Modified at S/W Revision	A.02.00, A.03.00

Auto Couple

The Auto Couple feature provides a quick and convenient way to automatically couple multiple instrument settings. This helps ensure accurate measurements and optimum dynamic range. When the Auto Couple feature is activated, either from the front panel or remotely, all parameters of the current measurement that have an Auto/Manual mode are set to Auto mode and all measurement settings dependent on (or coupled to) the Auto/Man parameters are automatically adjusted for optimal performance.

However, the Auto Couple key actions are confined to the current measurement only. It does not affect other measurements in the mode, and it does not affect markers, marker functions, or trace or display attributes.

See "[More Information](#)" on page 1098

Key Path	Front-panel key
Remote Command	:COUPlE ALL NONE
Example	:COUP ALL
Notes	:COUPlE ALL puts all Auto/Man parameters in Auto mode (equivalent to pressing the Auto Couple key). :COUPLE NONE puts all Auto/Man parameters in manual mode. It decouples all the coupled instrument parameters and is not recommended for making measurements.
Initial S/W Revision	Prior to A.02.00

More Information

There are two types of functions that have Auto/Manual modes.

Auto/Man Active Function keys

An Auto/Man toggle key controls the binary state associated with an instrument parameter by toggling between **Auto** (where the parameter is automatically coupled to the other parameters it is dependent upon) and **Man** (where the parameter is controlled independent of the other parameters), as well as making the parameter the active function. The current mode is indicated on the softkey with either **Auto** or **Man** underlined as illustrated below.

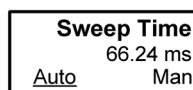

vsd07

Auto/Man 1-of-N keys

An Auto/Man 1-of-N key allows you to manually pick from a list of parameter values, or place the function in Auto, in which case the value is automatically selected (and indicated).

- If in Auto, Auto is underlined on the calling key.

- If in manual operation, manual is indicated on the calling key, but note that the calling key simply opens the menu and does **not** actually toggle the function.

BW

Accesses a menu of functions that enable you to specify and control the video and resolution bandwidths. You can also select the type of filter for the measurement and set the filter bandwidth.

Key Path	Front-panel key
Initial S/W Revision	Prior to A.02.00

Res BW

Sets the value of the resolution bandwidth (RBW). If an unavailable bandwidth is entered with the numeric keypad, the closest available bandwidth is selected.

LTE-Advanced FDD/TDD Auto RBW:

Bandwidth	RBW (KHz)
1.4MHz	20
3MHz	43
5MHz	68
10MHz	150
15MHz	220
20MHz	270

the resolution bandwidth is predefined based on the corresponding bandwidth of the single LTE carrier, which is listed above. When ResBW mode is Auto, the narrowest RBW over the active carriers is selected for Multi-carriers.

Key Path	BW
Mode	SA, WCDMA, C2K, WIMAX OFDMA, 1xEVDO, DVB-T/H, DTMB (CTTB), ISDB-T, CMMB, LTE, LTE-TDD, Digital Cable TV, WLAN, MSR, LTEAFDD, LTEATDD
Remote Command	<pre>[:SENSe]:CHPower:BANDwidth[:RESolution] <bandwidth> [:SENSe]:CHPower:BANDwidth[:RESolution]? [:SENSe]:CHPower:BANDwidth[:RESolution]:AUTO ON OFF 1 0 [:SENSe]:CHPower:BANDwidth[:RESolution]:AUTO?</pre>
Example	<pre>CHP:BAND 5 MHz CHP:BAND? CHP:BAND:AUTO ON CHP:BAND:AUTO?</pre>
Notes	You must be in the Spectrum Analysis mode, W-CDMA mode, cdma2000 mode, DVB-T/H mode, DTMB (CTTB) mode, ISDB-T mode, CMMB mode, Digital Cable TV mode, LTE mode, LTE TDD mode, WLAN mode, 1xEVDO mode, MSR, LTE-Advanced FDD/TDD mode or WIMAX OFDMA mode to use this command. Use :INSTrument:SElect to set the mode.
Couplings	Sweep time is coupled to the RBW. As the RBW changes, the sweep time (if set to Auto) is

changed to maintain amplitude calibration.
 Video bandwidth (VBW) is coupled to the RBW. As the resolution bandwidth changes, the video bandwidth (if set to Auto) changes to maintain the ratio of VBW/RBW (10:1).
 When the Res BW is set to Auto, the resolution bandwidth is auto-coupled to the span. The ratio of Span/RBW is approximately 106:1 when auto coupled. When Res BW is set to Man, and the bandwidths are entered manually, these bandwidths are used regardless of other analyzer settings.

Preset	SA: Auto WCDMA: 240 kHz C2K: 24 kHz WIMAX OFDMA: 100kHz 1xEVDO: 30kHz DVB-T/H: 3.9kHz DTMB (CTTB): 3.9kHz ISDB-T: 30kHz CMMB: 3.9kHz LTE: Auto LTETDD: Auto Digital Cable TV: 3.9kHz WLAN: 100 kHz MSR: 100kHz LTEAFDD/LTEATDD: Auto WCDMA, C2K, 1xEVDO, WIMAX OFDMA, DVB-T/H, DTMB (CTTB), ISDB-T, CMMB, Digital Cable TV, WLAN, MSR, LTEAFDD, LTEATDD: OFF SA, LTE, LTETDD, LTEAFDD, LTEATDD: ON
State Saved	Saved in instrument state.
Min	1 Hz
Max	8 MHz
Backwards Compatibility SCPI	[:SENSe] :CHPower :BWIDth [:RESolution]
Initial S/W Revision	Prior to A.02.00
Modified at S/W Revision	A.02.00, A.03.00

Video BW

Changes the analyzer post-detection filter (VBW).

Key Path	BW
Mode	SA, WCDMA, C2K, WIMAX OFDMA, 1xEVDO, DVB-T/H, DTMB (CTTB), ISDB-T, CMMB, LTE, LTETDD, Digital Cable TV, WLAN, MSR, LTEAFDD, LTEATDD
Remote Command	[:SENSe] :CHPower :BANDwidth :VIDeo <bandwidth> [:SENSe] :CHPower :BANDwidth :VIDeo?

	<pre>[:SENSe]:CHPower:BANDwidth:VIDeo:AUTO ON OFF 1 0 [:SENSe]:CHPower:BANDwidth:VIDeo:AUTO?</pre>
Example	<pre>CHP:BAND:VID 2.4 MHz CHP:BAND:VID? CHP:BAND:VID:AUTO OFF CHP:BAND:VID:AUTO?</pre>
Notes	You must be in the Spectrum Analysis mode, W-CDMA mode, cdma2000 mode, DVB-T/H mode, DTMB (CTTB) mode, ISDB-T mode, CMMB mode, Digital Cable TV mode, LTE mode, LTE TDD mode, WLAN mode, 1xEVDO mode, MSR, LTE-Advanced FDD/TDD mode or WIMAX OFDMA mode to use this command. Use :INSTRument:SElect to set the mode.
Dependencies	See Couplings
Couplings	<p>Video bandwidth (VBW) is coupled to the RBW. As the resolution bandwidth changes, the video bandwidth (if set to Auto) changes to maintain the ratio set by VBW/RBW.</p> <p>Sweep Time is coupled to the Video Bandwidth (VBW). As the VBW is changed, the sweep time (when set to Auto) is changed to maintain amplitude calibration. This occurs because of common hardware between the two circuits, even though the Video BW filter is not actually “in-circuit” when the detector is set to Average. Because the purpose of the average detector and the VBW filter are the same, either can be used to reduce the variance of the result.</p> <p>Although the VBW filter is not “in-circuit” when using the average detector, the Video BW key can have an effect on (Auto) sweep time, and is not disabled. In this case, reducing the VBW setting increases the sweep time, which increases the averaging time, producing a lower-variance trace.</p> <p>When using the average detector with either Sweep Time set to Man, or in zero span, the VBW setting has no effect and is disabled (grayed out).</p> <p>When the video bandwidth is AUTO coupled, the video bandwidth value is set to: Resolution Bandwidth * Video Bandwidth to Resolution Bandwidth Ratio</p>
Preset	<pre>SA: Auto WCDMA: 2.4MHz C2K: 240 kHz WIMAX OFDMA: Auto 1xEVDO: 300 kHz DVB-T/H: 39kHz DTMB (CTTB): 39kHz ISDB-T: 300kHz CMMB: 39kHz LTE, MSR: Auto LTETDD: Auto LTEAFDD,LTEATDD:Auto Digital Cable TV: 39kHz WLAN: Auto ON</pre>
State Saved	Saved in instrument state.

Min	1 Hz
Max	50 MHz
Initial S/W Revision	Prior to A.02.00
Modified at S/W Revision	A.02.00, A.03.00

Filter Type

Selects the type of bandwidth filter that is used. The choices are Gaussian or Flat top.

Key Path	BW
Mode	SA, WCDMA, C2K, WIMAX OFDMA, 1xEVDO, DVB-T/H, DTMB (CTTB), ISDB-T, CMMB, LTE, LTE-TDD, Digital Cable TV, WLAN, MSR, LTEAFDD, LTEATDD
Remote Command	[:SENSe] :CHPower :BANDwidth :SHApe GAUSSian FLATtop [:SENSe] :CHPower :BANDwidth :SHApe?
Example	CHP:BAND:SHAP GAUS CHP:BAND:SHAP?
Preset	GAUSSian
State Saved	Saved in instrument state.
Range	Gaussian Flattop
Backwards Compatibility SCPI	[:SENSe] :CHPower :BWIDth :SHApe
Initial S/W Revision	Prior to A.02.00
Modified at S/W Revision	A.02.00, A.03.00

Cont (Continuous Measurement/Sweep)

Sets the analyzer for Continuous measurement operation. The single/continuous state is Meas Global so the setting will affect all measurements. If you are Paused, pressing **Cont** does a Resume.

Key Path	Front-panel key
Remote Command	:INITiate:CONTinuous OFF ON 0 1 :INITiate:CONTinuous?
Example	:INIT:CONT 0 puts analyzer in Single measurement operation. :INIT:CONT 1 puts analyzer in Continuous measurement operation
Preset	ON (Note that SYST:PRESet sets INIT:CONT to ON but *RST sets INIT:CONT to OFF)
State Saved	Saved in instrument state
Backwards Compatibility Notes	For Spectrum Analysis mode in ESA and PSA, there is no Cont hardkey, instead there is a Sweep Single/Cont key. In these analyzers, switching the Sweep Single/Cont key from Single to Cont restarts averages (displayed average count reset to 1), but does not restart Max Hold and Min Hold . The X-Series has Single and Cont keys in place of the SweepSingleCont key. In the X-Series, if in single measurement, the Cont key (and INIT:CONT ON) switches to continuous measurement, but never restarts a measurement and never resets a sweep.
Initial S/W Revision	Prior to A.02.00

In Swept SA Measurement (Spectrum Analysis Mode):

The analyzer takes repetitive sweeps, averages, measurements, etc., when in Continuous mode. When the average count reaches the Average/Hold Number the count stops incrementing, but the analyzer keeps sweeping. See the Trace/Detector section for the averaging formula used both before and after the Average/Hold Number is reached. The trigger condition must be met prior to each sweep. The type of trace processing for multiple sweeps, is set under the Trace/Detector key, with choices of **Trace Average**, **Max Hold**, or **Min Hold**.

In Other Measurements/Modes:

With **Avg/Hold Num** (in the **Meas Setup** menu) set to **Off** or set to **On** with a value of 1, a sweep is taken after the trigger condition is met; and the analyzer continues to take new sweeps after the current sweep has completed and the trigger condition is again met. However, with **Avg/Hold Num** set to On with a value >1, multiple sweeps (data acquisitions) are taken for the measurement. The trigger condition must be met prior to each sweep. The sweep is not stopped when the average count k equals the number N set for Avg/Hold Num is reached, but the number k stops incrementing. A measurement average usually applies to all traces, marker results, and numeric results. But sometimes it only applies to the numeric results.

If the analyzer is in Single measurement, pressing the **Cont** key does not change k and does not cause the sweep to be reset; the only action is to put the analyzer into Continuous measurement operation.

If it is already in continuous sweep:

the INIT:CONT 1 command has no effect

the INIT:CONT 0 command will place the analyzer in Single Sweep but will have no effect on the current sequence until $k = N$, at which point the current sequence will stop and the instrument will go to the idle state.

File

See "File" on page 426

FREQ Channel

Accesses a menu of keys that allow you to control the Frequency and Channel parameters of the instrument.

Some features in the Frequency menu are the same for all measurements – they do not change as you change measurements. Settings like these are called “Meas Global” and are unaffected by Meas Preset. For example, the Center Freq setting is the same for all measurements – it does not change as you change measurements.

Key Path	Front-panel key
Initial S/W Revision	Prior to A.02.00

Center Freq

Sets the frequency that corresponds to the horizontal center of the graticule (when frequency Scale Type is set to linear). While adjusting the Center Frequency the Span is held constant, which means that both Start Frequency and Stop Frequency will change.

Pressing Center Freq also sets the frequency entry mode to Center/Span. In Center/Span mode, the center frequency and span values are displayed below the graticule, and the default active function in the Frequency menu is **Center Freq**.

The center frequency setting is the same for all measurements within a mode, that is, it is Meas Global. Some modes are also able to share a Mode Global center frequency value. If this is the case, the Mode will have a **Global Settings** key in its **Mode Setup** menu.

The **Center Freq** function sets (and queries) the Center Frequency for the currently selected input. If your analyzer has multiple inputs, and you select another input, the Center Freq changes to the value for that input. SCPI commands are available to directly set the Center Freq for a specific input.

Center Freq is remembered as you go from input to input. Thus you can set a Center Freq of 10 GHz with the RF Input selected, change to BBIQ and set a Center Freq of 20 MHz, then switch to External Mixing and set a Center Freq of 60 GHz, and when you go back to the RF Input the Center Freq will go back to 10 GHz; back to BBIQ and it is 20 MHz; back to External Mixing and it is 60 GHz.

See ["RF Center Freq" on page 1111](#)

See [Ext Mix Center Freq](#)

See ["I/Q Center Freq" on page 1112](#)

See ["Center Frequency Presets" on page 1108](#)

Key Path	FREQ Channel
Scope	Meas Global
Remote Command	[:SENSe] :FREQuency :CENTer <freq> [:SENSe] :FREQuency :CENTer ?

Example	FREQ:CENT 50 MHz FREQ:CENT UP changes the center frequency to 150 MHz if you use FREQ:CENT:STEP 100 MHz to set the center frequency step size to 100 MHz FREQ:CENT?
Notes	This command sets either the RF or I/Q Center Frequency depending on the selected input. For RF input it is equivalent to FREQ:RF:CENT For I/Q input it is equivalent to FREQ:IQ:CENT Preset and Max values are dependent on Hardware Options (5xx) If no terminator (e.g. MHz) is sent the terminator Hz is used. If a terminator with unit other than Frequency is used, an invalid suffix error message is generated.
Dependencies	The Center Frequency can be limited by Start or Stop Freq limits, if the Span is so large that Start or Stop reach their limit.
Couplings	When operating in "swept span", any value of the Center Frequency or Span that is within the frequency range of the analyzer is allowed when the value is being set through the front panel numeric key pad or the SCPI command. The other parameter is forced to a different value if needed, to keep the Start and the Stop Frequencies within the analyzer's frequency range
Preset	Depends on instrument maximum frequency, mode, measurement, and selected input. See "Center Frequency Presets" on page 1108 and "RF Center Freq" on page 1111 and Ext Mix Center Freq and "I/Q Center Freq" on page 1112 .
State Saved	Saved in instrument state
Min	Depends on instrument maximum frequency, mode, measurement, and selected input.. See "Center Frequency Presets" on page 1108 and "RF Center Freq" on page 1111 and "I/Q Center Freq" on page 1112 .
Max	Depends on instrument maximum frequency, mode, measurement, and selected input.. See "Center Frequency Presets" on page 1108 and "RF Center Freq" on page 1111 and "I/Q Center Freq" on page 1112 .
Default Unit	Hz
Status Bits/OPC Dependencies	Non-overlapped
Initial S/W Revision	Prior to A.02.00

Center Frequency Presets

The following table provides the Center Frequency Presets for the Spectrum Analyzer mode, and the Max Freq, for the various frequency options:

Freq Option	CF after Mode Preset	Stop Freq after Mode Preset	Max Freq (can't tune above)
503 (all but N9000A)		1.805 GHz	3.6 GHz 3.7 GHz

9 Channel Power Measurement
FREQ Channel

Freq Optio n	CF after Mode Prese t	Stop Freq after Mode Prese t	Max Freq (can't tune abov e)	
503 (N9000A)		1.505 GHz	3.0 GHz	3.08 GHz
504 (M9420A)		1 GHz	3.8GHz	3.88 GHz
506 (M9420A)		1 GHz	6.0GHz	6.08 GHz
507 (all but N9000A)		3.505 GHz	7.0 GHz	7.1 GHz
507 (N9000A)		3.755 GHz	7.5 GHz	7.58 GHz
508 (all but N9038A)		1.805 GHz	3.6 GHz	8.5 GHz
508 (N9038A)		4.205 GHz	8.4 GHz	8.5 GHz
513		6.805 GHz	13.6 GHz	13.8 GHz
526 (all but N9000A and N9038A)		13.255 GHz	26.5 GHz	27.0 GHz
526 (N9000A)		13.255 GHz	26.5 GHz	26.5 5 GHz
526 (N9038A)		1.805 GHz	3.6 GHz	27.0 GHz
532	16.005 GHz		32.0 GHz	32.5 GHz
543	21.505 GHz		43.0 GHz	TBD
544	22.005 GHz		44.0 GHz	44.5 GHz
550	25.005 GHz		50.0 GHz	51 GHz

Input 2:

Model	CF after Mode Preset	Stop Freq after Mode Preset	Max Freq (can't tune above)
N9000A opt C75	0.7505GHz	1.5 GHz	1.58 GHz
N9038A	505 MHz	1 GHz	1.000025 GHz

Tracking Generator Frequency Limits (N9000A only):

Tracking Generator Option	Min Freq (clips to this freq when turn TG on and can't tune below while TG on)	If above this Freq, Stop Freq clipped to this Freq when TG turned on	Max Freq (can't tune above) while TG on
T03	9 kHz	3.0 GHz	3.08 GHz
T06	9 kHz	6.0 GHz	6.05 GHz

Tracking Generator Frequency Limits(M9290A only):

Tracking Generator Option	Min Freq (clips to this freq when turn TG on and can't tune below while TG on)	If above this Freq, Stop Freq clipped to this Freq when TG turned on	Max Freq (can't tune above) while TG on
T03	2 MHz	3.08 GHz	3.08 GHz
T07	2 MHz	7.575 GHz	7.575 GHz
T13	2 MHz	13.8 GHz	13.8 GHz
T26	2 MHz	26.55 GHz	26.55 GHz

The following table shows the Center Frequency Presets for modes other than Spectrum Analyzer:

Mode	CF Preset for RF
WCDMA	1 GHz
WIMAXOFDMA,	1 GHz
BASIC	1 GHz
ADEMOD	1 GHz
VSA	1 GHz
TDSCDMA	1 GHz

Mode	CF Preset for RF
PNOISE	1 GHz
LTE	1 GHz
LTETDD	1 GHz
MSR	1 GHz
GSM	935.2 MHz
NFIGURE	1.505 GHz

RF Center Freq

SCPI command for specifying the RF Center Frequency. This command will set the Center Frequency to be used when the RF input is selected, even if the RF input is not the input that is selected at the time the command is sent. Note that the **Center Freq** function in the **Frequency** menu on the front panel always applies to the currently selected input.

Scope	Meas Global
Remote Command	[:SENSe] :FREQuency :RF :CENTer <freq> [:SENSe] :FREQuency :RF :CENTer?
Example	FREQ:RF:CENT 30 MHz
Notes	This command is the same in all modes, but the parameter is Measurement Global. So the value is independent in each mode and common across all the measurements in the mode.
Dependencies	If the electronic/soft attenuator is enabled, any attempt to set Center Frequency such that the Stop Frequency would be >3.6 GHz fails and results in an advisory message. If the equivalent SCPI command is sent, this same message is generated as part of a “-221, Settings conflict” warning. If Source Mode is set to Tracking, and the Max or Min Center Freq is therefore limited by the limits of the source, a warning message is generated, “Data out of range;clipped to source max/min” if these limits are exceeded. Note that for an external source, these limits can be affected by the settings of Source Numerator, Source Denominator and Power Sweep.
Preset	See table above
State Saved	Saved in instrument state.
Min	-79.999995 MHz, unless Source Mode is set to Tracking, in which case it is limited by the minimum frequency of the Source
Max	See table above. Basically instrument maximum frequency - 5 Hz. Note that, if the Source Mode is set to Tracking, the effective instrument maximum frequency may be limited by the source maximum frequency. If the knob or step keys are being used, also depends on the value of the other three interdependent parameters Span, Start Frequency and Stop Frequency
Initial S/W Revision	Prior to A.02.00
Modified at S/W Revision	A.03.00

Ext Mix Center Freq

SCPI command for specifying the External Mixer Center Frequency. This command will set the Center Frequency to be used when the External Mixer is selected, even if the External Mixer input is not the input which is selected at the time the command is sent. Note that the **Center Freq** function in the **Frequency** menu on the front panel always applies to the currently selected input.

Scope	Meas Global
Remote Command	[:SENSe] :FREQuency:EMIXer:CENTer <freq> [:SENSe] :FREQuency:EMIXer:CENTer?
Example	:FREQ:EMIX:CENT 60 GHz :FREQ:EMIX:CENT?
Notes	This command is the same in all modes, but the parameter is Measurement Global. So the value is independent in each mode and common across all the measurements in the mode.
Couplings	When returning to External Mixing after having been switched to one of the other inputs (e.g., RF), you will come back into the settings that you had when you left External Mixing. So you will come back to the band you were in with the Center Frequency that you had. However, Span is not an input-dependent parameter, therefore you will bring the span over from the other input. Therefore, the analyzer comes back with the span from the previous input, limited as necessary by the current mixer setup.
Preset	When a Mode Preset is performed while in External Mixing, the Start frequency of the current Mode is set to the nominal Min Freq of the lowest harmonic range in the Harmonic Table for the current mixer setup. Similarly, the Stop frequency of the current Mode is set to the nominal Max Freq of the highest harmonic range in the Harmonic Table. The Center Freq thus presets to the point arithmetically equidistant from these two frequencies. If the current measurement has a limited Span available to it, and cannot achieve the Span shown in the table (Span=Stop Freq – Start Freq), the analyzer uses the maximum Span the measurement allows, and still sets the Center Freq to the midpoint of the Start and Stop Freq values in the Harmonic Table. When Restore Input/Output Defaults is performed, the mixer presets to the 11970A, whose Start and Stop frequencies are 26.5 and 40 GHz respectively. The center of these two frequencies is 33.25 GHz. Therefore, after a Restore Input/Output Defaults, if you go into External Mixing and do a Mode Preset while in the Spectrum Analyzer Mode, the resulting Center Freq is 33.25 GHz.
State Saved	Saved in instrument state.
Min	The minimum frequency in the currently selected mixer band + 5 Hz
Max	The maximum frequency in the currently selected mixer band - 5 Hz If the knob or step keys are being used, also depends on the value of the other three interdependent parameters Span, Start Frequency and Stop Frequency
Initial S/W Revision	A.08.01

I/Q Center Freq

SCPI command for specifying the I/Q Center Frequency. This command will set the Center Frequency to be used when the I/Q input is selected, even if the I/Q input is not the input which is selected at the time the command is sent. Note that the

Center Freq function in the **Frequency** menu on the front panel always applies to the currently selected input.

Scope	Meas Global
Remote Command	[:SENSe] :FREQuency :IQ :CENTer <freq> [:SENSe] :FREQuency :IQ :CENTer ?
Example	FREQ:IQ:CENt: 30 MHz
Notes	This command is the same in all modes, but the parameter is Measurement Global. So the value is independent in each mode and common across all the measurements in the mode.
Preset	0 Hz
State Saved	Saved in instrument state.
Min	-40.049995 MHz
Max	40.049995 MHz
Initial S/W Revision	Prior to A.02.00

CF Step

Changes the step size for the center frequency and start and stop frequency functions. Once a step size has been selected and the center frequency function is active, the step keys (and the UP|DOWN parameters for Center Frequency from remote commands) change the center frequency by the step-size value. The step size function is useful for finding harmonics and sidebands beyond the current frequency span of the analyzer.

Note that the start and stop frequencies also step by the CF Step value.

Key Path	FREQ Channel
Remote Command	[:SENSe] :FREQuency :CENTer :STEP [:INCRement] <freq> [:SENSe] :FREQuency :CENTer :STEP [:INCRement] ? [:SENSe] :FREQuency :CENTer :STEP :AUTO OFF ON 0 1 [:SENSe] :FREQuency :CENTer :STEP :AUTO ?
Example	FREQ:CENt:STEP:AUTO ON FREQ:CENt:STEP 500 MHz FREQ:CENt UP increases the current center frequency value by 500 MHz FREQ:CENt:STEP? FREQ:CENt:STEP:AUTO?
Notes	Preset and Max values are depending on Hardware Options (503, 507, 508, 513, 526)
Notes	Preset and Max values are dependent on Hardware Options (5xx)
Dependencies	Freq Offset is not available in External Mixing. In this case the Freq Offset key is grayed out and shows a value of zero. It will once again be available, and show the previously set value, when you return to the RF Input.
Dependencies	Span, RBW, Center frequency If the electronic/soft attenuator is enabled, any attempt to change the value of the center frequency >3.6 GHz by pressing the Up-arrow key, fails and results in an advisory message. If the

	equivalent SCPI command is sent, this same message is generated as part of a “-221, Settings conflict” warning.
Couplings	When auto-coupled in a non-zero span, the center frequency step size is set to 10% of the span. When auto-coupled in zero span, the center frequency step size is set to the equivalent -3 dB RBW value.
Preset	Auto ADEMOD: 1 MHz ON
State Saved	Saved in instrument state
Min	– (the maximum frequency of the instrument). That is, 27 GHz max freq instrument has a CF step range of +/- 27 GHz. Note that this is the maximum frequency given the current settings of the instrument, so in External Mixing, for example, it is the maximum frequency of the current mixer band.
Max	The maximum frequency of the instrument. That is, 27 GHz max freq instrument has a CF step range of +/- 27 GHz. Note that this is the maximum frequency given the current settings of the instrument, so in External Mixing, for example, it is the maximum frequency of the current mixer band.
Default Unit	Hz
Status Bits/OPC dependencies	non-overlapped
Initial S/W Revision	Prior to A.02.00
Modified at S/W Revision	A.03.00

Freq Offset

Enables you to set a frequency offset value to account for frequency conversions outside of the analyzer. This value is added to the display readout of the marker frequency, center frequency, start frequency, stop frequency, and all other absolute frequency settings in the analyzer including frequency count. When a frequency offset is entered, the value appears below the center of the graticule. To eliminate an offset, perform a Mode Preset or set the frequency offset to 0 Hz.

See ["More Information" on page 1115](#).

Key Path	FREQ Channel
Scope	Meas Global
Remote Command	[:SENSe] :FREQuency:OFFSet <freq> [:SENSe] :FREQuency:OFFSet?
Example	FREQ:OFFS 10 MHz
Notes	Preset and Max values are dependent on Hardware Options (503, 507, 508, 513, 526)
Dependencies	Freq Offset is not available in External Mixing. In this case the Freq Offset key is grayed out and shows a value of zero. However, the value of CF Offset that was set for the RF Input is retained and restored when the user switches back to the RF Input.

Preset	See " Center Frequency Presets " on page 2932
State Saved	Saved in instrument state
Min	-500 GHz
Max	500 GHz
Default Unit	Hz
Status Bits/OPC dependencies	Non-overlapped
Backwards Compatibility SCPI	DISPlay:WINDow[1]:TRACe:X[:SCALE]:OFFSet
	The DISPlay version of the command is in the instrument for compatibility across platforms and is not recommended for new development.
Backwards Compatibility Notes	<ol style="list-style-type: none"> 1. In pre-X-Series instruments, Frequency Offset could not be adjusted by the knob or step keys. That is no longer the case. 2. Some previous spectrum analyzers did not adjust frequency counter results for the Frequency Offset. The X-Series does adjust the frequency counter for the offset.
Initial S/W Revision	Prior to A.02.00
Modified at S/W Revision	A.04.00, A.08.50

More Information

This command does not affect any bandwidths or the settings of relative frequency parameters such as delta markers or span. It does not affect the current hardware settings of the analyzer, but only the displayed frequency values. Entering an offset does not affect the trace position or display, just the value of the start and stop frequency and the values represented by the trace data. The frequency values of exported trace data, queried trace data, markers, trace data used in calculations such as N dB points, trace math, etc., are all affected by Freq Offset. Changing the offset, even on a trace that is not updating will immediately change all of the above, without taking new data.

NOTE

If a trace is exported with a nonzero Freq Offset, the exported data will contain the trace data with the offset applied. Therefore, if that trace were to be imported back into the analyzer, you would want Freq Offset to be 0, or the offset would be applied again to data which is already offset. No such care need be taken when saving a State+Trace file because the data and state are saved together.

Input/Output

See ["Input/Output" on page 241](#)

Marker

Accesses a menu that enables you to select, set up and control the markers for the current measurement.

Key Path	Front-panel key
Initial S/W Revision	Prior to A.02.00

Select Marker

Displays 12 markers available for selection.

Key Path	Marker
Initial S/W Revision	Prior to A.02.00

Marker Type

Sets the marker control mode to **Normal**, **Delta**, **Fixed** or **Off**. All interactions and dependencies detailed under the key description are enforced when the remote command is sent. If the selected marker is Off, pressing Marker sets it to Normal and places it at the center of the screen on the trace determined by the **Marker Trace** rules. At the same time, **Marker X Axis Value** appears on the Active Function area.

The default active function is the active function for the currently selected marker control mode. If the current control mode is Off, there is no active function and the active function is turned off.

Key Path	Marker
Mode	SA, WCDMA, C2K, WIMAX OFDMA, 1xEVDO, DVB-T/H, DTMB (CTTB), ISDB-T, CMMB, LTE, LTETDD, Digital Cable TV, WLAN, MSR, LTEAFDD, LTEATDD
Remote Command	:CALCulate:CHPower:MARKer[1] 2 ... 12:MODE POSITION DELTa OFF :CALCulate:CHPower:MARKer[1] 2 ... 12:MODE?
Example	CALC:CHP:MARK3:MODE POS CALC:CHP:MARK3:MODE?
Notes	If the selected marker is Off, pressing Marker sets it to Normal and places it at the center of the screen on the trace determined by the Marker Trace rules. At the same time, Marker X Axis Value appears on the Active Function area. Default Active Function: the active function for the selected marker's current control mode. If the current control mode is Off, there is no active function and the active function is turned off. Active Function Display: the marker X axis value entered in the active function area displays the marker value to its full entered precision.
Preset	OFF
State Saved	Saved in instrument state.
Range	Normal Delta Off
Initial S/W Revision	Prior to A.02.00
Modified at S/W Revision	A.02.00, A.03.00

Properties

Accesses the marker properties menu.

Key Path	Marker
Initial S/W Revision	Prior to A.02.00

Select Marker

Displays 12 markers available for selection.

Key Path	Marker
Initial S/W Revision	Prior to A.02.00

Relative To

Sets the reference marker to which the selected marker is relative.

Key Path	Marker, Properties
Mode	SA, WCDMA, C2K, WIMAX OFDMA, 1xEVDO, DVB-T/H, DTMB (CTTB), ISDB-T, CMMB, LTE, LTETDD, Digital Cable TV, WLAN, MSR, LTEAFDD, LTEATDD
Remote Command	:CALCulate:CHPower:MARKer[1] 2 ... 12:REference <integer> :CALCulate:CHPower:MARKer[1] 2 ... 12:REference?
Example	CALC:CHP:MARK:REF 5 CALC:CHP:MARK:REF?
Notes	A marker cannot be relative to itself so that choice is grayed out, and if sent from SCPI generates error -221: "Settings conflict; marker cannot be relative to itself." When queried, a single value is returned (the specified marker numbers relative marker). You must be in the Spectrum Analysis or WCDMA mode to use this command. Use :INSTRument:SElect to set the mode.
Preset	2 3 4 5 6 7 8 9 10 11 12 1
State Saved	Saved in instrument state.
Min	1
Max	12
Initial S/W Revision	Prior to A.02.00
Modified at S/W Revision	A.02.00, A.03.00

Couple Markers

When this function is active, moving any marker causes an "equal X Axis movement" of every other marker that is not set to **Off**. By "equal X Axis movement" we mean that we preserve the difference between each marker's X Axis value (in the fundamental x-axis units of the trace that marker is on) and the X Axis value of the marker being moved (in the same fundamental x-axis units).

This may result in markers going off screen.

Key Path	Marker
Mode	SA, WCDMA, C2K, WIMAX OFDMA, 1xEVDO, DVB-T/H, DTMB (CTTB), ISDB-T, CMMB, LTE, LTETDD, Digital Cable TV, WLAN, MSR, LTEAFDD, LTEATDD
Remote Command	:CALCulate:CHPower:MARKer:COUPlE[:STATe] ON OFF 1 0 :CALCulate:CHPower:MARKer:COUPlE[:STATe]?
Example	CALC:CHPower:MARK:COUP ON
Preset	OFF
State Saved	Saved in instrument state.
Range	On Off
Initial S/W Revision	A.02.00

All Markers Off

Turns off all markers.

Key Path	Marker
Mode	SA, WCDMA, C2K, WIMAX OFDMA, 1xEVDO, DVB-T/H, DTMB (CTTB), ISDB-T, CMMB, LTE, LTETDD, Digital Cable TV, WLAN, MSR, LTEAFDD, LTEATDD
Remote Command	:CALCulate:CHPower:MARKer:AOFF
Example	CALC:CHP:MARK:AOFF
Initial S/W Revision	Prior to A.02.00
Modified at S/W Revision	A.02.00, A.03.00

Marker X Axis Value (Remote Command Only)

Sets the marker X Axis value in the current marker X Axis Scale unit. It has no effect if the control mode is **Off**, but is the SCPI equivalent of entering an X value if the control mode is **Normal**, **Delta**, or **Fixed**.

Mode	SA, WCDMA, CDMA2K, WIMAXOFDMA, CDMA1XEV, DVB, DTMB, ISDBT, CMMB, LTE, LTETDD, DCTV, WLAN, MSR, LTEAFDD, LTEATDD
Remote Command	:CALCulate:CHPower:MARKer[1] 2 ... 12:X <real> :CALCulate:CHPower:MARKer[1] 2 ... 12:X?
Example	CALC:CHP:MARK3:X 0 CALC:CHP:MARK3:X?
Notes	The query returns the marker's absolute X Axis value if the control mode is Normal , or the offset from the marker's reference marker if the control mode is Delta . The query is returned in the fundamental units for the current marker X Axis scale: Hz for Frequency .
Preset	After a preset, all markers are turned OFF, so Marker X Axis Value query returns a not a number (NAN).
State Saved	Saved in instrument state.
Min	-9.9E+37

Max	9.9E+37
Initial S/W Revision	Prior to A.02.00
Modified at S/W Revision	A.02.00, A.03.00

Marker X Axis Position (Remote Command Only)

Sets the marker X Axis Scale position in trace points. This setting has no effect if the control mode is **Off**, but is the SCPI equivalent of entering a value if the control mode is **Normal** or **Delta**. The entered value is immediately translated into the current X Axis Scale units for setting the value of the marker.

Mode	SA, WCDMA, CDMA2K, WIMAXOFDMA, CDMA1XEV, DVB, DTMB, ISDBT, CMMB, LTE, LTETDD, DCTV, WLAN, MSR, LTEAFDD, LTEATDD
Remote Command	:CALCulate:CHPower:MARKer[1] 2 ... 12:X:POsition <real> :CALCulate:CHPower:MARKer[1] 2 ... 12:X:POsition?
Example	CALC:CHP:MARK10:X:POS 0 CALC:CHP:MARK10:X:POS?
Notes	The query returns the marker's absolute X Axis value in trace points if the control mode is Normal , or the offset from the marker's reference marker in trace points if the control mode is Delta .
Preset	After a preset, all markers are turned OFF, so Marker X Axis Value query returns a not a number (NAN).
State Saved	Saved in instrument state.
Min	-9.9E+37
Max	9.9E+37
Initial S/W Revision	Prior to A.02.00
Modified at S/W Revision	A.02.00, A.03.00

Marker Y Axis Value (Remote Command only)

Returns the marker Y Axis value in the current marker Y Axis unit.

Mode	SA, WCDMA, CDMA2K, WIMAXOFDMA, CDMA1XEV, DVB, DTMB, ISDBT, CMMB, LTE, LTETDD, DCTV, WLAN, MSR, LTEAFDD, LTEATDD
Remote Command	:CALCulate:CHPower:MARKer[1] 2 ... 12:Y?
Example	CALC:CHP:MARK11:Y?
Preset	Result dependent on Markers setup and signal source.
State Saved	Saved in instrument state.
Initial S/W Revision	Prior to A.02.00
Modified at S/W Revision	A.02.00, A.03.00

Backward Compatibility SCPI Commands

Sets or queries the state of a marker. Setting a marker which is OFF to state ON or 1 puts it in Normal mode and places it at the center of the screen.

Mode	SA, WCDMA, CDMA2K, WIMAXOFDMA, CDMA1XEV, DVB, DTMB, ISDBT, CMMB, LTE, LTETDD, DCTV, WLAN, MSR, LTEAFDD, LTEATDD
Remote Command	:CALCulate:CHPower:MARKer[1] 2 ... 12:STATe OFF ON 0 1 :CALCulate:CHPower:MARKer[1] 2 ... 12:STATe?
Example	CALC:CHP:MARK3:STAT ON CALC:CHP:MARK3:STAT?
Preset	OFF
State Saved	Saved in instrument state.
Range	On Off
Initial S/W Revision	Prior to A.02.00
Modified at S/W Revision	A.02.00, A.03.00

Marker Function

There are no 'Marker Functions' supported in Channel Power, so this front-panel key displays a blank menu when pressed.

Key Path	Front-panel key
Initial S/W Revision	Prior to A.02.00

Marker To

There is no 'Marker To' functionality supported in Channel Power measurement, so this front-panel key displays a blank key menu when pressed.

Key Path	Front-panel key
Initial S/W Revision	Prior to A.02.00

Meas

The information in this section is common to all measurements. For key and remote command information for a specific measurement, refer to the section that describes the measurement of interest.

Measurements available under the Meas key are specific to the current Mode.

When viewing Help for measurements, note the following:

NOTE

Operation for some keys differs between measurements. The information displayed in Help pertains to the current measurement. To see how a key operates in a different measurement, exit Help (press the Cancel Esc key), select the measurement, then reenter Help (press the Help key) and press that key.

Key Path	Front-panel key
Initial S/W Revision	Prior to A.02.00

Remote Measurement Functions

This section contains the following topics:

["Measurement Group of Commands" on page 3141](#)

["Current Measurement Query \(Remote Command Only\)" on page 3144](#)

["Limit Test Current Results \(Remote Command Only\)" on page 3144](#)

["Data Query \(Remote Command Only\)" on page 3144](#)

["Calculate/Compress Trace Data Query \(Remote Command Only\)" on page 3144](#)

["Calculate Peaks of Trace Data \(Remote Command Only\)" on page 3150](#)

["Hardware-Accelerated Fast Power Measurement \(Remote Command Only\)" on page 3151](#)

["Format Data: Numeric Data \(Remote Command Only\)" on page 3165](#)

["Format Data: Byte Order \(Remote Command Only\)" on page 3166](#)

Initial S/W Revision	Prior to A.02.00
----------------------	------------------

Measurement Group of Commands

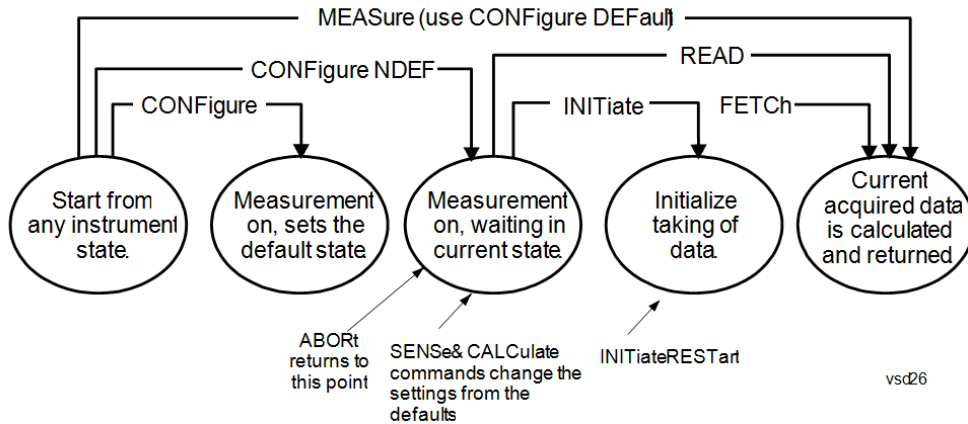

Measure Commands:

:MEASure:<measurement>[n]?

This is a fast single-command way to make a measurement using the factory default instrument settings. These are the settings and units that conform to the Mode Setup settings (e.g. radio standard) that you have currently selected.

- Stops the current measurement (if any) and sets up the instrument for the specified measurement using the factory defaults
- Initiates the data acquisition for the measurement
- Blocks other SCPI communication, waiting until the measurement is complete before returning results.
- If the function does averaging, it is turned on and the number of averages is set to 10.
- After the data is valid it returns the scalar results, or the trace data, for the specified measurement. The type of data returned may be defined by an [n] value that is sent with the command.
- The scalar measurement results will be returned if the optional [n] value is not included, or is set to 1. If the [n] value is set to a value other than 1, the selected trace data results will be returned. See each command for details of what types of scalar results or trace data results are available.
- ASCII is the default format for the data output. (Older versions of Spectrum Analysis and Phase Noise mode measurements only use ASCII.) The binary data formats should be used for handling large blocks of data since they are smaller and faster than the ASCII format. Refer to the FORMat:DATA command for more information.

If you need to change some of the measurement parameters from the factory default settings you can set up the measurement with the CONFigure command. Use the commands in the SENSE:<measurement> and CALCulate:<measurement> subsystems to change the settings. Then you can use the READ? command to initiate the measurement and query the results.

If you need to repeatedly make a given measurement with settings other than the factory defaults, you can use the commands in the SENSE:<measurement> and CALCulate:<measurement> subsystems to set up the measurement. Then use the READ? command to initiate the measurement and query results.

Measurement settings persist if you initiate a different measurement and then return to a previous one. Use READ:<measurement>? if you want to use those persistent settings. If you want to go back to the default settings, use MEASure:<measurement>?.

Configure Commands:

:CONFigure:<measurement>

This command stops the current measurement (if any) and sets up the instrument for the specified measurement using the factory default instrument settings. It does not initiate the taking of measurement data unless INIT:CONTinuous is ON. If you change any measurement settings after using the CONFigure command, the READ command can be used to initiate a measurement without changing the settings back to their defaults.

In the Swept SA measurement in Spectrum Analyzer mode the CONFigure command also turns the averaging function on and sets the number of averages to 10 for all measurements.

:CONFigure: <measurement>: NDEFault stops the current measurement and changes to the specified measurement. It does not change the settings to the defaults. It does not initiate the taking of measurement data unless INIT:CONTinuous is ON.

The CONFigure? query returns the current measurement name.

The CONFigure:CATalog? query returns a quoted string of all licensed measurement names in the current mode. For example, "SAN, CHP, OBW, ACP, PST, TXP, SPUR, SEM, LIST".

Fetch Commands:

:FETCh:<measurement>[n]?

This command puts selected data from the most recent measurement into the output buffer. Use FETCh if you have already made a good measurement and you want to return several types of data (different [n] values, for example, both scalars and trace data) from a single measurement. FETCh saves you the time of re-making the measurement. You can only FETCh results from the measurement that is currently active, it will not change to a different measurement. An error message is reported if a measurement other than the current one is specified.

If you need to get new measurement data, use the READ command, which is equivalent to an INITiate followed by a FETCh.

The scalar measurement results will be returned if the optional [n] value is not included, or is set to 1. If the [n] value is set to a value other than 1, the selected trace data results will be returned. See each command for details of what types of scalar results or trace data results are available. The binary data formats should be used for handling large blocks of data since they are smaller and transfer faster than the ASCII format. (FORMat:DATA)

FETCh may be used to return results other than those specified with the original READ or MEASure command that you sent.

INITiate Commands:

:INITiate:<measurement>

This command is not available for measurements in all the instrument modes:

- Initiates a trigger cycle for the specified measurement, but does not output any data. You must then use the FETCh<meas> command to return data. If a
-

measurement other than the current one is specified, the instrument will switch to that measurement and then initiate it.

- For example, suppose you have previously initiated the ACP measurement, but now you are running the channel power measurement. If you send INIT:ACP? it will change from channel power to ACP and will initiate an ACP measurement.
- Does not change any of the measurement settings. For example, if you have previously started the ACP measurement and you send INIT:ACP? it will initiate a new ACP measurement using the same instrument settings as the last time ACP was run.
- If your selected measurement is currently active (in the idle state) it triggers the measurement, assuming the trigger conditions are met. Then it completes one trigger cycle. Depending upon the measurement and the number of averages, there may be multiple data acquisitions, with multiple trigger events, for one full trigger cycle. It also holds off additional commands on GPIB until the acquisition is complete.

READ Commands:

:READ:<measurement>[n]?

- Does not preset the measurement to the factory default settings. For example, if you have previously initiated the ACP measurement and you send READ:ACP? it will initiate a new measurement using the same instrument settings.
 - Initiates the measurement and puts valid data into the output buffer. If a measurement other than the current one is specified, the instrument will switch to that measurement before it initiates the measurement and returns results.
 - For example, suppose you have previously initiated the ACP measurement, but now you are running the channel power measurement. Then you send READ:ACP? It will change from channel power back to ACP and, using the previous ACP settings, will initiate the measurement and return results.
 - Blocks other SCPI communication, waiting until the measurement is complete before returning the results
 - If the optional [n] value is not included, or is set to 1, the scalar measurement results will be returned. If the [n] value is set to a value other than 1, the selected trace data results will be returned. See each command for details of what types of scalar results or trace data results are available. The binary data formats should be used when handling large blocks of data since they are smaller and faster than the ASCII format. (FORMat:DATA)
-

Current Measurement Query (Remote Command Only)

This command returns the name of the measurement that is currently running.

Remote Command	:CONFigure?
Example	CONF?
Initial S/W Revision	Prior to A.02.00

Limit Test Current Results (Remote Command Only)

Queries the status of the current measurement limit testing. It returns a 0 if the measured results pass when compared with the current limits. It returns a 1 if the measured results fail any limit tests.

Remote Command	:CALCulate:CLIMits:FAIL?
Example	CALC:CLIM:FAIL? queries the current measurement to see if it fails the defined limits. Returns a 0 or 1: 0 it passes, 1 it fails.
Initial S/W Revision	Prior to A.02.00

Data Query (Remote Command Only)

Returns the designated measurement data for the currently selected measurement and subopcode.

n = any valid subopcode for the current measurement. See the measurement command results table for your current measurement, for information about what data is returned for the subopcodes.

This command uses the data setting specified by the FORMat:BORDER and FORMat:DATA commands and can return real or ASCII data. (See the format command descriptions under Input/Output in the Analyzer Setup section.)

Remote Command	:CALCulate:DATA[n]?
Notes	The return trace depends on the measurement. In CALCulate:<meas>:DATA[n], n is any valid subopcode for the current measurement. It returns the same data as the FETCH:<measurement>? query where <measurement> is the current measurement.
Initial S/W Revision	Prior to A.02.00

Calculate/Compress Trace Data Query (Remote Command Only)

Returns compressed data for the currently selected measurement and sub-opcode [n].

n = any valid sub-opcode for that measurement. See the MEASure:<measurement>? command description of your specific measurement for information on the data that can be returned.

The data is returned in the current Y Axis Unit of the analyzer. The command is used with a sub-opcode <n> (default=1) to specify the trace. With trace queries, it is best if the analyzer is not sweeping during the query. Therefore, it is generally advisable to be in Single Sweep, or Update=Off.

This command is used to compress or decimate a long trace to extract and return only the desired data. A typical example would be to acquire N frames of GSM data and return the mean power of the first burst in each frame. The command can also be used to identify the best curve fit for the data.

Remote Command	:CALCulate:DATA<n>:COMPRESS? BLOCK CFIT MAXimum MINimum MEAN DMEan RMS RMSCubed SAMPlE SDEVIation PPHase [,<soffset> [,<length>[,<roffset>[,<rlimit>]]]]
Example	To query the mean power of a set of GSM bursts: Supply a signal that is a set of GSM bursts. Select the IQ Waveform measurement (in IQ Analyzer Mode). Set the sweep time to acquire at least one burst. Set the triggers such that acquisition happens at a known position relative to a burst. Then query the mean burst levels using, CALC:DATA2:COMP? MEAN, 24e-6, 526e-6 (These parameter values correspond to GSM signals, where 526e-6 is the length of the burst in the slot and you just want 1 burst.)
Notes	The command supports 5 parameters. Note that the last 4 (<soffset>, <length>, <roffset>, <rlimit>) are optional. But these optional parameters must be entered in the specified order. For example, if you want to specify <length>, then you must also specify <soffset>. See details below for a definition of each of these parameters. This command uses the data in the format specified by FORMat:DATA, returning either binary or ASCII data.
Initial S/W Revision	Prior to A.02.00

- BLOCK or block data - returns all the data points from the region of the trace data that you specify. For example, it could be used to return the data points of an input signal over several timeslots, excluding the portions of the trace data that you do not want. (This is x,y pairs for trace data and I,Q pairs for complex data.)
- CFIT or curve fit - applies curve fitting routines to the data. <soffset> and <length> are required to define the data that you want. <roffset> is an optional parameter for the desired order of the curve equation. The query will return the following values: the x-offset (in seconds) and the curve coefficients ((order + 1) values).

MIN, MAX, MEAN, DME, RMS, RMSC, SAMP, SDEV and PPH return one data value for each specified region (or <length>) of trace data, for as many regions as possible

until you run out of trace data (using <roffset> to specify regions). Or they return the number of regions you specify (using <rlimit>) ignoring any data beyond that.

- MINimum - returns the minimum data point (y value) for the specified region (s) of trace data. For I/Q trace data, the minimum magnitude of the I/Q pairs is returned.
- MAXimum - returns the maximum data point (y value) for the specified region(s) of trace data. For I/Q trace data, the maximum magnitude of the I/Q pairs is returned.
- MEAN - returns a single value that is the arithmetic mean of the data point values (in dB/ dBm) for the specified region(s) of trace data. For I/Q trace data, the mean of the magnitudes of the I/Q pairs is returned. See the following equations.

NOTE

If the original trace data is in dB, this function returns the arithmetic mean of those log values, not log of the mean power which is a more useful value. The mean of the log is the better measurement technique when measuring CW signals in the presence of noise. The mean of the power, expressed in dB, is useful in power measurements such as Channel Power. To achieve the mean of the power, use the RMS option.

Equation 1

Mean Value of Data Points for Specified Region(s)

$$\text{MEAN} = \frac{1}{n} \sum_{X_i \in \text{region}(s)} X_i$$

where X_i is a data point value, and n is the number of data points in the specified region(s).

Equation 2

Mean Value of I/Q Data Pairs for Specified Region(s)

$$\text{MEAN} = \frac{1}{n} \sum_{X_i \in \text{region}(s)} |X_i|$$

where $|X_i|$ is the magnitude of an I/Q pair, and n is the number of I/Q pairs in the specified region(s).

- DMEan - returns a single value that is the mean power (in dB/ dBm) of the data point values for the specified region(s) of trace data. See the following equation:

Equation 3

DMEan Value of Data Points for Specified Region(s)

$$\text{DME} = 10 \times \log_{10} \left(\frac{1}{n} \sum_{X_i \in \text{region}(s)} 10^{\frac{X_i}{10}} \right)$$

- RMS - returns a single value that is the average power on a root-mean-squared voltage scale (arithmetic rms) of the data point values for the specified region(s) of trace data. See the following equation.

NOTE

For I/Q trace data, the rms of the magnitudes of the I/Q pairs is returned. See the following equation.

This function is very useful for I/Q trace data. However, if the original trace data is in dB, this function returns the rms of the log values which is not usually needed.

Equation 4

RMS Value of Data Points for Specified Region(s)

$$\text{RMS} = \sqrt{\frac{1}{n} \sum_{X_i \in \text{region}(s)} X_i^2}$$

where X_i is a data point value, and n is the number of data points in the specified region(s).

Equation 5

RMS Value of I/Q Data Pairs for Specified Region(s)

$$\text{RMS} = \sqrt{\frac{1}{n} \sum_{X_i \in \text{region}(s)} X_i X_i^*}$$

where X_i is the complex value representation of an I/Q pair, X_i^* its conjugate complex number, and n is the number of I/Q pairs in the specified region(s).

Once you have the rms value for a region of trace data (linear or I/Q), you may want to calculate the mean power. You must convert this rms value (peak volts) to power in dBm:

$$10 \times \log[10 \times (\text{rms value})^2]$$

- SAMPlE - returns the first data value (x,y pair) for the specified region(s) of trace data. For I/Q trace data, the first I/Q pair is returned.

- SDEViation - returns a single value that is the arithmetic standard deviation for the data point values for the specified region(s) of trace data. See the following equation.
- For I/Q trace data, the standard deviation of the magnitudes of the I/Q pairs is returned. See the following equation.

Equation 6

Standard Deviation of Data Point Values for Specified Region(s)

$$SDEV = \sqrt{\frac{1}{n} \sum_{X_i \in \text{region}(s)} (X_i - \bar{X})^2}$$

where X_i is a data point value, \bar{X} is the arithmetic mean of the data point values for the specified region(s), and n is the number of data points in the specified region(s).

$$SDEV = \sqrt{\frac{1}{n} \sum_{X_i \in \text{region}(s)} (|X_i| - \bar{X})^2}$$

where $|X_i|$ is the magnitude of an I/Q pair, \bar{X} is the mean of the magnitudes for the specified region(s), and n is the number of data points in the specified region(s).

- PPHase - returns the x,y pairs of both rms power (dBm) and arithmetic mean phase (radian) for every specified region and frequency offset (Hz). The number of pairs is defined by the specified number of regions. This parameter can be used for I/Q vector ($n=0$) in Waveform (time domain) measurement and all parameters are specified by data point in PPHase.

The rms power of the specified region may be expressed as:

$$\text{Power} = 10 \times \log [10 \times (\text{RMS I/Q value})] + 10.$$

The RMS I/Q value (peak volts) is:

$$\sqrt{\frac{1}{n} \sum_{X_i \in \text{region}} X_i X_i^*}$$

where X_i is the complex value representation of an I/Q pair, X_i^* its conjugate complex number, and n is the number of I/Q pairs in the specified region.

The arithmetic mean phase of the specified region may be expressed as:

$$\frac{1}{n} \sum_{Y_i \in \text{region}} Y_i$$

where Y_i is the unwrapped phase of I/Q pair with applying frequency correction and n is the number of I/Q pairs in the specified region.

The frequency correction is made by the frequency offset calculated by the arithmetic mean of every specified region's frequency offset. Each frequency offset is calculated by the least square method against the unwrapped phase of I/Q pair.

Sample Trace Data - Constant Envelope

(See below for explanation of variables.)

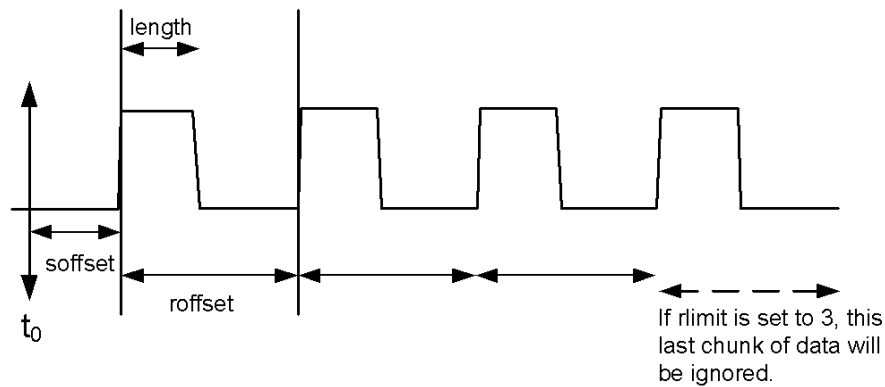

Sample Trace Data - Not Constant Envelope

(See below for explanation of variables.)

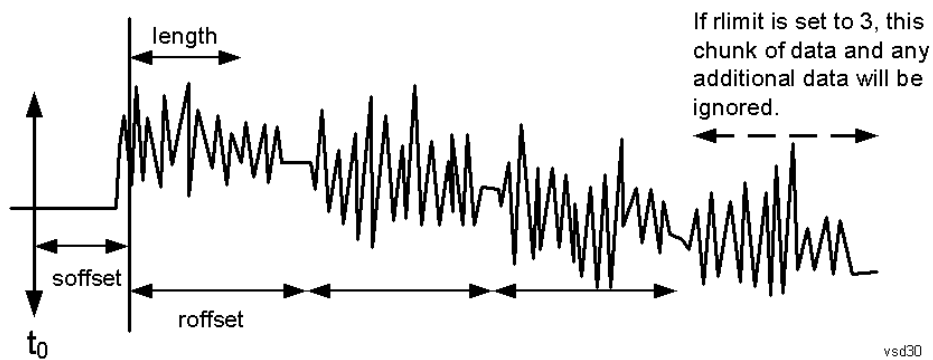

<soffset> - start offset is an optional real number. (It is in seconds for time-domain traces, and is a dimensionless index 0 to Npoints - 1, for frequency-domain traces). It specifies the amount of data at the beginning of the trace that will be ignored before the decimation process starts. It is the time or frequency change from the start of the trace to the point where you want to start using the data. The default value is zero.

<length> - is an optional real number. (It is in seconds for time-domain traces, and is a dimensionless index 0 to Npoints - 1, for frequency-domain traces). It defines how much data will be compressed into one value. This parameter has a default value equal to the current trace length.

<roffset> - repeat offset is an optional real number. (It is in seconds for time-domain traces, and is a dimensionless index 0 to Npoints - 1, for frequency-domain traces). It defines the beginning of the next field of trace elements to be compressed. This is relative to the beginning of the previous field. This parameter has a default value equal to the <length> variable. Note that this parameter is used for a completely different purpose when curve fitting (see CFIT above).

<rlimit> - repeat limit is an optional integer. It specifies the number of data items that you want returned. It will ignore any additional items beyond that number. You can use the Start offset and the Repeat limit to pick out exactly what part of the data you want to use. The default value is all the data.

Calculate Peaks of Trace Data (Remote Command Only)

Returns a list of all the peaks for the currently selected measurement and sub-opcode [n]. The peaks must meet the requirements of the peak threshold and excursion values.

n = any valid sub-opcode for the current measurement. See the MEASure:<measurement> command description of your specific measurement for information on the data that can be returned.

The command can only be used with specific sub-opcodes with measurement results that are trace data. Both real and complex traces can be searched, but complex traces are converted to magnitude in dBm. In many measurements the sub-opcode n=0, is the raw trace data which cannot be searched for peaks. And Sub-opcode n=1, is often calculated results values which also cannot be searched for peaks.

This command uses the data setting specified by the FORMat:BORDER and FORMat:DATA commands and can return real or ASCII data. If the format is set to INT,32, it returns REAL,32 data.

The command has four types of parameters:

- Threshold (in dBm)
- Excursion (in dB)
- Sorting order (amplitude, frequency, time)
- Optional in some measurements: Display line use (all, > display line, < display line)

Remote Command

For Swept SA measurement:

```
:CALCulate:DATA[1]|2|...|6:PEAKS? <threshold>,<excursion>[,AMPLitude
| FREQuency | TIME[,ALL | GTDLine | LTDLine]]
```

	<p>For most other measurements: <code>:CALCulate:DATA[1] 2 ... 6:PEAKs? <threshold>,<excursion>[,AMPLitude FREQuency TIME]</code></p>
Example	<p>Example for Swept SA measurement in Spectrum Analyzer Mode: <code>CALC:DATA4:PEAK? -40, 10, FREQ, GTDL</code> This will identify the peaks of trace 4 that are above -40 dBm, with excursions of at least 10 dB. The peaks are returned in order of increasing frequency, starting with the lowest frequency. Only the peaks that are above the display line are returned.</p> <p>Query Results 1: With <code>FORMat:DATA REAL, 32</code> selected, it returns a list of floating-point numbers. The first value in the list is the number of peak points that are in the following list. A peak point consists of two values: a peak amplitude followed by its corresponding frequency (or time).</p> <p>If no peaks are found the peak list will consist of only the number of peaks, (0).</p>
Notes	<p><n> - is the trace that will be used</p> <p><threshold> - is the level below which trace data peaks are ignored. Note that the threshold value is required and is always used as a peak criterion. To effectively disable the threshold criterion for this command, provide a substantially low threshold value such as -200 dBm. Also note that the threshold value used in this command is independent of and has no effect on the threshold value stored under the Peak Criteria menu.</p> <p><excursion> - is the minimum amplitude variation (rise and fall) required for a signal to be identified as peak. Note that the excursion value is required and is always used as a peak criterion. To effectively disable the excursion criterion for this command, provide the minimum value of 0.0 dB. Also note that the excursion value used in this command is independent of and has no effect on the excursion value stored under the Peak Criteria menu.</p> <p>Values must be provided for threshold and excursion. The sorting and display line parameters are optional (defaults are <code>AMPLitude</code> and <code>ALL</code>).</p> <p>Note that there is always a Y-axis value for the display line, regardless of whether the display line state is on or off. It is the current Y-axis value of the display line which is used by this command to determine whether a peak should be reported</p> <p>Sorting order: <code>AMPLitude</code> - lists the peaks in order of descending amplitude, with the highest peak first (default if optional parameter not sent) <code>FREQuency</code> - lists the peaks in order of occurrence, left to right across the x-axis. <code>TIME</code> - lists the peaks in order of occurrence, left to right across the x-axis.</p> <p>Peaks vs. Display Line: <code>ALL</code> - lists all of the peaks found (default if optional parameter not sent). <code>GTDL</code> (greater than display line) - lists all of the peaks found above the display line. <code>LTDL</code> (less than display line) - lists all of the peaks found below the display line.</p>
Initial S/W Revision	Prior to A.02.00

Hardware-Accelerated Fast Power Measurement (Remote Command Only)

The Fast Power option (FP2) enables very fast channel power measurements for instruments with the prerequisite hardware (DP2 and/or B40). It accomplishes this by performing real-time overlapped FFTs at the hardware layer, using software for basic post-processing before returning the result to the user. The upshot of this

approach is improved throughput for user applications that require many sequential power measurements.

The analysis bandwidth of FP2 is limited by the licenses in the instrument, but its maximum overall analysis bandwidth per acquisition is 40 MHz.

FP2 is remote-only, which means the instrument does not switch to any particular mode or measurement. FP2 commands can be sent while another application is in use on the front panel.

Each Fast Power measurement can be predefined using an array index, and up to 1,000 measurements can be stored. In the following documentation, instances of [1,2,...,999] can be substituted with a particular measurement index, e.g. CALC:FPOW:POW1?, CALC:FPOW:POW2?, CALC:FPOW:POW134?. In this way, power measurements can be defined one time in a batch, and then executed multiple times without having to redefine them, similar to “list mode” on other measurements.

In addition to basic channel power measurements, there are a number of other measurement “functions” for each channel, including peak power, peak frequency, and power spectral density. See the Function parameter for more information.

Reset Fast Power Measurement (Remote Command Only)

Resets the measurement configuration to the defaults.

Mode	All
Remote Command	:CALCulate:FPOWer:POWer[1,2,...,999]:RESet
Example	:CALC:FPOW:POW1:RES
Notes	Option FP2 is required.
Initial S/W Revision	A.14.00

Define Fast Power Measurement (Remote Command Only)

Fast Power acquisitions are configured using the DEFine command. This command accepts a comma-delimited string of configuration parameters and their appropriate values, which are all specified in the subsection below.

Mode	All
Remote Command	:CALCulate:FPOWer:POWer[1,2,...,999]:DEFine "configuration string"
Example	:CALC:FPOW:POW1:DEF "CenterFrequency=2e9, AcquisitionTime=0.005"
Notes	See below for a list of measurement variables that can be defined in the configuration string.
Initial S/W Revision	A.14.00

Acquisition Time

Example	CALC:FPOW:POW1:DEF "AcquisitionTime=0.002"
Notes	The acquisition time parameter sets the time in which the entire spectrum is measured. An increase in the acquisition time yields an improvement in measurement repeatability.
Preset	0.001 s
Range	0 s to 1 s
Default Unit	Time (s)
Initial S/W Revision	A.14.00

Center Frequency

Example	CALC:FPOW:POW1:DEF "CenterFrequency=2e9"
Notes	The center frequency parameter sets the frequency in which the measurement is centered around. The OffsetFrequency parameter is calculated relative to the center frequency.
Preset	1 GHz
Range	0 Hz to maximum instrument frequency
Default Unit	Frequency (Hz)
Initial S/W Revision	A.14.00

DC Coupled

Example	CALC:FPOW:POW1:DEF "DCCoupled=True"
Notes	The DC coupled parameter allows the user to specify whether the DC blocking capacitor is utilized. Set parameter to true when measuring frequencies below 10 MHz.
Preset	False
Range	True (DC Coupled) or False (AC Coupled)
Default Unit	Boolean
Initial S/W Revision	A.14.00

DetectorType

Example	CALC:FPOW:POW1:DEF "DetectorType=Peak"
Notes	Option FP2 is required. The detector type parameter allows the user to choose whether a RMS average or peak value is used during the measurement.
Preset	RmsAverage
Range	RmsAverage, Peak
Initial S/W Revision	A.14.00

Do Noise Correction

Example	CALC:FPOW:POW1:DEF "DoNoiseCorrection=True"
Notes	<p>When noise correction is enabled, the linear noise power contributed by the analyzer is subtracted from all measurements. This effectively lowers the noise floor of the analyzer.</p> <p>When noise correction is enabled, the first measurement for a given set of input parameters will take extra time. This is because the analyzer takes an extra acquisition with the RF input disconnected from the analyzer's front end to measure the noise of just the analyzer. The measured noise floor is stored in a cache so the noise acquisition will occur only once for the same state settings. In other words, if noise correction was turned on and the analyzer made an acquisition at frequency A, then frequency B, and back again to frequency A, the hidden initial noise floor acquisition would only occur for the first acquisition at frequency A and the cached noise floor would be used the second time frequency A was measured.</p>
Preset	False
Range	True (enable noise correction) or False (disable noise correction)
Default Unit	Boolean
Initial S/W Revision	A.14.00

Do Spur Suppression

Example	CALC:FPOW:POW1:DEF "DoSpurSuppression=True"
Notes	<p>When measuring very low level signals, or when large out-of-band inputs are input into the analyzer, sometimes unwanted spurs and residuals can appear in the measured spectrum. Spur suppression is a method to help minimize the levels of these internally generated spurs and residuals.</p> <p>When spur suppression is enabled, the analyzer will automatically take two acquisitions using two different internal analog LO frequencies. The FFT spectrums from both acquisitions are combined by taking the minimum power between both traces on a per FFT bin basis. External signals will have the same amplitude for both traces and therefore will return the expected amplitudes. However, low level spurs and residuals generated internally to the analyzer tend to move to different FFT bins depending on the internal analog LO frequency used, and therefore tend to be suppressed using this spur suppression method.</p> <p>Because two acquisitions, rather than a single acquisition, are made when spur suppression is enabled, the measurement time will always be slower when spur suppression is enabled.</p>
Preset	False
Range	True (enable spur suppression) or False (disable spur suppression)
Default Unit	Boolean
Initial S/W Revision	A.14.00

Electronic Attenuator Bypass

Example	CALC:FPOW:POW1:DEF "ElecAttBypass =False"
Notes	The electronic attenuation bypass parameter allows the user to either utilize or bypass the electronic attenuator. The electronic attenuator is only available for frequencies up to 3.6 GHz. Set parameter to true when using frequencies above 3.6 GHz and set the parameter to false when using the preamp.
Preset	True
Range	True (bypass electronic attenuator) or False (use electronic attenuator)
Default Unit	Boolean
Initial S/W Revision	A.14.00

Electronic Attenuation

Example	CALC:FPOW:POW1:DEF "ElecAttenuation=10"
Notes	Option EA3 is required. The electronic attenuation value parameter sets the amount of electrical attenuation from 0 to 24 dB (1 dB steps). Set "ElecAttBypass=False" to make sure the electronic attenuator path is enabled.
Preset	0 dB
Range	0 – 24 dB (1 dB steps)
Default Unit	dB
Initial S/W Revision	A.14.00

IF Gain

Example	CALC:FPOW:POW1:DEF "IFGain=10"
Notes	The IF gain parameter allows the user to specify the gain at the IF stage anywhere from -6 to 16 dB (1 dB steps). This is an advanced feature, and for most cases this should remain at its default value of 0 dB.
Preset	0 dB
Range	-6 – 16 dB (1 dB steps)
Default Unit	dB
Initial S/W Revision	A.14.00

IF Type

Example	CALC:FPOW:POW1:DEF "IFType=B25M"
Notes	The IF type parameter allows the user to select between different IF paths. For example, if the signal is less than 25 MHz wide, then the user can select the B25M path to take advantage of

	additional filtering on this analog IF path.
Preset	B40M
Range	B10M, B25M, B40M
Initial S/W Revision	A.14.00

Include Power Spectrum

Example	CALC:FPOW:POW1:DEF "IncludePowerSpectrum=True"
Notes	The power spectrum parameter allows the user to read data on the entire spectrum for diagnostic purposes. It is not recommended for production use. See CALC:FPOW:POW[n]:READ2? for details on the binary format of the response.
Preset	False
Range	True (return both channel power and full power spectrum) or False (returns only channel power)
Default Unit	Boolean
Initial S/W Revision	A.14.00

Mechanical Attenuation

Example	CALC:FPOW:POW1:DEF "MechAttenuation=10"
Notes	The mechanical attenuation value parameter sets the amount of mechanical attenuation anywhere from 0 to 70 dB (2 dB steps).
Preset	0 dB
Range	0 – 70 dB (2 dB steps)
Default Unit	dB
Initial S/W Revision	A.14.00

Preamp Mode

Example	CALC:FPOW:POW1:DEF "PreAmpMode=Low"
Notes	The license for the appropriate preamp is required. The preamp mode parameter specifies whether the preamps are being utilized. Low allows any preamps up to 3.6 GHz, and Full allows all licensed preamps. Set "ElecAttBypass=True" in order to utilize any preamps.
Preset	Off
Range	Off, Low, Full
Initial S/W Revision	A.14.00

Resolution Bandwidth Mode

Example	CALC:FPOW:POW1:DEF "PreAmpMode=Low"
Notes	The resolution bandwidth mode parameter allows the user to choose whether the RBW filter is automatically or manually set. The BestSpeed value minimizes measurement time, while the Narrowest value minimizes RBW size (minimum of two FFT bins per RBW). To manually specify an RBW, set this parameter to Explicit, and set the ResolutionBW parameter to the desired value.
Preset	BestSpeed
Range	BestSpeed, Narrowest, Explicit
Initial S/W Revision	A.14.00

Resolution Bandwidth

Example	CALC:FPOW:POW1:DEF "ResolutionBW=25e3"
Notes	The resolution bandwidth parameter sets the 3-dB bandwidth of the RBW filter. The ResolutionBWMode parameter must be set to Explicit in order to manually set the RBW.
Preset	0 Hz
Default Unit	Hz
Initial S/W Revision	A.14.00

Trigger Delay

Example	CALC:FPOW:POW1:DEF "TriggerDelay=0.025"
Notes	The trigger delay parameter sets the time after an external trigger is detected until the measurement is performed.
Preset	0 s
Range	0 – 1 s
Default Unit	Seconds
Initial S/W Revision	A.14.00

Trigger Level

Example	CALC:FPOW:POW1:DEF "TriggerLevel=2"
Notes	The trigger level parameter sets the voltage value at which an external trigger is detected.
Preset	1.2 V
Range	-5 to 5 V
Default Unit	Volts
Initial S/W Revision	A.14.00

Trigger Slope

Example	CALC:FPOW:POW1:DEF "TriggerSlope=Negative"
Notes	The trigger slope parameter indicates the direction of the edge trigger voltage for detection.
Preset	Positive
Range	Positive, Negative
Initial S/W Revision	A.14.00

Trigger Source

Example	CALC:FPOW:POW1:DEF "TriggerSource=Ext1"
Notes	The trigger source parameter allows the user to choose between measurement's triggering freely or controlled by an external input. Ext1 and Ext2 correspond to Trigger 1 In and Trigger 2 In, respectively.
Preset	Free
Range	Free, Ext1, Ext2
Initial S/W Revision	A.14.00

Trigger Timeout

Example	CALC:FPOW:POW1:DEF "TriggerTimeout=0.1"
Notes	The trigger timeout parameter sets the time in which the analyzer will wait for a trigger before automatically performing the measurement.
Preset	1 s
Range	0 – 1 s
Default Unit	Seconds
Initial S/W Revision	A.14.00

Signal Input

Example	CALC:FPOW:POW1:DEF "SignalInput=Fp50MHzCW"
Notes	The signal input parameter allows the user to select between using the main RF input or the internal analyzer reference CW signal of 50 MHz.
Preset	FpMainRf
Range	FpMainRf, Fp50MHzCW
Initial S/W Revision	A.14.00

Use Preselector

Example	CALC:FPOW:POW1:DEF "UsePreSelector=True"
Notes	The preselector parameter allows the user to either utilize or bypass the front end tunable filter at frequencies above 3.6 GHz. For frequencies below 3.6 GHz, the preselector is automatically bypassed, so you do not need to set this parameter to False in those cases.
Preset	False
Range	True (use preselector above 3.6 GHz), or False (preselector bypassed)
Default Unit	Boolean
Initial S/W Revision	A.14.00

Channel Bandwidth Array

Example	CALC:FPOW:POW1:DEF "Bandwidth=[3.84e6, 5e6, 3.84e6]"
Notes	The bandwidth parameter array defines the bandwidth of each channel that will be measured. All array parameters should have the same number of elements. Alternatively, if all the elements are the same value, a single number with no square brackets can be used to define the parameter.
Preset	[1e6]
Range	0 to 40 MHz
Default Unit	Hz
Initial S/W Revision	A.14.00

Channel Filter Type Array

Example	CALC:FPOW:POW1:DEF "FilterType=[RRC, IBW, RRC]"
Notes	The filter type parameter allows the user to choose between an integration bandwidth (IBW) filter or a root-raised-cosine (RRC) filter. The integration bandwidth filter weighs all frequencies within the bandwidth equally. The root-raised-cosine filter has an associated shape parameter, defined by the FilterAlpha parameter. All array parameters should have the same number of elements. Alternatively, if all the elements are the same value, a single value with no square brackets can be used to define the parameter.
Preset	[IBW]
Range	IBW, RRC
Initial S/W Revision	A.14.00

Channel Filter Alpha Array

Example	CALC:FPOW:POW1:DEF "FilterAlpha=[0.5, 0.0, 0.5]"
Notes	The filter alpha parameter allows the user to adjust the alpha value associated with the root-

	raised-cosine (RRC) filter type. Set FilterType to RRC in order to utilize this parameter. All array parameters should have the same number of elements. Alternatively, if all the elements are the same value, a single number with no square brackets can be used to define the parameter.
Preset	[0.22]
Range	0.0 – 1.0
Initial S/W Revision	A.14.00

Channel Measurement Function Array

Example	CALC:FPOW:POW1:DEF "Function=[BandPower, PeakPower, BandPower]"
Notes	This parameter array defines what measurement is being made for each individually-specified channel: BandPower: Total power within the specified bandwidth of the channel (dBm) BandDensity: Total power density within the specified bandwidth of the channel (dBm/Hz) PeakPower: The peak power value within the specified bandwidth of the channel (dBm) PeakFrequency: The frequency which corresponds to the peak power value within the specified bandwidth of the channel. This frequency is relative to the center frequency (Hz) XdBBandwidth: The half power (-3.01 dB) bandwidth of the highest amplitude signal that resides within the channel (Hz), dB is configurable using XdBBandwidth parameter OccupiedBandwidth: The bandwidth at which 99% of the total power resides within the channel (Hz), percentage configurable using OccupiedBandwidthPercent parameter All array parameters should have the same number of elements. Alternatively, if all the elements are the same value, a single value with no square brackets can be used to define the parameter.
Preset	[BandPower]
Range	BandPower, BandDensity, PeakPower, PeakFrequency, XdBBandwidth, OccupiedBandwidth
Initial S/W Revision	A.14.00

Channel Offset Frequency Array

Example	CALC:FPOW:POW1:DEF "OffsetFrequency=[-5e6, 0, 5e6]"
Notes	The offset frequency parameter array defines the difference between the center frequency to the center frequency of each channel. All array parameters should have the same number of elements.
Preset	[0]
Range	0 to 20 MHz
Default Unit	Hz
Initial S/W Revision	A.14.00

Channel Occupied Bandwidth Percent Array

Example	CALC:FPOW:POW1:DEF "OccupiedBandwidthPercent =[0.95, 0.95, 0.95]"
Notes	This parameter only applies for channels whose Function is set to OccupiedBandwidth. The occupied bandwidth percent parameter specifies the percent of total power in these channels. The valid range for this parameter is 0.0 to 1.0, where 1.0 represents 100%. The default for this parameter is 0.99, which will return the bandwidth that contains 99% of the total channel power.
Preset	[0.99]
Range	0 – 1.0
Initial S/W Revision	A.14.00

Channel x-dB Bandwidth Array

Example	CALC:FPOW:POW1:DEF "XdBBandwidth =[-6.02, -3.01, -1.0]"
Notes	This parameter only applies for channels whose Function is set to XdBBandwidth. The X dB bandwidth parameter is used to specify the power relative to the peak channel power over which the bandwidth is calculated. The parameter value must be a negative number.
Preset	[-3.01]
Range	-200 to 0 dB
Default Unit	dB
Initial S/W Revision	A.14.00

Define Fast Power Measurement Query (Remote Command Only)

The DEFine? command is used to retrieve a list of all defined parameters in an ASCII string format

```

M All
o
d
e
R :CALCulate:FPOwer:POWer[1,2,...,999]:DEFine?
e
m
o
t
e
C
o
m
m
a
n
d

```

E :CALC:FPOW:POW1:DEF?

**x
a
m
p
l
e**

N This command query is used to retrieve a list of all defined parameters in an ASCII format.

o The following is an example of the returned results:

t "DCCoupled=False,ElecAttBypass=True,ElecAttenuation=0,IFGain=0,MechAttenuation=0,PreAmpMode=Off,PreSelectorOf
e fset=0,UsePreSelector=False,ExternalReferenceFrequency=10000000,FrequencyReferenceSource=AutoExternalFrequenc
s yReference,IFType=B40M,LOMode=SLW,SignalInput=FpMainRf,AcquisitionTime=0.001,CenterFrequency=1000000000,Re
solutionBW=0,ResolutionBWMode=BestSpeed,DetectorType=RmsAverage,Bandwidth=[1000000],OffsetFrequency=
[0],Function=[BandPower],FilterType=[IBW],FilterAlpha=[0.22],OccupiedBandwidthPercent=[0.99],XdBBandwidth=[-
3.01],DoNoiseCorrection=False,DoSpurSuppression=False,MeasurementMethod=HardwareFFT,IncludePowerSpectrum=F
alse,TriggerDelay=0,TriggerLevel=1.2,TriggerSlope=Positive,TriggerSource=Free,TriggerTimeout=1"

I A.14.00

**n
i
t
i
a
l**

**S
/
W**

**R
e
v
i
s
i
o
n**

Configure Fast Power Measurement (Remote Command Only)

The configure command begins hardware setup and returns immediately, with no acquisition made. This can be used in parallel with other hardware operations to effectively hide the hardware setup time.

Mode	All
Remote Command	:CALCulate:FPOwer:POWer[1,2,...,999]:CONFigure
Example	:CALC:FPOW:POW1:CONF

Notes	Option FP2 is required.
Initial S/W Revision	A.14.00

Initiate Fast Power Measurement (Remote Command Only)

The INITiate command begins an acquisition and returns immediately. The results of the measurement can be retrieved using FETCh.

Mode	All
Remote Command	:CALCulate:FPOWer:POWer[1,2,...,999]:INITiate
Example	:CALC:FPOW:POW1:INIT
Notes	Option FP2 is required.
Initial S/W Revision	A.14.00

Fetch Fast Power Measurement (Remote Command Only)

The FETCh command query is used to retrieve the results of an acquisition initiated by the INIT command. The returned results are in ASCII string format. The string begins and ends with quotation marks.

Mode	All
Remote Command	:CALCulate:FPOWer:POWer[1,2,...,999]:FETCh?
Example	:CALC:FPOW:POW1:FETC?
Notes	Option FP2 is required. Returns m comma-separated ASCII values, where m corresponds to the number of bandwidths defined. 1. Declared function return in the 1st specified channel 2. Declared function return in the 2nd specified channel ... m. Declared function return in the last specified channel The INIT and FETC? command sequence performs the same functionality of a single CALC:FPOW:POW[n]? query. Units of the returned values are dependent on the Function parameter for each channel.
Initial S/W Revision	A.14.00

Execute Fast Power Measurement (Remote Command Only)

This command query is used as shorthand for an INIT command immediately followed by a FETC? command. The returned results are in ASCII string format. The string begins and ends with quotation marks.

Mode	All
Remote Command	:CALCulate:FPOwer:POWer[1,2,...,999]?
Example	:CALC:FPOW:POW1?
Notes	Option FP2 is required. See notes for Fast Power Fetch for return format.
Initial S/W Revision	A.14.00

Binary Read Fast Power Measurement (Remote Command Only)

This command query is used as shorthand for an INIT command immediately followed by a FETC? command. The returned results are in a binary format.

Mode	All
Remote Command	:CALCulate:FPOwer:POWer[1,2,...,999]:READ? :CALCulate:FPOwer:POWer[1,2,...,999]:READ1?
Example	:CALC:FPOW:POW1:READ? :CALC:FPOW:POW1:READ1?
Notes	Option FP2 is required. Returns m 4 byte floating point binary values (Little-Endian), where m corresponds to the number of bandwidths defined.
Initial S/W Revision	A.14.00

Diagnostic Binary Read Fast Power Measurement (Remote Command Only)

This command query is used as shorthand for an INIT command immediately followed by a FETC? command. The returned results are in a binary format. This command is used primarily for diagnostic purposes to test for ADC overloads and to visibly inspect the spectrum.

Mode	All
Remote Command	:CALCulate:FPOwer:POWer[1,2,...,999]:READ2?
Example	:CALC:FPOW:POW1:READ2?
Notes	Option FP2 is required. <div style="display: flex; align-items: flex-start;"> <div style="background-color: #cccccc; padding: 2px 5px; margin-right: 10px;">NOTE</div> <div> <p>Spectrum data is only returned if the IncludePowerSpectrum parameter is set to True. If IncludePowerSpectrum is False, the number of spectrum points will be zero (0).</p> </div> </div> <p>Units of the returned values are dependent on the Function parameter per channel (e.g. dBm for BandPower, Hz for PeakFrequency). Returns binary data (Little-Endian) that contains information on m amount of channels, along with ADC over range and full spectrum data.</p>

	The following is the binary format of the response.
	Bandwidth Return Value
	1. Number of channels specified, m [4 byte int]
	2. Declared function result for the 1st specified channel [4 byte float]
	3. Declared function result for the 2nd specified channel [4 byte float]
	...
	(m + 1). Declared function result for the last (mth) specified channel [4 byte float]
	ADC Over Range
	1. ADC over-range occurred (1: true, 0: false) [2 byte short]
	Spectrum Data
	1. Number of points in the spectrum data, k [4 byte int]
	2. Start frequency of spectrum data (Hz) [8 byte double]
	3. Step frequency of spectrum data (Hz) [8 byte double]
	4. FFT bin at 1st point (dBm) [4 byte float]
	5. FFT bin at 2nd point (dBm) [4 byte float]
	...
	(k + 3). FFT bin at last (kth) point (dBm) [4 byte float]
Initial S/W Revision	A.14.00

Format Data: Numeric Data (Remote Command Only)

This command specifies the format of the trace data input and output. It specifies the formats used for trace data during data transfer across any remote port. It affects only the data format for setting and querying trace data for the :TRACe[:DATA], TRACe[:DATA]?, :CALCulate:DATA[n]?, and FETCh:SANalyzer[n]? commands and queries.

Remote Command	:FORMat[:TRACe][:DATA] ASCii INTeger,32 REAL,32 REAL,64 :FORMat[:TRACe][:DATA]?
Notes	The query response is: ASCii: ASC,8 REAL,32: REAL,32 REAL,64: REAL,64 INTeger,32: INT,32 When the numeric data format is REAL or ASCii, data is output in the current Y Axis unit. When the data format is INTeger, data is output in units of m dBm (.001 dBm). The INT,32 format returns binary 32-bit integer values in internal units (m dBm), in a definite length block.
Dependencies	Sending a data format spec with an invalid number (for example, INT,48) generates no error. The analyzer simply uses the default (8 for ASCii, 32 for INTeger, 32 for REAL). Sending data to the analyzer which does not conform to the current FORMat specified, results in an error. Sending ASCII data when a definite block is expected generates message -161 "Invalid

	Block Data" and sending a definite block when ASCII data is expected generates message -121 "Invalid Character in Number".
Preset	ASCIi
Backwards Compatibility Notes	Note that the INT,32 format is only applicable to the command, TRACe:DATA. This preserves backwards compatibility for the Swept SA measurement. For all other commands/queries which honor FORMat:DATA, if INT,32 is sent the analyzer will behave as though it were set to REAL,32.
Initial S/W Revision	Prior to A.02.00

The specs for each output type follow:

ASCIi - Amplitude values are in ASCII, in the current Y Axis Unit, one ASCII character per digit, values separated by commas, each value in the form:

SX.YYYYYEsZZ

Where:

S = sign (+ or -)

X = one digit to left of decimal point

Y = 5 digits to right of decimal point

E = E, exponent header

s = sign of exponent (+ or -)

ZZ = two digit exponent

REAL,32 - Binary 32-bit real values in the current Y Axis Unit, in a definite length block.

REAL,64 - Binary 64-bit real values in the current Y Axis Unit, in a definite length block.

Format Data: Byte Order (Remote Command Only)

This command selects the binary data byte order for data transfer and other queries. It controls whether binary data is transferred in normal or swapped mode. This command affects only the byte order for setting and querying trace data for the :TRACe[:DATA], TRACe[:DATA]? , :CALCulate:DATA[n]? and FETCh:SANalyzer[n]? commands and queries.

By definition any command that says it uses FORMat:DATA uses any format supported by FORMat:DATA.

The NORMal order is a byte sequence that begins with the most significant byte (MSB) first, and ends with the least significant byte (LSB) last in the sequence: 1|2|3|4. SWAPped order is when the byte sequence begins with the LSB first, and ends with the MSB last in the sequence: 4|3|2|1.

Remote Command :FORMat:BORDER NORMal | SWAPped

9 Channel Power Measurement
Meas

	:FORMat:BORDER?
Preset	NORMal
Initial S/W Revision	Prior to A.02.00

Meas Setup

Displays the setup menu for the currently selected measurement. The parameters included in this menu are as follows.

- Averaging
- IF Gain
- Channel Power Span
- Integrated Bandwidth
- Filter Bandwidth
- Root Raised Cosine (RRC) Filter

Key Path	Front-panel key
Initial S/W Revision	Prior to A.02.00

Avg/Hold Num

Specifies the number of measurement averages used to calculate the measurement result. The average is displayed at the end of each sweep. After the specified number of average counts, the averaging mode (terminal control) setting determines the averaging action.

Key Path	Meas Setup
Mode	SA, WCDMA, C2K, WIMAX OFDMA, 1xEVDO, DVB-T/H, DTMB (CTTB), ISDB-T, CMMB, LTE, LTETDD, Digital Cable TV, WLAN, MSR, LTEAFDD, LTEATDD
Remote Command	<pre>[:SENSe]:CHPower:AVERage:COUNT <integer> [:SENSe]:CHPower:AVERage:COUNT? [:SENSe]:CHPower:AVERage[:STATe] ON OFF 1 0 [:SENSe]:CHPower:AVERage[:STATe]?</pre>
Example	<pre>CHP:AVER:COUN 15 CHP:AVER:COUN? CHP:AVER ON CHP:AVER?</pre>
Notes	You must be in the Spectrum Analysis mode, W-CDMA mode, cdma2000 mode, DVB-T/H mode, DTMB (CTTB) mode, ISDB-T mode, CMMB mode, Digital Cable TV mode, LTE mode, LTE TDD mode 1xEVDO mode or WIMAX OFDMA mode to use this command. Use :INSTrument:SElect to set the mode.
Preset	<pre>SA: 10 WCDMA: 200 WIMAX OFDMA, LTE, LTETDD, MSR: 200 CDMA2K: 20</pre>

	1xEVDO: 20 DVB-T/H: 20 DTMB (CTTB): 20 ISDB-T: 10 CMMB: 10 Digital Cable TV: 10 WLAN: 10 LTEAFDD, LTEATDD:200 ON
State Saved	Saved in instrument state.
Min	1
Max	10000
Initial S/W Revision	Prior to A.02.00
Modified at S/W Revision	A.02.00, A.03.00

Avg Mode

Allows you to select the type of termination control used for the averaging function. This determines the averaging action after the specified number of data acquisitions (average count) is reached.

When set to Exponential (Exp) the measurement averaging continues using the specified number of averages to compute each exponentially-weighted averaged value. The average is displayed at the end of each sweep.

When set to Repeat, the measurement resets the average counter each time the specified number of averages is reached.

Key Path	Meas Setup
Mode	SA, WCDMA, C2K, WIMAX OFDMA, 1xEVDO, DVB-T/H, DTMB (CTTB), ISDB-T, CMMB, LTE, LTETDD, Digital Cable TV, WLAN, MSR, LTEAFDD, LTEATDD
Remote Command	[:SENSe] :CHPower :AVERage :TCONtrol EXPonential REPEAT [:SENSe] :CHPower :AVERage :TCONtrol ?
Example	CHP:AVER:TCON EXP CHP:AVER:TCON?
Notes	You must be in the Spectrum Analysis mode, W-CDMA mode, cdma2000 mode, DVB-T/H mode, DTMB (CTTB) mode, ISDB-T mode, CMMB mode, Digital Cable TV mode, LTE mode, LTE TDD mode, WLAN mode, 1xEVDO mode or WIMAX OFDMA mode to use this command. Use :INSTrument:SElect to set the mode.
Preset	EXP
State Saved	Saved in instrument state.
Range	Exp Repeat

Initial S/W Revision	Prior to A.02.00
Modified at S/W Revision	A.02.00, A.03.00

Integ BW

Specifies the range of integration used in calculating the power in the channel. The integration bandwidth (IBW) is displayed on the trace as two markers connected by an arrow.

Key Path	Meas Setup
Mode	SA, WCDMA, C2K, WIMAX OFDMA, 1xEVDO, DVB-T/H, DTMB (CTTB), ISDB-T, CMMB, LTE, LTETDD, Digital Cable TV, WLAN, LTEAFDD, LTEATDD
Remote Command	[:SENSe]:CHPower:BANDwidth:INTEgration <bandwidth> [:SENSe]:CHPower:BANDwidth:INTEgration?
Example	CHP:BAND:INT 10MHz CHP:BAND:INT?
Notes	You must be in the Spectrum Analysis mode, W-CDMA mode, cdma2000 mode, DVB-T/H mode, DTMB (CTTB) mode, ISDB-T mode, CMMB mode, Digital Cable TV mode, LTE mode, LTE TDD mode, WLAN mode, 1xEVDO mode or WIMAX OFDMA mode to use this command. Use :INSTrument:SElect to set the mode.
Dependencies	For MSR/LTE-Advanced FDD/TDD mode, this key is blank. In order to keep backwards compatible with the legacy LTE FDD/TDD, the scpi command is supported in LTE & LTE-A converged application.
Couplings	The minimum value of the span is coupled with the integration bandwidth.
Preset	SA: 2 MHz WCDMA: 5 MHz C2K: 1.23 MHz WIMAX OFDMA: 10 MHz 1xEVDO: 1.23 MHz DVB-T/H: 7.61MHz DTMB (CTTB): 8MHz ISDB-T: 5.6MHz CMMB: 8MHz LTE: 5 MHz LTETDD: 5 MHz Digital Cable TV: 8MHz WLAN: if Radio Std is 802.11a/g(OFDM/DSSS-OFDM): 20 MHz if Radio Std is 802.11b: 25 MHz if Radio Std is 802.11n(20MHz): 20 MHz if Radio Std is 802.11n(40MHz): 40 MHz

	if Radio Std is 802.11ac (20 MHz): 20 MHz
	if Radio Std is 802.11ac (40 MHz): 40 MHz
	if Radio Std is 802.11ac (80 MHz): 80 MHz
	if Radio Std is 802.11ac (160 MHz): 160 MHz
	if Radio Std is 802.11ac (80 MHz + 80 MHz): 80 MHz
	if Radio Std is 802.11ah (1 MHz): 1 MHz
	if Radio Std is 802.11ah (2 MHz): 2 MHz
	if Radio Std is 802.11ah (4 MHz): 4 MHz
	if Radio Std is 802.11ah (8 MHz): 8 MHz
	if Radio Std is 802.11ah (16 MHz): 16 MHz
	if Radio Std is 802.11j/p (20 MHz): 20 MHz
	if Radio Std is 802.11j/p (10 MHz): 10 MHz
	if Radio Std is 802.11p (5 MHz): 5 MHz

State Saved	Saved in instrument state.
Min	100 Hz
Max	Hardware Maximum Span
Initial S/W Revision	Prior to A.02.00
Modified at S/W Revision	A.02.00, A.03.00, A.14.50

PhNoise Opt

Selects the LO (local oscillator) phase noise behavior for various operating conditions. Refer to ["PhNoise Opt" on page 1713](#)

in the Swept SA measurement for details.

Key Path	Meas Setup
Initial S/W Revision	A.04.20

PhNoise Opt Auto

Selects the LO (local oscillator) phase noise behavior to optimize dynamic range and speed for various instrument operating conditions. Refer to PhNoise Opt Auto State@3215 in the Swept SA measurement for details.

Key Path	Meas Setup
Remote Command	[:SENSe] :CHPower:FREQuency:SYNTHeSis:AUTO[:STATe] OFF ON 0 1 [:SENSe] :CHPower:FREQuency:SYNTHeSis:AUTO[:STATe] ?
Example	CHP:FREQ:SYNT:AUTO 1 CHP:FREQ:SYNT:AUTO?
Preset	OFF
State Saved	Saved in instrument state.

Range	Auto Man
Readback Text	"Auto" is underlined when Auto is selected, otherwise Man is underlined.
Initial S/W Revision	A.04.20

PhNoise Opt State

Selects the LO (local oscillator) phase noise behavior for various operating conditions. Refer to "[PhNoise Opt](#)" on page 1713 in the Swept SA measurement for details.

Key Path	Meas Setup
Remote Command	[:SENSe] :CHPower:FREQuency:SYNTHeSis[:STATe] 1 2 3 [:SENSe] :CHPower:FREQuency:SYNTHeSis[:STATe] ?
Example	CHP:FREQ:SYNT 1 CHP:FREQ:SYNT?
Notes	Parameter key: 1. optimizes phase noise for close-in from the carrier. 2. optimizes phase noise for wide-offset from the carrier. 3. optimizes LO for tuning speed.
Couplings	Best Close-in Φ Noise The frequency below which the phase noise is optimized is model dependent: PXA with option EP1: [offset <140 kHz] Models with option EP2: [offset <70 kHz] CXA with option EP4: [offset <90 kHz] CXA without option EP4: n/a All other models: [offset <20 kHz] Best Wide-offset Φ Noise The frequency below which the phase noise is optimized is model dependent: PXA with option EP1: [offset >160 kHz] Models with option EP2: [offset >100 kHz] CXA with option EP4: [offset >130 kHz] CXA without option EP4: n/a All other models: [offset >30 kHz] Fast Tuning The Fast Tuning details are model dependent: CXA without option EP4: n/a PXA with option EP1: [single loop] Models with option EP2: [medium loop bandwidth] All other models: [same as Close-in]
Preset	3
State Saved	Saved in instrument state.

Range	Best Close-in Φ Noise [offset < 140 kHz] Best Wide-offset Φ Noise [offset > 160 kHz] Fast Tuning [same as Close-in] [] is model dependent. See Couplings for details.
Initial S/W Revision	A.04.20

IF Gain

Sets the IF Gain function to Auto, Low Gain or High Gain. These settings affect sensitivity and IF overloads.

Key Path	Meas Setup
Dependencies	The IF Gain keys (FFT IF Gain and Swept IF Gain) have no effect when the U7227A USB Preamplifier is connected. This is not annotated or reflected on any softkey; there are no keys grayed out nor any SCPI locked out. The analyzer simply behaves as though both FFT IF Gain and Swept IF Gain are set to Low regardless of the setting on the keys.
Initial S/W Revision	Prior to A.02.00

IF Gain Auto

Activates the auto rules for IF Gain. When Auto is active, the IF Gain is set to High Gain under any of the following conditions:

- The input attenuator is set to 0 dB
- The preamp is turned On and the frequency range is under 3.6 GHz

For other settings, Auto sets the IF Gain to Low Gain.

Key Path	Meas Setup, IF Gain
Remote Command	[:SENSe] :CHPower:IF:GAIN:AUTO[:STATe] ON OFF 1 0 [:SENSe] :CHPower:IF:GAIN:AUTO[:STATe] ?
Example	CHP:IF:GAIN:AUTO ON CHP:IF:GAIN:AUTO?
Couplings	When the auto attenuation exists (for example, with an electrical attenuator), IF Gain State differs depending on the condition. Auto sets IF Gain to High Gain under any of the following conditions: The input attenuator is set to 0 dB, or the preamp is turned on and the frequency range is under 3.6 GHz. For other conditions, Auto sets IF Gain to Low Gain.
Preset	OFF
State Saved	Saved in instrument state.
Range	Off On
Initial S/W Revision	Prior to A.02.00

IF Gain State

Selects the range of the IF Gain.

Key Path	Meas Setup, IF Gain
Remote Command	[:SENSe] :CHPower :IF :GAIN [:STATe] ON OFF 1 0 [:SENSe] :CHPower :IF :GAIN [:STATe] ?
Example	CHP :IF :GAIN ON CHP :IF :GAIN ?
Notes	ON = high gain OFF = low gain
Couplings	When the auto attenuation exists (for example, with an electrical attenuator), IF Gain State differs depending on the condition. Auto sets IF Gain to High Gain under any of the following conditions: The input attenuator is set to 0 dB, or the preamp is turned on and the frequency range is under 3.6 GHz. For other conditions, Auto sets IF Gain to Low Gain.
Preset	OFF
State Saved	Saved in instrument state.
Range	Low Gain High Gain
Initial S/W Revision	Prior to A.02.00

Method

Turns the Root Raised Cosine (RRC) filter On or Off. The α value (roll off) for the filter is set to the value of the Filter Alpha parameter, and the RRC filter bandwidth is set to the Filter BW parameter.

Key Path	Meas Setup
Mode	SA, WCDMA, WIMAX OFDMA, DVB-T/H, DTMB (CTTB), ISDB-T, CMMB, LTE, LTE-TDD, Digital Cable TV, WLAN, LTE-FDD, LTE-TDD
Remote Command	[:SENSe] :CHPower :FILTer [:RRC] [:STATe] OFF ON 0 1 [:SENSe] :CHPower :FILTer [:RRC] [:STATe] ?
Example	CHP :FILT OFF CHP :FILT ?
Notes	This parameter is normally used when TETRA is selected as the Radio Std. You must be in the Spectrum Analysis mode, DVB-T/H mode, DTMB (CTTB) mode, ISDB-T mode, CMMB mode, LTE mode, LTE TDD mode, WLAN mode, WIMAX OFDMA mode or W-CDMA mode to use this command. Use :INSTRument:SElect to set the mode.
Dependencies	For CDMA2K mode, this key is blank. For 1xEVDO mode, this key is blank. For MSR mode, this key is blank. For LTE-Advanced FDD/TDD mode, this key is blank. In order to keep backwards compatible with the legacy LTE FDD/TDD, the scpi command is supported in LTE & LTE-A converged application For WLAN 802.11 ac (80 + 80 MHz), RRC Weighted is not supported.
Preset	OFF

State Saved	Saved in instrument state.
Range	Integ BW RRC Weighted
Initial S/W Revision	Prior to A.02.00
Modified at S/W Revision	A.02.00, A.03.00, A.10.00

Method

Turns the Root Raised Cosine (RRC) filter On or Off. The α value (roll off) for the filter is set to the value of the Filter Alpha parameter, and the RRC filter bandwidth is set to the Filter BW parameter.

Key Path	Meas Setup
Mode	SA, WCDMA,WIMAX OFDMA, DVB-T/H, DTMB (CTTB), ISDB-T, CMMB, LTE, LTETDD, Digital Cable TV, WLAN, LTEAFDD, LTEATDD
Remote Command	<code>[:SENSE] :CHPower:FILTer [:RRC] [:STATE] OFF ON 0 1</code> <code>[:SENSE] :CHPower:FILTer [:RRC] [:STATE] ?</code>
Example	CHP:FILT OFF CHP:FILT?
Notes	This parameter is normally used when TETRA is selected as the Radio Std. You must be in the Spectrum Analysis mode, DVB-T/H mode, DTMB (CTTB) mode, ISDB-T mode, CMMB mode, LTE mode, LTE TDD mode, WLAN mode,WIMAX OFDMA mode or W-CDMA mode to use this command. Use :INSTrument:SElect to set the mode.
Dependencies	For CDMA2K mode, this key is blank. For 1xEVDO mode, this key is blank. For MSR mode, this key is blank. For LTE-Advanced FDD/TDD mode, this key is blank. In order to keep backwards compatible with the legacy LTE FDD/TDD, the scpi command is supported in LTE & LTE-A converged application For WLAN 802.11 ac (80 + 80 MHz), RRC Weighted is not supported .
Preset	OFF
State Saved	Saved in instrument state.
Range	Integ BW RRC Weighted
Initial S/W Revision	Prior to A.02.00
Modified at S/W Revision	A.02.00, A.03.00, A.10.00

Filter Alpha

Inputs the alpha value for the Root Raised Cosine (RRC) filter.

Key Path	Meas Setup, Method
Mode	SA, WCDMA,WIMAX OFDMA, DVB-T/H, DTMB (CTTB), ISDB-T, CMMB, LTE, LTETDD, Digital Cable TV, WLAN, LTEAFDD, LTEATDD

Remote Command	<code>[:SENSe]:CHPower:FILTer[:RRC]:ALPHa <real></code> <code>[:SENSe]:CHPower:FILTer[:RRC]:ALPHa?</code>
Example	CHP:FILT:ALPH 0.5 CHP:FILT:ALPH?
Notes	This parameter is normally used when TETRA is selected as the Radio Std. You must be in the Spectrum Analysis mode, DVB-T/H mode, DTMB (CTTB) mode, ISDB-T mode, CMMB mode, LTE mode, LTE TDD mode, WLAN mode,WIMAX OFMDA mode or W-CDMA mode to use this command. Use :INSTrument:SElect to set the mode.
Dependencies	For CDMA2K mode, this key is blank. For 1xEVDO mode, this key is blank. For MSR mode, this key is blank. For LTE-Advanced FDD/TDD mode, this key is blank In order to keep backwards compitible with the legacy LTE FDD/TDD, the scpi command is supported in LTE & LTE-A converged application
Preset	SA, WCDMA, , WIMXA OFMDA, DVB-T/H, ISDB-T, CMMB, LTE, LTETDD, WLAN: 0.22 DTMB (CTTB): 0.05 Digital Cable TV: 0.15
State Saved	Saved in instrument state.
Min	0.01
Max	1.00
Initial S/W Revision	Prior to A.02.00
Modified at S/W Revision	A.02.00, A.03.00, A.10.00

Filter BW

Inputs the Root Raised Cosine (RRC) filter bandwidth. Normally, the filter bandwidth is the same as the symbol rate of the signal.

Key Path	Meas Setup, Method, RRC Weighted
Mode	SA, WCDMA,WIMAX OFDMA, DVB-T/H, DTMB (CTTB), ISDB-T, CMMB, LTE, LTETDD, Digital Cable TV, WLAN, LTEAFDD, LTEATDD
Remote Command	<code>[:SENSe]:CHPower:FILTer[:RRC]:BANDwidth <real></code> <code>[:SENSe]:CHPower:FILTer[:RRC]:BANDwidth?</code>
Example	CHP:FILT:BAND 10MHz CHP:FILT:BAND?
Notes	This parameter is normally used when TETRA is selected as the Radio Std. You must be in the Spectrum Analysis mode, DVB-T/H mode, DTMB (CTTB) mode, ISDB-T mode, CMMB mode, LTE mode, LTE TDD mode, WLAN mode,WIMAX OFMDA mode or W-CDMA mode to use this command. Use :INSTrument:SElect to set the mode.
Dependencies	For CDMA2K mode, this key is blank. For 1xEVDO mode, this key is blank.

	<p>For MSR mode, this key is blank.</p> <p>For LTE-Advanced FDD/TDD, this key is blank.</p> <p>In order to keep backwards compatible with the legacy LTE FDD/TDD, the scpi command is supported in LTE & LTE-A converged application</p>
Preset	<p>SA, LTE, LTETDD: 3.84MHz</p> <p>WCDMA: 3.84MHz</p> <p>WIMAX OFDMA: 10MHz</p> <p>DVB-T/H: 8MHz</p> <p>DTMB (CTTB): 7.56MHz</p> <p>ISDB-T: 5.6MHz</p> <p>CMMB: 7.512MHz</p> <p>Digital Cable TV: 6.9MHz</p> <p>WLAN:</p> <p>if Radio Std is 802.11a/g(OFDM/DSSS-OFDM): 16.6 MHz</p> <p>if Radio Std is 802.11b: 22 MHz</p> <p>if Radio Std is 802.11n(20MHz): 17.8 MHz</p> <p>if Radio Std is 802.11n(40MHz): 36.6 MHz</p>
State Saved	Saved in instrument state.
Min	100 Hz
Max	100 MHz
Backwards Compatibility SCPI	[:SENSe] :CHPower :FILTer [:RRC] :BWIDth
Initial S/W Revision	Prior to A.02.00
Modified at S/W Revision	A.02.00, A.03.00, A.10.00

Limits

Accesses the Limits menu that allows you to set up the test limit for channel power or power spectral density.

When DVB-T/H mode or DTMB (CTTB) mode is selected or DVB-T radio standard is selected in SA mode, this functionality is disabled and input signal will be compared against pre-defined spectrum mask, instead. See 1.3.2 Limit Line Mask for DVB-T for more details.

In DVB-T/H, DTMB (CTTB), ISDB-T, CMMB mode, this key is blank. If DVB-T is selected as current Radio Std in SA Mode, this key is grayed out.

In MSR, LTE-Advanced FDD/TDD mode, this feature is not supported and the key is blank because the power of each carrier may be different.

Key Path	Meas Setup
Initial S/W Revision	A.10.00

Power Limit

If Power Limit is on, Power Limit is used as threshold which can judge whether the real measured channel power can be passed or not. If real measured channel power exceeds Power Limit, channel power test fails, otherwise, it passes. If Power Limit is off, channel power test is always passed.

Key Path	Meas Setup, Limits
Mode	SA, WCDMA, C2K, WIMAX OFDMA, 1xEVDO, LTE, LTETDD, Digital Cable TV, WLAN, LTEAFDD, LTEATDD
Remote Command	<pre>:CALCulate:CHPower:LIMit:POWer <amp;pl> :CALCulate:CHPower:LIMit:POWer? :CALCulate:CHPower:LIMit:POWer:STATe OFF ON 0 1 :CALCulate:CHPower:LIMit:POWer:STATe?</pre>
Example	<pre>CALC:CHP:LIM:POW 16.00 CALC:CHP:LIM:POW? CALC:CHP:LIM:POW:STAT ON CALC:CHP:LIM:POW:STAT?</pre>
Notes	<p>This parameter and PSD Limit can determine Pass/Fail criteria.</p> <p>If ((power limit = On) and (PSD limit= Off)) Pass if (power test passes) Fail if (power test fails)</p> <p>If ((power limit = On) and (PSD limit= On)) Pass if (both power test and PSD test pass) Fail if (either of power test or PSD test fails)</p> <p>If ((power limit = Off) and (PSD limit= On)) Pass if (PSD test passes) Fail if (PSD test fails)</p> <p>If ((power limit = Off) and (PSD limit= Off)) Always Pass</p> <p>For MSR mode, this key is blank. For LTE-Advanced FDD/TDD mode, this key is blank.</p> <p>In order to keep backwards compatible with the legacy LTE FDD/TDD, the scpi command is supported in LTE & LTE-A converged application</p> <p>For WLAN 802.11ac (80 MHz + 80 MHz), the power test and the PSD test are performed to both carriers. Which means the power (or PSD) readouts of both carriers should be compared with the power (or PSD) limit individually, and the test passes only when both values are lower than the limit.</p>
Preset	<pre>16.00 SA, WCDMA, C2K, WIMAX OFDMA, 1xEVDO, DVB-T/H, DTMB (CTTB), LTE, LTETDD, Digital Cable TV: OFF WLAN: ON</pre>
State Saved	Saved in instrument state.

Min	-200.0
Max	200.0
Initial S/W Revision	A.10.00

PSD Limit

If PSD (power spectral density) Limit is ON, PSD Limit is used as threshold which can judge whether the real measured PSD can be passed or not. If real measured PSD exceeds PSD Limit, PSD test fails, otherwise, it passes. If PSD is off, PSD test is always passed.

Key Path	Meas Setup, Limits
Mode	SA, WCDMA, C2K, WIMAX OFDMA, 1xEVDO, LTE, LTETDD, Digital Cable TV, WLAN
Remote Command	<pre> :CALCulate:CHPower:LIMit:PSDensity <real> :CALCulate:CHPower:LIMit:PSDensity? :CALCulate:CHPower:LIMit:PSDensity:STATe OFF ON 0 1 :CALCulate:CHPower:LIMit:PSDensity:STATe? </pre>
Example	<pre> CALC:CHP:LIM:PSD 4.00 CALC:CHP:LIM:PSD? CALC:CHP:LIM:POW:STAT ON CALC:CHP:LIM:POW:STAT? </pre>
Notes	<p>This parameter and Power Limit can determine Pass/Fail criteria.</p> <p>If ((power limit = On) and (PSD limit= Off)) Pass if (power test passes) Fail if (power test fails)</p> <p>If ((power limit = On) and (PSD limit= On)) Pass if (both power test and PSD test pass) Fail if (either of power test or PSD test fails)</p> <p>If ((power limit = Off) and (PSD limit= On)) Pass if (PSD test passes) Fail if (PSD test fails)</p> <p>If ((power limit = Off) and (PSD limit= Off)) Always Pass</p> <p>For MSR mode, this key is blank.</p> <p>For LTE-Advanced FDD/TDD mode, this key is blank.</p> <p>For WLAN 802.11ac (80 MHz + 80 MHz), the power test and the PSD test are performed to both carriers. Which means the PSD (or power) readouts of both carriers should be compared with the PSD (or power) limit individually, and the test passes only when both values are lower than the limit.</p>
Couplings	The value is automatically converted when PSD Unit is changed.
Preset	<pre> 4.00 SA, WCDMA, C2K, WIMAX OFDMA, 1Xevdo, LTE, LTETDD, Digital Cable TV: OFF WLAN: ON </pre>

State Saved	Saved in instrument state.
Min	-200.0
Max	200.0
Initial S/W Revision	A.10.00

Power Limit Fail (remote command only)

The command is query only and used to query if power test passes or fails. When DVB-T/H mode or DTMB (CTTB) mode is selected or DVB-T radio standard is selected in SA mode, this query SCPI command does not make any sense.

Remote Command	:CALCulate:CHPower:LIMit:POWer:FAIL?
Example	CALC:CHP:LIM:POW:FAIL?
Notes	This command is query only. When Power Limit is off, the returned value is always 0 (pass). When Power Limit is on, the returned value is 0(pass) while power test passes and 1(fail) while power test fails. In MSR, LTE-Advanced FDD/TDD mode, this feature is not supported. In order to keep backwards compatible with the legacy LTE FDD/TDD, the scpi command is supported in LTE & LTE-A converged application.
Initial S/W Revision	A.10.00

PSD Limit Fail (remote command only)

The command is query only and used to query if PSD test passes or fails. When DVB-T/H mode or DTMB (CTTB) mode is selected or DVB-T radio standard is selected in SA mode, this query SCPI command does not make any sense.

Remote Command	:CALCulate:CHPower:LIMit:PSD:FAIL?
Example	CALC:CHP:LIM:PSD:FAIL?
Notes	This command is query only. When PSD Limit is off, the returned value is always 0 (pass). When PSD Limit is on, the returned value is 0(pass) while PSD test passes and 1(fail) while PSD test fails.
Initial S/W Revision	A.10.00

PSD Unit

Sets the unit bandwidth for Power Spectral Density. The available units are dBm/Hz and dBm/MHz.

Key Path	Meas Setup
Mode	SA, WCDMA, WIMAX OFDMA, 1xEVDO, DVB-T/H, DTMB (CTTB), LTE, LTETDD, Digital Cable TV, WLAN, MSR, LTEAFDD, LTEATDD
Remote Command	:UNIT:CHPower:POWer:PSD DBMHZ DBMMHZ

	:UNIT:CHPower:POWer:PSD?
Example	UNIT:CHP:POW:PSD DBMMHZ UNIT:CHP:POW:PSD?
Couplings	When the PSD unit is changed, the PSD result of the "MEAS READ FETCH:CHP1?" is also changed by the PSD unit basis (in either dBm/Hz or dBm/MHz).
Preset	DBMHZ WLAN: DBMMHZ
State Saved	Saved in instrument state.
Range	dBm/Hz dBm/MHz
Initial S/W Revision	Prior to A.02.00
Modified at S/W Revision	A.02.00, A.03.00

Meas Preset

Restores all the measurement parameters to their default values.

Key Path	Meas Setup
Mode	SA, WCDMA, C2K, WIMAX OFDMA, 1xEVDO, DVB-T/H, DTMB (CTTB), ISDB-T, CMMB, LTE, LTETDD, Digital Cable TV, WLAN, MSR, LTEAFDD, LTEATDD
Remote Command	:CONFigure:CHPower
Example	CONF:CHP
Initial S/W Revision	Prior to A.02.00
Modified at S/W Revision	A.02.00, A.03.00

Mode

See ["Mode" on page 353](#)

Mode Preset

Returns the active mode to a known state.

Mode Preset does the following for the currently active mode:

- Aborts the currently running measurement.
- Brings up the default menu for the mode, with no active function.
- Sets measurement Global settings to their preset values for the active mode only.
- Activates the default measurement.
- Brings up the default menu for the mode.
- Clears the input and output buffers.
- Sets Status Byte to 0.

Mode Preset does not:

- Cause a mode switch
- Affect mode persistent settings
- Affect system settings
- See "[How-To Preset](#)" on page 1168 for more information.

Key Path	Front-panel key
Remote Command	:SYSTem:PRESet
Example	:SYST:PRES
Notes	<p>*RST is preferred over :SYST:PRES for remote operation. *RST does a Mode Preset, as done by the :SYST:PRES command, and it sets the measurement mode to Single measurement rather than Continuous for optimal remote control throughput.</p> <p>Clears all pending OPC bits. The Status Byte is set to 0.</p>
Couplings	A Mode Preset aborts the currently running measurement, activates the default measurement, and gets the mode to a consistent state with all of the default couplings set.
Backwards Compatibility Notes	<p>In the X-Series, the legacy "Factory Preset" has been replaced with Mode Preset, which only presets the currently active mode, not the entire instrument. In the X-Series, the way to preset the entire instrument is by using System, Restore System Defaults All, which behaves essentially the same way as restore System Defaults does on ESA and PSA.</p> <p>There is also no "Preset Type" as there is on the PSA. There is a green Mode Preset front-panel key that does a Mode Preset and a white-with-green-letters User Preset front-panel key that does a User Preset. The old PRESet:TYPE command is ignored (without generating an error), and SYST:PRES without a parameter does a Mode Preset, which should cover most backward code compatibility issues.</p> <p>The settings and correction data under the Input/Output front-panel key (examples: Input Z Corr,</p>

Ext Amp Gain, etc.) are no longer part of any Mode, so they will not be preset by a Mode Preset. They are preset using Restore Input/Output Defaults, Restore System Defaults All. Note that because User Preset does a Recall State, and all of these settings are saved in State, they ARE recalled when using User Preset.

Initial S/W Revision Prior to A.02.00

How-To Preset

The table below shows all possible presets, their corresponding SCPI commands and front-panel access (key paths). Instrument settings depend on the current measurement context. Some settings are local to the current measurement, some are global (common) across all the measurements in the current mode, and some are global to all the available modes. In a similar way, restoring the settings to their preset state can be done within the different contexts.

Auto Couple - is a measurement local key. It sets all Auto/Man parameter couplings in the measurement to Auto. Any Auto/Man selection that is local to other measurements in the mode will not be affected.

Meas Preset - is a measurement local key. Meas Preset resets all the variables local to the current measurement except the persistent ones.

Mode Preset - resets all the current mode's measurement local and measurement global variables except the persistent ones.

Restore Mode Defaults - resets ALL the Mode variables (and all the Meas global and Meas local variables), including the persistent ones.

Type Of Preset	SCPI Command	Front Panel Access
Auto Couple	:COUPle ALL	Auto Couple front-panel key
Meas Preset	:CONFigure: <Measurement>	Meas Setup Menu
Mode Preset	:SYSTem:PRESet	Mode Preset (green key)
Restore Mode Defaults	:INSTrument:DEFault	Mode Setup Menu
Restore All Mode Defaults	:SYSTem:DEFault MODes	System Menu; Restore System Default Menu
*RST	*RST	not possible (Mode Preset with Single)
Restore Input/Output Defaults	:SYSTem:DEFault INPut	System Menu; Restore System Default Menu
Restore Power On Defaults	:SYSTem:DEFault PON	System Menu; Restore System Default Menu
Restore Alignment Defaults	:SYSTem:DEFault ALIGn	System Menu; Restore System Default Menu
Restore Miscellaneous Defaults	:SYSTem:DEFault MISC	System Menu; Restore System Default Menu

9 Channel Power Measurement
Mode Preset

Restore All System Defaults	:SYSTem:DEFault [ALL] :SYSTem:PRESet:PERSistent	System Menu; Restore System Default Menu
User Preset	:SYSTem:PRESet:USER	User Preset Menu
User Preset All Modes	:SYSTem:PRESet:USER:ALL	User Preset Menu
Power On Mode Preset	:SYSTem:PON:TYPE MODE	System Menu
Power On User Preset	:SYSTem:PON:TYPE USER	System Menu
Power On Last State	:SYSTem:PON:TYPE LAST	System Menu

Mode Setup

See ["Mode Setup" on page 388](#)

Peak Search

Places the selected marker on the trace point with the maximum y-axis value. Pressing Peak Search with the selected marker Off causes the selected marker to be set to Normal, then a peak search is immediately performed.

Key Path	Front panel key
Mode	SA, WCDMA, C2K, WIMAX OFDMA, 1xEVDO, DVB-T/H, DTMB (CTTB), ISDB-T, CMMB, LTE, LTE-TDD, Digital Cable TV, WLAN, MSR, LTEAFDD, LTEATDD
Remote Command	:CALCulate:CHPower:MARKer[1] 2 ... 12:MAXimum
Example	CALC:CHP:MARK2:MAX
Initial S/W Revision	Prior to A.02.00
Modified at S/W Revision	A.02.00, A.03.00

Print

See "Print " on page 430

Quick Save

The Quick Save front-panel key repeats the most recent save that was performed from the Save menu, with the following exceptions:

- Register saves are not remembered as Saves for the purpose of the Quick Save function
- If the current measurement does not support the last non-register save that was performed, an informational message is generated, “File type not supported for this measurement”

Quick Save repeats the last type of qualified save (that is, a save qualified by the above criteria) in the last save directory by creating a unique filename using the Auto File Naming algorithm described below.

If Quick Save is pressed after startup and before any qualified Save has been performed, the Quick Save function performs a Screen Image save using the current settings for Screen Image saves (current theme, current directory), which then becomes the “last save” for the purpose of subsequent Quick Saves.

The Auto File Naming feature automatically generates a file name for use when saving a file. The filename consists of a prefix and suffix separated by a dot, as is standard for the Windows® file system. A default prefix exists for each of the available file types:

Type	Default Prefix	Menu
State	State_	(Save/Recall)
Trace + State	State_	(Save/Recall)
Screen	Screen_	(Save/Recall)
Amplitude Corrections	Ampcor_	(Import/Export)
Traces	Trace_	(Import/Export)
Limit Lines	LLine_	(Import/Export)
Measurement Result	MeasR_	(Import/Export)
Capture Buffer	CapBuf_	(Import/Export)

A four digit number is appended to the prefix to create a unique file name. The numbering sequence starts at 0000 within each Mode for each file type and updates incrementally to 9999, then wraps to 0000 again. It remembers where it was through a Mode Preset and when leaving and returning to the Mode. It is reset by Restore Misc Defaults and Restore System Defaults and subsequent running of the instrument application. So, for example, the first auto file name generated for State files is State_0000.state. The next is State_0001, and so forth.

One of the key features of Auto File Name is that we guarantee that the Auto File Name will never conflict with an existing file. The algorithm looks for the next

available number. If it gets to 9999, then it looks for holes. If it find no holes, that is no more numbers are available, it gives an error.

For example, if when we get to State_0010.state there is already a State_0010.state file in the current directory, it advances the counter to State_0011.state to ensure that no conflict will exist (and then it verifies that State_0011.state also does not exist in the current directory and advances again if it does, and so forth).

If you enter a file name for a given file type, then the prefix becomes the filename you entered instead of the default prefix, followed by an underscore. The last four letters (the suffix) are the 4-digit number.

For example, if you save a measurement results file as “fred.csv”, then the next auto file name chosen for a measurement results save will be fred_0000.csv.

NOTE

Although 0000 is used in the example above, the number that is used is actually the current number in the Meas Results sequence, that is, the number that would have been used if you had not entered your own file name.

If the filename you entered ends with _dddd, where d=any number, making it look just like an auto file name, then the next auto file name picks up where you left off with the suffix being dddd + 1.

Key Path	Front-panel key
Notes	No remote command for this key specifically.
Initial S/W Revision	Prior to A.02.00

Recall

The **Recall** menu lets you choose what you want to recall, and where you want to recall it from. Among the types of files you can recall are **States and Traces**. In addition, an **Import (Data)** option lets you recall a number of data types stored in CSV files (as used by Excel and other spreadsheet programs).

The default paths for Recall are data type dependent and are the same as for the Save key.

Key Path	Front-panel key
Notes	<p>No remote command for this key specifically, but the :MMEM:LOAD command is available for specific file types. An example is :MMEM:LOAD:STATe <filename>.</p> <p>If you try to recall a State file for a mode that is not licensed or not available in the instrument, an error message will occur and the state will not change.</p>
Backwards Compatibility Notes	<p>In legacy analyzers, it was possible to load a state without affecting the trace data, limit lines or correction data. Similarly (since User Preset is actually loading a state), it was possible to do a User Preset without affecting the trace data, limit lines or correction data.</p> <p>In the X-Series, "state" always includes all of this data; so whenever state is loaded, all of the traces, limit lines and corrections are affected. Although this differs from previous behavior, it is desirable behavior, and should not cause adverse issues for users.</p>
Backwards Compatibility Notes	<p>Recall for the X-Series supports backward compatibility in the sense that you can recall a state file from any X-Series model number and any version of X-Series software. This is only possible if part of the recalling process goes through a limiting step after recalling the mode settings, at least for settings that may vary with version number, model number, option and license differences. If you try to recall a state file onto an instrument with less capability than what was available on the instrument during the save, the recall will ignore the state it doesn't support and it will limit the recalled setting to what it allows.</p> <p>Example: if the saved state includes preamp ON, but the recalling instrument does not have a preamp; the preamp is limited to OFF. Conversely, if you save a state without a preamp, the preamp is OFF in the state file. When this saved file is recalled on an instrument with a licensed preamp, the preamp is changed to OFF. Another example is if the saved state has center frequency set to 20 GHz, but the instrument recalling the saved state is a different model and only supports 13.5 GHz. In this case, the center frequency is limited along with any other frequency based settings. Since the center frequency can't be preserved in this case, the recall limiting tries to at least preserve span to keep the measurement setup as intact as possible.</p> <p>It may be appropriate to issue a warning if the state is limited on the recall; warnings do not go out to SCPI so this would only affect the manual user.</p> <p>Note that there is no state file compatibility outside of the X-Series. For example, you cannot recall a state file from ESA or PSA.</p>
Initial S/W Revision	Prior to A.02.00

State

The **Recall State** menu lets you choose a register or file from which to recall the state.

The content of a state file includes all of the settings and data required to return the analyzer as closely as possible to the Mode it was in, with the exact settings that

were in place, when the save occurred. The Mode settings in each state file include the settings that are affected by Mode Preset, as well as the additional settings affected by Restore Mode Defaults; all of the Mode's settings. In addition, all of the settings of the **Input/Output** system are included, even though they are outside of the Mode's state, because they are needed to restore the complete setup. Persistent System settings (for example, GPIB address) are not affected by either a Mode Preset or Restore Mode Defaults, nor are they included in a saved State file.

Since each state file is only for one Mode, the settings for other Modes are unaffected when it is loaded. **Recall State** will cause a mode switch if the state being recalled is not from the current active mode.

After the recall completes, the message "File <filename> recalled" or "Recalled State Register <register number>" is displayed.

For rapid recalls, the State menu lists 16 registers that you can choose from to recall. Pressing a Register key initiates the recall. You can also select a file from which to recall.

The default path for all State Files is:

My Documents\<<mode name>\state

where <mode name> is the parameter used to select the mode with the INST:SEL command (for example, SA for the Spectrum Analyzer).

See ["More Information" on page 1177](#).

Key Path	Recall
Mode	All
Remote Command	:MMEMory:LOAD:STATe <filename>
Example	:MMEM:LOAD:STAT "myState.state" This recalls the file myState.state on the default path
Example	MMEM:LOAD:STAT "MyStateFile.state" This loads the state file data (on the default file directory path) into the instrument state.
Notes	When you pick a file to recall, the analyzer first verifies that the file is recallable in the current instrument by checking the software version and model number of the instrument. If everything matches, a full recall proceeds by aborting the currently running measurement, clearing any pending operations, and then loading the State from the saved state file. You can open state files from any mode, so recalling a State file switches to the mode that was active when the save occurred. After switching to the mode of the saved state file, mode settings and data (if any for the mode) are loaded with values from the saved file. The saved measurement of the mode becomes the newly active measurement and the data relevant to the measurement (if there is any) is recalled. <ul style="list-style-type: none"> - If there is a mismatch between file version or model number or instrument version or model number, the recall function tries to recall as much as possible and returns a warning message. It may limit settings that differ based on model number, licensing or version number. <p style="text-align: center;">After recalling the state, the Recall State function does the following:</p>

-
- Makes the saved measurement for the mode the active measurement.
 - Clears the input and output buffers.
 - Status Byte is set to 0.
 - Executes a *CLS

If the file specified is empty an error is generated. If the specified file does not exist, another error is generated. If there is a mismatch between the file and the proper file type, an error is generated. If there is a mismatch between file version or model number or instrument version or model number, a warning is displayed. Then it returns to the State menu and File Open dialog goes away.

After the Recall, the analyzer exits the Recall menu and returns to the previous menu.

Backwards Compatibility SCPI :MMEMory:LOAD:STATE 1,<filename>
For backwards compatibility, the above syntax is supported. The "1" is simply ignored.

Initial S/W Revision Prior to A.02.00

More Information

In measurements that support saving Traces, for example, Swept SA, the Trace data is saved along with the State in the State file. When recalling the State, the Trace data is recalled as well. Traces are recalled exactly as they were stored, including the writing mode and update and display modes. If a Trace was updating and visible when the State was saved, it will come back updating and visible, and its data will be rewritten right away. When you use State to save and recall traces, any trace whose data must be preserved should be placed in View or Blank mode before saving.

The following table describes the Trace Save and Recall possibilities:

You want to recall state and one trace's data, leaving other traces unaffected.	Save Trace+State from 1 trace. Make sure that no other traces are updating (they should all be in View or Blank mode) when the save is performed.	On Recall, specify the trace you want to load the one trace's data into. This trace will load in View. All other traces' data will be unaffected, although their trace mode will be as it was when the state save was performed.
You want to recall all traces	Save Trace+State from ALL traces.	On Recall, all traces will come back in View (or Blank if they were in Blank or Background when saved)
You want all traces to load exactly as they were when saved.	Save State	On recall, all traces' mode and data will be exactly as they were when saved. Any traces that were updating will have their data immediately overwritten.

From File...

When you press “From File”, the analyzer brings up a Windows dialog and a menu entitled “File Open.” This menu allows you to navigate to the various fields in the Windows dialog without using a keyboard or mouse. The **Tab** and **Arrow** keys can also be used for dialog navigation.

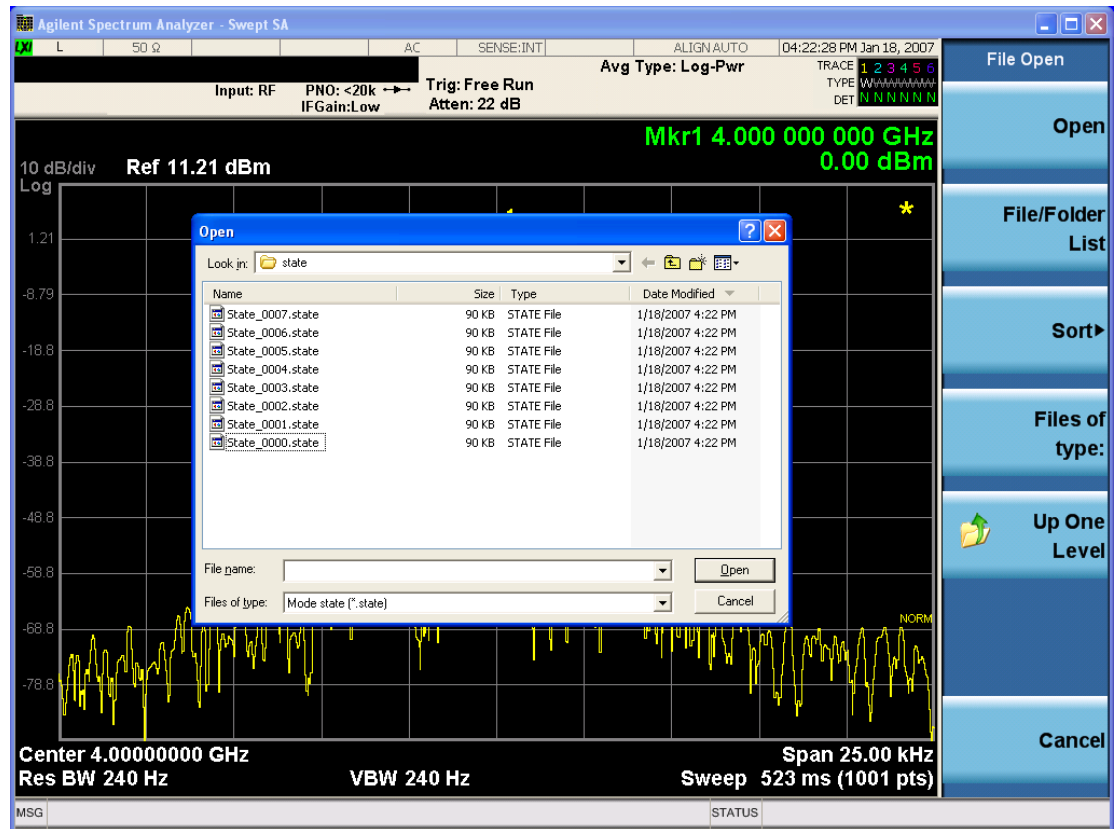

Listed below are the functions of the various fields in the dialog, and the corresponding softkeys:

Open

Performs the recall of the specified file. While the recall is being performed, the floppy icon appears briefly in the Meas bar.

File/Folder List

Enables you to navigate to the center of the dialog that contains the list of files and folders. Once here you can get information about the file and use the tab keys to navigate to the other fields in the dialog, such as Look In.

Look In

The **Look In** field shows the path from which the file will be recalled and allows you to change the path using the up and down arrow keys to navigate to other paths; the Enter key to open a directory; and the Backspace key to go back one directory. The **Look In** field first uses the last path from the Save As dialog **Save In:** path for that

same file type. There is no softkey for directly navigating to the Look In field, but you can use the left tab to get here from the File/Folder List.

User specified paths are remembered when you leave and return to a Mode and are reset back to the default using **Restore Mode Defaults**.

Sort

Accesses a menu that enables you to sort the files within the File Open dialog. Only one sorting type can be selected at a time and the sorting happens immediately. The sorting types are **By Date**, **By Name**, **By extension**, and **By Size**.

Files of Type

This field shows the file suffix for the type of file you have selected to recall. For example, if you navigated here while recalling State, "Mode state (*.state)" is in the field. If you navigated here while recalling Trace, "Mode state (*.trace)" is in the field. If you navigated here while importing a trace data file, "Trace Data (*.csv)" is in the field. For some file types, there is more than one choice in the dropdown menu, which you can select by using the up and down arrow keys and Enter.

Up One Level

This key corresponds to the icon of a folder with the up arrow that is in the tool bar of the dialog. When pressed, it causes the file and folder list to navigate up one level in the directory structure. The Backspace key does the same thing.

Cancel

This key corresponds to the **Cancel** selection in the dialog. It causes the current **Open** request to be cancelled. The ESC key does the same thing.

Key Path	Recall, State
Notes	Brings up the Open dialog for recalling a State Save Type
Initial S/W Revision	Prior to A.02.00

Edit Register Names

You may enter a custom name on any of the Register keys, to help you remember what you are using that state to save. To do this, press the **Edit Register Names** key, choose the register whose name you wish to edit, and then enter the desired label using the Alpha Editor or an external PC keyboard.

The maximum number of characters that can be added is 30. In most cases, 30 characters will fit on two lines of the key.

For more information and the SCPI command, see Edit Register Names under the **Save, State** function.

Key Path	Recall, State
Mode	All
Dependencies	N9060A-7FP or N9060B-2FP license required to edit the register names. When the feature is not licensed, sending the SCPI command generates an error, -221,"Settings conflict;Option not

	available"
Initial S/W Revision	A.11.00

Register 1 thru Register 16

Selecting any one of these register keys causes the State of the mode from the specified Register to be recalled. Each of the register keys annotates whether it is empty or at what date and time it was last modified. In addition, you can use the **Edit Register Names** key under **Save, State** to enter custom names for each register.

Registers are shared by all modes, so recalling from any one of the registers will cause a mode switch to the mode that was active when the save to the Register occurred.

Although these 16 registers are the only registers available from the front panel, there are 128 state registers available in the instrument. Registers 17-128 are only available from the SCPI interface, using the *RCL command.

After the recall completes, the message "Register <register number> recalled" appears in the message bar. If you are in the Spectrum Analyzer Mode, and you are recalling a register that was saved in the Spectrum Analyzer Mode, then after the recall, you will still be in the Recall Register menu. If the Recall causes you to switch modes, then after the Recall, you will be in the Frequency menu.

If a requested register is empty an error is generated.

Key Path	Recall, State
Example	*RCL 1
Range	1-16 from front panel, 1-128 from SCPI
Readback	Date and time with seconds resolution are displayed on the key OR A custom name of up to 30 characters entered using the Save, State,Edit Register Names key OR “(empty)” if no prior save operation has been performed to this register.
Initial S/W Revision	Prior to A.02.00
Modified at S/W Revision	Prior to A.11.00

Register 1 thru Register 16

Selecting any one of these register keys causes the State of the mode from the specified Register to be recalled. Each of the register keys annotates whether it is empty or at what date and time it was last modified. In addition, you can use the **Edit Register Names** key under **Save, State** to enter custom names for each register.

Registers are shared by all modes, so recalling from any one of the registers will cause a mode switch to the mode that was active when the save to the Register occurred.

Although these 16 registers are the only registers available from the front panel, there are 128 state registers available in the instrument. Registers 17-128 are only available from the SCPI interface, using the *RCL command.

After the recall completes, the message "Register <register number> recalled" appears in the message bar. If you are in the Spectrum Analyzer Mode, and you are recalling a register that was saved in the Spectrum Analyzer Mode, then after the recall, you will still be in the Recall Register menu. If the Recall causes you to switch modes, then after the Recall, you will be in the Frequency menu.

If a requested register is empty an error is generated.

Key Path	Recall, State
Example	*RCL 1
Range	1-16 from front panel, 1-128 from SCPI
Readback	Date and time with seconds resolution are displayed on the key OR A custom name of up to 30 characters entered using the Save, State,Edit Register Names key OR “(empty)” if no prior save operation has been performed to this register.
Initial S/W Revision	Prior to A.02.00
Modified at S/W Revision	Prior to A.11.00

Trace (+State)

The Recall Trace (+State) menu lets you choose a register or file from which to recall the Trace+State state file.

A saved state contains all of the settings and data required to return the analyzer as closely as possible to the exact setup it had when the save occurred. This includes the Input/Output settings, even though they are outside of the Mode’s state, because they are needed to restore the complete setup. A Trace+State file also includes trace data from one trace or all traces, which will load in View mode when the Trace+State file is recalled. Recall Trace (+State) will also cause a mode switch if the state being recalled is not for the current active mode.

After the recall completes, the message "File <filename> recalled" or “Recalled Trace Register <register number>” is displayed.

For rapid recalls, the Trace (+State) menu lists 5 registers to choose from to recall. Pressing a Register key initiates the recall. You can also select a file from which to recall.

The default path for all State Files including .trace files is:

My Documents\<<mode name>\state

where <mode name> is the parameter used to select the mode with the INST:SEL command (for example, SA for the Spectrum Analyzer).

Key Path	Recall
Mode	SA
Remote Command	<pre>:MMEMory:LOAD:TRACe TRACE1 TRACE2 TRACE3 TRACE4 TRACE5 TRACE6,<filename> :MMEMory:LOAD:TRACe:REGister TRACE1 TRACE2 TRACE3 TRACE4 TRACE5 TRACE6,<integer></pre>
Example	<pre>MMEM:LOAD:TRAC TRACE2, "MyTraceFile.trace"</pre> <p>This loads the trace file data (on the default file directory path) into the specified trace; if it is a "single trace" save file, that trace is loaded to trace 2, and is set to be not updating.</p> <pre>:MMEM:LOAD:TRAC:REG TRACE1,2</pre> <p>restores the trace data in register 2 to Trace 1</p>
Notes	<p>When you perform the recall, the recalling Trace function must first verify the file is recallable in this instrument by checking instrument software version and model number, since it includes State. If everything matches, a full recall proceeds by aborting the currently running measurement, and loading the state from the saved state file to as close as possible to the context in which the save occurred. You can open .trace files from any mode that supports them, so recalling a Trace file switches to the mode that was active when the save occurred. After switching to the mode of the saved state file, mode settings and data (if any for the mode) are loaded with values from the saved file and the saved measurement of the mode becomes the newly active measurement, and the data relevant to the measurement (if there is any) is recalled.</p> <p>Once the state is loaded, the trace data must be loaded. The internal flags are consulted to see which trace to load and the "To Trace" setting to see where to load it. Trace data is always loaded with the specified trace set to View, so that the data is visible and not updating (so as not to erase the recalled data). If the file is an "all trace" file, all traces are loaded with the saved data (to the original trace the data was saved from) and set to View. Traces whose data is not loaded are restored to the update state that existed when they were saved.</p> <p>After the Recall the analyzer exits the Recall menu and returns to the previous menu.</p> <p>Some modes and measurements do not have available all 6 traces. Phase Noise mode command, for example, is: <code>MMEMory:LOAD:TRACe TRACE1 TRACE2 TRACE3,<filename></code></p> <p>Some modes and measurements have more than 6 traces available. The Realtime SA mode command, for example, is: <code>MMEMory:STORe:TRACe TRACE1 TRACE2 TRACE3 TRACE4 TRACE5 TRACE6 TRACE7 TRACE8 TRACE9 TRACE10 TRACE11 TRACE12 ALL,<filename></code></p>
Initial S/W Revision	Prior to A.02.00

To Trace

These menu selections let you choose the Trace where the recalled saved trace will go. Not all modes have the full 6 traces available. The default is the currently selected trace, selected in this menu or in the Trace/Detector, Export Data, Import Data, or Save Trace menus, except if you have chosen All, then it remains chosen until you specifically change it to a single trace.

If the .trace file is an "all trace" file, "**To Trace**" is ignored and the traces each go back to the trace from which they were saved.

Once selected, the key returns back to the Recall Trace menu and the selected Trace number is annotated on the key. Now you have selected exactly where the

trace needs to be recalled. To trigger a recall of the selected Trace, you must select the **Open** key in the Recall Trace menu.

When you select a trace, it makes that trace the current trace, so it displays on top of all of the other traces.

Key Path	Save, Data, Trace
Mode	SA
Initial S/W Revision	Prior to A.02.00

Register 1 thru Register 16

Selecting any one of these register keys causes the State of the mode from the specified Register to be recalled. Each of the register keys annotates whether it is empty or at what date and time it was last modified. In addition, you can use the **Edit Register Names** key under **Save, State** to enter custom names for each register.

Registers are shared by all modes, so recalling from any one of the registers will cause a mode switch to the mode that was active when the save to the Register occurred.

Although these 16 registers are the only registers available from the front panel, there are 128 state registers available in the instrument. Registers 17-128 are only available from the SCPI interface, using the *RCL command.

After the recall completes, the message "Register <register number> recalled" appears in the message bar. If you are in the Spectrum Analyzer Mode, and you are recalling a register that was saved in the Spectrum Analyzer Mode, then after the recall, you will still be in the Recall Register menu. If the Recall causes you to switch modes, then after the Recall, you will be in the Frequency menu.

If a requested register is empty an error is generated.

Key Path	Recall, State
Example	*RCL 1
Range	1-16 from front panel, 1-128 from SCPI
Readback	Date and time with seconds resolution are displayed on the key OR A custom name of up to 30 characters entered using the Save, State, Edit Register Names key OR “(empty)” if no prior save operation has been performed to this register.
Initial S/W Revision	Prior to A.02.00
Modified at S/W Revision	Prior to A.11.00

From File...

When you press “From File”, the analyzer brings up a Windows dialog and a menu entitled “**File Open.**” This menu allows you to navigate to the various fields in the

Windows dialog without using a keyboard or mouse. The **Tab** and **Arrow** keys can also be used for dialog navigation.

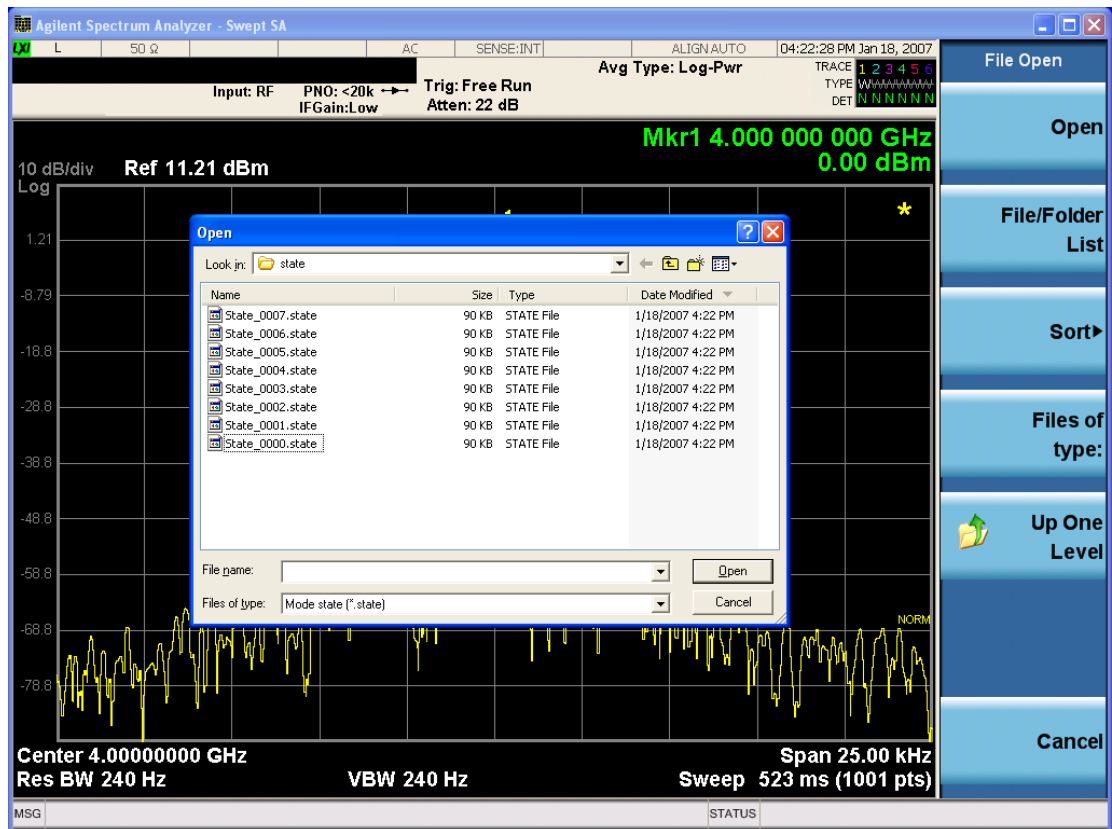

Listed below are the functions of the various fields in the dialog, and the corresponding softkeys:

Open

Performs the recall of the specified file. While the recall is being performed, the floppy icon appears briefly in the Meas bar.

File/Folder List

Enables you to navigate to the center of the dialog that contains the list of files and folders. Once here you can get information about the file and use the tab keys to navigate to the other fields in the dialog, such as Look In.

Look In

The **Look In** field shows the path from which the file will be recalled and allows you to change the path using the up and down arrow keys to navigate to other paths; the Enter key to open a directory; and the Backspace key to go back one directory. The **Look In** field first uses the last path from the Save As dialog **Save In:** path for that same file type. There is no softkey for directly navigating to the Look In field, but you can use the left tab to get here from the File/Folder List.

User specified paths are remembered when you leave and return to a Mode and are reset back to the default using **Restore Mode Defaults**.

Sort

Accesses a menu that enables you to sort the files within the File Open dialog. Only one sorting type can be selected at a time and the sorting happens immediately. The sorting types are **By Date, By Name, By extension, and By Size**.

Files of Type

This field shows the file suffix for the type of file you have selected to recall. For example, if you navigated here while recalling State, "Mode state (*.state)" is in the field. If you navigated here while recalling Trace, "Mode state (*.trace)" is in the field. If you navigated here while importing a trace data file, "Trace Data (*.csv)" is in the field. For some file types, there is more than one choice in the dropdown menu, which you can select by using the up and down arrow keys and Enter.

Up One Level

This key corresponds to the icon of a folder with the up arrow that is in the tool bar of the dialog. When pressed, it causes the file and folder list to navigate up one level in the directory structure. The Backspace key does the same thing.

Cancel

This key corresponds to the **Cancel** selection in the dialog. It causes the current **Open** request to be cancelled. The ESC key does the same thing.

Key Path	Recall, State
Notes	Brings up the Open dialog for recalling a State Save Type
Initial S/W Revision	Prior to A.02.00

Data (Import)

Importing a data file loads data that was previously saved from the current measurement or from other measurements and/or modes that produce compatible data files. The Import Menu only contains Data Types that are supported by the current measurement.

Since the commonly exported data files are in .csv format, the data can be edited by the user prior to importing. This allows you to export a data file, manipulate the data in Excel (the most common PC Application for manipulating .csv files) and then import it.

Importing Data loads measurement data from the specified file into the specified or default destination, depending on the data type selected. Selecting an Import Data menu key will not actually cause the importing to occur, since the analyzer still needs to know from where to get the data. Pressing the Open key in this menu brings up the Open dialog and Open menu that provides you with the options from where to recall the data. Once a filename has been selected or entered in the Open menu, the recall occurs as soon as the Open button is pressed.

Key Path	Recall
Mode	All
Notes	The menu is built from whatever data types are available for the mode. Some keys will be missing completely, so the key locations in the sub-menu will vary. No SCPI command directly controls the Data Type that this key controls. The Data Type is included in the MMEM:LOAD commands.
Dependencies	If a file type is not used by a certain measurement, it is grayed out for that measurement. The key for a file type will not show at all if there are no measurements in the Mode that support it.
Preset	Is not affected by Preset or shutdown, but is reset during Restore Mode Defaults
Readback	The data type that is currently selected
Initial S/W Revision	Prior to A.02.00

Amplitude Correction

This key selects the Amplitude Corrections as the data type to be imported. When pressed a second time, it brings up the Select Menu, which lets you select the Correction into which the data will be imported.

Amplitude Corrections are fully discussed in the documentation of the Input/Output key, under the Corrections key.

A set of preloaded Corrections files can be found in the directory

/My Documents/ EMC Limits and Ampcor.

When the Amplitude Correction is an Antenna correction and the Antenna Unit in the file is not **None**, the Y Axis Unit setting will change to match the Antenna Unit in the file.

Key Path	Recall
Mode	SA EDGE GSM PN
Remote Command	:MMEMory:LOAD:CORRection 1 2 3 4 5 6 7 8, <filename>
Example	:MMEM:LOAD:CORR 2, "myAmpcor.csv" recalls the Amplitude Correction data from the file myAmpcor.csv in the current directory to the 2nd Amplitude Correction table, and turns on Correction 2. The default path is D:\Users\Instrument\My Documents\amplitudeCorrections\
Dependencies	Only the first correction array (Correction 1) supports antenna units. This means that a correction file with an Antenna Unit can only be loaded into the Corrections 1 register. Consequently only for Correction 1 does the dropdown in the Recall dialog include ant, and if an attempt is made to load a correction file into any other Correction register which DOES contain an antenna unit, a Mass Storage error is generated. Corrections are not supported by all Measurements. If in a Mode in which some Measurements support it, this key will be grayed out in measurements that do not. The key will not show at all if no measurements in the Mode support it. Errors are reported if the file is empty or missing, or if the file type does not match, or if there is a mismatch between the file type and the destination data type. If any of these occur during manual operation, the analyzer returns to the Import Data menu and the File Open dialog goes away.

	This key does not appear unless you have the proper option installed in your instrument. This command will generate an "Option not available" error unless you have the proper option installed in your instrument.
Couplings	When a correction file is loaded from mass storage, it is automatically turned on (Correction ON) and ApplyCorrections is set to On. This allows you to see its effect, thus confirming the load.
Readback	selected Correction
Backwards Compatibility SCPI	:MMEMory:LOAD:CORRection ANTenna CABLE OTHER USER, <filename> For backwards compatibility, ANTenna maps to 1, CABLE maps to 2, OTHER maps to 3 and USER maps to 4
Initial S/W Revision	A.02.00

Amplitude Correction

These keys let you select which Correction to import the data into. Once selected, the key returns back to the Import Data menu and the selected Correction number is annotated on the key. The next step is to select the Open key in the Import Data menu.

Antenna corrections are a particular kind of Amplitude Corrections – they are distinguished in the corrections file by having the Antenna Unit set to a value other than None. Only Correction 1 supports Antenna Units.

Key Path	Recall, Data, Amplitude Correction
Notes	auto return
Dependencies	Only Correction 1 may be used to load a Correction that contains an Antenna Unit other than None
Preset	Not part of Preset, but is reset to Correction 1 by Restore Input/Output Defaults; survives shutdown.
State Saved	The current Correction number is saved in instrument state
Initial S/W Revision	A.02.00

Trace

This key selects Trace as the data type to be imported. When pressed a second time, it brings up the Trace Menu, which lets you select the Trace into which the data will be imported.

The trace file contains "meta" data which describes the state of the analyzer when the trace was exported (see "[Trace File Contents](#)" on page 3216). If the meta data in the file does not match the current SA state, the "invalid data indicator" (*) is displayed.

Key Path	Recall, Data
Remote Command	:MMEMory:LOAD:TRACe:DATA TRACE1 TRACE2 TRACE3 TRACE4 TRACE5 TRACE6,<filename>
Example	:MMEM:LOAD:TRAC DATA TRACE2, "myTrace2.csv" Imports the 2nd trace from the file myTrace2.csv in the current path. The default path is My Documents\SA\data\traces
Dependencies	<p>For SA measurements, a trace cannot be recalled from a trace file that was exported with ALL traces selected.</p> <p>A trace cannot be imported if the number of trace points in the file do not match the number of sweep points currently set for the measurement. If this happens, an error message is generated.</p> <p>Errors are reported if the file is empty or missing, or if the file type does not match, or if there is a mismatch between the file type and the destination data type.</p> <p>If any error occurs while trying to load a file manually (as opposed to during remote operation), the analyzer returns to the Import Data menu and the File Open dialog goes away.</p>
Couplings	When a trace is imported, Trace Update is always turned OFF for that trace and Trace Display is always turned ON.
Readback	Selected Trace
Status Bits/OPC dependencies	Sequential - aborts the current measurement.
Initial S/W Revision	Prior to A.02.00

Select Trace

These keys let you pick the Trace into which to import the data; either 1, 2, 3, 4, 5 or 6. The default is the currently selected trace, selected in this menu or in the Trace/Det, Export Data, Recall Trace, or Save Trace menus; except if you have chosen **All** then **All** remains chosen until you specifically change it to a single trace.

Once selected, the key returns back to the Import Data menu and the selected Trace number is annotated on the key. The next step is to select the Open key in the Import Data menu.

Key Path	Recall, Data, Trace
Notes	Auto return
Couplings	When you select the trace into which to import the data, it makes that trace the current trace, so it displays on top of all of the other traces.
Preset	Not part of Preset, but is reset to TRACE1 by Restore Mode Defaults; survives shutdown
State Saved	The current trace number is saved in State
Initial S/W Revision	Prior to A.02.00

Limit

This key selects Limit Lines as the data type to be imported. When pressed a second time, it brings up the Limits Menu, which lets you select into which Limit the data will be imported.

A set of preloaded Limits files can be found in the directory

/My Documents/ EMC Limits and Ampcor.

Under this directory, the directory called Limits (Legacy Naming) contains a set of legacy limits, generally the same files that were supplied with older Agilent EMC analyzers, that use the legacy suffix .lim, and the old 8-character file names. In the directory called Limits, the same files can be found, with the same suffix, but with longer, more descriptive filenames.

Key Path	Recall, Data
Remote Command	:MMEMory:LOAD:LIMit LLINE1 LLINE2,<filename>
Example	:MMEM:LOAD:LIM LLINE2, "myLimitLine2.csv" Imports the 2nd Limit Line from the file myLimitLine2.csv in the current path. The default path is My Documents\SA\data\limits
Dependencies	Errors are reported if the file is empty or missing, or if the file type does not match, or if there is a mismatch between the file type and the destination data type. If any of these occur during manual operation, the analyzer returns to the Import Data menu and the File Open dialog goes away. This key will only appear if you have the proper option installed in your instrument.
Couplings	When a limit line is loaded from mass storage, it is automatically turned on. This allows the user to see it, thus confirming the load. The Margin settings will match those when the limit was saved The instrument cannot mix Limits domains (X Axis Unit must be Frequency or Time for both Limits). So when a Limits file is loaded, the analyzer will set the Limits domain (X Axis Unit) to match that of the file. If this changes the Limits domain from what it was before the file was loaded, all Limits data in all Limits sets will be erased before the data loads. If this operation is over the remote interface there will be no warning if this occurs, so care should be taken to know the domain of the file you are loading.
Readback	Selected Limit Line
Status Bits/OPC dependencies	Sequential - aborts the current measurement
Initial S/W Revision	A.02.00

Limit Selection

These keys let you pick which Limit Line to import the data into; either 1, 2, 3, 4, 5 or 6. The default is the currently selected limit. Once selected, the key returns back to the Import Data menu and the selected Limit Line number is annotated on the key. Now you have selected exactly what needs to be imported. In order to trigger an import of the selected Limit Line, you must select the Open key in the Import Data menu.

An example of using this menu is: If you select 2 and continue to the File Open menu, Limit Line 2 will be imported from the file selected or entered in File Name option in the File Open dialog.

Key Path	Recall, Data, Limit Line
Notes	Auto return
Preset	Not part of Preset, but is reset to LLINE1 by Restore Mode Defaults; survives a shutdown.
State Saved	The selected limit number is saved in instrument state
Initial S/W Revision	A.02.00

Open...

When you press “Open”, the analyzer brings up a Windows dialog and a menu entitled “**File Open.**” This menu allows you to navigate to the various fields in the Windows dialog without using a keyboard or mouse. The **Tab** and **Arrow** keys can also be used for dialog navigation.

See "[From File...](#)" on page 3210 in **Recall, State**, for a full description of this dialog and menu.

Key Path	Recall, Data
Notes	The key location is mode-dependent and will vary. Brings up Open dialog for recalling a <mode specific> Save Type
Initial S/W Revision	Prior to A.02.00

Restart

The Restart function restarts the current sweep, or measurement, or set of averaged/held sweeps or measurements. If you are Paused, pressing Restart does a Resume.

The Restart function is accessed in several ways:

- Pressing the Restart key
- Sending the remote command INIT:IMMEDIATE
- Sending the remote command INIT:RESTART

See ["More Information" on page 1191](#)

Key Path	Front-panel key
Remote Command	:INITiate[:IMMEDIATE] :INITiate:RESTART
Example	:INIT:IMM :INIT:REST
Notes	:INITiate:RESTART and :INITiate:IMMEDIATE perform exactly the same function.
Couplings	Resets average/hold count k. For the first sweep overwrites all active (update=on) traces with new current data. For application modes, it resets other parameters as required by the measurement.
Status Bits/OPC dependencies	This is an Overlapped command. The STATus:OPERation register bits 0 through 8 are cleared. The STATus:QUESTionable register bit 9 (INTEgrity sum) is cleared. The SWEEPING bit is set. The MEASURING bit is set.
Backwards Compatibility Notes	For Spectrum Analysis mode in ESA and PSA, the Restart hardkey and the INITiate:RESTART command restart trace averages (displayed average count reset to 1) for a trace in Clear Write , but did not restart Max Hold and Min Hold . In the X-Series, the Restart hardkey and the INITiate:RESTART command restart not only Trace Average , but MaxHold and MinHold traces as well. For wireless comms modes in ESA and PSA, the Restart hardkey and the INITiate:RESTART command restart every measurement, which includes all traces and numeric results. There is no change to this operation.
Initial S/W Revision	Prior to A.02.00

More Information

The **Restart** function first aborts the current sweep/measurement as quickly as possible. It then resets the sweep and trigger systems, sets up the measurement and initiates a new data measurement sequence with a new data acquisition (sweep) taken once the trigger condition is met.

If the analyzer is in the process of aligning when **Restart** is executed, the alignment finishes before the restart function is performed.

Even when set for Single operation, multiple sweeps may be taken when Restart is pressed (for example, when averaging/holding is on). Thus when we say that **Restart** "restarts a measurement," we may mean:

- It restarts the current sweep
- It restarts the current measurement
- It restarts the current set of sweeps if any trace is in Trace Average, Max Hold or Min Hold
- It restarts the current set of measurements if Averaging, or Max Hold, or Min Hold is on for the measurement
- depending on the current settings.

With **Average/Hold Number** (in **Meas Setup** menu) set to 1, or Averaging off, or no trace in Trace Average or Hold, a single sweep is equivalent to a single measurement. A single sweep is taken after the trigger condition is met; and the analyzer stops sweeping once that sweep has completed. However, with **Average/Hold Number** > 1 and at least one trace set to **Trace Average, Max Hold, or Min Hold (SA Measurement)** or **Averaging on (most other measurements)**, multiple sweeps/data acquisitions are taken for a single measurement. The trigger condition must be met prior to each sweep. The sweep is stopped when the average count k equals the number N set for **Average/Hold Number**. A measurement average usually applies to all traces, marker results, and numeric results; but sometimes it only applies to the numeric results.

Once the full set of sweeps has been taken, the analyzer will go to idle state. To take one more sweep without resetting the average count, increment the average count by 1, by pressing the step up key while **Average/Hold Number** is the active function, or sending the remote command `CALC: AVER: TCON UP`.

Save

The **Save** menu lets you choose what you want to save and where you want to save it. Among the types of files you can save are **States**, **Traces**, and **Screen Images**. In addition, an **Export (Data)** option lets you save a number of data types as CSV files for easy import into Excel and other spreadsheet programs.

Key Path	Front-panel key
Mode	All
Notes	No remote command for this key specifically, but the :MMEM:STORe command is available for specific file types. An example is :MMEM:STOR:STATe <filename>.
Initial S/W Revision	Prior to A.02.00

State

The Save State menu lets you choose a register or file for saving the state.

The content of a state file includes all of the settings and data required to return the analyzer as closely as possible to the Mode it was in, with the exact settings which were in place, when the save occurred. The Mode settings in each state file include the settings that are affected by Mode Preset, as well as the additional settings affected by Restore Mode Defaults; all of the Mode's settings. In addition, all of the settings of the **Input/Output** system are included, even though they are outside of the Mode's state, because they are needed to restore the complete setup. Persistent **System** settings (for example, Verbose SCPI) are not affected by either Mode Preset or Restore Mode Defaults, nor are they included in a saved State file.

After the save completes, the message "File <filename> saved" or "State Register <register number> saved" is displayed.

For rapid saving, the State menu lists 16 registers to save to. Pressing a Register key initiates the save. You can also select a file to save to.

The default path for all State Files is:

My Documents\<<mode name>\state

where <mode name> is the parameter used to select the mode with the INST:SEL command (for example, SA for the Spectrum Analyzer).

Key Path	Save
Mode	All
Remote Command	:MMEMory:STORe:STATe <filename>
Example	MMEM:STOR:STATe "MyStateFile.state" This stores the current instrument state data in the file MyStateFile.state in the default directory.
Notes	Both single and double quotes are supported for any filename parameter over remote. After saving to a register, that register's menu key is updated with the date the time, unless a custom label has been entered for that key. After saving to a register, you remain in the Save State menu, so that you can see the Register

	key update. After saving to a file, the analyzer automatically returns to the previous menu and any Save As dialog goes away.
Backwards Compatibility SCPI	:MMEMory:STORe:STATe 1,<filename> For backwards compatibility, the above syntax is supported. The "1" is simply ignored. The command is sequential.
Initial S/W Revision	Prior to A.02.00

To File . . .

When you press "To File", the analyzer brings up a Windows dialog and a menu entitled "**Save As.**" This menu allows you to navigate to the various fields in the Windows dialog without using a keyboard or mouse. The **Tab** and **Arrow** keys can also be used for dialog navigation.

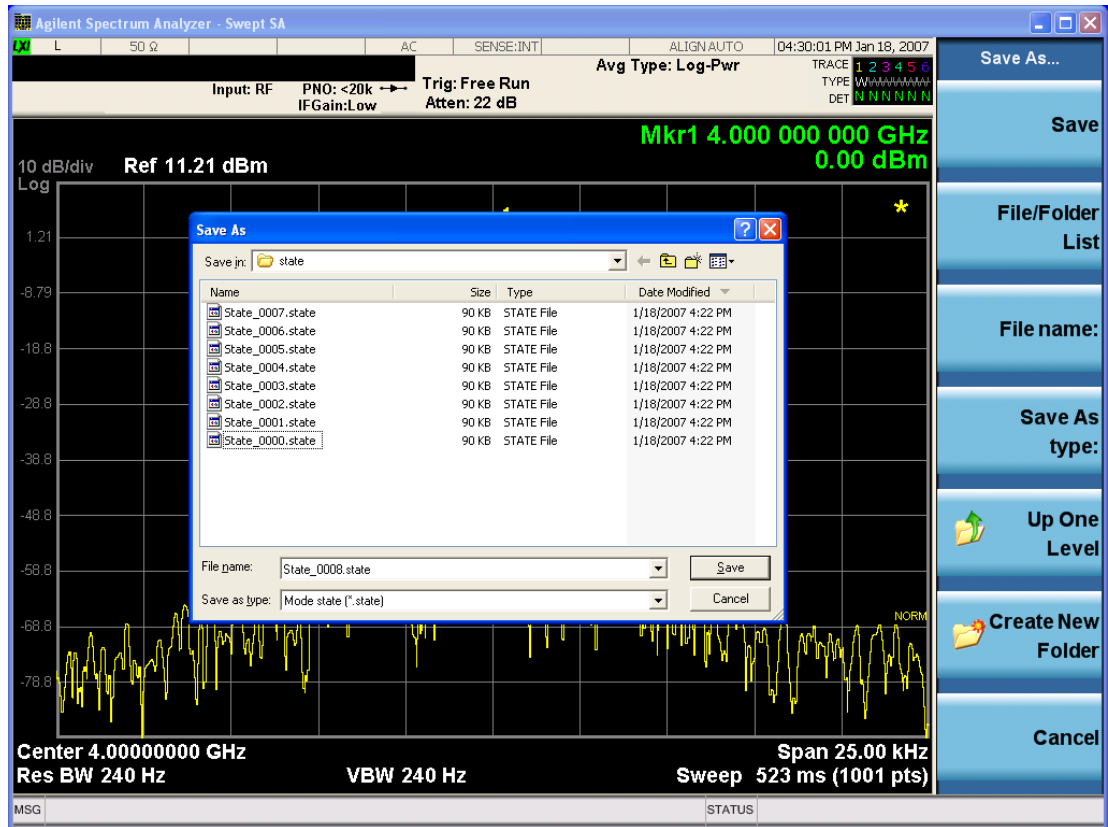

The Listed below are the functions of the various fields in the dialog, and the corresponding softkeys:

Save

Performs the save to the specified file of the selected type. If the file already exists, a dialog will appear that allows you to replace the existing file by selecting **OK**, or you can Cancel the request. If you select OK, the file will be overwritten. Using the C: drive is strongly discouraged, since it runs the risk of being overwritten during an instrument software upgrade.

While the save is being performed, the floppy icon appears briefly in the Meas bar.

File/Folder List

Enables you to navigate to the center of the dialog that contains the list of files and folders. Once here you can get information about the file and use the tab keys to navigate to the other fields in the dialog, such as Save In.

Save In

The Save In field shows the path to which the file will be saved and allows you to change the path using the up and down arrow keys to navigate to other paths; the Enter key to open a directory; and the Backspace key to go back one directory. The **Save In field** defaults to the default path for this type of file and remembers the last path you used to save this type of file. There is no softkey for directly navigating to the Save In field but you can use left tab to get here from the File/Folder List.

User specified paths are remembered when you leave and return to a Mode and are reset back to the default using **Restore Mode Defaults**.

File Name

The **File Name** field is initially loaded with an automatically generated filename specific to the appropriate Save Type. The automatically generated filename is guaranteed not to conflict with any filename currently in the directory. You may replace or modify this filename using the File Name key. See the ["Quick Save " on page 3181](#) documentation for more on the automatic file naming algorithm.

When you press the **File Name** key the analyzer displays the Alpha Editor. Use the knob to choose the letter to add and the front-panel Enter key to add the letter to the file name. The BK character moves you back and the FW character moves you forward in the filename. The Select key on the front panel generates a space character. When you are done entering the filename press the **Done** softkey. This returns back to the **File Open** dialog and menu, but does not cause the save to occur.

Save As Type

This field shows the file suffix for the type of file you have selected to save. For example, if you navigated here while saving State, "Mode state (*.state)" is in the field. If you navigated here from saving Trace, "Mode state (*.trace)" is in the field. If you navigated here while exporting a trace data file, "Trace Data (*.csv)" is in the field. For some file types, there is more than one choice in the dropdown, which you can select by using the up and down arrow keys and Enter.

Up One Level

This key corresponds to the icon of a folder with the up arrow that is in the tool bar of the dialog. When pressed, it causes the file and folder list to navigate up one level in the directory structure. The Backspace key does the same thing.

Create New Folder

This key corresponds to the icon of a folder with the "*" that is in the tool bar of the dialog. When pressed, a new folder is created in the current directory with the name **New Folder** and you can enter a new folder name using the Alpha Editor.

Cancel

This key corresponds to the **Cancel** selection in the dialog. It causes the current **Save As** request to be cancelled. The ESC key does the same thing.

Key Path	Save, State
Mode	All
Notes	Brings up Save As dialog for saving a State Save Type
Initial S/W Revision	Prior to A.02.00

Edit Register Names

You may enter a custom name on any of the Register keys, to help you remember what you are using that state to save. To do this, press the **Edit Register Names** key,

choose the register whose name you wish to edit, and then enter the desired label using the Alpha Editor or an external PC keyboard.

The maximum number of characters that can be added is 30. In most cases, 30 characters will fit on two lines of the key.

See ["More Information" on page 1197](#)

Key Path	Save, State
Mode	All
Remote Command	:MMEMory:REGister:STATe:LABe1 <reg number>,"label" :MMEMory:REGister:STATe:LABe1? <reg number>
Example	:MMEM:REG:STAT:LAB 1,"my label"
Notes	<reg number> is an integer from 1 to 16. If the SCPI specifies an invalid register number an error message is generated, -222,"Data out of range;Invalid register label number" "label" is a string from 0 to 30 characters in length. If a label exceeds 30 characters, an error message is generated, -150,"String data error;Label clipped to 30 characters" "label" of length 0 erases the custom label and restores the default (time and date) label. E.g.: :MMEM:REG:STAT:LAB 1,""
Dependencies	N9060A-7FP or N9060B-2FP license required to edit the register names. When the feature is not licensed, sending this command generates an error, -221,"Settings conflict;Option not available"
Preset	The names are unaffected by Preset or power cycle but are set to the default label (time and date) on a "Restore System Defaults->Misc"
Initial S/W Revision	A.11.00

More Information

When you edit one of the register names, the time and date field will be replaced by the custom name.

If you delete all the characters in the custom name, it restores the default (time and date).

The register names are stored within the state files, but they are not part of the instrument state; that is, once you have edited a register name, loading a new state will not change that register name. Another consequence of this is that the names will be persistent through a power cycle. Also, if a named state file is transferred to another analyzer, it will bring its custom name along with it.

If you try to edit the name of an empty register, the analyzer will first save the state to have a file to put the name in. If you load a named state file into an analyzer with older firmware it will ignore the metadata.

The *SAV and *RCL commands will not be affected by the custom register names, nor will the MMEM commands.

Register 1 thru Register 16

Selecting any one of these register menu keys causes the State of the currently active mode to be saved to the specified Register. The registers are provided for rapid saving and recalling, since you do not need to specify a filename or navigate to

a file. Each of the register menu keys annotates whether it is empty or at what date and time it was last modified. In addition, you can use the **Edit Register Names** key to enter custom names for each register.

Although these 16 registers are the only registers available from the front panel, there are 128 state registers available in the instrument. Registers 17-128 are only available from the SCPI interface, using the *SAV command.

There is one set of 128 state registers in the instrument, not one set for each Mode. When a state is saved, the Mode it was saved from is saved with it; then when it is recalled, the instrument switches to that Mode.

After the save completes, the corresponding register menu key annotation is updated with the date and time and the message "Register <register number> saved" is displayed.

Key Path	Save, State
Mode	All
Example	*SAV 1
Range	1-16 from front panel, 1-128 from SCPI
Readback	Date and time with seconds resolution are displayed on the key OR A custom name of up to 30 characters entered using the Edit Register Names key OR “(empty)” if no prior save operation has been performed to this register.
Initial S/W Revision	Prior to A.02.00
Modified at S/W Revision	A.11.00

Register 1 thru Register 16

Selecting any one of these register menu keys causes the State of the currently active mode to be saved to the specified Register. The registers are provided for rapid saving and recalling, since you do not need to specify a filename or navigate to a file. Each of the register menu keys annotates whether it is empty or at what date and time it was last modified. In addition, you can use the **Edit Register Names** key to enter custom names for each register.

Although these 16 registers are the only registers available from the front panel, there are 128 state registers available in the instrument. Registers 17-128 are only available from the SCPI interface, using the *SAV command.

There is one set of 128 state registers in the instrument, not one set for each Mode. When a state is saved, the Mode it was saved from is saved with it; then when it is recalled, the instrument switches to that Mode.

After the save completes, the corresponding register menu key annotation is updated with the date and time and the message "Register <register number> saved" is displayed.

Key Path	Save, State
Mode	All
Example	*SAV 1
Range	1-16 from front panel, 1-128 from SCPI
Readback	Date and time with seconds resolution are displayed on the key OR A custom name of up to 30 characters entered using the Edit Register Names key OR “(empty)” if no prior save operation has been performed to this register.
Initial S/W Revision	Prior to A.02.00
Modified at S/W Revision	A.11.00

Trace (+State)

The **Save Trace (+State)** menu lets you choose a register or file specifying where to save the Trace+State state file.

A saved state contains all of the settings and data required to return the analyzer as closely as possible to the exact setup it had when the save occurred. This includes the Input/Output settings, even though they are outside of the Mode’s state, because they are needed to restore the complete setup. A Trace+State file also includes trace data from one trace or all traces, which will load in View mode when the Trace+State file is recalled.

After the save completes, the message "File <filename> saved" or "Trace Register <register number> saved" is displayed.

For rapid saves, the Trace (+State) menu lists 5 registers to save to. Pressing a Register key initiates the save. You can also select a file to save to.

The default path for all State Files including .trace files is:

My Documents\<<mode name>\state

where <mode name> is the parameter used to select the mode with the INST:SEL command (for example, Basic for the IQAnalyzer).

This key is grayed out for measurements that do not support trace saves. It is blanked for modes that do not support trace saves. Saving **Trace** is identical to saving State except a .trace extension is used on the file instead of .state, and internal flags are set in the file indicating which trace was saved. You may select to save one trace or ALL traces.

Key Path	Save
Mode	SA
Remote Command	:MMEMory:STORe:TRACe TRACE1 TRACE2 TRACE3 TRACE4 TRACE5 TRACE6 ALL,<filename>

	<code>:MMEMory:STORe:TRACe:REGister TRACE1 TRACE2 TRACE3 TRACE4 TRACE5 TRACE6 ALL,<integer></code>
Example	<p><code>:MMEM:STOR:TRAC TRACE1</code>, "myState.trace" saves the file myState.trace on the default path and flags it as a "single trace" file with Trace 1 as the single trace (even though all of the traces are in fact stored).</p> <p><code>:MMEM:STOR:TRAC ALL</code>, "myState.trace" saves the file myState.trace on the default path and flags it as an "all traces" file</p> <p><code>:MMEM:STOR:TRAC:REG TRACE1, 2</code> stores trace 1 data in trace register 2</p>
Notes	<p>This command actually performs a save state, which in the Swept SA measurement includes the trace data. However it flags it (in the file) as a "save trace" file of the specified trace (or all traces).</p> <p>Some modes and measurements do not have available all 6 traces. The Phase Noise mode command, for example, is: <code>MMEMory:STORe:TRACe TRACE1 TRACE2 TRACE3 ALL,<filename></code></p> <p>Some modes and measurements have more than 6 traces available. The Realtime SA mode command, for example, is: <code>MMEMory:STORe:TRACe TRACE1 TRACE2 TRACE3 TRACE4 TRACE5 TRACE6 TRACE7 TRACE8 TRACE9 TRACE10 TRACE11 TRACE12 ALL,<filename></code></p> <p>The range for the register parameter is 1-5</p> <p>When you initiate a save, if the file already exists, a dialog will appear that allows you to replace the existing file by selecting OK or you can Cancel the request. If you select OK, the file will be overwritten. Using the C: drive is strongly discouraged, since it runs the risk of being overwritten during an instrument software upgrade.</p> <p>Both single and double quotes are supported for any filename parameter over remote.</p> <p>After saving to a register, that register's menu key is updated with the date and time of the save.</p> <p>After saving to a register, you remain in the Save Trace menu, so that you can see the Register key update. After saving to a file, the analyzer automatically returns to the previous menu and any Save As dialog goes away.</p>
Initial S/W Revision	Prior to A.02.00

Register 1 thru Register 16

Selecting any one of these register menu keys causes the State of the currently active mode to be saved to the specified Register. The registers are provided for rapid saving and recalling, since you do not need to specify a filename or navigate to a file. Each of the register menu keys annotates whether it is empty or at what date and time it was last modified. In addition, you can use the **Edit Register Names** key to enter custom names for each register.

Although these 16 registers are the only registers available from the front panel, there are 128 state registers available in the instrument. Registers 17-128 are only available from the SCPI interface, using the *SAV command.

There is one set of 128 state registers in the instrument, not one set for each Mode. When a state is saved, the Mode it was saved from is saved with it; then when it is recalled, the instrument switches to that Mode.

After the save completes, the corresponding register menu key annotation is updated with the date and time and the message "Register <register number> saved" is displayed.

Key Path	Save, State
Mode	All
Example	*SAV 1
Range	1-16 from front panel, 1-128 from SCPI
Readback	Date and time with seconds resolution are displayed on the key OR A custom name of up to 30 characters entered using the Edit Register Names key OR “(empty)” if no prior save operation has been performed to this register.
Initial S/W Revision	Prior to A.02.00
Modified at S/W Revision	A.11.00

From Trace

Accesses a menu that enables you to select the trace to be saved. Once a trace is selected, the key returns to the Save Trace menu and the selected trace number is annotated on the key. The default is the currently selected trace, selected in this menu or in the Trace/Det, Export Data, Import Data or Recall Trace menus, except if you have chosen All then it remains chosen until you specifically change it to a single trace. To save the Trace you must select the **Save As** key in the Save Trace menu.

When you select a trace, it makes that trace the current trace, so it displays on top of all of the other traces.

Key Path	Save, Trace + State
Mode	SA
Initial S/W Revision	Prior to A.02.00

From File...

When you press “From File”, the analyzer brings up a Windows dialog and a menu entitled “**File Open.**” This menu allows you to navigate to the various fields in the Windows dialog without using a keyboard or mouse. The **Tab** and **Arrow** keys can also be used for dialog navigation.

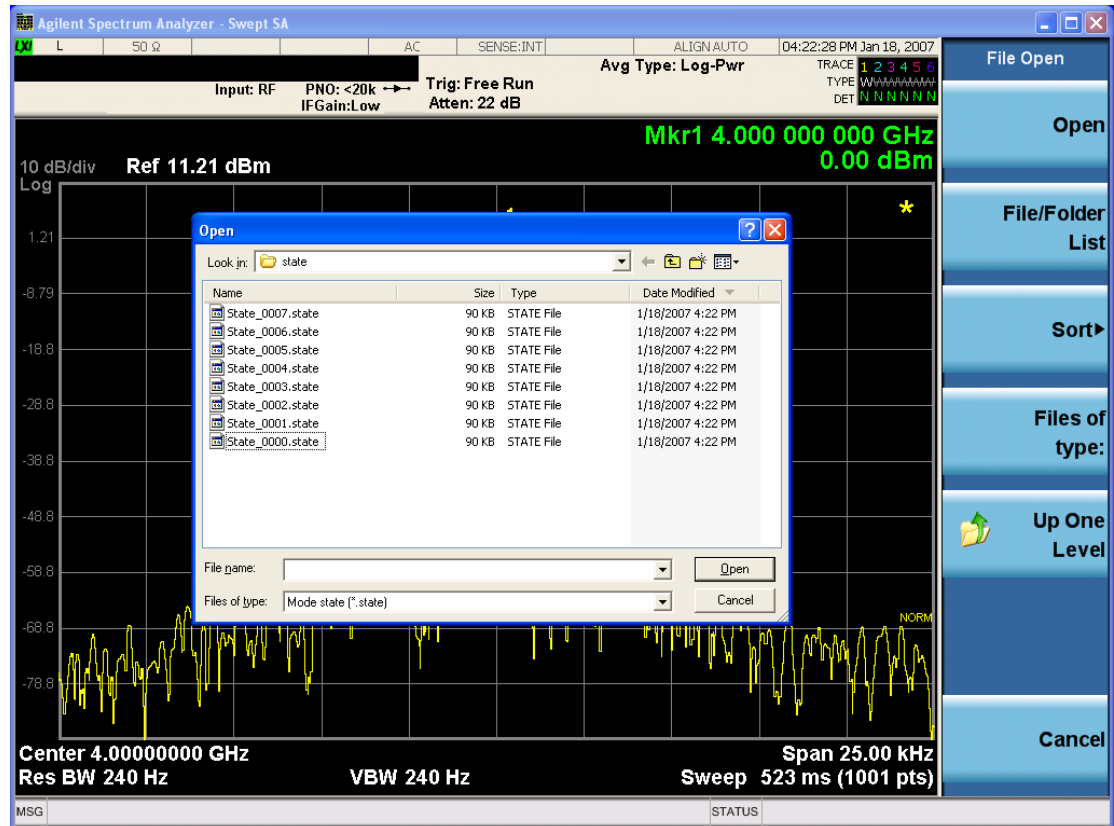

Listed below are the functions of the various fields in the dialog, and the corresponding softkeys:

Open

Performs the recall of the specified file. While the recall is being performed, the floppy icon appears briefly in the Meas bar.

File/Folder List

Enables you to navigate to the center of the dialog that contains the list of files and folders. Once here you can get information about the file and use the tab keys to navigate to the other fields in the dialog, such as Look In.

Look In

The **Look In** field shows the path from which the file will be recalled and allows you to change the path using the up and down arrow keys to navigate to other paths; the Enter key to open a directory; and the Backspace key to go back one directory. The **Look In** field first uses the last path from the Save As dialog **Save In:** path for that same file type. There is no softkey for directly navigating to the Look In field, but you can use the left tab to get here from the File/Folder List.

User specified paths are remembered when you leave and return to a Mode and are reset back to the default using **Restore Mode Defaults**.

Sort

Accesses a menu that enables you to sort the files within the File Open dialog. Only one sorting type can be selected at a time and the sorting happens immediately. The sorting types are **By Date**, **By Name**, **By extension**, and **By Size**.

Files of Type

This field shows the file suffix for the type of file you have selected to recall. For example, if you navigated here while recalling State, "Mode state (*.state)" is in the field. If you navigated here while recalling Trace, "Mode state (*.trace)" is in the field. If you navigated here while importing a trace data file, "Trace Data (*.csv)" is in the field. For some file types, there is more than one choice in the dropdown menu, which you can select by using the up and down arrow keys and Enter.

Up One Level

This key corresponds to the icon of a folder with the up arrow that is in the tool bar of the dialog. When pressed, it causes the file and folder list to navigate up one level in the directory structure. The Backspace key does the same thing.

Cancel

This key corresponds to the **Cancel** selection in the dialog. It causes the current **Open** request to be cancelled. The ESC key does the same thing.

Key Path	Recall, State
Notes	Brings up the Open dialog for recalling a State Save Type
Initial S/W Revision	Prior to A.02.00

Data (Export)

Exporting a data file stores data from the current measurement to mass storage files. The Export Menu only contains data types that are supported by the current measurement.

Since the commonly exported data files are in .csv format, the data can be edited by you prior to importing. This allows you to export a data file, manipulate the data in Excel (the most common PC Application for manipulating .csv files) and then import it.

Selecting an Export Data menu key will not actually cause the exporting to occur, since the analyzer still needs to know where you wish to save the data. Pressing the Save As key in this menu brings up the Save As dialog and Save As menu that allows you to specify the destination file and directory. Once a filename has been selected or entered in the Open menu, the export will occur as soon as the Save key is pressed.

Key Path	Save
Mode	All
Notes	The menu is built from whatever data types are available for the mode. So the key locations in the sub menu will vary. No SCPI command directly controls the Data Type that this key controls. The Data Type is included in the MMEM:STORe commands.

Dependencies	If a file type is not used by a certain measurement, that type is grayed out for that measurement. The key for a file type will not show at all if there are no measurements in the Mode that support it.
Preset	Is not affected by a Preset or shutdown, but is reset during Restore Mode Defaults
Readback	The data type that is currently selected
Initial S/W Revision	Prior to A.02.00

Amplitude Correction

Pressing this key selects **Amplitude Corrections** as the data type to be exported. Pressing this key again brings up the Select Menu, which allows the user to select which **Amplitude Correction** to save.

Amplitude Corrections are fully discussed in the documentation of the Input/Output key, under the Corrections softkey.

See "[Correction Data File](#)" on page 1204

Key Path	Save
Remote Command	:MMEMory:STORe:CORRection 1 2 3 4 5 6, <filename>
Example	:MMEM:STOR:CORR 2 "myAmpcor.csv" saves Correction 2 to the file myAmpcor.csv on the current path. The default path is My Documents\amplitudeCorrections.
Notes	If the save is initiated via SCPI, and the file already exists, the file will be overwritten. Using the C: drive is strongly discouraged, since it runs the risk of being overwritten during an instrument software upgrade. Both single and double quotes are supported for any filename parameter over SCPI.
Dependencies	Corrections are not supported by all Measurements. If in a Mode in which some Measurements support it, this key will be grayed out in measurements that do not. The key will not show at all if no measurements in the Mode support it. This key will not appear unless you have the proper option installed in your instrument.
Readback	Selected Correction
Backwards Compatibility SCPI	:MMEMory:STORe:CORRection ANTenna CABLe OTHer USER, <filename> For backwards compatibility, ANTenna maps to 1, CABLe maps to 2, OTHer maps to 3 and USER maps to 4
Initial S/W Revision	A.02.00

Correction Data File

A Corrections Data File contains a copy of one of the analyzer correction tables. Corrections provide a way to adjust the trace display for predetermined gain curves (such as for cable loss).

Corrections files are text files in .csv (comma separated values) form, to make them importable into Excel or other spreadsheet programs. The format for Corrections files is as follows.

Line #	Type of field	Example	Notes
1	File type, must be "Amplitude Correction"	Amplitude Correction	May not be omitted
2	File Description (in quotes)	"Correction Factors for 11966E"	60 characters max; may be empty but may not be omitted. If exceeds 60 characters, error -233 Too much data reported
3	Comment (in quotes)	"Class B Radiated"	60 characters max; may be empty but may not be omitted. . If exceeds 60 characters, error -233 Too much data reported
4	Instrument Version, Model #	A.02.06,N9020A	May be empty but may not be omitted
5	Option List, File Format Version	K03 LFE EXM ,01	May be empty but may not be omitted
6	Freq Unit to be used for all frequency values in the file	Frequency Unit,MHz	assumed to be Hz if omitted
7	Antenna Unit	Antenna Unit,None	If omitted leaves the Antenna unit unchanged. The amplitude unit in the Antenna Unit field is a conversion factor that is used to adjust the Y Axis Units of the current mode, if the mode supports Antenna Units. For more details on antenna correction data, refer to the Input/Output,Corrections key description. Allowable values: dBuv/m, dBuA/m, dBG, dBpT, None
8	Freq Interpolation	Frequency Interpolation,Linear	if omitted leaves the Freq Interpolation unchanged. Allowable values: Linear, Logarithmic
9	Bias value in mA	Bias,0.00	If omitted leaves the Bias value unchanged (added as of A.08.50)
10	Bias State	Bias State,On	If omitted leaves the Bias State unchanged. Allowable values: On, Off (added as of A.08.50)

Line #	Type of field	Example	Notes
11	Overlap, two values, Freq1 and Freq2, separated by commas.	Overlap,33500,40000	Uses Freq Unit from line 6. Thus, in this example Freq1=33.5 GHz, Freq2= 40.0 GHz (see note below). If omitted leaves the overlap unchanged (added as of A.08.50)
12	DATA marker	DATA	Corrections data begins in the next line

Lines 2 through 5 can be empty but must appear in the file. Lines 6 through 11 are optional, the lines can be left out of the file altogether.

The Overlap row and the two Bias rows apply only to external mixing. Both are read-only, they are never written by the analyzer. The only way to insert or modify these rows is to edit the file with a text editor or a spreadsheet editor. These rows are intended for use by mixer manufacturers, as they allow the manufacturer to insert data about how the mixer corrections were generated and how they should be applied. The Bias rows allow you to specify whether to turn Bias on or off when the Correction is turned on and to specify a Bias value (turning off the Correction does not change the Bias, but turning it back on again sets it to the value specified in the file). The Overlap row allows you to specify an overlap region in which two different corrections may be applied. It is expected that in the corrections data itself, there will be TWO corrections values exactly at Max Freq, otherwise Overlap is ignored. The way the overlap is processed is as follows: if at any given time the current analyzer Start Freq is greater than Freq 1 and lower than Freq 2, and the current Stop Freq is greater than Freq 2, extend the first correction point at or above Freq 2 down to Freq 1, rather than using the correction data between Freq1 and Freq2.

The Antenna Unit row can only be used in Correction register 1, because there can only be one setting for Antenna Unit at any given time. If a Correction whose Antenna Unit is set to anything but None is loaded into any Correction register but 1, an error is generated (Mass storage error; Can only load an Antenna Unit into Correction 1). When a correction file is saved from any Correction register but 1, Antenna Unit is always written as None.

Similarly, the Bias rows can only be used in Correction register 1, because there can only be one setting for Bias at any given time. If a Correction file with a Bias or Bias State row is loaded into any Correction register but 1, an error is generated: Mass storage error; Can only load Bias Settings into Correction 1

The data follows the DATA row, as comma separated X, Y pairs; one pair per line.

For example, suppose you have an Antenna to correct for on an N9020A version A.02.06 and the correction data is:

– 0 dB at 200 MHz

- 17 dB at 210 MHz
- 14.8 dB at 225 MHz

Then the file will look like:

- Amplitude Correction
- "Correction Factors for 11966E"
- "Class B Radiated"
- A.02.06,N9020A
- P13 EA3 UK6,01
- Frequency Unit,MHz
- Antenna Unit,dBuV/m
- Frequency Interpolation,Linear
- DATA
- 200.000000,0.00
- 210.000000,17.00
- 225.000000,14.80

The choices for the 1 of N fields in the metadata are as follows:

- Frequency Unit: Hz, kHz, MHz, GHz
- Antenna Unit: dBuv/m, dBuA/m, dBG, dBpT, None
- Frequency Interpolation: Logarithmic, Linear

Amplitude Correction

These keys let you choose which Correction to save. Once selected, the key returns back to the Export Data menu and the selected Correction number is annotated on the key.

The next step in the Save process is to select the Save As key in the Export Data menu.

Key Path	Save, Data, Amplitude Correction
Preset	Not part of a Preset, but is reset to Correction 1 by Restore Input/Output Defaults. Survives a shutdown.
Readback	1
Initial S/W Revision	A.02.00

Trace

Pressing this key selects Traces as the data type to be exported. Pressing this key when it is already selected brings up the Trace Menu, which allows you to select which Trace to save.

The trace file contains “meta” data which describes the current state of the analyzer. The metadata is detailed in ["Trace File Contents" on page 1208](#) below.

Key Path	Save, Data
Remote Command	:MMEMory:STORe:TRACe:DATA TRACE1 TRACE2 TRACE3 TRACE4 TRACE5 TRACE6 ALL,<filename>
Example	:MMEM:STOR:TRAC:DATA TRACE2, "myTrace2.csv" Exports the 2nd trace to the file myTrace2.csv in the current path. The default path is My Documents\SA\data\traces
Notes	If the save is initiated via SCPI, and the file already exists, the file will be overwritten. Using the C: drive is strongly discouraged, since it runs the risk of being overwritten during an instrument software upgrade. Both single and double quotes are supported for any filename parameter over SCPI.
Dependencies	For SA measurements, traces cannot be recalled from a trace file that was saved with ALL traces selected.
Couplings	When you select which trace to save, it makes that trace the current trace, so it displays on top of all of the other traces.
Readback	selected Trace
Status Bits/OPC dependencies	Sequential - waits for previous measurement to complete
Initial S/W Revision	Prior to A.02.00

Trace File Contents

A Trace Data File contains the data for one trace.

Metadata: Trace Specific

Besides the trace data, there is metadata describing the context by which the trace was produced. Some of the metadata is trace specific:

- Trace Type
- Detector
- Trace math (function, operand1, operand2, offset, reference)
- Trace name/number

When importing a trace, the detector and/or trace math function specified in the metadata is imported with the trace, so that the annotation correctly shows the detector and/or math type that was used to generate the data

Metadata: Display Specific

There is also some display-related metadata:

- Ref Level Offset
- External Gain
- X-Axis Unit
- Y-Axis Unit

Metadata: Measurement Related

The rest of the metadata is measurement specific and reflects the state of the measurement the last time the trace was updated. These are the “measurement-related instrument settings” which, if changed, cause a measurement restart.

- Number of Points
- Sweep Time
- Start Frequency
- Stop Frequency
- Average Count (actual; not the limit for the instrument)
- Average Type
- RBW
- RBW Filter Type
- RBW Filter BW Type
- VBW
- Sweep Type (FFT vs. Swept)
- Log/Lin X Scale (sometimes called Log Sweep)
- Preamp (on/off, band)
- Trigger (source, level, slope, delay)
- Phase Noise optimization setting
- Swept IF Gain
- FFT IF Gain
- AC/DC setting (RF Coupling)

- FFT Width
- External Reference setting
- Input (which input is in use)
- RF calibrator on/off
- Attenuation

Because any inactive trace can have a value that does not match the rest of the measurement, when performing a Save the metadata for each trace is pulled from the individual trace, not from the measurement.

A revision number is also included in the trace database, to allow for future changes.

The choices for the various 1 of N and binary fields are as follows:

- Average Type: Power(RMS), Voltage, LogPower(Video)
- RBW Filter Type: Flattop, EMI, Gaussian
- RBW Filter BW: 3dB, 6dB, Noise, Impulse
- Sweep Type: Swept, FFT
- PreAmp State: On, Off
- PreAmp Band: Low, Full
- Trigger Source: Free, RFBurst, Video, Line, Periodic, Ext1, Ext2, TV
- Trigger Slope: Positive, Negative
- Phase Noise Optimization: Fast, Narrow, Wide
- Swept IF Gain: Low, High
- FFT If Gain: Autorange, Low, High
- Input: RF, BBIQ
- RF Calibrator: 50M, 400G, Comb, Off
- Trace Type: ClearWrite, TraceAverage, MaxHold, MinHold
- Detector: Normal, Average, Peak, NegPeak, Sample
- Trace Math: Off, PowerDifference, PowerSum, LogOffset, LogDifference
- Y Axis Unit: dBm, dBmV, dBmA, W, V, A, dBuV, dBuA, dBuV/m, dBuA/m, dBuV, dBpT, dBG, dB

After the header, just before the trace data, a line with just the word DATA on it is inserted to flag the start of the trace data.

The following file example shows the first lines of a Trace 1 file with X Axis Unit = Hz and Y Axis Unit = dBuV, after importing into Excel (the second row contains the Title):

Trace	
"AS/NZS 1044; Conducted >1000 W, Motors, Average"	
A.01.00	E4410A
526 EA3 B25 P26 PFR	1
Segment	0
Number of Points	1001
Sweep Time	0.066266667
Start Frequency	18827440
Stop Frequency	24463718
Average Count	0
Average Type	Power(RMS)
RBW	51000
RBW Filter	Gaussian
RBW Filter BW	3dB
VBW	51000
Sweep Type	Swept
X Axis Scale	Lin
PreAmp State	Off
PreAmp Band	Low
Trigger Source	Video
Trigger Level	1.2
Trigger Slope	Positive
Trigger Delay	1.00E-06
Phase Noise Optimization	Fast
Swept IF Gain	Low
FFT IF Gain	Autorange
RF Coupling	AC
FFT Width	411900
Ext Ref	10000000
Input	RF
RF Calibrator	Off

Attenuation	10
Ref Level Offset	0
External Gain	0
Trace Type	ClearWrite
Detector	Normal
Trace Math	Off
Trace Math Oper1	Trace5
Trace Math Oper2	Trace6
Trace Math Offset	0
Trace Name	Trace1
X Axis Unit	Hz
Y Axis Unit	dBm
DATA	
1.6009301E+07	4.82047E+01
1.6018694E+07	4.69737E+01
1.6028087E+07	4.81207E+01
1.6037480E+07	4.72487E+01
1.6046873E+07	4.66437E+01
1.6056266E+07	4.66237E+01
1.6065659E+07	4.66967E+01
1.6075052E+07	4.77117E+01
1.6084445E+07	4.75787E+01
1.6093838E+07	4.83297E+01
1.6103231E+07	4.71327E+01
1.6112624E+07	4.78957E+01
1.6122017E+07	4.67507E+01
1.6131410E+07	4.81137E+01

Limit

Pressing this key selects Limit Lines as the data type to be exported. Pressing the key a second time brings up the Limit Menu that allows you to select which **Limit Line** to save.

- See ["Limits File Contents" on page 1213](#).
- See [".csv file format" on page 1213](#)
- See [".lim file format" on page 1214](#)

Key Path	Save, Data
Remote Command	:MMEMory:STORe:LIMit LLINE1 LLINE2,<filename>
Example	:MMEM:STOR:LIM LLINE2, "myLimitLine2.csv" Saves the 2nd Limit Line to the file myLimitLine2.csv in the current path. The default path is My Documents\SA\data\limits
Notes	If the save is initiated via SCPI, and the file already exists, the file will be overwritten. Using the C: drive is strongly discouraged, since it runs the risk of being overwritten during an instrument software upgrade. Both single and double quotes are supported for any filename parameter over SCPI.
Dependencies	This key will only appear if you have the proper option installed in your instrument.
Preset	1; not part of Preset, but is reset by Restore Mode Defaults and survives power cycles
State Saved	The selected Limit number is saved in instrument state.
Readback	selected Limit Line
Status Bits/OPC dependencies	Sequential - waits for previous measurement to complete
Initial S/W Revision	A.02.00

Limits File Contents

Limits may be exported into a data file with a .csv extension. They may be imported from that data file; they may also be imported from a legacy limit file with a .lim extension. The .lim files meet the specification for limit files contained in the EMI measurement guide, HP E7415A.

.csv file format

Except for information in quotes, limit line files are not case sensitive. Information in bold is required verbatim; other text is example text, and italic text is commentary which should not be present in the file.

The first five lines are system-required header lines, and must be in the correct order.

Limit	<i>Data file type name</i>
"FCC Part 15"	<i>File Description</i>
"Class B Radiated"	<i>Comment</i>
A.01.00.R0001,N9020A	<i>Instrument Version, Model Number</i>
P13 EA3 UK6 ,01	<i>Option List, File Format Version</i>

The next few lines describe the parameters; on export they will be in the order shown, on import they can be in any order. If some parameters are missing, they will revert to the default.

Type, Upper	Upper Lower
X Axis Unit, MHz	MHz S; other units should be converted; this also specifies the domain
Amplitude Unit, dBm	dBm V; all other units should be converted appropriately
Frequency Interpolation, Linear	Logarithmic Linear
Amplitude Interpolation, Logarithmic	Logarithmic Linear
X Control, Fixed	Fixed Relative; on input we consider only the first three characters
Y Control, Fixed	Fixed Relative; on input we consider only the first three characters
Margin, 0	Always in dB. A 0 margin is equivalent to margin off
X Offset, 10	Expressed in the X axis units
Y Offset, 5	Expressed in the Amplitude units

The Amplitude Unit line in the limits file may contain an antenna factor unit, for example:

Amplitude Unit=dBuV/m

Antenna factor units are dBuV/m, dBuA/m, dBpT, and dBG. In this case, the unit is treated exactly as though it were dBuV, meaning that all of the limits are interpreted to have units of dBuV. The box does NOT change Y Axis Units when such a limit is loaded in.

The X axis unit also specifies the domain (time or frequency). It is not possible to have both time-domain lines and frequency-domain lines at the same time; if a time-domain line is imported while the other lines are in the frequency domain (or vice-versa), all limit lines will be deleted prior to import.

If the sign of the margin is inappropriate for the limit type (for example a positive margin for an upper limit), the sign of the margin will be changed internally so that it is appropriate.

The remaining lines describe the data. Each line in the file represents an X-Y pair. The X values should be monotonically non-decreasing, although adjacent lines in the file can have the same X value as an aid to building a stair-stepped limit line. To specify a region over which there is no limit, use +1000 dBm for upper limits or -1000 dBm for lower limits.

The data region begins with the keyword DATA:

DATA
200.000000,-10.00
300.000000,-10.00
300.000000,-20.00
500.000000,-20.00

.lim file format

This is a legacy format which allows files saved from older analyzers to be loaded into the X-Series. Design of files in this format is not recommended.

Limit Selection

These keys let you pick which Limit Line to save. Once selected, the key returns back to the **Export Data** menu and the selected Limit Line number is annotated on the key.

The next step in the Save process is to select the Save As key in the Export Data menu.

Key Path	Save, Data, Limit Line
Notes	auto return
Preset	Not part of Preset, but is reset to LLINE1 by Restore Mode Defaults; survives shutdown
Initial S/W Revision	A.02.00

Measurement Results

Pressing this key selects Meas Results as the data type to be exported.

The Meas Results file contains information which describes the current state of the analyzer. It is detailed in Meas Result File Contents below.

Key Path	Save, Data
Remote Command	:MMEMory:STORe:RESults <string>
Example	:MMEM:STOR:RES "MeasR_0000.csv"
Notes	<p>If the save is initiated via SCPI and the file already exists, the file will be overwritten.</p> <p>The SCPI command exports Channel Power measurement results to the file specified as the parameter in the current path. The default path is My Documents\<current mode>\data\chp\results.<="" p=""> <p>Using the C: drive is strongly discouraged, since it runs the risk of being overwritten during an instrument software upgrade.</p> <p>The SCPI parameter is a quoted string, which specifies the filename. Both single and double quotes are supported for any filename parameter over SCPI.</p> </current></p>
Dependencies	The current active measurement must be the Channel Power measurement to use this command.
Status Bits/OPC dependencies	Sequential – waits for the previous measurement to complete.
Initial S/W Revision	Prior to A.02.00

Meas Results File Contents

A Meas Results File contains measurement results with the following information.

- File ID string, which is “MeasResult”
- Measurement ID following Mode ID, which is “SA:CHP” for example.
- Firmware rev and model number
- Option string
- Auto Sweep Time Rules
- Average Mode
- Average Number
- Average State
- Center Frequency

- Detector
- Electrical Atten
- Electrical Atten State
- IFGain
- IFGainAuto
- Impedance
- Integ BW
- Internal Preamp
- Internal Preamp Band
- Mechanical Atten
- MechanicalAttenStepEnum
- PSD Unit
- Resolution Band Width
- Resolution Bandwidth Shape
- RRC Filter Alpha
- RRC Filter BW
- RRC Filter State
- Span
- Sweep Points
- Sweep Time
- Sweep Time Auto
- TriggerSource
- Video Bandwidth
- Y Axis Unit

The file contains these data followed by MeasResult1 and MeasResult2 that flag the start of the measurement results. Each line of Measurement Results consists of two comma separated values, MeasResult1 value and MeasResult2 value. MeasResult1

contains the same results as MEAS/READ/FETCh:CHPower1; MeasResult2, MEAS/READ/FETCh:CHPower2.

Exported file is .csv file. The Meas Results file, when imported into Excel, will show the following data:

MeasResult	
SA:CHP	
A.10.53	N9030A
526 ALV ATP B1X B1Y B25 B40 BBA CR3 CRP DCF DDA DP2 DRD EA3 EDP EMC EP1 ERC ESC ESP EXM FSA LFE LNP MAT MPB NFE NUL P26 PFR PNC RTL RTS S40 SB1 SEC SM1 TVT YAS YAV	1
Auto Sweep Time Rules	Normal
Average Mode	Exponential
Average Number	10
Average State	TRUE
Center Frequency	13255000000
Detector	Average
IFGain	FALSE
IFGainAuto	FALSE
Impedance	50
Integ BW	2000000
Internal Preamp	FALSE
Internal Preamp Band	Low
PSD Unit	DbmHz
Resolution Band Width	27000
Resolution Bandwidth Shape	Gaussian
RRC Filter Alpha	0.22
RRC Filter BW	3840000
RRC Filter State	FALSE
Span	3000000
Sweep Points	1001
Sweep Time	0.004933333
Sweep Time Auto	TRUE
TriggerSource	Free
Video Bandwidth	270000
Y Axis Unit	DecibelMilliwatt
MeasResult1	MeasResult2
-76.8141133132837	-95.29174

-139.824413269924	-94.99601
	-94.95281
	-95.17146

Save As . . .

When you press “Save As”, the analyzer brings up a Windows dialog and a menu entitled “**Save As.**” This menu allows you to navigate to the various fields in the Windows dialog without using a keyboard or mouse. The **Tab** and **Arrow** keys can also be used for dialog navigation.

See "[To File . . .](#)" on page 3202 in **Save, State** for a full description of this dialog and menu.

The default path for saving files is:

For all of the Trace Data Files:

- My Documents\`<mode name>`\data\traces

For all of the Limit Data Files:

- My Documents\`<mode name>`\data\limits

For all of the Measurement Results Data Files:

- My Documents\`<mode name>`\data\`<measurement name>`\results

For all of the Capture Buffer Data Files:

- My Documents\`<mode name>`\data\captureBuffer

Key Path	Save, Data
Mode	All
Notes	The key location is mode-dependent and will vary. Brings up the Save As dialog for saving a <code><mode specific></code> Save Type. The save is performed immediately and does not wait until the measurement is complete.
Initial S/W Revision	Prior to A.02.00

Screen Image

Pressing Screen Image accesses a menu of functions that enable you to specify a format and location for the saved screen image. It brings up a menu that allows you to specify the color scheme of the Screen Image (Themes) or navigate to the Save As dialog to perform the actual save.

Screen Image files contain an exact representation of the analyzer display. They cannot be loaded back onto the analyzer, but they can be loaded into your PC for use in many popular applications.

The image to be saved is actually captured when the **Save** front panel key is pressed, and kept in temporary storage to be used if you ask for a Screen Image save. When the Screen Image key is pressed, a "thumbnail" of the captured image is displayed, as shown below:

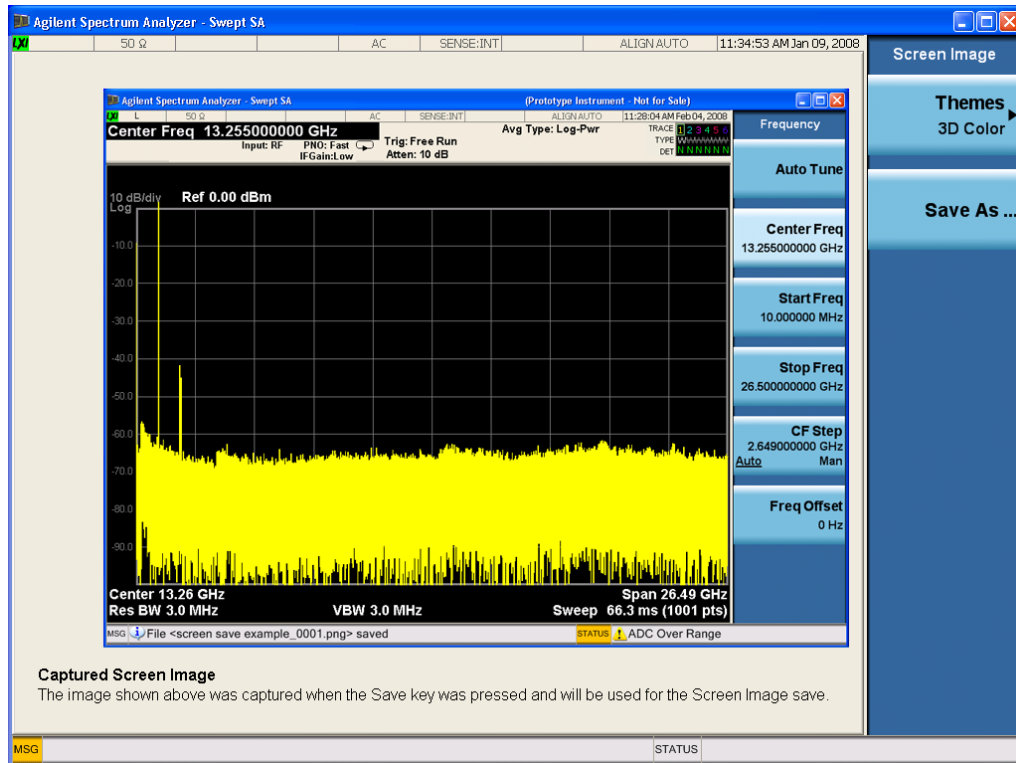

When you continue on into the **Save As** menu and complete the Screen Image save, the image depicted in the thumbnail is the one that gets saved, showing the menus that were on the screen before going into the **Save** menus. The save is performed immediately and does not wait until the measurement is complete.

After you have completed the save, the **Quick Save** front-panel key lets you quickly repeat the last save performed, using an auto-named file, with the current screen data.

NOTE

For versions previous to A.01.55, if you initiate a screen image save by navigating through the Save menus, the image that is saved will contain the Save menu softkeys, not the menus and the active function that were on the screen when you first pressed the Save front panel key.

Key Path	Save
Mode	All
Remote Command	:MMEMory:STORe:SCReen <filename>
Example	:MMEM:STOR:SCR "myScreen.png" This stores the current screen image in the file MyScreenFile.png in the default directory.
Backwards Compatibility SCPI	HCOPy:SDUMp:DATA?

returns the screen image in a <DEFINITE LENGTH ARBITRARY RESPONSE DATA> element. The response data is IEEE Block format; the controlling computer can strip the header and store the result as a .png file.

Initial S/W Revision Prior to A.02.00

Themes

Accesses a menu of functions that enable you to choose the theme to be used when saving the screen image.

The **Themes** option is the same as the **Themes** option under the **Display and Page Setup** dialogs. It allows you to choose between themes to be used when saving the screen image.

Key Path	Save, Screen Image
Remote Command	:MMEMory:STORe:SCReen:THEMe TDColor TDMonochrome FCOLOR FMONochrome :MMEMory:STORe:SCReen:THEMe?
Example	:MMEM:STOR:SCR:THEM TDM
Preset	3D Color; Is not part of Preset, but is reset by Restore Misc Defaults or Restore System Defaults All and survives subsequent running of the modes.
Readback	3D Color 3D Mono Flat Color Flat Mono
Backwards Compatibility Notes	In ESA and PSA we offer the choice of "Reverse Bitmap" or "Reverse Metafile" when saving screen images. This is much like the "Flat Color" theme available in X-Series. Also, if you selected Reverse Bitmap AND a black & white screen image, that would be much like "Flat Monochrome". In other words, each of the X-Series themes has a similar screen image type in ESA/PSA. But they are not identical.
Initial S/W Revision	Prior to A.02.00

3D Color

Selects a standard color theme with each object filled, shaded and colored as designed.

Key Path	Save, Screen Image, Themes
Example	MMEM:STOR:SCR:THEM TDC
Readback	3D Color
Initial S/W Revision	Prior to A.02.00

3D Monochrome

Selects a format that is like 3D color but shades of gray are used instead of colors.

Key Path	Save, Screen Image, Themes
Example	MMEM:STOR:SCR:THEM TDM
Readback	3D Mono
Initial S/W Revision	Prior to A.02.00

Flat Color

Selects a format that is best when the screen is to be printed on an ink printer.

Key Path	Save, Screen Image, Themes
Example	MMEM:STOR:SCR:THEM FCOL
Readback	Flat Color
Initial S/W Revision	Prior to A.02.00

Flat Monochrome

Selects a format that is like Flat Color. But only black is used (no colors, not even gray), and no fill.

Key Path	Save, Screen Image, Themes
Example	MMEM:STOR:SCR:THEM FMON
Readback	Flat Mono
Initial S/W Revision	Prior to A.02.00

Save As...

When you press "Save As", the analyzer brings up a Windows dialog and a menu entitled "**Save As.**" This menu allows you to navigate to the various fields in the Windows dialog without using a keyboard or mouse. The **Tab** and **Arrow** keys can also be used for dialog navigation.

See "[To File . . .](#)" on page 3202 in **Save, State** for a full description of this dialog and menu.

The default path for Screen Images is

- My Documents\`<mode name>`\screen.

where `<mode name>` is the parameter used to select the mode with the INST:SEL command (for example, SA for the Spectrum Analyzer).

Key Path	Save, Screen Image
Notes	Brings up Save As dialog for saving a Screen Image Save Type
Initial S/W Revision	Prior to A.02.00

Mass Storage Catalog (Remote Command Only)

Key path	SCPI Only
Remote Command	:MMEMory:CATalog? [<code><directory_name></code>]
Notes	The string must be a valid logical path. Queries disk usage information (drive capacity, free space available) and obtains a list of files and directories in a specified directory in the following format: <code><numeric_value>,<numeric_value>,{<file_entry>}</code>

It returns two numeric parameters and as many strings as there are files and directories. The first parameter indicates the total amount of storage currently used in bytes. The second parameter indicates the total amount of storage available, also in bytes. The <file_entry> is a string. Each <file_entry> indicates the name, type, and size of one file in the directory list:

<file_name>,<file_type>,<file_size>

As the windows file system has an extension that indicates file type, <file_type> is always empty. <file_size> provides the size of the file in bytes. For directories, <file_entry> is surrounded by square brackets and both <file_type> and <file_size> are empty

Initial S/W Revision Prior to A.02.00

Mass Storage Change Directory (Remote Command Only)

Key path **SCPI Only**

Remote Command :MMEMory:CDIRectory [<directory_name>]
 :MMEMory:CDIRectory?

Notes The string must be a valid logical path.
 Changes the default directory for a mass memory file system. The <directory_name> parameter is a string. If no parameter is specified, the directory is set to the *RST value.
 At *RST, this value is set to the default user data storage area, that is defined as System.Environment.SpecialFolder.Personal.
 Query returns full path of the default directory.

Initial S/W Revision Prior to A.02.00

Mass Storage Copy (Remote Command Only)

Key path **SCPI Only**

Remote Command :MMEMory:COpy <string>,<string>[,<string>,<string>]

Notes The string must be a valid logical path.
 Copies an existing file to a new file or an existing directory to a new directory.
 Two forms of parameters are allowed. The first form has two parameters. In this form, the first parameter specifies the source, and the second parameter specifies the destination.
 The second form has four parameters. In this form, the first and third parameters specify the source. The second and fourth parameters specify the directories. The first pair of parameters specifies the source. The second pair specifies the destination. An error is generated if the source doesn't exist or the destination file already exists.
 This command will generate an "access denied" error if the destination is a restricted folder (e.g., C:\Windows) and the current user does not have Power User or Administrator privileges.

Mass Storage Device Copy (Remote Command Only)

This command transfers data to/from a file and a peripheral device.

Key path **SCPI Only**

Remote Command	:MMEMory:COPIY:DEVIce <source_string>,<dest_string>
Notes	<p>The strings must be a valid logical path or a valid device keyword. If the dest_string is a device keyword, the data is copied from the source file to the device. If the source_string is a device keyword, the data is copied to the source file from the device.</p> <p>Valid device keywords are: SNS (smart noise source)</p> <p>An error is generated if the file or device is not found.</p>

Mass Storage Delete (Remote Command Only)

Key path	SCPI Only
Remote Command	:MMEMory:DELeTe <file_name>[,<directory_name>]
Notes	<p>The string must be a valid logical path.</p> <p>Removes a file from the specified directory. The <file_name> parameter specifies the file name to be removed. This command will generate an “access denied” error if the file is in a restricted folder (e.g., C:\Windows) and the current user does not have Power User or Administrator privileges.</p>
Initial S/W Revision	Prior to A.02.00

Mass Storage Data (Remote Command Only)

Creates a file containing the specified data OR queries the data from an existing file.

Key path	SCPI Only
Remote Command	:MMEMory:DATA <file_name>, <data> :MMEMory:DATA? <file_name>
Notes	<p>The string must be a valid logical path.</p> <p>The command form is MMEMory:DATA <file_name>,<data>. It loads <data> into the file <file_name>. <data> is in 488.2 block format. <file_name> is string data.</p> <p>The query form is MMEMory:DATA? <file_name> with the response being the associated <data> in block format.</p>
Initial S/W Revision	Prior to A.02.00

Mass Storage Make Directory (Remote Command Only)

Key path	SCPI Only
Remote Command	:MMEMory:MDIRectory <directory_name>
Notes	<p>The string must be a valid logical path.</p> <p>Creates a new directory. The <directory_name> parameter specifies the name to be created.</p> <p>This command will generate an “access denied” error if the new directory would be in a restricted folder (e.g., C:\Windows) and the current user does not have Power User or Administrator privileges.</p>
Initial S/W Revision	Prior to A.02.00

Mass Storage Move (Remote Command Only)

Key path	SCPI Only
Remote Command	:MMEMory:MOVE <string>,<string>[,<string>,<string>]
Notes	<p>The string must be a valid logical path.</p> <p>Moves an existing file to a new file or an existing directory to a new directory.</p> <p>Two forms of parameters are allowed. The first form has two parameters. In this form, the first parameter specifies the source, and the second parameter specifies the destination.</p> <p>The second form has four parameters. In this form, the first and third parameters specify the source. The second and fourth parameters specify the directories. The first pair of parameters specifies the source. The second pair specifies the destination. An error is generated if the source doesn't exist or the destination file already exists.</p> <p>This command will generate an "access denied" error if the destination is a restricted folder (e.g., C:\Windows) and the current user does not have Power User or Administrator privileges.</p>
Initial S/W Revision	Prior to A.02.00

Mass Storage Remove Directory (Remote Command Only)

Key path	SCPI Only
Remote Command	:MMEMory:RDIRECTory <directory_name>
Notes	<p>The string must be a valid logical path.</p> <p>Removes a directory. The <directory_name> parameter specifies the directory name to be removed. All files and directories under the specified directory shall also be removed.</p> <p>This command will generate an "access denied" error if the folder is a restricted folder (e.g., C:\Windows) or is in a restricted folder and the current user does not have Power User or Administrator privileges.</p>
Initial S/W Revision	Prior to A.02.00

Mass Storage Determine Removable Media (Remote Command Only)

This command is used to determine if any removable media devices are connected to the instrument. Primarily, these are USB memory devices plugged-in to the front panel or rear panel USB ports. On instruments with PC6 or PC7 CPU's, one SD card slot is available for removable media. The instrument's primary disk drive is not a removable media device.

Key Path	SCPI Only
Remote Command	:MMEMory:RMEDIA:LIST?
Notes	<p>The return value is a string containing a list of partition identifiers that are removable media devices. Each identifier is separated by a comma. If no removable media is present, an empty string is returned.</p> <p>Examples:</p> <ul style="list-style-type: none"> - One removable device present results in a return string of "F:".

- Two removable devices present results in a return string of "F:,G:".
- No removable devices present results in a return string of "".

Initial S/W Revision x.15.00

Mass Storage Determine Removable Media Label (Remote Command Only)

This command is used to set or query a removable media device's label.

Key Path	SCPI Only
Remote Command	:MMEMory:RMEDia:LABel <partition>,<string> :MMEMory:RMEDia:LABel? <partition>
Example	MMEM:RMED:LAB "F:","My Device"
Notes	If the <partition> specified does not exist or is not a removable media device, the error - 252,"Missing Media" is generated. Setting the removable media label requires Administrative privileges. If the currently logged in user does not have appropriate privileges the error "-221.9900,Settings conflict;Administrator privileges required" is generated.
Initial S/W Revision	x.15.00

Mass Storage Determine Removable Media Write-protect status (Remote Command Only)

This command is used to query a removable media device's write-protect status.

Key Path	SCPI Only
Remote Command	:MMEMory:RMEDia:WPRotect? <partition>
Example	MMEM:RMED:WPR? "F:"
Notes	The return value is 1 if the device is write-protected, or 0 if the device is write-enabled. If the <partition> specified does not exist or is not a removable media device the error - 252,"Missing Media" is generated.
Preset	The return value will be depending on SD card installed.
Initial S/W Revision	x.15.00

Mass Storage Determine Removable Media size (Remote Command Only)

This command is used to query a removable media device's total memory size (not available memory size).

Key Path	SCPI Only
Remote Command	:MMEMory:RMEDia:SIZE? <partition>

Example	MMEM:RMED:SIZE? "F:"
Notes	The return value is integer value in GBytes. Any device that is less than 1 GB returns 0 GB. If the <partition> specified does not exist or is not a removable media device, the error - 252, "Missing Media" is generated.
Initial S/W Revision	x.15.00

:SYSTem:SET (Remote Command Only)

Remote command that allows the user to obtain the state of the currently active mode in a form that can then be loaded back into the instrument quickly.

Remote Command	SYSTem:SET <instrument state in IEEE Block> SYSTem:SET?
Notes	SYST:SET? returns current instrument state of the active mode in IEEE Block data format. The state is in a machine readable format only. Sending the query returns the following format: <syst set preamble><state block data> Where: <syst set preamble> is the format: #NMMM N=number of digits that comprise MMM MMM=length in bytes of following data <state block data> is machine readable state data Example response: #42016<state data> The state is recalled by sending the SYST:SET? Response data to the instrument. From example above: SYST:SET #42016<state data>
Initial S/W Revision	x.17.00

Single (Single Measurement/Sweep)

Sets the analyzer for Single measurement operation. The single/continuous state is Meas Global, so the setting will affect all the measurements. If you are Paused, pressing **Single** does a Resume.

See "[More Information](#)" on page 1227

Key Path	Front-panel key
Example	:INIT:CONT OFF
Notes	See Cont key description.
Backwards Compatibility Notes	<p>For Spectrum Analysis mode in ESA and PSA, the Single hardkey and the INITiate:IMM switched from continuous measurement to single measurement and restarted sweeps and averages (displayed average count reset to 1), but did not restart Max Hold and Min Hold. In the X-Series, the Single hardkey and the INITiate:IMM command initiate a sweep/ measurement/ average sequence/hold sequence including MaxHold and MinHold.</p> <p>For Spectrum Analysis mode in ESA and PSA, the Single hardkey restarted the sweep regardless of whether or not you were in an active sweep or sweep sequence. In the X-Series, Restart does this but Single only restarts the sweep or sweep sequence if you are in the idle state.</p> <p>INIT[:IMM] in ESA & PSA Spectrum Analysis Mode does an implied ABORt. In some other PSA Modes, INIT[:IMM] is ignored if not in the idle state. . The X-Series follows the ESA/PSA SA Mode model, which may cause some Modes to have compatibility problems.</p>
Initial S/W Revision	Prior to A.02.00

More Information

See "[Restart](#)" on page 3199 for details on the INIT:IMMEDIATE (Restart) function.

If you are already in single sweep, the INIT:CONT OFF command has no effect.

If you are already in Single Sweep, then pressing the **Single** key in the middle of a sweep does not restart the sweep or sequence. Similarly, pressing the **Single** key does not restart the sweep or sequence if the sweep is not in the idle state (for example, if you are taking a very slow sweep, or the analyzer is waiting for a trigger). Instead, it results in a message. "Already in Single, press Restart to initiate a new sweep or sequence". Even though pressing the **Single** key in the middle of a sweep does not restart the sweep, sending INIT:IMMEDIATE does reset it.

To take one more sweep without resetting the average count, increment the average count by 1, by pressing the step up key while **Average/Hold Number** is the active function, or sending the remote command CALC:AVER:TCON UP.

Source

The Source key accesses menus for controlling a Source in Tracking Source mode

Key Path	Front-panel key
Dependencies	<p>Operation with a source requires a license. If the proper license is not installed, the following occurs:</p> <ul style="list-style-type: none"> - When the Source key is pressed the user sees an informational message, "Option not installed" - If any SCPI command in the :SOURce subsystem is sent it generates a message, "Settings conflict;option not installed"
Initial S/W Revision	A.06.01

NOTE

Option T03 or T06 is required for the Tracking Generator function in CXA. Option T03, T07, T13 or T26 is required for the Tracking Generator function in CXA-m.

When using the CXA-m Tracking Generator, if the Source Frequency is in the frequency range of the below table, and the Source Amplitude is in the corresponding amplitude range of the below table, a warning status message is generated, +313 "Source Uncal". This is also true if Power Sweep is on and any amplitude in the Power Sweep (as calculated by Amplitude, Power Sweep, and Amptd Offset) is in that range.

CXA-m TG Un-calibrated Amplitude Range

Frequency Range	Amplitude Range
$2 \text{ MHz} \leq \text{frequency} < 10 \text{ GHz}$	$-40 \text{ dBm} \leq \text{amplitude} < -35 \text{ dBm}$
$10 \text{ GHz} \leq \text{frequency} < 20 \text{ GHz}$	$-40 \text{ dBm} \leq \text{amplitude} < -35 \text{ dBm}$ or $-5 \text{ dBm} < \text{amplitude} \leq 0 \text{ dBm}$
$20 \text{ GHz} \leq \text{frequency} \leq 26.55 \text{ GHz}$	$-12 \text{ dBm} < \text{amplitude} \leq 0 \text{ dBm}$

RF Output

Allows you to turn the source RF Power on or off.

NOTE

When the RF Output is turned on, the Source Mode is set to Tracking. See the Source Mode key description for special considerations concerning how to configure your N5172B or N5182B source for use with External Source Control.

Key Path	Source
Scope	Meas Global
Remote Command	:OUTPut[:EXTErnal] [:STATe] ON OFF 1 0 :OUTPut[:EXTErnal] [:STATe]?

Example	:OUTP ON :OUTP?
Dependencies	Grayed out in measurements that do not support a source. If you go to such a measurement the output will be forced to Off. Grayed out if there is no valid source selection, in this case go to the Select Source menu to choose, configure and/or verify your source When there is no available Source Mode (other than Off), due to other couplings, then the RF Output key is grayed out.
Couplings	When RF Output is turned On, Source Mode is set to Tracking When Source Mode is turned Off, RF Output is turned Off. When Source Mode is turned Off (or forced to Off by another coupling), RF Output is turned Off. Turning RF Output Off does not affect Source Mode or other settings.
Preset	OFF (on either a Mode Preset, a Source Preset, or Restore Input/Output Defaults)
State Saved	Part of the Input/Output system, which means it is Loaded and Saved with state.
Range	On Off
Initial S/W Revision	A.06.01
Modified at S/W Revision	A.10.01

Amplitude

Allows you to access the Amplitude sub-menu to control various amplitude parameters of the Source. The resolution of the Source amplitude parameters is coupled to match the minimum resolution of the source when the source is acquired. When the source is released, the amplitude parameter resolution reverts to default values.

Key Path	Source
Readback	In square brackets, the amplitude value from Amplitude key in the next menu level down
Initial S/W Revision	A.06.01

Amplitude

Allows you to adjust the power level of the selected source. Note that the actual amplitude is also affected by the Amplitude Offset and Power Sweep parameters.

Key Path	Source, Amplitude
Scope	Mode Global
Remote Command	:SOURce[:EXTeRna1]:POWer[:LEVel][:IMMeDiate][:AMPLitude] <amp1> :SOURce[:EXTeRna1]:POWer[:LEVel][:IMMeDiate][:AMPLitude]?
Example	:OUTP ON :SOUR:POW -10dBm
Dependencies	If the requested setting of Source Amplitude causes the calculated external source start or stop Amplitude to exceed the external source capability, a warning status message is generated,

	<p>“Data out of Range; clipped to source max/min” The “Show Source Capabilities and Settings” menu can then be examined to check the source capabilities.</p> <p>This parameter test and clip is also performed at source acquisition.</p>
Preset	<p>-10.00 dBm (On Source Preset and Restore Input/Output Defaults)</p> <p>Not affected by Mode Preset</p>
State Saved	Part of the Input/Output system, which means it is Loaded and Saved with state.
Min	The range of the amplitude parameter is dependent on the amplitude range of the source that is selected, and the settings of Amplitude Offset and Power Sweep.
Max	The range of the amplitude parameter is dependent on the amplitude range of the source that is selected, and the settings of Amplitude Offset and Power Sweep.
Backwards Compatibility SCPI	<p>:SOURce:POWer:STARt <amp1></p> <p>:SOURce:POWer:STARt?</p> <p>This alias is for the ESA tracking generator. It specifies the source output power level at the start of the power sweep, just as does :SOURce:POWer.</p>
Initial S/W Revision	A.06.01
Modified at S/W Revision	A.10.01

Power Sweep

Allows you to set up a Power Sweep. Power Sweep is useful for measuring saturation behavior in a test device, such as a power amplifier.

Pressing the key sets the power-sweep function to On or Off. The value of the power-sweep range is displayed in the active function block, and can be adjusted, when set to On.

The source will sweep the power between the start power defined by the Amplitude function and the stop power = start power + power sweep value:

Source (start) amplitude = Amplitude – Amplitude Offset

Source (stop) amplitude = Amplitude – Amplitude Offset + Power Sweep

In Stepped Tracking, such as is used with an external source or the CXA-m TG, the analyzer controls the source with step sweep mode, which provides a linear progression from one selected frequency, amplitude, or both, to another, pausing at linearly spaced points (steps) along the sweep. The analyzer continues to sweep the specified frequency range when power sweep is on, although generally Power Sweep is performed in Zero Span.

With CXA options T03, T06, the hardware is capable of continuous power sweeps. This makes it possible to use the swept sweep time rules and should be employed for faster sweeps. Care should be taken to limit the sweep time you use as there are no sweep time couplings to Power Sweep settings. The recommended minimum sweep time depends on the RBW and power-sweep range. Start by computing $(1.28/\text{RBW}) * (\text{abs}(\text{startPower} - \text{stopPower}) / (5 \text{ dB}))$. The recommended minimum sweep time is the larger of this value and 50 ms.

Some external Sources have mechanical attenuators, which are not used in Power Sweep in order to save wear on the attenuators. To allow an acceptable range of Power Sweep without changing the mechanical attenuation, the Sources are put in a mode that allows the Source to handle a wide amplitude range without switching the attenuators. When the Power Sweep settings put the Source in an amplitude range that requires the mechanical attenuators, the analyzer displays a condition warning message:

Settings Alert;Src pwr ramp>ALC range

Key Path	Source, Amplitude
Mode	SA
Scope	Mode Global
Remote Command	:SOURce:POWer:SWEep <rel_amp1> :SOURce:POWer:SWEep? :SOURce:POWer:SWEep:STATe ON OFF 1 0 :SOURce:POWer:SWEep:STATe?
Example	:SOUR:POW -5 :SOUR:POW:SWE:STAT ON :SOUR:POW:SWE 10 Set source start power to - 5 dBm and stop power + 5dBm (-5 + 10).
Example	:SOUR:POW:SWE:STAT ON
Dependencies	If the requested setting of Power Sweep causes the calculated external source start or stop Amplitude to exceed the external source capability, a warning status message is generated, "Data out of Range; clipped to source max/min". The Show Source Capabilities and Settings menu can then be examined to check the source capabilities. This parameter test and clip is also performed at source acquisition.
Preset	This is unaffected by "Mode Preset" but is set to 0dB on a "Source Preset" or "Restore Input/Output Defaults".
State Saved	Part of the Input/Output system, which means it is Loaded and Saved with state.
Min	-500 dB
Max	+500 dB
Backwards Compatibility SCPI	:SOURce[:EXTeRnAl][:SWEep]:POWer:SPAN <rel_amp1> :SOURce[:EXTeRnAl][:SWEep]:POWer:SPAN? This alias is for the ESA tracking generator and PSA option 215. It specifies the range of power levels through which the source output will sweep just as does :SOURce:POWer:SWEep.
Initial S/W Revision	A.06.01
Remote Command	:SOURce[:EXTeRnAl]:POWer:MODE FIXed SWEep :SOURce[:EXTeRnAl]:POWer:MODE?
Notes	The ESA tracking generator and the PSA option 215 support this SCPI command. It sets the source output to be at a single amplitude (fixed) or to sweep through a range of power levels

	SOURce:POWer:MODE FIXed is equivalent to :SOURce:POWer:SWEep:STATe OFF
	SOURce:POWer:MODE SWEep is equivalent to :SOURce:POWer:SWEep:STATe ON
Preset	This is unaffected by "Mode Preset" but is set to FIXed on a "Source Preset" or "Restore Input/Output Defaults".
Initial S/W Revision	A.06.01
Modified at S/W Revision	A.10.01

Amptd Offset

Offsets the displayed power of the source in the Amplitude parameter. Using the amplitude offset allows you to take into account any system losses or gains (for example, due to cable loss), thereby displaying the actual power delivered to the device under test. See the equations under the Source, Amplitude, Power Sweep key.

Key Path	Source, Amplitude
Mode	SA
Scope	Mode Global
Remote Command	:SOURce:CORRection:OFFSet <rel_amp1> :SOURce:CORRection:OFFSet?
Example	:SOUR:CORR:OFFS 5 Sets the displayed source offset power to 5 dB.
Dependencies	If the requested setting of Amptd Offset causes the calculated external source start or stop Amplitude to exceed the external source capability, a warning status message is generated, "Data out of Range; clipped to source max/min". The Show Source Capabilities and Settings menu can then be examined to check the source capabilities. This parameter test and clip is also performed at source acquisition.
Preset	This is unaffected by Mode Preset but is set to 0.00dBm on a Source Preset or Restore Input/Output Defaults.
State Saved	Part of the Input/Output system, which means it is Loaded and Saved with state.
Min	-1000 dB
Max	+1000 dB
Initial S/W Revision	A.06.01

Amptd Step Auto/Man

Allows you to set the step size associated with the Source Amplitude key. When auto-coupled, the step size is the current Scale/Div setting under the Amplitude hardkey (note that this is true even if the analyzer is currently in Linear amplitude scale).

Once a step size has been selected and the Source Amplitude function is active, the step keys (and the UP|DOWN parameters for Source Amplitude from remote commands) change the Source Amplitude by the step-size value.

You may change the step size manually by pressing Amptd Step and entering a value. The function (and the step size) will return to Auto when a Mode Preset or Auto Couple is performed.

Key Path	Source, Amplitude
Scope	Mode Global
Remote Command	<pre>:SOURce:POWer:STEP[:INCRement] <amp;lt;1> :SOURce:POWer:STEP[:INCRement]? :SOURce:POWer:STEP:AUTO OFF ON 0 1 :SOURce:POWer:STEP:AUTO?</pre>
Example	<pre>:SOUR:POW:STEP 0.1 Set amplitude step to 0.1 dB :SOUR:POW:STEP:AUTO ON</pre>
Couplings	In Auto, coupled to the size of one logarithmic vertical graticule division
Preset	Auto
State Saved	Part of the Input/Output system, which means it is Loaded and Saved with state.
Min	0.1 dB
Max	20 dB
Initial S/W Revision	A.06.01

Frequency

Allows a you to access the Frequency sub-menu. This menu lets you use a stepped tracking source for stimulus/response measurements for some added flexibility. Because with such a source, the source frequency does not need to track 1:1 with the analyzer LO frequency, it is possible to measure scalar harmonic and subharmonic responses of devices. For example, the second harmonic response is measured by stepping the analyzer and source so that the analyzer is always at twice the source frequency. In addition, the frequency offset capability allows the measurement of frequency conversion devices (like mixers).

In tracking mode, the source frequency tracks the analyzer frequency according to the source frequency equation:

$$\text{Source Frequency} = (\text{Analyzer Frequency} * \text{Multiplier Numerator} / \text{Multiplier Denominator}) + \text{Source Frequency Offset}$$

NOTE

Analyzer Frequency is the frequency to which the analyzer is set, which is the analyzer's displayed frequency, offset by any Freq Offset set under the Frequency hardkey. Source Frequency Offset is the value set under **Source, Frequency, Freq Offset.**

Key Path	Source
----------	---------------

Readback	none in Tracking Source mode
Initial S/W Revision	A.06.01

Multiplier Numerator

The multiplier numerator parameter offsets the source frequency from the analyzer frequency. The source frequency tracks the SA frequency according to the source frequency equation shown under the **Source, Frequency** key description.

The multiplier numerator must be restricted to operate within the range of the source minimum and maximum frequencies.

Key Path	Source, Frequency
Mode	SA
Scope	Mode Global
Remote Command	:SOURce:FREQuency[:MULTIplier]:NUMerator <integer> :SOURce:FREQuency[:MULTIplier]:NUMerator?
Example	:SOUR:FREQ:NUM 3 Sets the source frequency multiplier numerator to 3.
Dependencies	If the currently selected source does not support this capability (for example, an internal Tracking Generator which must track the LO), this key is forced to its Preset value and grayed out
Preset	This is unaffected by Mode Preset but is set to 1 on a Source Preset or Restore Input/Output Defaults.
State Saved	Part of the Input/Output system, which means it is Loaded and Saved with state.
Min	1
Max	1000
Initial S/W Revision	A.06.01

Multiplier Denominator

The multiplier denominator parameter offsets the source frequency from the analyzer frequency. The source frequency tracks the SA frequency according to the source frequency equation shown under the **Source, Frequency** key description.

The multiplier denominator must be restricted to operate within the range of the source minimum and maximum frequencies.

Key Path	Source, Frequency
Mode	SA
Scope	Mode Global
Remote Command	:SOURce:FREQuency[:MULTIplier]:DENominator <integer> :SOURce:FREQuency[:MULTIplier]:DENominator?
Example	:SOUR:FREQ:DEN 3 Sets the source frequency multiplier denominator to 3

Dependencies	If the currently selected source does not support this capability (for example, an internal Tracking Generator which must track the LO), this key is forced to its Preset value and grayed out
Preset	This is unaffected by Mode Preset but is set to 1 on a Source Preset or Restore Input/Output Defaults.
State Saved	Part of the Input/Output system, which means it is Loaded and Saved with state
Min	1
Max	1000
Initial S/W Revision	A.06.01

Source Sweep Reverse

Allows you to reverse the source sweep direction

Normally, the source will sweep from a lower frequency to a higher frequency. However, there are test scenarios in which the source sweep needs to be “reversed”. In this case, it sweeps from a higher frequency to a lower frequency. For example, when the DUT is a frequency converter and a measurement of the Lower Side Band characteristics is desired, a reverse sweep is employed. Reverse sweeps are supported for such scenarios, but two cautions are in order:

4. Reverse Sweep only reverses the direction of the source’s sweep, not the analyzer’s sweep. Unless you are actually using a device like a frequency converter and looking at the lower sideband, thus effectively reversing the direction of the source’s sweep, the source will be sweeping in the opposite direction from the analyzer, and it will not be possible track the desired device output frequency.
5. Any time you are using a frequency converter, care must be taken in setting up all of the sweep parameters, including analyzer start/stop frequency and source multiplier, to make sure that the analyzer’s sweep tracks the output of the converter device.

Key Path	Source, Frequency
Mode	SA
Scope	Mode Global
Remote Command	:SOURce:FREQuency:SSReverse:ON OFF 0 1 :SOURce:FREQuency:SSReverse?
Example	SOUR:FREQ:SSR:OFF SOUR:FREQ:SSR?
Notes	You must be in Spectrum Analyzer mode to use this command. Use INSTRument:SElect to set the mode.
Dependencies	If the currently selected source does not support this capability (for example, an internal Tracking Generator which must track the LO), this key is forced to its Preset value and grayed out
Preset	This is unaffected by Mode Preset but is set to OFF on a Source Preset or Restore Input/Output Defaults.

State Saved	Part of the Input/Output system, which means it is Loaded and Saved with state
Range	On Off
Initial S/W Revision	A.06.01

Freq Offset

The frequency offset parameter offsets the source frequency from the analyzer frequency. The source frequency tracks the SA frequency according to the equations under the **Source, Frequency** key.

Pressing the key sets the Freq Offset function to On or Off. The value of Freq Offset is displayed in the active function block, and can be adjusted, when set to On.

The frequency offset must be restricted to operate within the range of the source minimum and maximum frequencies.

Key Path	Source, Frequency
Mode	SA
Scope	Mode Global
Remote Command	:SOURce:FREQuency:OFFSet <freq> :SOURce:FREQuency:OFFSet? :SOURce:FREQuency:OFFSet:STATe ON OFF 1 0 :SOURce:FREQuency:OFFSet:STATe?
Example	:SOUR:FREQ:OFFS 10MHz Sets the source frequency offset to 10MHz.
Dependencies	If the currently selected source does not support this capability (for example, an internal Tracking Generator which must track the LO), this key is forced to its Preset value and grayed out
Preset	This is unaffected by Mode Preset but is set to 0.00Hz on a Source Preset or Restore Input/Output Defaults.
State Saved	Part of the Input/Output system, which means it is loaded and saved with state
Min	-500 GHz
Max	500 GHz
Backwards Compatibility SCPI	:SOURce:EXTernal1:SWEep:OFFSet:FREQuency <freq> :SOURce:EXTernal1:SWEep:OFFSet:FREQuency? The PSA option 215 supports this SCPI command. This command is equivalent to :SOURce:FREQuency:OFFSet
Initial S/W Revision	A.06.01
Modified at S/W Revision	A.10.01

Source Mode

Accesses the Source Mode softkey menu. This menu lets you select Tracking mode for the Source, and also allows you to set the Source Mode to OFF.

The Source Mode can be set to Tracking without the user setting it directly. There are several couplings that cause Source Mode to be automatically set to Tracking (detailed in the table below). One important coupling is that Source Mode is forced to Tracking when the RF Output is turned on if the measurement supports Tracking. Since Source Mode is set to Off on a Mode Preset, this means that you will rarely need to change the Source Mode setting directly.

NOTE

When the Source Mode is set to Tracking, the analyzer acquires control of the source. When this happens the source is told to save its state and then perform a preset. Usually both of these operations take very little time; however, on an N5172B or an N5182B, if many Source real-time apps are in use, both save and preset can take many seconds. If it takes longer than the analyzer expects to acquire control, you will see an error: “Source connection lost, check interface connection”. If you see this error, and you are using an N5172B or an N5182B, you can shorten the acquire time by presetting your MXG before attempting to use External Source Control.

Key Path	Source
Scope	Meas Global
Remote Command	:INSTrument:SOURce[:SElect] TRACKing OFF :INSTrument:SOURce[:SElect]?
Example	:INST:SOUR TRAC
Dependencies	<p>Grayed out if no Source is selected, in this case go to the Select Source menu to choose, configure and/or verify your source</p> <p>Grayed out and forced to Off if either BBIQ or External Mixing are selected</p> <p>Blanked in Modes that do not support a source</p> <p>Grayed out in Measurements that do not support a source</p> <p>Tracking is grayed out when Manual FFT is selected</p> <p>Tracking is grayed out when the RF Preselector is on (in models which support the RF Preselector).</p>
Couplings	<p>When RF Output is turned On, Source Mode is set to Tracking. When Source Mode is turned Off, RF Output is turned Off.</p> <p>Whenever you switch to an application (Mode) in which the Source Mode was previously set to Tracking, it is again set to Tracking. That is, the last setting of the Source Mode is remembered when you leave an application (Mode) and restored when you return</p> <p>Source Mode is forced to Tracking when the RF Output is turned on if the measurement supports Tracking</p> <p>If Source Mode is set to Tracking, then it is forced to Off when you select a measurement that does not support Tracking.</p> <p>If Source Mode is set to Tracking, then it is forced to Off when you turn on the RF Preselector (in models which support the RF Preselector).</p> <p>Whenever the Source Mode is set to Tracking, the analyzer acquires the Source. Similarly, the Source is released whenever the Source Mode is set to Off. This is true whether the Source Mode was set directly by you, was set indirectly through a coupling, if you switched to an application (Mode) that had previously been set to Tracking, or if you switched to an application (Mode) in which the Source Mode is not set to Tracking.</p> <p>For an external source, “acquiring the source” involves contacting the external instrument over</p>

the remote interface (which puts it into Remote) and taking control of it.
 When you set the Source Mode to OFF, it releases the Source (and puts it into Local). For an external source, this means you are now free to operate the source for other purposes.
 When the Source is acquired, its previous state is saved, and when it is released, that state is restored, so that you can acquire and then release the source and it will return to the state it was in before you acquired it.

Preset	OFF
State Saved	Saved in instrument state
Initial S/W Revision	A.06.01
Modified at S/W Revision	A.10.01

Select Source

The Select Source menu allows you to maintain a list of available external Sources, and choose the Source that you want to use from the list. It shows the currently selected source at the bottom of the screen.

While in the Select Source menu, you can see, and select from, a list of the currently available sources. The sources listed in this table are as follows:

- Any internal sources which are installed and licensed

NOTE

Only one internal source can be installed, displayed at address “INTERNAL”

- Any external sources which you have previously configured, whether or not they are currently connected, displayed with their VISA address

Note that only external sources that are supported by the Tracking Source Mode are displayed in the Available Source List. Here are the Keysight/Agilent sources currently supported:

Source	PXA	MXA	EXA	CXA	MXE (Presel off)
MXG N5181A	X	X	X	X	X
MXG N5182A	X	X	X	X	X
MXG N5183A	X	X	X		X
EXG N5171B	X	X	X	X	X
MXG N5181B	X	X	X	X	X
EXG	X	X	X	X	X

N5172B					
EXG	X	X	X	X	X
N5173B					
MXG	X	X	X	X	X
N5182B					
MXG	X	X	X	X	X
N5183B					
PSG	X	X	X		
E8257D					
PSG	X	X	X		
E8267D					

NOTE

For X-Series software versions earlier than A.10.01, option UNZ (Fast switching) was required on the MXG for some use cases. This is no longer the case, option ESC now works without MXG option UNZ for all use cases. (Note that you will get better performance if your MXG has option UNZ, because without option UNZ your sweep speeds will be noticeably slower.)

While in the Select Source menu and its submenus, detailed instructions are presented that tell you how to operate the Select Source functions. Basically they tell you to first use the up and down arrow keys to move the selection highlighted in the “Available Source List” to the source that you want to use. The list of available sources includes any sources that you have previously used (unless you have deleted them) and any found while in the “Add Source to List” menu.

When the source you want to use is highlighted, press “Select Highlighted Source” or “Enter”. The source you have selected shows up at the bottom of the screen as the “Current Source”. Press “Verify Current Source Connection” to make sure that the interface connection to the Source is still functional.

At any time you may use the “Add Source to List” or “Delete Highlighted Source” keys to find new sources or remove a source from the list of available sources.

Key Path	Source
Readback Text	Two lines of readback give the type information and serial number of the current source, in square brackets
Initial S/W Revision	A.06.01

Select Highlighted Source

You can navigate up and down in the list with the up and down arrow keys, and can select any entry by pressing the Select Highlighted Source key (or by double-clicking on the entry in the table with a mouse). The highlighted source becomes the Current Source and is prominently displayed at the bottom of the screen.

At any given time there is only one selected Source for the entire system; once a Source is selected, it becomes the Current Source and will be used by all applications that support Source Control.

For example, if no Source has yet been selected, the statement at the bottom of the screen would say

Current Source

None

If an N5182A connected via USB were the Current Source, the statement at the bottom of the screen might say:

Current Source

Agilent N5182A US00000258 at USB0::2931::7937::US00000258::0::INSTR

The SCPI command defined below allows the programmatic user to directly define the VISA address via a string parameter. The parameter is checked for proper syntax, the connection to the instrument is verified, and the source is added to the Available Source List if it verifies. If it does not verify or no source is found at that address, an error message is generated.

Normally the source selection activities should be performed only when the user changes the hardware connection configuration or activates/deactivates a source option license; shutdown and startup of the application will not cause source re-selection.

The Agilent IO Libraries Suite provides an “Agilent VISA Help” document that has a section that shows the proper syntax for valid VISA address strings, in the ViOpen function definition.

Key Path	Source, Select Source
Mode	SA
Remote Command	:SYSTem:COMMunicate:SOURce[1]:ADDRess <address string> :SYSTem:COMMunicate:SOURce[1]:ADDRess?
Example	Different examples for setting external source address :SYST:COMM:SOUR:ADDR "TCPIP0::MyHostName::INSTR" :SYST:COMM:SOUR:ADDR "TCPIP0::123.121.100.210::INSTR" :SYST:COMM:SOUR:ADDR "USB0::12212::32145::US1234567A::INSTR" :SYST:COMM:SOUR:ADDR "GPIB1::19::INSTR"
Notes	Empty string is allowed and means no source is defined or selected.
Remote Command Notes	The address string is the VISA address for external sources and "INTERNAL" for an internal source
Dependencies	Operation with a source requires a license. If the proper license is not installed, the SCPI command generates an error message, "Settings conflict;option not installed" If no supported source, or no source at all, is found at the specified address, the SCPI command generates an error message
Preset	The current source selection is unaffected by a Mode Preset and Source Preset but reverts to [None] on a Restore Input/Output Defaults. If an internal Tracking Generator is installed, then instead of None, the default selection will be INTERNAL.

State Saved	<p>Selected Source is</p> <ul style="list-style-type: none"> - Power On Persistent (survives power cycle) - Part of the Input/Output system, which means it is Loaded and Saved with state.
Readback	<p>Two lines of readback give the type information and serial number of the current source on the Select Source key in the form</p> <p>[<source type>] [<serial number>]</p> <p>[None] shows in the type area and blank in the serial number area if a source has not been configured.</p> <p>[Internal TG] shows in type area and serial number in the serial number area if an internal Tracking Generator has been selected.</p> <p>For example: [MXG]/n, [US01020022]. This indicates an MXG of serial number US01020022.</p>
Backwards Compatibility SCPI	<p>:SYSTem:COMMunicate:LAN:SOURce[:EXTernal]:IP <address string></p> <p>:SYSTem:COMMunicate:LAN:SOURce[:EXTernal]:IP?</p> <p>This command is provided for compatibility with PSA Option 215. The address string is reformatted for the X-Series. For example, if the customer sends</p> <p>:SYSTem:COMMunicate:LAN:SOURce:EXTernal:IP 146.208.172.111</p> <p>The analyzer turns this into</p> <p>:SYSTem:COMMunicate:SOURce:ADDRes "TCPIP0::146.208.172.111::INSTR"</p>
Initial S/W Revision	A.06.01
Modified at S/W Revision	A.10.01

Delete Highlighted Source

Deletes the highlighted source from the list of available sources. You will be prompted with a dialog box to make sure you REALLY want to do this. The prompt says "The highlighted source will be permanently deleted from the list. Are you sure you want to do this? Press Enter to proceed, or Cancel (ESC) to cancel."

Key Path	Source, Select Source
Initial S/W Revision	A.06.01

Add Source To List

This menu allows you to add to the list of available sources from various interfaces.

Key Path	Source, Select Source
Initial S/W Revision	A.06.01

USB

Sources on USB (once installed) can be added to the list by pressing "Add Installed USB Sources." Any supported source found will be added to the list.

See ["Add Installed USB Sources" on page 3259](#) for information on connecting and installing USB devices.

Key Path	Source, Select Source, Add Source to List
Initial S/W Revision	A.06.01

Add Installed USB Sources

Press this key to add USB sources to the Available Source List. Note that this function will ONLY find sources that have previously been installed onto the USB. For information on how to install a USB source, see ["Installing a USB source" on page 1243](#)

Key Path	Source, Select Source, Add Source to List, USB
Notes	If no installed USB device is found which is a supported source, an error message is generated
Initial S/W Revision	A.06.01

Installing a USB source

USB is the only interface which requires no runtime action by the user in the Select Source menu, but does require “installation” when a source is plugged in.

You start by connecting the USB source to the analyzer. You will get a series of messages indicating that the analyzer is installing required device software.

When the installation is complete, you will get a message to that effect. You can then use the “Add Installed USB Sources” function (above) to add the source to the list of sources in the Available Source List.

GPIB

Lets you add GPIB sources to the Available Source List.

For the GPIB interface to work properly, it must be configured as a Controller. You can find this setting in the System menu under System, I/O Config, GPIB. Set the GPIB Controller function to Enabled.

Note that you must also make sure that the GPIB interface is not set to “Ignore” in the Agilent Connection Expert. If it is set to **Ignore**, then even if the GPIB Controller is set to **Enabled**, it is not possible for the analyzer to find a GPIB connected source. See ["More Information" on page 1243](#).

Key Path	Source, Select Source, Add Source to List
Initial S/W Revision	A.06.01

More Information

If you suspect that the GPIB interface is not set to Ignore, run the Agilent Connection Expert (ACE). To run ACE, press Source, Select Source, Add Source to List, LAN, Run Connection Expert. Look for the GPIB branch on the interface tree:

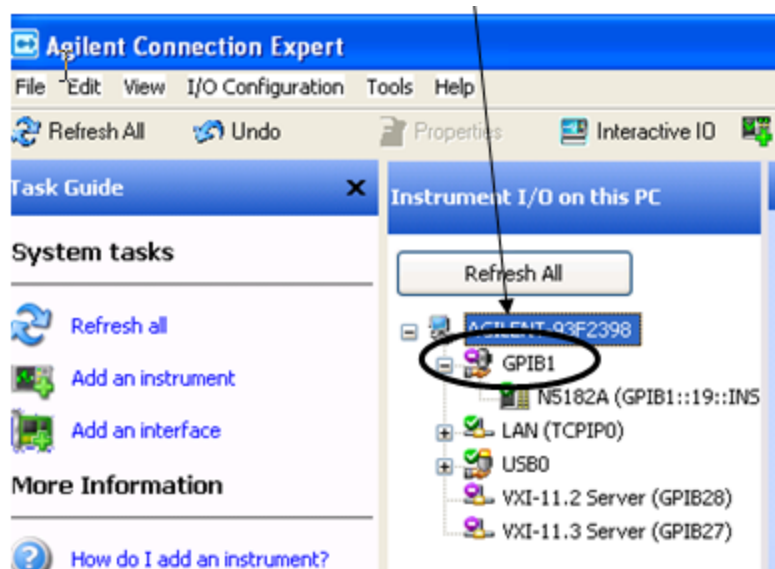

Right click on the GPIB branch (you will have to plug in a mouse to do this). You should see a dialog like the one below. If this dialog says **Stop Ignoring**, select **Stop Ignoring** and close ACE.

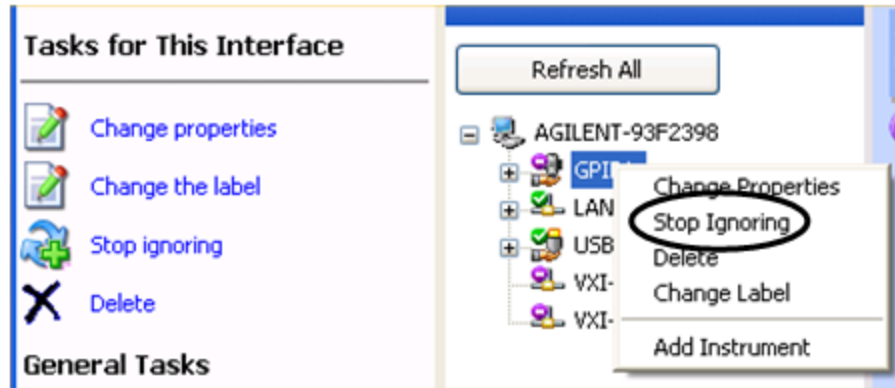

Scan & Add GPIB Sources

Sources on GPIB can be added by pressing **Scan & Add GPIB Sources**. Any supported source found will be added to the Available Source List.

NOTE

This will cause any older, non-SCPI compatible devices on your GPIB to generate error messages.

Key Path	Source, Select Source, Add Source to List, GPIB
Notes	If the GPIB controller mode is not enabled, an error message is generated If no GPIB device is found which is a supported source, an error message is generated
Initial S/W Revision	A.06.01

Enter GPIB Address

Opens a menu that lets you enter the GPIB address of the desired source directly.

NOTE

For this to work properly, the GPIB interface must be configured as GPIB1. This is the default state and should normally be the case. To see how to verify this, see **"More Information" on page 1245**.

Key Path	Source, Select Source, Add Source to List, GPIB
Initial S/W Revision	A.06.01

More Information

If you suspect that the GPIB interface is not set to GPIB1, run the Agilent Connection Expert (ACE). To run ACE, press Source, Select Source, Add Source to List, LAN, Run Connection Expert. Look for the GPIB branch on the interface tree:

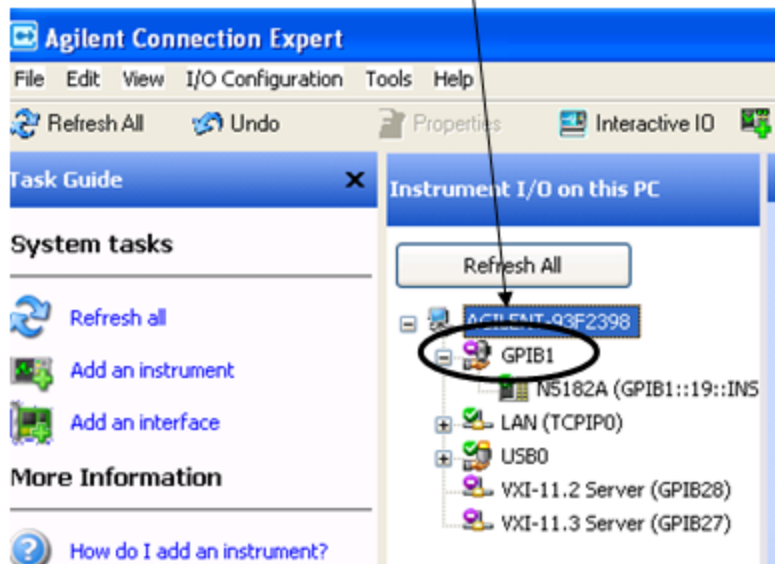

If this branch is not labeled **GPIB1**, right click on the GPIB branch (you will have to plug in a mouse to do this) and select **Change Properties**.

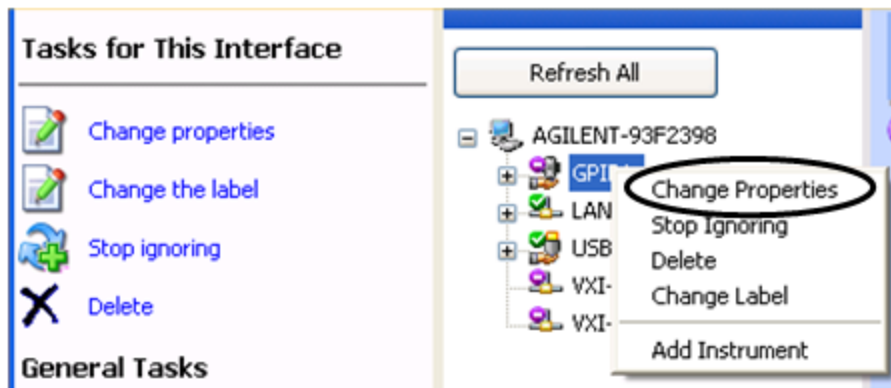

You should see a dialog like the one below. Click on the drop-down arrow under VISA Interface ID, select GPIB1 and click OK

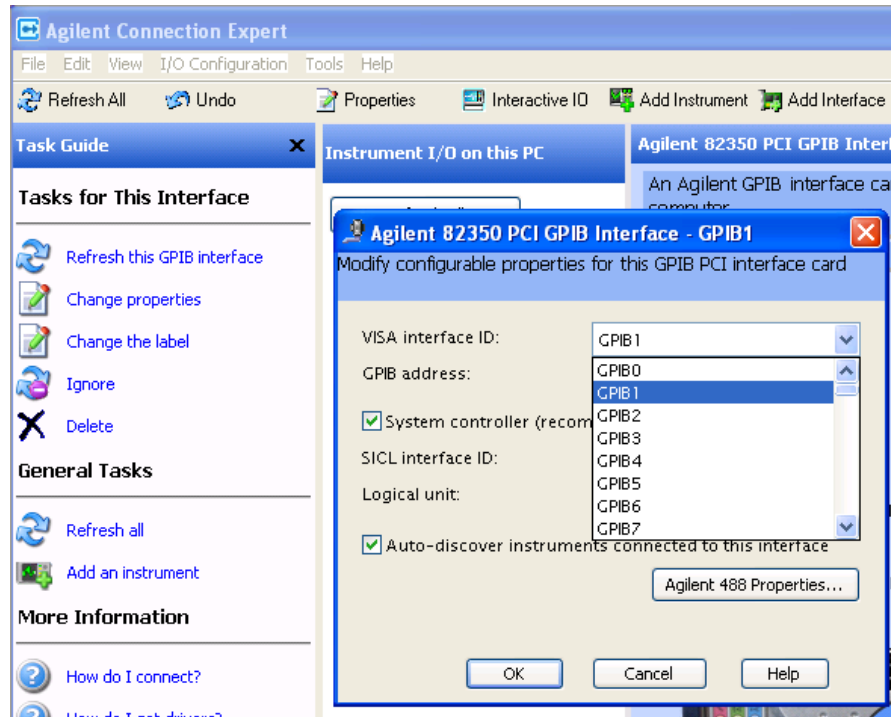

GPIB Address

Lets you enter the GPIB address. After you enter the address press **Add** to add the source at that address to the Available Source List.

Key Path	Source, Select Source, Add Source to List, GPIB, Enter GPIB Address
Preset	Unaffected by Mode Preset but set to 19 by "Restore Input/Output defaults"
State Saved	No
Min	0
Max	30
Initial S/W Revision	A.06.01

Add

Add the source at the entered GPIB address to the Available Source List. If a supported source is found at that address it will be added to the list.

Key Path	Source, Select Source, Add Source to List, GPIB, Enter GPIB Address
Notes	If GPIB controller mode is not enabled, an error message is generated If no supported source is found at the specified address, an error message is generated
Initial S/W Revision	A.06.01

LAN

The LAN cannot be scanned directly from the analyzer software, but you can import the list of currently configured devices from Agilent Connection Expert by pressing

“Add From Connection Expert List.” The Connection Expert list depends on which instruments have already been discovered by the Agilent Connection Expert application. Any connected, supported sources in that list will be added.

You can also enter the IP address and press “Add”. If a supported source is found at that address it will be added.

If you want to discover sources on the LAN, you can open Connection Expert by pressing the “Run Connection Expert...” softkey.

Key Path	Source, Select Source, Add Source to List
Initial S/W Revision	A.06.01

Enter LAN Address

Opens up a menu which lets you enter the IP address of the desired source directly.

Key Path	Source, Select Source, Add Source to List, LAN
Initial S/W Revision	A.06.01

IP Address

Lets you enter the IP address of the desired source. After you enter the address you should press “Add” to add the source at that address to the Available Source List.

Key Path	Source
Preset	Unaffected by Mode Preset but set to 0.0.0.0 by Restore Input/Output defaults
State Saved	No
Initial S/W Revision	A.06.01

Add

Adds the source at the entered IP address to the Available Source List. If a supported source is found at that address it will be added to the list.

Key Path	Source
Notes	If no supported source is found at the specified address, an error message is generated
Initial S/W Revision	A.06.01

Run Connection Expert...

Runs the Agilent Connection Expert so that you can scan the LAN for sources.

Key Path	Source, Select Source, Add Source to List, LAN
Initial S/W Revision	A.06.01

Add From Connection Expert List

You can import the list of currently configured devices from Agilent Connection Expert by pressing **Add From Connection Expert List**. The Connection Expert list

depends on which instruments have already been discovered by the Agilent Connection Expert application. Any connected, supported sources in that list will be added.

Key Path	Source, Select Source, Add Source to List, LAN
Notes	If no supported source is found in the Connection Expert list, an error message is generated
Initial S/W Revision	A.06.01

Verify Current Source Connection

This key verifies the interface connection to the Current Source (it does NOT verify any signal connections!)

Until the selected source is verified, a statement appears at the bottom of the screen which says (in red):

This Source has not been verified. Press "Verify Source" to check the interface connection.

When you press this key, the connection is checked to the selected source. If all is well, the statement is changed to (in green):

This connection to this source has been verified.

If the verification fails, the statement at the bottom will change to (in red):

Verification of this source failed. Check the interface connection

The selected source is also verified whenever it is acquired. If a Source's connection has been verified by any means, then that Source is considered to have been verified until either the analyzer software is shut down or if, in attempting to use the Source, communication with it fails.

Key Path	Source, Select Source
Initial S/W Revision	A.06.01

Source Setup

This menu is used to set up miscellaneous source functions, including trigger settings. For more on triggering in Tracking Mode, see ["Tracking Setup Details" on page 1248](#). For information on bypassing the Microwave Preselector, see ["Use of the YTF \(Microwave or mm Preselector\) with External Source Control" on page 1249](#)

Key Path	Source
Mode	SA
Initial S/W Revision	A.06.01

Tracking Setup Details

When an external source is operating in Tracking Mode, operation can be greatly enhanced by using hardware triggers. Below is a typical connection diagram showing

a hardware handshake using Trigger 1 inputs and outputs on the analyzer (trigger 2 in and out is also a valid connection).

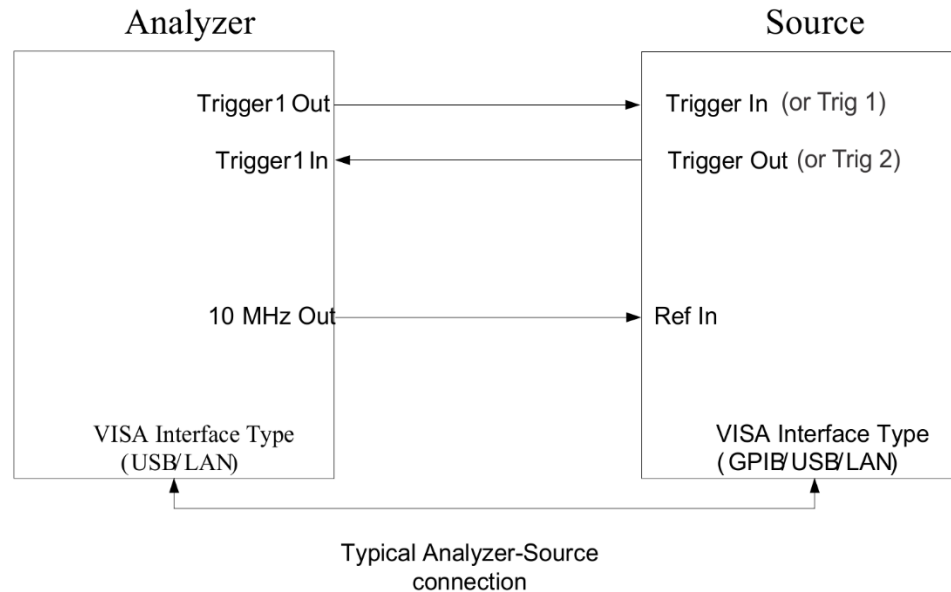

Analyzer Trigger 1 Out: Triggers the external source to step to next point in the frequency step/list.

Analyzer Trigger 1 In: Triggers the analyzer to make a measurement on this point

Source Trigger In (or “Trig 1” at default setting for N5181B/82B, N5183B MXG or N5171B/72B, N5173B EXG):

Triggers the source to step to the next point.

Source Trigger Out (or “Trig 2” at default setting for N5181B/82B, N5183B MXG or N5171B/72B, N5173B EXG): Indicates that the source has settled.

IO interface Connection: analyzer can connect to sources with its GPIB, USB or LAN interface.

Notes:

- Trigger sync connections are optional – synchronization can be done via remote commands if Bus Trigger is enabled in the Source Setup menu.
- Connection from the SA external frequency reference output to the source frequency reference input (10 MHz Out to Ref In) is not required, but may improve the measurement accuracy.

Use of the YTF (Microwave or mm Preselector) with External Source Control

In most stimulus/response measurements that utilize External Source Control, the source exactly tracks the tuned analyzer frequency. Consequently, preselection is not needed, and you can achieve greatly superior amplitude accuracy and

repeatability by bypassing the YTF (Preselector) using the Microwave Preselector Bypass control in the Amplitude, μ W Path Control menu.

NOTE

This control is only available if option MPB is installed.

There are rare but important cases, however, where the source is tuned to a different frequency than the analyzer, using the Multiplier and Reverse controls in the Source, Frequency menu. For example, you might be tuning the source to $\frac{1}{2}$ of the analyzer frequency when looking at second harmonic distortion in a DUT. In these cases, it would be commonplace for there to be an undesired signal at the analyzer input that is at an image frequency that you will want to reject with the YTF.

Understanding these cases is important for proper operation of the Microwave Preselector with External Source Control, so that you only bypass it when it will improve accuracy but not hinder the measurement.

Point Trigger

Shows point trigger type selected and navigates to the Point Trigger menu.

The Point Trigger menu lists all analyzer point trigger types. The analyzer and source point trigger synchronization can be done using SCPI bus commands or by using external trigger output and input lines.

NOTE

For X-Series software versions earlier than A.10.01, hardware triggering was unavailable in stepped tracking at frequencies above 3.6 GHz, so above 3.6 GHz, software triggering was always used. This is no longer the case.

Key Path	Source, Source Setup
Mode	SA
Scope	Mode Global
Remote Command	:SOURCE:TRIGGER:TYPE BUS EXTERNAL[1] EXTERNAL2 :SOURCE:TRIGGER:TYPE?
Example	:SOUR:TRIG:TYPE EXT1 Selects analyzer external trigger 1 in and out for point trigger synchronization with selected source
Dependencies	If an internal Tracking Generator is selected, then this menu is unavailable. Additionally, the External 1 and External 2 Trigger keys on the Spectrum Analyzer are released from any grayout that may have been forced on them by the external source Point Trigger selection. In some models, there is no second External input. In these models, the External 2 key is blanked and the EXTERNAL2 parameter will generate a "Hardware missing; Not available for this model number" message.
Couplings	The source control point trigger selection can select external trigger 1 or 2 in for synchronized point triggering. This can conflict with the selection under the Trigger hardkey, if it has External 1 or 2 selected. If there is a conflict when the selection is made under the Point Trigger menu, the Trigger selection under the Trigger hardkey will be changed to Free Run.
Preset	This is unaffected by "Mode Preset" but is set to EXTERNAL1 on a "Source Preset" or "Restore Input/Output Defaults".

State Saved	Part of the Input/Output system, which means it is Loaded and Saved with state
Readback	1-of-N selection
Initial S/W Revision	A.06.01

SW Trigger

Analyzer and source point trigger synchronization is setup using the SCPI commands. Source is stepped via SCPI commands. Analyzer waits for source to settle by polling source.

Key Path	Source, Source Setup, Point Trigger
Mode	SA
Example	:SOUR:TRIG:TYPE BUS
Readback	SW Trigger
Initial S/W Revision	A.06.01

Ext Trigger 1

Analyzer and source point trigger synchronization is setup using the analyzer Trigger 1 Output and Trigger 1 Input. The Source is stepped via Trigger 1 Output. The Analyzer waits for source to settle via Trigger 1 Input.

Key Path	Source, Source Setup, Point Trigger
Mode	SA
Example	:SOUR:TRIG:TYP EXT1
Couplings	<p>With an acquired source, selecting this point trigger mode overrides existing external trigger 1 output level, slope, and delay, and external trigger 1 type and polarity.</p> <p>External trigger 1 input level = 1.20 V</p> <p>External trigger 1 input slope = Positive</p> <p>External trigger 1 input delay = Off</p> <p>External trigger 1 output type = Source Point Trigger</p> <p>External trigger 1 output polarity = Positive</p> <p>When this selection is made:</p> <ul style="list-style-type: none"> - The External 1 key in the Trigger menu (under the Trigger hardkey) is grayed out and, if External 1 was previously selected, it will be changed to Free Run. - Trig 1 Out selected under Output Config in the Input/Output menu will be changed to Source Point Trigger <p>If the user subsequently goes into the Trig 1 Out menu and selects a different Trigger Output, the Point Trigger will revert to SW Trigger.</p>
Readback	Ext Trigger 1
Initial S/W Revision	A.06.01

Ext Trigger 2

Analyzer and source point trigger synchronization is setup using the analyzer Trigger 2 Output and Trigger 2 Input. The Source is stepped via Trigger 2 Output. The Analyzer waits for source to settle via Trigger 2 Input.

Key Path	Source, Source Setup, Point Trigger
Mode	SA
Example	:SOUR:TRIG:TYP EXT2
Dependencies	This key is blanked out on CXA as there is only one trigger input
Couplings	<p>With an acquired source, selecting this point trigger mode overrides existing external trigger 2 output level, slope, and delay, and external trigger 2 type and polarity.</p> <p>External trigger 2 input level = 1.20 V</p> <p>External trigger 2 input slope = Positive</p> <p>External trigger 2 input delay = Off</p> <p>External trigger 2 output type = Source Point Trigger</p> <p>External trigger 2 output polarity = Positive</p> <p>When this selection is made:</p> <ul style="list-style-type: none"> - The External 2 key in the Trigger menu (under the Trigger hardkey) is grayed out and, if External 2 was previously selected, it will be changed to Free Run. - Trig 2 Out selected under Output Config in the Input/Output menu will be changed to Source Point Trigger - If the user subsequently goes into the Trig 2 Out menu and selects a different Trigger Output, the Point Trigger will revert to SW Trigger.
Readback	Ext Trigger 2
Initial S/W Revision	A.06.01

Show Source Capabilities & Settings

Shows the capabilities of the currently selected Source. The menu is useful for displaying source capabilities such as frequency and amplitude ranges. In addition, the results of the source control sweep algorithms can be viewed. This gives information of the source range required for a given analyzer sweep range. This can be used dynamically as a way of configuring the sweep settings.

Key Path	Source, Source Setup
Mode	SA
Dependencies	If no source is selected this key is grayed out.
Initial S/W Revision	A.06.01

Source Preset

The Source Preset key forces all the settings in the analyzer's Source State to their preset condition.

The Source State is the set of Source settings that is maintained and remembered by the analyzer for use in the Tracking Source Mode. The Source State variables are controlled and set in the menus under the Source front panel key. These settings include:

- RF Output Off
- Amplitude = - 10 dBm
- Amplitude Step = Auto
- Power Sweep = 0 dB
- Amplitude Offset = 0 dB
- Source Sweep Reverse = Off
- Multiplier Numerator = 1
- Multiplier Denominator = 1
- Freq Offset = 0 Hz
- Point trigger is set to "Ext1"

The Source State is saved along with the state of the current Mode when you save a State, and is recalled when that Mode State is recalled.

When the analyzer first starts up, a Source Preset is performed. In the Input/Output menu, Restore Input/Output Defaults will also perform a Source Preset.

A Mode Preset, from modes that support the External Source, will turn the RF Off but will **not** perform a Source Preset. By the same token, Source Preset does **not** perform a Mode Preset.

Source Preset does **not** change the Source Mode nor the selection of which physical source is being used, nor does it release the current source (the source remains under the control of the analyzer) nor exit the Source menu.

Key Path	Source
Mode	SA
Remote Command	:SOURce:PRESet
Example	:SOUR:PRES
Preset	Initiates a Source Preset
State Saved	No
Initial S/W Revision	A.06.01

Span X Scale

Accesses a menu of functions that enable you set the horizontal scale parameters.

Key Path	Front-panel key
Initial S/W Revision	Prior to A.02.00

Span

Changes the frequency range symmetrically about the center frequency.

The default (and minimum) Span is calculated using the number of carriers and the carrier width where;

$$\text{Span} = (\text{Upper Carrier Freq} + (\text{max offset IBW} * (1 + \alpha)) / 2) - (\text{Lower Carrier Freq} - (\text{max offset IBW} * (1 + \alpha)) / 2)$$

The span is increased by a factor of 1 + Filter Alpha if the RRC Filter is on.

Key Path	Span X Scale
Mode	SA, WCDMA, C2K, WIMAX OFDMA, 1xEVDO, DVB-T/H, DTMB (CTTB), ISDB-T, CMMB, LTE, LTETDD, Digital Cable TV, WLAN, LTEAFDD, LTEATDD
Remote Command	<pre>[:SENSe] :CHPower:FREQuency:SPAN <freq> [:SENSe] :CHPower:FREQuency:SPAN? [:SENSe] :CHPower:FREQuency:SPAN:AUTO ON OFF 1 0 [:SENSe] :CHPower:FREQuency:SPAN:AUTO?</pre>
Example	<pre>CHP:FREQ:SPAN 10 MHz CHP:FREQ:SPAN? :CHP:FREQ:SPAN:AUTO OFF :CHP:FREQ:SPAN:AUTO?</pre>
Notes	<p>You must be in the Spectrum Analysis mode, W-CDMA mode, cdma2000 mode, DVB-T/H mode, DTMB (CTTB) mode, ISDB-T mode, CMMB mode, Digital Cable TV mode, LTE mode, LTE TDD mode, LTE-Advanced FDD mode, LTE-Advanced TDD mode, WLAN mode, 1xEVDO mode or WIMAX OFDMA mode to use this command. Use :INSTRument:SElect to set the mode.</p> <p>Span Auto/Man State (:SENSe):CHPower:FREQuency:SPAN:AUTO) is only available in LTE/LTE-Advanced FDD and LTE/LTE-Advanced TDD modes. The BAF SCPI is LTE/LTE-Advanced FDD and LTE/LTE-Advanced TDD modes only.</p> <p>The span value will be adjusted when the relevant carrier parameters such as bandwidth, integration bandwidth, number of component carriers etc. are changed whatever the span state is Auto or Man.</p> <p>When in Man state, if the input value is less than the required sum of total integration bandwidths and gaps of the multi-carriers, the required span value will be set.</p>
Dependencies	<p>For MSR mode, this key is blank.</p> <p>For WLAN 802.11ac (80 MHz + 80 MHz), the key is not enabled and its value is coupled with the spacing between the center frequencies of the two carriers.</p> <p>Span = Center Frequency 1 – Center Frequency 2 + Integ BW + 40 MHz Margin.</p>

	When the calculated span is over 1 GHz, it's still coupled to its maximum value, which is 1 GHz.
Couplings	<p>When Res BW is set to Auto, the resolution bandwidth is auto-coupled to span. The ratio of span /RBW is approximately 106:1. When the Res BW is set to Man, bandwidths are entered by the user, and these bandwidths are used regardless of other analyzer settings.</p> <p>Since Span is coupled to Integ BW in the factory default condition, if you change the integration bandwidth setting, the span setting changes by a proportional amount until a limit value is reached. However, the span can be individually set. The minimum value of the span is coupled with the integration bandwidth.</p> <p>When the state of Span is Auto, the span value is automatically determined by multi-carrier configuration. Otherwise, the span can accept User's input.</p> <p>When the span value is set manually, the state of span is automatically changes to Man.</p>
Preset	<p>SA: 3 MHz</p> <p>WCDMA: 7.5 MHz</p> <p>C2K: 1.845 MHz</p> <p>WIMAX OFDMA: 20 MHz</p> <p>1xEVDO: 2.0MHz</p> <p>DVB-T/H: 10MHz</p> <p>DTMB (CTTB): 10MHz</p> <p>ISDB-T: 10MHz</p> <p>CMMB: 10MHz</p> <p>LTE: 7.5 MHz</p> <p>LTETDD: 7.5 MHz</p> <p>Digital Cable TV: 10MHz</p> <p>WLAN:</p> <p>if Radio Std is 802.11a/g(OFDM/DSSS-OFDM): 30 MHz</p> <p>if Radio Std is 802.11b: 37.5MHz</p> <p>if Radio Std is 802.11n(20MHz): 30 MHz</p> <p>if Radio Std is 802.11n(40MHz): 60 MHz</p> <p>if Radio Std is 802.11ac (20 MHz): 30 MHz</p> <p>if Radio Std is 802.11ac (40 MHz): 60 MHz</p> <p>if Radio Std is 802.11ac (80 MHz): 120 MHz</p> <p>if Radio Std is 802.11ac (160 MHz): 240 MHz</p> <p>if Radio Std is 802.11ac (80 MHz + 80 MHz): 360 MHz</p> <p>if Radio Std is 802.11ah (1 MHz): 1.5 MHz</p> <p>if Radio Std is 802.11ah (2 MHz): 3 MHz</p> <p>if Radio Std is 802.11ah (4 MHz): 6 MHz</p> <p>if Radio Std is 802.11ah (8 MHz): 12 MHz</p> <p>if Radio Std is 802.11ah (16 MHz): 24 MHz</p> <p>if Radio Std is 802.11j/p (20 MHz): 30 MHz</p> <p>if Radio Std is 802.11j/p (10 MHz): 15 MHz</p> <p>if Radio Std is 802.11p (5 MHz): 7.5 MHz</p> <p>ON</p>

State Saved	Saved in instrument state.
Min	100 Hz
Max	Hardware Maximum Span
Initial S/W Revision	Prior to A.02.00
Modified at S/W Revision	A.02.00, A.03.00, A14.50,A16.00

Full Span

Changes the span to show the full frequency range of the spectrum analyzer.

Key Path	Span X Scale
Mode	SA, WCDMA, C2K, WIMAX OFDMA, 1xEVDO, DVB-T/H, DTMB (CTTB), ISDB-T, CMMB, LTE, LTETDD, Digital Cable TV, WLAN, LTEAFDD, LTEATDD
Remote Command	[:SENSe] :CHPower :FREQuency :SPAN :FULL
Example	CHP:FREQ:SPAN:FULL
Notes	You must be in the Spectrum Analysis mode, W-CDMA mode, cdma2000 mode, DVB-T/H mode, DTMB (CTTB) mode, ISDB-T mode, CMMB mode, Digital Cable TV mode, LTE mode, LTE TDD mode, WLAN mode, 1xEVDO mode or WIMAX OFDMA mode to use this command. Use :INSTrument:SElect to set the mode.
Dependencies	For MSR mode, this key is blank. For LTE-Advanced FDD/TDD mode, this key is blank. In order to keep backwards compatible with the legacy LTE FDD/TDD, the scpi command is supported in LTE & LTE-A converged application
Couplings	Selecting full span changes the measurement span value.
Initial S/W Revision	Prior to A.02.00
Modified at S/W Revision	A.02.00, A.03.00

Last Span

Changes the span to the previous span setting. If no previous span value exists, then the span remains unchanged.

Key Path	Span X Scale
Mode	SA, WCDMA, C2K, WIMAX OFDMA, 1xEVDO, DVB-T/H, DTMB (CTTB), ISDB-T, CMMB, LTE, LTETDD, Digital Cable TV, WLAN, LTEAFDD, LTEATDD
Remote Command	[:SENSe] :CHPower :FREQuency :SPAN :PREVious
Example	CHP:FREQ:SPAN:PREV
Notes	You must be in the Spectrum Analysis mode, W-CDMA mode, cdma2000 mode, DVB-T/H mode, DTMB (CTTB) mode, ISDB-T mode, CMMB mode, Digital Cable TV mode, LTE mode, LTE TDD mode, WLAN mode, 1xEVDO mode or WIMAX OFDMA mode to use this command. Use :INSTrument:SElect to set the mode.

9 Channel Power Measurement
Span X Scale

Dependencies	For MSR mode, this key is blank. For LTE-Advanced FDD/TDD mode, when the key is pressed, the state of SPAN key is changed to Man. If the previous span value is less than the required sum of total integration bandwidths and gaps of the multi-carriers, the value is set to the span value instead of the previous one.
Couplings	Selecting last span changes the measurement span value.
Initial S/W Revision	Prior to A.02.00
Modified at S/W Revision	A.02.00, A.03.00, A.14.50

Sweep/Control

Accesses a menu of functions that enable you to set up and control the sweep time and source for the current measurement. See "[Sweep/Control](#)" on page 927 for more information.

Key Path	Front-panel key
Initial S/W Revision	Prior to A.02.00

Sweep Time

Selects the length of time that the spectrum analyzer sweeps the displayed frequency span. Additional overhead time, which impacts the sweep rate, is not calculated as part of the sweep time. In fact:

sweep rate = span/sweep time

update rate = 1/(sweep time + overhead)

sweep cycle time = sweep time + overhead

Sweep time is coupled to RBW and VBW, and is impacted by the number of sweep points, so changing those parameters may change the sweep time.

Key Path	Sweep/Control
Mode	SA, WCDMA, C2K, WIMAX OFDMA, 1xEVDO, DVB-T/H, DTMB (CTTB), ISDB-T, CMMB, LTE, LTETDD, Digital Cable TV, WLAN, MSR, LTEAFDD, LTEATDD
Remote Command	<pre>[:SENSe]:CHPower:SWEep:TIME <time> [:SENSe]:CHPower:SWEep:TIME? [:SENSe]:CHPower:SWEep:TIME:AUTO OFF ON 0 1 [:SENSe]:CHPower:SWEep:TIME:AUTO?</pre>
Example	<pre>CHP:SWE:TIME 25ms CHP:SWE:TIME? CHP:SWE:TIME:AUTO OFF CHP:SWE:TIME:AUTO?</pre>
Preset	SA, WIMAX OFDMA: Automatically Calculated WCDMA: 1.0 ms CDMA2K: 9.4ms 1xEVDO: Automatically Calculated DVB-T/H: Automatically Calculated DTMB (CTTB): Automatically Calculated ISDB-T: Automatically Calculated CMMB: Automatically Calculated LTE, MSR: Automatically Calculated LTETDD: Automatically Calculated

	Digital Cable TV: Automatically Calculated WLAN: Automatically Calculated LTEAFDD,LTEATDD:Automatically Calculated
State Saved	Saved in instrument state.
Min	1 ms
Max	4000 s
Initial S/W Revision	Prior to A.02.00
Modified at S/W Revision	A.02.00, A.03.00

Sweep Setup

Accesses a menu that enables you to set the sweep state for the current measurement.

Key Path	Sweep/Control
Initial S/W Revision	Prior to A.02.00

Pause

Pauses a measurement after the current data acquisition is complete. When Paused, the label on the key changes to Resume. Pressing the Resume key resumes the measurement at the point it was at when paused. See ["Pause/Resume" on page 2263](#) for more details.

Key Path	Sweep/Control
Initial S/W Revision	Prior to A.02.00

Gate

Accesses a menu that enables you to control the gating function. The Gate functionality is used to view signals best viewed by qualifying them with other events.

Gate setup parameters are the same for all measurements – they do not change as you change measurements. Settings like these are called “Meas Global” and are unaffected by Meas Preset.

Note that Sweep Time autocoupling rules and annotation are changed by Gate being on.

Key Path	Sweep/Control
Scope	Meas Global
Readback	The state and method of Gate, as [Off, LO] or [On, Video]. Note that for measurements that only support gated LO, the method is nonetheless read back, but always as LO.
Initial S/W Revision	Prior to A.02.00

Gate On/Off

Turns the gate function on and off.

When the Gate Function is on, the selected Gate Method is used along with the gate settings and the signal at the gate source to control the sweep and video system with the gate signal. Not all measurements allow every type of Gate Methods.

When Gate is on, the annunciation in the measurement bar reflects that it is on and what method is used, as seen in the following "Gate: LO" annunciator graphic.

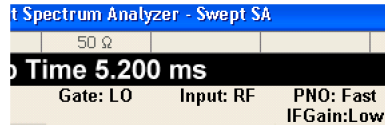

Key Path	Sweep/Control, Gate
Remote Command	[:SENSE] :SWEep:EGATe [:STATe] OFF ON 0 1 [:SENSE] :SWEep:EGATe [:STATe] ?
Example	SWE:EGAT ON SWE:EGAT?

Dependencies

The function is unavailable (grayed out) and Off when:

- Gate Method is LO or Video and FFT Sweep Type is manually selected.
- Gate Method is FFT and Swept Sweep Type is manually selected.
- Marker Count is ON.

The following are unavailable whenever Gate is on:

- FFT under Sweep Type when Method=LO or Video or Swept under Sweep Type when Method=FFT

Marker Count

While Gate is on, the Auto Rules for Sweep Type are modified so that the choice agrees with the Gate Method: i.e., FFT for Method = FFT and Swept for Method = LO or Video.

The Gate softkey and all SCPI under the [:SENSE]:SWEep:EGATe SCPI node are grayed out when Source Mode is Tracking with an external source. This is because the Gate circuitry is used to sync the external source. If the Tracking Source is turned on, the Gate is turned off.

When in the ACP measurement:

- When Meas Method is RBW or FAST, this function is unavailable and the key is grayed out.
- Whenever Gate is on, Meas Method, RBW or FAST is unavailable and keys for those are grayed out.
- When Gate is on, Offset Res BW and Offset Video BW are ignored (if you set these values) and the measurement works as if all Offset Res BW and all Offset Video BW are coupled with the Res BW and the Video BW under the BW menu. When Gate is

	on, the Offset BW key in the Offset/Limit menu is grayed out.
Preset	Off LTETDD: On
State Saved	Saved in instrument state
Range	On Off
Backwards Compatibility SCPI	[:SENSe] : SWEEp : TIME : GATE [: STATe] ESA compatibility
Backwards Compatibility Notes	In ESA, Trig Delay (On) and Gate (On) could not be active at the same time.. This dependency does not exist in PSA or in the X-Series.
Initial S/W Revision	Prior to A.02.00

Gate View On/Off

Turning on Gate View in the Swept SA measurement provides a single-window gate view display..

Turning on Gate View in other measurements shows the split-screen Gate View. In these measurements, when the Gate View is on, the regular view of the current measurement traces and results are reduced vertically to about 70% of the regular height. The Zero Span window, showing the positions of the Gate, is shown between the Measurement Bar and the reduced measurement window. By reducing the height of the measurement window, some of the annotation on the Data Display may not fit and is not shown.

Key Path	Sweep/Control, Gate
Remote Command	[:SENSe] : SWEEp : EGATe : VIEW ON OFF 1 0 [:SENSe] : SWEEp : EGATe : VIEW?
Example	SWE:EGAT:VIEW ON turns on the gate view.
Dependencies	In the Swept SA measurement: In Gate View, the regular Sweep Time key is grayed out . When pressed, the grayed out key puts up the informational message "Use Gate View Sweep Time in the Gate menu." In the other measurements: When you turn Gate View on, the lower window takes on the current state of the instrument. Upon leaving Gate View, the instrument takes on the state of the lower window. When you turn Gate View on, the upper window Sweep Time is set to the gate view sweep time.
Couplings	These couplings apply to the Swept SA measurement: <ul style="list-style-type: none"> - When Gate View is turned on, the instrument is set to Zero Span. - Gate View automatically turns off whenever a Span other than Zero is selected. - Gate View automatically turns off if you press the Last Span key while in Gate View, and the instrument returns to the Span it was in before entering Gate View (even if that is Zero Span). - When Gate View is turned on, the sweep time used is the gate view sweep time. This is set according to the rules in section "Gate View Setup " on page 2809

- When Gate View is turned off, Sweep Time is set to the normal Swept SA measurement sweep time.
- If Gate View is on and Gate is off, then turning on Gate turns off Gate View.

Preset	OFF
State Saved	Saved in instrument state
Range	On Off
Initial S/W Revision	Prior to A.02.00

A sample of the Gate View screen in the Swept SA measurement is shown in the following graphic :

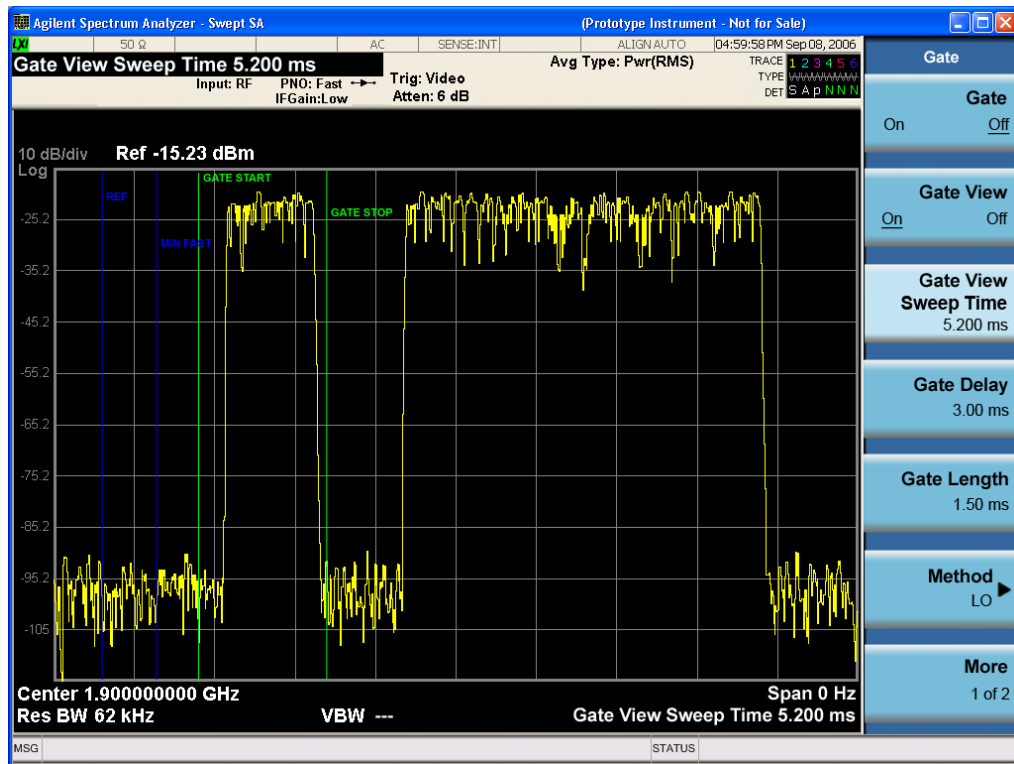

A sample of the Gate View screen in other measurements is shown in the following graphic . This example is for the ACP measurement:

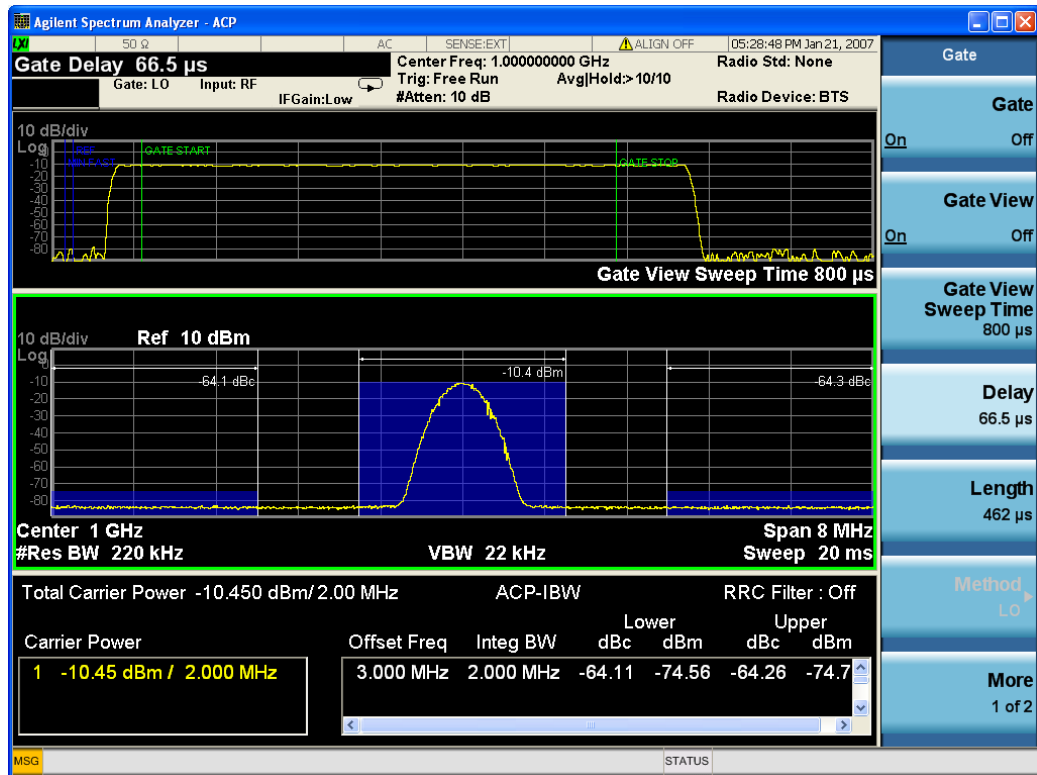

Turning Gate View off returns the analyzer to the Normal measurement view.

In the Swept SA, the normal measurement view is the single-window Swept SA view. When returning to this view, the Swept SA measurement returns to the Span it was in before entering **Gate View** (even if that is Zero Span).

The **Gate View** window is triggered from the Gate Source, with zero trigger delay. Also, when updating the **Gate View** window, the Gate itself must not operate. So it is internally shut off while the gate view window is being updated. For the Swept SA measurement, this means that the Gate is internally shut off whenever the gate view window is displayed. The measurement bar and softkeys continue to show the Trigger source for the main sweep window and give no indication that the Gate is shut off or that the Gate View window is triggered from the Gate Source.

When in **Gate View**, vertical lines are displayed in the Gate View window as follows:

- Green lines are displayed at the gate edges as follows: in Edge Gate, a line is shown for Delay and one for the end of the Gate period, defined by Length. In Level Gate a line is shown only for Delay. You can adjust the position of the green lines by adjusting the gate length and the gate delay. These lines update in the Gate View window as the active function changes, even if the window is not being updated. In Gated LO and Gated Video, these lines are positioned relative to the delay reference line (not relative to 0 time). In Gated FFT, their location is relative to the left edge of the screen.

- A blue line is displayed showing the delay reference, that is, the reference point for the Gate Delay within the Zero Span window. The blue line represents where (in time) the effective location of the gate start would be if the gate were programmed to zero delay.
-
- The second blue line is labeled "MIN FAST" as shown in the figure above because it represents the minimum Gate Delay for fast Gated LO operation. This line is only displayed in Gated LO. You cannot scroll (knob) or decrement (down key) the Gate Delay to less than that represented by the position of this line, it can only be set below this position manually, although once there it can be moved freely with the knob while below the line.
- A yellow line in the Gated Video case only, is displayed at B_{length} , where B_{length} is the display point (bucket) length for the swept trace, which is given by the sweep time for that trace divided by number of Points - 1. So it is referenced to 0 time, not to the delay reference. This line is labeled NEXT PT (it is not shown in the figure above because the figure above is for Gated LO).
- The yellow line represents the edge of a display point (bucket). Normally in Gated Video, the bucket length must be selected so that it exceeds the off time of the burst. There is another way to use the analyzer in Gated Video measurements, and that is to set the bucket width much shorter than the off time of the burst. Then use the Max Hold trace function to fill in "missing" buckets more slowly. This allows you to see some of the patterns of the Gated Video results earlier, though seeing a completely filled-in spectrum later.

Gate View Setup

Accesses a menu that enables you to setup parameters relevant to the Gate View

Key Path	Sweep/Control, Gate
Scope	Meas Global
Initial S/W Revision	A.10.00

Gate View Sweep Time

Controls the sweep time in the Gate View window. To provide an optimal view of the gate signal, the analyzer initializes Gate View Sweep Time based on the current settings of Gate Delay and Gate Length.

Key Path	Sweep/Control, Gate, Gate View Setup
Remote Command	[:SENSe] :SWEep:EGATe:TIME <time> [:SENSe] :SWEep:EGATe:TIME?
Example	SWE:EGAT:TIME 500 ms
Dependencies	Gate View Sweep Time is initialized: <ul style="list-style-type: none"> – On Preset (after initializing delay and length). – Every time the Gate Method is set/changed. <p>Additionally, in the Swept SA measurement, whenever you do a Preset, or leave Gate View, the analyzer remembers the Gate Delay and Gate Length settings. Then, when returning to Gate View, if the current Gate Delay and/or Gate Length do not match the remembered values Gate View Sweep Time is re-initialized.</p>
Preset	519.3 μ s WiMAX OFDMA: 5 ms GSM/EDGE: 1 ms
State Saved	Saved in instrument state
Max	6000 s
Initial S/W Revision	Prior to A.02.00

Gate View Start Time

Controls the time at the left edge of the Gate View.

Key Path	Sweep/Control, Gate, Gate View Setup
Remote Command	[:SENSe] :SWEep:EGATe:VIEW:STARt <time> [:SENSe] :SWEep:EGATe:VIEW:STARt?
Example	SWE:EGAT:VIEW:STAR 10ms
Notes	Units of time are required or no units; otherwise an invalid suffix error message will be generated. See error -131.
Preset	0 ms
State Saved	Saved in instrument state
Min	0
Max	500 ms
Initial S/W Revision	A.10.00

Gate Delay

Controls the length of time from the time the gate condition goes True until the gate is turned on.

Key Path	Sweep/Control, Gate
Remote Command	[:SENSe] :SWEep:EGATe:DELAy <time> [:SENSe] :SWEep:EGATe:DELAy?

Example	SWE:EGAT:DElay 500ms SWE:EGAT:DElay?
Notes	Units of time are required or no units; otherwise an invalid suffix error message will be generated.
Preset	57.7 us WiMAX OFDMA: 71 us GSM/EDGE: 600 us WLAN: 500 us
State Saved	Saved in instrument state
Min	0.0 us
Max	100 s
Backwards Compatibility SCPI	[:SENSE]:SWEep:TIME:GATE:DElay ESA compatibility
Initial S/W Revision	Prior to A.02.00

Gate Length

Controls the length of time that the gate is on after it opens.

Key Path	Sweep/Control, Gate
Remote Command	[:SENSE]:SWEep:EGATE:LENGth <time> [:SENSE]:SWEep:EGATE:LENGth?
Example	SWE:EGAT:LENG 1 SWE:EGAT:LENG?
Notes	Units of time are required or no units; otherwise an invalid suffix error message will be generated.
Dependencies	Grayed out when Gate Method is set to FFT in which case the label changes to that shown below. <div style="border: 1px solid black; padding: 5px; display: inline-block; margin-bottom: 10px;"> Gate Length (=1.83/RBW) 2.8 ms </div> <small>vsd 39-1</small> The key is also grayed out if Gate Control = Level.
Preset	461.6 us WiMAX OFDMA: 50 us GSM/EDGE: 200 us WLAN: 1.54 ms
State Saved	Saved in instrument state
Min	100 ns
Max	5 s
Backwards Compatibility SCPI	[:SENSE]:SWEep:TIME:GATE:LENGth ESA compatibility
Initial S/W Revision	Prior to A.02.00

Method

This lets you choose one of the three different types of gating.

Not all types of gating are available for all measurements.

Key Path	Sweep/Control, Gate
Remote Command	[:SENSe] :SWEep:EGATe:METhod LO VIDeo FFT [:SENSe] :SWEep:EGATe:METhod?
Example	SWE:EGAT:METh FFT
Preset	LO
State Saved	Saved in instrument state
Initial S/W Revision	Prior to A.02.00

LO

When Gate is set to On, the LO sweeps whenever the gate conditions as specified in the Gate menu are satisfied by the signal at the Gate Source.

This form of gating is more sophisticated, and results in faster measurements. With Gated LO, the analyzer only sweeps while the gate conditions are satisfied. This means that a sweep could take place over several gate events. It would start when the gate signal goes true and stop when it goes false, and then continue when it goes true again. But since the LO is sweeping as long as the gate conditions are satisfied, the sweep typically finishes much more quickly than with Gated Video.

When in zero span, there is no actual sweep performed. But data is only taken while the gate conditions are satisfied. So even though there is no sweep, the gate settings will impact when data is acquired.

Key Path	Sweep/Control, Gate, Method
Dependencies	Key is unavailable when Gate is On and FFT Sweep Type manually selected. When selected, Sweep Type is forced to Swept and the FFT key in Sweep Type is grayed out.
Readback	LO
Initial S/W Revision	Prior to A.02.00

Video

When Gate is set to On, the video signal is allowed to pass through whenever the gate conditions as specified in the Gate menu are satisfied by the signal at the Gate Source.

This form of gating may be thought of as a simple switch, which connects the signal to the input of the spectrum analyzer. When the gate conditions are satisfied, the switch is closed, and when the gate conditions are not satisfied, the switch is open. So we only look at the signal while the gate conditions are satisfied.

With this type of gating, you usually set the analyzer to sweep very slowly. In fact, a general rule is to sweep slowly enough that the gate is guaranteed to be closed at

least once per data measurement interval (bucket). Then if the peak detector is used, each bucket will represent the peak signal as it looks with the gate closed.

Key Path	Sweep/Control, Gate, Method
Dependencies	Key is unavailable when Gate is On and FFT Sweep Type manually selected. When selected, Sweep Type is forced to Swept and the FFT key in Sweep Type is grayed out
Readback	Video
Initial S/W Revision	Prior to A.02.00

FFT

When Gate is set to On, an FFT is performed whenever the gate conditions as specified in the Gate menu are satisfied by the signal at the Gate Source. This is an FFT measurement which begins when the gate conditions are satisfied. Since the time period of an FFT is approximately $1.83/\text{RBW}$, you get a measurement that starts under predefined conditions and takes place over a predefined period. So, in essence, this is a gated measurement. You have limited control over the gate length but it works in FFT sweeps, which the other two methods do not.

Gated FFT cannot be done in zero span since the instrument is not sweeping. So in zero span the Gated LO method is used. Data is still only taken while the gate conditions are satisfied, so the gate settings do impact when data is acquired.

The Gate Length will be $1.83/\text{RBW}$.

This is a convenient way to make a triggered FFT measurement under control of an external gating signal.

Key Path	Sweep/Control, Gate
Dependencies	Key is unavailable when Gate is On and Swept Sweep Type is manually selected. When selected, Sweep Type is forced to FFT and the Swept key in Sweep Type is grayed out Key is unavailable when gate Control is set to Level. Forces Gate Length to $1.83/\text{RBW}$
Readback	FFT
Initial S/W Revision	Prior to A.02.00

Gate Source

The menus under the **Gate Source** key are the same as those under the **Trigger key**, with the exception that neither **Free Run** nor **Video** are available as Gate Source selections. However, a different SCPI command is used to select the Gate Source (see table below) because you may independently set the Gate Source and the Trigger Source.

Any changes to the settings in the setup menus under each Gate Source selection key (for example: Trigger Level, Trigger Delay, etc.) also affect the corresponding settings under the Trigger menu keys. The SCPI commands used for these are the same for Trigger and Gate, since there is only one setting which affects both Gate and Trigger. Example: to set the Trigger Level for External 1 you use the command

:TRIG:EXT1:LEV regardless of whether you are using External 1 as a Trigger Source or a Gate Source.

Key Path	Sweep/Control, Gate
Remote Command	[:SENSe] : SWEEp : EGATe : SOURce EXTerna11 EXTerna12 LINE FRAMe RFBurst TV PXI [:SENSe] : SWEEp : EGATe : SOURce?
Dependencies	In some models, there is no second External input. In these models, the External 2 key is blanked and the EXTernal2 parameter will generate a "Hardware missing; Not available for this model number" error. PXI trigger is only supported in PXI (modular) instruments.
Preset	EXTernal 1 GSM/EDGE, MSR: FRAMe LTETDD: EXTernal 1When Direction is Downlink, FRAMe when Direction is Uplink.
Backwards Compatibility Notes	In ESA, there is a single Gate input port. In PSA, the Gate Source may be taken from one of two specified input ports. In the X-Series, any Trigger Source can be a Gate Source.
Initial S/W Revision	Prior to A.02.00
Modified at S/W Revision	A.03.00, A.14.00

Line

Pressing this key, when it is not selected, selects the line signal as the trigger. A new sweep/measurement will start synchronized with the next cycle of the line voltage. Pressing this key, when it is already selected, access the line trigger setup menu.

Key Path	Trigger
Example	TRIG:SOUR LINE Swept SA measurement TRIG:<meas>:SOUR LINE Measurements other than Swept SA
Dependencies	Line trigger is not available when operating from a "dc power source", for example, when the instrument is powered from batteries.
State Saved	Saved in instrument state
Status Bits/OPC dependencies	The Status Operation Register bit 5 "Waiting for Trigger" is set at the same time as the Sweeping or Measuring bit is set. It is cleared when the trigger actually occurs (that is, after the trigger event occurs and all the applicable trigger criteria have been met). A corresponding pop-up message ("Waiting for trigger") is generated if no trigger signal appears after approximately 2 sec. This message goes away when a trigger signal appears.
Initial S/W Revision	Prior to A.02.00

Trig Slope

Controls the trigger polarity. It is set positive to trigger on a rising edge and negative to trigger on a falling edge.

Key Path	Trigger, Line
Remote Command	:TRIGger[:SEQuence] : LINE : SLOPe POSitive NEGative

	:TRIGger[:SEQuence]:LINE:SLOPe?
Example	TRIG:LINE:SLOP NEG
Preset	POSitive
State Saved	Saved in instrument state
Backwards Compatibility Notes	The legacy :TRIGger[:SEQuence]:SLOPe command affects the slopes for the VID, LINE, EXT1, EXT2, and RFB triggers.
Initial S/W Revision	Prior to A.02.00

External 1

Pressing this key, when it is not selected, selects an external input signal as the trigger. A new sweep/measurement will start when the external trigger condition is met using the external 1 input connector on the rear panel.

Pressing this key, when it is already selected, accesses the external 1 trigger setup menu.

Key Path	Trigger
Example	TRIG:SOUR EXT1 Swept SA measurement TRIG:<meas>:SOUR EXT1 Measurements other than Swept SA
Dependencies	Grayed out if in use by Point Trigger in the Source Setup menu. Forced to Free Run if already selected and Point Trigger is set to External 1.
State Saved	Saved in instrument state
Status Bits/OPC dependencies	The Status Operation Register bit 5 "Waiting for Trigger" is set at the same time as the Sweeping or Measuring bit is set. It is cleared when the trigger actually occurs (that is, after the trigger event occurs and all the applicable trigger criteria have been met). A corresponding pop-up message ("Waiting for trigger") is generated if no trigger signal appears after approximately 2 sec. This message goes away when a trigger signal appears.
Initial S/W Revision	Prior to A.02.00

Trigger Level

Sets the value where the external 1 trigger input will trigger a new sweep/measurement.

Key Path	Trigger, External 1
Remote Command	:TRIGger[:SEQuence]:EXTernal1:LEVel <level> :TRIGger[:SEQuence]:EXTernal1:LEVel?
Example	TRIG:EXT1:LEV 0.4 V
Couplings	This same level is used for the Ext1 trigger source in the Trigger menu, for the Ext1 selection in the Periodic Timer sync source (in the Trigger menu and in the Gate Source menu), and also for the Ext1 selection in the Gate Source menu.
Preset	1.2 V
State Saved	Saved in instrument state

Min	-5 V
Max	5 V
Default Unit	V
Backwards Compatibility SCPI	:TRIGger[:SEquence]:EXTernal:LEVel For backward compatibility, the parameter EXTernal is mapped to EXTernal1
Backwards Compatibility SCPI	:TRIGger[:SEquence]:FRAMe:EXTernal1:LEVel
Initial S/W Revision	Prior to A.02.00

Trig Slope

Controls the trigger polarity. It is set positive to trigger on a rising edge and negative to trigger on a falling edge.

Key Path	Trigger, External 1
Remote Command	:TRIGger[:SEquence]:EXTernal1:SLOPe POSitive NEGative :TRIGger[:SEquence]:EXTernal1:SLOPe?
Example	TRIG:EXT1:SLOP NEG
Couplings	This same slope is used in the Ext1 selection for the trigger source in the Trigger menu and for the period timer sync source (in the Trigger menu and in the Gate Source menu).
Preset	POSitive
State Saved	Saved in instrument state
Backwards Compatibility SCPI	:TRIGger[:SEquence]:EXTernal:SLOPe For backward compatibility, the parameter EXTernal is mapped to EXTernal1
Backwards Compatibility SCPI	:TRIGger[:SEquence]:FRAMe:EXTernal1:SLOPe
Backwards Compatibility Notes	The legacy :TRIGger[:SEquence]:SLOPe command affects the slopes for the VID, LINE, EXT1, EXT2, and RFB triggers.
Initial S/W Revision	Prior to A.02.00

Zero Span Delay Comp On/Off

In zero span, there is a natural delay in the signal path, which comes from the RBW filter. This is usually desirable, as it allows you to trigger on events and also see those events, because the signal is delayed from the trigger event. However, in some cases it is desirable to eliminate this delay, so that trigger events line up exactly with the zero time point in zero span. You can use the **Zero Span Delay Comp On/Off** feature to enable or disable zero span delay compensation.

Key Path	Trigger, External 1
Remote Command	:TRIGger[:SEquence]:EXTernal1:DELay:COMPensation OFF ON 0 1 :TRIGger[:SEquence]:EXTernal1:DELay:COMPensation?
Example	TRIG:EXT1:DEL:COMP ON

Dependencies	No effect except in zero-span, but not locked out in nonzero spans. Blanked in modes that do not support zero-span measurements. If the SCPI command is sent when the key is blanked, an error is returned: -221, "Settings conflict; Feature not supported for this measurement" In analyzers shipping N9060A, this feature requires N9060A-7FP.
Preset	OFF
State Saved	Saved in instrument state
Initial S/W Revision	A.11.00

External 2

Pressing this key, when it is not selected, selects an external input signal as the trigger. A new sweep/measurement will start when the external trigger condition is met using the external 2 input connector. The external trigger 2 input connector is on the rear panel.

Pressing this key, when it is already selected, accesses the external 2 trigger setup menu.

Key Path	Trigger
Example	TRIG:SOUR EXT2 Swept SA measurement TRIG:<meas>:SOUR EXT2 Measurements other than Swept SA
Dependencies	In some models, there is no second External input. In these models, the External 2 key is blanked and the EXternal2 parameter will generate a "Hardware missing; Not available for this model number" message. Grayed out if in use by Point Trigger in the Source Setup menu. Forced to Free Run if already selected and Point Trigger is set to External 2.
State Saved	Saved in instrument state
Status Bits/OPC dependencies	The Status Operation Register bit 5 "Waiting for Trigger" is set at the same time as the Sweeping or Measuring bit is set. It is cleared when the trigger actually occurs (that is, after the trigger event occurs and all the applicable trigger criteria have been met). A corresponding pop-up message ("Waiting for trigger") is generated if no trigger signal appears after approximately 2 sec. This message goes away when a trigger signal appears.
Initial S/W Revision	Prior to A.02.00
Modified at S/W Revision	A.03.00

Trigger Level

Sets the value where the external 2 trigger input will trigger a new sweep/measurement.

Key Path	Trigger, External 2
Remote Command	:TRIGger[:SEquence]:EXTernal2:LEVel :TRIGger[:SEquence]:EXTernal2:LEVel?

Example	TRIG:EXT2:LEV 1.1 V
Couplings	This same level is used for the Ext2 trigger source in the Trigger menu, for the Ext2 selection in the Periodic Timer sync source (in the Trigger menu and in the Gate Source menu), and also for the Ext2 selection in the Gate Source menu.
Preset	1.2 V
State Saved	Saved in instrument state
Min	-5 V
Max	5 V
Default Unit	V
Backwards Compatibility SCPI	:TRIGger[:SEquence]:FRAME:EXTerna12:LEVe1
Initial S/W Revision	Prior to A.02.00

Trig Slope

Controls the trigger polarity. It is set positive to trigger on a rising edge and negative to trigger on a falling edge.

Key Path	Trigger, External 2
Remote Command	:TRIGger[:SEquence]:EXTerna12:SLOPe POSitive NEGative :TRIGger[:SEquence]:EXTerna12:SLOPe?
Example	TRIG:EXT2:SLOP NEG
Couplings	This same slope is used in the Ext2 selection for the trigger source in the Trigger menu and for the period timer sync source (in the Trigger menu and in the Gate Source menu).
Preset	POSitive
State Saved	Saved in instrument state
Backwards Compatibility SCPI	:TRIGger[:SEquence]:FRAME:EXTerna12:SLOPe
Backwards Compatibility Notes	The legacy :TRIGger[:SEquence]:SLOPe command affects the slopes for the VID, LINE, EXT1, EXT2, and RFB triggers.
Initial S/W Revision	Prior to A.02.00

Zero Span Delay Comp On/Off

In zero span, there is a natural delay in the signal path, which comes from the RBW filter. This is usually desirable, as it allows you to trigger on events and also see those events, because the signal is delayed from the trigger event. However, in some cases it is desirable to eliminate this delay, so that trigger events line up exactly with the zero time point in zero span. You can use the **Zero Span Delay Comp On/Off** feature to enable or disable zero span delay compensation.

Key Path	Trigger, External 2
Remote Command	:TRIGger[:SEquence]:EXTerna12:DELaY:COMPensation OFF ON 0 1 :TRIGger[:SEquence]:EXTerna12:DELaY:COMPensation?

Example	TRIG:EXT2:DEL:COMP ON
Dependencies	No effect except in zero-span, but not locked out in nonzero spans. Blanked in modes that do not support zero-span measurements. If the SCPI command is sent when the key is blanked, an error is returned: -221, "Settings conflict; Feature not supported for this measurement" In analyzers shipping N9060A, this feature requires N9060A-7FP.
Preset	OFF
State Saved	Saved in instrument state
Initial S/W Revision	A.11.00

RF Burst

Pressing this key, when it is not selected, selects the RF Burst as the trigger. A new sweep/measurement will start when an RF burst envelope signal is identified from the signal at the RF Input connector. Pressing this key, when it is already selected, accesses the RF Burst trigger setup menu.

In some models, a variety of burst trigger circuitry is available, resulting in various available burst trigger bandwidths. The analyzer automatically chooses the appropriate trigger path based on the hardware configuration and other settings of the analyzer.

Key Path	Trigger
Example	TRIG:SOUR RFB Swept SA measurement TRIG:<meas>:SOUR RFB Measurements other than Swept SA
State Saved	Saved in instrument state
Status Bits/OPC dependencies	The Status Operation Register bit 5 "Waiting for Trigger" is set at the same time as the Sweeping or Measuring bit is set. It is cleared when the trigger actually occurs (that is, after the trigger event occurs and all the applicable trigger criteria have been met). A corresponding pop-up message ("Waiting for trigger") is generated if no trigger signal appears after approximately 2 sec. This message goes away when a trigger signal appears.
Backwards Compatibility Notes	The legacy command: :TRIGger[:SEQuence]:RFBurst:FSElectivity[:STATe] OFF ON 0 1 is not supported in the X-Series, as the hardware to do Frequency Selective burst triggers does not exist in X-Series.
Initial S/W Revision	Prior to A.02.00
Modified at S/W Revision	A.04.00

Absolute Trigger Level

Sets the absolute trigger level for the RF burst envelope.

When using the External Mixing path, the Absolute Trigger Level is uncalibrated because the factory default was set to accommodate the expected IF levels for the RF path.

Key Path	Trigger, RF Burst
Scope	Meas Global
Remote Command	:TRIGger[:SEquence]:RFBurst:LEVel:ABSolute <amp1> :TRIGger[:SEquence]:RFBurst:LEVel:ABSolute?
Example	TRIG:RFB:LEV:ABS 10 dBm sets the trigger level of the RF burst envelope signal to the absolute level of 10 dBm
Notes	Sending this command does not switch the setting from relative to absolute; to switch it you need to send the :TRIGger[:SEquence]:RFBurst:LEVel:TYPE command, below. Amplitude Corrections are not taken into account by the Absolute Trigger Level. For example, if you have given yourself effective gain with an amplitude correction factor, the Absolute Trigger will not fire until you have set the trigger level that far below the displayed signal level, rather than simply to the displayed signal level. This is only true for Amplitude Corrections, not External Gain or Ref Level Offset functions. If mode is Bluetooth, the default value is -50 dBm.
Couplings	This same level is used for the RF Burst trigger source in the Trigger menu, for the RF Burst selection in the Periodic Timer sync source (in the Trigger menu and in the Gate Source menu), and also for the RF Burst selection in the Gate Source menu
Preset	-20 dBm
State Saved	Saved in instrument state
Min	-200 dBm
Max	100 dBm
Default Unit	depends on the current selected Y-Axis unit
Backwards Compatibility SCPI	:TRIGger[:SEquence]:FRAMe:RFBurst:LEVel:ABSolute
Initial S/W Revision	Prior to A.02.00
Modified at S/W Revision	A.04.00

Key Path	Trigger, RF Burst
Remote Command	:TRIGger[:SEquence]:RFBurst:LEVel:TYPE ABSolute RELative :TRIGger[:SEquence]:RFBurst:LEVel:TYPE?
Example	TRIG:RFB:LEV:TYPE REL sets the trigger level type of the RF burst trigger to Relative.
Preset	ABSolute
State Saved	Saved in instrument state
Initial S/W Revision	Prior to A.02.00
Modified at S/W Revision	A.04.00

Relative Trigger Level

Sets the relative trigger level for the RF burst envelope.

In some models, the relative burst trigger function is implemented in hardware. In other models, without the advanced triggering hardware required, the relative burst trigger function is implemented in software in some measurements, and is unavailable in other measurements.

When implemented in software, the relative RF Burst trigger function is implemented as follows:

5. The measurement starts with the absolute RF Burst trigger setting. If it cannot get a trigger with that level, auto trigger fires and the acquisition starts anyway. After the acquisition, the measurement searches for the peak in the acquired waveform and saves it.
6. Now, in the next cycle of the measurement, the measurement determines a new absolute RF Burst level based on the peak value from the first measurement and the Relative RF Burst Trigger Level (always 0 or negative dB) set by the user. The following formula is used:
7. absolute RF Burst level = peak level of the previous acquisition + relative RF Burst level
8. If the new absolute RF Burst level differs from the previous by more than 0.5 dB, the new level is sent to the hardware; otherwise it is not updated (to avoid slowing down the acquisition)

Steps 2 and 3 repeat for subsequent measurements.

Key Path	Trigger, RF Burst
Scope	Meas Global
Remote Command	:TRIGger[:SEquence]:RFBurst:LEVel:RELative <rel_amp1> :TRIGger[:SEquence]:RFBurst:LEVel:RELative?
Example	TRIG:RFB:LEV:REL -10 dB sets the trigger level of the RF burst envelope signal to the relative level of -10 dB
Notes	Sending this command does not switch the setting from absolute to relative; to switch it you need to send the :TRIGger[:SEquence]:RFBurst:LEVel:TYPE command, above. The relative trigger level is not available in some measurements. In those measurements the RELative parameter, and the :TRIGger[:SEquence]:RFBurst:LEVel:TYPE command (above), will generate an error if sent.
Dependencies	This key is grayed out and Absolute Trigger Level selected if the required hardware is not present in your analyzer and the current measurement does not support Relative triggering.
Preset	-6 dB GSM: -25 dB
State Saved	Saved in instrument state
Min	-45 dB
Max	0 dB

Default Unit	dB or dBc
Backwards Compatibility SCPI	:TRIGger[:SEquence]:RFBurst:LEVel This legacy command is aliased to :TRIGger[:SEquence]:RFBurst:LEVel:RELative because the PSA had ONLY relative burst triggering
Initial S/W Revision	Prior to A.02.00
Modified at S/W Revision	A.04.00

Trigger Slope

It is set positive to trigger on a rising edge and negative to trigger on a falling edge.

Key Path	Trigger, RF Burst
Remote Command	:TRIGger[:SEquence]:RFBurst:SLOPe POSitive NEGative :TRIGger[:SEquence]:RFBurst:SLOPe?
Example	TRIG:RFB:SLOP NEG
Couplings	This same slope is used in the RF Burst selection for the trigger source in the Trigger menu and for the period timer sync source (in the Trigger menu and in the Gate Source menu).
Preset	POSitive
State Saved	Saved in instrument state
Backwards Compatibility SCPI	:TRIGger[:SEquence]:FRAME:RFBurst:SLOPe
Backwards Compatibility Notes	The legacy :TRIGger[:SEquence]:SLOPe command affects the slopes for the VID, LINE, EXT1, EXT2, and RFB triggers.
Initial S/W Revision	Prior to A.02.00

Zero Span Delay Comp On/Off

In zero span, there is a natural delay in the signal path, which comes from the RBW filter. This is usually desirable, as it allows you to trigger on events and also see those events, because the signal is delayed from the trigger event. However, in some cases it is desirable to eliminate this delay, so that trigger events line up exactly with the zero time point in zero span. You can use the **Zero Span Delay Comp On/Off** feature to enable or disable zero span delay compensation.

Key Path	Trigger, RF Burst
Remote Command	:TRIGger[:SEquence]:RFBurst:DELAy:COMPensation OFF ON 0 1 :TRIGger[:SEquence]:RFBurst:DELAy:COMPensation?
Example	TRIG:RFB:DEL:COMP ON
Dependencies	No effect except in zero-span, but not locked out in nonzero spans. Blanked in modes that do not support zero-span measurements. If the SCPI command is sent when the key is blanked, an error is returned: -221, "Settings conflict; Feature not supported for this measurement" In analyzers shipping N9060A, this feature requires N9060A-7FP.

Preset	OFF
State Saved	Saved in instrument state
Initial S/W Revision	A.11.00

Periodic Timer (Frame Trigger)

Pressing this key, when it is not selected, selects the internal periodic timer signal as the trigger. Triggering occurrences are set by the **Period** parameter, which is modified by the **Sync Source** and **Offset**. Pressing this key, when it is already selected, accesses the periodic timer trigger setup functions.

If you do not have a sync source selected (it is Off), then the internal timer will not be synchronized with any external timing events.

Key Path	Trigger
Example	TRIG:SOUR FRAM Swept SA measurement TRIG:<meas>:SOUR FRAM Measurements other than Swept SA
State Saved	Saved in instrument state
Readback	[Sync: <value of Sync Source>], for example, [Sync: External 1]
Status Bits/OPC dependencies	The Status Operation Register bit 5 "Waiting for Trigger" is set at the same time as the Sweeping or Measuring bit is set. It is cleared when the trigger actually occurs (that is, after the trigger event occurs and all the applicable trigger criteria have been met). A corresponding pop-up message ("Waiting for trigger") is generated if no trigger signal appears after approximately 2 sec. This message goes away when a trigger signal appears.
Initial S/W Revision	Prior to A.02.00

Periodic Timer Triggering:

This feature selects the internal periodic timer signal as the trigger. Trigger occurrences are set by the **Periodic Timer** parameter, which is modified by the **Sync Source** and **Offset**.

The figure below shows the action of the periodic timer trigger. Before reviewing the figure, we'll explain some uses for the periodic trigger.

A common application is measuring periodic burst RF signals for which a trigger signal is not easily available. For example, we might be measuring a TDMA radio which bursts every 20 ms. Let's assume that the 20 ms period is very consistent. Let's also assume that we do not have an external trigger source available that is synchronized with the period, and that the signal-to-noise ratio of the signal is not high enough to provide a clean RF burst trigger at all of the analysis frequencies. For example, we might want to measure spurious transmissions at an offset from the carrier that is larger than the bandwidth of the RF burst trigger. In this application, we can set the Periodic Timer to a 20.00 ms period and adjust the offset from that timer to position our trigger just where we want it. If we find that the 20.00 ms is not exactly right, we can adjust the period slightly to minimize the drift between the period timer and the signal to be measured.

A second way to use this feature would be to use **Sync Source** temporarily, instead of **Offset**. In this case, we might tune to the signal in a narrow span and use the RF Burst trigger to synchronize the periodic timer. Then we would turn the sync source off so that it would not miss-trigger. Miss-triggering can occur when we are tuned so far away from the RF burst trigger that it is no longer reliable.

A third example would be to synchronize to a signal that has a reference time element of much longer period than the period of interest. In some CDMA applications, it is useful to look at signals with a short periodicity, by synchronizing that periodicity to the "even-second clock" edge that happens every two seconds. Thus, we could connect the even-second clock trigger to Ext1 and use then Ext1 as the sync source for the periodic timer.

The figure below illustrates this third example. The top trace represents the even-second clock. It causes the periodic timer to synchronize with the leading edge shown. The analyzer trigger occurs at a time delayed by the accumulated offset from the period trigger event. The periodic timer continues to run, and triggers continue to occur, with a periodicity determined by the analyzer time base. The timer output (labeled "late event") will drift away from its ideal time due to imperfect matching between the time base of the signal being measured and the time base of the analyzer, and also because of imperfect setting of the period parameter. But the synchronization is restored on the next even-second clock event. ("Accumulated offset" is described in the in the **Offset** function section.)

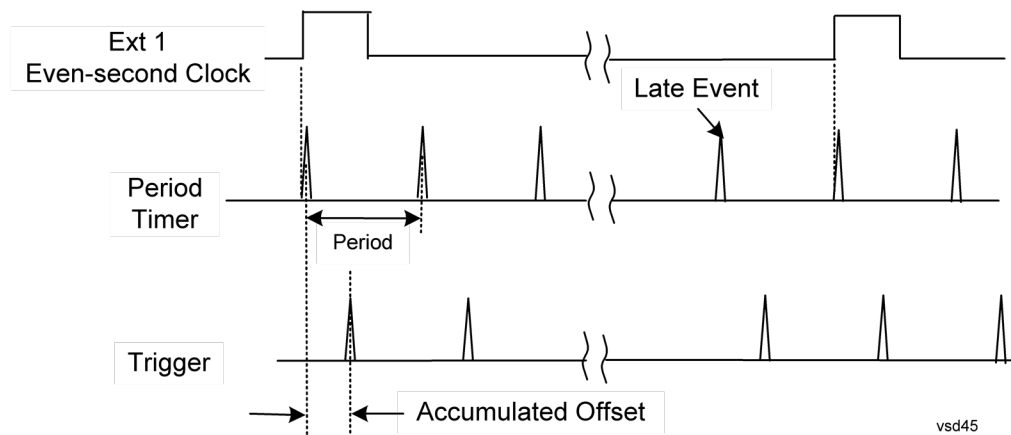

Period

Sets the period of the internal periodic timer clock. For digital communications signals, this is usually set to the frame period of your current input signal. In the case that sync source is not set to OFF, and the external sync source rate is changed for some reason, the periodic timer is synchronized at the every external synchronization pulse by resetting the internal state of the timer circuit.

Key Path	Trigger, Periodic Timer
Remote Command	:TRIGger[:SEquence]:FRAMe:PERiod <time> :TRIGger[:SEquence]:FRAMe:PERiod?
Example	TRIG:FRAM:PER 100 ms

Dependencies	The invalid data indicator turns on when the period is changed, until the next sweep/measurement completes.
Couplings	The same period is used in the Gate Source selection of the period timer.
Preset	20 ms GSM: 4.615383
State Saved	Saved in instrument state
Min	100.000 ns
Max	559.0000 ms
Default Unit	S
Initial S/W Revision	Prior to A.02.00

Offset

Adjusts the accumulated offset between the periodic timer events and the trigger event. Adjusting the accumulated offset is different than setting an offset, and requires explanation.

The periodic timer is usually not synchronized with any external events, so the timing of its output events has no absolute meaning. Since the timing relative to external events (RF signals) is important, you need to be able to adjust (offset) it. However, you have no direct way to see when the periodic timer events occur. All that you can see is the trigger timing. When you want to adjust the trigger timing, you will be changing the internal offset between the periodic timer events and the trigger event. Because the absolute value of that internal offset is unknown, we will just call that the accumulated offset. Whenever the Offset parameter is changed, you are changing that accumulated offset. You can reset the displayed offset using Reset Offset Display. Changing the display does not change the value of the accumulated offset, and you can still make additional changes to accumulated offset.

To avoid ambiguity, we define that an increase in the "offset" parameter, either from the knob or the SCPI adjust command, serves to delay the timing of the trigger event.

Key Path	Trigger, Periodic Timer
Remote Command	:TRIGger[:SEquence]:FRAMe:OFFSet <time> :TRIGger[:SEquence]:FRAMe:OFFSet?
Example	TRIG:FRAM:OFFS 1.2 ms
Notes	The front panel interface (for example, the knob), and this command, adjust the accumulated offset, which is shown on the active function display. However, the actual amount sent to the hardware each time the offset is updated is the delta value, that is, the current accumulated offset value minus the previous accumulated offset value. Note that the accumulated offset value is essentially arbitrary; it represents the accumulated offset from the last time the offset was zeroed (with the Reset Offset Display key). Note that this command does not change the period of the trigger waveform. Note also that Offset is used only when the sync source is set to OFF, otherwise delay is used, see section "Trig Delay" on page 568.

	An increase in the "offset" parameter, either from the knob or the SCPI adjust command, serves to delay the timing of the trigger event.
Notes	When the SCPI command is sent the value shown on the key (and the Active Function, if this happens to be the active function) is updated with the new value. However, the actual amount sent to the hardware is the delta value, that is, the current accumulated offset value minus the previous accumulated offset value. The SCPI query simply returns the value currently showing on the key.
Dependencies	The invalid data indicator turns on when the offset is changed, until the next sweep/measurement completes.
Couplings	The same offset is used in the Gate Source selection of the period timer.
Preset	0 s
State Saved	Saved in instrument state
Min	-10.000 s
Max	10.000 s
Default Unit	S
Initial S/W Revision	Prior to A.02.00

Offset Adjust (Remote Command Only)

This remote command does not work at all like the related front panel keys. This command lets you advance the phase of the frame trigger by the amount you specify.

It does not change the period of the trigger waveform. If the command is sent multiple times, it advances the phase of the frame trigger an additional amount each time it is sent. Negative numbers are permitted.

Remote Command	:TRIGger[:SEquence]:FRAMe:ADJust <time>
Example	TRIG:FRAM:ADJ 1.2 ms
Notes	Note also that Offset is used only when the sync source is set to OFF, otherwise delay is used, see section "Trig Delay" on page 568 An increase in the "offset" parameter, either from the knob or the SCPI adjust command, serves to delay the timing of the trigger event.
Notes	The front panel interface (for example, the knob) and the :TRIG:FRAM:OFFS command adjust the accumulated offset, which is shown on the active function display. However, the actual amount sent to the hardware is the delta value, that is, the current offset value minus the previous offset value. When the SCPI command is sent the value shown on the key (and the Active Function, if this happens to be the active function) is updated by increasing it (or decreasing it if the value sent is negative) by the amount specified in the SCPI command. This is a "command only" SCPI command, with no query.
Dependencies	The invalid data indicator turns on when the offset is changed, until the next sweep/measurement completes.
Couplings	The same offset is used in the Gate Source selection of the period timer.

Preset	0 s
State Saved	Saved in instrument state
Min	-10.000 s
Max	10.000 s
Default Unit	S
Initial S/W Revision	Prior to A.02.00

Reset Offset Display

Resets the value of the periodic trigger offset display setting to 0.0 seconds. The current displayed trigger location may include an offset value defined with the **Offset** key. Pressing this key redefines the currently displayed trigger location as the new trigger point that is 0.0 s offset. The **Offset** key can then be used to add offset relative to this new timing.

Key Path	Trigger, Periodic Timer
Remote Command	:TRIGger[:SEquence]:FRAMe:OFFSet:DISPlay:RESet
Example	TRIG:FRAM:OFFS:DISP:RES
Initial S/W Revision	Prior to A.02.00

Sync Source

Selects a signal source for you to synchronize your periodic timer trigger to, otherwise you are triggering at some arbitrary location in the frame. Synchronization reduces the precision requirements on the setting of the period.

For convenience you may adjust the level and slope of the selected sync source in a conditional branch setup menu accessed from the Sync Source menu. Note that these settings match those in the **Trigger** and **Gate Source** menus; that is, each trigger source has only one value of level and slope, regardless of which menu it is accessed from.

Key Path	Trigger, Periodic Timer
Remote Command	:TRIGger[:SEquence]:FRAMe:SYNC EXTerna11 EXTerna12 RFBurst PXI OFF :TRIGger[:SEquence]:FRAMe:SYNC?
Example	TRIG:FRAM:SYNC EXT2
Dependencies	In some models, there is no second External input. In these models, the External 2 key is blanked and the EXTerna12 parameter will generate a "Hardware missing; Not available for this model number" message. PXI trigger is only supported in PXI (modular) instruments.
Preset	Off GSM/EDGE, MSR,LTE,LTETDD: RFBurst
State Saved	Saved in instrument state

Readback	The current setting is read back to this key and it is also Readback to the previous Periodic Timer trigger key.
Backwards Compatibility SCPI	:TRIGger[:SEQuence]:FRAMe:SYNC EXTernal For backward compatibility, the parameter EXTernal is mapped to EXTernal1
Initial S/W Revision	Prior to A.02.00
Modified at S/W Revision	A.03.00, A.14.00

Off

Turns off the sync source for your periodic trigger. With the sync source off, the timing will drift unless the signal source frequency is locked to the analyzer frequency reference.

Key Path	Trigger, Periodic Timer, Sync Source
Example	TRIG:FRAM:SYNC OFF
Readback	Off
Initial S/W Revision	Prior to A.02.00

External 1

Pressing this key, when it is not selected, selects an external input signal as the trigger. A new sweep/measurement will start when the external trigger condition is met using the external 1 input connector on the rear panel.

Pressing this key, when it is already selected, accesses the external 1 trigger setup menu.

Key Path	Trigger
Example	TRIG:SOUR EXT1 Swept SA measurement TRIG:<meas>:SOUR EXT1 Measurements other than Swept SA
Dependencies	Grayed out if in use by Point Trigger in the Source Setup menu. Forced to Free Run if already selected and Point Trigger is set to External 1.
State Saved	Saved in instrument state
Status Bits/OPC dependencies	The Status Operation Register bit 5 "Waiting for Trigger" is set at the same time as the Sweeping or Measuring bit is set. It is cleared when the trigger actually occurs (that is, after the trigger event occurs and all the applicable trigger criteria have been met). A corresponding pop-up message ("Waiting for trigger") is generated if no trigger signal appears after approximately 2 sec. This message goes away when a trigger signal appears.
Initial S/W Revision	Prior to A.02.00

Trigger Level

Sets the value where the external 1 trigger input will trigger a new sweep/measurement.

Key Path	Trigger, External 1
Remote Command	:TRIGger[:SEquence]:EXTernal1:LEVel <level> :TRIGger[:SEquence]:EXTernal1:LEVel?
Example	TRIG:EXT1:LEV 0.4 V
Couplings	This same level is used for the Ext1 trigger source in the Trigger menu, for the Ext1 selection in the Periodic Timer sync source (in the Trigger menu and in the Gate Source menu), and also for the Ext1 selection in the Gate Source menu.
Preset	1.2 V
State Saved	Saved in instrument state
Min	-5 V
Max	5 V
Default Unit	V
Backwards Compatibility SCPI	:TRIGger[:SEquence]:EXTernal:LEVel For backward compatibility, the parameter EXTernal is mapped to EXTernal1
Backwards Compatibility SCPI	:TRIGger[:SEquence]:FRAMe:EXTernal1:LEVel
Initial S/W Revision	Prior to A.02.00

Trig Slope

Controls the trigger polarity. It is set positive to trigger on a rising edge and negative to trigger on a falling edge.

Key Path	Trigger, External 1
Remote Command	:TRIGger[:SEquence]:EXTernal1:SLOPe POSitive NEGative :TRIGger[:SEquence]:EXTernal1:SLOPe?
Example	TRIG:EXT1:SLOP NEG
Couplings	This same slope is used in the Ext1 selection for the trigger source in the Trigger menu and for the period timer sync source (in the Trigger menu and in the Gate Source menu).
Preset	POSitive
State Saved	Saved in instrument state
Backwards Compatibility SCPI	:TRIGger[:SEquence]:EXTernal:SLOPe For backward compatibility, the parameter EXTernal is mapped to EXTernal1
Backwards Compatibility SCPI	:TRIGger[:SEquence]:FRAMe:EXTernal1:SLOPe
Backwards Compatibility Notes	The legacy :TRIGger[:SEquence]:SLOPe command affects the slopes for the VID, LINE, EXT1, EXT2, and RFB triggers.
Initial S/W Revision	Prior to A.02.00

External 2

Pressing this key, when it is not selected, selects an external input signal as the trigger. A new sweep/measurement will start when the external trigger condition is met using the external 2 input connector. The external trigger 2 input connector is on the rear panel.

Pressing this key, when it is already selected, accesses the external 2 trigger setup menu.

Key Path	Trigger
Example	TRIG:SOUR EXT2 Swept SA measurement TRIG:<meas>:SOUR EXT2 Measurements other than Swept SA
Dependencies	In some models, there is no second External input. In these models, the External 2 key is blanked and the EXTernal2 parameter will generate a "Hardware missing; Not available for this model number" message. Grayed out if in use by Point Trigger in the Source Setup menu. Forced to Free Run if already selected and Point Trigger is set to External 2.
State Saved	Saved in instrument state
Status Bits/OPC dependencies	The Status Operation Register bit 5 "Waiting for Trigger" is set at the same time as the Sweeping or Measuring bit is set. It is cleared when the trigger actually occurs (that is, after the trigger event occurs and all the applicable trigger criteria have been met). A corresponding pop-up message ("Waiting for trigger") is generated if no trigger signal appears after approximately 2 sec. This message goes away when a trigger signal appears.
Initial S/W Revision	Prior to A.02.00
Modified at S/W Revision	A.03.00

Trigger Level

Sets the value where the external 2 trigger input will trigger a new sweep/measurement.

Key Path	Trigger, External 2
Remote Command	:TRIGger[:SEquence]:EXTernal2:LEVel :TRIGger[:SEquence]:EXTernal2:LEVel?
Example	TRIG:EXT2:LEV 1.1 V
Couplings	This same level is used for the Ext2 trigger source in the Trigger menu, for the Ext2 selection in the Periodic Timer sync source (in the Trigger menu and in the Gate Source menu), and also for the Ext2 selection in the Gate Source menu.
Preset	1.2 V
State Saved	Saved in instrument state
Min	-5 V
Max	5 V
Default Unit	V
Backwards	:TRIGger[:SEquence]:FRAME:EXTernal2:LEVel

Compatibility SCPI

Initial S/W Revision Prior to A.02.00

Trig Slope

Controls the trigger polarity. It is set positive to trigger on a rising edge and negative to trigger on a falling edge.

Key Path	Trigger, External 2
Remote Command	:TRIGger[:SEquence]:EXTernal2:SLOPe POSitive NEGative :TRIGger[:SEquence]:EXTernal2:SLOPe?
Example	TRIG:EXT2:SLOP NEG
Couplings	This same slope is used in the Ext2 selection for the trigger source in the Trigger menu and for the period timer sync source (in the Trigger menu and in the Gate Source menu).
Preset	POSitive
State Saved	Saved in instrument state
Backwards Compatibility SCPI	:TRIGger[:SEquence]:FRAMe:EXTernal2:SLOPe
Backwards Compatibility Notes	The legacy :TRIGger[:SEquence]:SLOPe command affects the slopes for the VID, LINE, EXT1, EXT2, and RFB triggers.
Initial S/W Revision	Prior to A.02.00

RF Burst

Pressing this key, when it is not selected, selects the RF Burst as the trigger. A new sweep/measurement will start when an RF burst envelope signal is identified from the signal at the RF Input connector. Pressing this key, when it is already selected, accesses the RF Burst trigger setup menu.

In some models, a variety of burst trigger circuitry is available, resulting in various available burst trigger bandwidths. The analyzer automatically chooses the appropriate trigger path based on the hardware configuration and other settings of the analyzer.

Key Path	Trigger
Example	TRIG:SOUR RFB Swept SA measurement TRIG:<meas>:SOUR RFB Measurements other than Swept SA
State Saved	Saved in instrument state
Status Bits/OPC dependencies	The Status Operation Register bit 5 "Waiting for Trigger" is set at the same time as the Sweeping or Measuring bit is set. It is cleared when the trigger actually occurs (that is, after the trigger event occurs and all the applicable trigger criteria have been met). A corresponding pop-up message ("Waiting for trigger") is generated if no trigger signal appears after approximately 2 sec. This message goes away when a trigger signal appears.
Backwards Compatibility Notes	The legacy command: :TRIGger[:SEquence]:RFBurst:FSElectivity[:STATe] OFF ON 0 1

	is not supported in the X-Series, as the hardware to do Frequency Selective burst triggers does not exist in X-Series.
Initial S/W Revision	Prior to A.02.00
Modified at S/W Revision	A.04.00

Absolute Trigger Level

Sets the absolute trigger level for the RF burst envelope.

When using the External Mixing path, the Absolute Trigger Level is uncalibrated because the factory default was set to accommodate the expected IF levels for the RF path.

Key Path	Trigger, RF Burst
Scope	Meas Global
Remote Command	:TRIGger[:SEquence]:RFBurst:LEVel:ABSolute <ampl> :TRIGger[:SEquence]:RFBurst:LEVel:ABSolute?
Example	TRIG:RFB:LEV:ABS 10 dBm sets the trigger level of the RF burst envelope signal to the absolute level of 10 dBm
Notes	Sending this command does not switch the setting from relative to absolute; to switch it you need to send the :TRIGger[:SEquence]:RFBurst:LEVel:TYPE command, below. Amplitude Corrections are not taken into account by the Absolute Trigger Level. For example, if you have given yourself effective gain with an amplitude correction factor, the Absolute Trigger will not fire until you have set the trigger level that far below the displayed signal level, rather than simply to the displayed signal level. This is only true for Amplitude Corrections, not External Gain or Ref Level Offset functions. If mode is Bluetooth, the default value is -50 dBm.
Couplings	This same level is used for the RF Burst trigger source in the Trigger menu, for the RF Burst selection in the Periodic Timer sync source (in the Trigger menu and in the Gate Source menu), and also for the RF Burst selection in the Gate Source menu
Preset	-20 dBm
State Saved	Saved in instrument state
Min	-200 dBm
Max	100 dBm
Default Unit	depends on the current selected Y-Axis unit
Backwards Compatibility SCPI	:TRIGger[:SEquence]:FRAMe:RFBurst:LEVel:ABSolute
Initial S/W Revision	Prior to A.02.00
Modified at S/W Revision	A.04.00

Key Path	Trigger, RF Burst
Remote Command	:TRIGger[:SEquence]:RFBurst:LEVel:TYPE ABSolute RELative :TRIGger[:SEquence]:RFBurst:LEVel:TYPE?
Example	TRIG:RFB:LEV:TYPE REL sets the trigger level type of the RF burst trigger to Relative.
Preset	ABSolute
State Saved	Saved in instrument state
Initial S/W Revision	Prior to A.02.00
Modified at S/W Revision	A.04.00

Trigger Slope

It is set positive to trigger on a rising edge and negative to trigger on a falling edge.

Key Path	Trigger, RF Burst
Remote Command	:TRIGger[:SEquence]:RFBurst:SLOPe POSitive NEGative :TRIGger[:SEquence]:RFBurst:SLOPe?
Example	TRIG:RFB:SLOP NEG
Couplings	This same slope is used in the RF Burst selection for the trigger source in the Trigger menu and for the period timer sync source (in the Trigger menu and in the Gate Source menu).
Preset	POSitive
State Saved	Saved in instrument state
Backwards Compatibility SCPI	:TRIGger[:SEquence]:FRAMe:RFBurst:SLOPe
Backwards Compatibility Notes	The legacy :TRIGger[:SEquence]:SLOPe command affects the slopes for the VID, LINE, EXT1, EXT2, and RFB triggers.
Initial S/W Revision	Prior to A.02.00

Zero Span Delay Comp On/Off

In zero span, there is a natural delay in the signal path, which comes from the RBW filter. This is usually desirable, as it allows you to trigger on events and also see those events, because the signal is delayed from the trigger event. However, in some cases it is desirable to eliminate this delay, so that trigger events line up exactly with the zero time point in zero span. You can use the **Zero Span Delay Comp On/Off** feature to enable or disable zero span delay compensation.

Key Path	Trigger, RF Burst
Remote Command	:TRIGger[:SEquence]:RFBurst:DELay:COMPensation OFF ON 0 1 :TRIGger[:SEquence]:RFBurst:DELay:COMPensation?
Example	TRIG:RFB:DEL:COMP ON
Dependencies	No effect except in zero-span, but not locked out in nonzero spans.

	Blanked in modes that do not support zero-span measurements. If the SCPI command is sent when the key is blanked, an error is returned: -221, "Settings conflict; Feature not supported for this measurement" In analyzers shipping N9060A, this feature requires N9060A-7FP.
Preset	OFF
State Saved	Saved in instrument state
Initial S/W Revision	A.11.00

Sync Holdoff

Sync Holdoff specifies the duration that the sync source signal must be kept false before the transition to true to be recognized as the sync timing. The periodic timer phase is aligned when the sync source signal becomes true, after the Holdoff time is satisfied.

A holdoff of 2 ms will work with most WiMAX signals, but there may be cases where the burst off duration is less than 1 ms and this value will need to be changed.

Key Path	Trigger, Periodic Timer
Remote Command	:TRIGger[:SEquence]:FRAMe:SYNC:HOLDoff <time> :TRIGger[:SEquence]:FRAMe:SYNC:HOLDoff? :TRIGger[:SEquence]:FRAMe:SYNC:HOLDoff:STATe OFF ON 0 1 :TRIGger[:SEquence]:FRAMe:SYNC:HOLDoff:STATe?
Preset	On, 1.000 ms
State Saved	Saved in instrument state
Min	0 ms
Max	+500 ms
Default Unit	s
Initial S/W Revision	Prior to A.02.00

Control Edge/Level

Sets the method of controlling the gating function from the gating signal.

Edge

In Edge triggering, the gate opens (after the Delay) on the selected edge (for example, positive) of the gate signal and closes on the alternate edge (for example, negative).

Level

In Level triggering, the gate opens (after the Delay) when the gate signal has achieved a certain level and stays open as long as that level is maintained.

Key Path	Sweep/Control, Gate
Remote Command	[:SENSe]:SWEep:EGATe:CONTRol EDGE LEVEl [:SENSe]:SWEep:EGATe:CONTRol?

Example	SWE:EGAT:CONT EDGE
Dependencies	If the Gate Method is FFT the Control key is grayed out and Edge is selected. If the Gate Source is TV, Frame or Line, the Control key is grayed out and Edge is selected.
Preset	EDGE
State Saved	Saved in instrument state
Backwards Compatibility SCPI	[:SENSe]:SWEep:TIME:GATE:TYPE ESA Compatibility
Initial S/W Revision	Prior to A.02.00

Gate Holdoff

Lets you increase or decrease the wait time after a gate event ends before the analyzer will respond to the next gate signal.

After any Gate event finishes, the analyzer must wait for the sweep system to settle before it can respond to another Gate signal. The analyzer calculates a "wait time," taking into account a number of factors, including RBW and Phase Noise Optimization settings. The goal is to achieve the same accuracy when gated as in ungated operation. The figure below illustrates this concept:

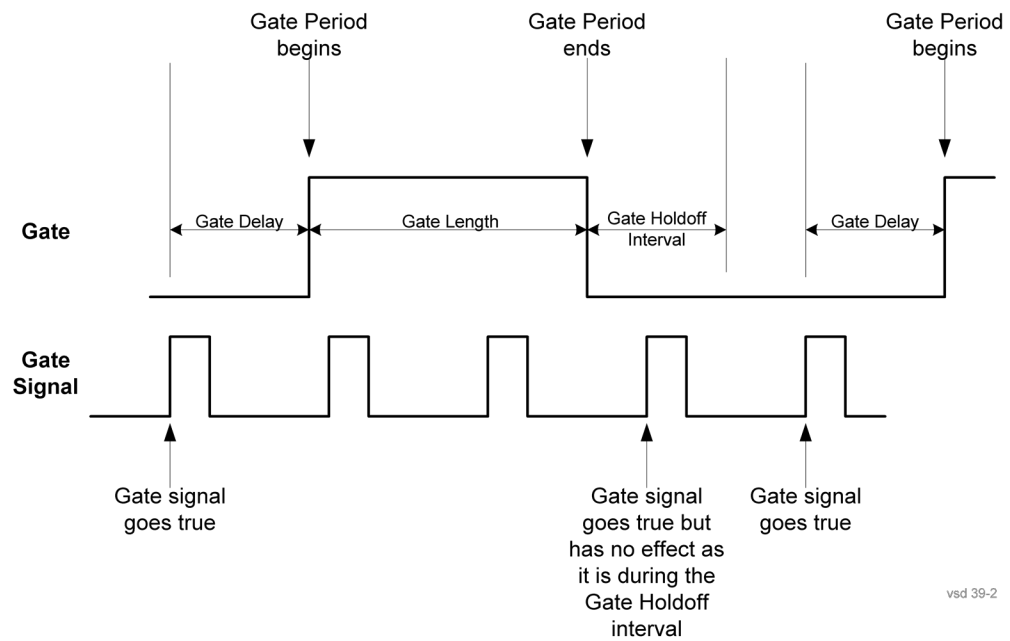

When Gate Holdoff is in Auto, the wait time calculated by the analyzer is used. When Gate Time is in Manual, the user may adjust the wait time, usually decreasing it in order to achieve greater speed, but at the risk of decreasing accuracy.

When the **Method** key is set to **Video** or **FFT**, the **Gate Holdoff** function has no effect.

In measurements that do not support Auto, the value shown when Auto is selected is “---” and the manually set holdoff is returned to a query.

Key Path	Sweep/Control, Gate
Remote Command	[:SENSe]:SWEep:EGATe:HOLDoff <time> [:SENSe]:SWEep:EGATe:HOLDoff? [:SENSe]:SWEep:EGATe:HOLDoff:AUTO OFF ON 0 1 [:SENSe]:SWEep:EGATe:HOLDoff:AUTO?
Example	SWE:EGAT:HOLD 0.0002 SWE:EGAT:HOLD? SWE:EGAT:HOLD:AUTO ON SWE:EGAT:HOLD:AUTO?
Couplings	When Gate Holdoff is Auto , the Gate Holdoff key shows the value calculated by the analyzer for the wait time. Pressing the Gate Holdoff key while it is in Auto and not selected, causes the key to become selected and allows the user to adjust the value. If the value is adjusted, the setting changes to Man . Pressing the Gate Holdoff key, while it is in Auto and selected, does not change the value of Gate Holdoff , but causes the setting to change to Man . Now the user can adjust the value. Pressing the key while it is in Man and selected, cause the value to change back to Auto . Pressing the key while it is in Man and not selected, causes the key to become selected and allows the user to adjust the value. When Method is set to Video or FFT , the Gate Holdoff function has no effect.
Preset	Auto Auto/On
State Saved	Saved in instrument state
Min	1 µsec
Max	1 sec
Initial S/W Revision	Prior to A.02.00

Gate Delay Compensation

This function allows you to select an RBW-dependent value by which to adjust the gate delay, to compensate for changes in the delay caused by RBW effects.

You can select between uncompensated operation and two types of compensation, **Delay Until RBW Settled** and **Compensate for RBW Group Delay**.

See "[More Information](#)" on page 1292

Key Path	Sweep/Control, Gate
Scope	Meas Global
Remote Command	[:SENSe]:SWEep:EGATe:DELay:COMPensation:TYPE OFF SETTled GDELay [:SENSe]:SWEep:EGATe:DELay:COMPensation:TYPE?
Example	SWE:EGAT:DEL:COMP:TYPE SETT SWE:EGAT:DEL:COMP:TYPE?

Notes	<p>Although this function is Meas Global, there are some measurements that do not support this function. In those measurements the operation will be Uncompensated. Going into one of those measurements will not change the Meas Global selection; it will simply display the grayed-out menu key with “Uncompensated” showing as the selection. This is a non-forceful grayout, so the SCPI command is still accepted.</p> <p>If Gate Delay Compensation is not supported at all within a particular mode, the key is not displayed, and if the SCPI command is sent while in a measurement within that mode, an “Undefined Header” message is generated.</p> <p>Measurements that do not support this function include: Swept SA</p>
Preset	<p>TD-SCDMA mode: Compensate for RBW Group Delay All other modes: Delay Until RBW Settled</p>
State Saved	Saved in instrument state
Range	Uncompensated Delay Until RBW Settled Compensate for RBW Group Delay
Readback text	Uncompensated Settled Group Delay
Initial S/W Revision	Prior to A.02.00
Modified at S/W Revision	A.11.0

More Information

Selecting **Uncompensated** means that the actual gate delay is as you sets it.

Selecting **Delay Until RBW Settled** causes the gate delay to be increased above the user setting by an amount equal to $3.06/\text{RBW}$. This compensated delay causes the GATE START and GATE STOP lines on the display to move by the compensation amount, and the actual hardware gate delay to be increased by the same amount. All the other gate lines (for example, MIN FAST) are unaffected. If the RBW subsequently changes, the compensation is readjusted for the new RBW. The value shown on the **Gate Delay** key does NOT change.

Delay Until RBW Settled allows excellent measurements of gated signals, by allowing the IF to settle following any transient that affects the burst. Excellent measurements also require that the analysis region not extend into the region affected by the falling edge of the burst. Thus, excellent measurements can only be made over a width that declines with narrowing RBWs, which is achieved by decreasing the gate length below the user setting by an amount equal to $2.53/\text{RBW}$. Therefore, for general purpose compensation, you will still want to change the gate length with changes in RBW even if the gate delay is compensated. The compensated Gate Length is limited by the analyzer so that it will never go below 10% of the value shown on the Gate Length key, as otherwise the sweep times could get very long. Anytime the **Gate Length and RBW** values combine in such a way that this limiting takes place, a warning is displayed . For measurements which contain multiple sweeps with different RBW like SEM and SPUR, the smallest RBW is used for this limiting.

Selecting **Compensate for RBW Group Delay** causes the gate delay to be increased above the user setting by an amount equal to $1.81/\text{RBW}$. This compensated delay

causes the GATE START, GATE STOP lines on the display to move by the compensation amount, and the actual hardware gate delay to be increased by the same amount. All the other gate lines (for example, MIN FAST) are unaffected. If the RBW subsequently changes, the compensation is readjusted for the new RBW. The value shown on the **Gate Delay** key does NOT change. **Compensate for RBW Group Delay** also includes gate length compensation; the gate length itself is adjusted as necessary to attempt to compensate for delay effects imposed by the RBW.

Compensate for RBW Group Delay is similar to **Delay Until RBW Settled**, but compensates for the group delay of the RBW filter, rather than the filter settling time. As the RBW gets narrow, this can allow the settling tail of the RBW to affect the beginning part of the gated measurement, and allow the beginning of the RBW settling transient to affect the end of the gated measurement. These two effects are symmetric because the RBW response is symmetric. Because the gate length is not automatically compensated, some users might find this compensation to be more intuitive than compensation for RBW settling.

Min Fast Position Query (Remote Command Only)

This command queries the position of the MIN FAST line, relative to the delay reference (REF) line. See section ["Gate View On/Off" on page 2806](#). If this query is sent while not in gate view, the MinFast calculation is performed based on the current values of the appropriate parameters and the result is returned. Knowing this value lets you set an optimal gate delay value for the current measurement setup.

Remote Command	<code>[:SENSe] :SWEep:EGATe:MINFast?</code>
Example	<code>SWE:EGAT:MIN?</code>
Initial S/W Revision	Prior to A.02.00

Gate Preset (Remote Command Only)

Presets the time-gated spectrum analysis capability.

This command sets gate parameter values to the ESA preset values, as follows:

Gate trigger type = edge

Gate polarity = positive

Gate delay = 1 us

Gate length = 1 us

Remote Command	<code>[:SENSe];SWEep:TIME:GATE:PRESet ESA Compatibility</code>
Initial S/W Revision	Prior to A.02.00

Gate Level (Remote Command Only)

Sets the gate input transition point level for the external TRIGGER inputs on the front and rear panel. This is a legacy command for PSA compatibility. It is simply an alias to the equivalent trigger level command.

Remote Command	<code>[:SENSe]:SWEep:EGATe:EXTernal[1] 2:LEVe1 <voltage></code> <code>[:SENSe]:SWEep:EGATe:EXTernal[1] 2:LEVe1?</code>
Notes	This command is simply an alias to <code>:TRIGger[:SEQuence]:EXTernal[1]2:LEVe1</code>
Initial S/W Revision	Prior to A.02.00

Gate Polarity (Remote Command Only)

Sets the polarity for the gate signal. This setup is now done using the gate trigger's slope setting.

When Positive (Pos) is selected, a positive-going edge (Edge) or a high voltage (Level) will satisfy the gate condition, after the delay set with the Gate Delay key. When Negative (Neg) is selected, a negative-going edge (Edge) or a low voltage (Level) will satisfy the gate condition after the delay.

Remote Command	<code>[:SENSe]:SWEep:EGATe:POLarity NEGative POSitive</code> <code>[:SENSe]:SWEep:EGATe:POLarity?</code>
Example	<code>SWE:EGAT:POL NEG</code> <code>SWE:EGAT:POL?</code>
Preset	POSitive
State Saved	Saved in instrument state
Backwards Compatibility SCPI	<code>[:SENSe]:SWEep:TIME:GATE:POLarity</code> ESA compatibility
Initial S/W Revision	Prior to A.02.00

Remote Command	<code>[:SENSe]:SWEep:TIME:GATE:LEVe1 HIGH LOW</code> <code>[:SENSe]:SWEep:TIME:GATE:LEVe1?</code> ESA compatibility
Preset	HIGH
Initial S/W Revision	Prior to A.02.00

Gate

Accesses a menu that enables you to control the gating function. See ["Gate" on page 2804](#) section for more details.

The Gate functionality is used to view signals best viewed by qualifying them with other events.

Key Path	Sweep/Control
Initial S/W Revision	Prior to A.02.00

System

See "[System](#)" on page 431

Trace/Detector

Accesses a menu of functions that enable you to control the detectors for the current measurement.

Key Path	Front-panel key
Initial S/W Revision	Prior to A.02.00

Trace Type

Allows you to select the type of trace you want to use for the current measurement. The first page of this menu contains a 1-of-N selection of the trace type (**Clear Write, Average, Max Hold, Min Hold**) for the selected trace.

Key Path	Trace/Detector
Mode	SA, WCDMA, C2K, WIMAX OFDMA, 1xEVDO, DVB-T/H, DTMB (CTTB), ISDB-T, CMMB, LTE, LTETDD, Digital Cable TV, WLAN, MSR, LTEAFDD, LTEATDD
Remote Command	:TRACe:CHPower:TYPE WRITe AVERAge MAXHold MINHold :TRACe:CHPower:TYPE?
Example	TRAC:CHP:TYPE WRIT TRAC:CHP:TYPE?
Notes	WRITe = Clear Write AVERAge = Average MAXHold = Maximum Hold MINHold = Minimum Hold
Couplings	When Detector setting is "Auto" ([:SENSe]:CHPower:DETEctor:AUTO?), Detector ([:SENSe]:CHPower:DETEctor[:FUNCTion]?) switches aligning with the switch of this parameter: "NORMal" with WRITe (Clear Write), "AVERAge" with AVERAge, "POSitive (peak)" with MAXHold, and "NEGative (peak)" with MINHold.
Preset	AVERAge
State Saved	Saved in instrument state.
Range	ClearWrite Average MaxHold MinHold
Initial S/W Revision	Prior to A.02.00
Modified at S/W Revision	A.02.00, A.03.00

Detector

Accesses a menu of functions that enable you to control the detectors for the current measurement. The following choices are available:

- Auto– the detector selected depends on marker functions, trace functions, average type, and the trace averaging function.

- Normal—the detector determines the peak of the CW-like signals, and it yields alternating maximums and minimums of noise-like signals. This is also referred to as Rosenfell detection.
- Average—the detector determines the average of the signal within the sweep points. The averaging method depends upon the Average Type selection (voltage, power or log scales).
- Peak—the detector determines the maximum of the signal within the sweep points.
- Sample—the detector indicates the instantaneous level of the signal at the center of the sweep points represented by each display point.
- Negative Peak—the detector determines the minimum of the signal within the sweep points.

Key Path	Detector
Initial S/W Revision	Prior to A.02.00

Auto

Sets the detector for the currently selected trace to Auto.

Key Path	Trace/Detector
Mode	SA, WCDMA, C2K, WIMAX OFDMA, 1xEVDO, DVB-T/H, DTMB (CTTB), ISDB-T, CMMB, LTE, LTETDD, Digital Cable TV, WLAN, MSR, LTEAFDD, LTEATDD
Remote Command	<code>[:SENSe]:CHPower:DETEctor:AUTO ON OFF 1 0</code> <code>[:SENSe]:CHPower:DETEctor:AUTO?</code>
Example	CHP:DET:AUTO ON CHP:DET:AUTO?
Couplings	When Detector setting is "Auto" (<code>[:SENSe]:CHPower:DETEctor:AUTO?</code>), Detector (<code>[:SENSe]:CHPower:DETEctor:[FUNction]?</code>) switches aligning with the switch of this parameter: "NORMal" with Clear Write, "AVERage" with AVERage, "POSitive (peak)" with MAXHold, and "NEGative (peak)" with MINHold.
Preset	Others: ON DVB-T/H, DTMB (CTTB), ISDB-T, CMMB, Digital Cable TV: OFF
State Saved	Saved in instrument state.
Initial S/W Revision	Prior to A.02.00
Modified at S/W Revision	A.02.00, A.03.00

Detector Selection

Selects a detector to be used by the analyzer for the current measurement.

Key Path	Trace/Detector
Mode	SA, WCDMA, C2K, WIMAX OFDMA, 1xEVDO, DVB-T/H, DTMB (CTTB), ISDB-T, CMMB, LTE, LTETDD, Digital Cable TV, WLAN, MSR, LTEAFDD, LTEATDD
Remote Command	[[:SENSE]:CHPower:DETECTOR[:FUNCTION] NORMal AVERage POSitive SAMPlE NEGative [:SENSE]:CHPower:DETECTOR[:FUNCTION]?
Example	CHP:DET NORM CHP:DET?
Notes	<p>When you manually select a detector (instead of selecting Auto), that detector is used regardless of other analyzer settings.</p> <p>The Normal detector determines the peak of CW-like signals, and it yields alternating maximums and minimums of noise-like signals. This method of detection is also referred to as Rosenfell detection.</p> <p>The Average detector determines the average of the signal within the sweep points. The averaging method is Power Average (RMS).</p> <p>The Peak detector determines the maximum of the signal within the sweep points.</p> <p>The Sample detector indicates the instantaneous level of the signal at the center of the sweep points represented by each display point.</p> <p>The Negative Peak detector determines the minimum of the signal within the sweep points.</p>
Couplings	When Detector setting is "Auto" ([:SENSE]:CHPower:DETECTOR:AUTO?), Detector ([:SENSE]:CHPower:DETECTOR[:FUNCTION]?) switches aligning with the switch of this parameter: "NORMal" with Clear Write, "AVERage" with AVERage, "POSitive (peak)" with MAXHold, and "NEGative (peak)" with MINHold.
Preset	AVERage
State Saved	Saved in instrument state.
Range	Normal Average Peak Sample Negative Peak
Initial S/W Revision	Prior to A.02.00
Modified at S/W Revision	A.02.00, A.03.00

Trigger

See ["Trigger" on page 529](#)

Free Run

See ["Free Run " on page 537](#)

Video

See ["Video \(IF Envelope\) " on page 538](#)

Trigger Level

See ["Trigger Level" on page 538](#)

Trig Slope

See ["Trig Slope" on page 539](#)

Trig Delay

See ["Trig Delay" on page 540](#)

X Axis Relative to Trigger

See ["X Axis Relative to Trigger" on page 583](#)

Line

See ["Line" on page 2814](#)

Trig Slope

See ["Trig Slope" on page 2814](#)

Trig Delay

See ["Trig Delay" on page 543](#)

X Axis Relative to Trigger

See ["X Axis Relative to Trigger" on page 583](#)

External 1

See ["External 1" on page 2828](#)

Trigger Level

See ["Trigger Level" on page 2828](#)

Trig Slope

See ["Trig Slope" on page 2829](#)

Trig Delay

See ["Trig Delay" on page 546](#)

X Axis Relative to Trigger

See ["X Axis Relative to Trigger" on page 583](#)

Zero Span Delay Comp

See ["Zero Span Delay Comp On/Off " on page 2816](#)

External 2

See ["External 2 " on page 2829](#)

Trigger Level

See ["Trigger Level" on page 2830](#)

Trig Slope

See ["Trig Slope" on page 2831](#)

Trig Delay

See ["Trig Delay " on page 549](#)

X Axis Relative to Trigger

See ["X Axis Relative to Trigger" on page 583](#)

Zero Span Delay Comp

See ["Zero Span Delay Comp On/Off" on page 2818](#)

RF Burst

See ["RF Burst" on page 2831](#)

Absolute Trigger

See ["Absolute Trigger Level" on page 2832](#)

Relative Trigger

See ["Relative Trigger Level" on page 2833](#)

Trig Slope

See ["Trigger Slope" on page 2834](#)

Trig Delay

See ["Trig Delay" on page 554](#)

X Axis Relative to Trigger

See ["X Axis Relative to Trigger" on page 583](#)

Zero Span Delay Comp

See ["Zero Span Delay Comp On/Off" on page 2834](#)

Periodic Timer

See ["Periodic Timer \(Frame Trigger\)" on page 2823](#)

Period

See ["Period" on page 2824](#)

Offset

See ["Offset" on page 2825](#)

Offset Adjust (Remote Command Only)

See ["Offset Adjust \(Remote Command Only\)" on page 2826](#)

Reset Offset Display

See ["Reset Offset Display" on page 2827](#)

Sync Source

See ["Sync Source" on page 2827](#)

Off

See ["Off" on page 2828](#)

External 1

See ["External 1" on page 2828](#)

Trigger Level

See ["Trigger Level" on page 2828](#)

Trig Slope

See ["Trig Slope" on page 2829](#)

External 2

See ["External 2 " on page 2829](#)

Trigger Level

See ["Trigger Level" on page 2830](#)

Trig Slope

See ["Trig Slope" on page 2831](#)

RF Burst

See ["RF Burst" on page 2831](#)

Absolute Trigger

See ["Absolute Trigger Level" on page 2832](#)

Relative Trigger

See ["Relative Trigger Level" on page 2833](#)

Trig Slope

See ["Trigger Slope" on page 2834](#)

Zero Span Delay Comp

See ["Zero Span Delay Comp On/Off" on page 2834](#)

Trig Delay

See ["Trig Delay" on page 568](#)

X Axis Relative to Trigger

See ["X Axis Relative to Trigger" on page 583](#)

Sync Holdoff

See ["Sync Holdoff" on page 1289](#)

Baseband I/Q

See ["Baseband I/Q " on page 570](#)

I/Q Mag

See ["I/Q Mag" on page 570](#)

Trigger Level

See ["Trigger Level" on page 570](#)

Trig Slope

See ["Trig Slope" on page 571](#)

Trig Delay

See ["Trig Delay" on page 571](#)

X Axis Relative to Trigger

See ["X Axis Relative to Trigger" on page 583](#)

I (Demodulated)

See ["I \(Demodulated\)" on page 572](#)

Trigger Level

See ["Trigger Level" on page 573](#)

Trig Slope

See ["Trig Slope" on page 573](#)

Trig Delay

See ["Trig Delay" on page 573](#)

X Axis Relative to Trigger

See ["X Axis Relative to Trigger" on page 583](#)

Q (Demodulated)

See ["Q \(Demodulated\)" on page 575](#)

Trigger Level

See ["Trigger Level" on page 575](#)

Trig Slope

See ["Trig Slope" on page 575](#)

Trig Delay

See ["Trig Delay" on page 576](#)

X Axis Relative to Trigger

See ["X Axis Relative to Trigger" on page 583](#)

Input I

See ["Input I" on page 577](#)

Trigger Level

See ["Trigger Level" on page 577](#)

Trig Slope

See ["Trig Slope" on page 578](#)

Trig Delay

See ["Trig Delay" on page 578](#)

X Axis Relative to Trigger

See ["X Axis Relative to Trigger" on page 583](#)

Input Q

See ["Input Q" on page 579](#)

Trigger Level

See ["Trigger Level" on page 579](#)

Trig Slope

See ["Trig Slope" on page 580](#)

Trig Delay

See ["Trig Delay" on page 580](#)

X Axis Relative to Trigger

See ["X Axis Relative to Trigger" on page 583](#)

Auxiliary Channel I/Q Mag

See ["Auxiliary Channel I/Q Mag" on page 581](#)

Trigger Level

See ["Trigger Level" on page 582](#)

Trig Slope

See ["Trig Slope" on page 582](#)

Trig Delay

See ["Trig Delay" on page 582](#)

X Axis Relative to Trigger

See ["X Axis Relative to Trigger" on page 583](#)

Trigger Center Frequency

See ["Trigger Center Frequency" on page 583](#)

Trigger Bandwidth

See ["Trigger Bandwidth" on page 584](#)

TV

See ["TV" on page 2835](#)

TV Line

See ["TV Line" on page 2836](#)

Field

See ["Field" on page 2836](#)

Entire Frame

See ["Entire Frame" on page 2837](#)

Field One

See ["Field One" on page 2837](#)

Field Two

See ["Field Two" on page 2837](#)

Standard

See ["Standard" on page 2838](#)

NTSC-M

See ["NTSC-M" on page 2838](#)

NTSC-Japan

See ["NTSC-Japan" on page 2839](#)

NTSC-4.43

See ["NTSC-4.43" on page 2839](#)

PAL-M

See ["PAL-M" on page 2839](#)

PAL-N

See ["PAL-N" on page 2839](#)

PAL-N Combin

See ["PAL-N-Combin" on page 2839](#)

PAL-B,D,G,H,I

See ["PAL-B,D,G,H,I" on page 2839](#)

PAL-60

See ["PAL-60" on page 2840](#)

SECAM-L

See ["SECAM-L" on page 2840](#)

Auto/Holdoff

See ["Auto/Holdoff" on page 590](#)

Auto Trig

See ["Auto Trig" on page 590](#)

Trig Holdoff

See ["Trig Holdoff" on page 591](#)

Holdoff Type

See ["Holdoff Type" on page 591](#)

User Preset

Accesses a menu that gives you the following three choices:

- **User Preset** – recalls a state previously saved using the Save User Preset function.
- **User Preset All Modes** – presets all of the modes in the analyzer
- **Save User Preset**– saves the current state for the current mode

Key Path	Front-panel key
Backwards Compatibility Notes	<p>User Preset is actually loading a state, and in legacy analyzers, it was possible to load a state without affecting the trace data, limit lines or correction data. Similarly it was possible to do a User Preset without affecting the trace data, limit lines or correction data.</p> <p>In the X-Series, “state” always includes all of this data; so whenever state is loaded, or User Preset is executed, all of the traces, limit lines and corrections are affected. Although this differs from previous behavior, it is desirable behavior, and should not cause adverse issues for users.</p> <p>On ESA and PSA, User Preset affected the entire instrument’s state. In the X-Series, User Preset only recalls the state for the active mode. There is a User Preset file for each mode. User Preset can never cause a mode switch as it can in legacy analyzers. If you want to recall all modes to their user preset file state, you will need to do a User Preset after mode switching into each mode.</p> <p>User Preset recalls mode state which can now include data like traces; whereas on ESA and PSA, User Preset did not affect data.</p>
Initial S/W Revision	Prior to A.02.00

User Preset

User Preset sets the state of the currently active mode back to the state that was previously saved for this mode using the Save User Preset menu key or the SCPI command, **SYST:PRES:USER:SAV**. **It not only recalls the** Mode Preset settings, but it also recalls all of the mode persistent settings, and the Input/Output system setting that existed at the time Save User Preset was executed.

If a Save User Preset has not been done at any time, User Preset recalls the default user preset file for the currently active mode. The default user preset files are created if, at power-on, a mode detects there is no user preset file. There will never be a scenario when there is no user preset file to restore. For each mode, the default user preset state is the same state that would be saved if a Save User Preset is performed in each mode right after doing a Restore Mode Default and after a Restore Input/Output Defaults.

The User Preset function does the following:

- Aborts the currently running measurement.
- Sets the mode State to the values defined by Save User Preset.

- Makes the saved measurement for the currently running mode the active measurement.
- Brings up the saved menu for the power-on mode.
- Clears the input and output buffers.
- Sets the Status Byte to 0.

Key Path	User Preset
Remote Command	:SYSTem:PRESet:USER
Example	:SYST:PRES:USER
Notes	:SYST:PRES:USER:SAVE is used to save the current state as the user preset state. Clears all pending OPC bits. The Status Byte is set to 0. Pressing the User Preset front-panel key while already in the User Preset menu will cause the User Preset to get executed
Couplings	A user preset will cause the currently running measurement to be aborted and cause the saved measurement to be active. Recalling a User Preset file has the same issues that recalling a Save State file has. Some settings may need to be limited and therefore re-coupled, since the capabilities of the mode may have changes when the User Preset file was last saved.
Initial S/W Revision	Prior to A.02.00

User Preset All Modes

Recalls all of the User Preset files for each mode, switches to the power-on mode, and activates the saved measurement from the power-on mode User Preset file.

NOTE

When the instrument is secured, all of the user preset files are converted back to their default user preset files.

The User Preset function does the following:

- Aborts the currently running measurement.
- Switches the Mode to the power-on mode.
- Restores the User Preset files for each mode.
- Makes the saved measurement for the power-on mode the active measurement.
- Brings up the saved menu for the power-on mode.
- Clears the input and output buffers.
- Sets the Status Byte to 0.

Key Path	User Preset
----------	-------------

Remote Command	:SYSTem:PRESet:USER:ALL
Example	:SYST:PRES:USER:SAVE :SYST:PRES:USER:ALL
Notes	Clears all pending OPC bits. The Status Byte is set to 0. :SYST:PRES:USER:SAVE is used to save the current state as the user preset state.
Couplings	A user preset will cause the currently running measurement to be aborted, cause a mode switch to the power-on mode, and cause the saved measurement to be active in the power-on mode. Recalling a User Preset file has the same issues that recalling a Save State file has. Some settings may need to be limited and therefore re-coupled, since the capabilities of the mode may have changes when the User Preset file was last saved.
Initial S/W Revision	Prior to A.02.00

Save User Preset

Saves the currently active mode and its State. You can recall this User Preset file by pressing the User Preset menu key or sending the SYST:PRES:USER remote command. This same state is also saved by the Save State function.

Key Path	User Preset
Remote Command	:SYSTem:PRESet:USER:SAVE
Example	:SYST:PRES:USER:SAVE
Notes	:SYST:PRES:SAVE creates the same file as if the user requested a *SAV or a MMEM:STOR:STAT, except User Preset Save does not allow the user to specify the filename or the location of the file.
Initial S/W Revision	Prior to A.02.00

View/Display

Accesses a menu of functions that enable you to control the instrument display as well as turn the bar graph On and Off.

If current mode is NOT DVB-T/H, DTMB (CTTB), ISDB-T, MSR, LTE-Advanced FDD/TDD or CMMB mode, the front panel views only contain one view: Spectrum View. The results of the measurement can be displayed as a single spectrum trace view or displayed with a Bar Graph trace on the spectrum trace.

Spectrum View with Bar Graph off

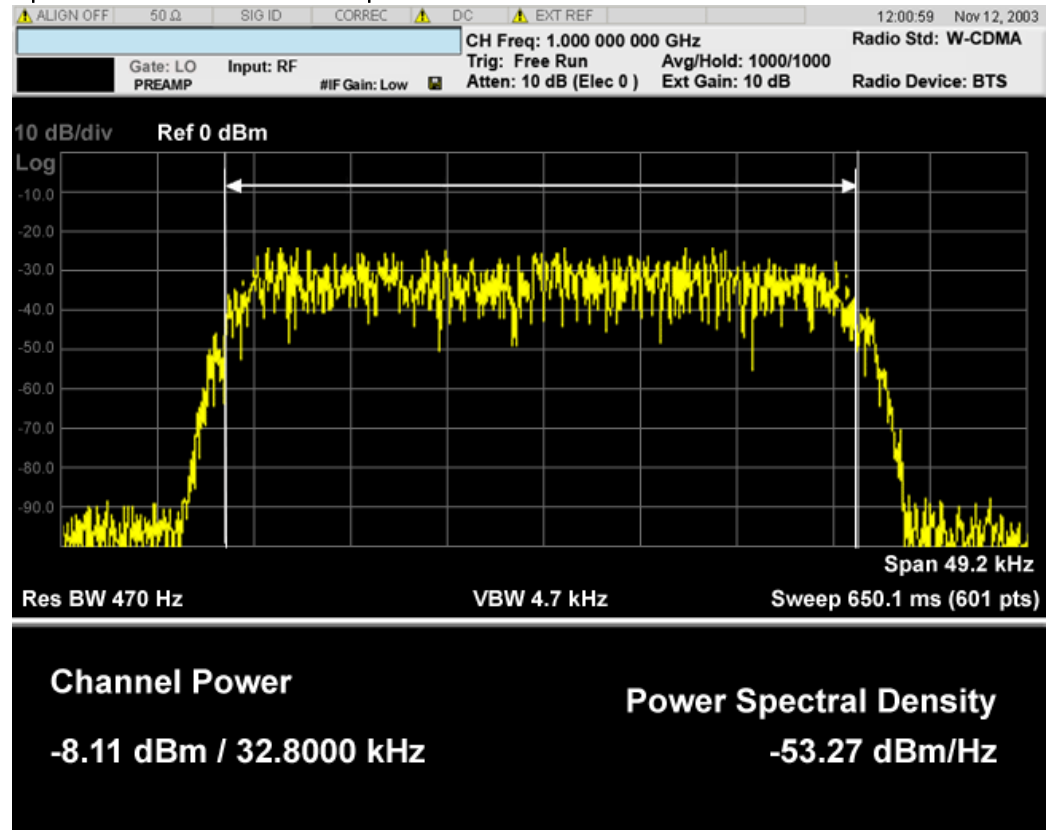

Spectrum View with Bar Graph on

This View is the same as the 'Spectrum' view, but has a blue bar between the markers that indicates the measured output power level. The bar graph is activated when the "Bar Graph" Soft Key is set to ON under the View/Display menu. The actual measured output power level is displayed on the display at the bottom of the bar.

9 Channel Power Measurement
View/Display

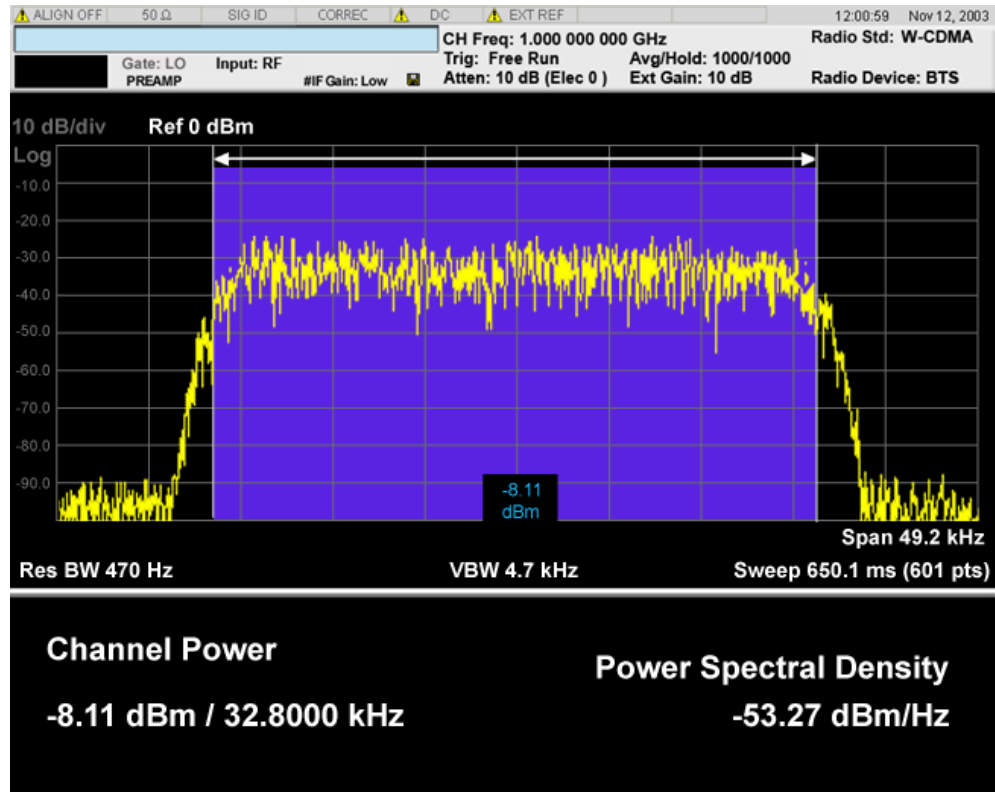

If current mode is MSR and LTE-Advanced FDD/TDD, there are two views, Power Results and Carrier Info. Power Results view is almost the same as the common CHP view.

If the current mode is WLAN and the format is WLAN 802.11ac 80+80 MHz, the spectrum view is changed a little so that the results of both carrier segments can be displayed.

Spectrum View with Bar Graph off for WLAN 802.11ac (80 + 80 MHz):

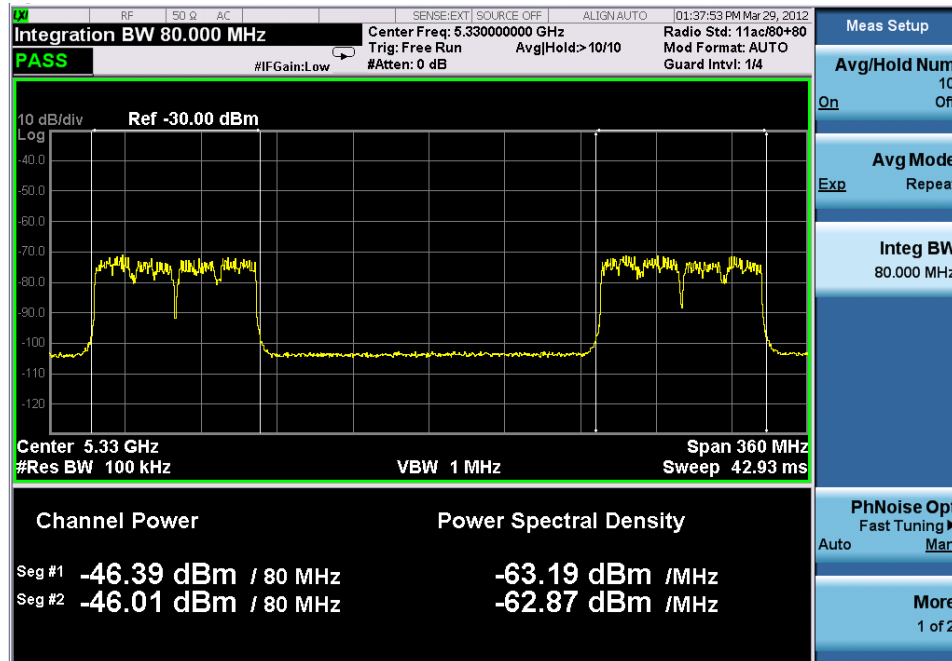

Spectrum View with Bar Graph on for WLAN 802.11ac (80 + 80 MHz):

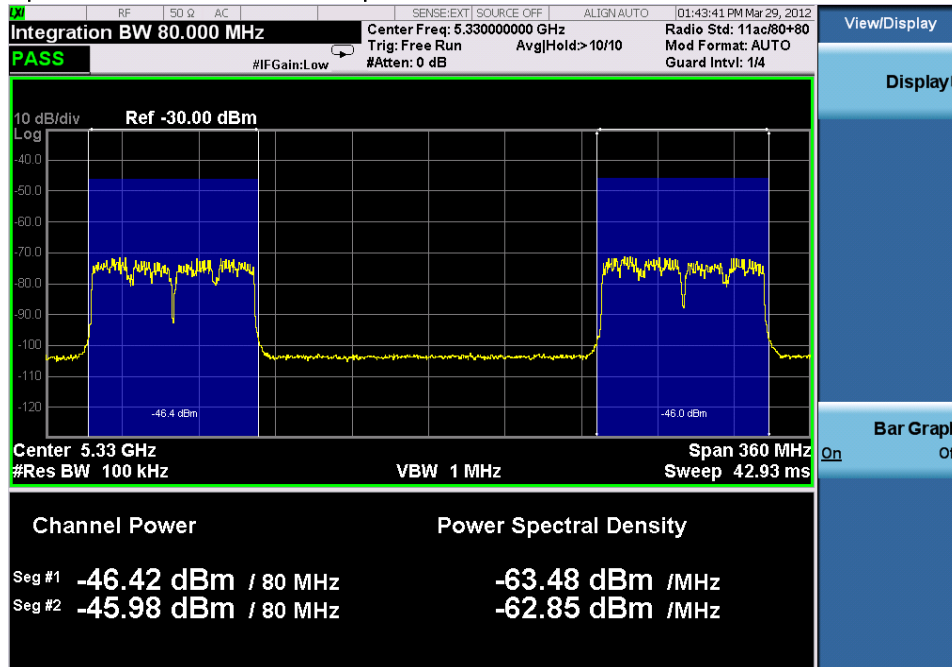

Power Results:

The spectrum trace and power bars are displayed in the upper window. Total carrier power, total PSD and total format carrier power are displayed in the lower window. Total format carrier power is total power of carriers of the same Radio Format. If there is no carrier of the corresponding format, it is not displayed. Thus items in the total format power table changes depending on the carrier configuration. Since the metrics window of MSR and LTE-Advanced FDD/TDD is a bit denser than the

common CHP, vertical positions of total power and power spectral density goes up a little bit.

Carrier Info:

The lower window of Power Results view is replaced by the carrier info table in this view. Carrier center frequency can be displayed in either offset or absolute frequency depending on Carrier Freq. The table can be scrolled by Carrier Result on Meas Setup menu or by Select Carrier on Config Carriers menu. The highlighted row changes as either Carrier Result or Select Carrier is changed. The highlighted row and these keys are not coupled.

View selection by name (MSR and LTE-Advanced FDD/TDD only)

Selects the results view. The following SCPI command allows you to select the desired measurement view by enumeration.

Key Path	No equivalent front-panel key
Mode	MSR, LTEAFDD, LTEATDD
Remote Command	:DISPlay:CHPower:VIEW[:SElect] PRESult CINformation :DISPlay:CHPower:VIEW[:SElect]?
Example	:DISP:CHP:VIEW PRES :DISP:CHP:VIEW?
Preset	PRESult
State Saved	Saved in instrument state
Range	Power Results Carrier Info
Initial S/W Revision	A.10.00

Selects the results view. The following SCPI command allows you to select the desired measurement view by enumeration.

Key Path	No equivalent front-panel key
Mode	MSR, LTEAFDD, LTEATDD
Remote Command	:DISPlay:CHPower:VIEW:NSElect <integer> :DISPlay:CHPower:VIEW:NSElect?
Example	DISP:CHP:VIEW:NSEL 1 DISP:CHP:VIEW:NSEL?
Preset	1
State Saved	Saved in instrument state
Min	1
Max	2
Initial S/W Revision	A.10.00

View selection by name (DTMB (CTTB), DVB-T/H only)

Selects the results view. The following SCPI command allows you to select the desired measurement view by enumeration.

Key Path	No equivalent front-panel key
Mode	DVB-T/H, DTMB (CTTB)
Remote Command	:DISP:CHPower:VIEW[:SElect] RFSPectrum SHOUlder MASK :DISP:CHPower:VIEW[:SElect]?
Example	DISP:CHP:VIEW RFSP DISP:CHP:VIEW?
Preset	RFSPectrum
State Saved	Saved in instrument state.
Range	RF Spectrum Shoulder Attenuation Spectrum Mask
Initial S/W Revision	A.02.00

View selection by name (ISDB-T, CMMB only)

Selects the results view. The following SCPI command allows you to select the desired measurement view by enumeration.

Key Path	No equivalent front-panel key
Mode	ISDB-T, CMMB
Remote Command	:DISP:CHPower:VIEW[:SElect] RFSPectrum SHOUlder :DISP:CHPower:VIEW[:SElect]?
Example	DISP:CHP:VIEW RFSP DISP:CHP:VIEW?
Preset	RFSPectrum
State Saved	Saved in instrument state.
Range	RF Spectrum Shoulder Attenuation
Initial S/W Revision	A.03.00

Key Path	Front-panel key
Initial S/W Revision	Prior to A.02.00

Display

The Display menu is common to most measurements, and is used for configuring items on the display. Some Display menu settings apply to all the measurements in a mode, and some only to the current measurement. Those under the **System Display Settings** key apply to all measurements in all modes.

Key Path	Display
Key Path	View/Display
Initial S/W Revision	Prior to A.02.00

Annotation

Turns on and off various parts of the display annotation. The annotation is divided up into four categories:

13. Meas Bar: This is the measurement bar at the top of the screen. It does not include the settings panel or the Active Function. Turning off the Meas Bar turns off the settings panel and the Active Function. When the Meas Bar is off, the graticule area expands to fill the area formerly occupied by the Meas Bar.
14. Screen Annotation: this is the annotation and annunciation around the graticule, including any annotation on lines (such as the display line, the threshold line, etc.) This does NOT include the marker number or the N dB result. When off, the graticule expands to fill the entire graticule area.
15. Trace annotation: these are the labels on the traces, showing their detector (or their math mode).
16. Active Function annotation: this is the active function display in the meas bar, and all of the active function values displayed on softkeys.

See the figure below. Each type of annotation can be turned on and off individually.

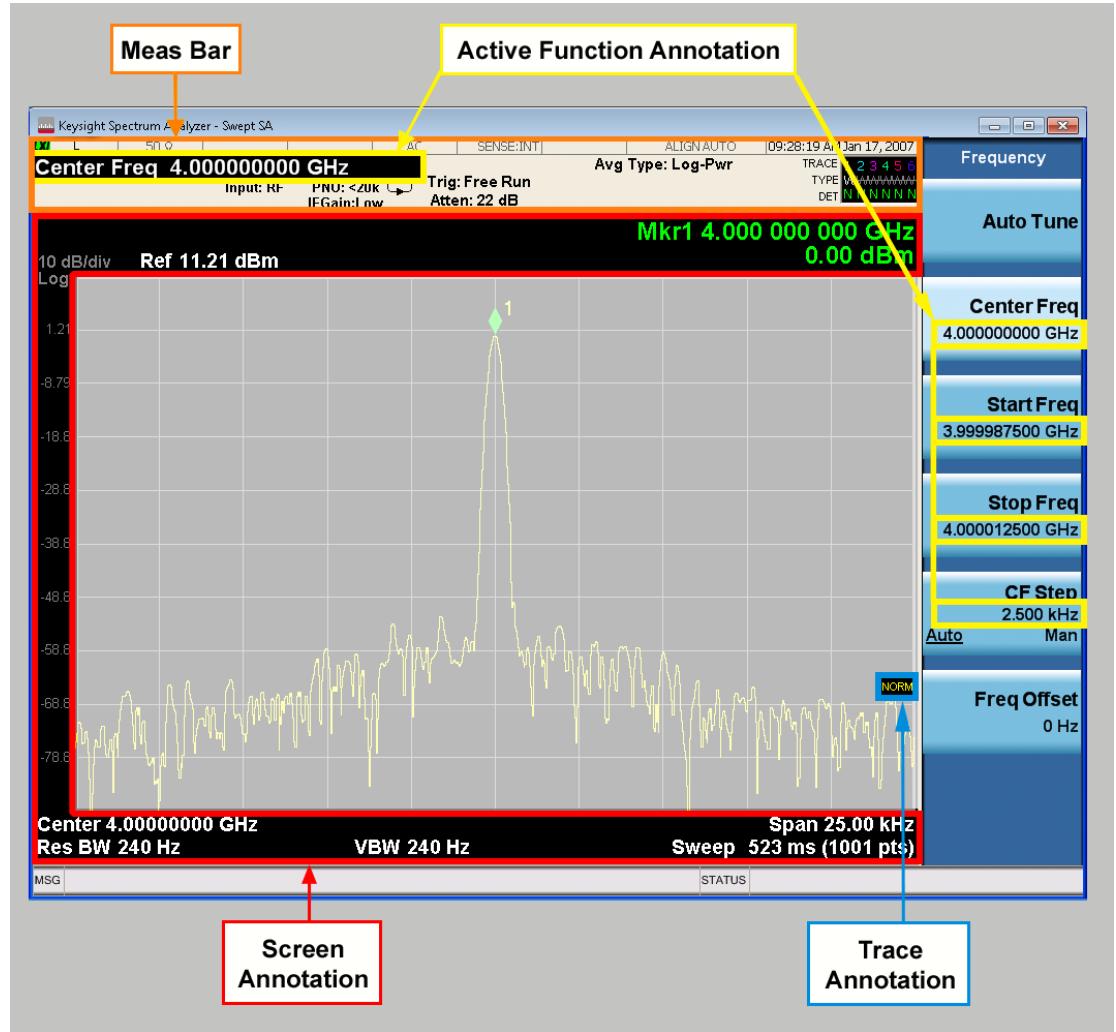

Key Path	View/Display, Display
Initial S/W Revision	Prior to A.02.00

Meas Bar On/Off

This function turns the Measurement Bar on and off, including the settings panel. When off, the graticule area expands to fill the area formerly occupied by the Measurement Bar.

Key Path	View/Display, Display, Annotation
Remote Command	:DISPlay:ANNotation:MBAR[:STATe] OFF ON 0 1 :DISPlay:ANNotation:MBAR[:STATe]?
Example	DISP:ANN:MBAR OFF
Dependencies	Grayed out and forced to OFF when System Display Settings, Annotation is set to Off.

Preset	On This should remain Off through a Preset when System DisplaySettings, Annotation is set to Off.
State Saved	Saved in instrument state.
Initial S/W Revision	Prior to A.02.00

Screen

This controls the display of the annunciation and annotation around the graticule, including any annotation on lines (such as the display line, the threshold line, etc.) and the y-axis annotation. This does NOT include marker annotation (or the N dB result). When off, the graticule expands to fill the entire graticule area, leaving only the 1.5% gap above the graticule as described in the Trace/Detector chapter.

Key Path	View/Display, Display, Annotation
Remote Command	:DISP:ANN:SCR:STATe OFF ON 0 1 :DISP:ANN:SCR:STATe?
Example	DISP:ANN:SCR OFF
Dependencies	Grayed-out and forced to OFF when System Display Settings, Annotation is set to Off.
Preset	On This should remain Off through a Preset when System DisplaySettings, Annotation is set to Off
State Saved	Saved in instrument state.
Initial S/W Revision	Prior to A.02.00

Trace

Turns on and off the labels on the traces, showing their detector (or their math mode) as described in the Trace/Detector section.

If trace math is being performed with a trace, then the trace math annotation will replace the detector annotation.

Key Path	View/Display, Display, Annotation
Remote Command	:DISP:ANN:TRACe[:STATe] ON OFF 1 0 :DISP:ANN:TRACe[:STATe]?
Example	DISP:ANN:TRAC OFF
Preset	Off
State Saved	Saved in instrument state.
Initial S/W Revision	Prior to A.02.00

Active Function Values On/Off

Turns on and off the active function display in the Meas Bar, and all of the active function values displayed on the softkeys.

Note that all of the softkeys that have active functions have these numeric values blanked when this function is on. This is a security feature..

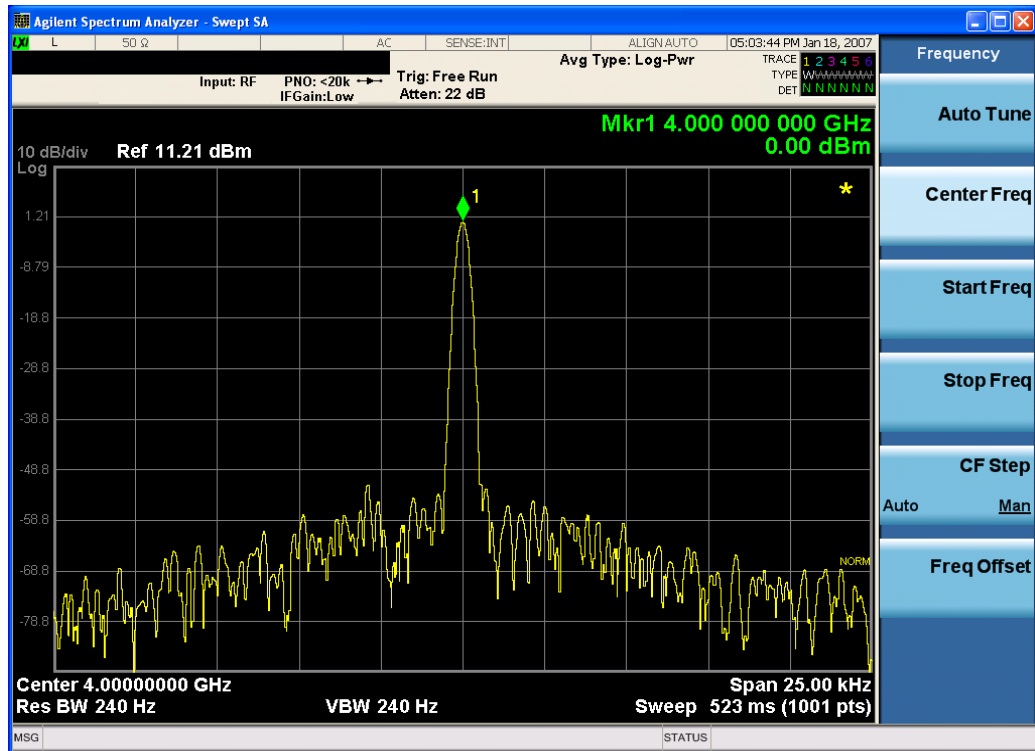

Key Path	View/Display, Display, Annotation
Remote Command	:DISPlay:ACTivefunc[:STATe] ON OFF 1 0 :DISPlay:ACTivefunc[:STATe]?
Example	DISP:ACT OFF
Dependencies	Grayed out and forced to OFF when System Display Settings, Annotation is set to Off.
Preset	On This should remain Off through a Preset when System DisplaySettings, Annotation is set to Off
State Saved	Saved in instrument state.
Initial S/W Revision	Prior to A.02.00

Title

Displays menu keys that enable you to change or clear a title on your display.

Key Path	View/Display, Display
Initial S/W Revision	Prior to A.02.00

Change Title

Writes a title into the "measurement name" field in the banner, for example, "Swept SA".

Press Change Title to enter a new title through the alpha editor. Press Enter or Return to complete the entry. Press ESC to cancel the entry and preserve your existing title.

The display title will replace the measurement name. It remains for this measurement until you press **Change Title** again, or you recall a state, or a Preset is performed. A title can also be cleared by pressing **Title, Clear Title**.

NOTE

Notice the inclusion of the <measurement> parameter in the command below. Because each measurement remembers the Display Title, the command must be qualified with the measurement name. For the Swept SA measurement this is not the case; no <measurement> parameter is used when changing the Display Title for the Swept SA measurement.

Key Path	View/Display, Display, Title
Mode	All
Remote Command	:DISPlay:<measurement>:ANNotation:TITLe:DATA <string> :DISPlay:<measurement>:ANNotation:TITLe:DATA?
Example	DISP:ANN:TITL:DATA "This Is My Title" This example is for the Swept SA measurement in the Spectrum Analyzer mode. The SANalyzer <measurement> name is not used. DISP:ACP:ANN:TITL:DATA "This Is My Title" This example is for Measurements other than Swept SA. Both set the title to: This Is My Title
Notes	Pressing this key cancels any active function. When a title is edited the previous title remains intact (it is not cleared) and the cursor goes at the end so that characters can be added or BKSP can be used to go back over previous characters.
Preset	No title (measurement name instead)
State Saved	Saved in instrument state.
Initial S/W Revision	Prior to A.02.00

Clear Title

Clears a title from the front-panel display. Once cleared, the title cannot be retrieved. After the title is cleared, the current Measurement Name replaces it in the

title bar.

Key Path	View/Display, Display, Title
Example	The following commands clear the title and restore the measurement's original title: DISP:ANN:TITL:DATA "" This example is for the Swept SA measurement in the Spectrum Analyzer mode. The SANalyzer <measurement> name is not used. DISP:ACP:ANN:TITL:DATA "" This example is for ACP; in measurements other than Swept SA the measurement name is required.
Notes	Uses the :DISPlay:<measurement>:ANNotation:TITLe:DATA <string> command with an empty string (in the Swept SA, the <measurement> is omitted).
Preset	Performed on Preset.
Initial S/W Revision	Prior to A.02.00

Graticule

Pressing Graticule turns the display graticule On or Off. It also turns the graticule y-axis annotation on and off.

Key Path	View/Display, Display
Remote Command	:DISPlay:WINDow[1]:TRACe:GRATicule:GRID[:STATe] OFF ON 0 1 :DISPlay:WINDow[1]:TRACe:GRATicule:GRID[:STATe]?
Example	DISP:WIND:TRAC:GRAT:GRID OFF
Notes	The graticule is the set of horizontal and vertical lines that make up the grid/divisions for the x-axis and y-axis.
Preset	On
State Saved	Saved in instrument state
Initial S/W Revision	Prior to A.02.00

System Display Settings

These settings are "Mode Global" – they affect all modes and measurements and are reset only by **Restore Misc Defaults** or **Restore System Defaults** under System.

Key Path	View/Display, Display
Initial S/W Revision	Prior to A.02.00

Annotation Local Settings

This is a Mode Global override of the meas local annotation settings. When it is **All Off**, it forces **ScreenAnnotation, Meas Bar, Trace, and Active Function Values** settings to be **OFF** for all measurements in all modes. This provides the security based "annotation off" function of previous analyzers; hence it uses the legacy SCPI command.

When it is **All Off**, the **Screen, Meas Bar, Trace, and Active Function Values** keys under the **Display, Annotation** menu are grayed out and forced to **Off**. When **Local Settings** is selected, you are able to set the local annotation settings on a measurement by measurement basis.

Key Path	View/Display, Display, System Display Settings
Remote Command	:DISP:WINDow[1]:ANNotation[:ALL] OFF ON 0 1 :DISP:WINDow[1]:ANNotation[:ALL]?
Example	:DISP:WIND:ANN OFF
Preset	On (Set by Restore Misc Defaults)
State Saved	Not saved in instrument state.
Backwards Compatibility Notes	The WINDow parameter and optional subopcode is included for backwards compatibility but ignored – all windows are equally affected.
Initial S/W Revision	Prior to A.02.00

Themes

Accesses a menu of functions that enable you to choose the theme to be used when saving the screen image.

The **Themes** option is the same as the **Themes** option under the **Display** and **Page Setup** dialogs. It allows you to choose between themes to be used when saving the screen image.

Key Path	Save, Screen Image
Remote Command	:MMEMory:STORe:SCReem:THEMe TDColor TDMonochrome FCOLOR FMONochrome :MMEMory:STORe:SCReem:THEMe?
Example	:MMEM:STOR:SCR:THEM TDM
Preset	3D Color; Is not part of Preset, but is reset by Restore Misc Defaults or Restore System Defaults All and survives subsequent running of the modes.
Readback	3D Color 3D Mono Flat Color Flat Mono
Backwards Compatibility Notes	In ESA and PSA we offer the choice of "Reverse Bitmap" or "Reverse Metafile" when saving screen images. This is much like the "Flat Color" theme available in X-Series. Also, if you selected Reverse Bitmap AND a black & white screen image, that would be much like "Flat Monochrome". In other words, each of the X-Series themes has a similar screen image type in ESA/PSA. But they are not identical.
Initial S/W Revision	Prior to A.02.00

3D Color

Selects a standard color theme with each object filled, shaded and colored as designed.

Key Path	Save, Screen Image, Themes
Example	MMEM:STOR:SCR:THEM TDC
Readback	3D Color
Initial S/W Revision	Prior to A.02.00

3D Monochrome

Selects a format that is like 3D color but shades of gray are used instead of colors.

Key Path	Save, Screen Image, Themes
Example	MMEM:STOR:SCR:THEM TDM
Readback	3D Mono
Initial S/W Revision	Prior to A.02.00

Flat Color

Selects a format that is best when the screen is to be printed on an ink printer.

Key Path	Save, Screen Image, Themes
Example	MMEM:STOR:SCR:THEM FCOL
Readback	Flat Color
Initial S/W Revision	Prior to A.02.00

Flat Monochrome

Selects a format that is like Flat Color. But only black is used (no colors, not even gray), and no fill.

Key Path	Save, Screen Image, Themes
Example	MMEM:STOR:SCR:THEM FMON
Readback	Flat Mono
Initial S/W Revision	Prior to A.02.00

Backlight

Accesses the display backlight on/off keys. This setting may interact with settings under the Windows "Power" menu.

When the backlight is off, pressing ESC, TAB, SPACE, ENTER, UP, DOWN, LEFT, RIGHT, DEL, BKSP, CTRL, or ALT turns the backlight on without affecting the application. Pressing any other key will turn backlight on and could potentially perform the action as well.

Key Path	View/Display, Display, System Display Settings
Remote Command	:DISPlay:BACKlight ON OFF :DISPlay:BACKlight?
Preset	ON (Set by Restore Misc Defaults)
Initial S/W Revision	Prior to A.02.00

Backlight Intensity

An active function used to set the backlight intensity. It goes from 0 to 100 where 100 is full on and 0 is off. This value is independent of the values set under the Backlight on/off key.

Key Path	View/Display, Display, System Display Settings
Remote Command	:DISPlay:BACKlight:INTensity <integer> :DISPlay:BACKlight:INTensity?
Example	DISP:BACK:INT 50
Preset	100 (Set by Restore Misc Defaults)
Min	0
Max	100
Initial S/W Revision	Prior to A.02.00

Bar Graph

Turns the Bar Graph On and Off.

Key Path	DVB-T/H, DTMB (CTTB), ISDB-T, CMMB: View/Display, RF SpectrumOthers: View/Display
Mode	SA, WCDMA, C2K, WIMAX OFDMA, 1xEVDO, DVB-T/H, DTMB (CTTB), ISDB-T, CMMB, LTE, LTETDD, Digital Cable TV, WLAN, MSR, LTEAFDD, LTEATDD
Remote Command	:DISPlay:CHPower:VIEW[1]:WINDow[1]:BGRaph ON OFF 1 0 :DISPlay:CHPower:VIEW[1]:WINDow[1]:BGRaph?
Example	DISP:CHP:VIEW:WIND:BGR ON DISP:CHP:VIEW:WIND:BGR?
Notes	You must be in the Spectrum Analysis mode, W-CDMA mode, cdma2000 mode, DVB-T/H mode, DTMB (CTTB) mode, ISDB-T mode, CMMB mode, Digital Cable TV mode, LTE mode, LTE TDD mode, WLAN mode, 1xEVDO mode, MSR, LTE-Advanced FDD/TDD mode or WIMAX OFDMA mode to use this command. Use :INSTrument:SElect to set the mode.
Preset	OFF
State Saved	Saved in instrument state.
Range	On Off
Initial S/W Revision	Prior to A.02.00

Modified at S/W	A.02.00, A.03.00
Revision	

10 Occupied Bandwidth Measurement

The Occupied Bandwidth measurement computes and displays the bandwidth occupied by a given percentage of the total mean power of a signal. For measurement results and views, see ["View/Display" on page 1567](#).

This topic contains the following sections:

["Remote Commands for Occupied Bandwidth" on page 1326](#)

["Remote Command Results for Occupied Bandwidth Measurement" on page 1327](#)

Remote Commands for Occupied Bandwidth

The following commands and queries can be used to retrieve the measurement results:

```
:CONFigure:OBWidth  
:CONFigure:OBWidth:NDEFault  
:INITiate:OBWidth  
:FETCh:OBWidth[n]?  
:MEASure:OBWidth[n]?  
:READ:OBWidth[n]?  
:FETCh:OBWidth:OBWidth?  
:MEASure:OBWidth:OBWidth?  
:READ:OBWidth:OBWidth?  
:FETCh:OBWidth:FERRor?  
:MEASure:OBWidth:FERRor?  
:READ:OBWidth:FERRor?  
:FETCh:OBWidth:XDB?  
:MEASure:OBWidth:XDB?  
:READ:OBWidth:XDB?
```

See also the section, ["Remote Measurement Functions"](#) on page 3140.

Remote Command Results for Occupied Bandwidth Measurement

The following table describes the results returned by the FETCh:OBWidth[n]?, MEASure:OBWidth[n]?, and READ:OBWidth[n]? queries listed above, according to the index value n.

n	Results Returned
n=1 (or not specified)	Returns 7 scalar results, in the following order: <ol style="list-style-type: none"> 1. Occupied bandwidth – Hz 2. Total Power or OBW Power – dBm (Power reference type can be changed with the Power Ref key in Meas Setup. Total Power will be obsolete in TD-SCDMA mode, this place will be replaced by NaN) 3. Span - Hz 4. Spectrum Trace Points - points 5. Res BW – Hz 6. Transmit Frequency Error Hz 7. x DB Bandwidth - Hz
2	Returns the frequency-domain spectrum trace (data array) for the entire frequency range being measured.
3 (Mode = MSR, LTEAFDD, LTEATDD)	<ol style="list-style-type: none"> 1. Number of active carriers Returns number of active carriers within Span in Auto detected mode, otherwise the command is out of scope.
4	Returns OBW Boundaries table results in the following order: <ol style="list-style-type: none"> 1. Occupied bandwidth – Hz 2. Total Power or OBW Power – dBm (Power reference type is changed with Power Ref key in Meas Setup. Total Power will be obsolete in TD-SCDMA mode, this place will be replaced by NaN) 3. x dB Reference Power – dBm 4. x dB Reference Power Frequency - offset frequency [Hz] 5. x dB Reference Power Frequency – absolute frequency [Hz] 6. NaN (9.91E+37) 7. NaN (9.91E+37) 8. NaN (9.91E+37) 9. Lower OBW boundary - offset frequency [Hz] 10. Lower OBW boundary - absolute frequency [Hz] 11. Lower OBW boundary - absolute power [dBm] 12. Lower OBW boundary - relative power [dBc] 13. Upper OBW boundary - offset frequency [Hz] 14. Upper OBW boundary - absolute frequency [Hz] 15. Upper OBW boundary - absolute power [dBm]

n	Results Returned
	16. Upper OBW boundary - relative power [dBc]
	17. Lower x dB BW boundary - offset frequency [Hz]
	18. Lower x dB BW boundary - absolute frequency [Hz]
	19. Lower x dB BW boundary - absolute power [dBm]
	20. NaN (9.91E+37)
	21. Upper x dB BW boundary - offset frequency [Hz]
	22. Upper x dB BW boundary - absolute frequency [Hz]
	23. Upper x dB BW boundary - absolute power [dBm]
	24. NaN (9.91E+37)
	The results 6, 7, 8, 20 and 24 always return NaN (9.91E+37)

Key Path	Meas
Initial S/W Revision	Prior to A.02.00
Modified at S/W Revision	A.16.00

AMPTD Y Scale (Amplitude/Y Scale)

Activates the Reference Value function and displays the Amplitude menu keys. These functions control how data on the vertical (Y) axis is displayed and control instrument settings that affect the vertical axis

See ["AMPTD Y Scale" on page 598](#) for more information.

Key Path	Front-panel key
Initial S/W Revision	Prior to A.02.00

Ref Value

Sets the absolute power reference value. However, since the Auto Scaling is defaulted to On, this value is automatically determined by the measurement result. When you set a value manually, Auto Scaling automatically changes to Off.

Key Path	AMPTD Y Scale
Mode	SA, WCDMA, C2K, WIMAX OFDMA, TD-SCDMA, 1xEVDO, ISDB-T, CMMB, LTE, LTETDD, BLUETOOTH, WLAN, MSR, LTEAFDD, LTEATDD
Remote Command	:DISPlay:OBWidth:VIEW[1]:WINDow[1]:TRACe:Y[:SCALE]:RLEVel <real> :DISPlay:OBWidth:VIEW[1]:WINDow[1]:TRACe:Y[:SCALE]:RLEVel?
Example	DISP:OBW:VIEW:WIND:TRAC:Y:RLEV 125 DISP:OBW:VIEW:WIND:TRAC:Y:RLEV?
Notes	You must be in the Spectrum Analysis mode, W-CDMA mode, cdma2000 mode, TD-SCDMA mode, ISDB-T mode, CMMB mode, BLUETOOTH mode, LTE mode, LTE TDD mode, WLAN mode, 1xEVDO mode, MSR, LTE-Advanced FDD/TDD or WIMAX OFDMA mode to use this command. Use:INSTrument:SElect to set the mode.
Couplings	When the Auto Scaling is On, this value is automatically determined by the measurement result. When you set a value manually, Auto Scaling automatically changes to Off.
Preset	10.00 dBm
State Saved	Saved in instrument state.
Min	-250.00 dBm
Max	250.00 dBm
Initial S/W Revision	Prior to A.02.00
Modified at S/W Revision	A.03.00

Attenuation

This menu controls the attenuator functions and interactions between the attenuation system components.

There are two attenuator configurations in the X-Series. One is a dual attenuator configuration consisting of a mechanical attenuator and an optional electronic attenuator. The other configuration uses a single attenuator with combined

mechanical and electronic sections that controls all the attenuation functions. Different models in the X-Series come with different configurations.

See "Dual Attenuator Configurations:" on page 1330

See "Single Attenuator Configuration:" on page 1331

Most Attenuation settings are the same for all measurements – they do not change as you change measurements. Settings like these are called “Meas Global” and are unaffected by Meas Preset.

Key Path	AMPTD Y Scale
Scope	Meas Global
Dependencies	In measurements that support the I/Q inputs, this key is unavailable when I/Q is the selected input, and is replaced by the Range key in that case.
Readback Line	Contains a summary in [] brackets of the current total attenuation. See the descriptions of the , " (Mech) Atten " on page 3103, and "Enable Elec Atten" on page 3105 keys for more detail on the contributors to the total attenuation. Note that when "Pre-Adjust for Min Clip" is on, this value can change at the start of every measurement.
Initial S/W Revision	Prior to A.02.00
Modified at S/W Revision	A.03.00

Dual Attenuator Configurations:

Configuration 1: Mechanical attenuator + optional electronic attenuator

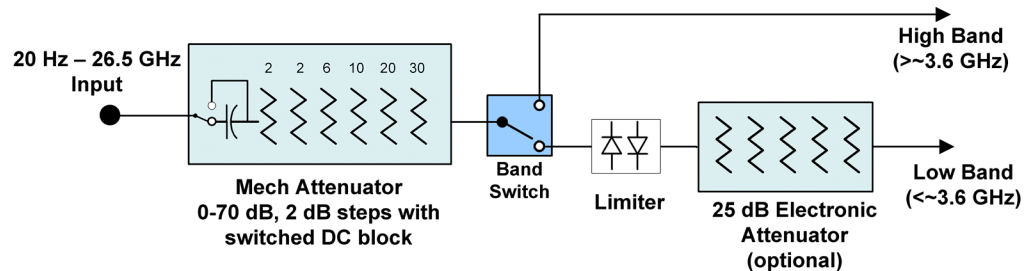

Configuration 2: Mechanical attenuator, no optional electronic attenuator

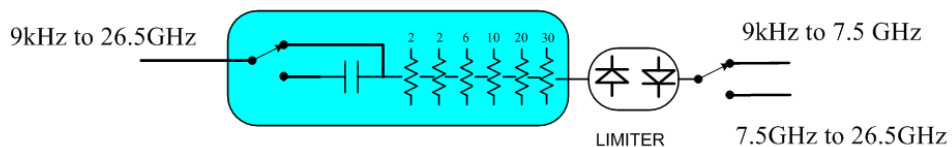

(note that Configuration 2 is not strictly speaking a dual-section attenuator, since there is no electronic section available. However, it behaves exactly like Configuration 1 without the Electronic Attenuator option EA3, therefore for the sake of this document it is grouped into the “Dual Attenuator” configuration)

Single Attenuator Configuration:

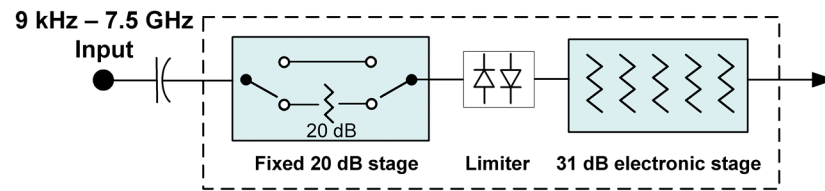

You can tell which attenuator configuration you have by pressing the Attenuation key, which (in most Modes) opens the Attenuation menu. If the first key in the Attenuation menu says **Mech Atten** you have the dual attenuator configuration. If the first key says **Atten** you have the single attenuator configuration.



In the single attenuator configuration, you control the attenuation with a single control, as the fixed stage has only two states. In the dual attenuator configuration, both stages have significant range so you are given separate control of the mechanical and electronic attenuator stages.

When you have the dual attenuator configuration, you may still have only a single attenuator, because unless option EA3 (the Electronic Attenuator option) is available, and you purchase it, you will have only the mechanical attenuator.

(Mech) Atten

This key is labeled **Mech Atten** in dual attenuator models and **Atten** in single attenuator models. In the dual attenuator configuration, this key only affects the mechanical attenuator.

This key lets you modify the attenuation applied to the RF input signal path. This value is normally auto coupled to the Ref Level, the Internal Preamp Gain, any External Gain that is entered, and the Max Mixer Level, as described in the table below.

See "[Attenuator Configurations and Auto/Man](#)" on page 1333

Key Path	AMPTD Y Scale, Attenuation
Remote Command	[:SENSe]:POWer[:RF]:ATTenuation <rel_amp1> [:SENSe]:POWer[:RF]:ATTenuation? [:SENSe]:POWer[:RF]:ATTenuation:AUTO OFF ON 0 1 [:SENSe]:POWer[:RF]:ATTenuation:AUTO?
Example	POW:ATT 20 Dual attenuator configuration: sets the mechanical attenuator to 20 dB Single attenuator mode: sets the main attenuation to 20 dB (see below for definition of "main")

	<p>attenuation).</p> <p>If the attenuator was in Auto, it sets it to Manual.</p>
Dependencies	<p>Some measurements do not support the Auto setting of (Mech) Atten. In these measurements, the Auto/Man selection is not available, and the Auto/Man line on the key disappears.</p> <p>In dual attenuator configurations, when the electronic attenuator is enabled, the mechanical attenuator has no auto setting and the Auto/Man line on the key disappears. The state of Auto/Man is remembered and restored when the electronic attenuator is once again disabled. This is described in more detail in the "Enable Elec Atten" on page 3105 key description.</p> <p>See "Attenuator Configurations and Auto/Man" on page 1333 for more information on the Auto/Man functionality of Attenuation.</p>
Couplings	<p>When (Mech) Atten is in Auto, it uses the following algorithm to determine a value:</p> <p>If the USB Preamp is connected to USB, use 0 dB.</p> <p>Otherwise, $Atten = ReferenceLevel + PreAmpGain + ExternalGain - RefLevelOffset - MaxMixerLevel + IF\ Gain$.</p> <p>Limit this value to be between 6 dB and the Max value. No value below 6 dB can ever be chosen by Auto.</p> <p>The resulting value is rounded up to the largest value possible given the attenuation step setting. That is, 50.01 dB would change to 60 dB (for a 10 dB attenuation step).</p> <p>The "IF Gain" term in the equation above is either 0 dB or +10 dB, depending on the settings of FFT IF Gain, Swept IF Gain, max Ref Level and the Auto/Man setting of Mech Atten.</p> <p>In External Mixing and BBIQ, where the Attenuator is not in the signal path, the Attenuator setting changes as described above when (Mech) Atten is in Auto, but no changes are made to the actual attenuator hardware setting until the input is changed back to the RF Input.</p>
Preset	<p>The preset for Mech Attenuation is "Auto."</p> <p>The Auto value of attenuation is:</p> <p>CXA, EXA, MXA and PXA: 10 dB</p>
State Saved	<p>Saved in instrument state</p>
Min	<p>0 dB</p> <p>The attenuation set by this key cannot be decreased below 6 dB with the knob or step keys. To get to a value below 6 dB it has to be directly entered from the keypad or via SCPI. This protects from adjusting the attenuation to a dangerously small value which can put the instrument at risk of damage to input circuitry. However, if the current mechanical attenuation is below 6 dB it can be increased with the knob and step keys, but not decreased.</p>
Max	<p>CXA N9000A-503/507: 50 dB</p> <p>CXA N9000A-513/526: 70dB</p> <p>EXA: 60 dB</p> <p>MXA and PXA: 70 dB</p> <p>In the single attenuator configuration, the total of ATT and EATT cannot exceed 50 dB, so if the EATT is set to 24 dB first, the main attenuation cannot be greater than 26 dB and will be reduced accordingly; if the main attenuator is set to 40 dB first, EATT cannot be greater than 10 dB.</p>
Initial S/W Revision	<p>Prior to A.02.00</p>
Modified at S/W Revision	<p>A.03.00</p>

Attenuator Configurations and Auto/Man

As described in the Attenuation key description, there are two distinct attenuator configurations available in the X-Series, the single attenuator and dual attenuator configurations. In dual attenuator configurations, we have the mechanical attenuation and the electronic attenuation, and the current total attenuation is the sum of the electronic + mechanical attenuation. In single attenuator configurations, we refer to the attenuation set using the **(Mech) Atten** key (or POW:ATT SCPI) as the “main” attenuation; and the attenuation that is set by the SCPI command POW:EATT as the “soft” attenuation (the POW:EATT command is honored even in the single attenuator configuration, for compatibility purposes). Then the current total attenuation is the sum of the main + soft attenuation. See the **Elec Atten** key description for more on “soft” attenuation.

In the dual attenuator configuration, when the electronic attenuator is enabled, there is no Auto/Man functionality for the mechanical attenuator, and the third line of the key label (the Auto/Man line) disappears:

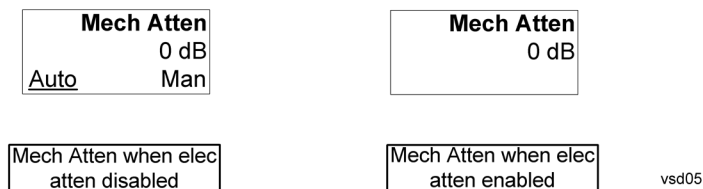

Enable Elec Atten

Enables the Electronic Attenuator.

The electronic attenuator offers finer steps than the mechanical attenuator, has no acoustical noise, is faster, and is less subject to wear. These advantages primarily aid in remote operation and are negligible for front panel use. See ["Using the Electronic Attenuator: Pros and Cons" on page 1335](#) for a detailed discussion of the pros and cons of using the electronic attenuator.

For the single attenuator configuration, for SCPI backwards compatibility, the “soft” attenuation feature replaces the dual attenuator configuration’s electronic attenuator. All the same couplings and limitations apply. See ["Attenuator Configurations and Auto/Man" on page 3105](#)

See [Error! Reference source not found.](#)

Key Path	AMPTD Y Scale, Attenuation
Remote Command	[:SENSe] :POWer [:RF] :EATTenuation:STATe OFF ON 0 1 [:SENSe] :POWer [:RF] :EATTenuation:STATe ?
Example	POW:EATT:STAT ON
Dependencies	This key only appears in Dual Attenuator models with an Electronic Attenuator installed. It does not appear in models with the Single Attenuator configuration, as in the single attenuator configuration there is no “electronic attenuator” there is only a single integrated attenuator (which has both a mechanical and electronic stage). However, in the single attenuator configuration, EATT SCPI commands are accepted for compatibility with other X-series

instruments and set a “soft” attenuation as described in "[Attenuator Configurations and Auto/Man](#)" on page 3105.

The electronic attenuator (and the “soft” attenuation function provided in single attenuator configurations) is unavailable above 3.6 GHz. Therefore, if the Stop Frequency of the analyzer is > 3.6 GHz then the **Enable Elec Atten** key will be OFF and grayed out.

If the Internal Preamp is on, meaning it is set to Low Band or Full, the electronic attenuator (and the “soft” attenuation function provided in single attenuator configurations) is unavailable. In this case the **Enable Elec Atten** key will be OFF and grayed out.

If either of the above is true, if the SCPI command is sent, an error indicating that the electronic attenuator is unavailable will be sent.

If the electronic/soft Attenuator is enabled, then the Stop Freq of the analyzer is limited to 3.6 GHz and the Internal Preamp is unavailable.

The SCPI-only “soft” electronic attenuation for the single-attenuator configuration is not available in all measurements; in particular, it is not available in the Swept SA measurement.

Couplings	Enabling and disabling the Electronic Attenuator affects the setting of the Mechanical Attenuator (in dual attenuator configurations). This is described in more detail below this table.
Preset	OFF for Swept SA measurement; ON for all other measurements that support the electronic attenuator
State Saved	Saved in instrument state
Initial S/W Revision	Prior to A.02.00
Modified at S/W Revision	A.03.00

Mechanical Attenuator Transition Rules

When the Electronic Attenuator is enabled, the Mechanical Attenuator transitions to a state that has no Auto function. Below are the rules for transitioning the Mechanical Attenuator. NOTE that the information below ONLY applies to the dual attenuator configurations, and ONLY when the Electronic Attenuator is installed:

When the Electronic Attenuation is enabled from a disabled state:

- The Mechanical Attenuator is initialized to 10 dB (this is its optimal performance setting). You can then set it as desired with SCPI, numeric keypad, step keys, or knob, and it behaves as it normally would in manual mode
- The Auto/Man state of (Mech) Atten is saved
- The Auto/Man line on the (Mech) Atten key disappears and the auto rules are disabled
- The Electronic Attenuator is set to 10 dB less than the previous value of the Mechanical Attenuator, within the limitation that it must stay within the range of 0 to 24 dB of attenuation.

Examples in the dual attenuator configuration:

- Mech Atten at 20 dB. Elec Atten enabled, Mech Atten set to 10 dB, and Elec Atten set to 10 dB. New total attenuation equals the value before Elec Atten enabled.
- Mech Atten at 0 dB. Elec Atten enabled, Mech Atten set to 10 dB, and Elec Atten set to 0 dB. New total attenuation does not equal the value before Elec Atten enabled.
- Mech Atten at 40 dB. Elec Atten enabled, Mech Atten set to 10 dB, and Elec Atten set to 24 dB. New total attenuation does not equal the value before Elec Atten enabled.

When the Electronic Attenuation is disabled from an enabled state:

- The Elec Atten key is grayed out
- The Auto/Man state of (Mech) Atten is restored
- If now in Auto, (Mech) Atten recouples
- If now in Man, (Mech) Atten is set to the value of total attenuation that existed before the Elec Atten was disabled. The resulting value is rounded up to the smallest value possible given the (Mech) Atten Step setting - (That is, 57 dB changes to 58 dB when (Mech) Atten Step is 2 dB.)

Using the Electronic Attenuator: Pros and Cons

The electronic attenuator offers finer steps than the mechanical attenuator, has no acoustical noise, is faster, and is less subject to wear.

The “finer steps” advantage of the electronic attenuator is beneficial in optimizing the alignment of the analyzer dynamic range to the signal power in the front panel as well as remote use. Thus, you can achieve improved relative signal measurement accuracy. Compared to a mechanical attenuator with 2 dB steps, the 1 dB resolution of the electronic attenuator only gives better resolution when the odd-decibel steps are used. Those odd-decibel steps are less accurately calibrated than the even-decibel steps, so one tradeoff for this superior relative accuracy is reduced absolute amplitude accuracy.

Another disadvantage of the electronic attenuator is that the spectrum analyzer loses its “Auto” setting, making operation less convenient.

Also, the relationship between the dynamic range specifications (TOI, SHI, compression and noise) and instrument performance are less well-known with the electrical attenuator. With the mechanical attenuator, TOI, SHI and compression threshold levels increase dB-for-dB with increasing attenuation, and the noise floor does as well. With the electronic attenuator, there is an excess attenuation of about 1 to 3 dB between 0 and 3.6 GHz, making the effective TOI, SHI, and so forth, less

well known. Excess attenuation is the actual attenuation relative to stated attenuation. Excess attenuation is accounted for in the analyzer calibration

Elec Atten

Controls the Electronic Attenuator in dual attenuator configurations. This key does not appear in single attenuator configurations, as the control of both the mechanical and electronic stages of the single attenuator is integrated into the single **Atten** key.

Key Path	AMPTD Y Scale, Attenuation
Remote Command	[:SENSe]:POWer[:RF]:EATTenuation <rel_amp1> [:SENSe]:POWer[:RF]:EATTenuation?
Notes	Electronic Attenuation's specification is defined only when Mechanical Attenuation is 6 dB.
Dependencies	This key only appears in Dual Attenuator models with an Electronic Attenuator installed. It does not appear in models with the Single Attenuator configuration, as in the single attenuator configuration there is no "electronic attenuator" there is only a single integrated attenuator (which has both a mechanical and electronic stage). However, in the single attenuator configuration, EATT SCPI commands are accepted for compatibility with other X-series instruments and set a "soft" attenuation as described in "Attenuator Configurations and Auto/Man" on page 3105 . The "soft" attenuation is treated as an addition to the "main" attenuation value set by the Atten softkey or the POW:ATT SCPI command and affects the total attenuation displayed on the Attenuation key and the Meas Bar. When Enable Elec Atten is off or grayed out, the Elec Atten key is grayed out.
Preset	0 dB
State Saved	Saved in instrument state
Min	0 dB
Max	Dual attenuator configuration: 24 dB Single attenuator configuration: the total of ATT and EATT cannot exceed 50 dB, so if the EATT is set to 24 dB first, the main attenuation cannot be greater than 26 dB and will be reduced accordingly; if the main attenuator is set to 40 dB first, EATT cannot be greater than 10 dB
Initial S/W Revision	Prior to A.02.00
Modified at S/W Revision	A.03.00

Adjust Atten for Min Clip

Sets the combination of mechanical and electronic attenuation and gain based on the current measured signal level so that clipping will be at a minimum.

This is an "immediate action" function, that is, it executes once, when the key is pressed.

This key does not appear in measurements that do not support this functionality. The spectrum analyzer measurement, Swept SA, does not support this functionality.

Key Path	AMPTD Y Scale, Attenuation
Remote Command	[:SENSe]:POWer[:RF]:RANGe:OPTimize IMMEDIATE

Initial S/W Revision	Prior to A.02.00
Modified at S/W Revision	A.03.00

Pre-Adjust for Min Clip

If this function is on, it does the adjustment described under "[Adjust Atten for Min Clip](#)" on page 3108 each time a measurement restarts. Therefore, in Continuous measurement mode, it only executes before the first measurement.

In dual attenuator models, you can set **Elec+Mech Atten**, in which case both attenuators participate in the autoranging, or **Elec Atten Only**, in which case the mechanical attenuator does not participate in the autoranging. This latter case results in less wear on the mechanical attenuator and is usually faster.

This key is grayed out in measurements that do not support this functionality. The spectrum analyzer measurement, Swept SA, does not support this functionality.

Key Path	AMPTD Y Scale, Attenuation
Remote Command	<code>[:SENSe] :POWer [:RF] :RANGe :OPTimize :ATTenuation OFF ELECTrical COMBined</code> <code>[:SENSe] :POWer [:RF] :RANGe :OPTimize :ATTenuation ?</code>
Notes	The SCPI parameter ELECTrical sets this function to On in single attenuator models. The SCPI parameter COMBined is mapped to ELECTrical in single attenuator models; if you send COMBined, it sets the function to On and returns ELEC to a query.
Dependencies	This key only appears in Dual Attenuator models with an Electronic Attenuator installed. In instruments with Dual Attenuator model, when Enable Elec Atten is off or grayed out, the Pre-Adjust for Min Clip key is grayed out.
Preset	OFF for Swept SA measurement; ON for all other measurements that support Pre-Adjust for Min Clip
State Saved	Saved in instrument state
Range	Dual attenuator models: Off Elec Atten Only Mech + Elec Atten Single attenuator models: Off On
Initial S/W Revision	Prior to A.02.00
Modified at S/W Revision	A.03.00

Remote Command	<code>[:SENSe] :POWer [:RF] :RANGe :AUTO ON OFF 1 0</code> <code>[:SENSe] :POWer [:RF] :RANGe :AUTO ?</code>
Notes	ON aliases to "Elec Atten Only" (:POW:RANG:OPT:ATT ELEC) OFF aliases to "Off" (:POW:RANG:OPT:ATT OFF)

	The query :POW:RANG:AUTO? returns true if :POW:RANG:OPT:ATT is not "Off"
Initial S/W Revision	Prior to A.02.00

Off

Turns **Pre-Adjust for Min Clip** off. This is the default setting.

This key is grayed out in measurements that do not support this functionality. The spectrum analyzer measurement, Swept SA, does not support this functionality.

Key Path	AMPTD Y Scale, Attenuation, Pre-Adjust for Min Clip
Example	:POW:RANGe:OPT:ATT OFF
Initial S/W Revision	Prior to A.02.00

Elec Atten Only

Selects only the electric attenuator to participate in auto ranging. This offers less wear on the mechanical attenuator and is usually faster.

This key is grayed out in measurements that do not support this functionality. The spectrum analyzer measurement, Swept SA, does not support this functionality.

Key Path	AMPTD Y Scale, Attenuation, Pre-Adjust for Min Clip
Example	:POW:RANGe:OPT:ATT ELEC
Initial S/W Revision	Prior to A.02.00

Mech + Elec Atten

In dual attenuator models, this selects both attenuators participate in the autoranging.

This key is grayed out in measurements that do not support this functionality. The spectrum analyzer measurement, Swept SA, does not support this functionality.

Key Path	AMPTD Y Scale, Attenuation, Pre-Adjust for Min Clip
Example	:POW:RANGe:OPT:ATT COMB
Initial S/W Revision	Prior to A.02.00

(Mech) Atten Step

This controls the step size used when making adjustments to the input attenuation.

This key is labeled **Mech Atten Step** in dual attenuator models and **Atten Step** in single attenuator models. In the dual attenuator configuration, this key only affects the step size of the mechanical attenuator.

Key Path	AMPTD Y Scale, Attenuation
Remote Command	[:SENSe] :POWer [:RF] :ATTenuation :STEP [:INCRe ment] 10 dB 2 dB [:SENSe] :POWer [:RF] :ATTenuation :STEP [:INCRe ment] ?

Example	POW:ATT:STEP 2
Notes	Note this feature works like a 1-N choice from the front panel, but it takes a specific value (in dB) when used remotely. The only valid values are 2 and 10.
Dependencies	Blanked in CXA and EXA if option FSA (2 dB steps) is not present. If blanked, attempts to set it via SCPI will yield an error.
Couplings	When the attenuation step size changes, the current mechanical attenuation value is adjusted (if necessary) to be quantized to the new step size. That is, if step is set to 10 dB, mech atten is increased if necessary so it is a multiple of 10 dB
Preset	PXA and MXA: 2 dB EXA and CXA: 10 dB (2 dB with option FSA)
State Saved	Saved in instrument state
Initial S/W Revision	Prior to A.02.00
Modified at S/W Revision	A.03.00

Scale/Div

Sets the logarithmic units per vertical graticule division on the display. When the Auto Scaling is On, the Scale/Div is automatically determined by the measurement result. When you set a value manually, Auto Scaling is automatically toggled to Off.

Key Path	AMPTD Y Scale
Mode	SA, WCDMA, C2K, WIMAX OFDMA, TD-SCDMA, 1xEVDO, ISDB-T, CMMB, LTE, LTETDD, BLUETOOTH, WLAN, MSR, LTEAFDD, LTEATDD
Remote Command	:DISPlay:OBWidth:VIEW[1]:WINDow[1]:TRACe:Y[:SCALE]:PDIVision <rel_aml> :DISPlay:OBWidth:VIEW[1]:WINDow[1]:TRACe:Y[:SCALE]:PDIVision?
Example	DISP:OBW:VIEW:WIND:TRAC:Y:PDIV 5 DISP:OBW:VIEW:WIND:TRAC:Y:PDIV?
Notes	You must be in the Spectrum Analysis mode, W-CDMA mode, cdma2000 mode, TD-SCDMA mode, ISDB-T mode, CMMB mode, LTE mode, LTE TDD mode, BLUETOOTH mode, WLAN mode, 1xEVDO mode, MSR, LTE-Advanced FDD/TDD or WIMAX OFDMA mode to use this command. Use :INSTrument:SElect to set the mode.
Couplings	When the Auto Scaling is On, this value is automatically determined by the measurement result. When you set a value manually, Auto Scaling automatically changes to Off.
Preset	10.00 dB
State Saved	Saved in instrument state.
Min	0.10 dB
Max	20.00 dB
Initial S/W Revision	Prior to A.02.00
Modified at S/W Revision	A.03.00

Presel Center

When this key is pressed, the centering of the preselector filter is adjusted to optimize the amplitude accuracy at the frequency of the selected marker. If the selected marker is not on when Presel Center is pressed, the analyzer will turn on the selected marker, perform a peak search, and then perform centering on the marker's center frequency. If the selected marker is already on and between the start and stop frequencies of the analyzer, the analyzer performs the preselector calibration on that marker's frequency. If the selected marker is already on, but outside the frequency range between Start Freq and Stop Freq, the analyzer will first perform a peak search, and then perform centering on the marker's center frequency.

The value displayed on the **Presel Adjust** key will change to reflect the new preselector tuning (see **Presel Adjust**).

A number of considerations should be observed to ensure proper operation. See ["Proper Preselector Operation" on page 1341](#).

Key Path	AMPTD Y Scale
Remote Command	[:SENSe] :POWer [:RF] :PCENter
Example	POW:PCEN
Notes	Note that the rules outlined above under the key description apply for the remote command as well as the key. The result of the command is dependent on marker position, and so forth. Any message shown by the key press is also shown in response to the remote command.
Dependencies	<ul style="list-style-type: none"> - Grayed out if the microwave preselector is off.) - If the selected marker's frequency is below Band 1, advisory message 0.5001 is generated and no action is taken. - Grayed out if entirely in Band 0. - Blank in models that do not include a preselector, such as option 503. If the SCPI is sent in these instruments, it is accepted without error, and the query always returns 0. - Grayed out in the Spectrogram View.
Couplings	<p>The active marker position determines where the centering will be attempted.</p> <p>If the analyzer is in a measurement such as averaging when centering is initiated, the act of centering the preselector will restart averaging but the first average trace will not be taken until the centering is completed.</p>
Status Bits/OPC dependencies	<p>When centering the preselector, *OPC will not return true until the process is complete and a subsequent measurement has completed, nor will results be returned to a READ or MEASure command.</p> <p>The Measuring bit should remain set while this command is operating and should not go false until the subsequent sweep/measurement has completed.</p>
Initial S/W Revision	Prior to A.02.00
Modified at S/W Revision	A.03.00

Proper Preselector Operation

A number of considerations should be observed to ensure proper operation:

3. If the selected marker is off, the analyzer will turn on a marker, perform a peak search, and adjust the preselector using the selected marker's frequency. It uses the "highest peak" peak search method unqualified by threshold or excursion, so that there is no chance of a 'no peak found' error. It continues with that peak, even if it is the peak of just noise. Therefore, for this operation to work properly, there should be a signal on screen in a preselected range for the peak search to find.
4. If the selected marker is already on, the analyzer will attempt the centering at that marker's frequency. There is no preselector for signals below about 3.6 GHz, therefore if the marker is on a signal below 3.6 GHz, no centering will be attempted and an advisory message generated
5. In some models, the preselector can be bypassed. If it is bypassed, no centering will be attempted in that range and a message will be generated.

Preselector Adjust

Allows you to manually adjust the preselector filter frequency to optimize its response to the signal of interest. This function is only available when "[Presel Center](#)" on page 3111 is available.

For general purpose signal analysis, using Presel Center is recommended. Centering the filter minimizes the impact of long-term preselector drift. Presel Adjust can be used instead to manually optimize the preselector. One application of manual optimization would be to peak the preselector response, which both optimizes the signal-to-noise ratio and minimizes amplitude variations due to small (short-term) preselector drifting.

Key Path	AMPTD Y Scale
Scope	Meas Global
Remote Command	[:SENSe]:POWer[:RF]:PADJust <freq> [:SENSe]:POWer[:RF]:PADJust?
Example	POW:PADJ 100KHz POW:PADJ?
Notes	The value on the key reads out to 0.1 MHz resolution.
Dependencies	<ul style="list-style-type: none"> - Grayed out if microwave preselector is off.) - Grayed out if entirely in Band 0. - Blank in models that do not include a preselector, such as option 503. If the SCPI is sent in these instruments, it is accepted without error, and the query always returns 0.

	- Grayed out in the Spectrogram View.
Preset	0 MHz
State Saved	The Presel Adjust value set by Presel Center , or by manually adjusting Presel Adjust , is not saved in instrument state, and does not survive a Preset or power cycle.
Min	-500 MHz
Max	500 MHz
Default Unit	Hz
Backwards Compatibility SCPI	<code>[:SENSe] :POWer [:RF] :MW :PADJust</code> <code>[:SENSe] :POWer [:RF] :MMW :PADJust</code> PSA had multiple preselectors, but the X-Series has only one. These commands simply alias to <code>[:SENSe] :POWer [:RF] :PADJust</code>
Initial S/W Revision	Prior to A.02.00
Modified at S/W Revision	A.03.00

Remote Command	<code>[:SENSe] :POWer [:RF] :PADJust :PRESelector MWAVE MMWave EXTERNAL</code> <code>[:SENSe] :POWer [:RF] :PADJust :PRESelector?</code>
Notes	PSA had multiple preselectors, and you could select which preselector to adjust. Since the X-Series has only one mm/uW preselector, the preselector selection softkey is no longer available. However, to provide backward compatibility, we accept the legacy remote commands. The command form has no effect, the query always returns MWAVE
Initial S/W Revision	Prior to A.02.00

Y Axis Unit

Displays the menu keys that enable you to change the vertical (Y) axis amplitude unit. The analyzer retains the entered Y Axis Unit separately for both Log and Lin amplitude scale types. For example, if Scale Type has been set to Log, and you set Y Axis Unit to dBm, pressing Scale Type (Log) sets the Y Axis Unit to dBm. If Scale Type has been set to Lin and you set Y Axis Unit to V, pressing Scale Type (Lin) sets the Y Axis Unit to V. Pressing Scale Type (Log) again sets the Y axis unit back to dBm.

NOTE

The units of current (A, dBmA, dBuA) are calculated based on 50 ohms input impedance.

All four of the EMI units (dBμA/m, dBμV/m, dBG, dBpT) are treated by the instrument exactly as though they were dBuV. The user must load an appropriate correction factor using Amplitude Corrections for accurate and meaningful results.

If a SCPI command is sent to the analyzer that uses one of the EMI units as a terminator, the analyzer treats it as though DBUV had been sent as the terminator.

Key Path	AMPTD Y Scale
Mode	SA

Scope	Meas Global
Remote Command	:UNIT:POWer DBM DBMV DBMA V W A DBUV DBUA DBPW DBUVM DBUAM DBPT DBG :UNIT:POWer?
Example	UNIT:POW dBmV UNIT:POW?
Notes	The Y axis unit has either logarithmic or linear characteristics. The set of units that is logarithmic consists of dBm, dBmV, dBmA, dBμV, dBμA, dBμV/m, dBμA/m, dBpT, and dBG. The set of units that are linear consists of V, W, and A. The chosen unit will determine how the reference level and all the amplitude-related outputs like trace data, marker data, etc. read out.
Notes	The settings of Y Axis Unit and Scale Type, affect how the data is read over the remote interface. When using the remote interface no unit is returned, so you must know what the Y axis unit is to interpret the results: Example 1, set the following: Scale Type (Log) Y Axis Unit, dBm Scale/Div, 1 dB Ref Level, 10 dBm This sets the top line to 10 dBm with each vertical division representing 1 dB. Thus, if a point on trace 1 is on the fifth graticule line from the top, it represents 5 dBm and will read out remotely as 5. Example 2, set the following: Scale Type (Lin) Y Axis Unit, Volts Ref Level, 100 mV (10 mV/div) This sets the top line to 100 mV and the bottom line to 0 V, so each vertical division represents 10 mV. Thus, if a point on trace 1 is on the fifth graticule line from the top, it represents 50 mV and will read out remotely as 50.
Dependencies	If an amplitude correction with an Antenna Unit other than None is applied and enabled, then that antenna unit is forced and the key with that unit is the only Y Axis Unit available. All other Y Axis Unit keys are grayed out. If an amplitude correction with an Antenna Unit other than None is applied and enabled, and you then turn off that correction or set Apply Corrections to No , the Y Axis Unit that existed before the Antenna Unit was applied is restored.
Couplings	The analyzer retains the entered Y Axis Unit separately for both Log and Lin amplitude scale types
Preset	dBm for log scale, V for linear. The true 'preset' value is dBm, since at preset the Y Scale type is set to logarithmic.
State Saved	Saved in instrument state
Readback line	1-of-N selection
Initial S/W Revision	Prior to A.02.00
Modified at S/W Revision	A.02.00, A.04.00, A.11.00

dBm

Sets the amplitude unit for the selected amplitude scale (log/lin) to dBm.

Key Path	AMPTD Y Scale, Y Axis Unit
Example	UNIT:POW DBM
Dependencies	Grayed out if an Amplitude Correction with an Antenna Unit is ON.
Readback	dBm
Initial S/W Revision	Prior to A.02.00
Modified at S/W Revision	A.02.00

dBmV

Sets the amplitude unit for the selected amplitude scale (log/lin) to dBmV.

Key Path	AMPTD Y Scale, Y Axis Unit
Example	UNIT:POW DBMV
Dependencies	Grayed out if an Amplitude Correction with an Antenna Unit is ON.
Readback	dBmV
Initial S/W Revision	Prior to A.02.00
Modified at S/W Revision	A.02.00

dBmA

Sets the amplitude unit for the selected amplitude scale (log/lin) to dBmA.

Key Path	AMPTD Y Scale, Y Axis Unit
Example	UNIT:POW DBMA
Dependencies	Grayed out if an Amplitude Correction with an Antenna Unit is ON.
Readback	dBmA
Initial S/W Revision	Prior to A.02.00
Modified at S/W Revision	A.02.00

W

Sets the amplitude unit for the selected amplitude scale (log/lin) to watt.

Key Path	AMPTD Y Scale, Y Axis Unit
Example	UNIT:POW W
Dependencies	Grayed out if an Amplitude Correction with an Antenna Unit is ON.
Readback	W
Initial S/W Revision	Prior to A.02.00

Modified at S/W Revision	A.02.00
--------------------------	---------

V

Sets the amplitude unit for the selected amplitude scale (log/lin) to volt.

Key Path	AMPTD Y Scale, Y Axis Unit
Example	UNIT:POW V
Dependencies	Grayed out if an Amplitude Correction with an Antenna Unit is ON.
Readback	V
Initial S/W Revision	Prior to A.02.00
Modified at S/W Revision	A.02.00

A

Sets the amplitude unit for the selected amplitude scale (log/lin) to Ampere.

Key Path	AMPTD Y Scale, Y Axis Unit
Example	UNIT:POW A
Dependencies	Grayed out if an Amplitude Correction with an Antenna Unit is ON.
Readback	A
Initial S/W Revision	Prior to A.02.00
Modified at S/W Revision	A.02.00

dB μ V

Sets the amplitude unit for the selected amplitude scale (log/lin) to dB μ V.

Key Path	AMPTD Y Scale, Y Axis Unit
Example	UNIT:POW DBUV
Dependencies	Grayed out if an Amplitude Correction with an Antenna Unit is ON.
Readback	dB μ V
Initial S/W Revision	Prior to A.02.00
Modified at S/W Revision	A.02.00

dB μ A

Sets the amplitude unit for the selected amplitude scale (log/lin) to dB μ A.

NOTE

The unit dBuA can also appear as an Antenna Unit. This will be used by customers using current probes, because current probes are often supplied with conversion tables that provide the transducer factors. When dBuA is used as an Antenna Unit the normal conversion from power to amps for dBuA (based on the analyzer input impedance) is not done, but instead the conversion is based solely on the Correction that contains the transducer factors. This is what distinguishes dBuA as a normal unit from dBuA as an antenna unit. When querying the Y-Axis unit, you can query the Antenna Unit to distinguish between regular dBuA and the dBuA antenna unit. If :CORR:CSET:ANT? returns NOC (for No Conversion), you are using a normal Y Axis dBuA. If it returns UA you are using an Antenna Unit dBuA.

Key Path	AMPTD Y Scale, Y Axis Unit
Example	UNIT:POW DBUA
Dependencies	Grayed out if an Amplitude Correction with an Antenna Unit is ON.
Readback	dB μ A
Initial S/W Revision	Prior to A.02.00
Modified at S/W Revision	A.02.00

Antenna Unit

When a Correction is turned on that uses an Antenna Unit, the Y Axis Unit changes to that Antenna Unit. All of the keys in the Y-Axis Unit menu are then greyed out, except the Antenna Unit key. The unit being used is shown on this key and is shown as selected in the submenu.

Key Path	AMPTD Y Scale, Y Axis Unit
Dependencies	Grayed out if no Amplitude Correction with an Antenna Unit is on.
Readback line	Currently selected unit
Initial S/W Revision	A.11.00

dB μ V/m

Sets the amplitude unit for the selected amplitude scale (log/lin) to dB μ V/m. This is an antenna unit, and this key is grayed out unless a Correction with this Antenna Unit selected is ON. If this is the case, all of the other Antenna Units are grayed out.

Key Path	AMPTD Y Scale, Y Axis Unit, Antenna Unit
Example	UNIT:POW DBUVM
Dependencies	Grayed out if no Amplitude Correction with an Antenna Unit is on.
Readback	dB μ V/m
Initial S/W Revision	A.02.00

dB μ A/m

Sets the amplitude unit for the selected amplitude scale (log/lin) to dB μ A/m. This is an antenna unit, and this key is grayed out unless a Correction with this Antenna Unit

selected is ON. If this is the case, all of the other Antenna Units are grayed out.

Key Path	AMPTD Y Scale, Y Axis Unit, Antenna Unit
Example	UNIT:POW DBUAM
Dependencies	Grayed out if no Amplitude Correction with an Antenna Unit is on.
Readback	dB μ A/m
Initial S/W Revision	A.02.00

dB μ A

Sets the amplitude unit for the selected amplitude scale (log/lin) to dB μ A. This is an antenna unit, and this key is grayed out unless a Correction with this Antenna Unit selected is ON. If this is the case, all of the other Antenna Units are grayed out.

Key Path	AMPTD Y Scale, Y Axis Unit, Antenna Unit
Example	UNIT:POW DBUAM
Dependencies	Grayed out if no Amplitude Correction with an Antenna Unit is on.
Readback	dB μ A
Initial S/W Revision	A.11.00

dBpT

Sets the amplitude unit for the selected amplitude scale (log/lin) to dBpT. This is an antenna unit, and this key is grayed out unless a Correction with this Antenna Unit selected is ON. If this is the case, all of the other Antenna Units are grayed out.

Key Path	AMPTD Y Scale, Y Axis Unit, Antenna Unit
Example	UNIT:POW DBPT
Dependencies	Grayed out if no Amplitude Correction with an Antenna Unit is on.
Readback	dBpT
Initial S/W Revision	A.02.00

dBG

Sets the amplitude unit for the selected amplitude scale (log/lin) to dBG. This is an antenna unit, and this key is grayed out unless a Correction with this Antenna Unit selected is ON. If this is the case, all of the other Antenna Units are grayed out.

Key Path	AMPTD Y Scale, Y Axis Unit, Antenna Unit
Example	UNIT:POW DBG
Dependencies	Grayed out if no Amplitude Correction with an Antenna Unit is on.
Readback	dBG
Initial S/W Revision	A.02.00

None

This is selected if no Antenna Unit is currently on, however you cannot actually set this value, since it is always grayed out. The key is included simply to provide an indication on the Readback line of the Antenna Unit key when there is no Antenna Unit selected.

Key Path	AMPTD Y Scale, Y Axis Unit, Antenna Unit
Readback	"None"
Initial S/W Revision	A.11.00

Reference Level Offset

Adds an offset value to the displayed reference level. The reference level is the absolute amplitude represented by the top graticule line on the display.

See ["More Information" on page 1348](#)

Key Path	AMPTD Y Scale
Mode	SA
Scope	Meas Global
Remote Command	:DISPlay:WINDow[1]:TRACe:Y[:SCALe]:RLEVe1:OFFSet <rel_amp1> :DISPlay:WINDow[1]:TRACe:Y[:SCALe]:RLEVe1:OFFSet?
Example	DISP:WIND:TRAC:Y:RLEV:OFFS 12.7 Sets the Ref Level Offset to 12.7 dB. The only valid suffix is dB. If no suffix is sent, dB will be assumed.
Preset	0 dBm
State Saved	Saved in instrument state
Min	The range for Ref Lvl Offset is variable. It is limited to values that keep the reference level within the range of -327.6 dB to 327.6 dB.
Max	327.6 dB
Backwards Compatibility Notes	6. In pre-X-Series instruments, Ref Level Offset could not be adjusted by the knob or step keys. That is no longer the case. 7. In ESA and PSA, Ref Level Offset was applied to the data as it was acquired; thus if the Offset changed the new offset was not applied until new trace data was taken. In X-Series, the offset is applied as the data is displayed/queried, so if you change the offset, it will change the data immediately.
Initial S/W Revision	Prior to A.02.00
Modified at S/W Revision	A.04.00

More Information

Offsets are used when gain or loss occurs between a device under test and the analyzer input. Thus, the signal level measured by the analyzer may be thought of as the level at the input of an external amplitude conversion device. Entering an offset

does not affect the trace position or attenuation value, just the value of the top line of the display and the values represented by the trace data. Thus, the values of exported trace data, queried trace data, marker amplitudes, trace data used in calculations such as N dB points, trace math, peak threshold, and so forth, are all affected by Ref Level Offset.

NOTE

Changing the offset causes the analyzer to immediately stop the current sweep and prepare to begin a new sweep, but the data will not change until the trace data updates, because the offset is applied to the data as it is taken. If a trace is exported with a nonzero Ref Level Offset, the exported data will contain the trace data with the offset applied.

The maximum reference level available is dependent on the reference level offset. That is, Ref Level - Ref Level Offset must be in the range -170 to +30 dBm. For example, the reference level value range can be initially set to values from -170 dBm to 30 dBm with no reference level offset. If the reference level is first set to -20 dBm, then the reference level offset can be set to values of -150 to +50 dB.

If the reference level offset is first set to -30 dB, then the reference level can be set to values of -200 dBm to 0 dBm. In this case, the reference level is “clamped” at 0 dBm because the maximum limit of +30 dBm is reached with a reference level setting of 0 dBm with an offset of -30 dB. If instead, the reference level offset is first set to 30 dB, then the reference level can be set to values of -140 to +60 dBm.

μW Path Control

The **μW Path Control** functions include the **μW Preselector Bypass** (Option MPB) and **Low Noise Path** (Option LNP) controls in the High Band path circuits.

When the μW Preselector is bypassed, the user has better flatness, but will be subject to spurs from out of band interfering signals. When the Low Noise Path is enabled, the analyzer automatically switches around certain circuitry in the high frequency bands which can contribute to noise, when it is appropriate based on other analyzer settings.

For most applications, the preset state is Standard Path, which gives the best remote-control throughput, minimizes acoustic noise from switching and minimizes the risk of wear out in the hardware switches. For applications that utilize the wideband IF paths, the preset state is the μW Preselector Bypass path, if option MPB is present. This is because, when using a wideband IF such as the 140 MHz IF, the μW Preselector’s bandwidth can be narrower than the available IF bandwidth, causing degraded amplitude flatness and phase linearity, so it is desirable to bypass the preselector in the default case.

Users may choose Low Noise Path Enable. It gives a lower noise floor, especially in the 21-26.5 GHz region, though without improving many measures of dynamic range, and without giving the best possible noise floor. The preamp, if purchased and used, gives better noise floor than does the Low Noise Path, however its compression threshold and third-order intercept are much poorer than that of the non-preamp Low Noise Path. There are some applications, typically for signals around -30 dBm, for which the third-order dynamic range of the standard path is good enough, but the noise floor is not low enough even with 0 dB input attenuation.

When the third-order dynamic range of the preamp path is too little and the noise floor of the standard path is too high, the Low Noise Path can provide the best dynamic range.

Key Path	AMPTD Y Scale
Mode	SA, BASIC, PNOISE, VSA , LTE, LTETDD
Scope	Meas Global
Remote Command	[:SENSe] :POWer [:RF] :MW:PATH STD LNPath MPBypass FULL [:SENSe] :POWer [:RF] :MW:PATH?
Example	:POW:MW:PATH LNP Enables the Low Noise path
Notes	If a Presel Center is performed, the analyzer will momentarily switch to the Standard Path, regardless of the setting of μW Path Control The DC Block will always be switched in when the low noise path is switched in, to protect succeeding circuitry from DC. Note that this does not mean “when the low noise path is enabled” but when, based on the Low Noise Path rules, the path is actually switched in. This can happen when the selection is Low Noise Path Enable . In the case where the DC Block is switched in the analyzer is now AC coupled. However, if the user has selected DC coupling, the UI will still behave as though it were DC coupled, including all annunciation, warnings, status bits, and responses to SCPI queries. This is because, based on other settings, the analyzer could switch out the low noise path at any time and hence go back to being DC coupled. Alignment switching ignores the settings in this menu, and restores them when finished.
Dependencies	Unavailable in BBIQ and External Mixing
Preset	All modes other than IQ Analyzer mode and VXA: STD IQ Analyzer, VXA and WLAN mode: MPB option present and licensed: MPB MPB option not present and licensed: STD
State Saved	Save in instrument state
Readback	Value selected in the submenu
Initial S/W Revision	A.04.00
Modified at S/W Revision	A.10.00

Standard Path

This path gives the best remote-control throughput, minimizes acoustic noise from switching and minimizes the risk of wear in the hardware switches, particularly in remote test scenarios where both low band and high band setups will follow in rapid succession.

In this path, the bypass of the low band/high band switch and microwave preamp is never activated, which can cause some noise degradation but preserves the life of the bypass switch.

Key Path	AMPTD Y Scale, μW Path Control
Example	:POW:MW:PATH STD

Readback Text	Standard Path
Initial S/W Revision	A.04.00

μW Preselector Bypass

This key toggles the preselector bypass switch for band 1 and higher. When the microwave preselector is on, the signal path is preselected. When the microwave preselector is off, the signal path is not preselected. The preselected path is the normal path for the analyzer.

The preselector is a tunable bandpass filter which prevents signals away from the frequency of interest from combining in the mixer to generate in-band spurious signals (images). The consequences of using a preselector filter are its limited bandwidth, the amplitude and phase ripple in its passband, and any amplitude and phase instability due to center frequency drift.

Option MPB or pre-selector bypass provides an unpreselected input mixer path for certain X-Series signal analyzers with frequency ranges above 3.6 GHz. This signal path allows a wider bandwidth and less amplitude variability, which is an advantage when doing modulation analysis and broadband signal analysis. The disadvantage is that, without the preselector, image signals will be displayed. Another disadvantage of bypassing the preselector is increased LO emission levels at the front panel input port.

Image responses are separated from the real signal by twice the 1st IF. For IF Paths of 10 MHz and 25 MHz, the 1st IF is 322.5 MHz, so the image response and the real signal will be separated by 645 MHz. The 1st IF will be different for other IF Path settings. When viewing a real signal and its corresponding image response in internal mixing, the image response will be to the left of the real signal.

Also, the image response and the real signal typically have the same amplitude and exhibit the same shape factor.

However, if Option FS1, Fast Sweep Capability, is enabled, the image response in the Swept SA measurement will appear lower in amplitude and have a much wider shape factor compared to the real signal.

Key Path	AMPTD Y Scale, μW Path Control
Example	:POW:MW:PATH MPB
Dependencies	Key is blanked if current mode does not support it. Key is grayed out if mode supports it but current measurement does not support it. Key is blank unless Option MPB is present and licensed. If SCPI command sent when MPB not present, error -241, "Hardware missing; Option not installed" is generated.
Readback Text	μW Preselector Bypass
Initial S/W Revision	A.04.00

Remote Command	[:SENSe] :POWer [:RF] :MW:PRESelector [:STATe] ON OFF 0 1
-----------------------	--

	<code>[:SENSe] :POWer [:RF] :MW:PRESelector [:STATe] ?</code>
Example	:POW:MW:PRES OFF Bypasses the microwave preselector
Notes	The ON parameter sets the STD path (:POW:MW:PATH STD) The OFF parameter sets path MPB (:POW:MW:PATH MPB)
Preset	ON

Internal Preamp

Accesses a menu of keys that control the internal preamps. Turning on the preamp gives a better noise figure, but a poorer TOI to noise floor dynamic range. You can optimize this setting for your particular measurement.

The instrument takes the preamp gain into account as it sweeps. If you sweep outside of the range of the preamp the instrument will also account for that. The displayed result will always reflect the correct gain.

For some measurements, when the preamp is on and any part of the displayed frequency range is below the lowest frequency for which the preamp has specifications, a warning condition message appears in the status line. For example ,for a preamp with a 9 kHz lowest specified frequency: "Preamp: Accy unspec'd below 9 kHz".

Key Path	AMPTD Y Scale
Scope	Meas Global
Remote Command	<code>[:SENSe] :POWer [:RF] :GAIN [:STATe] OFF ON 0 1</code> <code>[:SENSe] :POWer [:RF] :GAIN [:STATe] ?</code>
Dependencies	Preamp is not available on all hardware platforms. If the preamp is not present or is unlicensed, the key is not shown. The preamp is not available when the electronic/soft attenuator is enabled.
Couplings	The act of connecting the U7227A USB Preamplifier to one of the analyzer's USB ports will cause the Internal Preamp to be switched on. When this happens an informational message will be generated: "Internal Preamp turned on for optimal operation with USB Preamp." Note that if the Internal Preamp was already on, there will be no change to the setting, but if it was Off it will be switched On, to Full Range. Note that this same action occurs when the SA mode is selected while the USB Preamp is connected to one of the analyzer's USB ports, if it is the first time that the SA mode has run since powerup, or if the last time the SA mode was running the USB Preamp was NOT connected. Subsequently disconnecting the USB Preamp from USB does not change the Internal Preamp setting nor restore the previous setting.
Preset	OFF
State Saved	Saved in instrument state
Initial S/W Revision	Prior to A.02.00
Modified at S/W Revision	A.14.00

Key Path	AMPTD Y Scale, Internal Preamp
Scope	Meas Global
Remote Command	[:SENSe] :POWer [:RF] :GAIN :BAND LOW FULL [:SENSe] :POWer [:RF] :GAIN :BAND ?
Dependencies	Preamp is not available on all hardware platforms. If the preamp is not present or is unlicensed, the key is not shown. If a POW:GAIN:BAND FULL command is sent when a low band preamp is available, the preamp band parameter is to LOW instead of FULL, and an "Option not installed" message is generated.
Preset	LOW
State Saved	Saved in instrument state
Initial S/W Revision	Prior to A.02.00

Off

Turns the internal preamp off

Key Path	AMPTD Y Scale, Internal Preamp
Example	:POW:GAIN OFF
Readback	Off
Initial S/W Revision	Prior to A.02.00

Low Band

Sets the internal preamp to use only the low band.

The frequency range of the installed (optional) low-band preamp is displayed in square brackets on the **Low Band** key label.

Key Path	AMPTD Y Scale, Internal Preamp
Example	:POW:GAIN ON :POW:GAIN:BAND LOW
Readback	Low Band
Initial S/W Revision	Prior to A.02.00

Full Range

Sets the internal preamp to use its full range. The low band (0-3.6 GHz or 0-3GHz, depending on the model) is supplied by the low band preamp and the frequencies above low band are supplied by the high band preamp.

The frequency range of the installed (optional) preamp is displayed in square brackets on the **Full Range** key label. If the high band option is not installed the Full Range key does not appear.

Key Path	AMPTD Y Scale, Internal Preamp
----------	---------------------------------------

Example	:POW:GAIN ON :POW:GAIN:BAND FULL
Readback	Full Range
Initial S/W Revision	Prior to A.02.00

Ref Position

Positions the reference level at the top, center or bottom of the Y Scale display. Changing the reference position does not change the reference level value.

Key Path	AMPTD Y Scale
Mode	SA, WCDMA, C2K, WIMAX OFDMA, TD-SCDMA, 1xEVDO, ISDB-T, CMMB, LTE, LTETDD, BLUETOOTH, WLAN, MSR, LTEAFDD, LTEATDD
Remote Command	:DISPlay:OBWidth:VIEW[1]:WINDow[1]:TRACe:Y[:SCALE]:RPOsition TOP CENTER BOTTom :DISPlay:OBWidth:VIEW[1]:WINDow[1]:TRACe:Y[:SCALE]:RPOsition?
Example	DISP:OBW:VIEW:WIND:TRAC:Y:RPOS BOTT DISP:OBW:VIEW:WIND:TRAC:Y:RPOS?
Notes	You must be in the Spectrum Analysis mode, W-CDMA mode, cdma2000 mode, TD-SCDMA mode, ISDB-T mode, CMMB mode, LTE mode, LTE TDD mode, BLUETOOTH mode, WLAN mode, 1xEVDO mode, MSR, LTE-Advanced FDD/TDD or WIMAX OFDMA mode to use this command. Use:INSTrument:SElect to set the mode.
Preset	TOP
State Saved	Saved in instrument state.
Range	Top Ctr Bot
Initial S/W Revision	Prior to A.02.00
Modified at S/W Revision	A.03.00

Auto Scaling

Allows you to toggle the Auto Scaling function between On and Off.

Key Path	AMPTD Y Scale
Mode	SA, WCDMA, C2K, WIMAX OFDMA, TD-SCDMA, 1xEVDO, ISDB-T, CMMB, LTE, LTETDD, BLUETOOTH, WLAN, MSR, LTEAFDD, LTEATDD
Remote Command	:DISPlay:OBWidth:VIEW[1]:WINDow[1]:TRACe:Y[:SCALE]:COUPle 0 1 OFF ON :DISPlay:OBWidth:VIEW[1]:WINDow[1]:TRACe:Y[:SCALE]:COUPle?
Example	DISP:OBW:VIEW:WIND:TRAC:Y:COUP ON DISP:OBW:VIEW:WIND:TRAC:Y:COUP?
Couplings	When Auto Scaling is On, upon pressing the Restart front-panel key, this function automatically sets the scale per division to 10 dB and determines reference values based on the measurement results.

	When you set a value to either Scale/Div or Ref Value manually, Auto Scaling automatically changes to Off.
Preset	1
State Saved	Saved in instrument state.
Range	On Off
Initial S/W Revision	Prior to A.02.00
Modified at S/W Revision	A.03.00

Auto Couple

The Auto Couple feature provides a quick and convenient way to automatically couple multiple instrument settings. This helps ensure accurate measurements and optimum dynamic range. When the Auto Couple feature is activated, either from the front panel or remotely, all parameters of the current measurement that have an Auto/Manual mode are set to Auto mode and all measurement settings dependent on (or coupled to) the Auto/Man parameters are automatically adjusted for optimal performance.

However, the Auto Couple keyactions are confined to the current measurement only. It does not affect other measurements in the mode, and it does not affect markers, marker functions, or trace or display attributes.

See "[More Information](#)" on page 1356

Key Path	Front-panel key
Remote Command	:COUPle ALL NONE
Example	:COUP ALL
Notes	:COUPle ALL puts all Auto/Man parameters in Auto mode (equivalent to pressing the Auto Couple key). :COUPLE NONE puts all Auto/Man parameters in manual mode. It decouples all the coupled instrument parameters and is not recommended for making measurements.
Initial S/W Revision	Prior to A.02.00

More Information

There are two types of functions that have Auto/Manual modes.

Auto/Man Active Function keys

An Auto/Man toggle key controls the binary state associated with an instrument parameter by toggling between **Auto** (where the parameter is automatically coupled to the other parameters it is dependent upon) and **Man** (where the parameter is controlled independent of the other parameters), as well as making the parameter the active function. The current mode is indicated on the softkey with either **Auto** or **Man** underlined as illustrated below.

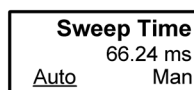

vsd07

Auto/Man 1-of-N keys

An Auto/Man 1-of-N key allows you to manually pick from a list of parameter values, or place the function in Auto, in which case the value is automatically selected (and indicated).

- If in Auto, Auto is underlined on the calling key.

- If in manual operation, manual is indicated on the calling key, but note that the calling key simply opens the menu and does **not** actually toggle the function.

BW

Accesses a menu of functions that enable you to specify and control the video and resolution bandwidths. You can also select the type of filter for the measurement.

Key Path	Front-panel key
Initial S/W Revision	Prior to A.02.00

Res BW

Sets the resolution bandwidth for the current measurement. If an unavailable bandwidth is entered with the numeric keypad, the closest available bandwidth is selected.

Key Path	BW
Mode	SA, WCDMA, C2K, WIMAX OFDMA, TD-SCDMA, 1xEVDO, ISDB-T, CMMB, LTE, LTETDD, BLUETOOTH, WLAN, MSR, LTEAFDD, LTEATDD
Remote Command	<pre>[:SENSe]:OBWidth:BAWdwidth[:RESolution] <bandwidth> [:SENSe]:OBWidth:BAWdwidth[:RESolution]? [:SENSe]:OBWidth:BAWdwidth[:RESolution]:AUTO ON OFF 1 0 [:SENSe]:OBWidth:BAWdwidth[:RESolution]:AUTO?</pre>
Example	<pre>OBW:BAND 250000 OBW:BAND? OBW:BAND:AUTO OFF OBW:BAND:AUTO?</pre>
Notes	You must be in the Spectrum Analysis mode, W-CDMA mode, cdma2000 mode, TD-SCDMA mode, ISDB-T mode, CMMB mode, LTE mode, LTE TDD mode, BLUETOOTH mode, WLAN mode, 1xEVDO mode, MSR, LTE-Advanced FDD/TDD or WIMAX OFDMA mode to use this command. Use:INSTrument:SElect to set the mode.
Couplings	<p>Sweep time is coupled to RBW. As the RBW changes, the sweep time (if set to Auto) is changed to maintain amplitude calibration.</p> <p>Video bandwidth (VBW) is coupled to RBW. As the resolution bandwidth changes, the video bandwidth (if set to Auto) changes to maintain the ratio of VBW/RBW (10:1).</p> <p>When Res BW is set to Auto, the resolution bandwidth is auto-coupled to span. The ratio of Span/RBW is approximately 106:1 when auto coupled. When Res BW is set to Man, bandwidths are entered manually, and these bandwidths are used regardless of other analyzer settings.</p>
Preset	<pre>SA: Auto WCDMA: 30 kHz CDMA2K: 12 kHz WIMAX OFDMA: 100 kHz TD-SCDMA: 30 kHz 1xEVDO: 30 kHz ISDB-T: 10 kHz CMMB: 3 kHz</pre>

	LTE: 30 kHz LTETDD: 30 kHz BLUETOOTH:10 kHz WLAN: 100kHz MSR: 30 kHz, LTEAFDD, LTEATDD: 30 kHz SA: ON WCDMA, C2K, TD-SCDMA, WIMAX OFDMA, 1xEVDO , ISDB-T, CMMB, LTE, LTETDD, WLAN, MSR, LTEAFDD, LTEATDD: OFF
State Saved	Saved in instrument state.
Min	1 Hz
Max	8 MHz
Backwards Compatibility SCPI	[:SENSe]:OBWidth:BWIDth[:RESolution]
Initial S/W Revision	Prior to A.02.00
Modified at S/W Revision	A.03.00

Video BW

Changes the analyzer post-detection filter.

Key Path	BW
Mode	SA, WCDMA, C2K, WIMAX OFDMA, TD-SCDMA, 1xEVDO, ISDB-T, CMMB, LTE, LTETDD, BLUETOOTH, WLAN, MSR, LTEAFDD, LTEATDD
Remote Command	[:SENSe]:OBWidth:BA NDwidth:VIDeo <bandwidth> [:SENSe]:OBWidth:BA NDwidth:VIDeo? [:SENSe]:OBWidth:BA NDwidth:VIDeo:AUTO ON OFF 1 0 [:SENSe]:OBWidth:BA NDwidth:VIDeo:AUTO?
Example	OBW:BA ND:VID 5 MHz OBW:BA ND:VID? OBW:BA ND:VID:AUTO ON OBW:BA ND:VID:AUTO?
Notes	You must be in the Spectrum Analysis mode, W-CDMA mode, cdma2000 mode, TD-SCDMA mode, ISDB-T mode, CMMB mode, LTE mode, LTE TDD mode, BLUETOOTH mode, WLAN mode, 1xEVDO mode, MSR, LTE-Advanced FDD/TDD or WIMAX OFDMA mode to use this command. Use:INSTrument:SElect to set the mode.
Dependencies	When using the average detector with either Sweep Time set to Man, or in zero span, the VBW setting has no effect and is disabled (grayed out).
Couplings	Video bandwidth (VBW) is coupled to RBW. As the resolution bandwidth changes, the video bandwidth (if set to Auto) changes to maintain the ratio set by VBW/RBW. Sweep Time is coupled to Video Bandwidth (VBW). As the VBW is changed, the sweep time (when

set to Auto) is changed to maintain amplitude calibration. This occurs because of common hardware between the two circuits, even though the Video BW filter is not actually “in-circuit” when the detector is set to Average. Because the purpose of the average detector and the VBW filter are the same, either can be used to reduce the variance of the result.

Although the VBW filter is not “in-circuit” when using the average detector, the Video BW key can have an effect on (Auto) sweep time, and is not disabled. In this case, reducing the VBW setting increases the sweep time, which increases the averaging time, producing a lower-variance trace.

When the video bandwidth is AUTO coupled, the video bandwidth value is set to:
 Resolution Bandwidth * Video Bandwidth to Resolution Bandwidth Ratio

Preset	SA, LTE, LTETDD, WLAN, MSR, LTEAFDD, LTEATDD: Auto WCDMA: 300 kHz CDMA2K:120 kHz WIMAX OFDMA: 1 MHz TD-SCDMA: 300 kHz 1xEVDO: 300 kHz ISDB-T: 300 Hz CMMB: 3 kHz BLUETOOTH: 30 kHz ON ISDB-T, CMMB: OFF
State Saved	Saved in instrument state.
Min	1 Hz
Max	50 MHz
Backwards Compatibility SCPI	[:SENSe] :OBWidth :BWIDth :VIDeo
Initial S/W Revision	Prior to A.02.00
Modified at S/W Revision	A.03.00

Filter Type

Allows you to select the type of filter to be used for the current measurement. Besides the Gaussian filter shape, there are certain special filter types, such as Flat Top, that are desirable under certain conditions.

Key Path	BW
Mode	SA, WCDMA, C2K, WIMAX OFDMA, TD-SCDMA, 1xEVDO, ISDB-T, CMMB, LTE, LTETDD, BLUETOOTH, WLAN, MSR, LTEAFDD, LTEATDD
Remote Command	[:SENSe] :OBWidth :BANDwidth :SHAPE GAUSSian FLATtop [:SENSe] :OBWidth :BANDwidth :SHAPE?
Example	OBW:BAND:SHAP GAUS OBW:BAND:SHAP?

Preset	GAUSSian
State Saved	Saved in instrument state.
Range	Gaussian Flattop
Backwards Compatibility SCPI	[:SENSe] :OBwidth :BWIDth :SHAPE
Initial S/W Revision	Prior to A.02.00
Modified at S/W Revision	A.03.00

Cont (Continuous Measurement/Sweep)

Sets the analyzer for Continuous measurement operation. The single/continuous state is Meas Global so the setting will affect all measurements. If you are Paused, pressing **Cont** does a Resume.

Key Path	Front-panel key
Remote Command	:INITiate:CONTinuous OFF ON 0 1 :INITiate:CONTinuous?
Example	:INIT:CONT 0 puts analyzer in Single measurement operation. :INIT:CONT 1 puts analyzer in Continuous measurement operation
Preset	ON (Note that SYST:PRESet sets INIT:CONT to ON but *RST sets INIT:CONT to OFF)
State Saved	Saved in instrument state
Backwards Compatibility Notes	For Spectrum Analysis mode in ESA and PSA, there is no Cont hardkey, instead there is a Sweep Single/Cont key. In these analyzers, switching the Sweep Single/Cont key from Single to Cont restarts averages (displayed average count reset to 1), but does not restart Max Hold and Min Hold . The X-Series has Single and Cont keys in place of the SweepSingleCont key. In the X-Series, if in single measurement, the Cont key (and INIT:CONT ON) switches to continuous measurement, but never restarts a measurement and never resets a sweep.
Initial S/W Revision	Prior to A.02.00

In Swept SA Measurement (Spectrum Analysis Mode):

The analyzer takes repetitive sweeps, averages, measurements, etc., when in Continuous mode. When the average count reaches the Average/Hold Number the count stops incrementing, but the analyzer keeps sweeping. See the Trace/Detector section for the averaging formula used both before and after the Average/Hold Number is reached. The trigger condition must be met prior to each sweep. The type of trace processing for multiple sweeps, is set under the Trace/Detector key, with choices of **Trace Average**, **Max Hold**, or **Min Hold**.

In Other Measurements/Modes:

With **Avg/Hold Num** (in the **Meas Setup** menu) set to **Off** or set to **On** with a value of 1, a sweep is taken after the trigger condition is met; and the analyzer continues to take new sweeps after the current sweep has completed and the trigger condition is again met. However, with **Avg/Hold Num** set to On with a value >1, multiple sweeps (data acquisitions) are taken for the measurement. The trigger condition must be met prior to each sweep. The sweep is not stopped when the average count k equals the number N set for Avg/Hold Num is reached, but the number k stops incrementing. A measurement average usually applies to all traces, marker results, and numeric results. But sometimes it only applies to the numeric results.

If the analyzer is in Single measurement, pressing the **Cont** key does not change k and does not cause the sweep to be reset; the only action is to put the analyzer into Continuous measurement operation.

If it is already in continuous sweep:

the INIT:CONT 1 command has no effect

the INIT:CONT 0 command will place the analyzer in Single Sweep but will have no effect on the current sequence until $k = N$, at which point the current sequence will stop and the instrument will go to the idle state.

File

See "File" on page 426

FREQ Channel

Accesses a menu of keys that allow you to control the Frequency and Channel parameters of the instrument.

Some features in the Frequency menu are the same for all measurements – they do not change as you change measurements. Settings like these are called “Meas Global” and are unaffected by Meas Preset. For example, the Center Freq setting is the same for all measurements – it does not change as you change measurements.

Key Path	Front-panel key
Initial S/W Revision	Prior to A.02.00

Center Freq

Sets the frequency that corresponds to the horizontal center of the graticule (when frequency Scale Type is set to linear). While adjusting the Center Frequency the Span is held constant, which means that both Start Frequency and Stop Frequency will change.

Pressing Center Freq also sets the frequency entry mode to Center/Span. In Center/Span mode, the center frequency and span values are displayed below the graticule, and the default active function in the Frequency menu is **Center Freq**.

The center frequency setting is the same for all measurements within a mode, that is, it is Meas Global. Some modes are also able to share a Mode Global center frequency value. If this is the case, the Mode will have a **Global Settings** key in its **Mode Setup** menu.

The **Center Freq** function sets (and queries) the Center Frequency for the currently selected input. If your analyzer has multiple inputs, and you select another input, the Center Freq changes to the value for that input. SCPI commands are available to directly set the Center Freq for a specific input.

Center Freq is remembered as you go from input to input. Thus you can set a Center Freq of 10 GHz with the RF Input selected, change to BBIQ and set a Center Freq of 20 MHz, then switch to External Mixing and set a Center Freq of 60 GHz, and when you go back to the RF Input the Center Freq will go back to 10 GHz; back to BBIQ and it is 20 MHz; back to External Mixing and it is 60 GHz.

See ["RF Center Freq" on page 1369](#)

See [Ext Mix Center Freq](#)

See ["I/Q Center Freq" on page 1370](#)

See ["Center Frequency Presets" on page 1366](#)

Key Path	FREQ Channel
Scope	Meas Global
Remote Command	[:SENSE] :FREQuency:CENTer <freq>

[:SENSe] :FREQuency :CENTer?	
Example	FREQ:CENT 50 MHz FREQ:CENT UP changes the center frequency to 150 MHz if you use FREQ:CENT:STEP 100 MHz to set the center frequency step size to 100 MHz FREQ:CENT?
Notes	This command sets either the RF or I/Q Center Frequency depending on the selected input. For RF input it is equivalent to FREQ:RF:CENT For I/Q input it is equivalent to FREQ:IQ:CENT Preset and Max values are dependent on Hardware Options (5xx) If no terminator (e.g. MHz) is sent the terminator Hz is used. If a terminator with unit other than Frequency is used, an invalid suffix error message is generated.
Dependencies	The Center Frequency can be limited by Start or Stop Freq limits, if the Span is so large that Start or Stop reach their limit.
Couplings	When operating in "swept span", any value of the Center Frequency or Span that is within the frequency range of the analyzer is allowed when the value is being set through the front panel numeric key pad or the SCPI command. The other parameter is forced to a different value if needed, to keep the Start and the Stop Frequencies within the analyzer's frequency range
Preset	Depends on instrument maximum frequency, mode, measurement, and selected input. See "Center Frequency Presets" on page 1366 and "RF Center Freq" on page 1369 and Ext Mix Center Freq and "I/Q Center Freq" on page 1370 .
State Saved	Saved in instrument state
Min	Depends on instrument maximum frequency, mode, measurement, and selected input.. See "Center Frequency Presets" on page 1366 and "RF Center Freq" on page 1369 and "I/Q Center Freq" on page 1370 .
Max	Depends on instrument maximum frequency, mode, measurement, and selected input.. See "Center Frequency Presets" on page 1366 and "RF Center Freq" on page 1369 and "I/Q Center Freq" on page 1370 .
Default Unit	Hz
Status Bits/OPC Dependencies	Non-overlapped
Initial S/W Revision	Prior to A.02.00

Center Frequency Presets

The following table provides the Center Frequency Presets for the Spectrum Analyzer mode, and the Max Freq, for the various frequency options:

Freq Option	CF after Mode Preset	Stop Freq after Mode Preset	Max Freq (can't tune above)
503 (all but N9000A)		1.805 GHz	3.6 GHz 3.7 GHz

Freq Optio n	CF after Mode Prese t	Stop Freq after Mode Prese t	Max Freq (can't tune abov e)	
503 (N9000A)		1.505 GHz	3.0 GHz	3.08 GHz
504 (M9420A)		1 GHz	3.8GHz	3.88 GHz
506 (M9420A)		1 GHz	6.0GHz	6.08 GHz
507 (all but N9000A)		3.505 GHz	7.0 GHz	7.1 GHz
507 (N9000A)		3.755 GHz	7.5 GHz	7.58 GHz
508 (all but N9038A)		1.805 GHz	3.6 GHz	8.5 GHz
508 (N9038A)		4.205 GHz	8.4 GHz	8.5 GHz
513		6.805 GHz	13.6 GHz	13.8 GHz
526 (all but N9000A and N9038A)		13.255 GHz	26.5 GHz	27.0 GHz
526 (N9000A)		13.255 GHz	26.5 GHz	26.5 5 GHz
526 (N9038A)		1.805 GHz	3.6 GHz	27.0 GHz
532	16.005 GHz		32.0 GHz	32.5 GHz
543	21.505 GHz		43.0 GHz	TBD
544	22.005 GHz		44.0 GHz	44.5 GHz
550	25.005 GHz		50.0 GHz	51 GHz

Input 2:

Model	CF after Mode Preset	Stop Freq after Mode Preset	Max Freq (can't tune above)
N9000A opt C75	0.7505GHz	1.5 GHz	1.58 GHz
N9038A	505 MHz	1 GHz	1.000025 GHz

Tracking Generator Frequency Limits (N9000A only):

Tracking Generator Option	Min Freq (clips to this freq when turn TG on and can't tune below while TG on)	If above this Freq, Stop Freq clipped to this Freq when TG turned on	Max Freq (can't tune above) while TG on
T03	9 kHz	3.0 GHz	3.08 GHz
T06	9 kHz	6.0 GHz	6.05 GHz

Tracking Generator Frequency Limits(M9290A only):

Tracking Generator Option	Min Freq (clips to this freq when turn TG on and can't tune below while TG on)	If above this Freq, Stop Freq clipped to this Freq when TG turned on	Max Freq (can't tune above) while TG on
T03	2 MHz	3.08 GHz	3.08 GHz
T07	2 MHz	7.575 GHz	7.575 GHz
T13	2 MHz	13.8 GHz	13.8 GHz
T26	2 MHz	26.55 GHz	26.55 GHz

The following table shows the Center Frequency Presets for modes other than Spectrum Analyzer:

Mode	CF Preset for RF
WCDMA	1 GHz
WIMAXOFDMA,	1 GHz
BASIC	1 GHz
ADEMOD	1 GHz
VSA	1 GHz
TDSCDMA	1 GHz
PNOISE	1 GHz

Mode	CF Preset for RF
LTE	1 GHz
LTETDD	1 GHz
MSR	1 GHz
GSM	935.2 MHz
NFIGURE	1.505 GHz

RF Center Freq

SCPI command for specifying the RF Center Frequency. This command will set the Center Frequency to be used when the RF input is selected, even if the RF input is not the input that is selected at the time the command is sent. Note that the **Center Freq** function in the **Frequency** menu on the front panel always applies to the currently selected input.

Scope	Meas Global
Remote Command	[:SENSe] :FREQuency:RF:CENTer <freq> [:SENSe] :FREQuency:RF:CENTer?
Example	FREQ:RF:CENT 30 MHz
Notes	This command is the same in all modes, but the parameter is Measurement Global. So the value is independent in each mode and common across all the measurements in the mode.
Dependencies	If the electronic/soft attenuator is enabled, any attempt to set Center Frequency such that the Stop Frequency would be >3.6 GHz fails and results in an advisory message. If the equivalent SCPI command is sent, this same message is generated as part of a “-221, Settings conflict” warning. If Source Mode is set to Tracking, and the Max or Min Center Freq is therefore limited by the limits of the source, a warning message is generated, “Data out of range;clipped to source max/min” if these limits are exceeded. Note that for an external source, these limits can be affected by the settings of Source Numerator, Source Denominator and Power Sweep.
Preset	See table above
State Saved	Saved in instrument state.
Min	-79.999995 MHz, unless Source Mode is set to Tracking, in which case it is limited by the minimum frequency of the Source
Max	See table above. Basically instrument maximum frequency - 5 Hz. Note that, if the Source Mode is set to Tracking, the effective instrument maximum frequency may be limited by the source maximum frequency. If the knob or step keys are being used, also depends on the value of the other three interdependent parameters Span, Start Frequency and Stop Frequency
Initial S/W Revision	Prior to A.02.00
Modified at S/W Revision	A.03.00

Ext Mix Center Freq

SCPI command for specifying the External Mixer Center Frequency. This command will set the Center Frequency to be used when the External Mixer is selected, even if the External Mixer input is not the input which is selected at the time the command is sent. Note that the **Center Freq** function in the **Frequency** menu on the front panel always applies to the currently selected input.

Scope	Meas Global
Remote Command	[:SENSe] :FREQuency:EMIXer:CENTer <freq> [:SENSe] :FREQuency:EMIXer:CENTer?
Example	:FREQ:EMIX:CENT 60 GHz :FREQ:EMIX:CENT?
Notes	This command is the same in all modes, but the parameter is Measurement Global. So the value is independent in each mode and common across all the measurements in the mode.
Couplings	When returning to External Mixing after having been switched to one of the other inputs (e.g., RF), you will come back into the settings that you had when you left External Mixing. So you will come back to the band you were in with the Center Frequency that you had. However, Span is not an input-dependent parameter, therefore you will bring the span over from the other input. Therefore, the analyzer comes back with the span from the previous input, limited as necessary by the current mixer setup.
Preset	When a Mode Preset is performed while in External Mixing, the Start frequency of the current Mode is set to the nominal Min Freq of the lowest harmonic range in the Harmonic Table for the current mixer setup. Similarly, the Stop frequency of the current Mode is set to the nominal Max Freq of the highest harmonic range in the Harmonic Table. The Center Freq thus presets to the point arithmetically equidistant from these two frequencies. If the current measurement has a limited Span available to it, and cannot achieve the Span shown in the table (Span=Stop Freq – Start Freq), the analyzer uses the maximum Span the measurement allows, and still sets the Center Freq to the midpoint of the Start and Stop Freq values in the Harmonic Table. When Restore Input/Output Defaults is performed, the mixer presets to the 11970A, whose Start and Stop frequencies are 26.5 and 40 GHz respectively. The center of these two frequencies is 33.25 GHz. Therefore, after a Restore Input/Output Defaults, if you go into External Mixing and do a Mode Preset while in the Spectrum Analyzer Mode, the resulting Center Freq is 33.25 GHz.
State Saved	Saved in instrument state.
Min	The minimum frequency in the currently selected mixer band + 5 Hz
Max	The maximum frequency in the currently selected mixer band - 5 Hz If the knob or step keys are being used, also depends on the value of the other three interdependent parameters Span, Start Frequency and Stop Frequency
Initial S/W Revision	A.08.01

I/Q Center Freq

SCPI command for specifying the I/Q Center Frequency. This command will set the Center Frequency to be used when the I/Q input is selected, even if the I/Q input is not the input which is selected at the time the command is sent. Note that the

Center Freq function in the **Frequency** menu on the front panel always applies to the currently selected input.

Scope	Meas Global
Remote Command	<code>[:SENSe] :FREQuency:IQ:CENTer <freq></code> <code>[:SENSe] :FREQuency:IQ:CENTer?</code>
Example	FREQ:IQ:CENT: 30 MHz
Notes	This command is the same in all modes, but the parameter is Measurement Global. So the value is independent in each mode and common across all the measurements in the mode.
Preset	0 Hz
State Saved	Saved in instrument state.
Min	-40.049995 MHz
Max	40.049995 MHz
Initial S/W Revision	Prior to A.02.00

CF Step

Changes the step size for the center frequency and start and stop frequency functions. Once a step size has been selected and the center frequency function is active, the step keys (and the UP|DOWN parameters for Center Frequency from remote commands) change the center frequency by the step-size value. The step size function is useful for finding harmonics and sidebands beyond the current frequency span of the analyzer.

Note that the start and stop frequencies also step by the CF Step value.

Key Path	FREQ Channel
Remote Command	<code>[:SENSe] :FREQuency:CENTer:STEP [:INCRement] <freq></code> <code>[:SENSe] :FREQuency:CENTer:STEP [:INCRement]?</code> <code>[:SENSe] :FREQuency:CENTer:STEP:AUTO OFF ON 0 1</code> <code>[:SENSe] :FREQuency:CENTer:STEP:AUTO?</code>
Example	FREQ:CENT:STEP:AUTO ON FREQ:CENT:STEP 500 MHz FREQ:CENT UP increases the current center frequency value by 500 MHz FREQ:CENT:STEP? FREQ:CENT:STEP:AUTO?
Notes	Preset and Max values are depending on Hardware Options (503, 507, 508, 513, 526)
Notes	Preset and Max values are dependent on Hardware Options (5xx)
Dependencies	Freq Offset is not available in External Mixing. In this case the Freq Offset key is grayed out and shows a value of zero. It will once again be available, and show the previously set value, when you return to the RF Input.
Dependencies	Span, RBW, Center frequency If the electronic/soft attenuator is enabled, any attempt to change the value of the center

	frequency >3.6 GHz by pressing the Up-arrow key, fails and results in an advisory message. If the equivalent SCPI command is sent, this same message is generated as part of a “-221, Settings conflict” warning.
Couplings	When auto-coupled in a non-zero span, the center frequency step size is set to 10% of the span. When auto-coupled in zero span, the center frequency step size is set to the equivalent -3 dB RBW value.
Preset	Auto ADEM0D: 1 MHz ON
State Saved	Saved in instrument state
Min	– (the maximum frequency of the instrument). That is, 27 GHz max freq instrument has a CF step range of +/- 27 GHz. Note that this is the maximum frequency given the current settings of the instrument, so in External Mixing, for example, it is the maximum frequency of the current mixer band.
Max	The maximum frequency of the instrument. That is, 27 GHz max freq instrument has a CF step range of +/- 27 GHz. Note that this is the maximum frequency given the current settings of the instrument, so in External Mixing, for example, it is the maximum frequency of the current mixer band.
Default Unit	Hz
Status Bits/OPC dependencies	non-overlapped
Initial S/W Revision	Prior to A.02.00
Modified at S/W Revision	A.03.00

Freq Offset

Enables you to set a frequency offset value to account for frequency conversions outside of the analyzer. This value is added to the display readout of the marker frequency, center frequency, start frequency, stop frequency, and all other absolute frequency settings in the analyzer including frequency count. When a frequency offset is entered, the value appears below the center of the graticule. To eliminate an offset, perform a Mode Preset or set the frequency offset to 0 Hz.

See ["More Information" on page 1373](#).

Key Path	FREQ Channel
Scope	Meas Global
Remote Command	[:SENSe] :FREQuency:OFFSet <freq> [:SENSe] :FREQuency:OFFSet?
Example	FREQ:OFFS 10 MHz
Notes	Preset and Max values are dependent on Hardware Options (503, 507, 508, 513, 526)
Dependencies	Freq Offset is not available in External Mixing. In this case the Freq Offset key is grayed out and shows a value of zero. However, the value of CF Offset that was set for the RF Input is retained and restored when the user switches back to the RF Input.

Preset	See " Center Frequency Presets " on page 2932
State Saved	Saved in instrument state
Min	-500 GHz
Max	500 GHz
Default Unit	Hz
Status Bits/OPC dependencies	Non-overlapped
Backwards Compatibility SCPI	DISPlay:WINDow[1]:TRACe:X[:SCALE]:OFFSet
	The DISPlay version of the command is in the instrument for compatibility across platforms and is not recommended for new development.
Backwards Compatibility Notes	<ol style="list-style-type: none"> 1. In pre-X-Series instruments, Frequency Offset could not be adjusted by the knob or step keys. That is no longer the case. 2. Some previous spectrum analyzers did not adjust frequency counter results for the Frequency Offset. The X-Series does adjust the frequency counter for the offset.
Initial S/W Revision	Prior to A.02.00
Modified at S/W Revision	A.04.00, A.08.50

More Information

This command does not affect any bandwidths or the settings of relative frequency parameters such as delta markers or span. It does not affect the current hardware settings of the analyzer, but only the displayed frequency values. Entering an offset does not affect the trace position or display, just the value of the start and stop frequency and the values represented by the trace data. The frequency values of exported trace data, queried trace data, markers, trace data used in calculations such as N dB points, trace math, etc., are all affected by Freq Offset. Changing the offset, even on a trace that is not updating will immediately change all of the above, without taking new data.

NOTE

If a trace is exported with a nonzero Freq Offset, the exported data will contain the trace data with the offset applied. Therefore, if that trace were to be imported back into the analyzer, you would want Freq Offset to be 0, or the offset would be applied again to data which is already offset. No such care need be taken when saving a State+Trace file because the data and state are saved together.

Input/Output

See ["Input/Output" on page 241](#)

Marker

Accesses a menu that enables you to select, set up and control the markers for the current measurement.

Key Path	Front-panel key
Initial S/W Revision	Prior to A.02.00

Select Marker

Displays the menu keys that enable you to select, set up and control the markers for the current measurement

Key Path	Marker
Initial S/W Revision	Prior to A.02.00

Select Marker

Displays 12 markers available for selection.

Key Path	Marker, Properties
Initial S/W Revision	Prior to A.02.00

Marker Type

Sets the marker control mode to **Normal**, **Delta** or **Off**. If the selected marker is Off, pressing Marker sets it to Normal and places a single marker at the center of the display. At the same time, **Marker X Axis Value** appears on the Active Function area.

Key Path	Marker
Mode	SA, WCDMA, C2K, WIMAX OFDMA, TD-SCDMA, 1xEVDO, ISDB-T, CMMB, LTE, LTETDD, BLUETOOTH, WLAN, MSR, LTEAFDD, LTEATDD
Remote Command	:CALCulate:OBWidth:MARKer[1] 2 ... 12:MODE POSition DELTA OFF :CALCulate:OBWidth:MARKer[1] 2 ... 12:MODE?
Example	CALC:OBW:MARK:MODE POS CALC:OBW:MARK:MODE?
Notes	If the selected marker is Off, pressing Marker sets it to Normal and places it at the center of the screen on the trace determined by the Marker Trace rules. At the same time, Marker X Axis Value appears on the Active Function area. Default Active Function: the active function for the selected marker's current control mode. If the current control mode is Off, there is no active function and the active function is turned off. Active Function Display: the marker X axis value entered in the active function area displays the marker value to its full entered precision.
Preset	OFF
State Saved	Saved in instrument state.

Range	Normal Delta Off
Initial S/W Revision	Prior to A.02.00
Modified at S/W Revision	A.03.00

Properties

Accesses the marker properties menu.

Key Path	Marker
Initial S/W Revision	Prior to A.02.00

Select Marker

Displays the menu keys that enable you to select, set up and control the markers for the current measurement

Key Path	Marker
Initial S/W Revision	Prior to A.02.00

Select Marker

Displays 12 markers available for selection.

Key Path	Marker, Properties
Initial S/W Revision	Prior to A.02.00

Relative To

Selects the desired marker. The selected marker will be relative to its reference marker.

Key Path	Marker, Properties
Mode	SA, WCDMA, C2K, WIMAX OFDMA, TD-SCDMA, 1xEVDO, ISDB-T, CMMB, LTE, LTETDD, BLUETOOTH, WLAN, MSR, LTEAFDD, LTEATDD
Remote Command	:CALCulate:OBwidth:MARKer[1] 2 ... 12:REFerence <integer> :CALCulate:OBwidth:MARKer[1] 2 ... 12:REFerence?
Example	CALC:OBW:MARK:REF 2 CALC:OBW:MARK:REF?
Notes	A marker cannot be relative to itself so that choice is grayed out, and if sent from SCPI generates error -221: "Settings conflict; marker cannot be relative to itself." When queried a single value is returned (the specified marker numbers relative marker). You must be in the Spectrum Analysis mode, WCDMA mode, TD-SCDMA mode, 1xEVDO mode, WIMAX OFDMA mode ISDB-T mode, WLAN mode, CMMB mode, LTE mode, LTETDD mode or BLUETOOTH mode to use this command. Use:INSTRument:SELEct to set the mode.
Preset	2 3 4 5 6 7 8 9 10 11 12 1

State Saved	Saved in instrument state.
Min	1
Max	12
Readback	Current selected relative to marker number.
Initial S/W Revision	Prior to A.02.00
Modified at S/W Revision	A.03.00

All Markers Off

Turns off all markers.

Key Path	Marker
Mode	SA, WCDMA, C2K, WIMAX OFDMA, TD-SCDMA, 1xEVDO, ISDB-T, CMMB, LTE, LTETDD, BLUETOOTH, WLAN, MSR, LTEAFDD, LTEATDD
Remote Command	:CALCulate:OBwidth:MARKer:AOff
Example	CALC:OBW:MARK:AOff
Initial S/W Revision	Prior to A.02.00
Modified at S/W Revision	A.03.00

Marker X Axis Value (Remote Command Only)

Sets the marker X Axis value in the current marker X Axis Scale unit. It has no effect if the control mode is **Off**.

Key Path	SCPI only
Mode	SA, WCDMA, C2K, WIMAX OFDMA, TD-SCDMA, 1xEVDO, ISDB-T, CMMB, LTE, LTETDD, BLUETOOTH, WLAN, MSR, LTEAFDD, LTEATDD
Remote Command	:CALCulate:OBwidth:MARKer[1] 2 ... 12:X <freq> :CALCulate:OBwidth:MARKer[1] 2 ... 12:X?
Example	CALC:OBW:MARK3:X 0 CALC:OBW:MARK3:X?
Notes	The query returns the marker's absolute X Axis value if the control mode is Normal , or the offset from the marker's reference marker if the control mode is Delta . The query is returned in the fundamental units for the current marker X Axis scale: Hz for Frequency .
Preset	After a preset, all markers are turned OFF, so Marker X Axis Value query returns a not a number (NAN).
State Saved	No
Min	-9.9E+37
Max	9.9E+37
Initial S/W Revision	Prior to A.02.00

Modified at S/W Revision	A.03.00
--------------------------	---------

Marker X Axis Position (Remote Command Only)

Sets the marker X position in trace points. It has no effect if the control mode is **Off**.

Key Path	SCPI only
Mode	SA, WCDMA, C2K, WIMAX OFDMA, TD-SCDMA, 1xEVDO, ISDB-T, CMMB, LTE, LTETDD, BLUETOOTH, WLAN, MSR, LTEAFDD, LTEATDD
Remote Command	:CALCulate:OBwidth:MARKer[1] 2 ... 12:X:POSition <real> :CALCulate:OBwidth:MARKer[1] 2 ... 12:X:POSition?
Example	CALC:OBW:MARK10:X:POS 0 CALC:OBW:MARK10:X:POS?
Notes	The query returns the marker's absolute X Axis value in trace points if the control mode is Normal , or the offset from the marker's reference marker in trace points if the control mode is Delta .
Preset	After a preset, all markers are turned OFF, so Marker X Axis Value query returns a not a number (NaN).
State Saved	No
Min	-9.9E+37
Max	9.9E+37
Initial S/W Revision	Prior to A.02.00
Modified at S/W Revision	A.03.00

Marker Y Axis Value (Remote Command Only)

Returns the marker Y Axis value in the current marker Y Axis unit.

Key Path	SCPI only
Mode	SA, WCDMA, C2K, WIMAX OFDMA, TD-SCDMA, 1xEVDO, ISDB-T, CMMB, LTE, LTETDD, BLUETOOTH, WLAN, MSR, LTEAFDD, LTEATDD
Remote Command	:CALCulate:OBwidth:MARKer[1] 2 ... 12:Y?
Example	CALC:OBW:MARK11:Y?
Preset	Result dependent on Markers setup and signal source.
State Saved	No
Min	-9.9E+37
Max	9.9E+37
Initial S/W Revision	Prior to A.02.00
Modified at S/W Revision	A.03.00

Backward Compatibility SCPI Commands

Sets or queries the state of a marker. Setting a marker which is OFF to state ON or 1 puts it in **Normal** mode and places it at the center of the screen.

Key Path	SCPI only
Mode	SA, WCDMA, C2K, WIMAX OFDMA, TD-SCDMA, 1xEVDO, ISDB-T, CMMB, LTE, LTETDD, BLUETOOTH, WLAN, MSR, LTEAFDD, LTEATDD
Remote Command	:CALCulate:OBWidth:MARKer[1] 2 ... 12:STATe OFF ON 0 1 :CALCulate:OBWidth:MARKer[1] 2 ... 12:STATe?
Example	CALC:OBW:MARK3:STAT ON CALC:OBW:MARK3:STAT?
Preset	OFF
State Saved	Saved in instrument state.
Initial S/W Revision	Prior to A.02.00
Modified at S/W Revision	A.03.00

Marker Function

There are no 'Marker Functions' supported in this measurement. When pressed, this key displays a blank menu.

Key Path	Front panel key
Initial S/W Revision	Prior to A.02.00

Marker To

There is no 'Marker To' functionality supported in this measurement. When pressed, this key displays a blank menu.

Key Path	Front panel key
Initial S/W Revision	Prior to A.02.00

Meas

The information in this section is common to all measurements. For key and remote command information for a specific measurement, refer to the section that describes the measurement of interest.

Measurements available under the Meas key are specific to the current Mode.

When viewing Help for measurements, note the following:

NOTE

Operation for some keys differs between measurements. The information displayed in Help pertains to the current measurement. To see how a key operates in a different measurement, exit Help (press the Cancel Esc key), select the measurement, then reenter Help (press the Help key) and press that key.

Key Path	Front-panel key
Initial S/W Revision	Prior to A.02.00

Remote Measurement Functions

This section contains the following topics:

["Measurement Group of Commands" on page 3141](#)

["Current Measurement Query \(Remote Command Only\)" on page 3144](#)

["Limit Test Current Results \(Remote Command Only\)" on page 3144](#)

["Data Query \(Remote Command Only\)" on page 3144](#)

["Calculate/Compress Trace Data Query \(Remote Command Only\)" on page 3144](#)

["Calculate Peaks of Trace Data \(Remote Command Only\)" on page 3150](#)

["Hardware-Accelerated Fast Power Measurement \(Remote Command Only\)" on page 3151](#)

["Format Data: Numeric Data \(Remote Command Only\)" on page 3165](#)

["Format Data: Byte Order \(Remote Command Only\)" on page 3166](#)

Initial S/W Revision	Prior to A.02.00
----------------------	------------------

Measurement Group of Commands

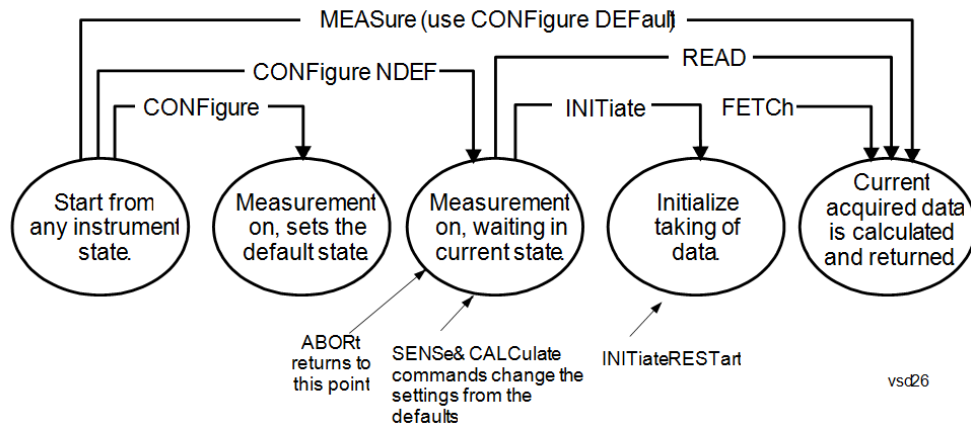

Measure Commands:

:MEASure:<measurement>[n]?

This is a fast single-command way to make a measurement using the factory default instrument settings. These are the settings and units that conform to the Mode Setup settings (e.g. radio standard) that you have currently selected.

- Stops the current measurement (if any) and sets up the instrument for the specified measurement using the factory defaults
- Initiates the data acquisition for the measurement
- Blocks other SCPI communication, waiting until the measurement is complete before returning results.
- If the function does averaging, it is turned on and the number of averages is set to 10.
- After the data is valid it returns the scalar results, or the trace data, for the specified measurement. The type of data returned may be defined by an [n] value that is sent with the command.
- The scalar measurement results will be returned if the optional [n] value is not included, or is set to 1. If the [n] value is set to a value other than 1, the selected trace data results will be returned. See each command for details of what types of scalar results or trace data results are available.
- ASCII is the default format for the data output. (Older versions of Spectrum Analysis and Phase Noise mode measurements only use ASCII.) The binary data formats should be used for handling large blocks of data since they are smaller and faster than the ASCII format. Refer to the FORMat:DATA command for more information.

If you need to change some of the measurement parameters from the factory default settings you can set up the measurement with the CONFIGure command. Use the commands in the SENSE:<measurement> and CALCulate:<measurement> subsystems to change the settings. Then you can use the READ? command to initiate the measurement and query the results.

If you need to repeatedly make a given measurement with settings other than the factory defaults, you can use the commands in the SENSE:<measurement> and CALCulate:<measurement> subsystems to set up the measurement. Then use the READ? command to initiate the measurement and query results.

Measurement settings persist if you initiate a different measurement and then return to a previous one. Use READ:<measurement>? if you want to use those persistent settings. If you want to go back to the default settings, use MEASure:<measurement>?.

Configure Commands:

:CONFigure:<measurement>

This command stops the current measurement (if any) and sets up the instrument for the specified measurement using the factory default instrument settings. It does not initiate the taking of measurement data unless INIT:CONTinuous is ON. If you change any measurement settings after using the CONFigure command, the READ command can be used to initiate a measurement without changing the settings back to their defaults.

In the Swept SA measurement in Spectrum Analyzer mode the CONFigure command also turns the averaging function on and sets the number of averages to 10 for all measurements.

:CONFigure: <measurement>: NDEFault stops the current measurement and changes to the specified measurement. It does not change the settings to the defaults. It does not initiate the taking of measurement data unless INIT:CONTinuous is ON.

The CONFigure? query returns the current measurement name.

The CONFigure:CATalog? query returns a quoted string of all licensed measurement names in the current mode. For example, "SAN, CHP, OBW, ACP, PST, TXP, SPUR, SEM, LIST".

Fetch Commands:

:FETCh:<measurement>[n]?

This command puts selected data from the most recent measurement into the output buffer. Use FETCh if you have already made a good measurement and you want to return several types of data (different [n] values, for example, both scalars and trace data) from a single measurement. FETCh saves you the time of re-making the measurement. You can only FETCh results from the measurement that is currently active, it will not change to a different measurement. An error message is reported if a measurement other than the current one is specified.

If you need to get new measurement data, use the READ command, which is equivalent to an INITiate followed by a FETCh.

The scalar measurement results will be returned if the optional [n] value is not included, or is set to 1. If the [n] value is set to a value other than 1, the selected trace data results will be returned. See each command for details of what types of scalar results or trace data results are available. The binary data formats should be used for handling large blocks of data since they are smaller and transfer faster than the ASCII format. (FORMat:DATA)

FETCh may be used to return results other than those specified with the original READ or MEASure command that you sent.

INITiate Commands:

:INITiate:<measurement>

This command is not available for measurements in all the instrument modes:

- Initiates a trigger cycle for the specified measurement, but does not output any data. You must then use the FETCh<meas> command to return data. If a

measurement other than the current one is specified, the instrument will switch to that measurement and then initiate it.

- For example, suppose you have previously initiated the ACP measurement, but now you are running the channel power measurement. If you send INIT:ACP? it will change from channel power to ACP and will initiate an ACP measurement.
- Does not change any of the measurement settings. For example, if you have previously started the ACP measurement and you send INIT:ACP? it will initiate a new ACP measurement using the same instrument settings as the last time ACP was run.
- If your selected measurement is currently active (in the idle state) it triggers the measurement, assuming the trigger conditions are met. Then it completes one trigger cycle. Depending upon the measurement and the number of averages, there may be multiple data acquisitions, with multiple trigger events, for one full trigger cycle. It also holds off additional commands on GPIB until the acquisition is complete.

READ Commands:

:READ:<measurement>[n]?

- Does not preset the measurement to the factory default settings. For example, if you have previously initiated the ACP measurement and you send READ:ACP? it will initiate a new measurement using the same instrument settings.
 - Initiates the measurement and puts valid data into the output buffer. If a measurement other than the current one is specified, the instrument will switch to that measurement before it initiates the measurement and returns results.
 - For example, suppose you have previously initiated the ACP measurement, but now you are running the channel power measurement. Then you send READ:ACP? It will change from channel power back to ACP and, using the previous ACP settings, will initiate the measurement and return results.
 - Blocks other SCPI communication, waiting until the measurement is complete before returning the results
 - If the optional [n] value is not included, or is set to 1, the scalar measurement results will be returned. If the [n] value is set to a value other than 1, the selected trace data results will be returned. See each command for details of what types of scalar results or trace data results are available. The binary data formats should be used when handling large blocks of data since they are smaller and faster than the ASCII format. (FORMat:DATA)
-

Current Measurement Query (Remote Command Only)

This command returns the name of the measurement that is currently running.

Remote Command	:CONFiGure?
Example	CONF?
Initial S/W Revision	Prior to A.02.00

Limit Test Current Results (Remote Command Only)

Queries the status of the current measurement limit testing. It returns a 0 if the measured results pass when compared with the current limits. It returns a 1 if the measured results fail any limit tests.

Remote Command	:CALCuLate:CLIMits:FAIL?
Example	CALC:CLIM:FAIL? queries the current measurement to see if it fails the defined limits. Returns a 0 or 1: 0 it passes, 1 it fails.
Initial S/W Revision	Prior to A.02.00

Data Query (Remote Command Only)

Returns the designated measurement data for the currently selected measurement and subopcode.

n = any valid subopcode for the current measurement. See the measurement command results table for your current measurement, for information about what data is returned for the subopcodes.

This command uses the data setting specified by the FORMat:BORDER and FORMat:DATA commands and can return real or ASCII data. (See the format command descriptions under Input/Output in the Analyzer Setup section.)

Remote Command	:CALCuLate:DATA[n]?
Notes	The return trace depends on the measurement. In CALCulate:<meas>:DATA[n], n is any valid subopcode for the current measurement. It returns the same data as the FETCh:<measurement>? query where <measurement> is the current measurement.
Initial S/W Revision	Prior to A.02.00

Calculate/Compress Trace Data Query (Remote Command Only)

Returns compressed data for the currently selected measurement and sub-opcode [n].

n = any valid sub-opcode for that measurement. See the MEASure:<measurement>? command description of your specific measurement for information on the data that can be returned.

The data is returned in the current Y Axis Unit of the analyzer. The command is used with a sub-opcode <n> (default=1) to specify the trace. With trace queries, it is best if the analyzer is not sweeping during the query. Therefore, it is generally advisable to be in Single Sweep, or Update=Off.

This command is used to compress or decimate a long trace to extract and return only the desired data. A typical example would be to acquire N frames of GSM data and return the mean power of the first burst in each frame. The command can also be used to identify the best curve fit for the data.

Remote Command	:CALCulate:DATA<n>:COMPRESS? BLOCK CFIT MAXimum MINimum MEAN DMEan RMS RMSCubed SAMPLE SDEVIation PPHase [,<soffset> [,<length>[,<roffset>[,<rlimit>]]]]
Example	To query the mean power of a set of GSM bursts: Supply a signal that is a set of GSM bursts. Select the IQ Waveform measurement (in IQ Analyzer Mode). Set the sweep time to acquire at least one burst. Set the triggers such that acquisition happens at a known position relative to a burst. Then query the mean burst levels using, CALC:DATA2:COMP? MEAN, 24e-6, 526e-6 (These parameter values correspond to GSM signals, where 526e-6 is the length of the burst in the slot and you just want 1 burst.)
Notes	The command supports 5 parameters. Note that the last 4 (<soffset>, <length>, <roffset>, <rlimit>) are optional. But these optional parameters must be entered in the specified order. For example, if you want to specify <length>, then you must also specify <soffset>. See details below for a definition of each of these parameters. This command uses the data in the format specified by FORMat:DATA, returning either binary or ASCII data.
Initial S/W Revision	Prior to A.02.00

- BLOCK or block data - returns all the data points from the region of the trace data that you specify. For example, it could be used to return the data points of an input signal over several timeslots, excluding the portions of the trace data that you do not want. (This is x,y pairs for trace data and I,Q pairs for complex data.)
- CFIT or curve fit - applies curve fitting routines to the data. <soffset> and <length> are required to define the data that you want. <roffset> is an optional parameter for the desired order of the curve equation. The query will return the following values: the x-offset (in seconds) and the curve coefficients ((order + 1) values).

MIN, MAX, MEAN, DME, RMS, RMSC, SAMP, SDEV and PPH return one data value for each specified region (or <length>) of trace data, for as many regions as possible until you run out of trace data (using <roffset> to specify regions). Or they return the number of regions you specify (using <rlimit>) ignoring any data beyond that.

- MINimum - returns the minimum data point (y value) for the specified region (s) of trace data. For I/Q trace data, the minimum magnitude of the I/Q pairs is returned.
- MAXimum - returns the maximum data point (y value) for the specified region(s) of trace data. For I/Q trace data, the maximum magnitude of the I/Q pairs is returned.
- MEAN - returns a single value that is the arithmetic mean of the data point values (in dB/ dBm) for the specified region(s) of trace data. For I/Q trace data, the mean of the magnitudes of the I/Q pairs is returned. See the following equations.

NOTE

If the original trace data is in dB, this function returns the arithmetic mean of those log values, not log of the mean power which is a more useful value. The mean of the log is the better measurement technique when measuring CW signals in the presence of noise. The mean of the power, expressed in dB, is useful in power measurements such as Channel Power. To achieve the mean of the power, use the RMS option.

Equation 1

Mean Value of Data Points for Specified Region(s)

$$MEAN = \frac{1}{n} \sum_{X_i \in \text{region}(s)} X_i$$

where X_i is a data point value, and n is the number of data points in the specified region(s).

Equation 2

Mean Value of I/Q Data Pairs for Specified Region(s)

$$MEAN = \frac{1}{n} \sum_{X_i \in \text{region}(s)} |X_i|$$

where $|X_i|$ is the magnitude of an I/Q pair, and n is the number of I/Q pairs in the specified region(s).

- DMEan - returns a single value that is the mean power (in dB/ dBm) of the data point values for the specified region(s) of trace data. See the following

equation:

Equation 3

DMEan Value of Data Points for Specified Region(s)

$$\text{DME} = 10 \times \log_{10} \left(\frac{1}{n} \sum_{X_i \in \text{region}(s)} 10^{\frac{X_i}{10}} \right)$$

- RMS - returns a single value that is the average power on a root-mean-squared voltage scale (arithmetic rms) of the data point values for the specified region(s) of trace data. See the following equation.

NOTE

For I/Q trace data, the rms of the magnitudes of the I/Q pairs is returned. See the following equation.

This function is very useful for I/Q trace data. However, if the original trace data is in dB, this function returns the rms of the log values which is not usually needed.

Equation 4

RMS Value of Data Points for Specified Region(s)

$$\text{RMS} = \sqrt{\frac{1}{n} \sum_{X_i \in \text{region}(s)} X_i^2}$$

where X_i is a data point value, and n is the number of data points in the specified region(s).

Equation 5

RMS Value of I/Q Data Pairs for Specified Region(s)

$$\text{RMS} = \sqrt{\frac{1}{n} \sum_{X_i \in \text{region}(s)} X_i X_i^*}$$

where X_i is the complex value representation of an I/Q pair, X_i^* its conjugate complex number, and n is the number of I/Q pairs in the specified region(s).

Once you have the rms value for a region of trace data (linear or I/Q), you may want to calculate the mean power. You must convert this rms value (peak volts) to power in dBm:

$$10 \times \log[10 \times (\text{rms value})^2]$$

- SAMPLe - returns the first data value (x,y pair) for the specified region(s) of trace data. For I/Q trace data, the first I/Q pair is returned.
- SDEVIation - returns a single value that is the arithmetic standard deviation for the data point values for the specified region(s) of trace data. See the following equation.
- For I/Q trace data, the standard deviation of the magnitudes of the I/Q pairs is returned. See the following equation.

Equation 6

Standard Deviation of Data Point Values for Specified Region(s)

$$SDEV = \sqrt{\frac{1}{n} \sum_{X_i \in \text{region}(s)} (X_i - \bar{X})^2}$$

where X_i is a data point value, \bar{X} is the arithmetic mean of the data point values for the specified region(s), and n is the number of data points in the specified region(s).

$$SDEV = \sqrt{\frac{1}{n} \sum_{X_i \in \text{region}(s)} (|X_i| - \bar{X})^2}$$

where $|X_i|$ is the magnitude of an I/Q pair, \bar{X} is the mean of the magnitudes for the specified region(s), and n is the number of data points in the specified region(s).

- PPHase - returns the x,y pairs of both rms power (dBm) and arithmetic mean phase (radian) for every specified region and frequency offset (Hz). The number of pairs is defined by the specified number of regions. This parameter can be used for I/Q vector (n=0) in Waveform (time domain) measurement and all parameters are specified by data point in PPHase.

The rms power of the specified region may be expressed as:

$$\text{Power} = 10 \times \log [10 \times (\text{RMS I/Q value})] + 10.$$

The RMS I/Q value (peak volts) is:

$$\sqrt{\frac{1}{n} \sum_{X_i \in \text{region}} X_i X_i^*}$$

where X_i is the complex value representation of an I/Q pair, X_i^* its conjugate complex number, and n is the number of I/Q pairs in the specified region.

The arithmetic mean phase of the specified region may be expressed as:

$$\frac{1}{n} \sum_{Y_i \in \text{region}} Y_i$$

where Y_i is the unwrapped phase of I/Q pair with applying frequency correction and n is the number of I/Q pairs in the specified region.

The frequency correction is made by the frequency offset calculated by the arithmetic mean of every specified region's frequency offset. Each frequency offset is calculated by the least square method against the unwrapped phase of I/Q pair.

Sample Trace Data - Constant Envelope

(See below for explanation of variables.)

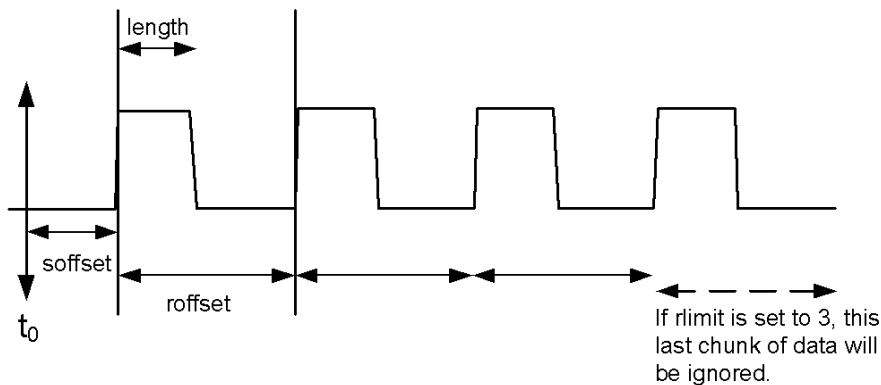

Sample Trace Data - Not Constant Envelope

(See below for explanation of variables.)

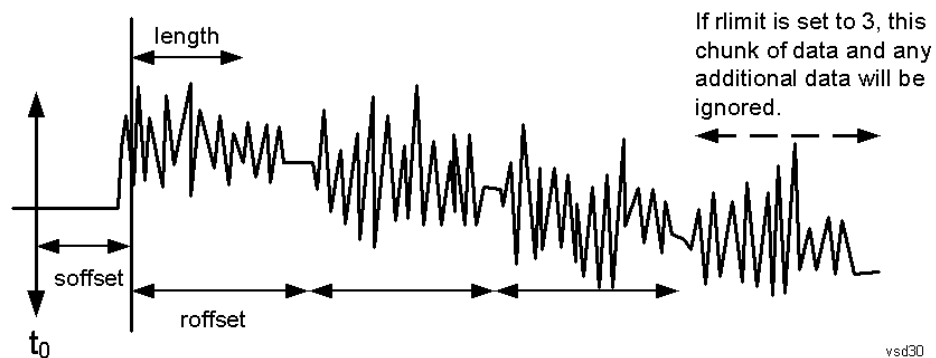

<soffset> - start offset is an optional real number. (It is in seconds for time-domain traces, and is a dimensionless index 0 to Npoints - 1, for frequency-domain traces). It specifies the amount of data at the beginning of the trace that will be ignored before the decimation process starts. It is the time or frequency change from the start of the trace to the point where you want to start using the data. The default value is zero.

<length> - is an optional real number. (It is in seconds for time-domain traces, and is a dimensionless index 0 to Npoints - 1, for frequency-domain traces). It defines how much data will be compressed into one value. This parameter has a default value equal to the current trace length.

<roffset> - repeat offset is an optional real number. (It is in seconds for time-domain traces, and is a dimensionless index 0 to Npoints - 1, for frequency-domain traces). It defines the beginning of the next field of trace elements to be compressed. This is relative to the beginning of the previous field. This parameter has a default value equal to the <length> variable. Note that this parameter is used for a completely different purpose when curve fitting (see CFIT above).

<rlimit> - repeat limit is an optional integer. It specifies the number of data items that you want returned. It will ignore any additional items beyond that number. You can use the Start offset and the Repeat limit to pick out exactly what part of the data you want to use. The default value is all the data.

Calculate Peaks of Trace Data (Remote Command Only)

Returns a list of all the peaks for the currently selected measurement and sub-opcode [n]. The peaks must meet the requirements of the peak threshold and excursion values.

n = any valid sub-opcode for the current measurement. See the MEASure:<measurement> command description of your specific measurement for information on the data that can be returned.

The command can only be used with specific sub-opcodes with measurement results that are trace data. Both real and complex traces can be searched, but complex traces are converted to magnitude in dBm. In many measurements the sub-opcode n=0, is the raw trace data which cannot be searched for peaks. And Sub-opcode n=1, is often calculated results values which also cannot be searched for peaks.

This command uses the data setting specified by the FORMat:BORDER and FORMat:DATA commands and can return real or ASCII data. If the format is set to INT,32, it returns REAL,32 data.

The command has four types of parameters:

- Threshold (in dBm)
- Excursion (in dB)
- Sorting order (amplitude, frequency, time)
- Optional in some measurements: Display line use (all, > display line, < display line)

Remote Command

For Swept SA measurement:

```
:CALCulate:DATA[1]|2|...|6:PEAKS? <threshold>,<excursion>[,AMPLitude  
| FREQuency | TIME[,ALL | GTDLine | LTDLine]]
```

For most other measurements:

	:CALCulate:DATA[1] 2 ... 6:PEAKs? <threshold>,<excursion>[,AMPLitude FREQUENCY TIME]
Example	<p>Example for Swept SA measurement in Spectrum Analyzer Mode:</p> <p>CALC:DATA4:PEAK? -40, 10, FREQ, GTDL This will identify the peaks of trace 4 that are above -40 dBm, with excursions of at least 10 dB. The peaks are returned in order of increasing frequency, starting with the lowest frequency. Only the peaks that are above the display line are returned.</p> <p>Query Results 1:</p> <p>With FORMat:DATA REAL, 32 selected, it returns a list of floating-point numbers. The first value in the list is the number of peak points that are in the following list. A peak point consists of two values: a peak amplitude followed by its corresponding frequency (or time).</p> <p>If no peaks are found the peak list will consist of only the number of peaks, (0).</p>
Notes	<p><n> - is the trace that will be used</p> <p><threshold> - is the level below which trace data peaks are ignored. Note that the threshold value is required and is always used as a peak criterion. To effectively disable the threshold criterion for this command, provide a substantially low threshold value such as -200 dBm. Also note that the threshold value used in this command is independent of and has no effect on the threshold value stored under the Peak Criteria menu.</p> <p><excursion> - is the minimum amplitude variation (rise and fall) required for a signal to be identified as peak. Note that the excursion value is required and is always used as a peak criterion. To effectively disable the excursion criterion for this command, provide the minimum value of 0.0 dB. Also note that the excursion value used in this command is independent of and has no effect on the excursion value stored under the Peak Criteria menu.</p> <p>Values must be provided for threshold and excursion. The sorting and display line parameters are optional (defaults are AMPLitude and ALL).</p> <p>Note that there is always a Y-axis value for the display line, regardless of whether the display line state is on or off. It is the current Y-axis value of the display line which is used by this command to determine whether a peak should be reported</p> <p>Sorting order:</p> <p>AMPLitude - lists the peaks in order of descending amplitude, with the highest peak first (default if optional parameter not sent)</p> <p>FREQUENCY - lists the peaks in order of occurrence, left to right across the x-axis.</p> <p>TIME - lists the peaks in order of occurrence, left to right across the x-axis.</p> <p>Peaks vs. Display Line:</p> <p>ALL - lists all of the peaks found (default if optional parameter not sent).</p> <p>GTDLLine (greater than display line) - lists all of the peaks found above the display line.</p> <p>LTDLine (less than display line) - lists all of the peaks found below the display line.</p>
Initial S/W Revision	Prior to A.02.00

Hardware-Accelerated Fast Power Measurement (Remote Command Only)

The Fast Power option (FP2) enables very fast channel power measurements for instruments with the prerequisite hardware (DP2 and/or B40). It accomplishes this by performing real-time overlapped FFTs at the hardware layer, using software for basic post-processing before returning the result to the user. The upshot of this

approach is improved throughput for user applications that require many sequential power measurements.

The analysis bandwidth of FP2 is limited by the licenses in the instrument, but its maximum overall analysis bandwidth per acquisition is 40 MHz.

FP2 is remote-only, which means the instrument does not switch to any particular mode or measurement. FP2 commands can be sent while another application is in use on the front panel.

Each Fast Power measurement can be predefined using an array index, and up to 1,000 measurements can be stored. In the following documentation, instances of [1,2,...,999] can be substituted with a particular measurement index, e.g. CALC:FPOW:POW1?, CALC:FPOW:POW2?, CALC:FPOW:POW134?. In this way, power measurements can be defined one time in a batch, and then executed multiple times without having to redefine them, similar to “list mode” on other measurements.

In addition to basic channel power measurements, there are a number of other measurement “functions” for each channel, including peak power, peak frequency, and power spectral density. See the Function parameter for more information.

Reset Fast Power Measurement (Remote Command Only)

Resets the measurement configuration to the defaults.

Mode	All
Remote Command	:CALCulate:FPOWer:POWer[1,2,...,999]:RESet
Example	:CALC:FPOW:POW1:RES
Notes	Option FP2 is required.
Initial S/W Revision	A.14.00

Define Fast Power Measurement (Remote Command Only)

Fast Power acquisitions are configured using the DEFine command. This command accepts a comma-delimited string of configuration parameters and their appropriate values, which are all specified in the subsection below.

Mode	All
Remote Command	:CALCulate:FPOWer:POWer[1,2,...,999]:DEFine "configuration string"
Example	:CALC:FPOW:POW1:DEF "CenterFrequency=2e9, AcquisitionTime=0.005"
Notes	See below for a list of measurement variables that can be defined in the configuration string.
Initial S/W Revision	A.14.00

Acquisition Time

Example	CALC:FPOW:POW1:DEF "AcquisitionTime=0.002"
Notes	The acquisition time parameter sets the time in which the entire spectrum is measured. An increase in the acquisition time yields an improvement in measurement repeatability.
Preset	0.001 s
Range	0 s to 1 s
Default Unit	Time (s)
Initial S/W Revision	A.14.00

Center Frequency

Example	CALC:FPOW:POW1:DEF "CenterFrequency=2e9"
Notes	The center frequency parameter sets the frequency in which the measurement is centered around. The OffsetFrequency parameter is calculated relative to the center frequency.
Preset	1 GHz
Range	0 Hz to maximum instrument frequency
Default Unit	Frequency (Hz)
Initial S/W Revision	A.14.00

DC Coupled

Example	CALC:FPOW:POW1:DEF "DCCoupled=True"
Notes	The DC coupled parameter allows the user to specify whether the DC blocking capacitor is utilized. Set parameter to true when measuring frequencies below 10 MHz.
Preset	False
Range	True (DC Coupled) or False (AC Coupled)
Default Unit	Boolean
Initial S/W Revision	A.14.00

DetectorType

Example	CALC:FPOW:POW1:DEF "DetectorType=Peak"
Notes	Option FP2 is required. The detector type parameter allows the user to choose whether a RMS average or peak value is used during the measurement.
Preset	RmsAverage
Range	RmsAverage, Peak
Initial S/W Revision	A.14.00

Do Noise Correction

Example	CALC:FPOW:POW1:DEF "DoNoiseCorrection=True"
Notes	<p>When noise correction is enabled, the linear noise power contributed by the analyzer is subtracted from all measurements. This effectively lowers the noise floor of the analyzer.</p> <p>When noise correction is enabled, the first measurement for a given set of input parameters will take extra time. This is because the analyzer takes an extra acquisition with the RF input disconnected from the analyzer's front end to measure the noise of just the analyzer. The measured noise floor is stored in a cache so the noise acquisition will occur only once for the same state settings. In other words, if noise correction was turned on and the analyzer made an acquisition at frequency A, then frequency B, and back again to frequency A, the hidden initial noise floor acquisition would only occur for the first acquisition at frequency A and the cached noise floor would be used the second time frequency A was measured.</p>
Preset	False
Range	True (enable noise correction) or False (disable noise correction)
Default Unit	Boolean
Initial S/W Revision	A.14.00

Do Spur Suppression

Example	CALC:FPOW:POW1:DEF "DoSpurSuppression=True"
Notes	<p>When measuring very low level signals, or when large out-of-band inputs are input into the analyzer, sometimes unwanted spurs and residuals can appear in the measured spectrum. Spur suppression is a method to help minimize the levels of these internally generated spurs and residuals.</p> <p>When spur suppression is enabled, the analyzer will automatically take two acquisitions using two different internal analog LO frequencies. The FFT spectrums from both acquisitions are combined by taking the minimum power between both traces on a per FFT bin basis. External signals will have the same amplitude for both traces and therefore will return the expected amplitudes. However, low level spurs and residuals generated internally to the analyzer tend to move to different FFT bins depending on the internal analog LO frequency used, and therefore tend to be suppressed using this spur suppression method.</p> <p>Because two acquisitions, rather than a single acquisition, are made when spur suppression is enabled, the measurement time will always be slower when spur suppression is enabled.</p>
Preset	False
Range	True (enable spur suppression) or False (disable spur suppression)
Default Unit	Boolean
Initial S/W Revision	A.14.00

Electronic Attenuator Bypass

Example	CALC:FPOW:POW1:DEF "ElecAttBypass =False"
---------	---

Notes	The electronic attenuation bypass parameter allows the user to either utilize or bypass the electronic attenuator. The electronic attenuator is only available for frequencies up to 3.6 GHz. Set parameter to true when using frequencies above 3.6 GHz and set the parameter to false when using the preamp.
Preset	True
Range	True (bypass electronic attenuator) or False (use electronic attenuator)
Default Unit	Boolean
Initial S/W Revision	A.14.00

Electronic Attenuation

Example	CALC:FPOW:POW1:DEF "ElecAttenuation=10"
Notes	Option EA3 is required. The electronic attenuation value parameter sets the amount of electrical attenuation from 0 to 24 dB (1 dB steps). Set "ElecAttBypass=False" to make sure the electronic attenuator path is enabled.
Preset	0 dB
Range	0 – 24 dB (1 dB steps)
Default Unit	dB
Initial S/W Revision	A.14.00

IF Gain

Example	CALC:FPOW:POW1:DEF "IFGain=10"
Notes	The IF gain parameter allows the user to specify the gain at the IF stage anywhere from -6 to 16 dB (1 dB steps). This is an advanced feature, and for most cases this should remain at its default value of 0 dB.
Preset	0 dB
Range	-6 – 16 dB (1 dB steps)
Default Unit	dB
Initial S/W Revision	A.14.00

IF Type

Example	CALC:FPOW:POW1:DEF "IFType=B25M"
Notes	The IF type parameter allows the user to select between different IF paths. For example, if the signal is less than 25 MHz wide, then the user can select the B25M path to take advantage of additional filtering on this analog IF path.

Preset	B40M
Range	B10M, B25M, B40M
Initial S/W Revision	A.14.00

Include Power Spectrum

Example	CALC:FPOW:POW1:DEF "IncludePowerSpectrum=True"
Notes	The power spectrum parameter allows the user to read data on the entire spectrum for diagnostic purposes. It is not recommended for production use. See CALC:FPOW:POW[n]:READ2? for details on the binary format of the response.
Preset	False
Range	True (return both channel power and full power spectrum) or False (returns only channel power)
Default Unit	Boolean
Initial S/W Revision	A.14.00

Mechanical Attenuation

Example	CALC:FPOW:POW1:DEF "MechAttenuation=10"
Notes	The mechanical attenuation value parameter sets the amount of mechanical attenuation anywhere from 0 to 70 dB (2 dB steps).
Preset	0 dB
Range	0 – 70 dB (2 dB steps)
Default Unit	dB
Initial S/W Revision	A.14.00

Preamp Mode

Example	CALC:FPOW:POW1:DEF "PreAmpMode=Low"
Notes	The license for the appropriate preamp is required. The preamp mode parameter specifies whether the preamps are being utilized. Low allows any preamps up to 3.6 GHz, and Full allows all licensed preamps. Set "ElecAttBypass=True" in order to utilize any preamps.
Preset	Off
Range	Off, Low, Full
Initial S/W Revision	A.14.00

Resolution Bandwidth Mode

Example	CALC:FPOW:POW1:DEF "PreAmpMode=Low"
Notes	The resolution bandwidth mode parameter allows the user to choose whether the RBW filter is automatically or manually set. The BestSpeed value minimizes measurement time, while the Narrowest value minimizes RBW size (minimum of two FFT bins per RBW). To manually specify an RBW, set this parameter to Explicit, and set the ResolutionBW parameter to the desired value.
Preset	BestSpeed
Range	BestSpeed, Narrowest, Explicit
Initial S/W Revision	A.14.00

Resolution Bandwidth

Example	CALC:FPOW:POW1:DEF "ResolutionBW=25e3"
Notes	The resolution bandwidth parameter sets the 3-dB bandwidth of the RBW filter. The ResolutionBWMode parameter must be set to Explicit in order to manually set the RBW.
Preset	0 Hz
Default Unit	Hz
Initial S/W Revision	A.14.00

Trigger Delay

Example	CALC:FPOW:POW1:DEF "TriggerDelay=0.025"
Notes	The trigger delay parameter sets the time after an external trigger is detected until the measurement is performed.
Preset	0 s
Range	0 – 1 s
Default Unit	Seconds
Initial S/W Revision	A.14.00

Trigger Level

Example	CALC:FPOW:POW1:DEF "TriggerLevel=2"
Notes	The trigger level parameter sets the voltage value at which an external trigger is detected.
Preset	1.2 V
Range	-5 to 5 V
Default Unit	Volts
Initial S/W Revision	A.14.00

Trigger Slope

Example	CALC:FPOW:POW1:DEF "TriggerSlope=Negative"
Notes	The trigger slope parameter indicates the direction of the edge trigger voltage for detection.
Preset	Positive
Range	Positive, Negative
Initial S/W Revision	A.14.00

Trigger Source

Example	CALC:FPOW:POW1:DEF "TriggerSource=Ext1"
Notes	The trigger source parameter allows the user to choose between measurement's triggering freely or controlled by an external input. Ext1 and Ext2 correspond to Trigger 1 In and Trigger 2 In, respectively.
Preset	Free
Range	Free, Ext1, Ext2
Initial S/W Revision	A.14.00

Trigger Timeout

Example	CALC:FPOW:POW1:DEF "TriggerTimeout=0.1"
Notes	The trigger timeout parameter sets the time in which the analyzer will wait for a trigger before automatically performing the measurement.
Preset	1 s
Range	0 – 1 s
Default Unit	Seconds
Initial S/W Revision	A.14.00

Signal Input

Example	CALC:FPOW:POW1:DEF "SignalInput=Fp50MHzCW"
Notes	The signal input parameter allows the user to select between using the main RF input or the internal analyzer reference CW signal of 50 MHz.
Preset	FpMainRf
Range	FpMainRf, Fp50MHzCW
Initial S/W Revision	A.14.00

Use Preselector

Example	CALC:FPOW:POW1:DEF "UsePreSelector=True"
Notes	The preselector parameter allows the user to either utilize or bypass the front end tunable filter at frequencies above 3.6 GHz. For frequencies below 3.6 GHz, the preselector is automatically bypassed, so you do not need to set this parameter to False in those cases.
Preset	False
Range	True (use preselector above 3.6 GHz), or False (preselector bypassed)
Default Unit	Boolean
Initial S/W Revision	A.14.00

Channel Bandwidth Array

Example	CALC:FPOW:POW1:DEF "Bandwidth=[3.84e6, 5e6, 3.84e6]"
Notes	The bandwidth parameter array defines the bandwidth of each channel that will be measured. All array parameters should have the same number of elements. Alternatively, if all the elements are the same value, a single number with no square brackets can be used to define the parameter.
Preset	[1e6]
Range	0 to 40 MHz
Default Unit	Hz
Initial S/W Revision	A.14.00

Channel Filter Type Array

Example	CALC:FPOW:POW1:DEF "FilterType=[RRC, IBW, RRC]"
Notes	The filter type parameter allows the user to choose between an integration bandwidth (IBW) filter or a root-raised-cosine (RRC) filter. The integration bandwidth filter weighs all frequencies within the bandwidth equally. The root-raised-cosine filter has an associated shape parameter, defined by the FilterAlpha parameter. All array parameters should have the same number of elements. Alternatively, if all the elements are the same value, a single value with no square brackets can be used to define the parameter.
Preset	[IBW]
Range	IBW, RRC
Initial S/W Revision	A.14.00

Channel Filter Alpha Array

Example	CALC:FPOW:POW1:DEF "FilterAlpha=[0.5, 0.0, 0.5]"
Notes	The filter alpha parameter allows the user to adjust the alpha value associated with the root-

	raised-cosine (RRC) filter type. Set FilterType to RRC in order to utilize this parameter. All array parameters should have the same number of elements. Alternatively, if all the elements are the same value, a single number with no square brackets can be used to define the parameter.
Preset	[0.22]
Range	0.0 – 1.0
Initial S/W Revision	A.14.00

Channel Measurement Function Array

Example	CALC:FPOW:POW1:DEF "Function=[BandPower, PeakPower, BandPower]"
Notes	This parameter array defines what measurement is being made for each individually-specified channel: BandPower: Total power within the specified bandwidth of the channel (dBm) BandDensity: Total power density within the specified bandwidth of the channel (dBm/Hz) PeakPower: The peak power value within the specified bandwidth of the channel (dBm) PeakFrequency: The frequency which corresponds to the peak power value within the specified bandwidth of the channel. This frequency is relative to the center frequency (Hz) XdBBandwidth: The half power (-3.01 dB) bandwidth of the highest amplitude signal that resides within the channel (Hz), dB is configurable using XdBBandwidth parameter OccupiedBandwidth: The bandwidth at which 99% of the total power resides within the channel (Hz), percentage configurable using OccupiedBandwidthPercent parameter All array parameters should have the same number of elements. Alternatively, if all the elements are the same value, a single value with no square brackets can be used to define the parameter.
Preset	[BandPower]
Range	BandPower, BandDensity, PeakPower, PeakFrequency, XdBBandwidth, OccupiedBandwidth
Initial S/W Revision	A.14.00

Channel Offset Frequency Array

Example	CALC:FPOW:POW1:DEF "OffsetFrequency=[-5e6, 0, 5e6]"
Notes	The offset frequency parameter array defines the difference between the center frequency to the center frequency of each channel. All array parameters should have the same number of elements.
Preset	[0]
Range	0 to 20 MHz
Default Unit	Hz
Initial S/W Revision	A.14.00

Channel Occupied Bandwidth Percent Array

Example	CALC:FPOW:POW1:DEF "OccupiedBandwidthPercent =[0.95, 0.95, 0.95]"
Notes	This parameter only applies for channels whose Function is set to OccupiedBandwidth. The occupied bandwidth percent parameter specifies the percent of total power in these channels. The valid range for this parameter is 0.0 to 1.0, where 1.0 represents 100%. The default for this parameter is 0.99, which will return the bandwidth that contains 99% of the total channel power.
Preset	[0.99]
Range	0 – 1.0
Initial S/W Revision	A.14.00

Channel x-dB Bandwidth Array

Example	CALC:FPOW:POW1:DEF "XdBBandwidth =[-6.02, -3.01, -1.0]"
Notes	This parameter only applies for channels whose Function is set to XdBBandwidth. The X dB bandwidth parameter is used to specify the power relative to the peak channel power over which the bandwidth is calculated. The parameter value must be a negative number.
Preset	[-3.01]
Range	-200 to 0 dB
Default Unit	dB
Initial S/W Revision	A.14.00

Define Fast Power Measurement Query (Remote Command Only)

The DEFine? command is used to retrieve a list of all defined parameters in an ASCII string format

```

M All
o
d
e
R :CALCulate:FPOWer:POWer[1,2,...,999]:DEFine?
e
m
o
t
e
C
o
m
m
a
n

```

d

E :CALC:FPOW:POW1:DEF?

**x
a
m
p
l
e**

N This command query is used to retrieve a list of all defined parameters in an ASCII format.

O The following is an example of the returned results:

t "DCCoupled=False,ElecAttBypass=True,ElecAttenuation=0,IFGain=0,MechAttenuation=0,PreAmpMode=Off,PreSelectorOf
e fset=0,UsePreSelector=False,ExternalReferenceFrequency=10000000,FrequencyReferenceSource=AutoExternalFrequenc
s yReference,IFType=B40M,LOMode=SLW,SignalInput=FpMainRf,AcquisitionTime=0.001,CenterFrequency=1000000000,Re
solutionBW=0,ResolutionBWMode=BestSpeed,DetectorType=RmsAverage,Bandwidth=[1000000],OffsetFrequency=
[0],Function=[BandPower],FilterType=[BW],FilterAlpha=[0.22],OccupiedBandwidthPercent=[0.99],XdBBandwidth=[-
3.01],DoNoiseCorrection=False,DoSpurSuppression=False,MeasurementMethod=HardwareFFT,IncludePowerSpectrum=F
alse,TriggerDelay=0,TriggerLevel=1.2,TriggerSlope=Positive,TriggerSource=Free,TriggerTimeout=1"

I A.14.00

**n
i
t
i
a
l**

**S
/
W**

**R
e
v
i
s
i
o
n**

Configure Fast Power Measurement (Remote Command Only)

The configure command begins hardware setup and returns immediately, with no acquisition made. This can be used in parallel with other hardware operations to effectively hide the hardware setup time.

Mode	All
Remote Command	:CALCulate:FPOWer:POWer[1,2,...,999]:CONFigure
Example	:CALC:FPOW:POW1:CONF

Notes	Option FP2 is required.
Initial S/W Revision	A.14.00

Initiate Fast Power Measurement (Remote Command Only)

The INITiate command begins an acquisition and returns immediately. The results of the measurement can be retrieved using FETCh.

Mode	All
Remote Command	:CALCulate:FPOWer:POWer[1,2,...,999]:INITiate
Example	:CALC:FPOW:POW1:INIT
Notes	Option FP2 is required.
Initial S/W Revision	A.14.00

Fetch Fast Power Measurement (Remote Command Only)

The FETCh command query is used to retrieve the results of an acquisition initiated by the INIT command. The returned results are in ASCII string format. The string begins and ends with quotation marks.

Mode	All
Remote Command	:CALCulate:FPOWer:POWer[1,2,...,999]:FETCh?
Example	:CALC:FPOW:POW1:FETC?
Notes	Option FP2 is required. Returns m comma-separated ASCII values, where m corresponds to the number of bandwidths defined. 1. Declared function return in the 1st specified channel 2. Declared function return in the 2nd specified channel ... m. Declared function return in the last specified channel The INIT and FETC? command sequence performs the same functionality of a single CALC:FPOW:POW[n]? query. Units of the returned values are dependent on the Function parameter for each channel.
Initial S/W Revision	A.14.00

Execute Fast Power Measurement (Remote Command Only)

This command query is used as shorthand for an INIT command immediately followed by a FETC? command. The returned results are in ASCII string format. The string begins and ends with quotation marks.

Mode	All
Remote Command	:CALCulate:FPOWer:POWer[1,2,...,999]?
Example	:CALC:FPOW:POW1?
Notes	Option FP2 is required. See notes for Fast Power Fetch for return format.
Initial S/W Revision	A.14.00

Binary Read Fast Power Measurement (Remote Command Only)

This command query is used as shorthand for an INIT command immediately followed by a FETC? command. The returned results are in a binary format.

Mode	All
Remote Command	:CALCulate:FPOWer:POWer[1,2,...,999]:READ? :CALCulate:FPOWer:POWer[1,2,...,999]:READ1?
Example	:CALC:FPOW:POW1:READ? :CALC:FPOW:POW1:READ1?
Notes	Option FP2 is required. Returns m 4 byte floating point binary values (Little-Endian), where m corresponds to the number of bandwidths defined.
Initial S/W Revision	A.14.00

Diagnostic Binary Read Fast Power Measurement (Remote Command Only)

This command query is used as shorthand for an INIT command immediately followed by a FETC? command. The returned results are in a binary format. This command is used primarily for diagnostic purposes to test for ADC overloads and to visibly inspect the spectrum.

Mode	All
Remote Command	:CALCulate:FPOWer:POWer[1,2,...,999]:READ2?
Example	:CALC:FPOW:POW1:READ2?
Notes	Option FP2 is required. <div style="display: flex; align-items: flex-start; margin-top: 10px;"> <div style="background-color: #cccccc; padding: 2px 5px; margin-right: 10px;">NOTE</div> <div> <p>Spectrum data is only returned if the IncludePowerSpectrum parameter is set to True. If IncludePowerSpectrum is False, the number of spectrum points will be zero (0).</p> <p>Units of the returned values are dependent on the Function parameter per channel (e.g. dBm for BandPower, Hz for PeakFrequency). Returns binary data (Little-Endian) that contains information on m amount of channels, along with ADC over range and full spectrum data.</p> </div> </div>

The following is the binary format of the response.

Bandwidth Return Value

1. Number of channels specified, m [4 byte int]
2. Declared function result for the 1st specified channel [4 byte float]
3. Declared function result for the 2nd specified channel [4 byte float]
- ...
- (m + 1). Declared function result for the last (mth) specified channel [4 byte float]

ADC Over Range

1. ADC over-range occurred (1: true, 0: false) [2 byte short]

Spectrum Data

1. Number of points in the spectrum data, k [4 byte int]
2. Start frequency of spectrum data (Hz) [8 byte double]
3. Step frequency of spectrum data (Hz) [8 byte double]
4. FFT bin at 1st point (dBm) [4 byte float]
5. FFT bin at 2nd point (dBm) [4 byte float]
- ...
- (k + 3). FFT bin at last (kth) point (dBm) [4 byte float]

Initial S/W Revision A.14.00

Format Data: Numeric Data (Remote Command Only)

This command specifies the format of the trace data input and output. It specifies the formats used for trace data during data transfer across any remote port. It affects only the data format for setting and querying trace data for the :TRACe[:DATA], TRACe[:DATA]?, :CALCulate:DATA[n]? and FETCh:SANalyzer[n]? commands and queries.

Remote Command	:FORMat[:TRACe][:DATA] ASCii INTEger,32 REAL,32 REAL,64 :FORMat[:TRACe][:DATA]?
-----------------------	---

Notes	<p>The query response is:</p> <p>ASCii: ASC,8</p> <p>REAL,32: REAL,32</p> <p>REAL,64: REAL,64</p> <p>INTEger,32: INT,32</p> <p>When the numeric data format is REAL or ASCii, data is output in the current Y Axis unit. When the data format is INTEger, data is output in units of m dBm (.001 dBm).</p> <p>The INT,32 format returns binary 32-bit integer values in internal units (m dBm), in a definite length block.</p>
-------	---

Dependencies	<p>Sending a data format spec with an invalid number (for example, INT,48) generates no error. The analyzer simply uses the default (8 for ASCii, 32 for INTEger, 32 for REAL).</p> <p>Sending data to the analyzer which does not conform to the current FORMat specified, results in an error. Sending ASCII data when a definite block is expected generates message -161 "Invalid</p>
--------------	---

	Block Data" and sending a definite block when ASCII data is expected generates message -121 "Invalid Character in Number".
Preset	AScii
Backwards Compatibility Notes	Note that the INT,32 format is only applicable to the command, TRACe:DATA. This preserves backwards compatibility for the Swept SA measurement. For all other commands/queries which honor FORMat:DATA, if INT,32 is sent the analyzer will behave as though it were set to REAL,32.
Initial S/W Revision	Prior to A.02.00

The specs for each output type follow:

AScii - Amplitude values are in ASCII, in the current Y Axis Unit, one ASCII character per digit, values separated by commas, each value in the form:

SX.YYYYYEsZZ

Where:

S = sign (+ or -)

X = one digit to left of decimal point

Y = 5 digits to right of decimal point

E = E, exponent header

s = sign of exponent (+ or -)

ZZ = two digit exponent

REAL,32 - Binary 32-bit real values in the current Y Axis Unit, in a definite length block.

REAL,64 - Binary 64-bit real values in the current Y Axis Unit, in a definite length block.

Format Data: Byte Order (Remote Command Only)

This command selects the binary data byte order for data transfer and other queries. It controls whether binary data is transferred in normal or swapped mode. This command affects only the byte order for setting and querying trace data for the :TRACe[:DATA], TRACe[:DATA]? , :CALCulate:DATA[n]? and FETCh:SANalyzer[n]? commands and queries.

By definition any command that says it uses FORMat:DATA uses any format supported by FORMat:DATA.

The NORMal order is a byte sequence that begins with the most significant byte (MSB) first, and ends with the least significant byte (LSB) last in the sequence: 1|2|3|4. SWAPped order is when the byte sequence begins with the LSB first, and ends with the MSB last in the sequence: 4|3|2|1.

Remote Command	:FORMat:BORDER NORMa1 SWAPped
-----------------------	--

	:FORMat:BORDER?
Preset	NORMal
Initial S/W Revision	Prior to A.02.00

Meas Setup

Displays the setup menu for the current measurement. The measurement setup parameters include the number of measurement averages used to calculate the measurement result and the averaging mode. The setup menu also includes the option to reset the measurement settings to their factory defaults.

Key Path	Front-panel key
Initial S/W Revision	Prior to A.02.00

Avg/Hold Num

Specifies the number of measurement averages used when calculating the measurement result. The average is displayed at the end of each sweep.

Initiates an averaging routine that averages the sweep points in a number of successive sweeps, resulting in trace smoothing.

After the specified number of average counts, the average mode (termination control) setting determines the average action.

Key Path	Meas Setup
Mode	SA, WCDMA, C2K, WIMAX OFDMA, TD-SCDMA, 1xEVDO, ISDB-T, CMMB, LTE, LTE-TDD, BLUETOOTH, WLAN, MSR, LTEAFDD, LTEATDD
Remote Command	<pre>[:SENSe]:OBWidth:AVERage:COUNT <integer> [:SENSe]:OBWidth:AVERage:COUNT? [:SENSe]:OBWidth:AVERage[:STATe] ON OFF 1 0 [:SENSe]:OBWidth:AVERage[:STATe]?</pre>
Example	<pre>OBW:AVER:COUN 1500 OBW:AVER:COUN? OBW:AVER ON OBW:AVER?</pre>
Notes	You must be in the Spectrum Analysis mode, W-CDMA mode, cdma2000 mode, TD-SCDMA mode, ISDB-T mode, CMMB mode, LTE mode, LTE TDD mode, BLUETOOTH mode, WLAN mode, 1xEVDO mode, MSR, LTE-Advanced FDD/TDD or WIMAX OFDMA mode to use this command. Use:INSTRument:SElect to set the mode.
Couplings	<p>None</p> <p>Averaging state is coupled to Max Hold. If Max Hold is changed from Off to On, Averaging state is automatically set to On.</p>
Preset	<p>10</p> <p>ON</p>
State Saved	Saved in instrument state.
Min	1
Max	10000
Backwards	[:SENSe]:EBWidth:AVERage:COUNT

Compatibility SCPI

Initial S/W Revision	Prior to A.02.00
Modified at S/W Revision	A.03.00

Avg Mode

Enables you to set the averaging mode.

- When set to Exponential (Exp) the measurement averaging continues using the specified number of averages to compute each averaged value. The average is displayed at the end of each sweep.
- When set to Repeat, the measurement resets the average counter each time the specified number of averages is reached.

Key Path	Meas Setup
Mode	SA, WCDMA, C2K, WIMAX OFDMA, TD-SCDMA , 1xEVDO, ISDB-T, CMMB, LTE, LTETDD, BLUETOOTH, WLAN, MSR, LTEAFDD, LTEATDD
Remote Command	[:SENSE]:OBWidth:AVERage:TCONtrol EXPonential REPeat [:SENSE]:OBWidth:AVERage:TCONtrol?
Example	OBW:AVER:TCON REP OBW:AVER:TCON?
Notes	You must be in the Spectrum Analysis mode, W-CDMA mode, cdma2000 mode, TD-SCDMA mode, ISDB-T mode, CMMB mode, LTE mode, LTE TDD mode, BLUETOOTH mode, WLAN mode, 1xEVDO mode, MSR, LTE-Advanced FDD/TDD or WIMAX OFDMA mode to use this command. Use:INSTrument:SElect to set the mode.
Preset	EXP
State Saved	Saved in instrument state.
Range	Exp Repeat
Initial S/W Revision	Prior to A.02.00
Modified at S/W Revision	A.03.00

Occ BW % Pwr

Assigns the percentage of the total power that is measured within the Occupied Bandwidth for the current measurement. The resulting Occupied Bandwidth limits are displayed by markers placed on the frequencies of the specified percentage.

Key Path	Meas Setup
Mode	SA, WCDMA, C2K, WIMAX OFDMA, TD-SCDMA, 1xEVDO, ISDB-T, CMMB, LTE, LTETDD, BLUETOOTH, WLAN, MSR, LTEAFDD, LTEATDD
Remote Command	[:SENSE]:OBWidth:PERCent <real>

	[:SENSe]:OBwidth:PERCent?
Example	OBW:PERC 75 OBW:PERC?
Notes	You must be in the Spectrum Analysis mode, W-CDMA mode, cdma2000 mode, TD-SCDMA mode, ISDB-T mode, CMMB mode, LTE mode, LTE TDD mode, BLUETOOTH mode, WLAN mode, 1xEVDO mode, MSR, LTE-Advanced FDD/TDD or WIMAX OFDMA mode to use this command. Use:INSTrument:SElect to set the mode. If Mode is BLUETOOTH, the key will be grayed out.
Preset	99.00
State Saved	Saved in instrument state.
Min	10
Max	99.99
Initial S/W Revision	Prior to A.02.00
Modified at S/W Revision	A.03.00

x dB

Sets the x dB value used for the "x dB bandwidth" result that measures the bandwidth between two points on the signal which is x dB down from the highest signal point within the OBW Span.

Key Path	Meas Setup
Mode	SA, WCDMA, C2K, WIMAX OFDMA, TD-SCDMA, 1xEVDO, ISDB-T, CMMB, LTE, LTE TDD, BLUETOOTH, WLAN, MSR, LTEAFDD, LTEATDD
Remote Command	[:SENSe]:OBwidth:XDB <rel_amp1> [:SENSe]:OBwidth:XDB?
Example	OBW:XDB -20 OBW:XDB?
Notes	You must be in the Spectrum Analysis mode, W-CDMA mode, cdma2000 mode, TD-SCDMA mode, ISDB-T mode, CMMB mode, LTE mode, LTE TDD mode, BLUETOOTH mode, WLAN mode, 1xEVDO mode, MSR, LTE-Advanced FDD/TDD or WIMAX OFDMA mode to use this command. Use:INSTrument:SElect to set the mode.
Preset	-26.0 dB BLUETOOTH: -20.0 dB.
State Saved	Saved in instrument state.
Min	-100.0 dB
Max	-0.1 dB
Backwards Compatibility SCPI	[:SENSe]:EBwidth:XDB
Initial S/W Revision	Prior to A.02.00
Modified at S/W Revision	A.03.00

IF Gain

The **IF Gain** key can be used to set the IF Gain function to Auto, Low Gain or High Gain. These settings affect sensitivity and IF overloads.

This only applies to the RF input. It does not apply to baseband I/Q input.

Key Path	Meas Setup, IF Gain
Dependencies	The IF Gain keys (FFT IF Gain and Swept IF Gain) have no effect when the U7227A USB Preamplifier is connected. This is not annotated or reflected on any softkey; there are no keys grayed out nor any SCPI locked out. The analyzer simply behaves as though both FFT IF Gain and Swept IF Gain are set to Low regardless of the setting on the keys.
Initial S/W Revision	Prior to A.02.00

IF Gain Auto

Activates the Auto Rules for IF Gain. When Auto is active, the IF Gain is set to High Gain under and of the following conditions:

- the input attenuator is set to 0 dB
- the preamp is turned On and the frequency range is under 3.6 GHz

For other settings, Auto sets the IF Gain to Low Gain.

Key Path	Meas Setup, IF Gain
Mode	SA, WCDMA, C2K, WIMAX OFDMA, TD-SCDMA, 1xEVDO, ISDB-T, CMMB, LTE, LTE-TDD, BLUETOOTH, WLAN, MSR, LTEAFDD, LTEATDD
Remote Command	[:SENSe] :OBWidth :IF :GAIN :AUTO [:STATe] ON OFF 1 0 [:SENSe] :OBWidth :IF :GAIN :AUTO [:STATe] ?
Example	OBW :IF :GAIN :AUTO OFF OBW :IF :GAIN :AUTO ?
Couplings	When the auto attenuation exists (for example, with electrical attenuator), the IF Gain setting is changed as following rule. Auto sets IF Gain to High Gain under any of the following conditions: the input attenuator is set to 0 dB, or the preamp is turned on and the frequency range is less than 3.6 GHz. For other settings, Auto sets IF Gain to Low Gain.
Preset	OFF
State Saved	Saved in instrument state.
Range	Off On
Initial S/W Revision	Prior to A.02.00
Modified at S/W Revision	A.03.00

IF Gain State

Selects the range of the IF Gain.

Key Path	Meas Setup, IF Gain
Mode	SA, WCDMA, C2K, WIMAX OFDMA, TD-SCDMA, 1xEVDO, ISDB-T, CMMB, LTE, LTETDD, BLUETOOTH, WLAN, MSR, LTEAFDD, LTEATDD
Remote Command	[:SENSe]:OBwidth:IF:GAIN[:STATe] ON OFF 1 0 [:SENSe]:OBwidth:IF:GAIN[:STATe]?
Example	OBW:IF:GAIN ON OBW:IF:GAIN?
Notes	ON = high gain OFF = low gain
Couplings	When the auto attenuation exists (for example, with electrical attenuator), the IF Gain setting is changed as following rule. Auto sets IF Gain to High Gain under any of the following conditions: the input attenuator is set to 0 dB, or the preamp is turned on and the frequency range is less than 3.6 GHz. For other settings, Auto sets IF Gain to Low Gain.
Preset	OFF
State Saved	Saved in instrument state.
Range	Low Gain High Gain
Initial S/W Revision	Prior to A.02.00
Modified at S/W Revision	A.03.00

Limit (for all modes except MSR and LTE-Advanced FDD/TDD)

Enables you to turn on or off limit checking at the specified frequency. For results that fail the limit test, a red FAIL appears in the measure bar.

Key Path	Meas Setup
Mode	SA, WCDMA, C2K, WIMAX OFDMA, TD-SCDMA, 1xEVDO, ISDB-T, CMMB, LTE, LTETDD, BLUETOOTH, WLAN
Remote Command	:CALCulate:OBwidth:LIMit:FBLimit <freq> :CALCulate:OBwidth:LIMit:FBLimit? :CALCulate:OBwidth:LIMit[:TEST] ON OFF 1 0 :CALCulate:OBwidth:LIMit[:TEST]?
Example	CALC:OBW:LIM:FBL 50 kHz CALC:OBW:LIM:FBL? CALC:OBW:LIM OFF CALC:OBW:LIM?
Notes	You must be in the Spectrum Analysis mode, W-CDMA mode, cdma2000 mode, TD-SCDMA mode, ISDB-T mode, CMMB mode, LTE mode, LTE TDD mode, BLUETOOTH mode, WLAN mode, 1xEVDO mode or WIMAX OFDMA mode to use this command. Use:INSTrument:SElect to set the mode.
Preset	SA, WCDMA: 5 MHz

C2K: 1.48 MHz
 WIMAX OFDMA: 10 MHz
 TD-SCDMA: 1.6 MHz
 1xEVDO: 1.48 MHz
 ISDB-T: 5.7 MHz
 CMMB: 7.512 MHz
 LTE, LTETDD: 5 MHz
 BLUETOOTH: 1 MHz
 WLAN:
 If Radio Std is 802.11a/g(OFDM/DSSS-OFDM): 20MHz
 If Radio Std is 802.11b: 25 MHz
 If Radio Std is 802.11n(20MHz): 20 MHz
 If Radio Std is 802.11n(40MHz): 40 MHz
 If Radio Std is 802.11ac(20MHz): 20 MHz
 If Radio Std is 802.11ac(40MHz): 40 MHz
 If Radio Std is 802.11ac(80MHz): 80 MHz
 If Radio Std is 802.11ac(160MHz): 160 MHz
 If Radio Std is 802.11ah(1MHz): 1 MHz
 If Radio Std is 802.11ah(2MHz): 2 MHz
 If Radio Std is 802.11ah(4MHz): 4 MHz
 If Radio Std is 802.11ah(8MHz): 8 MHz
 If Radio Std is 802.11ah(16MHz): 16 MHz
 If Radio Std is 802.11j/p(10MHz): 10 MHz
 If Radio Std is 802.11j/p(5MHz): 5 MHz
 SA: OFF
 WCDMA, WIMAX OFDMA, TD-SCDMA, 1xEVDO, ISDB-T, CMMB, LTE, LTETDD: ON

State Saved	Saved in instrument state.
Min	1 kHz
Max	Depends on instrument maximum frequency.
Initial S/W Revision	Prior to A.02.00
Modified at S/W Revision	A.03.00

Meas Preset

Restores all measurement parameters to their default values.

Key Path	Meas Setup
Mode	SA, WCDMA, C2K, WIMAX OFDMA, TD-SCDMA, 1xEVDO, ISDB-T, CMMB, LTE, LTETDD, BLUETOOTH, WLAN, MSR, LTEAFDD, LTEATDD
Remote Command	:CONFigure:OBWidth

Example	CONF:OBW
Initial S/W Revision	Prior to A.02.00
Modified at S/W Revision	A.03.00

Max Hold (Remote Command Only)

When On, Max Hold displays and holds the maximum responses of the current measurement. Turn Max Hold to Off to disable the maximum hold feature.

Key Path	SCPI Only
Mode	SA, WCDMA, C2K, WIMAX OFDMA, TD-SCDMA, 1xEVDO, ISDB-T, CMMB, LTE, LTE TDD, BLUETOOTH, WLAN, MSR, LTEAFDD, LTEATDD
Remote Command	[:SENSe]:OBwidth:MAXHold ON OFF 1 0 [:SENSe]:OBwidth:MAXHold?
Example	OBW:MAXH ON OBW:MAXH?
Notes	You must be in the Spectrum Analysis mode, W-CDMA mode, cdma2000 mode, TD-SCDMA mode, ISDB-T mode, CMMB mode, LTE mode, LTE TDD mode, BLUETOOTH mode, WLAN mode, 1xEVDO mode, MSR, LTE-Advanced FDD/TDD or WIMAX OFDMA mode to use this command. Use:INSTrument:SElect to set the mode.
Couplings	Max Hold is coupled to Average/Hold state. The Max Hold function is activated only if Average state is On. If Max Hold is changed to On when Average state is Off, Average state is automatically set to On.
Preset	OFF
State Saved	Saved in instrument state.
Range	On Off
Backwards Compatibility SCPI	[:SENSe]:EBwidth:MAXHold
Initial S/W Revision	Prior to A.02.00
Modified at S/W Revision	A.03.00

Mode

See "[Mode](#)" on page 353

Mode Preset

Returns the active mode to a known state.

Mode Preset does the following for the currently active mode:

- Aborts the currently running measurement.
- Brings up the default menu for the mode, with no active function.
- Sets measurement Global settings to their preset values for the active mode only.
- Activates the default measurement.
- Brings up the default menu for the mode.
- Clears the input and output buffers.
- Sets Status Byte to 0.

Mode Preset does not:

- Cause a mode switch
- Affect mode persistent settings
- Affect system settings
- See "[How-To Preset](#)" on [page 1419](#) for more information.

Key Path	Front-panel key
Remote Command	:SYSTem:PRESet
Example	:SYST:PRES
Notes	<p>*RST is preferred over :SYST:PRES for remote operation. *RST does a Mode Preset, as done by the :SYST:PRES command, and it sets the measurement mode to Single measurement rather than Continuous for optimal remote control throughput.</p> <p>Clears all pending OPC bits. The Status Byte is set to 0.</p>
Couplings	A Mode Preset aborts the currently running measurement, activates the default measurement, and gets the mode to a consistent state with all of the default couplings set.
Backwards Compatibility Notes	<p>In the X-Series, the legacy "Factory Preset" has been replaced with Mode Preset, which only presets the currently active mode, not the entire instrument. In the X-Series, the way to preset the entire instrument is by using System, Restore System Defaults All, which behaves essentially the same way as restore System Defaults does on ESA and PSA.</p> <p>There is also no "Preset Type" as there is on the PSA. There is a green Mode Preset front-panel key that does a Mode Preset and a white-with-green-letters User Preset front-panel key that does a User Preset. The old PRESet:TYPE command is ignored (without generating an error), and SYST:PRES without a parameter does a Mode Preset, which should cover most backward code compatibility issues.</p> <p>The settings and correction data under the Input/Output front-panel key (examples: Input Z Corr,</p>

Ext Amp Gain, etc.) are no longer part of any Mode, so they will not be preset by a Mode Preset. They are preset using Restore Input/Output Defaults, Restore System Defaults All. Note that because User Preset does a Recall State, and all of these settings are saved in State, they ARE recalled when using User Preset.

Initial S/W Revision Prior to A.02.00

How-To Preset

The table below shows all possible presets, their corresponding SCPI commands and front-panel access (key paths). Instrument settings depend on the current measurement context. Some settings are local to the current measurement, some are global (common) across all the measurements in the current mode, and some are global to all the available modes. In a similar way, restoring the settings to their preset state can be done within the different contexts.

Auto Couple - is a measurement local key. It sets all Auto/Man parameter couplings in the measurement to Auto. Any Auto/Man selection that is local to other measurements in the mode will not be affected.

Meas Preset - is a measurement local key. Meas Preset resets all the variables local to the current measurement except the persistent ones.

Mode Preset - resets all the current mode's measurement local and measurement global variables except the persistent ones.

Restore Mode Defaults - resets ALL the Mode variables (and all the Meas global and Meas local variables), including the persistent ones.

Type Of Preset	SCPI Command	Front Panel Access
Auto Couple	:COUPle ALL	Auto Couple front-panel key
Meas Preset	:CONFigure: <Measurement>	Meas Setup Menu
Mode Preset	:SYSTem:PRESet	Mode Preset (green key)
Restore Mode Defaults	:INSTrument:DEFault	Mode Setup Menu
Restore All Mode Defaults	:SYSTem:DEFault MODes	System Menu; Restore System Default Menu
*RST	*RST	not possible (Mode Preset with Single)
Restore Input/Output Defaults	:SYSTem:DEFault INPut	System Menu; Restore System Default Menu
Restore Power On Defaults	:SYSTem:DEFault PON	System Menu; Restore System Default Menu
Restore Alignment Defaults	:SYSTem:DEFault ALIGn	System Menu; Restore System Default Menu
Restore Miscellaneous Defaults	:SYSTem:DEFault MISC	System Menu; Restore System Default Menu

10 Occupied Bandwidth Measurement
Mode Preset

Restore All System Defaults	:SYSTem:DEFault [ALL] :SYSTem:PRESet:PERSistent	System Menu; Restore System Default Menu
User Preset	:SYSTem:PRESet:USER	User Preset Menu
User Preset All Modes	:SYSTem:PRESet:USER:ALL	User Preset Menu
Power On Mode Preset	:SYSTem:PON:TYPE MODE	System Menu
Power On User Preset	:SYSTem:PON:TYPE USER	System Menu
Power On Last State	:SYSTem:PON:TYPE LAST	System Menu

Mode Setup

See ["Mode Setup" on page 388](#)

Peak Search

Places the selected marker on the trace point with the maximum y-axis value for that marker's trace. Pressing **Peak Search** with the selected marker off causes the selected marker to be set to Normal, then a peak search is immediately performed.

Key Path	Front panel key
Mode	SA, WCDMA, C2K, WIMAX OFDMA, TD-SCDMA, 1xEVDO, ISDB-T, CMMB, LTE, LTETDD, BLUETOOTH, WLAN, MSR, LTEAFDD, LTEATDD
Remote Command	:CALCulate:OBWidth:MARKer[1] 2 ... 12:MAXimum
Example	CALC:OBW:MARK2:MAX
Initial S/W Revision	Prior to A.02.00
Modified at S/W Revision	A.03.00

Print

See "Print " on page 430

Quick Save

The Quick Save front-panel key repeats the most recent save that was performed from the Save menu, with the following exceptions:

- Register saves are not remembered as Saves for the purpose of the Quick Save function
- If the current measurement does not support the last non-register save that was performed, an informational message is generated, “File type not supported for this measurement”

Quick Save repeats the last type of qualified save (that is, a save qualified by the above criteria) in the last save directory by creating a unique filename using the Auto File Naming algorithm described below.

If Quick Save is pressed after startup and before any qualified Save has been performed, the Quick Save function performs a Screen Image save using the current settings for Screen Image saves (current theme, current directory), which then becomes the “last save” for the purpose of subsequent Quick Saves.

The Auto File Naming feature automatically generates a file name for use when saving a file. The filename consists of a prefix and suffix separated by a dot, as is standard for the Windows® file system. A default prefix exists for each of the available file types:

Type	Default Prefix	Menu
State	State_	(Save/Recall)
Trace + State	State_	(Save/Recall)
Screen	Screen_	(Save/Recall)
Amplitude Corrections	Ampcor_	(Import/Export)
Traces	Trace_	(Import/Export)
Limit Lines	LLine_	(Import/Export)
Measurement Result	MeasR_	(Import/Export)
Capture Buffer	CapBuf_	(Import/Export)

A four digit number is appended to the prefix to create a unique file name. The numbering sequence starts at 0000 within each Mode for each file type and updates incrementally to 9999, then wraps to 0000 again. It remembers where it was through a Mode Preset and when leaving and returning to the Mode. It is reset by Restore Misc Defaults and Restore System Defaults and subsequent running of the instrument application. So, for example, the first auto file name generated for State files is State_0000.state. The next is State_0001, and so forth.

One of the key features of Auto File Name is that we guarantee that the Auto File Name will never conflict with an existing file. The algorithm looks for the next

available number. If it gets to 9999, then it looks for holes. If it find no holes, that is no more numbers are available, it gives an error.

For example, if when we get to State_0010.state there is already a State_0010.state file in the current directory, it advances the counter to State_0011.state to ensure that no conflict will exist (and then it verifies that State_0011.state also does not exist in the current directory and advances again if it does, and so forth).

If you enter a file name for a given file type, then the prefix becomes the filename you entered instead of the default prefix, followed by an underscore. The last four letters (the suffix) are the 4-digit number.

For example, if you save a measurement results file as “fred.csv”, then the next auto file name chosen for a measurement results save will be fred_0000.csv.

NOTE

Although 0000 is used in the example above, the number that is used is actually the current number in the Meas Results sequence, that is, the number that would have been used if you had not entered your own file name.

If the filename you entered ends with _dddd, where d=any number, making it look just like an auto file name, then the next auto file name picks up where you left off with the suffix being dddd + 1.

Key Path	Front-panel key
Notes	No remote command for this key specifically.
Initial S/W Revision	Prior to A.02.00

Recall

The **Recall** menu lets you choose what you want to recall, and where you want to recall it from. Among the types of files you can recall are **States and Traces**. In addition, an **Import (Data)** option lets you recall a number of data types stored in CSV files (as used by Excel and other spreadsheet programs).

The default paths for Recall are data type dependent and are the same as for the Save key.

Key Path	Front-panel key
Notes	<p>No remote command for this key specifically, but the :MMEM:LOAD command is available for specific file types. An example is :MMEM:LOAD:STATe <filename>.</p> <p>If you try to recall a State file for a mode that is not licensed or not available in the instrument, an error message will occur and the state will not change.</p>
Backwards Compatibility Notes	<p>In legacy analyzers, it was possible to load a state without affecting the trace data, limit lines or correction data. Similarly (since User Preset is actually loading a state), it was possible to do a User Preset without affecting the trace data, limit lines or correction data.</p> <p>In the X-Series, “state” always includes all of this data; so whenever state is loaded, all of the traces, limit lines and corrections are affected. Although this differs from previous behavior, it is desirable behavior, and should not cause adverse issues for users.</p>
Backwards Compatibility Notes	<p>Recall for the X-Series supports backward compatibility in the sense that you can recall a state file from any X-Series model number and any version of X-Series software. This is only possible if part of the recalling process goes through a limiting step after recalling the mode settings, at least for settings that may vary with version number, model number, option and license differences. If you try to recall a state file onto an instrument with less capability than what was available on the instrument during the save, the recall will ignore the state it doesn't support and it will limit the recalled setting to what it allows.</p> <p>Example: if the saved state includes preamp ON, but the recalling instrument does not have a preamp; the preamp is limited to OFF. Conversely, if you save a state without a preamp, the preamp is OFF in the state file. When this saved file is recalled on an instrument with a licensed preamp, the preamp is changed to OFF. Another example is if the saved state has center frequency set to 20 GHz, but the instrument recalling the saved state is a different model and only supports 13.5 GHz. In this case, the center frequency is limited along with any other frequency based settings. Since the center frequency can't be preserved in this case, the recall limiting tries to at least preserve span to keep the measurement setup as intact as possible.</p> <p>It may be appropriate to issue a warning if the state is limited on the recall; warnings do not go out to SCPI so this would only affect the manual user.</p> <p>Note that there is no state file compatibility outside of the X-Series. For example, you cannot recall a state file from ESA or PSA.</p>
Initial S/W Revision	Prior to A.02.00

State

The **Recall State** menu lets you choose a register or file from which to recall the state.

The content of a state file includes all of the settings and data required to return the analyzer as closely as possible to the Mode it was in, with the exact settings that

were in place, when the save occurred. The Mode settings in each state file include the settings that are affected by Mode Preset, as well as the additional settings affected by Restore Mode Defaults; all of the Mode's settings. In addition, all of the settings of the **Input/Output** system are included, even though they are outside of the Mode's state, because they are needed to restore the complete setup. Persistent System settings (for example, GPIB address) are not affected by either a Mode Preset or Restore Mode Defaults, nor are they included in a saved State file.

Since each state file is only for one Mode, the settings for other Modes are unaffected when it is loaded. **Recall State** will cause a mode switch if the state being recalled is not from the current active mode.

After the recall completes, the message "File <filename> recalled" or "Recalled State Register <register number>" is displayed.

For rapid recalls, the State menu lists 16 registers that you can choose from to recall. Pressing a Register key initiates the recall. You can also select a file from which to recall.

The default path for all State Files is:

My Documents\<<mode name>\state

where <mode name> is the parameter used to select the mode with the INST:SEL command (for example, SA for the Spectrum Analyzer).

See ["More Information" on page 1428](#).

Key Path	Recall
Mode	All
Remote Command	:MMEMory:LOAD:STATe <filename>
Example	:MMEM:LOAD:STAT "myState.state" This recalls the file myState.state on the default path
Example	MMEM:LOAD:STAT "MyStateFile.state" This loads the state file data (on the default file directory path) into the instrument state.
Notes	When you pick a file to recall, the analyzer first verifies that the file is recallable in the current instrument by checking the software version and model number of the instrument. If everything matches, a full recall proceeds by aborting the currently running measurement, clearing any pending operations, and then loading the State from the saved state file. You can open state files from any mode, so recalling a State file switches to the mode that was active when the save occurred. After switching to the mode of the saved state file, mode settings and data (if any for the mode) are loaded with values from the saved file. The saved measurement of the mode becomes the newly active measurement and the data relevant to the measurement (if there is any) is recalled. <ul style="list-style-type: none"> - If there is a mismatch between file version or model number or instrument version or model number, the recall function tries to recall as much as possible and returns a warning message. It may limit settings that differ based on model number, licensing or version number. <p style="text-align: center;">After recalling the state, the Recall State function does the following:</p>

- Makes the saved measurement for the mode the active measurement.
- Clears the input and output buffers.
- Status Byte is set to 0.
- Executes a *CLS

If the file specified is empty an error is generated. If the specified file does not exist, another error is generated. If there is a mismatch between the file and the proper file type, an error is generated. If there is a mismatch between file version or model number or instrument version or model number, a warning is displayed. Then it returns to the State menu and File Open dialog goes away.

After the Recall, the analyzer exits the Recall menu and returns to the previous menu.

Backwards Compatibility SCPI :MMEMory:LOAD:STATE 1,<filename>
For backwards compatibility, the above syntax is supported. The "1" is simply ignored.

Initial S/W Revision Prior to A.02.00

More Information

In measurements that support saving Traces, for example, Swept SA, the Trace data is saved along with the State in the State file. When recalling the State, the Trace data is recalled as well. Traces are recalled exactly as they were stored, including the writing mode and update and display modes. If a Trace was updating and visible when the State was saved, it will come back updating and visible, and its data will be rewritten right away. When you use State to save and recall traces, any trace whose data must be preserved should be placed in View or Blank mode before saving.

The following table describes the Trace Save and Recall possibilities:

You want to recall state and one trace's data, leaving other traces unaffected.	Save Trace+State from 1 trace. Make sure that no other traces are updating (they should all be in View or Blank mode) when the save is performed.	On Recall, specify the trace you want to load the one trace's data into. This trace will load in View. All other traces' data will be unaffected, although their trace mode will be as it was when the state save was performed.
You want to recall all traces	Save Trace+State from ALL traces.	On Recall, all traces will come back in View (or Blank if they were in Blank or Background when saved)
You want all traces to load exactly as they were when saved.	Save State	On recall, all traces' mode and data will be exactly as they were when saved. Any traces that were updating will have their data immediately overwritten.

From File...

When you press “From File”, the analyzer brings up a Windows dialog and a menu entitled “File Open.” This menu allows you to navigate to the various fields in the Windows dialog without using a keyboard or mouse. The **Tab** and **Arrow** keys can also be used for dialog navigation.

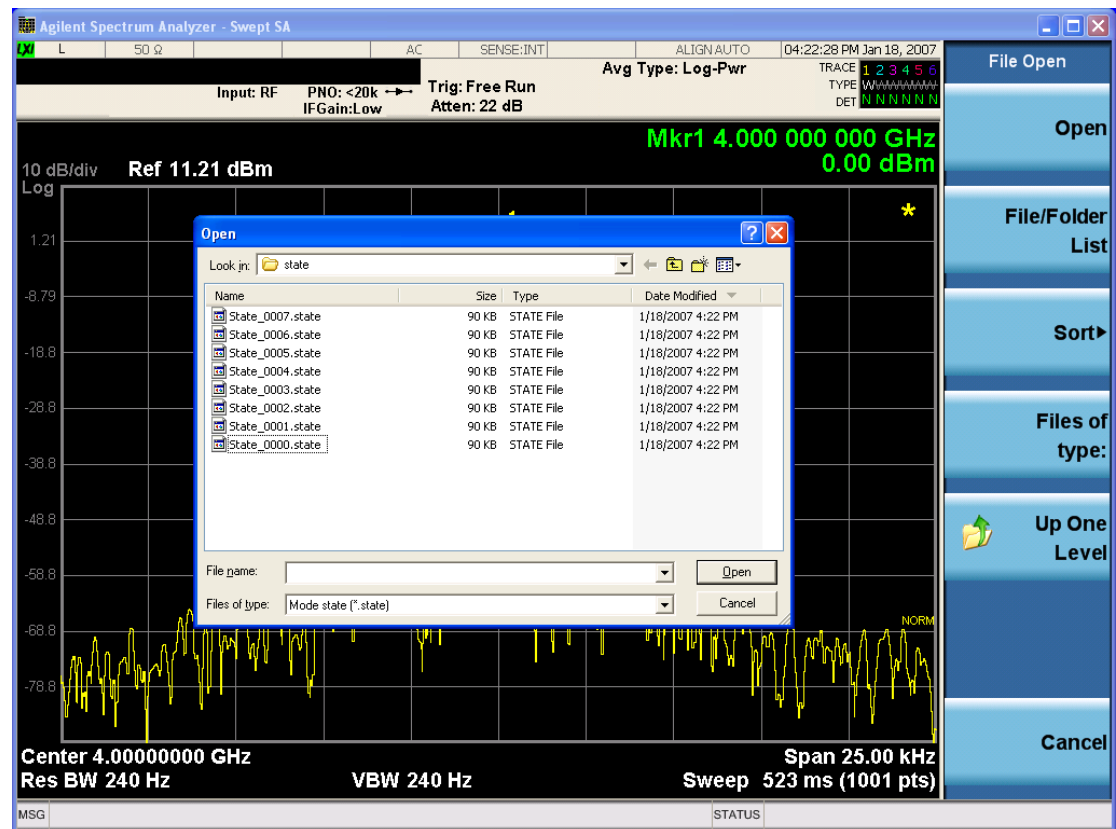

Listed below are the functions of the various fields in the dialog, and the corresponding softkeys:

Open

Performs the recall of the specified file. While the recall is being performed, the floppy icon appears briefly in the Meas bar.

File/Folder List

Enables you to navigate to the center of the dialog that contains the list of files and folders. Once here you can get information about the file and use the tab keys to navigate to the other fields in the dialog, such as Look In.

Look In

The **Look In** field shows the path from which the file will be recalled and allows you to change the path using the up and down arrow keys to navigate to other paths; the Enter key to open a directory; and the Backspace key to go back one directory. The **Look In** field first uses the last path from the Save As dialog **Save In:** path for that

same file type. There is no softkey for directly navigating to the Look In field, but you can use the left tab to get here from the File/Folder List.

User specified paths are remembered when you leave and return to a Mode and are reset back to the default using **Restore Mode Defaults**.

Sort

Accesses a menu that enables you to sort the files within the File Open dialog. Only one sorting type can be selected at a time and the sorting happens immediately. The sorting types are **By Date**, **By Name**, **By extension**, and **By Size**.

Files of Type

This field shows the file suffix for the type of file you have selected to recall. For example, if you navigated here while recalling State, "Mode state (*.state)" is in the field. If you navigated here while recalling Trace, "Mode state (*.trace)" is in the field. If you navigated here while importing a trace data file, "Trace Data (*.csv)" is in the field. For some file types, there is more than one choice in the dropdown menu, which you can select by using the up and down arrow keys and Enter.

Up One Level

This key corresponds to the icon of a folder with the up arrow that is in the tool bar of the dialog. When pressed, it causes the file and folder list to navigate up one level in the directory structure. The Backspace key does the same thing.

Cancel

This key corresponds to the **Cancel** selection in the dialog. It causes the current **Open** request to be cancelled. The ESC key does the same thing.

Key Path	Recall, State
Notes	Brings up the Open dialog for recalling a State Save Type
Initial S/W Revision	Prior to A.02.00

Edit Register Names

You may enter a custom name on any of the Register keys, to help you remember what you are using that state to save. To do this, press the **Edit Register Names** key, choose the register whose name you wish to edit, and then enter the desired label using the Alpha Editor or an external PC keyboard.

The maximum number of characters that can be added is 30. In most cases, 30 characters will fit on two lines of the key.

For more information and the SCPI command, see Edit Register Names under the **Save, State** function.

Key Path	Recall, State
Mode	All
Dependencies	N9060A-7FP or N9060B-2FP license required to edit the register names. When the feature is not licensed, sending the SCPI command generates an error, -221,"Settings conflict;Option not

	available"
Initial S/W Revision	A.11.00

Register 1 thru Register 16

Selecting any one of these register keys causes the State of the mode from the specified Register to be recalled. Each of the register keys annotates whether it is empty or at what date and time it was last modified. In addition, you can use the **Edit Register Names** key under **Save, State** to enter custom names for each register.

Registers are shared by all modes, so recalling from any one of the registers will cause a mode switch to the mode that was active when the save to the Register occurred.

Although these 16 registers are the only registers available from the front panel, there are 128 state registers available in the instrument. Registers 17-128 are only available from the SCPI interface, using the *RCL command.

After the recall completes, the message "Register <register number> recalled" appears in the message bar. If you are in the Spectrum Analyzer Mode, and you are recalling a register that was saved in the Spectrum Analyzer Mode, then after the recall, you will still be in the Recall Register menu. If the Recall causes you to switch modes, then after the Recall, you will be in the Frequency menu.

If a requested register is empty an error is generated.

Key Path	Recall, State
Example	*RCL 1
Range	1-16 from front panel, 1-128 from SCPI
Readback	Date and time with seconds resolution are displayed on the key OR A custom name of up to 30 characters entered using the Save, State,Edit Register Names key OR “(empty)” if no prior save operation has been performed to this register.
Initial S/W Revision	Prior to A.02.00
Modified at S/W Revision	Prior to A.11.00

Register 1 thru Register 16

Selecting any one of these register keys causes the State of the mode from the specified Register to be recalled. Each of the register keys annotates whether it is empty or at what date and time it was last modified. In addition, you can use the **Edit Register Names** key under **Save, State** to enter custom names for each register.

Registers are shared by all modes, so recalling from any one of the registers will cause a mode switch to the mode that was active when the save to the Register occurred.

Although these 16 registers are the only registers available from the front panel, there are 128 state registers available in the instrument. Registers 17-128 are only available from the SCPI interface, using the *RCL command.

After the recall completes, the message "Register <register number> recalled" appears in the message bar. If you are in the Spectrum Analyzer Mode, and you are recalling a register that was saved in the Spectrum Analyzer Mode, then after the recall, you will still be in the Recall Register menu. If the Recall causes you to switch modes, then after the Recall, you will be in the Frequency menu.

If a requested register is empty an error is generated.

Key Path	Recall, State
Example	*RCL 1
Range	1-16 from front panel, 1-128 from SCPI
Readback	Date and time with seconds resolution are displayed on the key OR A custom name of up to 30 characters entered using the Save, State, Edit Register Names key OR “(empty)” if no prior save operation has been performed to this register.
Initial S/W Revision	Prior to A.02.00
Modified at S/W Revision	Prior to A.11.00

Trace (+State)

The Recall Trace (+State) menu lets you choose a register or file from which to recall the Trace+State state file.

A saved state contains all of the settings and data required to return the analyzer as closely as possible to the exact setup it had when the save occurred. This includes the Input/Output settings, even though they are outside of the Mode’s state, because they are needed to restore the complete setup. A Trace+State file also includes trace data from one trace or all traces, which will load in View mode when the Trace+State file is recalled. Recall Trace (+State) will also cause a mode switch if the state being recalled is not for the current active mode.

After the recall completes, the message "File <filename> recalled" or “Recalled Trace Register <register number>” is displayed.

For rapid recalls, the Trace (+State) menu lists 5 registers to choose from to recall. Pressing a Register key initiates the recall. You can also select a file from which to recall.

The default path for all State Files including .trace files is:

My Documents\<mode name>\state

where <mode name> is the parameter used to select the mode with the INST:SEL command (for example, SA for the Spectrum Analyzer).

Key Path	Recall
Mode	SA
Remote Command	<pre>:MMEMory:LOAD:TRACe TRACE1 TRACE2 TRACE3 TRACE4 TRACE5 TRACE6,<filename> :MMEMory:LOAD:TRACe:REGister TRACE1 TRACE2 TRACE3 TRACE4 TRACE5 TRACE6,<integer></pre>
Example	<pre>MMEM:LOAD:TRAC TRACE2, "MyTraceFile.trace"</pre> <p>This loads the trace file data (on the default file directory path) into the specified trace; if it is a "single trace" save file, that trace is loaded to trace 2, and is set to be not updating.</p> <pre>:MMEM:LOAD:TRAC:REG TRACE1,2</pre> <p>restores the trace data in register 2 to Trace 1</p>
Notes	<p>When you perform the recall, the recalling Trace function must first verify the file is recallable in this instrument by checking instrument software version and model number, since it includes State. If everything matches, a full recall proceeds by aborting the currently running measurement, and loading the state from the saved state file to as close as possible to the context in which the save occurred. You can open .trace files from any mode that supports them, so recalling a Trace file switches to the mode that was active when the save occurred. After switching to the mode of the saved state file, mode settings and data (if any for the mode) are loaded with values from the saved file and the saved measurement of the mode becomes the newly active measurement, and the data relevant to the measurement (if there is any) is recalled.</p> <p>Once the state is loaded, the trace data must be loaded. The internal flags are consulted to see which trace to load and the "To Trace" setting to see where to load it. Trace data is always loaded with the specified trace set to View, so that the data is visible and not updating (so as not to erase the recalled data). If the file is an "all trace" file, all traces are loaded with the saved data (to the original trace the data was saved from) and set to View. Traces whose data is not loaded are restored to the update state that existed when they were saved.</p> <p>After the Recall the analyzer exits the Recall menu and returns to the previous menu.</p> <p>Some modes and measurements do not have available all 6 traces. Phase Noise mode command, for example, is: <code>MMEMory:LOAD:TRACe TRACE1 TRACE2 TRACE3,<filename></code></p> <p>Some modes and measurements have more than 6 traces available. The Realtime SA mode command, for example, is: <code>MMEMory:STORe:TRACe TRACE1 TRACE2 TRACE3 TRACE4 TRACE5 TRACE6 TRACE7 TRACE8 TRACE9 TRACE10 TRACE11 TRACE12 ALL,<filename></code></p>
Initial S/W Revision	Prior to A.02.00

To Trace

These menu selections let you choose the Trace where the recalled saved trace will go. Not all modes have the full 6 traces available. The default is the currently selected trace, selected in this menu or in the Trace/Detector, Export Data, Import Data, or Save Trace menus, except if you have chosen All, then it remains chosen until you specifically change it to a single trace.

If the .trace file is an "all trace" file, "**To Trace**" is ignored and the traces each go back to the trace from which they were saved.

Once selected, the key returns back to the Recall Trace menu and the selected Trace number is annotated on the key. Now you have selected exactly where the

trace needs to be recalled. To trigger a recall of the selected Trace, you must select the **Open** key in the Recall Trace menu.

When you select a trace, it makes that trace the current trace, so it displays on top of all of the other traces.

Key Path	Save, Data, Trace
Mode	SA
Initial S/W Revision	Prior to A.02.00

Register 1 thru Register 16

Selecting any one of these register keys causes the State of the mode from the specified Register to be recalled. Each of the register keys annotates whether it is empty or at what date and time it was last modified. In addition, you can use the **Edit Register Names** key under **Save, State** to enter custom names for each register.

Registers are shared by all modes, so recalling from any one of the registers will cause a mode switch to the mode that was active when the save to the Register occurred.

Although these 16 registers are the only registers available from the front panel, there are 128 state registers available in the instrument. Registers 17-128 are only available from the SCPI interface, using the *RCL command.

After the recall completes, the message "Register <register number> recalled" appears in the message bar. If you are in the Spectrum Analyzer Mode, and you are recalling a register that was saved in the Spectrum Analyzer Mode, then after the recall, you will still be in the Recall Register menu. If the Recall causes you to switch modes, then after the Recall, you will be in the Frequency menu.

If a requested register is empty an error is generated.

Key Path	Recall, State
Example	*RCL 1
Range	1-16 from front panel, 1-128 from SCPI
Readback	Date and time with seconds resolution are displayed on the key OR A custom name of up to 30 characters entered using the Save, State, Edit Register Names key OR “(empty)” if no prior save operation has been performed to this register.
Initial S/W Revision	Prior to A.02.00
Modified at S/W Revision	Prior to A.11.00

From File...

When you press “From File”, the analyzer brings up a Windows dialog and a menu entitled “**File Open.**” This menu allows you to navigate to the various fields in the

Windows dialog without using a keyboard or mouse. The **Tab** and **Arrow** keys can also be used for dialog navigation.

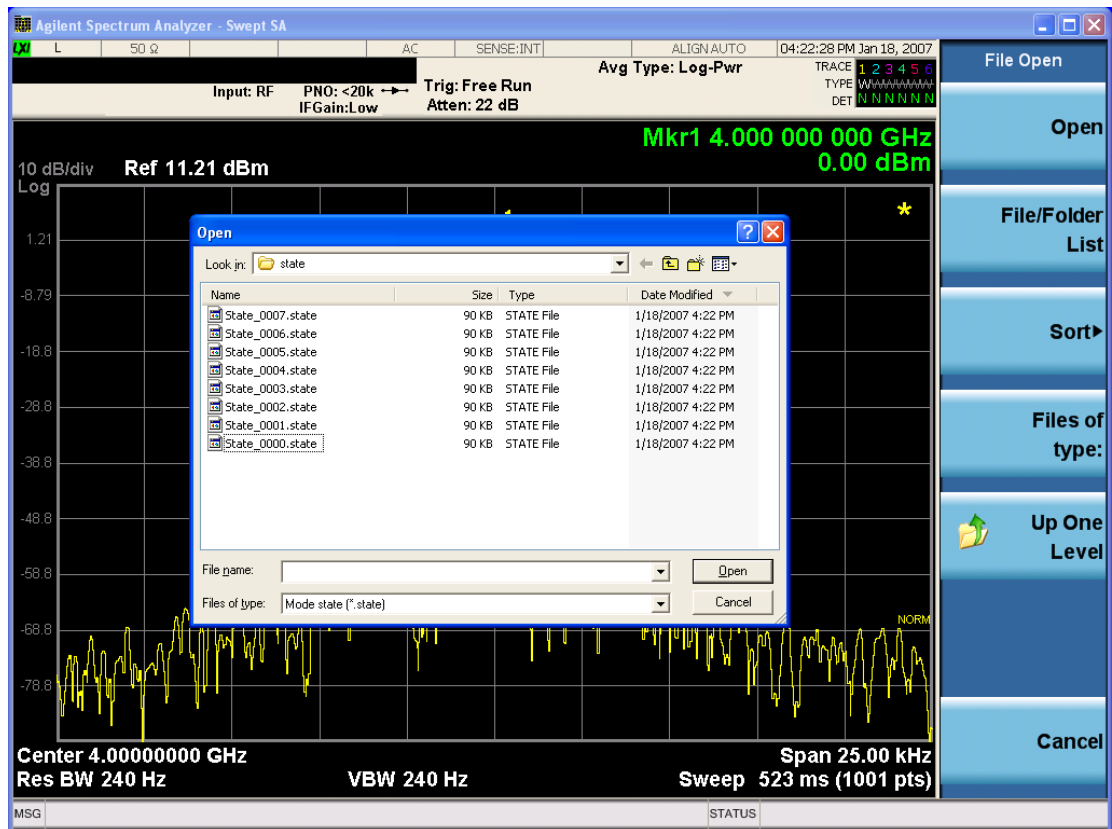

Listed below are the functions of the various fields in the dialog, and the corresponding softkeys:

Open

Performs the recall of the specified file. While the recall is being performed, the floppy icon appears briefly in the Meas bar.

File/Folder List

Enables you to navigate to the center of the dialog that contains the list of files and folders. Once here you can get information about the file and use the tab keys to navigate to the other fields in the dialog, such as Look In.

Look In

The **Look In** field shows the path from which the file will be recalled and allows you to change the path using the up and down arrow keys to navigate to other paths; the Enter key to open a directory; and the Backspace key to go back one directory. The **Look In** field first uses the last path from the Save As dialog **Save In:** path for that same file type. There is no softkey for directly navigating to the Look In field, but you can use the left tab to get here from the File/Folder List.

User specified paths are remembered when you leave and return to a Mode and are reset back to the default using **Restore Mode Defaults**.

Sort

Accesses a menu that enables you to sort the files within the File Open dialog. Only one sorting type can be selected at a time and the sorting happens immediately. The sorting types are **By Date, By Name, By extension, and By Size**.

Files of Type

This field shows the file suffix for the type of file you have selected to recall. For example, if you navigated here while recalling State, "Mode state (*.state)" is in the field. If you navigated here while recalling Trace, "Mode state (*.trace)" is in the field. If you navigated here while importing a trace data file, "Trace Data (*.csv)" is in the field. For some file types, there is more than one choice in the dropdown menu, which you can select by using the up and down arrow keys and Enter.

Up One Level

This key corresponds to the icon of a folder with the up arrow that is in the tool bar of the dialog. When pressed, it causes the file and folder list to navigate up one level in the directory structure. The Backspace key does the same thing.

Cancel

This key corresponds to the **Cancel** selection in the dialog. It causes the current **Open** request to be cancelled. The ESC key does the same thing.

Key Path	Recall, State
Notes	Brings up the Open dialog for recalling a State Save Type
Initial S/W Revision	Prior to A.02.00

Data (Import)

Importing a data file loads data that was previously saved from the current measurement or from other measurements and/or modes that produce compatible data files. The Import Menu only contains Data Types that are supported by the current measurement.

Since the commonly exported data files are in .csv format, the data can be edited by the user prior to importing. This allows you to export a data file, manipulate the data in Excel (the most common PC Application for manipulating .csv files) and then import it.

Importing Data loads measurement data from the specified file into the specified or default destination, depending on the data type selected. Selecting an Import Data menu key will not actually cause the importing to occur, since the analyzer still needs to know from where to get the data. Pressing the Open key in this menu brings up the Open dialog and Open menu that provides you with the options from where to recall the data. Once a filename has been selected or entered in the Open menu, the recall occurs as soon as the Open button is pressed.

Key Path	Recall
Mode	All
Notes	The menu is built from whatever data types are available for the mode. Some keys will be missing completely, so the key locations in the sub-menu will vary. No SCPI command directly controls the Data Type that this key controls. The Data Type is included in the MMEM:LOAD commands.
Dependencies	If a file type is not used by a certain measurement, it is grayed out for that measurement. The key for a file type will not show at all if there are no measurements in the Mode that support it.
Preset	Is not affected by Preset or shutdown, but is reset during Restore Mode Defaults
Readback	The data type that is currently selected
Initial S/W Revision	Prior to A.02.00

Amplitude Correction

This key selects the Amplitude Corrections as the data type to be imported. When pressed a second time, it brings up the Select Menu, which lets you select the Correction into which the data will be imported.

Amplitude Corrections are fully discussed in the documentation of the Input/Output key, under the Corrections key.

A set of preloaded Corrections files can be found in the directory

/My Documents/ EMC Limits and Ampcor.

When the Amplitude Correction is an Antenna correction and the Antenna Unit in the file is not **None**, the Y Axis Unit setting will change to match the Antenna Unit in the file.

Key Path	Recall
Mode	SA EDGE GSM PN
Remote Command	:MMEMory:LOAD:CORRection 1 2 3 4 5 6 7 8, <filename>
Example	:MMEM:LOAD:CORR 2, "myAmpcor.csv" recalls the Amplitude Correction data from the file myAmpcor.csv in the current directory to the 2nd Amplitude Correction table, and turns on Correction 2. The default path is D:\Users\Instrument\My Documents\amplitudeCorrections\
Dependencies	Only the first correction array (Correction 1) supports antenna units. This means that a correction file with an Antenna Unit can only be loaded into the Corrections 1 register. Consequently only for Correction 1 does the dropdown in the Recall dialog include ant, and if an attempt is made to load a correction file into any other Correction register which DOES contain an antenna unit, a Mass Storage error is generated. Corrections are not supported by all Measurements. If in a Mode in which some Measurements support it, this key will be grayed out in measurements that do not. The key will not show at all if no measurements in the Mode support it. Errors are reported if the file is empty or missing, or if the file type does not match, or if there is a mismatch between the file type and the destination data type. If any of these occur during manual operation, the analyzer returns to the Import Data menu and the File Open dialog goes away.

	This key does not appear unless you have the proper option installed in your instrument. This command will generate an “Option not available” error unless you have the proper option installed in your instrument.
Couplings	When a correction file is loaded from mass storage, it is automatically turned on (Correction ON) and ApplyCorrections is set to On. This allows you to see its effect, thus confirming the load.
Readback	selected Correction
Backwards Compatibility SCPI	:MMEMory:LOAD:CORRection ANTenna CABLE OTHER USER, <filename> For backwards compatibility, ANTenna maps to 1, CABLE maps to 2, OTHER maps to 3 and USER maps to 4
Initial S/W Revision	A.02.00

Amplitude Correction

These keys let you select which Correction to import the data into. Once selected, the key returns back to the Import Data menu and the selected Correction number is annotated on the key. The next step is to select the Open key in the Import Data menu.

Antenna corrections are a particular kind of Amplitude Corrections – they are distinguished in the corrections file by having the Antenna Unit set to a value other than None. Only Correction 1 supports Antenna Units.

Key Path	Recall, Data, Amplitude Correction
Notes	auto return
Dependencies	Only Correction 1 may be used to load a Correction that contains an Antenna Unit other than None
Preset	Not part of Preset, but is reset to Correction 1 by Restore Input/Output Defaults; survives shutdown.
State Saved	The current Correction number is saved in instrument state
Initial S/W Revision	A.02.00

Trace

This key selects Trace as the data type to be imported. When pressed a second time, it brings up the Trace Menu, which lets you select the Trace into which the data will be imported.

The trace file contains “meta” data which describes the state of the analyzer when the trace was exported (see ["Trace File Contents" on page 3216](#)). If the meta data in the file does not match the current SA state, the “invalid data indicator” (*) is displayed.

Key Path	Recall, Data
Remote Command	:MMEMory:LOAD:TRACe:DATA TRACE1 TRACE2 TRACE3 TRACE4 TRACE5 TRACE6,<filename>
Example	:MMEM:LOAD:TRAC DATA TRACE2, "myTrace2.csv" Imports the 2nd trace from the file myTrace2.csv in the current path. The default path is My Documents\SA\data\traces
Dependencies	<p>For SA measurements, a trace cannot be recalled from a trace file that was exported with ALL traces selected.</p> <p>A trace cannot be imported if the number of trace points in the file do not match the number of sweep points currently set for the measurement. If this happens, an error message is generated.</p> <p>Errors are reported if the file is empty or missing, or if the file type does not match, or if there is a mismatch between the file type and the destination data type.</p> <p>If any error occurs while trying to load a file manually (as opposed to during remote operation), the analyzer returns to the Import Data menu and the File Open dialog goes away.</p>
Couplings	When a trace is imported, Trace Update is always turned OFF for that trace and Trace Display is always turned ON.
Readback	Selected Trace
Status Bits/OPC dependencies	Sequential - aborts the current measurement.
Initial S/W Revision	Prior to A.02.00

Select Trace

These keys let you pick the Trace into which to import the data; either 1, 2, 3, 4, 5 or 6. The default is the currently selected trace, selected in this menu or in the Trace/Det, Export Data, Recall Trace, or Save Trace menus; except if you have chosen **All** then **All** remains chosen until you specifically change it to a single trace.

Once selected, the key returns back to the Import Data menu and the selected Trace number is annotated on the key. The next step is to select the Open key in the Import Data menu.

Key Path	Recall, Data, Trace
Notes	Auto return
Couplings	When you select the trace into which to import the data, it makes that trace the current trace, so it displays on top of all of the other traces.
Preset	Not part of Preset, but is reset to TRACE1 by Restore Mode Defaults; survives shutdown
State Saved	The current trace number is saved in State
Initial S/W Revision	Prior to A.02.00

Limit

This key selects Limit Lines as the data type to be imported. When pressed a second time, it brings up the Limits Menu, which lets you select into which Limit the data will be imported.

A set of preloaded Limits files can be found in the directory

/My Documents/ EMC Limits and Ampcor.

Under this directory, the directory called Limits (Legacy Naming) contains a set of legacy limits, generally the same files that were supplied with older Agilent EMC analyzers, that use the legacy suffix .lim, and the old 8-character file names. In the directory called Limits, the same files can be found, with the same suffix, but with longer, more descriptive filenames.

Key Path	Recall, Data
Remote Command	:MMEMory:LOAD:LIMit LLINE1 LLINE2,<filename>
Example	:MMEM:LOAD:LIM LLINE2, "myLimitLine2.csv" Imports the 2nd Limit Line from the file myLimitLine2.csv in the current path. The default path is My Documents\SA\data\limits
Dependencies	Errors are reported if the file is empty or missing, or if the file type does not match, or if there is a mismatch between the file type and the destination data type. If any of these occur during manual operation, the analyzer returns to the Import Data menu and the File Open dialog goes away. This key will only appear if you have the proper option installed in your instrument.
Couplings	When a limit line is loaded from mass storage, it is automatically turned on. This allows the user to see it, thus confirming the load. The Margin settings will match those when the limit was saved The instrument cannot mix Limits domains (X Axis Unit must be Frequency or Time for both Limits). So when a Limits file is loaded, the analyzer will set the Limits domain (X Axis Unit) to match that of the file. If this changes the Limits domain from what it was before the file was loaded, all Limits data in all Limits sets will be erased before the data loads. If this operation is over the remote interface there will be no warning if this occurs, so care should be taken to know the domain of the file you are loading.
Readback	Selected Limit Line
Status Bits/OPC dependencies	Sequential - aborts the current measurement
Initial S/W Revision	A.02.00

Limit Selection

These keys let you pick which Limit Line to import the data into; either 1, 2, 3, 4, 5 or 6. The default is the currently selected limit. Once selected, the key returns back to the Import Data menu and the selected Limit Line number is annotated on the key. Now you have selected exactly what needs to be imported. In order to trigger an import of the selected Limit Line, you must select the Open key in the Import Data menu.

An example of using this menu is: If you select 2 and continue to the File Open menu, Limit Line 2 will be imported from the file selected or entered in File Name option in the File Open dialog.

Key Path	Recall, Data, Limit Line
Notes	Auto return
Preset	Not part of Preset, but is reset to LLINE1 by Restore Mode Defaults; survives a shutdown.
State Saved	The selected limit number is saved in instrument state
Initial S/W Revision	A.02.00

Open...

When you press “Open”, the analyzer brings up a Windows dialog and a menu entitled “**File Open.**” This menu allows you to navigate to the various fields in the Windows dialog without using a keyboard or mouse. The **Tab** and **Arrow** keys can also be used for dialog navigation.

See "[From File...](#)" on page 3210 in **Recall, State**, for a full description of this dialog and menu.

Key Path	Recall, Data
Notes	The key location is mode-dependent and will vary. Brings up Open dialog for recalling a <mode specific> Save Type
Initial S/W Revision	Prior to A.02.00

Restart

The Restart function restarts the current sweep, or measurement, or set of averaged/held sweeps or measurements. If you are Paused, pressing Restart does a Resume.

The Restart function is accessed in several ways:

- Pressing the Restart key
- Sending the remote command INIT:IMMEDIATE
- Sending the remote command INIT:RESTART

See ["More Information" on page 1442](#)

Key Path	Front-panel key
Remote Command	:INITiate[:IMMEDIATE] :INITiate:RESTART
Example	:INIT:IMM :INIT:REST
Notes	:INITiate:RESTART and :INITiate:IMMEDIATE perform exactly the same function.
Couplings	Resets average/hold count k. For the first sweep overwrites all active (update=on) traces with new current data. For application modes, it resets other parameters as required by the measurement.
Status Bits/OPC dependencies	This is an Overlapped command. The STATus:OPERation register bits 0 through 8 are cleared. The STATus:QUESTionable register bit 9 (INTegrity sum) is cleared. The SWEEPING bit is set. The MEASURING bit is set.
Backwards Compatibility Notes	For Spectrum Analysis mode in ESA and PSA, the Restart hardkey and the INITiate:RESTART command restart trace averages (displayed average count reset to 1) for a trace in Clear Write , but did not restart Max Hold and Min Hold . In the X-Series, the Restart hardkey and the INITiate:RESTART command restart not only Trace Average , but MaxHold and MinHold traces as well. For wireless comms modes in ESA and PSA, the Restart hardkey and the INITiate:RESTART command restart every measurement, which includes all traces and numeric results. There is no change to this operation.
Initial S/W Revision	Prior to A.02.00

More Information

The **Restart** function first aborts the current sweep/measurement as quickly as possible. It then resets the sweep and trigger systems, sets up the measurement and initiates a new data measurement sequence with a new data acquisition (sweep) taken once the trigger condition is met.

If the analyzer is in the process of aligning when **Restart** is executed, the alignment finishes before the restart function is performed.

Even when set for Single operation, multiple sweeps may be taken when Restart is pressed (for example, when averaging/holding is on). Thus when we say that **Restart** "restarts a measurement," we may mean:

- It restarts the current sweep
- It restarts the current measurement
- It restarts the current set of sweeps if any trace is in Trace Average, Max Hold or Min Hold
- It restarts the current set of measurements if Averaging, or Max Hold, or Min Hold is on for the measurement
- depending on the current settings.

With **Average/Hold Number** (in **Meas Setup** menu) set to 1, or Averaging off, or no trace in Trace Average or Hold, a single sweep is equivalent to a single measurement. A single sweep is taken after the trigger condition is met; and the analyzer stops sweeping once that sweep has completed. However, with **Average/Hold Number** > 1 and at least one trace set to **Trace Average, Max Hold, or Min Hold (SA Measurement)** or **Averaging on (most other measurements)**, multiple sweeps/data acquisitions are taken for a single measurement. The trigger condition must be met prior to each sweep. The sweep is stopped when the average count k equals the number N set for **Average/Hold Number**. A measurement average usually applies to all traces, marker results, and numeric results; but sometimes it only applies to the numeric results.

Once the full set of sweeps has been taken, the analyzer will go to idle state. To take one more sweep without resetting the average count, increment the average count by 1, by pressing the step up key while **Average/Hold Number** is the active function, or sending the remote command `CALC: AVER: TCON UP`.

Save

The **Save** menu lets you choose what you want to save and where you want to save it. Among the types of files you can save are **States**, **Traces**, and **Screen Images**. In addition, an **Export (Data)** option lets you save a number of data types as CSV files for easy import into Excel and other spreadsheet programs.

Key Path	Front-panel key
Mode	All
Notes	No remote command for this key specifically, but the :MMEM:STORe command is available for specific file types. An example is :MMEM:STOR:STATe <filename>.
Initial S/W Revision	Prior to A.02.00

State

The Save State menu lets you choose a register or file for saving the state.

The content of a state file includes all of the settings and data required to return the analyzer as closely as possible to the Mode it was in, with the exact settings which were in place, when the save occurred. The Mode settings in each state file include the settings that are affected by Mode Preset, as well as the additional settings affected by Restore Mode Defaults; all of the Mode's settings. In addition, all of the settings of the **Input/Output** system are included, even though they are outside of the Mode's state, because they are needed to restore the complete setup. Persistent **System** settings (for example, Verbose SCPI) are not affected by either Mode Preset or Restore Mode Defaults, nor are they included in a saved State file.

After the save completes, the message "File <filename> saved" or "State Register <register number> saved" is displayed.

For rapid saving, the State menu lists 16 registers to save to. Pressing a Register key initiates the save. You can also select a file to save to.

The default path for all State Files is:

My Documents\<<mode name>\state

where <mode name> is the parameter used to select the mode with the INST:SEL command (for example, SA for the Spectrum Analyzer).

Key Path	Save
Mode	All
Remote Command	:MMEMory:STORe:STATe <filename>
Example	MMEM:STOR:STATe "MyStateFile.state" This stores the current instrument state data in the file MyStateFile.state in the default directory.
Notes	Both single and double quotes are supported for any filename parameter over remote. After saving to a register, that register's menu key is updated with the date the time, unless a custom label has been entered for that key. After saving to a register, you remain in the Save State menu, so that you can see the Register

	key update. After saving to a file, the analyzer automatically returns to the previous menu and any Save As dialog goes away.
Backwards Compatibility SCPI	:MMEMory:STORe:STATe 1,<filename> For backwards compatibility, the above syntax is supported. The "1" is simply ignored. The command is sequential.
Initial S/W Revision	Prior to A.02.00

To File . . .

When you press "To File", the analyzer brings up a Windows dialog and a menu entitled "**Save As.**" This menu allows you to navigate to the various fields in the Windows dialog without using a keyboard or mouse. The **Tab** and **Arrow** keys can also be used for dialog navigation.

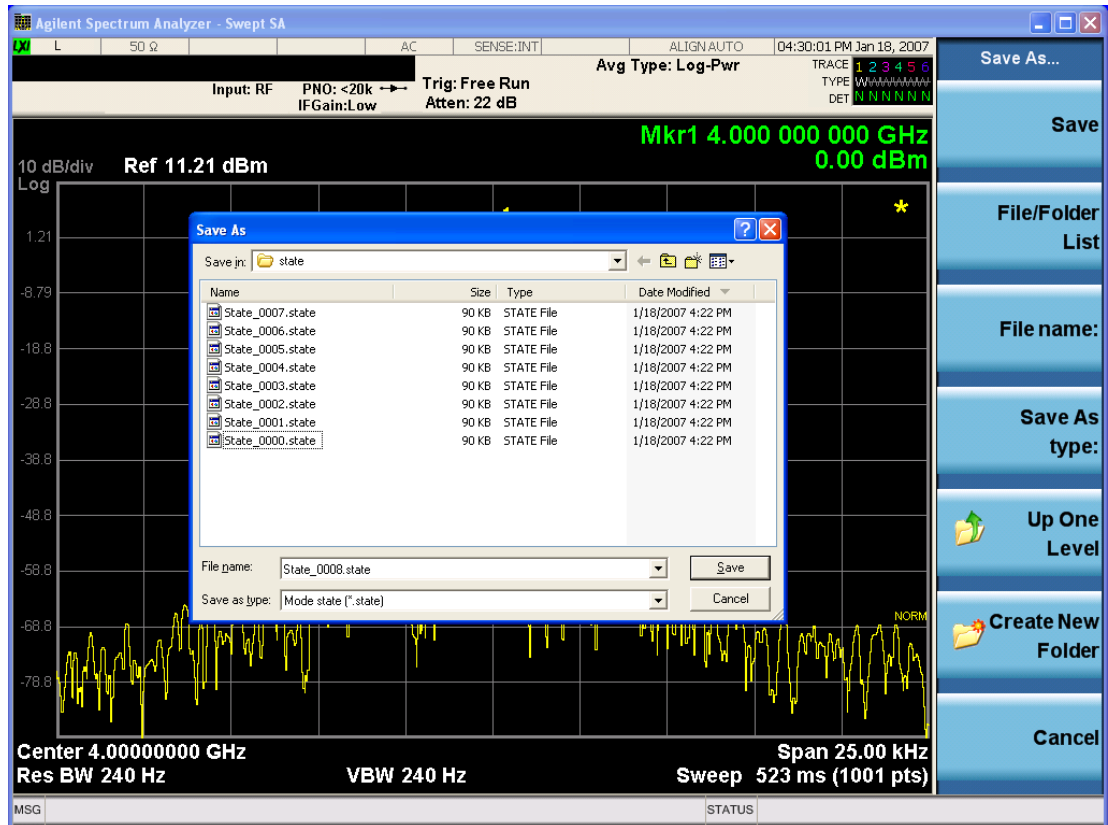

The Listed below are the functions of the various fields in the dialog, and the corresponding softkeys:

Save

Performs the save to the specified file of the selected type. If the file already exists, a dialog will appear that allows you to replace the existing file by selecting **OK**, or you can Cancel the request. If you select OK, the file will be overwritten. Using the C: drive is strongly discouraged, since it runs the risk of being overwritten during an instrument software upgrade.

While the save is being performed, the floppy icon appears briefly in the Meas bar.

File/Folder List

Enables you to navigate to the center of the dialog that contains the list of files and folders. Once here you can get information about the file and use the tab keys to navigate to the other fields in the dialog, such as Save In.

Save In

The Save In field shows the path to which the file will be saved and allows you to change the path using the up and down arrow keys to navigate to other paths; the Enter key to open a directory; and the Backspace key to go back one directory. The **Save In field** defaults to the default path for this type of file and remembers the last path you used to save this type of file. There is no softkey for directly navigating to the Save In field but you can use left tab to get here from the File/Folder List.

User specified paths are remembered when you leave and return to a Mode and are reset back to the default using **Restore Mode Defaults**.

File Name

The **File Name** field is initially loaded with an automatically generated filename specific to the appropriate Save Type. The automatically generated filename is guaranteed not to conflict with any filename currently in the directory. You may replace or modify this filename using the File Name key. See the ["Quick Save " on page 3181](#) documentation for more on the automatic file naming algorithm.

When you press the **File Name** key the analyzer displays the Alpha Editor. Use the knob to choose the letter to add and the front-panel Enter key to add the letter to the file name. The BK character moves you back and the FW character moves you forward in the filename. The Select key on the front panel generates a space character. When you are done entering the filename press the **Done** softkey. This returns back to the **File Open** dialog and menu, but does not cause the save to occur.

Save As Type

This field shows the file suffix for the type of file you have selected to save. For example, if you navigated here while saving State, "Mode state (*.state)" is in the field. If you navigated here from saving Trace, "Mode state (*.trace)" is in the field. If you navigated here while exporting a trace data file, "Trace Data (*.csv)" is in the field. For some file types, there is more than one choice in the dropdown, which you can select by using the up and down arrow keys and Enter.

Up One Level

This key corresponds to the icon of a folder with the up arrow that is in the tool bar of the dialog. When pressed, it causes the file and folder list to navigate up one level in the directory structure. The Backspace key does the same thing.

Create New Folder

This key corresponds to the icon of a folder with the "*" that is in the tool bar of the dialog. When pressed, a new folder is created in the current directory with the name **New Folder** and you can enter a new folder name using the Alpha Editor.

Cancel

This key corresponds to the **Cancel** selection in the dialog. It causes the current **Save As** request to be cancelled. The ESC key does the same thing.

Key Path	Save, State
Mode	All
Notes	Brings up Save As dialog for saving a State Save Type
Initial S/W Revision	Prior to A.02.00

Edit Register Names

You may enter a custom name on any of the Register keys, to help you remember what you are using that state to save. To do this, press the **Edit Register Names** key,

choose the register whose name you wish to edit, and then enter the desired label using the Alpha Editor or an external PC keyboard.

The maximum number of characters that can be added is 30. In most cases, 30 characters will fit on two lines of the key.

See ["More Information" on page 1448](#)

Key Path	Save, State
Mode	All
Remote Command	:MMEMory:REGister:STATe:LABe1 <reg number>,"label" :MMEMory:REGister:STATe:LABe1? <reg number>
Example	:MMEM:REG:STAT:LAB 1,"my label"
Notes	<reg number> is an integer from 1 to 16. If the SCPI specifies an invalid register number an error message is generated, -222,"Data out of range;Invalid register label number" "label" is a string from 0 to 30 characters in length. If a label exceeds 30 characters, an error message is generated, -150,"String data error;Label clipped to 30 characters" "label" of length 0 erases the custom label and restores the default (time and date) label. E.g.: :MMEM:REG:STAT:LAB 1,""
Dependencies	N9060A-7FP or N9060B-2FP license required to edit the register names. When the feature is not licensed, sending this command generates an error, -221,"Settings conflict;Option not available"
Preset	The names are unaffected by Preset or power cycle but are set to the default label (time and date) on a "Restore System Defaults->Misc"
Initial S/W Revision	A.11.00

More Information

When you edit one of the register names, the time and date field will be replaced by the custom name.

If you delete all the characters in the custom name, it restores the default (time and date).

The register names are stored within the state files, but they are not part of the instrument state; that is, once you have edited a register name, loading a new state will not change that register name. Another consequence of this is that the names will be persistent through a power cycle. Also, if a named state file is transferred to another analyzer, it will bring its custom name along with it.

If you try to edit the name of an empty register, the analyzer will first save the state to have a file to put the name in. If you load a named state file into an analyzer with older firmware it will ignore the metadata.

The *SAV and *RCL commands will not be affected by the custom register names, nor will the MMEM commands.

Register 1 thru Register 16

Selecting any one of these register menu keys causes the State of the currently active mode to be saved to the specified Register. The registers are provided for rapid saving and recalling, since you do not need to specify a filename or navigate to

a file. Each of the register menu keys annotates whether it is empty or at what date and time it was last modified. In addition, you can use the **Edit Register Names** key to enter custom names for each register.

Although these 16 registers are the only registers available from the front panel, there are 128 state registers available in the instrument. Registers 17-128 are only available from the SCPI interface, using the *SAV command.

There is one set of 128 state registers in the instrument, not one set for each Mode. When a state is saved, the Mode it was saved from is saved with it; then when it is recalled, the instrument switches to that Mode.

After the save completes, the corresponding register menu key annotation is updated with the date and time and the message "Register <register number> saved" is displayed.

Key Path	Save, State
Mode	All
Example	*SAV 1
Range	1-16 from front panel, 1-128 from SCPI
Readback	Date and time with seconds resolution are displayed on the key OR A custom name of up to 30 characters entered using the Edit Register Names key OR “(empty)” if no prior save operation has been performed to this register.
Initial S/W Revision	Prior to A.02.00
Modified at S/W Revision	A.11.00

Register 1 thru Register 16

Selecting any one of these register menu keys causes the State of the currently active mode to be saved to the specified Register. The registers are provided for rapid saving and recalling, since you do not need to specify a filename or navigate to a file. Each of the register menu keys annotates whether it is empty or at what date and time it was last modified. In addition, you can use the **Edit Register Names** key to enter custom names for each register.

Although these 16 registers are the only registers available from the front panel, there are 128 state registers available in the instrument. Registers 17-128 are only available from the SCPI interface, using the *SAV command.

There is one set of 128 state registers in the instrument, not one set for each Mode. When a state is saved, the Mode it was saved from is saved with it; then when it is recalled, the instrument switches to that Mode.

After the save completes, the corresponding register menu key annotation is updated with the date and time and the message "Register <register number> saved" is displayed.

Key Path	Save, State
Mode	All
Example	*SAV 1
Range	1-16 from front panel, 1-128 from SCPI
Readback	Date and time with seconds resolution are displayed on the key OR A custom name of up to 30 characters entered using the Edit Register Names key OR “(empty)” if no prior save operation has been performed to this register.
Initial S/W Revision	Prior to A.02.00
Modified at S/W Revision	A.11.00

Trace (+State)

The **Save Trace (+State)** menu lets you choose a register or file specifying where to save the Trace+State state file.

A saved state contains all of the settings and data required to return the analyzer as closely as possible to the exact setup it had when the save occurred. This includes the Input/Output settings, even though they are outside of the Mode’s state, because they are needed to restore the complete setup. A Trace+State file also includes trace data from one trace or all traces, which will load in View mode when the Trace+State file is recalled.

After the save completes, the message "File <filename> saved" or "Trace Register <register number> saved" is displayed.

For rapid saves, the Trace (+State) menu lists 5 registers to save to. Pressing a Register key initiates the save. You can also select a file to save to.

The default path for all State Files including .trace files is:

My Documents\<<mode name>\state

where <mode name> is the parameter used to select the mode with the INST:SEL command (for example, Basic for the IQAnalyzer).

This key is grayed out for measurements that do not support trace saves. It is blanked for modes that do not support trace saves. Saving **Trace** is identical to saving State except a .trace extension is used on the file instead of .state, and internal flags are set in the file indicating which trace was saved. You may select to save one trace or ALL traces.

Key Path	Save
Mode	SA
Remote Command	:MMEMory:STORe:TRACe TRACE1 TRACE2 TRACE3 TRACE4 TRACE5 TRACE6 ALL,<filename>

	<code>:MMEMory:STORe:TRACe:REGister TRACE1 TRACE2 TRACE3 TRACE4 TRACE5 TRACE6 ALL,<integer></code>
Example	<p>:MMEM:STOR:TRAC TRACE1, "myState.trace" saves the file myState.trace on the default path and flags it as a "single trace" file with Trace 1 as the single trace (even though all of the traces are in fact stored).</p> <p>:MMEM:STOR:TRAC ALL, "myState.trace" saves the file myState.trace on the default path and flags it as an "all traces" file</p> <p>:MMEM:STOR:TRAC:REG TRACE1, 2 stores trace 1 data in trace register 2</p>
Notes	<p>This command actually performs a save state, which in the Swept SA measurement includes the trace data. However it flags it (in the file) as a "save trace" file of the specified trace (or all traces).</p> <p>Some modes and measurements do not have available all 6 traces. The Phase Noise mode command, for example, is: <code>MMEMory:STORe:TRACe TRACE1 TRACE2 TRACE3 ALL,<filename></code></p> <p>Some modes and measurements have more than 6 traces available. The Realtime SA mode command, for example, is: <code>MMEMory:STORe:TRACe TRACE1 TRACE2 TRACE3 TRACE4 TRACE5 TRACE6 TRACE7 TRACE8 TRACE9 TRACE10 TRACE11 TRACE12 ALL,<filename></code></p> <p>The range for the register parameter is 1-5</p> <p>When you initiate a save, if the file already exists, a dialog will appear that allows you to replace the existing file by selecting OK or you can Cancel the request. If you select OK, the file will be overwritten. Using the C: drive is strongly discouraged, since it runs the risk of being overwritten during an instrument software upgrade.</p> <p>Both single and double quotes are supported for any filename parameter over remote.</p> <p>After saving to a register, that register's menu key is updated with the date and time of the save.</p> <p>After saving to a register, you remain in the Save Trace menu, so that you can see the Register key update. After saving to a file, the analyzer automatically returns to the previous menu and any Save As dialog goes away.</p>
Initial S/W Revision	Prior to A.02.00

Register 1 thru Register 16

Selecting any one of these register menu keys causes the State of the currently active mode to be saved to the specified Register. The registers are provided for rapid saving and recalling, since you do not need to specify a filename or navigate to a file. Each of the register menu keys annotates whether it is empty or at what date and time it was last modified. In addition, you can use the **Edit Register Names** key to enter custom names for each register.

Although these 16 registers are the only registers available from the front panel, there are 128 state registers available in the instrument. Registers 17-128 are only available from the SCPI interface, using the *SAV command.

There is one set of 128 state registers in the instrument, not one set for each Mode. When a state is saved, the Mode it was saved from is saved with it; then when it is recalled, the instrument switches to that Mode.

After the save completes, the corresponding register menu key annotation is updated with the date and time and the message "Register <register number> saved" is displayed.

Key Path	Save, State
Mode	All
Example	*SAV 1
Range	1-16 from front panel, 1-128 from SCPI
Readback	Date and time with seconds resolution are displayed on the key OR A custom name of up to 30 characters entered using the Edit Register Names key OR "(empty)" if no prior save operation has been performed to this register.
Initial S/W Revision	Prior to A.02.00
Modified at S/W Revision	A.11.00

From Trace

Accesses a menu that enables you to select the trace to be saved. Once a trace is selected, the key returns to the Save Trace menu and the selected trace number is annotated on the key. The default is the currently selected trace, selected in this menu or in the Trace/Det, Export Data, Import Data or Recall Trace menus, except if you have chosen All then it remains chosen until you specifically change it to a single trace. To save the Trace you must select the **Save As** key in the Save Trace menu.

When you select a trace, it makes that trace the current trace, so it displays on top of all of the other traces.

Key Path	Save, Trace + State
Mode	SA
Initial S/W Revision	Prior to A.02.00

From File...

When you press "From File", the analyzer brings up a Windows dialog and a menu entitled "**File Open.**" This menu allows you to navigate to the various fields in the Windows dialog without using a keyboard or mouse. The **Tab** and **Arrow** keys can also be used for dialog navigation.

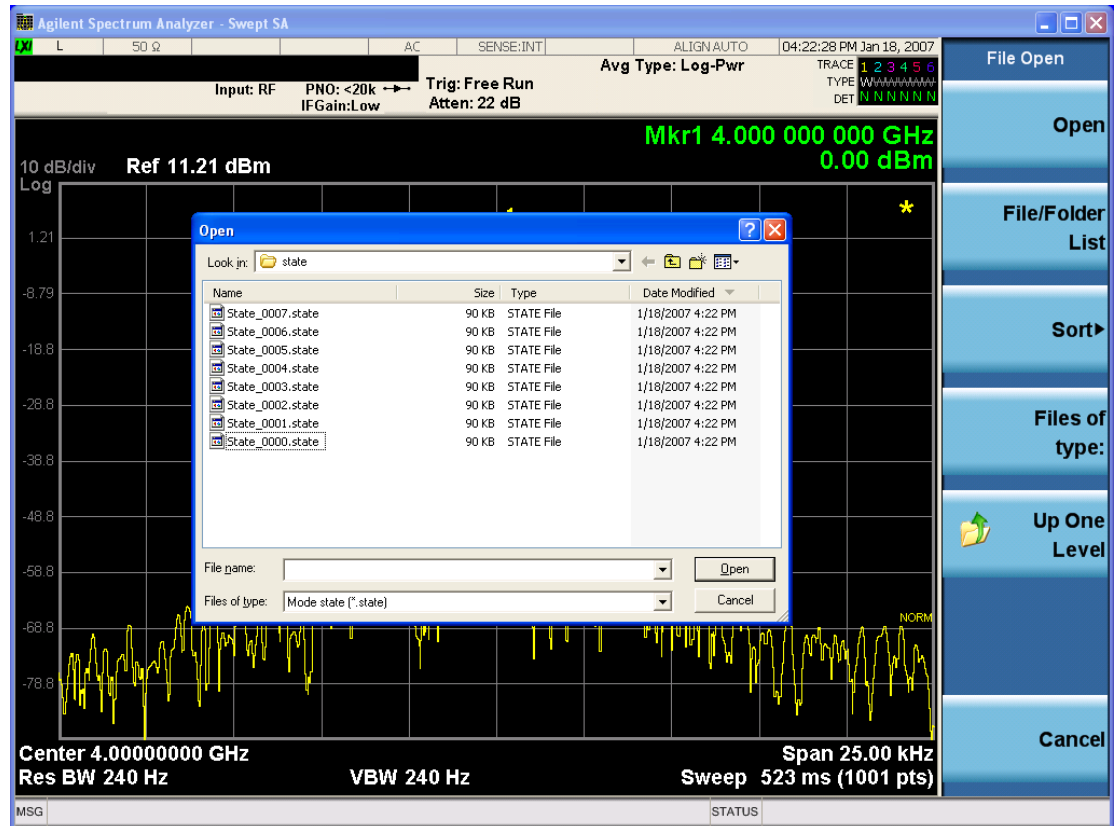

Listed below are the functions of the various fields in the dialog, and the corresponding softkeys:

Open

Performs the recall of the specified file. While the recall is being performed, the floppy icon appears briefly in the Meas bar.

File/Folder List

Enables you to navigate to the center of the dialog that contains the list of files and folders. Once here you can get information about the file and use the tab keys to navigate to the other fields in the dialog, such as Look In.

Look In

The **Look In** field shows the path from which the file will be recalled and allows you to change the path using the up and down arrow keys to navigate to other paths; the Enter key to open a directory; and the Backspace key to go back one directory. The **Look In** field first uses the last path from the Save As dialog **Save In:** path for that same file type. There is no softkey for directly navigating to the Look In field, but you can use the left tab to get here from the File/Folder List.

User specified paths are remembered when you leave and return to a Mode and are reset back to the default using **Restore Mode Defaults**.

Sort

Accesses a menu that enables you to sort the files within the File Open dialog. Only one sorting type can be selected at a time and the sorting happens immediately. The sorting types are **By Date**, **By Name**, **By extension**, and **By Size**.

Files of Type

This field shows the file suffix for the type of file you have selected to recall. For example, if you navigated here while recalling State, "Mode state (*.state)" is in the field. If you navigated here while recalling Trace, "Mode state (*.trace)" is in the field. If you navigated here while importing a trace data file, "Trace Data (*.csv)" is in the field. For some file types, there is more than one choice in the dropdown menu, which you can select by using the up and down arrow keys and Enter.

Up One Level

This key corresponds to the icon of a folder with the up arrow that is in the tool bar of the dialog. When pressed, it causes the file and folder list to navigate up one level in the directory structure. The Backspace key does the same thing.

Cancel

This key corresponds to the **Cancel** selection in the dialog. It causes the current **Open** request to be cancelled. The ESC key does the same thing.

Key Path	Recall, State
Notes	Brings up the Open dialog for recalling a State Save Type
Initial S/W Revision	Prior to A.02.00

Data (Export)

Exporting a data file stores data from the current measurement to mass storage files. The Export Menu only contains data types that are supported by the current measurement.

Since the commonly exported data files are in .csv format, the data can be edited by you prior to importing. This allows you to export a data file, manipulate the data in Excel (the most common PC Application for manipulating .csv files) and then import it.

Selecting an Export Data menu key will not actually cause the exporting to occur, since the analyzer still needs to know where you wish to save the data. Pressing the Save As key in this menu brings up the Save As dialog and Save As menu that allows you to specify the destination file and directory. Once a filename has been selected or entered in the Open menu, the export will occur as soon as the Save key is pressed.

Key Path	Save
Mode	All
Notes	The menu is built from whatever data types are available for the mode. So the key locations in the sub menu will vary. No SCPI command directly controls the Data Type that this key controls. The Data Type is included in the MMEM:STORe commands.

Dependencies	If a file type is not used by a certain measurement, that type is grayed out for that measurement. The key for a file type will not show at all if there are no measurements in the Mode that support it.
Preset	Is not affected by a Preset or shutdown, but is reset during Restore Mode Defaults
Readback	The data type that is currently selected
Initial S/W Revision	Prior to A.02.00

Amplitude Correction

Pressing this key selects **Amplitude Corrections** as the data type to be exported. Pressing this key again brings up the Select Menu, which allows the user to select which **Amplitude Correction** to save.

Amplitude Corrections are fully discussed in the documentation of the Input/Output key, under the Corrections softkey.

See "[Correction Data File](#)" on page 1455

Key Path	Save
Remote Command	:MMEMory:STORe:CORRection 1 2 3 4 5 6, <filename>
Example	:MMEM:STOR:CORR 2 "myAmpcor.csv" saves Correction 2 to the file myAmpcor.csv on the current path. The default path is My Documents\amplitudeCorrections.
Notes	If the save is initiated via SCPI, and the file already exists, the file will be overwritten. Using the C: drive is strongly discouraged, since it runs the risk of being overwritten during an instrument software upgrade. Both single and double quotes are supported for any filename parameter over SCPI.
Dependencies	Corrections are not supported by all Measurements. If in a Mode in which some Measurements support it, this key will be grayed out in measurements that do not. The key will not show at all if no measurements in the Mode support it. This key will not appear unless you have the proper option installed in your instrument.
Readback	Selected Correction
Backwards Compatibility SCPI	:MMEMory:STORe:CORRection ANTenna CABLe OTHer USER, <filename> For backwards compatibility, ANTenna maps to 1, CABLe maps to 2, OTHer maps to 3 and USER maps to 4
Initial S/W Revision	A.02.00

Correction Data File

A Corrections Data File contains a copy of one of the analyzer correction tables. Corrections provide a way to adjust the trace display for predetermined gain curves (such as for cable loss).

Corrections files are text files in .csv (comma separated values) form, to make them importable into Excel or other spreadsheet programs. The format for Corrections files is as follows.

Line #	Type of field	Example	Notes
1	File type, must be "Amplitude Correction"	Amplitude Correction	May not be omitted
2	File Description (in quotes)	"Correction Factors for 11966E"	60 characters max; may be empty but may not be omitted. If exceeds 60 characters, error -233 Too much data reported
3	Comment (in quotes)	"Class B Radiated"	60 characters max; may be empty but may not be omitted. . If exceeds 60 characters, error -233 Too much data reported
4	Instrument Version, Model #	A.02.06,N9020A	May be empty but may not be omitted
5	Option List, File Format Version	K03 LFE EXM ,01	May be empty but may not be omitted
6	Freq Unit to be used for all frequency values in the file	Frequency Unit,MHz	assumed to be Hz if omitted
7	Antenna Unit	Antenna Unit,None	If omitted leaves the Antenna unit unchanged. The amplitude unit in the Antenna Unit field is a conversion factor that is used to adjust the Y Axis Units of the current mode, if the mode supports Antenna Units. For more details on antenna correction data, refer to the Input/Output,Corrections key description. Allowable values: dBuv/m, dBuA/m, dBG, dBpT, None
8	Freq Interpolation	Frequency Interpolation,Linear	if omitted leaves the Freq Interpolation unchanged. Allowable values: Linear, Logarithmic
9	Bias value in mA	Bias,0.00	If omitted leaves the Bias value unchanged (added as of A.08.50)
10	Bias State	Bias State,On	If omitted leaves the Bias State unchanged. Allowable values: On, Off (added as of A.08.50)

Line #	Type of field	Example	Notes
11	Overlap, two values, Freq1 and Freq2, separated by commas.	Overlap,33500,40000	Uses Freq Unit from line 6. Thus, in this example Freq1=33.5 GHz, Freq2= 40.0 GHz (see note below). If omitted leaves the overlap unchanged (added as of A.08.50)
12	DATA marker	DATA	Corrections data begins in the next line

Lines 2 through 5 can be empty but must appear in the file. Lines 6 through 11 are optional, the lines can be left out of the file altogether.

The Overlap row and the two Bias rows apply only to external mixing. Both are read-only, they are never written by the analyzer. The only way to insert or modify these rows is to edit the file with a text editor or a spreadsheet editor. These rows are intended for use by mixer manufacturers, as they allow the manufacturer to insert data about how the mixer corrections were generated and how they should be applied. The Bias rows allow you to specify whether to turn Bias on or off when the Correction is turned on and to specify a Bias value (turning off the Correction does not change the Bias, but turning it back on again sets it to the value specified in the file). The Overlap row allows you to specify an overlap region in which two different corrections may be applied. It is expected that in the corrections data itself, there will be TWO corrections values exactly at Max Freq, otherwise Overlap is ignored. The way the overlap is processed is as follows: if at any given time the current analyzer Start Freq is greater than Freq 1 and lower than Freq 2, and the current Stop Freq is greater than Freq 2, extend the first correction point at or above Freq 2 down to Freq 1, rather than using the correction data between Freq1 and Freq2.

The Antenna Unit row can only be used in Correction register 1, because there can only be one setting for Antenna Unit at any given time. If a Correction whose Antenna Unit is set to anything but None is loaded into any Correction register but 1, an error is generated (Mass storage error; Can only load an Antenna Unit into Correction 1). When a correction file is saved from any Correction register but 1, Antenna Unit is always written as None.

Similarly, the Bias rows can only be used in Correction register 1, because there can only be one setting for Bias at any given time. If a Correction file with a Bias or Bias State row is loaded into any Correction register but 1, an error is generated: Mass storage error; Can only load Bias Settings into Correction 1

The data follows the DATA row, as comma separated X, Y pairs; one pair per line.

For example, suppose you have an Antenna to correct for on an N9020A version A.02.06 and the correction data is:

- 0 dB at 200 MHz

- 17 dB at 210 MHz
- 14.8 dB at 225 MHz

Then the file will look like:

- Amplitude Correction
- "Correction Factors for 11966E"
- "Class B Radiated"
- A.02.06,N9020A
- P13 EA3 UK6,01
- Frequency Unit,MHz
- Antenna Unit,dBuV/m
- Frequency Interpolation,Linear
- DATA
- 200.000000,0.00
- 210.000000,17.00
- 225.000000,14.80

The choices for the 1 of N fields in the metadata are as follows:

- Frequency Unit: Hz, kHz, MHz, GHz
- Antenna Unit: dBuv/m, dBuA/m, dBG, dBpT, None
- Frequency Interpolation: Logarithmic, Linear

Amplitude Correction

These keys let you choose which Correction to save. Once selected, the key returns back to the Export Data menu and the selected Correction number is annotated on the key.

The next step in the Save process is to select the Save As key in the Export Data menu.

Key Path	Save, Data, Amplitude Correction
Preset	Not part of a Preset, but is reset to Correction 1 by Restore Input/Output Defaults. Survives a shutdown.
Readback	1
Initial S/W Revision	A.02.00

Trace

Pressing this key selects Traces as the data type to be exported. Pressing this key when it is already selected brings up the Trace Menu, which allows you to select which Trace to save.

The trace file contains “meta” data which describes the current state of the analyzer. The metadata is detailed in ["Trace File Contents" on page 1459](#) below.

Key Path	Save, Data
Remote Command	:MMEMory:STORe:TRACe:DATA TRACE1 TRACE2 TRACE3 TRACE4 TRACE5 TRACE6 ALL,<filename>
Example	:MMEM:STOR:TRAC:DATA TRACE2, "myTrace2.csv" Exports the 2nd trace to the file myTrace2.csv in the current path. The default path is My Documents\SA\data\traces
Notes	If the save is initiated via SCPI, and the file already exists, the file will be overwritten. Using the C: drive is strongly discouraged, since it runs the risk of being overwritten during an instrument software upgrade. Both single and double quotes are supported for any filename parameter over SCPI.
Dependencies	For SA measurements, traces cannot be recalled from a trace file that was saved with ALL traces selected.
Couplings	When you select which trace to save, it makes that trace the current trace, so it displays on top of all of the other traces.
Readback	selected Trace
Status Bits/OPC dependencies	Sequential - waits for previous measurement to complete
Initial S/W Revision	Prior to A.02.00

Trace File Contents

A Trace Data File contains the data for one trace.

Metadata: Trace Specific

Besides the trace data, there is metadata describing the context by which the trace was produced. Some of the metadata is trace specific:

- Trace Type
- Detector
- Trace math (function, operand1, operand2, offset, reference)
- Trace name/number

When importing a trace, the detector and/or trace math function specified in the metadata is imported with the trace, so that the annotation correctly shows the detector and/or math type that was used to generate the data

Metadata: Display Specific

There is also some display-related metadata:

- Ref Level Offset
- External Gain
- X-Axis Unit
- Y-Axis Unit

Metadata: Measurement Related

The rest of the metadata is measurement specific and reflects the state of the measurement the last time the trace was updated. These are the “measurement-related instrument settings” which, if changed, cause a measurement restart.

- Number of Points
- Sweep Time
- Start Frequency
- Stop Frequency
- Average Count (actual; not the limit for the instrument)
- Average Type
- RBW
- RBW Filter Type
- RBW Filter BW Type
- VBW
- Sweep Type (FFT vs. Swept)
- Log/Lin X Scale (sometimes called Log Sweep)
- Preamp (on/off, band)
- Trigger (source, level, slope, delay)
- Phase Noise optimization setting
- Swept IF Gain
- FFT IF Gain
- AC/DC setting (RF Coupling)

- FFT Width
- External Reference setting
- Input (which input is in use)
- RF calibrator on/off
- Attenuation

Because any inactive trace can have a value that does not match the rest of the measurement, when performing a Save the metadata for each trace is pulled from the individual trace, not from the measurement.

A revision number is also included in the trace database, to allow for future changes.

The choices for the various 1 of N and binary fields are as follows:

- Average Type: Power(RMS), Voltage, LogPower(Video)
- RBW Filter Type: Flattop, EMI, Gaussian
- RBW Filter BW: 3dB, 6dB, Noise, Impulse
- Sweep Type: Swept, FFT
- PreAmp State: On, Off
- PreAmp Band: Low, Full
- Trigger Source: Free, RFBurst, Video, Line, Periodic, Ext1, Ext2, TV
- Trigger Slope: Positive, Negative
- Phase Noise Optimization: Fast, Narrow, Wide
- Swept IF Gain: Low, High
- FFT If Gain: Autorange, Low, High
- Input: RF, BBIQ
- RF Calibrator: 50M, 400G, Comb, Off
- Trace Type: ClearWrite, TraceAverage, MaxHold, MinHold
- Detector: Normal, Average, Peak, NegPeak, Sample
- Trace Math: Off, PowerDifference, PowerSum, LogOffset, LogDifference
- Y Axis Unit: dBm, dBmV, dBmA, W, V, A, dBuV, dBuA, dBuV/m, dBuA/m, dBuV, dBpT, dBG, dB

After the header, just before the trace data, a line with just the word DATA on it is inserted to flag the start of the trace data.

The following file example shows the first lines of a Trace 1 file with X Axis Unit = Hz and Y Axis Unit = dBuV, after importing into Excel (the second row contains the Title):

Trace	
"AS/NZS 1044; Conducted >1000 W, Motors, Average"	
A.01.00	E4410A
526 EA3 B25 P26 PFR	1
Segment	0
Number of Points	1001
Sweep Time	0.066266667
Start Frequency	18827440
Stop Frequency	24463718
Average Count	0
Average Type	Power(RMS)
RBW	51000
RBW Filter	Gaussian
RBW Filter BW	3dB
VBW	51000
Sweep Type	Swept
X Axis Scale	Lin
PreAmp State	Off
PreAmp Band	Low
Trigger Source	Video
Trigger Level	1.2
Trigger Slope	Positive
Trigger Delay	1.00E-06
Phase Noise Optimization	Fast
Swept IF Gain	Low
FFT IF Gain	Autorange
RF Coupling	AC
FFT Width	411900
Ext Ref	10000000
Input	RF
RF Calibrator	Off

Attenuation	10
Ref Level Offset	0
External Gain	0
Trace Type	ClearWrite
Detector	Normal
Trace Math	Off
Trace Math Oper1	Trace5
Trace Math Oper2	Trace6
Trace Math Offset	0
Trace Name	Trace1
X Axis Unit	Hz
Y Axis Unit	dBm
DATA	
1.6009301E+07	4.82047E+01
1.6018694E+07	4.69737E+01
1.6028087E+07	4.81207E+01
1.6037480E+07	4.72487E+01
1.6046873E+07	4.66437E+01
1.6056266E+07	4.66237E+01
1.6065659E+07	4.66967E+01
1.6075052E+07	4.77117E+01
1.6084445E+07	4.75787E+01
1.6093838E+07	4.83297E+01
1.6103231E+07	4.71327E+01
1.6112624E+07	4.78957E+01
1.6122017E+07	4.67507E+01
1.6131410E+07	4.81137E+01

Limit

Pressing this key selects Limit Lines as the data type to be exported. Pressing the key a second time brings up the Limit Menu that allows you to select which **Limit Line** to save.

- See ["Limits File Contents" on page 1464](#).
- See [".csv file format" on page 1464](#)
- See [".lim file format" on page 1465](#)

Key Path	Save, Data
Remote Command	:MMEMory:STORe:LIMit LLINE1 LLINE2,<filename>
Example	:MMEM:STOR:LIM LLINE2, "myLimitLine2.csv" Saves the 2nd Limit Line to the file myLimitLine2.csv in the current path. The default path is My Documents\SA\data\limits
Notes	If the save is initiated via SCPI, and the file already exists, the file will be overwritten. Using the C: drive is strongly discouraged, since it runs the risk of being overwritten during an instrument software upgrade. Both single and double quotes are supported for any filename parameter over SCPI.
Dependencies	This key will only appear if you have the proper option installed in your instrument.
Preset	1; not part of Preset, but is reset by Restore Mode Defaults and survives power cycles
State Saved	The selected Limit number is saved in instrument state.
Readback	selected Limit Line
Status Bits/OPC dependencies	Sequential - waits for previous measurement to complete
Initial S/W Revision	A.02.00

Limits File Contents

Limits may be exported into a data file with a .csv extension. They may be imported from that data file; they may also be imported from a legacy limit file with a .lim extension. The .lim files meet the specification for limit files contained in the EMI measurement guide, HP E7415A.

.csv file format

Except for information in quotes, limit line files are not case sensitive. Information in bold is required verbatim; other text is example text, and italic text is commentary which should not be present in the file.

The first five lines are system-required header lines, and must be in the correct order.

Limit	<i>Data file type name</i>
"FCC Part 15"	<i>File Description</i>
"Class B Radiated"	<i>Comment</i>
A.01.00.R0001,N9020A	<i>Instrument Version, Model Number</i>
P13 EA3 UK6 ,01	<i>Option List, File Format Version</i>

The next few lines describe the parameters; on export they will be in the order shown, on import they can be in any order. If some parameters are missing, they will revert to the default.

Type, Upper	Upper Lower
X Axis Unit, MHz	MHz S; other units should be converted; this also specifies the domain
Amplitude Unit, dBm	dBm V; all other units should be converted appropriately
Frequency Interpolation, Linear	Logarithmic Linear
Amplitude Interpolation, Logarithmic	Logarithmic Linear
X Control, Fixed	Fixed Relative; on input we consider only the first three characters
Y Control, Fixed	Fixed Relative; on input we consider only the first three characters
Margin, 0	Always in dB. A 0 margin is equivalent to margin off
X Offset, 10	Expressed in the X axis units
Y Offset, 5	Expressed in the Amplitude units

The Amplitude Unit line in the limits file may contain an antenna factor unit, for example:

Amplitude Unit=dBuV/m

Antenna factor units are dBuV/m, dBuA/m, dBpT, and dBG. In this case, the unit is treated exactly as though it were dBuV, meaning that all of the limits are interpreted to have units of dBuV. The box does NOT change Y Axis Units when such a limit is loaded in.

The X axis unit also specifies the domain (time or frequency). It is not possible to have both time-domain lines and frequency-domain lines at the same time; if a time-domain line is imported while the other lines are in the frequency domain (or vice-versa), all limit lines will be deleted prior to import.

If the sign of the margin is inappropriate for the limit type (for example a positive margin for an upper limit), the sign of the margin will be changed internally so that it is appropriate.

The remaining lines describe the data. Each line in the file represents an X-Y pair. The X values should be monotonically non-decreasing, although adjacent lines in the file can have the same X value as an aid to building a stair-stepped limit line. To specify a region over which there is no limit, use +1000 dBm for upper limits or -1000 dBm for lower limits.

The data region begins with the keyword DATA:

DATA
200.000000,-10.00
300.000000,-10.00
300.000000,-20.00
500.000000,-20.00

.lim file format

This is a legacy format which allows files saved from older analyzers to be loaded into the X-Series. Design of files in this format is not recommended.

Limit Selection

These keys let you pick which Limit Line to save. Once selected, the key returns back to the **Export Data** menu and the selected Limit Line number is annotated on the key.

The next step in the Save process is to select the Save As key in the Export Data menu.

Key Path	Save, Data, Limit Line
Notes	auto return
Preset	Not part of Preset, but is reset to LLINE1 by Restore Mode Defaults; survives shutdown
Initial S/W Revision	A.02.00

Measurement Results

Pressing this key selects Meas Results as the data type to be exported.

The Meas Results file contains measurement result sets, plus information describing the current state of the analyzer, as detailed in ["Meas Results File Definition" on page 1466](#) and ["Meas Results File Example" on page 1468](#) below.

Key Path	Save, Data
Remote Command	:MMEMory:STORe:RESults <string>
Example	:MMEM:STOR:RES "MeasR_0000.csv"
Notes	<p>If the save is initiated via SCPI and the file already exists, the file will be overwritten.</p> <p>The SCPI command exports Occupied Bandwidth measurement results to the file specified as the parameter in the current path. The default path is My Documents\<current mode>\data\obw\results.<="" p=""> <p>Using the C: drive is strongly discouraged, since it runs the risk of being overwritten during an instrument software upgrade.</p> <p>The SCPI parameter is a quoted string that specifies the filename. Both single and double quotes are supported for any filename parameter over SCPI.</p> </current></p>
Dependencies	The current active measurement must be the Occupied Bandwidth measurement to use this command.
Status Bits/OPC dependencies	Sequential – waits for the previous measurement to complete
Initial S/W Revision	Prior to A.02.00

Meas Results File Definition

The content of a Meas Results File is defined in this section.

The first lines in the file consist of identification and instrument configuration details, as follows.

- File ID string, which is “MeasResult”
- Measurement ID following Mode ID, which is “SA:OBW” for example.
- Firmware rev and model number
- Option string
- Auto Sweep Time Rules
- Average Mode

- Average Number
- Average State
- Center Frequency
- Detector
- Electrical Atten
- Electrical Atten State
- IFGain
- IFGainAuto
- Internal Preamp
- Internal Preamp Band
- Limit
- Limit State
- Max Hold
- Mechanical Atten
- MechanicalAttenStepEnum
- OBW Percent Pwr
- Resolution Band Width
- Resolution Bandwidth Shape
- Span
- Sweep Points
- Sweep Time
- Sweep Time Auto
- TriggerSource
- Video Bandwidth
- x DB

The data above is followed in the file by a line containing “MeasResult1” and “MeasResult2”. This line forms a header for each set of measurement results, which

appear in subsequent lines. Each line of Measurement Results consists of two comma-separated values, for MeasResult1 and MeasResult2 respectively.

The MeasResult1 set in the file corresponds to the data returned by MEAS|READ|FETCh:OBWidth1, and the MeasResult2 set corresponds to the data returned by MEAS|READ|FETCh:OBWidth2.

The exported file is in CSV format, with a .csv extension.

Meas Results File Example

When imported into Microsoft Excel, a typical Meas Results CSV file appears as shown in the example below.

MeasResult	
SA:OBW	
A.10.53	N9030A
526 ALV ATP B1X B1Y B25 B40 BBA CR3 CRP DCF DDA DP2 DRD EA3 EDP EMC EP1 ERC ESC ESP EXM FSA LFE LNP MAT MPB NFE NUL P26 PFR PNC RTL RTS S40 SB1 SEC SM1 TVT YAS YAV	1
Auto Sweep Time Rules	Normal
Average Mode	Exponential
Average Number	10
Average State	TRUE
Center Frequency	1.33E+10
Detector	Average
IFGain	FALSE
IFGainAuto	FALSE
Internal Preamp	FALSE
Internal Preamp Band	Low
Limit	5000000
Limit State	FALSE
Max Hold	FALSE
OBW Percent Pwr	99
Resolution Band Width	27000
Resolution Bandwidth Shape	Gaussian
Span	3000000
Sweep Points	1001
Sweep Time	0.004933
Sweep Time Auto	TRUE
TriggerSource	Free

Video Bandwidth	270000
x DB	-26
MeasResult1	MeasResult2
2971020.10835045	-94.3702543927405
-74.9741251886604	-94.1447790390963

Save As . . .

When you press “Save As”, the analyzer brings up a Windows dialog and a menu entitled “**Save As.**” This menu allows you to navigate to the various fields in the Windows dialog without using a keyboard or mouse. The **Tab** and **Arrow** keys can also be used for dialog navigation.

See "[To File . . .](#)" on page 3202 in **Save, State** for a full description of this dialog and menu.

The default path for saving files is:

For all of the Trace Data Files:

- My Documents\`<mode name>`\data\traces

For all of the Limit Data Files:

- My Documents\`<mode name>`\data\limits

For all of the Measurement Results Data Files:

- My Documents\`<mode name>`\data\`<measurement name>`\results

For all of the Capture Buffer Data Files:

- My Documents\`<mode name>`\data\captureBuffer

Key Path	Save, Data
Mode	All
Notes	The key location is mode-dependent and will vary. Brings up the Save As dialog for saving a <code><mode specific></code> Save Type. The save is performed immediately and does not wait until the measurement is complete.
Initial S/W Revision	Prior to A.02.00

Screen Image

Pressing Screen Image accesses a menu of functions that enable you to specify a format and location for the saved screen image. It brings up a menu that allows you to specify the color scheme of the Screen Image (Themes) or navigate to the Save As dialog to perform the actual save.

Screen Image files contain an exact representation of the analyzer display. They cannot be loaded back onto the analyzer, but they can be loaded into your PC for use in many popular applications.

The image to be saved is actually captured when the **Save** front panel key is pressed, and kept in temporary storage to be used if you ask for a Screen Image save. When the Screen Image key is pressed, a "thumbnail" of the captured image is displayed, as shown below:

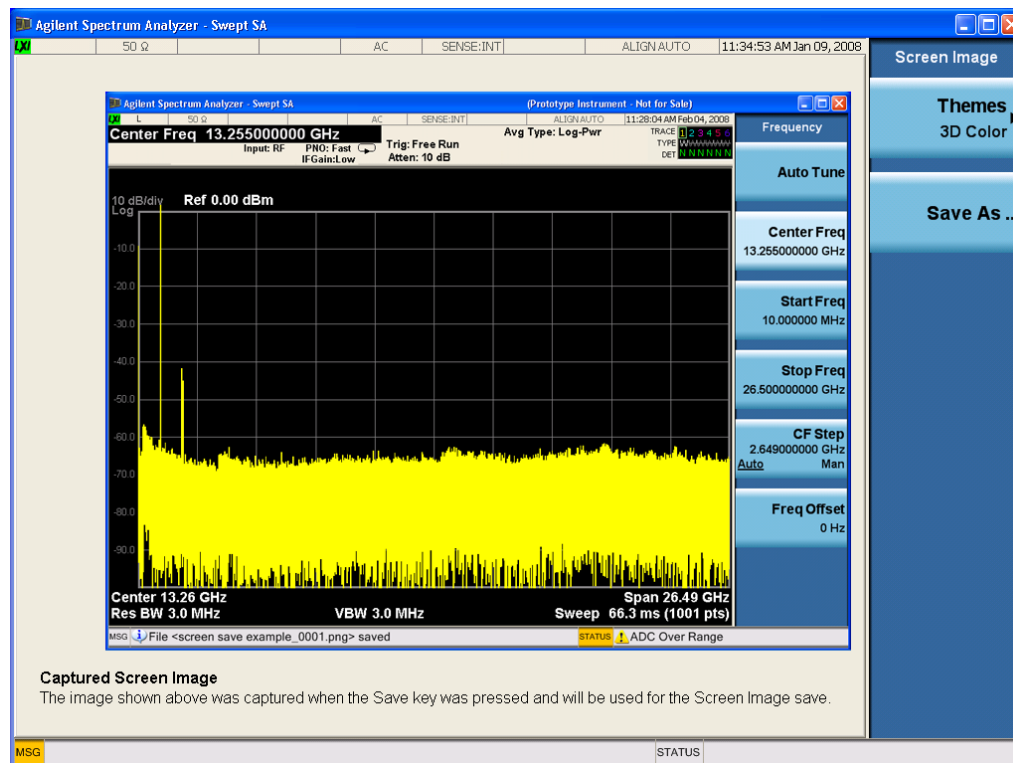

When you continue on into the **Save As** menu and complete the Screen Image save, the image depicted in the thumbnail is the one that gets saved, showing the menus that were on the screen before going into the **Save** menus. The save is performed immediately and does not wait until the measurement is complete.

After you have completed the save, the **Quick Save** front-panel key lets you quickly repeat the last save performed, using an auto-named file, with the current screen data.

NOTE

For versions previous to A.01.55, if you initiate a screen image save by navigating through the Save menus, the image that is saved will contain the Save menu softkeys, not the menus and the active function that were on the screen when you first pressed the Save front panel key.

Key Path	Save
Mode	All
Remote Command	:MMEMory:STORe:SCReen <filename>
Example	:MMEM:STOR:SCR "myScreen.png"

	This stores the current screen image in the file MyScreenFile.png in the default directory.
Backwards Compatibility SCPI	HCOPY:SDUMP:DATA? returns the screen image in a <DEFINITE LENGTH ARBITRARY RESPONSE DATA> element. The response data is IEEE Block format; the controlling computer can strip the header and store the result as a .png file.
Initial S/W Revision	Prior to A.02.00

Themes

Accesses a menu of functions that enable you to choose the theme to be used when saving the screen image.

The **Themes** option is the same as the **Themes** option under the **Display** and **Page Setup** dialogs. It allows you to choose between themes to be used when saving the screen image.

Key Path	Save, Screen Image
Remote Command	:MMEMory:STORe:SCReen:THEMe TDCoLor TDMonochrome FCOLor FMONochrome :MMEMory:STORe:SCReen:THEMe?
Example	:MMEM:STOR:SCR:THEM TDM
Preset	3D Color; Is not part of Preset, but is reset by Restore Misc Defaults or Restore System Defaults All and survives subsequent running of the modes.
Readback	3D Color 3D Mono Flat Color Flat Mono
Backwards Compatibility Notes	In ESA and PSA we offer the choice of "Reverse Bitmap" or "Reverse Metafile" when saving screen images. This is much like the "Flat Color" theme available in X-Series. Also, if you selected Reverse Bitmap AND a black & white screen image, that would be much like "Flat Monochrome". In other words, each of the X-Series themes has a similar screen image type in ESA/PSA. But they are not identical.
Initial S/W Revision	Prior to A.02.00

3D Color

Selects a standard color theme with each object filled, shaded and colored as designed.

Key Path	Save, Screen Image, Themes
Example	MMEM:STOR:SCR:THEM TDC
Readback	3D Color
Initial S/W Revision	Prior to A.02.00

3D Monochrome

Selects a format that is like 3D color but shades of gray are used instead of colors.

Key Path	Save, Screen Image, Themes
----------	----------------------------

Example	MMEM:STOR:SCR:THEM TDM
Readback	3D Mono
Initial S/W Revision	Prior to A.02.00

Flat Color

Selects a format that is best when the screen is to be printed on an ink printer.

Key Path	Save, Screen Image, Themes
Example	MMEM:STOR:SCR:THEM FCOL
Readback	Flat Color
Initial S/W Revision	Prior to A.02.00

Flat Monochrome

Selects a format that is like Flat Color. But only black is used (no colors, not even gray), and no fill.

Key Path	Save, Screen Image, Themes
Example	MMEM:STOR:SCR:THEM FMON
Readback	Flat Mono
Initial S/W Revision	Prior to A.02.00

Save As...

When you press “Save As”, the analyzer brings up a Windows dialog and a menu entitled “**Save As.**” This menu allows you to navigate to the various fields in the Windows dialog without using a keyboard or mouse. The **Tab** and **Arrow** keys can also be used for dialog navigation.

See "[To File . . .](#)" on page 3202 in **Save, State** for a full description of this dialog and menu.

The default path for Screen Images is

- My Documents\`<mode name>`\screen.

where `<mode name>` is the parameter used to select the mode with the INST:SEL command (for example, SA for the Spectrum Analyzer).

Key Path	Save, Screen Image
Notes	Brings up Save As dialog for saving a Screen Image Save Type
Initial S/W Revision	Prior to A.02.00

Mass Storage Change Directory (Remote Command Only)

Key path	SCPI Only
----------	------------------

Remote Command	:MMEMory:CDIRectory [<directory_name>] :MMEMory:CDIRectory?
Notes	The string must be a valid logical path. Changes the default directory for a mass memory file system. The <directory_name> parameter is a string. If no parameter is specified, the directory is set to the *RST value. At *RST, this value is set to the default user data storage area, that is defined as System.Environment.SpecialFolder.Personal. Query returns full path of the default directory.
Initial S/W Revision	Prior to A.02.00

Mass Storage Copy (Remote Command Only)

Key path	SCPI Only
Remote Command	:MMEMory:COpy <string>,<string>[,<string>,<string>]
Notes	The string must be a valid logical path. Copies an existing file to a new file or an existing directory to a new directory. Two forms of parameters are allowed. The first form has two parameters. In this form, the first parameter specifies the source, and the second parameter specifies the destination. The second form has four parameters. In this form, the first and third parameters specify the source. The second and fourth parameters specify the directories. The first pair of parameters specifies the source. The second pair specifies the destination. An error is generated if the source doesn't exist or the destination file already exists. This command will generate an "access denied" error if the destination is a restricted folder (e.g., C:\Windows) and the current user does not have Power User or Administrator privileges.

Mass Storage Device Copy (Remote Command Only)

This command transfers data to/from a file and a peripheral device.

Key path	SCPI Only
Remote Command	:MMEMory:COpy:DEvice <source_string>,<dest_string>
Notes	The strings must be a valid logical path or a valid device keyword. If the dest_string is a device keyword, the data is copied from the source file to the device. If the source_string is a device keyword, the data is copied to the source file from the device. Valid device keywords are: SNS (smart noise source) An error is generated if the file or device is not found.

Mass Storage Delete (Remote Command Only)

Key path	SCPI Only
Remote Command	:MMEMory:DElete <file_name>[,<directory_name>]
Notes	The string must be a valid logical path.

Removes a file from the specified directory. The <file_name> parameter specifies the file name to be removed. This command will generate an “access denied” error if the file is in a restricted folder (e.g., C:\Windows) and the current user does not have Power User or Administrator privileges.

Initial S/W Revision Prior to A.02.00

Mass Storage Data (Remote Command Only)

Creates a file containing the specified data OR queries the data from an existing file.

Key path **SCPI Only**

Remote Command :MMEMory:DATA <file_name>, <data>
 :MMEMory:DATA? <file_name>

Notes The string must be a valid logical path.

 The command form is MMEMory:DATA <file_name>,<data>. It loads <data> into the file <file_name>. <data> is in 488.2 block format. <file_name> is string data.

 The query form is MMEMory:DATA? <file_name> with the response being the associated <data> in block format.

Initial S/W Revision Prior to A.02.00

Mass Storage Make Directory (Remote Command Only)

Key path **SCPI Only**

Remote Command :MMEMory:MDIRectory <directory_name>

Notes The string must be a valid logical path.

 Creates a new directory. The <directory_name> parameter specifies the name to be created.

 This command will generate an “access denied” error if the new directory would be in a restricted folder (e.g., C:\Windows) and the current user does not have Power User or Administrator privileges.

Initial S/W Revision Prior to A.02.00

Mass Storage Move (Remote Command Only)

Key path **SCPI Only**

Remote Command :MMEMory:MOVE <string>,<string>[,<string>,<string>]

Notes The string must be a valid logical path.

 Moves an existing file to a new file or an existing directory to a new directory.

 Two forms of parameters are allowed. The first form has two parameters. In this form, the first parameter specifies the source, and the second parameter specifies the destination.

 The second form has four parameters. In this form, the first and third parameters specify the source. The second and fourth parameters specify the directories. The first pair of parameters specifies the source. The second pair specifies the destination. An error is generated if the source doesn't exist or the destination file already exists.

 This command will generate an “access denied” error if the destination is a restricted folder (e.g.,

	C:\Windows) and the current user does not have Power User or Administrator privileges.
Initial S/W Revision	Prior to A.02.00

Mass Storage Remove Directory (Remote Command Only)

Key path	SCPI Only
Remote Command	:MMEMory:RDIRECTory <directory_name>
Notes	<p>The string must be a valid logical path.</p> <p>Removes a directory. The <directory_name> parameter specifies the directory name to be removed. All files and directories under the specified directory shall also be removed.</p> <p>This command will generate an “access denied” error if the folder is a restricted folder (e.g., C:\Windows) or is in a restricted folder and the current user does not have Power User or Administrator privileges.</p>
Initial S/W Revision	Prior to A.02.00

Mass Storage Catalog (Remote Command Only)

Key path	SCPI Only
Remote Command	:MMEMory:CATalog? [<directory_name>]
Notes	<p>The string must be a valid logical path.</p> <p>Queries disk usage information (drive capacity, free space available) and obtains a list of files and directories in a specified directory in the following format:</p> <p><numeric_value>,<numeric_value>,{<file_entry>}</p> <p>It returns two numeric parameters and as many strings as there are files and directories. The first parameter indicates the total amount of storage currently used in bytes. The second parameter indicates the total amount of storage available, also in bytes. The <file_entry> is a string. Each <file_entry> indicates the name, type, and size of one file in the directory list:</p> <p><file_name>,<file_type>,<file_size></p> <p>As the windows file system has an extension that indicates file type, <file_type> is always empty. <file_size> provides the size of the file in bytes. For directories, <file_entry> is surrounded by square brackets and both <file_type> and <file_size> are empty</p>
Initial S/W Revision	Prior to A.02.00

Mass Storage Determine Removable Media (Remote Command Only)

This command is used to determine if any removable media devices are connected to the instrument. Primarily, these are USB memory devices plugged-in to the front panel or rear panel USB ports. On instruments with PC6 or PC7 CPU's, one SD card slot is available for removable media. The instrument's primary disk drive is not a removable media device.

Key Path	SCPI Only
----------	-----------

Remote Command	:MMEMory:RMEDia:LIST?
Notes	The return value is a string containing a list of partition identifiers that are removable media devices. Each identifier is separated by a comma. If no removable media is present, an empty string is returned. Examples: <ul style="list-style-type: none"> - One removable device present results in a return string of "F:". - Two removable devices present results in a return string of "F:,G:". - No removable devices present results in a return string of "".
Initial S/W Revision	x.15.00

Mass Storage Determine Removable Media Label (Remote Command Only)

This command is used to set or query a removable media device's label.

Key Path	SCPI Only
Remote Command	:MMEMory:RMEDia:LABel <partition>,<string> :MMEMory:RMEDia:LABel? <partition>
Example	MMEM:RMED:LAB "F:","My Device"
Notes	If the <partition> specified does not exist or is not a removable media device, the error - 252,"Missing Media" is generated. Setting the removable media label requires Administrative privileges. If the currently logged in user does not have appropriate privileges the error "-221.9900,Settings conflict;Administrator privileges required" is generated.
Initial S/W Revision	x.15.00

Mass Storage Determine Removable Media Write-protect status (Remote Command Only)

This command is used to query a removable media device's write-protect status.

Key Path	SCPI Only
Remote Command	:MMEMory:RMEDia:WPRotect? <partition>
Example	MMEM:RMED:WPR? "F:"
Notes	The return value is 1 if the device is write-protected, or 0 if the device is write-enabled. If the <partition> specified does not exist or is not a removable media device the error - 252,"Missing Media" is generated.
Preset	The return value will be depending on SD card installed.
Initial S/W Revision	x.15.00

Mass Storage Determine Removable Media size (Remote Command Only)

This command is used to query a removable media device's total memory size (not available memory size).

Key Path	SCPI Only
Remote Command	:MMEMory:RMEDia:SIZE? <partition>
Example	MMEM:RMED:SIZE? "F:"
Notes	The return value is integer value in GBytes. Any device that is less than 1 GB returns 0 GB. If the <partition> specified does not exist or is not a removable media device, the error - 252, "Missing Media" is generated.
Initial S/W Revision	x.15.00

:SYSTem:SET (Remote Command Only)

Remote command that allows the user to obtain the state of the currently active mode in a form that can then be loaded back into the instrument quickly.

Remote Command	SYSTem:SET <instrument state in IEEE Block> SYSTem:SET?
Notes	SYST:SET? returns current instrument state of the active mode in IEEE Block data format. The state is in a machine readable format only. Sending the query returns the following format: <syst set preamble><state block data> Where: <syst set preamble> is the format: #NMMM N=number of digits that comprise MMM MMM=length in bytes of following data <state block data> is machine readable state data Example response: #42016<state data> The state is recalled by sending the SYST:SET? Response data to the instrument. From example above: SYST:SET #42016<state data>
Initial S/W Revision	x.17.00

Single (Single Measurement/Sweep)

Sets the analyzer for Single measurement operation. The single/continuous state is Meas Global, so the setting will affect all the measurements. If you are Paused, pressing **Single** does a Resume.

See "[More Information](#)" on page 1478

Key Path	Front-panel key
Example	:INIT:CONT OFF
Notes	See Cont key description.
Backwards Compatibility Notes	<p>For Spectrum Analysis mode in ESA and PSA, the Single hardkey and the INITiate:IMM switched from continuous measurement to single measurement and restarted sweeps and averages (displayed average count reset to 1), but did not restart Max Hold and Min Hold. In the X-Series, the Single hardkey and the INITiate:IMM command initiate a sweep/ measurement/ average sequence/hold sequence including MaxHold and MinHold.</p> <p>For Spectrum Analysis mode in ESA and PSA, the Single hardkey restarted the sweep regardless of whether or not you were in an active sweep or sweep sequence. In the X-Series, Restart does this but Single only restarts the sweep or sweep sequence if you are in the idle state.</p> <p>INIT[:IMM] in ESA & PSA Spectrum Analysis Mode does an implied ABORT. In some other PSA Modes, INIT[:IMM] is ignored if not in the idle state. . The X-Series follows the ESA/PSA SA Mode model, which may cause some Modes to have compatibility problems.</p>
Initial S/W Revision	Prior to A.02.00

More Information

See "[Restart](#)" on page 3199 for details on the INIT:IMMEDIATE (Restart) function.

If you are already in single sweep, the INIT:CONT OFF command has no effect.

If you are already in Single Sweep, then pressing the **Single** key in the middle of a sweep does not restart the sweep or sequence. Similarly, pressing the **Single** key does not restart the sweep or sequence if the sweep is not in the idle state (for example, if you are taking a very slow sweep, or the analyzer is waiting for a trigger). Instead, it results in a message. "Already in Single, press Restart to initiate a new sweep or sequence". Even though pressing the **Single** key in the middle of a sweep does not restart the sweep, sending INIT:IMMEDIATE does reset it.

To take one more sweep without resetting the average count, increment the average count by 1, by pressing the step up key while **Average/Hold Number** is the active function, or sending the remote command CALC:AVER:TCON UP.

Source

The Source key accesses menus for controlling a Source in Tracking Source mode

Key Path	Front-panel key
Dependencies	Operation with a source requires a license. If the proper license is not installed, the following occurs: <ul style="list-style-type: none"> - When the Source key is pressed the user sees an informational message, "Option not installed" - If any SCPI command in the :SOURce subsystem is sent it generates a message, "Settings conflict;option not installed"
Initial S/W Revision	A.06.01

NOTE

Option T03 or T06 is required for the Tracking Generator function in CXA. Option T03, T07, T13 or T26 is required for the Tracking Generator function in CXA-m.

When using the CXA-m Tracking Generator, if the Source Frequency is in the frequency range of the below table, and the Source Amplitude is in the corresponding amplitude range of the below table, a warning status message is generated, +313 "Source Uncal". This is also true if Power Sweep is on and any amplitude in the Power Sweep (as calculated by Amplitude, Power Sweep, and Amptd Offset) is in that range.

CXA-m TG Un-calibrated Amplitude Range

Frequency Range	Amplitude Range
2 MHz \leq frequency < 10 GHz	-40 dBm \leq amplitude < -35 dBm
10 GHz \leq frequency < 20 GHz	-40 dBm \leq amplitude < -35 dBm or -5 dBm < amplitude \leq 0 dBm
20 GHz \leq frequency \leq 26.55 GHz	-12 dBm < amplitude \leq 0 dBm

RF Output

Allows you to turn the source RF Power on or off.

NOTE

When the RF Output is turned on, the Source Mode is set to Tracking. See the Source Mode key description for special considerations concerning how to configure your N5172B or N5182B source for use with External Source Control.

Key Path	Source
Scope	Meas Global
Remote Command	:OUTPut[:EXTErnal] [:STATe] ON OFF 1 0 :OUTPut[:EXTErnal] [:STATe]?

Example	:OUTP ON :OUTP?
Dependencies	Grayed out in measurements that do not support a source. If you go to such a measurement the output will be forced to Off. Grayed out if there is no valid source selection, in this case go to the Select Source menu to choose, configure and/or verify your source When there is no available Source Mode (other than Off), due to other couplings, then the RF Output key is grayed out.
Couplings	When RF Output is turned On, Source Mode is set to Tracking When Source Mode is turned Off, RF Output is turned Off. When Source Mode is turned Off (or forced to Off by another coupling), RF Output is turned Off. Turning RF Output Off does not affect Source Mode or other settings.
Preset	OFF (on either a Mode Preset, a Source Preset, or Restore Input/Output Defaults)
State Saved	Part of the Input/Output system, which means it is Loaded and Saved with state.
Range	On Off
Initial S/W Revision	A.06.01
Modified at S/W Revision	A.10.01

Amplitude

Allows you to access the Amplitude sub-menu to control various amplitude parameters of the Source. The resolution of the Source amplitude parameters is coupled to match the minimum resolution of the source when the source is acquired. When the source is released, the amplitude parameter resolution reverts to default values.

Key Path	Source
Readback	In square brackets, the amplitude value from Amplitude key in the next menu level down
Initial S/W Revision	A.06.01

Amplitude

Allows you to adjust the power level of the selected source. Note that the actual amplitude is also affected by the Amplitude Offset and Power Sweep parameters.

Key Path	Source, Amplitude
Scope	Mode Global
Remote Command	:SOURce[:EXTeRnAl]:POWer[:LEVel][:IMMediate][:AMPLitude] <amp1> :SOURce[:EXTeRnAl]:POWer[:LEVel][:IMMediate][:AMPLitude]?
Example	:OUTP ON :SOUR:POW -10dBm
Dependencies	If the requested setting of Source Amplitude causes the calculated external source start or stop Amplitude to exceed the external source capability, a warning status message is generated,

	<p>“Data out of Range; clipped to source max/min” The “Show Source Capabilities and Settings” menu can then be examined to check the source capabilities.</p> <p>This parameter test and clip is also performed at source acquisition.</p>
Preset	<p>-10.00 dBm (On Source Preset and Restore Input/Output Defaults)</p> <p>Not affected by Mode Preset</p>
State Saved	<p>Part of the Input/Output system, which means it is Loaded and Saved with state.</p>
Min	<p>The range of the amplitude parameter is dependent on the amplitude range of the source that is selected, and the settings of Amplitude Offset and Power Sweep.</p>
Max	<p>The range of the amplitude parameter is dependent on the amplitude range of the source that is selected, and the settings of Amplitude Offset and Power Sweep.</p>
Backwards Compatibility SCPI	<p>:SOURce:POWer:STARt <amp1></p> <p>:SOURce:POWer:STARt?</p> <p>This alias is for the ESA tracking generator. It specifies the source output power level at the start of the power sweep, just as does :SOURce:POWer.</p>
Initial S/W Revision	A.06.01
Modified at S/W Revision	A.10.01

Power Sweep

Allows you to set up a Power Sweep. Power Sweep is useful for measuring saturation behavior in a test device, such as a power amplifier.

Pressing the key sets the power-sweep function to On or Off. The value of the power-sweep range is displayed in the active function block, and can be adjusted, when set to On.

The source will sweep the power between the start power defined by the Amplitude function and the stop power = start power + power sweep value:

Source (start) amplitude = Amplitude – Amplitude Offset

Source (stop) amplitude = Amplitude – Amplitude Offset + Power Sweep

In Stepped Tracking, such as is used with an external source or the CXA-m TG, the analyzer controls the source with step sweep mode, which provides a linear progression from one selected frequency, amplitude, or both, to another, pausing at linearly spaced points (steps) along the sweep. The analyzer continues to sweep the specified frequency range when power sweep is on, although generally Power Sweep is performed in Zero Span.

With CXA options T03, T06, the hardware is capable of continuous power sweeps. This makes it possible to use the swept sweep time rules and should be employed for faster sweeps. Care should be taken to limit the sweep time you use as there are no sweep time couplings to Power Sweep settings. The recommended minimum sweep time depends on the RBW and power-sweep range. Start by computing $(1.28/\text{RBW}) * (\text{abs}(\text{startPower} - \text{stopPower}) / (5 \text{ dB}))$. The recommended minimum sweep time is the larger of this value and 50 ms.

Some external Sources have mechanical attenuators, which are not used in Power Sweep in order to save wear on the attenuators. To allow an acceptable range of Power Sweep without changing the mechanical attenuation, the Sources are put in a mode that allows the Source to handle a wide amplitude range without switching the attenuators. When the Power Sweep settings put the Source in an amplitude range that requires the mechanical attenuators, the analyzer displays a condition warning message:

Settings Alert;Src pwr ramp>ALC range

Key Path	Source, Amplitude
Mode	SA
Scope	Mode Global
Remote Command	:SOURce:POWer:SWEep <rel_amp1> :SOURce:POWer:SWEep? :SOURce:POWer:SWEep:STATe ON OFF 1 0 :SOURce:POWer:SWEep:STATe?
Example	:SOUR:POW -5 :SOUR:POW:SWE:STAT ON :SOUR:POW:SWE 10 Set source start power to - 5 dBm and stop power + 5dBm (-5 + 10).
Example	:SOUR:POW:SWE:STAT ON
Dependencies	If the requested setting of Power Sweep causes the calculated external source start or stop Amplitude to exceed the external source capability, a warning status message is generated, "Data out of Range; clipped to source max/min". The Show Source Capabilities and Settings menu can then be examined to check the source capabilities. This parameter test and clip is also performed at source acquisition.
Preset	This is unaffected by "Mode Preset" but is set to 0dB on a "Source Preset" or "Restore Input/Output Defaults".
State Saved	Part of the Input/Output system, which means it is Loaded and Saved with state.
Min	-500 dB
Max	+500 dB
Backwards Compatibility SCPI	:SOURce[:EXTeRnAl][:SWEep]:POWer:SPAN <rel_amp1> :SOURce[:EXTeRnAl][:SWEep]:POWer:SPAN? This alias is for the ESA tracking generator and PSA option 215. It specifies the range of power levels through which the source output will sweep just as does :SOURce:POWer:SWEep.
Initial S/W Revision	A.06.01
Remote Command	:SOURce[:EXTeRnAl]:POWer:MODE FIXed SWEep :SOURce[:EXTeRnAl]:POWer:MODE?
Notes	The ESA tracking generator and the PSA option 215 support this SCPI command. It sets the source output to be at a single amplitude (fixed) or to sweep through a range of power levels

	SOURce:POWer:MODE FIXed is equivalent to :SOURce:POWer:SWEEp:STATe OFF
	SOURce:POWer:MODE SWEEp is equivalent to :SOURce:POWer:SWEEp:STATe ON
Preset	This is unaffected by "Mode Preset" but is set to FIXed on a "Source Preset" or "Restore Input/Output Defaults".
Initial S/W Revision	A.06.01
Modified at S/W Revision	A.10.01

Amptd Offset

Offsets the displayed power of the source in the Amplitude parameter. Using the amplitude offset allows you to take into account any system losses or gains (for example, due to cable loss), thereby displaying the actual power delivered to the device under test. See the equations under the Source, Amplitude, Power Sweep key.

Key Path	Source, Amplitude
Mode	SA
Scope	Mode Global
Remote Command	:SOURce:CORRection:OFFSet <rel_amp1> :SOURce:CORRection:OFFSet?
Example	:SOUR:CORR:OFFS 5 Sets the displayed source offset power to 5 dB.
Dependencies	If the requested setting of Amptd Offset causes the calculated external source start or stop Amplitude to exceed the external source capability, a warning status message is generated, "Data out of Range; clipped to source max/min". The Show Source Capabilities and Settings menu can then be examined to check the source capabilities. This parameter test and clip is also performed at source acquisition.
Preset	This is unaffected by Mode Preset but is set to 0.00dBm on a Source Preset or Restore Input/Output Defaults.
State Saved	Part of the Input/Output system, which means it is Loaded and Saved with state.
Min	-1000 dB
Max	+1000 dB
Initial S/W Revision	A.06.01

Amptd Step Auto/Man

Allows you to set the step size associated with the Source Amplitude key. When auto-coupled, the step size is the current Scale/Div setting under the Amplitude hardkey (note that this is true even if the analyzer is currently in Linear amplitude scale).

Once a step size has been selected and the Source Amplitude function is active, the step keys (and the UP|DOWN parameters for Source Amplitude from remote commands) change the Source Amplitude by the step-size value.

You may change the step size manually by pressing Amptd Step and entering a value. The function (and the step size) will return to Auto when a Mode Preset or Auto Couple is performed.

Key Path	Source, Amplitude
Scope	Mode Global
Remote Command	<pre>:SOURce:POWer:STEP[:INCRement] <amp;lt;1> :SOURce:POWer:STEP[:INCRement]? :SOURce:POWer:STEP:AUTO OFF ON 0 1 :SOURce:POWer:STEP:AUTO?</pre>
Example	<pre>:SOUR:POW:STEP 0.1 Set amplitude step to 0.1 dB :SOUR:POW:STEP:AUTO ON</pre>
Couplings	In Auto, coupled to the size of one logarithmic vertical graticule division
Preset	Auto
State Saved	Part of the Input/Output system, which means it is Loaded and Saved with state.
Min	0.1 dB
Max	20 dB
Initial S/W Revision	A.06.01

Frequency

Allows a you to access the Frequency sub-menu. This menu lets you use a stepped tracking source for stimulus/response measurements for some added flexibility. Because with such a source, the source frequency does not need to track 1:1 with the analyzer LO frequency, it is possible to measure scalar harmonic and subharmonic responses of devices. For example, the second harmonic response is measured by stepping the analyzer and source so that the analyzer is always at twice the source frequency. In addition, the frequency offset capability allows the measurement of frequency conversion devices (like mixers).

In tracking mode, the source frequency tracks the analyzer frequency according to the source frequency equation:

$$\text{Source Frequency} = (\text{Analyzer Frequency} * \text{Multiplier Numerator} / \text{Multiplier Denominator}) + \text{Source Frequency Offset}$$

NOTE

Analyzer Frequency is the frequency to which the analyzer is set, which is the analyzer's displayed frequency, offset by any Freq Offset set under the Frequency hardkey. Source Frequency Offset is the value set under **Source, Frequency, Freq Offset.**

Key Path	Source
----------	---------------

Readback	none in Tracking Source mode
Initial S/W Revision	A.06.01

Multiplier Numerator

The multiplier numerator parameter offsets the source frequency from the analyzer frequency. The source frequency tracks the SA frequency according to the source frequency equation shown under the **Source, Frequency** key description.

The multiplier numerator must be restricted to operate within the range of the source minimum and maximum frequencies.

Key Path	Source, Frequency
Mode	SA
Scope	Mode Global
Remote Command	:SOURce:FREQuency[:MULTIplier]:NUMerator <integer> :SOURce:FREQuency[:MULTIplier]:NUMerator?
Example	:SOUR:FREQ:NUM 3 Sets the source frequency multiplier numerator to 3.
Dependencies	If the currently selected source does not support this capability (for example, an internal Tracking Generator which must track the LO), this key is forced to its Preset value and grayed out
Preset	This is unaffected by Mode Preset but is set to 1 on a Source Preset or Restore Input/Output Defaults.
State Saved	Part of the Input/Output system, which means it is Loaded and Saved with state.
Min	1
Max	1000
Initial S/W Revision	A.06.01

Multiplier Denominator

The multiplier denominator parameter offsets the source frequency from the analyzer frequency. The source frequency tracks the SA frequency according to the source frequency equation shown under the **Source, Frequency** key description.

The multiplier denominator must be restricted to operate within the range of the source minimum and maximum frequencies.

Key Path	Source, Frequency
Mode	SA
Scope	Mode Global
Remote Command	:SOURce:FREQuency[:MULTIplier]:DENominator <integer> :SOURce:FREQuency[:MULTIplier]:DENominator?
Example	:SOUR:FREQ:DEN 3 Sets the source frequency multiplier denominator to 3

Dependencies	If the currently selected source does not support this capability (for example, an internal Tracking Generator which must track the LO), this key is forced to its Preset value and grayed out
Preset	This is unaffected by Mode Preset but is set to 1 on a Source Preset or Restore Input/Output Defaults.
State Saved	Part of the Input/Output system, which means it is Loaded and Saved with state
Min	1
Max	1000
Initial S/W Revision	A.06.01

Source Sweep Reverse

Allows you to reverse the source sweep direction

Normally, the source will sweep from a lower frequency to a higher frequency. However, there are test scenarios in which the source sweep needs to be “reversed”. In this case, it sweeps from a higher frequency to a lower frequency. For example, when the DUT is a frequency converter and a measurement of the Lower Side Band characteristics is desired, a reverse sweep is employed. Reverse sweeps are supported for such scenarios, but two cautions are in order:

4. Reverse Sweep only reverses the direction of the source’s sweep, not the analyzer’s sweep. Unless you are actually using a device like a frequency converter and looking at the lower sideband, thus effectively reversing the direction of the source’s sweep, the source will be sweeping in the opposite direction from the analyzer, and it will not be possible track the desired device output frequency.
5. Any time you are using a frequency converter, care must be taken in setting up all of the sweep parameters, including analyzer start/stop frequency and source multiplier, to make sure that the analyzer’s sweep tracks the output of the converter device.

Key Path	Source, Frequency
Mode	SA
Scope	Mode Global
Remote Command	:SOURce:FREQuency:SSReverse:ON OFF 0 1 :SOURce:FREQuency:SSReverse?
Example	SOUR:FREQ:SSR:OFF SOUR:FREQ:SSR?
Notes	You must be in Spectrum Analyzer mode to use this command. Use INSTRument:SElect to set the mode.
Dependencies	If the currently selected source does not support this capability (for example, an internal Tracking Generator which must track the LO), this key is forced to its Preset value and grayed out
Preset	This is unaffected by Mode Preset but is set to OFF on a Source Preset or Restore Input/Output Defaults.

State Saved	Part of the Input/Output system, which means it is Loaded and Saved with state
Range	On Off
Initial S/W Revision	A.06.01

Freq Offset

The frequency offset parameter offsets the source frequency from the analyzer frequency. The source frequency tracks the SA frequency according to the equations under the **Source, Frequency** key.

Pressing the key sets the Freq Offset function to On or Off. The value of Freq Offset is displayed in the active function block, and can be adjusted, when set to On.

The frequency offset must be restricted to operate within the range of the source minimum and maximum frequencies.

Key Path	Source, Frequency
Mode	SA
Scope	Mode Global
Remote Command	:SOURce:FREQuency:OFFSet <freq> :SOURce:FREQuency:OFFSet? :SOURce:FREQuency:OFFSet:STATe ON OFF 1 0 :SOURce:FREQuency:OFFSet:STATe?
Example	:SOUR:FREQ:OFFS 10MHz Sets the source frequency offset to 10MHz.
Dependencies	If the currently selected source does not support this capability (for example, an internal Tracking Generator which must track the LO), this key is forced to its Preset value and grayed out
Preset	This is unaffected by Mode Preset but is set to 0.00Hz on a Source Preset or Restore Input/Output Defaults.
State Saved	Part of the Input/Output system, which means it is loaded and saved with state
Min	-500 GHz
Max	500 GHz
Backwards Compatibility SCPI	:SOURce:EXTernal:SWEep:OFFSet:FREQuency <freq> :SOURce:EXTernal:SWEep:OFFSet:FREQuency? The PSA option 215 supports this SCPI command. This command is equivalent to :SOURce:FREQuency:OFFSet
Initial S/W Revision	A.06.01
Modified at S/W Revision	A.10.01

Source Mode

Accesses the Source Mode softkey menu. This menu lets you select Tracking mode for the Source, and also allows you to set the Source Mode to OFF.

The Source Mode can be set to Tracking without the user setting it directly. There are several couplings that cause Source Mode to be automatically set to Tracking (detailed in the table below). One important coupling is that Source Mode is forced to Tracking when the RF Output is turned on if the measurement supports Tracking. Since Source Mode is set to Off on a Mode Preset, this means that you will rarely need to change the Source Mode setting directly.

NOTE

When the Source Mode is set to Tracking, the analyzer acquires control of the source. When this happens the source is told to save its state and then perform a preset. Usually both of these operations take very little time; however, on an N5172B or an N5182B, if many Source real-time apps are in use, both save and preset can take many seconds. If it takes longer than the analyzer expects to acquire control, you will see an error: “Source connection lost, check interface connection”. If you see this error, and you are using an N5172B or an N5182B, you can shorten the acquire time by presetting your MXG before attempting to use External Source Control.

Key Path	Source
Scope	Meas Global
Remote Command	:INSTrument:SOURce[:SElect] TRACKing OFF :INSTrument:SOURce[:SElect]?
Example	:INST:SOUR TRAC
Dependencies	<p>Grayed out if no Source is selected, in this case go to the Select Source menu to choose, configure and/or verify your source</p> <p>Grayed out and forced to Off if either BBIQ or External Mixing are selected</p> <p>Blanked in Modes that do not support a source</p> <p>Grayed out in Measurements that do not support a source</p> <p>Tracking is grayed out when Manual FFT is selected</p> <p>Tracking is grayed out when the RF Preselector is on (in models which support the RF Preselector).</p>
Couplings	<p>When RF Output is turned On, Source Mode is set to Tracking. When Source Mode is turned Off, RF Output is turned Off.</p> <p>Whenever you switch to an application (Mode) in which the Source Mode was previously set to Tracking, it is again set to Tracking. That is, the last setting of the Source Mode is remembered when you leave an application (Mode) and restored when you return</p> <p>Source Mode is forced to Tracking when the RF Output is turned on if the measurement supports Tracking</p> <p>If Source Mode is set to Tracking, then it is forced to Off when you select a measurement that does not support Tracking.</p> <p>If Source Mode is set to Tracking, then it is forced to Off when you turn on the RF Preselector (in models which support the RF Preselector).</p> <p>Whenever the Source Mode is set to Tracking, the analyzer acquires the Source. Similarly, the Source is released whenever the Source Mode is set to Off. This is true whether the Source Mode was set directly by you, was set indirectly through a coupling, if you switched to an application (Mode) that had previously been set to Tracking, or if you switched to an application (Mode) in which the Source Mode is not set to Tracking.</p> <p>For an external source, “acquiring the source” involves contacting the external instrument over</p>

the remote interface (which puts it into Remote) and taking control of it.
 When you set the Source Mode to OFF, it releases the Source (and puts it into Local). For an external source, this means you are now free to operate the source for other purposes.
 When the Source is acquired, its previous state is saved, and when it is released, that state is restored, so that you can acquire and then release the source and it will return to the state it was in before you acquired it.

Preset	OFF
State Saved	Saved in instrument state
Initial S/W Revision	A.06.01
Modified at S/W Revision	A.10.01

Select Source

The Select Source menu allows you to maintain a list of available external Sources, and choose the Source that you want to use from the list. It shows the currently selected source at the bottom of the screen.

While in the Select Source menu, you can see, and select from, a list of the currently available sources. The sources listed in this table are as follows:

- Any internal sources which are installed and licensed

NOTE

Only one internal source can be installed, displayed at address “INTERNAL”

- Any external sources which you have previously configured, whether or not they are currently connected, displayed with their VISA address

Note that only external sources that are supported by the Tracking Source Mode are displayed in the Available Source List. Here are the Keysight/Agilent sources currently supported:

Source	PXA	MXA	EXA	CXA	MXE (Presel off)
MXG N5181A	X	X	X	X	X
MXG N5182A	X	X	X	X	X
MXG N5183A	X	X	X		X
EXG N5171B	X	X	X	X	X
MXG N5181B	X	X	X	X	X
EXG	X	X	X	X	X

N5172B					
EXG	X	X	X	X	X
N5173B					
MXG	X	X	X	X	X
N5182B					
MXG	X	X	X	X	X
N5183B					
PSG	X	X	X		
E8257D					
PSG	X	X	X		
E8267D					

NOTE

For X-Series software versions earlier than A.10.01, option UNZ (Fast switching) was required on the MXG for some use cases. This is no longer the case, option ESC now works without MXG option UNZ for all use cases. (Note that you will get better performance if your MXG has option UNZ, because without option UNZ your sweep speeds will be noticeably slower.)

While in the Select Source menu and its submenus, detailed instructions are presented that tell you how to operate the Select Source functions. Basically they tell you to first use the up and down arrow keys to move the selection highlighted in the “Available Source List” to the source that you want to use. The list of available sources includes any sources that you have previously used (unless you have deleted them) and any found while in the “Add Source to List” menu.

When the source you want to use is highlighted, press “Select Highlighted Source” or “Enter”. The source you have selected shows up at the bottom of the screen as the “Current Source”. Press “Verify Current Source Connection” to make sure that the interface connection to the Source is still functional.

At any time you may use the “Add Source to List” or “Delete Highlighted Source” keys to find new sources or remove a source from the list of available sources.

Key Path	Source
Readback Text	Two lines of readback give the type information and serial number of the current source, in square brackets
Initial S/W Revision	A.06.01

Select Highlighted Source

You can navigate up and down in the list with the up and down arrow keys, and can select any entry by pressing the Select Highlighted Source key (or by double-clicking on the entry in the table with a mouse). The highlighted source becomes the Current Source and is prominently displayed at the bottom of the screen.

At any given time there is only one selected Source for the entire system; once a Source is selected, it becomes the Current Source and will be used by all applications that support Source Control.

For example, if no Source has yet been selected, the statement at the bottom of the screen would say

Current Source

None

If an N5182A connected via USB were the Current Source, the statement at the bottom of the screen might say:

Current Source

Agilent N5182A US00000258 at USB0::2931::7937::US00000258::0::INSTR

The SCPI command defined below allows the programmatic user to directly define the VISA address via a string parameter. The parameter is checked for proper syntax, the connection to the instrument is verified, and the source is added to the Available Source List if it verifies. If it does not verify or no source is found at that address, an error message is generated.

Normally the source selection activities should be performed only when the user changes the hardware connection configuration or activates/deactivates a source option license; shutdown and startup of the application will not cause source re-selection.

The Agilent IO Libraries Suite provides an “Agilent VISA Help” document that has a section that shows the proper syntax for valid VISA address strings, in the ViOpen function definition.

Key Path	Source, Select Source
Mode	SA
Remote Command	:SYSTem:COMMunicate:SOURce[1]:ADDRess <address string> :SYSTem:COMMunicate:SOURce[1]:ADDRess?
Example	Different examples for setting external source address :SYST:COMM:SOUR:ADDR "TCPIP0::MyHostName::INSTR" :SYST:COMM:SOUR:ADDR "TCPIP0::123.121.100.210::INSTR" :SYST:COMM:SOUR:ADDR "USB0::12212::32145::US1234567A::INSTR" :SYST:COMM:SOUR:ADDR "GPIB1::19::INSTR"
Notes	Empty string is allowed and means no source is defined or selected.
Remote Command Notes	The address string is the VISA address for external sources and "INTERNAL" for an internal source
Dependencies	Operation with a source requires a license. If the proper license is not installed, the SCPI command generates an error message, "Settings conflict;option not installed" If no supported source, or no source at all, is found at the specified address, the SCPI command generates an error message
Preset	The current source selection is unaffected by a Mode Preset and Source Preset but reverts to [None] on a Restore Input/Output Defaults. If an internal Tracking Generator is installed, then instead of None, the default selection will be INTERNAL.

State Saved	<p>Selected Source is</p> <ul style="list-style-type: none"> - Power On Persistent (survives power cycle) - Part of the Input/Output system, which means it is Loaded and Saved with state.
Readback	<p>Two lines of readback give the type information and serial number of the current source on the Select Source key in the form</p> <p>[<source type>] [<serial number>]</p> <p>[None] shows in the type area and blank in the serial number area if a source has not been configured.</p> <p>[Internal TG] shows in type area and serial number in the serial number area if an internal Tracking Generator has been selected.</p> <p>For example: [MXG]/n, [US01020022]. This indicates an MXG of serial number US01020022.</p>
Backwards Compatibility SCPI	<p>:SYSTem:COMMunicate:LAN:SOURce[:EXTernal]:IP <address string></p> <p>:SYSTem:COMMunicate:LAN:SOURce[:EXTernal]:IP?</p> <p>This command is provided for compatibility with PSA Option 215. The address string is reformatted for the X-Series. For example, if the customer sends</p> <p>:SYSTem:COMMunicate:LAN:SOURce:EXTernal:IP 146.208.172.111</p> <p>The analyzer turns this into</p> <p>:SYSTem:COMMunicate:SOURce:ADDRes "TCPIP0::146.208.172.111::INSTR"</p>
Initial S/W Revision	A.06.01
Modified at S/W Revision	A.10.01

Delete Highlighted Source

Deletes the highlighted source from the list of available sources. You will be prompted with a dialog box to make sure you REALLY want to do this. The prompt says "The highlighted source will be permanently deleted from the list. Are you sure you want to do this? Press Enter to proceed, or Cancel (ESC) to cancel."

Key Path	Source, Select Source
Initial S/W Revision	A.06.01

Add Source To List

This menu allows you to add to the list of available sources from various interfaces.

Key Path	Source, Select Source
Initial S/W Revision	A.06.01

USB

Sources on USB (once installed) can be added to the list by pressing "Add Installed USB Sources." Any supported source found will be added to the list.

See ["Add Installed USB Sources" on page 3259](#) for information on connecting and installing USB devices.

Key Path	Source, Select Source, Add Source to List
Initial S/W Revision	A.06.01

Add Installed USB Sources

Press this key to add USB sources to the Available Source List. Note that this function will ONLY find sources that have previously been installed onto the USB. For information on how to install a USB source, see ["Installing a USB source" on page 1494](#)

Key Path	Source, Select Source, Add Source to List, USB
Notes	If no installed USB device is found which is a supported source, an error message is generated
Initial S/W Revision	A.06.01

Installing a USB source

USB is the only interface which requires no runtime action by the user in the Select Source menu, but does require “installation” when a source is plugged in.

You start by connecting the USB source to the analyzer. You will get a series of messages indicating that the analyzer is installing required device software.

When the installation is complete, you will get a message to that effect. You can then use the “Add Installed USB Sources” function (above) to add the source to the list of sources in the Available Source List.

GPIB

Lets you add GPIB sources to the Available Source List.

For the GPIB interface to work properly, it must be configured as a Controller. You can find this setting in the System menu under System, I/O Config, GPIB. Set the GPIB Controller function to Enabled.

Note that you must also make sure that the GPIB interface is not set to “Ignore” in the Agilent Connection Expert. If it is set to **Ignore**, then even if the GPIB Controller is set to **Enabled**, it is not possible for the analyzer to find a GPIB connected source. See ["More Information" on page 1494](#) .

Key Path	Source, Select Source, Add Source to List
----------	---

Initial S/W Revision	A.06.01
----------------------	---------

More Information

If you suspect that the GPIB interface is not set to Ignore, run the Agilent Connection Expert (ACE). To run ACE, press Source, Select Source, Add Source to List, LAN, Run Connection Expert. Look for the GPIB branch on the interface tree:

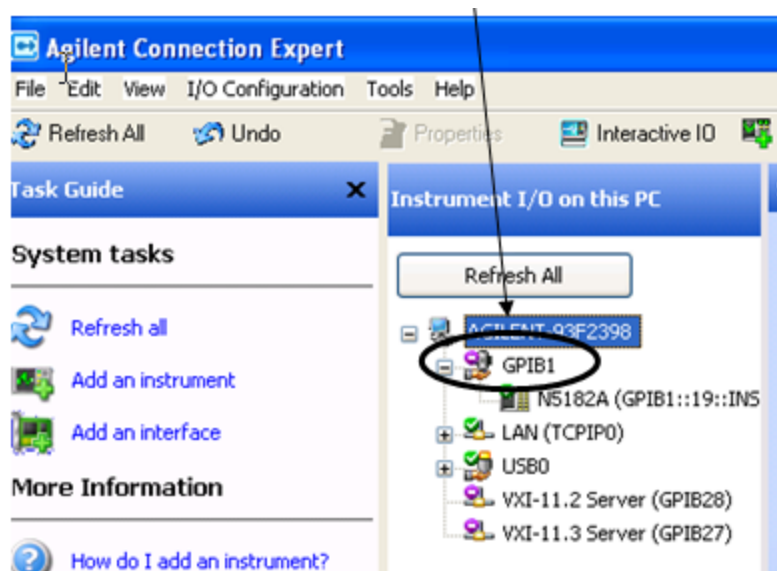

Right click on the GPIB branch (you will have to plug in a mouse to do this). You should see a dialog like the one below. If this dialog says **Stop Ignoring**, select **Stop Ignoring** and close ACE.

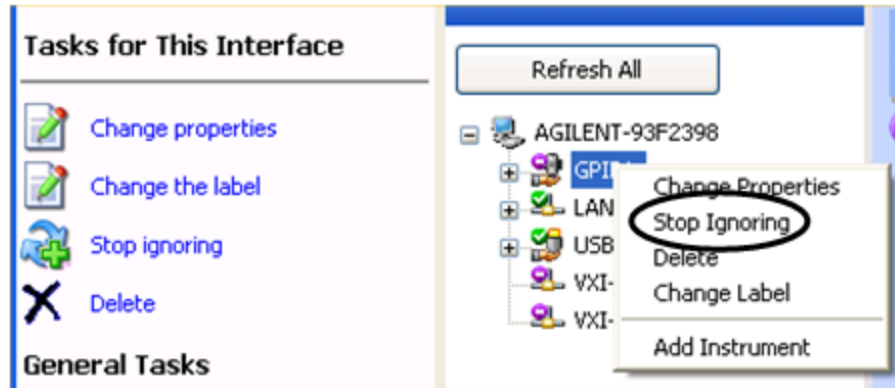

Scan & Add GPIB Sources

Sources on GPIB can be added by pressing **Scan & Add GPIB Sources**. Any supported source found will be added to the Available Source List.

NOTE

This will cause any older, non-SCPI compatible devices on your GPIB to generate error messages.

Key Path	Source, Select Source, Add Source to List, GPIB
Notes	If the GPIB controller mode is not enabled, an error message is generated If no GPIB device is found which is a supported source, an error message is generated
Initial S/W Revision	A.06.01

Enter GPIB Address

Opens a menu that lets you enter the GPIB address of the desired source directly.

NOTE

For this to work properly, the GPIB interface must be configured as GPIB1. This is the default state and should normally be the case. To see how to verify this, see **"More Information" on page 1496**.

Key Path	Source, Select Source, Add Source to List, GPIB
Initial S/W Revision	A.06.01

More Information

If you suspect that the GPIB interface is not set to GPIB1, run the Agilent Connection Expert (ACE). To run ACE, press Source, Select Source, Add Source to List, LAN, Run Connection Expert. Look for the GPIB branch on the interface tree:

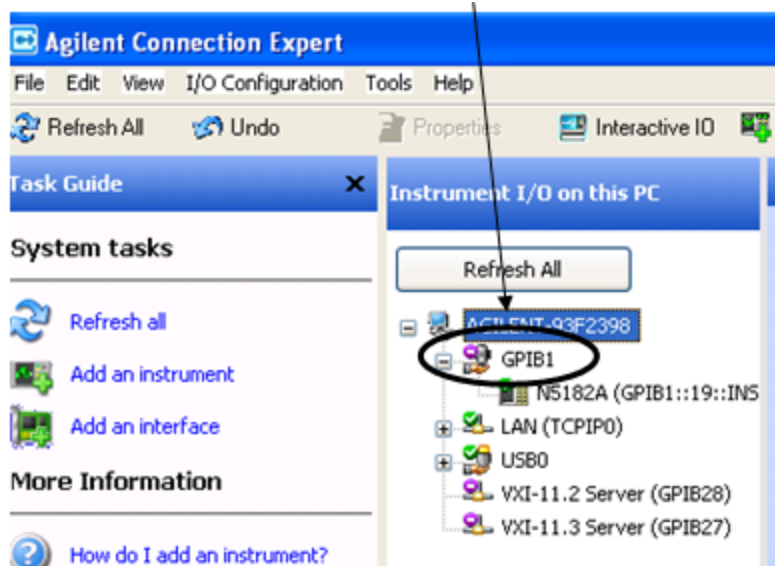

If this branch is not labeled **GPIB1**, right click on the GPIB branch (you will have to plug in a mouse to do this) and select **Change Properties**.

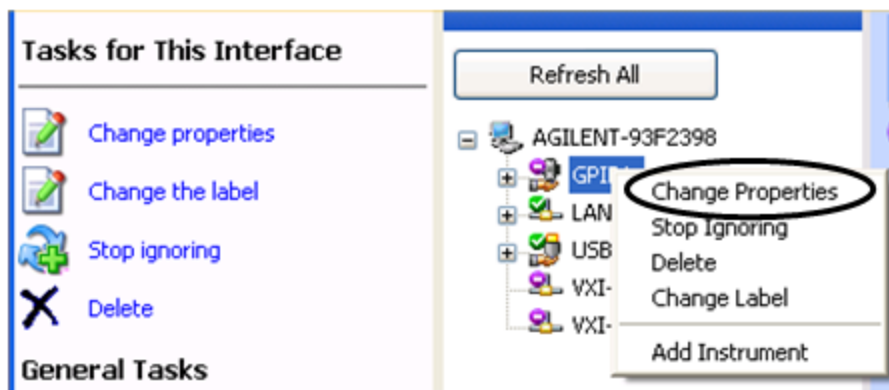

You should see a dialog like the one below. Click on the drop-down arrow under VISA Interface ID, select GPIB1 and click OK

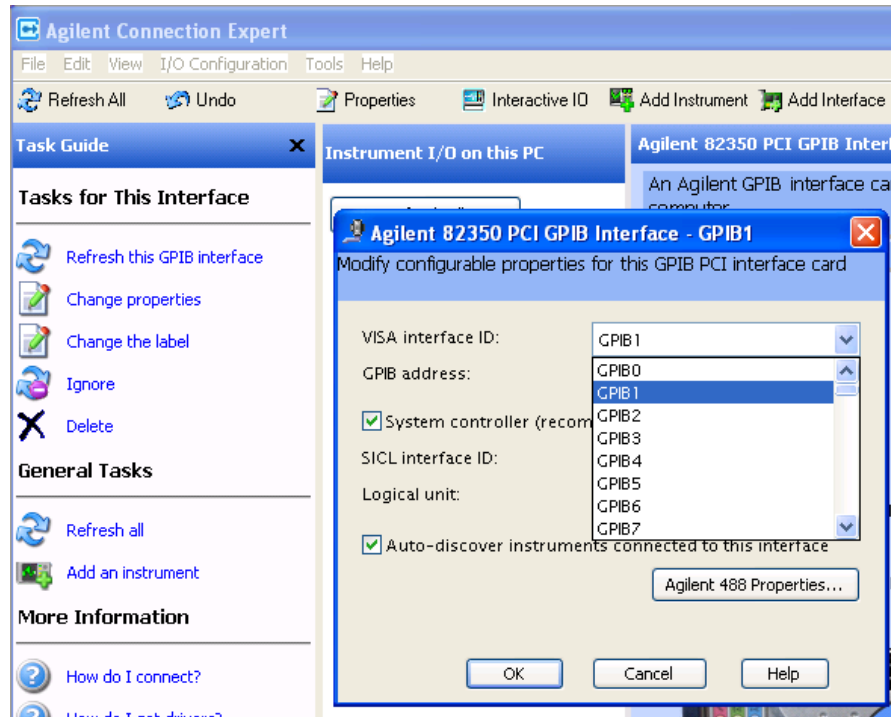

GPIB Address

Lets you enter the GPIB address. After you enter the address press **Add** to add the source at that address to the Available Source List.

Key Path	Source, Select Source, Add Source to List, GPIB, Enter GPIB Address
Preset	Unaffected by Mode Preset but set to 19 by "Restore Input/Output defaults"
State Saved	No
Min	0
Max	30
Initial S/W Revision	A.06.01

Add

Add the source at the entered GPIB address to the Available Source List. If a supported source is found at that address it will be added to the list.

Key Path	Source, Select Source, Add Source to List, GPIB, Enter GPIB Address
Notes	If GPIB controller mode is not enabled, an error message is generated If no supported source is found at the specified address, an error message is generated
Initial S/W Revision	A.06.01

LAN

The LAN cannot be scanned directly from the analyzer software, but you can import the list of currently configured devices from Agilent Connection Expert by pressing

“Add From Connection Expert List.” The Connection Expert list depends on which instruments have already been discovered by the Agilent Connection Expert application. Any connected, supported sources in that list will be added.

You can also enter the IP address and press “Add”. If a supported source is found at that address it will be added.

If you want to discover sources on the LAN, you can open Connection Expert by pressing the “Run Connection Expert...” softkey.

Key Path	Source, Select Source, Add Source to List
Initial S/W Revision	A.06.01

Enter LAN Address

Opens up a menu which lets you enter the IP address of the desired source directly.

Key Path	Source, Select Source, Add Source to List, LAN
Initial S/W Revision	A.06.01

IP Address

Lets you enter the IP address of the desired source. After you enter the address you should press “Add” to add the source at that address to the Available Source List.

Key Path	Source
Preset	Unaffected by Mode Preset but set to 0.0.0.0 by Restore Input/Output defaults
State Saved	No
Initial S/W Revision	A.06.01

Add

Adds the source at the entered IP address to the Available Source List. If a supported source is found at that address it will be added to the list.

Key Path	Source
Notes	If no supported source is found at the specified address, an error message is generated
Initial S/W Revision	A.06.01

Run Connection Expert...

Runs the Agilent Connection Expert so that you can scan the LAN for sources.

Key Path	Source, Select Source, Add Source to List, LAN
Initial S/W Revision	A.06.01

Add From Connection Expert List

You can import the list of currently configured devices from Agilent Connection Expert by pressing **Add From Connection Expert List**. The Connection Expert list

depends on which instruments have already been discovered by the Agilent Connection Expert application. Any connected, supported sources in that list will be added.

Key Path	Source, Select Source, Add Source to List, LAN
Notes	If no supported source is found in the Connection Expert list, an error message is generated
Initial S/W Revision	A.06.01

Verify Current Source Connection

This key verifies the interface connection to the Current Source (it does NOT verify any signal connections!)

Until the selected source is verified, a statement appears at the bottom of the screen which says (in red):

This Source has not been verified. Press "Verify Source" to check the interface connection.

When you press this key, the connection is checked to the selected source. If all is well, the statement is changed to (in green):

This connection to this source has been verified.

If the verification fails, the statement at the bottom will change to (in red):

Verification of this source failed. Check the interface connection

The selected source is also verified whenever it is acquired. If a Source's connection has been verified by any means, then that Source is considered to have been verified until either the analyzer software is shut down or if, in attempting to use the Source, communication with it fails.

Key Path	Source, Select Source
Initial S/W Revision	A.06.01

Source Setup

This menu is used to set up miscellaneous source functions, including trigger settings. For more on triggering in Tracking Mode, see ["Tracking Setup Details" on page 1499](#). For information on bypassing the Microwave Preselector, see ["Use of the YTF \(Microwave or mm Preselector\) with External Source Control" on page 1500](#)

Key Path	Source
Mode	SA
Initial S/W Revision	A.06.01

Tracking Setup Details

When an external source is operating in Tracking Mode, operation can be greatly enhanced by using hardware triggers. Below is a typical connection diagram showing

a hardware handshake using Trigger 1 inputs and outputs on the analyzer (trigger 2 in and out is also a valid connection).

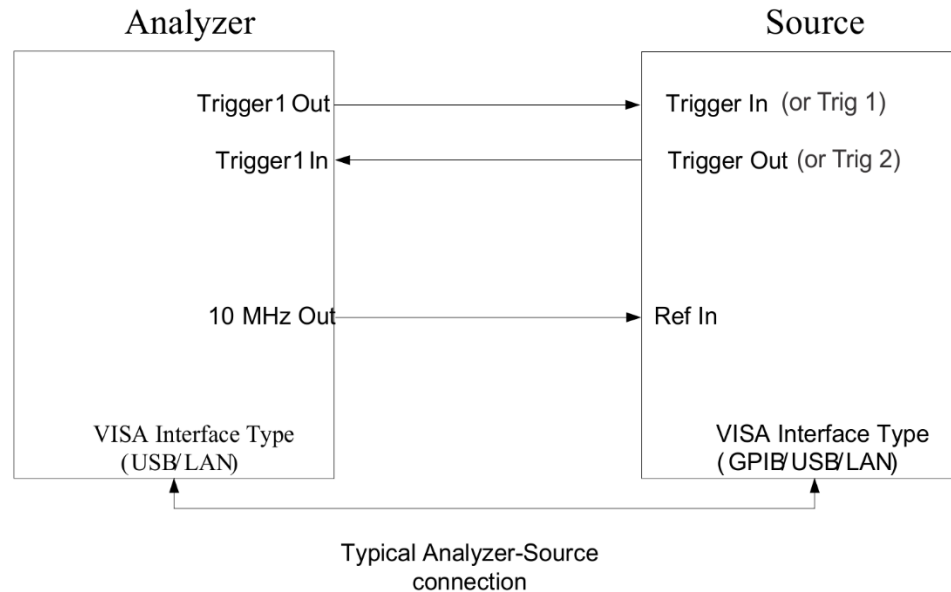

Analyzer Trigger 1 Out: Triggers the external source to step to next point in the frequency step/list.

Analyzer Trigger 1 In: Triggers the analyzer to make a measurement on this point

Source Trigger In (or “Trig 1” at default setting for N5181B/82B, N5183B MXG or N5171B/72B, N5173B EXG):

Triggers the source to step to the next point.

Source Trigger Out (or “Trig 2” at default setting for N5181B/82B, N5183B MXG or N5171B/72B, N5173B EXG): Indicates that the source has settled.

IO interface Connection: analyzer can connect to sources with its GPIB, USB or LAN interface.

Notes:

- Trigger sync connections are optional – synchronization can be done via remote commands if Bus Trigger is enabled in the Source Setup menu.
- Connection from the SA external frequency reference output to the source frequency reference input (10 MHz Out to Ref In) is not required, but may improve the measurement accuracy.

Use of the YTF (Microwave or mm Preselector) with External Source Control

In most stimulus/response measurements that utilize External Source Control, the source exactly tracks the tuned analyzer frequency. Consequently, preselection is not needed, and you can achieve greatly superior amplitude accuracy and

repeatability by bypassing the YTF (Preselector) using the Microwave Preselector Bypass control in the Amplitude, μ W Path Control menu.

NOTE

This control is only available if option MPB is installed.

There are rare but important cases, however, where the source is tuned to a different frequency than the analyzer, using the Multiplier and Reverse controls in the Source, Frequency menu. For example, you might be tuning the source to $\frac{1}{2}$ of the analyzer frequency when looking at second harmonic distortion in a DUT. In these cases, it would be commonplace for there to be an undesired signal at the analyzer input that is at an image frequency that you will want to reject with the YTF.

Understanding these cases is important for proper operation of the Microwave Preselector with External Source Control, so that you only bypass it when it will improve accuracy but not hinder the measurement.

Point Trigger

Shows point trigger type selected and navigates to the Point Trigger menu.

The Point Trigger menu lists all analyzer point trigger types. The analyzer and source point trigger synchronization can be done using SCPI bus commands or by using external trigger output and input lines.

NOTE

For X-Series software versions earlier than A.10.01, hardware triggering was unavailable in stepped tracking at frequencies above 3.6 GHz, so above 3.6 GHz, software triggering was always used. This is no longer the case.

Key Path	Source, Source Setup
Mode	SA
Scope	Mode Global
Remote Command	:SOURCE:TRIGGER:TYPE BUS EXTERNAL[1] EXTERNAL2 :SOURCE:TRIGGER:TYPE?
Example	:SOUR:TRIG:TYPE EXT1 Selects analyzer external trigger 1 in and out for point trigger synchronization with selected source
Dependencies	If an internal Tracking Generator is selected, then this menu is unavailable. Additionally, the External 1 and External 2 Trigger keys on the Spectrum Analyzer are released from any grayout that may have been forced on them by the external source Point Trigger selection. In some models, there is no second External input. In these models, the External 2 key is blanked and the EXTERNAL2 parameter will generate a "Hardware missing; Not available for this model number" message.
Couplings	The source control point trigger selection can select external trigger 1 or 2 in for synchronized point triggering. This can conflict with the selection under the Trigger hardkey, if it has External 1 or 2 selected. If there is a conflict when the selection is made under the Point Trigger menu, the Trigger selection under the Trigger hardkey will be changed to Free Run.
Preset	This is unaffected by "Mode Preset" but is set to EXTERNAL1 on a "Source Preset" or "Restore Input/Output Defaults".

State Saved	Part of the Input/Output system, which means it is Loaded and Saved with state
Readback	1-of-N selection
Initial S/W Revision	A.06.01

SW Trigger

Analyzer and source point trigger synchronization is setup using the SCPI commands. Source is stepped via SCPI commands. Analyzer waits for source to settle by polling source.

Key Path	Source, Source Setup, Point Trigger
Mode	SA
Example	:SOUR:TRIG:TYPE BUS
Readback	SW Trigger
Initial S/W Revision	A.06.01

Ext Trigger 1

Analyzer and source point trigger synchronization is setup using the analyzer Trigger 1 Output and Trigger 1 Input. The Source is stepped via Trigger 1 Output. The Analyzer waits for source to settle via Trigger 1 Input.

Key Path	Source, Source Setup, Point Trigger
Mode	SA
Example	:SOUR:TRIG:TYP EXT1
Couplings	<p>With an acquired source, selecting this point trigger mode overrides existing external trigger 1 output level, slope, and delay, and external trigger 1 type and polarity.</p> <p>External trigger 1 input level = 1.20 V</p> <p>External trigger 1 input slope = Positive</p> <p>External trigger 1 input delay = Off</p> <p>External trigger 1 output type = Source Point Trigger</p> <p>External trigger 1 output polarity = Positive</p> <p>When this selection is made:</p> <ul style="list-style-type: none"> - The External 1 key in the Trigger menu (under the Trigger hardkey) is grayed out and, if External 1 was previously selected, it will be changed to Free Run. - Trig 1 Out selected under Output Config in the Input/Output menu will be changed to Source Point Trigger <p>If the user subsequently goes into the Trig 1 Out menu and selects a different Trigger Output, the Point Trigger will revert to SW Trigger.</p>
Readback	Ext Trigger 1
Initial S/W Revision	A.06.01

Ext Trigger 2

Analyzer and source point trigger synchronization is setup using the analyzer Trigger 2 Output and Trigger 2 Input. The Source is stepped via Trigger 2 Output. The Analyzer waits for source to settle via Trigger 2 Input.

Key Path	Source, Source Setup, Point Trigger
Mode	SA
Example	:SOUR:TRIG:TYP EXT2
Dependencies	This key is blanked out on CXA as there is only one trigger input
Couplings	<p>With an acquired source, selecting this point trigger mode overrides existing external trigger 2 output level, slope, and delay, and external trigger 2 type and polarity.</p> <p>External trigger 2 input level = 1.20 V</p> <p>External trigger 2 input slope = Positive</p> <p>External trigger 2 input delay = Off</p> <p>External trigger 2 output type = Source Point Trigger</p> <p>External trigger 2 output polarity = Positive</p> <p>When this selection is made:</p> <ul style="list-style-type: none"> - The External 2 key in the Trigger menu (under the Trigger hardkey) is grayed out and, if External 2 was previously selected, it will be changed to Free Run. - Trig 2 Out selected under Output Config in the Input/Output menu will be changed to Source Point Trigger - If the user subsequently goes into the Trig 2 Out menu and selects a different Trigger Output, the Point Trigger will revert to SW Trigger.
Readback	Ext Trigger 2
Initial S/W Revision	A.06.01

Show Source Capabilities & Settings

Shows the capabilities of the currently selected Source. The menu is useful for displaying source capabilities such as frequency and amplitude ranges. In addition, the results of the source control sweep algorithms can be viewed. This gives information of the source range required for a given analyzer sweep range. This can be used dynamically as a way of configuring the sweep settings.

Key Path	Source, Source Setup
Mode	SA
Dependencies	If no source is selected this key is grayed out.
Initial S/W Revision	A.06.01

Source Preset

The Source Preset key forces all the settings in the analyzer's Source State to their preset condition.

The Source State is the set of Source settings that is maintained and remembered by the analyzer for use in the Tracking Source Mode. The Source State variables are controlled and set in the menus under the Source front panel key. These settings include:

- RF Output Off
- Amplitude = - 10 dBm
- Amplitude Step = Auto
- Power Sweep = 0 dB
- Amplitude Offset = 0 dB
- Source Sweep Reverse = Off
- Multiplier Numerator = 1
- Multiplier Denominator = 1
- Freq Offset = 0 Hz
- Point trigger is set to "Ext1"

The Source State is saved along with the state of the current Mode when you save a State, and is recalled when that Mode State is recalled.

When the analyzer first starts up, a Source Preset is performed. In the Input/Output menu, Restore Input/Output Defaults will also perform a Source Preset.

A Mode Preset, from modes that support the External Source, will turn the RF Off but will **not** perform a Source Preset. By the same token, Source Preset does **not** perform a Mode Preset.

Source Preset does **not** change the Source Mode nor the selection of which physical source is being used, nor does it release the current source (the source remains under the control of the analyzer) nor exit the Source menu.

Key Path	Source
Mode	SA
Remote Command	:SOURce:PRESet
Example	:SOUR:PRES
Preset	Initiates a Source Preset
State Saved	No
Initial S/W Revision	A.06.01

Span X Scale

Activates the Span function and displays the menu of span functions. The parameter values are measurement independent.

Key Path	Front-panel key
Initial S/W Revision	Prior to A.02.00

Span

Set the frequency of the occupied bandwidth span for the current measurement.

Key Path	Span X Scale
Mode	SA, WCDMA, C2K, WIMAX OFDMA, TD-SCDMA, 1xEVDO, ISDB-T, CMMB, LTE, LTETDD, BLUETOOTH, WLAN, MSR, LTEAFDD, LTEATDD
Remote Command	[[:SENSe]:OBWidth:FREQuency:SPAN <freq> [:SENSe]:OBWidth:FREQuency:SPAN? [:SENSe]:OBWidth:FREQuency:SPAN:AUTO ON OFF 0 1 [:SENSe]:OBWidth:FREQuency:SPAN:AUTO?
Example	OBW:FREQ:SPAN 2.4 MHz OBW:FREQ:SPAN? OBW:FREQ:SPAN:AUTO 0 OBW:FREQ:SPAN:AUTO?
Notes	Span Auto Detector ([:SENSe]:OBWidth:FREQuency:SPAN:AUTO) is only available in MSR and LTE-Advanced FDD/TDD mode. The BAF SCPI is MSR and LTE-Advanced FDD/TDD only.
Couplings	When changing the Occupied Bandwidth Span, the Resolution Bandwidth and Video Bandwidth are set to AUTO to prevent the span from clipping. This is only available in MSR and LTE-Advanced FDD/TDD mode.
Preset	SA: 3 MHz WCDMA: 10 MHz WIMAX OFDMA: 20 MHz CDMA2K: 2 MHz TD-SCDMA: 4.8 MHz 1xEVDO: 3.75 MHz ISDB-T: 20 MHz CMMB: 8 MHz LTE, LTETDD, LTEAFDD, LTEATDD: 10 MHz BLUETOOTH:2 MHz WLAN: If Radio Std is 802.11a/g /j/p 20 MHz 802.11n(20MHz) 802.11ac(20MHz): 25 MHz If Radio Std is 802.11b: 30MHz If Radio Std is 802.11n(40MHz), 802.11ac (40MHz): 50 MHz

	<p>If Radio Std is 802.11ac(80MHz): 100MHz If Radio Std is 802.11ac(160MHz): 200MHz If Radio Std is 802.11ah(1MHz): 1.25MHz If Radio Std is 802.11ah(2MHz): 2.5MHz If Radio Std is 802.11ah(4MHz): 5MHz If Radio Std is 802.11ah(8MHz): 10MHz If Radio Std is 802.11ah(16MHz): 20MHz If Radio Std is 802.11j/p(10MHz): 12.5MHz If Radio Std is 802.11j/p(5MHz): 6.25MHz MSR: 20MHz ON</p>
State Saved	Saved in instrument state.
Min	100 Hz
Max	Hardware Maximum Span
Backwards Compatibility SCPI	[:SENSe] :EBwidth:FREquency:SPAN
Initial S/W Revision	Prior to A.02.00
Modified at S/W Revision	A.03.00, A.10.00, A.14.00

Full Span

Changes the Occupied Bandwidth Span to show the full frequency range of the analyzer. When using external mixing, it changes the displayed frequency span to the frequency range specified for the selected external mixing band.

Key Path	Span X Scale
Mode	SA, WCDMA, C2K, WIMAX OFDMA, ISDB-T, CMMB, LTE, LTETDD, BLUETOOTH, WLAN, LTEAFDD, LTEATDD
Remote Command	[:SENSe] :OBwidth:FREquency:SPAN:FULL
Example	OBW:FREQ:SPAN:FULL
Notes	You must be in the Spectrum Analysis mode, W-CDMA mode, ISDB-T mode, CMMB mode, LTE mode, LTE TDD mode, BLUETOOTH mode, WLAN mode, cdma2000 mode, MSR or WIMAX OFDMA mode to use this command. Use:INSTrument:SElect to set the mode.
Dependencies	For MSR and LTE-Advanced FDD/TDD mode, this key is blank. In order to keep backwards compatible with the legacy LTE FDD/TDD, the scpi command is supported in LTE & LTE-A converged application.
Couplings	Selecting full span changes the measurement span value.
Initial S/W Revision	Prior to A.02.00
Modified at S/W Revision	A.03.00

Last Span

Changes the measurement frequency span to previous measurement span setting. If there is no existing previous span value then the span remains unchanged.

Key Path	Span X Scale
Mode	SA, WCDMA, C2K, WIMAX OFDMA, ISDB-T, CMMB, LTE, LTETDD, BLUETOOTH, WLAN, MSR, LTEAFDD, LTEATDD
Remote Command	[:SENSe]:OBWidth:FREQuency:SPAN:PREVious
Example	OBW:FREQ:SPAN:PREV
Notes	You must be in the Spectrum Analysis mode, W-CDMA mode, ISDB-T mode, CMMB mode, LTE mode, LTE TDD mode, BLUETOOTH mode, WLAN mode, cdma2000 mode, MSR, LTE-Advanced FDD/TDD or WIMAX OFDMA mode to use this command. Use:INSTrument:SElect to set the mode.
Couplings	Selecting last span changes the measurement span value.
Initial S/W Revision	Prior to A.02.00
Modified at S/W Revision	A.03.00

Sweep/Control

Displays a menu of functions that enable you to set up and control the sweep time and source for the current measurement.

For details about this key, see "[Sweep/Control](#)" on page 927.

Key Path	Front-panel key
Initial S/W Revision	Prior to A.02.00

Sweep Time

Selects the length of time in which the spectrum analyzer sweeps the displayed frequency span. Additional overhead time, which impacts the sweep rate, is not calculated as part of the sweep time. In fact:

- sweep rate = span/sweep time
- update rate = 1/(sweep time + overhead)
- sweep cycle time = sweep time + overhead

Sweep time is coupled to RBW and VBW, and is impacted by the number of sweep points, so changing those parameters may change the sweep time.

This function is not available when the selected input is I/Q.

Key Path	Sweep/Control
Mode	SA, WCDMA, C2K, WIMAX OFDMA, TD-SCDMA, 1xEVDO, ISDB-T, CMMB, LTE, LTETDD, BLUETOOTH, WLAN, MSR, LTEAFDD, LTEATDD
Remote Command	[:SENSe] :OBWidth :SWEep :TIME <time> [:SENSe] :OBWidth :SWEep :TIME ? [:SENSe] :OBWidth :SWEep :TIME :AUTO OFF ON 0 1 [:SENSe] :OBWidth :SWEep :TIME :AUTO ?
Example	OBW:SWE:TIME 50 ms OBW:SWE:TIME? OBW:SWE:TIME:AUTO ON OBW:SWE:TIME:AUTO?
Couplings	When you manually change the Time, this state automatically goes to 'Man'.
Preset	SA, WIMAX OFDMA, C2K, TD-SCDMA, 1xEVDO, ISDB-T, CMMB, LTE, LTETDD, BLUETOOTH, WLAN, MSR, LTEAFDD, LTEATDD: Automatically Calculated WCDMA: 32.6 ms SA, WIMAX OFDMA, C2K, TD-SCDMA, 1xEVDO, ISDB-T, CMMB, LTE, LTETDD, WLAN, MSR, LTEAFDD, LTEATDD: ON WCDMA: OFF
State Saved	Saved in instrument state.

Min	1 ms
Max	4000 s
Initial S/W Revision	Prior to A.02.00
Modified at S/W Revision	A.03.00

Sweep Setup

Accesses the sweep setup settings for the current measurement.

Key Path	Sweep/Control
Initial S/W Revision	Prior to A.02.00

Pause

Pauses the measurement after the current data acquisition is complete.

When Paused, the label on the key changes to **Resume**. Pressing **Resume** resumes the measurement at the point where it had been paused.

See "[Pause/Resume](#)" on page 2263 for more information.

Key Path	Sweep/Control
Initial S/W Revision	Prior to A.02.00

Gate

Accesses a menu that enables you to control the gating function. The Gate functionality is used to view signals best viewed by qualifying them with other events.

Gate setup parameters are the same for all measurements – they do not change as you change measurements. Settings like these are called “Meas Global” and are unaffected by Meas Preset.

Note that Sweep Time autocoupling rules and annotation are changed by Gate being on.

Key Path	Sweep/Control
Scope	Meas Global
Readback	The state and method of Gate, as [Off, LO] or [On, Video]. Note that for measurements that only support gated LO, the method is nonetheless read back, but always as LO.
Initial S/W Revision	Prior to A.02.00

Gate On/Off

Turns the gate function on and off.

When the Gate Function is on, the selected Gate Method is used along with the gate settings and the signal at the gate source to control the sweep and video system with the gate signal. Not all measurements allow every type of Gate Methods.

When Gate is on, the annunciation in the measurement bar reflects that it is on and what method is used, as seen in the following "Gate: LO" annunciator graphic.

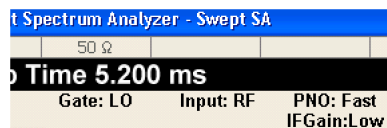

Key Path	Sweep/Control, Gate
Remote Command	[:SENSe] :SWEep:EGATe [:STATe] OFF ON 0 1 [:SENSe] :SWEep:EGATe [:STATe] ?
Example	SWE:EGAT ON SWE:EGAT?
Dependencies	The function is unavailable (grayed out) and Off when: <ul style="list-style-type: none"> - Gate Method is LO or Video and FFT Sweep Type is manually selected. - Gate Method is FFT and Swept Sweep Type is manually selected. - Marker Count is ON. <p>The following are unavailable whenever Gate is on:</p> <ul style="list-style-type: none"> - FFT under Sweep Type when Method=LO or Video or Swept under Sweep Type when Method=FFT <p>Marker Count</p> <p>While Gate is on, the Auto Rules for Sweep Type are modified so that the choice agrees with the Gate Method: i.e., FFT for Method = FFT and Swept for Method = LO or Video.</p> <p>The Gate softkey and all SCPI under the [:SENSe]:SWEep:EGATe SCPI node are grayed out when Source Mode is Tracking with an external source. This is because the Gate circuitry is used to sync the external source. If the Tracking Source is turned on, the Gate is turned off.</p> <p>When in the ACP measurement:</p> <ul style="list-style-type: none"> - When Meas Method is RBW or FAST, this function is unavailable and the key is grayed out. - Whenever Gate is on, Meas Method, RBW or FAST is unavailable and keys for those are grayed out. - When Gate is on, Offset Res BW and Offset Video BW are ignored (if you set these values) and the measurement works as if all Offset Res BW and all Offset Video BW are coupled with the Res BW and the Video BW under the BW menu. When Gate is on, the Offset BW key in the Offset/Limit menu is grayed out.
Preset	Off LTETDD: On

State Saved	Saved in instrument state
Range	On Off
Backwards Compatibility SCPI	[:SENSe]:SWEep:TIME:GATE[:STATe] ESA compatibility
Backwards Compatibility Notes	In ESA, Trig Delay (On) and Gate (On) could not be active at the same time.. This dependency does not exist in PSA or in the X-Series.
Initial S/W Revision	Prior to A.02.00

Gate View On/Off

Turning on Gate View in the Swept SA measurement provides a single-window gate view display..

Turning on Gate View in other measurements shows the split-screen Gate View. In these measurements, when the Gate View is on, the regular view of the current measurement traces and results are reduced vertically to about 70% of the regular height. The Zero Span window, showing the positions of the Gate, is shown between the Measurement Bar and the reduced measurement window. By reducing the height of the measurement window, some of the annotation on the Data Display may not fit and is not shown.

Key Path	Sweep/Control, Gate
Remote Command	[:SENSe]:SWEep:EGATe:VIEW ON OFF 1 0 [:SENSe]:SWEep:EGATe:VIEW?
Example	SWE:EGAT:VIEW ON turns on the gate view.
Dependencies	In the Swept SA measurement: In Gate View, the regular Sweep Time key is grayed out . When pressed, the grayed out key puts up the informational message "Use Gate View Sweep Time in the Gate menu." In the other measurements: When you turn Gate View on, the lower window takes on the current state of the instrument. Upon leaving Gate View, the instrument takes on the state of the lower window. When you turn Gate View on, the upper window Sweep Time is set to the gate view sweep time.
Couplings	These couplings apply to the Swept SA measurement: <ul style="list-style-type: none"> - When Gate View is turned on, the instrument is set to Zero Span. - Gate View automatically turns off whenever a Span other than Zero is selected. - Gate View automatically turns off if you press the Last Span key while in Gate View, and the instrument returns to the Span it was in before entering Gate View (even if that is Zero Span). - When Gate View is turned on, the sweep time used is the gate view sweep time. This is set according to the rules in section "Gate View Setup" on page 2809 - When Gate View is turned off, Sweep Time is set to the normal Swept SA measurement sweep time.

- If Gate View is on and Gate is off, then turning on Gate turns off Gate View.

Preset	OFF
State Saved	Saved in instrument state
Range	On Off
Initial S/W Revision	Prior to A.02.00

A sample of the Gate View screen in the Swept SA measurement is shown in the following graphic :

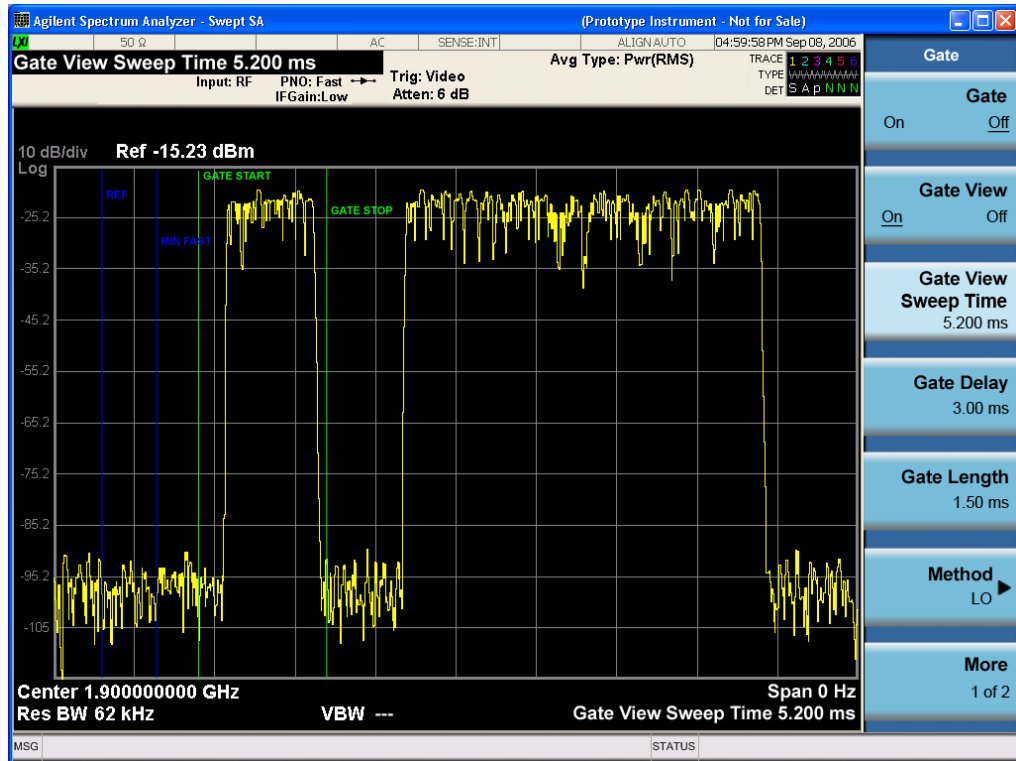

A sample of the Gate View screen in other measurements is shown in the following graphic . This example is for the ACP measurement:

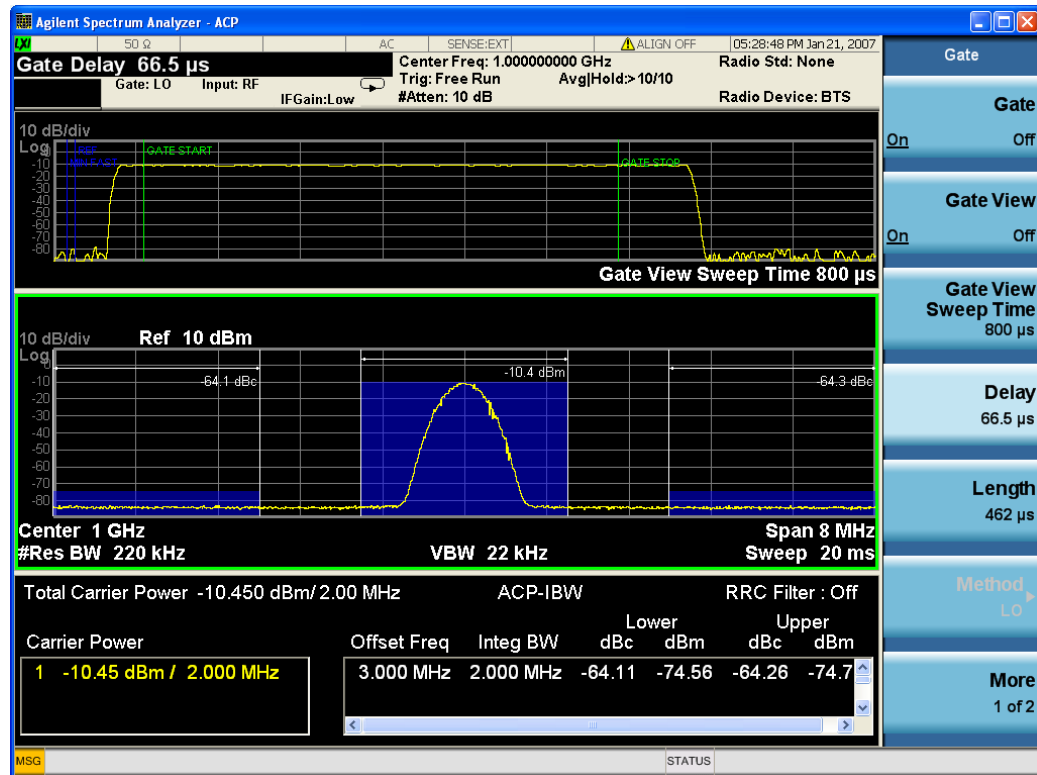

Turning Gate View off returns the analyzer to the Normal measurement view.

In the Swept SA, the normal measurement view is the single-window Swept SA view. When returning to this view, the Swept SA measurement returns to the Span it was in before entering **Gate View** (even if that is Zero Span).

The **Gate View** window is triggered from the Gate Source, with zero trigger delay. Also, when updating the **Gate View** window, the Gate itself must not operate. So it is internally shut off while the gate view window is being updated. For the Swept SA measurement, this means that the Gate is internally shut off whenever the gate view window is displayed. The measurement bar and softkeys continue to show the Trigger source for the main sweep window and give no indication that the Gate is shut off or that the Gate View window is triggered from the Gate Source.

When in **Gate View**, vertical lines are displayed in the Gate View window as follows:

- Green lines are displayed at the gate edges as follows: in Edge Gate, a line is shown for Delay and one for the end of the Gate period, defined by Length. In Level Gate a line is shown only for Delay. You can adjust the position of the green lines by adjusting the gate length and the gate delay. These lines update in the Gate View window as the active function changes, even if the window is not being updated. In Gated LO and Gated Video, these lines are positioned relative to the delay reference line (not relative to 0 time). In Gated FFT, their location is relative to the left edge of the screen.

- A blue line is displayed showing the delay reference, that is, the reference point for the Gate Delay within the Zero Span window. The blue line represents where (in time) the effective location of the gate start would be if the gate were programmed to zero delay.
-
- The second blue line is labeled "MIN FAST" as shown in the figure above because it represents the minimum Gate Delay for fast Gated LO operation. This line is only displayed in Gated LO. You cannot scroll (knob) or decrement (down key) the Gate Delay to less than that represented by the position of this line, it can only be set below this position manually, although once there it can be moved freely with the knob while below the line.
- A yellow line in the Gated Video case only, is displayed at Blength, where Blength is the display point (bucket) length for the swept trace, which is given by the sweep time for that trace divided by number of Points - 1. So it is referenced to 0 time, not to the delay reference. This line is labeled NEXT PT (it is not shown in the figure above because the figure above is for Gated LO).
- The yellow line represents the edge of a display point (bucket). Normally in Gated Video, the bucket length must be selected so that it exceeds the off time of the burst. There is another way to use the analyzer in Gated Video measurements, and that is to set the bucket width much shorter than the off time of the burst. Then use the Max Hold trace function to fill in "missing" buckets more slowly. This allows you to see some of the patterns of the Gated Video results earlier, though seeing a completely filled-in spectrum later.

Gate View Setup

Accesses a menu that enables you to setup parameters relevant to the Gate View

Key Path	Sweep/Control, Gate
Scope	Meas Global
Initial S/W Revision	A.10.00

Gate View Sweep Time

Controls the sweep time in the Gate View window. To provide an optimal view of the gate signal, the analyzer initializes Gate View Sweep Time based on the current settings of Gate Delay and Gate Length.

Key Path	Sweep/Control, Gate, Gate View Setup
Remote Command	[:SENSe] :SWEep:EGATe:TIME <time>

	[:SENSe] :SWEep:EGATe:TIME?
Example	SWE:EGAT:TIME 500 ms
Dependencies	Gate View Sweep Time is initialized: <ul style="list-style-type: none"> - On Preset (after initializing delay and length). - Every time the Gate Method is set/changed. <p>Additionally, in the Swept SA measurement, whenever you do a Preset, or leave Gate View, the analyzer remembers the Gate Delay and Gate Length settings. Then, when returning to Gate View, if the current Gate Delay and/or Gate Length do not match the remembered values Gate View Sweep Time is re-initialized.</p>
Preset	519.3 μ s WiMAX OFDMA: 5 ms GSM/EDGE: 1 ms
State Saved	Saved in instrument state
Max	6000 s
Initial S/W Revision	Prior to A.02.00

Gate View Start Time

Controls the time at the left edge of the Gate View.

Key Path	Sweep/Control, Gate, Gate View Setup
Remote Command	[:SENSe] :SWEep:EGATe:VIEW:STARt <time> [:SENSe] :SWEep:EGATe:VIEW:STARt?
Example	SWE:EGAT:VIEW:STAR 10ms
Notes	Units of time are required or no units; otherwise an invalid suffix error message will be generated. See error -131.
Preset	0 ms
State Saved	Saved in instrument state
Min	0
Max	500 ms
Initial S/W Revision	A.10.00

Gate Delay

Controls the length of time from the time the gate condition goes True until the gate is turned on.

Key Path	Sweep/Control, Gate
Remote Command	[:SENSe] :SWEep:EGATe:DELay <time> [:SENSe] :SWEep:EGATe:DELay?
Example	SWE:EGAT:DELay 500ms

	SWE:EGAT:DElay?
Notes	Units of time are required or no units; otherwise an invalid suffix error message will be generated.
Preset	57.7 us WiMAX OFDMA: 71 us GSM/EDGE: 600 us WLAN: 500 us
State Saved	Saved in instrument state
Min	0.0 us
Max	100 s
Backwards Compatibility SCPI	[:SENSe] :SWEep :TIME :GATE :DElay ESA compatibility
Initial S/W Revision	Prior to A.02.00

Gate Length

Controls the length of time that the gate is on after it opens.

Key Path	Sweep/Control, Gate
Remote Command	[:SENSe] :SWEep :EGATE :LENGth <time> [:SENSe] :SWEep :EGATE :LENGth?
Example	SWE:EGAT:LENG 1 SWE:EGAT:LENG?
Notes	Units of time are required or no units; otherwise an invalid suffix error message will be generated.
Dependencies	Grayed out when Gate Method is set to FFT in which case the label changes to that shown below. <div style="border: 1px solid gray; padding: 5px; display: inline-block; margin-bottom: 10px;"> Gate Length (=1.83/RBW) 2.8 ms </div> <small>vsd 39-1</small> The key is also grayed out if Gate Control = Level.
Preset	461.6 us WiMAX OFDMA: 50 us GSM/EDGE: 200 us WLAN: 1.54 ms
State Saved	Saved in instrument state
Min	100 ns
Max	5 s
Backwards Compatibility SCPI	[:SENSe] :SWEep :TIME :GATE :LENGth ESA compatibility
Initial S/W Revision	Prior to A.02.00

Method

This lets you choose one of the three different types of gating.

Not all types of gating are available for all measurements.

Key Path	Sweep/Control, Gate
Remote Command	[:SENSe] :SWEep:EGATe:METhod LO VIDeo FFT [:SENSe] :SWEep:EGATe:METhod?
Example	SWE:EGAT:METH FFT
Preset	LO
State Saved	Saved in instrument state
Initial S/W Revision	Prior to A.02.00

LO

When Gate is set to On, the LO sweeps whenever the gate conditions as specified in the Gate menu are satisfied by the signal at the Gate Source.

This form of gating is more sophisticated, and results in faster measurements. With Gated LO, the analyzer only sweeps while the gate conditions are satisfied. This means that a sweep could take place over several gate events. It would start when the gate signal goes true and stop when it goes false, and then continue when it goes true again. But since the LO is sweeping as long as the gate conditions are satisfied, the sweep typically finishes much more quickly than with Gated Video.

When in zero span, there is no actual sweep performed. But data is only taken while the gate conditions are satisfied. So even though there is no sweep, the gate settings will impact when data is acquired.

Key Path	Sweep/Control, Gate, Method
Dependencies	Key is unavailable when Gate is On and FFT Sweep Type manually selected. When selected, Sweep Type is forced to Swept and the FFT key in Sweep Type is grayed out.
Readback	LO
Initial S/W Revision	Prior to A.02.00

Video

When Gate is set to On, the video signal is allowed to pass through whenever the gate conditions as specified in the Gate menu are satisfied by the signal at the Gate Source.

This form of gating may be thought of as a simple switch, which connects the signal to the input of the spectrum analyzer. When the gate conditions are satisfied, the switch is closed, and when the gate conditions are not satisfied, the switch is open. So we only look at the signal while the gate conditions are satisfied.

With this type of gating, you usually set the analyzer to sweep very slowly. In fact, a general rule is to sweep slowly enough that the gate is guaranteed to be closed at

least once per data measurement interval (bucket). Then if the peak detector is used, each bucket will represent the peak signal as it looks with the gate closed.

Key Path	Sweep/Control, Gate, Method
Dependencies	Key is unavailable when Gate is On and FFT Sweep Type manually selected. When selected, Sweep Type is forced to Swept and the FFT key in Sweep Type is grayed out
Readback	Video
Initial S/W Revision	Prior to A.02.00

FFT

When Gate is set to On, an FFT is performed whenever the gate conditions as specified in the Gate menu are satisfied by the signal at the Gate Source. This is an FFT measurement which begins when the gate conditions are satisfied. Since the time period of an FFT is approximately $1.83/\text{RBW}$, you get a measurement that starts under predefined conditions and takes place over a predefined period. So, in essence, this is a gated measurement. You have limited control over the gate length but it works in FFT sweeps, which the other two methods do not.

Gated FFT cannot be done in zero span since the instrument is not sweeping. So in zero span the Gated LO method is used. Data is still only taken while the gate conditions are satisfied, so the gate settings do impact when data is acquired.

The Gate Length will be $1.83/\text{RBW}$.

This is a convenient way to make a triggered FFT measurement under control of an external gating signal.

Key Path	Sweep/Control, Gate
Dependencies	Key is unavailable when Gate is On and Swept Sweep Type is manually selected. When selected, Sweep Type is forced to FFT and the Swept key in Sweep Type is grayed out Key is unavailable when gate Control is set to Level. Forces Gate Length to $1.83/\text{RBW}$
Readback	FFT
Initial S/W Revision	Prior to A.02.00

Gate Source

The menus under the **Gate Source** key are the same as those under the **Trigger key**, with the exception that neither **Free Run** nor **Video** are available as Gate Source selections. However, a different SCPI command is used to select the Gate Source (see table below) because you may independently set the Gate Source and the Trigger Source.

Any changes to the settings in the setup menus under each Gate Source selection key (for example: Trigger Level, Trigger Delay, etc.) also affect the corresponding settings under the Trigger menu keys. The SCPI commands used for these are the same for Trigger and Gate, since there is only one setting which affects both Gate and Trigger. Example: to set the Trigger Level for External 1 you use the command

:TRIG:EXT1:LEV regardless of whether you are using External 1 as a Trigger Source or a Gate Source.

Key Path	Sweep/Control, Gate
Remote Command	[:SENSe] :SWEep :EGATe :SOURce EXTerna11 EXTerna12 LINE FRAMe RFBurst TV PXI [:SENSe] :SWEep :EGATe :SOURce ?
Dependencies	In some models, there is no second External input. In these models, the External 2 key is blanked and the EXTerna12 parameter will generate a "Hardware missing; Not available for this model number" error. PXI trigger is only supported in PXI (modular) instruments.
Preset	EXTerna1 GSM/EDGE, MSR: FRAMe LTETDD: EXTerna1When Direction is Downlink, FRAMe when Direction is Uplink.
Backwards Compatibility Notes	In ESA, there is a single Gate input port. In PSA, the Gate Source may be taken from one of two specified input ports. In the X-Series, any Trigger Source can be a Gate Source.
Initial S/W Revision	Prior to A.02.00
Modified at S/W Revision	A.03.00, A.14.00

Line

Pressing this key, when it is not selected, selects the line signal as the trigger. A new sweep/measurement will start synchronized with the next cycle of the line voltage. Pressing this key, when it is already selected, access the line trigger setup menu.

Key Path	Trigger
Example	TRIG:SOUR LINE Swept SA measurement TRIG:<meas>:SOUR LINE Measurements other than Swept SA
Dependencies	Line trigger is not available when operating from a "dc power source", for example, when the instrument is powered from batteries.
State Saved	Saved in instrument state
Status Bits/OPC dependencies	The Status Operation Register bit 5 "Waiting for Trigger" is set at the same time as the Sweeping or Measuring bit is set. It is cleared when the trigger actually occurs (that is, after the trigger event occurs and all the applicable trigger criteria have been met). A corresponding pop-up message ("Waiting for trigger") is generated if no trigger signal appears after approximately 2 sec. This message goes away when a trigger signal appears.
Initial S/W Revision	Prior to A.02.00

Trig Slope

Controls the trigger polarity. It is set positive to trigger on a rising edge and negative to trigger on a falling edge.

Key Path	Trigger, Line
Remote Command	:TRIGger [:SEQuence] :LINE :SLOPe POSitive NEGative

	:TRIGger[:SEQuence]:LINE:SLOPe?
Example	TRIG:LINE:SLOP NEG
Preset	POSitive
State Saved	Saved in instrument state
Backwards Compatibility Notes	The legacy :TRIGger[:SEQuence]:SLOPe command affects the slopes for the VID, LINE, EXT1, EXT2, and RFB triggers.
Initial S/W Revision	Prior to A.02.00

External 1

Pressing this key, when it is not selected, selects an external input signal as the trigger. A new sweep/measurement will start when the external trigger condition is met using the external 1 input connector on the rear panel.

Pressing this key, when it is already selected, accesses the external 1 trigger setup menu.

Key Path	Trigger
Example	TRIG:SOUR EXT1 Swept SA measurement TRIG:<meas>:SOUR EXT1 Measurements other than Swept SA
Dependencies	Grayed out if in use by Point Trigger in the Source Setup menu. Forced to Free Run if already selected and Point Trigger is set to External 1.
State Saved	Saved in instrument state
Status Bits/OPC dependencies	The Status Operation Register bit 5 "Waiting for Trigger" is set at the same time as the Sweeping or Measuring bit is set. It is cleared when the trigger actually occurs (that is, after the trigger event occurs and all the applicable trigger criteria have been met). A corresponding pop-up message ("Waiting for trigger") is generated if no trigger signal appears after approximately 2 sec. This message goes away when a trigger signal appears.
Initial S/W Revision	Prior to A.02.00

Trigger Level

Sets the value where the external 1 trigger input will trigger a new sweep/measurement.

Key Path	Trigger, External 1
Remote Command	:TRIGger[:SEQuence]:EXTernal1:LEVel <level> :TRIGger[:SEQuence]:EXTernal1:LEVel?
Example	TRIG:EXT1:LEV 0.4 V
Couplings	This same level is used for the Ext1 trigger source in the Trigger menu, for the Ext1 selection in the Periodic Timer sync source (in the Trigger menu and in the Gate Source menu), and also for the Ext1 selection in the Gate Source menu.
Preset	1.2 V
State Saved	Saved in instrument state

Min	-5 V
Max	5 V
Default Unit	V
Backwards Compatibility SCPI	:TRIGger[:SEquence]:EXTernal:LEVel
	For backward compatibility, the parameter EXTernal is mapped to EXTernal1
Backwards Compatibility SCPI	:TRIGger[:SEquence]:FRAME:EXTernal1:LEVel
Initial S/W Revision	Prior to A.02.00

Trig Slope

Controls the trigger polarity. It is set positive to trigger on a rising edge and negative to trigger on a falling edge.

Key Path	Trigger, External 1
Remote Command	:TRIGger[:SEquence]:EXTernal1:SLOPe POSitive NEGative :TRIGger[:SEquence]:EXTernal1:SLOPe?
Example	TRIG:EXT1:SLOP NEG
Couplings	This same slope is used in the Ext1 selection for the trigger source in the Trigger menu and for the period timer sync source (in the Trigger menu and in the Gate Source menu).
Preset	POSitive
State Saved	Saved in instrument state
Backwards Compatibility SCPI	:TRIGger[:SEquence]:EXTernal:SLOPe
	For backward compatibility, the parameter EXTernal is mapped to EXTernal1
Backwards Compatibility SCPI	:TRIGger[:SEquence]:FRAME:EXTernal1:SLOPe
Backwards Compatibility Notes	The legacy :TRIGger[:SEquence]:SLOPe command affects the slopes for the VID, LINE, EXT1, EXT2, and RFB triggers.
Initial S/W Revision	Prior to A.02.00

Zero Span Delay Comp On/Off

In zero span, there is a natural delay in the signal path, which comes from the RBW filter. This is usually desirable, as it allows you to trigger on events and also see those events, because the signal is delayed from the trigger event. However, in some cases it is desirable to eliminate this delay, so that trigger events line up exactly with the zero time point in zero span. You can use the **Zero Span Delay Comp On/Off** feature to enable or disable zero span delay compensation.

Key Path	Trigger, External 1
Remote Command	:TRIGger[:SEquence]:EXTernal1:DElay:COMPensation OFF ON 0 1 :TRIGger[:SEquence]:EXTernal1:DElay:COMPensation?

Example	TRIG:EXT1:DEL:COMP ON
Dependencies	No effect except in zero-span, but not locked out in nonzero spans. Blanked in modes that do not support zero-span measurements. If the SCPI command is sent when the key is blanked, an error is returned: -221, "Settings conflict; Feature not supported for this measurement" In analyzers shipping N9060A, this feature requires N9060A-7FP.
Preset	OFF
State Saved	Saved in instrument state
Initial S/W Revision	A.11.00

External 2

Pressing this key, when it is not selected, selects an external input signal as the trigger. A new sweep/measurement will start when the external trigger condition is met using the external 2 input connector. The external trigger 2 input connector is on the rear panel.

Pressing this key, when it is already selected, accesses the external 2 trigger setup menu.

Key Path	Trigger
Example	TRIG:SOUR EXT2 Swept SA measurement TRIG:<meas>:SOUR EXT2 Measurements other than Swept SA
Dependencies	In some models, there is no second External input. In these models, the External 2 key is blanked and the EXTernal2 parameter will generate a "Hardware missing; Not available for this model number" message. Grayed out if in use by Point Trigger in the Source Setup menu. Forced to Free Run if already selected and Point Trigger is set to External 2.
State Saved	Saved in instrument state
Status Bits/OPC dependencies	The Status Operation Register bit 5 "Waiting for Trigger" is set at the same time as the Sweeping or Measuring bit is set. It is cleared when the trigger actually occurs (that is, after the trigger event occurs and all the applicable trigger criteria have been met). A corresponding pop-up message ("Waiting for trigger") is generated if no trigger signal appears after approximately 2 sec. This message goes away when a trigger signal appears.
Initial S/W Revision	Prior to A.02.00
Modified at S/W Revision	A.03.00

Trigger Level

Sets the value where the external 2 trigger input will trigger a new sweep/measurement.

Key Path	Trigger, External 2
Remote Command	:TRIGger[:SEquence]:EXTernal2:LEVel :TRIGger[:SEquence]:EXTernal2:LEVel?

Example	TRIG:EXT2:LEV 1.1 V
Couplings	This same level is used for the Ext2 trigger source in the Trigger menu, for the Ext2 selection in the Periodic Timer sync source (in the Trigger menu and in the Gate Source menu), and also for the Ext2 selection in the Gate Source menu.
Preset	1.2 V
State Saved	Saved in instrument state
Min	-5 V
Max	5 V
Default Unit	V
Backwards Compatibility SCPI	:TRIGger[:SEQuence]:FRAME:EXTerna12:LEVel
Initial S/W Revision	Prior to A.02.00

Trig Slope

Controls the trigger polarity. It is set positive to trigger on a rising edge and negative to trigger on a falling edge.

Key Path	Trigger, External 2
Remote Command	:TRIGger[:SEQuence]:EXTerna12:SLOPe POSitive NEGative :TRIGger[:SEQuence]:EXTerna12:SLOPe?
Example	TRIG:EXT2:SLOP NEG
Couplings	This same slope is used in the Ext2 selection for the trigger source in the Trigger menu and for the period timer sync source (in the Trigger menu and in the Gate Source menu).
Preset	POSitive
State Saved	Saved in instrument state
Backwards Compatibility SCPI	:TRIGger[:SEQuence]:FRAME:EXTerna12:SLOPe
Backwards Compatibility Notes	The legacy :TRIGger[:SEQuence]:SLOPe command affects the slopes for the VID, LINE, EXT1, EXT2, and RFB triggers.
Initial S/W Revision	Prior to A.02.00

Zero Span Delay Comp On/Off

In zero span, there is a natural delay in the signal path, which comes from the RBW filter. This is usually desirable, as it allows you to trigger on events and also see those events, because the signal is delayed from the trigger event. However, in some cases it is desirable to eliminate this delay, so that trigger events line up exactly with the zero time point in zero span. You can use the **Zero Span Delay Comp On/Off** feature to enable or disable zero span delay compensation.

Key Path	Trigger, External 2
Remote Command	:TRIGger[:SEQuence]:EXTerna12:DElAY:COMPensation OFF ON 0 1

:TRIGger[:SEquence]:EXternal2:DElay:COMPensation?	
Example	TRIG:EXT2:DEL:COMP ON
Dependencies	No effect except in zero-span, but not locked out in nonzero spans. Blanked in modes that do not support zero-span measurements. If the SCPI command is sent when the key is blanked, an error is returned: -221, "Settings conflict; Feature not supported for this measurement" In analyzers shipping N9060A, this feature requires N9060A-7FP.
Preset	OFF
State Saved	Saved in instrument state
Initial S/W Revision	A.11.00

RF Burst

Pressing this key, when it is not selected, selects the RF Burst as the trigger. A new sweep/measurement will start when an RF burst envelope signal is identified from the signal at the RF Input connector. Pressing this key, when it is already selected, accesses the RF Burst trigger setup menu.

In some models, a variety of burst trigger circuitry is available, resulting in various available burst trigger bandwidths. The analyzer automatically chooses the appropriate trigger path based on the hardware configuration and other settings of the analyzer.

Key Path	Trigger
Example	TRIG:SOUR RFB Swept SA measurement TRIG:<meas>:SOUR RFB Measurements other than Swept SA
State Saved	Saved in instrument state
Status Bits/OPC dependencies	The Status Operation Register bit 5 "Waiting for Trigger" is set at the same time as the Sweeping or Measuring bit is set. It is cleared when the trigger actually occurs (that is, after the trigger event occurs and all the applicable trigger criteria have been met). A corresponding pop-up message ("Waiting for trigger") is generated if no trigger signal appears after approximately 2 sec. This message goes away when a trigger signal appears.
Backwards Compatibility Notes	The legacy command: :TRIGger[:SEquence]:RFBurst:FSElectivity[:STATe] OFF ON 0 1 is not supported in the X-Series, as the hardware to do Frequency Selective burst triggers does not exist in X-Series.
Initial S/W Revision	Prior to A.02.00
Modified at S/W Revision	A.04.00

Absolute Trigger Level

Sets the absolute trigger level for the RF burst envelope.

When using the External Mixing path, the Absolute Trigger Level is uncalibrated because the factory default was set to accommodate the expected IF levels for the RF path.

Key Path	Trigger, RF Burst
Scope	Meas Global
Remote Command	:TRIGger[:SEquence]:RFBurst:LEVel:ABSolute <aml> :TRIGger[:SEquence]:RFBurst:LEVel:ABSolute?
Example	TRIG:RFB:LEV:ABS 10 dBm sets the trigger level of the RF burst envelope signal to the absolute level of 10 dBm
Notes	Sending this command does not switch the setting from relative to absolute; to switch it you need to send the :TRIGger[:SEquence]:RFBurst:LEVel:TYPE command, below. Amplitude Corrections are not taken into account by the Absolute Trigger Level. For example, if you have given yourself effective gain with an amplitude correction factor, the Absolute Trigger will not fire until you have set the trigger level that far below the displayed signal level, rather than simply to the displayed signal level. This is only true for Amplitude Corrections, not External Gain or Ref Level Offset functions. If mode is Bluetooth, the default value is -50 dBm.
Couplings	This same level is used for the RF Burst trigger source in the Trigger menu, for the RF Burst selection in the Periodic Timer sync source (in the Trigger menu and in the Gate Source menu), and also for the RF Burst selection in the Gate Source menu
Preset	-20 dBm
State Saved	Saved in instrument state
Min	-200 dBm
Max	100 dBm
Default Unit	depends on the current selected Y-Axis unit
Backwards Compatibility SCPI	:TRIGger[:SEquence]:FRAME:RFBurst:LEVel:ABSolute
Initial S/W Revision	Prior to A.02.00
Modified at S/W Revision	A.04.00

Key Path	Trigger, RF Burst
Remote Command	:TRIGger[:SEquence]:RFBurst:LEVel:TYPE ABSolute RELative :TRIGger[:SEquence]:RFBurst:LEVel:TYPE?
Example	TRIG:RFB:LEV:TYPE REL sets the trigger level type of the RF burst trigger to Relative.
Preset	ABSolute
State Saved	Saved in instrument state
Initial S/W Revision	Prior to A.02.00
Modified at S/W Revision	A.04.00

Relative Trigger Level

Sets the relative trigger level for the RF burst envelope.

In some models, the relative burst trigger function is implemented in hardware. In other models, without the advanced triggering hardware required, the relative burst trigger function is implemented in software in some measurements, and is unavailable in other measurements.

When implemented in software, the relative RF Burst trigger function is implemented as follows:

5. The measurement starts with the absolute RF Burst trigger setting. If it cannot get a trigger with that level, auto trigger fires and the acquisition starts anyway. After the acquisition, the measurement searches for the peak in the acquired waveform and saves it.
6. Now, in the next cycle of the measurement, the measurement determines a new absolute RF Burst level based on the peak value from the first measurement and the Relative RF Burst Trigger Level (always 0 or negative dB) set by the user. The following formula is used:
7. absolute RF Burst level = peak level of the previous acquisition + relative RF Burst level
8. If the new absolute RF Burst level differs from the previous by more than 0.5 dB, the new level is sent to the hardware; otherwise it is not updated (to avoid slowing down the acquisition)

Steps 2 and 3 repeat for subsequent measurements.

Key Path	Trigger, RF Burst
Scope	Meas Global
Remote Command	:TRIGger[:SEquence]:RFBurst:LEVel:RELative <rel_amp1> :TRIGger[:SEquence]:RFBurst:LEVel:RELative?
Example	TRIG:RFB:LEV:REL -10 dB sets the trigger level of the RF burst envelope signal to the relative level of -10 dB
Notes	Sending this command does not switch the setting from absolute to relative; to switch it you need to send the :TRIGger[:SEquence]:RFBurst:LEVel:TYPE command, above. The relative trigger level is not available in some measurements. In those measurements the RELative parameter, and the :TRIGger[:SEquence]:RFBurst:LEVel:TYPE command (above), will generate an error if sent.
Dependencies	This key is grayed out and Absolute Trigger Level selected if the required hardware is not present in your analyzer and the current measurement does not support Relative triggering.
Preset	-6 dB GSM: -25 dB

State Saved	Saved in instrument state
Min	-45 dB
Max	0 dB
Default Unit	dB or dBc
Backwards Compatibility SCPI	:TRIGger[:SEquence]:RFBurst:LEVel This legacy command is aliased to :TRIGger[:SEquence]:RFBurst:LEVel:RELative because the PSA had ONLY relative burst triggering
Initial S/W Revision	Prior to A.02.00
Modified at S/W Revision	A.04.00

Trigger Slope

It is set positive to trigger on a rising edge and negative to trigger on a falling edge.

Key Path	Trigger, RF Burst
Remote Command	:TRIGger[:SEquence]:RFBurst:SLOPe POSitive NEGative :TRIGger[:SEquence]:RFBurst:SLOPe?
Example	TRIG:RFB:SLOP NEG
Couplings	This same slope is used in the RF Burst selection for the trigger source in the Trigger menu and for the period timer sync source (in the Trigger menu and in the Gate Source menu).
Preset	POSitive
State Saved	Saved in instrument state
Backwards Compatibility SCPI	:TRIGger[:SEquence]:FRAME:RFBurst:SLOPe
Backwards Compatibility Notes	The legacy :TRIGger[:SEquence]:SLOPe command affects the slopes for the VID, LINE, EXT1, EXT2, and RFB triggers.
Initial S/W Revision	Prior to A.02.00

Zero Span Delay Comp On/Off

In zero span, there is a natural delay in the signal path, which comes from the RBW filter. This is usually desirable, as it allows you to trigger on events and also see those events, because the signal is delayed from the trigger event. However, in some cases it is desirable to eliminate this delay, so that trigger events line up exactly with the zero time point in zero span. You can use the **Zero Span Delay Comp On/Off** feature to enable or disable zero span delay compensation.

Key Path	Trigger, RF Burst
Remote Command	:TRIGger[:SEquence]:RFBurst:DElay:COMPensation OFF ON 0 1 :TRIGger[:SEquence]:RFBurst:DElay:COMPensation?
Example	TRIG:RFB:DEL:COMP ON
Dependencies	No effect except in zero-span, but not locked out in nonzero spans.

	Blanked in modes that do not support zero-span measurements. If the SCPI command is sent when the key is blanked, an error is returned: -221, "Settings conflict; Feature not supported for this measurement" In analyzers shipping N9060A, this feature requires N9060A-7FP.
Preset	OFF
State Saved	Saved in instrument state
Initial S/W Revision	A.11.00

Periodic Timer (Frame Trigger)

Pressing this key, when it is not selected, selects the internal periodic timer signal as the trigger. Triggering occurrences are set by the **Period** parameter, which is modified by the **Sync Source** and **Offset**. Pressing this key, when it is already selected, accesses the periodic timer trigger setup functions.

If you do not have a sync source selected (it is Off), then the internal timer will not be synchronized with any external timing events.

Key Path	Trigger
Example	TRIG:SOUR FRAM Swept SA measurement TRIG:<meas>:SOUR FRAM Measurements other than Swept SA
State Saved	Saved in instrument state
Readback	[Sync: <value of Sync Source>], for example, [Sync: External 1]
Status Bits/OPC dependencies	The Status Operation Register bit 5 "Waiting for Trigger" is set at the same time as the Sweeping or Measuring bit is set. It is cleared when the trigger actually occurs (that is, after the trigger event occurs and all the applicable trigger criteria have been met). A corresponding pop-up message ("Waiting for trigger") is generated if no trigger signal appears after approximately 2 sec. This message goes away when a trigger signal appears.
Initial S/W Revision	Prior to A.02.00

Periodic Timer Triggering:

This feature selects the internal periodic timer signal as the trigger. Trigger occurrences are set by the **Periodic Timer** parameter, which is modified by the **Sync Source** and **Offset**.

The figure below shows the action of the periodic timer trigger. Before reviewing the figure, we'll explain some uses for the periodic trigger.

A common application is measuring periodic burst RF signals for which a trigger signal is not easily available. For example, we might be measuring a TDMA radio which bursts every 20 ms. Let's assume that the 20 ms period is very consistent. Let's also assume that we do not have an external trigger source available that is synchronized with the period, and that the signal-to-noise ratio of the signal is not high enough to provide a clean RF burst trigger at all of the analysis frequencies. For example, we might want to measure spurious transmissions at an offset from the carrier that is larger than the bandwidth of the RF burst trigger. In this application, we can set the Periodic Timer to a 20.00 ms period and adjust the offset from that timer to position our trigger just where we want it. If we find that the 20.00 ms is not

exactly right, we can adjust the period slightly to minimize the drift between the period timer and the signal to be measured.

A second way to use this feature would be to use **Sync Source** temporarily, instead of **Offset**. In this case, we might tune to the signal in a narrow span and use the RF Burst trigger to synchronize the periodic timer. Then we would turn the sync source off so that it would not miss-trigger. Miss-triggering can occur when we are tuned so far away from the RF burst trigger that it is no longer reliable.

A third example would be to synchronize to a signal that has a reference time element of much longer period than the period of interest. In some CDMA applications, it is useful to look at signals with a short periodicity, by synchronizing that periodicity to the "even-second clock" edge that happens every two seconds. Thus, we could connect the even-second clock trigger to Ext1 and use then Ext1 as the sync source for the periodic timer.

The figure below illustrates this third example. The top trace represents the even-second clock. It causes the periodic timer to synchronize with the leading edge shown. The analyzer trigger occurs at a time delayed by the accumulated offset from the period trigger event. The periodic timer continues to run, and triggers continue to occur, with a periodicity determined by the analyzer time base. The timer output (labeled "late event") will drift away from its ideal time due to imperfect matching between the time base of the signal being measured and the time base of the analyzer, and also because of imperfect setting of the period parameter. But the synchronization is restored on the next even-second clock event. ("Accumulated offset" is described in the in the **Offset** function section.)

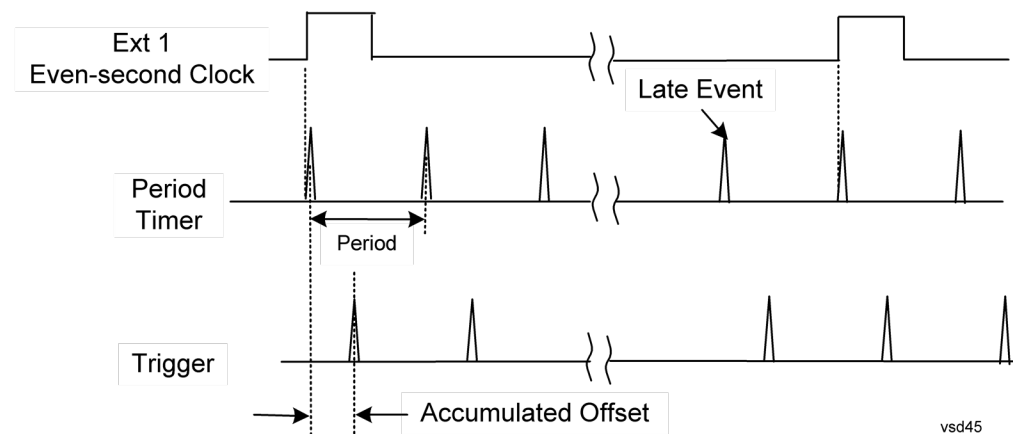

Period

Sets the period of the internal periodic timer clock. For digital communications signals, this is usually set to the frame period of your current input signal. In the case that sync source is not set to OFF, and the external sync source rate is changed for some reason, the periodic timer is synchronized at the every external synchronization pulse by resetting the internal state of the timer circuit.

Key Path	Trigger, Periodic Timer
Remote Command	:TRIGGER[:SEQUENCE]:FRAME:PERIOD <time>

	:TRIGger[:SEQuence]:FRAMe:PERiod?
Example	TRIG:FRAM:PER 100 ms
Dependencies	The invalid data indicator turns on when the period is changed, until the next sweep/measurement completes.
Couplings	The same period is used in the Gate Source selection of the period timer.
Preset	20 ms GSM: 4.615383
State Saved	Saved in instrument state
Min	100.000 ns
Max	559.0000 ms
Default Unit	S
Initial S/W Revision	Prior to A.02.00

Offset

Adjusts the accumulated offset between the periodic timer events and the trigger event. Adjusting the accumulated offset is different than setting an offset, and requires explanation.

The periodic timer is usually not synchronized with any external events, so the timing of its output events has no absolute meaning. Since the timing relative to external events (RF signals) is important, you need to be able to adjust (offset) it. However, you have no direct way to see when the periodic timer events occur. All that you can see is the trigger timing. When you want to adjust the trigger timing, you will be changing the internal offset between the periodic timer events and the trigger event. Because the absolute value of that internal offset is unknown, we will just call that the accumulated offset. Whenever the Offset parameter is changed, you are changing that accumulated offset. You can reset the displayed offset using Reset Offset Display. Changing the display does not change the value of the accumulated offset, and you can still make additional changes to accumulated offset.

To avoid ambiguity, we define that an increase in the "offset" parameter, either from the knob or the SCPI adjust command, serves to delay the timing of the trigger event.

Key Path	Trigger, Periodic Timer
Remote Command	:TRIGger[:SEQuence]:FRAMe:OFFSet <time> :TRIGger[:SEQuence]:FRAMe:OFFSet?
Example	TRIG:FRAM:OFFS 1.2 ms
Notes	The front panel interface (for example, the knob), and this command, adjust the accumulated offset, which is shown on the active function display. However, the actual amount sent to the hardware each time the offset is updated is the delta value, that is, the current accumulated offset value minus the previous accumulated offset value. Note that the accumulated offset value is essentially arbitrary; it represents the accumulated offset from the last time the offset was zeroed (with the Reset Offset Display key). Note that this command does not change the period of the trigger waveform. Note also that Offset

	is used only when the sync source is set to OFF, otherwise delay is used, see section "Trig Delay" on page 568 . An increase in the "offset" parameter, either from the knob or the SCPI adjust command, serves to delay the timing of the trigger event.
Notes	When the SCPI command is sent the value shown on the key (and the Active Function, if this happens to be the active function) is updated with the new value. However, the actual amount sent to the hardware is the delta value, that is, the current accumulated offset value minus the previous accumulated offset value. The SCPI query simply returns the value currently showing on the key.
Dependencies	The invalid data indicator turns on when the offset is changed, until the next sweep/measurement completes.
Couplings	The same offset is used in the Gate Source selection of the period timer.
Preset	0 s
State Saved	Saved in instrument state
Min	-10.000 s
Max	10.000 s
Default Unit	S
Initial S/W Revision	Prior to A.02.00

Offset Adjust (Remote Command Only)

This remote command does not work at all like the related front panel keys. This command lets you advance the phase of the frame trigger by the amount you specify.

It does not change the period of the trigger waveform. If the command is sent multiple times, it advances the phase of the frame trigger an additional amount each time it is sent. Negative numbers are permitted.

Remote Command	:TRIGger[:SEquence]:FRAMe:ADJust <time>
Example	TRIG:FRAM:ADJ 1.2 ms
Notes	Note also that Offset is used only when the sync source is set to OFF, otherwise delay is used, see section "Trig Delay" on page 568 . An increase in the "offset" parameter, either from the knob or the SCPI adjust command, serves to delay the timing of the trigger event.
Notes	The front panel interface (for example, the knob) and the :TRIG:FRAM:OFFS command adjust the accumulated offset, which is shown on the active function display. However, the actual amount sent to the hardware is the delta value, that is, the current offset value minus the previous offset value. When the SCPI command is sent the value shown on the key (and the Active Function, if this happens to be the active function) is updated by increasing it (or decreasing it if the value sent is negative) by the amount specified in the SCPI command. This is a "command only" SCPI command, with no query.
Dependencies	The invalid data indicator turns on when the offset is changed, until the next sweep/measurement completes.

Couplings	The same offset is used in the Gate Source selection of the period timer.
Preset	0 s
State Saved	Saved in instrument state
Min	-10.000 s
Max	10.000 s
Default Unit	S
Initial S/W Revision	Prior to A.02.00

Reset Offset Display

Resets the value of the periodic trigger offset display setting to 0.0 seconds. The current displayed trigger location may include an offset value defined with the **Offset** key. Pressing this key redefines the currently displayed trigger location as the new trigger point that is 0.0 s offset. The **Offset** key can then be used to add offset relative to this new timing.

Key Path	Trigger, Periodic Timer
Remote Command	:TRIGger[:SEquence]:FRAMe:OFFSet:DISPlay:RESet
Example	TRIG:FRAM:OFFS:DISP:RES
Initial S/W Revision	Prior to A.02.00

Sync Source

Selects a signal source for you to synchronize your periodic timer trigger to, otherwise you are triggering at some arbitrary location in the frame. Synchronization reduces the precision requirements on the setting of the period.

For convenience you may adjust the level and slope of the selected sync source in a conditional branch setup menu accessed from the Sync Source menu. Note that these settings match those in the **Trigger** and **Gate Source** menus; that is, each trigger source has only one value of level and slope, regardless of which menu it is accessed from.

Key Path	Trigger, Periodic Timer
Remote Command	:TRIGger[:SEquence]:FRAMe:SYNC EXTerna11 EXTerna12 RFBurst PXI OFF :TRIGger[:SEquence]:FRAMe:SYNC?
Example	TRIG:FRAM:SYNC EXT2
Dependencies	In some models, there is no second External input. In these models, the External 2 key is blanked and the EXTerna12 parameter will generate a "Hardware missing; Not available for this model number" message. PXI trigger is only supported in PXI (modular) instruments.
Preset	Off GSM/EDGE, MSR,LTE,LTETDD: RFBurst
State Saved	Saved in instrument state

Readback	The current setting is read back to this key and it is also Readback to the previous Periodic Timer trigger key.
Backwards Compatibility SCPI	:TRIGger[:SEQuence]:FRAMe:SYNC EXTernal For backward compatibility, the parameter EXTernal is mapped to EXTernal1
Initial S/W Revision	Prior to A.02.00
Modified at S/W Revision	A.03.00, A.14.00

Off

Turns off the sync source for your periodic trigger. With the sync source off, the timing will drift unless the signal source frequency is locked to the analyzer frequency reference.

Key Path	Trigger, Periodic Timer, Sync Source
Example	TRIG:FRAM:SYNC OFF
Readback	Off
Initial S/W Revision	Prior to A.02.00

External 1

Pressing this key, when it is not selected, selects an external input signal as the trigger. A new sweep/measurement will start when the external trigger condition is met using the external 1 input connector on the rear panel.

Pressing this key, when it is already selected, accesses the external 1 trigger setup menu.

Key Path	Trigger
Example	TRIG:SOUR EXT1 Swept SA measurement TRIG:<meas>:SOUR EXT1 Measurements other than Swept SA
Dependencies	Grayed out if in use by Point Trigger in the Source Setup menu. Forced to Free Run if already selected and Point Trigger is set to External 1.
State Saved	Saved in instrument state
Status Bits/OPC dependencies	The Status Operation Register bit 5 "Waiting for Trigger" is set at the same time as the Sweeping or Measuring bit is set. It is cleared when the trigger actually occurs (that is, after the trigger event occurs and all the applicable trigger criteria have been met). A corresponding pop-up message ("Waiting for trigger") is generated if no trigger signal appears after approximately 2 sec. This message goes away when a trigger signal appears.
Initial S/W Revision	Prior to A.02.00

Trigger Level

Sets the value where the external 1 trigger input will trigger a new sweep/measurement.

Key Path	Trigger, External 1
Remote Command	:TRIGger[:SEquence]:EXTernal1:LEVel <level> :TRIGger[:SEquence]:EXTernal1:LEVel?
Example	TRIG:EXT1:LEV 0.4 V
Couplings	This same level is used for the Ext1 trigger source in the Trigger menu, for the Ext1 selection in the Periodic Timer sync source (in the Trigger menu and in the Gate Source menu), and also for the Ext1 selection in the Gate Source menu.
Preset	1.2 V
State Saved	Saved in instrument state
Min	-5 V
Max	5 V
Default Unit	V
Backwards Compatibility SCPI	:TRIGger[:SEquence]:EXTernal:LEVel For backward compatibility, the parameter EXTernal is mapped to EXTernal1
Backwards Compatibility SCPI	:TRIGger[:SEquence]:FRAME:EXTernal1:LEVel
Initial S/W Revision	Prior to A.02.00

Trig Slope

Controls the trigger polarity. It is set positive to trigger on a rising edge and negative to trigger on a falling edge.

Key Path	Trigger, External 1
Remote Command	:TRIGger[:SEquence]:EXTernal1:SLOPe POSitive NEGative :TRIGger[:SEquence]:EXTernal1:SLOPe?
Example	TRIG:EXT1:SLOP NEG
Couplings	This same slope is used in the Ext1 selection for the trigger source in the Trigger menu and for the period timer sync source (in the Trigger menu and in the Gate Source menu).
Preset	POSitive
State Saved	Saved in instrument state
Backwards Compatibility SCPI	:TRIGger[:SEquence]:EXTernal:SLOPe For backward compatibility, the parameter EXTernal is mapped to EXTernal1
Backwards Compatibility SCPI	:TRIGger[:SEquence]:FRAME:EXTernal1:SLOPe
Backwards Compatibility Notes	The legacy :TRIGger[:SEquence]:SLOPe command affects the slopes for the VID, LINE, EXT1, EXT2, and RFB triggers.
Initial S/W Revision	Prior to A.02.00

External 2

Pressing this key, when it is not selected, selects an external input signal as the trigger. A new sweep/measurement will start when the external trigger condition is

met using the external 2 input connector. The external trigger 2 input connector is on the rear panel.

Pressing this key, when it is already selected, accesses the external 2 trigger setup menu.

Key Path	Trigger
Example	TRIG:SOUR EXT2 Swept SA measurement TRIG:<meas>:SOUR EXT2 Measurements other than Swept SA
Dependencies	In some models, there is no second External input. In these models, the External 2 key is blanked and the EXTernal2 parameter will generate a "Hardware missing; Not available for this model number" message. Grayed out if in use by Point Trigger in the Source Setup menu. Forced to Free Run if already selected and Point Trigger is set to External 2.
State Saved	Saved in instrument state
Status Bits/OPC dependencies	The Status Operation Register bit 5 "Waiting for Trigger" is set at the same time as the Sweeping or Measuring bit is set. It is cleared when the trigger actually occurs (that is, after the trigger event occurs and all the applicable trigger criteria have been met). A corresponding pop-up message ("Waiting for trigger") is generated if no trigger signal appears after approximately 2 sec. This message goes away when a trigger signal appears.
Initial S/W Revision	Prior to A.02.00
Modified at S/W Revision	A.03.00

Trigger Level

Sets the value where the external 2 trigger input will trigger a new sweep/measurement.

Key Path	Trigger, External 2
Remote Command	:TRIGger[:SEquence]:EXTernal2:LEVel :TRIGger[:SEquence]:EXTernal2:LEVel?
Example	TRIG:EXT2:LEV 1.1 V
Couplings	This same level is used for the Ext2 trigger source in the Trigger menu, for the Ext2 selection in the Periodic Timer sync source (in the Trigger menu and in the Gate Source menu), and also for the Ext2 selection in the Gate Source menu.
Preset	1.2 V
State Saved	Saved in instrument state
Min	-5 V
Max	5 V
Default Unit	V
Backwards Compatibility SCPI	:TRIGger[:SEquence]:FRAME:EXTernal2:LEVel
Initial S/W Revision	Prior to A.02.00

Trig Slope

Controls the trigger polarity. It is set positive to trigger on a rising edge and negative to trigger on a falling edge.

Key Path	Trigger, External 2
Remote Command	:TRIGger[:SEquence]:EXTerna12:SLOPe POSitive NEGative :TRIGger[:SEquence]:EXTerna12:SLOPe?
Example	TRIG:EXT2:SLOP NEG
Couplings	This same slope is used in the Ext2 selection for the trigger source in the Trigger menu and for the period timer sync source (in the Trigger menu and in the Gate Source menu).
Preset	POSitive
State Saved	Saved in instrument state
Backwards Compatibility SCPI	:TRIGger[:SEquence]:FRAME:EXTerna12:SLOPe
Backwards Compatibility Notes	The legacy :TRIGger[:SEquence]:SLOPe command affects the slopes for the VID, LINE, EXT1, EXT2, and RFB triggers.
Initial S/W Revision	Prior to A.02.00

RF Burst

Pressing this key, when it is not selected, selects the RF Burst as the trigger. A new sweep/measurement will start when an RF burst envelope signal is identified from the signal at the RF Input connector. Pressing this key, when it is already selected, accesses the RF Burst trigger setup menu.

In some models, a variety of burst trigger circuitry is available, resulting in various available burst trigger bandwidths. The analyzer automatically chooses the appropriate trigger path based on the hardware configuration and other settings of the analyzer.

Key Path	Trigger
Example	TRIG:SOUR RFB Swept SA measurement TRIG:<meas>:SOUR RFB Measurements other than Swept SA
State Saved	Saved in instrument state
Status Bits/OPC dependencies	The Status Operation Register bit 5 "Waiting for Trigger" is set at the same time as the Sweeping or Measuring bit is set. It is cleared when the trigger actually occurs (that is, after the trigger event occurs and all the applicable trigger criteria have been met). A corresponding pop-up message ("Waiting for trigger") is generated if no trigger signal appears after approximately 2 sec. This message goes away when a trigger signal appears.
Backwards Compatibility Notes	The legacy command: :TRIGger[:SEquence]:RFBurst:FSElectivity[:STATE] OFF ON 0 1 is not supported in the X-Series, as the hardware to do Frequency Selective burst triggers does not exist in X-Series.
Initial S/W Revision	Prior to A.02.00
Modified at S/W Revision	A.04.00

Absolute Trigger Level

Sets the absolute trigger level for the RF burst envelope.

When using the External Mixing path, the Absolute Trigger Level is uncalibrated because the factory default was set to accommodate the expected IF levels for the RF path.

Key Path	Trigger, RF Burst
Scope	Meas Global
Remote Command	:TRIGger[:SEquence]:RFBurst:LEVel:ABSolute <ampl> :TRIGger[:SEquence]:RFBurst:LEVel:ABSolute?
Example	TRIG:RFB:LEV:ABS 10 dBm sets the trigger level of the RF burst envelope signal to the absolute level of 10 dBm
Notes	Sending this command does not switch the setting from relative to absolute; to switch it you need to send the :TRIGger[:SEquence]:RFBurst:LEVel:TYPE command, below. Amplitude Corrections are not taken into account by the Absolute Trigger Level. For example, if you have given yourself effective gain with an amplitude correction factor, the Absolute Trigger will not fire until you have set the trigger level that far below the displayed signal level, rather than simply to the displayed signal level. This is only true for Amplitude Corrections, not External Gain or Ref Level Offset functions. If mode is Bluetooth, the default value is -50 dBm.
Couplings	This same level is used for the RF Burst trigger source in the Trigger menu, for the RF Burst selection in the Periodic Timer sync source (in the Trigger menu and in the Gate Source menu), and also for the RF Burst selection in the Gate Source menu
Preset	-20 dBm
State Saved	Saved in instrument state
Min	-200 dBm
Max	100 dBm
Default Unit	depends on the current selected Y-Axis unit
Backwards Compatibility SCPI	:TRIGger[:SEquence]:FRAMe:RFBurst:LEVel:ABSolute
Initial S/W Revision	Prior to A.02.00
Modified at S/W Revision	A.04.00

Key Path	Trigger, RF Burst
Remote Command	:TRIGger[:SEquence]:RFBurst:LEVel:TYPE ABSolute RELative :TRIGger[:SEquence]:RFBurst:LEVel:TYPE?
Example	TRIG:RFB:LEV:TYPE REL sets the trigger level type of the RF burst trigger to Relative.
Preset	ABSolute

State Saved	Saved in instrument state
Initial S/W Revision	Prior to A.02.00
Modified at S/W Revision	A.04.00

Relative Trigger Level

Sets the relative trigger level for the RF burst envelope.

In some models, the relative burst trigger function is implemented in hardware. In other models, without the advanced triggering hardware required, the relative burst trigger function is implemented in software in some measurements, and is unavailable in other measurements.

When implemented in software, the relative RF Burst trigger function is implemented as follows:

5. The measurement starts with the absolute RF Burst trigger setting. If it cannot get a trigger with that level, auto trigger fires and the acquisition starts anyway. After the acquisition, the measurement searches for the peak in the acquired waveform and saves it.
6. Now, in the next cycle of the measurement, the measurement determines a new absolute RF Burst level based on the peak value from the first measurement and the Relative RF Burst Trigger Level (always 0 or negative dB) set by the user. The following formula is used:
7. absolute RF Burst level = peak level of the previous acquisition + relative RF Burst level
8. If the new absolute RF Burst level differs from the previous by more than 0.5 dB, the new level is sent to the hardware; otherwise it is not updated (to avoid slowing down the acquisition)

Steps 2 and 3 repeat for subsequent measurements.

Key Path	Trigger, RF Burst
Scope	Meas Global
Remote Command	<code>:TRIGger[:SEquence]:RFBurst:LEVel:RELative <rel_amp1></code> <code>:TRIGger[:SEquence]:RFBurst:LEVel:RELative?</code>
Example	TRIG:RFB:LEV:REL -10 dB sets the trigger level of the RF burst envelope signal to the relative level of -10 dB
Notes	Sending this command does not switch the setting from absolute to relative; to switch it you need to send the :TRIGger[:SEquence]:RFBurst:LEVel:TYPE command, above. The relative trigger level is not available in some measurements. In those measurements the RELative parameter, and the :TRIGger[:SEquence]:RFBurst:LEVel:TYPE command (above), will generate an error if sent.

Dependencies	This key is grayed out and Absolute Trigger Level selected if the required hardware is not present in your analyzer and the current measurement does not support Relative triggering.
Preset	-6 dB GSM: -25 dB
State Saved	Saved in instrument state
Min	-45 dB
Max	0 dB
Default Unit	dB or dBc
Backwards Compatibility SCPI	:TRIGger[:SEquence]:RFBurst:LEVel This legacy command is aliased to :TRIGger[:SEquence]:RFBurst:LEVel:RELative because the PSA had ONLY relative burst triggering
Initial S/W Revision	Prior to A.02.00
Modified at S/W Revision	A.04.00

Trigger Slope

It is set positive to trigger on a rising edge and negative to trigger on a falling edge.

Key Path	Trigger, RF Burst
Remote Command	:TRIGger[:SEquence]:RFBurst:SLOPe POSitive NEGative :TRIGger[:SEquence]:RFBurst:SLOPe?
Example	TRIG:RFB:SLOP NEG
Couplings	This same slope is used in the RF Burst selection for the trigger source in the Trigger menu and for the period timer sync source (in the Trigger menu and in the Gate Source menu).
Preset	POSitive
State Saved	Saved in instrument state
Backwards Compatibility SCPI	:TRIGger[:SEquence]:FRAME:RFBurst:SLOPe
Backwards Compatibility Notes	The legacy :TRIGger[:SEquence]:SLOPe command affects the slopes for the VID, LINE, EXT1, EXT2, and RFB triggers.
Initial S/W Revision	Prior to A.02.00

Zero Span Delay Comp On/Off

In zero span, there is a natural delay in the signal path, which comes from the RBW filter. This is usually desirable, as it allows you to trigger on events and also see those events, because the signal is delayed from the trigger event. However, in some cases it is desirable to eliminate this delay, so that trigger events line up exactly with the zero time point in zero span. You can use the **Zero Span Delay Comp On/Off** feature to enable or disable zero span delay compensation.

Key Path	Trigger, RF Burst
----------	-------------------

Remote Command	:TRIGger[:SEquence]:RFBurst:DELay:COMPensation OFF ON 0 1 :TRIGger[:SEquence]:RFBurst:DELay:COMPensation?
Example	TRIG:RFB:DEL:COMP ON
Dependencies	No effect except in zero-span, but not locked out in nonzero spans. Blanked in modes that do not support zero-span measurements. If the SCPI command is sent when the key is blanked, an error is returned: -221, "Settings conflict; Feature not supported for this measurement" In analyzers shipping N9060A, this feature requires N9060A-7FP.
Preset	OFF
State Saved	Saved in instrument state
Initial S/W Revision	A.11.00

TV

Pressing this key, when it is not selected, selects the TV input signal as the trigger. A new sweep/measurement will start synchronized with the next occurrence of the synchronizing pulse of the selected TV line number.

Pressing this key, when it is already selected, opens a menu of TV Trigger setup functions. The default active function in this menu is the TV line number on which you want to trigger.

The Frame and Field options enable you to determine how the fields of the TV picture signal will be affected by the trigger system. One complete TV image consists of one frame of 525 or 625 horizontal lines depending on the TV standard being used. Each frame is composed of two fields of interlacing lines, each consisting of 262 1/2 lines (or 312 1/2 lines). The fields are called Field One and Field Two. Field One is viewed as having 263 lines (or 313 lines) and Field Two is viewed as having 262 lines (or 312 lines).

For the 525 line NTSC video standard, we refer to TV lines as follows (these are the Field Modes):

Entire Frame, lines 1 to 525

Field One, lines 1 to 263

Field Two, lines 1 to 262 (note that this really refers to "actual" lines 264 to 525)

For the 625 line PAL and SECAM video standards, we refer to TV lines as follows:

Entire Frame, lines 1 to 625

Field One, lines 1 to 313

Field Two, lines 314 to 625

As the Field is changed, the appropriate value for Line is chosen to keep triggering on the same line as before, or if this is not possible, the corresponding line in the new Field. For example, suppose line 264 is selected while in the NTSC-M standard and the Entire Frame mode. This is the first line in Field Two. If Field Two is then selected, the Line number changes to Line 1, the same actual line in the TV signal. If Field One

is then selected, the line number stays at 1, but now we are triggering in the first line in Field One. The only exception to this is if we are on the last line of Field One and change to Field Two. In this case, we go to the last line in Field Two.

Key Path	Trigger
Example	TRIG:SOUR TV Swept SA measurement TRIG:<meas>:SOUR TV Measurements other than Swept SA
Dependencies	This key only appears in Modes which support TV Trigger, otherwise the key is blanked. If the SCPI command is sent while the key is blanked, an error is returned.
Readback	This key displays the value read back from TV Line
Status Bits/OPC dependencies	The Status Operation Register bit 5 "Waiting for Trigger" is set at the same time as the Sweeping or Measuring bit is set. It is cleared when the trigger actually occurs (that is, after the trigger event occurs and all the applicable trigger criteria have been met). A corresponding pop-up message ("Waiting for trigger") is generated if no trigger signal appears after approximately 2 sec. This message goes away when a trigger signal appears.
Initial S/W Revision	Prior to A.02.00

TV Line

Selects the TV line number to trigger on. Line number range is dependent on the settings of the **Standard** and **Field** menus within the TV trigger setup functions. When the line number is incremented beyond the upper limit, the value will change to the lower limit and continue incrementing from there. When the line number is decremented below the lower limit, the value will change to the upper limit and continue decrementing from there.

Key Path	Trigger, TV
Remote Command	:TRIGger[:SEquence]:TV:LINE <integer> :TRIGger[:SEquence]:TV:LINE?
Example	TRIG:TV:LINE 20 TRIG:TV:LINE?
Notes	The range of the TV line number is dependent on the settings of the Standard and Field menus within the TV trigger setup functions.
Preset	17
State Saved	Saved in instrument state
Min	The minimum value is the minimum line, and rolls over to the maximum value. The minimum line number depends on which Field and standard are selected.
Max	The maximum value is the maximum line, and rolls over to the minimum value. The maximum line number depends on which Field and standard are selected.
Initial S/W Revision	Prior to A.02.00

Field

Accesses the menu to select the field.

Key Path	Trigger, TV
----------	--------------------

Remote Command	:TRIGger[:SEquence]:TV:FMODe ENTire ODD EVEN :TRIGger[:SEquence]:TV:FMODe?
Example	TRIG:TV:FMOD EVEN
Notes	ODD is Field 1 EVEN is Field 2
Dependencies	This command is available only when Option B7B (TV trigger) is installed.
Preset	ENTire
Readback	Displays the Readback value
Initial S/W Revision	Prior to A.02.00

Entire Frame

When you select Entire Frame it causes the selected line number to be viewed as an offset into the entire frame starting with line 1, the first line in Field One.

Key Path	Trigger, TV, Field
Example	TRIG:TV:FMOD ENT
Min	1, for all formats.
Max	525, for formats NTSC-M, NTSC-Japan, NTSC-4.43, PAL-M and PAL-60 625, for formats PAL-B, D, G, H, I, PAL-N, PAL-N Combin, and SECAM-L.
Readback	Entire Frame
Initial S/W Revision	Prior to A.02.00

Field One

When you select Field One it causes the selected line number to be viewed as an offset into the first field starting with Line 1, the first line in Field One.

Key Path	Trigger, TV, Field
Example	TRIG:TV:FMOD ODD
Min	Field 1 (ODD) The minimum line is 1
Max	Field 1 (ODD) Maximum line is 263 for formats NTSC-M, NTSC-Japan, NTSC-4.43, PAL-M and PAL-60 Maximum line is 313 for formats PAL-B, D, G, H, I, PAL-N, PAL-N Combin, and SECAM-L.
Readback	Field 1
Initial S/W Revision	Prior to A.02.00

Field Two

When you select Field Two it causes the selected line number to be viewed as an offset into the second field. If Line 1 is selected, it is the 264th line of the frame (NTSC-M, NTSC-Japan, NTSC-4.43, PAL-M, PAL-60) or the 314th line of the frame (PAL-B,D,G,H,I, PAL-N, PAL-N-Combin, SECAM-L).

Key Path	Trigger, TV, Field
Example	TRIG:TV:FMODEVEN
Min	Field 2 (EVEN) The minimum line is 1
Max	Field 2 (EVEN) The maximum line 262 for formats NTSC-M, NTSC-Japan, NTSC-4.43, PAL-M and PAL-60 The maximum line is 312 for formats PAL-B, D, G, H, I, PAL-N, PAL-N Combin, and SECAM-L
Readback	Field 2
Initial S/W Revision	Prior to A.02.00

Standard

Accesses the Standard menu keys which select from the following TV standards: **NTSC-M, NTSC-Japan, NTSC-4.43, PAL-M, PAL-B,D,G,H,I, PAL-N, PAL-N-Combin, PAL-60, SECAM-L.**

As the TV standard is changed, the current line value is clipped as necessary to keep it valid for the chosen standard and field mode. For example, line 600 is selected in Entire Frame mode in PAL-N; if NTSC-M is selected, the line number is clipped to 525. Or, if line 313 is selected in Field 1 mode in PAL-N and NTSC-M is selected, the line number is clipped to 263. Changing back to the PAL-N standard will leave the line number at 263.

Key Path	Trigger, TV
Remote Command	:TRIGger[:SEquence]:TV:STANdard MNTSc JNTSc NTSC443 MPAL BPAL NPAL CPAL PAL60 LSEC :TRIGger[:SEquence]:TV:STANdard?
Example	TRIG:TV:STAN MPAL TRIG:TV:STAN?
Preset	MNTS
State Saved	Saved in instrument state
Readback	Displays Readback value
Initial S/W Revision	Prior to A.02.00

NTSC-M

Sets the TV standard to NTSC-M.

Key Path	Trigger, TV, Standard
Example	TRIG:TV:STAN MNTS
Readback	NTSC-M
Initial S/W Revision	Prior to A.02.00

NTSC-Japan

Sets the TV standard to **NTSC-Japan**.

Key Path	Trigger, TV, Standard
Example	TRIG:TV:STAN JNTS
Readback	NTSC-Japan
Initial S/W Revision	Prior to A.02.00

NTSC-4.43

Sets the TV standard to **NTSC-4.43**.

Key Path	Trigger, TV, Standard
Example	TRIG:TV:STAN NTSC443
Readback	NTSC-Japan
Initial S/W Revision	Prior to A.02.00

PAL-M

Sets the TV standard to **PAL-M**.

Key Path	Trigger, TV, Standard
Example	TRIG:TV:STAN MPAL
Readback	PAL-M
Initial S/W Revision	Prior to A.02.00

PAL-N

Sets the TV standard to **PAL-N**.

Key Path	Trigger, TV, Standard
Example	TRIG:TV:STAN NPAL
Readback	PAL-N
Initial S/W Revision	Prior to A.02.00

PAL-N-Combin

Sets the TV standard to **PAL-N-Combin**.

Key Path	Trigger, TV, Standard
Example	TRIG:TV:STAN CPAL
Readback	PAL-N-C
Initial S/W Revision	Prior to A.02.00

PAL-B,D,G,H,I

Sets the TV standard to **PAL-B,D,G,H,I**

Key Path	Trigger, TV, Standard
Example	TRIG:TV:STAN BPAL
Readback	PAL-B
Initial S/W Revision	Prior to A.02.00

PAL-60

Sets the TV standard to **PAL-60**.

Key Path	Trigger, TV, Standard
Example	TRIG:TV:STAN PAL60
Readback	PAL-N
Initial S/W Revision	Prior to A.02.00

SECAM-L

Sets the TV standard to **SECAM-L**.

Key Path	Trigger, TV, Standard
Example	TRIG:TV:STAN LSEC
Readback	SECAM-L
Initial S/W Revision	Prior to A.02.00

Control Edge/Level

Sets the method of controlling the gating function from the gating signal.

Edge

In Edge triggering, the gate opens (after the Delay) on the selected edge (for example, positive) of the gate signal and closes on the alternate edge (for example, negative).

Level

In Level triggering, the gate opens (after the Delay) when the gate signal has achieved a certain level and stays open as long as that level is maintained.

Key Path	Sweep/Control, Gate
Remote Command	[:SENSe] :SWEep:EGATe:CONTRo1 EDGE LEVe1 [:SENSe] :SWEep:EGATe:CONTRo1?
Example	SWE:EGAT:CONT EDGE
Dependencies	If the Gate Method is FFT the Control key is grayed out and Edge is selected. If the Gate Source is TV, Frame or Line, the Control key is grayed out and Edge is selected.
Preset	EDGE
State Saved	Saved in instrument state
Backwards Compatibility SCPI	[:SENSe] :SWEep:TIME:GATE:TYPE ESA Compatibility

Initial S/W Revision Prior to A.02.00

Gate Holdoff

Lets you increase or decrease the wait time after a gate event ends before the analyzer will respond to the next gate signal.

After any Gate event finishes, the analyzer must wait for the sweep system to settle before it can respond to another Gate signal. The analyzer calculates a "wait time," taking into account a number of factors, including RBW and Phase Noise Optimization settings. The goal is to achieve the same accuracy when gated as in ungated operation. The figure below illustrates this concept:

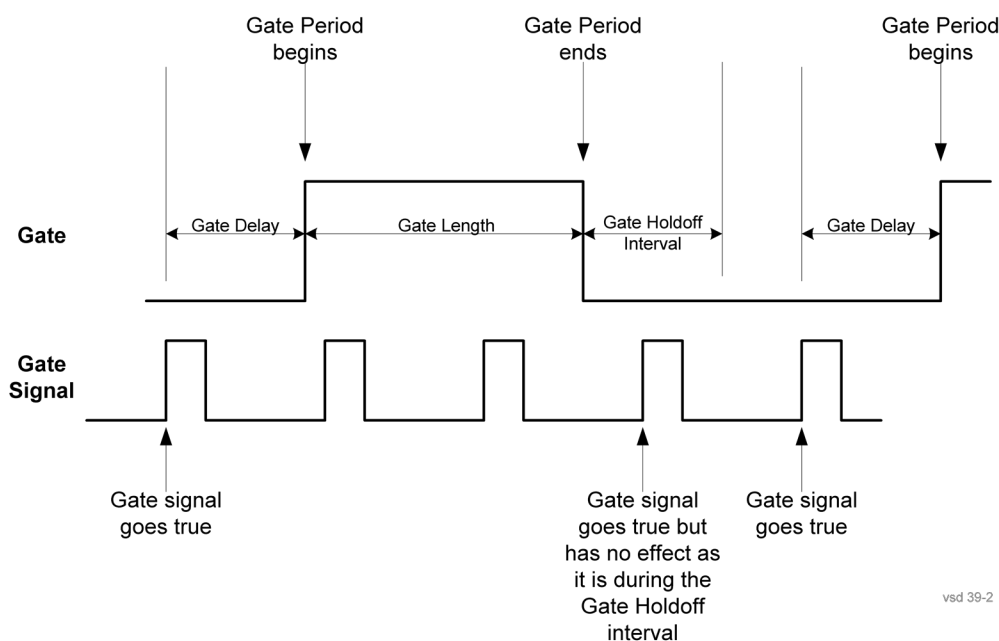

When Gate Holdoff is in Auto, the wait time calculated by the analyzer is used. When Gate Time is in Manual, the user may adjust the wait time, usually decreasing it in order to achieve greater speed, but at the risk of decreasing accuracy.

When the **Method** key is set to **Video** or **FFT**, the **Gate Holdoff** function has no effect.

In measurements that do not support Auto, the value shown when Auto is selected is "---" and the manually set holdoff is returned to a query.

Key Path	Sweep/Control, Gate
Remote Command	[:SENSe]:SWEep:EGATe:HOLDoff <time> [:SENSe]:SWEep:EGATe:HOLDoff? [:SENSe]:SWEep:EGATe:HOLDoff:AUTO OFF ON 0 1 [:SENSe]:SWEep:EGATe:HOLDoff:AUTO?
Example	SWE:EGAT:HOLD 0.0002 SWE:EGAT:HOLD?

	SWE:EGAT:HOLD:AUTO ON SWE:EGAT:HOLD:AUTO?
Couplings	<p>When Gate Holdoff is Auto, the Gate Holdoff key shows the value calculated by the analyzer for the wait time.</p> <p>Pressing the Gate Holdoff key while it is in Auto and not selected, causes the key to become selected and allows the user to adjust the value. If the value is adjusted, the setting changes to Man.</p> <p>Pressing the Gate Holdoff key, while it is in Auto and selected, does not change the value of Gate Holdoff, but causes the setting to change to Man. Now the user can adjust the value.</p> <p>Pressing the key while it is in Man and selected, cause the value to change back to Auto.</p> <p>Pressing the key while it is in Man and not selected, causes the key to become selected and allows the user to adjust the value.</p> <p>When Method is set to Video or FFT, the Gate Holdoff function has no effect.</p>
Preset	Auto Auto/On
State Saved	Saved in instrument state
Min	1 µsec
Max	1 sec
Initial S/W Revision	Prior to A.02.00

Gate Delay Compensation

This function allows you to select an RBW-dependent value by which to adjust the gate delay, to compensate for changes in the delay caused by RBW effects.

You can select between uncompensated operation and two types of compensation, **Delay Until RBW Settled** and **Compensate for RBW Group Delay**.

See "[More Information](#)" on page 1548

Key Path	Sweep/Control, Gate
Scope	Meas Global
Remote Command	[:SENSe] :SWEep:EGATe:DELay:COMPensation:TYPE OFF SETTled GDELay [:SENSe] :SWEep:EGATe:DELay:COMPensation:TYPE?
Example	SWE:EGAT:DEL:COMP:TYPE SETT SWE:EGAT:DEL:COMP:TYPE?
Notes	<p>Although this function is Meas Global, there are some measurements that do not support this function. In those measurements the operation will be Uncompensated. Going into one of those measurements will not change the Meas Global selection; it will simply display the grayed-out menu key with "Uncompensated" showing as the selection. This is a non-forceful grayout, so the SCPI command is still accepted.</p> <p>If Gate Delay Compensation is not supported at all within a particular mode, the key is not displayed, and if the SCPI command is sent while in a measurement within that mode, an "Undefined Header" message is generated.</p> <p>Measurements that do not support this function include:</p>

	Swept SA
Preset	TD-SCDMA mode: Compensate for RBW Group Delay All other modes: Delay Until RBW Settled
State Saved	Saved in instrument state
Range	Uncompensated Delay Until RBW Settled Compensate for RBW Group Delay
Readback text	Uncompensated Settled Group Delay
Initial S/W Revision	Prior to A.02.00
Modified at S/W Revision	A.11.0

More Information

Selecting **Uncompensated** means that the actual gate delay is as you sets it.

Selecting **Delay Until RBW Settled** causes the gate delay to be increased above the user setting by an amount equal to $3.06/\text{RBW}$. This compensated delay causes the GATE START and GATE STOP lines on the display to move by the compensation amount, and the actual hardware gate delay to be increased by the same amount. All the other gate lines (for example, MIN FAST) are unaffected. If the RBW subsequently changes, the compensation is readjusted for the new RBW. The value shown on the **Gate Delay** key does NOT change.

Delay Until RBW Settled allows excellent measurements of gated signals, by allowing the IF to settle following any transient that affects the burst. Excellent measurements also require that the analysis region not extend into the region affected by the falling edge of the burst. Thus, excellent measurements can only be made over a width that declines with narrowing RBWs, which is achieved by decreasing the gate length below the user setting by an amount equal to $2.53/\text{RBW}$. Therefore, for general purpose compensation, you will still want to change the gate length with changes in RBW even if the gate delay is compensated. The compensated Gate Length is limited by the analyzer so that it will never go below 10% of the value shown on the Gate Length key, as otherwise the sweep times could get very long. Anytime the **Gate Length and RBW** values combine in such a way that this limiting takes place, a warning is displayed . For measurements which contain multiple sweeps with different RBW like SEM and SPUR, the smallest RBW is used for this limiting.

Selecting **Compensate for RBW Group Delay** causes the gate delay to be increased above the user setting by an amount equal to $1.81/\text{RBW}$. This compensated delay causes the GATE START, GATE STOP lines on the display to move by the compensation amount, and the actual hardware gate delay to be increased by the same amount. All the other gate lines (for example, MIN FAST) are unaffected. If the RBW subsequently changes, the compensation is readjusted for the new RBW. The value shown on the **Gate Delay** key does NOT change. **Compensate for RBW Group Delay** also includes gate length compensation; the gate length itself is adjusted as necessary to attempt to compensate for delay effects imposed by the RBW.

Compensate for RBW Group Delay is similar to **Delay Until RBW Settled** , but compensates for the group delay of the RBW filter, rather than the filter settling

time. As the RBW gets narrow, this can allow the settling tail of the RBW to affect the beginning part of the gated measurement, and allow the beginning of the RBW settling transient to affect the end of the gated measurement. These two effects are symmetric because the RBW response is symmetric. Because the gate length is not automatically compensated, some users might find this compensation to be more intuitive than compensation for RBW settling.

Min Fast Position Query (Remote Command Only)

This command queries the position of the MIN FAST line, relative to the delay reference (REF) line. See section "Gate View On/Off" on page 2806. If this query is sent while not in gate view, the MinFast calculation is performed based on the current values of the appropriate parameters and the result is returned. Knowing this value lets you set an optimal gate delay value for the current measurement setup.

Remote Command	[:SENSe] :SWEep:EGATe:MINFast?
Example	SWE:EGAT:MIN?
Initial S/W Revision	Prior to A.02.00

Gate Preset (Remote Command Only)

Presets the time-gated spectrum analysis capability.

This command sets gate parameter values to the ESA preset values, as follows:

Gate trigger type = edge

Gate polarity = positive

Gate delay = 1 us

Gate length = 1 us

Remote Command	[:SENSe] :SWEep:TIME:GATE:PRESet ESA Compatibility
Initial S/W Revision	Prior to A.02.00

Gate Level (Remote Command Only)

Sets the gate input transition point level for the external TRIGGER inputs on the front and rear panel. This is a legacy command for PSA compatibility. It is simply an alias to the equivalent trigger level command.

Remote Command	[:SENSe] :SWEep:EGATe:EXTernal[1] 2:LEVel <voltage> [:SENSe] :SWEep:EGATe:EXTernal[1] 2:LEVel?
Notes	This command is simply an alias to :TRIGger[:SEQUence]:EXTernal[1]2:LEVel
Initial S/W Revision	Prior to A.02.00

Gate Polarity (Remote Command Only)

Sets the polarity for the gate signal. This setup is now done using the gate trigger's slope setting.

When Positive (Pos) is selected, a positive-going edge (Edge) or a high voltage (Level) will satisfy the gate condition, after the delay set with the Gate Delay key. When Negative (Neg) is selected, a negative-going edge (Edge) or a low voltage (Level) will satisfy the gate condition after the delay.

Remote Command	<code>[:SENSe] :SWEep:EGATe:POLarity NEGative POSitive</code> <code>[:SENSe] :SWEep:EGATe:POLarity?</code>
Example	SWE:EGAT:POL NEG SWE:EGAT:POL?
Preset	POSitive
State Saved	Saved in instrument state
Backwards Compatibility SCPI	[:SENSe] :SWEep:TIME:GATE:POLarity ESA compatibility
Initial S/W Revision	Prior to A.02.00

Remote Command	<code>[:SENSe] :SWEep:TIME:GATE:LEVe1 HIGH LOW</code> <code>[:SENSe] :SWEep:TIME:GATE:LEVe1?</code> ESA compatibility
Preset	HIGH
Initial S/W Revision	Prior to A.02.00

Points

Sets the number of points per sweep. The resolution of setting the sweep time depends on the number of points selected. The current value of points is displayed parenthetically, next to the sweep time in the lower-right corner of the display.

Key Path	Sweep/Control
Mode	SA, WCDMA, C2K, WIMAX OFDMA, TD-SCDMA, 1xEVDO, ISDB-T, CMMB, LTE, LTETDD, BLUETOOTH, WLAN, MSR, LTEAFDD, LTEATDD
Remote Command	<code>[:SENSe] :OBWidth:SWEep:POINts <integer></code> <code>[:SENSe] :OBWidth:SWEep:POINts?</code>
Example	OBW:SWE:POIN 1500 OBW:SWE:POIN?
Notes	This function is not available when signal identification is set to On (external mixing). Affected by: log sweep Grayed out in measurements that don't support swept

	<p>Blanked in modes that do not support swept. Whenever the number of sweep points change:</p> <ul style="list-style-type: none"> - All trace data is erased - Any traces with Update Off also go to Display Off (like going from View to Blank in the older analyzers) - Sweep time is re-quantized - Any limit lines that are on are updated - If averaging/hold is on, averaging/hold starts over
Couplings	Whenever the number of sweep points change, the sweep time is re-quantized.
Preset	LTE, LTETDD, MSR, LTEAFDD, LTEATDD: 2001 Other: 1001
State Saved	Saved in instrument state.
Min	101
Max	20001
Initial S/W Revision	Prior to A.02.00
Modified at S/W Revision	A.03.00

System

See "System" on page 431

Trace/Detector

Accesses a menu of functions that enable you to control the detectors for the current measurement.

Key Path	Front-panel key
Initial S/W Revision	Prior to A.02.00

Trace Type

Allows you to select the type of trace you want to you use for the current measurement.

The first page of this menu contains a 1-of-N selection of the trace type (Clear Write, Average, Max Hold, Min Hold) for the selected trace.

Key Path	Trace/Detector
Mode	SA, WCDMA, C2K, WIMAX OFDMA, TD-SCDMA, 1xEVDO, ISDB-T, CMMB, LTE, LTETDD, BLUETOOTH, WLAN, MSR, LTEAFDD, LTEATDD
Remote Command	:TRACe:OBWidth:TYPE WRITe AVERAge MAXHold MINHold :TRACe:OBWidth:TYPE?
Example	TRAC:OBW:TYPE MINH TRAC:OBW:TYPE?
Notes	WRITe = Clear Write AVERAge = Average MAXHold = Maximum Hold MINHold = Minimum Hold
Couplings	When Detector setting is "Auto" ([[:SENSe]:OBWidth:DETEctor:AUTO?]), Detector ([[:SENSe]:OBWidth:DETEctor:FUNCTion?]) switches aligning with the switch of this parameter: "NORMal" with WRITe (Clear Write), "AVERAge" with AVERAge, "POSitive (peak)" with MAXHold, and "NEGative (peak)" with MINHold.
Preset	AVERAge BLUETOOTH: MAX HOLD.
State Saved	Saved in instrument state.
Range	WRITe AVERAge MAXHold MINHold
Initial S/W Revision	Prior to A.02.00
Modified at S/W Revision	A.03.00

Detector

Accesses a menu of functions that enables you to control the detectors for the current measurement. The following choices are available:

- **Auto**– the detector selected depends on marker functions, trace functions, average type, and the trace averaging function.
- **Normal**–the detector determines the peak of the CW-like signals, and it yields alternating maximums and minimums of noise-like signals. This is also referred to as Rosenfell detection.
- **Average**–the detector determines the average of the signal within the sweep points. The averaging method depends upon the Average Type selection (voltage, power or log scales).
- **Peak (Positive)**–the detector determines the maximum of the signal within the sweep points.
- **Sample**–the detector indicates the instantaneous level of the signal at the center of the sweep points represented by each display point.
- **Negative Peak**–the detector determines the minimum of the signal within the sweep points.

Key Path	Detector
Initial S/W Revision	Prior to A.02.00

Auto

When the detector choice is Auto, the analyzer selects the detector. The selected detector depends on marker functions, trace functions, and trace averaging functions for the current measurement.

Key Path	Trace/Detector
Mode	SA, WCDMA, C2K, WIMAX OFDMA, 1xEVDO, ISDB-T, CMMB, LTE, LTETDD, BLUETOOTH, WLAN, MSR, LTEAFDD, LTEATDD
Remote Command	[:SENSe]:OBWidth:DETEctor:AUTO ON OFF 1 0 [:SENSe]:OBWidth:DETEctor:AUTO?
Example	OBW:DET:AUTO ON OBW:DET:AUTO?
Couplings	When Detector setting is "Auto" (:SENSe):OBWidth:DETEctor:AUTO?), Detector (:SENSe):OBWidth:DETEctor[:FUNCTion]?) switches aligning with the switch of this parameter: "NORMal" with Clear Write, "AVERage" with AVERage, "POSitive (peak)" with MAXHold, and "NEGative (peak)" with MINHold.
Preset	ON ISDB-T: OFF
State Saved	Saved in instrument state.
Initial S/W Revision	Prior to A.02.00
Modified at S/W Revision	A.03.00

Detector Selection

Allows you to select a specific detector for the current measurement. When the detector choice is Auto, the analyzer selects the detector. The selected detector depends on marker functions, trace functions, and trace averaging functions for the current measurement.

Key Path	Trace/Detector
Mode	SA, WCDMA, C2K, WIMAX OFDMA, TD-SCDMA, 1xEVDO, ISDB-T, CMMB, LTE, LTETDD, BLUETOOTH, WLAN, MSR, LTEAFDD, LTEATDD
Remote Command	<code>[:SENSe]:OBWidth:DETEctor[:FUNction] NORMal AVERage POSitive SAMPlE NEGative</code> <code>[:SENSe]:OBWidth:DETEctor[:FUNction]?</code>
Example	OBW:DET NORM OBW:DET?
Notes	When you manually select a detector (instead of selecting Auto), that detector is used regardless of other analyzer settings. The detector choices are: The Normal detector determines the peak of CW-like signals, and it yields alternating maximums and minimums of noise-like signals. This is also referred to as Rosenfell detection. The Average detector determines the average of the signal within the sweep points. The averaging method is Power Average (RMS). The Peak detector determines the maximum of the signal within the sweep points. The Sample detector indicates the instantaneous level of the signal at the center of the sweep points represented by each display point. The Negative Peak detector determines the minimum of the signal within the sweep points.
Couplings	When Detector setting is "Auto" (<code>[:SENSe]:OBWidth:DETEctor:AUTO?</code>), Detector (<code>[:SENSe]:OBWidth:DETEctor[:FUNction]?</code>) switches aligning with the switch of this parameter: "NORMal" with Clear Write, "AVERage" with AVERage, "POSitive (peak)" with MAXHold, and "NEGative (peak)" with MINHold.
Preset	AVERage ISDB-T: Peak BLUETOOTH: Peak
State Saved	Saved in instrument state.
Range	Normal Average Peak Sample Negative Peak
Initial S/W Revision	Prior to A.02.00
Modified at S/W Revision	A.03.00

Trigger

See ["Trigger" on page 529](#)

Free Run

See ["Free Run " on page 537](#)

Video

See ["Video \(IF Envelope\) " on page 538](#)

Trigger Level

See ["Trigger Level" on page 538](#)

Trig Slope

See ["Trig Slope" on page 539](#)

Trig Delay

See ["Trig Delay" on page 540](#)

X Axis Relative to Trigger

See ["X Axis Relative to Trigger" on page 583](#)

Line

See ["Line" on page 2814](#)

Trig Slope

See ["Trig Slope" on page 2814](#)

Trig Delay

See ["Trig Delay" on page 543](#)

X Axis Relative to Trigger

See ["X Axis Relative to Trigger" on page 583](#)

External 1

See ["External 1" on page 2828](#)

Trigger Level

See ["Trigger Level" on page 2828](#)

Trig Slope

See ["Trig Slope" on page 2829](#)

Trig Delay

See ["Trig Delay" on page 546](#)

X Axis Relative to Trigger

See ["X Axis Relative to Trigger" on page 583](#)

Zero Span Delay Comp

See ["Zero Span Delay Comp On/Off " on page 2816](#)

External 2

See ["External 2 " on page 2829](#)

Trigger Level

See ["Trigger Level" on page 2830](#)

Trig Slope

See ["Trig Slope" on page 2831](#)

Trig Delay

See ["Trig Delay " on page 549](#)

X Axis Relative to Trigger

See ["X Axis Relative to Trigger" on page 583](#)

Zero Span Delay Comp

See ["Zero Span Delay Comp On/Off" on page 2818](#)

RF Burst

See ["RF Burst" on page 2831](#)

Absolute Trigger

See ["Absolute Trigger Level" on page 2832](#)

Relative Trigger

See ["Relative Trigger Level" on page 2833](#)

Trig Slope

See ["Trigger Slope" on page 2834](#)

Trig Delay

See ["Trig Delay" on page 554](#)

X Axis Relative to Trigger

See ["X Axis Relative to Trigger" on page 583](#)

Zero Span Delay Comp

See ["Zero Span Delay Comp On/Off" on page 2834](#)

Periodic Timer

See ["Periodic Timer \(Frame Trigger\)" on page 2823](#)

Period

See ["Period" on page 2824](#)

Offset

See ["Offset" on page 2825](#)

Offset Adjust (Remote Command Only)

See ["Offset Adjust \(Remote Command Only\)" on page 2826](#)

Reset Offset Display

See ["Reset Offset Display" on page 2827](#)

Sync Source

See ["Sync Source" on page 2827](#)

Off

See ["Off" on page 2828](#)

External 1

See ["External 1" on page 2828](#)

Trigger Level

See ["Trigger Level" on page 2828](#)

Trig Slope

See ["Trig Slope" on page 2829](#)

External 2

See ["External 2 " on page 2829](#)

Trigger Level

See ["Trigger Level" on page 2830](#)

Trig Slope

See ["Trig Slope" on page 2831](#)

RF Burst

See ["RF Burst" on page 2831](#)

Absolute Trigger

See ["Absolute Trigger Level" on page 2832](#)

Relative Trigger

See ["Relative Trigger Level" on page 2833](#)

Trig Slope

See ["Trigger Slope" on page 2834](#)

Zero Span Delay Comp

See ["Zero Span Delay Comp On/Off" on page 2834](#)

Trig Delay

See ["Trig Delay" on page 568](#)

X Axis Relative to Trigger

See ["X Axis Relative to Trigger" on page 583](#)

Sync Holdoff

See ["Sync Holdoff" on page 1289](#)

Baseband I/Q

See ["Baseband I/Q " on page 570](#)

I/Q Mag

See ["I/Q Mag" on page 570](#)

Trigger Level

See ["Trigger Level" on page 570](#)

Trig Slope

See ["Trig Slope" on page 571](#)

Trig Delay

See ["Trig Delay" on page 571](#)

X Axis Relative to Trigger

See ["X Axis Relative to Trigger" on page 583](#)

I (Demodulated)

See ["I \(Demodulated\)" on page 572](#)

Trigger Level

See ["Trigger Level" on page 573](#)

Trig Slope

See ["Trig Slope" on page 573](#)

Trig Delay

See ["Trig Delay" on page 573](#)

X Axis Relative to Trigger

See ["X Axis Relative to Trigger" on page 583](#)

Q (Demodulated)

See ["Q \(Demodulated\)" on page 575](#)

Trigger Level

See ["Trigger Level" on page 575](#)

Trig Slope

See ["Trig Slope" on page 575](#)

Trig Delay

See ["Trig Delay" on page 576](#)

X Axis Relative to Trigger

See ["X Axis Relative to Trigger" on page 583](#)

Input I

See ["Input I" on page 577](#)

Trigger Level

See ["Trigger Level" on page 577](#)

Trig Slope

See ["Trig Slope" on page 578](#)

Trig Delay

See ["Trig Delay" on page 578](#)

X Axis Relative to Trigger

See ["X Axis Relative to Trigger" on page 583](#)

Input Q

See ["Input Q" on page 579](#)

Trigger Level

See ["Trigger Level" on page 579](#)

Trig Slope

See ["Trig Slope" on page 580](#)

Trig Delay

See ["Trig Delay" on page 580](#)

X Axis Relative to Trigger

See ["X Axis Relative to Trigger" on page 583](#)

Auxiliary Channel I/Q Mag

See ["Auxiliary Channel I/Q Mag" on page 581](#)

Trigger Level

See ["Trigger Level" on page 582](#)

Trig Slope

See ["Trig Slope" on page 582](#)

Trig Delay

See ["Trig Delay" on page 582](#)

X Axis Relative to Trigger

See ["X Axis Relative to Trigger" on page 583](#)

Trigger Center Frequency

See ["Trigger Center Frequency" on page 583](#)

Trigger Bandwidth

See ["Trigger Bandwidth" on page 584](#)

TV

See ["TV" on page 2835](#)

TV Line

See ["TV Line" on page 2836](#)

Field

See ["Field" on page 2836](#)

Entire Frame

See ["Entire Frame" on page 2837](#)

Field One

See ["Field One" on page 2837](#)

Field Two

See ["Field Two" on page 2837](#)

Standard

See ["Standard" on page 2838](#)

NTSC-M

See ["NTSC-M" on page 2838](#)

NTSC-Japan

See ["NTSC-Japan" on page 2839](#)

NTSC-4.43

See ["NTSC-4.43" on page 2839](#)

PAL-M

See ["PAL-M" on page 2839](#)

PAL-N

See ["PAL-N" on page 2839](#)

PAL-N Combin

See ["PAL-N-Combin" on page 2839](#)

PAL-B,D,G,H,I

See ["PAL-B,D,G,H,I" on page 2839](#)

PAL-60

See "PAL-60" on page 2840

SECAM-L

See "SECAM-L" on page 2840

Auto/Holdoff

See "Auto/Holdoff" on page 590

Auto Trig

See "Auto Trig" on page 590

Trig Holdoff

See "Trig Holdoff" on page 591

Holdoff Type

See "Holdoff Type" on page 591

User Preset

Accesses a menu that gives you the following three choices:

- **User Preset** – recalls a state previously saved using the Save User Preset function.
- **User Preset All Modes** – presets all of the modes in the analyzer
- **Save User Preset**– saves the current state for the current mode

Key Path	Front-panel key
Backwards Compatibility Notes	<p>User Preset is actually loading a state, and in legacy analyzers, it was possible to load a state without affecting the trace data, limit lines or correction data. Similarly it was possible to do a User Preset without affecting the trace data, limit lines or correction data.</p> <p>In the X-Series, “state” always includes all of this data; so whenever state is loaded, or User Preset is executed, all of the traces, limit lines and corrections are affected. Although this differs from previous behavior, it is desirable behavior, and should not cause adverse issues for users.</p> <p>On ESA and PSA, User Preset affected the entire instrument’s state. In the X-Series, User Preset only recalls the state for the active mode. There is a User Preset file for each mode. User Preset can never cause a mode switch as it can in legacy analyzers. If you want to recall all modes to their user preset file state, you will need to do a User Preset after mode switching into each mode.</p> <p>User Preset recalls mode state which can now include data like traces; whereas on ESA and PSA, User Preset did not affect data.</p>
Initial S/W Revision	Prior to A.02.00

User Preset

User Preset sets the state of the currently active mode back to the state that was previously saved for this mode using the Save User Preset menu key or the SCPI command, **SYST:PRES:USER:SAV**. **It not only recalls the** Mode Preset settings, but it also recalls all of the mode persistent settings, and the Input/Output system setting that existed at the time Save User Preset was executed.

If a Save User Preset has not been done at any time, User Preset recalls the default user preset file for the currently active mode. The default user preset files are created if, at power-on, a mode detects there is no user preset file. There will never be a scenario when there is no user preset file to restore. For each mode, the default user preset state is the same state that would be saved if a Save User Preset is performed in each mode right after doing a Restore Mode Default and after a Restore Input/Output Defaults.

The User Preset function does the following:

- Aborts the currently running measurement.
- Sets the mode State to the values defined by Save User Preset.

- Makes the saved measurement for the currently running mode the active measurement.
- Brings up the saved menu for the power-on mode.
- Clears the input and output buffers.
- Sets the Status Byte to 0.

Key Path	User Preset
Remote Command	:SYSTem:PRESet:USER
Example	:SYST:PRES:USER
Notes	:SYST:PRES:USER:SAVE is used to save the current state as the user preset state. Clears all pending OPC bits. The Status Byte is set to 0. Pressing the User Preset front-panel key while already in the User Preset menu will cause the User Preset to get executed
Couplings	A user preset will cause the currently running measurement to be aborted and cause the saved measurement to be active. Recalling a User Preset file has the same issues that recalling a Save State file has. Some settings may need to be limited and therefore re-coupled, since the capabilities of the mode may have changes when the User Preset file was last saved.
Initial S/W Revision	Prior to A.02.00

User Preset All Modes

Recalls all of the User Preset files for each mode, switches to the power-on mode, and activates the saved measurement from the power-on mode User Preset file.

NOTE

When the instrument is secured, all of the user preset files are converted back to their default user preset files.

The User Preset function does the following:

- Aborts the currently running measurement.
- Switches the Mode to the power-on mode.
- Restores the User Preset files for each mode.
- Makes the saved measurement for the power-on mode the active measurement.
- Brings up the saved menu for the power-on mode.
- Clears the input and output buffers.
- Sets the Status Byte to 0.

Key Path	User Preset
----------	-------------

Remote Command	:SYSTem:PRESet:USER:ALL
Example	:SYST:PRES:USER:SAVE :SYST:PRES:USER:ALL
Notes	Clears all pending OPC bits. The Status Byte is set to 0. :SYST:PRES:USER:SAVE is used to save the current state as the user preset state.
Couplings	A user preset will cause the currently running measurement to be aborted, cause a mode switch to the power-on mode, and cause the saved measurement to be active in the power-on mode. Recalling a User Preset file has the same issues that recalling a Save State file has. Some settings may need to be limited and therefore re-coupled, since the capabilities of the mode may have changes when the User Preset file was last saved.
Initial S/W Revision	Prior to A.02.00

Save User Preset

Saves the currently active mode and its State. You can recall this User Preset file by pressing the User Preset menu key or sending the SYST:PRES:USER remote command. This same state is also saved by the Save State function.

Key Path	User Preset
Remote Command	:SYSTem:PRESet:USER:SAVE
Example	:SYST:PRES:USER:SAVE
Notes	:SYST:PRES:SAVE creates the same file as if the user requested a *SAV or a MMEM:STOR:STAT, except User Preset Save does not allow the user to specify the filename or the location of the file.
Initial S/W Revision	Prior to A.02.00

View/Display

Accesses a menu of functions that enable you to set the view and display parameters for the current measurement.

Key Path	Front-panel key
Initial S/W Revision	Prior to A.02.00

Display

The Display menu is common to most measurements, and is used for configuring items on the display. Some Display menu settings apply to all the measurements in a mode, and some only to the current measurement. Those under the **System Display Settings** key apply to all measurements in all modes.

Key Path	Display
Key Path	View/Display
Initial S/W Revision	Prior to A.02.00

Annotation

Turns on and off various parts of the display annotation. The annotation is divided up into four categories:

13. Meas Bar: This is the measurement bar at the top of the screen. It does not include the settings panel or the Active Function. Turning off the Meas Bar turns off the settings panel and the Active Function. When the Meas Bar is off, the graticule area expands to fill the area formerly occupied by the Meas Bar.
14. Screen Annotation: this is the annotation and annunciation around the graticule, including any annotation on lines (such as the display line, the threshold line, etc.) This does NOT include the marker number or the N dB result. When off, the graticule expands to fill the entire graticule area.
15. Trace annotation: these are the labels on the traces, showing their detector (or their math mode).
16. Active Function annotation: this is the active function display in the meas bar, and all of the active function values displayed on softkeys.

See the figure below. Each type of annotation can be turned on and off individually.

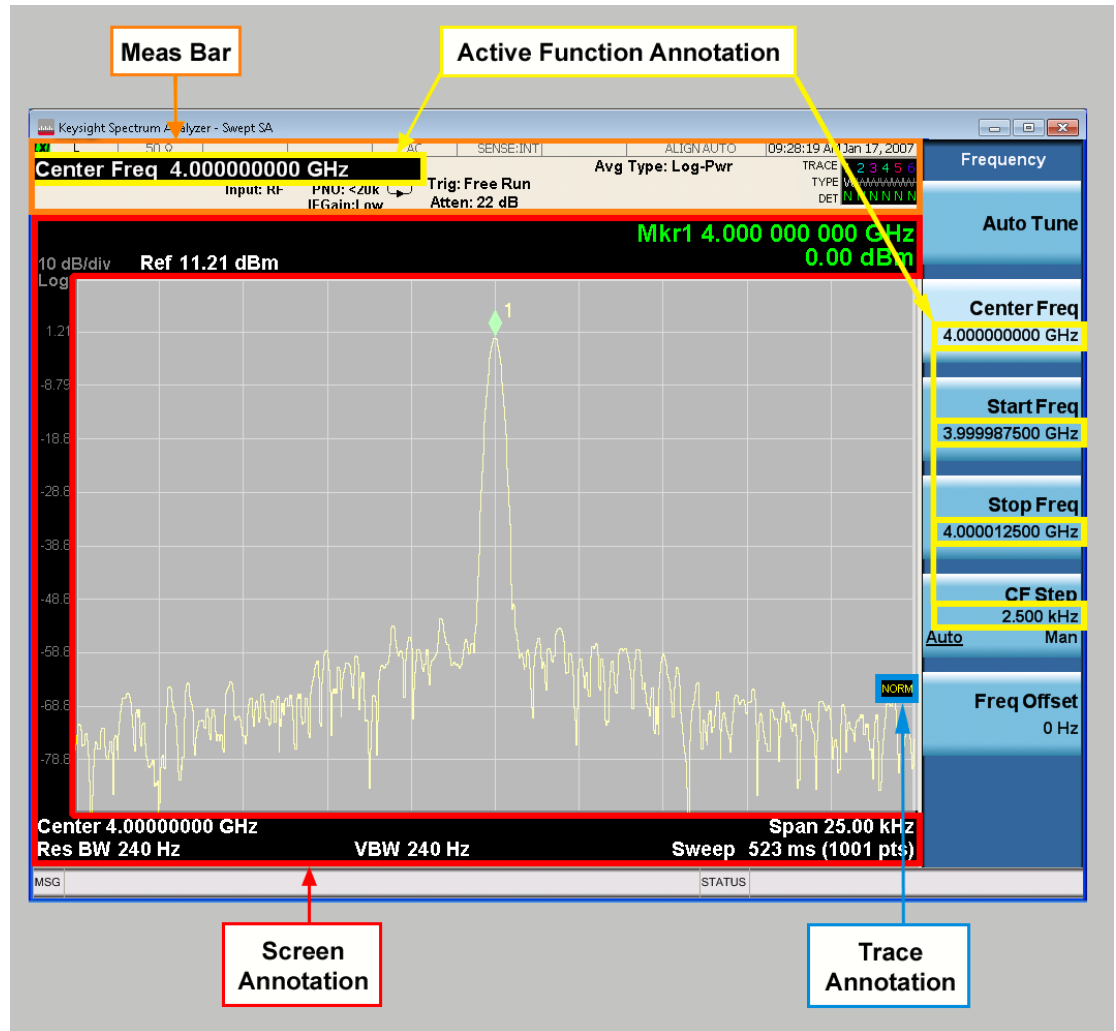

Key Path	View/Display, Display
Initial S/W Revision	Prior to A.02.00

Meas Bar On/Off

This function turns the Measurement Bar on and off, including the settings panel. When off, the graticule area expands to fill the area formerly occupied by the Measurement Bar.

Key Path	View/Display, Display, Annotation
Remote Command	:DISPlay:ANNotation:MBAR[:STATE] OFF ON 0 1 :DISPlay:ANNotation:MBAR[:STATE]?
Example	DISP:ANN:MBAR OFF
Dependencies	Grayed out and forced to OFF when System Display Settings, Annotation is set to Off.
Preset	On

	This should remain Off through a Preset when System DisplaySettings, Annotation is set to Off.
State Saved	Saved in instrument state.
Initial S/W Revision	Prior to A.02.00

Screen

This controls the display of the annunciation and annotation around the graticule, including any annotation on lines (such as the display line, the threshold line, etc.) and the y-axis annotation. This does NOT include marker annotation (or the N dB result). When off, the graticule expands to fill the entire graticule area, leaving only the 1.5% gap above the graticule as described in the Trace/Detector chapter.

Key Path	View/Display, Display, Annotation
Remote Command	:DISPlay:ANNotation:SCReen[:STATe] OFF ON 0 1 :DISPlay:ANNotation:SCReen[:STATe]?
Example	DISP:ANN:SCR OFF
Dependencies	Grayed-out and forced to OFF when System Display Settings, Annotation is set to Off.
Preset	On This should remain Off through a Preset when System DisplaySettings, Annotation is set to Off
State Saved	Saved in instrument state.
Initial S/W Revision	Prior to A.02.00

Trace

Turns on and off the labels on the traces, showing their detector (or their math mode) as described in the Trace/Detector section.

If trace math is being performed with a trace, then the trace math annotation will replace the detector annotation.

Key Path	View/Display, Display, Annotation
Remote Command	:DISPlay:ANNotation:TRACe[:STATe] ON OFF 1 0 :DISPlay:ANNotation:TRACe[:STATe]?
Example	DISP:ANN:TRAC OFF
Preset	Off
State Saved	Saved in instrument state.
Initial S/W Revision	Prior to A.02.00

Active Function Values On/Off

Turns on and off the active function display in the Meas Bar, and all of the active function values displayed on the softkeys.

Note that all of the softkeys that have active functions have these numeric values blanked when this function is on. This is a security feature..

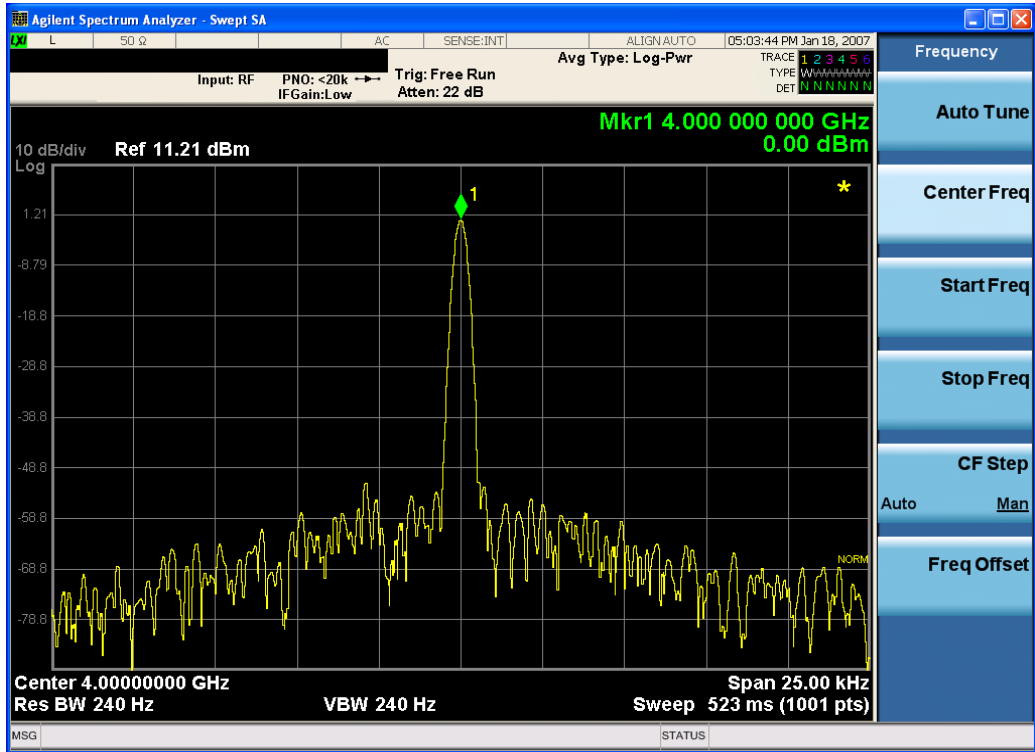

Key Path	View/Display, Display, Annotation
Remote Command	:DISPlay:ACTivefunc[:STATe] ON OFF 1 0 :DISPlay:ACTivefunc[:STATe]?
Example	DISP:ACT OFF
Dependencies	Grayed out and forced to OFF when System Display Settings, Annotation is set to Off.
Preset	On This should remain Off through a Preset when System DisplaySettings, Annotation is set to Off
State Saved	Saved in instrument state.
Initial S/W Revision	Prior to A.02.00

Title

Displays menu keys that enable you to change or clear a title on your display.

Key Path	View/Display, Display
Initial S/W Revision	Prior to A.02.00

Change Title

Writes a title into the "measurement name" field in the banner, for example, "Swept SA".

Press Change Title to enter a new title through the alpha editor. Press Enter or Return to complete the entry. Press ESC to cancel the entry and preserve your existing title.

The display title will replace the measurement name. It remains for this measurement until you press **Change Title** again, or you recall a state, or a Preset is performed. A title can also be cleared by pressing **Title**, **Clear Title**.

NOTE

Notice the inclusion of the <measurement> parameter in the command below. Because each measurement remembers the Display Title, the command must be qualified with the measurement name. For the Swept SA measurement this is not the case; no <measurement> parameter is used when changing the Display Title for the Swept SA measurement.

Key Path	View/Display, Display, Title
Mode	All
Remote Command	:DISPlay:<measurement>:ANNotation:TITLe:DATA <string> :DISPlay:<measurement>:ANNotation:TITLe:DATA?
Example	DISP:ANN:TITL:DATA "This Is My Title" This example is for the Swept SA measurement in the Spectrum Analyzer mode. The SANalyzer <measurement> name is not used. DISP:ACP:ANN:TITL:DATA "This Is My Title" This example is for Measurements other than Swept SA. Both set the title to: This Is My Title
Notes	Pressing this key cancels any active function. When a title is edited the previous title remains intact (it is not cleared) and the cursor goes at the end so that characters can be added or BKSP can be used to go back over previous characters.
Preset	No title (measurement name instead)
State Saved	Saved in instrument state.
Initial S/W Revision	Prior to A.02.00

Clear Title

Clears a title from the front-panel display. Once cleared, the title cannot be retrieved. After the title is cleared, the current Measurement Name replaces it in the title bar.

Key Path	View/Display, Display, Title
Example	<p>The following commands clear the title and restore the measurement's original title:</p> <pre>DISP:ANN:TITL:DATA ""</pre> <p>This example is for the Swept SA measurement in the Spectrum Analyzer mode. The SANalyzer <measurement> name is not used.</p> <pre>DISP:ACP:ANN:TITL:DATA ""</pre> <p>This example is for ACP; in measurements other than Swept SA the measurement name is required.</p>
Notes	Uses the :DISPlay:<measurement>:ANNotation:TITLe:DATA <string> command with an empty string (in the Swept SA, the <measurement> is omitted).
Preset	Performed on Preset.
Initial S/W Revision	Prior to A.02.00

Graticule

Pressing Graticule turns the display graticule On or Off. It also turns the graticule y-axis annotation on and off.

Key Path	View/Display, Display
Remote Command	<pre>:DISPlay:WINDow[1]:TRACe:GRATicule:GRID[:STATe] OFF ON 0 1</pre> <pre>:DISPlay:WINDow[1]:TRACe:GRATicule:GRID[:STATe]?</pre>
Example	DISP:WIND:TRAC:GRAT:GRID OFF
Notes	The graticule is the set of horizontal and vertical lines that make up the grid/divisions for the x-axis and y-axis.
Preset	On
State Saved	Saved in instrument state
Initial S/W Revision	Prior to A.02.00

System Display Settings

These settings are "Mode Global" – they affect all modes and measurements and are reset only by **Restore Misc Defaults** or **Restore System Defaults** under System.

Key Path	View/Display, Display
Initial S/W Revision	Prior to A.02.00

Annotation Local Settings

This is a Mode Global override of the meas local annotation settings. When it is **All Off**, it forces **ScreenAnnotation, Meas Bar, Trace, and Active Function Values** settings to be **OFF** for all measurements in all modes. This provides the security

based "annotation off" function of previous analyzers; hence it uses the legacy SCPI command.

When it is **All Off**, the **Screen, Meas Bar, Trace**, and **Active Function Values** keys under the **Display, Annotation** menu are grayed out and forced to **Off**. When **Local Settings** is selected, you are able to set the local annotation settings on a measurement by measurement basis.

Key Path	View/Display, Display, System Display Settings
Remote Command	:DISPlay:WINDow[1]:ANNotation[:ALL] OFF ON 0 1 :DISPlay:WINDow[1]:ANNotation[:ALL]?
Example	:DISP:WIND:ANN OFF
Preset	On (Set by Restore Misc Defaults)
State Saved	Not saved in instrument state.
Backwards Compatibility Notes	The WINDow parameter and optional subopcode is included for backwards compatibility but ignored – all windows are equally affected.
Initial S/W Revision	Prior to A.02.00

Themes

Accesses a menu of functions that enable you to choose the theme to be used when saving the screen image.

The **Themes** option is the same as the **Themes** option under the **Display** and **Page Setup** dialogs. It allows you to choose between themes to be used when saving the screen image.

Key Path	Save, Screen Image
Remote Command	:MMEMory:STORe:SCReem:THEMe TDCoLor TDMonochrome FCOLor FMONochrome :MMEMory:STORe:SCReem:THEMe?
Example	:MMEM:STOR:SCR:THEM TDM
Preset	3D Color; Is not part of Preset, but is reset by Restore Misc Defaults or Restore System Defaults All and survives subsequent running of the modes.
Readback	3D Color 3D Mono Flat Color Flat Mono
Backwards Compatibility Notes	In ESA and PSA we offer the choice of "Reverse Bitmap" or "Reverse Metafile" when saving screen images. This is much like the "Flat Color" theme available in X-Series. Also, if you selected Reverse Bitmap AND a black & white screen image, that would be much like "Flat Monochrome". In other words, each of the X-Series themes has a similar screen image type in ESA/PSA. But they are not identical.
Initial S/W Revision	Prior to A.02.00

3D Color

Selects a standard color theme with each object filled, shaded and colored as designed.

Key Path	Save, Screen Image, Themes
Example	MMEM:STOR:SCR:THEM TDC
Readback	3D Color
Initial S/W Revision	Prior to A.02.00

3D Monochrome

Selects a format that is like 3D color but shades of gray are used instead of colors.

Key Path	Save, Screen Image, Themes
Example	MMEM:STOR:SCR:THEM TDM
Readback	3D Mono
Initial S/W Revision	Prior to A.02.00

Flat Color

Selects a format that is best when the screen is to be printed on an ink printer.

Key Path	Save, Screen Image, Themes
Example	MMEM:STOR:SCR:THEM FCOL
Readback	Flat Color
Initial S/W Revision	Prior to A.02.00

Flat Monochrome

Selects a format that is like Flat Color. But only black is used (no colors, not even gray), and no fill.

Key Path	Save, Screen Image, Themes
Example	MMEM:STOR:SCR:THEM FMON
Readback	Flat Mono
Initial S/W Revision	Prior to A.02.00

Backlight

Accesses the display backlight on/off keys. This setting may interact with settings under the Windows "Power" menu.

When the backlight is off, pressing ESC, TAB, SPACE, ENTER, UP, DOWN, LEFT, RIGHT, DEL, BKSP, CTRL, or ALT turns the backlight on without affecting the application. Pressing any other key will turn backlight on and could potentially perform the action as well.

Key Path	View/Display, Display, System Display Settings
Remote Command	:DISPlay:BACKlight ON OFF :DISPlay:BACKlight?

Preset	ON (Set by Restore Misc Defaults)
Initial S/W Revision	Prior to A.02.00

Backlight Intensity

An active function used to set the backlight intensity. It goes from 0 to 100 where 100 is full on and 0 is off. This value is independent of the values set under the Backlight on/off key.

Key Path	View/Display, Display, System Display Settings
Remote Command	:DISPlay:BACKlight:INTensity <integer> :DISPlay:BACKlight:INTensity?
Example	DISP:BACK:INT 50
Preset	100 (Set by Restore Misc Defaults)
Min	0
Max	100
Initial S/W Revision	Prior to A.02.00

View Selection

Enables you to select the view from either OBW Results or OBW Boundaries. There are two available commands; ID string and numeric ID value. For more details of the commands, see:

- ["View Selection by Name" on page 1576](#)
- ["View Selection by Number" on page 1576](#)

In the following table:

- The Enumerated ID is used with the SCPI Command :DISP:OBW:VIEW[:SEL]
- The Numeric ID is used with the SCPI Command :DISP:OBW:VIEW:NSEL

Enumerated ID	Numeric ID	View Name & Details
OBWResults	1	OBW Results Provides a combination view of the spectrum trace and the measurement summary data.
BOUNdaries	2	OBW Boundaries Provides a combination view of the spectrum trace and the OBW boundaries table. The OBW boundaries table shows Occupied bandwidth and X dB bandwidth for both lower and upper boundaries.

View Selection by Name

Key Path	View/Display
Mode	SA, WCDMA, C2K, 1xEV-DO, WIMAX OFDMA, TD-SCDMA, DVB-T/H, LTE, LTETDD, MSR, LTEAFDD, LTEATDD
Remote Command	:DISPlay:OBWidth:VIEW[:SElect] OBWResults BOUNDaries :DISPlay:OBWidth:VIEW[:SElect]?
Example	DISP:OBW:VIEW OBWR DISP:OBW:VIEW?
Preset	OBWResults
State Saved	Saved in instrument state
Range	OBWResults BOUNDaries
Initial S/W Revision	A.16.00

View Selection by Number

Key Path	SCPI only
Mode	SA, WCDMA, C2K, 1xEV-DO, WIMAX OFDMA, TD-SCDMA, DVB-T/H, LTE, LTETDD, MSR, LTEAFDD, LTEATDD
Remote Command	:DISPlay:OBWidth:VIEW:NSElect <integer> :DISPlay:OBWidth:VIEW:NSElect?
Example	DISP:OBW:VIEW:NSEL 2 DISP:OBW:VIEW:NSEL?
Preset	1
State Saved	Saved in instrument state
Min	1
Max	2
Initial S/W Revision	A.16.00

OBW Results

The spectrum trace is displayed in the upper window. Measurement results such as Occupied Bandwidth or Power are displayed in the lower window. For more details, and samples of screen content for each supported mode, see ["Spectrum View" on page 1578](#) below.

The following result descriptions are available:

Occupied Bandwidth

The occupied bandwidth result is $f_2 - f_1$, where f_1 and f_2 are the lower and upper carrier boundary point. f_1 and f_2 are calculated with a Occupied Bandwidth algorithms.

Total Power or OBW Power

The total power is the power integrated in the specified span setting. The OBW power is calculated from multiplying the total power by OBW percent power. The

user can select the total power or the OBW power with the Power Ref key in Meas Setup.

Transmit Freq Error

The transmit freq error (transmit frequency error) result is calculated as the difference between $(f_2+f_1)/2$ and the tuned center frequency of the signal, where f_1 and f_2 are the lower and upper carrier boundary point.

x dB Bandwidth

The x dB result is a bandwidth measured between two points on the signal which are a certain number of dBs down from the highest signal point within the OBW Span. For example, if the 'x dB' parameter is set to -26 dB, and the 'Occupied BW Span' is set to 10 MHz, then the maximum signal power level is first determined from the 10 MHz wide trace sweep. Next, the two furthest frequencies below (x_{db_f1}) and above (x_{db_f2}) the frequency of the maximum level occurrence are found where the signal level is 26 dB below the peak level. This calculation also uses linear interpolation to find the lower and upper carrier boundary point within the width of a sweep point (the span divided by the number of sweep points).

The x dB bandwidth is calculated to be $x_{db_f2} - x_{db_f1}$.

% of OBW Power

This is the setting parameter. See ["Occ BW % Pwr" on page 1411](#).

x dB

This is the setting parameter. See ["x dB" on page 1412](#).

OBW Boundaries

Occupied bandwidth and X dB bandwidth for both lower and upper boundaries are displayed. For a sample of the screen contents, see ["Boundary Frequency" on page 1582](#).

Occupied Bandwidth

See ["OBW Results" on page 1576](#) above.

Total Power or OBW Power

See ["OBW Results" on page 1576](#) above.

x dB

This is the setting parameter. See ["x dB" on page 1412](#).

x dB Ref Pwr The x dB reference power result shows the power of the highest signal point within the OBW Span. **x dB At Freq**

The x dB reference power frequency result shows the frequency of the highest signal point within the OBW Span. The frequency display type, either Offset or Absolute, can be selected with the Frequency key under OBW Boundaries in the View/Display menu.

OBW Boundaries Results

Name	Corresponding Results
Lower OBW boundary - offset frequency [Hz]	Offset frequency of the lower OBW boundary from center frequency
Lower OBW	Absolute power on the point of lower OBW boundary

Name	Corresponding Results
boundary - absolute power [dB]	
Lower OBW boundary - relative power [dBc]	Relative power on the point of lower OBW boundary
Upper OBW boundary - offset frequency [Hz]	Offset frequency of the upper OBW boundary from center frequency
Upper OBW boundary - absolute power [dB]	Absolute power on the point of upper OBW boundary
Upper OBW boundary - relative power [dBc]	Relative power on the point of upper OBW boundary
Lower x dB BW boundary - offset frequency [Hz]	Offset frequency of the lower x dB BW boundary from center frequency
Lower x dB BW boundary - absolute power [dB]	Absolute power on the point of lower x dB BW boundary
Upper x dB BW boundary - offset frequency [Hz]	Offset frequency of the lower x dB BW boundary from center frequency
Upper x dB BW boundary - absolute power [dB]	Absolute power on the point of lower x dB BW boundary

Spectrum View

For SA, WCDMA, C2K, 1xEVDO, WIMAX OFDMA, WLAN modes:

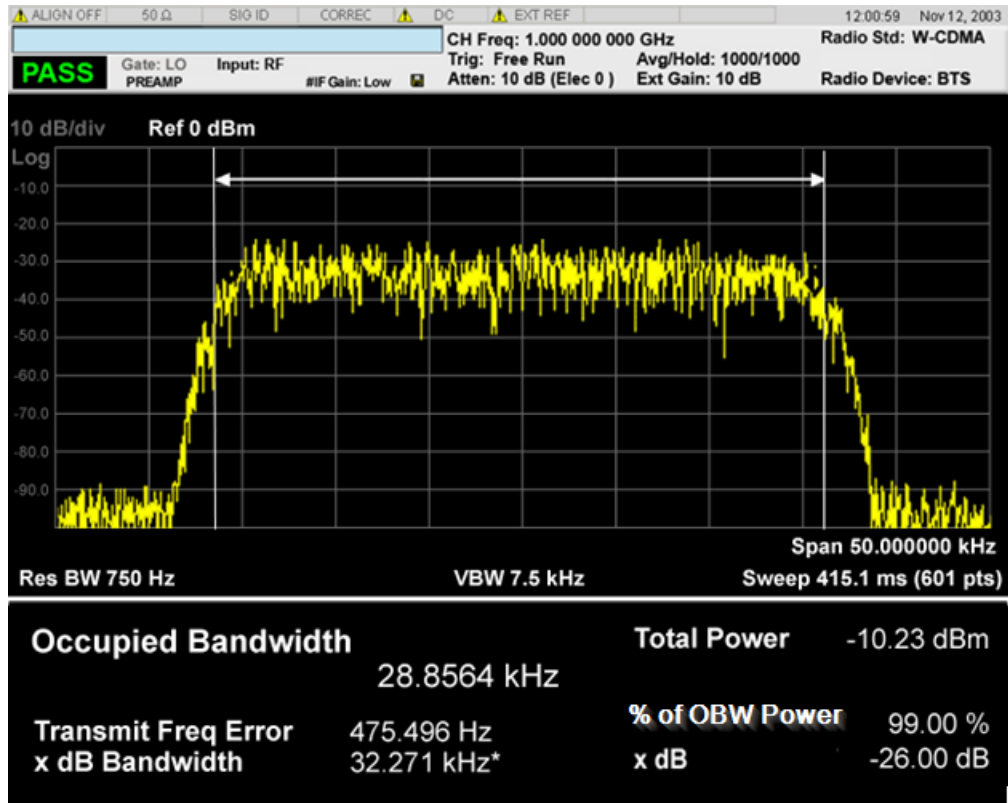

For TD-SCDMA mode only:

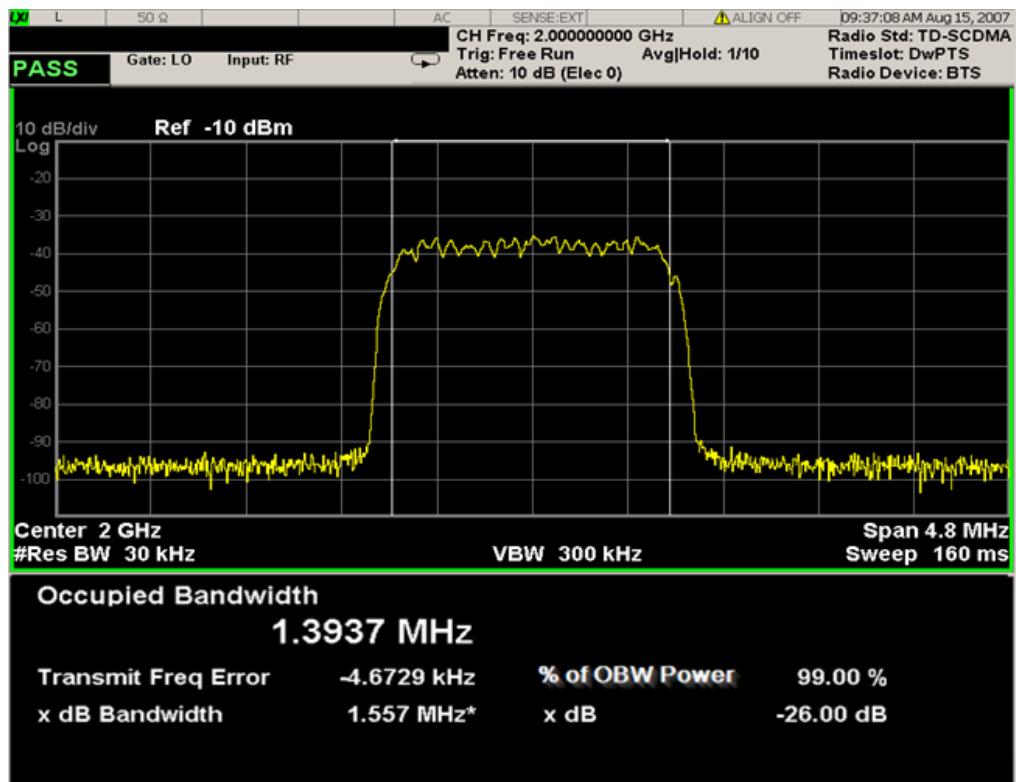

For Bluetooth mode only:

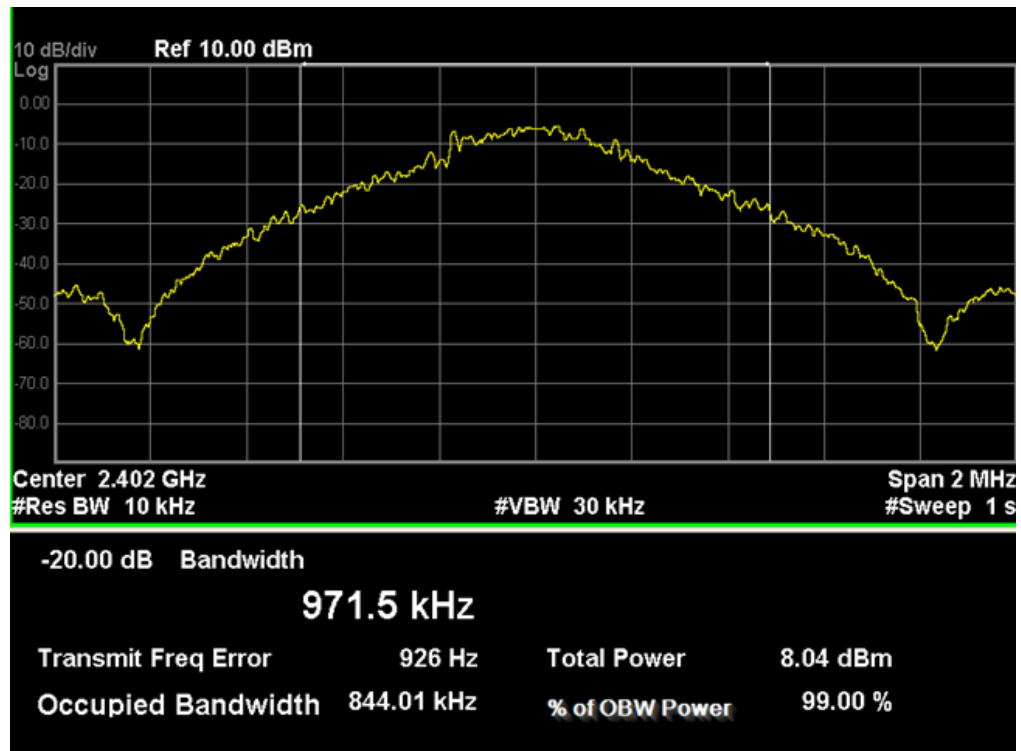

For MSR mode only:

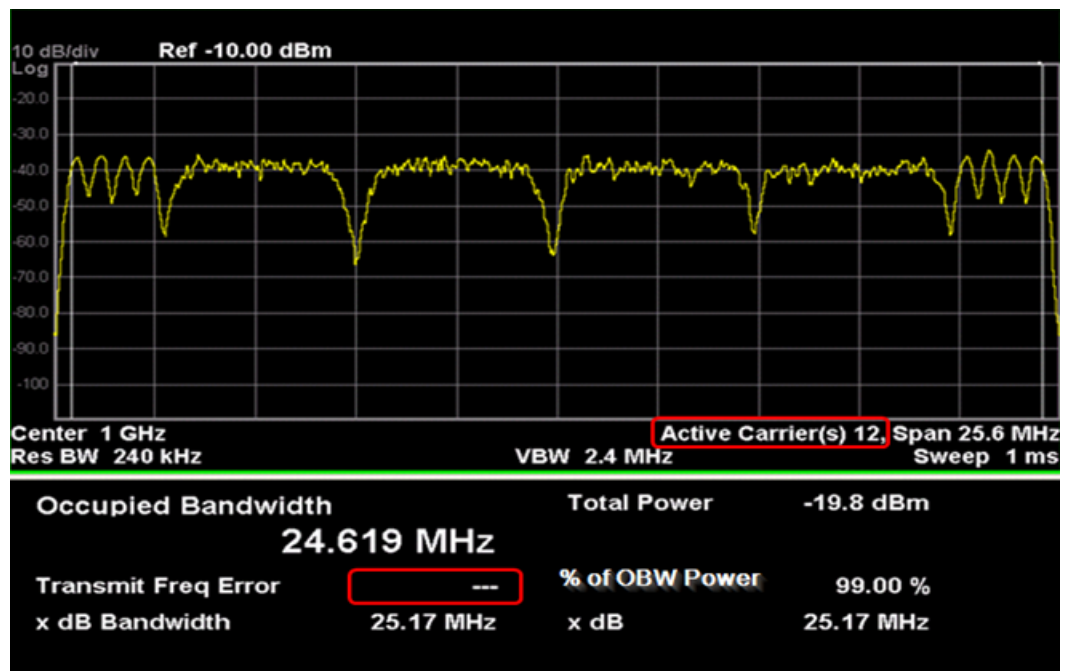

The number of active carriers is displayed. Since span is determined from detected carriers in auto mode, it is necessary to show how many carriers are identified as active., as highlighted above.

When there is one active carrier, Transmit Freq Error is displayed. Otherwise, “---” is displayed, as shown above.

For LTE-Advanced FDD/TDD mode only:

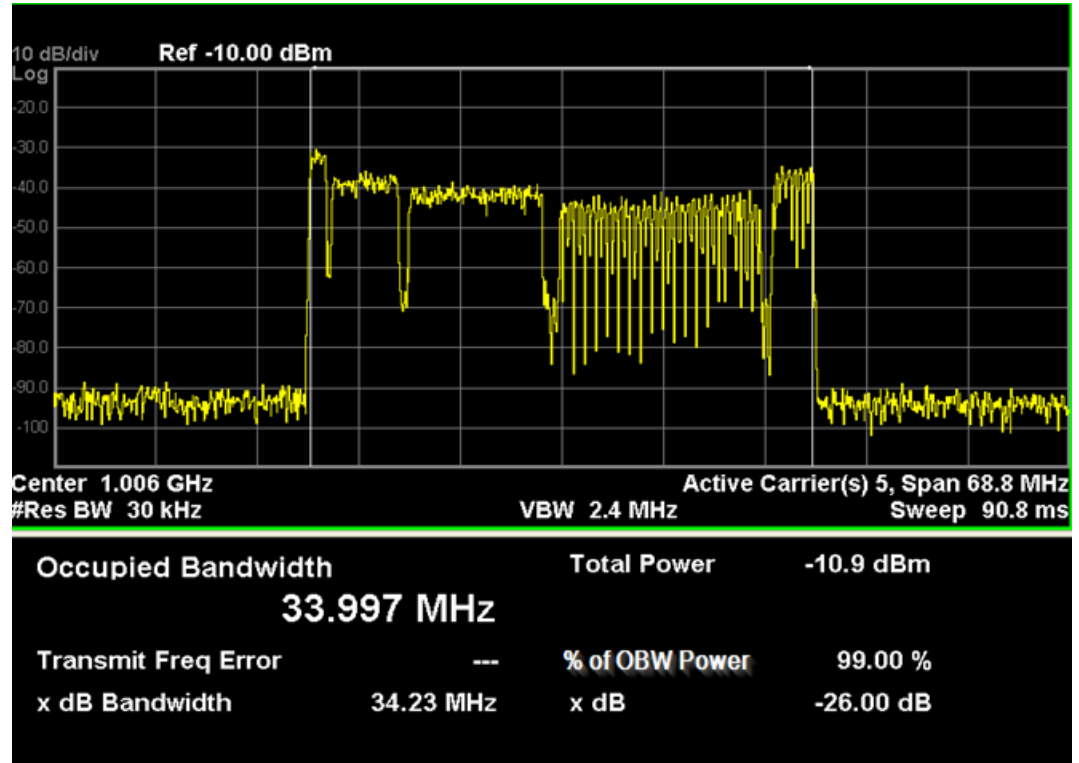

The number of active carriers is displayed to show how many carriers are identified as active in auto detected mode of span, otherwise “-” is displayed to indicate that it is out of scope.

When there is one active carrier, Transmit Freq Error is displayed. Otherwise, “---” is displayed.

OBW Boundaries View

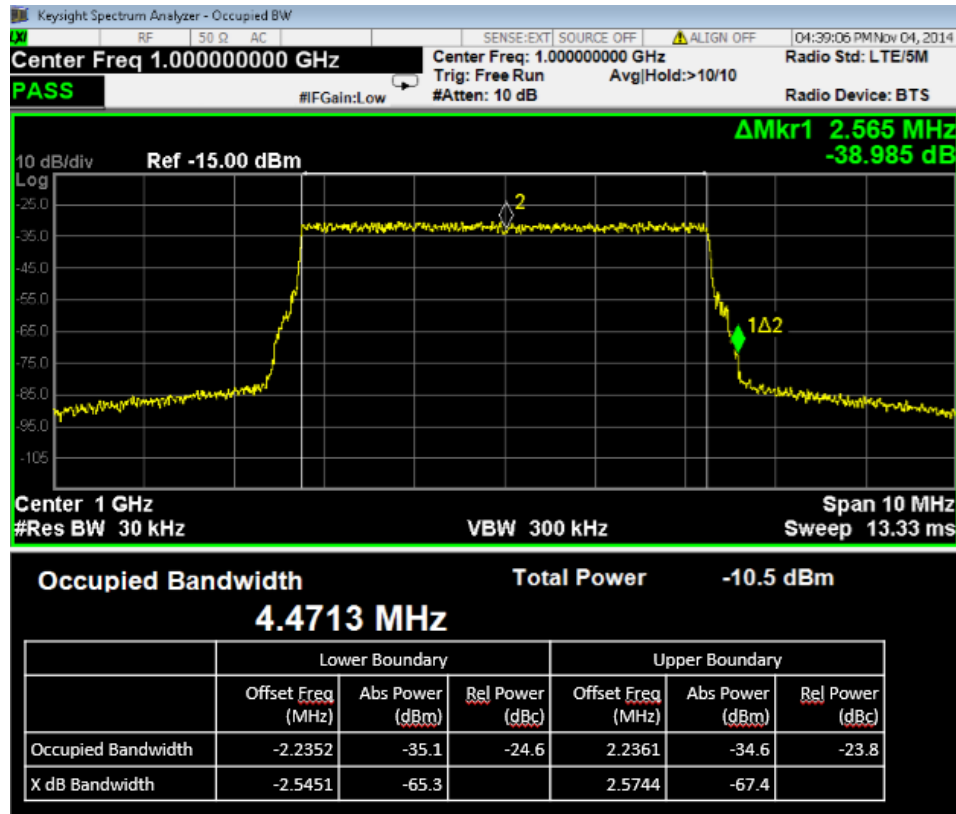

Boundary Frequency

Selects frequency display type from either Offset or Absolute:

- **OFFSet**: offsets from Center Freq to OBW boundary frequency are displayed.
- **ABSolute**: absolute frequencies are displayed.

Key Path	View/Display, OBW Boundaries
Remote Command	:DISPlay:OBwidth:VIEW2:WINDow2:BOUNDaries:FREquency OFFSet ABSolute :DISPlay:OBwidth:VIEW2:WINDow2:BOUNDaries:FREquency?
Example	DISP:OBW:VIEW2:WIND2:BOUN:FREQ ABS DISP:OBW:VIEW2:WIND2:BOUN:FREQ?
Preset	OFFSet
State Saved	Saved in instrument state
Range	Offset Absolute
Initial S/W Revision	A.16.00

x dB BW Boundaries

Turns the x dB BW Boundaries On and Off.

Key Path	View/Display
Remote Command	:DISP:OBW:VIEW:WINDow[1]:XDB 0 1 OFF ON :DISP:OBW:VIEW:WINDow[1]:XDB?
Example	DISP:OBW:VIEW:WIND:XDB 1 DISP:OBW:VIEW:WIND:XDB?
Preset	0
State Saved	Saved in instrument state
Range	On Off
Initial S/W Revision	A.16.00

11 ACP Measurement

ACP is a measurement of the amount of interference, or power, in an adjacent frequency channel. The results are displayed as a bar graph or as spectrum data, with measurement data at specified offsets. For measurement results and views, see ["View/Display" on page 1892](#).

This topic contains the following sections:

["Measurement Commands for ACP" on page 1585](#)

["Remote Command Results for ACP Measurement" on page 1586](#)

Measurement Commands for ACP

The following commands are used to retrieve the measurement results:

`:CONFigure:ACPower`

`:CONFigure:ACPower:NDEFault`

`:INITiate:ACPower`

`:FETCh:ACPower[n]?`

`:READ:ACPower[n]?`

`:MEASure:ACPower[n]?`

For more measurement related commands, see the SENSE subsystem, and the section ["Remote Measurement Functions" on page 3140](#).

Remote Command Results for ACP Measurement

Condition	N	Results Returned
Mode = SA mode, Radio Std = None, Number of carriers = 1 and only offset A is on	Not specified or n = 1	Returns 3 comma-separated values that correspond to: <ol style="list-style-type: none"> 1. Reference carrier power, 2. lower-adjacent channel power (dBc), and 3. upper-adjacent channel power (dBc).
Mode = DTMB (CTTB) or CMMB, Radio BW = 8 MHz, Number of carriers = 1 and Meas Type = Total power reference	Not specified or n = 1	Returns 32 comma-separated scalar results, in the following order. <ol style="list-style-type: none"> 1. 0.0 2. Total carrier power (dBm) 3. 0.0 4. Reference carrier power (dBm) 5. Lower offset A - relative power (dB) 6. Lower offset A - absolute power (dBm) 7. Upper offset A - relative power (dB) 8. Upper offset A - absolute power (dBm) 9. Lower offset B - relative power (dB) 10. Lower offset B - absolute power (dBm) 11. Upper offset B - relative power (dB) 12. Upper offset B - absolute power (dBm) ... 25. Lower offset F - relative power (dB) 26. Lower offset F - absolute power (dBm) 27. Upper offset F - relative power (dB) 28. Upper offset F - absolute power (dBm) 29. Inside Adjacent Channel - relative power (dB) 30. Inside Adjacent Channel - absolute power (dBm) 31. Outside Adjacent Channel - relative power (dB) 32. Outside Adjacent Channel - absolute power (dBm) <p>If Radio Device = Exciter, the last four (29, 30, 31 and 32) results returned -999.0.</p> <p>If the results are not available, -999.0 is returned.</p>

Condition	N	Results Returned
		<p style="text-align: center;">NOTE</p> <p>* Inside Adjacent Channel - absolute power: the maximum of the Lower offset A - absolute power and the Upper offset A - absolute power;</p> <p>** Inside Adjacent Channel - relative power: the result of Reference carrier power subtracted from Inside Adjacent Channel - absolute power;</p> <p>*** Outside Adjacent Channel - absolute power: the root mean square of the absolute power of the offset B upper/lower, the offset C upper/lower and the offset D upper/lower;</p> <p>**** Outside Adjacent Channel - relative power: the result of Reference carrier power subtracted from Outside Adjacent Channel - absolute power;</p>
Mode = DTMB (CTTB) or CMMB, Radio BW = 8 MHz, Number of carriers = 1 and Meas Type = Power spectral density reference	not specified or n = 1	Returns 32 comma-separated scalar results, in the following order. 1. 0.0 2. Total carrier power (dBm/Hz or dBm/MHz) 3. 0.0 4. Reference carrier power (dBm/Hz or dBm/MHz) 5. Lower offset A - relative power (dB) 6. Lower offset A - absolute power (dBm/Hz or dBm/MHz) 7. Upper offset A - relative power (dB) 8. Upper offset A - absolute power (dBm/Hz or dBm/MHz) 9. Lower offset B - relative power (dB) 10. Lower offset B - absolute power (dBm/Hz or dBm/MHz) 11. Upper offset B - relative power (dB) 12. Upper offset B - absolute power (dBm/Hz or dBm/MHz) ... 25. Lower offset F - relative power (dB) 26. Lower offset F - absolute power (dBm/Hz or dBm/MHz) 27. Upper offset F - relative power (dB)

Condition	N	Results Returned
		28. Upper offset F - absolute power (dBm/Hz or dBm/MHz) 29. -999.0 30. -999.0 31. -999.0 32. -999.0 The last four (29, 30, 31 and 32) results always returned -999.0. If the results are not available, -999.0 is returned.
Meas Type = Total power reference	Not specified or n = 1	Returns 28 comma-separated scalar results, in the following order. 1. 0.0 2. Total carrier power (dBm) 3. 0.0 4. Reference carrier power (dBm) 5. Lower offset A - relative power (dB) 6. Lower offset A - absolute power (dBm) 7. Upper offset A - relative power (dB) 8. Upper offset A - absolute power (dBm) 9. Lower offset B - relative power (dB) 10. Lower offset B - absolute power (dBm) 11. Upper offset B - relative power (dB) 12. Upper offset B - absolute power (dBm) ... 25. Lower offset F - relative power (dB) 26. Lower offset F - absolute power (dBm) 27. Upper offset F - relative power (dB) 28. Upper offset F - absolute power (dBm) If the results are not available, -999.0 is returned. When in MSR and LTE-Advanced FDD/TDD, this trace includes only outer offset results and their reference value (s).
Meas Type = Power spectral density reference	not specified or n = 1	Returns 28 comma-separated scalar results, in the following order. 1. 0.0 2. Total carrier power (dBm/Hz or dBm/MHz) 3. 0.0 4. Reference carrier power (dBm/Hz or dBm/MHz) 5. Lower offset A - relative power (dB) 6. Lower offset A - absolute power (dBm/Hz or dBm/MHz) 7. Upper offset A - relative power (dB)

Condition	N	Results Returned
		8. Upper offset A - absolute power (dBm/Hz or dBm/MHz) 9. Lower offset B - relative power (dB) 10. Lower offset B - absolute power (dBm/Hz or dBm/MHz) 11. Upper offset B - relative power (dB) 12. Upper offset B - absolute power (dBm/Hz or dBm/MHz) ... 25. Lower offset F - relative power (dB) 26. Lower offset F - absolute power (dBm/Hz or dBm/MHz) 27. Upper offset F - relative power (dB) 28. Upper offset F - absolute power (dBm/Hz or dBm/MHz) If the results are not available, -999.0 is returned. When in MSR and LTE-Advanced FDD/TDD, this trace includes only outer offset results and their reference value (s).
Meas Method = FAST	not specified or n = 1	Returns 5 comma-separated results, in the following order: 1. Reference carrier - absolute power (dBm) 2. Lower offset A - absolute power (dBm) 3. Upper offset A - absolute power (dBm) 4. Lower offset B - absolute power (dBm) 5. Upper offset B - absolute power (dBm)
Mode = MSR , LTEAFDD, LTEATDD, Meas Type = Total power reference and Power Ref = Left & Right Carriers	Not specified or n = 1	Returns 28 comma-separated scalar results, in the following order. 1. 0.0 2. Total carrier power (dBm) 3. Left Reference carrier power (dBm) 4. Right Reference carrier power (dBm) 5. Lower offset A - relative power (dB) 6. Lower offset A - absolute power (dBm) 7. Upper offset A - relative power (dB) 8. Upper offset A - absolute power (dBm) 9. Lower offset B - relative power (dB) 10. Lower offset B - absolute power (dBm) 11. Upper offset B - relative power (dB) 12. Upper offset B - absolute power (dBm) ... 25. Lower offset F - relative power (dB) 26. Lower offset F - absolute power (dBm) 27. Upper offset F - relative power (dB) 28. Upper offset F - absolute power (dBm) If the results are not available, -999.0 is returned.

Condition	N	Results Returned
Mode = MSR , LTEAFDD, LTEATDD, Meas Type = Power spectral density reference and Power Ref = Left & Right Carriers	not specified or n = 1	Returns 28 comma-separated scalar results, in the following order. 1. 0.0 2. Total carrier power (dBm/Hz or dBm/MHz) 3. Left reference carrier power (dBm/Hz or dBm/MHz) 4. Right reference carrier power (dBm/Hz or dBm/MHz) 5. Lower offset A - relative power (dB) 6. Lower offset A - absolute power (dBm/Hz or dBm/MHz) 7. Upper offset A - relative power (dB) 8. Upper offset A - absolute power (dBm/Hz or dBm/MHz) 9. Lower offset B - relative power (dB) 10. Lower offset B - absolute power (dBm/Hz or dBm/MHz) 11. Upper offset B - relative power (dB) 12. Upper offset B - absolute power (dBm/Hz or dBm/MHz) ... 25. Lower offset F - relative power (dB) 26. Lower offset F - absolute power (dBm/Hz or dBm/MHz) 27. Upper offset F - relative power (dB) 28. Upper offset F - absolute power (dBm/Hz or dBm/MHz) If the results are not available, -999.0 is returned. When in MSR and LTE-Advanced FDD/TDD, this trace includes only outer offset results and their reference value (s).
Meas Type = Total power reference	n = 2	Returns 48 scalar results, in the following order: 1. Channel (1) - relative power (dB) 2. Channel (1) - absolute power (dBm) 3. Channel (2) - relative power (dB) 4. Channel (2) - absolute power (dBm) ... 23. Channel (12) - relative power (dB) 24. Channel (12) - absolute power (dBm) 25. Lower offset A - relative power (dB) 26. Lower offset A - absolute power (dBm) 27. Upper offset A - relative power (dB) 28. Upper offset A - absolute power (dBm) 29. Lower offset B - relative power (dB) 30. Lower offset B - absolute power (dBm) 31. Upper offset B - relative power (dB) 32. Upper offset B - absolute power (dBm) ...

Condition	N	Results Returned
		45. Lower offset F - relative power (dB) 46. Lower offset F - absolute power (dBm) 47. Upper offset F - relative power (dB) 48. Upper offset F - absolute power (dBm) If the results are not available, -999.0 is returned. When in MSR and LTE-Advanced FDD/TDD, this trace includes only outer offset results and their reference value (s).
Meas Type = Power spectral density reference	n = 2	Returns 48 scalar results, in the following order: 1. Channel (1) - relative power (dB) 2. Channel (1) - absolute power (dBm/Hz or dBm/MHz) 3. Channel (2) - relative power (dB) 4. Channel (2) - absolute power (dBm/Hz or dBm/MHz) ... 23. Channel (12) - relative power (dB) 24. Channel (12) - absolute power (dBm/Hz or dBm/MHz) 25. Lower offset A - relative power (dB) 26. Lower offset A - absolute power (dBm/Hz or dBm/MHz) 27. Upper offset A - relative power (dB) 28. Upper offset A - absolute power (dBm/Hz or dBm/MHz) 29. Lower offset B - relative power (dB) 30. Lower offset B - absolute power (dBm/Hz or dBm/MHz) 31. Upper offset B - relative power (dB) 32. Upper offset B - absolute power (dBm/Hz or dBm/MHz) ... 45. Lower offset F - relative power (dB) 46. Lower offset F - absolute power (dBm/Hz or dBm/MHz) 47. Upper offset F - relative power (dB) 48. Upper offset F - absolute power (dBm/Hz or dBm/MHz) If the results are not available, -999.0 is returned. When in MSR and LTE-Advanced FDD/TDD, this trace includes only outer offset results.
Mode = DTMB (CTTB) or CMMB, Radio BW = 8 MHz and Meas Type = Total power reference	n = 3	Returns 28 scalar values of the pass/fail (0 = passed, or 1 = failed) determined by testing the relative to the reference carrier and by testing the absolute power limit of the offset frequencies (measured as total power in dB): 1. Lower offset A - relative limit result 2. Lower offset A - absolute limit result 3. Upper offset A - relative limit result 4. Upper offset A - absolute limit result 5. Lower offset B - relative limit result

Condition	N	Results Returned
		6. Lower offset B - absolute limit result 7. Upper offset B - relative limit result 8. Upper offset B - absolute limit result ... 21. Lower offset F - relative limit result 22. Lower offset F - absolute limit result 23. Upper offset F - relative limit result 24. Upper offset F - absolute limit result 25. Inside Adjacent Channel - relative limit result 26. Inside Adjacent Channel - absolute limit result 27. Outside Adjacent Channel - relative limit result 28. Outside Adjacent Channel - absolute limit result If Radio Device = Exciter, the last four (25, 26, 27 and 28) results returned -999.0.
Mode = DTMB (CTTB) or CMMB, Radio BW = 8 MHz and Meas Type = Power spectral density reference	n = 3	Returns 28 scalar values of the pass/fail (0 = passed, or 1 = failed) determined by testing the relative to the reference carrier and by testing the absolute power limit of the offset frequencies (measured as power spectral density in dB): 1. Lower offset A - relative limit result 2. Lower offset A - absolute limit result 3. Upper offset A - relative limit result 4. Upper offset A - absolute limit result 5. Lower offset B - relative limit result 6. Lower offset B - absolute limit result 7. Upper offset B - relative limit result 8. Upper offset B - absolute limit result ... 21. Lower offset F - relative limit result 22. Lower offset F - absolute limit result 23. Upper offset F - relative limit result 24. Upper offset F - absolute limit result 25. -999.0 26. -999.0 27. -999.0 28. -999.0 The last four results always returned -999.0.
Meas Type = Total power reference	n = 3	Returns 24 scalar values of the pass/fail (0 = passed, or 1 = failed) determined by testing the relative to the reference carrier and by testing the absolute power limit of the offset frequencies (measured as total power in dB): 1. Lower offset A - relative limit result

Condition	N	Results Returned
		2. Lower offset A - absolute limit result 3. Upper offset A - relative limit result 4. Upper offset A - absolute limit result 5. Lower offset B - relative limit result 6. Lower offset B - absolute limit result 7. Upper offset B - relative limit result 8. Upper offset B - absolute limit result ... 21 Lower offset F - relative limit result 22 Lower offset F - absolute limit result 23 Upper offset F - relative limit result 24 Upper offset F - absolute limit result When in MSR and LTE-Advanced FDD/TDD, this trace includes only outer offset results.
Meas Type = Power spectral density reference	n = 3	Returns 24 scalar values of the pass/fail (0 = passed, or 1 = failed) determined by testing the relative to the reference carrier and by testing the absolute power limit of the offset frequencies (measured as power spectral density in dB): 1. Lower offset A - relative limit result 2. Lower offset A - absolute limit result 3. Upper offset A - relative limit result 4. Upper offset A - absolute limit result 5. Lower offset B - relative limit result 6. Lower offset B - absolute limit result 7. Upper offset B - relative limit result 8. Upper offset B - absolute limit result ... 21 Lower offset F - relative limit result 22 Lower offset F - absolute limit result 23 Upper offset F - relative limit result 24 Upper offset F - absolute limit result When in MSR and LTE-Advanced FDD/TDD, this trace includes only outer offset results.
	n = 4	Returns <Num Pts> comma-separated scalar values representing the Y values in Trace 1
	n = 5	Returns <Num Pts> comma-separated scalar values representing the Y values in Trace 2
	n = 6	Returns <Num Pts> comma-separated scalar values representing the Y values in Trace 3
Meas Type = Total power reference	n = 7	Returns (2 * Number of Carriers) scalar results, in the following order:

Condition	N	Results Returned
		<p>The Number of Carriers is the value filled in Carriers under Carrier Setup menu. If license N9060A-5FP is enabled, max value of Number of Carriers is 18, otherwise, max value of Number of Carriers is 12. In MSR mode, max value of Number of Carriers is 100. In LTE-Advanced FDD/TDD mode, max value of number of carriers is 5.</p> <ol style="list-style-type: none"> 1. Channel (1) - relative power (dB) 2. Channel (1) - absolute power (dBm) 3. Channel (2) - relative power (dB) 4. Channel (2) - absolute power (dBm) <p>...</p> <p>2 * Number of Carriers - 1. Channel (Number of Carriers) - relative power (dB)</p> <p>2 * Number of Carriers. Channel (Number of Carriers) - absolute power (dBm)</p> <p>If the results are not available, 9.91E+37 is returned.</p>
Meas Type = Power spectral density reference	n = 7	<p>Returns (2 * Number of Carriers) scalar results, in the following order: The Number of Carriers is the value filled in Carriers under Carrier Setup menu.</p> <p>If license N9060A-5FP is enabled, max value of Number of Carriers is 18, otherwise, max value of Number of Carriers is 12. In MSR mode, max value of Number of Carriers is 100. In LTE-Advanced FDD/TDD mode, max value of number of carriers is 5.</p> <ol style="list-style-type: none"> 1. Channel (1) - relative power (dB) 2. Channel (1) - absolute power (dBm/Hz or dBm/MHz) 3. Channel (2) - relative power (dB) 4. Channel (2) - absolute power (dBm/Hz or dBm/MHz) <p>...</p> <p>2 * Number of Carriers - 1. Channel (Number of Carriers) - relative power (dB)</p> <p>2 * Number of Carriers. Channel (Number of Carriers) - absolute power (dBm/Hz or dBm/MHz)</p> <p>If the results are not available, 9.91E+37 is returned</p>
Mode = MSR,LTEAFDD,LTEATDD	n = 8	<p>Returns scalar results, in the following order:</p> <ol style="list-style-type: none"> 1. 0.0 2. Total carrier power (dBm) 3. 0.0 4. Reference carrier power (dBm, dBm/Hz or dBm/MHz) 5. Inner Lower offset A - relative power (dB) 6. Inner Lower offset A - absolute power (dBm, dBm/Hz or dBm/MHz) 7. Inner Upper offset A - relative power (dB)

Condition	N	Results Returned
		<p>8. Inner Upper offset A - absolute power (dBm, dBm/Hz or dBm/MHz)</p> <p>9. Inner Lower offset B - relative power (dB)</p> <p>10. Inner Lower offset B - absolute power (dBm, dBm/Hz or dBm/MHz)</p> <p>11. Inner Upper offset B - relative power (dB)</p> <p>12. Inner Upper offset B - absolute power (dBm, dBm/Hz or dBm/MHz)</p> <p>...</p> <p>25. Inner Lower offset F - relative power (dB)</p> <p>26. Inner Lower offset F - absolute power (dBm, dBm/Hz or dBm/MHz)</p> <p>27. Inner Upper offset F - relative power (dB)</p> <p>28. Inner Upper offset F - absolute power (dBm, dBm/Hz or dBm/MHz)</p> <p>When Power Ref is either Left & Right Carriers or Max Power Carrier in Sub-block, the first four values are</p> <ol style="list-style-type: none"> 1. 0.0 2. Total carrier power (dBm) 3. Reference carrier in the lower sub-block (dBm, dBm/Hz or dBm/MHz) 4. Reference carrier in the upper sub-block (dBm, dBm/Hz or dBm/MHz) <p>Unit of absolute power results.</p> <p>dBm: Meas Type = Total Pwr Ref</p> <p>dBm/Hz: Meas Type = PSD Ref, PSD Unit = dBm/Hz</p> <p>dBm/MHz: Meas Type = PSD Ref, PSD Unit = dBm/MHz</p> <p>If the results are not available, 9.91E+37 is returned.</p>
Mode = MSR, LTEAFDD,LTEATDD	n = 9	<p>Returns scalar values of the pass/fail (0 = passed, or 1 = failed) determined by testing the relative to the reference carrier and by testing the absolute power limit of the offset frequencies.</p> <ol style="list-style-type: none"> 1. Inner Lower offset A - relative limit result 2. Inner Lower offset A - absolute limit result 3. Inner Upper offset A - relative limit result 4. Inner Upper offset A - absolute limit result 5. Inner Lower offset B - relative limit result 6. Inner Lower offset B - absolute limit result 7. Inner Upper offset B - relative limit result 8. Inner Upper offset B - absolute limit result <p>...</p> <p>21. Inner Lower offset F - relative limit result</p>

Condition	N	Results Returned
Mode = MSR, LTEAFDD,LTEATDD	n = 10	<p>22. Inner Lower offset F - absolute limit result</p> <p>23. Inner Upper offset F - relative limit result</p> <p>24. Inner Upper offset F - absolute limit result</p> <hr/> <p>Returns scalar values of offset results. Numbers returned in this trace is 10 x actually measured offsets. Note that upper and lower sides of an offset are returned separately. For example, when only outer offset A is measured with offset side both, 10 x 2 = 20 values are returned.</p> <ol style="list-style-type: none"> 1. Inner = 1 or Outer = 2. 2. Offset A~F. (A=1, B=2, ... F=6) 3. Offset Side. Lower=1 or Upper=2 4. Relative power or relative PSD (dBc or dB) 5. Absolute power (dBm) or absolute PSD (dBm/Hz or dBm/MHz) 6. Reference power (dBm) or reference PSD (dBm/Hz or dBm/MHz) 7. Reference Index 1 8. Reference Index 2 9. 0 (Reserved) 10.0 (Reserved) <p>...</p> <ol style="list-style-type: none"> 10(n-1)+1. Inner = 1 or Outer = 2. 10(n-1)+2. Offset A~F. (A=1, B=2, ... F=6) 10(n-1)+3. Offset Side. Lower=1 or Upper=2 10(n-1)+4. Relative power or relative PSD (dBc or dB) 10(n-1)+5. Absolute power (dBm) or absolute PSD (dBm/Hz or dBm/MHz) 10(n-1)+6. Reference power (dBm) or reference PSD (dBm/Hz or dBm/MHz) 10(n-1)+7. Reference Index 1 10(n-1)+8. Reference Index 2 10(n-1)+9. 0 (Reserved) 10(n-1)+10.0 (Reserved) <p>Where n is number of offsets.</p> <p>Meas Type determines which type of power result is returned, i.e. power or PSD. Unit for PSD results is determined by PSD Unit.</p> <p>If result is not available, 9.91E+37 is returned.</p>

Key Path	Front-panel key
Initial S/W Revision	Prior to A.02.00
Modified at S/W Revision	A.13.00

AMPTD Y Scale

Accesses a menu of functions that enable you to set the vertical scale parameters. The parameter values are measurement independent, except all Attenuation values and the Internal Preamp selections, which are the same across all measurements.

Key Path	Front-panel key
Initial S/W Revision	Prior to A.02.00

Ref Value

Sets the value for the absolute power reference. However, since the Auto Scaling is defaulted to On, this value is automatically determined by the measurement result. When you set a value manually, Auto Scaling automatically changes to Off.

Key Path	AMPTD Y Scale
Mode	SA, WCDMA, C2K, WIMAX OFDMA, TD-SCDMA, 1xEVDO, DVB-T/H, DTMB (CTTB), ISDB-T, CMMB, LTE, LTETDD, Digital Cable TV, MSR, LTEAFDD, LTEATDD
Remote Command	:DISP:ACPower:VIEW[1]:WINDow[1]:TRACe:Y[:SCALE]:RLEV1 <real> :DISP:ACPower:VIEW[1]:WINDow[1]:TRACe:Y[:SCALE]:RLEV1?
Example	DISP:ACP:VIEW:WIND:TRAC:Y:RLEV 100 DISP:ACP:VIEW:WIND:TRAC:Y:RLEV?
Notes	You must be in the mode that includes ACP measurements to use this command. Use :INSTrument:SElect to set the mode.
Couplings	When the Auto Scaling is On, this value is automatically determined by the measurement result. When you set a value manually, Auto Scaling automatically changes to Off.
Preset	10dBm
State Saved	Saved in instrument state.
Min	-250.00 dBm
Max	250.00 dBm
Initial S/W Revision	Prior to A.02.00
Modified at S/W Revision	A.02.00, A.03.00

Attenuation

This menu controls the attenuator functions and interactions between the attenuation system components.

There are two attenuator configurations in the X-Series. One is a dual attenuator configuration consisting of a mechanical attenuator and an optional electronic attenuator. The other configuration uses a single attenuator with combined mechanical and electronic sections that controls all the attenuation functions. Different models in the X-Series come with different configurations.

See "[Dual Attenuator Configurations:](#)" on page 1599

See ["Single Attenuator Configuration:" on page 1600](#)

Most Attenuation settings are the same for all measurements – they do not change as you change measurements. Settings like these are called “Meas Global” and are unaffected by Meas Preset.

Key Path	AMPTD Y Scale
Scope	Meas Global
Dependencies	In measurements that support the I/Q inputs, this key is unavailable when I/Q is the selected input, and is replaced by the Range key in that case.
Readback Line	Contains a summary in [] brackets of the current total attenuation. See the descriptions of the , " (Mech) Atten " on page 3103, and " Enable Elec Atten " on page 3105 keys for more detail on the contributors to the total attenuation. Note that when "Pre-Adjust for Min Clip" is on, this value can change at the start of every measurement.
Initial S/W Revision	Prior to A.02.00
Modified at S/W Revision	A.03.00

Dual Attenuator Configurations:

Configuration 1: Mechanical attenuator + optional electronic attenuator

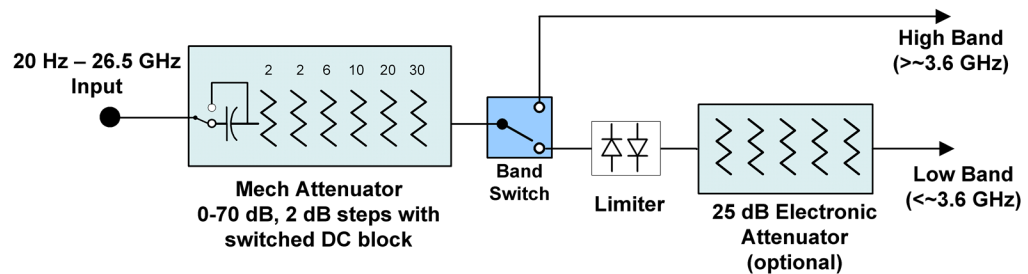

Configuration 2: Mechanical attenuator, no optional electronic attenuator

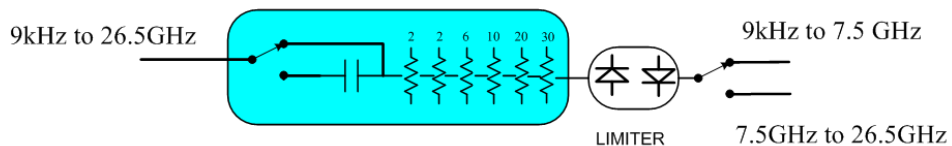

(note that Configuration 2 is not strictly speaking a dual-section attenuator, since there is no electronic section available. However, it behaves exactly like Configuration 1 without the Electronic Attenuator option EA3, therefore for the sake of this document it is grouped into the “Dual Attenuator” configuration)

Single Attenuator Configuration:

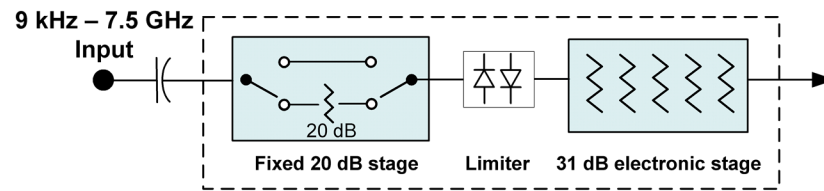

You can tell which attenuator configuration you have by pressing the Attenuation key, which (in most Modes) opens the Attenuation menu. If the first key in the Attenuation menu says **Mech Atten** you have the dual attenuator configuration. If the first key says **Atten** you have the single attenuator configuration.



In the single attenuator configuration, you control the attenuation with a single control, as the fixed stage has only two states. In the dual attenuator configuration, both stages have significant range so you are given separate control of the mechanical and electronic attenuator stages.

When you have the dual attenuator configuration, you may still have only a single attenuator, because unless option EA3 (the Electronic Attenuator option) is available, and you purchase it, you will have only the mechanical attenuator.

(Mech) Atten

This key is labeled **Mech Atten** in dual attenuator models and **Atten** in single attenuator models. In the dual attenuator configuration, this key only affects the mechanical attenuator.

This key lets you modify the attenuation applied to the RF input signal path. This value is normally auto coupled to the Ref Level, the Internal Preamp Gain, any External Gain that is entered, and the Max Mixer Level, as described in the table below.

See "[Attenuator Configurations and Auto/Man](#)" on page 1602

Key Path	AMPTD Y Scale, Attenuation
Remote Command	[:SENSe]:POWer[:RF]:ATTenuation <rel_amp1> [:SENSe]:POWer[:RF]:ATTenuation? [:SENSe]:POWer[:RF]:ATTenuation:AUTO OFF ON 0 1 [:SENSe]:POWer[:RF]:ATTenuation:AUTO?
Example	POW:ATT 20 Dual attenuator configuration: sets the mechanical attenuator to 20 dB Single attenuator mode: sets the main attenuation to 20 dB (see below for definition of "main")

	<p>attenuation).</p> <p>If the attenuator was in Auto, it sets it to Manual.</p>
Dependencies	<p>Some measurements do not support the Auto setting of (Mech) Atten. In these measurements, the Auto/Man selection is not available, and the Auto/Man line on the key disappears.</p> <p>In dual attenuator configurations, when the electronic attenuator is enabled, the mechanical attenuator has no auto setting and the Auto/Man line on the key disappears. The state of Auto/Man is remembered and restored when the electronic attenuator is once again disabled. This is described in more detail in the "Enable Elec Atten" on page 3105 key description.</p> <p>See "Attenuator Configurations and Auto/Man" on page 1602 for more information on the Auto/Man functionality of Attenuation.</p>
Couplings	<p>When (Mech) Atten is in Auto, it uses the following algorithm to determine a value:</p> <p>If the USB Preamp is connected to USB, use 0 dB.</p> <p>Otherwise, $Atten = ReferenceLevel + PreAmpGain + ExternalGain - RefLevelOffset - MaxMixerLevel + IF\ Gain$.</p> <p>Limit this value to be between 6 dB and the Max value. No value below 6 dB can ever be chosen by Auto.</p> <p>The resulting value is rounded up to the largest value possible given the attenuation step setting. That is, 50.01 dB would change to 60 dB (for a 10 dB attenuation step).</p> <p>The "IF Gain" term in the equation above is either 0 dB or +10 dB, depending on the settings of FFT IF Gain, Swept IF Gain, max Ref Level and the Auto/Man setting of Mech Atten.</p> <p>In External Mixing and BBIQ, where the Attenuator is not in the signal path, the Attenuator setting changes as described above when (Mech) Atten is in Auto, but no changes are made to the actual attenuator hardware setting until the input is changed back to the RF Input.</p>
Preset	<p>The preset for Mech Attenuation is "Auto."</p> <p>The Auto value of attenuation is:</p> <p>CXA, EXA, MXA and PXA: 10 dB</p>
State Saved	<p>Saved in instrument state</p>
Min	<p>0 dB</p> <p>The attenuation set by this key cannot be decreased below 6 dB with the knob or step keys. To get to a value below 6 dB it has to be directly entered from the keypad or via SCPI. This protects from adjusting the attenuation to a dangerously small value which can put the instrument at risk of damage to input circuitry. However, if the current mechanical attenuation is below 6 dB it can be increased with the knob and step keys, but not decreased.</p>
Max	<p>CXA N9000A-503/507: 50 dB</p> <p>CXA N9000A-513/526: 70dB</p> <p>EXA: 60 dB</p> <p>MXA and PXA: 70 dB</p> <p>In the single attenuator configuration, the total of ATT and EATT cannot exceed 50 dB, so if the EATT is set to 24 dB first, the main attenuation cannot be greater than 26 dB and will be reduced accordingly; if the main attenuator is set to 40 dB first, EATT cannot be greater than 10 dB.</p>
Initial S/W Revision	<p>Prior to A.02.00</p>
Modified at S/W Revision	<p>A.03.00</p>

Attenuator Configurations and Auto/Man

As described in the Attenuation key description, there are two distinct attenuator configurations available in the X-Series, the single attenuator and dual attenuator configurations. In dual attenuator configurations, we have the mechanical attenuation and the electronic attenuation, and the current total attenuation is the sum of the electronic + mechanical attenuation. In single attenuator configurations, we refer to the attenuation set using the **(Mech) Atten** key (or POW:ATT SCPI) as the “main” attenuation; and the attenuation that is set by the SCPI command POW:EATT as the “soft” attenuation (the POW:EATT command is honored even in the single attenuator configuration, for compatibility purposes). Then the current total attenuation is the sum of the main + soft attenuation. See the **Elec Atten** key description for more on “soft” attenuation.

In the dual attenuator configuration, when the electronic attenuator is enabled, there is no Auto/Man functionality for the mechanical attenuator, and the third line of the key label (the Auto/Man line) disappears:

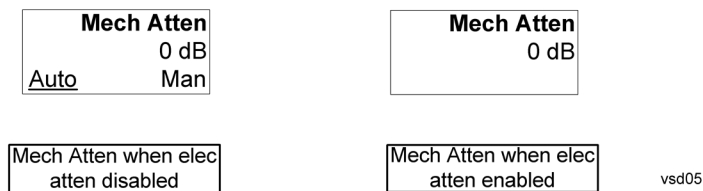

Enable Elec Atten

Enables the Electronic Attenuator.

The electronic attenuator offers finer steps than the mechanical attenuator, has no acoustical noise, is faster, and is less subject to wear. These advantages primarily aid in remote operation and are negligible for front panel use. See ["Using the Electronic Attenuator: Pros and Cons" on page 1604](#) for a detailed discussion of the pros and cons of using the electronic attenuator.

For the single attenuator configuration, for SCPI backwards compatibility, the “soft” attenuation feature replaces the dual attenuator configuration’s electronic attenuator. All the same couplings and limitations apply. See ["Attenuator Configurations and Auto/Man" on page 3105](#)

See [Error! Reference source not found.](#)

Key Path	AMPTD Y Scale, Attenuation
Remote Command	[:SENSe] :POWer [:RF] :EATTenuation:STATe OFF ON 0 1 [:SENSe] :POWer [:RF] :EATTenuation:STATe ?
Example	POW:EATT:STAT ON
Dependencies	This key only appears in Dual Attenuator models with an Electronic Attenuator installed. It does not appear in models with the Single Attenuator configuration, as in the single attenuator configuration there is no “electronic attenuator” there is only a single integrated attenuator (which has both a mechanical and electronic stage). However, in the single attenuator configuration, EATT SCPI commands are accepted for compatibility with other X-series

instruments and set a “soft” attenuation as described in "[Attenuator Configurations and Auto/Man](#)" on page 3105.

The electronic attenuator (and the “soft” attenuation function provided in single attenuator configurations) is unavailable above 3.6 GHz. Therefore, if the Stop Frequency of the analyzer is > 3.6 GHz then the **Enable Elec Atten** key will be OFF and grayed out.

If the Internal Preamp is on, meaning it is set to Low Band or Full, the electronic attenuator (and the “soft” attenuation function provided in single attenuator configurations) is unavailable. In this case the **Enable Elec Atten** key will be OFF and grayed out.

If either of the above is true, if the SCPI command is sent, an error indicating that the electronic attenuator is unavailable will be sent.

If the electronic/soft Attenuator is enabled, then the Stop Freq of the analyzer is limited to 3.6 GHz and the Internal Preamp is unavailable.

The SCPI-only “soft” electronic attenuation for the single-attenuator configuration is not available in all measurements; in particular, it is not available in the Swept SA measurement.

Couplings	Enabling and disabling the Electronic Attenuator affects the setting of the Mechanical Attenuator (in dual attenuator configurations). This is described in more detail below this table.
Preset	OFF for Swept SA measurement; ON for all other measurements that support the electronic attenuator
State Saved	Saved in instrument state
Initial S/W Revision	Prior to A.02.00
Modified at S/W Revision	A.03.00

Mechanical Attenuator Transition Rules

When the Electronic Attenuator is enabled, the Mechanical Attenuator transitions to a state that has no Auto function. Below are the rules for transitioning the Mechanical Attenuator. NOTE that the information below ONLY applies to the dual attenuator configurations, and ONLY when the Electronic Attenuator is installed:

When the Electronic Attenuation is enabled from a disabled state:

- The Mechanical Attenuator is initialized to 10 dB (this is its optimal performance setting). You can then set it as desired with SCPI, numeric keypad, step keys, or knob, and it behaves as it normally would in manual mode
- The Auto/Man state of (Mech) Atten is saved
- The Auto/Man line on the (Mech) Atten key disappears and the auto rules are disabled
- The Electronic Attenuator is set to 10 dB less than the previous value of the Mechanical Attenuator, within the limitation that it must stay within the range of 0 to 24 dB of attenuation.

Examples in the dual attenuator configuration:

- Mech Atten at 20 dB. Elec Atten enabled, Mech Atten set to 10 dB, and Elec Atten set to 10 dB. New total attenuation equals the value before Elec Atten enabled.
- Mech Atten at 0 dB. Elec Atten enabled, Mech Atten set to 10 dB, and Elec Atten set to 0 dB. New total attenuation does not equal the value before Elec Atten enabled.
- Mech Atten at 40 dB. Elec Atten enabled, Mech Atten set to 10 dB, and Elec Atten set to 24 dB. New total attenuation does not equal the value before Elec Atten enabled.

When the Electronic Attenuation is disabled from an enabled state:

- The Elec Atten key is grayed out
- The Auto/Man state of (Mech) Atten is restored
- If now in Auto, (Mech) Atten recouples
- If now in Man, (Mech) Atten is set to the value of total attenuation that existed before the Elec Atten was disabled. The resulting value is rounded up to the smallest value possible given the (Mech) Atten Step setting - (That is, 57 dB changes to 58 dB when (Mech) Atten Step is 2 dB.)

Using the Electronic Attenuator: Pros and Cons

The electronic attenuator offers finer steps than the mechanical attenuator, has no acoustical noise, is faster, and is less subject to wear.

The “finer steps” advantage of the electronic attenuator is beneficial in optimizing the alignment of the analyzer dynamic range to the signal power in the front panel as well as remote use. Thus, you can achieve improved relative signal measurement accuracy. Compared to a mechanical attenuator with 2 dB steps, the 1 dB resolution of the electronic attenuator only gives better resolution when the odd-decibel steps are used. Those odd-decibel steps are less accurately calibrated than the even-decibel steps, so one tradeoff for this superior relative accuracy is reduced absolute amplitude accuracy.

Another disadvantage of the electronic attenuator is that the spectrum analyzer loses its “Auto” setting, making operation less convenient.

Also, the relationship between the dynamic range specifications (TOI, SHI, compression and noise) and instrument performance are less well-known with the electrical attenuator. With the mechanical attenuator, TOI, SHI and compression threshold levels increase dB-for-dB with increasing attenuation, and the noise floor does as well. With the electronic attenuator, there is an excess attenuation of about 1 to 3 dB between 0 and 3.6 GHz, making the effective TOI, SHI, and so forth, less

well known. Excess attenuation is the actual attenuation relative to stated attenuation. Excess attenuation is accounted for in the analyzer calibration

Elec Atten

Controls the Electronic Attenuator in dual attenuator configurations. This key does not appear in single attenuator configurations, as the control of both the mechanical and electronic stages of the single attenuator is integrated into the single **Atten** key.

Key Path	AMPTD Y Scale, Attenuation
Remote Command	[:SENSe]:POWer[:RF]:EATTenuation <rel_amp1> [:SENSe]:POWer[:RF]:EATTenuation?
Notes	Electronic Attenuation's specification is defined only when Mechanical Attenuation is 6 dB.
Dependencies	This key only appears in Dual Attenuator models with an Electronic Attenuator installed. It does not appear in models with the Single Attenuator configuration, as in the single attenuator configuration there is no "electronic attenuator" there is only a single integrated attenuator (which has both a mechanical and electronic stage). However, in the single attenuator configuration, EATT SCPI commands are accepted for compatibility with other X-series instruments and set a "soft" attenuation as described in "Attenuator Configurations and Auto/Man" on page 3105 . The "soft" attenuation is treated as an addition to the "main" attenuation value set by the Atten softkey or the POW:ATT SCPI command and affects the total attenuation displayed on the Attenuation key and the Meas Bar. When Enable Elec Atten is off or grayed out, the Elec Atten key is grayed out.
Preset	0 dB
State Saved	Saved in instrument state
Min	0 dB
Max	Dual attenuator configuration: 24 dB Single attenuator configuration: the total of ATT and EATT cannot exceed 50 dB, so if the EATT is set to 24 dB first, the main attenuation cannot be greater than 26 dB and will be reduced accordingly; if the main attenuator is set to 40 dB first, EATT cannot be greater than 10 dB
Initial S/W Revision	Prior to A.02.00
Modified at S/W Revision	A.03.00

Adjust Atten for Min Clip

Sets the combination of mechanical and electronic attenuation and gain based on the current measured signal level so that clipping will be at a minimum.

This is an "immediate action" function, that is, it executes once, when the key is pressed.

This key does not appear in measurements that do not support this functionality. The spectrum analyzer measurement, Swept SA, does not support this functionality.

Key Path	AMPTD Y Scale, Attenuation
Remote Command	[:SENSe]:POWer[:RF]:RANGe:OPTimize IMMEDIATE

Initial S/W Revision	Prior to A.02.00
Modified at S/W Revision	A.03.00

Pre-Adjust for Min Clip

If this function is on, it does the adjustment described under "[Adjust Atten for Min Clip](#)" on page 3108 each time a measurement restarts. Therefore, in Continuous measurement mode, it only executes before the first measurement.

In dual attenuator models, you can set **Elec+Mech Atten**, in which case both attenuators participate in the autoranging, or **Elec Atten Only**, in which case the mechanical attenuator does not participate in the autoranging. This latter case results in less wear on the mechanical attenuator and is usually faster.

This key is grayed out in measurements that do not support this functionality. The spectrum analyzer measurement, Swept SA, does not support this functionality.

Key Path	AMPTD Y Scale, Attenuation
Remote Command	<code>[:SENSe] :POWer [:RF] :RANGe :OPTimize :ATTenuation OFF ELECTrical COMBined</code> <code>[:SENSe] :POWer [:RF] :RANGe :OPTimize :ATTenuation?</code>
Notes	The SCPI parameter ELECTrical sets this function to On in single attenuator models. The SCPI parameter COMBined is mapped to ELECTrical in single attenuator models; if you send COMBined, it sets the function to On and returns ELEC to a query.
Dependencies	This key only appears in Dual Attenuator models with an Electronic Attenuator installed. In instruments with Dual Attenuator model, when Enable Elec Atten is off or grayed out, the Pre-Adjust for Min Clip key is grayed out.
Preset	OFF for Swept SA measurement; ON for all other measurements that support Pre-Adjust for Min Clip
State Saved	Saved in instrument state
Range	Dual attenuator models: Off Elec Atten Only Mech + Elec Atten Single attenuator models: Off On
Initial S/W Revision	Prior to A.02.00
Modified at S/W Revision	A.03.00

Remote Command	<code>[:SENSe] :POWer [:RF] :RANGe :AUTO ON OFF 1 0</code> <code>[:SENSe] :POWer [:RF] :RANGe :AUTO?</code>
Notes	ON aliases to "Elec Atten Only" (:POW:RANG:OPT:ATT ELEC) OFF aliases to "Off" (:POW:RANG:OPT:ATT OFF)

	The query :POW:RANG:AUTO? returns true if :POW:RANG:OPT:ATT is not "Off"
Initial S/W Revision	Prior to A.02.00

Off

Turns **Pre-Adjust for Min Clip** off. This is the default setting.

This key is grayed out in measurements that do not support this functionality. The spectrum analyzer measurement, Swept SA, does not support this functionality.

Key Path	AMPTD Y Scale, Attenuation, Pre-Adjust for Min Clip
Example	:POW:RANGe:OPT:ATT OFF
Initial S/W Revision	Prior to A.02.00

Elec Atten Only

Selects only the electric attenuator to participate in auto ranging. This offers less wear on the mechanical attenuator and is usually faster.

This key is grayed out in measurements that do not support this functionality. The spectrum analyzer measurement, Swept SA, does not support this functionality.

Key Path	AMPTD Y Scale, Attenuation, Pre-Adjust for Min Clip
Example	:POW:RANGe:OPT:ATT ELEC
Initial S/W Revision	Prior to A.02.00

Mech + Elec Atten

In dual attenuator models, this selects both attenuators participate in the autoranging.

This key is grayed out in measurements that do not support this functionality. The spectrum analyzer measurement, Swept SA, does not support this functionality.

Key Path	AMPTD Y Scale, Attenuation, Pre-Adjust for Min Clip
Example	:POW:RANGe:OPT:ATT COMB
Initial S/W Revision	Prior to A.02.00

(Mech) Atten Step

This controls the step size used when making adjustments to the input attenuation.

This key is labeled **Mech Atten Step** in dual attenuator models and **Atten Step** in single attenuator models. In the dual attenuator configuration, this key only affects the step size of the mechanical attenuator.

Key Path	AMPTD Y Scale, Attenuation
Remote Command	[:SENSe] :POWer [:RF] :ATTenuation :STEP [:INCRement] 10 dB 2 dB [:SENSe] :POWer [:RF] :ATTenuation :STEP [:INCRement] ?

Example	POW:ATT:STEP 2
Notes	Note this feature works like a 1-N choice from the front panel, but it takes a specific value (in dB) when used remotely. The only valid values are 2 and 10.
Dependencies	Blanked in CXA and EXA if option FSA (2 dB steps) is not present. If blanked, attempts to set it via SCPI will yield an error.
Couplings	When the attenuation step size changes, the current mechanical attenuation value is adjusted (if necessary) to be quantized to the new step size. That is, if step is set to 10 dB, mech atten is increased if necessary so it is a multiple of 10 dB
Preset	PXA and MXA: 2 dB EXA and CXA: 10 dB (2 dB with option FSA)
State Saved	Saved in instrument state
Initial S/W Revision	Prior to A.02.00
Modified at S/W Revision	A.03.00

Max Mixer Level

Controls the limitation on the Ref Level for a given attenuation setting, and therefore also interacts with the Auto rules for selecting the attenuation as a coupling from the reference level.

Key Path	AMPTD Y Scale, Attenuation
Remote Command	[:SENSe] :POWer [:RF] :MIXer :RANGe [:UPPer] <real> [:SENSe] :POWer [:RF] :MIXer :RANGe [:UPPer] ?
Example	POW:MIX:RANG -15 dBm
Preset	-10 dBm
State Saved	Saved in instrument state
Min	-50 dBm
Max	0 dBm
Default Unit	Depends on the current selected Y axis unit, see Swept SA discussion of Y Axis Unit
Initial S/W Revision	Prior to A.02.00

Scale/Div

Sets the units-per-division of the vertical scale in the logarithmic display. However, since the Auto Scaling is defaulted to On, this value is automatically determined by the measurement result. When you set a value manually, Auto Scaling automatically changes to Off.

Key Path	AMPTD Y Scale
Mode	SA, WCDMA, C2K, WIMAX OFDMA, TD-SCDMA, 1xEVDO, DVB-T/H, DTMB (CTTB), ISDB-T, CMMB, LTE, LTETDD, Digital Cable TV, MSR, LTEAFDD, LTEATDD
Remote Command	:DISPlay:ACPower:VIEW[1]:WINDow[1]:TRACe:Y[:SCALE]:PDIVision <rel_

	<code>amp1></code>
	<code>:DISP:ACPower:VIEW[1]:WINDow[1]:TRACe:Y[:SCALe]:PDIVision?</code>
Example	DISP:ACP:VIEW:WIND:TRAC:Y:PDIV 5 DISP:ACP:VIEW:WIND:TRAC:Y:PDIV?
Notes	You must be in the mode that includes ACP measurements to use this command. Use :INSTrument:SElect to set the mode.
Couplings	When the Auto Scaling is On, this value is automatically determined by the measurement result. When you set a value manually, Auto Scaling automatically changes to Off.
Preset	10.00 dB
State Saved	Saved in instrument state.
Min	0.10 dB
Max	20.00 dB
Initial S/W Revision	Prior to A.02.00
Modified at S/W Revision	A.02.00, A.03.00

Presel Center

When this key is pressed, the centering of the preselector filter is adjusted to optimize the amplitude accuracy at the frequency of the selected marker. If the selected marker is not on when Presel Center is pressed, the analyzer will turn on the selected marker, perform a peak search, and then perform centering on the marker's center frequency. If the selected marker is already on and between the start and stop frequencies of the analyzer, the analyzer performs the preselector calibration on that marker's frequency. If the selected marker is already on, but outside the frequency range between Start Freq and Stop Freq, the analyzer will first perform a peak search, and then perform centering on the marker's center frequency.

The value displayed on the **Presel Adjust** key will change to reflect the new preselector tuning (see **Presel Adjust**).

A number of considerations should be observed to ensure proper operation. See ["Proper Preselector Operation" on page 1610](#).

Key Path	AMPTD Y Scale
Remote Command	<code>[:SENSe] :POWer [:RF] :PCENter</code>
Example	POW:PCEN
Notes	Note that the rules outlined above under the key description apply for the remote command as well as the key. The result of the command is dependent on marker position, and so forth. Any message shown by the key press is also shown in response to the remote command.
Dependencies	<ul style="list-style-type: none"> - Grayed out if the microwave preselector is off.) - If the selected marker's frequency is below Band 1, advisory message 0.5001 is generated and no action is taken.

	<ul style="list-style-type: none"> - Grayed out if entirely in Band 0. - Blank in models that do not include a preselector, such as option 503. If the SCPI is sent in these instruments, it is accepted without error, and the query always returns 0. - Grayed out in the Spectrogram View.
Couplings	<p>The active marker position determines where the centering will be attempted.</p> <p>If the analyzer is in a measurement such as averaging when centering is initiated, the act of centering the preselector will restart averaging but the first average trace will not be taken until the centering is completed.</p>
Status Bits/OPC dependencies	<p>When centering the preselector, *OPC will not return true until the process is complete and a subsequent measurement has completed, nor will results be returned to a READ or MEASure command.</p> <p>The Measuring bit should remain set while this command is operating and should not go false until the subsequent sweep/measurement has completed.</p>
Initial S/W Revision	Prior to A.02.00
Modified at S/W Revision	A.03.00

Proper Preselector Operation

A number of considerations should be observed to ensure proper operation:

3. If the selected marker is off, the analyzer will turn on a marker, perform a peak search, and adjust the preselector using the selected marker's frequency. It uses the "highest peak" peak search method unqualified by threshold or excursion, so that there is no chance of a 'no peak found' error. It continues with that peak, even if it is the peak of just noise. Therefore, for this operation to work properly, there should be a signal on screen in a preselected range for the peak search to find.
4. If the selected marker is already on, the analyzer will attempt the centering at that marker's frequency. There is no preselector for signals below about 3.6 GHz, therefore if the marker is on a signal below 3.6 GHz, no centering will be attempted and an advisory message generated
5. In some models, the preselector can be bypassed. If it is bypassed, no centering will be attempted in that range and a message will be generated.

Preselector Adjust

Allows you to manually adjust the preselector filter frequency to optimize its response to the signal of interest. This function is only available when "**Presel Center**" on page 3111 is available.

For general purpose signal analysis, using Presel Center is recommended. Centering the filter minimizes the impact of long-term preselector drift. Presel Adjust

can be used instead to manually optimize the preselector. One application of manual optimization would be to peak the preselector response, which both optimizes the signal-to-noise ratio and minimizes amplitude variations due to small (short-term) preselector drifting.

Key Path	AMPTD Y Scale
Scope	Meas Global
Remote Command	<code>[:SENSe]:POWer[:RF]:PADJust <freq></code> <code>[:SENSe]:POWer[:RF]:PADJust?</code>
Example	POW:PADJ 100KHz POW:PADJ?
Notes	The value on the key reads out to 0.1 MHz resolution.
Dependencies	<ul style="list-style-type: none"> - Grayed out if microwave preselector is off.) - Grayed out if entirely in Band 0. - Blank in models that do not include a preselector, such as option 503. If the SCPI is sent in these instruments, it is accepted without error, and the query always returns 0. - Grayed out in the Spectrogram View.
Preset	0 MHz
State Saved	The Presel Adjust value set by Presel Center , or by manually adjusting Presel Adjust , is not saved in instrument state, and does not survive a Preset or power cycle.
Min	-500 MHz
Max	500 MHz
Default Unit	Hz
Backwards Compatibility SCPI	<code>[:SENSe]:POWer[:RF]:MW:PADJust</code> <code>[:SENSe]:POWer[:RF]:MMW:PADJust</code> PSA had multiple preselectors, but the X-Series has only one. These commands simply alias to <code>[:SENSe]:POWer[:RF]:PADJust</code>
Initial S/W Revision	Prior to A.02.00
Modified at S/W Revision	A.03.00
Remote Command	<code>[:SENSe]:POWer[:RF]:PADJust:PRESelector MWAVE MMWave EXTERNAL</code> <code>[:SENSe]:POWer[:RF]:PADJust:PRESelector?</code>
Notes	PSA had multiple preselectors, and you could select which preselector to adjust. Since the X-Series has only one mm/uW preselector, the preselector selection softkey is no longer available. However, to provide backward compatibility, we accept the legacy remote commands. The command form has no effect, the query always returns MWAVE
Initial S/W Revision	Prior to A.02.00

Y Axis Unit

Displays the menu keys that enable you to change the vertical (Y) axis amplitude unit. The analyzer retains the entered Y Axis Unit separately for both Log and Lin amplitude scale types. For example, if Scale Type has been set to Log, and you set Y Axis Unit to dBm, pressing Scale Type (Log) sets the Y Axis Unit to dBm. If Scale Type has been set to Lin and you set Y Axis Unit to V, pressing Scale Type (Lin) sets the Y Axis Unit to V. Pressing Scale Type (Log) again sets the Y axis unit back to dBm.

NOTE

The units of current (A, dBmA, dBuA) are calculated based on 50 ohms input impedance.

All four of the EMI units (dB μ A/m, dB μ V/m, dBG, dBpT) are treated by the instrument exactly as though they were dBuV. The user must load an appropriate correction factor using Amplitude Corrections for accurate and meaningful results.

If a SCPI command is sent to the analyzer that uses one of the EMI units as a terminator, the analyzer treats it as though DBUV had been sent as the terminator.

Key Path	AMPTD Y Scale
Mode	SA
Scope	Meas Global
Remote Command	:UNIT:POWer DBM DBMV DBMA V W A DBUV DBUA DBPW DBUVM DBUAM DBPT DBG :UNIT:POWer?
Example	UNIT:POW dBmV UNIT:POW?
Notes	The Y axis unit has either logarithmic or linear characteristics. The set of units that is logarithmic consists of dBm, dBmV, dBmA, dB μ V, dB μ A, dB μ V/m, dB μ A/m, dBpT, and dBG. The set of units that are linear consists of V, W, and A. The chosen unit will determine how the reference level and all the amplitude-related outputs like trace data, marker data, etc. read out.
Notes	The settings of Y Axis Unit and Scale Type, affect how the data is read over the remote interface. When using the remote interface no unit is returned, so you must know what the Y axis unit is to interpret the results: Example 1, set the following: Scale Type (Log) Y Axis Unit, dBm Scale/Div, 1 dB Ref Level, 10 dBm This sets the top line to 10 dBm with each vertical division representing 1 dB. Thus, if a point on trace 1 is on the fifth graticule line from the top, it represents 5 dBm and will read out remotely as 5. Example 2, set the following: Scale Type (Lin) Y Axis Unit, Volts Ref Level, 100 mV (10 mV/div)

	This sets the top line to 100 mV and the bottom line to 0 V, so each vertical division represents 10 mV. Thus, if a point on trace 1 is on the fifth graticule line from the top, it represents 50 mV and will read out remotely as 50.
Dependencies	If an amplitude correction with an Antenna Unit other than None is applied and enabled, then that antenna unit is forced and the key with that unit is the only Y Axis Unit available. All other Y Axis Unit keys are grayed out. If an amplitude correction with an Antenna Unit other than None is applied and enabled, and you then turn off that correction or set Apply Corrections to No , the Y Axis Unit that existed before the Antenna Unit was applied is restored.
Couplings	The analyzer retains the entered Y Axis Unit separately for both Log and Lin amplitude scale types
Preset	dBm for log scale, V for linear. The true 'preset' value is dBm, since at preset the Y Scale type is set to logarithmic.
State Saved	Saved in instrument state
Readback line	1-of-N selection
Initial S/W Revision	Prior to A.02.00
Modified at S/W Revision	A.02.00, A.04.00, A.11.00

dBm

Sets the amplitude unit for the selected amplitude scale (log/lin) to dBm.

Key Path	AMPTD Y Scale, Y Axis Unit
Example	UNIT:POW DBM
Dependencies	Grayed out if an Amplitude Correction with an Antenna Unit is ON.
Readback	dBm
Initial S/W Revision	Prior to A.02.00
Modified at S/W Revision	A.02.00

dBmV

Sets the amplitude unit for the selected amplitude scale (log/lin) to dBmV.

Key Path	AMPTD Y Scale, Y Axis Unit
Example	UNIT:POW DBMV
Dependencies	Grayed out if an Amplitude Correction with an Antenna Unit is ON.
Readback	dBmV
Initial S/W Revision	Prior to A.02.00
Modified at S/W Revision	A.02.00

dBmA

Sets the amplitude unit for the selected amplitude scale (log/lin) to dBmA.

Key Path	AMPTD Y Scale, Y Axis Unit
Example	UNIT:POW DBMA
Dependencies	Grayed out if an Amplitude Correction with an Antenna Unit is ON.
Readback	dBmA
Initial S/W Revision	Prior to A.02.00
Modified at S/W Revision	A.02.00

W

Sets the amplitude unit for the selected amplitude scale (log/lin) to watt.

Key Path	AMPTD Y Scale, Y Axis Unit
Example	UNIT:POW W
Dependencies	Grayed out if an Amplitude Correction with an Antenna Unit is ON.
Readback	W
Initial S/W Revision	Prior to A.02.00
Modified at S/W Revision	A.02.00

V

Sets the amplitude unit for the selected amplitude scale (log/lin) to volt.

Key Path	AMPTD Y Scale, Y Axis Unit
Example	UNIT:POW V
Dependencies	Grayed out if an Amplitude Correction with an Antenna Unit is ON.
Readback	V
Initial S/W Revision	Prior to A.02.00
Modified at S/W Revision	A.02.00

A

Sets the amplitude unit for the selected amplitude scale (log/lin) to Ampere.

Key Path	AMPTD Y Scale, Y Axis Unit
Example	UNIT:POW A
Dependencies	Grayed out if an Amplitude Correction with an Antenna Unit is ON.
Readback	A
Initial S/W Revision	Prior to A.02.00
Modified at S/W Revision	A.02.00

dB μ V

Sets the amplitude unit for the selected amplitude scale (log/lin) to dB μ V.

Key Path	AMPTD Y Scale, Y Axis Unit
Example	UNIT:POW DBUV
Dependencies	Grayed out if an Amplitude Correction with an Antenna Unit is ON.
Readback	dB μ V
Initial S/W Revision	Prior to A.02.00
Modified at S/W Revision	A.02.00

dB μ A

Sets the amplitude unit for the selected amplitude scale (log/lin) to dB μ A.

NOTE

The unit dBuA can also appear as an Antenna Unit. This will be used by customers using current probes, because current probes are often supplied with conversion tables that provide the transducer factors. When dBuA is used as an Antenna Unit the normal conversion from power to amps for dBuA (based on the analyzer input impedance) is not done, but instead the conversion is based solely on the Correction that contains the transducer factors. This is what distinguishes dBuA as a normal unit from dBuA as an antenna unit. When querying the Y-Axis unit, you can query the Antenna Unit to distinguish between regular dBuA and the dBuA antenna unit. If :CORR:CSET:ANT? returns NOC (for No Conversion), you are using a normal Y Axis dBuA. If it returns UA you are using an Antenna Unit dBuA.

Key Path	AMPTD Y Scale, Y Axis Unit
Example	UNIT:POW DBUA
Dependencies	Grayed out if an Amplitude Correction with an Antenna Unit is ON.
Readback	dB μ A
Initial S/W Revision	Prior to A.02.00
Modified at S/W Revision	A.02.00

Antenna Unit

When a Correction is turned on that uses an Antenna Unit, the Y Axis Unit changes to that Antenna Unit. All of the keys in the Y-Axis Unit menu are then greyed out, except the Antenna Unit key. The unit being used is shown on this key and is shown as selected in the submenu.

Key Path	AMPTD Y Scale, Y Axis Unit
Dependencies	Grayed out if no Amplitude Correction with an Antenna Unit is on.
Readback line	Currently selected unit
Initial S/W Revision	A.11.00

dB μ V/m

Sets the amplitude unit for the selected amplitude scale (log/lin) to dB μ V/m. This is an antenna unit, and this key is grayed out unless a Correction with this Antenna Unit selected is ON. If this is the case, all of the other Antenna Units are grayed out.

Key Path	AMPTD Y Scale, Y Axis Unit, Antenna Unit
Example	UNIT:POW DBUVM
Dependencies	Grayed out if no Amplitude Correction with an Antenna Unit is on.
Readback	dB μ V/m
Initial S/W Revision	A.02.00

dB μ A/m

Sets the amplitude unit for the selected amplitude scale (log/lin) to dB μ A/m. This is an antenna unit, and this key is grayed out unless a Correction with this Antenna Unit selected is ON. If this is the case, all of the other Antenna Units are grayed out.

Key Path	AMPTD Y Scale, Y Axis Unit, Antenna Unit
Example	UNIT:POW DBUAM
Dependencies	Grayed out if no Amplitude Correction with an Antenna Unit is on.
Readback	dB μ A/m
Initial S/W Revision	A.02.00

dB μ A

Sets the amplitude unit for the selected amplitude scale (log/lin) to dB μ A. This is an antenna unit, and this key is grayed out unless a Correction with this Antenna Unit selected is ON. If this is the case, all of the other Antenna Units are grayed out.

Key Path	AMPTD Y Scale, Y Axis Unit, Antenna Unit
Example	UNIT:POW DBUAM
Dependencies	Grayed out if no Amplitude Correction with an Antenna Unit is on.
Readback	dB μ A
Initial S/W Revision	A.11.00

dBpT

Sets the amplitude unit for the selected amplitude scale (log/lin) to dBpT. This is an antenna unit, and this key is grayed out unless a Correction with this Antenna Unit selected is ON. If this is the case, all of the other Antenna Units are grayed out.

Key Path	AMPTD Y Scale, Y Axis Unit, Antenna Unit
Example	UNIT:POW DBPT
Dependencies	Grayed out if no Amplitude Correction with an Antenna Unit is on.

Readback	dBpT
Initial S/W Revision	A.02.00

dBG

Sets the amplitude unit for the selected amplitude scale (log/lin) to dBG. This is an antenna unit, and this key is grayed out unless a Correction with this Antenna Unit selected is ON. If this is the case, all of the other Antenna Units are grayed out.

Key Path	AMPTD Y Scale, Y Axis Unit, Antenna Unit
Example	UNIT:POW DBG
Dependencies	Grayed out if no Amplitude Correction with an Antenna Unit is on.
Readback	dBG
Initial S/W Revision	A.02.00

None

This is selected if no Antenna Unit is currently on, however you cannot actually set this value, since it is always grayed out. The key is included simply to provide an indication on the Readback line of the Antenna Unit key when there is no Antenna Unit selected.

Key Path	AMPTD Y Scale, Y Axis Unit, Antenna Unit
Readback	"None"
Initial S/W Revision	A.11.00

Reference Level Offset

Adds an offset value to the displayed reference level. The reference level is the absolute amplitude represented by the top graticule line on the display.

See ["More Information" on page 1618](#)

Key Path	AMPTD Y Scale
Mode	SA
Scope	Meas Global
Remote Command	:DISPlay:WINDow[1]:TRACe:Y[:SCALe]:RLEVel:OFFSet <rel_amp1> :DISPlay:WINDow[1]:TRACe:Y[:SCALe]:RLEVel:OFFSet?
Example	DISP:WIND:TRAC:Y:RLEV:OFFS 12.7 Sets the Ref Level Offset to 12.7 dB. The only valid suffix is dB. If no suffix is sent, dB will be assumed.
Preset	0 dBm
State Saved	Saved in instrument state
Min	The range for Ref Lvl Offset is variable. It is limited to values that keep the reference level within the range of -327.6 dB to 327.6 dB.

Max	327.6 dB
Backwards Compatibility Notes	<p>6. In pre-X-Series instruments, Ref Level Offset could not be adjusted by the knob or step keys. That is no longer the case.</p> <p>7. In ESA and PSA, Ref Level Offset was applied to the data as it was acquired; thus if the Offset changed the new offset was not applied until new trace data was taken. In X-Series, the offset is applied as the data is displayed/queried, so if you change the offset, it will change the data immediately.</p>
Initial S/W Revision	Prior to A.02.00
Modified at S/W Revision	A.04.00

More Information

Offsets are used when gain or loss occurs between a device under test and the analyzer input. Thus, the signal level measured by the analyzer may be thought of as the level at the input of an external amplitude conversion device. Entering an offset does not affect the trace position or attenuation value, just the value of the top line of the display and the values represented by the trace data. Thus, the values of exported trace data, queried trace data, marker amplitudes, trace data used in calculations such as N dB points, trace math, peak threshold, and so forth, are all affected by Ref Level Offset.

NOTE

Changing the offset causes the analyzer to immediately stop the current sweep and prepare to begin a new sweep, but the data will not change until the trace data updates, because the offset is applied to the data as it is taken. If a trace is exported with a nonzero Ref Level Offset, the exported data will contain the trace data with the offset applied.

The maximum reference level available is dependent on the reference level offset. That is, Ref Level - Ref Level Offset must be in the range -170 to +30 dBm. For example, the reference level value range can be initially set to values from -170 dBm to 30 dBm with no reference level offset. If the reference level is first set to -20 dBm, then the reference level offset can be set to values of -150 to +50 dB.

If the reference level offset is first set to -30 dB, then the reference level can be set to values of -200 dBm to 0 dBm. In this case, the reference level is “clamped” at 0 dBm because the maximum limit of +30 dBm is reached with a reference level setting of 0 dBm with an offset of -30 dB. If instead, the reference level offset is first set to 30 dB, then the reference level can be set to values of -140 to +60 dBm.

μW Path Control

The **μW Path Control** functions include the **μW Preselector Bypass** (Option MPB) and **Low Noise Path** (Option LNP) controls in the High Band path circuits.

When the μW Preselector is bypassed, the user has better flatness, but will be subject to spurs from out of band interfering signals. When the Low Noise Path is enabled, the analyzer automatically switches around certain circuitry in the high

frequency bands which can contribute to noise, when it is appropriate based on other analyzer settings.

For most applications, the preset state is Standard Path, which gives the best remote-control throughput, minimizes acoustic noise from switching and minimizes the risk of wear out in the hardware switches. For applications that utilize the wideband IF paths, the preset state is the μ W Preselector Bypass path, if option MPB is present. This is because, when using a wideband IF such as the 140 MHz IF, the μ W Preselector's bandwidth can be narrower than the available IF bandwidth, causing degraded amplitude flatness and phase linearity, so it is desirable to bypass the preselector in the default case.

Users may choose Low Noise Path Enable. It gives a lower noise floor, especially in the 21–26.5 GHz region, though without improving many measures of dynamic range, and without giving the best possible noise floor. The preamp, if purchased and used, gives better noise floor than does the Low Noise Path, however its compression threshold and third-order intercept are much poorer than that of the non-preamp Low Noise Path. There are some applications, typically for signals around –30 dBm, for which the third-order dynamic range of the standard path is good enough, but the noise floor is not low enough even with 0 dB input attenuation. When the third-order dynamic range of the preamp path is too little and the noise floor of the standard path is too high, the Low Noise Path can provide the best dynamic range.

Key Path	AMPTD Y Scale
Mode	SA, BASIC, PNOISE, VSA , LTE, LTETDD
Scope	Meas Global
Remote Command	[:SENSe] : POWer [: RF] : MW : PATH STD LNPath MPBypass FULL [:SENSe] : POWer [: RF] : MW : PATH?
Example	:POW:MW:PATH LNP Enables the Low Noise path
Notes	If a Presel Center is performed, the analyzer will momentarily switch to the Standard Path, regardless of the setting of μW Path Control The DC Block will always be switched in when the low noise path is switched in, to protect succeeding circuitry from DC. Note that this does not mean “when the low noise path is enabled” but when, based on the Low Noise Path rules, the path is actually switched in. This can happen when the selection is Low Noise Path Enable . In the case where the DC Block is switched in the analyzer is now AC coupled. However, if the user has selected DC coupling, the UI will still behave as though it were DC coupled, including all annunciation, warnings, status bits, and responses to SCPI queries. This is because, based on other settings, the analyzer could switch out the low noise path at any time and hence go back to being DC coupled. Alignment switching ignores the settings in this menu, and restores them when finished.
Dependencies	Unavailable in BBIQ and External Mixing
Preset	All modes other than IQ Analyzer mode and VXA: STD IQ Analyzer, VXA and WLAN mode: MPB option present and licensed: MPB MPB option not present and licensed: STD
State Saved	Save in instrument state

Readback	Value selected in the submenu
Initial S/W Revision	A.04.00
Modified at S/W Revision	A.10.00

Standard Path

This path gives the best remote-control throughput, minimizes acoustic noise from switching and minimizes the risk of wear in the hardware switches, particularly in remote test scenarios where both low band and high band setups will follow in rapid succession.

In this path, the bypass of the low band/high band switch and microwave preamp is never activated, which can cause some noise degradation but preserves the life of the bypass switch.

Key Path	AMPTD Y Scale, μW Path Control
Example	:POW:MW:PATH STD
Readback Text	Standard Path
Initial S/W Revision	A.04.00

μ W Preselector Bypass

This key toggles the preselector bypass switch for band 1 and higher. When the microwave preselect is on, the signal path is preselected. When the microwave preselector is off, the signal path is not preselected. The preselected path is the normal path for the analyzer.

The preselector is a tunable bandpass filter which prevents signals away from the frequency of interest from combining in the mixer to generate in-band spurious signals (images). The consequences of using a preselector filter are its limited bandwidth, the amplitude and phase ripple in its passband, and any amplitude and phase instability due to center frequency drift.

Option MPB or pre-selector bypass provides an unpreselected input mixer path for certain X-Series signal analyzers with frequency ranges above 3.6 GHz. This signal path allows a wider bandwidth and less amplitude variability, which is an advantage when doing modulation analysis and broadband signal analysis. The disadvantage is that, without the preselector, image signals will be displayed. Another disadvantage of bypassing the preselector is increased LO emission levels at the front panel input port.

Image responses are separated from the real signal by twice the 1st IF. For IF Paths of 10 MHz and 25 MHz, the 1st IF is 322.5 MHz, so the image response and the real signal will be separated by 645 MHz. The 1st IF will be different for other IF Path settings. When viewing a real signal and its corresponding image response in internal mixing, the image response will be to the left of the real signal.

Also, the image response and the real signal typically have the same amplitude and exhibit the same shape factor.

However, if Option FS1, Fast Sweep Capability, is enabled, the image response in the Swept SA measurement will appear lower in amplitude and have a much wider shape factor compared to the real signal.

Key Path	AMPTD Y Scale, μW Path Control
Example	:POW:MW:PATH MPB
Dependencies	Key is blanked if current mode does not support it. Key is grayed out if mode supports it but current measurement does not support it. Key is blank unless Option MPB is present and licensed. If SCPI command sent when MPB not present, error -241, "Hardware missing; Option not installed" is generated.
Readback Text	μ W Preselector Bypass
Initial S/W Revision	A.04.00

Remote Command	[:SENSe]:POWer[:RF]:MW:PRESelector[:STATe] ON OFF 0 1 [:SENSe]:POWer[:RF]:MW:PRESelector[:STATe]?
Example	:POW:MW:PRES OFF Bypasses the microwave preselector
Notes	The ON parameter sets the STD path (:POW:MW:PATH STD) The OFF parameter sets path MPB (:POW:MW:PATH MPB)
Preset	ON

Internal Preamp

Accesses a menu of keys that control the internal preamps. Turning on the preamp gives a better noise figure, but a poorer TOI to noise floor dynamic range. You can optimize this setting for your particular measurement.

The instrument takes the preamp gain into account as it sweeps. If you sweep outside of the range of the preamp the instrument will also account for that. The displayed result will always reflect the correct gain.

For some measurements, when the preamp is on and any part of the displayed frequency range is below the lowest frequency for which the preamp has specifications, a warning condition message appears in the status line. For example ,for a preamp with a 9 kHz lowest specified frequency: "Preamp: Accy unspec'd below 9 kHz".

Key Path	AMPTD Y Scale
Scope	Meas Global
Remote Command	[:SENSe]:POWer[:RF]:GAIN[:STATe] OFF ON 0 1 [:SENSe]:POWer[:RF]:GAIN[:STATe]?
Dependencies	Preamp is not available on all hardware platforms. If the preamp is not present or is unlicensed,

	the key is not shown. The preamp is not available when the electronic/soft attenuator is enabled.
Couplings	The act of connecting the U7227A USB Preamplifier to one of the analyzer's USB ports will cause the Internal Preamp to be switched on. When this happens an informational message will be generated: "Internal Preamp turned on for optimal operation with USB Preamp." Note that if the Internal Preamp was already on, there will be no change to the setting, but if it was Off it will be switched On, to Full Range. Note that this same action occurs when the SA mode is selected while the USB Preamp is connected to one of the analyzer's USB ports, if it is the first time that the SA mode has run since powerup, or if the last time the SA mode was running the USB Preamp was NOT connected. Subsequently disconnecting the USB Preamp from USB does not change the Internal Preamp setting nor restore the previous setting.
Preset	OFF
State Saved	Saved in instrument state
Initial S/W Revision	Prior to A.02.00
Modified at S/W Revision	A.14.00

Key Path	AMPTD Y Scale, Internal Preamp
Scope	Meas Global
Remote Command	[:SENSe] :POWer [:RF] :GAIN :BAND LOW FULL [:SENSe] :POWer [:RF] :GAIN :BAND ?
Dependencies	Preamp is not available on all hardware platforms. If the preamp is not present or is unlicensed, the key is not shown. If a POW:GAIN:BAND FULL command is sent when a low band preamp is available, the preamp band parameter is to LOW instead of FULL, and an "Option not installed" message is generated.
Preset	LOW
State Saved	Saved in instrument state
Initial S/W Revision	Prior to A.02.00

Off

Turns the internal preamp off

Key Path	AMPTD Y Scale, Internal Preamp
Example	:POW:GAIN OFF
Readback	Off
Initial S/W Revision	Prior to A.02.00

Low Band

Sets the internal preamp to use only the low band.

The frequency range of the installed (optional) low-band preamp is displayed in square brackets on the **Low Band** key label.

Key Path	AMPTD Y Scale, Internal Preamp
Example	:POW:GAIN ON :POW:GAIN:BAND LOW
Readback	Low Band
Initial S/W Revision	Prior to A.02.00

Full Range

Sets the internal preamp to use its full range. The low band (0-3.6 GHz or 0-3GHz, depending on the model) is supplied by the low band preamp and the frequencies above low band are supplied by the high band preamp.

The frequency range of the installed (optional) preamp is displayed in square brackets on the **Full Range** key label. If the high band option is not installed the Full Range key does not appear.

Key Path	AMPTD Y Scale, Internal Preamp
Example	:POW:GAIN ON :POW:GAIN:BAND FULL
Readback	Full Range
Initial S/W Revision	Prior to A.02.00

Ref Position

Positions the reference level at the top, center, or bottom of the Y- scale display. Changing the reference position does not change the reference level value.

Key Path	AMPTD Y Scale
Mode	SA, WCDMA, C2K, WIMAX OFDMA, TD-SCDMA, 1xEVDO, DVB-T/H, DTMB (CTTB), ISDB-T, CMMB, LTE, LTETDD, Digital Cable TV, MSR, LTEAFDD, LTEATDD
Remote Command	:DISPlay:ACPower:VIEW[1]:WINDow[1]:TRACe:Y[:SCALe]:RPOSition TOP CENTER BOTTom :DISPlay:ACPower:VIEW[1]:WINDow[1]:TRACe:Y[:SCALe]:RPOSition?
Example	DISP:ACP:VIEW:WIND:TRAC:Y:RPOS CENT DISP:ACP:VIEW:WIND:TRAC:Y:RPOS?
Notes	You must be in the mode that includes ACP measurements to use this command. Use :INSTrument:SElect to set the mode.
Preset	TOP
State Saved	Saved in instrument state.
Range	Top Ctr Bot
Initial S/W Revision	Prior to A.02.00
Modified at S/W Revision	A.02.00, A.03.00

Auto Scaling

Toggles the Auto Scaling function between On and Off.

Key Path	AMPTD Y Scale
Mode	SA, WCDMA, C2K, WIMAX OFDMA, TD-SCDMA, 1xEVDO, DVB-T/H, DTMB (CTTB), ISDB-T, CMMB, LTE, LTETDD, Digital Cable TV, MSR, LTEAFDD, LTEATDD
Remote Command	<code>:DISPlay:ACPower:VIEW[1]:WINDow[1]:TRACe:Y[:SCALe]:COUPlE 0 1 OFF ON</code> <code>:DISPlay:ACPower:VIEW[1]:WINDow[1]:TRACe:Y[:SCALe]:COUPlE?</code>
Example	DISP:ACP:VIEW:WIND:TRAC:Y:COUP ON DISP:ACP:VIEW:WIND:TRAC:Y:COUP?
Notes	You must be in the mode that includes ACP measurements to use this command. Use :INSTrument:SElect to set the mode.
Couplings	When Auto Scaling is On and the Restart front-panel key is pressed, this function automatically determines the scale per division and reference values based on the measurement results. When you set a value to either Scale/Div or Ref Value manually, Auto Scaling automatically changes to Off.
Preset	ON
State Saved	Saved in instrument state.
Range	On Off
Initial S/W Revision	Prior to A.02.00
Modified at S/W Revision	A.02.00, A.03.00

Auto Couple

The Auto Couple feature provides a quick and convenient way to automatically couple multiple instrument settings. This helps ensure accurate measurements and optimum dynamic range. When the Auto Couple feature is activated, either from the front panel or remotely, all parameters of the current measurement that have an Auto/Manual mode are set to Auto mode and all measurement settings dependent on (or coupled to) the Auto/Man parameters are automatically adjusted for optimal performance.

However, the Auto Couple keyactions are confined to the current measurement only. It does not affect other measurements in the mode, and it does not affect markers, marker functions, or trace or display attributes.

See "[More Information](#)" on page 1625

Key Path	Front-panel key
Remote Command	:COUPle ALL NONE
Example	:COUP ALL
Notes	:COUPle ALL puts all Auto/Man parameters in Auto mode (equivalent to pressing the Auto Couple key). :COUPLE NONE puts all Auto/Man parameters in manual mode. It decouples all the coupled instrument parameters and is not recommended for making measurements.
Initial S/W Revision	Prior to A.02.00

More Information

There are two types of functions that have Auto/Manual modes.

Auto/Man Active Function keys

An Auto/Man toggle key controls the binary state associated with an instrument parameter by toggling between **Auto** (where the parameter is automatically coupled to the other parameters it is dependent upon) and **Man** (where the parameter is controlled independent of the other parameters), as well as making the parameter the active function. The current mode is indicated on the softkey with either **Auto** or **Man** underlined as illustrated below.

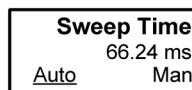

vsd07

Auto/Man 1-of-N keys

An Auto/Man 1-of-N key allows you to manually pick from a list of parameter values, or place the function in Auto, in which case the value is automatically selected (and indicated).

- If in Auto, Auto is underlined on the calling key.

- If in manual operation, manual is indicated on the calling key, but note that the calling key simply opens the menu and does **not** actually toggle the function.

BW

Accesses a menu of functions that enable you to specify and control the video and resolution bandwidths. You can also select the type of filter for the measurement and set the filter bandwidth.

Key Path	Front-panel key
Initial S/W Revision	Prior to A.02.00

Res BW

Sets the value of the resolution bandwidth. If an unavailable bandwidth is entered with the numeric keypad, the closest available bandwidth is selected.

LTE-Advanced FDD/TDD Auto RBW:

Bandwidth	RBW (KHz)
1.4MHz	51KHz
3MHz	
5MHz	100 KHz
10MHz	
15MHz	
20MHz	

the resolution bandwidth is predefined based on the corresponding bandwidth of the single LTE carrier, which is listed above. When ResBW mode is Auto, the narrowest RBW over the active carriers is selected for Multi-carriers.

Key Path	BW
Mode	SA, WCDMA, C2K, WIMAX OFDMA, TD-SCDMA, 1xEVDO, DVB-T/H, DTMB (CTTB), ISDB-T, CMMB, LTE, LTE-TDD, Digital Cable TV, MSR, LTEAFDD, LTEATDD
Remote Command	<pre>[:SENSe]:ACPower:BANDwidth[:RESolution] <freq> [:SENSe]:ACPower:BANDwidth[:RESolution]? [:SENSe]:ACPower:BANDwidth[:RESolution]:AUTO ON OFF 1 0 [:SENSe]:ACPower:BANDwidth[:RESolution]:AUTO?</pre>
Example	<pre>ACP:BAND 25kHz ACP:BAND? ACP:BAND:AUTO ON ACP:BAND:AUTO?</pre>
Notes	<p>This key is available only in IBW mode.</p> <p>This parameter is preset by the Meas Method selection. Preset values are as follows:</p> <p>IBW: 100 kHz IBWR: 27 kHz FAST (WCDMA): 390 kHz</p>

	<p>When Meas Method is “Fast Power” and Fast Power RBW mode is “Speed,” RBW is calculated as follows:</p> $RBW = \text{Span} \times 2.442 \times 10^{-3}$ <p>You must be in the mode that includes ACP measurements to use this command. Use :INSTrument:SElect to set the mode.</p>
Dependencies	When Meas Method is RBW, FAST, or Fast Power and Fast Power RBW mode is Speed, this key is grayed out and disabled. If the key is pressed, an advisory message is generated. If the equivalent remote command is sent, a "Setting conflict" warning is generated.
Couplings	The resolution bandwidth is coupled to the video bandwidth based on the video to resolution bandwidth ratio setting if AUTO is selected.
Preset	SA: 220 kHz WCDMA: 100 kHz WIMAX OFDMA: 100 kHz C2K: 15 kHz TD-SCDMA: 30 kHz 1xEVDO: 30 kHz DVB-T/H: 39 kHz DTMB (CTTB): 39 kHz ISDB-T: 39 kHz CMMB: 39 kHz LTE: 100 kHz LTETDD: 100 kHz Digital Cable TV: 39 kHz MSR: 100 kHz LTEAFDD, LTEATDD: 100kHz LTE, LTETDD, LTEAFDD, LTEATDD: 1 Others:0
State Saved	Saved in instrument state.
Min	1 Hz
Max	8 MHz
Backwards Compatibility SCPI	[:SENSe]:ACPower:BWIDth[:RESolution] [:SENSe]:ACP:SWEep:BWIDth BWIDth[:RESolution] (PSA W-CDMA, PSA cdma2000)
Initial S/W Revision	Prior to A.02.00
Modified at S/W Revision	A.02.00, A.03.00

Video BW

Changes the analyzer post-detection filter (VBW).

Key Path	BW
----------	-----------

Mode	SA, WCDMA, C2K, WIMAX OFDMA, TD-SCDMA, 1xEVDO, DVB-T/H, DTMB (CTTB), ISDB-T, CMMB, LTE, LTETDD, Digital Cable TV, MSR, LTEAFDD,LTEATDD
Remote Command	<pre>[:SENSe]:ACPower:BA NDwidth:VIDeo <freq> [:SENSe]:ACPower:BA NDwidth:VIDeo? [:SENSe]:ACPower:BA NDwidth:VIDeo:AUTO OFF ON 0 1 [:SENSe]:ACPower:BA NDwidth:VIDeo:AUTO?</pre>
Example	<pre>ACP:BA ND:VID 1kHz ACP:BA ND:VID? ACP:BWID:VID:AUTO ON ACP:BWID:VID:AUTO?</pre>
Notes	The values shown in this table reflect the conditions after a Mode Preset.
Dependencies	When Meas Method is RBW, FAST, or Fast Power, this key is grayed out and disabled. If the key is pressed, an advisory message is generated. If the equivalent remote command is sent, a "Setting conflict" warning is generated.
Preset	<pre>SA: 22 kHz WCDMA, WIMAX OFDMA: 1 MHz C2K: Method RBW: grayed out (1.2 MHz) Method IBW: 150 kHz TD-SCDMA: 300 kHz 1xEVDO: 300 kHz DVB-T/H: 390 kHz DTMB (CTTB): 390 kHz ISDB-T: 390 kHz CMMB: 390 kHz LTE, LTETDD, MSR: Auto LTETDD: 1 MHz Digital Cable TV: 390 kHz LTEAFDD,LTEATDD: Auto SA: ON WCDMA: OFF WIMAX OFDMA: OFF TD-SCDMA: OFF DVB-T/H: OFF DTMB (CTTB): OFF CDMA1xEVDO: OFF ISDB-T: OFF CMMB: OFF LTE, MSR: ON LTETDD: ON Digital Cable TV: OFF</pre>

	LTEAFDD, LTEATDD: ON
State Saved	Saved in instrument state.
Min	1 Hz
Max	50 MHz
Backwards Compatibility SCPI	[:SENSe] :ACPoweR :BWIDth :VIDeo
Initial S/W Revision	Prior to A.02.00
Modified at S/W Revision	A.02.00, A.03.00

RBW Control

Accesses a menu that enables you to select the filter bandwidth and type.

Key Path	BW
Initial S/W Revision	Prior to A.02.00

Filter Type

Selects the type of bandwidth filter that is used. The choices are Gaussian or Flat top.

Key Path	BW, RBW Control
Mode	SA, WCDMA, C2K, WIMAX OFDMA, TD-SCDMA, 1xEVDO, DVB-T/H, DTMB (CTTB), ISDB-T, CMMB, LTE, LTE-TDD, Digital Cable TV, MSR, LTEAFDD, LTEATDD
Remote Command	[:SENSe] :ACPoweR :BANDwidth :SHAPE GAUSSian FLATtop [:SENSe] :ACPoweR :BANDwidth :SHAPE?
Example	ACP:BAND:SHAP GAUS ACP:BAND:SHAP?
Dependencies	When Meas Method is FAST or Fast Power, this key is grayed out and disabled. If the key is pressed, an advisory message is generated. If the equivalent remote command is sent, a "Setting conflict" warning is generated.
Preset	GAUSSian C2K: FLATtop
State Saved	Saved in instrument state.
Range	Gaussian (Normal) Flattop
Backwards Compatibility SCPI	[:SENSe] :ACPoweR :BWIDth :SHAPE
Initial S/W Revision	Prior to A.02.00
Modified at S/W Revision	A.02.00, A.03.00

Filter BW

Selects a Gaussian filter based on its –3 dB (Normal) bandwidth or its –6 dB bandwidth.

Key Path	BW, RBW Control
Mode	SA, WCDMA, C2K, WIMAX OFDMA, TD-SCDMA, 1xEVDO, DVB-T/H, DTMB (CTTB), ISDB-T, CMMB, LTE, LTETDD, Digital Cable TV, MSR, LTEAFDD, LTEATDD
Remote Command	[:SENSe] :ACPower :BANDwidth :TYPE DB3 DB6 [:SENSe] :ACPower :BANDwidth :TYPE?
Example	ACP:BAND:TYPE DB3 ACP:BAND:TYPE?
Dependencies	When Filter Type is Flattop or Meas Method is RBW, FAST, or Fast Power, this key is grayed out and disabled. If the key is pressed, an advisory message is generated. If the equivalent remote command is sent, a "Setting conflict" warning is generated.
Preset	DB3
State Saved	Saved in instrument state.
Range	–3 dB (Normal)–6 dB
Backwards Compatibility SCPI	[:SENSe] :ACPower :BWIDth :TYPE
Initial S/W Revision	Prior to A.02.00
Modified at S/W Revision	A.02.00, A.03.00

Cont (Continuous Measurement/Sweep)

Sets the analyzer for Continuous measurement operation. The single/continuous state is Meas Global so the setting will affect all measurements. If you are Paused, pressing **Cont** does a Resume.

Key Path	Front-panel key
Remote Command	:INITiate:CONTinuous OFF ON 0 1 :INITiate:CONTinuous?
Example	:INIT:CONT 0 puts analyzer in Single measurement operation. :INIT:CONT 1 puts analyzer in Continuous measurement operation
Preset	ON (Note that SYST:PRESet sets INIT:CONT to ON but *RST sets INIT:CONT to OFF)
State Saved	Saved in instrument state
Backwards Compatibility Notes	For Spectrum Analysis mode in ESA and PSA, there is no Cont hardkey, instead there is a Sweep Single/Cont key. In these analyzers, switching the Sweep Single/Cont key from Single to Cont restarts averages (displayed average count reset to 1), but does not restart Max Hold and Min Hold . The X-Series has Single and Cont keys in place of the SweepSingleCont key. In the X-Series, if in single measurement, the Cont key (and INIT:CONT ON) switches to continuous measurement, but never restarts a measurement and never resets a sweep.
Initial S/W Revision	Prior to A.02.00

In Swept SA Measurement (Spectrum Analysis Mode):

The analyzer takes repetitive sweeps, averages, measurements, etc., when in Continuous mode. When the average count reaches the Average/Hold Number the count stops incrementing, but the analyzer keeps sweeping. See the Trace/Detector section for the averaging formula used both before and after the Average/Hold Number is reached. The trigger condition must be met prior to each sweep. The type of trace processing for multiple sweeps, is set under the Trace/Detector key, with choices of **Trace Average**, **Max Hold**, or **Min Hold**.

In Other Measurements/Modes:

With **Avg/Hold Num** (in the **Meas Setup** menu) set to **Off** or set to **On** with a value of 1, a sweep is taken after the trigger condition is met; and the analyzer continues to take new sweeps after the current sweep has completed and the trigger condition is again met. However, with **Avg/Hold Num** set to On with a value >1, multiple sweeps (data acquisitions) are taken for the measurement. The trigger condition must be met prior to each sweep. The sweep is not stopped when the average count k equals the number N set for Avg/Hold Num is reached, but the number k stops incrementing. A measurement average usually applies to all traces, marker results, and numeric results. But sometimes it only applies to the numeric results.

If the analyzer is in Single measurement, pressing the **Cont** key does not change k and does not cause the sweep to be reset; the only action is to put the analyzer into Continuous measurement operation.

If it is already in continuous sweep:

the INIT:CONT 1 command has no effect

the INIT:CONT 0 command will place the analyzer in Single Sweep but will have no effect on the current sequence until $k = N$, at which point the current sequence will stop and the instrument will go to the idle state.

File

See "File" on page 426

FREQ Channel

Accesses a menu of keys that allow you to control the Frequency and Channel parameters of the instrument.

Some features in the Frequency menu are the same for all measurements – they do not change as you change measurements. Settings like these are called “Meas Global” and are unaffected by Meas Preset. For example, the Center Freq setting is the same for all measurements – it does not change as you change measurements.

Key Path	Front-panel key
Initial S/W Revision	Prior to A.02.00

Center Freq

Sets the frequency that corresponds to the horizontal center of the graticule (when frequency Scale Type is set to linear). While adjusting the Center Frequency the Span is held constant, which means that both Start Frequency and Stop Frequency will change.

Pressing Center Freq also sets the frequency entry mode to Center/Span. In Center/Span mode, the center frequency and span values are displayed below the graticule, and the default active function in the Frequency menu is **Center Freq**.

The center frequency setting is the same for all measurements within a mode, that is, it is Meas Global. Some modes are also able to share a Mode Global center frequency value. If this is the case, the Mode will have a **Global Settings** key in its **Mode Setup** menu.

The **Center Freq** function sets (and queries) the Center Frequency for the currently selected input. If your analyzer has multiple inputs, and you select another input, the Center Freq changes to the value for that input. SCPI commands are available to directly set the Center Freq for a specific input.

Center Freq is remembered as you go from input to input. Thus you can set a Center Freq of 10 GHz with the RF Input selected, change to BBIQ and set a Center Freq of 20 MHz, then switch to External Mixing and set a Center Freq of 60 GHz, and when you go back to the RF Input the Center Freq will go back to 10 GHz; back to BBIQ and it is 20 MHz; back to External Mixing and it is 60 GHz.

See ["RF Center Freq" on page 1639](#)

See [Ext Mix Center Freq](#)

See ["I/Q Center Freq" on page 1640](#)

See ["Center Frequency Presets" on page 1636](#)

Key Path	FREQ Channel
Scope	Meas Global
Remote Command	[:SENSe] :FREQuency :CENTer <freq> [:SENSe] :FREQuency :CENTer ?

Example	FREQ:CENT 50 MHz FREQ:CENT UP changes the center frequency to 150 MHz if you use FREQ:CENT:STEP 100 MHz to set the center frequency step size to 100 MHz FREQ:CENT?
Notes	This command sets either the RF or I/Q Center Frequency depending on the selected input. For RF input it is equivalent to FREQ:RF:CENT For I/Q input it is equivalent to FREQ:IQ:CENT Preset and Max values are dependent on Hardware Options (5xx) If no terminator (e.g. MHz) is sent the terminator Hz is used. If a terminator with unit other than Frequency is used, an invalid suffix error message is generated.
Dependencies	The Center Frequency can be limited by Start or Stop Freq limits, if the Span is so large that Start or Stop reach their limit.
Couplings	When operating in "swept span", any value of the Center Frequency or Span that is within the frequency range of the analyzer is allowed when the value is being set through the front panel numeric key pad or the SCPI command. The other parameter is forced to a different value if needed, to keep the Start and the Stop Frequencies within the analyzer's frequency range
Preset	Depends on instrument maximum frequency, mode, measurement, and selected input. See "Center Frequency Presets" on page 1636 and "RF Center Freq" on page 1639 and Ext Mix Center Freq and "I/Q Center Freq" on page 1640 .
State Saved	Saved in instrument state
Min	Depends on instrument maximum frequency, mode, measurement, and selected input.. See "Center Frequency Presets" on page 1636 and "RF Center Freq" on page 1639 and "I/Q Center Freq" on page 1640 .
Max	Depends on instrument maximum frequency, mode, measurement, and selected input.. See "Center Frequency Presets" on page 1636 and "RF Center Freq" on page 1639 and "I/Q Center Freq" on page 1640 .
Default Unit	Hz
Status Bits/OPC Dependencies	Non-overlapped
Initial S/W Revision	Prior to A.02.00

Center Frequency Presets

The following table provides the Center Frequency Presets for the Spectrum Analyzer mode, and the Max Freq, for the various frequency options:

Freq Option	CF after Mode Preset	Stop Freq after Mode Preset	Max Freq (can't tune above)
503 (all but N9000A)		1.805 GHz	3.6 GHz 3.7 GHz

Freq Option	CF after Mode Present	Stop Freq after Mode Present	Max Freq (can't tune above)	
503 (N9000A)		1.505 GHz	3.0 GHz	3.08 GHz
504 (M9420A)		1 GHz	3.8GHz	3.88 GHz
506 (M9420A)		1 GHz	6.0GHz	6.08 GHz
507 (all but N9000A)		3.505 GHz	7.0 GHz	7.1 GHz
507 (N9000A)		3.755 GHz	7.5 GHz	7.58 GHz
508 (all but N9038A)		1.805 GHz	3.6 GHz	8.5 GHz
508 (N9038A)		4.205 GHz	8.4 GHz	8.5 GHz
513		6.805 GHz	13.6 GHz	13.8 GHz
526 (all but N9000A and N9038A)		13.255 GHz	26.5 GHz	27.0 GHz
526 (N9000A)		13.255 GHz	26.5 GHz	26.5 5 GHz
526 (N9038A)		1.805 GHz	3.6 GHz	27.0 GHz
532	16.005 GHz		32.0 GHz	32.5 GHz
543	21.505 GHz		43.0 GHz	TBD
544	22.005 GHz		44.0 GHz	44.5 GHz
550	25.005 GHz		50.0 GHz	51 GHz

Input 2:

Model	CF after Mode Preset	Stop Freq after Mode Preset	Max Freq (can't tune above)
N9000A opt C75	0.7505GHz	1.5 GHz	1.58 GHz
N9038A	505 MHz	1 GHz	1.000025 GHz

Tracking Generator Frequency Limits (N9000A only):

Tracking Generator Option	Min Freq (clips to this freq when turn TG on and can't tune below while TG on)	If above this Freq, Stop Freq clipped to this Freq when TG turned on	Max Freq (can't tune above) while TG on
T03	9 kHz	3.0 GHz	3.08 GHz
T06	9 kHz	6.0 GHz	6.05 GHz

Tracking Generator Frequency Limits(M9290A only):

Tracking Generator Option	Min Freq (clips to this freq when turn TG on and can't tune below while TG on)	If above this Freq, Stop Freq clipped to this Freq when TG turned on	Max Freq (can't tune above) while TG on
T03	2 MHz	3.08 GHz	3.08 GHz
T07	2 MHz	7.575 GHz	7.575 GHz
T13	2 MHz	13.8 GHz	13.8 GHz
T26	2 MHz	26.55 GHz	26.55 GHz

The following table shows the Center Frequency Presets for modes other than Spectrum Analyzer:

Mode	CF Preset for RF
WCDMA	1 GHz
WIMAXOFDMA,	1 GHz
BASIC	1 GHz
ADEMOD	1 GHz
VSA	1 GHz
TDSCDMA	1 GHz

Mode	CF Preset for RF
PNOISE	1 GHz
LTE	1 GHz
LTETDD	1 GHz
MSR	1 GHz
GSM	935.2 MHz
NFIGURE	1.505 GHz

RF Center Freq

SCPI command for specifying the RF Center Frequency. This command will set the Center Frequency to be used when the RF input is selected, even if the RF input is not the input that is selected at the time the command is sent. Note that the **Center Freq** function in the **Frequency** menu on the front panel always applies to the currently selected input.

Scope	Meas Global
Remote Command	[:SENSe] :FREQuency:RF:CENTer <freq> [:SENSe] :FREQuency:RF:CENTer?
Example	FREQ:RF:CENT 30 MHz
Notes	This command is the same in all modes, but the parameter is Measurement Global. So the value is independent in each mode and common across all the measurements in the mode.
Dependencies	If the electronic/soft attenuator is enabled, any attempt to set Center Frequency such that the Stop Frequency would be >3.6 GHz fails and results in an advisory message. If the equivalent SCPI command is sent, this same message is generated as part of a “-221, Settings conflict” warning. If Source Mode is set to Tracking, and the Max or Min Center Freq is therefore limited by the limits of the source, a warning message is generated, “Data out of range;clipped to source max/min” if these limits are exceeded. Note that for an external source, these limits can be affected by the settings of Source Numerator, Source Denominator and Power Sweep.
Preset	See table above
State Saved	Saved in instrument state.
Min	-79.999995 MHz, unless Source Mode is set to Tracking, in which case it is limited by the minimum frequency of the Source
Max	See table above. Basically instrument maximum frequency - 5 Hz. Note that, if the Source Mode is set to Tracking, the effective instrument maximum frequency may be limited by the source maximum frequency. If the knob or step keys are being used, also depends on the value of the other three interdependent parameters Span, Start Frequency and Stop Frequency
Initial S/W Revision	Prior to A.02.00
Modified at S/W Revision	A.03.00

Ext Mix Center Freq

SCPI command for specifying the External Mixer Center Frequency. This command will set the Center Frequency to be used when the External Mixer is selected, even if the External Mixer input is not the input which is selected at the time the command is sent. Note that the **Center Freq** function in the **Frequency** menu on the front panel always applies to the currently selected input.

Scope	Meas Global
Remote Command	[:SENSe] :FREQuency:EMIXer:CENTer <freq> [:SENSe] :FREQuency:EMIXer:CENTer?
Example	:FREQ:EMIX:CENt 60 GHz :FREQ:EMIX:CENt?
Notes	This command is the same in all modes, but the parameter is Measurement Global. So the value is independent in each mode and common across all the measurements in the mode.
Couplings	When returning to External Mixing after having been switched to one of the other inputs (e.g., RF), you will come back into the settings that you had when you left External Mixing. So you will come back to the band you were in with the Center Frequency that you had. However, Span is not an input-dependent parameter, therefore you will bring the span over from the other input. Therefore, the analyzer comes back with the span from the previous input, limited as necessary by the current mixer setup.
Preset	When a Mode Preset is performed while in External Mixing, the Start frequency of the current Mode is set to the nominal Min Freq of the lowest harmonic range in the Harmonic Table for the current mixer setup. Similarly, the Stop frequency of the current Mode is set to the nominal Max Freq of the highest harmonic range in the Harmonic Table. The Center Freq thus presets to the point arithmetically equidistant from these two frequencies. If the current measurement has a limited Span available to it, and cannot achieve the Span shown in the table (Span=Stop Freq – Start Freq), the analyzer uses the maximum Span the measurement allows, and still sets the Center Freq to the midpoint of the Start and Stop Freq values in the Harmonic Table. When Restore Input/Output Defaults is performed, the mixer presets to the 11970A, whose Start and Stop frequencies are 26.5 and 40 GHz respectively. The center of these two frequencies is 33.25 GHz. Therefore, after a Restore Input/Output Defaults, if you go into External Mixing and do a Mode Preset while in the Spectrum Analyzer Mode, the resulting Center Freq is 33.25 GHz.
State Saved	Saved in instrument state.
Min	The minimum frequency in the currently selected mixer band + 5 Hz
Max	The maximum frequency in the currently selected mixer band - 5 Hz If the knob or step keys are being used, also depends on the value of the other three interdependent parameters Span, Start Frequency and Stop Frequency
Initial S/W Revision	A.08.01

I/Q Center Freq

SCPI command for specifying the I/Q Center Frequency. This command will set the Center Frequency to be used when the I/Q input is selected, even if the I/Q input is not the input which is selected at the time the command is sent. Note that the

Center Freq function in the **Frequency** menu on the front panel always applies to the currently selected input.

Scope	Meas Global
Remote Command	[:SENSe] :FREQUency :IQ :CENTer <freq> [:SENSe] :FREQUency :IQ :CENTer ?
Example	FREQ:IQ:CENt: 30 MHz
Notes	This command is the same in all modes, but the parameter is Measurement Global. So the value is independent in each mode and common across all the measurements in the mode.
Preset	0 Hz
State Saved	Saved in instrument state.
Min	-40.049995 MHz
Max	40.049995 MHz
Initial S/W Revision	Prior to A.02.00

CF Step

Changes the step size for the center frequency and start and stop frequency functions. Once a step size has been selected and the center frequency function is active, the step keys (and the UP|DOWN parameters for Center Frequency from remote commands) change the center frequency by the step-size value. The step size function is useful for finding harmonics and sidebands beyond the current frequency span of the analyzer.

Note that the start and stop frequencies also step by the CF Step value.

Key Path	FREQ Channel
Remote Command	[:SENSe] :FREQUency :CENTer :STEP [:INCRement] <freq> [:SENSe] :FREQUency :CENTer :STEP [:INCRement] ? [:SENSe] :FREQUency :CENTer :STEP :AUTO OFF ON 0 1 [:SENSe] :FREQUency :CENTer :STEP :AUTO ?
Example	FREQ:CENt:STEP:AUTO ON FREQ:CENt:STEP 500 MHz FREQ:CENt UP increases the current center frequency value by 500 MHz FREQ:CENt:STEP? FREQ:CENt:STEP:AUTO?
Notes	Preset and Max values are depending on Hardware Options (503, 507, 508, 513, 526)
Notes	Preset and Max values are dependent on Hardware Options (5xx)
Dependencies	Freq Offset is not available in External Mixing. In this case the Freq Offset key is grayed out and shows a value of zero. It will once again be available, and show the previously set value, when you return to the RF Input.
Dependencies	Span, RBW, Center frequency If the electronic/soft attenuator is enabled, any attempt to change the value of the center frequency >3.6 GHz by pressing the Up-arrow key, fails and results in an advisory message. If the

	equivalent SCPI command is sent, this same message is generated as part of a “-221, Settings conflict” warning.
Couplings	When auto-coupled in a non-zero span, the center frequency step size is set to 10% of the span. When auto-coupled in zero span, the center frequency step size is set to the equivalent -3 dB RBW value.
Preset	Auto ADEMOD: 1 MHz ON
State Saved	Saved in instrument state
Min	– (the maximum frequency of the instrument). That is, 27 GHz max freq instrument has a CF step range of +/- 27 GHz. Note that this is the maximum frequency given the current settings of the instrument, so in External Mixing, for example, it is the maximum frequency of the current mixer band.
Max	The maximum frequency of the instrument. That is, 27 GHz max freq instrument has a CF step range of +/- 27 GHz. Note that this is the maximum frequency given the current settings of the instrument, so in External Mixing, for example, it is the maximum frequency of the current mixer band.
Default Unit	Hz
Status Bits/OPC dependencies	non-overlapped
Initial S/W Revision	Prior to A.02.00
Modified at S/W Revision	A.03.00

Freq Offset

Enables you to set a frequency offset value to account for frequency conversions outside of the analyzer. This value is added to the display readout of the marker frequency, center frequency, start frequency, stop frequency, and all other absolute frequency settings in the analyzer including frequency count. When a frequency offset is entered, the value appears below the center of the graticule. To eliminate an offset, perform a Mode Preset or set the frequency offset to 0 Hz.

See "[More Information](#)" on page 1643.

Key Path	FREQ Channel
Scope	Meas Global
Remote Command	[:SENSe] :FREQuency:OFFSet <freq> [:SENSe] :FREQuency:OFFSet?
Example	FREQ:OFFS 10 MHz
Notes	Preset and Max values are dependent on Hardware Options (503, 507, 508, 513, 526)
Dependencies	Freq Offset is not available in External Mixing. In this case the Freq Offset key is grayed out and shows a value of zero. However, the value of CF Offset that was set for the RF Input is retained and restored when the user switches back to the RF Input.

Preset	See " Center Frequency Presets " on page 2932
State Saved	Saved in instrument state
Min	-500 GHz
Max	500 GHz
Default Unit	Hz
Status Bits/OPC dependencies	Non-overlapped
Backwards Compatibility SCPI	DISPlay:WINDow[1]:TRACe:X[:SCALE]:OFFSet
	The DISPlay version of the command is in the instrument for compatibility across platforms and is not recommended for new development.
Backwards Compatibility Notes	<ol style="list-style-type: none"> 1. In pre-X-Series instruments, Frequency Offset could not be adjusted by the knob or step keys. That is no longer the case. 2. Some previous spectrum analyzers did not adjust frequency counter results for the Frequency Offset. The X-Series does adjust the frequency counter for the offset.
Initial S/W Revision	Prior to A.02.00
Modified at S/W Revision	A.04.00, A.08.50

More Information

This command does not affect any bandwidths or the settings of relative frequency parameters such as delta markers or span. It does not affect the current hardware settings of the analyzer, but only the displayed frequency values. Entering an offset does not affect the trace position or display, just the value of the start and stop frequency and the values represented by the trace data. The frequency values of exported trace data, queried trace data, markers, trace data used in calculations such as N dB points, trace math, etc., are all affected by Freq Offset. Changing the offset, even on a trace that is not updating will immediately change all of the above, without taking new data.

NOTE

If a trace is exported with a nonzero Freq Offset, the exported data will contain the trace data with the offset applied. Therefore, if that trace were to be imported back into the analyzer, you would want Freq Offset to be 0, or the offset would be applied again to data which is already offset. No such care need be taken when saving a State+Trace file because the data and state are saved together.

Input/Output

See ["Input/Output" on page 241](#)

Marker

Accesses a menu that enables you to select, set up and control the markers for the current measurement. Note that this hard key and all sub keys are unavailable when "**Meas Method**" on page 1721 is set to RBW.

Key Path	Front-panel key
Initial S/W Revision	Prior to A.02.00

Select Marker

Displays 12 markers available for selection. Note that this key is unavailable when "**Meas Method**" on page 1721 is set to RBW.

Key Path	Marker
Initial S/W Revision	Prior to A.02.00

Marker Type

Sets the marker control mode to **Normal**, **Delta**, **Fixed** or **Off**. All interactions and dependencies detailed under the key description are enforced when the remote command is sent. If the selected marker is Off, pressing Marker sets it to Normal and places it at the center of the screen on the trace determined by the **Marker Trace** rules. At the same time, **Marker X Axis Value** appears on the Active Function area.

The default active function is the active function for the currently selected marker control mode. If the current control mode is Off, there is no active function and the active function is turned off.

Key Path	Marker
Mode	SA, WCDMA, C2K, WIMAX OFDMA, TD-SCDMA, 1xEVDO, DVB-T/H, DTMB (CTTB), ISDB-T, CMMB, LTE, LTETDD, Digital Cable TV, MSR, LTEAFDD,LTEATDD
Remote Command	:CALCulate:ACPower:MARKer[1] 2 ... 12:MODE POSITION DELTa OFF :CALCulate:ACPower:MARKer[1] 2 ... 12:MODE?
Example	CALC:ACP:MARK2:MODE DELT CALC:ACP:MARK2:MODE?
Notes	If the selected marker is Off, pressing Marker sets it to Normal and places it at the center of the screen on the trace determined by the Marker Trace rules. At the same time, Marker X Axis Value appears on the Active Function area. Default Active Function: the active function for the selected marker's current control mode. If the current control mode is Off, there is no active function and the active function is turned off. Active Function Display: the marker X axis value entered in the active function area will display the marker value to its full entered precision. You must be in the mode that includes ACP measurements to use this command. Use :INSTrument:SElect to set the mode.
Dependencies	This key is unavailable when " Meas Method " on page 1721 is set to RBW.
Preset	OFF OFF OFF OFF OFF OFF OFF OFF OFF OFF OFF OFF

State Saved	Saved in instrument state.
Range	Normal Delta Off
Initial S/W Revision	Prior to A.02.00
Modified at S/W Revision	A.02.00, A.03.00

Properties

Accesses the marker properties menu. Note that this key is unavailable when "Meas Method" on page 1721 is set to RBW.

Key Path	Marker
Initial S/W Revision	Prior to A.02.00

Select Marker

Displays 12 markers available for selection. Note that this key is unavailable when "Meas Method" on page 1721 is set to RBW.

Key Path	Marker
Initial S/W Revision	Prior to A.02.00

Relative To

Selects the desired marker. The selected marker will be relative to its reference marker.

Key Path	Marker, Properties
Mode	SA, WCDMA, C2K, WIMAX OFDMA, TD-SCDMA, 1xEVDO, DVB-T/H, DTMB (CTTB), ISDB-T, CMMB, LTE, LTE-TDD, Digital Cable TV, MSR, LTEAFDD, LTEATDD
Remote Command	:CALCulate:ACPower:MARKer[1] 2 ... 12:REFerence <integer> :CALCulate:ACPower:MARKer[1] 2 ... 12:REFerence?
Example	CALC:ACP:MARK2:REF 6 CALC:ACP:MARK2:REF?
Notes	A marker cannot be relative to itself so that choice is grayed out, and if sent from a remote command, generates error -221: "Settings conflict; marker cannot be relative to itself." When queried a single value will be returned (the specified marker numbers relative marker). You must be in the mode that includes ACP measurements to use this command. Use :INSTrument:SElect to set the mode.
Dependencies	This key is unavailable when "Meas Method" on page 1721 is set to RBW.
Preset	2 3 4 5 6 7 8 9 10 11 12 1
State Saved	Saved in instrument state.
Min	1

Max	12
Initial S/W Revision	Prior to A.02.00
Modified at S/W Revision	A.02.00, A.03.00

Marker Trace

Selects the trace that you want your marker to be placed on. A marker is associated with one and only one trace. This trace is used to determine the placement, result, and X Axis Scale of the marker. All markers have an associated trace, even **Fixed** markers; it is from that trace that they determine their attributes and behaviors, and it is to that trace that they go when they become Normal or Delta markers.

Key Path	Marker, Properties
Mode	SA, WCDMA, C2K, WIMAX OFDMA, TD-SCDMA, 1xEVDO, DVB-T/H, DTMB (CTTB), ISDB-T, CMMB, LTE, LTETDD, Digital Cable TV, MSR, LTEAFDD, LTEATDD
Remote Command	:CALCulate:ACPower:MARKer[1] 2 ... 12:TRACe 1 2 3 :CALCulate:ACPower:MARKer[1] 2 ... 12:TRACe?
Example	CALC:ACP:MARK2:TRAC 2 CALC:ACP:MARK2:TRAC?
Notes	If the selected marker is Off, pressing Marker sets it to Normal and places it at the center of the screen on the trace determined by the Marker Trace rules. At the same time, Marker X Axis Value appears on the Active Function area. Default Active Function: the active function for the selected marker's current control mode. If the current control mode is Off, there is no active function and the active function is turned off. Active Function Display: the marker X axis value entered in the active function area will display the marker value to its full entered precision.
Dependencies	This key is unavailable when " Meas Method " on page 1721 is set to RBW.
Couplings	This is not affected by Auto Coupling. Sending the remote command causes the addressed marker to become selected.
Preset	All Markers Off
State Saved	Saved in instrument state.
Range	1 2 3
Initial S/W Revision	Prior to A.02.00
Modified at S/W Revision	A.02.00, A.03.00

Couple Markers

When this function is On, moving any marker causes an equal X axis movement of every other marker which is not **Off**. By "equal X axis movement" we mean that we preserve the difference between each marker's X axis value (in the fundamental x-axis units of the trace that marker is on) and the X axis value of the marker being moved (in the same fundamental x-axis units).

Key Path	Marker
Mode	SA, WCDMA, C2K, WIMAX OFDMA, TD-SCDMA, 1xEVDO, DVB-T/H, DTMB (CTTB), ISDB-T, CMMB, LTE, LTETDD, Digital Cable TV, MSR, LTEAFDD, LTEATDD
Remote Command	:CALCulate:ACPower:MARKer:COUPle[:STATe] ON OFF 1 0 :CALCulate:ACPower:MARKer:COUPle[:STATe]?
Example	CALC:ACP:MARK:COUP ON
Dependencies	This key is unavailable when " Meas Method " on page 1721 is set to RBW.
Preset	OFF
State Saved	Saved in instrument state.
Range	On Off
Initial S/W Revision	Prior to A.02.00
Modified at S/W Revision	A.02.00, A.03.00

Marker All Off

Turns all active markers off.

Key Path	Marker
Mode	SA, WCDMA, C2K, WIMAX OFDMA, TD-SCDMA, 1xEVDO, DVB-T/H, DTMB (CTTB), ISDB-T, CMMB, LTE, LTETDD, Digital Cable TV, MSR, LTEAFDD, LTEATDD
Remote Command	:CALCulate:ACPower:MARKer:AOFF
Example	CALC:ACP:MARK:AOFF
Dependencies	This key is unavailable when " Meas Method " on page 1721 is set to RBW.
Initial S/W Revision	Prior to A.02.00
Modified at S/W Revision	A.02.00, A.03.00

Marker X Axis Value (Remote Command only)

Sets the marker X axis value in the current marker X Axis Scale unit. This value has no effect if the control mode is **Off**, but is the SCPI equivalent of entering an X value if the control mode is **Normal**, **Delta** or **Fixed**.

Mode	SA, WCDMA, C2K, WIMAX OFDMA, TD-SCDMA, 1xEVDO, DVB-T/H, DTMB (CTTB), ISDB-T, CMMB, LTE, LTETDD, Digital Cable TV, MSR, LTEAFDD, LTEATDD
Remote Command	:CALCulate:ACPower:MARKer[1] 2 ... 12:X <freq> :CALCulate:ACPower:MARKer[1] 2 ... 12:X?
Example	CALC:ACP:MARK3:X 0 CALC:ACP:MARK3:X?
Notes	The query returns the marker's absolute X Axis value if the control mode is Normal , or the offset from the marker's reference marker if the control mode is Delta . If the marker is Off the response

	is not a number.
Dependencies	Unavailable when "Meas Method" on page 1721 is set to RBW.
Preset	After a preset, all Markers are turned OFF, so Marker X Axis Value query will return a not a number (NAN).
State Saved	No
Min	-9.9E+37
Max	9.9E+37
Initial S/W Revision	Prior to A.02.00
Modified at S/W Revision	A.02.00, A.03.00

Marker X Axis Position (Remote Command only)

Sets the marker X position in trace points. It has no effect if the control mode is **Off**, but is the SCPI equivalent of entering a value if the control mode is **Normal, Delta** or **Fixed**. The entered value is immediately translated into the current X Axis Scale units for setting the value of the marker.

Mode	SA, WCDMA, C2K, WIMAX OFDMA, TD-SCDMA, 1xEVDO, DVB-T/H, DTMB (CTTB), ISDB-T, CMMB, LTE, LTETDD, Digital Cable TV, MSR, LTEAFDD, LTEATDD
Remote Command	:CALCulate:ACPower:MARKer[1] 2 ... 12:X:POsition <real> :CALCulate:ACPower:MARKer[1] 2 ... 12:X:POsition?
Example	CALC:ACP:MARK10:X:POS 0 CALC:ACP:MARK10:X:POS?
Notes	The query returns the marker's absolute X Axis value in trace points if the control mode is Normal , or the offset from the marker's reference marker in trace points if the control mode is Delta . The value is returned as a real number, not an integer, corresponding to the translation from X Axis Scale units to trace points (see "Fractional Trace Points"). If the marker is Off the response is not a number. When a Marker is turned on, it is placed center of the screen on the trace. Therefore the default value depends on instrument condition, although the Preset/Default is defined as 500 (this value might be expected value when all offset is on).
Dependencies	Unavailable when "Meas Method" on page 1721 is set to RBW.
Preset	After a preset, all Markers are turned OFF, so Marker X Axis Value query will return a not a number (NAN).
State Saved	No
Min	-9.9E+37
Max	9.9E+37
Initial S/W Revision	Prior to A.02.00
Modified at S/W Revision	A.02.00, A.03.00

Marker Y Axis Value (Remote Command only)

Returns the marker Y axis value in the current marker Y axis unit.

Mode	SA, WCDMA, C2K, WIMAX OFDMA, TD-SCDMA, 1xEVDO, DVB-T/H, DTMB (CTTB), ISDB-T, CMMB, LTE, LTETDD, Digital Cable TV, MSR, LTEAFDD, LTEATDD
Remote Command	:CALCulate:ACPower:MARKer[1] 2 ... 12:Y?
Example	CALC:ACP:MARK11:Y?
Notes	Since the result value is always calculated from acquisition data, the default value is arbitrary. Although the Preset/Default values are defined.
Dependencies	Unavailable when "Meas Method" on page 1721 is set to RBW.
Preset	Result dependent on markers setup and signal source.
State Saved	No
Backwards Compatibility SCPI	:CALCulate:ACPower:MARKer[1] 2 ... 12:FUNCTION:RESult?
Initial S/W Revision	Prior to A.02.00
Modified at S/W Revision	A.02.00, A.03.00

Backward Compatibility Remote Commands

Sets or queries the state of a marker. Setting a marker which is off to the on state or 1 puts it in Normal mode and places it at the center of the screen.

Mode	SA, WCDMA, WIMAXOFDMA, CDMA2K, TDSCDMA, CDMA1XEV, DVB, DTMB, ISDBT, CMMB, LTE, LTETDD, DCTV, MSR, LTEAFDD, LTEATDD
Remote Command	:CALCulate:ACPower:MARKer[1] 2 ... 12:STATe OFF ON 0 1 :CALCulate:ACPower:MARKer[1] 2 ... 12:STATe?
Example	CALC:ACP:MARK2:STAT ON CALC:ACP:MARK2:STAT?
Notes	This parameter is also accessed from Marker, Properties, 1 You must be in the mode that includes ACP measurements to use this command. Use :INSTrument:SElect to set the mode.
Preset	OFF OFF OFF OFF OFF OFF OFF OFF OFF OFF OFF OFF
State Saved	Saved in instrument state.
Range	On Off
Initial S/W Revision	Prior to A.02.00
Modified at S/W Revision	A.02.00, A.03.00

Marker Function

There are no Marker Functions supported in the ACP measurement. The front-panel key will display a blank key menu when pressed.

Key Path	Front-panel key
Initial S/W Revision	Prior to A.02.00

Marker To

There is no Marker To functionality supported in ACP. The front-panel key will display a blank key menu when pressed.

Key Path	Front-panel key
Initial S/W Revision	Prior to A.02.00

Meas

The information in this section is common to all measurements. For key and remote command information for a specific measurement, refer to the section that describes the measurement of interest.

Measurements available under the Meas key are specific to the current Mode.

When viewing Help for measurements, note the following:

NOTE

Operation for some keys differs between measurements. The information displayed in Help pertains to the current measurement. To see how a key operates in a different measurement, exit Help (press the Cancel Esc key), select the measurement, then reenter Help (press the Help key) and press that key.

Key Path	Front-panel key
Initial S/W Revision	Prior to A.02.00

Remote Measurement Functions

This section contains the following topics:

["Measurement Group of Commands" on page 3141](#)

["Current Measurement Query \(Remote Command Only\)" on page 3144](#)

["Limit Test Current Results \(Remote Command Only\)" on page 3144](#)

["Data Query \(Remote Command Only\)" on page 3144](#)

["Calculate/Compress Trace Data Query \(Remote Command Only\)" on page 3144](#)

["Calculate Peaks of Trace Data \(Remote Command Only\)" on page 3150](#)

["Hardware-Accelerated Fast Power Measurement \(Remote Command Only\)" on page 3151](#)

["Format Data: Numeric Data \(Remote Command Only\)" on page 3165](#)

["Format Data: Byte Order \(Remote Command Only\)" on page 3166](#)

Initial S/W Revision	Prior to A.02.00
----------------------	------------------

Measurement Group of Commands

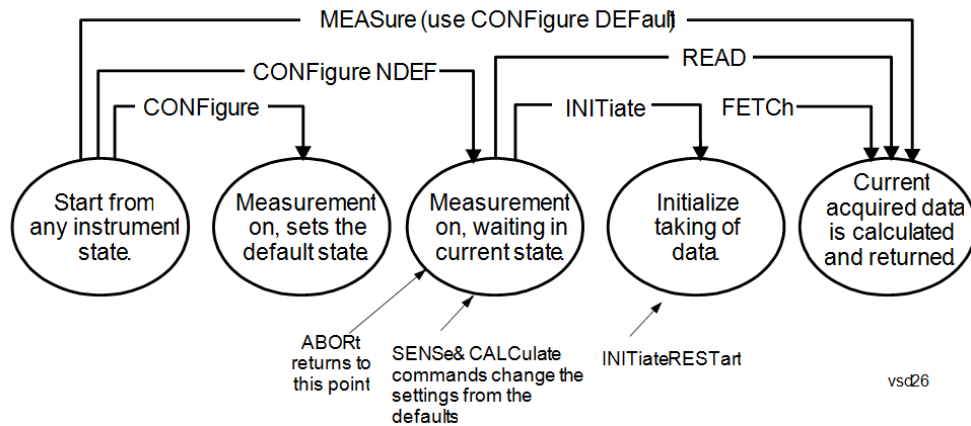

Measure Commands:

:MEASure:<measurement>[n]?

This is a fast single-command way to make a measurement using the factory default instrument settings. These are the settings and units that conform to the Mode Setup settings (e.g. radio standard) that you have currently selected.

- Stops the current measurement (if any) and sets up the instrument for the specified measurement using the factory defaults
- Initiates the data acquisition for the measurement
- Blocks other SCPI communication, waiting until the measurement is complete before returning results.
- If the function does averaging, it is turned on and the number of averages is set to 10.
- After the data is valid it returns the scalar results, or the trace data, for the specified measurement. The type of data returned may be defined by an [n] value that is sent with the command.
- The scalar measurement results will be returned if the optional [n] value is not included, or is set to 1. If the [n] value is set to a value other than 1, the selected trace data results will be returned. See each command for details of what types of scalar results or trace data results are available.
- ASCII is the default format for the data output. (Older versions of Spectrum Analysis and Phase Noise mode measurements only use ASCII.) The binary data formats should be used for handling large blocks of data since they are smaller and faster than the ASCII format. Refer to the FORMat:DATA command for more information.

If you need to change some of the measurement parameters from the factory default settings you can set up the measurement with the CONFigure command. Use the commands in the SENSE:<measurement> and CALCulate:<measurement> subsystems to change the settings. Then you can use the READ? command to initiate the measurement and query the results.

If you need to repeatedly make a given measurement with settings other than the factory defaults, you can use the commands in the SENSE:<measurement> and CALCulate:<measurement> subsystems to set up the measurement. Then use the READ? command to initiate the measurement and query results.

Measurement settings persist if you initiate a different measurement and then return to a previous one. Use READ:<measurement>? if you want to use those persistent settings. If you want to go back to the default settings, use MEASure:<measurement>?.

Configure Commands:

:CONFigure:<measurement>

This command stops the current measurement (if any) and sets up the instrument for the specified measurement using the factory default instrument settings. It does not initiate the taking of measurement data unless INIT:CONTinuous is ON. If you change any measurement settings after using the CONFigure command, the READ command can be used to initiate a measurement without changing the settings back to their defaults.

In the Swept SA measurement in Spectrum Analyzer mode the CONFigure command also turns the averaging function on and sets the number of averages to 10 for all measurements.

:CONFigure: <measurement>: NDEFault stops the current measurement and changes to the specified measurement. It does not change the settings to the defaults. It does not initiate the taking of measurement data unless INIT:CONTinuous is ON.

The CONFigure? query returns the current measurement name.

The CONFigure:CATalog? query returns a quoted string of all licensed measurement names in the current mode. For example, "SAN, CHP, OBW, ACP, PST, TXP, SPUR, SEM, LIST".

Fetch Commands:

:FETCh:<measurement>[n]?

This command puts selected data from the most recent measurement into the output buffer. Use FETCh if you have already made a good measurement and you want to return several types of data (different [n] values, for example, both scalars and trace data) from a single measurement. FETCh saves you the time of re-making the measurement. You can only FETCh results from the measurement that is currently active, it will not change to a different measurement. An error message is reported if a measurement other than the current one is specified.

If you need to get new measurement data, use the READ command, which is equivalent to an INITiate followed by a FETCh.

The scalar measurement results will be returned if the optional [n] value is not included, or is set to 1. If the [n] value is set to a value other than 1, the selected trace data results will be returned. See each command for details of what types of scalar results or trace data results are available. The binary data formats should be used for handling large blocks of data since they are smaller and transfer faster than the ASCII format. (FORMat:DATA)

FETCh may be used to return results other than those specified with the original READ or MEASure command that you sent.

INITiate Commands:

:INITiate:<measurement>

This command is not available for measurements in all the instrument modes:

- Initiates a trigger cycle for the specified measurement, but does not output any data. You must then use the FETCh<meas> command to return data. If a

measurement other than the current one is specified, the instrument will switch to that measurement and then initiate it.

- For example, suppose you have previously initiated the ACP measurement, but now you are running the channel power measurement. If you send INIT:ACP? it will change from channel power to ACP and will initiate an ACP measurement.
- Does not change any of the measurement settings. For example, if you have previously started the ACP measurement and you send INIT:ACP? it will initiate a new ACP measurement using the same instrument settings as the last time ACP was run.
- If your selected measurement is currently active (in the idle state) it triggers the measurement, assuming the trigger conditions are met. Then it completes one trigger cycle. Depending upon the measurement and the number of averages, there may be multiple data acquisitions, with multiple trigger events, for one full trigger cycle. It also holds off additional commands on GPIB until the acquisition is complete.

READ Commands:

:READ:<measurement>[n]?

- Does not preset the measurement to the factory default settings. For example, if you have previously initiated the ACP measurement and you send READ:ACP? it will initiate a new measurement using the same instrument settings.
 - Initiates the measurement and puts valid data into the output buffer. If a measurement other than the current one is specified, the instrument will switch to that measurement before it initiates the measurement and returns results.
 - For example, suppose you have previously initiated the ACP measurement, but now you are running the channel power measurement. Then you send READ:ACP? It will change from channel power back to ACP and, using the previous ACP settings, will initiate the measurement and return results.
 - Blocks other SCPI communication, waiting until the measurement is complete before returning the results
 - If the optional [n] value is not included, or is set to 1, the scalar measurement results will be returned. If the [n] value is set to a value other than 1, the selected trace data results will be returned. See each command for details of what types of scalar results or trace data results are available. The binary data formats should be used when handling large blocks of data since they are smaller and faster than the ASCII format. (FORMat:DATA)
-

Current Measurement Query (Remote Command Only)

This command returns the name of the measurement that is currently running.

Remote Command	:CONFiGure?
Example	CONF?
Initial S/W Revision	Prior to A.02.00

Limit Test Current Results (Remote Command Only)

Queries the status of the current measurement limit testing. It returns a 0 if the measured results pass when compared with the current limits. It returns a 1 if the measured results fail any limit tests.

Remote Command	:CALCuLate:CLIMits:FAIL?
Example	CALC:CLIM:FAIL? queries the current measurement to see if it fails the defined limits. Returns a 0 or 1: 0 it passes, 1 it fails.
Initial S/W Revision	Prior to A.02.00

Data Query (Remote Command Only)

Returns the designated measurement data for the currently selected measurement and subopcode.

n = any valid subopcode for the current measurement. See the measurement command results table for your current measurement, for information about what data is returned for the subopcodes.

This command uses the data setting specified by the FORMat:BORDER and FORMat:DATA commands and can return real or ASCII data. (See the format command descriptions under Input/Output in the Analyzer Setup section.)

Remote Command	:CALCuLate:DATA[n]?
Notes	The return trace depends on the measurement. In CALCulate:<meas>:DATA[n], n is any valid subopcode for the current measurement. It returns the same data as the FETCh:<measurement>? query where <measurement> is the current measurement.
Initial S/W Revision	Prior to A.02.00

Calculate/Compress Trace Data Query (Remote Command Only)

Returns compressed data for the currently selected measurement and sub-opcode [n].

n = any valid sub-opcode for that measurement. See the MEASure:<measurement>? command description of your specific measurement for information on the data that can be returned.

The data is returned in the current Y Axis Unit of the analyzer. The command is used with a sub-opcode <n> (default=1) to specify the trace. With trace queries, it is best if the analyzer is not sweeping during the query. Therefore, it is generally advisable to be in Single Sweep, or Update=Off.

This command is used to compress or decimate a long trace to extract and return only the desired data. A typical example would be to acquire N frames of GSM data and return the mean power of the first burst in each frame. The command can also be used to identify the best curve fit for the data.

Remote Command	:CALCulate:DATA<n>:COMPRESS? BLOCK CFIT MAXimum MINimum MEAN DMEan RMS RMSCubed SAMPLE SDEVIation PPHase [,<soffset> [,<length>[,<roffset>[,<rlimit>]]]]
Example	To query the mean power of a set of GSM bursts: Supply a signal that is a set of GSM bursts. Select the IQ Waveform measurement (in IQ Analyzer Mode). Set the sweep time to acquire at least one burst. Set the triggers such that acquisition happens at a known position relative to a burst. Then query the mean burst levels using, CALC:DATA2:COMP? MEAN, 24e-6, 526e-6 (These parameter values correspond to GSM signals, where 526e-6 is the length of the burst in the slot and you just want 1 burst.)
Notes	The command supports 5 parameters. Note that the last 4 (<soffset>, <length>, <roffset>, <rlimit>) are optional. But these optional parameters must be entered in the specified order. For example, if you want to specify <length>, then you must also specify <soffset>. See details below for a definition of each of these parameters. This command uses the data in the format specified by FORMat:DATA, returning either binary or ASCII data.
Initial S/W Revision	Prior to A.02.00

- BLOCK or block data - returns all the data points from the region of the trace data that you specify. For example, it could be used to return the data points of an input signal over several timeslots, excluding the portions of the trace data that you do not want. (This is x,y pairs for trace data and I,Q pairs for complex data.)
- CFIT or curve fit - applies curve fitting routines to the data. <soffset> and <length> are required to define the data that you want. <roffset> is an optional parameter for the desired order of the curve equation. The query will return the following values: the x-offset (in seconds) and the curve coefficients ((order + 1) values).

MIN, MAX, MEAN, DME, RMS, RMSC, SAMP, SDEV and PPH return one data value for each specified region (or <length>) of trace data, for as many regions as possible until you run out of trace data (using <roffset> to specify regions). Or they return the number of regions you specify (using <rlimit>) ignoring any data beyond that.

- MINimum - returns the minimum data point (y value) for the specified region (s) of trace data. For I/Q trace data, the minimum magnitude of the I/Q pairs is returned.
- MAXimum - returns the maximum data point (y value) for the specified region(s) of trace data. For I/Q trace data, the maximum magnitude of the I/Q pairs is returned.
- MEAN - returns a single value that is the arithmetic mean of the data point values (in dB/ dBm) for the specified region(s) of trace data. For I/Q trace data, the mean of the magnitudes of the I/Q pairs is returned. See the following equations.

NOTE

If the original trace data is in dB, this function returns the arithmetic mean of those log values, not log of the mean power which is a more useful value. The mean of the log is the better measurement technique when measuring CW signals in the presence of noise. The mean of the power, expressed in dB, is useful in power measurements such as Channel Power. To achieve the mean of the power, use the RMS option.

Equation 1

Mean Value of Data Points for Specified Region(s)

$$MEAN = \frac{1}{n} \sum_{X_i \in \text{region}(s)} X_i$$

where X_i is a data point value, and n is the number of data points in the specified region(s).

Equation 2

Mean Value of I/Q Data Pairs for Specified Region(s)

$$MEAN = \frac{1}{n} \sum_{X_i \in \text{region}(s)} |X_i|$$

where $|X_i|$ is the magnitude of an I/Q pair, and n is the number of I/Q pairs in the specified region(s).

- DMEan - returns a single value that is the mean power (in dB/ dBm) of the data point values for the specified region(s) of trace data. See the following

equation:

Equation 3

DMEan Value of Data Points for Specified Region(s)

$$\text{DME} = 10 \times \log_{10} \left(\frac{1}{n} \sum_{X_i \in \text{region}(s)} 10^{\frac{X_i}{10}} \right)$$

- RMS - returns a single value that is the average power on a root-mean-squared voltage scale (arithmetic rms) of the data point values for the specified region(s) of trace data. See the following equation.

NOTE

For I/Q trace data, the rms of the magnitudes of the I/Q pairs is returned. See the following equation.

This function is very useful for I/Q trace data. However, if the original trace data is in dB, this function returns the rms of the log values which is not usually needed.

Equation 4

RMS Value of Data Points for Specified Region(s)

$$\text{RMS} = \sqrt{\frac{1}{n} \sum_{X_i \in \text{region}(s)} X_i^2}$$

where X_i is a data point value, and n is the number of data points in the specified region(s).

Equation 5

RMS Value of I/Q Data Pairs for Specified Region(s)

$$\text{RMS} = \sqrt{\frac{1}{n} \sum_{X_i \in \text{region}(s)} X_i X_i^*}$$

where X_i is the complex value representation of an I/Q pair, X_i^* its conjugate complex number, and n is the number of I/Q pairs in the specified region(s).

Once you have the rms value for a region of trace data (linear or I/Q), you may want to calculate the mean power. You must convert this rms value (peak volts) to power in dBm:

$$10 \times \log[10 \times (\text{rms value})^2]$$

- SAMPlE - returns the first data value (x,y pair) for the specified region(s) of trace data. For I/Q trace data, the first I/Q pair is returned.
- SDEVIation - returns a single value that is the arithmetic standard deviation for the data point values for the specified region(s) of trace data. See the following equation.
- For I/Q trace data, the standard deviation of the magnitudes of the I/Q pairs is returned. See the following equation.

Equation 6

Standard Deviation of Data Point Values for Specified Region(s)

$$SDEV = \sqrt{\frac{1}{n} \sum_{X_i \in \text{region}(s)} (X_i - \bar{X})^2}$$

where X_i is a data point value, \bar{X} is the arithmetic mean of the data point values for the specified region(s), and n is the number of data points in the specified region(s).

$$SDEV = \sqrt{\frac{1}{n} \sum_{X_i \in \text{region}(s)} (|X_i| - \bar{X})^2}$$

where $|X_i|$ is the magnitude of an I/Q pair, \bar{X} is the mean of the magnitudes for the specified region(s), and n is the number of data points in the specified region(s).

- PPHase - returns the x,y pairs of both rms power (dBm) and arithmetic mean phase (radian) for every specified region and frequency offset (Hz). The number of pairs is defined by the specified number of regions. This parameter can be used for I/Q vector (n=0) in Waveform (time domain) measurement and all parameters are specified by data point in PPHase.

The rms power of the specified region may be expressed as:

$$\text{Power} = 10 \times \log [10 \times (\text{RMS I/Q value})] + 10.$$

The RMS I/Q value (peak volts) is:

$$\sqrt{\frac{1}{n} \sum_{X_i \in \text{region}} X_i X_i^*}$$

where X_i is the complex value representation of an I/Q pair, X_i^* its conjugate complex number, and n is the number of I/Q pairs in the specified region.

The arithmetic mean phase of the specified region may be expressed as:

$$\frac{1}{n} \sum_{Y_i \in \text{region}} Y_i$$

where Y_i is the unwrapped phase of I/Q pair with applying frequency correction and n is the number of I/Q pairs in the specified region.

The frequency correction is made by the frequency offset calculated by the arithmetic mean of every specified region's frequency offset. Each frequency offset is calculated by the least square method against the unwrapped phase of I/Q pair.

Sample Trace Data - Constant Envelope

(See below for explanation of variables.)

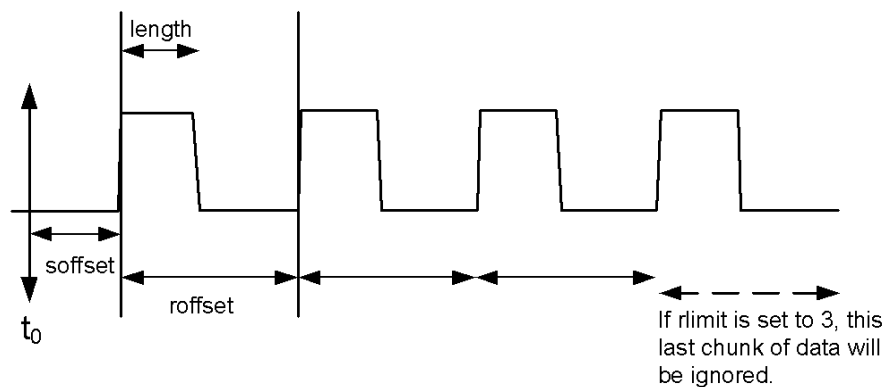

Sample Trace Data - Not Constant Envelope

(See below for explanation of variables.)

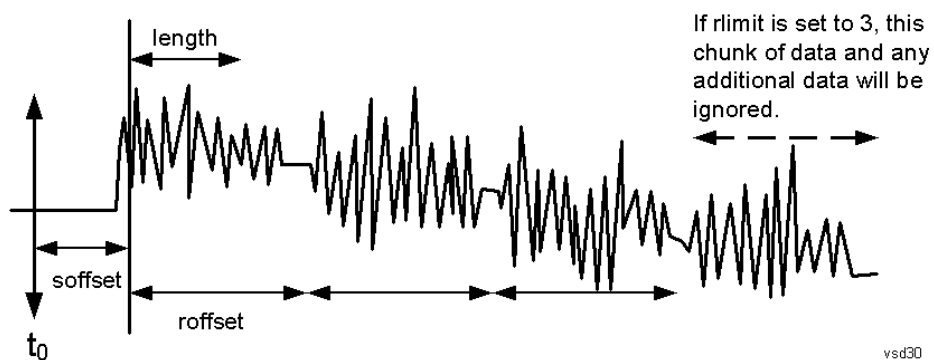

<soffset> - start offset is an optional real number. (It is in seconds for time-domain traces, and is a dimensionless index 0 to $N_{\text{points}} - 1$, for frequency-domain traces). It specifies the amount of data at the beginning of the trace that will be ignored before the decimation process starts. It is the time or frequency change from the start of the trace to the point where you want to start using the data. The default value is zero.

<length> - is an optional real number. (It is in seconds for time-domain traces, and is a dimensionless index 0 to Npoints - 1, for frequency-domain traces). It defines how much data will be compressed into one value. This parameter has a default value equal to the current trace length.

<roffset> - repeat offset is an optional real number. (It is in seconds for time-domain traces, and is a dimensionless index 0 to Npoints - 1, for frequency-domain traces). It defines the beginning of the next field of trace elements to be compressed. This is relative to the beginning of the previous field. This parameter has a default value equal to the <length> variable. Note that this parameter is used for a completely different purpose when curve fitting (see CFIT above).

<rlimit> - repeat limit is an optional integer. It specifies the number of data items that you want returned. It will ignore any additional items beyond that number. You can use the Start offset and the Repeat limit to pick out exactly what part of the data you want to use. The default value is all the data.

Calculate Peaks of Trace Data (Remote Command Only)

Returns a list of all the peaks for the currently selected measurement and sub-opcode [n]. The peaks must meet the requirements of the peak threshold and excursion values.

n = any valid sub-opcode for the current measurement. See the MEASure:<measurement> command description of your specific measurement for information on the data that can be returned.

The command can only be used with specific sub-opcodes with measurement results that are trace data. Both real and complex traces can be searched, but complex traces are converted to magnitude in dBm. In many measurements the sub-opcode n=0, is the raw trace data which cannot be searched for peaks. And Sub-opcode n=1, is often calculated results values which also cannot be searched for peaks.

This command uses the data setting specified by the FORMat:BORDER and FORMat:DATA commands and can return real or ASCII data. If the format is set to INT,32, it returns REAL,32 data.

The command has four types of parameters:

- Threshold (in dBm)
- Excursion (in dB)
- Sorting order (amplitude, frequency, time)
- Optional in some measurements: Display line use (all, > display line, < display line)

Remote Command

For Swept SA measurement:

```
:CALCulate:DATA[1]|2|...|6:PEAKS? <threshold>,<excursion>[,AMPLitude  
| FREQuency | TIME[,ALL | GTDLine | LTDLine]]
```

For most other measurements:

	<code>:CALCulate:DATA[1] 2 ... 6:PEAKs? <threshold>,<excursion>[,AMPLitude FREQUENCY TIME]</code>
Example	<p>Example for Swept SA measurement in Spectrum Analyzer Mode:</p> <p>CALC:DATA4:PEAK? -40, 10, FREQ, GTDL This will identify the peaks of trace 4 that are above -40 dBm, with excursions of at least 10 dB. The peaks are returned in order of increasing frequency, starting with the lowest frequency. Only the peaks that are above the display line are returned.</p> <p>Query Results 1:</p> <p>With FORMat:DATA REAL, 32 selected, it returns a list of floating-point numbers. The first value in the list is the number of peak points that are in the following list. A peak point consists of two values: a peak amplitude followed by its corresponding frequency (or time).</p> <p>If no peaks are found the peak list will consist of only the number of peaks, (0).</p>
Notes	<p><n> - is the trace that will be used</p> <p><threshold> - is the level below which trace data peaks are ignored. Note that the threshold value is required and is always used as a peak criterion. To effectively disable the threshold criterion for this command, provide a substantially low threshold value such as -200 dBm. Also note that the threshold value used in this command is independent of and has no effect on the threshold value stored under the Peak Criteria menu.</p> <p><excursion> - is the minimum amplitude variation (rise and fall) required for a signal to be identified as peak. Note that the excursion value is required and is always used as a peak criterion. To effectively disable the excursion criterion for this command, provide the minimum value of 0.0 dB. Also note that the excursion value used in this command is independent of and has no effect on the excursion value stored under the Peak Criteria menu.</p> <p>Values must be provided for threshold and excursion. The sorting and display line parameters are optional (defaults are AMPLitude and ALL).</p> <p>Note that there is always a Y-axis value for the display line, regardless of whether the display line state is on or off. It is the current Y-axis value of the display line which is used by this command to determine whether a peak should be reported</p> <p>Sorting order:</p> <p>AMPLitude - lists the peaks in order of descending amplitude, with the highest peak first (default if optional parameter not sent)</p> <p>FREQUENCY - lists the peaks in order of occurrence, left to right across the x-axis.</p> <p>TIME - lists the peaks in order of occurrence, left to right across the x-axis.</p> <p>Peaks vs. Display Line:</p> <p>ALL - lists all of the peaks found (default if optional parameter not sent).</p> <p>GTDLLine (greater than display line) - lists all of the peaks found above the display line.</p> <p>LTDLine (less than display line) - lists all of the peaks found below the display line.</p>
Initial S/W Revision	Prior to A.02.00

Hardware-Accelerated Fast Power Measurement (Remote Command Only)

The Fast Power option (FP2) enables very fast channel power measurements for instruments with the prerequisite hardware (DP2 and/or B40). It accomplishes this by performing real-time overlapped FFTs at the hardware layer, using software for basic post-processing before returning the result to the user. The upshot of this

approach is improved throughput for user applications that require many sequential power measurements.

The analysis bandwidth of FP2 is limited by the licenses in the instrument, but its maximum overall analysis bandwidth per acquisition is 40 MHz.

FP2 is remote-only, which means the instrument does not switch to any particular mode or measurement. FP2 commands can be sent while another application is in use on the front panel.

Each Fast Power measurement can be predefined using an array index, and up to 1,000 measurements can be stored. In the following documentation, instances of [1,2,...,999] can be substituted with a particular measurement index, e.g. CALC:FPOW:POW1?, CALC:FPOW:POW2?, CALC:FPOW:POW134?. In this way, power measurements can be defined one time in a batch, and then executed multiple times without having to redefine them, similar to “list mode” on other measurements.

In addition to basic channel power measurements, there are a number of other measurement “functions” for each channel, including peak power, peak frequency, and power spectral density. See the Function parameter for more information.

Reset Fast Power Measurement (Remote Command Only)

Resets the measurement configuration to the defaults.

Mode	All
Remote Command	:CALCulate:FPOWer:POWer[1,2,...,999]:RESet
Example	:CALC:FPOW:POW1:RES
Notes	Option FP2 is required.
Initial S/W Revision	A.14.00

Define Fast Power Measurement (Remote Command Only)

Fast Power acquisitions are configured using the DEFine command. This command accepts a comma-delimited string of configuration parameters and their appropriate values, which are all specified in the subsection below.

Mode	All
Remote Command	:CALCulate:FPOWer:POWer[1,2,...,999]:DEFine "configuration string"
Example	:CALC:FPOW:POW1:DEF "CenterFrequency=2e9, AcquisitionTime=0.005"
Notes	See below for a list of measurement variables that can be defined in the configuration string.
Initial S/W Revision	A.14.00

Acquisition Time

Example	CALC:FPOW:POW1:DEF "AcquisitionTime=0.002"
Notes	The acquisition time parameter sets the time in which the entire spectrum is measured. An increase in the acquisition time yields an improvement in measurement repeatability.
Preset	0.001 s
Range	0 s to 1 s
Default Unit	Time (s)
Initial S/W Revision	A.14.00

Center Frequency

Example	CALC:FPOW:POW1:DEF "CenterFrequency=2e9"
Notes	The center frequency parameter sets the frequency in which the measurement is centered around. The OffsetFrequency parameter is calculated relative to the center frequency.
Preset	1 GHz
Range	0 Hz to maximum instrument frequency
Default Unit	Frequency (Hz)
Initial S/W Revision	A.14.00

DC Coupled

Example	CALC:FPOW:POW1:DEF "DCCoupled=True"
Notes	The DC coupled parameter allows the user to specify whether the DC blocking capacitor is utilized. Set parameter to true when measuring frequencies below 10 MHz.
Preset	False
Range	True (DC Coupled) or False (AC Coupled)
Default Unit	Boolean
Initial S/W Revision	A.14.00

DetectorType

Example	CALC:FPOW:POW1:DEF "DetectorType=Peak"
Notes	Option FP2 is required. The detector type parameter allows the user to choose whether a RMS average or peak value is used during the measurement.
Preset	RmsAverage
Range	RmsAverage, Peak
Initial S/W Revision	A.14.00

Do Noise Correction

Example	CALC:FPOW:POW1:DEF "DoNoiseCorrection=True"
Notes	<p>When noise correction is enabled, the linear noise power contributed by the analyzer is subtracted from all measurements. This effectively lowers the noise floor of the analyzer.</p> <p>When noise correction is enabled, the first measurement for a given set of input parameters will take extra time. This is because the analyzer takes an extra acquisition with the RF input disconnected from the analyzer's front end to measure the noise of just the analyzer. The measured noise floor is stored in a cache so the noise acquisition will occur only once for the same state settings. In other words, if noise correction was turned on and the analyzer made an acquisition at frequency A, then frequency B, and back again to frequency A, the hidden initial noise floor acquisition would only occur for the first acquisition at frequency A and the cached noise floor would be used the second time frequency A was measured.</p>
Preset	False
Range	True (enable noise correction) or False (disable noise correction)
Default Unit	Boolean
Initial S/W Revision	A.14.00

Do Spur Suppression

Example	CALC:FPOW:POW1:DEF "DoSpurSuppression=True"
Notes	<p>When measuring very low level signals, or when large out-of-band inputs are input into the analyzer, sometimes unwanted spurs and residuals can appear in the measured spectrum. Spur suppression is a method to help minimize the levels of these internally generated spurs and residuals.</p> <p>When spur suppression is enabled, the analyzer will automatically take two acquisitions using two different internal analog LO frequencies. The FFT spectrums from both acquisitions are combined by taking the minimum power between both traces on a per FFT bin basis. External signals will have the same amplitude for both traces and therefore will return the expected amplitudes. However, low level spurs and residuals generated internally to the analyzer tend to move to different FFT bins depending on the internal analog LO frequency used, and therefore tend to be suppressed using this spur suppression method.</p> <p>Because two acquisitions, rather than a single acquisition, are made when spur suppression is enabled, the measurement time will always be slower when spur suppression is enabled.</p>
Preset	False
Range	True (enable spur suppression) or False (disable spur suppression)
Default Unit	Boolean
Initial S/W Revision	A.14.00

Electronic Attenuator Bypass

Example	CALC:FPOW:POW1:DEF "ElecAttBypass =False"
---------	---

Notes	The electronic attenuation bypass parameter allows the user to either utilize or bypass the electronic attenuator. The electronic attenuator is only available for frequencies up to 3.6 GHz. Set parameter to true when using frequencies above 3.6 GHz and set the parameter to false when using the preamp.
Preset	True
Range	True (bypass electronic attenuator) or False (use electronic attenuator)
Default Unit	Boolean
Initial S/W Revision	A.14.00

Electronic Attenuation

Example	CALC:FPOW:POW1:DEF "ElecAttenuation=10"
Notes	Option EA3 is required. The electronic attenuation value parameter sets the amount of electrical attenuation from 0 to 24 dB (1 dB steps). Set "ElecAttBypass=False" to make sure the electronic attenuator path is enabled.
Preset	0 dB
Range	0 – 24 dB (1 dB steps)
Default Unit	dB
Initial S/W Revision	A.14.00

IF Gain

Example	CALC:FPOW:POW1:DEF "IFGain=10"
Notes	The IF gain parameter allows the user to specify the gain at the IF stage anywhere from -6 to 16 dB (1 dB steps). This is an advanced feature, and for most cases this should remain at its default value of 0 dB.
Preset	0 dB
Range	-6 – 16 dB (1 dB steps)
Default Unit	dB
Initial S/W Revision	A.14.00

IF Type

Example	CALC:FPOW:POW1:DEF "IFType=B25M"
Notes	The IF type parameter allows the user to select between different IF paths. For example, if the signal is less than 25 MHz wide, then the user can select the B25M path to take advantage of additional filtering on this analog IF path.

Preset	B40M
Range	B10M, B25M, B40M
Initial S/W Revision	A.14.00

Include Power Spectrum

Example	CALC:FPOW:POW1:DEF "IncludePowerSpectrum=True"
Notes	The power spectrum parameter allows the user to read data on the entire spectrum for diagnostic purposes. It is not recommended for production use. See CALC:FPOW:POW[n]:READ2? for details on the binary format of the response.
Preset	False
Range	True (return both channel power and full power spectrum) or False (returns only channel power)
Default Unit	Boolean
Initial S/W Revision	A.14.00

Mechanical Attenuation

Example	CALC:FPOW:POW1:DEF "MechAttenuation=10"
Notes	The mechanical attenuation value parameter sets the amount of mechanical attenuation anywhere from 0 to 70 dB (2 dB steps).
Preset	0 dB
Range	0 – 70 dB (2 dB steps)
Default Unit	dB
Initial S/W Revision	A.14.00

Preamp Mode

Example	CALC:FPOW:POW1:DEF "PreAmpMode=Low"
Notes	The license for the appropriate preamp is required. The preamp mode parameter specifies whether the preamps are being utilized. Low allows any preamps up to 3.6 GHz, and Full allows all licensed preamps. Set "ElecAttBypass=True" in order to utilize any preamps.
Preset	Off
Range	Off, Low, Full
Initial S/W Revision	A.14.00

Resolution Bandwidth Mode

Example	CALC:FPOW:POW1:DEF "PreAmpMode=Low"
Notes	The resolution bandwidth mode parameter allows the user to choose whether the RBW filter is automatically or manually set. The BestSpeed value minimizes measurement time, while the Narrowest value minimizes RBW size (minimum of two FFT bins per RBW). To manually specify an RBW, set this parameter to Explicit, and set the ResolutionBW parameter to the desired value.
Preset	BestSpeed
Range	BestSpeed, Narrowest, Explicit
Initial S/W Revision	A.14.00

Resolution Bandwidth

Example	CALC:FPOW:POW1:DEF "ResolutionBW=25e3"
Notes	The resolution bandwidth parameter sets the 3-dB bandwidth of the RBW filter. The ResolutionBWMode parameter must be set to Explicit in order to manually set the RBW.
Preset	0 Hz
Default Unit	Hz
Initial S/W Revision	A.14.00

Trigger Delay

Example	CALC:FPOW:POW1:DEF "TriggerDelay=0.025"
Notes	The trigger delay parameter sets the time after an external trigger is detected until the measurement is performed.
Preset	0 s
Range	0 – 1 s
Default Unit	Seconds
Initial S/W Revision	A.14.00

Trigger Level

Example	CALC:FPOW:POW1:DEF "TriggerLevel=2"
Notes	The trigger level parameter sets the voltage value at which an external trigger is detected.
Preset	1.2 V
Range	-5 to 5 V
Default Unit	Volts
Initial S/W Revision	A.14.00

Trigger Slope

Example	CALC:FPOW:POW1:DEF "TriggerSlope=Negative"
Notes	The trigger slope parameter indicates the direction of the edge trigger voltage for detection.
Preset	Positive
Range	Positive, Negative
Initial S/W Revision	A.14.00

Trigger Source

Example	CALC:FPOW:POW1:DEF "TriggerSource=Ext1"
Notes	The trigger source parameter allows the user to choose between measurement's triggering freely or controlled by an external input. Ext1 and Ext2 correspond to Trigger 1 In and Trigger 2 In, respectively.
Preset	Free
Range	Free, Ext1, Ext2
Initial S/W Revision	A.14.00

Trigger Timeout

Example	CALC:FPOW:POW1:DEF "TriggerTimeout=0.1"
Notes	The trigger timeout parameter sets the time in which the analyzer will wait for a trigger before automatically performing the measurement.
Preset	1 s
Range	0 – 1 s
Default Unit	Seconds
Initial S/W Revision	A.14.00

Signal Input

Example	CALC:FPOW:POW1:DEF "SignalInput=Fp50MHzCW"
Notes	The signal input parameter allows the user to select between using the main RF input or the internal analyzer reference CW signal of 50 MHz.
Preset	FpMainRf
Range	FpMainRf, Fp50MHzCW
Initial S/W Revision	A.14.00

Use Preselector

Example	CALC:FPOW:POW1:DEF "UsePreSelector=True"
Notes	The preselector parameter allows the user to either utilize or bypass the front end tunable filter at frequencies above 3.6 GHz. For frequencies below 3.6 GHz, the preselector is automatically bypassed, so you do not need to set this parameter to False in those cases.
Preset	False
Range	True (use preselector above 3.6 GHz), or False (preselector bypassed)
Default Unit	Boolean
Initial S/W Revision	A.14.00

Channel Bandwidth Array

Example	CALC:FPOW:POW1:DEF "Bandwidth=[3.84e6, 5e6, 3.84e6]"
Notes	The bandwidth parameter array defines the bandwidth of each channel that will be measured. All array parameters should have the same number of elements. Alternatively, if all the elements are the same value, a single number with no square brackets can be used to define the parameter.
Preset	[1e6]
Range	0 to 40 MHz
Default Unit	Hz
Initial S/W Revision	A.14.00

Channel Filter Type Array

Example	CALC:FPOW:POW1:DEF "FilterType=[RRC, IBW, RRC]"
Notes	The filter type parameter allows the user to choose between an integration bandwidth (IBW) filter or a root-raised-cosine (RRC) filter. The integration bandwidth filter weighs all frequencies within the bandwidth equally. The root-raised-cosine filter has an associated shape parameter, defined by the FilterAlpha parameter. All array parameters should have the same number of elements. Alternatively, if all the elements are the same value, a single value with no square brackets can be used to define the parameter.
Preset	[IBW]
Range	IBW, RRC
Initial S/W Revision	A.14.00

Channel Filter Alpha Array

Example	CALC:FPOW:POW1:DEF "FilterAlpha=[0.5, 0.0, 0.5]"
Notes	The filter alpha parameter allows the user to adjust the alpha value associated with the root-

	raised-cosine (RRC) filter type. Set FilterType to RRC in order to utilize this parameter. All array parameters should have the same number of elements. Alternatively, if all the elements are the same value, a single number with no square brackets can be used to define the parameter.
Preset	[0.22]
Range	0.0 – 1.0
Initial S/W Revision	A.14.00

Channel Measurement Function Array

Example	CALC:FPOW:POW1:DEF "Function=[BandPower, PeakPower, BandPower]"
Notes	This parameter array defines what measurement is being made for each individually-specified channel: BandPower: Total power within the specified bandwidth of the channel (dBm) BandDensity: Total power density within the specified bandwidth of the channel (dBm/Hz) PeakPower: The peak power value within the specified bandwidth of the channel (dBm) PeakFrequency: The frequency which corresponds to the peak power value within the specified bandwidth of the channel. This frequency is relative to the center frequency (Hz) XdBBandwidth: The half power (-3.01 dB) bandwidth of the highest amplitude signal that resides within the channel (Hz), dB is configurable using XdBBandwidth parameter OccupiedBandwidth: The bandwidth at which 99% of the total power resides within the channel (Hz), percentage configurable using OccupiedBandwidthPercent parameter All array parameters should have the same number of elements. Alternatively, if all the elements are the same value, a single value with no square brackets can be used to define the parameter.
Preset	[BandPower]
Range	BandPower, BandDensity, PeakPower, PeakFrequency, XdBBandwidth, OccupiedBandwidth
Initial S/W Revision	A.14.00

Channel Offset Frequency Array

Example	CALC:FPOW:POW1:DEF "OffsetFrequency=[-5e6, 0, 5e6]"
Notes	The offset frequency parameter array defines the difference between the center frequency to the center frequency of each channel. All array parameters should have the same number of elements.
Preset	[0]
Range	0 to 20 MHz
Default Unit	Hz
Initial S/W Revision	A.14.00

Channel Occupied Bandwidth Percent Array

Example	CALC:FPOW:POW1:DEF "OccupiedBandwidthPercent =[0.95, 0.95, 0.95]"
Notes	This parameter only applies for channels whose Function is set to OccupiedBandwidth. The occupied bandwidth percent parameter specifies the percent of total power in these channels. The valid range for this parameter is 0.0 to 1.0, where 1.0 represents 100%. The default for this parameter is 0.99, which will return the bandwidth that contains 99% of the total channel power.
Preset	[0.99]
Range	0 – 1.0
Initial S/W Revision	A.14.00

Channel x-dB Bandwidth Array

Example	CALC:FPOW:POW1:DEF "XdBBandwidth =[-6.02, -3.01, -1.0]"
Notes	This parameter only applies for channels whose Function is set to XdBBandwidth. The X dB bandwidth parameter is used to specify the power relative to the peak channel power over which the bandwidth is calculated. The parameter value must be a negative number.
Preset	[-3.01]
Range	-200 to 0 dB
Default Unit	dB
Initial S/W Revision	A.14.00

Define Fast Power Measurement Query (Remote Command Only)

The DEFine? command is used to retrieve a list of all defined parameters in an ASCII string format

```

M All
o
d
e
R :CALCulate:FPOwer:POWer[1,2,...,999]:DEFine?
e
m
o
t
e
C
o
m
m
a
n

```

d

E :CALC:FPOW:POW1:DEF?

**x
a
m
p
l
e**

N This command query is used to retrieve a list of all defined parameters in an ASCII format.

O The following is an example of the returned results:

t "DCCoupled=False,ElecAttBypass=True,ElecAttenuation=0,IFGain=0,MechAttenuation=0,PreAmpMode=Off,PreSelectorOf
e fset=0,UsePreSelector=False,ExternalReferenceFrequency=10000000,FrequencyReferenceSource=AutoExternalFrequenc
s yReference,IFType=B40M,LOMode=SLW,SignalInput=FpMainRf,AcquisitionTime=0.001,CenterFrequency=1000000000,Re
solutionBW=0,ResolutionBWMode=BestSpeed,DetectorType=RmsAverage,Bandwidth=[1000000],OffsetFrequency=
[0],Function=[BandPower],FilterType=[BW],FilterAlpha=[0.22],OccupiedBandwidthPercent=[0.99],XdBBandwidth=[-
3.01],DoNoiseCorrection=False,DoSpurSuppression=False,MeasurementMethod=HardwareFFT,IncludePowerSpectrum=F
alse,TriggerDelay=0,TriggerLevel=1.2,TriggerSlope=Positive,TriggerSource=Free,TriggerTimeout=1"

I A.14.00

**n
i
t
i
a
l**

**S
/
W**

**R
e
v
i
s
i
o
n**

Configure Fast Power Measurement (Remote Command Only)

The configure command begins hardware setup and returns immediately, with no acquisition made. This can be used in parallel with other hardware operations to effectively hide the hardware setup time.

Mode	All
Remote Command	:CALCulate:FPOWer:POWer[1,2,...,999]:CONFigure
Example	:CALC:FPOW:POW1:CONF

Notes	Option FP2 is required.
Initial S/W Revision	A.14.00

Initiate Fast Power Measurement (Remote Command Only)

The INITiate command begins an acquisition and returns immediately. The results of the measurement can be retrieved using FETCh.

Mode	All
Remote Command	:CALCulate:FPOWer:POWer[1,2,...,999]:INITiate
Example	:CALC:FPOW:POW1:INIT
Notes	Option FP2 is required.
Initial S/W Revision	A.14.00

Fetch Fast Power Measurement (Remote Command Only)

The FETCh command query is used to retrieve the results of an acquisition initiated by the INIT command. The returned results are in ASCII string format. The string begins and ends with quotation marks.

Mode	All
Remote Command	:CALCulate:FPOWer:POWer[1,2,...,999]:FETCh?
Example	:CALC:FPOW:POW1:FETC?
Notes	Option FP2 is required. Returns m comma-separated ASCII values, where m corresponds to the number of bandwidths defined. 1. Declared function return in the 1st specified channel 2. Declared function return in the 2nd specified channel ... m. Declared function return in the last specified channel The INIT and FETC? command sequence performs the same functionality of a single CALC:FPOW:POW[n]? query. Units of the returned values are dependent on the Function parameter for each channel.
Initial S/W Revision	A.14.00

Execute Fast Power Measurement (Remote Command Only)

This command query is used as shorthand for an INIT command immediately followed by a FETC? command. The returned results are in ASCII string format. The string begins and ends with quotation marks.

Mode	All
Remote Command	:CALCulate:FPOWer:POWer[1,2,...,999]?
Example	:CALC:FPOW:POW1?
Notes	Option FP2 is required. See notes for Fast Power Fetch for return format.
Initial S/W Revision	A.14.00

Binary Read Fast Power Measurement (Remote Command Only)

This command query is used as shorthand for an INIT command immediately followed by a FETC? command. The returned results are in a binary format.

Mode	All
Remote Command	:CALCulate:FPOWer:POWer[1,2,...,999]:READ? :CALCulate:FPOWer:POWer[1,2,...,999]:READ1?
Example	:CALC:FPOW:POW1:READ? :CALC:FPOW:POW1:READ1?
Notes	Option FP2 is required. Returns m 4 byte floating point binary values (Little-Endian), where m corresponds to the number of bandwidths defined.
Initial S/W Revision	A.14.00

Diagnostic Binary Read Fast Power Measurement (Remote Command Only)

This command query is used as shorthand for an INIT command immediately followed by a FETC? command. The returned results are in a binary format. This command is used primarily for diagnostic purposes to test for ADC overloads and to visibly inspect the spectrum.

Mode	All
Remote Command	:CALCulate:FPOWer:POWer[1,2,...,999]:READ2?
Example	:CALC:FPOW:POW1:READ2?
Notes	Option FP2 is required. <div style="display: flex; align-items: flex-start; margin-top: 10px;"> <div style="background-color: #cccccc; padding: 2px 5px; margin-right: 10px;">NOTE</div> <div> <p>Spectrum data is only returned if the IncludePowerSpectrum parameter is set to True. If IncludePowerSpectrum is False, the number of spectrum points will be zero (0).</p> <p>Units of the returned values are dependent on the Function parameter per channel (e.g. dBm for BandPower, Hz for PeakFrequency). Returns binary data (Little-Endian) that contains information on m amount of channels, along with ADC over range and full spectrum data.</p> </div> </div>

The following is the binary format of the response.

Bandwidth Return Value

1. Number of channels specified, m [4 byte int]
2. Declared function result for the 1st specified channel [4 byte float]
3. Declared function result for the 2nd specified channel [4 byte float]
- ...
- (m + 1). Declared function result for the last (mth) specified channel [4 byte float]

ADC Over Range

1. ADC over-range occurred (1: true, 0: false) [2 byte short]

Spectrum Data

1. Number of points in the spectrum data, k [4 byte int]
 2. Start frequency of spectrum data (Hz) [8 byte double]
 3. Step frequency of spectrum data (Hz) [8 byte double]
 4. FFT bin at 1st point (dBm) [4 byte float]
 5. FFT bin at 2nd point (dBm) [4 byte float]
 - ...
 - (k + 3). FFT bin at last (kth) point (dBm) [4 byte float]
-

Initial S/W Revision A.14.00

Format Data: Numeric Data (Remote Command Only)

This command specifies the format of the trace data input and output. It specifies the formats used for trace data during data transfer across any remote port. It affects only the data format for setting and querying trace data for the :TRACe[:DATA], TRACe[:DATA]?, :CALCulate:DATA[n]? and FETCh:SANalyzer[n]? commands and queries.

Remote Command	:FORMat[:TRACe][:DATA] ASCii INTEger,32 REAL,32 REAL,64 :FORMat[:TRACe][:DATA]?
-----------------------	---

Notes The query response is:

ASCii: ASC,8

REAL,32: REAL,32

REAL,64: REAL,64

INTEger,32: INT,32

When the numeric data format is REAL or ASCii, data is output in the current Y Axis unit. When the data format is INTEger, data is output in units of m dBm (.001 dBm).

The INT,32 format returns binary 32-bit integer values in internal units (m dBm), in a definite length block.

Dependencies	Sending a data format spec with an invalid number (for example, INT,48) generates no error. The analyzer simply uses the default (8 for ASCii, 32 for INTEger, 32 for REAL).
--------------	--

Sending data to the analyzer which does not conform to the current FORMat specified, results in an error. Sending ASCII data when a definite block is expected generates message -161 "Invalid"

	Block Data" and sending a definite block when ASCII data is expected generates message -121 "Invalid Character in Number".
Preset	AScii
Backwards Compatibility Notes	Note that the INT,32 format is only applicable to the command, TRACe:DATA. This preserves backwards compatibility for the Swept SA measurement. For all other commands/queries which honor FORMat:DATA, if INT,32 is sent the analyzer will behave as though it were set to REAL,32.
Initial S/W Revision	Prior to A.02.00

The specs for each output type follow:

AScii - Amplitude values are in ASCII, in the current Y Axis Unit, one ASCII character per digit, values separated by commas, each value in the form:

SX.YYYYYEsZZ

Where:

S = sign (+ or -)

X = one digit to left of decimal point

Y = 5 digits to right of decimal point

E = E, exponent header

s = sign of exponent (+ or -)

ZZ = two digit exponent

REAL,32 - Binary 32-bit real values in the current Y Axis Unit, in a definite length block.

REAL,64 - Binary 64-bit real values in the current Y Axis Unit, in a definite length block.

Format Data: Byte Order (Remote Command Only)

This command selects the binary data byte order for data transfer and other queries. It controls whether binary data is transferred in normal or swapped mode. This command affects only the byte order for setting and querying trace data for the :TRACe[:DATA], TRACe[:DATA]? , :CALCulate:DATA[n]? and FETCh:SANalyzer[n]? commands and queries.

By definition any command that says it uses FORMat:DATA uses any format supported by FORMat:DATA.

The NORMal order is a byte sequence that begins with the most significant byte (MSB) first, and ends with the least significant byte (LSB) last in the sequence: 1|2|3|4. SWAPped order is when the byte sequence begins with the LSB first, and ends with the MSB last in the sequence: 4|3|2|1.

Remote Command	:FORMat:BORDER NORMa1 SWAPped
-----------------------	--

	:FORMat:BORDER?
Preset	NORMal
Initial S/W Revision	Prior to A.02.00

Meas Setup

Displays the setup menu for the currently selected measurement. The functions included in the measurement setup menu include setting the parameters for the carriers, offsets, bandwidths, measurement methods and types. This menu also allows you to turn noise correction on and off.

Key Path	Front-panel key
Initial S/W Revision	Prior to A.02.00

Average/Hold Number

Specifies the number of measurement averages used to calculate the measurement result. The average will be displayed at the end of each sweep. After the specified number of average counts, the average mode (termination control) setting determines the average action.

Key Path	Meas Setup
Mode	SA, WCDMA, C2K, WIMAX OFDMA, TD-SCDMA, 1xEVDO, DVB-T/H, DTMB (CTTB), ISDB-T, CMMB, LTE, LTE-TDD, Digital Cable TV, MSR, LTEAFDD, LTEATDD
Remote Command	<pre>[:SENSe] :ACPower:AVERage:COUNT <integer> [:SENSe] :ACPower:AVERage:COUNT? [:SENSe] :ACPower:AVERage[:STATe] OFF ON 0 1 [:SENSe] :ACPower:AVERage[:STATe]?</pre>
Example	<pre>ACP:AVER:COUN 250 ACP:AVER:COUN? ACP:AVER OFF ACP:AVER?</pre>
Notes	You must be in the mode that includes ACP measurements to use this command. Use :INSTrument:SElect to set the mode.
Preset	10 ON
State Saved	Saved in instrument state.
Min	1
Max	1000
Backwards Compatibility SCPI	<pre>[:SENSe] :ACPR:AVERage:COUNT [:SENSe] :MCPower:AVERage:COUNT (PSA Power Suite, PSA W-CDMA, PSA cdma2000)</pre>
Initial S/W Revision	Prior to A.02.00
Modified at S/W Revision	A.02.00, A.03.00

Avg Mode

Enables you to set the averaging mode. This determines the averaging action after the specified number of data acquisitions (average count) is reached.

When set to Exponential (Exp) the measurement averaging continues using the specified number of averages to compute each averaged value. The average will be displayed at the end of each sweep.

When set to Repeat, the measurement resets the average counter each time the specified number of averages is reached.

Key Path	Meas Setup
Mode	SA, WCDMA, C2K, WIMAX OFDMA, TD-SCDMA, 1xEVDO, DVB-T/H, DTMB (CTTB), ISDB-T, CMMB, LTE, LTETDD, Digital Cable TV, MSR, LTEAFDD, LTEATDD
Remote Command	[:SENSe] :ACPower:AVERage:TCONtrol EXPonential REPeat [:SENSe] :ACPower:AVERage:TCONtrol?
Example	ACP:AVER:TCON EXP ACP:AVER:TCON?
Notes	You must be in the mode that includes ACP measurements to use this command. Use :INSTrument:SElect to set the mode.
Preset	EXPonential
State Saved	Saved in instrument state.
Range	Exp Repeat
Backwards Compatibility SCPI	[:SENSe] :ACPR:AVERage:TCONtrol
Initial S/W Revision	Prior to A.02.00
Modified at S/W Revision	A.02.00, A.03.00

Carrier Setup (This menu is unavailable in MSR)

Accesses a menu that contains Carriers, Ref Carrier, Ref Car Freq, Ref Car Pwr and Configure Carriers.

Key Path	Meas Setup
Initial S/W Revision	Prior to A.02.00

Carriers

Specifies the number of carriers to be measured.

Key Path	Meas Setup, Carrier Setup, Configure Carriers
Mode	SA, WCDMA, C2K, WIMAX OFDMA, 1xEVDO, TD-SCDMA, DVB-T/H, DTMB (CTTB), ISDB-T, CMMB, LTE, LTETDD, Digital Cable TV, LTEAFDD, LTEATDD
Remote Command	[:SENSe] :ACPower:CARRier[1] 2:COUNT <integer>

[:SENSe]:ACPower:CARRier[1] 2:COUNT?	
Example	ACP:CARR:COUN 1 ACP:CARR:COUN?
Notes	Carrier sub op code. 1 for BTS, 2 for MS. Default is BTS. Note that Carrier sub op code 2 is supported only in Non-SA modes. In the SA mode, Carrier sub op code 1 is used for both BTS and MS. You must be in the mode that includes ACP measurements to use this command. Use :INSTrument:SELEct to set the mode. For LTE-Advanced FDD/TDD mode, this key is blank. In order to keep backwards compatible with the legacy LTE FDD/TDD, the scpi command is supported in LTE & LTE-A converged application.
Dependencies	When Number of Carriers is 1, Ref Carrier is grayed out. If N9060A-5FP license is enabled, Max of Carrier is 18, otherwise, Max of Carrier is 12.
Couplings	Changing this parameter might affect the Span.
Preset	1
State Saved	Saved in instrument state.
Min	1
Max	Refer to Dependencies item.
Initial S/W Revision	Prior to A.02.00
Modified at S/W Revision	A.02.00, A.03.00

Ref Carrier

Sets the reference carrier. Relative power measurements are made from the reference carrier.

If set to Auto, the measurement selects the carrier with the highest power as the reference carrier and the Ref Carrier parameter is updated. If a value is entered when Ref Carrier Mode is set to Auto, the mode changes to Man.

If set to Man, the value that you enter for the Ref Carrier is used as the reference carrier.

Key Path	Meas Setup, Carrier Setup
Mode	SA, WCDMA, C2K, WIMAX OFDMA, 1xEVDO, TD-SCDMA, DVB-T/H, DTMB (CTTB), ISDB-T, CMMB, LTE, LTE-TDD, Digital Cable TV, LTEAFDD, LTEATDD
Remote Command	[:SENSe]:ACPower:CARRier[1] 2:RCARrier <integer> [:SENSe]:ACPower:CARRier[1] 2:RCARrier? [:SENSe]:ACPower:CARRier[1] 2:RCARrier:AUTO OFF ON 0 1 [:SENSe]:ACPower:CARRier[1] 2:RCARrier:AUTO?
Example	ACP:CARR:RCAR 1 ACP:CARR:RCAR? ACP:CARR:RCAR:AUTO OFF

	ACP:CARR:RCAR:AUTO?
Notes	Carrier sub op code. 1 for BTS, 2 for MS. Default is BTS. Note that Carrier sub op code 2 is supported only in Non-SA modes. In the SA mode, Carrier sub op code 1 is used for both BTS and MS. You must be in the mode that includes ACP measurements to use this command. Use :INSTrument:SElect to set the mode. For LTE-Advanced FDD/TDD mode, this key is blank. In order to keep backwards compatible with the legacy LTE FDD/TDD, the scpi command is supported in LTE & LTE-A converged application.
Dependencies	If there is only one carrier, this key will be grayed out.
Couplings	If you enter a carrier value that is currently configured as having no power present, that carrier will be changed to having power present. If you enter a ref carrier this parameter will be set to manual.
Preset	Auto determined
State Saved	Saved in instrument state.
Min	1
Max	Number of available carriers
Backwards Compatibility SCPI	[:SENSe] :MCPower :RCARrier [1] 2 (PSA Power Suite)
Initial S/W Revision	Prior to A.02.00
Modified at S/W Revision	A.02.00, A.03.00

Ref Car Freq

Sets the reference carrier frequency.

Key Path	Meas Setup, Carrier Setup
Mode	SA, WCDMA, C2K, WIMAX OFDMA, 1xEVDO, TD-SCDMA, DVB-T/H, DTMB (CTTB), ISDB-T, CMMB, LTE, LTETDD, Digital Cable TV, LTEAFDD, LTEATDD
Remote Command	[:SENSe] :ACPpower :CARRier [1] 2 :RCFRrequency <freq> [:SENSe] :ACPpower :CARRier [1] 2 :RCFRrequency? [:SENSe] :ACPpower :CARRier [1] 2 :RCFRrequency :AUTO OFF ON 0 1 [:SENSe] :ACPpower :CARRier [1] 2 :RCFRrequency :AUTO?
Example	ACP:CARR:RCFR 250 MHz ACP:CARR:RCFR? ACP:CARR:RCFR:AUTO OFF ACP:CARR:RCFR:AUTO?
Notes	Carrier sub op code. 1 for BTS, 2 for MS. Default is BTS. Note that Carrier sub op code 2 is supported only in Non-SA modes. In the SA mode, Carrier sub op code 1 is used for both BTS and MS. You must be in the mode that includes ACP measurements to use this command. Use

	:INSTRument:SElect to set the mode. For LTE-Advanced FDD/TDD mode, this key is blank. In order to keep backwards compatible with the legacy LTE FDD/TDD, the scpi command is supported in LTE & LTE-A converged application
Couplings	LTE-Advanced FDD/TDD not supported the following couplings. Coupled to the Center Frequency. If the center frequency changes, the Ref Carrier Frequency is calculated using the following three steps; $\text{Ref Freq1} = \text{Ctr Freq} - (\text{Total of all Carrier Widths} / 2)$ $\text{Ref Freq2} = \text{Ref Freq1} + (\text{Total of all Carrier Widths up to Ref Carrier})$ $\text{Ref Freq} = \text{Ref Freq2} + (0.5 * \text{Carrier Width of Ref Carrier})$ If reference carrier frequency changes the Center Frequency is calculated using the following three steps; $\text{Ctr Freq1} = \text{Ref Freq} - (0.5 * \text{Carrier Width of Ref Carrier})$ $\text{Ctr Freq2} = \text{Ctr Freq1} - (\text{Total of all Carrier Widths up to Ref Carrier})$ $\text{Ctr Freq} = \text{Ctr Freq2} + (\text{Total of all Carrier Widths} / 2)$ This ensures that the carriers are always centered on the screen. If there is only one carrier present the Reference Carrier Frequency will be the same as the Center Frequency.
Preset	Calculated based on the current Center Frequency
State Saved	Saved in instrument state.
Min	-79.999995 MHz
Max	Hardware Dependent: Option 503 = 3.699999995 GHz Option 508 = 8.499999995 GHz Option 513 = 13.799999995 GHz Option 526 = 26.999999995 GHz
Initial S/W Revision	Prior to A.02.00
Modified at S/W Revision	A.02.00, A.03.00

Power Ref (SA and W-CDMA Only)

Selects the power reference type.

- Ref Carrier – Power of the specified carrier is the reference of measurement. Use the Ref Carrier key under Carrier Setup to select Carrier Index. See "[Ref Carrier](#)" on page 1683 for more information.
- Manual – Power or PSD specified by the user is the reference of measurement.
- Total Multicarriers – Total Power of multi carriers is the power reference of measurement. Each carrier power is calculated with its own carrier configuration settings.

Key Path	Meas Setup, Carrier Setup
Mode	SA, WCDMA
Remote Command	[:SENSe]:ACPower:CARRier[1] 2:PREFERENCE:TYPE RCARRier MANua1 TMCARRiers [:SENSe]:ACPower:CARRier[1] 2:PREFERENCE:TYPE?
Example	ACP:CARR:PREF:TYPE RCARRier ACP:CARR:PREF:TYPE?
Notes	This command is available only in SA and WCDMA. Carrier sub op code: 1 for BTS, 2 for MS. Default is BTS. Carrier sub op code 2 is supported only in Non-SA modes. In the SA mode, Carrier sub op code 1 is used for both BTS and MS. You must be in the SA or WCDMA mode.
Preset	RCARRier
State Saved	Saved in instrument state
Range	Reference Carrier Manual Total Multicarriers
Readback	Indirect readback as below: 
Initial S/W Revision	A.10.00
Modified at S/W Revision	A.16.00

Configure Carriers

Accesses a menu that contains Carrier, Carrier Pwr Present, Carrier Width and Carrier Integ BW parameters.

Key Path	Meas Setup, Carrier Setup
Initial S/W Revision	Prior to A.02.00

Carrier

Selects the carrier to configure for the current measurement.

Key Path	Meas Setup, Carrier Setup, Configure Carriers
Mode	SA, WCDMA, C2K, WIMAX OFDMA, 1xEVDO, TD-SCDMA, DVB-T/H, DTMB (CTTB), ISDB-T, CMMB, LTE, LTETDD, Digital Cable TV
Couplings	Max value is the number of available carriers, so this value might change when the number of carriers is changed.
Preset	1
State Saved	No

Min	1
Max	Number of available carriers
Initial S/W Revision	Prior to A.02.00
Modified at S/W Revision	A.02.00, A.03.00

Carrier Coupling

Couples carrier settings to carrier #1. The coupled parameters are Carrier Power Present, Carrier Spacing, Measurement Noise Bandwidth, Method, and Filter Alpha.

Key Path	Meas Setup, Carrier Setup, Configure Carriers
Mode	SA, WCDMA, C2K, WIMAX OFDMA, 1xEVDO, TD-SCDMA, DVB-T/H, DTMB (CTTB), ISDB-T, CMMB, LTE, LTETDD, Digital Cable TV, LTEAFDD, LTEATDD
Remote Command	<code>[:SENSe]:ACPoweR:CARRier[1] 2:LIST:COUPle OFF ON 0 1, OFF ON 0 1, OFF ON 0 1, OFF ON 0 1, OFF ON 0 1, OFF ON 0 1</code> <code>[:SENSe]:ACPoweR:CARRier[1] 2:LIST:COUPle?</code>
Example	ACP:CARR:LIST:COUP OFF ACP:CARR:LIST:COUP?
Notes	Carrier sub op code. 1 for BTS, 2 for MS. Default is BTS. Note that Carrier sub op code 2 is supported only in Non-SA modes. In the SA mode, Carrier sub op code 1 is used for both BTS and MS. You must be in the mode that includes ACP measurements to use this command. Use :INSTrument:SElect to set the mode. For LTE-Advanced FDD/TDD mode, this key is blank. In order to keep backwards compatible with the legacy LTE FDD/TDD, the scpi command is supported in LTE & LTE-A converged application.
Couplings	When Couple is selected, the carrier settings are coupled to carrier #1. Coupled parameters are Carrier Power Present, Carrier Spacing, Measurement Noise Bandwidth, Method and Filter Alpha. When a setting is changed, the couple is set to Man automatically. Carrier #1 is always set to couple and cannot be changed. Couple/Man selection on the Carrier key is not displayed when selected carrier number is #1.
Preset	ON
State Saved	Saved in instrument state.
Range	Couple Man
Initial S/W Revision	Prior to A.02.00
Modified at S/W Revision	A.02.00, A.03.00

Carrier Pwr Present

Configures the carriers for this measurement. It allows spaces to be inserted between carriers. Carriers with the power present parameter set to Yes are carriers, and those with the power present parameter set to No are spaces. Each carrier power present is set to Yes or No. The individual carriers can be set by selecting the

desired carrier on the carrier menu key using the up down arrows, the knob, or numeric keypad, then toggling the carrier power present using the carrier power present menu key.

The query for this parameter returns the current values for all of the carriers. If a carrier is defined as having no power present, the power displayed will be relative to the reference carrier, otherwise the absolute power will be displayed.

If you change the carrier power present to no and that carrier is currently configured as the reference carrier, the next carrier to the left (or the right if there are no carriers to the left) will be assigned as the reference carrier. This also applies to the scenario where there are only two carriers configured as having power present and you configure only one carrier to have no power present.

Key Path	Meas Setup, Carrier Setup, Configure Carriers
Mode	SA, WCDMA, C2K, WIMAX OFDMA, 1xEVDO, TD-SCDMA, DVB-T/H, DTMB (CTTB), ISDB-T, CMMB, LTE, LTE-TDD, Digital Cable TV, LTEAFDD, LTEATDD
Remote Command	<code>[:SENSe]:ACPpower:CARRier[1] 2:LIST:PPResent YES NO, YES NO, YES NO, YES NO, YES NO, YES NO</code> <code>[:SENSe]:ACPpower:CARRier[1] 2:LIST:PPResent?</code>
Example	ACP:CARR2:LIST:PPR YES ACP:CARR2:LIST:PPR?
Notes	Carrier sub op code. 1 for BTS, 2 for MS. Default is BTS. Note that Carrier sub op code 2 is supported only in Non-SA modes. In the SA mode, Carrier sub op code 1 is used for both BTS and MS. When setting these values remotely, the position in the list sent corresponds to the carrier. Missing values are not permitted, therefore if you want to change values 2 and 6 you must send all values up to 6. Subsequent values will remain unchanged, unless the number of values sent is greater than the number of carriers, then subsequent values will be ignored. For LTE-Advanced FDD/TDD mode, this key is blank. In order to keep backwards compatible with the legacy LTE FDD/TDD, the scpi command is supported in LTE & LTE-A converged application.
Dependencies	If there is only one carrier, this key will be grayed out.
Couplings	Coupled to the number of carriers. When the SCPI command is sent, the number of carriers will be set to the number of entries in the parameter list.
Preset	YES
State Saved	Saved in instrument state.
Range	Yes No
Backwards Compatibility SCPI	<code>[:SENSe]:MCPower:CARRier[1] 2:LIST:PPResent (PSA Power Suite)</code>
Initial S/W Revision	Prior to A.02.00
Modified at S/W Revision	A.02.00, A.03.00

Carrier Spacing

Sets the width of the carrier spacing. This will be the value applied to all the current slots, whether they are carriers or spaces.

Enter each carrier spacing value individually by selecting the desired carrier on the carrier menu key using the up down arrows, the knob, or the numeric keypad, then enter the carrier width using the carrier spacing menu key.

Key Path	Meas Setup, Carrier Setup, Configure Carriers
Mode	SA, WCDMA, C2K, WIMAX OFDMA, 1xEVDO, TD-SCDMA, DVB-T/H, DTMB (CTTB), ISDB-T, CMMB, LTE, LTETDD, Digital Cable TV, LTEAFDD, LTEATDD
Remote Command	<code>[:SENSe]:ACPowEr:CARRier[1] 2:LIST:WIDTh <freq>, <freq>, <freq>, <freq>, <freq>, <freq></code> <code>[:SENSe]:ACPowEr:CARRier[1] 2:LIST:WIDTh?</code>
Example	ACP:CARR2:LIST:WIDT 25kHz ACP:CARR2:LIST:WIDT?
Notes	Carrier sub op code. 1 for BTS, 2 for MS. Default is BTS. Note that Carrier sub op code 2 is supported only in Non-SA modes. In the SA mode, Carrier sub op code 1 is used for both BTS and MS. When setting these values remotely, the position in the list sent corresponds to the carrier. Missing values are not permitted, therefore if you want to change values 2 and 6 you must send all values up to 6. Subsequent values will remain unchanged, unless the number of values sent is greater than the number of carriers, then subsequent values will be ignored. You must be in the mode that includes ACP measurements to use this command. Use :INSTrument:SElect to set the mode. For LTE-Advanced FDD/TDD mode, this key is blank. In order to keep backwards compatible with the legacy LTE FDD/TDD, the scpi command is supported in LTE & LTE-A converged application.
Couplings	Coupled to the number of carriers. When the SCPI command is sent, the number of carriers will be set to the number of entries in the parameter list. Changing Carrier Spacing might affect the Span.
Preset	SA, WCDMA: 5 MHz WIMAX OFDMA: 10 MHz C2K: 1.25 MHz 1xEVDO: 1.25 MHz TD-SCDMA: 1.6 MHz DVB-T/H: 8 MHz DTMB (CTTB): 8 MHz ISDB-T: 6 MHz CMMB: 8 MHz LTE: 5 MHz LTETDD: 5 MHz Digital Cable TV: 8 MHz
State Saved	Saved in instrument state.

Min	0 Hz
Max	Depends on instrument maximum frequency. Same as the Max Span of Swept SA Measurement.
Backwards Compatibility SCPI	[:SENSe]:MCPower:CARRier[1] 2:LIST:WIDTh (PSA Power Suite)
Initial S/W Revision	Prior to A.02.00
Modified at S/W Revision	A.02.00, A.03.00, A.16.00

Measurement Noise Bandwidth

Specifies the Measurement Noise Bandwidth used to calculate the power in the carriers.

Each Measurement Noise Bandwidth value is entered individually by selecting the desired carrier on the carrier menu key using the up down arrows, the knob, or the numeric keypad. Then enter the measurement noise bandwidth using the measurement noise bandwidth key.

Key Path	Meas Setup, Carrier Setup, Configure Carriers
Mode	SA, WCDMA, C2K, WIMAX OFDMA, TD-SCDMA, 1xEVDO, DVB-T/H, DTMB (CTTB), ISDB-T, CMMB, LTE, LTETDD, Digital Cable TV, LTEAFDD, LTEATDD
Remote Command	[:SENSe]:ACPpower:CARRier[1] 2:LIST:BANDwidth[:INTEgration] <freq>, <freq>, <freq>, <freq>, <freq> [:SENSe]:ACPpower:CARRier[1] 2:LIST:BANDwidth[:INTEgration]?
Example	ACP:CARR2:LIST:BAND 25kHz ACP:CARR2:LIST:BAND?
Notes	In the WCDMA mode, the preset/default value is defined as 3.84 MHz. But internally, 4.6848 MHz is used as the default value. Carrier sub op code. 1 for BTS, 2 for MS. Default is BTS. Note that Carrier sub op code 2 is supported only in Non-SA modes. In the SA mode, Carrier sub op code 1 is used for both BTS and MS. When setting these values remotely, the position in the list sent corresponds to the carrier. Missing values are not permitted, therefore if you want to change values 2 and 6 you must send all values up to 6. Subsequent values will remain unchanged, unless the number of values sent is greater than the number of carriers, then subsequent values will be ignored. You must be in the mode that includes ACP measurements to use this command. Use :INSTrument:SElect to set the mode. For LTE-Advanced FDD/TDD mode, this key is blank. In order to keep backwards compatible with the legacy LTE FDD/TDD, the scpi command is supported in LTE & LTE-A converged application.
Couplings	Coupled to the number of carriers. When the SCPI command is sent, the number of carriers is set to the number of entries in the parameter list.
Preset	SA: 2 MHz WCDMA: 3.84 MHz WIMAX OFDMA: 10 MHz

	C2K: 1.23MHz TD-SCDMA: 1.28 MHz 1xEVDO: 1.23 MHz DVB-T/H: 7.61 MHz DTMB (CTTB): 7.56 MHz ISDB-T: 5.6 MHz CMMB: 7.512 MHz LTE, LTETDD: 4.515 MHz 4.5 MHz Digital Cable TV: 8.0 MHz
State Saved	Saved in instrument state.
Min	10 Hz
Max	Depends on instrument maximum frequency. Same as the Max Span of Swept SA Measurement.
Backwards Compatibility SCPI	<pre>[:SENSe]:ACPower:BANDwidth:INTEgration [:SENSe]:ACPower:BWIDth:INTEgration [:SENSe]:ACPower:CARRier[1] 2:LIST:BWIDth[:INTEgration] [:SENSe]:MCPower:CARRier[1] 2:LIST:BANDwidth[:INTEgration] (PSA Power Suite) [:SENSe]:MCPower:CARRier[1] 2:LIST:BWIDth[:INTEgration] (PSA Power Suite)</pre>
Initial S/W Revision	Prior to A.02.00
Modified at S/W Revision	A.02.00, A.03.00, A.16.00

Method for Carrier

Accesses the carrier configuration method settings.

Key Path	Meas Setup, Carrier Setup, Configure Carriers
Mode	SA, WCDMA, WIMAX OFDMA, TD-SCDMA, DVB-T/H, DTMB (CTTB), ISDB-T, CMMB, LTE, LTETDD, Digital Cable TV, LTEAFDD, LTEATDD
Remote Command	<pre>[:SENSe]:ACPower:CARRier[1] 2:LIST:FILTer[:RRC][:STATe] ON OFF 1 0, ON OFF 1 0, ON OFF 1 0, ON OFF 1 0, ON OFF 1 0, ON OFF 1 0 [:SENSe]:ACPower:CARRier[1] 2:LIST:FILTer[:RRC][:STATe]?</pre>
Example	<pre>ACP:CARR:LIST:FILT 0,0,0,0 ACP:CARR:LIST:FILT?</pre>
Notes	<p>The binary values translate as follows:</p> <p>1 ON = RRC Weighted</p> <p>0 OFF = Integ BW</p> <p>Maximum of Array length depends on the number of carriers.</p> <p>You must be in the mode that includes ACP measurements to use this command. Use :INSTrument:SElect to set the mode.</p> <p>For LTE-Advanced FDD/TDD mode, this key is blank. In order to keep backwards compatible with</p>

	the legacy LTE FDD/TDD, the scpi command is supported in LTE & LTE-A converged application.
Preset	SA, LTE, LTETDD: OFF WCDMA: ON WIMAX OFDMA: OFF TD-SCDMA: ON DVB-T/H: OFF DTMB (CTTB): ON ISDB-T, CMMB: OFF Digital Cable TV: OFF
State Saved	Saved in instrument state.
Range	IntegBW RRC Weight
Initial S/W Revision	Prior to A.02.00
Modified at S/W Revision	A.02.00, A.03.00

Filter Alpha for Carrier

Inputs the alpha value for the filter used in the current carrier configuration.

Key Path	Meas Setup, Carrier Setup, Configure Carriers, Method, RRC Weighted
Mode	SA, WCDMA, WIMAX OFDMA, TD-SCDMA, DVB-T/H, DTMB (CTTB), ISDB-T, CMMB, LTE, LTETDD, Digital Cable TV, LTEAFDD, LTEATDD
Remote Command	<code>[:SENSe]:ACPower:CARRier[1] 2:LIST:FILTer:ALPHa <real>, <real>, <real>, <real>, <real></code> <code>[:SENSe]:ACPower:CARRier[1] 2:LIST:FILTer:ALPHa?</code>
Example	ACP:CARR2:LIST:FILT:ALPH 0.5 ACP:CARR2:LIST:FILT:ALPH?
Notes	You must be in the mode that includes ACP measurements to use this command. Use :INSTrument:SElect to set the mode. For LTE-Advanced FDD/TDD mode, this key is blank. In order to keep backwards compatible with the legacy LTE FDD/TDD, the scpi command is supported in LTE & LTE-A converged application.
Preset	0.22 C2K: No DTMB (CTTB): 0.05 Digital Cable TV: 0.15
State Saved	Saved in instrument state.
Min	0.01
Max	1.0
Initial S/W Revision	Prior to A.02.00
Modified at S/W Revision	A.02.00, A.03.00

Offset/Limits

Accesses a menu of functions that contains Offset, Offset Freq/Offset To Edge, Offset Integ BW, Upper Offset Limit and Lower Offset parameters. When in the MSR and LTE-Advanced FDD/TDD mode, the softkey label changes to Outer Offset/Limits.

Key Path	Meas Setup
Initial S/W Revision	Prior to A.02.00
Modified at S/W Revision	A.13.00

Select Offset

Selects the offset to configure.

Key Path	Meas Setup, Offset/Limits, Limits
Mode	SA, WCDMA, C2K, WIMAX OFDMA, TD-SCDMA, 1xEVDO, DVB-T/H, DTMB (CTTB), ISDB-T, CMMB, LTE, LTETDD, Digital Cable TV, MSR, LTEAFDD, LTEATDD
Preset	A
State Saved	Saved in instrument state.
Range	Offset A Offset B Offset C Offset D Offset E Offset F
Initial S/W Revision	Prior to A.02.00
Modified at S/W Revision	A.02.00, A.03.00, A.13.00

Offset Freq

This parameter determines the frequency difference between the center of the main channel and the center of the carrier.

Each Offset Freq state value is entered individually by selecting the desired carrier on the carrier menu key using the up down arrows, RPG or numeric keypad. Then enter the Offset Freq State using the Offset Frequency key.

The list contains up to six (6) entries, depending on the mode selected, for offset frequencies. Each offset frequency in the list corresponds to a reference bandwidth in the bandwidth list.

An offset frequency of zero turns the display of the measurement for that offset off, but the measurement is still made and reported. You can turn off (not use) specific offsets with the [:SENSe]:ACP:OFFSet:LIST:STATe command.

Turning the offset off has the same effect as setting the frequency of the offset to 0 Hz and will cause it to be removed from the results screen.

Key Path	Meas Setup, Offset/Limits
Mode	SA, WCDMA, C2K, WIMAX OFDMA, TD-SCDMA, 1xEVDO, DVB-T/H, DTMB (CTTB), ISDB-T, CMMB, LTE, LTETDD, Digital Cable TV, MSR, LTEAFDD, LTEATDD
Remote Command	[:SENSe] :ACP:Power:OFFSet[1] 2 [:OUTer] :LIST [:FREQuency] <freq> , <freq> , <freq> , <freq> , <freq>

	<pre>[:SENSe]:ACPower:OFFSet[1] 2[:OUTer]:LIST[:FREQuency]? [:SENSe]:ACPower:OFFSet[1] 2[:OUTer]:LIST:STATe OFF ON 0 1, OFF ON 0 1, OFF ON 0 1, OFF ON 0 1, OFF ON 0 1, OFF ON 0 1 [:SENSe]:ACPower:OFFSet[1] 2[:OUTer]:LIST:STATe?</pre>
Example	<pre>ACP:OFFS1:LIST 0,0,0,0,0 ACP:OFFS1:LIST? ACP:OFFS2:LIST:STAT 1,1,0,0,0 ACP:OFFS2:LIST:STAT?</pre>
Notes	<p>The label for this menu key will change depending on the currently selected radio standard or mode. For cdma2000 the label for the menu key will be Offset to Edge. For all other supported standards the label will be Offset Freq.</p> <p>When setting these values remotely, the position in the list sent corresponds to the offset. Missing values are not permitted, unless the number of values sent is greater than the number of carriers, then subsequent values will be ignored.</p> <p>Offset sub op code. 1 for BTS, 2 for MS. Default is BTS.</p> <p>Note that Offset sub op code 2 is supported only in Non-SA modes.</p> <p>In the SA mode, Offset sub op code 1 is used for both BTS and MS.</p> <p>You must be in the mode that includes ACP measurements to use this command. Use :INSTrument:SElect to set the mode.</p>
Couplings	Changing Offset Frequency might affect the Span. See the Span key section for details.
Preset	<pre>SA: 3 MHz, 0 Hz, 0 Hz, 0 Hz, 0 Hz, 0 Hz 3 MHz, 0 Hz, 0 Hz, 0 Hz, 0 Hz, 0 Hz WCDMA: 5.0 MHz, 10.0 MHz, 0 Hz, 0 Hz, 0 Hz, 0 Hz 5.0 MHz, 10.0 MHz, 0 Hz, 0 Hz, 0 Hz, 0 Hz WIMAX OFDMA: 10 MHz, 20 MHz, 0 Hz, 0 Hz, 0 Hz, 0 Hz 10 MHz, 20 MHz, 0 Hz, 0 Hz, 0 Hz, 0 Hz C2K:750KHz, 1.980 MHz, 0 Hz, 0 Hz, 0 Hz, 0 Hz 885 kHz, 1.980 MHz, 0 Hz, 0 Hz, 0 Hz, 0 Hz TD-SCDMA: 1.6 MHz, 3.2 MHz, 0 Hz, 0 Hz, 0 Hz, 0 Hz 1.6 MHz, 3.2 MHz, 0 Hz, 0 Hz, 0 Hz, 0 Hz 1xEVDO: 750KHz, 1.98MHz, 3.125MHz, 4.000MHz, 7.500MHz, 7.500MHz 885KHz, 1.98MHz, 3.125MHz, 4.000MHz, 7.500MHz, 7.500MHz DVB-T/H: 8 MHz, 16 MHz, 0 Hz, 0 Hz, 0 Hz, 0 Hz 8 MHz, 16 MHz, 0 Hz, 0 Hz, 0 Hz, 0 Hz DTMB (CTTB): 8 MHz, 16 MHz, 24 MHz, 32 MHz, 0 Hz, 0 Hz 8 MHz, 16 MHz, 24 MHz, 32 MHz, 0 Hz, 0 Hz ISDB-T: 6 MHz, 12 MHz, 0 Hz, 0 Hz, 0 Hz, 0 Hz 6 MHz, 12 MHz, 0 Hz, 0 Hz, 0 Hz, 0 Hz CMMB: 8 MHz, 16 MHz, 24 MHz, 32 MHz, 0 Hz, 0 Hz 8 MHz, 16 MHz, 24 MHz, 32 MHz, 0 Hz, 0 Hz LTE, LTEFDD, MSR, LTEAFDD, LTEATDD: 5 MHz, 10 MHz, 0, 0, 0, 0 5 MHz, 10 MHz, 0, 0, 0, 0 Digital Cable TV: 8 MHz, 16 MHz, 0 Hz, 0 Hz, 0 Hz, 0 Hz 8 MHz, 16 MHz, 0 Hz, 0 Hz, 0 Hz, 0 Hz SA: ON, OFF, OFF, OFF, OFF, OFF ON, OFF, OFF, OFF, OFF, OFF WCDMA: ON, ON, OFF, OFF, OFF, OFF ON, ON, OFF, OFF, OFF, OFF WIMAX OFDMA: ON, ON, OFF, OFF, OFF, OFF ON, ON, OFF, OFF, OFF, OFF TD-SCDMA: ON, ON, OFF, OFF, OFF, OFF ON, ON, OFF, OFF, OFF, OFF DVB-T/H: ON, ON, OFF, OFF, OFF, OFF ON, ON, OFF, OFF, OFF, OFF DTMB (CTTB): ON, ON, OFF, OFF, OFF, OFF ON, ON, OFF, OFF, OFF, OFF</pre>

	CDMA1xEVDO: ON, ON, OFF, OFF, OFF, OFF ON, ON, OFF, OFF, OFF, OFF ISDB-T: ON, ON, OFF, OFF, OFF, OFF ON, ON, OFF, OFF, OFF, OFF CMMB: ON, ON, ON, ON, OFF, OFF ON, ON, ON, ON, OFF, OFF LTE, LTETDD, MSR, LTEAFDD, LTEATDD: ON, ON, OFF, OFF, OFF, OFF ON, OFF, OFF, OFF, OFF, OFF Digital Cable TV: ON, ON, OFF, OFF, OFF, OFF ON, ON, OFF, OFF, OFF, OFF
State Saved	Saved in instrument state.
Min	0 Hz
Max	Depends on instrument maximum frequency. Same as the Max Span of Swept SA Measurement.
Backwards Compatibility SCPI	[:SENSe]:MCPower:OFFSet[1] 2:LIST[:FREQUENCY] (PSA Power Suite)
Initial S/W Revision	Prior to A.02.00
Modified at S/W Revision	A.02.00, A.03.00, A.13.00, A.16.00

Integ BW

Sets the Integration Bandwidth for the offsets. Each resolution bandwidth in the list corresponds to an offset frequency in the list defined by [:SENSe]:ACP:OFFSet[n] [:OUTer]:LIST[:FREQUENCY].

Enter each value individually by selecting the desired offset on the offset menu key using the up down arrows, the knob, or the numeric keypad, then enter the Offset Integration Bandwidth using the Offset Integration Bandwidth menu key.

You can turn off (not use) specific offsets with the [:SENSe]:ACP:OFFSet[n] [:OUTer]:LIST:STATe command.

Key Path	Meas Setup, Offset/Limits
Mode	SA, WCDMA, C2K, WIMAX OFDMA, TD-SCDMA, 1xEVDO, DVB-T/H, DTMB (CTTB), ISDB-T, CMMB, LTE, LTETDD, Digital Cable TV, MSR, LTEAFDD, LTEATDD
Remote Command	[:SENSe]:ACPPower:OFFSet[1] 2[:OUTer]:LIST:BANDwidth[:INTEgration] <freq>, <freq>, <freq>, <freq>, <freq>, <freq> [:SENSe]:ACPPower:OFFSet[1] 2[:OUTer]:LIST:BANDwidth[:INTEgration]?
Example	ACP:OFFS2:LIST:BAND 2MHz, 2MHz, 2MHz, 2MHz, 2MHz, 2MHz ACP:OFFS2:LIST:BAND?
Notes	When setting these values remotely, the position in the list sent corresponds to the offset. Missing values are not permitted i.e. if you want to change the second value, you must send all values up to it. Subsequent values will remain unchanged, unless the number of values sent is greater than the number of carriers, then subsequent values will be ignored. Offset sub op code. 1 for BTS, 2 for MS. Default is BTS. Note that Offset sub op code 2 is supported only in Non-SA modes. In the SA mode, Offset sub op code 1 is used for both BTS and MS. You must be in the mode that includes ACP measurements to use this command. Use :INSTrument:SElect to set the mode.

Couplings	Changing Integ BW might affect the Span. See Span section for details.
Preset	SA: 2 MHz, 2 MHz, 2 MHz, 2 MHz, 2 MHz, 2 MHz 2 MHz, 2 MHz, 2 MHz, 2 MHz, 2 MHz, 2 MHz WCDMA: 3.84 MHz, 3.84 MHz, 3.84 MHz, 3.84 MHz, 3.84 MHz, 3.84 MHz 3.84 MHz, 3.84 MHz, 3.84 MHz, 3.84 MHz, 3.84 MHz, 3.84 MHz WIMAX OFDMA: 10 MHz, 10 MHz, 10 MHz, 10 MHz, 10 MHz, 10 MHz 10 MHz, 10 MHz, 10 MHz, 10 MHz, 10 MHz, 10 MHz C2K: 30 kHz, 30 kHz, 30 kHz, 30 kHz, 30 kHz, 30 kHz 30 kHz, 30 kHz, 30 kHz, 30 kHz, 30 kHz, 30 kHz TD-SCDMA: 1.28 MHz, 1.28 MHz, 1.28 MHz, 1.28 MHz, 1.28 MHz, 1.28 MHz 1xEVDO: C2K: 30 kHz, 30 kHz, 30 kHz, 30 kHz, 30 kHz, 30 kHz 30 kHz, 30 kHz, 30 kHz, 30 kHz, 30 kHz, 30 kHz DVB-T/H: 7.61 MHz, 7.61 MHz, 7.61 MHz, 7.61 MHz, 7.61 MHz, 7.61 MHz 7.61 MHz, 7.61 MHz, 7.61 MHz, 7.61 MHz, 7.61 MHz, 7.61 MHz DTMB (CTTB): 7.56 MHz, 7.56 MHz, 7.56 MHz, 7.56 MHz, 7.56 MHz, 7.56 MHz 7.56 MHz, 7.56 MHz, 7.56 MHz, 7.56 MHz, 7.56 MHz, 7.56 MHz ISDB-T: 5.6 MHz, 5.6 MHz, 5.6 MHz, 5.6 MHz, 5.6 MHz, 5.6 MHz 5.6 MHz, 5.6 MHz, 5.6 MHz, 5.6 MHz, 5.6 MHz, 5.6 MHz CMMB: 7.512 MHz, 7.512 MHz, 7.512 MHz, 7.512 MHz, 7.512 MHz, 7.512 MHz 7.512 MHz, 7.512 MHz, 7.512 MHz, 7.512 MHz, 7.512 MHz, 7.512 MHz LTE, LTEFDD, MSR, LTEAFDD, LTEATDD: 4.515 MHz, 4.515 MHz, 4.515 MHz, 4.515 MHz, 4.515 MHz, 4.515 MHz 4.5 MHz, 4.5 MHz, 4.5 MHz, 4.5 MHz, 4.5 MHz, 4.5 MHz Digital Cable TV: 8.0 MHz, 8.0 MHz, 8.0 MHz, 8.0 MHz, 8.0 MHz, 8.0 MHz 8.0 MHz, 8.0 MHz, 8.0 MHz, 8.0 MHz, 8.0 MHz, 8.0 MHz
State Saved	Saved in instrument state.
Min	10 Hz
Max	Depends on instrument maximum frequency. Same as the Max Span on Swept SA Measurement.
Backwards Compatibility SCPI	[:SENSe]:ACPower:OFFSet[1] 2:LIST:BWIDth[:INTEgration] [:SENSe]:ACPR:OFFSet[1] 2:LIST:BANDwidth [:SENSe]:ACPR:OFFSet[1] 2:LIST:BWIDth [:SENSe]:MCPower:OFFSet[1] 2:LIST:BANDwidth[:INTEgration] (PSA Power Suite) [:SENSe]:MCPower:OFFSet[1] 2:LIST:BWIDth[:INTEgration] (PSA Power Suite)
Initial S/W Revision	Prior to A.02.00
Modified at S/W Revision	A.02.00, A.03.00, A.13.00, A.16.00

Offset BW

Accesses the offset bandwidth menu.

Key Path	Meas Setup, Offset/Limits
Initial S/W Revision	Prior to A.02.00

Res BW

Sets the resolution bandwidth. If an unavailable bandwidth is entered with the numeric keypad, the closest available bandwidth is selected.

Key Path	Meas Setup, Offset/Limits
Mode	SA, WCDMA, C2K, WIMAX OFDMA, TD-SCDMA, 1xEVDO, DVB-T/H, DTMB (CTTB), ISDB-T, CMMB, LTE, LTETDD, Digital Cable TV, MSR, LTEAFDD, LTEATDD
Remote Command	<pre>[:SENSe]:ACPpower:OFFSet[1] 2[:OUTer]:LIST:BANDwidth:RESolution <freq>, <freq>, <freq>, <freq>, <freq>, <freq> [:SENSe]:ACPpower:OFFSet[1] 2[:OUTer]:LIST:BANDwidth:RESolution? [:SENSe]:ACPpower:OFFSet[1] 2[:OUTer]:LIST:BANDwidth:RESolution:AUTO ON OFF 1 0, ON OFF 1 0, ON OFF 1 0, ON OFF 1 0, ON OFF 1 0, ON OFF 1 0 [:SENSe]:ACPpower:OFFSet[1] 2[:OUTer]:LIST:BANDwidth:RESolution:AUTO?</pre>
Example	<pre>ACP:OFFS2:LIST:BAND:RES 220kHz, 220kHz, 220kHz, 220kHz, 220kHz, 220kHz ACP:OFFS2:LIST:BAND:RES? ACP:OFFS2:LIST:BAND:RES:AUTO 1,1,1,1,1,1 ACP:OFFS2:LIST:BAND:RES:AUTO?</pre>
Notes	<p>Offset sub op code. 1 for BTS, 2 for MS. Default is BTS.</p> <p>Note that Offset sub op code 2 is supported only in Non-SA modes.</p> <p>In the SA mode, Offset sub op code 1 is used for both BTS and MS.</p> <p>You must be in the mode that includes ACP measurements to use this command. Use :INSTRument:SElect to set the mode.</p>
Dependencies	When Meas Method is RBW, FAST or Fast Power, this key is grayed out and disabled. If the key is pressed, an advisory message is generated. If the equivalent remote command is sent, a "Setting conflict" warning is generated.
Couplings	When Res BW Mode is AUTO, this value is exactly same as Res BW under BW key. And when this value is changed by user, Res BW Mode is also changed to Man.
Preset	<pre>SA: 220 kHz, 220 kHz, 220 kHz, 220 kHz, 220 kHz, 220 kHz WCDMA: 100 kHz, 100 kHz, 100 kHz, 100 kHz, 100 kHz, 100 kHz WIMAX OFDMA: 100 kHz, 100 kHz, 100 kHz, 100 kHz, 100 kHz, 100 kHz C2K: Method:RBW 30 kHz Method: IBW C2K: 15 kHz, 15 kHz, 15 kHz, 15 kHz, 15 kHz, 15 kHz 15 kHz, 15 kHz, 15 kHz, 15 kHz, 15 kHz, 15 kHz TD-SCDMA: 30 kHz, 30 kHz, 30 kHz, 30 kHz, 30 kHz, 30 kHz 1xEVDO: 30KHz, 30KHz, 30KHz, 30KHz, 30KHz, 30KHz 30KHz, 30KHz, 30KHz, 30KHz, 30KHz, 30KHz DVB-T/H: 39 kHz, 39 kHz, 39 kHz, 39 kHz, 39 kHz, 39 kHz 39 kHz, 39 kHz, 39 kHz, 39 kHz, 39 kHz, 39 kHz DTMB (CTTB): 39 kHz, 39 kHz, 39 kHz, 39 kHz, 39 kHz, 39 kHz 39 kHz, 39 kHz, 39 kHz, 39 kHz, 39 kHz, 39 kHz</pre>

	ISDB-T: 39 kHz, 39 kHz, 39 kHz, 39 kHz, 39 kHz, 39 kHz 39 kHz, 39 kHz, 39 kHz, 39 kHz, 39 kHz, 39 kHz CMMB: 39 kHz, 39 kHz, 39 kHz, 39 kHz, 39 kHz, 39 kHz 39 kHz, 39 kHz, 39 kHz, 39 kHz, 39 kHz, 39 kHz LTE, LTETDD, MSR, LTEAFDD, LTEATDD: 100 kHz, 100 kHz, 100 kHz, 100 kHz, 100kHz, 100 kHz 100 kHz, 100 kHz, 100 kHz, 100 kHz, 100 kHz, 100 kHz Digital Cable TV: 39 kHz, 39 kHz, 39 kHz, 39 kHz, 39 kHz, 39 kHz 39 kHz, 39 kHz, 39 kHz, 39 kHz, 39 kHz, 39 kHz 1, 1, 1, 1, 1, 1
State Saved	Saved in instrument state.
Min	1 Hz
Max	8 MHz
Backwards Compatibility SCPI	[:SENSe]:ACPpower:OFFSet[1] 2:LIST:BWIDth:RESolution
Initial S/W Revision	Prior to A.02.00
Modified at S/W Revision	A.02.00, A.03.00, A.13.00

Video BW

Enables you to change the analyzer post-detection filter (VBW).

Key Path	Meas Setup, Offset/Limits, Offset BW
Mode	SA, WCDMA, C2K, WIMAX OFDMA, TD-SCDMA, 1xEVDO, DVB-T/H, DTMB (CTTB), ISDB-T, CMMB, LTE, LTETDD, Digital Cable TV, MSR, LTEAFDD, LTEATDD
Remote Command	[:SENSe]:ACPpower:OFFSet[1] 2[:OUTer]:LIST:BWIDth:VIDeo <freq>, <freq>, <freq>, <freq>, <freq> [:SENSe]:ACPpower:OFFSet[1] 2[:OUTer]:LIST:BWIDth:VIDeo? [:SENSe]:ACPpower:OFFSet[1] 2[:OUTer]:LIST:BWIDth:VIDeo:AUTO OFF ON 0 1, OFF ON 0 1, OFF ON 0 1, OFF ON 0 1, OFF ON 0 1, OFF ON 0 1, OFF ON 0 1 [:SENSe]:ACPpower:OFFSet[1] 2[:OUTer]:LIST:BWIDth:VIDeo:AUTO?
Example	ACP:OFFS2:LIST:BWIDth:VIDeo 5MHz, 5MHz, 5MHz, 5MHz, 5MHz, 5MHz ACP:OFFS2:LIST:BWIDth:VIDeo? ACP:OFFS2:LIST:BWIDth:VIDeo:AUTO 0,0,0,0,1,1 ACP:OFFS2:LIST:BWIDth:VIDeo:AUTO?
Notes	The values shown in this table reflect the conditions after a Mode Preset. Offset sub op code. 1 for BTS, 2 for MS. Default is BTS. Note that Offset sub op code 2 is supported only in Non-SA modes. In the SA mode, Offset sub op code 1 is used for both BTS and MS. You must be in the mode that includes ACP measurements to use this command. Use :INSTrument:SElect to set the mode.
Dependencies	When Meas Method is RBW or FAST or Fast Power, this key is grayed out and disabled. If the

	key is pressed, an advisory message is generated. If the equivalent remote command is sent, a "Setting conflict" warning is generated.
Preset	SA: 22 kHz, 22 kHz, 22 kHz, 22 kHz, 22 kHz, 22 kHz WCDMA, WIMAX OFDMA: 1 MHz, 1 MHz, 1 MHz, 1 MHz, 1 MHz, 1 MHz C2K: 150 kHz, 150 kHz, 150 kHz, 150 kHz, 150 kHz, 150 kHz 150 kHz, 150 kHz, 150 kHz, 1150 kHz, 1150 kHz, 150 kHz TD-SCDMA: 300 kHz, 300 kHz, 300 kHz, 300 kHz, 300 kHz, 300 kHz 1xEVDO: 300kHz, 300kHz, 300kHz, 300kHz, 300kHz, 300kHz 300kHz, 300kHz, 300kHz, 300kHz, 300kHz, 300kHz DVB-T/H: 390 kHz, 390 kHz, 390 kHz, 390 kHz, 390 kHz, 390 kHz 390 kHz, 390 kHz, 390 kHz, 390 kHz, 390 kHz, 390 kHz DTMB (CTTB): 390 kHz, 390 kHz, 390 kHz, 390 kHz, 390 kHz, 390 kHz 390 kHz, 390 kHz, 390 kHz, 390 kHz, 390 kHz, 390 kHz ISDB-T: 390 kHz, 390 kHz, 390 kHz, 390 kHz, 390 kHz, 390 kHz 390 kHz, 390 kHz, 390 kHz, 390 kHz, 390 kHz, 390 kHz CMMB: 390 kHz, 390 kHz, 390 kHz, 390 kHz, 390 kHz, 390 kHz 390 kHz, 390 kHz, 390 kHz, 390 kHz, 390 kHz, 390 kHz LTE, LTETDD, MSR, LTEAFDD, LTEATDD: 1 MHz, 1 MHz, 1 MHz, 1 MHz, 1 MHz, 1 MHz Digital Cable TV: 390 kHz, 390 kHz, 390 kHz, 390 kHz, 390 kHz, 390 kHz 390 kHz, 390 kHz, 390 kHz, 390 kHz, 390 kHz, 390 kHz ON, ON, ON, ON, ON, ON
State Saved	Saved in instrument state.
Min	1 Hz
Max	50 MHz
Backwards Compatibility SCPI	[:SENSE] :ACPower:OFFSet[1] 2 :LIST:BWIDth:VIDeo
Initial S/W Revision	Prior to A.02.00
Modified at S/W Revision	A.02.00, A.03.00, A.13.00

RBW Control

Accesses the resolution bandwidth control menu.

Key Path	Meas Setup, Offset/Limits, Offset BW
Initial S/W Revision	Prior to A.02.00

Filter Type

Selects the type of bandwidth filter that is used.

Key Path	Meas Setup, Offset/Limits, Offset BW, RBW Control
Mode	SA, WCDMA, C2K, WIMAX OFDMA, TD-SCDMA, 1xEVDO, DVB-T/H, DTMB (CTTB), ISDB-T, CMMB, LTE, LTETDD, Digital Cable TV, MSR, LTEAFDD, LTEATDD
Remote Command	[:SENSE] :ACPower:OFFSet[1] 2 [:OUTer] :LIST:BWIDth:SHAPE GAUSSian

	<p>FLATtop, GAUSSian FLATtop, GAUSSian FLATtop, GAUSSian FLATtop, GAUSSian FLATtop, GAUSSian FLATtop, GAUSSian FLATtop</p> <p>[:SENSe]:ACPower:OFFSet[1] 2[:OUTer]:LIST:BANDwidth:SHAPE?</p>
Example	<p>ACP:OFFS2:LIST:BAND:SHAP FLAT, GAUS, GAUS, GAUS, GAUS, GAUS</p> <p>ACP:OFFS2:LIST:BAND:SHAP?</p>
Notes	<p>Offset sub op code. 1 for BTS, 2 for MS. Default is BTS.</p> <p>Note that Offset sub op code 2 is supported only in Non-SA modes.</p> <p>In the SA mode, Offset sub op code 1 is used for both BTS and MS.</p> <p>You must be in the mode that includes ACP measurements to use this command. Use :INSTrument:SElect to set the mode.</p>
Dependencies	<p>When Res BW Mode for the offset is Auto, this key is grayed out and disabled. Since Res BW Mode for the offset is preset to Auto on changing Meas Method to RBW, FAST or Fast Power, this key is grayed out and disabled too. If the key is pressed, an advisory message is generated. If the equivalent remote command is sent, a "Setting conflict" warning is generated.</p>
Couplings	See the description above
Preset	GAUSSian, GAUSSian, GAUSSian, GAUSSian, GAUSSian, GAUSSian
State Saved	Saved in instrument state.
Range	GAUSSian FLATtop
Backwards Compatibility SCPI	[:SENSe]:ACPower:OFFSet[1] 2:LIST:BWIDth:SHAPE
Initial S/W Revision	Prior to A.02.00
Modified at S/W Revision	A.02.00, A.03.00, A.13.00

Filter BW

Selects a Gaussian filter based on its –3 dB (Normal) bandwidth or its –6 dB bandwidth.

Key Path	Meas Setup, Offset/Limits, Offset BW, RBW Control
Mode	SA, WCDMA, C2K, WIMAX OFDMA, TD-SCDMA, 1xEVDO, DVB-T/H, DTMB (CTTB), ISDB-T, CMMB, LTE, LTETDD, Digital Cable TV, MSR, LTEAFDD, LTEATDD
Remote Command	<p>[:SENSe]:ACPower:OFFSet[1] 2[:OUTer]:LIST:BANDwidth:TYPE DB3 DB6, DB3 DB6, DB3 DB6, DB3 DB6, DB3 DB6, DB3 DB6</p> <p>[:SENSe]:ACPower:OFFSet[1] 2[:OUTer]:LIST:BANDwidth:TYPE?</p>
Example	<p>ACP:OFFS2:LIST:BAND:TYPE DB3, DB3, DB3, DB3, DB3, DB3</p> <p>ACP:OFFS2:LIST:BAND:TYPE?</p>
Notes	<p>Offset sub op code. 1 for BTS, 2 for MS. Default is BTS.</p> <p>Note that Offset sub op code 2 is supported only in Non-SA modes.</p> <p>In the SA mode, Offset sub op code 1 is used for both BTS and MS.</p> <p>You must be in the mode that includes ACP measurements to use this command. Use :INSTrument:SElect to set the mode.</p>
Dependencies	When Filter Type if Flattop or Res BW Mode for the offset is Auto, this key is grayed out and

	disabled. Since Res BW Mode for the offset is preset to Auto on changing Meas Method to RBW, FAST or Fast Power, this key is grayed out and disabled too. If the key is pressed, an advisory message is generated. If the equivalent remote command is sent, a "Setting conflict" warning is generated.
Preset	DB3, DB3, DB3, DB3, DB3, DB3
State Saved	Saved in instrument state.
Range	-3 dB (Normal) -6 dB
Backwards Compatibility SCPI	[:SENSe] :ACP:OFFSet[1] 2 :LIST:BWIDth:TYPE
Initial S/W Revision	Prior to A.02.00
Modified at S/W Revision	A.02.00, A.03.00, A.13.00

Limits

Limits key accesses a menu of functions that contains Select Offset, Abs Limit, Rel Limit and Fail Mask parameters.

Key Path	Meas Setup, Offset/Limits
Initial S/W Revision	A.03.00

Select Offset

Selects the offset to configure.

Key Path	Meas Setup, Offset/Limits, Limits
Mode	SA, WCDMA, C2K, WIMAX OFDMA, TD-SCDMA, 1xEVDO, DVB-T/H, DTMB (CTTB), ISDB-T, CMMB, LTE, LTETDD, Digital Cable TV, MSR, LTEAFDD, LTEATDD
Preset	A
State Saved	Saved in instrument state.
Range	Offset A Offset B Offset C Offset D Offset E Offset F
Initial S/W Revision	Prior to A.02.00
Modified at S/W Revision	A.02.00, A.03.00, A.13.00

Abs Limit

Enters an absolute limit value, which sets the absolute amplitude levels to test against for each of the custom offsets. The list must contain six (6) entries. If there is more than one offset, the offset closest to the carrier channel is the first one in the list. [:SENSe]:ACP:OFFSet[n][:OUTer]:LIST:TEST selects the type of testing to be done at each offset.

You can turn off (not use) specific offsets with the [:SENSe]:ACP:OFFSet[n][:OUTer]:LIST:STATe command.

The query returns the six (6) sets of real numbers that are the current absolute amplitude test limits.

Key Path	Meas Setup, Offset/Limits, Limits
Mode	SA, WCDMA, C2K, WIMAX OFDMA, TD-SCDMA, 1xEVDO, DVB-T/H, DTMB (CTTB), ISDB-T, CMMB, LTE, LTETDD, Digital Cable TV, MSR,LTEAFDD,LTEATDD
Remote Command	<code>[:SENSe]:ACPpower:OFFSet[1] 2[:OUTer]:LIST:ABSolute <real>, <real>, <real>, <real>, <real>, <real></code> <code>[:SENSe]:ACPpower:OFFSet[1] 2[:OUTer]:LIST:ABSolute?</code>
Example	ACP:OFFS2:LIST:ABS -10, -10, -10, -10, -10, -10 ACP:OFFS2:LIST:ABS?
Notes	Offset sub op code. 1 for BTS, 2 for MS. Default is BTS. Note that Offset sub op code 2 is supported only in Non-SA modes. In the SA mode, Offset sub op code 1 is used for both BTS and MS. You must be in the mode that includes ACP measurements to use this command. Use :INSTrument:SElect to set the mode.
Couplings	None If current mode is DTMB (CTTB) or CMMB and current device type is Transmitter, the value from position 2 to position 4 are coupled, changing any one will change the others.
Preset	SA: 0dBm, 0 dBm, 0 dBm, 0 dBm, 0 dBm, 0 dBm 0dBm, 0 dBm, 0 dBm, 0 dBm, 0 dBm, 0 dBm WCDMA: 50 dBm, 50 dBm, 50 dBm, 50 dBm, 50 dBm, 50 dBm 50 dBm, 50 dBm, 50 dBm, 50 dBm, 50 dBm, 50 dBm C2K: 50 dBm, 50 dBm, 50 dBm, 50 dBm, 50 dBm, 50 dBm 50 dBm, 50 dBm, 50 dBm, 50 dBm, 50 dBm, 50 dBm WIMAX OFDMA: 50,50,50,50,50,50 TD-SCDMA: 50 dBm, 50 dBm, 50 dBm, 50 dBm, 50 dBm, 50 dBm 50 dBm, 50 dBm, 50 dBm, 50 dBm, 50 dBm, 50 dBm 1xEVDO: -27dBm, -27dBm, -13dBm, -13dBm, -13dBm, -13dBm -27dBm, -27dBm, -13dBm, -13dBm, -13dBm, -13dBm DVB-T/H: 50 dBm, 50 dBm, 50 dBm, 50 dBm, 50 dBm, 50 dBm 50 dBm, 50 dBm, 50 dBm, 50 dBm, 50 dBm, 50 dBm DTMB (CTTB): 11.14 dBm, 11.14dBm, 11.14 dBm, 11.14 dBm, 50 dBm, 50 dBm 11.14 dBm, 11.14 dBm, 11.14 dBm, 11.14 dBm, 50 dBm, 50 dBm ISDB-T: 50 dBm, 50 dBm, 50 dBm, 50 dBm, 50 dBm, 50 dBm 50 dBm, 50 dBm, 50 dBm, 50 dBm, 50 dBm, 50 dBm CMMB: 11.14 dBm, 11.14dBm, 11.14 dBm, 11.14 dBm, 50 dBm, 50 dBm 11.14 dBm, 11.14 dBm, 11.14 dBm, 11.14 dBm, 50 dBm, 50 dBm LTE, LTETDD, MSR, LTEAFDD, LTEATDD: -8.45, -8.45, -8.45, -8.45, -8.45, -8.45 -50.0, -50.0, -50.0, -50.0, -50.0, -50.0 Digital Cable TV: 50 dBm, 50 dBm, 50 dBm, 50 dBm, 50 dBm, 50 dBm 50 dBm, 50 dBm, 50 dBm, 50 dBm, 50 dBm, 50 dBm
State Saved	Saved in instrument state.
Min	-200.0 dBm

Max	50.0 dBm
Backwards Compatibility SCPI	<code>[:SENSe]:ACPR:OFFSet[1] 2:LIST:ABSolute (PSA W-CDMA, PSA cdma2000)</code> <code>[:SENSe]:MCPower:OFFSet[1] 2:LIST:ABSolute (PSA W-CDMA)</code>
Initial S/W Revision	Prior to A.02.00
Modified at S/W Revision	A.02.00, A.03.00, A.13.00

Rel Lim (Car)

Enters a relative limit value for the carrier level. This sets the amplitude levels to test against for the specified offsets.

The amplitude level is relative to the carrier amplitude. If multiple offsets are available, the list contains six (6) entries. The offset closest to the carrier channel is the first one in the list.

`[:SENSe]:ACP:OFFSet[n][:OUTer]:LIST:TEST` selects the type of testing to be done at each offset.

You can turn off (not use) specific offsets with the `[:SENSe]:ACP:OFFSet[n][:OUTer]:LIST:STATE` command.

The query returns the six (6) sets of real numbers that are the current amplitude test limits, relative to the carrier, for each offset.

Offset[n] n = 1 is base station and n = 2 is mobiles. The default is base station (1).

Key Path	Meas Setup, Offset/Limits, Limits,
Mode	SA, WCDMA, C2K, WIMAX OFDMA, TD-SCDMA, 1xEVDO, DVB-T/H, DTMB (CTTB), ISDB-T, CMMB, LTE, LTE-TDD, Digital Cable TV, MSR, LTEAFDD, LTEATDD
Remote Command	<code>[:SENSe]:ACPower:OFFSet[1] 2[:OUTer]:LIST:RCARrier <real>, <real>, <real>, <real>, <real>, <real></code> <code>[:SENSe]:ACPower:OFFSet[1] 2[:OUTer]:LIST:RCARrier?</code>
Example	ACP:OFFS2:LIST:RCAR 0,0,0,0,0,0 ACP:OFFS2:LIST:RCAR?
Notes	Offset sub op code. 1 for BTS, 2 for MS. Default is BTS. Note that Offset sub op code 2 is supported only in Non-SA modes. In the SA mode, Offset sub op code 1 is used for both BTS and MS. You must be in the mode that includes ACP measurements to use this command. Use <code>:INSTrument:SElect</code> to set the mode.
Couplings	None If current mode is DTMB (CTTB) or CMMB and current device type is Transmitter, the value from position 2 to position 4 are coupled, changing any one will change the others.
Preset	SA: -45, -60, 0, 0, 0, 0 -45, -60, 0, 0, 0, 0 WCDMA: -44.2, -49.2, -49.2, -49.2, -49.2, -49.2 -32.2, -42.2, -42.2, -42.2, -42.2, -42.2 C2K: 0, 0, 0, 0, 0, 0 0, 0, 0, 0, 0, 0 WIMAX OFDMA: -50, -60, 0, 0, 0, 0

	TD-SCDMA: -40, -45, -45, -45, -45, -45 -33, -43, -43, -43, -43, -43 1xEVDO: -45, -55, -55, -55, -55, -55 -45, -55, -55, -55, -55, -55 DVB-T/H: -60, -60, 0, 0, 0, 0 -60, -60, 0, 0, 0, 0 DTMB (CTTB): -45, -60, -60, -60, 50, 50 -45, -60, -60, -60, 50, 50 ISDB-T: -60, -60, 0, 0, 0, 0 -60, -60, 0, 0, 0, 0 CMMB: -45, -60, -60, -60, 50, 50 -45, -60, -60, -60, 50, 50 LTE, LTETDD, MSR, LTEAFDD, LTEATDD: -44.2, -44.2, -44.2, -44.2, -44.2, -44.2 -29.2, -29.2, -29.2, -29.2, -29.2, -29.2 Digital Cable TV: -58, -62, -65, -73, -73, -73 -58, -62, -65, -73, -73, -73
State Saved	Saved in instrument state.
Min	-150
Max	50.0
Backwards Compatibility SCPI	[:SENSe]:MCPower:OFFSet[1] 2:LIST:RCARrier (PSA WCDMA)
Initial S/W Revision	Prior to A.02.00
Modified at S/W Revision	A.02.00, A.03.00, A.04.00, A.13.00

Positive Offset Limit (SCPI only)

Enables you to set the upper limit for the upper segment of the specified offset pair.

Mode	SA, WCDMA, CDMA2K, WIMAXOFDMA, TDSCDMA, CDMA1XEV, DVB, DTMB, LTE, LTETDD, DCTV, MSR, LTEAFDD, LTEATDD
Remote Command	:CALCulate:ACPower:OFFSet[:OUTer]:LIST:LIMit:POSitive[:UPPer]:DATA <real>, <real>, <real>, <real>, <real>, <real> :CALCulate:ACPower:OFFSet[:OUTer]:LIST:LIMit:POSitive[:UPPer]:DATA?
Example	CALC:ACP:OFFS:LIST:LIM:POS:DATA 0, 0, 0, 0, 0, 0 CALC:ACP:OFFS:LIST:LIM:POS:DATA?
Notes	SCPI only command
Preset	SA: -45, -60, 0, 0, 0, 0 -45, -60, 0, 0, 0, 0 WCDMA: -44.2, -49.2, -49.2, -49.2, -49.2, -49.2 -32.2, -42.2, -42.2, -42.2, -42.2, -42.2 C2K: 0, 0, 0, 0, 0, 0 0, 0, 0, 0, 0, 0 WIMAX OFDMA: -50, -60, 0, 0, 0, 0 TD-SCDMA: -40, -45, -45, -45, -45, -45 -33, -43, -43, -43, -43, -43 1xEVDO: -45, -55, -55, -55, -55, -55 -45, -55, -55, -55, -55, -55 DVB-T/H: -60, -60, 0, 0, 0, 0 -60, -60, 0, 0, 0, 0 DTMB (CTTB): -45, -60, -60, -60, 0, 0 -45, -60, -60, -60, 0, 0 Digital Cable TV: -58, -62, -65, -73, -73, -73 -58, -62, -65, -73, -73, -73 LTE, LTETDD, MSR, LTEAFDD, LTEATDD: -44.2, -44.2, -44.2, -44.2, -44.2, -44.2 -29.2, -29.2, -29.2, -29.2, -29.2, -29.2
State Saved	Saved in instrument state.

Min	-150.0
Max	50.0
Backwards Compatibility SCPI	:CALCulate:MCPower:OFFSet:LIST:LIMit:POSitive[:UPPer]:DATA (PSA Power Suite)
Initial S/W Revision	A.04.00
Modified at S/W Revision	A.13.00

Negative Offset Limit

Enables you to set the upper limit for the lower segment of the specified offset pair.

Mode	SA, WCDMA, CDMA2K, WIMAXOFDMA, TDSCDMA, CDMA1XEV, DVB, DTMB, LTE, LTETDD, DCTV, MSR, LTEAFDD, LTEATDD
Remote Command	:CALCulate:ACPower:OFFSet[:OUTer]:LIST:LIMit:NEGative[:UPPer]:DATA <real>, <real>, <real>, <real>, <real>, <real> :CALCulate:ACPower:OFFSet[:OUTer]:LIST:LIMit:NEGative[:UPPer]:DATA?
Example	CALC:ACP:OFFS:LIST:LIM:NEG:DATA 0, 0, 0, 0, 0, 0 CALC:ACP:OFFS:LIST:LIM:NEG:DATA?
Notes	SCPI only command
Preset	SA: -45, -60, 0, 0, 0, 0 -45, -60, 0, 0, 0, 0 WCDMA: -44.2, -49.2, -49.2, -49.2, -49.2, -49.2 -32.2, -42.2, -42.2, -42.2, -42.2, -42.2 C2K: 0, 0, 0, 0, 0, 0 0, 0, 0, 0, 0, 0 WIMAX OFDMA: -50, -60, 0, 0, 0, 0 TD-SCDMA: -40, -45, -45, -45, -45, -45 -33, -43, -43, -43, -43, -43 1xEVDO: -45, -55, -55, -55, -55, -55 -45, -55, -55, -55, -55, -55 DVB-T/H: -60, -60, 0, 0, 0, 0 -60, -60, 0, 0, 0, 0 DTMB (CTTB): -45, -60, -60, -60, 0, 0 -45, -60, -60, -60, 0, 0 Digital Cable TV: -58, -62, -65, -73, -73, -73 -58, -62, -65, -73, -73, -73 LTE, LTETDD, MSR, LTEAFDD, LTEATDD: -44.2, -44.2, -44.2, -44.2, -44.2, -44.2 -29.2, -29.2, -29.2, -29.2, -29.2, -29.2
State Saved	Saved in instrument state.
Min	-150.0
Max	50.0
Backwards Compatibility SCPI	:CALCulate:MCPower:OFFSet:LIST:LIMit:NEGative[:UPPer]:DATA (PSA Power Suite)
Initial S/W Revision	A.04.00
Modified at S/W Revision	A.13.00

Rel Limit (PSD)

Enters a relative limit value for the level of the power spectral density. This sets the amplitude levels to test against for any custom offsets. The amplitude level is

relative to the power spectral density. If multiple offsets are available, the list contains six (6) entries. The offset closest to the carrier channel is the first one in the list.

`[[:SENSe]:ACP:OFFSet[n]:[:OUTer]:LIST:TEST` selects the type of testing to be done at each offset.

You can turn off (not use) specific offsets with the `[[:SENSe]:ACP:OFFSet[n]:[:OUTer]:LIST:STATe` command.

The query returns the six (6) sets of real numbers that are the current amplitude test limits, relative to the power spectral density, for each offset.

Offset[n] n = 1 is base station and n = 2 is mobiles. The default is base station (1).

Key Path	Meas Setup, Offset/Limits, Limits
Mode	SA, WCDMA, C2K, WIMAX OFDMA, TD-SCDMA, 1xEVDO, DVB-T/H, DTMB (CTTB), ISDB-T, CMMB, LTE, LTETDD, Digital Cable TV, MSR, LTEAFDD, LTEATDD
Remote Command	<code>[[:SENSe]:ACP:OFFSet[1] 2[:OUTer]:LIST:RPSDensity <rel_ampl>, <rel_ampl>, <rel_ampl>, <rel_ampl>, <rel_ampl></code> <code>[[:SENSe]:ACP:OFFSet[1] 2[:OUTer]:LIST:RPSDensity?</code>
Example	ACP:OFFS2:LIST:RPSD 10,10,10,10,10,10 ACP:OFFS2:LIST:RPSD?
Notes	Offset sub op code. 1 for BTS, 2 for MS. Default is BTS. Note that Offset sub op code 2 is supported only in Non-SA modes. In the SA mode, Offset sub op code 1 is used for both BTS and MS. You must be in the mode that includes ACP measurements to use this command. Use <code>:INSTRument:SElect</code> to set the mode.
Preset	SA: -28.87 dB, -43.87 dB, 0 dB, 0 dB, 0 dB, 0 dB -28.87 dB, -43.87 dB, 0 dB, 0 dB, 0 dB, 0 dB WCDMA: -44.2 dB, -49.2 dB, -49.2 dB, -49.2 dB, -49.2 dB, -49.2 dB -32.2 dB, -42.2 dB, -42.2 dB, -42.2 dB C2K: 0 dB, 0 dB, 0 dB, 0 dB, 0 dB, 0 dB 0 dB, 0 dB, 0 dB, 0 dB, 0 dB, 0 dB WIMAX OFDMA: -25,-35,0,0,0,0 TD-SCDMA: -40 dB, -45 dB, -45 dB, -45 dB, -45 dB, -45 dB -33 dB, -43 dB, -43 dB, -43 dB, -43 dB, -43 dB 1xEVDO: -45, -55, -55, -55, -55, -55 -45, -55, -55, -55, -55, -55 DVB-T/H: -60 dB, -60 dB, 0 dB, 0 dB, 0 dB, 0 dB -60 dB, -60 dB, 0 dB, 0 dB, 0 dB, 0 dB DTMB (CTTB): 50 dB, 50 dB, 50 dB, 50 dB, 50 dB, 50 dB 50 dB, 50 dB, 50 dB, 50 dB, 50 dB, 50 dB ISDB-T: -60 dB, -60 dB, 0 dB, 0 dB, 0 dB, 0 dB -60 dB, -60 dB, 0 dB, 0 dB, 0 dB, 0 dB CMMB: 50 dB, 50 dB, 50 dB, 50 dB, 50 dB, 50 dB 50 dB, 50 dB, 50 dB, 50 dB, 50 dB, 50 dB LTE, LTETDD, MSR, LTEAFDD, LTEATDD: 0, 0, 0, 0, 0, 0 0, 0, 0, 0, 0, 0 Digital Cable TV: 50 dB, 50 dB, 50 dB, 50 dB, 50 dB, 50 dB 50 dB, 50 dB, 50 dB, 50 dB, 50 dB, 50 dB
State Saved	Saved in instrument state.
Min	-150.0 dB

Max	50.0 dB
Initial S/W Revision	Prior to A.02.00
Modified at S/W Revision	A.02.00, A.03.00, A.13.00

Fail Mask

Accesses a menu that enables you to select one of the logic keys for the fail conditions between the measurement results and the test limits. The setting defines the type of testing to be done at any custom offset frequencies. The measured powers are tested against the absolute values defined with [:SENSe]:ACP:OFFSet[n][:OUTer]:LIST:ABSolute, or the relative values defined with [:SENSe]:ACP:OFFSet[n][:OUTer]:LIST:RPSDensity and [:SENSe]:ACP:OFFSet[n][:OUTer]:LIST:RCARrier.

You can turn off (not use) specific offsets with the [:SENSe]:ACP:OFFSet[n][:OUTer]:LIST:STATe command.

- Absolute – Fail is shown if one of the absolute ACP measurement results is larger than the limit for Abs Limit.
- Relative – Fail is shown if one of the relative ACP measurement results is larger than the limit for Rel Lim (Car) or Rel Lim (PSD).
- Abs AND Rel – Fail is shown if one of the absolute ACP measurement results is larger than the limit for Abs Limit AND one of the relative ACP measurement results is larger than the limit for Rel Lim (Car) or Rel Lim (PSD).
- Abs OR Rel – Fail is shown if one of the absolute ACP measurement results is larger than the limit for Abs Limit OR one of the relative ACP measurement results is larger than the limit for Rel Lim (Car) or Rel Lim (PSD).

Key Path	Meas Setup, Offset/Limits, Limits
Mode	SA, WCDMA, C2K, WIMAX OFDMA, TD-SCDMA, 1xEVDO, DVB-T/H, DTMB (CTTB), ISDB-T, CMMB, LTE, LTETDD, Digital Cable TV, MSR, LTEAFDD, LTEATDD
Remote Command	[:SENSe]:ACP:OFFSet[1] 2[:OUTer]:LIST:TEST ABSolute AND OR RELative, ABSolute AND OR RELative, ABSolute AND OR RELative, ABSolute AND OR RELative, ABSolute AND OR RELative [:SENSe]:ACP:OFFSet[1] 2[:OUTer]:LIST:TEST?
Example	ACP:OFFS2:LIST:TEST ABS, ABS, ABS, ABS, ABS, ABS ACP:OFFS2:LIST:TEST?
Notes	Offset sub op code. 1 for BTS, 2 for MS. Default is BTS. Note that Offset sub op code 2 is supported only in Non-SA modes. In the SA mode, Offset sub op code 1 is used for both BTS and MS.

	You must be in the mode that includes ACP measurements to use this command. Use :INSTrument:SElect to set the mode.
Couplings	None If current mode is DTMB (CTTB) or CMMB and current device type is Transmitter, the value from position 2 to position 4 are coupled, changing any one will change the others.
Preset	SA, WCDMA, C2K, TD-SCDMA: REL, REL, REL, REL, REL, REL REL, REL, REL, REL, REL, REL WIMAX OFDMA: REL, REL, REL, REL, REL, REL DVB-T/H: REL, REL, REL, REL, REL, REL DTMB (CTTB): OR,AND, AND,AND, REL, REL CDMA1xEVDO: REL, REL, ABS, REL, REL, REL REL, REL, ABS, REL, REL, REL ISDB-T : REL, REL, REL, REL, REL, REL CMMB : OR,AND, AND,AND, REL, REL LTE, LTETDD, MSR, LTEAFDD, LTEATDD: AND, AND, AND, AND, AND, AND AND, AND, AND, AND, AND, AND Digital Cable TV: REL, REL, REL, REL, REL, REL
State Saved	Saved in instrument state.
Range	Absolute Relative Abs AND Rel (fail if both fail) Abs OR Rel (fail if either fails)
Backwards Compatibility SCPI	[:SENSe] :MCPower :OFFSet [1] 2 :LIST :TEST
Initial S/W Revision	Prior to A.02.00
Modified at S/W Revision	A.02.00, A.03.00, A.04.00, A13.00

Offset Side

Enables you to turn off (not use) specific offsets with [:SENSe]:ACPpower:OFFSet[1]|2 [:Outer]:LIST:SIDE.

- NEGative - Negative (lower) sideband only
- BOTH - Both of the negative (lower) and positive (upper) sidebands
- POSitive - Positive (upper) sideband only

The figure below shows the relation between the negative/positive offset side setups and the upper/lower results in the MSR and LTE-Advanced FDD/TDD.

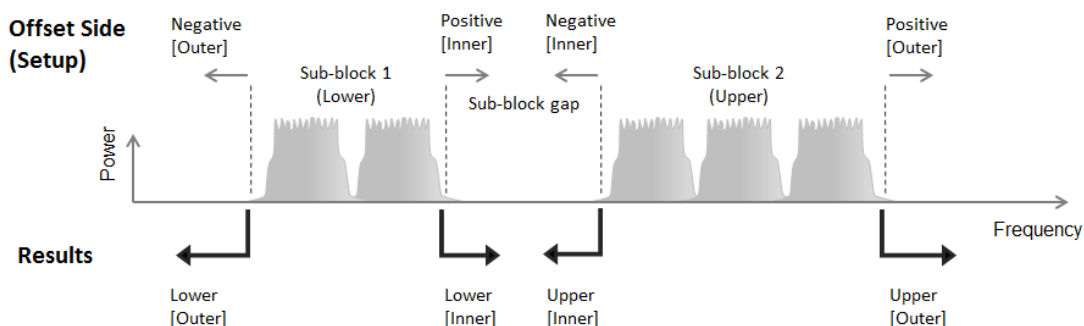

Key Path	Meas Setup, Offset/Limits
Mode	SA, WCDMA, C2K, WIMAX OFDMA, TD-SCDMA, 1xEVDO, DTMB (CTTB), DVB-T/H, LTE, LTETDD, Digital Cable TV, MSR,LTEAFDD,LTEATDD
Remote Command	[:SENSe]:ACPoweR:OFFSet[1] 2[:OUTer]:LIST:SIDE NEGative BOTH POSitive,NEGative BOTH POSitive,NEGative BOTH POSitive,NEGative BOTH POSitive,NEGative BOTH POSitive [:SENSe]:ACPoweR:OFFSet[1] 2[:OUTer]:LIST:SIDE?
Example	ACP:OFFS:LIST:SIDE BOTH ACP:OFFS:LIST:SIDE?
Notes	OFFSet1 is for BTS, 2 for MS. Default is BTS. You must be in the Spectrum Analysis mode, W-CDMA mode, cdma2000 mode, TD-SCDMA mode, DTMB (CTTB) mode, DVB-T/H mode, ISDB-T mode, CMMB mode, Digital Cable TV mode, 1xEVDO mode, WIMAX OFDMA mode, LTE mode, LTETDD, LTEAFDD, LTEATDD or MSR mode to use this command. Use :INSTrument:SElect to set the mode. If you set POS or NEG in an offset, result of the inactive side will return -999.
Preset	BOTH, BOTH, BOTH, BOTH, BOTH, BOTH BOTH, BOTH, BOTH, BOTH, BOTH, BOTH
State Saved	Saved in instrument state.
Range	Neg Both Pos
Initial S/W Revision	A.03.00
Modified at S/W Revision	A.13.00

Method for Offset

This key allows you to turn RRC filtering of each offset on or off. The value (roll off) for the filter will be set to the value of the Filter Alpha parameter.

Key Path	Meas Setup, Offset/Limits
Mode	SA, WCDMA, WIMAX OFDMA,TD-SCDMA, DVB-T/H, DTMB (CTTB), ISDB-T, CMMB, LTE, LTETDD, Digital Cable TV, MSR, LTEAFDD,LTEATDD
Remote Command	[:SENSe]:ACPoweR:OFFSet[1] 2[:OUTer]:LIST:FILTer[:RRC][:STATE] ON OFF 1 0, ON OFF 1 0, ON OFF 1 0, ON OFF 1 0, ON OFF 1 0, ON OFF 1 0 [:SENSe]:ACPoweR:OFFSet[1] 2[:OUTer]:LIST:FILTer[:RRC][:STATE]?
Example	ACP:OFFS:LIST:FILT 1,0,0 ACP:OFFS:LIST:FILT?
Notes	1 ON = RRC Weighted, 0 OFF = Integ BW This parameter is not available for cdma2000 and 1xEVDO. You must be in the mode that includes ACP measurements to use this command. Use :INSTrument:SElect to set the mode.
Preset	SA: 0, 0, 0, 0, 0, 0 0, 0, 0, 0, 0, 0 WCDMA:1, 1, 1, 1, 1, 1 1, 1, 1, 1, 1, 1 C2K: NO

	WIMAX OFDMA: 0, 0, 0, 0, 0, 0 0, 0, 0, 0, 0, 0 TD-SCDMA: 1, 1, 1, 1, 1, 1 1, 1, 1, 1, 1, 1 DVB-T/H: 0, 0, 0, 0, 0, 0 0, 0, 0, 0, 0, 0 DTMB (CTTB): 1, 1, 1, 1, 1, 1 1, 1, 1, 1, 1, 1 ISDB-T: 0, 0, 0, 0, 0, 0 0, 0, 0, 0, 0, 0 CMMB: 1, 1, 1, 1, 1, 1 1, 1, 1, 1, 1, 1 LTE: 0, 0, 0, 0, 0, 0 0, 0, 0, 0, 0, 0 LTETDD: 0, 0, 0, 0, 0, 0 0, 0, 0, 0, 0, 0 Digital Cable TV: 0, 0, 0, 0, 0, 0 0, 0, 0, 0, 0, 0 MSR, LTEAFDD, LTEATDD: 0, 0, 0, 0, 0, 0 0, 0, 0, 0, 0, 0
State Saved	Saved in instrument state.
Range	Integ BW RRC Weighted
Initial S/W Revision	A.03.00
Modified at S/W Revision	A.13.00

Method for Offset

This key allows you to turn RRC filtering of each offset on or off. The value (roll off) for the filter will be set to the value of the Filter Alpha parameter.

Key Path	Meas Setup, Offset/Limits
Mode	SA, WCDMA, WIMAX OFDMA, TD-SCDMA, DVB-T/H, DTMB (CTTB), ISDB-T, CMMB, LTE, LTETDD, Digital Cable TV, MSR, LTEAFDD, LTEATDD
Remote Command	<code>[:SENSe]:ACPower:OFFSet[1] 2[:OUTer]:LIST:FILTer[:RRC][:STATE] ON OFF 1 0, ON OFF 1 0, ON OFF 1 0, ON OFF 1 0, ON OFF 1 0, ON OFF 1 0</code> <code>[:SENSe]:ACPower:OFFSet[1] 2[:OUTer]:LIST:FILTer[:RRC][:STATE]?</code>
Example	ACP:OFFS:LIST:FILT 1,0,0 ACP:OFFS:LIST:FILT?
Notes	1 ON = RRC Weighted, 0 OFF = Integ BW This parameter is not available for cdma2000 and 1xEVDO. You must be in the mode that includes ACP measurements to use this command. Use :INSTrument:SElect to set the mode.
Preset	SA: 0, 0, 0, 0, 0, 0 0, 0, 0, 0, 0, 0 WCDMA:1, 1, 1, 1, 1, 1 1, 1, 1, 1, 1, 1 C2K: NO WIMAX OFDMA: 0, 0, 0, 0, 0, 0 0, 0, 0, 0, 0, 0 TD-SCDMA: 1, 1, 1, 1, 1, 1 1, 1, 1, 1, 1, 1 DVB-T/H: 0, 0, 0, 0, 0, 0 0, 0, 0, 0, 0, 0 DTMB (CTTB): 1, 1, 1, 1, 1, 1 1, 1, 1, 1, 1, 1 ISDB-T: 0, 0, 0, 0, 0, 0 0, 0, 0, 0, 0, 0

	CMMB: 1, 1, 1, 1, 1, 1 1, 1, 1, 1, 1, 1 LTE: 0, 0, 0, 0, 0, 0 0, 0, 0, 0, 0, 0 LTETDD: 0, 0, 0, 0, 0, 0 0, 0, 0, 0, 0, 0 Digital Cable TV: 0, 0, 0, 0, 0, 0 0, 0, 0, 0, 0, 0 MSR, LTEAFDD, LTEATDD: 0, 0, 0, 0, 0, 0 0, 0, 0, 0, 0, 0
State Saved	Saved in instrument state.
Range	Integ BW RRC Weighted
Initial S/W Revision	A.03.00
Modified at S/W Revision	A.13.00

Filter Alpha for Offset

Sets the alpha value for the RRC Filter for each offset.

Key Path	Meas Setup, Offset/Limits, Method, RRC Weighted
Mode	SA, WCDMA, WIMAX OFDMA, TD-SCDMA, DVB-T/H, DTMB (CTTB), ISDB-T, CMMB, LTE, LTETDD, Digital Cable TV, MSR, LTEAFDD, LTEATDD
Remote Command	<pre>[:SENSe]:ACPower:OFFSet[1] 2[:OUTer]:LIST:FILTer:ALPHa <real>, <real>, <real>, <real>, <real> [:SENSe]:ACPower:OFFSet[1] 2[:OUTer]:LIST:FILTer:ALPHa?</pre>
Example	<pre>ACP:OFFS:LIST:FILT:ALPH 0.5, 0.5, 0.5, 0.5, 0.5, 0.5 ACP:OFFS:LIST:FILT:ALPH?</pre>
Notes	<p>This parameter is not available for cdma2000 and 1xEVDO.</p> <p>You must be in the mode that includes ACP measurements to use this command. Use :INSTrument:SElect to set the mode.</p>
Preset	<pre>SA: 0.22, 0.22, 0.22, 0.22, 0.22, 0.22 0.22, 0.22, 0.22, 0.22, 0.22, 0.22 WCDMA: 0.22, 0.22, 0.22, 0.22, 0.22, 0.22 0.22, 0.22, 0.22, 0.22, 0.22, 0.22 WIMAX OFDMA: 0.22, 0.22, 0.22, 0.22, 0.22, 0.22 0.22, 0.22, 0.22, 0.22, 0.22, 0.22 C2K: NO TD-SCDMA: 0.22, 0.22, 0.22, 0.22, 0.22, 0.22 0.22, 0.22, 0.22, 0.22, 0.22, 0.22 DVB-T/H: 0.22, 0.22, 0.22, 0.22, 0.22, 0.22 0.22, 0.22, 0.22, 0.22, 0.22, 0.22 DTMB (CTTB): 0.05, 0.05, 0.05, 0.05, 0.05, 0.05 0.05, 0.05, 0.05, 0.05, 0.05, 0.05 ISDB-T : 0.22, 0.22, 0.22, 0.22, 0.22, 0.22 0.22, 0.22, 0.22, 0.22, 0.22, 0.22 CMMB : 0.22, 0.22, 0.22, 0.22, 0.22, 0.22 0.22, 0.22, 0.22, 0.22, 0.22, 0.22 LTE: 0.22, 0.22, 0.22, 0.22, 0.22, 0.22 0.22, 0.22, 0.22, 0.22, 0.22, 0.22 LTETDD: 0.22, 0.22, 0.22, 0.22, 0.22, 0.22 0.22, 0.22, 0.22, 0.22, 0.22, 0.22 Digital Cable TV: 0.15, 0.15, 0.15, 0.15, 0.15, 0.15 0.15, 0.15, 0.15, 0.15, 0.15, 0.15 MSR, LTEAFDD, LTEATDD: 0.22, 0.22, 0.22, 0.22, 0.22, 0.22 0.22, 0.22, 0.22, 0.22, 0.22, 0.22</pre>
State Saved	Saved in instrument state.
Min	0.01
Max	1.00

Initial S/W Revision	A.03.00
Modified at S/W Revision	A.13.00

Offset Frequency Define

This key allows you to select “Offset” definition. Each standard defines each “Offset” from Carrier.

3GPP2 requires the “From Carrier Center to MeasBW Closer Edge” definition. LTE conformance test requires “From Carrier Edge to MeasBW Center” and/or “From Carrier Edge to MeasBW Closer Edge” definition.

- CTOCenter – From the center of the carrier closest to the adjacent channel to the center of the adjacent channel Offset Integ BW
- CTOEdge - From the center of the carrier closest to the adjacent channel to the edge of the closest adjacent channel Offset Integ BW
- ETOCenter – From Center Frequency - Carrier Spacing / 2 (for lower offset), Center Frequency + Carrier Spacing / 2 (for upper offset) of the carrier closest to the adjacent channel's to the center of the adjacent channel Offset Integ BW
- ETOEdge - From Center Frequency - Carrier Spacing / 2 (for lower offset), Center Frequency + Carrier Spacing / 2 (for upper offset) of the carrier closest to the adjacent channel's to the edge of the closest adjacent channel Offset Integ BW

Key Path	Meas Setup, Offset/Limits
Mode	SA, WCDMA, C2K, WIMAX OFDMA, TD-SCDMA, 1xEVDO, DVB-T/H, DTMB (CTTB), ISDB-T, CMMB, LTE, LTETDD, Digital Cable TV, MSR, LTEAFDD, LTEATDD
Remote Command	[:SENSe]:ACPpower:OFFSet[1] 2[:OUTer]:TYPE CTOCenter CTOEdge ETOCenter ETOEdge [:SENSe]:ACPpower:OFFSet[1] 2[:OUTer]:TYPE?
Example	ACP:OFFS:TYPE ETOC ACP:OFFS:TYPE?
Notes	You must be in the mode that includes ACP measurements to use this command. Use :INSTrument:SElect to set the mode.
Preset	All Except C2K and 1xEVDO: CTOCenter C2K and 1xEVDO: CTOEdge
State Saved	Saved in instrument state.
Range	Carrier Center To Meas BW Center Carrier Center To Meas BW Edge Carrier Edge To Meas BW Center Carrier Edge To Meas BW Edge

Initial S/W Revision	A.03.00
Modified at S/W Revision	A.13.00

Carrier Result

Allows you to view and scroll through the carrier power results.

Key Path	Meas Setup
Mode	SA, WCDMA, C2K, WIMAX OFDMA, TD-SCDMA, 1xEVDO, DVB-T/H, DTMB (CTTB), ISDB-T, CMMB, LTE, LTE-TDD, Digital Cable TV, MSR, LTEAFDD, LTEATDD
Couplings	This key will be grayed out if there is only one carrier.
Preset	1
State Saved	No
Min	1
Max	Number of carriers.
Initial S/W Revision	Prior to A.02.00
Modified at S/W Revision	A.02.00, A.03.00

PhNoise Opt

Selects the LO (local oscillator) phase noise behavior for various desired operating conditions.

See ["More Information" on page 1715](#)

Path	Meas Setup
Remote Command	[:SENSe] :FREQuency :SYNThesis [:STATe] 1 2 3 4 5 [:SENSe] :FREQuency :SYNThesis [:STATe] ?
Example	FREQ:SYNT 2 selects optimization for best wide offset phase noise
Range	All but EPO: Best Close-In Best Wide-Offset Fast Tuning EPO: Best Close-In Best Wide-Offset Fast Tuning Balanced Best Spurs
Range (Long Form)	No EPx option: Best Close-In Φ Noise [offset < 20 kHz] Best Wide-Offset Φ Noise [offset > 30 kHz] Fast Tuning [same as Close-in] EPO:

Best Close-In Φ Noise
[offset < 600 kHz]
Balance Noise & Spurs
[offset < 600 kHz]
Best Spurs
[offset < 600 kHz]
Best Wide-Offset Φ Noise
[offset > 800 kHz]
Fast Tuning
EP1:
Best Close-In Φ Noise
[offset < 140 kHz]
Best Wide-Offset Φ Noise
[offset > 160 kHz]
Fast Tuning
[single loop]
EP2 & EP3:
Best Close-In Φ Noise
[offset < 70 kHz]
Best Wide-Offset Φ Noise
[offset > 100 kHz]
Fast Tuning
[medium loop bw]
EP4:
Best Close-In Φ Noise
[offset < 90 kHz]
Best Wide-Offset Φ Noise
[offset > 130 kHz]
Fast Tuning
[same as Close-in]

Notes

Parameter:

- 1: In instruments with EP0, balances close-in phase noise with spur avoidance. In instruments without EP0 optimizes phase noise for small frequency offsets from the carrier.
- 2: optimizes phase noise for wide frequency offsets from the carrier.
- 3: optimizes LO for tuning speed
- 4: In instruments with EP0, balances close-in phase noise with spur avoidance. In instruments without EP0 this setting is accepted but no action taken.
- 5: In instruments with EP0, emphasizes spur avoidance with close-in phase noise performance. In instruments without EP0 this setting is accepted but no action taken.

The actual behavior varies somewhat depending on model number and option; you always get fast tuning by choosing #3, but in some models, the “Fast Tuning” choice is identical to the “Best Close-In” choice. Specifically:

- Models with option EPO (for example UXA), have a two stage local oscillator, which switches to a single loop for fast tuning
- Models with option EP1 (for example PXA), have a two-loop local oscillator, which switches to a single loop for fast tuning
- Models with option EP2 (available, for example, for MXA), use a different loop bandwidth for the fast-tuning choice, which is a compromise between tuning speed and phase noise, giving good tuning speed at all offsets, although not as good as for Close-In; this is useful when you have to look across a wide range of spans
- In all other cases, Fast Tuning is the same as Best Close-In.

Dependencies	Does not appear in all models. The key is blank in those models, but the SCPI command is accepted for compatibility (although no action is taken).
Preset	Because this function is in Auto after preset, and because Span after preset > 314.16 kHz (see Auto rules, next section) the state of this function after Preset will be 2
Initial S/W Revision	Prior to A.02.00
Modified at S/W Revision	A.15.00

Path	Meas Setup, PhNoise Opt
Remote Command	<code>[:SENSe] :FREQuency:SYNTHeSis:AUTO[:STATe] OFF ON 0 1</code> <code>[:SENSe] :FREQuency:SYNTHeSis:AUTO[:STATe] ?</code>
Example	FREQ:SYNT:AUTO ON
Preset	ON
State Saved	Saved in instrument state.
Initial S/W Revision	Prior to A.02.00

More Information

The Phase Noise Optimization control lets you optimize the setup and behavior of the Local Oscillator (LO) depending on your specific measurement conditions. You may wish to trade off noise and speed, for example, to make a measurement faster without regard to noise or with optimum noise characteristics without regard to speed.

Here is detail about the various settings you can choose:

- ["Auto " on page 1716](#)
- ["Best Close-in \$\Phi\$ Noise" on page 1716](#)
- ["Best Wide-offset \$\Phi\$ Noise" on page 1717](#)
- ["Fast Tuning" on page 1717](#)
- ["Balance Noise and Spurs " on page 1716](#)

- "Best Spurs " on page 1716
- "Phase Noise Optimization Auto Rules" on page 1717

Auto

SCPI Example	FREQ:SYNT:AUTO ON
--------------	-------------------

Selects the LO (local oscillator) phase noise behavior to optimize dynamic range and speed for various instrument operating conditions. See "Phase Noise Optimization Auto Rules" on page 1717 for details on the Auto rules.

Best Close-in Φ Noise

SCPI Example	FREQ:SYNT 1
--------------	-------------

The LO phase noise is optimized for smaller offsets from the carrier, at the expense of phase noise farther out.

The actual frequency offset within which noise is optimized is shown with in square brackets, as this can vary depending on the hardware set in use. For example, in some analyzers this annotation appears as [offset <20 kHz]

In instruments with Option EP0, the LO is configured for the best possible phase noise at offsets up to 600 kHz from the carrier, regardless of spurious products that occur with some center frequencies.

Balance Noise and Spurs

SCPI Example	FREQ:SYNT 4
--------------	-------------

In instruments with EP0, the LO is configured for the best possible phase noise at offsets up to 600 kHz from the carrier whenever there are no significant spurs within the span observed with an on-screen carrier. When there will be such a spur, the LO is reconfigured in a way that allows the phase noise to increase by 7 dB mostly within ± 1 octave around 400 kHz offset. The spurs will always be below -70 dBc.

Best Spurs

SCPI Example	FREQ:SYNT 5
--------------	-------------

In instruments with EP0, the LO is configured for better phase noise than the "Wide-Offset" case close to the carrier, but the configuration has 11 dB worse phase noise than the "Best Close-In" case mostly within ± 1 octave around 300 kHz offset. Spurs are even lower than in the "Balance Noise and Spurs" case at better than -90 dBc, whether or not the carrier is on-screen.

This setting is never selected when Phase Noise Optimization is in Auto, you must select it manually.

Best Wide-offset Φ Noise

SCPI Example

FREQ:SYNT 2

The LO phase noise is optimized for wider offsets from the carrier. Optimization is especially improved for offsets from 70 kHz to 300 kHz. Closer offsets are compromised and the throughput of measurements (especially remote measurements where the center frequency is changing rapidly), is reduced.

The actual frequency offset beyond which noise is optimized is shown with in square brackets, as this can vary depending on the hardware set in use. For example, in some analyzers this annotation appears as [offset >30 kHz]

In instruments with Option EP0, the LO is configured for the best possible phase noise at offsets up to 600 kHz from the carrier whenever there are no significant spurs within the span observed with an on-screen carrier. When there will be such a spur, the LO is reconfigured in a way that allows the phase noise to increase by 7 dB mostly within ± 1 octave around 400 kHz offset. The spurs will always be below -70 dBc.

Fast Tuning

SCPI Example

FREQ:SYNT 3

In this mode, the LO behavior compromises phase noise at many offsets from the carrier in order to allow rapid measurement throughput when changing the center frequency or span. The term “fast tuning” refers to the time it takes to move the local oscillator to the start frequency and begin a sweep; this setting does not impact the actual sweep time in any way.

In instruments with EP1, the LO behavior compromises phase noise at offsets below 4 MHz in order to improve measurement throughput. The throughput is especially affected when moving the LO more than 2.5 MHz and up to 10 MHz from the stop frequency to the next start frequency.

In instruments with Option EP0, this is the same configuration as the Best Spurs configuration. It is available with this “Fast Tuning” label to inform the user, and to make the user interface more consistent with other X-Series analyzer family members.

(In models whose hardware does not provide for a fast tuning option, the settings for Best Close-in Φ Noise are used if Fast Tuning is selected. This gives the fastest possible tuning for that hardware set.)

Phase Noise Optimization Auto Rules

The X-Series has several grades of LO that offer different configurations when in the Auto Mode.

- ["Models with Option EP0" on page 1718](#) (available in UXA)
- ["Models with Option EP1" on page 1718](#) (available in PXA)

- "Models with Option EP2" on page 1719 (available, for example, in MXA for excellent phase noise)
- "Models with Option EP4" on page 1719 (available in CXA for improved phase noise)
- "All other Models" on page 1719

Models with Option EP0

Auto will choose:

Balanced Noise and Spurs whenever:

Center frequency is < 699.9 kHz

Otherwise, Auto will choose Fast Tuning whenever:

Span > 114.1 MHz, or when

RBW > 800 kHz

Otherwise, Auto will choose Best Wide-offset Φ Noise whenever:

RBW > 290 kHz, or when

Span > 4.2 MHz

Otherwise, Auto will choose Balanced Noise and Spurs.

The RBW to be used in the calculations above is the equivalent -3 dB bandwidth of the current RBW filter.

These rules apply whether in swept spans, zero span, or FFT spans.

Models with Option EP1

Auto will choose:

Fast Tuning whenever:

Span > 44.44 MHz, or when

RBW > 1.9 MHz, or if

Source Mode is set to "Tracking"

otherwise Auto will choose Best Close in Phase Noise whenever:

Center frequency is < 195 kHz, or when

CF ≥ 1 MHz and Span ≤ 1.3 MHz and RBW ≤ 75 kHz

otherwise, Auto will choose Best Wide-offset Phase Noise

The RBW to be used in the calculations above is the equivalent -3 dB bandwidth of the current RBW filter.

These rules apply whether in swept spans, zero span, or FFT spans.

Models with Option EP2

Auto will choose:

Best Close-in Φ Noise whenever:

CF < 130 kHz , or when

CF > 12 MHz and Span < 495 kHz and RBW < 40 kHz

Otherwise, Auto will choose Fast Tuning whenever:

Span > 22 MHz, or when

RBW > 400 kHz, or when

CF \leq 12 MHz and Span < 495 kHz and RBW < 23 kHz

Otherwise, Auto will choose Best Wide-offset Φ Noise.

The RBW to be used in the calculations above is the equivalent -3 dB bandwidth of the current RBW filter.

These rules apply whether in swept spans, zero span, or FFT spans.

Models with Option EP4

Auto will choose:

Fast Tuning whenever:

Span > 101 MHz or when

RBW > 1.15 MHz or if

Source Mode is set to "Tracking"

otherwise, Auto will choose Best Close in Phase Noise whenever:

CF is < 109 kHz or when

CF \geq 4.95 MHz and Span \leq 666 kHz and RBW < 28 kHz

Otherwise, Auto will choose Best Wide-offset Φ Noise.

The RBW to be used in the calculations above is the equivalent -3 dB bandwidth of the current RBW filter.

These rules apply whether in swept spans, zero span, or FFT spans.

All other Models

Auto will choose:

Fast Tuning whenever:

Span > 12.34 MHz, or when

RBW > 250 kHz, or if

Source Mode is set to “Tracking”

Otherwise, Auto will choose Best Close in Phase Noise whenever:

Center frequency is < 25 kHz, or when

CF >= 1 MHz and Span <= 141.4 kHz and RBW <= 5 kHz

Otherwise, Auto will choose Best Wide-offset Phase Noise

Note that in these models, the hardware does not actually provide for an extra-fast tuning option, so the settings for Fast Tuning are actually the same as Best Close-in, but the rules are implemented this way so that the user who doesn't care about phase noise but does care about tuning speed doesn't have to remember which of the other two settings gives faster tuning.

The RBW to be used in the calculations above is the equivalent –3 dB bandwidth of the current RBW filter.

These rules apply whether in swept spans, zero span, or FFT spans.

PhNoise Opt Auto

Selects the best LO (local oscillator) phase noise behavior for the ACP measurement.

Key Path	Meas Setup
Mode	SA, WCDMA, C2K, WIMAX OFDMA, TD-SCDMA, 1xEVDO, DVB-T/H, DTMB (CTTB), ISDB-T, CMMB, LTE, LTETDD, Digital Cable TV, MSR, LTEAFDD, LTEATDD
Remote Command	[:SENSe] :ACPpower:FREQuency:SYNTHeSis:AUTO[:STATe] OFF ON 0 1 [:SENSe] :ACPpower:FREQuency:SYNTHeSis:AUTO[:STATe]?
Example	ACP:FREQ:SYNT:AUTO 1 ACP:FREQ:SYNT:AUTO?
Preset	ON
State Saved	Saved in instrument state.
Range	Auto Man
Initial S/W Revision	Prior to A.02.00
Modified at S/W Revision	A.02.00, A.03.00, A.04.00

PhNoise Opt State

Selects the LO (local oscillator) phase noise behavior for various operating conditions.

Key Path	Meas Setup
Mode	SA, WCDMA, C2K, WIMAX OFDMA, TD-SCDMA, 1xEVDO, DVB-T/H, DTMB (CTTB), ISDB-T, CMMB, LTE, LTETDD, Digital Cable TV, MSR, LTEAFDD, LTEATDD
Remote Command	[:SENSe] :ACPpower:FREQuency:SYNTHeSis[:STATe] 1 2 3

	<code>[:SENSe] :ACPpower:FREQuency:SYNTHeSis[:STATe] ?</code>
Example	ACP:FREQ:SYNT 1 ACP:FREQ:SYNT?
Notes	Parameter key: 1 - optimizes phase noise for close-in from the carrier. 2 - optimizes phase noise for wide-offset from the carrier. 3 - optimizes LO for tuning speed.
Couplings	Best Close-in Φ Noise The frequency below which the phase noise is optimized is model dependent: PXA with option EP1: [offset <140 kHz] Models with option EP2: [offset <70 kHz] CXA with option EP4: [offset <90 kHz] CXA without option EP4: n/a All other models: [offset <20 kHz] Best Wide-offset Φ Noise The frequency below which the phase noise is optimized is model dependent: PXA with option EP1: [offset >160 kHz] Models with option EP2: [offset >100 kHz] CXA with option EP4: [offset >130 kHz] CXA without option EP4: n/a All other models: [offset >30 kHz] Fast Tuning The Fast Tuning details are model dependent: CXA without option EP4: n/a PXA with option EP1: [single loop] Models with option EP2: [medium loop bandwidth] All other models: [same as Close-in]
Preset	Because this function is in Auto after preset, the state of this function after Preset will be automatically calculated.
State Saved	Saved in instrument state.
Range	Best Close-in Φ Noise [offset < 140 kHz] Best Wide-offset Φ Noise [offset > 160 kHz] Fast Tuning [same as Close-in] [] is model dependent. See Couplings for details.
Initial S/W Revision	Prior to A.02.00
Modified at S/W Revision	A.02.00, A.03.00, A.04.00

Meas Method

Sets the desired method to measure ACP.

Integration BW – one sweep of the trace is taken, and the band power for each offset is computed. Depending on the status of the Meas Type parameter (Total

Power Reference or PSD Reference), results are displayed relative to the total power or the power spectral density. The display reflects either the current trace or a bar graph view.

Filtered IBW (max dynamic range) – the ACP Path is used to compute ACP when an ACP path is available. This method increases dynamic range, but increases measurement time as it limits the resolution bandwidth. This method is useful for improving dynamic range on a W-CDMA signal because a sharp cutoff bandpass filter is used. The accuracy of the adjacent channel power ratio is not degraded by this method, but the absolute accuracy of both adjacent channel power and carrier power are degraded by up to about 0.5 dB.

RBW – the algorithm uses zero-span and an appropriate RBW setting to capture all of the power in the carrier channel and the offsets. The zero-span algorithm (RBW method) is slower than the IBW method, but greatly improves repeatability.

Fast (in WCDMA mode or SA mode with 3GPP WCDMA radio standard selected) – this provides the same method as the Integration BW method, but is optimized for speed to measure a W-CDMA signal.

Fast (in CDMA2K mode or SA mode with CDMA2K radio standard selected) – this provides faster measurement using the FFT method with a limited parameter flexibility. When this is selected, CDMA2K preset offsets are given and control of the following are grayed out:

BW menu, Sweep/Control menu except Pause/Resume, Trace/Detector menu, Carrier Setup, Offset Limit, RRC Weighting, Filter Alpha, and Noise Correction softkeys in Meas Setup menu.

Fast Power (option FP2 required) - this provides faster measurement using the Hardware accelerated FFT method with a limited parameter flexibility. When this is selected, the following parameters are grayed out:

Sweep/Control menu except Pause/Resume, Select Trace key under Trace/Detector, Span key under Span X Scale, Offset BW key of Offset/Limits key under Meas Setup.

For Trigger, only Free Run, External 1 and External 2 are supported.

(note) This is available with the instrument version A.16.00 or later.

Key Path	Meas Setup
Mode	SA, WCDMA, C2K, WIMAX OFDMA, 1xEVDO, DVB-T/H, DTMB (CTTB), ISDB-T, CMMB, LTE, LTETDD, Digital Cable TV, MSR, LTEAFDD, LTEATDD
Remote Command	[:SENSe] :ACPower :METHod IBW IBWRange FAST RBW FPower [:SENSe] :ACPower :METHod?
Example	ACP:METH IBW ACP:METH?
Notes	FAST mode is only supported for WCDMA and C2K signal. You must be in the WCDMA or C2K mode or SA mode with 3GPP WCDMA or CDMA2K radio standard. Otherwise a setting conflict error message will be reported.

	<p>In the TDSCDMA mode, only the IBW method is available to use. Therefore, the measure method key is not displayed in the TD-SCDMA mode.</p> <p>CDMA1xEVDO mode supports only RBW and Integration BW method.</p> <p>C2K mode supports only RBW, Integration BW, FAST and Fast Power method.</p> <p>LTETDD mode supports only Integration BW, Filtered IBW and Fast Power method.</p> <p>MSR mode supports only Integration BW, Filtered IBW and Fast Power method.</p> <p>LTE-Advanced TDD/FDD mode support only IBW, Filtered IBW and Fast Power method.</p> <p>You must be in the mode that includes ACP measurements to use this command. Use :INSTrument:SElect to set the mode.</p>
Dependencies	<p>When RBW, FAST or Fast Power is selected, Gate function is not available. If you try to turn Gate On while Meas Method is RBW, FAST or Fast Power, an error is generated.</p> <p>When Gate function is ON, RBW, FAST and Fast Power are not available. If you try to change Meas Method to RBW, FAST or Fast Power, an error is generated.</p>
Couplings	<p>IBW (Range) restricts the Res BW available for making this measurement to 30 kHz. When selected, the Res BW is clipped to this value if required and an error number displayed.</p>
Preset	<p>SA, LTE, LTETDD, MSR, LTEAFDD, LTEATDD: IBW</p> <p>WCDMA: IBW</p> <p>C2K: RBW</p> <p>WIMAX OFDMA: IBW</p> <p>1xEVDO: IBW</p> <p>DVB-T/H: IBW</p> <p>DTMB (CTTB): IBW</p> <p>ISDB-T: IBW</p> <p>CMMB: IBW</p> <p>Digital Cable TV: IBW</p>
State Saved	<p>Saved in instrument state.</p>
Range	<p>Integration BW Filtered IBW (max dynamic range) RBW Fast Fast Power</p>
Readback Text	<p>IBW Filtered IBW RBW Fast Fast Power</p>
Backwards Compatibility SCPI	<p>[:SENSe] :ACPR :SWEep :TYPE</p> <p>[:SENSe] :MCPower :METHod (PSA Power Suite)</p>
Initial S/W Revision	<p>Prior to A.02.00</p>
Modified at S/W Revision	<p>A.02.00, A.03.00, A.16.00</p>

Meas Type

Changes the reference used for the measurement. This allows you to make absolute and relative power measurements of either total power or the power normalized to the measurement bandwidth.

Total Pwr Ref (TPR) sets the reference to the total carrier power. PSD Ref (PSDR) sets the reference to the power spectral density of the carrier.

Key Path	Meas Setup
Mode	SA, WCDMA, C2K, WIMAX OFDMA, TD-SCDMA, 1xEVDO, DVB-T/H, DTMB (CTTB), ISDB-T, CMMB, LTE, LTETDD, Digital Cable TV, MSR, LTEAFDD, LTEATDD
Remote Command	[:SENSe] :ACPower :TYPE TPreRef PSDRef [:SENSe] :ACPower :TYPE ?
Example	ACP:TYPE PSDR ACP:TYPE?
Notes	You must be in the mode that includes ACP measurements to use this command. Use :INSTrument:SElect to set the mode.
Preset	TPRef
State Saved	Saved in instrument state.
Range	Total Power Ref PSD Ref
Initial S/W Revision	Prior to A.02.00
Modified at S/W Revision	A.02.00, A.03.00

PSD Ref

Sets the unit bandwidth for Power Spectral Density. The available units are dBm/Hz and dBm/MHz.

Key Path	Meas Setup
Mode	A, WCDMA, C2K, WIMAX OFDMA, TD-SCDMA, 1xEVDO, DVB-T/H, DTMB (CTTB), ISDB-T, CMMB, LTE, LTETDD, Digital Cable TV, MSR, LTEAFDD, LTEATDD
Remote Command	:UNIT :ACPower :POWer :PSD DBMHZ DBMMHZ :UNIT :ACPower :POWer :PSD ?
Example	UNIT:ACP:POW:PSD DBMMHZ UNIT:ACP:POW:PSD?
Couplings	When the PSD unit is changed, the PSD reference result of the "MEAS READ FETCH:ACP[n]?" is also changed by the PSD unit basis (in either dBm/Hz or dBm/MHz).
Preset	DBMHZ
State Saved	Saved in instrument state.
Range	dBm/Hz dBm/MHz
Initial S/W Revision	Prior to A.02.00
Modified at S/W Revision	A.02.00, A.03.00

Limit Test

Turns limit checking for each offset On or Off. The limits may be specified within the Offset menu, for each offset, both sides of the carrier. For results that fail the limit, a red F is appended. In the Combined view, the bar turns red.

Key Path	Meas Setup
Mode	SA, WCDMA, C2K, WIMAX OFDMA, TD-SCDMA, 1xEVDO, DVB-T/H, DTMB (CTTB), ISDB-T, CMMB, LTE, LTE-TDD, Digital Cable TV, MSR, LTEAFDD, LTEATDD
Remote Command	:CALCulate:ACPower:LIMit:STATe OFF ON 0 1 :CALCulate:ACPower:LIMit:STATe?
Example	CALC:ACP:LIM:STAT OFF CALC:ACP:LIM:STAT?
Notes	You must be in the mode that includes ACP measurements to use this command. Use :INSTrument:SElect to set the mode.
Preset	SA: OFF WCDMA: ON C2K: ON WIMAX OFDMA: OFF TD-SCDMA: ON 1xEVDO: ON DVB-T/H: OFF DTMB (CTTB): ON ISDB-T: OFF CMMB: ON LTE, LTE-TDD, MSR, LTEAFDD, LTEATDD: ON Digital Cable TV: OFF
State Saved	Saved in instrument state.
Range	On Off
Backwards Compatibility SCPI	[:SENSe]:MCPower:LIMit[:STATe] [:SENSe]:ACPower:LIMit[:STATe]
Initial S/W Revision	Prior to A.02.00
Modified at S/W Revision	A.02.00, A.03.00

Noise Correction

Sets the measurement noise floor correction function to On or Off. On enables measurement noise correction when the measured power in the reference channel or any offset is close to the noise floor of the analyzer. Off turns these corrections off.

In analyzers with the noise floor extensions option (option NFE) enabled, there are two ways to compensate for the analyzer noise floor: through the NFE and through this noise corrections key. The techniques are results are similar but not identical. NFE uses a model of the analyzer noise floor, adapted to the current conditions such as center frequency, RBW and ambient temperature. The parameters of this model are measured in the factory or field calibration in a highly averaged measurement. So they are consistent. However, because the model is imperfect, the corrections are imperfect. Using NFE is very convenient; the user need not wait for the ACP noise corrections calibration to occur. The ACP NC calibration, though, has advantages of

being measured very recently, at the current ambient, and the exact center frequency, with no requirement that the model be perfect. So it will often (but not always) have slightly better dynamic range. If both ACP NC is turned on and NFE is turned on, the analyzer uses only the ACP NC. When ACP NC is turned off but NFE is on, NFE is used and performance should still be excellent.

When Meas Method is Fast Power, it has HW supported noise correction and it works either Noise Correction or NFE on.

Key Path	Meas Setup
Mode	SA, WCDMA, C2K, WIMAX OFDMA, TD-SCDMA, 1xEVDO, DVB-T/H, DTMB (CTTB), ISDB-T, CMMB, LTE, LTETDD, Digital Cable TV, MSR, LTEAFDD, LTEATDD
Remote Command	<code>[:SENSe]:ACPower:CORRection:NOISe[:AUTO] OFF ON 0 1</code> <code>[:SENSe]:ACPower:CORRection:NOISe[:AUTO]?</code>
Example	ACP:CORR:NOIS OFF ACP:CORR:NOIS?
Notes	You must be in the mode that includes ACP measurements to use this command. Use :INSTrument:SElect to set the mode.
Dependencies	This parameter is unavailable when Meas Method is set to RBW or Fast.
Preset	0
State Saved	Saved in instrument state.
Range	On Off
Initial S/W Revision	Prior to A.02.00
Modified at S/W Revision	A.02.00, A.03.00, A.04.00

Meas Preset

Restores all the measurement parameters to their default values.

Key Path	Meas Setup
Mode	SA, WCDMA, C2K, WIMAX OFDMA, TD-SCDMA, 1xEVDO, DVB-T/H, DTMB (CTTB), ISDB-T, CMMB, LTE, LTETDD, Digital Cable TV, MSR, LTEAFDD, LTEATDD
Remote Command	<code>:CONFigure:ACPower</code>
Example	CONF:ACP
Notes	You must be in the mode that includes ACP measurements to use this command. Use :INSTrument:SElect to set the mode.
Couplings	Selecting Meas Preset will restore all measurement parameters to their default values.
Initial S/W Revision	Prior to A.02.00
Modified at S/W Revision	A.02.00, A.03.00

Offset RRC Weighting (Backward Compatibility SCPI)

Mode	SA, WCDMA, TD-SCDMA, WIMAX OFDMA, DVB-T/H, DTMB (CTTB), ISDB-T, CMMB, LTE, LTETDD, Digital Cable TV, MSR, LTEAFDD, LTEATDD
Remote Command	[:SENSe]:ACPower:FILTer[:RRC][:STATe] OFF ON 0 1 [:SENSe]:ACPower:FILTer[:RRC][:STATe]?
Example	ACP:FILT OFF ACP:FILT?
Notes	This parameter is not available for cdma2000 and 1xEVDO The backwards Compatibility SCPI command, [:SENSe]:ACPR:FILTer[:RRC][:STATe], is provided to support same functionality as [:SENSe]:ACPr:FILTer[:RRC][:STATe] (PSA W-CDMA, PSA cdma2000 and PSA 1xEVDO) due to ACPr node conflicts with ACPower node. You must be in the mode that includes ACP measurements to use this command. Use :INSTrument:SElect to set the mode.
Couplings	This command is an alias to [:SENSe]:ACPower:OFFSet[1]2:LIST:FILTer[:RRC][:STATe] Sending the commands to set values of all offsets for BS and MS, however, sending the query always return a value of BS Offset A.
Preset	SA, WIMAX OFDMA, LTE, LTETDD, MSR: OFF WCDMA: ON C2K: NO TD-SCDMA: ON DVB-T/H: OFF DTMB (CTTB):ON ISDB-T: OFF CMMB: OFF Digital Cable TV: ON LTEAFDD, LTEATDD: OFF
State Saved	Saved in instrument state.
Backwards Compatibility SCPI	[:SENSe]:ACPR:FILTer[:RRC][:STATe] [:SENSe]:MCPower:FILTer[:RRC][:STATe]
Initial S/W Revision	Prior to A.02.00
Modified at S/W Revision	A.03.00

Offset Filter Alpha (Backward Compatibility SCPI)

Mode	SA, WCDMA, WIMAX OFDMA, TD-SCDMA, DVB-T/H, DTMB (CTTB), ISDB-T, CMMB, LTE, LTETDD, Digital Cable TV, MSR, LTEAFDD, LTEATDD
Remote Command	[:SENSe]:ACPower:FILTer[:RRC]:ALPHA <real> [:SENSe]:ACPower:FILTer[:RRC]:ALPHA?
Example	ACP:FILT:ALPH 0.5 ACP:FILT:ALPH?

Notes	<p>This parameter is not available for cdma2000 and 1xEVDO</p> <p>The backwards Compatibility SCPI command, [:SENSe]:ACPR:FILTer[:RRC]:ALPHa, is provided to support same functionality as [:SENSe]:ACPr:FILTer[:RRC]:ALPHa (PSA W-CDMA, PSA cdma2000 and PSA 1xEVDO) due to ACPr node conflicts with ACPower node.</p> <p>You must be in the mode that includes ACP measurements to use this command. Use :INSTrument:SElect to set the mode.</p>
Couplings	<p>This command is an alias to [:SENSe]:ACPower:OFFSet[1]2:LIST:FILTer:ALPhHa</p> <p>Sending the commands to set values of all offsets for BS and MS, however, sending the query always return a value of BS Offset A.</p>
Preset	<p>SA, WCDMA, WIMAX OFDMA, TD-SCDMA, DVB-T/H, ISDB-T, CMMB, LTE, LTEFDD, MSR: 0.22 C2K: NO DTMB (CTTB): 0.05 Digital Cable TV: 0.15 LTEAFDD, LTEATDD: 0.22</p>
State Saved	Saved in instrument state.
Min	0.01
Max	1.00
Backwards Compatibility SCPI	<p>[:SENSe]:ACPR:FILTer[:RRC]:ALPHa [:SENSe]:MCPower:FILTer[:RRC]:ALPHa</p>
Initial S/W Revision	Prior to A.02.00
Modified at S/W Revision	A.03.00

Method for Carrier (Backward Compatibility SCPI)

Mode	SA, WCDMA, WIMAX OFDMA, TD-SCDMA, DVB-T/H, DTMB (CTTB), ISDB-T, CMMB, LTE, LTEFDD, Digital Cable TV, MSR
Remote Command	<p>[:SENSe]:ACPower:CARRier[1]2:LIST:METhod IBW RRC, ... [:SENSe]:ACPower:CARRier[1]2:LIST:METhod?</p>
Example	<p>ACP:CARR2:LIST:METh RRC ACP:CARR2:LIST:METh?</p>
Notes	<p>You must be in the mode that includes ACP measurements to use this command. Use :INSTrument:SElect to set the mode.</p> <p>Maximum of Array length depends on the number of carriers.</p>
Couplings	<p>This command is an alias to [:SENSe]:ACPower:CARRier[1]2:LIST:FILTer[:RRC][:STATe]</p> <p>The enum value translates as follows: RRC Weighted = 1 ON Integ BW = 0 OFF</p> <p>Maximum of Array length depends on the number of carriers.</p>

11 ACP Measurement
Meas Setup

Preset	SA: IBW WCDMA: RRC WIMAX OFDMA: IBW TD-SCDMA: RRC DVB-T/H: IBW DTMB (CTTB): RRC ISDB-T: IBW CMMB: IBW LTE, MSR: IBW LTETDD: IBW Digital Cable TV: RRC
State Saved	Saved in instrument state.
Initial S/W Revision	Prior to A.02.00
Modified at S/W Revision	A.03.00

Mode

See "[Mode](#)" on page 353

Mode Preset

Returns the active mode to a known state.

Mode Preset does the following for the currently active mode:

- Aborts the currently running measurement.
- Brings up the default menu for the mode, with no active function.
- Sets measurement Global settings to their preset values for the active mode only.
- Activates the default measurement.
- Brings up the default menu for the mode.
- Clears the input and output buffers.
- Sets Status Byte to 0.

Mode Preset does not:

- Cause a mode switch
- Affect mode persistent settings
- Affect system settings
- See "[How-To Preset](#)" on page 1732 for more information.

Key Path	Front-panel key
Remote Command	:SYSTem:PRESet
Example	:SYST:PRES
Notes	<p>*RST is preferred over :SYST:PRES for remote operation. *RST does a Mode Preset, as done by the :SYST:PRES command, and it sets the measurement mode to Single measurement rather than Continuous for optimal remote control throughput.</p> <p>Clears all pending OPC bits. The Status Byte is set to 0.</p>
Couplings	A Mode Preset aborts the currently running measurement, activates the default measurement, and gets the mode to a consistent state with all of the default couplings set.
Backwards Compatibility Notes	<p>In the X-Series, the legacy "Factory Preset" has been replaced with Mode Preset, which only presets the currently active mode, not the entire instrument. In the X-Series, the way to preset the entire instrument is by using System, Restore System Defaults All, which behaves essentially the same way as restore System Defaults does on ESA and PSA.</p> <p>There is also no "Preset Type" as there is on the PSA. There is a green Mode Preset front-panel key that does a Mode Preset and a white-with-green-letters User Preset front-panel key that does a User Preset. The old PRESet:TYPE command is ignored (without generating an error), and SYST:PRES without a parameter does a Mode Preset, which should cover most backward code compatibility issues.</p> <p>The settings and correction data under the Input/Output front-panel key (examples: Input Z Corr,</p>

Ext Amp Gain, etc.) are no longer part of any Mode, so they will not be preset by a Mode Preset. They are preset using Restore Input/Output Defaults, Restore System Defaults All. Note that because User Preset does a Recall State, and all of these settings are saved in State, they ARE recalled when using User Preset.

Initial S/W Revision Prior to A.02.00

How-To Preset

The table below shows all possible presets, their corresponding SCPI commands and front-panel access (key paths). Instrument settings depend on the current measurement context. Some settings are local to the current measurement, some are global (common) across all the measurements in the current mode, and some are global to all the available modes. In a similar way, restoring the settings to their preset state can be done within the different contexts.

Auto Couple - is a measurement local key. It sets all Auto/Man parameter couplings in the measurement to Auto. Any Auto/Man selection that is local to other measurements in the mode will not be affected.

Meas Preset - is a measurement local key. Meas Preset resets all the variables local to the current measurement except the persistent ones.

Mode Preset - resets all the current mode's measurement local and measurement global variables except the persistent ones.

Restore Mode Defaults - resets ALL the Mode variables (and all the Meas global and Meas local variables), including the persistent ones.

Type Of Preset	SCPI Command	Front Panel Access
Auto Couple	:COUPle ALL	Auto Couple front-panel key
Meas Preset	:CONFigure: <Measurement>	Meas Setup Menu
Mode Preset	:SYSTem:PRESet	Mode Preset (green key)
Restore Mode Defaults	:INSTrument:DEFault	Mode Setup Menu
Restore All Mode Defaults	:SYSTem:DEFault MODes	System Menu; Restore System Default Menu
*RST	*RST	not possible (Mode Preset with Single)
Restore Input/Output Defaults	:SYSTem:DEFault INPut	System Menu; Restore System Default Menu
Restore Power On Defaults	:SYSTem:DEFault PON	System Menu; Restore System Default Menu
Restore Alignment Defaults	:SYSTem:DEFault ALIGn	System Menu; Restore System Default Menu
Restore Miscellaneous Defaults	:SYSTem:DEFault MISC	System Menu; Restore System Default Menu

Restore All System Defaults	:SYSTem:DEFault [ALL] :SYSTem:PRESet:PERSistent	System Menu; Restore System Default Menu
User Preset	:SYSTem:PRESet:USER	User Preset Menu
User Preset All Modes	:SYSTem:PRESet:USER:ALL	User Preset Menu
Power On Mode Preset	:SYSTem:PON:TYPE MODE	System Menu
Power On User Preset	:SYSTem:PON:TYPE USER	System Menu
Power On Last State	:SYSTem:PON:TYPE LAST	System Menu

Mode Setup

See ["Mode Setup" on page 388](#)

Peak Search

Places the selected marker on the trace point with the maximum y-axis value.

Key Path	Peak Search
Mode	SA, WCDMA, C2K, WIMAX OFDMA, TD-SCDMA, 1xEVDO, DVB-T/H, DTMB (CTTB), ISDB-T, CMMB, LTE, LTETDD, Digital Cable TV, MSR, LTEAFDD, LTEATDD
Remote Command	:CALCulate:ACPower:MARKer[1] 2 ... 12:MAXimum
Example	CALC:ACP:MARK2:MAX
Initial S/W Revision	Prior to A.02.00
Modified at S/W Revision	A.02.00, A.03.00

Next Peak

Moves the selected marker to the peak that has the next highest amplitude.

Key Path	Peak Search
Mode	SA, WCDMA, C2K, WIMAX OFDMA, TD-SCDMA, 1xEVDO, DVB-T/H, DTMB (CTTB), ISDB-T, CMMB, LTE, LTETDD, Digital Cable TV, MSR, LTEAFDD, LTEATDD
Remote Command	:CALCulate:ACPower:MARKer[1] 2 ... 12:MAXimum:NEXT
Example	CALC:ACP:MARK2:MAX:NEXT
Initial S/W Revision	Prior to A.02.00
Modified at S/W Revision	A.02.00, A.03.00

Next Pk Right

Moves the selected marker to the nearest peak to the right of the current marker that meets all enabled peak criteria.

Key Path	Peak Search
Mode	SA, WCDMA, C2K, WIMAX OFDMA, TD-SCDMA, 1xEVDO, DVB-T/H, DTMB (CTTB), ISDB-T, CMMB, LTE, LTETDD, Digital Cable TV, MSR, LTEAFDD, LTEATDD
Remote Command	:CALCulate:ACPower:MARKer[1] 2 ... 12:MAXimum:RIGHT
Example	CALC:ACP:MARK2:MAX:RIGH
Initial S/W Revision	Prior to A.02.00
Modified at S/W Revision	A.02.00, A.03.00

Next Pk Left

Moves the selected marker to the nearest peak to the left of the current marker that meets all enabled peak criteria.

Key Path	Peak Search
Mode	SA, WCDMA, C2K, WIMAX OFDMA, TD-SCDMA, 1xEVDO, DVB-T/H, DTMB (CTTB), ISDB-T, CMMB, LTE, LTETDD, Digital Cable TV, MSR, LTEAFDD, LTEATDD
Remote Command	:CALCulate:ACPower:MARKer[1] 2 ... 12:MAXimum:LEFT
Example	CALC:ACP:MARK2:MAX:LEFT
Initial S/W Revision	Prior to A.02.00
Modified at S/W Revision	A.02.00, A.03.00

Marker Delta

Sets the control mode for the selected marker to Delta mode.

See Marker Delta in the "Marker Functions" section for more information.

Key Path	Peak Search
Initial S/W Revision	Prior to A.02.00

Pk-Pk Search

Finds and displays the amplitude and frequency (or time, if in zero span) differences between the highest and lowest y-axis value.

Key Path	Peak Search
Mode	SA, WCDMA, C2K, WIMAX OFDMA, TD-SCDMA, 1xEVDO, DVB-T/H, DTMB (CTTB), ISDB-T, CMMB, LTE, LTETDD, Digital Cable TV, MSR, LTEAFDD, LTEATDD
Remote Command	:CALCulate:ACPower:MARKer[1] 2 ... 12:PTPeak
Example	CALC:ACP:MARK:PTP
Notes	Turns on the Marker Δ active function.
Couplings	This key is not available (key is grayed out) when Coupled Markers is on.
Initial S/W Revision	Prior to A.02.00
Modified at S/W Revision	A.02.00, A.03.00

Min Search

Moves the selected marker to the minimum y-axis value on the current trace.

Key Path	Peak Search
Mode	SA, WCDMA, C2K, WIMAX OFDMA, TD-SCDMA, 1xEVDO, DVB-T/H, DTMB (CTTB), ISDB-T, CMMB, LTE, LTETDD, Digital Cable TV, MSR, LTEAFDD, LTEATDD
Remote Command	:CALCulate:ACPower:MARKer[1] 2 ... 12:MINimum
Example	CALC:ACP:MARK:MIN
Initial S/W Revision	Prior to A.02.00

11 ACP Measurement
Peak Search

Modified at S/W	A.02.00, A.03.00
Revision	

Print

See "Print " on page 430

Quick Save

The Quick Save front-panel key repeats the most recent save that was performed from the Save menu, with the following exceptions:

- Register saves are not remembered as Saves for the purpose of the Quick Save function
- If the current measurement does not support the last non-register save that was performed, an informational message is generated, “File type not supported for this measurement”

Quick Save repeats the last type of qualified save (that is, a save qualified by the above criteria) in the last save directory by creating a unique filename using the Auto File Naming algorithm described below.

If Quick Save is pressed after startup and before any qualified Save has been performed, the Quick Save function performs a Screen Image save using the current settings for Screen Image saves (current theme, current directory), which then becomes the “last save” for the purpose of subsequent Quick Saves.

The Auto File Naming feature automatically generates a file name for use when saving a file. The filename consists of a prefix and suffix separated by a dot, as is standard for the Windows® file system. A default prefix exists for each of the available file types:

Type	Default Prefix	Menu
State	State_	(Save/Recall)
Trace + State	State_	(Save/Recall)
Screen	Screen_	(Save/Recall)
Amplitude Corrections	Ampcor_	(Import/Export)
Traces	Trace_	(Import/Export)
Limit Lines	LLine_	(Import/Export)
Measurement Result	MeasR_	(Import/Export)
Capture Buffer	CapBuf_	(Import/Export)

A four digit number is appended to the prefix to create a unique file name. The numbering sequence starts at 0000 within each Mode for each file type and updates incrementally to 9999, then wraps to 0000 again. It remembers where it was through a Mode Preset and when leaving and returning to the Mode. It is reset by Restore Misc Defaults and Restore System Defaults and subsequent running of the instrument application. So, for example, the first auto file name generated for State files is State_0000.state. The next is State_0001, and so forth.

One of the key features of Auto File Name is that we guarantee that the Auto File Name will never conflict with an existing file. The algorithm looks for the next

available number. If it gets to 9999, then it looks for holes. If it find no holes, that is no more numbers are available, it gives an error.

For example, if when we get to State_0010.state there is already a State_0010.state file in the current directory, it advances the counter to State_0011.state to ensure that no conflict will exist (and then it verifies that State_0011.state also does not exist in the current directory and advances again if it does, and so forth).

If you enter a file name for a given file type, then the prefix becomes the filename you entered instead of the default prefix, followed by an underscore. The last four letters (the suffix) are the 4-digit number.

For example, if you save a measurement results file as “fred.csv”, then the next auto file name chosen for a measurement results save will be fred_0000.csv.

NOTE

Although 0000 is used in the example above, the number that is used is actually the current number in the Meas Results sequence, that is, the number that would have been used if you had not entered your own file name.

If the filename you entered ends with _dddd, where d=any number, making it look just like an auto file name, then the next auto file name picks up where you left off with the suffix being dddd + 1.

Key Path	Front-panel key
Notes	No remote command for this key specifically.
Initial S/W Revision	Prior to A.02.00

Recall

The **Recall** menu lets you choose what you want to recall, and where you want to recall it from. Among the types of files you can recall are **States and Traces**. In addition, an **Import (Data)** option lets you recall a number of data types stored in CSV files (as used by Excel and other spreadsheet programs).

The default paths for Recall are data type dependent and are the same as for the Save key.

Key Path	Front-panel key
Notes	<p>No remote command for this key specifically, but the :MMEM:LOAD command is available for specific file types. An example is :MMEM:LOAD:STATe <filename>.</p> <p>If you try to recall a State file for a mode that is not licensed or not available in the instrument, an error message will occur and the state will not change.</p>
Backwards Compatibility Notes	<p>In legacy analyzers, it was possible to load a state without affecting the trace data, limit lines or correction data. Similarly (since User Preset is actually loading a state), it was possible to do a User Preset without affecting the trace data, limit lines or correction data.</p> <p>In the X-Series, “state” always includes all of this data; so whenever state is loaded, all of the traces, limit lines and corrections are affected. Although this differs from previous behavior, it is desirable behavior, and should not cause adverse issues for users.</p>
Backwards Compatibility Notes	<p>Recall for the X-Series supports backward compatibility in the sense that you can recall a state file from any X-Series model number and any version of X-Series software. This is only possible if part of the recalling process goes through a limiting step after recalling the mode settings, at least for settings that may vary with version number, model number, option and license differences. If you try to recall a state file onto an instrument with less capability than what was available on the instrument during the save, the recall will ignore the state it doesn't support and it will limit the recalled setting to what it allows.</p> <p>Example: if the saved state includes preamp ON, but the recalling instrument does not have a preamp; the preamp is limited to OFF. Conversely, if you save a state without a preamp, the preamp is OFF in the state file. When this saved file is recalled on an instrument with a licensed preamp, the preamp is changed to OFF. Another example is if the saved state has center frequency set to 20 GHz, but the instrument recalling the saved state is a different model and only supports 13.5 GHz. In this case, the center frequency is limited along with any other frequency based settings. Since the center frequency can't be preserved in this case, the recall limiting tries to at least preserve span to keep the measurement setup as intact as possible.</p> <p>It may be appropriate to issue a warning if the state is limited on the recall; warnings do not go out to SCPI so this would only affect the manual user.</p> <p>Note that there is no state file compatibility outside of the X-Series. For example, you cannot recall a state file from ESA or PSA.</p>
Initial S/W Revision	Prior to A.02.00

State

The **Recall State** menu lets you choose a register or file from which to recall the state.

The content of a state file includes all of the settings and data required to return the analyzer as closely as possible to the Mode it was in, with the exact settings that

were in place, when the save occurred. The Mode settings in each state file include the settings that are affected by Mode Preset, as well as the additional settings affected by Restore Mode Defaults; all of the Mode's settings. In addition, all of the settings of the **Input/Output** system are included, even though they are outside of the Mode's state, because they are needed to restore the complete setup. Persistent System settings (for example, GPIB address) are not affected by either a Mode Preset or Restore Mode Defaults, nor are they included in a saved State file.

Since each state file is only for one Mode, the settings for other Modes are unaffected when it is loaded. **Recall State** will cause a mode switch if the state being recalled is not from the current active mode.

After the recall completes, the message "File <filename> recalled" or "Recalled State Register <register number>" is displayed.

For rapid recalls, the State menu lists 16 registers that you can choose from to recall. Pressing a Register key initiates the recall. You can also select a file from which to recall.

The default path for all State Files is:

My Documents\<<mode name>\state

where <mode name> is the parameter used to select the mode with the INST:SEL command (for example, SA for the Spectrum Analyzer).

See "[More Information](#)" on page 1743.

Key Path	Recall
Mode	All
Remote Command	:MMEMory:LOAD:STATe <filename>
Example	:MMEM:LOAD:STAT "myState.state" This recalls the file myState.state on the default path
Example	MMEM:LOAD:STAT "MyStateFile.state" This loads the state file data (on the default file directory path) into the instrument state.
Notes	When you pick a file to recall, the analyzer first verifies that the file is recallable in the current instrument by checking the software version and model number of the instrument. If everything matches, a full recall proceeds by aborting the currently running measurement, clearing any pending operations, and then loading the State from the saved state file. You can open state files from any mode, so recalling a State file switches to the mode that was active when the save occurred. After switching to the mode of the saved state file, mode settings and data (if any for the mode) are loaded with values from the saved file. The saved measurement of the mode becomes the newly active measurement and the data relevant to the measurement (if there is any) is recalled. <ul style="list-style-type: none"> - If there is a mismatch between file version or model number or instrument version or model number, the recall function tries to recall as much as possible and returns a warning message. It may limit settings that differ based on model number, licensing or version number. <p>After recalling the state, the Recall State function does the following:</p>

- Makes the saved measurement for the mode the active measurement.
- Clears the input and output buffers.
- Status Byte is set to 0.
- Executes a *CLS

If the file specified is empty an error is generated. If the specified file does not exist, another error is generated. If there is a mismatch between the file and the proper file type, an error is generated. If there is a mismatch between file version or model number or instrument version or model number, a warning is displayed. Then it returns to the State menu and File Open dialog goes away.

After the Recall, the analyzer exits the Recall menu and returns to the previous menu.

Backwards Compatibility SCPI	:MMEMory:LOAD:STATe 1,<filename> For backwards compatibility, the above syntax is supported. The "1" is simply ignored.
Initial S/W Revision	Prior to A.02.00

More Information

In measurements that support saving Traces, for example, Swept SA, the Trace data is saved along with the State in the State file. When recalling the State, the Trace data is recalled as well. Traces are recalled exactly as they were stored, including the writing mode and update and display modes. If a Trace was updating and visible when the State was saved, it will come back updating and visible, and its data will be rewritten right away. When you use State to save and recall traces, any trace whose data must be preserved should be placed in View or Blank mode before saving.

The following table describes the Trace Save and Recall possibilities:

You want to recall state and one trace's data, leaving other traces unaffected.	Save Trace+State from 1 trace. Make sure that no other traces are updating (they should all be in View or Blank mode) when the save is performed.	On Recall, specify the trace you want to load the one trace's data into. This trace will load in View. All other traces' data will be unaffected, although their trace mode will be as it was when the state save was performed.
You want to recall all traces	Save Trace+State from ALL traces.	On Recall, all traces will come back in View (or Blank if they were in Blank or Background when saved)
You want all traces to load exactly as they were when saved.	Save State	On recall, all traces' mode and data will be exactly as they were when saved. Any traces that were updating will have their data immediately overwritten.

From File...

When you press “From File”, the analyzer brings up a Windows dialog and a menu entitled “File Open.” This menu allows you to navigate to the various fields in the Windows dialog without using a keyboard or mouse. The **Tab** and **Arrow** keys can also be used for dialog navigation.

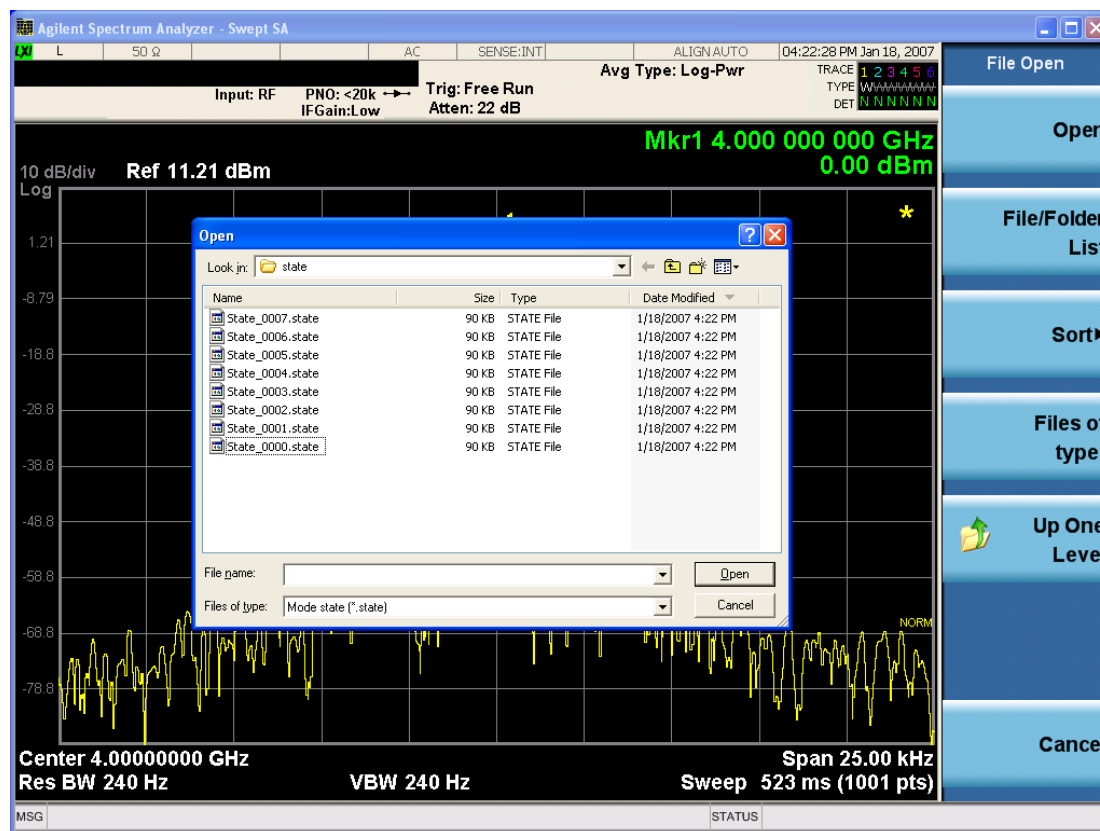

Listed below are the functions of the various fields in the dialog, and the corresponding softkeys:

Open

Performs the recall of the specified file. While the recall is being performed, the floppy icon appears briefly in the Meas bar.

File/Folder List

Enables you to navigate to the center of the dialog that contains the list of files and folders. Once here you can get information about the file and use the tab keys to navigate to the other fields in the dialog, such as Look In.

Look In

The **Look In** field shows the path from which the file will be recalled and allows you to change the path using the up and down arrow keys to navigate to other paths; the Enter key to open a directory; and the Backspace key to go back one directory. The **Look In** field first uses the last path from the Save As dialog **Save In:** path for that

same file type. There is no softkey for directly navigating to the Look In field, but you can use the left tab to get here from the File/Folder List.

User specified paths are remembered when you leave and return to a Mode and are reset back to the default using **Restore Mode Defaults**.

Sort

Accesses a menu that enables you to sort the files within the File Open dialog. Only one sorting type can be selected at a time and the sorting happens immediately. The sorting types are **By Date**, **By Name**, **By extension**, and **By Size**.

Files of Type

This field shows the file suffix for the type of file you have selected to recall. For example, if you navigated here while recalling State, "Mode state (*.state)" is in the field. If you navigated here while recalling Trace, "Mode state (*.trace)" is in the field. If you navigated here while importing a trace data file, "Trace Data (*.csv)" is in the field. For some file types, there is more than one choice in the dropdown menu, which you can select by using the up and down arrow keys and Enter.

Up One Level

This key corresponds to the icon of a folder with the up arrow that is in the tool bar of the dialog. When pressed, it causes the file and folder list to navigate up one level in the directory structure. The Backspace key does the same thing.

Cancel

This key corresponds to the **Cancel** selection in the dialog. It causes the current **Open** request to be cancelled. The ESC key does the same thing.

Key Path	Recall, State
Notes	Brings up the Open dialog for recalling a State Save Type
Initial S/W Revision	Prior to A.02.00

Edit Register Names

You may enter a custom name on any of the Register keys, to help you remember what you are using that state to save. To do this, press the **Edit Register Names** key, choose the register whose name you wish to edit, and then enter the desired label using the Alpha Editor or an external PC keyboard.

The maximum number of characters that can be added is 30. In most cases, 30 characters will fit on two lines of the key.

For more information and the SCPI command, see Edit Register Names under the **Save, State** function.

Key Path	Recall, State
Mode	All
Dependencies	N9060A-7FP or N9060B-2FP license required to edit the register names. When the feature is not licensed, sending the SCPI command generates an error, -221,"Settings conflict;Option not

	available"
Initial S/W Revision	A.11.00

Register 1 thru Register 16

Selecting any one of these register keys causes the State of the mode from the specified Register to be recalled. Each of the register keys annotates whether it is empty or at what date and time it was last modified. In addition, you can use the **Edit Register Names** key under **Save, State** to enter custom names for each register.

Registers are shared by all modes, so recalling from any one of the registers will cause a mode switch to the mode that was active when the save to the Register occurred.

Although these 16 registers are the only registers available from the front panel, there are 128 state registers available in the instrument. Registers 17-128 are only available from the SCPI interface, using the *RCL command.

After the recall completes, the message "Register <register number> recalled" appears in the message bar. If you are in the Spectrum Analyzer Mode, and you are recalling a register that was saved in the Spectrum Analyzer Mode, then after the recall, you will still be in the Recall Register menu. If the Recall causes you to switch modes, then after the Recall, you will be in the Frequency menu.

If a requested register is empty an error is generated.

Key Path	Recall, State
Example	*RCL 1
Range	1-16 from front panel, 1-128 from SCPI
Readback	Date and time with seconds resolution are displayed on the key OR A custom name of up to 30 characters entered using the Save, State, Edit Register Names key OR “(empty)” if no prior save operation has been performed to this register.
Initial S/W Revision	Prior to A.02.00
Modified at S/W Revision	Prior to A.11.00

Register 1 thru Register 16

Selecting any one of these register keys causes the State of the mode from the specified Register to be recalled. Each of the register keys annotates whether it is empty or at what date and time it was last modified. In addition, you can use the **Edit Register Names** key under **Save, State** to enter custom names for each register.

Registers are shared by all modes, so recalling from any one of the registers will cause a mode switch to the mode that was active when the save to the Register occurred.

Although these 16 registers are the only registers available from the front panel, there are 128 state registers available in the instrument. Registers 17-128 are only available from the SCPI interface, using the *RCL command.

After the recall completes, the message "Register <register number> recalled" appears in the message bar. If you are in the Spectrum Analyzer Mode, and you are recalling a register that was saved in the Spectrum Analyzer Mode, then after the recall, you will still be in the Recall Register menu. If the Recall causes you to switch modes, then after the Recall, you will be in the Frequency menu.

If a requested register is empty an error is generated.

Key Path	Recall, State
Example	*RCL 1
Range	1-16 from front panel, 1-128 from SCPI
Readback	Date and time with seconds resolution are displayed on the key OR A custom name of up to 30 characters entered using the Save, State, Edit Register Names key OR “(empty)” if no prior save operation has been performed to this register.
Initial S/W Revision	Prior to A.02.00
Modified at S/W Revision	Prior to A.11.00

Trace (+State)

The Recall Trace (+State) menu lets you choose a register or file from which to recall the Trace+State state file.

A saved state contains all of the settings and data required to return the analyzer as closely as possible to the exact setup it had when the save occurred. This includes the Input/Output settings, even though they are outside of the Mode’s state, because they are needed to restore the complete setup. A Trace+State file also includes trace data from one trace or all traces, which will load in View mode when the Trace+State file is recalled. Recall Trace (+State) will also cause a mode switch if the state being recalled is not for the current active mode.

After the recall completes, the message "File <filename> recalled" or “Recalled Trace Register <register number>” is displayed.

For rapid recalls, the Trace (+State) menu lists 5 registers to choose from to recall. Pressing a Register key initiates the recall. You can also select a file from which to recall.

The default path for all State Files including .trace files is:

My Documents\<mode name>\state

where <mode name> is the parameter used to select the mode with the INST:SEL command (for example, SA for the Spectrum Analyzer).

Key Path	Recall
Mode	SA
Remote Command	<pre>:MMEMory:LOAD:TRACe TRACE1 TRACE2 TRACE3 TRACE4 TRACE5 TRACE6,<filename> :MMEMory:LOAD:TRACe:REGister TRACE1 TRACE2 TRACE3 TRACE4 TRACE5 TRACE6,<integer></pre>
Example	<pre>MMEM:LOAD:TRAC TRACE2, "MyTraceFile.trace"</pre> <p>This loads the trace file data (on the default file directory path) into the specified trace; if it is a "single trace" save file, that trace is loaded to trace 2, and is set to be not updating.</p> <pre>:MMEM:LOAD:TRAC:REG TRACE1,2</pre> <p>restores the trace data in register 2 to Trace 1</p>
Notes	<p>When you perform the recall, the recalling Trace function must first verify the file is recallable in this instrument by checking instrument software version and model number, since it includes State. If everything matches, a full recall proceeds by aborting the currently running measurement, and loading the state from the saved state file to as close as possible to the context in which the save occurred. You can open .trace files from any mode that supports them, so recalling a Trace file switches to the mode that was active when the save occurred. After switching to the mode of the saved state file, mode settings and data (if any for the mode) are loaded with values from the saved file and the saved measurement of the mode becomes the newly active measurement, and the data relevant to the measurement (if there is any) is recalled.</p> <p>Once the state is loaded, the trace data must be loaded. The internal flags are consulted to see which trace to load and the "To Trace" setting to see where to load it. Trace data is always loaded with the specified trace set to View, so that the data is visible and not updating (so as not to erase the recalled data). If the file is an "all trace" file, all traces are loaded with the saved data (to the original trace the data was saved from) and set to View. Traces whose data is not loaded are restored to the update state that existed when they were saved.</p> <p>After the Recall the analyzer exits the Recall menu and returns to the previous menu.</p> <p>Some modes and measurements do not have available all 6 traces. Phase Noise mode command, for example, is: <code>MMEMory:LOAD:TRACe TRACE1 TRACE2 TRACE3,<filename></code></p> <p>Some modes and measurements have more than 6 traces available. The Realtime SA mode command, for example, is: <code>MMEMory:STORe:TRACe TRACE1 TRACE2 TRACE3 TRACE4 TRACE5 TRACE6 TRACE7 TRACE8 TRACE9 TRACE10 TRACE11 TRACE12 ALL,<filename></code></p>
Initial S/W Revision	Prior to A.02.00

To Trace

These menu selections let you choose the Trace where the recalled saved trace will go. Not all modes have the full 6 traces available. The default is the currently selected trace, selected in this menu or in the Trace/Detector, Export Data, Import Data, or Save Trace menus, except if you have chosen All, then it remains chosen until you specifically change it to a single trace.

If the .trace file is an "all trace" file, "**To Trace**" is ignored and the traces each go back to the trace from which they were saved.

Once selected, the key returns back to the Recall Trace menu and the selected Trace number is annotated on the key. Now you have selected exactly where the

trace needs to be recalled. To trigger a recall of the selected Trace, you must select the **Open** key in the Recall Trace menu.

When you select a trace, it makes that trace the current trace, so it displays on top of all of the other traces.

Key Path	Save, Data, Trace
Mode	SA
Initial S/W Revision	Prior to A.02.00

Register 1 thru Register 16

Selecting any one of these register keys causes the State of the mode from the specified Register to be recalled. Each of the register keys annotates whether it is empty or at what date and time it was last modified. In addition, you can use the **Edit Register Names** key under **Save, State** to enter custom names for each register.

Registers are shared by all modes, so recalling from any one of the registers will cause a mode switch to the mode that was active when the save to the Register occurred.

Although these 16 registers are the only registers available from the front panel, there are 128 state registers available in the instrument. Registers 17-128 are only available from the SCPI interface, using the *RCL command.

After the recall completes, the message "Register <register number> recalled" appears in the message bar. If you are in the Spectrum Analyzer Mode, and you are recalling a register that was saved in the Spectrum Analyzer Mode, then after the recall, you will still be in the Recall Register menu. If the Recall causes you to switch modes, then after the Recall, you will be in the Frequency menu.

If a requested register is empty an error is generated.

Key Path	Recall, State
Example	*RCL 1
Range	1-16 from front panel, 1-128 from SCPI
Readback	Date and time with seconds resolution are displayed on the key OR A custom name of up to 30 characters entered using the Save, State, Edit Register Names key OR “(empty)” if no prior save operation has been performed to this register.
Initial S/W Revision	Prior to A.02.00
Modified at S/W Revision	Prior to A.11.00

From File...

When you press “From File”, the analyzer brings up a Windows dialog and a menu entitled “**File Open.**” This menu allows you to navigate to the various fields in the

Windows dialog without using a keyboard or mouse. The **Tab** and **Arrow** keys can also be used for dialog navigation.

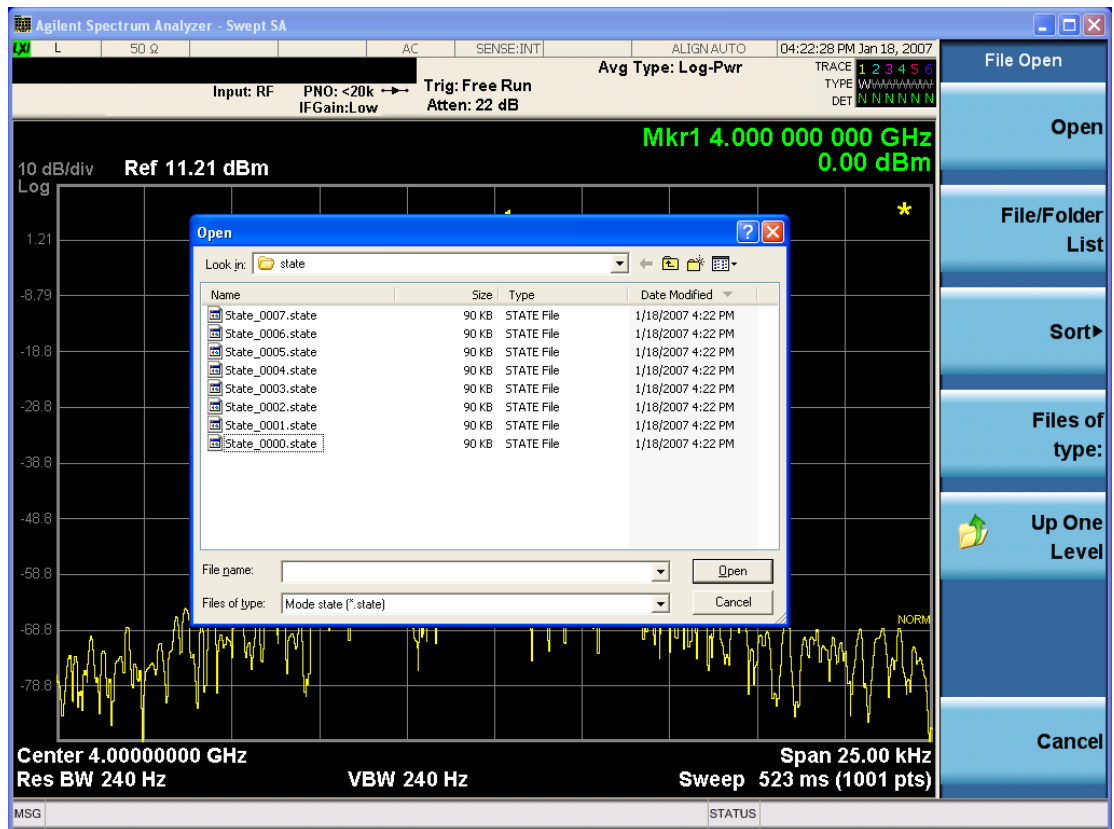

Listed below are the functions of the various fields in the dialog, and the corresponding softkeys:

Open

Performs the recall of the specified file. While the recall is being performed, the floppy icon appears briefly in the Meas bar.

File/Folder List

Enables you to navigate to the center of the dialog that contains the list of files and folders. Once here you can get information about the file and use the tab keys to navigate to the other fields in the dialog, such as Look In.

Look In

The **Look In** field shows the path from which the file will be recalled and allows you to change the path using the up and down arrow keys to navigate to other paths; the Enter key to open a directory; and the Backspace key to go back one directory. The **Look In** field first uses the last path from the Save As dialog **Save In:** path for that same file type. There is no softkey for directly navigating to the Look In field, but you can use the left tab to get here from the File/Folder List.

User specified paths are remembered when you leave and return to a Mode and are reset back to the default using **Restore Mode Defaults**.

Sort

Accesses a menu that enables you to sort the files within the File Open dialog. Only one sorting type can be selected at a time and the sorting happens immediately. The sorting types are **By Date, By Name, By extension, and By Size**.

Files of Type

This field shows the file suffix for the type of file you have selected to recall. For example, if you navigated here while recalling State, "Mode state (*.state)" is in the field. If you navigated here while recalling Trace, "Mode state (*.trace)" is in the field. If you navigated here while importing a trace data file, "Trace Data (*.csv)" is in the field. For some file types, there is more than one choice in the dropdown menu, which you can select by using the up and down arrow keys and Enter.

Up One Level

This key corresponds to the icon of a folder with the up arrow that is in the tool bar of the dialog. When pressed, it causes the file and folder list to navigate up one level in the directory structure. The Backspace key does the same thing.

Cancel

This key corresponds to the **Cancel** selection in the dialog. It causes the current **Open** request to be cancelled. The ESC key does the same thing.

Key Path	Recall, State
Notes	Brings up the Open dialog for recalling a State Save Type
Initial S/W Revision	Prior to A.02.00

Data (Import)

Importing a data file loads data that was previously saved from the current measurement or from other measurements and/or modes that produce compatible data files. The Import Menu only contains Data Types that are supported by the current measurement.

Since the commonly exported data files are in .csv format, the data can be edited by the user prior to importing. This allows you to export a data file, manipulate the data in Excel (the most common PC Application for manipulating .csv files) and then import it.

Importing Data loads measurement data from the specified file into the specified or default destination, depending on the data type selected. Selecting an Import Data menu key will not actually cause the importing to occur, since the analyzer still needs to know from where to get the data. Pressing the Open key in this menu brings up the Open dialog and Open menu that provides you with the options from where to recall the data. Once a filename has been selected or entered in the Open menu, the recall occurs as soon as the Open button is pressed.

Key Path	Recall
Mode	All
Notes	The menu is built from whatever data types are available for the mode. Some keys will be missing completely, so the key locations in the sub-menu will vary. No SCPI command directly controls the Data Type that this key controls. The Data Type is included in the MMEM:LOAD commands.
Dependencies	If a file type is not used by a certain measurement, it is grayed out for that measurement. The key for a file type will not show at all if there are no measurements in the Mode that support it.
Preset	Is not affected by Preset or shutdown, but is reset during Restore Mode Defaults
Readback	The data type that is currently selected
Initial S/W Revision	Prior to A.02.00

Amplitude Correction

This key selects the Amplitude Corrections as the data type to be imported. When pressed a second time, it brings up the Select Menu, which lets you select the Correction into which the data will be imported.

Amplitude Corrections are fully discussed in the documentation of the Input/Output key, under the Corrections key.

A set of preloaded Corrections files can be found in the directory

/My Documents/ EMC Limits and Ampcor.

When the Amplitude Correction is an Antenna correction and the Antenna Unit in the file is not **None**, the Y Axis Unit setting will change to match the Antenna Unit in the file.

Key Path	Recall
Mode	SA EDGE GSM PN
Remote Command	:MMEMory:LOAD:CORRection 1 2 3 4 5 6 7 8, <filename>
Example	:MMEM:LOAD:CORR 2, "myAmpcor.csv" recalls the Amplitude Correction data from the file myAmpcor.csv in the current directory to the 2nd Amplitude Correction table, and turns on Correction 2. The default path is D:\Users\Instrument\My Documents\amplitudeCorrections\
Dependencies	Only the first correction array (Correction 1) supports antenna units. This means that a correction file with an Antenna Unit can only be loaded into the Corrections 1 register. Consequently only for Correction 1 does the dropdown in the Recall dialog include .ant, and if an attempt is made to load a correction file into any other Correction register which DOES contain an antenna unit, a Mass Storage error is generated. Corrections are not supported by all Measurements. If in a Mode in which some Measurements support it, this key will be grayed out in measurements that do not. The key will not show at all if no measurements in the Mode support it. Errors are reported if the file is empty or missing, or if the file type does not match, or if there is a mismatch between the file type and the destination data type. If any of these occur during manual operation, the analyzer returns to the Import Data menu and the File Open dialog goes away.

	This key does not appear unless you have the proper option installed in your instrument. This command will generate an "Option not available" error unless you have the proper option installed in your instrument.
Couplings	When a correction file is loaded from mass storage, it is automatically turned on (Correction ON) and ApplyCorrections is set to On. This allows you to see its effect, thus confirming the load.
Readback	selected Correction
Backwards Compatibility SCPI	:MMEMory:LOAD:CORRection ANTenna CABLE OTHER USER, <filename> For backwards compatibility, ANTenna maps to 1, CABLE maps to 2, OTHER maps to 3 and USER maps to 4
Initial S/W Revision	A.02.00

Amplitude Correction

These keys let you select which Correction to import the data into. Once selected, the key returns back to the Import Data menu and the selected Correction number is annotated on the key. The next step is to select the Open key in the Import Data menu.

Antenna corrections are a particular kind of Amplitude Corrections – they are distinguished in the corrections file by having the Antenna Unit set to a value other than None. Only Correction 1 supports Antenna Units.

Key Path	Recall, Data, Amplitude Correction
Notes	auto return
Dependencies	Only Correction 1 may be used to load a Correction that contains an Antenna Unit other than None
Preset	Not part of Preset, but is reset to Correction 1 by Restore Input/Output Defaults; survives shutdown.
State Saved	The current Correction number is saved in instrument state
Initial S/W Revision	A.02.00

Trace

This key selects Trace as the data type to be imported. When pressed a second time, it brings up the Trace Menu, which lets you select the Trace into which the data will be imported.

The trace file contains "meta" data which describes the state of the analyzer when the trace was exported (see "[Trace File Contents](#)" on page 3216). If the meta data in the file does not match the current SA state, the "invalid data indicator" (*) is displayed.

Key Path	Recall, Data
Remote Command	:MMEMory:LOAD:TRACe:DATA TRACE1 TRACE2 TRACE3 TRACE4 TRACE5 TRACE6, <filename>
Example	:MMEM:LOAD:TRAC DATA TRACE2, "myTrace2.csv" Imports the 2nd trace from the file myTrace2.csv in the current path. The default path is My Documents\SA\data\traces
Dependencies	For SA measurements, a trace cannot be recalled from a trace file that was exported with ALL traces selected. A trace cannot be imported if the number of trace points in the file do not match the number of sweep points currently set for the measurement. If this happens, an error message is generated. Errors are reported if the file is empty or missing, or if the file type does not match, or if there is a mismatch between the file type and the destination data type. If any error occurs while trying to load a file manually (as opposed to during remote operation), the analyzer returns to the Import Data menu and the File Open dialog goes away.
Couplings	When a trace is imported, Trace Update is always turned OFF for that trace and Trace Display is always turned ON.
Readback	Selected Trace
Status Bits/OPC dependencies	Sequential - aborts the current measurement.
Initial S/W Revision	Prior to A.02.00

Select Trace

These keys let you pick the Trace into which to import the data; either 1, 2, 3, 4, 5 or 6. The default is the currently selected trace, selected in this menu or in the Trace/Det, Export Data, Recall Trace, or Save Trace menus; except if you have chosen **All** then **All** remains chosen until you specifically change it to a single trace.

Once selected, the key returns back to the Import Data menu and the selected Trace number is annotated on the key. The next step is to select the Open key in the Import Data menu.

Key Path	Recall, Data, Trace
Notes	Auto return
Couplings	When you select the trace into which to import the data, it makes that trace the current trace, so it displays on top of all of the other traces.
Preset	Not part of Preset, but is reset to TRACE1 by Restore Mode Defaults; survives shutdown
State Saved	The current trace number is saved in State
Initial S/W Revision	Prior to A.02.00

Limit

This key selects Limit Lines as the data type to be imported. When pressed a second time, it brings up the Limits Menu, which lets you select into which Limit the data will be imported.

A set of preloaded Limits files can be found in the directory

/My Documents/ EMC Limits and Ampcor.

Under this directory, the directory called Limits (Legacy Naming) contains a set of legacy limits, generally the same files that were supplied with older Agilent EMC analyzers, that use the legacy suffix .lim, and the old 8-character file names. In the directory called Limits, the same files can be found, with the same suffix, but with longer, more descriptive filenames.

Key Path	Recall, Data
Remote Command	:MMEMory:LOAD:LIMit LLINE1 LLINE2,<filename>
Example	:MMEM:LOAD:LIM LLINE2, "myLimitLine2.csv" Imports the 2nd Limit Line from the file myLimitLine2.csv in the current path. The default path is My Documents\SA\data\limits
Dependencies	Errors are reported if the file is empty or missing, or if the file type does not match, or if there is a mismatch between the file type and the destination data type. If any of these occur during manual operation, the analyzer returns to the Import Data menu and the File Open dialog goes away. This key will only appear if you have the proper option installed in your instrument.
Couplings	When a limit line is loaded from mass storage, it is automatically turned on. This allows the user to see it, thus confirming the load. The Margin settings will match those when the limit was saved The instrument cannot mix Limits domains (X Axis Unit must be Frequency or Time for both Limits). So when a Limits file is loaded, the analyzer will set the Limits domain (X Axis Unit) to match that of the file. If this changes the Limits domain from what it was before the file was loaded, all Limits data in all Limits sets will be erased before the data loads. If this operation is over the remote interface there will be no warning if this occurs, so care should be taken to know the domain of the file you are loading.
Readback	Selected Limit Line
Status Bits/OPC dependencies	Sequential - aborts the current measurement
Initial S/W Revision	A.02.00

Limit Selection

These keys let you pick which Limit Line to import the data into; either 1, 2, 3, 4, 5 or 6. The default is the currently selected limit. Once selected, the key returns back to the Import Data menu and the selected Limit Line number is annotated on the key. Now you have selected exactly what needs to be imported. In order to trigger an import of the selected Limit Line, you must select the Open key in the Import Data menu.

An example of using this menu is: If you select 2 and continue to the File Open menu, Limit Line 2 will be imported from the file selected or entered in File Name option in the File Open dialog.

Key Path	Recall, Data, Limit Line
Notes	Auto return
Preset	Not part of Preset, but is reset to LLINE1 by Restore Mode Defaults; survives a shutdown.
State Saved	The selected limit number is saved in instrument state
Initial S/W Revision	A.02.00

Open...

When you press “Open”, the analyzer brings up a Windows dialog and a menu entitled “**File Open.**” This menu allows you to navigate to the various fields in the Windows dialog without using a keyboard or mouse. The **Tab** and **Arrow** keys can also be used for dialog navigation.

See "[From File...](#)" on page 3210 in **Recall, State**, for a full description of this dialog and menu.

Key Path	Recall, Data
Notes	The key location is mode-dependent and will vary. Brings up Open dialog for recalling a <mode specific> Save Type
Initial S/W Revision	Prior to A.02.00

Restart

The Restart function restarts the current sweep, or measurement, or set of averaged/held sweeps or measurements. If you are Paused, pressing Restart does a Resume.

The Restart function is accessed in several ways:

- Pressing the Restart key
- Sending the remote command INIT:IMMediate
- Sending the remote command INIT:REStart

See ["More Information" on page 1757](#)

Key Path	Front-panel key
Remote Command	:INITiate[:IMMediate] :INITiate:REStart
Example	:INIT:IMM :INIT:REST
Notes	:INITiate:REStart and :INITiate:IMMediate perform exactly the same function.
Couplings	Resets average/hold count k. For the first sweep overwrites all active (update=on) traces with new current data. For application modes, it resets other parameters as required by the measurement.
Status Bits/OPC dependencies	This is an Overlapped command. The STATus:OPERation register bits 0 through 8 are cleared. The STATus:QUEStionable register bit 9 (INTegrity sum) is cleared. The SWEEPING bit is set. The MEASURING bit is set.
Backwards Compatibility Notes	For Spectrum Analysis mode in ESA and PSA, the Restart hardkey and the INITiate:REStart command restart trace averages (displayed average count reset to 1) for a trace in Clear Write , but did not restart Max Hold and Min Hold . In the X-Series, the Restart hardkey and the INITiate:REStart command restart not only Trace Average , but MaxHold and MinHold traces as well. For wireless comms modes in ESA and PSA, the Restart hardkey and the INITiate:REStart command restart every measurement, which includes all traces and numeric results. There is no change to this operation.
Initial S/W Revision	Prior to A.02.00

More Information

The **Restart** function first aborts the current sweep/measurement as quickly as possible. It then resets the sweep and trigger systems, sets up the measurement and initiates a new data measurement sequence with a new data acquisition (sweep) taken once the trigger condition is met.

If the analyzer is in the process of aligning when **Restart** is executed, the alignment finishes before the restart function is performed.

Even when set for Single operation, multiple sweeps may be taken when Restart is pressed (for example, when averaging/holding is on). Thus when we say that **Restart** "restarts a measurement," we may mean:

- It restarts the current sweep
- It restarts the current measurement
- It restarts the current set of sweeps if any trace is in Trace Average, Max Hold or Min Hold
- It restarts the current set of measurements if Averaging, or Max Hold, or Min Hold is on for the measurement
- depending on the current settings.

With **Average/Hold Number** (in **Meas Setup** menu) set to 1, or Averaging off, or no trace in Trace Average or Hold, a single sweep is equivalent to a single measurement. A single sweep is taken after the trigger condition is met; and the analyzer stops sweeping once that sweep has completed. However, with **Average/Hold Number** > 1 and at least one trace set to **Trace Average, Max Hold, or Min Hold (SA Measurement)** or **Averaging on (most other measurements)**, multiple sweeps/data acquisitions are taken for a single measurement. The trigger condition must be met prior to each sweep. The sweep is stopped when the average count k equals the number N set for **Average/Hold Number**. A measurement average usually applies to all traces, marker results, and numeric results; but sometimes it only applies to the numeric results.

Once the full set of sweeps has been taken, the analyzer will go to idle state. To take one more sweep without resetting the average count, increment the average count by 1, by pressing the step up key while **Average/Hold Number** is the active function, or sending the remote command `CALC: AVER: TCON UP`.

Save

The **Save** menu lets you choose what you want to save and where you want to save it. Among the types of files you can save are **States**, **Traces**, and **Screen Images**. In addition, an **Export (Data)** option lets you save a number of data types as CSV files for easy import into Excel and other spreadsheet programs.

Key Path	Front-panel key
Mode	All
Notes	No remote command for this key specifically, but the :MMEM:STORe command is available for specific file types. An example is :MMEM:STOR:STATe <filename>.
Initial S/W Revision	Prior to A.02.00

State

The Save State menu lets you choose a register or file for saving the state.

The content of a state file includes all of the settings and data required to return the analyzer as closely as possible to the Mode it was in, with the exact settings which were in place, when the save occurred. The Mode settings in each state file include the settings that are affected by Mode Preset, as well as the additional settings affected by Restore Mode Defaults; all of the Mode's settings. In addition, all of the settings of the **Input/Output** system are included, even though they are outside of the Mode's state, because they are needed to restore the complete setup. Persistent **System** settings (for example, Verbose SCPI) are not affected by either Mode Preset or Restore Mode Defaults, nor are they included in a saved State file.

After the save completes, the message "File <filename> saved" or "State Register <register number> saved" is displayed.

For rapid saving, the State menu lists 16 registers to save to. Pressing a Register key initiates the save. You can also select a file to save to.

The default path for all State Files is:

My Documents\<<mode name>\state

where <mode name> is the parameter used to select the mode with the INST:SEL command (for example, SA for the Spectrum Analyzer).

Key Path	Save
Mode	All
Remote Command	:MMEMory:STORe:STATe <filename>
Example	MMEM:STOR:STATe "MyStateFile.state" This stores the current instrument state data in the file MyStateFile.state in the default directory.
Notes	Both single and double quotes are supported for any filename parameter over remote. After saving to a register, that register's menu key is updated with the date the time, unless a custom label has been entered for that key. After saving to a register, you remain in the Save State menu, so that you can see the Register

	key update. After saving to a file, the analyzer automatically returns to the previous menu and any Save As dialog goes away.
Backwards Compatibility SCPI	:MMEMory:STORe:STATe 1,<filename> For backwards compatibility, the above syntax is supported. The "1" is simply ignored. The command is sequential.
Initial S/W Revision	Prior to A.02.00

To File . . .

When you press "To File", the analyzer brings up a Windows dialog and a menu entitled "**Save As.**" This menu allows you to navigate to the various fields in the Windows dialog without using a keyboard or mouse. The **Tab** and **Arrow** keys can also be used for dialog navigation.

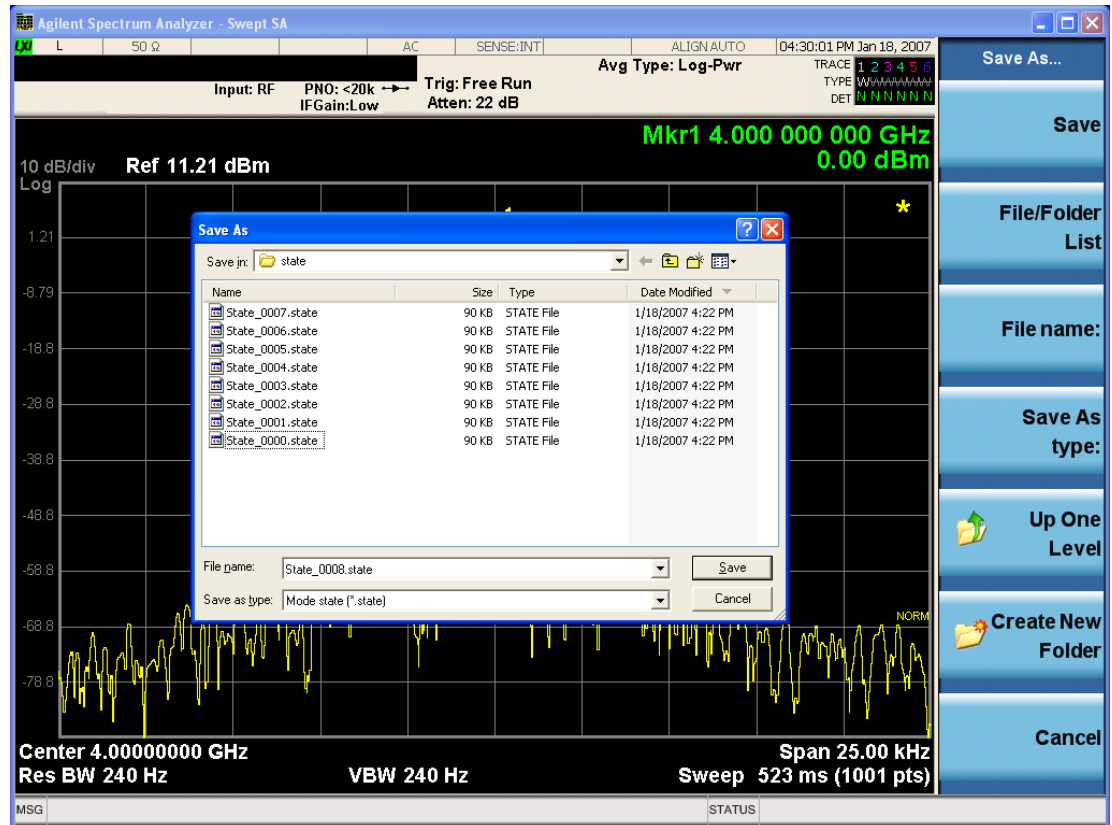

The Listed below are the functions of the various fields in the dialog, and the corresponding softkeys:

Save

Performs the save to the specified file of the selected type. If the file already exists, a dialog will appear that allows you to replace the existing file by selecting **OK**, or you can Cancel the request. If you select OK, the file will be overwritten. Using the C: drive is strongly discouraged, since it runs the risk of being overwritten during an instrument software upgrade.

While the save is being performed, the floppy icon appears briefly in the Meas bar.

File/Folder List

Enables you to navigate to the center of the dialog that contains the list of files and folders. Once here you can get information about the file and use the tab keys to navigate to the other fields in the dialog, such as Save In.

Save In

The Save In field shows the path to which the file will be saved and allows you to change the path using the up and down arrow keys to navigate to other paths; the Enter key to open a directory; and the Backspace key to go back one directory. The **Save In field** defaults to the default path for this type of file and remembers the last path you used to save this type of file. There is no softkey for directly navigating to the Save In field but you can use left tab to get here from the File/Folder List.

User specified paths are remembered when you leave and return to a Mode and are reset back to the default using **Restore Mode Defaults**.

File Name

The **File Name** field is initially loaded with an automatically generated filename specific to the appropriate Save Type. The automatically generated filename is guaranteed not to conflict with any filename currently in the directory. You may replace or modify this filename using the File Name key. See the "[Quick Save](#)" on [page 3181](#) documentation for more on the automatic file naming algorithm.

When you press the **File Name** key the analyzer displays the Alpha Editor. Use the knob to choose the letter to add and the front-panel Enter key to add the letter to the file name. The BK character moves you back and the FW character moves you forward in the filename. The Select key on the front panel generates a space character. When you are done entering the filename press the **Done** softkey. This returns back to the **File Open** dialog and menu, but does not cause the save to occur.

Save As Type

This field shows the file suffix for the type of file you have selected to save. For example, if you navigated here while saving State, "Mode state (*.state)" is in the field. If you navigated here from saving Trace, "Mode state (*.trace)" is in the field. If you navigated here while exporting a trace data file, "Trace Data (*.csv)" is in the field. For some file types, there is more than one choice in the dropdown, which you can select by using the up and down arrow keys and Enter.

Up One Level

This key corresponds to the icon of a folder with the up arrow that is in the tool bar of the dialog. When pressed, it causes the file and folder list to navigate up one level in the directory structure. The Backspace key does the same thing.

Create New Folder

This key corresponds to the icon of a folder with the "*" that is in the tool bar of the dialog. When pressed, a new folder is created in the current directory with the name **New Folder** and you can enter a new folder name using the Alpha Editor.

Cancel

This key corresponds to the **Cancel** selection in the dialog. It causes the current **Save As** request to be cancelled. The ESC key does the same thing.

Key Path	Save, State
Mode	All
Notes	Brings up Save As dialog for saving a State Save Type
Initial S/W Revision	Prior to A.02.00

Edit Register Names

You may enter a custom name on any of the Register keys, to help you remember what you are using that state to save. To do this, press the **Edit Register Names** key,

choose the register whose name you wish to edit, and then enter the desired label using the Alpha Editor or an external PC keyboard.

The maximum number of characters that can be added is 30. In most cases, 30 characters will fit on two lines of the key.

See ["More Information" on page 1763](#)

Key Path	Save, State
Mode	All
Remote Command	:MMEMory:REGister:STATe:LABe1 <reg number>,"label" :MMEMory:REGister:STATe:LABe1? <reg number>
Example	:MMEM:REG:STAT:LAB 1,"my label"
Notes	<reg number> is an integer from 1 to 16. If the SCPI specifies an invalid register number an error message is generated, -222,"Data out of range;Invalid register label number" "label" is a string from 0 to 30 characters in length. If a label exceeds 30 characters, an error message is generated, -150,"String data error;Label clipped to 30 characters" "label" of length 0 erases the custom label and restores the default (time and date) label. E.g.: :MMEM:REG:STAT:LAB 1,""
Dependencies	N9060A-7FP or N9060B-2FP license required to edit the register names. When the feature is not licensed, sending this command generates an error, -221,"Settings conflict;Option not available"
Preset	The names are unaffected by Preset or power cycle but are set to the default label (time and date) on a "Restore System Defaults->Misc"
Initial S/W Revision	A.11.00

More Information

When you edit one of the register names, the time and date field will be replaced by the custom name.

If you delete all the characters in the custom name, it restores the default (time and date).

The register names are stored within the state files, but they are not part of the instrument state; that is, once you have edited a register name, loading a new state will not change that register name. Another consequence of this is that the names will be persistent through a power cycle. Also, if a named state file is transferred to another analyzer, it will bring its custom name along with it.

If you try to edit the name of an empty register, the analyzer will first save the state to have a file to put the name in. If you load a named state file into an analyzer with older firmware it will ignore the metadata.

The *SAV and *RCL commands will not be affected by the custom register names, nor will the MMEM commands.

Register 1 thru Register 16

Selecting any one of these register menu keys causes the State of the currently active mode to be saved to the specified Register. The registers are provided for rapid saving and recalling, since you do not need to specify a filename or navigate to

a file. Each of the register menu keys annotates whether it is empty or at what date and time it was last modified. In addition, you can use the **Edit Register Names** key to enter custom names for each register.

Although these 16 registers are the only registers available from the front panel, there are 128 state registers available in the instrument. Registers 17-128 are only available from the SCPI interface, using the *SAV command.

There is one set of 128 state registers in the instrument, not one set for each Mode. When a state is saved, the Mode it was saved from is saved with it; then when it is recalled, the instrument switches to that Mode.

After the save completes, the corresponding register menu key annotation is updated with the date and time and the message "Register <register number> saved" is displayed.

Key Path	Save, State
Mode	All
Example	*SAV 1
Range	1-16 from front panel, 1-128 from SCPI
Readback	Date and time with seconds resolution are displayed on the key OR A custom name of up to 30 characters entered using the Edit Register Names key OR “(empty)” if no prior save operation has been performed to this register.
Initial S/W Revision	Prior to A.02.00
Modified at S/W Revision	A.11.00

Register 1 thru Register 16

Selecting any one of these register menu keys causes the State of the currently active mode to be saved to the specified Register. The registers are provided for rapid saving and recalling, since you do not need to specify a filename or navigate to a file. Each of the register menu keys annotates whether it is empty or at what date and time it was last modified. In addition, you can use the **Edit Register Names** key to enter custom names for each register.

Although these 16 registers are the only registers available from the front panel, there are 128 state registers available in the instrument. Registers 17-128 are only available from the SCPI interface, using the *SAV command.

There is one set of 128 state registers in the instrument, not one set for each Mode. When a state is saved, the Mode it was saved from is saved with it; then when it is recalled, the instrument switches to that Mode.

After the save completes, the corresponding register menu key annotation is updated with the date and time and the message "Register <register number> saved" is displayed.

Key Path	Save, State
Mode	All
Example	*SAV 1
Range	1-16 from front panel, 1-128 from SCPI
Readback	Date and time with seconds resolution are displayed on the key OR A custom name of up to 30 characters entered using the Edit Register Names key OR “(empty)” if no prior save operation has been performed to this register.
Initial S/W Revision	Prior to A.02.00
Modified at S/W Revision	A.11.00

Trace (+State)

The **Save Trace (+State)** menu lets you choose a register or file specifying where to save the Trace+State state file.

A saved state contains all of the settings and data required to return the analyzer as closely as possible to the exact setup it had when the save occurred. This includes the Input/Output settings, even though they are outside of the Mode’s state, because they are needed to restore the complete setup. A Trace+State file also includes trace data from one trace or all traces, which will load in View mode when the Trace+State file is recalled.

After the save completes, the message "File <filename> saved" or "Trace Register <register number> saved" is displayed.

For rapid saves, the Trace (+State) menu lists 5 registers to save to. Pressing a Register key initiates the save. You can also select a file to save to.

The default path for all State Files including .trace files is:

My Documents\<<mode name>\state

where <mode name> is the parameter used to select the mode with the INST:SEL command (for example, Basic for the IQAnalyzer).

This key is grayed out for measurements that do not support trace saves. It is blanked for modes that do not support trace saves. Saving **Trace** is identical to saving State except a .trace extension is used on the file instead of .state, and internal flags are set in the file indicating which trace was saved. You may select to save one trace or ALL traces.

Key Path	Save
Mode	SA
Remote Command	:MMEMory:STORe:TRACe TRACE1 TRACE2 TRACE3 TRACE4 TRACE5 TRACE6 ALL,<filename>

	<code>:MMEMory:STORe:TRACe:REGister TRACE1 TRACE2 TRACE3 TRACE4 TRACE5 TRACE6 ALL,<integer></code>
Example	<p>:MMEM:STOR:TRAC TRACE1, "myState.trace" saves the file myState.trace on the default path and flags it as a "single trace" file with Trace 1 as the single trace (even though all of the traces are in fact stored).</p> <p>:MMEM:STOR:TRAC ALL, "myState.trace" saves the file myState.trace on the default path and flags it as an "all traces" file</p> <p>:MMEM:STOR:TRAC:REG TRACE1, 2 stores trace 1 data in trace register 2</p>
Notes	<p>This command actually performs a save state, which in the Swept SA measurement includes the trace data. However it flags it (in the file) as a "save trace" file of the specified trace (or all traces).</p> <p>Some modes and measurements do not have available all 6 traces. The Phase Noise mode command, for example, is: <code>MMEMory:STORe:TRACe TRACE1 TRACE2 TRACE3 ALL,<filename></code></p> <p>Some modes and measurements have more than 6 traces available. The Realtime SA mode command, for example, is: <code>MMEMory:STORe:TRACe TRACE1 TRACE2 TRACE3 TRACE4 TRACE5 TRACE6 TRACE7 TRACE8 TRACE9 TRACE10 TRACE11 TRACE12 ALL,<filename></code></p> <p>The range for the register parameter is 1-5</p> <p>When you initiate a save, if the file already exists, a dialog will appear that allows you to replace the existing file by selecting OK or you can Cancel the request. If you select OK, the file will be overwritten. Using the C: drive is strongly discouraged, since it runs the risk of being overwritten during an instrument software upgrade.</p> <p>Both single and double quotes are supported for any filename parameter over remote.</p> <p>After saving to a register, that register's menu key is updated with the date and time of the save.</p> <p>After saving to a register, you remain in the Save Trace menu, so that you can see the Register key update. After saving to a file, the analyzer automatically returns to the previous menu and any Save As dialog goes away.</p>
Initial S/W Revision	Prior to A.02.00

Register 1 thru Register 16

Selecting any one of these register menu keys causes the State of the currently active mode to be saved to the specified Register. The registers are provided for rapid saving and recalling, since you do not need to specify a filename or navigate to a file. Each of the register menu keys annotates whether it is empty or at what date and time it was last modified. In addition, you can use the **Edit Register Names** key to enter custom names for each register.

Although these 16 registers are the only registers available from the front panel, there are 128 state registers available in the instrument. Registers 17-128 are only available from the SCPI interface, using the *SAV command.

There is one set of 128 state registers in the instrument, not one set for each Mode. When a state is saved, the Mode it was saved from is saved with it; then when it is recalled, the instrument switches to that Mode.

After the save completes, the corresponding register menu key annotation is updated with the date and time and the message "Register <register number> saved" is displayed.

Key Path	Save, State
Mode	All
Example	*SAV 1
Range	1-16 from front panel, 1-128 from SCPI
Readback	Date and time with seconds resolution are displayed on the key OR A custom name of up to 30 characters entered using the Edit Register Names key OR “(empty)” if no prior save operation has been performed to this register.
Initial S/W Revision	Prior to A.02.00
Modified at S/W Revision	A.11.00

From Trace

Accesses a menu that enables you to select the trace to be saved. Once a trace is selected, the key returns to the Save Trace menu and the selected trace number is annotated on the key. The default is the currently selected trace, selected in this menu or in the Trace/Det, Export Data, Import Data or Recall Trace menus, except if you have chosen All then it remains chosen until you specifically change it to a single trace. To save the Trace you must select the **Save As** key in the Save Trace menu.

When you select a trace, it makes that trace the current trace, so it displays on top of all of the other traces.

Key Path	Save, Trace + State
Mode	SA
Initial S/W Revision	Prior to A.02.00

From File...

When you press “From File”, the analyzer brings up a Windows dialog and a menu entitled “**File Open.**” This menu allows you to navigate to the various fields in the Windows dialog without using a keyboard or mouse. The **Tab** and **Arrow** keys can also be used for dialog navigation.

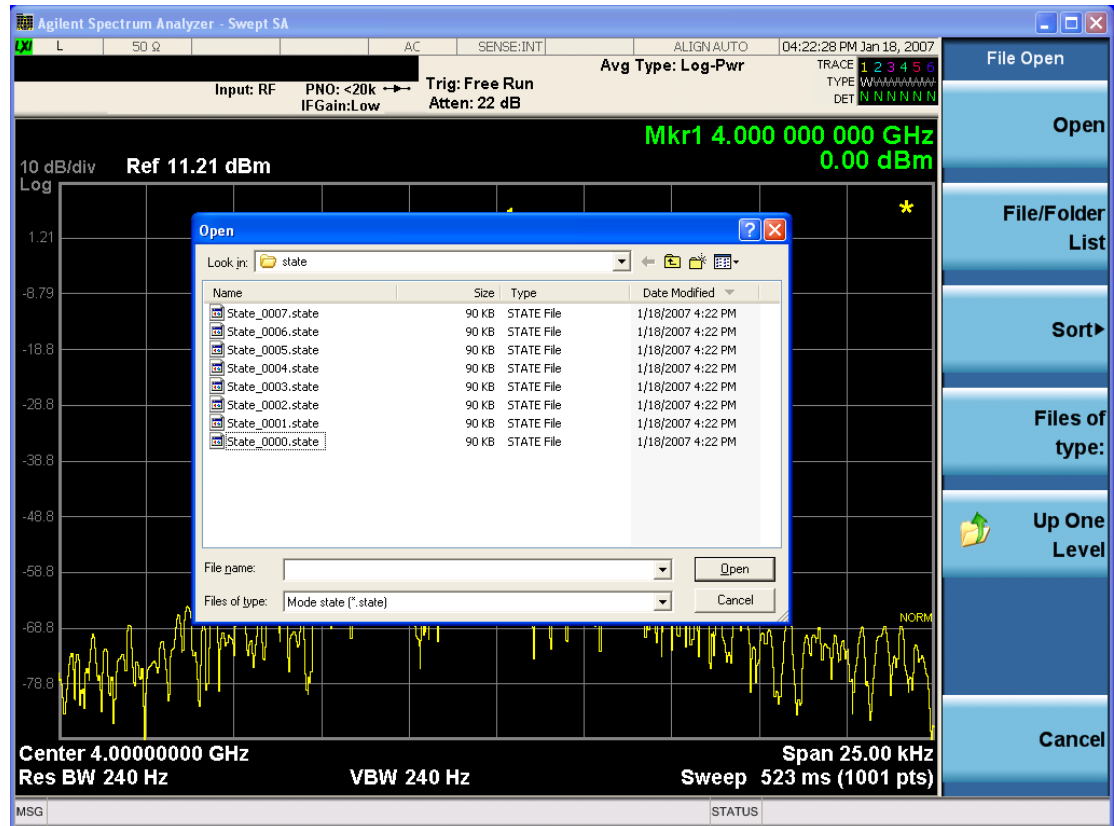

Listed below are the functions of the various fields in the dialog, and the corresponding softkeys:

Open

Performs the recall of the specified file. While the recall is being performed, the floppy icon appears briefly in the Meas bar.

File/Folder List

Enables you to navigate to the center of the dialog that contains the list of files and folders. Once here you can get information about the file and use the tab keys to navigate to the other fields in the dialog, such as Look In.

Look In

The **Look In** field shows the path from which the file will be recalled and allows you to change the path using the up and down arrow keys to navigate to other paths; the Enter key to open a directory; and the Backspace key to go back one directory. The **Look In** field first uses the last path from the Save As dialog **Save In:** path for that same file type. There is no softkey for directly navigating to the Look In field, but you can use the left tab to get here from the File/Folder List.

User specified paths are remembered when you leave and return to a Mode and are reset back to the default using **Restore Mode Defaults**.

Sort

Accesses a menu that enables you to sort the files within the File Open dialog. Only one sorting type can be selected at a time and the sorting happens immediately. The sorting types are **By Date**, **By Name**, **By extension**, and **By Size**.

Files of Type

This field shows the file suffix for the type of file you have selected to recall. For example, if you navigated here while recalling State, "Mode state (*.state)" is in the field. If you navigated here while recalling Trace, "Mode state (*.trace)" is in the field. If you navigated here while importing a trace data file, "Trace Data (*.csv)" is in the field. For some file types, there is more than one choice in the dropdown menu, which you can select by using the up and down arrow keys and Enter.

Up One Level

This key corresponds to the icon of a folder with the up arrow that is in the tool bar of the dialog. When pressed, it causes the file and folder list to navigate up one level in the directory structure. The Backspace key does the same thing.

Cancel

This key corresponds to the **Cancel** selection in the dialog. It causes the current **Open** request to be cancelled. The ESC key does the same thing.

Key Path	Recall, State
Notes	Brings up the Open dialog for recalling a State Save Type
Initial S/W Revision	Prior to A.02.00

Data (Export)

Exporting a data file stores data from the current measurement to mass storage files. The Export Menu only contains data types that are supported by the current measurement.

Since the commonly exported data files are in .csv format, the data can be edited by you prior to importing. This allows you to export a data file, manipulate the data in Excel (the most common PC Application for manipulating .csv files) and then import it.

Selecting an Export Data menu key will not actually cause the exporting to occur, since the analyzer still needs to know where you wish to save the data. Pressing the Save As key in this menu brings up the Save As dialog and Save As menu that allows you to specify the destination file and directory. Once a filename has been selected or entered in the Open menu, the export will occur as soon as the Save key is pressed.

Key Path	Save
Mode	All
Notes	The menu is built from whatever data types are available for the mode. So the key locations in the sub menu will vary. No SCPI command directly controls the Data Type that this key controls. The Data Type is included in the MMEM:STORe commands.

Dependencies	If a file type is not used by a certain measurement, that type is grayed out for that measurement. The key for a file type will not show at all if there are no measurements in the Mode that support it.
Preset	Is not affected by a Preset or shutdown, but is reset during Restore Mode Defaults
Readback	The data type that is currently selected
Initial S/W Revision	Prior to A.02.00

Amplitude Correction

Pressing this key selects **Amplitude Corrections** as the data type to be exported. Pressing this key again brings up the Select Menu, which allows the user to select which **Amplitude Correction** to save.

Amplitude Corrections are fully discussed in the documentation of the Input/Output key, under the Corrections softkey.

See "[Correction Data File](#)" on page 1770

Key Path	Save
Remote Command	:MMEMory:STORe:CORRection 1 2 3 4 5 6, <filename>
Example	:MMEM:STOR:CORR 2 "myAmpcor.csv" saves Correction 2 to the file myAmpcor.csv on the current path. The default path is My Documents\amplitudeCorrections.
Notes	If the save is initiated via SCPI, and the file already exists, the file will be overwritten. Using the C: drive is strongly discouraged, since it runs the risk of being overwritten during an instrument software upgrade. Both single and double quotes are supported for any filename parameter over SCPI.
Dependencies	Corrections are not supported by all Measurements. If in a Mode in which some Measurements support it, this key will be grayed out in measurements that do not. The key will not show at all if no measurements in the Mode support it. This key will not appear unless you have the proper option installed in your instrument.
Readback	Selected Correction
Backwards Compatibility SCPI	:MMEMory:STORe:CORRection ANTenna CABLe OTHer USER, <filename> For backwards compatibility, ANTenna maps to 1, CABLe maps to 2, OTHer maps to 3 and USER maps to 4
Initial S/W Revision	A.02.00

Correction Data File

A Corrections Data File contains a copy of one of the analyzer correction tables. Corrections provide a way to adjust the trace display for predetermined gain curves (such as for cable loss).

Corrections files are text files in .csv (comma separated values) form, to make them importable into Excel or other spreadsheet programs. The format for Corrections files is as follows.

Line #	Type of field	Example	Notes
1	File type, must be "Amplitude Correction"	Amplitude Correction	May not be omitted
2	File Description (in quotes)	"Correction Factors for 11966E"	60 characters max; may be empty but may not be omitted. If exceeds 60 characters, error -233 Too much data reported
3	Comment (in quotes)	"Class B Radiated"	60 characters max; may be empty but may not be omitted. . If exceeds 60 characters, error -233 Too much data reported
4	Instrument Version, Model #	A.02.06,N9020A	May be empty but may not be omitted
5	Option List, File Format Version	K03 LFE EXM ,01	May be empty but may not be omitted
6	Freq Unit to be used for all frequency values in the file	Frequency Unit,MHz	assumed to be Hz if omitted
7	Antenna Unit	Antenna Unit,None	If omitted leaves the Antenna unit unchanged. The amplitude unit in the Antenna Unit field is a conversion factor that is used to adjust the Y Axis Units of the current mode, if the mode supports Antenna Units. For more details on antenna correction data, refer to the Input/Output,Corrections key description. Allowable values: dBuv/m, dBuA/m, dBG, dBpT, None
8	Freq Interpolation	Frequency Interpolation,Linear	if omitted leaves the Freq Interpolation unchanged. Allowable values: Linear, Logarithmic
9	Bias value in mA	Bias,0.00	If omitted leaves the Bias value unchanged (added as of A.08.50)
10	Bias State	Bias State,On	If omitted leaves the Bias State unchanged. Allowable values: On, Off (added as of A.08.50)

Line #	Type of field	Example	Notes
11	Overlap, two values, Freq1 and Freq2, separated by commas.	Overlap,33500,40000	Uses Freq Unit from line 6. Thus, in this example Freq1=33.5 GHz, Freq2= 40.0 GHz (see note below). If omitted leaves the overlap unchanged (added as of A.08.50)
12	DATA marker	DATA	Corrections data begins in the next line

Lines 2 through 5 can be empty but must appear in the file. Lines 6 through 11 are optional, the lines can be left out of the file altogether.

The Overlap row and the two Bias rows apply only to external mixing. Both are read-only, they are never written by the analyzer. The only way to insert or modify these rows is to edit the file with a text editor or a spreadsheet editor. These rows are intended for use by mixer manufacturers, as they allow the manufacturer to insert data about how the mixer corrections were generated and how they should be applied. The Bias rows allow you to specify whether to turn Bias on or off when the Correction is turned on and to specify a Bias value (turning off the Correction does not change the Bias, but turning it back on again sets it to the value specified in the file). The Overlap row allows you to specify an overlap region in which two different corrections may be applied. It is expected that in the corrections data itself, there will be TWO corrections values exactly at Max Freq, otherwise Overlap is ignored. The way the overlap is processed is as follows: if at any given time the current analyzer Start Freq is greater than Freq 1 and lower than Freq 2, and the current Stop Freq is greater than Freq 2, extend the first correction point at or above Freq 2 down to Freq 1, rather than using the correction data between Freq1 and Freq2.

The Antenna Unit row can only be used in Correction register 1, because there can only be one setting for Antenna Unit at any given time. If a Correction whose Antenna Unit is set to anything but None is loaded into any Correction register but 1, an error is generated (Mass storage error; Can only load an Antenna Unit into Correction 1). When a correction file is saved from any Correction register but 1, Antenna Unit is always written as None.

Similarly, the Bias rows can only be used in Correction register 1, because there can only be one setting for Bias at any given time. If a Correction file with a Bias or Bias State row is loaded into any Correction register but 1, an error is generated: Mass storage error; Can only load Bias Settings into Correction 1

The data follows the DATA row, as comma separated X, Y pairs; one pair per line.

For example, suppose you have an Antenna to correct for on an N9020A version A.02.06 and the correction data is:

– 0 dB at 200 MHz

- 17 dB at 210 MHz
- 14.8 dB at 225 MHz

Then the file will look like:

- Amplitude Correction
- "Correction Factors for 11966E"
- "Class B Radiated"
- A.02.06,N9020A
- P13 EA3 UK6,01
- Frequency Unit,MHz
- Antenna Unit,dBuV/m
- Frequency Interpolation,Linear
- DATA
- 200.000000,0.00
- 210.000000,17.00
- 225.000000,14.80

The choices for the 1 of N fields in the metadata are as follows:

- Frequency Unit: Hz, kHz, MHz, GHz
- Antenna Unit: dBuv/m, dBuA/m, dBG, dBpT, None
- Frequency Interpolation: Logarithmic, Linear

Amplitude Correction

These keys let you choose which Correction to save. Once selected, the key returns back to the Export Data menu and the selected Correction number is annotated on the key.

The next step in the Save process is to select the Save As key in the Export Data menu.

Key Path	Save, Data, Amplitude Correction
Preset	Not part of a Preset, but is reset to Correction 1 by Restore Input/Output Defaults. Survives a shutdown.
Readback	1
Initial S/W Revision	A.02.00

Trace

Pressing this key selects Traces as the data type to be exported. Pressing this key when it is already selected brings up the Trace Menu, which allows you to select which Trace to save.

The trace file contains “meta” data which describes the current state of the analyzer. The metadata is detailed in ["Trace File Contents" on page 1774](#) below.

Key Path	Save, Data
Remote Command	:MMEMory:STORe:TRACe:DATA TRACE1 TRACE2 TRACE3 TRACE4 TRACE5 TRACE6 ALL,<filename>
Example	:MMEM:STOR:TRAC:DATA TRACE2, "myTrace2.csv" Exports the 2nd trace to the file myTrace2.csv in the current path. The default path is My Documents\SA\data\traces
Notes	If the save is initiated via SCPI, and the file already exists, the file will be overwritten. Using the C: drive is strongly discouraged, since it runs the risk of being overwritten during an instrument software upgrade. Both single and double quotes are supported for any filename parameter over SCPI.
Dependencies	For SA measurements, traces cannot be recalled from a trace file that was saved with ALL traces selected.
Couplings	When you select which trace to save, it makes that trace the current trace, so it displays on top of all of the other traces.
Readback	selected Trace
Status Bits/OPC dependencies	Sequential - waits for previous measurement to complete
Initial S/W Revision	Prior to A.02.00

Trace File Contents

A Trace Data File contains the data for one trace.

Metadata: Trace Specific

Besides the trace data, there is metadata describing the context by which the trace was produced. Some of the metadata is trace specific:

- Trace Type
- Detector
- Trace math (function, operand1, operand2, offset, reference)
- Trace name/number

When importing a trace, the detector and/or trace math function specified in the metadata is imported with the trace, so that the annotation correctly shows the detector and/or math type that was used to generate the data

Metadata: Display Specific

There is also some display-related metadata:

- Ref Level Offset
- External Gain
- X-Axis Unit
- Y-Axis Unit

Metadata: Measurement Related

The rest of the metadata is measurement specific and reflects the state of the measurement the last time the trace was updated. These are the “measurement-related instrument settings” which, if changed, cause a measurement restart.

- Number of Points
- Sweep Time
- Start Frequency
- Stop Frequency
- Average Count (actual; not the limit for the instrument)
- Average Type
- RBW
- RBW Filter Type
- RBW Filter BW Type
- VBW
- Sweep Type (FFT vs. Swept)
- Log/Lin X Scale (sometimes called Log Sweep)
- Preamp (on/off, band)
- Trigger (source, level, slope, delay)
- Phase Noise optimization setting
- Swept IF Gain
- FFT IF Gain
- AC/DC setting (RF Coupling)

- FFT Width
- External Reference setting
- Input (which input is in use)
- RF calibrator on/off
- Attenuation

Because any inactive trace can have a value that does not match the rest of the measurement, when performing a Save the metadata for each trace is pulled from the individual trace, not from the measurement.

A revision number is also included in the trace database, to allow for future changes.

The choices for the various 1 of N and binary fields are as follows:

- Average Type: Power(RMS), Voltage, LogPower(Video)
- RBW Filter Type: Flattop, EMI, Gaussian
- RBW Filter BW: 3dB, 6dB, Noise, Impulse
- Sweep Type: Swept, FFT
- PreAmp State: On, Off
- PreAmp Band: Low, Full
- Trigger Source: Free, RFBurst, Video, Line, Periodic, Ext1, Ext2, TV
- Trigger Slope: Positive, Negative
- Phase Noise Optimization: Fast, Narrow, Wide
- Swept IF Gain: Low, High
- FFT If Gain: Autorange, Low, High
- Input: RF, BBIQ
- RF Calibrator: 50M, 400G, Comb, Off
- Trace Type: ClearWrite, TraceAverage, MaxHold, MinHold
- Detector: Normal, Average, Peak, NegPeak, Sample
- Trace Math: Off, PowerDifference, PowerSum, LogOffset, LogDifference
- Y Axis Unit: dBm, dBmV, dBmA, W, V, A, dBuV, dBuA, dBuV/m, dBuA/m, dBuV, dBpT, dBG, dB

After the header, just before the trace data, a line with just the word DATA on it is inserted to flag the start of the trace data.

The following file example shows the first lines of a Trace 1 file with X Axis Unit = Hz and Y Axis Unit = dBuV, after importing into Excel (the second row contains the Title):

Trace	
"AS/NZS 1044; Conducted >1000 W, Motors, Average"	
A.01.00	E4410A
526 EA3 B25 P26 PFR	1
Segment	0
Number of Points	1001
Sweep Time	0.066266667
Start Frequency	18827440
Stop Frequency	24463718
Average Count	0
Average Type	Power(RMS)
RBW	51000
RBW Filter	Gaussian
RBW Filter BW	3dB
VBW	51000
Sweep Type	Swept
X Axis Scale	Lin
PreAmp State	Off
PreAmp Band	Low
Trigger Source	Video
Trigger Level	1.2
Trigger Slope	Positive
Trigger Delay	1.00E-06
Phase Noise Optimization	Fast
Swept IF Gain	Low
FFT IF Gain	Autorange
RF Coupling	AC
FFT Width	411900
Ext Ref	10000000
Input	RF
RF Calibrator	Off

Attenuation	10
Ref Level Offset	0
External Gain	0
Trace Type	ClearWrite
Detector	Normal
Trace Math	Off
Trace Math Oper1	Trace5
Trace Math Oper2	Trace6
Trace Math Offset	0
Trace Name	Trace1
X Axis Unit	Hz
Y Axis Unit	dBm
DATA	
1.6009301E+07	4.82047E+01
1.6018694E+07	4.69737E+01
1.6028087E+07	4.81207E+01
1.6037480E+07	4.72487E+01
1.6046873E+07	4.66437E+01
1.6056266E+07	4.66237E+01
1.6065659E+07	4.66967E+01
1.6075052E+07	4.77117E+01
1.6084445E+07	4.75787E+01
1.6093838E+07	4.83297E+01
1.6103231E+07	4.71327E+01
1.6112624E+07	4.78957E+01
1.6122017E+07	4.67507E+01
1.6131410E+07	4.81137E+01

Limit

Pressing this key selects Limit Lines as the data type to be exported. Pressing the key a second time brings up the Limit Menu that allows you to select which **Limit Line** to save.

- See "[Limits File Contents](#)" on page 1779.
- See "[.csv file format](#)" on page 1779
- See "[.lim file format](#)" on page 1780

Key Path	Save, Data
Remote Command	:MMEMory:STORe:LIMit LLINE1 LLINE2,<filename>
Example	:MMEM:STOR:LIM LLINE2, "myLimitLine2.csv" Saves the 2nd Limit Line to the file myLimitLine2.csv in the current path. The default path is My Documents\SA\data\limits
Notes	If the save is initiated via SCPI, and the file already exists, the file will be overwritten. Using the C: drive is strongly discouraged, since it runs the risk of being overwritten during an instrument software upgrade. Both single and double quotes are supported for any filename parameter over SCPI.
Dependencies	This key will only appear if you have the proper option installed in your instrument.
Preset	1; not part of Preset, but is reset by Restore Mode Defaults and survives power cycles
State Saved	The selected Limit number is saved in instrument state.
Readback	selected Limit Line
Status Bits/OPC dependencies	Sequential - waits for previous measurement to complete
Initial S/W Revision	A.02.00

Limits File Contents

Limits may be exported into a data file with a .csv extension. They may be imported from that data file; they may also be imported from a legacy limit file with a .lim extension. The .lim files meet the specification for limit files contained in the EMI measurement guide, HP E7415A.

.csv file format

Except for information in quotes, limit line files are not case sensitive. Information in bold is required verbatim; other text is example text, and italic text is commentary which should not be present in the file.

The first five lines are system-required header lines, and must be in the correct order.

Limit	<i>Data file type name</i>
"FCC Part 15"	<i>File Description</i>
"Class B Radiated"	<i>Comment</i>
A.01.00.R0001,N9020A	<i>Instrument Version, Model Number</i>
P13 EA3 UK6 ,01	<i>Option List, File Format Version</i>

The next few lines describe the parameters; on export they will be in the order shown, on import they can be in any order. If some parameters are missing, they will revert to the default.

Type, Upper	Upper Lower
X Axis Unit, MHz	MHz S; other units should be converted; this also specifies the domain
Amplitude Unit, dBm	dBm V; all other units should be converted appropriately
Frequency Interpolation, Linear	Logarithmic Linear
Amplitude Interpolation, Logarithmic	Logarithmic Linear
X Control, Fixed	Fixed Relative; on input we consider only the first three characters
Y Control, Fixed	Fixed Relative; on input we consider only the first three characters
Margin, 0	Always in dB. A 0 margin is equivalent to margin off
X Offset, 10	Expressed in the X axis units
Y Offset, 5	Expressed in the Amplitude units

The Amplitude Unit line in the limits file may contain an antenna factor unit, for example:

Amplitude Unit=dBuV/m

Antenna factor units are dBuV/m, dBuA/m, dBpT, and dBG. In this case, the unit is treated exactly as though it were dBuV, meaning that all of the limits are interpreted to have units of dBuV. The box does NOT change Y Axis Units when such a limit is loaded in.

The X axis unit also specifies the domain (time or frequency). It is not possible to have both time-domain lines and frequency-domain lines at the same time; if a time-domain line is imported while the other lines are in the frequency domain (or vice-versa), all limit lines will be deleted prior to import.

If the sign of the margin is inappropriate for the limit type (for example a positive margin for an upper limit), the sign of the margin will be changed internally so that it is appropriate.

The remaining lines describe the data. Each line in the file represents an X-Y pair. The X values should be monotonically non-decreasing, although adjacent lines in the file can have the same X value as an aid to building a stair-stepped limit line. To specify a region over which there is no limit, use +1000 dBm for upper limits or -1000 dBm for lower limits.

The data region begins with the keyword DATA:

```
DATA
200.000000,-10.00
300.000000,-10.00
300.000000,-20.00
500.000000,-20.00
```

.lim file format

This is a legacy format which allows files saved from older analyzers to be loaded into the X-Series. Design of files in this format is not recommended.

Limit Selection

These keys let you pick which Limit Line to save. Once selected, the key returns back to the **Export Data** menu and the selected Limit Line number is annotated on the key.

The next step in the Save process is to select the Save As key in the Export Data menu.

Key Path	Save, Data, Limit Line
Notes	auto return
Preset	Not part of Preset, but is reset to LLINE1 by Restore Mode Defaults; survives shutdown
Initial S/W Revision	A.02.00

Measurement Results

Pressing this key selects Meas Results as the data type to be exported.

The Meas Results file contains information which describes the current state of the analyzer. It is detailed in Meas Result File Contents below.

Key Path	Save, Data
Remote Command	:MMEMory:STORe:RESults <string>
Example	:MMEM:STOR:RES "MeasR_0000.csv"
Notes	<p>If the save is initiated via SCPI and the file already exists, the file will be overwritten.</p> <p>The SCPI command exports ACP measurement results to the file specified as the parameter in the current path. The default path is My Documents\<current mode>\data\acp\results.<="" p=""> <p>Using the C: drive is strongly discouraged, since it runs the risk of being overwritten during an instrument software upgrade.</p> <p>The SCPI parameter is a quoted string that specifies the filename. Both single and double quotes are supported for any filename parameter over SCPI.</p> </current></p>
Dependencies	The current active measurement must be the ACP measurement to use this command.
Status Bits/OPC dependencies	Sequential – waits for the previous measurement to complete
Initial S/W Revision	Prior to A.02.00

Meas Results File Contents

A Meas Results File contains measurement results with the following information.

- File ID string, which is “MeasResult”
- Measurement ID following Mode ID, which is “SA:ACP” for example.
- Firmware rev and model number
- Option string
- Auto Scaling
- Auto Sweep Time Rules
- Automatic Trigger Time
- Automatic Trigger Time State
- Average Mode

- Average Number
- Average State
- Bar Graph
- Carrier Coupling
- Carrier Pwr Present
- Carrier Spacing
- Carriers
- Center Frequency
- Center Frequency Step
- Center Frequency Step State
- Detector Auto
- Detector Selection
- Electrical Atten
- Electrical Atten State
- External Array Trigger Delay
- External Array Trigger Delay State
- External Array Trigger Level
- External Array Trigger Slope
- Filter Alpha
- Filter BW
- Filter Type
- Internal Preamp
- Internal Preamp Band
- Limit Test
- Line Trigger Delay
- Line Trigger Delay State
- Line Trigger Slope

- Meas Method
- Meas Type
- Measurement Noise Bandwidth
- Mechanical Atten
- MechanicalAttenStepEnum
- Method
- Noise Correction
- Offset Abs Limit
- Offset Fail
- Offset Filter Alpha
- Offset Filter BW
- Offset Filter Type
- Offset Freq
- Offset Freq State
- Offset Integ BW
- Offset Method
- Offset Rel Lim (Car)
- Offset Rel Lim (PSD)
- Offset Res BW
- Offset Res BW Mode
- Offset Video BW
- Offset Video BW Mode
- Periodic Timer Period
- Periodic Timer Sync Source
- Periodic Timer Trigger Delay
- Periodic Timer Trigger Delay State
- Points

- Power Ref
- Power Ref State
- Preselector Adjust
- PSD Ref
- PSD Unit
- Ref Car Freq
- Ref Car Freq State
- Ref Carrier
- Ref Carrier Mode
- Ref Position
- Ref Value
- Res BW
- Res BW Mode
- RFBurst Trigger Delay
- RFBurst Trigger Delay State
- RFBurst Trigger Level Abs
- RFBurst Trigger Level Rel
- RFBurst Trigger Level Type
- RFBurst Trigger Slope
- Scale/Div
- Span
- Sweep Time
- Sweep Time Auto
- Trigger Holdoff
- Trigger Holdoff State
- Trigger Source
- Video BW

– Video BW Auto

The file contains these data followed by MeasResult1, MeasResult2, and MeasResult3 that flag the start of the measurement results. Each line of Measurement Results consists of three comma separated values, MeasResult1 value, MeasResult2 value, and MeasResult3 value. MeasResult1 contains the same result as MEAS/READ/FETCH:ACPower1; MeasResult2, MEAS/READ/FETCH:ACPower2; MeasResult3, MEAS/READ/FETCH:ACPower3.

Exported file is .csv file. The Meas Results file, when imported into Excel, will show the following data:

MeasResult	
SA:ACP	
A.10.53	N9030 A
526 ALV	1
ATP B1X	
B1Y B25	
B40 BBA	
CR3 CRP	
DCF DDA	
DP2 DRD	
EA3 EDP	
EMC EP1	
ERC ESC	
ESP EXM	
FSA LFE	
LNP MAT	
MPB NFE	
NUL P26	
PFR PNC	
RTL RTS	
S40 SB1	
SEC SM1	
TVT YAS	
YAV	
Auto Scaling	TRUE
Auto Sweep Time Rules	Accy
Automatic Trigger Time	0.1
Automatic Trigger Time State	FALSE
Average Mode	Exponential

Average Number	10											
Average State	TRUE											
Bar Graph	TRUE											
Carrier Coupling	TRUE	TRUE	TRUE	TRUE	TRUE	TRUE	TRUE	TRUE	TRUE	TRUE	TRUE	TRUE
Carrier Pwr Present	Yes	Yes	Yes	Yes	Yes	Yes	Yes	Yes	Yes	Yes	Yes	Yes
Carrier Spacing	500000	500000	50000	50000	50000	50000	50000	50000	50000	50000	50000	50000
Carriers	1											
Center Frequency	1.33E+10											
Center Frequency Step	800000											
Center Frequency Step State	TRUE											
Detector Auto	TRUE											
Detector Selection	Average											
Electrical Atten	0											
Electrical Atten State	FALSE											
External Array Trigger Delay	1.00E-06	1.00E-06										
External Array Trigger Delay State	FALSE	FALSE										
External Array	1.2	1.2										

Trigger Level												
External Array Trigger Slope	Positive	Positive										
Filter Alpha	0.22	0.22	0.22	0.22	0.22	0.22	0.22	0.22	0.22	0.22	0.22	0.22
Filter BW	Minus3 dB											
Filter Type	Gaussian											
Internal Preamp	FALSE											
Internal Preamp Band	Low											
Limit Test	FALSE											
Line Trigger Delay	1.00E-06											
Line Trigger Delay State	FALSE											
Line Trigger Slope	Positive											
Meas Method	IbwSpec											
Meas Type	TPRef											
Measurement Noise Bandwidth	200000	200000	200000	200000	200000	200000	200000	200000	200000	200000	200000	200000
Mechanical Atten	10											
Mechanical AttenStepEnum	S2dB											
Method	IBW	IBW	IBW	IBW	IBW	IBW	IBW	IBW	IBW	IBW	IBW	IBW
Noise Correction	FALSE											
Offset Abs	0	0	0	0	0	0	0	0	0	0	0	0

Limit						
Offset Fail	Relative	Relative	Relative	Relative	Relative	Relative
Offset Filter Alpha	0.22					
Offset Filter BW	Minus3 dB	Minus3 dB	Minus3 dB	Minus3 dB	Minus3 dB	Minus3 dB
Offset Filter Type	Gaussian	Gaussian	Gaussian	Gaussian	Gaussian	Gaussian
Offset Freq	3000000	0	0	0	0	0
Offset Freq State	TRUE	FALSE	FALSE	FALSE	FALSE	FALSE
Offset Integ BW	2000000	2000000	2000000	2000000	2000000	2000000
Offset Method	FALSE					
Offset Rel Lim (Car)	-45	-60	0	0	0	0
Offset Rel Lim (PSD)	-28.87	-43.87	0	0	0	0
Offset Res BW	220000	220000	220000	220000	220000	220000
Offset Res BW Mode	TRUE	TRUE	TRUE	TRUE	TRUE	TRUE
Offset Video BW	22000	22000	22000	22000	22000	22000
Offset Video BW Mode	TRUE	TRUE	TRUE	TRUE	TRUE	TRUE
Periodic Timer Period	0.02					
Periodic Timer Sync	None					

Source	
Periodic Timer Trigger Delay	1.00E- 06
Periodic Timer Trigger Delay State	FALSE
Points	1001
Power Ref	-76.81 dBm
Power Ref State	On
Preselector Adjust	0
PSD Ref	- 139.82 dBm/H z
PSD Unit	DbmHz
Ref Car Freq	13.255 000000 GHz
Ref Car Freq State	On
Ref Carrier	1
Ref Carrier Mode	On
Ref Position	Top
Ref Value	-30
Res BW	220000
Res BW Mode	FALSE
RFBurst Trigger Delay	1.00E- 06
RFBurst Trigger Delay State	FALSE
RFBurst Trigger Level Abs	-20
RFBurst	-6

Trigger Level Rel		
RFBurst Trigger Level Type	Absolute	
RFBurst Trigger Slope	Positive	
Scale/Div	10	
Span	800000 0	
Sweep Time	0.02	
Sweep Time Auto	TRUE	
Trigger Holdoff	0.1	
Trigger Holdoff State	FALSE	
Trigger Source	Free	
Video BW	22000	
Video BW Auto	TRUE	
MeasResult 1	MeasResult2	MeasResult3
-76.8058517 744559	0	1
0.08479001 9950006	-76.805 851774 4559	0
0.02839291 28313787	-999	1
	-999	0
	-999	1

Save As . . .

When you press “Save As”, the analyzer brings up a Windows dialog and a menu entitled “**Save As.**” This menu allows you to navigate to the various fields in the

Windows dialog without using a keyboard or mouse. The **Tab** and **Arrow** keys can also be used for dialog navigation.

See "[To File . . .](#)" on page 3202 in **Save, State** for a full description of this dialog and menu.

The default path for saving files is:

For all of the Trace Data Files:

- My Documents\<<mode name>\data\traces

For all of the Limit Data Files:

- My Documents\<<mode name>\data\limits

For all of the Measurement Results Data Files:

- My Documents\<<mode name>\data\<<measurement name>\results

For all of the Capture Buffer Data Files:

- My Documents\<<mode name>\data\captureBuffer

Key Path	Save, Data
Mode	All
Notes	The key location is mode-dependent and will vary. Brings up the Save As dialog for saving a <mode specific> Save Type. The save is performed immediately and does not wait until the measurement is complete.
Initial S/W Revision	Prior to A.02.00

Screen Image

Pressing Screen Image accesses a menu of functions that enable you to specify a format and location for the saved screen image. It brings up a menu that allows you to specify the color scheme of the Screen Image (Themes) or navigate to the Save As dialog to perform the actual save.

Screen Image files contain an exact representation of the analyzer display. They cannot be loaded back onto the analyzer, but they can be loaded into your PC for use in many popular applications.

The image to be saved is actually captured when the **Save** front panel key is pressed, and kept in temporary storage to be used if you ask for a Screen Image save. When the Screen Image key is pressed, a "thumbnail" of the captured image is displayed, as shown below:

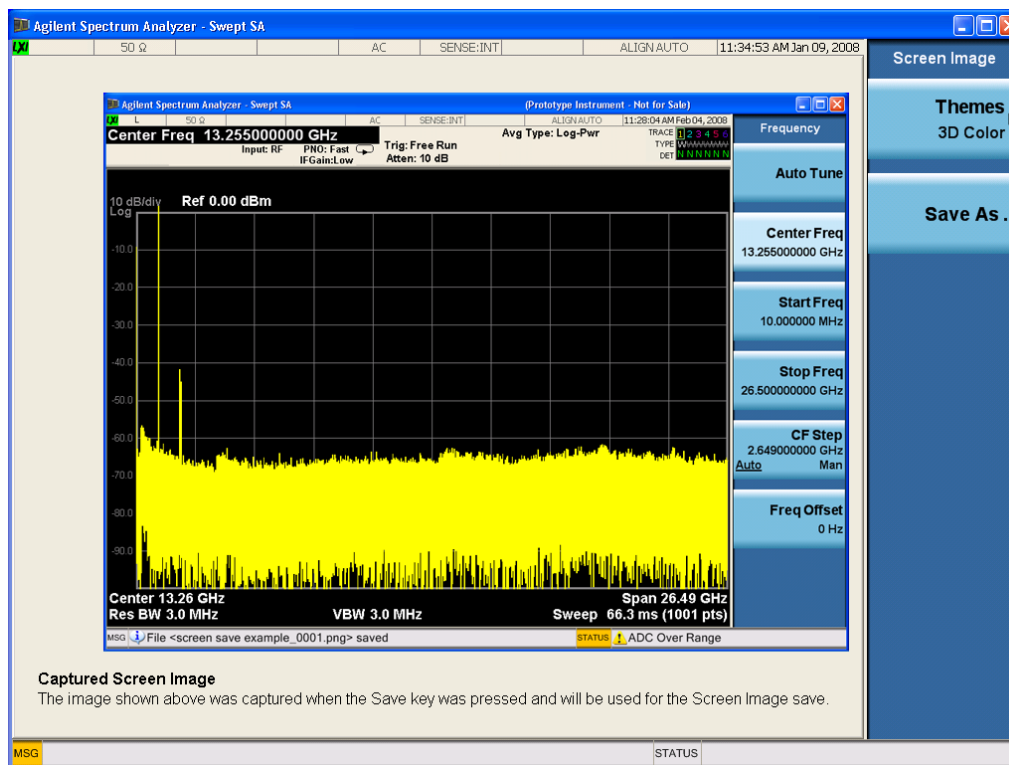

When you continue on into the **Save As** menu and complete the Screen Image save, the image depicted in the thumbnail is the one that gets saved, showing the menus that were on the screen before going into the **Save** menus. The save is performed immediately and does not wait until the measurement is complete.

After you have completed the save, the **Quick Save** front-panel key lets you quickly repeat the last save performed, using an auto-named file, with the current screen data.

NOTE

For versions previous to A.01.55, if you initiate a screen image save by navigating through the Save menus, the image that is saved will contain the Save menu softkeys, not the menus and the active function that were on the screen when you first pressed the Save front panel key.

Key Path	Save
Mode	All
Remote Command	:MMEMory:STORe:SCReen <filename>
Example	:MMEM:STOR:SCR "myScreen.png" This stores the current screen image in the file MyScreenFile.png in the default directory.
Backwards Compatibility SCPI	HCOpy:SDUMp:DATA? returns the screen image in a <DEFINITE LENGTH ARBITRARY RESPONSE DATA> element. The response data is IEEE Block format; the controlling computer can strip the header and store the result as a .png file.
Initial S/W Revision	Prior to A.02.00

Themes

Accesses a menu of functions that enable you to choose the theme to be used when saving the screen image.

The **Themes** option is the same as the **Themes** option under the **Display and Page Setup** dialogs. It allows you to choose between themes to be used when saving the screen image.

Key Path	Save, Screen Image
Remote Command	:MMEMory:STORe:SCReen:THEMe TDCoLor TDMonochrome FCOLor FMONochrome :MMEMory:STORe:SCReen:THEMe?
Example	:MMEM:STOR:SCR:THEM TDM
Preset	3D Color; Is not part of Preset, but is reset by Restore Misc Defaults or Restore System Defaults All and survives subsequent running of the modes.
Readback	3D Color 3D Mono Flat Color Flat Mono
Backwards Compatibility Notes	In ESA and PSA we offer the choice of "Reverse Bitmap" or "Reverse Metafile" when saving screen images. This is much like the "Flat Color" theme available in X-Series. Also, if you selected Reverse Bitmap AND a black & white screen image, that would be much like "Flat Monochrome". In other words, each of the X-Series themes has a similar screen image type in ESA/PSA. But they are not identical.
Initial S/W Revision	Prior to A.02.00

3D Color

Selects a standard color theme with each object filled, shaded and colored as designed.

Key Path	Save, Screen Image, Themes
Example	MMEM:STOR:SCR:THEM TDC
Readback	3D Color
Initial S/W Revision	Prior to A.02.00

3D Monochrome

Selects a format that is like 3D color but shades of gray are used instead of colors.

Key Path	Save, Screen Image, Themes
Example	MMEM:STOR:SCR:THEM TDM
Readback	3D Mono
Initial S/W Revision	Prior to A.02.00

Flat Color

Selects a format that is best when the screen is to be printed on an ink printer.

Key Path	Save, Screen Image, Themes
Example	MMEM:STOR:SCR:THEM FCOL
Readback	Flat Color
Initial S/W Revision	Prior to A.02.00

Flat Monochrome

Selects a format that is like Flat Color. But only black is used (no colors, not even gray), and no fill.

Key Path	Save, Screen Image, Themes
Example	MMEM:STOR:SCR:THEM FMON
Readback	Flat Mono
Initial S/W Revision	Prior to A.02.00

Save As...

When you press “Save As”, the analyzer brings up a Windows dialog and a menu entitled “**Save As.**” This menu allows you to navigate to the various fields in the Windows dialog without using a keyboard or mouse. The **Tab** and **Arrow** keys can also be used for dialog navigation.

See "[To File . . .](#)" on page 3202 in **Save, State** for a full description of this dialog and menu.

The default path for Screen Images is

– My Documents\`<mode name>`\screen.

where `<mode name>` is the parameter used to select the mode with the INST:SEL command (for example, SA for the Spectrum Analyzer).

Key Path	Save, Screen Image
Notes	Brings up Save As dialog for saving a Screen Image Save Type
Initial S/W Revision	Prior to A.02.00

Mass Storage Catalog (Remote Command Only)

Key path	SCPI Only
Remote Command	:MMEMory:CATaLog? [<code><directory_name></code>]
Notes	<p>The string must be a valid logical path.</p> <p>Queries disk usage information (drive capacity, free space available) and obtains a list of files and directories in a specified directory in the following format:</p> <p><code><numeric_value>,<numeric_value>,{<file_entry>}</code></p> <p>It returns two numeric parameters and as many strings as there are files and directories. The first parameter indicates the total amount of storage currently used in bytes. The second parameter</p>

indicates the total amount of storage available, also in bytes. The <file_entry> is a string. Each <file_entry> indicates the name, type, and size of one file in the directory list:

<file_name>,<file_type>,<file_size>

As the windows file system has an extension that indicates file type, <file_type> is always empty. <file_size> provides the size of the file in bytes. For directories, <file_entry> is surrounded by square brackets and both <file_type> and <file_size> are empty

Initial S/W Revision Prior to A.02.00

Mass Storage Change Directory (Remote Command Only)

Key path **SCPI Only**

Remote Command :MMEMory:CDIRectory [<directory_name>]
 :MMEMory:CDIRectory?

Notes The string must be a valid logical path.
 Changes the default directory for a mass memory file system. The <directory_name> parameter is a string. If no parameter is specified, the directory is set to the *RST value.
 At *RST, this value is set to the default user data storage area, that is defined as System.Environment.SpecialFolder.Personal.
 Query returns full path of the default directory.

Initial S/W Revision Prior to A.02.00

Mass Storage Copy (Remote Command Only)

Key path **SCPI Only**

Remote Command :MMEMory:COpy <string>,<string>[,<string>,<string>]

Notes The string must be a valid logical path.
 Copies an existing file to a new file or an existing directory to a new directory.
 Two forms of parameters are allowed. The first form has two parameters. In this form, the first parameter specifies the source, and the second parameter specifies the destination.
 The second form has four parameters. In this form, the first and third parameters specify the source. The second and fourth parameters specify the directories. The first pair of parameters specifies the source. The second pair specifies the destination. An error is generated if the source doesn't exist or the destination file already exists.
 This command will generate an "access denied" error if the destination is a restricted folder (e.g., C:\Windows) and the current user does not have Power User or Administrator privileges.

Mass Storage Device Copy (Remote Command Only)

This command transfers data to/from a file and a peripheral device.

Key path **SCPI Only**

Remote Command :MMEMory:COpy:DEvice <source_string>,<dest_string>

Notes The strings must be a valid logical path or a valid device keyword. If the dest_string is a device keyword, the data is copied from the source file to the device. If the source_string is a device

keyword, the data is copied to the source file from the device.

Valid device keywords are:

SNS (smart noise source)

An error is generated if the file or device is not found.

Mass Storage Delete (Remote Command Only)

Key path	SCPI Only
Remote Command	:MMEMory:DELeTe <file_name>[,<directory_name>]
Notes	The string must be a valid logical path. Removes a file from the specified directory. The <file_name> parameter specifies the file name to be removed. This command will generate an “access denied” error if the file is in a restricted folder (e.g., C:\Windows) and the current user does not have Power User or Administrator privileges.
Initial S/W Revision	Prior to A.02.00

Mass Storage Data (Remote Command Only)

Creates a file containing the specified data OR queries the data from an existing file.

Key path	SCPI Only
Remote Command	:MMEMory:DATA <file_name>, <data> :MMEMory:DATA? <file_name>
Notes	The string must be a valid logical path. The command form is MMEMory:DATA <file_name>,<data>. It loads <data> into the file <file_name>. <data> is in 488.2 block format. <file_name> is string data. The query form is MMEMory:DATA? <file_name> with the response being the associated <data> in block format.
Initial S/W Revision	Prior to A.02.00

Mass Storage Make Directory (Remote Command Only)

Key path	SCPI Only
Remote Command	:MMEMory:MDIRectory <directory_name>
Notes	The string must be a valid logical path. Creates a new directory. The <directory_name> parameter specifies the name to be created. This command will generate an “access denied” error if the new directory would be in a restricted folder (e.g., C:\Windows) and the current user does not have Power User or Administrator privileges.
Initial S/W Revision	Prior to A.02.00

Mass Storage Move (Remote Command Only)

Key path	SCPI Only
Remote Command	:MMEMory:MOVE <string>,<string>[,<string>,<string>]
Notes	<p>The string must be a valid logical path.</p> <p>Moves an existing file to a new file or an existing directory to a new directory.</p> <p>Two forms of parameters are allowed. The first form has two parameters. In this form, the first parameter specifies the source, and the second parameter specifies the destination.</p> <p>The second form has four parameters. In this form, the first and third parameters specify the source. The second and fourth parameters specify the directories. The first pair of parameters specifies the source. The second pair specifies the destination. An error is generated if the source doesn't exist or the destination file already exists.</p> <p>This command will generate an "access denied" error if the destination is a restricted folder (e.g., C:\Windows) and the current user does not have Power User or Administrator privileges.</p>
Initial S/W Revision	Prior to A.02.00

Mass Storage Remove Directory (Remote Command Only)

Key path	SCPI Only
Remote Command	:MMEMory:RDIRECTory <directory_name>
Notes	<p>The string must be a valid logical path.</p> <p>Removes a directory. The <directory_name> parameter specifies the directory name to be removed. All files and directories under the specified directory shall also be removed.</p> <p>This command will generate an "access denied" error if the folder is a restricted folder (e.g., C:\Windows) or is in a restricted folder and the current user does not have Power User or Administrator privileges.</p>
Initial S/W Revision	Prior to A.02.00

Mass Storage Determine Removable Media (Remote Command Only)

This command is used to determine if any removable media devices are connected to the instrument. Primarily, these are USB memory devices plugged-in to the front panel or rear panel USB ports. On instruments with PC6 or PC7 CPU's, one SD card slot is available for removable media. The instrument's primary disk drive is not a removable media device.

Key Path	SCPI Only
Remote Command	:MMEMory:RMEDIA:LIST?
Notes	<p>The return value is a string containing a list of partition identifiers that are removable media devices. Each identifier is separated by a comma. If no removable media is present, an empty string is returned.</p> <p>Examples:</p> <ul style="list-style-type: none"> - One removable device present results in a return string of "F:".

- Two removable devices present results in a return string of "F:,G:".
- No removable devices present results in a return string of "".

Initial S/W Revision x.15.00

Mass Storage Determine Removable Media Label (Remote Command Only)

This command is used to set or query a removable media device's label.

Key Path	SCPI Only
Remote Command	:MMEMory:RMEDia:LABel <partition>,<string> :MMEMory:RMEDia:LABel? <partition>
Example	MMEM:RMED:LAB "F:","My Device"
Notes	If the <partition> specified does not exist or is not a removable media device, the error - 252,"Missing Media" is generated. Setting the removable media label requires Administrative privileges. If the currently logged in user does not have appropriate privileges the error "-221.9900,Settings conflict;Administrator privileges required" is generated.
Initial S/W Revision	x.15.00

Mass Storage Determine Removable Media Write-protect status (Remote Command Only)

This command is used to query a removable media device's write-protect status.

Key Path	SCPI Only
Remote Command	:MMEMory:RMEDia:WPRotect? <partition>
Example	MMEM:RMED:WPR? "F:"
Notes	The return value is 1 if the device is write-protected, or 0 if the device is write-enabled. If the <partition> specified does not exist or is not a removable media device the error - 252,"Missing Media" is generated.
Preset	The return value will be depending on SD card installed.
Initial S/W Revision	x.15.00

Mass Storage Determine Removable Media size (Remote Command Only)

This command is used to query a removable media device's total memory size (not available memory size).

Key Path	SCPI Only
Remote Command	:MMEMory:RMEDia:SIZE? <partition>

Example	MMEM:RMED:SIZE? "F:"
Notes	The return value is integer value in GBytes. Any device that is less than 1 GB returns 0 GB. If the <partition> specified does not exist or is not a removable media device, the error - 252,"Missing Media" is generated.
Initial S/W Revision	x.15.00

:SYSTem:SET (Remote Command Only)

Remote command that allows the user to obtain the state of the currently active mode in a form that can then be loaded back into the instrument quickly.

Remote Command	SYSTem:SET <instrument state in IEEE Block> SYSTem:SET?
Notes	SYST:SET? returns current instrument state of the active mode in IEEE Block data format. The state is in a machine readable format only. Sending the query returns the following format: <syst set preamble><state block data> Where: <syst set preamble> is the format: #NMMM N=number of digits that comprise MMM MMM=length in bytes of following data <state block data> is machine readable state data Example response: #42016<state data> The state is recalled by sending the SYST:SET? Response data to the instrument. From example above: SYST:SET #42016<state data>
Initial S/W Revision	x.17.00

Single (Single Measurement/Sweep)

Sets the analyzer for Single measurement operation. The single/continuous state is Meas Global, so the setting will affect all the measurements. If you are Paused, pressing **Single** does a Resume.

See "[More Information](#)" on page 1800

Key Path	Front-panel key
Example	:INIT:CONT OFF
Notes	See Cont key description.
Backwards Compatibility Notes	For Spectrum Analysis mode in ESA and PSA, the Single hardkey and the INITiate:IMM switched from continuous measurement to single measurement and restarted sweeps and averages (displayed average count reset to 1), but did not restart Max Hold and Min Hold . In the X-Series, the Single hardkey and the INITiate:IMM command initiate a sweep/ measurement/ average sequence/hold sequence including MaxHold and MinHold . For Spectrum Analysis mode in ESA and PSA, the Single hardkey restarted the sweep regardless of whether or not you were in an active sweep or sweep sequence. In the X-Series, Restart does this but Single only restarts the sweep or sweep sequence if you are in the idle state. INIT[:IMM] in ESA & PSA Spectrum Analysis Mode does an implied ABORT. In some other PSA Modes, INIT[:IMM] is ignored if not in the idle state. . The X-Series follows the ESA/PSA SA Mode model, which may cause some Modes to have compatibility problems.
Initial S/W Revision	Prior to A.02.00

More Information

See "[Restart](#)" on page 3199 for details on the INIT:IMMEDIATE (Restart) function.

If you are already in single sweep, the INIT:CONT OFF command has no effect.

If you are already in Single Sweep, then pressing the **Single** key in the middle of a sweep does not restart the sweep or sequence. Similarly, pressing the **Single** key does not restart the sweep or sequence if the sweep is not in the idle state (for example, if you are taking a very slow sweep, or the analyzer is waiting for a trigger). Instead, it results in a message. "Already in Single, press Restart to initiate a new sweep or sequence". Even though pressing the **Single** key in the middle of a sweep does not restart the sweep, sending INIT:IMMEDIATE does reset it.

To take one more sweep without resetting the average count, increment the average count by 1, by pressing the step up key while **Average/Hold Number** is the active function, or sending the remote command CALC:AVER:TCON UP.

Source

The Source key accesses menus for controlling a Source in Tracking Source mode

Key Path	Front-panel key
Dependencies	<p>Operation with a source requires a license. If the proper license is not installed, the following occurs:</p> <ul style="list-style-type: none"> - When the Source key is pressed the user sees an informational message, "Option not installed" - If any SCPI command in the :SOURce subsystem is sent it generates a message, "Settings conflict;option not installed"
Initial S/W Revision	A.06.01

NOTE

Option T03 or T06 is required for the Tracking Generator function in CXA. Option T03, T07, T13 or T26 is required for the Tracking Generator function in CXA-m.

When using the CXA-m Tracking Generator, if the Source Frequency is in the frequency range of the below table, and the Source Amplitude is in the corresponding amplitude range of the below table, a warning status message is generated, +313 "Source Uncal". This is also true if Power Sweep is on and any amplitude in the Power Sweep (as calculated by Amplitude, Power Sweep, and Amptd Offset) is in that range.

CXA-m TG Un-calibrated Amplitude Range

Frequency Range	Amplitude Range
$2 \text{ MHz} \leq \text{frequency} < 10 \text{ GHz}$	$-40 \text{ dBm} \leq \text{amplitude} < -35 \text{ dBm}$
$10 \text{ GHz} \leq \text{frequency} < 20 \text{ GHz}$	$-40 \text{ dBm} \leq \text{amplitude} < -35 \text{ dBm}$ or $-5 \text{ dBm} < \text{amplitude} \leq 0 \text{ dBm}$
$20 \text{ GHz} \leq \text{frequency} \leq 26.55 \text{ GHz}$	$-12 \text{ dBm} < \text{amplitude} \leq 0 \text{ dBm}$

RF Output

Allows you to turn the source RF Power on or off.

NOTE

When the RF Output is turned on, the Source Mode is set to Tracking. See the Source Mode key description for special considerations concerning how to configure your N5172B or N5182B source for use with External Source Control.

Key Path	Source
Scope	Meas Global
Remote Command	:OUTPut[:EXTernal] [:STATe] ON OFF 1 0 :OUTPut[:EXTernal] [:STATe]?

Example	:OUTP ON :OUTP?
Dependencies	Grayed out in measurements that do not support a source. If you go to such a measurement the output will be forced to Off. Grayed out if there is no valid source selection, in this case go to the Select Source menu to choose, configure and/or verify your source When there is no available Source Mode (other than Off), due to other couplings, then the RF Output key is grayed out.
Couplings	When RF Output is turned On, Source Mode is set to Tracking When Source Mode is turned Off, RF Output is turned Off. When Source Mode is turned Off (or forced to Off by another coupling), RF Output is turned Off. Turning RF Output Off does not affect Source Mode or other settings.
Preset	OFF (on either a Mode Preset, a Source Preset, or Restore Input/Output Defaults)
State Saved	Part of the Input/Output system, which means it is Loaded and Saved with state.
Range	On Off
Initial S/W Revision	A.06.01
Modified at S/W Revision	A.10.01

Amplitude

Allows you to access the Amplitude sub-menu to control various amplitude parameters of the Source. The resolution of the Source amplitude parameters is coupled to match the minimum resolution of the source when the source is acquired. When the source is released, the amplitude parameter resolution reverts to default values.

Key Path	Source
Readback	In square brackets, the amplitude value from Amplitude key in the next menu level down
Initial S/W Revision	A.06.01

Amplitude

Allows you to adjust the power level of the selected source. Note that the actual amplitude is also affected by the Amplitude Offset and Power Sweep parameters.

Key Path	Source, Amplitude
Scope	Mode Global
Remote Command	:SOURce[:EXternal]:POWer[:LEVel][:IMMediate][:AMPLitude] <amp1> :SOURce[:EXternal]:POWer[:LEVel][:IMMediate][:AMPLitude]?
Example	:OUTP ON :SOUR:POW -10dBm
Dependencies	If the requested setting of Source Amplitude causes the calculated external source start or stop

	Amplitude to exceed the external source capability, a warning status message is generated, "Data out of Range; clipped to source max/min" The "Show Source Capabilities and Settings" menu can then be examined to check the source capabilities. This parameter test and clip is also performed at source acquisition.
Preset	-10.00 dBm (On Source Preset and Restore Input/Output Defaults) Not affected by Mode Preset
State Saved	Part of the Input/Output system, which means it is Loaded and Saved with state.
Min	The range of the amplitude parameter is dependent on the amplitude range of the source that is selected, and the settings of Amplitude Offset and Power Sweep.
Max	The range of the amplitude parameter is dependent on the amplitude range of the source that is selected, and the settings of Amplitude Offset and Power Sweep.
Backwards Compatibility SCPI	:SOURce:POWer:START <amp1> :SOURce:POWer:START? This alias is for the ESA tracking generator. It specifies the source output power level at the start of the power sweep, just as does :SOURce:POWer.
Initial S/W Revision	A.06.01
Modified at S/W Revision	A.10.01

Power Sweep

Allows you to set up a Power Sweep. Power Sweep is useful for measuring saturation behavior in a test device, such as a power amplifier.

Pressing the key sets the power-sweep function to On or Off. The value of the power-sweep range is displayed in the active function block, and can be adjusted, when set to On.

The source will sweep the power between the start power defined by the Amplitude function and the stop power = start power + power sweep value:

Source (start) amplitude = Amplitude – Amplitude Offset

Source (stop) amplitude = Amplitude – Amplitude Offset + Power Sweep

In Stepped Tracking, such as is used with an external source or the CXA-m TG, the analyzer controls the source with step sweep mode, which provides a linear progression from one selected frequency, amplitude, or both, to another, pausing at linearly spaced points (steps) along the sweep. The analyzer continues to sweep the specified frequency range when power sweep is on, although generally Power Sweep is performed in Zero Span.

With CXA options T03, T06, the hardware is capable of continuous power sweeps. This makes it possible to use the swept sweep time rules and should be employed for faster sweeps. Care should be taken to limit the sweep time you use as there are no sweep time couplings to Power Sweep settings. The recommended minimum sweep time depends on the RBW and power-sweep range. Start by computing $(1.28/RBW) * (abs(startPower - stopPower)/(5 \text{ dB}))$. The recommended minimum sweep time is the larger of this value and 50 ms.

Some external Sources have mechanical attenuators, which are not used in Power Sweep in order to save wear on the attenuators. To allow an acceptable range of Power Sweep without changing the mechanical attenuation, the Sources are put in a mode that allows the Source to handle a wide amplitude range without switching the attenuators. When the Power Sweep settings put the Source in an amplitude range that requires the mechanical attenuators, the analyzer displays a condition warning message:

Settings Alert;Src pwr ramp>ALC range

Key Path	Source, Amplitude
Mode	SA
Scope	Mode Global
Remote Command	:SOURce:POWer:SWEEp <rel_amp1> :SOURce:POWer:SWEEp? :SOURce:POWer:SWEEp:STATe ON OFF 1 0 :SOURce:POWer:SWEEp:STATe?
Example	:SOUR:POW -5 :SOUR:POW:SWE:STAT ON :SOUR:POW:SWE 10 Set source start power to - 5 dBm and stop power + 5dBm (-5 + 10).
Example	:SOUR:POW:SWE:STAT ON
Dependencies	If the requested setting of Power Sweep causes the calculated external source start or stop Amplitude to exceed the external source capability, a warning status message is generated, "Data out of Range; clipped to source max/min". The Show Source Capabilities and Settings menu can then be examined to check the source capabilities. This parameter test and clip is also performed at source acquisition.
Preset	This is unaffected by "Mode Preset" but is set to 0dB on a "Source Preset" or "Restore Input/Output Defaults".
State Saved	Part of the Input/Output system, which means it is Loaded and Saved with state.
Min	-500 dB
Max	+500 dB
Backwards Compatibility SCPI	:SOURce[:EXTErnal][:SWEEp]:POWer:SPAN <rel_amp1> :SOURce[:EXTErnal][:SWEEp]:POWer:SPAN? This alias is for the ESA tracking generator and PSA option 215. It specifies the range of power levels through which the source output will sweep just as does :SOURce:POWer:SWEEp.
Initial S/W Revision	A.06.01
Remote Command	:SOURce[:EXTErnal]:POWer:MODE FIXEd SWEEp :SOURce[:EXTErnal]:POWer:MODE?
Notes	The ESA tracking generator and the PSA option 215 support this SCPI command. It sets the source output to be at a single amplitude (fixed) or to sweep through a range of power levels

	SOURce:POWer:MODE FIXed is equivalent to :SOURce:POWer:SWEEp:STATe OFF
	SOURce:POWer:MODE SWEEp is equivalent to :SOURce:POWer:SWEEp:STATe ON
Preset	This is unaffected by "Mode Preset" but is set to FIXed on a "Source Preset" or "Restore Input/Output Defaults".
Initial S/W Revision	A.06.01
Modified at S/W Revision	A.10.01

Amptd Offset

Offsets the displayed power of the source in the Amplitude parameter. Using the amplitude offset allows you to take into account any system losses or gains (for example, due to cable loss), thereby displaying the actual power delivered to the device under test. See the equations under the Source, Amplitude, Power Sweep key.

Key Path	Source, Amplitude
Mode	SA
Scope	Mode Global
Remote Command	:SOURce:CORRection:OFFSet <rel_ampl> :SOURce:CORRection:OFFSet?
Example	:SOUR:CORR:OFFS 5 Sets the displayed source offset power to 5 dB.
Dependencies	If the requested setting of Amptd Offset causes the calculated external source start or stop Amplitude to exceed the external source capability, a warning status message is generated, "Data out of Range; clipped to source max/min". The Show Source Capabilities and Settings menu can then be examined to check the source capabilities. This parameter test and clip is also performed at source acquisition.
Preset	This is unaffected by Mode Preset but is set to 0.00dBm on a Source Preset or Restore Input/Output Defaults.
State Saved	Part of the Input/Output system, which means it is Loaded and Saved with state.
Min	-1000 dB
Max	+1000 dB
Initial S/W Revision	A.06.01

Amptd Step Auto/Man

Allows you to set the step size associated with the Source Amplitude key. When auto-coupled, the step size is the current Scale/Div setting under the Amplitude hardkey (note that this is true even if the analyzer is currently in Linear amplitude scale).

Once a step size has been selected and the Source Amplitude function is active, the step keys (and the UP|DOWN parameters for Source Amplitude from remote commands) change the Source Amplitude by the step-size value.

You may change the step size manually by pressing Amptd Step and entering a value. The function (and the step size) will return to Auto when a Mode Preset or Auto Couple is performed.

Key Path	Source, Amplitude
Scope	Mode Global
Remote Command	:SOURce:POWer:STEP[:INCRement] <amp1> :SOURce:POWer:STEP[:INCRement]? :SOURce:POWer:STEP:AUTO OFF ON 0 1 :SOURce:POWer:STEP:AUTO?
Example	:SOUR:POW:STEP 0.1 Set amplitude step to 0.1 dB :SOUR:POW:STEP:AUTO ON
Couplings	In Auto, coupled to the size of one logarithmic vertical graticule division
Preset	Auto
State Saved	Part of the Input/Output system, which means it is Loaded and Saved with state.
Min	0.1 dB
Max	20 dB
Initial S/W Revision	A.06.01

Frequency

Allows a you to access the Frequency sub-menu. This menu lets you use a stepped tracking source for stimulus/response measurements for some added flexibility. Because with such a source, the source frequency does not need to track 1:1 with the analyzer LO frequency, it is possible to measure scalar harmonic and subharmonic responses of devices. For example, the second harmonic response is measured by stepping the analyzer and source so that the analyzer is always at twice the source frequency. In addition, the frequency offset capability allows the measurement of frequency conversion devices (like mixers).

In tracking mode, the source frequency tracks the analyzer frequency according to the source frequency equation:

$$\text{Source Frequency} = (\text{Analyzer Frequency} * \text{Multiplier Numerator} / \text{Multiplier Denominator}) + \text{Source Frequency Offset}$$

NOTE

Analyzer Frequency is the frequency to which the analyzer is set, which is the analyzer's displayed frequency, offset by any Freq Offset set under the Frequency hardkey. **Source Frequency Offset** is the value set under **Source, Frequency, Freq Offset**.

Key Path	Source
----------	---------------

Readback	none in Tracking Source mode
Initial S/W Revision	A.06.01

Multiplier Numerator

The multiplier numerator parameter offsets the source frequency from the analyzer frequency. The source frequency tracks the SA frequency according to the source frequency equation shown under the **Source, Frequency** key description.

The multiplier numerator must be restricted to operate within the range of the source minimum and maximum frequencies.

Key Path	Source, Frequency
Mode	SA
Scope	Mode Global
Remote Command	:SOURCE:FREQUENCY[:MULTIPLIER]:NUMERATOR <integer> :SOURCE:FREQUENCY[:MULTIPLIER]:NUMERATOR?
Example	:SOUR:FREQ:NUM 3 Sets the source frequency multiplier numerator to 3.
Dependencies	If the currently selected source does not support this capability (for example, an internal Tracking Generator which must track the LO), this key is forced to its Preset value and grayed out
Preset	This is unaffected by Mode Preset but is set to 1 on a Source Preset or Restore Input/Output Defaults.
State Saved	Part of the Input/Output system, which means it is Loaded and Saved with state.
Min	1
Max	1000
Initial S/W Revision	A.06.01

Multiplier Denominator

The multiplier denominator parameter offsets the source frequency from the analyzer frequency. The source frequency tracks the SA frequency according to the source frequency equation shown under the **Source, Frequency** key description.

The multiplier denominator must be restricted to operate within the range of the source minimum and maximum frequencies.

Key Path	Source, Frequency
Mode	SA
Scope	Mode Global
Remote Command	:SOURCE:FREQUENCY[:MULTIPLIER]:DENOMINATOR <integer> :SOURCE:FREQUENCY[:MULTIPLIER]:DENOMINATOR?
Example	:SOUR:FREQ:DEN 3 Sets the source frequency multiplier denominator to 3
Dependencies	If the currently selected source does not support this capability (for example, an internal Tracking

	Generator which must track the LO), this key is forced to its Preset value and grayed out
Preset	This is unaffected by Mode Preset but is set to 1 on a Source Preset or Restore Input/Output Defaults.
State Saved	Part of the Input/Output system, which means it is Loaded and Saved with state
Min	1
Max	1000
Initial S/W Revision	A.06.01

Source Sweep Reverse

Allows you to reverse the source sweep direction

Normally, the source will sweep from a lower frequency to a higher frequency. However, there are test scenarios in which the source sweep needs to be “reversed”. In this case, it sweeps from a higher frequency to a lower frequency. For example, when the DUT is a frequency converter and a measurement of the Lower Side Band characteristics is desired, a reverse sweep is employed. Reverse sweeps are supported for such scenarios, but two cautions are in order:

4. Reverse Sweep only reverses the direction of the source’s sweep, not the analyzer’s sweep. Unless you are actually using a device like a frequency converter and looking at the lower sideband, thus effectively reversing the direction of the source’s sweep, the source will be sweeping in the opposite direction from the analyzer, and it will not be possible track the desired device output frequency.
5. Any time you are using a frequency converter, care must be taken in setting up all of the sweep parameters, including analyzer start/stop frequency and source multiplier, to make sure that the analyzer’s sweep tracks the output of the converter device.

Key Path	Source, Frequency
Mode	SA
Scope	Mode Global
Remote Command	:SOURce:FREQuency:SSReverse:ON OFF 0 1 :SOURce:FREQuency:SSReverse?
Example	SOUR:FREQ:SSR:OFF SOUR:FREQ:SSR?
Notes	You must be in Spectrum Analyzer mode to use this command. Use INSTRument:SElect to set the mode.
Dependencies	If the currently selected source does not support this capability (for example, an internal Tracking Generator which must track the LO), this key is forced to its Preset value and grayed out
Preset	This is unaffected by Mode Preset but is set to OFF on a Source Preset or Restore Input/Output Defaults.

State Saved	Part of the Input/Output system, which means it is Loaded and Saved with state
Range	On Off
Initial S/W Revision	A.06.01

Freq Offset

The frequency offset parameter offsets the source frequency from the analyzer frequency. The source frequency tracks the SA frequency according to the equations under the **Source, Frequency** key.

Pressing the key sets the Freq Offset function to On or Off. The value of Freq Offset is displayed in the active function block, and can be adjusted, when set to On.

The frequency offset must be restricted to operate within the range of the source minimum and maximum frequencies.

Key Path	Source, Frequency
Mode	SA
Scope	Mode Global
Remote Command	:SOURce:FREQuency:OFFSet <freq> :SOURce:FREQuency:OFFSet? :SOURce:FREQuency:OFFSet:STATe ON OFF 1 0 :SOURce:FREQuency:OFFSet:STATe?
Example	:SOUR:FREQ:OFFS 10MHz Sets the source frequency offset to 10MHz.
Dependencies	If the currently selected source does not support this capability (for example, an internal Tracking Generator which must track the LO), this key is forced to its Preset value and grayed out
Preset	This is unaffected by Mode Preset but is set to 0.00Hz on a Source Preset or Restore Input/Output Defaults.
State Saved	Part of the Input/Output system, which means it is loaded and saved with state
Min	-500 GHz
Max	500 GHz
Backwards Compatibility SCPI	:SOURce:EXTernal:SWEEp:OFFSet:FREQuency <freq> :SOURce:EXTernal:SWEEp:OFFSet:FREQuency? The PSA option 215 supports this SCPI command. This command is equivalent to : SOURce:FREQuency:OFFSet
Initial S/W Revision	A.06.01
Modified at S/W Revision	A.10.01

Source Mode

Accesses the Source Mode softkey menu. This menu lets you select Tracking mode for the Source, and also allows you to set the Source Mode to OFF.

The Source Mode can be set to Tracking without the user setting it directly. There are several couplings that cause Source Mode to be automatically set to Tracking (detailed in the table below). One important coupling is that Source Mode is forced to Tracking when the RF Output is turned on if the measurement supports Tracking. Since Source Mode is set to Off on a Mode Preset, this means that you will rarely need to change the Source Mode setting directly.

NOTE

When the Source Mode is set to Tracking, the analyzer acquires control of the source. When this happens the source is told to save its state and then perform a preset. Usually both of these operations take very little time; however, on an N5172B or an N5182B, if many Source real-time apps are in use, both save and preset can take many seconds. If it takes longer than the analyzer expects to acquire control, you will see an error: “Source connection lost, check interface connection”. If you see this error, and you are using an N5172B or an N5182B, you can shorten the acquire time by presetting your MXG before attempting to use External Source Control.

Key Path	Source
Scope	Meas Global
Remote Command	:INSTrument:SOURce[:SElect] TRACKing OFF :INSTrument:SOURce[:SElect]?
Example	:INST:SOUR TRAC
Dependencies	<p>Grayed out if no Source is selected, in this case go to the Select Source menu to choose, configure and/or verify your source</p> <p>Grayed out and forced to Off if either BBIQ or External Mixing are selected</p> <p>Blanked in Modes that do not support a source</p> <p>Grayed out in Measurements that do not support a source</p> <p>Tracking is grayed out when Manual FFT is selected</p> <p>Tracking is grayed out when the RF Preselector is on (in models which support the RF Preselector).</p>
Couplings	<p>When RF Output is turned On, Source Mode is set to Tracking. When Source Mode is turned Off, RF Output is turned Off.</p> <p>Whenever you switch to an application (Mode) in which the Source Mode was previously set to Tracking, it is again set to Tracking. That is, the last setting of the Source Mode is remembered when you leave an application (Mode) and restored when you return</p> <p>Source Mode is forced to Tracking when the RF Output is turned on if the measurement supports Tracking</p> <p>If Source Mode is set to Tracking, then it is forced to Off when you select a measurement that does not support Tracking.</p> <p>If Source Mode is set to Tracking, then it is forced to Off when you turn on the RF Preselector (in models which support the RF Preselector).</p> <p>Whenever the Source Mode is set to Tracking, the analyzer acquires the Source. Similarly, the Source is released whenever the Source Mode is set to Off. This is true whether the Source Mode was set directly by you, was set indirectly through a coupling, if you switched to an application (Mode) that had previously been set to Tracking, or if you switched to an application (Mode) in which the Source Mode is not set to Tracking.</p>

For an external source, “acquiring the source” involves contacting the external instrument over the remote interface (which puts it into Remote) and taking control of it.

When you set the Source Mode to OFF, it releases the Source (and puts it into Local). For an external source, this means you are now free to operate the source for other purposes.

When the Source is acquired, its previous state is saved, and when it is released, that state is restored, so that you can acquire and then release the source and it will return to the state it was in before you acquired it.

Preset	OFF
State Saved	Saved in instrument state
Initial S/W Revision	A.06.01
Modified at S/W Revision	A.10.01

Select Source

The Select Source menu allows you to maintain a list of available external Sources, and choose the Source that you want to use from the list. It shows the currently selected source at the bottom of the screen.

While in the Select Source menu, you can see, and select from, a list of the currently available sources. The sources listed in this table are as follows:

- Any internal sources which are installed and licensed

NOTE

Only one internal source can be installed, displayed at address “INTERNAL”

- Any external sources which you have previously configured, whether or not they are currently connected, displayed with their VISA address

Note that only external sources that are supported by the Tracking Source Mode are displayed in the Available Source List. Here are the Keysight/Agilent sources currently supported:

Source	PXA	MXA	EXA	CXA	MXE (Presel off)
MXG N5181A	X	X	X	X	X
MXG N5182A	X	X	X	X	X
MXG N5183A	X	X	X		X
EXG N5171B	X	X	X	X	X
MXG N5181B	X	X	X	X	X
EXG	X	X	X	X	X

N5172B					
EXG	X	X	X	X	X
N5173B					
MXG	X	X	X	X	X
N5182B					
MXG	X	X	X	X	X
N5183B					
PSG	X	X	X		
E8257D					
PSG	X	X	X		
E8267D					

NOTE

For X-Series software versions earlier than A.10.01, option UNZ (Fast switching) was required on the MXG for some use cases. This is no longer the case, option ESC now works without MXG option UNZ for all use cases. (Note that you will get better performance if your MXG has option UNZ, because without option UNZ your sweep speeds will be noticeably slower.)

While in the Select Source menu and its submenus, detailed instructions are presented that tell you how to operate the Select Source functions. Basically they tell you to first use the up and down arrow keys to move the selection highlighted in the “Available Source List” to the source that you want to use. The list of available sources includes any sources that you have previously used (unless you have deleted them) and any found while in the “Add Source to List” menu.

When the source you want to use is highlighted, press “Select Highlighted Source” or “Enter”. The source you have selected shows up at the bottom of the screen as the “Current Source”. Press “Verify Current Source Connection” to make sure that the interface connection to the Source is still functional.

At any time you may use the “Add Source to List” or “Delete Highlighted Source” keys to find new sources or remove a source from the list of available sources.

Key Path	Source
Readback Text	Two lines of readback give the type information and serial number of the current source, in square brackets
Initial S/W Revision	A.06.01

Select Highlighted Source

You can navigate up and down in the list with the up and down arrow keys, and can select any entry by pressing the Select Highlighted Source key (or by double-clicking on the entry in the table with a mouse). The highlighted source becomes the Current Source and is prominently displayed at the bottom of the screen.

At any given time there is only one selected Source for the entire system; once a Source is selected, it becomes the Current Source and will be used by all applications that support Source Control.

For example, if no Source has yet been selected, the statement at the bottom of the screen would say

Current Source

None

If an N5182A connected via USB were the Current Source, the statement at the bottom of the screen might say:

Current Source

Agilent N5182A US00000258 at USB0::2931::7937::US00000258::0::INSTR

The SCPI command defined below allows the programmatic user to directly define the VISA address via a string parameter. The parameter is checked for proper syntax, the connection to the instrument is verified, and the source is added to the Available Source List if it verifies. If it does not verify or no source is found at that address, an error message is generated.

Normally the source selection activities should be performed only when the user changes the hardware connection configuration or activates/deactivates a source option license; shutdown and startup of the application will not cause source re-selection.

The Agilent IO Libraries Suite provides an “Agilent VISA Help” document that has a section that shows the proper syntax for valid VISA address strings, in the ViOpen function definition.

Key Path	Source, Select Source
Mode	SA
Remote Command	:SYSTem:COMMunicate:SOURce[1]:ADDRess <address string> :SYSTem:COMMunicate:SOURce[1]:ADDRess?
Example	Different examples for setting external source address :SYST:COMM:SOUR:ADDR "TCPIP0::MyHostName::INSTR" :SYST:COMM:SOUR:ADDR "TCPIP0::123.121.100.210::INSTR" :SYST:COMM:SOUR:ADDR "USB0::12212::32145::US1234567A::INSTR" :SYST:COMM:SOUR:ADDR "GPIB1::19::INSTR"
Notes	Empty string is allowed and means no source is defined or selected.
Remote Command Notes	The address string is the VISA address for external sources and "INTERNAL" for an internal source
Dependencies	Operation with a source requires a license. If the proper license is not installed, the SCPI command generates an error message, "Settings conflict;option not installed" If no supported source, or no source at all, is found at the specified address, the SCPI command generates an error message
Preset	The current source selection is unaffected by a Mode Preset and Source Preset but reverts to

	[None] on a Restore Input/Output Defaults. If an internal Tracking Generator is installed, then instead of None, the default selection will be INTERNAL.
State Saved	Selected Source is <ul style="list-style-type: none"> - Power On Persistent (survives power cycle) - Part of the Input/Output system, which means it is Loaded and Saved with state.
Readback	Two lines of readback give the type information and serial number of the current source on the Select Source key in the form [<source type>] [<serial number>] [None] shows in the type area and blank in the serial number area if a source has not been configured. [Internal TG] shows in type area and serial number in the serial number area if an internal Tracking Generator has been selected. For example: [MXG]/n, [US01020022]. This indicates an MXG of serial number US01020022.
Backwards Compatibility SCPI	:SYSTem:COMMunicate:LAN:SOURce[:EXTernal]:IP <address string> :SYSTem:COMMunicate:LAN:SOURce[:EXTernal]:IP? This command is provided for compatibility with PSA Option 215. The address string is reformatted for the X-Series. For example, if the customer sends :SYSTem:COMMunicate:LAN:SOURce:EXTernal:IP 146.208.172.111 The analyzer turns this into :SYSTem:COMMunicate:SOURce:ADDRess "TCPIP0::146.208.172.111::INSTR"
Initial S/W Revision	A.06.01
Modified at S/W Revision	A.10.01

Delete Highlighted Source

Deletes the highlighted source from the list of available sources. You will be prompted with a dialog box to make sure you REALLY want to do this. The prompt says "The highlighted source will be permanently deleted from the list. Are you sure you want to do this? Press Enter to proceed, or Cancel (ESC) to cancel."

Key Path	Source, Select Source
Initial S/W Revision	A.06.01

Add Source To List

This menu allows you to add to the list of available sources from various interfaces.

Key Path	Source, Select Source
Initial S/W Revision	A.06.01

USB

Sources on USB (once installed) can be added to the list by pressing “Add Installed USB Sources.” Any supported source found will be added to the list.

See ["Add Installed USB Sources" on page 3259](#) for information on connecting and installing USB devices.

Key Path	Source, Select Source, Add Source to List
Initial S/W Revision	A.06.01

Add Installed USB Sources

Press this key to add USB sources to the Available Source List. Note that this function will ONLY find sources that have previously been installed onto the USB. For information on how to install a USB source, see ["Installing a USB source" on page 1816](#)

Key Path	Source, Select Source, Add Source to List, USB
Notes	If no installed USB device is found which is a supported source, an error message is generated
Initial S/W Revision	A.06.01

Installing a USB source

USB is the only interface which requires no runtime action by the user in the Select Source menu, but does require “installation” when a source is plugged in.

You start by connecting the USB source to the analyzer. You will get a series of messages indicating that the analyzer is installing required device software.

When the installation is complete, you will get a message to that effect. You can then use the “Add Installed USB Sources” function (above) to add the source to the list of sources in the Available Source List.

GPIB

Lets you add GPIB sources to the Available Source List.

For the GPIB interface to work properly, it must be configured as a Controller. You can find this setting in the System menu under System, I/O Config, GPIB. Set the GPIB Controller function to Enabled.

Note that you must also make sure that the GPIB interface is not set to “Ignore” in the Agilent Connection Expert. If it is set to **Ignore**, then even if the GPIB Controller is set to **Enabled**, it is not possible for the analyzer to find a GPIB connected source. See ["More Information" on page 1816](#).

Key Path	Source, Select Source, Add Source to List
Initial S/W Revision	A.06.01

More Information

If you suspect that the GPIB interface is not set to Ignore, run the Agilent Connection Expert (ACE). To run ACE, press Source, Select Source, Add Source to List, LAN, Run Connection Expert. Look for the GPIB branch on the interface tree:

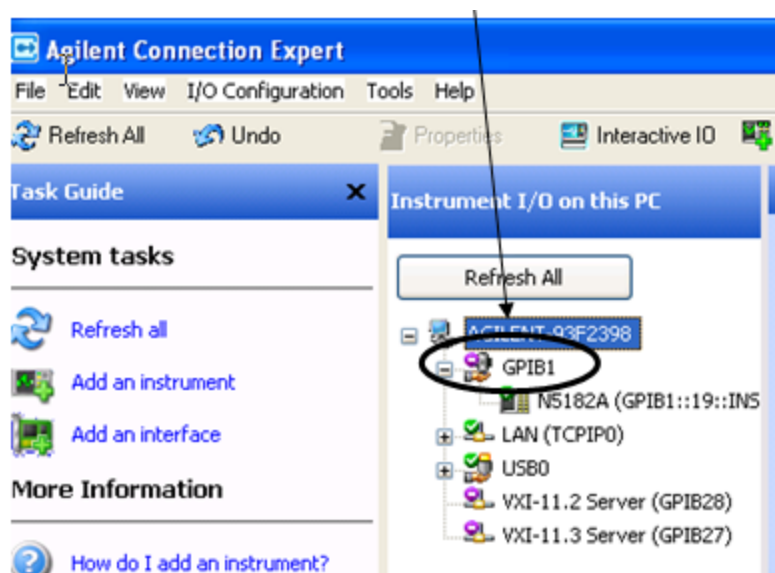

Right click on the GPIB branch (you will have to plug in a mouse to do this). You should see a dialog like the one below. If this dialog says **Stop Ignoring**, select **Stop Ignoring** and close ACE.

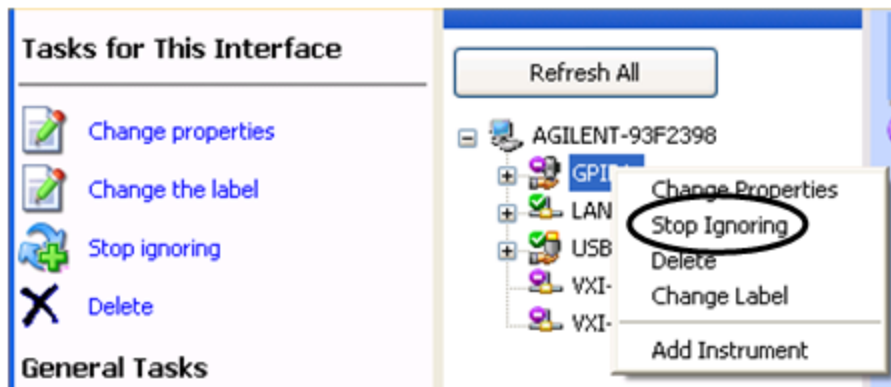

Scan & Add GPIB Sources

Sources on GPIB can be added by pressing **Scan & Add GPIB Sources**. Any supported source found will be added to the Available Source List.

NOTE

This will cause any older, non-SCPI compatible devices on your GPIB to generate error messages.

Key Path	Source, Select Source, Add Source to List, GPIB
Notes	If the GPIB controller mode is not enabled, an error message is generated If no GPIB device is found which is a supported source, an error message is generated
Initial S/W Revision	A.06.01

Enter GPIB Address

Opens a menu that lets you enter the GPIB address of the desired source directly.

NOTE

For this to work properly, the GPIB interface must be configured as GPIB1. This is the default state and should normally be the case. To see how to verify this, see **"More Information"** on page 1818.

Key Path	Source, Select Source, Add Source to List, GPIB
Initial S/W Revision	A.06.01

More Information

If you suspect that the GPIB interface is not set to GPIB1, run the Agilent Connection Expert (ACE). To run ACE, press Source, Select Source, Add Source to List, LAN, Run Connection Expert. Look for the GPIB branch on the interface tree:

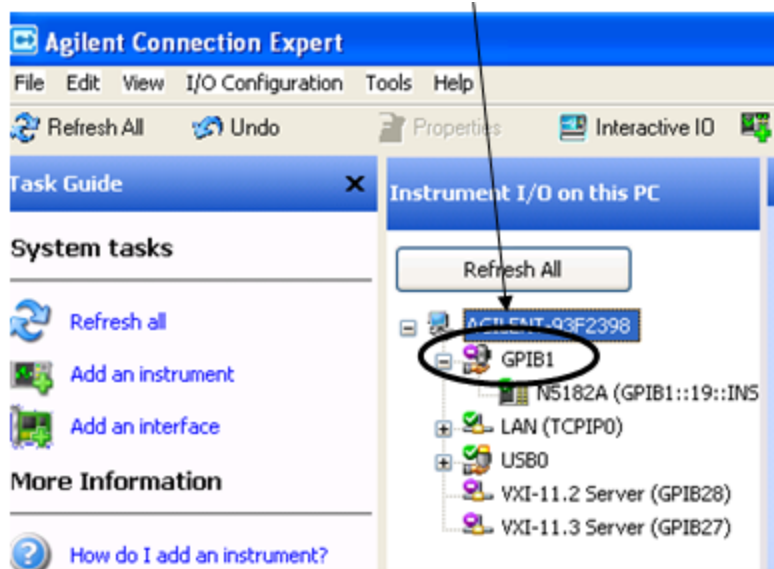

If this branch is not labeled **GPIB1**, right click on the GPIB branch (you will have to plug in a mouse to do this) and select **Change Properties**.

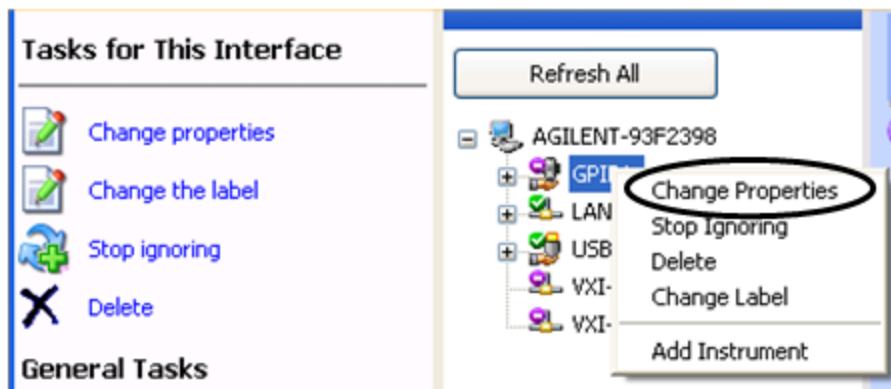

You should see a dialog like the one below. Click on the drop-down arrow under **VISA Interface ID**, select **GPIB1** and click **OK**

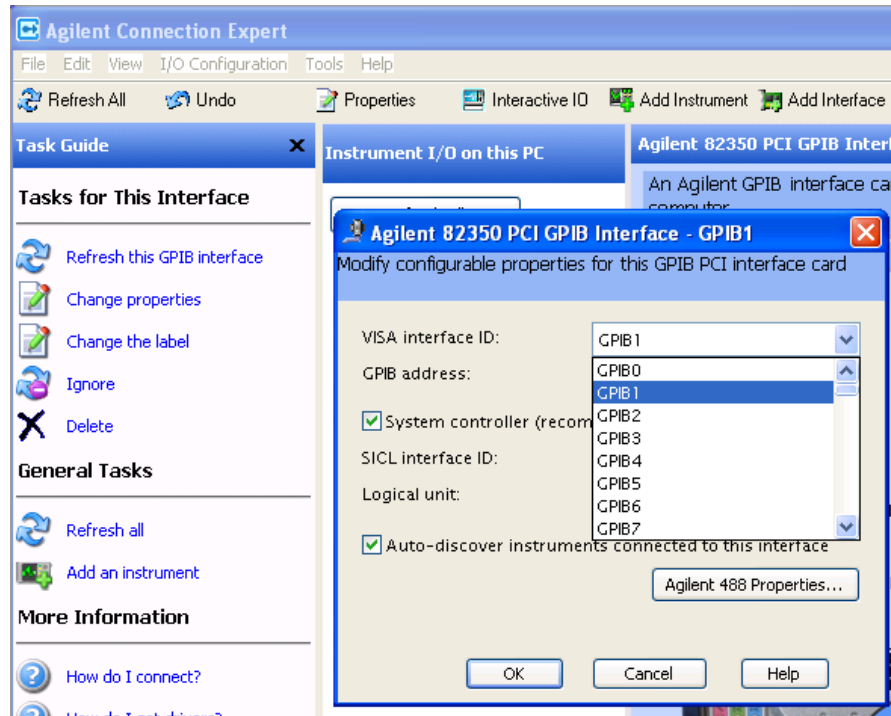

GPIB Address

Lets you enter the GPIB address. After you enter the address press **Add** to add the source at that address to the Available Source List.

Key Path	Source, Select Source, Add Source to List, GPIB, Enter GPIB Address
Preset	Unaffected by Mode Preset but set to 19 by "Restore Input/Output defaults"
State Saved	No
Min	0
Max	30
Initial S/W Revision	A.06.01

Add

Add the source at the entered GPIB address to the Available Source List. If a supported source is found at that address it will be added to the list.

Key Path	Source, Select Source, Add Source to List, GPIB, Enter GPIB Address
Notes	If GPIB controller mode is not enabled, an error message is generated If no supported source is found at the specified address, an error message is generated
Initial S/W Revision	A.06.01

LAN

The LAN cannot be scanned directly from the analyzer software, but you can import the list of currently configured devices from Agilent Connection Expert by pressing

“Add From Connection Expert List.” The Connection Expert list depends on which instruments have already been discovered by the Agilent Connection Expert application. Any connected, supported sources in that list will be added.

You can also enter the IP address and press “Add”. If a supported source is found at that address it will be added.

If you want to discover sources on the LAN, you can open Connection Expert by pressing the “Run Connection Expert...” softkey.

Key Path	Source, Select Source, Add Source to List
Initial S/W Revision	A.06.01

Enter LAN Address

Opens up a menu which lets you enter the IP address of the desired source directly.

Key Path	Source, Select Source, Add Source to List, LAN
Initial S/W Revision	A.06.01

IP Address

Lets you enter the IP address of the desired source. After you enter the address you should press “Add” to add the source at that address to the Available Source List.

Key Path	Source
Preset	Unaffected by Mode Preset but set to 0.0.0.0 by Restore Input/Output defaults
State Saved	No
Initial S/W Revision	A.06.01

Add

Adds the source at the entered IP address to the Available Source List. If a supported source is found at that address it will be added to the list.

Key Path	Source
Notes	If no supported source is found at the specified address, an error message is generated
Initial S/W Revision	A.06.01

Run Connection Expert...

Runs the Agilent Connection Expert so that you can scan the LAN for sources.

Key Path	Source, Select Source, Add Source to List, LAN
Initial S/W Revision	A.06.01

Add From Connection Expert List

You can import the list of currently configured devices from Agilent Connection Expert by pressing **Add From Connection Expert List**. The Connection Expert list depends on which instruments have already been discovered by the Agilent Connection Expert application. Any connected, supported sources in that list will be added.

Key Path	Source, Select Source, Add Source to List, LAN
Notes	If no supported source is found in the Connection Expert list, an error message is generated
Initial S/W Revision	A.06.01

Verify Current Source Connection

This key verifies the interface connection to the Current Source (it does NOT verify any signal connections!)

Until the selected source is verified, a statement appears at the bottom of the screen which says (in red):

This Source has not been verified. Press "Verify Source" to check the interface connection.

When you press this key, the connection is checked to the selected source. If all is well, the statement is changed to (in green):

This connection to this source has been verified.

If the verification fails, the statement at the bottom will change to (in red):

Verification of this source failed. Check the interface connection

The selected source is also verified whenever it is acquired. If a Source's connection has been verified by any means, then that Source is considered to have been verified until either the analyzer software is shut down or if, in attempting to use the Source, communication with it fails.

Key Path	Source, Select Source
Initial S/W Revision	A.06.01

Source Setup

This menu is used to set up miscellaneous source functions, including trigger settings. For more on triggering in Tracking Mode, see ["Tracking Setup Details" on page 1822](#). For information on bypassing the Microwave Preselector, see ["Use of the YTF \(Microwave or mm Preselector\) with External Source Control" on page 1823](#)

Key Path	Source
Mode	SA
Initial S/W Revision	A.06.01

Tracking Setup Details

When an external source is operating in Tracking Mode, operation can be greatly enhanced by using hardware triggers. Below is a typical connection diagram showing a hardware handshake using Trigger 1 inputs and outputs on the analyzer (trigger 2 in and out is also a valid connection).

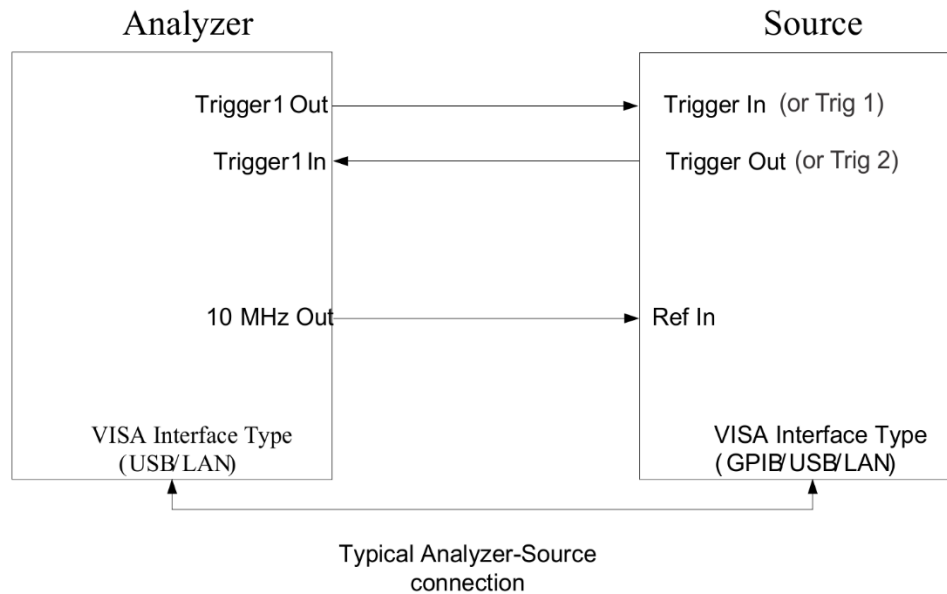

Analyzer Trigger 1 Out: Triggers the external source to step to next point in the frequency step/list.

Analyzer Trigger 1 In: Triggers the analyzer to make a measurement on this point

Source Trigger In (or “Trig 1” at default setting for N5181B/82B, N5183B MXG or N5171B/72B, N5173B EXG):

Triggers the source to step to the next point.

Source Trigger Out (or “Trig 2” at default setting for N5181B/82B, N5183B MXG or N5171B/72B, N5173B EXG): Indicates that the source has settled.

IO interface Connection: analyzer can connect to sources with its GPIB, USB or LAN interface.

Notes:

- Trigger sync connections are optional – synchronization can be done via remote commands if Bus Trigger is enabled in the Source Setup menu.
- Connection from the SA external frequency reference output to the source frequency reference input (10 MHz Out to Ref In) is not required, but may improve the measurement accuracy.

Use of the YTF (Microwave or mm Preselector) with External Source Control

In most stimulus/response measurements that utilize External Source Control, the source exactly tracks the tuned analyzer frequency. Consequently, preselection is not needed, and you can achieve greatly superior amplitude accuracy and repeatability by bypassing the YTF (Preselector) using the Microwave Preselector Bypass control in the Amplitude, μ W Path Control menu.

NOTE

This control is only available if option MPB is installed.

There are rare but important cases, however, where the source is tuned to a different frequency than the analyzer, using the Multiplier and Reverse controls in the Source, Frequency menu. For example, you might be tuning the source to $\frac{1}{2}$ of the analyzer frequency when looking at second harmonic distortion in a DUT. In these cases, it would be commonplace for there to be an undesired signal at the analyzer input that is at an image frequency that you will want to reject with the YTF.

Understanding these cases is important for proper operation of the Microwave Preselector with External Source Control, so that you only bypass it when it will improve accuracy but not hinder the measurement.

Point Trigger

Shows point trigger type selected and navigates to the Point Trigger menu.

The Point Trigger menu lists all analyzer point trigger types. The analyzer and source point trigger synchronization can be done using SCPI bus commands or by using external trigger output and input lines.

NOTE

For X-Series software versions earlier than A.10.01, hardware triggering was unavailable in stepped tracking at frequencies above 3.6 GHz, so above 3.6 GHz, software triggering was always used. This is no longer the case.

Key Path	Source, Source Setup
Mode	SA
Scope	Mode Global
Remote Command	:SOURce:TRIGger:TYPE BUS EXTernal[1] EXTernal2 :SOURce:TRIGger:TYPE?
Example	:SOUR:TRIG:TYPE EXT1 Selects analyzer external trigger 1 in and out for point trigger synchronization with selected source
Dependencies	If an internal Tracking Generator is selected, then this menu is unavailable, Additionally, the External 1 and External 2 Trigger keys on the Spectrum Analyzer are released from any grayout that may have been forced on them by the external source Point Trigger selection. In some models, there is no second External input. In these models, the External 2 key is blanked and the EXTernal2 parameter will generate a "Hardware missing; Not available for this model number" message.
Couplings	The source control point trigger selection can select external trigger 1 or 2 in for synchronized point triggering. This can conflict with the selection under the Trigger hardkey, if it has External 1 or 2 selected. If there is a conflict when the selection is made under the Point Trigger menu, the

	Trigger selection under the Trigger hardkey will be changed to Free Run.
Preset	This is unaffected by "Mode Preset" but is set to EXTERNAL1 on a "Source Preset" or "Restore Input/Output Defaults".
State Saved	Part of the Input/Output system, which means it is Loaded and Saved with state
Readback	1-of-N selection
Initial S/W Revision	A.06.01

SW Trigger

Analyzer and source point trigger synchronization is setup using the SCPI commands. Source is stepped via SCPI commands. Analyzer waits for source to settle by polling source.

Key Path	Source, Source Setup, Point Trigger
Mode	SA
Example	:SOUR:TRIG:TYPE BUS
Readback	SW Trigger
Initial S/W Revision	A.06.01

Ext Trigger 1

Analyzer and source point trigger synchronization is setup using the analyzer Trigger 1 Output and Trigger 1 Input. The Source is stepped via Trigger 1 Output. The Analyzer waits for source to settle via Trigger 1 Input.

Key Path	Source, Source Setup, Point Trigger
Mode	SA
Example	:SOUR:TRIG:TYP EXT1
Couplings	<p>With an acquired source, selecting this point trigger mode overrides existing external trigger 1 output level, slope, and delay, and external trigger 1 type and polarity.</p> <p>External trigger 1 input level = 1.20 V</p> <p>External trigger 1 input slope = Positive</p> <p>External trigger 1 input delay = Off</p> <p>External trigger 1 output type = Source Point Trigger</p> <p>External trigger 1 output polarity = Positive</p> <p>When this selection is made:</p> <ul style="list-style-type: none"> - The External 1 key in the Trigger menu (under the Trigger hardkey) is grayed out and, if External 1 was previously selected, it will be changed to Free Run. - Trig 1 Out selected under Output Config in the Input/Output menu will be changed to Source Point Trigger <p>If the user subsequently goes into the Trig 1 Out menu and selects a different Trigger Output, the Point Trigger will revert to SW Trigger.</p>

Readback	Ext Trigger 1
Initial S/W Revision	A.06.01

Ext Trigger 2

Analyzer and source point trigger synchronization is setup using the analyzer Trigger 2 Output and Trigger 2 Input. The Source is stepped via Trigger 2 Output. The Analyzer waits for source to settle via Trigger 2 Input.

Key Path	Source, Source Setup, Point Trigger
Mode	SA
Example	:SOUR:TRIG:TYP EXT2
Dependencies	This key is blanked out on CXA as there is only one trigger input
Couplings	<p>With an acquired source, selecting this point trigger mode overrides existing external trigger 2 output level, slope, and delay, and external trigger 2 type and polarity.</p> <p>External trigger 2 input level = 1.20 V External trigger 2 input slope = Positive External trigger 2 input delay = Off External trigger 2 output type = Source Point Trigger External trigger 2 output polarity = Positive</p> <p>When this selection is made:</p> <ul style="list-style-type: none"> - The External 2 key in the Trigger menu (under the Trigger hardkey) is grayed out and, if External 2 was previously selected, it will be changed to Free Run. - Trig 2 Out selected under Output Config in the Input/Output menu will be changed to Source Point Trigger - If the user subsequently goes into the Trig 2 Out menu and selects a different Trigger Output, the Point Trigger will revert to SW Trigger.
Readback	Ext Trigger 2
Initial S/W Revision	A.06.01

Show Source Capabilities & Settings

Shows the capabilities of the currently selected Source. The menu is useful for displaying source capabilities such as frequency and amplitude ranges. In addition, the results of the source control sweep algorithms can be viewed. This gives information of the source range required for a given analyzer sweep range. This can be used dynamically as a way of configuring the sweep settings.

Key Path	Source, Source Setup
Mode	SA
Dependencies	If no source is selected this key is grayed out.
Initial S/W Revision	A.06.01

Source Preset

The Source Preset key forces all the settings in the analyzer's Source State to their preset condition.

The Source State is the set of Source settings that is maintained and remembered by the analyzer for use in the Tracking Source Mode. The Source State variables are controlled and set in the menus under the Source front panel key. These settings include:

- RF Output Off
- Amplitude = - 10 dBm
- Amplitude Step = Auto
- Power Sweep = 0 dB
- Amplitude Offset = 0 dB
- Source Sweep Reverse = Off
- Multiplier Numerator = 1
- Multiplier Denominator = 1
- Freq Offset = 0 Hz
- Point trigger is set to "Ext1"

The Source State is saved along with the state of the current Mode when you save a State, and is recalled when that Mode State is recalled.

When the analyzer first starts up, a Source Preset is performed. In the Input/Output menu, Restore Input/Output Defaults will also perform a Source Preset.

A Mode Preset, from modes that support the External Source, will turn the RF Off but will **not** perform a Source Preset. By the same token, Source Preset does **not** perform a Mode Preset.

Source Preset does **not** change the Source Mode nor the selection of which physical source is being used, nor does it release the current source (the source remains under the control of the analyzer) nor exit the Source menu.

Key Path	Source
Mode	SA
Remote Command	:SOURce:PRESet
Example	:SOUR:PRES
Preset	Initiates a Source Preset
State Saved	No
Initial S/W Revision	A.06.01

SPAN X Scale

Accesses a menu of functions that enable you set the horizontal scale parameters.

Key Path	Front-panel key
Initial S/W Revision	Prior to A.02.00

Span

Changes the frequency range symmetrically about the center frequency.

The default (and minimum) span is calculated using the number of carriers and the carrier width where;

$$\text{Span} = (\text{Upper Carrier Freq} + (\text{max offset IBW} * (1 + \alpha)) / 2) - (\text{Lower Carrier Freq} - (\text{max offset IBW} * (1 + \alpha)) / 2)$$

The span is increased by a factor of 1 + Filter Alpha if the RRC Filter is on.

Key Path	SPAN X Scale
Mode	SA, WCDMA, C2K, WIMAX OFDMA, TD-SCDMA, 1xEVDO, DVB-T/H, DTMB (CTTB), ISDB-T, CMMB, LTE, LTETDD, Digital Cable TV, MSR, LTEAFDD, LTEATDD
Remote Command	[:SENSe] :ACPpower :FREQuency :SPAN <freq> [:SENSe] :ACPpower :FREQuency :SPAN?
Example	ACP:FREQ:SPAN 25MHz ACP:FREQ:SPAN?
Notes	You must be in the mode that includes ACP measurements to use this command. Use :INSTrument:SElect to set the mode.
Couplings	The span value is clipped when the carrier settings and/or the offset settings are changed. The value is changed to satisfy following formula: $\text{Span} = (\text{Upper Carrier Freq} + (\text{max offset IBW} * (1 + \alpha)) / 2) - (\text{Lower Carrier Freq} - (\text{max offset IBW} * (1 + \alpha)) / 2)$ This parameter is unavailable when Meas Method is Fast Power. In that case, the span is fixed by the formula above and also, the maximum span should be less than or equal to 40 MHz to gain valid results.
Preset	SA: 8 MHz WCDMA: 24.6848 MHz WIMAX OFDMA: 50 MHz C2K: 4.5 MHz TD-SCDMA: 8 MHz 1xEVDO: 4.05 MHz DVB-T/H: 40 MHz DTMB (CTTB): 72 MHz ISDB-T: 30 MHz CMMB: 72 MHz LTE, LTETDD, MSR: 25 MHz

	Digital Cable TV: 40 MHz LTEAFDD,LTEATDD: 25MHz
State Saved	Saved in instrument state.
Min	10 Hz
Max	Hardware Dependent: Option 503 = 3.7 GHz Option 507 = 7.1 GHz Option 508 = 8.5 GHz Option 513 = 13.8 GHz Option 526 = 27.0 GHz
Initial S/W Revision	Prior to A.02.00
Modified at S/W Revision	A.02.00, A.03.00

Full Span

Changes the span to show the full frequency range of the spectrum analyzer.

Key Path	SPAN X Scale
Mode	SA, WCDMA, C2K, WiMAX OFDMA, TD-SCDMA, 1xEVDO, DVB-T/H, DTMB (CTTB), ISDB-T, CMMB, LTE, LTETDD, Digital Cable TV
Remote Command	[:SENSe] :ACPower :FREQuency :SPAN :FULL
Example	ACP:FREQ:SPAN:FULL
Notes	You must be in the mode that includes ACP measurements to use this command. Use :INSTrument:SElect to set the mode.
Dependencies	For MSR and LTE-Advanced FDD/TDD mode, this key is blank.
Initial S/W Revision	Prior to A.02.00
Modified at S/W Revision	A.02.00, A.03.00

Last Span

Changes the span to the previous span setting. If no previous span value exists, then the span will remain unchanged.

Key Path	SPAN X Scale
Mode	SA, WCDMA, C2K, WIMAX OFDMA, TD-SCDMA, 1xEVDO, DVB-T/H, DTMB (CTTB), ISDB-T, CMMB, LTE, LTETDD, Digital Cable TV, MSR, LTEAFDD,LTEATDD
Remote Command	[:SENSe] :ACPower :FREQuency :SPAN :PREVious
Example	ACP:FREQ:SPAN:PREV
Notes	You must be in the mode that includes ACP measurements to use this command. Use :INSTrument:SElect to set the mode.

11 ACP Measurement
SPAN X Scale

Initial S/W Revision	Prior to A.02.00
Modified at S/W Revision	A.02.00, A.03.00

Sweep/Control

Accesses a menu of functions that enable you to set up and control the sweep time, and source.

See "[Sweep/Control](#)" on page 927 for more information.

Key Path	Front-panel key
Initial S/W Revision	Prior to A.02.00

Sweep Time

Selects the length of time in which the spectrum analyzer sweeps the displayed frequency span. In swept spans, the sweep time varies from 1 millisecond to 2000 seconds. Additional overhead time, which impacts the sweep rate, is not calculated as part of the sweep time. In fact:

sweep rate = span/sweep time

update rate = 1/(sweep time + overhead)

sweep cycle time = sweep time + overhead

Sweep time is coupled to RBW and VBW, and is impacted by the number of sweep points, so changing those parameters may change the sweep time.

If you increase the sweep time, you increase the length of the time data captured and the number of points measured. You might need to specify a specific sweep speed to accommodate a specific condition in your transmitter. For example, you may have a burst signal and need to measure an exact portion of the burst.

Selecting a specific sweep time may result in a long measurement time since the resulting number of data points may not be the optimum $2n$. Use `[:SENSe]:ACP:OFFSet:LIST:SWEep:TIME` to set the number of points used for measuring the offset channels for Basic and cdmaOne.

For cdma2000 and W-CDMA, this command sets the sweep time when using the sweep mode. See `[:SENSe]:ACP:SWEep:TYPE`

Key Path	Sweep/Control
Mode	SA, WCDMA, C2K, WIMAX OFDMA, TD-SCDMA, 1xEVDO, DVB-T/H, DTMB (CTTB), ISDB-T, CMMB, LTE, LTETDD, Digital Cable TV, MSR, LTEAFDD, LTEATDD
Remote Command	<pre>[:SENSe]:ACP:Power:SWEep:TIME <time> [:SENSe]:ACP:Power:SWEep:TIME? [:SENSe]:ACP:Power:SWEep:TIME:AUTO OFF ON 0 1 [:SENSe]:ACP:Power:SWEep:TIME:AUTO?</pre>
Example	<pre>ACP:SWE:TIME 50ms ACP:SWE:TIME? ACP:SWE:TIME:AUTO OFF</pre>

	ACP:SWE:TIME:AUTO?
Notes	This parameter is preset by Meas Method selection. Preset values are as follows: IBW: 29 ms IBWR: 108 ms FAST (WCDMA): 7.5 ms
Preset	SA, LTE, LTETDD, MSR: Automatically calculated WCDMA: 29 ms WIMAX OFDMA: Automatically calculated C2K: Automatically calculated TD-SCDMA: Automatically calculated 1xEVDO: Automatically calculated DVB-T/H: Automatically calculated DTMB (CTTB): Automatically calculated ISDB-T: Automatically calculated CMMB: Automatically calculated Digital Cable TV: Automatically calculated LTEAFDD, LTEATDD: Automatically calculated SA, LTE, LTETDD, MSR, LTEAFDD, LTEATDD: ON WCDMA: OFF C2K: OFF (method IBW) WIMAX OFDMA: ON TD-SCDMA: ON DVB-T/H: ON DTMB (CTTB): ON ISDB-T: ON CMMB: ON Digital Cable TV: ON
State Saved	Saved in instrument state.
Min	Min value depends on Meas Method. Meas Method is NOT FastPower: 1ms Meas Method is FastPower: Automatically calculated (depends on Span)
Max	4000 s
Initial S/W Revision	Prior to A.02.00
Modified at S/W Revision	A.02.00, A.03.00

Sweep Setup

Accesses the sweep setup menu.

Key Path	Sweep/Control
Initial S/W Revision	Prior to A.02.00

Auto Sweep Time Rules

Switches the analyzer between normal and accuracy sweep states.

Key Path	Sweep/Control, Sweep Setup
Mode	SA, WCDMA, C2K, WIMAX OFDMA, TD-SCDMA, 1xEVDO, DVB-T/H, DTMB (CTTB), ISDB-T, CMMB, LTE, LTETDD, Digital Cable TV, MSR, LTEAFDD, LTEATDD
Remote Command	[:SENSE] :ACPpower :SWEep :TIME :AUTO :RULes NORMal ACCuracy [:SENSE] :ACPpower :SWEep :TIME :AUTO :RULes ?
Example	ACP:SWE:TIME:AUTO:RUL NORM ACP:SWE:TIME:AUTO:RUL?
Notes	Set to Norm when Auto Couple is pressed or sent remotely.
Preset	SA, WCDMA, C2K, TD-SCDMA, 1xEVDO, DTMB (CTTB), LTE, LTETDD, MSR, LTEAFDD, LTEATDD: ACCuracy WIMAX OFDMA, DVB-T/H: NORMal ISDB-T, CMMB: NORMal Digital Cable TV: NORMal
State Saved	Saved in instrument state.
Range	Norm Accy
Initial S/W Revision	Prior to A.02.00
Modified at S/W Revision	A.02.00, A.03.00

Pause

Pauses a measurement after the current data acquisition is complete. When Paused, the label on the key changes to Resume. Pressing the Resume key resumes the measurement at the point where it was paused. When Paused, pressing **Restart**, **Single**, or **Cont** does a Resume

See "[Pause/Resume](#)" on page 2263 for more details.

Key Path	Sweep/Control
Initial S/W Revision	Prior to A.02.00

Gate

Accesses a menu that enables you to control the gating function. The Gate functionality is used to view signals best viewed by qualifying them with other events.

Gate setup parameters are the same for all measurements – they do not change as you change measurements. Settings like these are called “Meas Global” and are unaffected by Meas Preset.

Note that Sweep Time autocoupling rules and annotation are changed by Gate being on.

Key Path	Sweep/Control
Scope	Meas Global
Readback	The state and method of Gate, as [Off, LO] or [On, Video]. Note that for measurements that only support gated LO, the method is nonetheless read back, but always as LO.
Initial S/W Revision	Prior to A.02.00

Gate On/Off

Turns the gate function on and off.

When the Gate Function is on, the selected Gate Method is used along with the gate settings and the signal at the gate source to control the sweep and video system with the gate signal. Not all measurements allow every type of Gate Methods.

When Gate is on, the annunciation in the measurement bar reflects that it is on and what method is used, as seen in the following "Gate: LO" annunciator graphic.

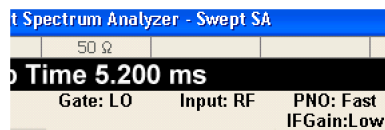

Key Path	Sweep/Control, Gate
Remote Command	[:SENSe] :SWEep :EGATe [:STATe] OFF ON 0 1 [:SENSe] :SWEep :EGATe [:STATe] ?
Example	SWE:EGAT ON SWE:EGAT?

Dependencies	The function is unavailable (grayed out) and Off when: <ul style="list-style-type: none"> - Gate Method is LO or Video and FFT Sweep Type is manually selected. - Gate Method is FFT and Swept Sweep Type is manually selected. - Marker Count is ON.
--------------	--

The following are unavailable whenever Gate is on:

- FFT under Sweep Type when Method=LO or Video or Swept under Sweep Type when Method=FFT

Marker Count

While Gate is on, the Auto Rules for Sweep Type are modified so that the choice agrees with the Gate Method: i.e., FFT for Method = FFT and Swept for Method = LO or Video.

The Gate softkey and all SCPI under the [:SENSe]:SWEep:EGATe SCPI node are grayed out when Source Mode is Tracking with an external source. This is because the Gate circuitry is used to sync the external source. If the Tracking Source is turned on, the Gate is turned off.

When in the ACP measurement:

- When Meas Method is RBW or FAST, this function is unavailable and the key is grayed out.

	<ul style="list-style-type: none"> - Whenever Gate is on, Meas Method, RBW or FAST is unavailable and keys for those are grayed out. - When Gate is on, Offset Res BW and Offset Video BW are ignored (if you set these values) and the measurement works as if all Offset Res BW and all Offset Video BW are coupled with the Res BW and the Video BW under the BW menu. When Gate is on, the Offset BW key in the Offset/Limit menu is grayed out.
Preset	Off LTETDD: On
State Saved	Saved in instrument state
Range	On Off
Backwards Compatibility SCPI	[:SENSe]:SWEep:TIME:GATE[:STATe] ESA compatibility
Backwards Compatibility Notes	In ESA, Trig Delay (On) and Gate (On) could not be active at the same time.. This dependency does not exist in PSA or in the X-Series.
Initial S/W Revision	Prior to A.02.00

Gate View On/Off

Turning on Gate View in the Swept SA measurement provides a single-window gate view display..

Turning on Gate View in other measurements shows the split-screen Gate View. In these measurements, when the Gate View is on, the regular view of the current measurement traces and results are reduced vertically to about 70% of the regular height. The Zero Span window, showing the positions of the Gate, is shown between the Measurement Bar and the reduced measurement window. By reducing the height of the measurement window, some of the annotation on the Data Display may not fit and is not shown.

Key Path	Sweep/Control, Gate
Remote Command	<code>[:SENSe] :SWEep:EGATe:VIEW ON OFF 1 0</code> <code>[:SENSe] :SWEep:EGATe:VIEW?</code>
Example	SWE:EGAT:VIEW ON turns on the gate view.
Dependencies	In the Swept SA measurement: In Gate View, the regular Sweep Time key is grayed out . When pressed, the grayed out key puts up the informational message "Use Gate View Sweep Time in the Gate menu." In the other measurements: When you turn Gate View on, the lower window takes on the current state of the instrument. Upon leaving Gate View, the instrument takes on the state of the lower window. When you turn Gate View on, the upper window Sweep Time is set to the gate view sweep time.
Couplings	These couplings apply to the Swept SA measurement: <ul style="list-style-type: none"> - When Gate View is turned on, the instrument is set to Zero Span.

- Gate View automatically turns off whenever a Span other than Zero is selected.
- Gate View automatically turns off if you press the Last Span key while in Gate View, and the instrument returns to the Span it was in before entering Gate View (even if that is Zero Span).
- When Gate View is turned on, the sweep time used is the gate view sweep time. This is set according to the rules in section "Gate View Setup " on page 2809
- When Gate View is turned off, Sweep Time is set to the normal Swept SA measurement sweep time.
- If Gate View is on and Gate is off, then turning on Gate turns off Gate View.

Preset	OFF
State Saved	Saved in instrument state
Range	On Off
Initial S/W Revision	Prior to A.02.00

A sample of the Gate View screen in the Swept SA measurement is shown in the following graphic :

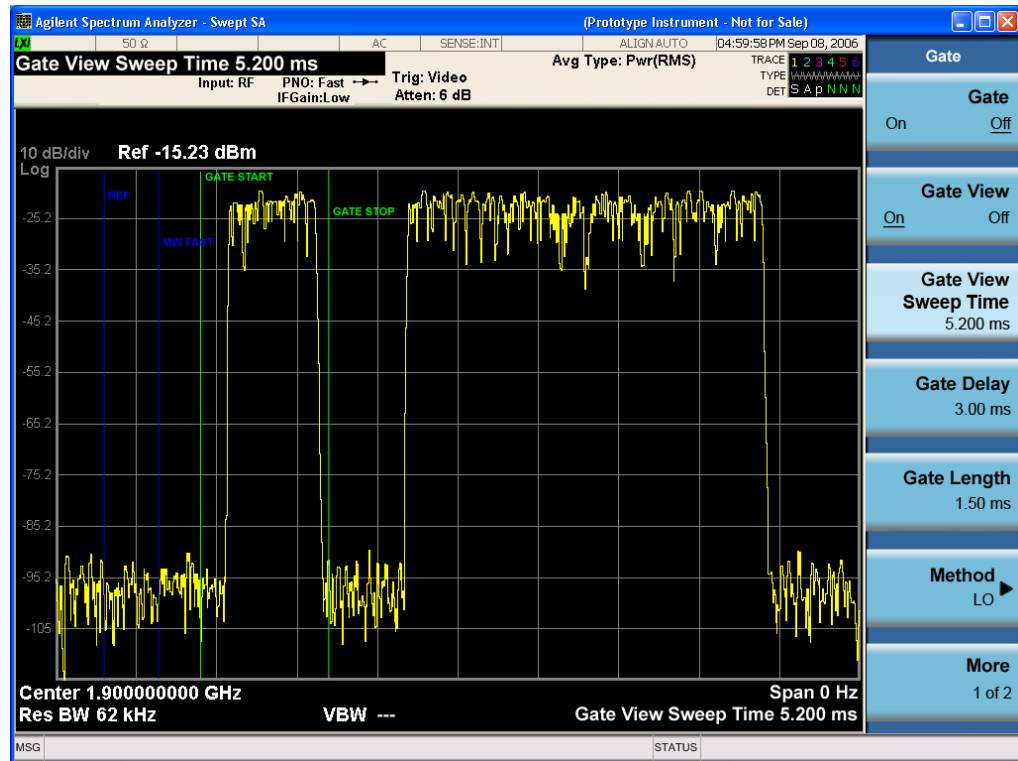

A sample of the Gate View screen in other measurements is shown in the following graphic . This example is for the ACP measurement:

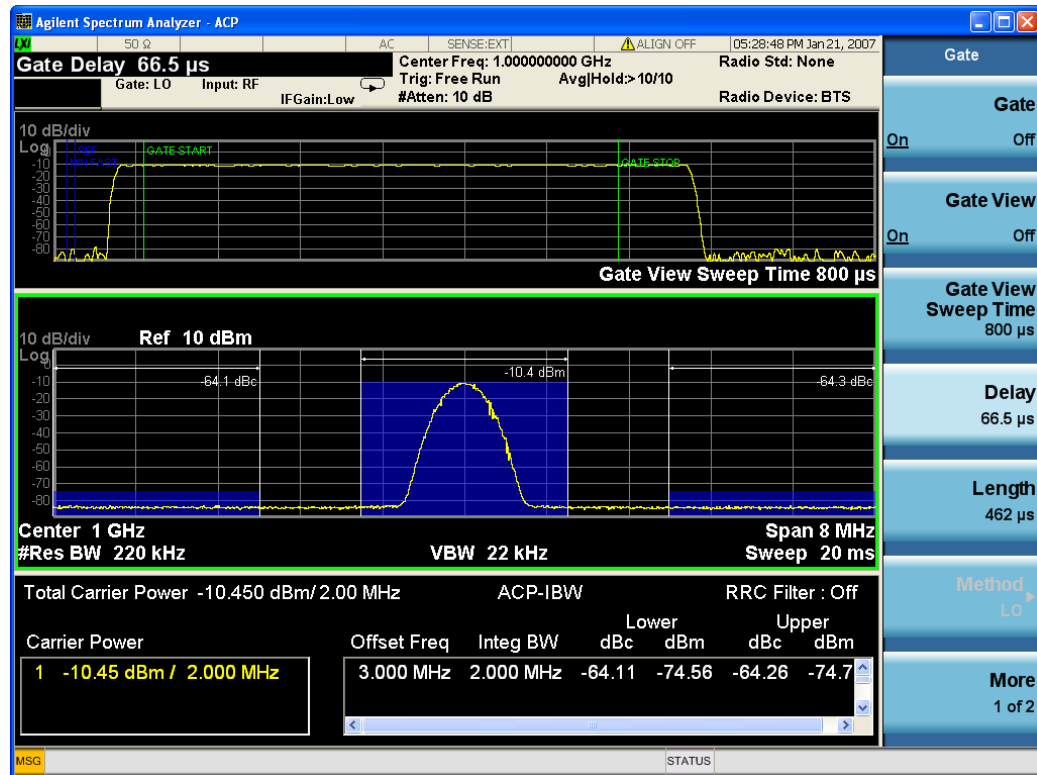

Turning Gate View off returns the analyzer to the Normal measurement view.

In the Swept SA, the normal measurement view is the single-window Swept SA view. When returning to this view, the Swept SA measurement returns to the Span it was in before entering **Gate View** (even if that is Zero Span).

The **Gate View** window is triggered from the Gate Source, with zero trigger delay. Also, when updating the **Gate View** window, the Gate itself must not operate. So it is internally shut off while the gate view window is being updated. For the Swept SA measurement, this means that the Gate is internally shut off whenever the gate view window is displayed. The measurement bar and softkeys continue to show the Trigger source for the main sweep window and give no indication that the Gate is shut off or that the Gate View window is triggered from the Gate Source.

When in **Gate View**, vertical lines are displayed in the Gate View window as follows:

- Green lines are displayed at the gate edges as follows: in Edge Gate, a line is shown for Delay and one for the end of the Gate period, defined by Length. In Level Gate a line is shown only for Delay. You can adjust the position of the green lines by adjusting the gate length and the gate delay. These lines update in the Gate View window as the active function changes, even if the window is not being updated. In Gated LO and Gated Video, these lines are positioned relative to the delay reference line (not relative to 0 time). In Gated FFT, their location is relative to the left edge of the screen.

- A blue line is displayed showing the delay reference, that is, the reference point for the Gate Delay within the Zero Span window. The blue line represents where (in time) the effective location of the gate start would be if the gate were programmed to zero delay.
-
- The second blue line is labeled "MIN FAST" as shown in the figure above because it represents the minimum Gate Delay for fast Gated LO operation. This line is only displayed in Gated LO. You cannot scroll (knob) or decrement (down key) the Gate Delay to less than that represented by the position of this line, it can only be set below this position manually, although once there it can be moved freely with the knob while below the line.
- A yellow line in the Gated Video case only, is displayed at Blength, where Blength is the display point (bucket) length for the swept trace, which is given by the sweep time for that trace divided by number of Points - 1. So it is referenced to 0 time, not to the delay reference. This line is labeled NEXT PT (it is not shown in the figure above because the figure above is for Gated LO).
- The yellow line represents the edge of a display point (bucket). Normally in Gated Video, the bucket length must be selected so that it exceeds the off time of the burst. There is another way to use the analyzer in Gated Video measurements, and that is to set the bucket width much shorter than the off time of the burst. Then use the Max Hold trace function to fill in "missing" buckets more slowly. This allows you to see some of the patterns of the Gated Video results earlier, though seeing a completely filled-in spectrum later.

Gate View Setup

Accesses a menu that enables you to setup parameters relevant to the Gate View

Key Path	Sweep/Control, Gate
Scope	Meas Global
Initial S/W Revision	A.10.00

Gate View Sweep Time

Controls the sweep time in the Gate View window. To provide an optimal view of the gate signal, the analyzer initializes Gate View Sweep Time based on the current settings of Gate Delay and Gate Length.

Key Path	Sweep/Control, Gate, Gate View Setup
Remote Command	[:SENSe] :SWEep:EGATe:TIME <time>

	[:SENSe] :SWEep:EGATe:TIME?
Example	SWE:EGAT:TIME 500 ms
Dependencies	Gate View Sweep Time is initialized: <ul style="list-style-type: none"> - On Preset (after initializing delay and length). - Every time the Gate Method is set/changed. <p>Additionally, in the Swept SA measurement, whenever you do a Preset, or leave Gate View, the analyzer remembers the Gate Delay and Gate Length settings. Then, when returning to Gate View, if the current Gate Delay and/or Gate Length do not match the remembered values Gate View Sweep Time is re-initialized.</p>
Preset	519.3 μ s WiMAX OFDMA: 5 ms GSM/EDGE: 1 ms
State Saved	Saved in instrument state
Max	6000 s
Initial S/W Revision	Prior to A.02.00

Gate View Start Time

Controls the time at the left edge of the Gate View.

Key Path	Sweep/Control, Gate, Gate View Setup
Remote Command	[:SENSe] :SWEep:EGATe:VIEW:STARt <time> [:SENSe] :SWEep:EGATe:VIEW:STARt?
Example	SWE:EGAT:VIEW:STAR 10ms
Notes	Units of time are required or no units; otherwise an invalid suffix error message will be generated. See error -131.
Preset	0 ms
State Saved	Saved in instrument state
Min	0
Max	500 ms
Initial S/W Revision	A.10.00

Gate Delay

Controls the length of time from the time the gate condition goes True until the gate is turned on.

Key Path	Sweep/Control, Gate
Remote Command	[:SENSe] :SWEep:EGATe:DELay <time> [:SENSe] :SWEep:EGATe:DELay?
Example	SWE:EGAT:DELay 500ms

	SWE:EGAT:DElAY?
Notes	Units of time are required or no units; otherwise an invalid suffix error message will be generated.
Preset	57.7 us WiMAX OFDMA: 71 us GSM/EDGE: 600 us WLAN: 500 us
State Saved	Saved in instrument state
Min	0.0 us
Max	100 s
Backwards Compatibility SCPI	[:SENSE] :SWEep:TIME:GATE:DElAY ESA compatibility
Initial S/W Revision	Prior to A.02.00

Gate Length

Controls the length of time that the gate is on after it opens.

Key Path	Sweep/Control, Gate
Remote Command	[:SENSE] :SWEep:EGATE:LENGth <time> [:SENSE] :SWEep:EGATE:LENGth?
Example	SWE:EGAT:LENG 1 SWE:EGAT:LENG?
Notes	Units of time are required or no units; otherwise an invalid suffix error message will be generated.
Dependencies	Grayed out when Gate Method is set to FFT in which case the label changes to that shown below. <div style="border: 1px solid gray; padding: 5px; display: inline-block; margin-bottom: 10px;"> Gate Length (=1.83/RBW) 2.8 ms </div> <small>vsd 39-1</small> The key is also grayed out if Gate Control = Level.
Preset	461.6 us WiMAX OFDMA: 50 us GSM/EDGE: 200 us WLAN: 1.54 ms
State Saved	Saved in instrument state
Min	100 ns
Max	5 s
Backwards Compatibility SCPI	[:SENSE] :SWEep:TIME:GATE:LENGth ESA compatibility
Initial S/W Revision	Prior to A.02.00

Method

This lets you choose one of the three different types of gating.

Not all types of gating are available for all measurements.

Key Path	Sweep/Control, Gate
Remote Command	[:SENSe] :SWEep:EGATe:METhod LO VIDeo FFT [:SENSe] :SWEep:EGATe:METhod?
Example	SWE:EGAT: METH FFT
Preset	LO
State Saved	Saved in instrument state
Initial S/W Revision	Prior to A.02.00

LO

When Gate is set to On, the LO sweeps whenever the gate conditions as specified in the Gate menu are satisfied by the signal at the Gate Source.

This form of gating is more sophisticated, and results in faster measurements. With Gated LO, the analyzer only sweeps while the gate conditions are satisfied. This means that a sweep could take place over several gate events. It would start when the gate signal goes true and stop when it goes false, and then continue when it goes true again. But since the LO is sweeping as long as the gate conditions are satisfied, the sweep typically finishes much more quickly than with Gated Video.

When in zero span, there is no actual sweep performed. But data is only taken while the gate conditions are satisfied. So even though there is no sweep, the gate settings will impact when data is acquired.

Key Path	Sweep/Control, Gate, Method
Dependencies	Key is unavailable when Gate is On and FFT Sweep Type manually selected. When selected, Sweep Type is forced to Swept and the FFT key in Sweep Type is grayed out.
Readback	LO
Initial S/W Revision	Prior to A.02.00

Video

When Gate is set to On, the video signal is allowed to pass through whenever the gate conditions as specified in the Gate menu are satisfied by the signal at the Gate Source.

This form of gating may be thought of as a simple switch, which connects the signal to the input of the spectrum analyzer. When the gate conditions are satisfied, the switch is closed, and when the gate conditions are not satisfied, the switch is open. So we only look at the signal while the gate conditions are satisfied.

With this type of gating, you usually set the analyzer to sweep very slowly. In fact, a general rule is to sweep slowly enough that the gate is guaranteed to be closed at

least once per data measurement interval (bucket). Then if the peak detector is used, each bucket will represent the peak signal as it looks with the gate closed.

Key Path	Sweep/Control, Gate, Method
Dependencies	Key is unavailable when Gate is On and FFT Sweep Type manually selected. When selected, Sweep Type is forced to Swept and the FFT key in Sweep Type is grayed out
Readback	Video
Initial S/W Revision	Prior to A.02.00

FFT

When Gate is set to On, an FFT is performed whenever the gate conditions as specified in the Gate menu are satisfied by the signal at the Gate Source. This is an FFT measurement which begins when the gate conditions are satisfied. Since the time period of an FFT is approximately $1.83/\text{RBW}$, you get a measurement that starts under predefined conditions and takes place over a predefined period. So, in essence, this is a gated measurement. You have limited control over the gate length but it works in FFT sweeps, which the other two methods do not.

Gated FFT cannot be done in zero span since the instrument is not sweeping. So in zero span the Gated LO method is used. Data is still only taken while the gate conditions are satisfied, so the gate settings do impact when data is acquired.

The Gate Length will be $1.83/\text{RBW}$.

This is a convenient way to make a triggered FFT measurement under control of an external gating signal.

Key Path	Sweep/Control, Gate
Dependencies	Key is unavailable when Gate is On and Swept Sweep Type is manually selected. When selected, Sweep Type is forced to FFT and the Swept key in Sweep Type is grayed out Key is unavailable when gate Control is set to Level. Forces Gate Length to $1.83/\text{RBW}$
Readback	FFT
Initial S/W Revision	Prior to A.02.00

Gate Source

The menus under the **Gate Source** key are the same as those under the **Trigger key**, with the exception that neither **Free Run** nor **Video** are available as Gate Source selections. However, a different SCPI command is used to select the Gate Source (see table below) because you may independently set the Gate Source and the Trigger Source.

Any changes to the settings in the setup menus under each Gate Source selection key (for example: Trigger Level, Trigger Delay, etc.) also affect the corresponding settings under the Trigger menu keys. The SCPI commands used for these are the same for Trigger and Gate, since there is only one setting which affects both Gate and Trigger. Example: to set the Trigger Level for External 1 you use the command

:TRIG:EXT1:LEV regardless of whether you are using External 1 as a Trigger Source or a Gate Source.

Key Path	Sweep/Control, Gate
Remote Command	[:SENSe] :SWEep :EGATe :SOURce EXTerna11 EXTerna12 LINE FRAMe RFBurst TV PXI [:SENSe] :SWEep :EGATe :SOURce ?
Dependencies	In some models, there is no second External input. In these models, the External 2 key is blanked and the EXTerna12 parameter will generate a "Hardware missing; Not available for this model number" error. PXI trigger is only supported in PXI (modular) instruments.
Preset	EXTerna1 GSM/EDGE, MSR: FRAMe LTETDD: EXTerna1When Direction is Downlink, FRAMe when Direction is Uplink.
Backwards Compatibility Notes	In ESA, there is a single Gate input port. In PSA, the Gate Source may be taken from one of two specified input ports. In the X-Series, any Trigger Source can be a Gate Source.
Initial S/W Revision	Prior to A.02.00
Modified at S/W Revision	A.03.00, A.14.00

Line

Pressing this key, when it is not selected, selects the line signal as the trigger. A new sweep/measurement will start synchronized with the next cycle of the line voltage. Pressing this key, when it is already selected, access the line trigger setup menu.

Key Path	Trigger
Example	TRIG:SOUR LINE Swept SA measurement TRIG:<meas>:SOUR LINE Measurements other than Swept SA
Dependencies	Line trigger is not available when operating from a "dc power source", for example, when the instrument is powered from batteries.
State Saved	Saved in instrument state
Status Bits/OPC dependencies	The Status Operation Register bit 5 "Waiting for Trigger" is set at the same time as the Sweeping or Measuring bit is set. It is cleared when the trigger actually occurs (that is, after the trigger event occurs and all the applicable trigger criteria have been met). A corresponding pop-up message ("Waiting for trigger") is generated if no trigger signal appears after approximately 2 sec. This message goes away when a trigger signal appears.
Initial S/W Revision	Prior to A.02.00

Trig Slope

Controls the trigger polarity. It is set positive to trigger on a rising edge and negative to trigger on a falling edge.

Key Path	Trigger, Line
Remote Command	:TRIGger [:SEQuence] :LINE :SLOPe POSitive NEGative

	:TRIGger[:SEQuence]:LINE:SLOPe?
Example	TRIG:LINE:SLOP NEG
Preset	POSitive
State Saved	Saved in instrument state
Backwards Compatibility Notes	The legacy :TRIGger[:SEQuence]:SLOPe command affects the slopes for the VID, LINE, EXT1, EXT2, and RFB triggers.
Initial S/W Revision	Prior to A.02.00

External 1

Pressing this key, when it is not selected, selects an external input signal as the trigger. A new sweep/measurement will start when the external trigger condition is met using the external 1 input connector on the rear panel.

Pressing this key, when it is already selected, accesses the external 1 trigger setup menu.

Key Path	Trigger
Example	TRIG:SOUR EXT1 Swept SA measurement TRIG:<meas>:SOUR EXT1 Measurements other than Swept SA
Dependencies	Grayed out if in use by Point Trigger in the Source Setup menu. Forced to Free Run if already selected and Point Trigger is set to External 1.
State Saved	Saved in instrument state
Status Bits/OPC dependencies	The Status Operation Register bit 5 "Waiting for Trigger" is set at the same time as the Sweeping or Measuring bit is set. It is cleared when the trigger actually occurs (that is, after the trigger event occurs and all the applicable trigger criteria have been met). A corresponding pop-up message ("Waiting for trigger") is generated if no trigger signal appears after approximately 2 sec. This message goes away when a trigger signal appears.
Initial S/W Revision	Prior to A.02.00

Trigger Level

Sets the value where the external 1 trigger input will trigger a new sweep/measurement.

Key Path	Trigger, External 1
Remote Command	:TRIGger[:SEQuence]:EXTernal1:LEVel <level> :TRIGger[:SEQuence]:EXTernal1:LEVel?
Example	TRIG:EXT1:LEV 0.4 V
Couplings	This same level is used for the Ext1 trigger source in the Trigger menu, for the Ext1 selection in the Periodic Timer sync source (in the Trigger menu and in the Gate Source menu), and also for the Ext1 selection in the Gate Source menu.
Preset	1.2 V
State Saved	Saved in instrument state

Min	-5 V
Max	5 V
Default Unit	V
Backwards Compatibility SCPI	:TRIGger[:SEquence]:EXTernal:LEVel
	For backward compatibility, the parameter EXTernal is mapped to EXTernal1
Backwards Compatibility SCPI	:TRIGger[:SEquence]:FRAME:EXTernal1:LEVel
Initial S/W Revision	Prior to A.02.00

Trig Slope

Controls the trigger polarity. It is set positive to trigger on a rising edge and negative to trigger on a falling edge.

Key Path	Trigger, External 1
Remote Command	:TRIGger[:SEquence]:EXTernal1:SLOPe POSitive NEGative :TRIGger[:SEquence]:EXTernal1:SLOPe?
Example	TRIG:EXT1:SLOP NEG
Couplings	This same slope is used in the Ext1 selection for the trigger source in the Trigger menu and for the period timer sync source (in the Trigger menu and in the Gate Source menu).
Preset	POSitive
State Saved	Saved in instrument state
Backwards Compatibility SCPI	:TRIGger[:SEquence]:EXTernal:SLOPe
	For backward compatibility, the parameter EXTernal is mapped to EXTernal1
Backwards Compatibility SCPI	:TRIGger[:SEquence]:FRAME:EXTernal1:SLOPe
Backwards Compatibility Notes	The legacy :TRIGger[:SEquence]:SLOPe command affects the slopes for the VID, LINE, EXT1, EXT2, and RFB triggers.
Initial S/W Revision	Prior to A.02.00

Zero Span Delay Comp On/Off

In zero span, there is a natural delay in the signal path, which comes from the RBW filter. This is usually desirable, as it allows you to trigger on events and also see those events, because the signal is delayed from the trigger event. However, in some cases it is desirable to eliminate this delay, so that trigger events line up exactly with the zero time point in zero span. You can use the **Zero Span Delay Comp On/Off** feature to enable or disable zero span delay compensation.

Key Path	Trigger, External 1
Remote Command	:TRIGger[:SEquence]:EXTernal1:DELay:COMPensation OFF ON 0 1 :TRIGger[:SEquence]:EXTernal1:DELay:COMPensation?

Example	TRIG:EXT1:DEL:COMP ON
Dependencies	No effect except in zero-span, but not locked out in nonzero spans. Blanked in modes that do not support zero-span measurements. If the SCPI command is sent when the key is blanked, an error is returned: -221, "Settings conflict; Feature not supported for this measurement" In analyzers shipping N9060A, this feature requires N9060A-7FP.
Preset	OFF
State Saved	Saved in instrument state
Initial S/W Revision	A.11.00

External 2

Pressing this key, when it is not selected, selects an external input signal as the trigger. A new sweep/measurement will start when the external trigger condition is met using the external 2 input connector. The external trigger 2 input connector is on the rear panel.

Pressing this key, when it is already selected, accesses the external 2 trigger setup menu.

Key Path	Trigger
Example	TRIG:SOUR EXT2 Swept SA measurement TRIG:<meas>:SOUR EXT2 Measurements other than Swept SA
Dependencies	In some models, there is no second External input. In these models, the External 2 key is blanked and the EXTERNAL2 parameter will generate a "Hardware missing; Not available for this model number" message. Grayed out if in use by Point Trigger in the Source Setup menu. Forced to Free Run if already selected and Point Trigger is set to External 2.
State Saved	Saved in instrument state
Status Bits/OPC dependencies	The Status Operation Register bit 5 "Waiting for Trigger" is set at the same time as the Sweeping or Measuring bit is set. It is cleared when the trigger actually occurs (that is, after the trigger event occurs and all the applicable trigger criteria have been met). A corresponding pop-up message ("Waiting for trigger") is generated if no trigger signal appears after approximately 2 sec. This message goes away when a trigger signal appears.
Initial S/W Revision	Prior to A.02.00
Modified at S/W Revision	A.03.00

Trigger Level

Sets the value where the external 2 trigger input will trigger a new sweep/measurement.

Key Path	Trigger, External 2
Remote Command	:TRIGger[:SEquence]:EXTerna12:LEVel :TRIGger[:SEquence]:EXTerna12:LEVel?

Example	TRIG:EXT2:LEV 1.1 V
Couplings	This same level is used for the Ext2 trigger source in the Trigger menu, for the Ext2 selection in the Periodic Timer sync source (in the Trigger menu and in the Gate Source menu), and also for the Ext2 selection in the Gate Source menu.
Preset	1.2 V
State Saved	Saved in instrument state
Min	-5 V
Max	5 V
Default Unit	V
Backwards Compatibility SCPI	:TRIGger[:SEQuence]:FRAME:EXTerna12:LEVe1
Initial S/W Revision	Prior to A.02.00

Trig Slope

Controls the trigger polarity. It is set positive to trigger on a rising edge and negative to trigger on a falling edge.

Key Path	Trigger, External 2
Remote Command	:TRIGger[:SEQuence]:EXTerna12:SLOPe POSitive NEGative :TRIGger[:SEQuence]:EXTerna12:SLOPe?
Example	TRIG:EXT2:SLOP NEG
Couplings	This same slope is used in the Ext2 selection for the trigger source in the Trigger menu and for the period timer sync source (in the Trigger menu and in the Gate Source menu).
Preset	POSitive
State Saved	Saved in instrument state
Backwards Compatibility SCPI	:TRIGger[:SEQuence]:FRAME:EXTerna12:SLOPe
Backwards Compatibility Notes	The legacy :TRIGger[:SEQuence]:SLOPe command affects the slopes for the VID, LINE, EXT1, EXT2, and RFB triggers.
Initial S/W Revision	Prior to A.02.00

Zero Span Delay Comp On/Off

In zero span, there is a natural delay in the signal path, which comes from the RBW filter. This is usually desirable, as it allows you to trigger on events and also see those events, because the signal is delayed from the trigger event. However, in some cases it is desirable to eliminate this delay, so that trigger events line up exactly with the zero time point in zero span. You can use the **Zero Span Delay Comp On/Off** feature to enable or disable zero span delay compensation.

Key Path	Trigger, External 2
Remote Command	:TRIGger[:SEQuence]:EXTerna12:DELAy:COMPensation OFF ON 0 1

:TRIGger[:SEquence]:EXternal2:DElay:COMPensation?	
Example	TRIG:EXT2:DEL:COMP ON
Dependencies	No effect except in zero-span, but not locked out in nonzero spans. Blanked in modes that do not support zero-span measurements. If the SCPI command is sent when the key is blanked, an error is returned: -221, "Settings conflict; Feature not supported for this measurement" In analyzers shipping N9060A, this feature requires N9060A-7FP.
Preset	OFF
State Saved	Saved in instrument state
Initial S/W Revision	A.11.00

RF Burst

Pressing this key, when it is not selected, selects the RF Burst as the trigger. A new sweep/measurement will start when an RF burst envelope signal is identified from the signal at the RF Input connector. Pressing this key, when it is already selected, accesses the RF Burst trigger setup menu.

In some models, a variety of burst trigger circuitry is available, resulting in various available burst trigger bandwidths. The analyzer automatically chooses the appropriate trigger path based on the hardware configuration and other settings of the analyzer.

Key Path	Trigger
Example	TRIG:SOUR RFB Swept SA measurement TRIG:<meas>:SOUR RFB Measurements other than Swept SA
State Saved	Saved in instrument state
Status Bits/OPC dependencies	The Status Operation Register bit 5 "Waiting for Trigger" is set at the same time as the Sweeping or Measuring bit is set. It is cleared when the trigger actually occurs (that is, after the trigger event occurs and all the applicable trigger criteria have been met). A corresponding pop-up message ("Waiting for trigger") is generated if no trigger signal appears after approximately 2 sec. This message goes away when a trigger signal appears.
Backwards Compatibility Notes	The legacy command: :TRIGger[:SEquence]:RFBurst:FSElectivity[:STATe] OFF ON 0 1 is not supported in the X-Series, as the hardware to do Frequency Selective burst triggers does not exist in X-Series.
Initial S/W Revision	Prior to A.02.00
Modified at S/W Revision	A.04.00

Absolute Trigger Level

Sets the absolute trigger level for the RF burst envelope.

When using the External Mixing path, the Absolute Trigger Level is uncalibrated because the factory default was set to accommodate the expected IF levels for the RF path.

Key Path	Trigger, RF Burst
Scope	Meas Global
Remote Command	<code>:TRIGger[:SEquence]:RFBurst:LEVel:ABSolute <aml></code> <code>:TRIGger[:SEquence]:RFBurst:LEVel:ABSolute?</code>
Example	TRIG:RFB:LEV:ABS 10 dBm sets the trigger level of the RF burst envelope signal to the absolute level of 10 dBm
Notes	Sending this command does not switch the setting from relative to absolute; to switch it you need to send the <code>:TRIGger[:SEquence]:RFBurst:LEVel:TYPE</code> command, below. Amplitude Corrections are not taken into account by the Absolute Trigger Level. For example, if you have given yourself effective gain with an amplitude correction factor, the Absolute Trigger will not fire until you have set the trigger level that far below the displayed signal level, rather than simply to the displayed signal level. This is only true for Amplitude Corrections, not External Gain or Ref Level Offset functions. If mode is Bluetooth, the default value is -50 dBm.
Couplings	This same level is used for the RF Burst trigger source in the Trigger menu, for the RF Burst selection in the Periodic Timer sync source (in the Trigger menu and in the Gate Source menu), and also for the RF Burst selection in the Gate Source menu
Preset	-20 dBm
State Saved	Saved in instrument state
Min	-200 dBm
Max	100 dBm
Default Unit	depends on the current selected Y-Axis unit
Backwards Compatibility SCPI	<code>:TRIGger[:SEquence]:FRAME:RFBurst:LEVel:ABSolute</code>
Initial S/W Revision	Prior to A.02.00
Modified at S/W Revision	A.04.00

Key Path	Trigger, RF Burst
Remote Command	<code>:TRIGger[:SEquence]:RFBurst:LEVel:TYPE ABSolute RELative</code> <code>:TRIGger[:SEquence]:RFBurst:LEVel:TYPE?</code>
Example	TRIG:RFB:LEV:TYPE REL sets the trigger level type of the RF burst trigger to Relative.
Preset	ABSolute
State Saved	Saved in instrument state
Initial S/W Revision	Prior to A.02.00
Modified at S/W Revision	A.04.00

Relative Trigger Level

Sets the relative trigger level for the RF burst envelope.

In some models, the relative burst trigger function is implemented in hardware. In other models, without the advanced triggering hardware required, the relative burst trigger function is implemented in software in some measurements, and is unavailable in other measurements.

When implemented in software, the relative RF Burst trigger function is implemented as follows:

5. The measurement starts with the absolute RF Burst trigger setting. If it cannot get a trigger with that level, auto trigger fires and the acquisition starts anyway. After the acquisition, the measurement searches for the peak in the acquired waveform and saves it.
6. Now, in the next cycle of the measurement, the measurement determines a new absolute RF Burst level based on the peak value from the first measurement and the Relative RF Burst Trigger Level (always 0 or negative dB) set by the user. The following formula is used:
7. absolute RF Burst level = peak level of the previous acquisition + relative RF Burst level
8. If the new absolute RF Burst level differs from the previous by more than 0.5 dB, the new level is sent to the hardware; otherwise it is not updated (to avoid slowing down the acquisition)

Steps 2 and 3 repeat for subsequent measurements.

Key Path	Trigger, RF Burst
Scope	Meas Global
Remote Command	:TRIGger[:SEquence]:RFBurst:LEVel:RELative <rel_amp1> :TRIGger[:SEquence]:RFBurst:LEVel:RELative?
Example	TRIG:RFB:LEV:REL -10 dB sets the trigger level of the RF burst envelope signal to the relative level of -10 dB
Notes	Sending this command does not switch the setting from absolute to relative; to switch it you need to send the :TRIGger[:SEquence]:RFBurst:LEVel:TYPE command, above. The relative trigger level is not available in some measurements. In those measurements the RELative parameter, and the :TRIGger[:SEquence]:RFBurst:LEVel:TYPE command (above), will generate an error if sent.
Dependencies	This key is grayed out and Absolute Trigger Level selected if the required hardware is not present in your analyzer and the current measurement does not support Relative triggering.
Preset	-6 dB GSM: -25 dB

State Saved	Saved in instrument state
Min	-45 dB
Max	0 dB
Default Unit	dB or dBc
Backwards Compatibility SCPI	:TRIGger[:SEquence]:RFBurst:LEVel This legacy command is aliased to :TRIGger[:SEquence]:RFBurst:LEVel:RELative because the PSA had ONLY relative burst triggering
Initial S/W Revision	Prior to A.02.00
Modified at S/W Revision	A.04.00

Trigger Slope

It is set positive to trigger on a rising edge and negative to trigger on a falling edge.

Key Path	Trigger, RF Burst
Remote Command	:TRIGger[:SEquence]:RFBurst:SLOPe POSitive NEGative :TRIGger[:SEquence]:RFBurst:SLOPe?
Example	TRIG:RFB:SLOP NEG
Couplings	This same slope is used in the RF Burst selection for the trigger source in the Trigger menu and for the period timer sync source (in the Trigger menu and in the Gate Source menu).
Preset	POSitive
State Saved	Saved in instrument state
Backwards Compatibility SCPI	:TRIGger[:SEquence]:FRAME:RFBurst:SLOPe
Backwards Compatibility Notes	The legacy :TRIGger[:SEquence]:SLOPe command affects the slopes for the VID, LINE, EXT1, EXT2, and RFB triggers.
Initial S/W Revision	Prior to A.02.00

Zero Span Delay Comp On/Off

In zero span, there is a natural delay in the signal path, which comes from the RBW filter. This is usually desirable, as it allows you to trigger on events and also see those events, because the signal is delayed from the trigger event. However, in some cases it is desirable to eliminate this delay, so that trigger events line up exactly with the zero time point in zero span. You can use the **Zero Span Delay Comp On/Off** feature to enable or disable zero span delay compensation.

Key Path	Trigger, RF Burst
Remote Command	:TRIGger[:SEquence]:RFBurst:DELAy:COMPensation OFF ON 0 1 :TRIGger[:SEquence]:RFBurst:DELAy:COMPensation?
Example	TRIG:RFB:DEL:COMP ON
Dependencies	No effect except in zero-span, but not locked out in nonzero spans.

	Blanked in modes that do not support zero-span measurements. If the SCPI command is sent when the key is blanked, an error is returned: -221, "Settings conflict; Feature not supported for this measurement" In analyzers shipping N9060A, this feature requires N9060A-7FP.
Preset	OFF
State Saved	Saved in instrument state
Initial S/W Revision	A.11.00

Periodic Timer (Frame Trigger)

Pressing this key, when it is not selected, selects the internal periodic timer signal as the trigger. Triggering occurrences are set by the **Period** parameter, which is modified by the **Sync Source** and **Offset**. Pressing this key, when it is already selected, accesses the periodic timer trigger setup functions.

If you do not have a sync source selected (it is Off), then the internal timer will not be synchronized with any external timing events.

Key Path	Trigger
Example	TRIG:SOUR FRAM Swept SA measurement TRIG:<meas>:SOUR FRAM Measurements other than Swept SA
State Saved	Saved in instrument state
Readback	[Sync: <value of Sync Source>], for example, [Sync: External 1]
Status Bits/OPC dependencies	The Status Operation Register bit 5 "Waiting for Trigger" is set at the same time as the Sweeping or Measuring bit is set. It is cleared when the trigger actually occurs (that is, after the trigger event occurs and all the applicable trigger criteria have been met). A corresponding pop-up message ("Waiting for trigger") is generated if no trigger signal appears after approximately 2 sec. This message goes away when a trigger signal appears.
Initial S/W Revision	Prior to A.02.00

Periodic Timer Triggering:

This feature selects the internal periodic timer signal as the trigger. Trigger occurrences are set by the **Periodic Timer** parameter, which is modified by the **Sync Source** and **Offset**.

The figure below shows the action of the periodic timer trigger. Before reviewing the figure, we'll explain some uses for the periodic trigger.

A common application is measuring periodic burst RF signals for which a trigger signal is not easily available. For example, we might be measuring a TDMA radio which bursts every 20 ms. Let's assume that the 20 ms period is very consistent. Let's also assume that we do not have an external trigger source available that is synchronized with the period, and that the signal-to-noise ratio of the signal is not high enough to provide a clean RF burst trigger at all of the analysis frequencies. For example, we might want to measure spurious transmissions at an offset from the carrier that is larger than the bandwidth of the RF burst trigger. In this application, we can set the Periodic Timer to a 20.00 ms period and adjust the offset from that timer to position our trigger just where we want it. If we find that the 20.00 ms is not

exactly right, we can adjust the period slightly to minimize the drift between the period timer and the signal to be measured.

A second way to use this feature would be to use **Sync Source** temporarily, instead of **Offset**. In this case, we might tune to the signal in a narrow span and use the RF Burst trigger to synchronize the periodic timer. Then we would turn the sync source off so that it would not miss-trigger. Miss-triggering can occur when we are tuned so far away from the RF burst trigger that it is no longer reliable.

A third example would be to synchronize to a signal that has a reference time element of much longer period than the period of interest. In some CDMA applications, it is useful to look at signals with a short periodicity, by synchronizing that periodicity to the "even-second clock" edge that happens every two seconds. Thus, we could connect the even-second clock trigger to Ext1 and use then Ext1 as the sync source for the periodic timer.

The figure below illustrates this third example. The top trace represents the even-second clock. It causes the periodic timer to synchronize with the leading edge shown. The analyzer trigger occurs at a time delayed by the accumulated offset from the period trigger event. The periodic timer continues to run, and triggers continue to occur, with a periodicity determined by the analyzer time base. The timer output (labeled "late event") will drift away from its ideal time due to imperfect matching between the time base of the signal being measured and the time base of the analyzer, and also because of imperfect setting of the period parameter. But the synchronization is restored on the next even-second clock event. ("Accumulated offset" is described in the in the **Offset** function section.)

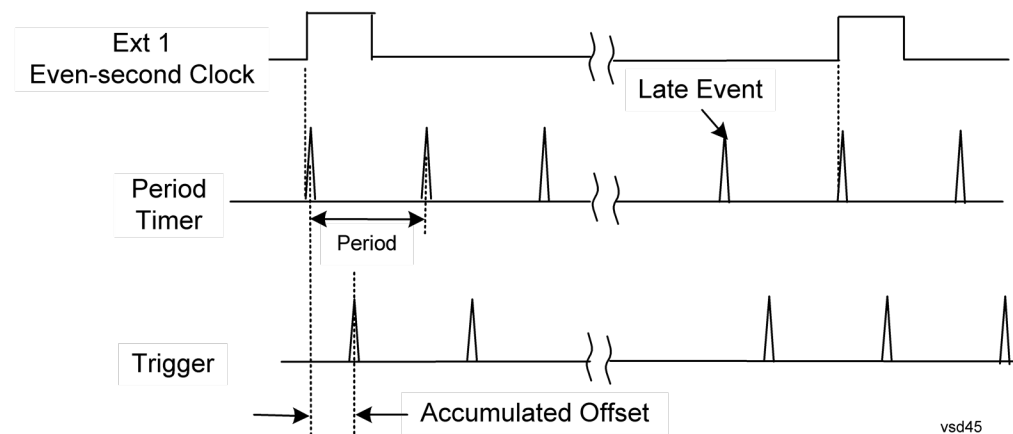

Period

Sets the period of the internal periodic timer clock. For digital communications signals, this is usually set to the frame period of your current input signal. In the case that sync source is not set to OFF, and the external sync source rate is changed for some reason, the periodic timer is synchronized at the every external synchronization pulse by resetting the internal state of the timer circuit.

Key Path	Trigger, Periodic Timer
Remote Command	:TRIGGER[:SEQUENCE]:FRAME:PERIOD <time>

	:TRIGger[:SEQuence]:FRAMe:PERiod?
Example	TRIG:FRAM:PER 100 ms
Dependencies	The invalid data indicator turns on when the period is changed, until the next sweep/measurement completes.
Couplings	The same period is used in the Gate Source selection of the period timer.
Preset	20 ms GSM: 4.615383
State Saved	Saved in instrument state
Min	100.000 ns
Max	559.0000 ms
Default Unit	S
Initial S/W Revision	Prior to A.02.00

Offset

Adjusts the accumulated offset between the periodic timer events and the trigger event. Adjusting the accumulated offset is different than setting an offset, and requires explanation.

The periodic timer is usually not synchronized with any external events, so the timing of its output events has no absolute meaning. Since the timing relative to external events (RF signals) is important, you need to be able to adjust (offset) it. However, you have no direct way to see when the periodic timer events occur. All that you can see is the trigger timing. When you want to adjust the trigger timing, you will be changing the internal offset between the periodic timer events and the trigger event. Because the absolute value of that internal offset is unknown, we will just call that the accumulated offset. Whenever the Offset parameter is changed, you are changing that accumulated offset. You can reset the displayed offset using Reset Offset Display. Changing the display does not change the value of the accumulated offset, and you can still make additional changes to accumulated offset.

To avoid ambiguity, we define that an increase in the "offset" parameter, either from the knob or the SCPI adjust command, serves to delay the timing of the trigger event.

Key Path	Trigger, Periodic Timer
Remote Command	:TRIGger[:SEQuence]:FRAMe:OFFSet <time> :TRIGger[:SEQuence]:FRAMe:OFFSet?
Example	TRIG:FRAM:OFFS 1.2 ms
Notes	The front panel interface (for example, the knob), and this command, adjust the accumulated offset, which is shown on the active function display. However, the actual amount sent to the hardware each time the offset is updated is the delta value, that is, the current accumulated offset value minus the previous accumulated offset value. Note that the accumulated offset value is essentially arbitrary; it represents the accumulated offset from the last time the offset was zeroed (with the Reset Offset Display key). Note that this command does not change the period of the trigger waveform. Note also that Offset

	is used only when the sync source is set to OFF, otherwise delay is used, see section "Trig Delay" on page 568 . An increase in the "offset" parameter, either from the knob or the SCPI adjust command, serves to delay the timing of the trigger event.
Notes	When the SCPI command is sent the value shown on the key (and the Active Function, if this happens to be the active function) is updated with the new value. However, the actual amount sent to the hardware is the delta value, that is, the current accumulated offset value minus the previous accumulated offset value. The SCPI query simply returns the value currently showing on the key.
Dependencies	The invalid data indicator turns on when the offset is changed, until the next sweep/measurement completes.
Couplings	The same offset is used in the Gate Source selection of the period timer.
Preset	0 s
State Saved	Saved in instrument state
Min	-10.000 s
Max	10.000 s
Default Unit	S
Initial S/W Revision	Prior to A.02.00

Offset Adjust (Remote Command Only)

This remote command does not work at all like the related front panel keys. This command lets you advance the phase of the frame trigger by the amount you specify.

It does not change the period of the trigger waveform. If the command is sent multiple times, it advances the phase of the frame trigger an additional amount each time it is sent. Negative numbers are permitted.

Remote Command	:TRIGger[:SEquence]:FRAMe:ADJust <time>
Example	TRIG:FRAM:ADJ 1.2 ms
Notes	Note also that Offset is used only when the sync source is set to OFF, otherwise delay is used, see section "Trig Delay" on page 568 . An increase in the "offset" parameter, either from the knob or the SCPI adjust command, serves to delay the timing of the trigger event.
Notes	The front panel interface (for example, the knob) and the :TRIG:FRAM:OFFS command adjust the accumulated offset, which is shown on the active function display. However, the actual amount sent to the hardware is the delta value, that is, the current offset value minus the previous offset value. When the SCPI command is sent the value shown on the key (and the Active Function, if this happens to be the active function) is updated by increasing it (or decreasing it if the value sent is negative) by the amount specified in the SCPI command. This is a "command only" SCPI command, with no query.
Dependencies	The invalid data indicator turns on when the offset is changed, until the next sweep/measurement completes.

Couplings	The same offset is used in the Gate Source selection of the period timer.
Preset	0 s
State Saved	Saved in instrument state
Min	-10.000 s
Max	10.000 s
Default Unit	S
Initial S/W Revision	Prior to A.02.00

Reset Offset Display

Resets the value of the periodic trigger offset display setting to 0.0 seconds. The current displayed trigger location may include an offset value defined with the **Offset** key. Pressing this key redefines the currently displayed trigger location as the new trigger point that is 0.0 s offset. The **Offset** key can then be used to add offset relative to this new timing.

Key Path	Trigger, Periodic Timer
Remote Command	:TRIGger[:SEquence]:FRAMe:OFFSet:DISPlay:RESet
Example	TRIG:FRAM:OFFS:DISP:RES
Initial S/W Revision	Prior to A.02.00

Sync Source

Selects a signal source for you to synchronize your periodic timer trigger to, otherwise you are triggering at some arbitrary location in the frame. Synchronization reduces the precision requirements on the setting of the period.

For convenience you may adjust the level and slope of the selected sync source in a conditional branch setup menu accessed from the Sync Source menu. Note that these settings match those in the **Trigger** and **Gate Source** menus; that is, each trigger source has only one value of level and slope, regardless of which menu it is accessed from.

Key Path	Trigger, Periodic Timer
Remote Command	:TRIGger[:SEquence]:FRAMe:SYNC EXTerna11 EXTerna12 RFBurst PXI OFF :TRIGger[:SEquence]:FRAMe:SYNC?
Example	TRIG:FRAM:SYNC EXT2
Dependencies	In some models, there is no second External input. In these models, the External 2 key is blanked and the EXTerna12 parameter will generate a "Hardware missing; Not available for this model number" message. PXI trigger is only supported in PXI (modular) instruments.
Preset	Off GSM/EDGE, MSR,LTE,LTETDD: RFBurst
State Saved	Saved in instrument state

Readback	The current setting is read back to this key and it is also Readback to the previous Periodic Timer trigger key.
Backwards Compatibility SCPI	:TRIGger[:SEquence]:FRAMe:SYNC EXTernal For backward compatibility, the parameter EXTernal is mapped to EXTernal1
Initial S/W Revision	Prior to A.02.00
Modified at S/W Revision	A.03.00, A.14.00

Off

Turns off the sync source for your periodic trigger. With the sync source off, the timing will drift unless the signal source frequency is locked to the analyzer frequency reference.

Key Path	Trigger, Periodic Timer, Sync Source
Example	TRIG:FRAM:SYNC OFF
Readback	Off
Initial S/W Revision	Prior to A.02.00

External 1

Pressing this key, when it is not selected, selects an external input signal as the trigger. A new sweep/measurement will start when the external trigger condition is met using the external 1 input connector on the rear panel.

Pressing this key, when it is already selected, accesses the external 1 trigger setup menu.

Key Path	Trigger
Example	TRIG:SOUR EXT1 Swept SA measurement TRIG:<meas>:SOUR EXT1 Measurements other than Swept SA
Dependencies	Grayed out if in use by Point Trigger in the Source Setup menu. Forced to Free Run if already selected and Point Trigger is set to External 1.
State Saved	Saved in instrument state
Status Bits/OPC dependencies	The Status Operation Register bit 5 "Waiting for Trigger" is set at the same time as the Sweeping or Measuring bit is set. It is cleared when the trigger actually occurs (that is, after the trigger event occurs and all the applicable trigger criteria have been met). A corresponding pop-up message ("Waiting for trigger") is generated if no trigger signal appears after approximately 2 sec. This message goes away when a trigger signal appears.
Initial S/W Revision	Prior to A.02.00

Trigger Level

Sets the value where the external 1 trigger input will trigger a new sweep/measurement.

Key Path	Trigger, External 1
Remote Command	:TRIGger[:SEquence]:EXTernal1:LEVel <level> :TRIGger[:SEquence]:EXTernal1:LEVel?
Example	TRIG:EXT1:LEV 0.4 V
Couplings	This same level is used for the Ext1 trigger source in the Trigger menu, for the Ext1 selection in the Periodic Timer sync source (in the Trigger menu and in the Gate Source menu), and also for the Ext1 selection in the Gate Source menu.
Preset	1.2 V
State Saved	Saved in instrument state
Min	-5 V
Max	5 V
Default Unit	V
Backwards Compatibility SCPI	:TRIGger[:SEquence]:EXTernal:LEVel For backward compatibility, the parameter EXTernal is mapped to EXTernal1
Backwards Compatibility SCPI	:TRIGger[:SEquence]:FRAME:EXTernal1:LEVel
Initial S/W Revision	Prior to A.02.00

Trig Slope

Controls the trigger polarity. It is set positive to trigger on a rising edge and negative to trigger on a falling edge.

Key Path	Trigger, External 1
Remote Command	:TRIGger[:SEquence]:EXTernal1:SLOPe POSitive NEGative :TRIGger[:SEquence]:EXTernal1:SLOPe?
Example	TRIG:EXT1:SLOP NEG
Couplings	This same slope is used in the Ext1 selection for the trigger source in the Trigger menu and for the period timer sync source (in the Trigger menu and in the Gate Source menu).
Preset	POSitive
State Saved	Saved in instrument state
Backwards Compatibility SCPI	:TRIGger[:SEquence]:EXTernal:SLOPe For backward compatibility, the parameter EXTernal is mapped to EXTernal1
Backwards Compatibility SCPI	:TRIGger[:SEquence]:FRAME:EXTernal1:SLOPe
Backwards Compatibility Notes	The legacy :TRIGger[:SEquence]:SLOPe command affects the slopes for the VID, LINE, EXT1, EXT2, and RFB triggers.
Initial S/W Revision	Prior to A.02.00

External 2

Pressing this key, when it is not selected, selects an external input signal as the trigger. A new sweep/measurement will start when the external trigger condition is

met using the external 2 input connector. The external trigger 2 input connector is on the rear panel.

Pressing this key, when it is already selected, accesses the external 2 trigger setup menu.

Key Path	Trigger
Example	TRIG:SOUR EXT2 Swept SA measurement TRIG:<meas>:SOUR EXT2 Measurements other than Swept SA
Dependencies	In some models, there is no second External input. In these models, the External 2 key is blanked and the EXTernal2 parameter will generate a "Hardware missing; Not available for this model number" message. Grayed out if in use by Point Trigger in the Source Setup menu. Forced to Free Run if already selected and Point Trigger is set to External 2.
State Saved	Saved in instrument state
Status Bits/OPC dependencies	The Status Operation Register bit 5 "Waiting for Trigger" is set at the same time as the Sweeping or Measuring bit is set. It is cleared when the trigger actually occurs (that is, after the trigger event occurs and all the applicable trigger criteria have been met). A corresponding pop-up message ("Waiting for trigger") is generated if no trigger signal appears after approximately 2 sec. This message goes away when a trigger signal appears.
Initial S/W Revision	Prior to A.02.00
Modified at S/W Revision	A.03.00

Trigger Level

Sets the value where the external 2 trigger input will trigger a new sweep/measurement.

Key Path	Trigger, External 2
Remote Command	:TRIGger[:SEquence]:EXTernal2:LEVel :TRIGger[:SEquence]:EXTernal2:LEVel?
Example	TRIG:EXT2:LEV 1.1 V
Couplings	This same level is used for the Ext2 trigger source in the Trigger menu, for the Ext2 selection in the Periodic Timer sync source (in the Trigger menu and in the Gate Source menu), and also for the Ext2 selection in the Gate Source menu.
Preset	1.2 V
State Saved	Saved in instrument state
Min	-5 V
Max	5 V
Default Unit	V
Backwards Compatibility SCPI	:TRIGger[:SEquence]:FRAME:EXTernal2:LEVel
Initial S/W Revision	Prior to A.02.00

Trig Slope

Controls the trigger polarity. It is set positive to trigger on a rising edge and negative to trigger on a falling edge.

Key Path	Trigger, External 2
Remote Command	:TRIGger[:SEQuence]:EXTerna12:SLOPe POSitive NEGative :TRIGger[:SEQuence]:EXTerna12:SLOPe?
Example	TRIG:EXT2:SLOP NEG
Couplings	This same slope is used in the Ext2 selection for the trigger source in the Trigger menu and for the period timer sync source (in the Trigger menu and in the Gate Source menu).
Preset	POSitive
State Saved	Saved in instrument state
Backwards Compatibility SCPI	:TRIGger[:SEQuence]:FRAMe:EXTerna12:SLOPe
Backwards Compatibility Notes	The legacy :TRIGger[:SEQuence]:SLOPe command affects the slopes for the VID, LINE, EXT1, EXT2, and RFB triggers.
Initial S/W Revision	Prior to A.02.00

RF Burst

Pressing this key, when it is not selected, selects the RF Burst as the trigger. A new sweep/measurement will start when an RF burst envelope signal is identified from the signal at the RF Input connector. Pressing this key, when it is already selected, accesses the RF Burst trigger setup menu.

In some models, a variety of burst trigger circuitry is available, resulting in various available burst trigger bandwidths. The analyzer automatically chooses the appropriate trigger path based on the hardware configuration and other settings of the analyzer.

Key Path	Trigger
Example	TRIG:SOUR RFB Swept SA measurement TRIG:<meas>:SOUR RFB Measurements other than Swept SA
State Saved	Saved in instrument state
Status Bits/OPC dependencies	The Status Operation Register bit 5 "Waiting for Trigger" is set at the same time as the Sweeping or Measuring bit is set. It is cleared when the trigger actually occurs (that is, after the trigger event occurs and all the applicable trigger criteria have been met). A corresponding pop-up message ("Waiting for trigger") is generated if no trigger signal appears after approximately 2 sec. This message goes away when a trigger signal appears.
Backwards Compatibility Notes	The legacy command: :TRIGger[:SEQuence]:RFBurst:FSElectivity[:STATe] OFF ON 0 1 is not supported in the X-Series, as the hardware to do Frequency Selective burst triggers does not exist in X-Series.
Initial S/W Revision	Prior to A.02.00
Modified at S/W Revision	A.04.00

Absolute Trigger Level

Sets the absolute trigger level for the RF burst envelope.

When using the External Mixing path, the Absolute Trigger Level is uncalibrated because the factory default was set to accommodate the expected IF levels for the RF path.

Key Path	Trigger, RF Burst
Scope	Meas Global
Remote Command	<code>:TRIGger[:SEquence]:RFBurst:LEVel:ABSolute <ampl></code> <code>:TRIGger[:SEquence]:RFBurst:LEVel:ABSolute?</code>
Example	TRIG:RFB:LEV:ABS 10 dBm sets the trigger level of the RF burst envelope signal to the absolute level of 10 dBm
Notes	<p>Sending this command does not switch the setting from relative to absolute; to switch it you need to send the <code>:TRIGger[:SEquence]:RFBurst:LEVel:TYPE</code> command, below.</p> <p>Amplitude Corrections are not taken into account by the Absolute Trigger Level. For example, if you have given yourself effective gain with an amplitude correction factor, the Absolute Trigger will not fire until you have set the trigger level that far below the displayed signal level, rather than simply to the displayed signal level. This is only true for Amplitude Corrections, not External Gain or Ref Level Offset functions.</p> <p>If mode is Bluetooth, the default value is -50 dBm.</p>
Couplings	This same level is used for the RF Burst trigger source in the Trigger menu, for the RF Burst selection in the Periodic Timer sync source (in the Trigger menu and in the Gate Source menu), and also for the RF Burst selection in the Gate Source menu
Preset	-20 dBm
State Saved	Saved in instrument state
Min	-200 dBm
Max	100 dBm
Default Unit	depends on the current selected Y-Axis unit
Backwards Compatibility SCPI	<code>:TRIGger[:SEquence]:FRAMe:RFBurst:LEVel:ABSolute</code>
Initial S/W Revision	Prior to A.02.00
Modified at S/W Revision	A.04.00

Key Path	Trigger, RF Burst
Remote Command	<code>:TRIGger[:SEquence]:RFBurst:LEVel:TYPE ABSolute RELative</code> <code>:TRIGger[:SEquence]:RFBurst:LEVel:TYPE?</code>
Example	TRIG:RFB:LEV:TYPE REL sets the trigger level type of the RF burst trigger to Relative.
Preset	ABSolute

State Saved	Saved in instrument state
Initial S/W Revision	Prior to A.02.00
Modified at S/W Revision	A.04.00

Relative Trigger Level

Sets the relative trigger level for the RF burst envelope.

In some models, the relative burst trigger function is implemented in hardware. In other models, without the advanced triggering hardware required, the relative burst trigger function is implemented in software in some measurements, and is unavailable in other measurements.

When implemented in software, the relative RF Burst trigger function is implemented as follows:

5. The measurement starts with the absolute RF Burst trigger setting. If it cannot get a trigger with that level, auto trigger fires and the acquisition starts anyway. After the acquisition, the measurement searches for the peak in the acquired waveform and saves it.
6. Now, in the next cycle of the measurement, the measurement determines a new absolute RF Burst level based on the peak value from the first measurement and the Relative RF Burst Trigger Level (always 0 or negative dB) set by the user. The following formula is used:
7. absolute RF Burst level = peak level of the previous acquisition + relative RF Burst level
8. If the new absolute RF Burst level differs from the previous by more than 0.5 dB, the new level is sent to the hardware; otherwise it is not updated (to avoid slowing down the acquisition)

Steps 2 and 3 repeat for subsequent measurements.

Key Path	Trigger, RF Burst
Scope	Meas Global
Remote Command	:TRIGger[:SEquence]:RFBurst:LEVel:RELative <rel_amp1> :TRIGger[:SEquence]:RFBurst:LEVel:RELative?
Example	TRIG:RFB:LEV:REL -10 dB sets the trigger level of the RF burst envelope signal to the relative level of -10 dB
Notes	Sending this command does not switch the setting from absolute to relative; to switch it you need to send the :TRIGger[:SEquence]:RFBurst:LEVel:TYPE command, above. The relative trigger level is not available in some measurements. In those measurements the RELative parameter, and the :TRIGger[:SEquence]:RFBurst:LEVel:TYPE command (above), will generate an error if sent.

Dependencies	This key is grayed out and Absolute Trigger Level selected if the required hardware is not present in your analyzer and the current measurement does not support Relative triggering.
Preset	-6 dB GSM: -25 dB
State Saved	Saved in instrument state
Min	-45 dB
Max	0 dB
Default Unit	dB or dBc
Backwards Compatibility SCPI	:TRIGger[:SEQuence]:RFBurst:LEVel This legacy command is aliased to :TRIGger[:SEQuence]:RFBurst:LEVel:RELative because the PSA had ONLY relative burst triggering
Initial S/W Revision	Prior to A.02.00
Modified at S/W Revision	A.04.00

Trigger Slope

It is set positive to trigger on a rising edge and negative to trigger on a falling edge.

Key Path	Trigger, RF Burst
Remote Command	:TRIGger[:SEQuence]:RFBurst:SLOPe POSitive NEGative :TRIGger[:SEQuence]:RFBurst:SLOPe?
Example	TRIG:RFB:SLOP NEG
Couplings	This same slope is used in the RF Burst selection for the trigger source in the Trigger menu and for the period timer sync source (in the Trigger menu and in the Gate Source menu).
Preset	POSitive
State Saved	Saved in instrument state
Backwards Compatibility SCPI	:TRIGger[:SEQuence]:FRAME:RFBurst:SLOPe
Backwards Compatibility Notes	The legacy :TRIGger[:SEQuence]:SLOPe command affects the slopes for the VID, LINE, EXT1, EXT2, and RFB triggers.
Initial S/W Revision	Prior to A.02.00

Zero Span Delay Comp On/Off

In zero span, there is a natural delay in the signal path, which comes from the RBW filter. This is usually desirable, as it allows you to trigger on events and also see those events, because the signal is delayed from the trigger event. However, in some cases it is desirable to eliminate this delay, so that trigger events line up exactly with the zero time point in zero span. You can use the **Zero Span Delay Comp On/Off** feature to enable or disable zero span delay compensation.

Key Path	Trigger, RF Burst
----------	-------------------

Remote Command	:TRIGger[:SEquence]:RFBurst:DElay:COMPensation OFF ON 0 1 :TRIGger[:SEquence]:RFBurst:DElay:COMPensation?
Example	TRIG:RFB:DEL:COMP ON
Dependencies	No effect except in zero-span, but not locked out in nonzero spans. Blanked in modes that do not support zero-span measurements. If the SCPI command is sent when the key is blanked, an error is returned: -221, "Settings conflict; Feature not supported for this measurement" In analyzers shipping N9060A, this feature requires N9060A-7FP.
Preset	OFF
State Saved	Saved in instrument state
Initial S/W Revision	A.11.00

TV

Pressing this key, when it is not selected, selects the TV input signal as the trigger. A new sweep/measurement will start synchronized with the next occurrence of the synchronizing pulse of the selected TV line number.

Pressing this key, when it is already selected, opens a menu of TV Trigger setup functions. The default active function in this menu is the TV line number on which you want to trigger.

The Frame and Field options enable you to determine how the fields of the TV picture signal will be affected by the trigger system. One complete TV image consists of one frame of 525 or 625 horizontal lines depending on the TV standard being used. Each frame is composed of two fields of interlacing lines, each consisting of 262 1/2 lines (or 312 1/2 lines). The fields are called Field One and Field Two. Field One is viewed as having 263 lines (or 313 lines) and Field Two is viewed as having 262 lines (or 312 lines).

For the 525 line NTSC video standard, we refer to TV lines as follows (these are the Field Modes):

Entire Frame, lines 1 to 525

Field One, lines 1 to 263

Field Two, lines 1 to 262 (note that this really refers to "actual" lines 264 to 525)

For the 625 line PAL and SECAM video standards, we refer to TV lines as follows:

Entire Frame, lines 1 to 625

Field One, lines 1 to 313

Field Two, lines 314 to 625

As the Field is changed, the appropriate value for Line is chosen to keep triggering on the same line as before, or if this is not possible, the corresponding line in the new Field. For example, suppose line 264 is selected while in the NTSC-M standard and the Entire Frame mode. This is the first line in Field Two. If Field Two is then selected, the Line number changes to Line 1, the same actual line in the TV signal. If Field One

is then selected, the line number stays at 1, but now we are triggering in the first line in Field One. The only exception to this is if we are on the last line of Field One and change to Field Two. In this case, we go to the last line in Field Two.

Key Path	Trigger
Example	TRIG:SOUR TV Swept SA measurement TRIG:<meas>:SOUR TV Measurements other than Swept SA
Dependencies	This key only appears in Modes which support TV Trigger, otherwise the key is blanked. If the SCPI command is sent while the key is blanked, an error is returned.
Readback	This key displays the value read back from TV Line
Status Bits/OPC dependencies	The Status Operation Register bit 5 "Waiting for Trigger" is set at the same time as the Sweeping or Measuring bit is set. It is cleared when the trigger actually occurs (that is, after the trigger event occurs and all the applicable trigger criteria have been met). A corresponding pop-up message ("Waiting for trigger") is generated if no trigger signal appears after approximately 2 sec. This message goes away when a trigger signal appears.
Initial S/W Revision	Prior to A.02.00

TV Line

Selects the TV line number to trigger on. Line number range is dependent on the settings of the **Standard** and **Field** menus within the TV trigger setup functions. When the line number is incremented beyond the upper limit, the value will change to the lower limit and continue incrementing from there. When the line number is decremented below the lower limit, the value will change to the upper limit and continue decrementing from there.

Key Path	Trigger, TV
Remote Command	:TRIGger[:SEquence]:TV:LINE <integer> :TRIGger[:SEquence]:TV:LINE?
Example	TRIG:TV:LINE 20 TRIG:TV:LINE?
Notes	The range of the TV line number is dependent on the settings of the Standard and Field menus within the TV trigger setup functions.
Preset	17
State Saved	Saved in instrument state
Min	The minimum value is the minimum line, and rolls over to the maximum value. The minimum line number depends on which Field and standard are selected.
Max	The maximum value is the maximum line, and rolls over to the minimum value. The maximum line number depends on which Field and standard are selected.
Initial S/W Revision	Prior to A.02.00

Field

Accesses the menu to select the field.

Key Path	Trigger, TV
----------	--------------------

Remote Command	:TRIGger[:SEquence]:TV:FMODe ENTire ODD EVEN :TRIGger[:SEquence]:TV:FMODe?
Example	TRIG:TV:FMOD EVEN
Notes	ODD is Field 1 EVEN is Field 2
Dependencies	This command is available only when Option B7B (TV trigger) is installed.
Preset	ENTire
Readback	Displays the Readback value
Initial S/W Revision	Prior to A.02.00

Entire Frame

When you select Entire Frame it causes the selected line number to be viewed as an offset into the entire frame starting with line 1, the first line in Field One.

Key Path	Trigger, TV, Field
Example	TRIG:TV:FMOD ENT
Min	1, for all formats.
Max	525, for formats NTSC-M, NTSC-Japan, NTSC-4.43, PAL-M and PAL-60 625, for formats PAL-B, D, G, H, I, PAL-N, PAL-N Combin, and SECAM-L.
Readback	Entire Frame
Initial S/W Revision	Prior to A.02.00

Field One

When you select Field One it causes the selected line number to be viewed as an offset into the first field starting with Line 1, the first line in Field One.

Key Path	Trigger, TV, Field
Example	TRIG:TV:FMOD ODD
Min	Field 1 (ODD) The minimum line is 1
Max	Field 1 (ODD) Maximum line is 263 for formats NTSC-M, NTSC-Japan, NTSC-4.43, PAL-M and PAL-60 Maximum line is 313 for formats PAL-B, D, G, H, I, PAL-N, PAL-N Combin, and SECAM-L.
Readback	Field 1
Initial S/W Revision	Prior to A.02.00

Field Two

When you select Field Two it causes the selected line number to be viewed as an offset into the second field. If Line 1 is selected, it is the 264th line of the frame (NTSC-M, NTSC-Japan, NTSC-4.43, PAL-M, PAL-60) or the 314th line of the frame (PAL-B,D,G,H,I, PAL-N, PAL-N-Combin, SECAM-L).

Key Path	Trigger, TV, Field
Example	TRIG:TV:FMODE EVEN
Min	Field 2 (EVEN) The minimum line is 1
Max	Field 2 (EVEN) The maximum line 262 for formats NTSC-M, NTSC-Japan, NTSC-4.43, PAL-M and PAL-60 The maximum line is 312 for formats PAL-B, D, G, H, I, PAL-N, PAL-N Combin, and SECAM-L
Readback	Field 2
Initial S/W Revision	Prior to A.02.00

Standard

Accesses the Standard menu keys which select from the following TV standards: **NTSC-M, NTSC-Japan, NTSC-4.43, PAL-M, PAL-B,D,G,H,I, PAL-N, PAL-N-Combin, PAL-60, SECAM-L.**

As the TV standard is changed, the current line value is clipped as necessary to keep it valid for the chosen standard and field mode. For example, line 600 is selected in Entire Frame mode in PAL-N; if NTSC-M is selected, the line number is clipped to 525. Or, if line 313 is selected in Field 1 mode in PAL-N and NTSC-M is selected, the line number is clipped to 263. Changing back to the PAL-N standard will leave the line number at 263.

Key Path	Trigger, TV
Remote Command	:TRIGger[:SEquence]:TV:STANdard MNTSc JNTSc NTSC443 MPAL BPAL NPAL CPAL PAL60 LSEC :TRIGger[:SEquence]:TV:STANdard?
Example	TRIG:TV:STAN MPAL TRIG:TV:STAN?
Preset	MNTS
State Saved	Saved in instrument state
Readback	Displays Readback value
Initial S/W Revision	Prior to A.02.00

NTSC-M

Sets the TV standard to NTSC-M.

Key Path	Trigger, TV, Standard
Example	TRIG:TV:STAN MNTS
Readback	NTSC-M
Initial S/W Revision	Prior to A.02.00

NTSC-Japan

Sets the TV standard to **NTSC-Japan**.

Key Path	Trigger, TV, Standard
Example	TRIG:TV:STAN JNTS
Readback	NTSC-Japan
Initial S/W Revision	Prior to A.02.00

NTSC-4.43

Sets the TV standard to **NTSC-4.43**.

Key Path	Trigger, TV, Standard
Example	TRIG:TV:STAN NTSC443
Readback	NTSC-Japan
Initial S/W Revision	Prior to A.02.00

PAL-M

Sets the TV standard to **PAL-M**.

Key Path	Trigger, TV, Standard
Example	TRIG:TV:STAN MPAL
Readback	PAL-M
Initial S/W Revision	Prior to A.02.00

PAL-N

Sets the TV standard to **PAL-N**.

Key Path	Trigger, TV, Standard
Example	TRIG:TV:STAN NPAL
Readback	PAL-N
Initial S/W Revision	Prior to A.02.00

PAL-N-Combin

Sets the TV standard to **PAL-N-Combin**.

Key Path	Trigger, TV, Standard
Example	TRIG:TV:STAN CPAL
Readback	PAL-N-C
Initial S/W Revision	Prior to A.02.00

PAL-B,D,G,H,I

Sets the TV standard to **PAL-B,D,G,H,I**

Key Path	Trigger, TV, Standard
Example	TRIG:TV:STAN BPAL
Readback	PAL-B
Initial S/W Revision	Prior to A.02.00

PAL-60

Sets the TV standard to **PAL-60**.

Key Path	Trigger, TV, Standard
Example	TRIG:TV:STAN PAL60
Readback	PAL-N
Initial S/W Revision	Prior to A.02.00

SECAM-L

Sets the TV standard to **SECAM-L**.

Key Path	Trigger, TV, Standard
Example	TRIG:TV:STAN LSEC
Readback	SECAM-L
Initial S/W Revision	Prior to A.02.00

Control Edge/Level

Sets the method of controlling the gating function from the gating signal.

Edge

In Edge triggering, the gate opens (after the Delay) on the selected edge (for example, positive) of the gate signal and closes on the alternate edge (for example, negative).

Level

In Level triggering, the gate opens (after the Delay) when the gate signal has achieved a certain level and stays open as long as that level is maintained.

Key Path	Sweep/Control, Gate
Remote Command	[:SENSe] :SWEep:EGATe:CONTRo1 EDGE LEVe1 [:SENSe] :SWEep:EGATe:CONTRo1?
Example	SWE:EGAT:CONT EDGE
Dependencies	If the Gate Method is FFT the Control key is grayed out and Edge is selected. If the Gate Source is TV, Frame or Line, the Control key is grayed out and Edge is selected.
Preset	EDGE
State Saved	Saved in instrument state
Backwards Compatibility SCPI	[:SENSe] :SWEep:TIME:GATE:TYPE ESA Compatibility

Initial S/W Revision Prior to A.02.00

Gate Holdoff

Lets you increase or decrease the wait time after a gate event ends before the analyzer will respond to the next gate signal.

After any Gate event finishes, the analyzer must wait for the sweep system to settle before it can respond to another Gate signal. The analyzer calculates a "wait time," taking into account a number of factors, including RBW and Phase Noise Optimization settings. The goal is to achieve the same accuracy when gated as in ungated operation. The figure below illustrates this concept:

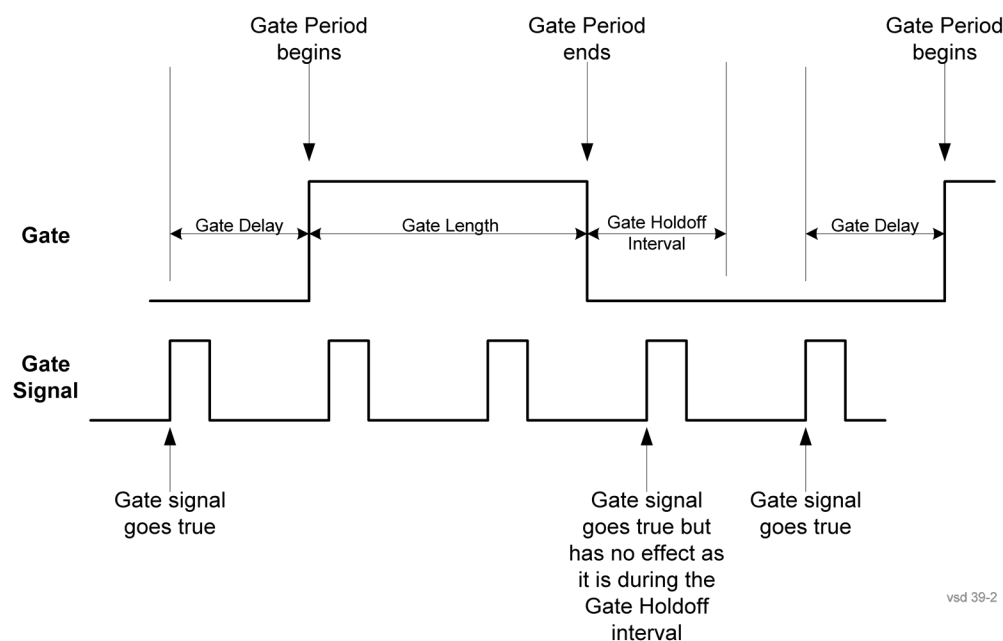

When Gate Holdoff is in Auto, the wait time calculated by the analyzer is used. When Gate Time is in Manual, the user may adjust the wait time, usually decreasing it in order to achieve greater speed, but at the risk of decreasing accuracy.

When the **Method** key is set to **Video** or **FFT**, the **Gate Holdoff** function has no effect.

In measurements that do not support Auto, the value shown when Auto is selected is "---" and the manually set holdoff is returned to a query.

Key Path	Sweep/Control, Gate
Remote Command	[:SENSe]:SWEep:EGATe:HOLDoff <time> [:SENSe]:SWEep:EGATe:HOLDoff? [:SENSe]:SWEep:EGATe:HOLDoff:AUTO OFF ON 0 1 [:SENSe]:SWEep:EGATe:HOLDoff:AUTO?
Example	SWE:EGAT:HOLD 0.0002 SWE:EGAT:HOLD?

	SWE:EGAT:HOLD:AUTO ON SWE:EGAT:HOLD:AUTO?
Couplings	<p>When Gate Holdoff is Auto, the Gate Holdoff key shows the value calculated by the analyzer for the wait time.</p> <p>Pressing the Gate Holdoff key while it is in Auto and not selected, causes the key to become selected and allows the user to adjust the value. If the value is adjusted, the setting changes to Man.</p> <p>Pressing the Gate Holdoff key, while it is in Auto and selected, does not change the value of Gate Holdoff, but causes the setting to change to Man. Now the user can adjust the value.</p> <p>Pressing the key while it is in Man and selected, cause the value to change back to Auto.</p> <p>Pressing the key while it is in Man and not selected, causes the key to become selected and allows the user to adjust the value.</p> <p>When Method is set to Video or FFT, the Gate Holdoff function has no effect.</p>
Preset	Auto Auto/On
State Saved	Saved in instrument state
Min	1 μ sec
Max	1 sec
Initial S/W Revision	Prior to A.02.00

Gate Delay Compensation

This function allows you to select an RBW-dependent value by which to adjust the gate delay, to compensate for changes in the delay caused by RBW effects.

You can select between uncompensated operation and two types of compensation, **Delay Until RBW Settled** and **Compensate for RBW Group Delay**.

See "[More Information](#)" on page 1871

Key Path	Sweep/Control, Gate
Scope	Meas Global
Remote Command	[:SENSe] :SWEep:EGATe:DELay:COMPensation:TYPE OFF SETTled GDELay [:SENSe] :SWEep:EGATe:DELay:COMPensation:TYPE?
Example	SWE:EGAT:DEL:COMP:TYPE SETT SWE:EGAT:DEL:COMP:TYPE?
Notes	<p>Although this function is Meas Global, there are some measurements that do not support this function. In those measurements the operation will be Uncompensated. Going into one of those measurements will not change the Meas Global selection; it will simply display the grayed-out menu key with "Uncompensated" showing as the selection. This is a non-forceful grayout, so the SCPI command is still accepted.</p> <p>If Gate Delay Compensation is not supported at all within a particular mode, the key is not displayed, and if the SCPI command is sent while in a measurement within that mode, an "Undefined Header" message is generated.</p> <p>Measurements that do not support this function include:</p>

	Swept SA
Preset	TD-SCDMA mode: Compensate for RBW Group Delay All other modes: Delay Until RBW Settled
State Saved	Saved in instrument state
Range	Uncompensated Delay Until RBW Settled Compensate for RBW Group Delay
Readback text	Uncompensated Settled Group Delay
Initial S/W Revision	Prior to A.02.00
Modified at S/W Revision	A.11.0

More Information

Selecting **Uncompensated** means that the actual gate delay is as you sets it.

Selecting **Delay Until RBW Settled** causes the gate delay to be increased above the user setting by an amount equal to $3.06/\text{RBW}$. This compensated delay causes the GATE START and GATE STOP lines on the display to move by the compensation amount, and the actual hardware gate delay to be increased by the same amount. All the other gate lines (for example, MIN FAST) are unaffected. If the RBW subsequently changes, the compensation is readjusted for the new RBW. The value shown on the **Gate Delay** key does NOT change.

Delay Until RBW Settled allows excellent measurements of gated signals, by allowing the IF to settle following any transient that affects the burst. Excellent measurements also require that the analysis region not extend into the region affected by the falling edge of the burst. Thus, excellent measurements can only be made over a width that declines with narrowing RBWs, which is achieved by decreasing the gate length below the user setting by an amount equal to $2.53/\text{RBW}$. Therefore, for general purpose compensation, you will still want to change the gate length with changes in RBW even if the gate delay is compensated. The compensated Gate Length is limited by the analyzer so that it will never go below 10% of the value shown on the Gate Length key, as otherwise the sweep times could get very long. Anytime the **Gate Length and RBW** values combine in such a way that this limiting takes place, a warning is displayed . For measurements which contain multiple sweeps with different RBW like SEM and SPUR, the smallest RBW is used for this limiting.

Selecting **Compensate for RBW Group Delay** causes the gate delay to be increased above the user setting by an amount equal to $1.81/\text{RBW}$. This compensated delay causes the GATE START, GATE STOP lines on the display to move by the compensation amount, and the actual hardware gate delay to be increased by the same amount. All the other gate lines (for example, MIN FAST) are unaffected. If the RBW subsequently changes, the compensation is readjusted for the new RBW. The value shown on the **Gate Delay** key does NOT change. **Compensate for RBW Group Delay** also includes gate length compensation; the gate length itself is adjusted as necessary to attempt to compensate for delay effects imposed by the RBW.

Compensate for RBW Group Delay is similar to **Delay Until RBW Settled** , but compensates for the group delay of the RBW filter, rather than the filter settling

time. As the RBW gets narrow, this can allow the settling tail of the RBW to affect the beginning part of the gated measurement, and allow the beginning of the RBW settling transient to affect the end of the gated measurement. These two effects are symmetric because the RBW response is symmetric. Because the gate length is not automatically compensated, some users might find this compensation to be more intuitive than compensation for RBW settling.

Min Fast Position Query (Remote Command Only)

This command queries the position of the MIN FAST line, relative to the delay reference (REF) line. See section "[Gate View On/Off](#)" on page 2806. If this query is sent while not in gate view, the MinFast calculation is performed based on the current values of the appropriate parameters and the result is returned. Knowing this value lets you set an optimal gate delay value for the current measurement setup.

Remote Command	<code>[:SENSe] :SWEep:EGATe:MINFast?</code>
Example	<code>SWE:EGAT:MIN?</code>
Initial S/W Revision	Prior to A.02.00

Gate Preset (Remote Command Only)

Presets the time-gated spectrum analysis capability.

This command sets gate parameter values to the ESA preset values, as follows:

Gate trigger type = edge

Gate polarity = positive

Gate delay = 1 us

Gate length = 1 us

Remote Command	<code>[:SENSe] :SWEep:TIME:GATE:PRESet ESA Compatibility</code>
Initial S/W Revision	Prior to A.02.00

Gate Level (Remote Command Only)

Sets the gate input transition point level for the external TRIGGER inputs on the front and rear panel. This is a legacy command for PSA compatibility. It is simply an alias to the equivalent trigger level command.

Remote Command	<code>[:SENSe] :SWEep:EGATe:EXTernal[1] 2:LEVel <voltage></code> <code>[:SENSe] :SWEep:EGATe:EXTernal[1] 2:LEVel?</code>
Notes	This command is simply an alias to <code>:TRIGger[:SEQUence]:EXTernal[1]2:LEVel</code>
Initial S/W Revision	Prior to A.02.00

Gate Polarity (Remote Command Only)

Sets the polarity for the gate signal. This setup is now done using the gate trigger's slope setting.

When Positive (Pos) is selected, a positive-going edge (Edge) or a high voltage (Level) will satisfy the gate condition, after the delay set with the Gate Delay key. When Negative (Neg) is selected, a negative-going edge (Edge) or a low voltage (Level) will satisfy the gate condition after the delay.

Remote Command	<code>[:SENSe] :SWEep:EGATe:POLarity NEGative POSitive</code> <code>[:SENSe] :SWEep:EGATe:POLarity?</code>
Example	SWE:EGAT:POL NEG SWE:EGAT:POL?
Preset	POSitive
State Saved	Saved in instrument state
Backwards Compatibility SCPI	[:SENSe] :SWEep:TIME:GATE:POLarity ESA compatibility
Initial S/W Revision	Prior to A.02.00

Remote Command	<code>[:SENSe] :SWEep:TIME:GATE:LEVe1 HIGH LOW</code> <code>[:SENSe] :SWEep:TIME:GATE:LEVe1?</code> ESA compatibility
Preset	HIGH
Initial S/W Revision	Prior to A.02.00

Points

Sets the number of points per sweep, from 1 to 20001. The sweep time resolution setting will depend on the number of points selected.

Key Path	Sweep/Control
Mode	SA, WCDMA, C2K, WIMAX OFDMA, TD-SCDMA, 1xEVDO, DVB-T/H, DTMB (CTTB), ISDB-T, CMMB, LTE, LTETDD, Digital Cable TV, MSR, LTEAFDD, LTEATDD
Remote Command	<code>[:SENSe] :ACPower:SWEep:POINts <integer></code> <code>[:SENSe] :ACPower:SWEep:POINts?</code>
Example	ACP:SWE:POIN 500 ACP:SWE:POIN?
Notes	Whenever the number of sweep points changes: <ul style="list-style-type: none"> - All trace data is erased - Any traces with Update Off will also go to Display Off (like going from View to Blank in the older analyzers)

- Sweep time is re-quantized
- Any limit lines that are on will be updated
- If averaging/hold is on, averaging/hold starts over

Dependencies	This parameter is automatically calculated and not configurable when Meas Method is set to Fast Power.
Couplings	Whenever the number of sweep points changes, the sweep time is re-quantized.
Preset	Others: 1001 DVB-T/H:2001 DTMB (CTTB): 2001 ISDB-T: 2001 CMMB: 2001 Digital Cable TV: 2001
State Saved	Saved in instrument state.
Min	1
Max	20001
Initial S/W Revision	Prior to A.02.00
Modified at S/W Revision	A.02.00, A.03.00

System

See "System" on page 431

Trace/Detector

Accesses a menu of functions that enable you to control the detectors for the current measurement.

Key Path	Front-panel key
Initial S/W Revision	Prior to A.02.00

Select Trace (Front-panel Only)

This key selects which trace the other parameters under the Trace/Detector menu will apply to.

Key Path	Trace/Detector
Notes	Front-panel only.
Couplings	When Meas Method is RBW, FAST or Fast Power, Select Trace is disabled.
Preset	1
State Saved	Saved in instrument state.
Range	1 2 3
Initial S/W Revision	Prior to A.02.00

Trace Type

Allows you to select the type of trace for the current measurement. The first page of this menu contains a selection of the trace type (Clear Write, Trace Average, Max Hold, Min Hold) for the selected trace.

Key Path	Trace/Detector
Mode	SA, WCDMA, C2K, WIMAX OFDMA, TD-SCDMA, 1xEVDO, DVB-T/H, DTMB (CTTB), ISDB-T, CMMB, LTE, LTETDD, Digital Cable TV, MSR, LTEAFDD, LTEATDD
Remote Command	:TRACe[1] 2 3:ACPower:TYPE WRITe AVERAge MAXHold MINHold :TRACe[1] 2 3:ACPower:TYPE?
Example	TRAC:ACP:TYPE MINH TRAC:ACP:TYPE?
Notes	WRITe = Clear Write AVERAge = Average MAXHold = Maximum Hold MINHold = Minimum Hold
Couplings	When Detector setting is "Auto" ([:SENSE]:ACPower:DETECTOR:AUTO?), Detector is set to what the Radio Standard defaults states (see detector section below) for all conditions of Trace Type and for all traces. When set to Manual, all Traces use the same detector type. When Average State = Off then Trace Types AVERAge, MaxHold and MinHold will not function, since Averaging is required to be 'on' for them to operate. When Meas Method is RBW or FAST, Trace Type is disabled.

Preset	AVERage
State Saved	Saved in instrument state.
Initial S/W Revision	Prior to A.02.00
Modified at S/W Revision	A.02.00, A.03.00

View/Blank

Enables you to select how to view the displayed trace.

Key Path	Trace/Detector
Mode	SA,WCDMA, C2K, WIMAX OFDMA, TD-SCDMA, 1xEVDO, DVB-T/H, DTMB (CTTB), ISDB-T, CMMB, LTE, LTETDD, Digital Cable TV, MSR, LTEAFDD,LTEATDD
Notes	No remote control. Front panel only.
Couplings	The four states of this 1-of-N actually set two variables, Update and Display, to their four possible combinations. Trace On: Update and Display both On View: Update Off and Display On (Not implemented) Blank: Update Off and Display Off Background: Update On, Display Off (Not implemented) See tables below for detail on remote commands to control these two variables. Selecting a trace type (Clear Write, Trace Average, Max Hold, Min Hold) for a trace (pressing the key or sending the equivalent remote command) puts the trace in 'Trace On' state (Update On and Display On), even if that trace type was already selected. When Meas Method is RBW or FAST, this key is grayed out.
Preset	Trace On
State Saved	Saved in instrument state.
Range	Trace On Blank
Initial S/W Revision	Prior to A.02.00
Modified at S/W Revision	A.03.00

Key Path	Trace/Detector
Mode	WCDMA, C2K, WIMAX OFDMA, TD-SCDMA, 1xEVDO, DVB-T/H, DTMB (CTTB), ISDB-T, CMMB, LTE, LTETDD, Digital Cable TV, MSR, LTEAFDD,LTEATDD
Remote Command	:TRACe[1] 2 3:ACPpower:UPDate[:STATe] ON OFF 0 1 :TRACe[1] 2 3:ACPpower:UPDate[:STATe]?
Example	TRAC:ACP:UPD ON TRAC:ACP:UPD?
Couplings	Whenever you set Update to On for any trace, the Display is set to On for that trace. When Meas Method is RBW or FAST, Trace Update is disabled.
Preset	1 0 0 (On for Trace 1; Off for 2 &3)

State Saved	Saved in instrument state.
Range	0 1
Initial S/W Revision	Prior to A.02.00
Modified at S/W Revision	A.03.00
<hr/>	
Key Path	Trace/Detector
Mode	WCDMA, C2K, WIMAX OFDMA, TD-SCDMA, 1xEVDO, DVB-T/H, DTMB (CTTB), ISDB-T, CMMB, LTE, LTETDD, Digital Cable TV, MSR, LTEAFDD, LTEATDD
Remote Command	:TRACe[1] 2 3:ACPpower:DISPlay[:STATe] ON OFF 0 1 :TRACe[1] 2 3:ACPpower:DISPlay[:STATe]?
Example	TRAC:ACP:DISP ON TRAC:ACP:DISP?
Couplings	Whenever you set Update to On for any trace, the Display is set to On for that trace. When Meas Method is RBW or FAST, Trace Display is disabled.
Preset	1 0 0 (On for Trace 1; Off for 2 & 3)
State Saved	Saved in instrument state.
Range	0 1
Initial S/W Revision	Prior to A.02.00
Modified at S/W Revision	A.03.00

Detector

Accesses a menu of functions that enables you to control the detectors for the current measurement. Allows up to three (3) traces, but each use the same detector type choice. The following choices are available:

- Auto– the detector selected is set to AVERage, unless the Radio Standard defaults state otherwise e.g. it is set to Peak for Radio Standard = PDC when Device = both MS and BTS, and when Radio Standard = NADC and Device = MS.
- Normal–the detector determines the peak of the CW-like signals, and it yields alternating maximums and minimums of noise-like signals. This is also referred to as Rosenfell detection.
- Average–the detector determines the average of the signal within the sweep points. The averaging method is Power (RMS).
- Peak–the detector determines the maximum of the signal within the sweep points.

- Sample—the detector indicates the instantaneous level of the signal at the center of the sweep points represented by each display point.
- Negative Peak—the detector determines the minimum of the signal within the sweep points.

In swept analysis, the time interval of the data collection for the display sweep points also represents a frequency interval. In FFT analysis, the sweep points represents just a frequency interval. The detector determines the relationship between the spectrum computed by the FFT and the single data point displayed for the sweep points. When Meas Method is Fast Power, Auto, Peak and Average are selectable.

Key Path	Trace/Detector
Initial S/W Revision	Prior to A.02.00

Auto

Sets the detector for the currently selected trace to auto.

Key Path	Trace/Detector
Mode	SA, WCDMA, C2K, WIMAX OFDMA, TD-SCDMA, 1xEVDO, DVB-T/H, DTMB (CTTB), ISDB-T, CMMB, LTE, LTETDD, Digital Cable TV, MSR, LTEAFDD, LTEATDD
Remote Command	[:SENSe] :ACPpower:DETECTOR:AUTO ON OFF 1 0 [:SENSe] :ACPpower:DETECTOR:AUTO?
Example	ACP:DET:AUTO 1 ACP:DET?
Couplings	When Detector setting is “Auto” ([:SENSe] :ACPpower:DETECTOR:AUTO?), Detector is set to what the Radio Standard defaults states (see detector section) for all conditions of Trace Type and for all traces. When set to Manual, all Traces use the same detector type. When Average State = Off then Trace Types AVERage, MaxHold and MinHold will not function, since Averaging is required to be ‘on’ for them to operate.
Preset	ON
State Saved	Saved in instrument state.
Range	ON OFF
Initial S/W Revision	Prior to A.02.00
Modified at S/W Revision	A.02.00, A.03.00

Detector Selection

Selects a detector to be used by the analyzer for the current measurement. All traces will use the same detector type, similar to Monitor Spectrum measurement

Key Path	Trace/Detector
Mode	SA, WCDMA, C2K, WIMAX OFDMA, TD-SCDMA, 1xEVDO, DVB-T/H, DTMB (CTTB), ISDB-T,

	CMMB, LTE, LTETDD, Digital Cable TV, MSR, LTEAFDD, LTEATDD
Remote Command	[:SENSe]:ACPpower:DETECTOR[:FUNCTION] AVERAge NEGative NORMal POSitive SAMPlE [:SENSe]:ACPpower:DETECTOR[:FUNCTION]?
Example	ACP:DET NORM ACP:DET?
Notes	<p>When you manually select a detector (instead of selecting Auto), that detector is used regardless of other analyzer settings.</p> <p>The detector choices are:</p> <ul style="list-style-type: none"> - The Normal detector determines the peak of CW-like signals, and it yields alternating maximums and minimums of noise-like signals. This is also referred to as Rosenfell detection. - The Average detector determines the average of the signal within the data range. The averaging method is Power (RMS). - The Peak detector determines the maximum of the signal within the data range. - The Sample detector indicates the instantaneous level of the signal at the center of the data represented by each display point. - The Negative Peak detector determines the minimum of the signal within the data range. <p>Because they may not find a spectral component's true peak, neither average nor sample detectors measure amplitudes of CW signals as accurately as peak or normal, but they do measure noise without the biases of peak detection.</p> <p>When Meas Method is Fast Power, Peak and Average are selectable.</p> <p>When a detector selection is made, the menu returns to the previous menu.</p>
Couplings	<p>When Detector setting is "Auto" (:SENSe):ACPpower:DETECTOR:AUTO?), Detector is set to what the Radio Standard defaults states (see detector section) for all conditions of Trace Type and for all traces. When set to Manual, all Traces use the same detector type. When Average State = Off then Trace Types AVERAge, MaxHold and MinHold will not function, since Averaging is required to be 'on' for them to operate.</p> <p>Only one detector type for all 3 traces is allowed.</p> <p>When Meas Method is RBW or FAST, Detector is disabled.</p>
Preset	AVERAge
State Saved	Saved in instrument state.
Range	Normal Average Peak Sample Negative Peak
Backwards Compatibility SCPI	[:SENSe]:ACPR:SWEEP:DETECTOR[:FUNCTION]
Initial S/W Revision	Prior to A.02.00
Modified at S/W Revision	A.02.00, A.03.00

Trigger

See ["Trigger" on page 529](#)

Free Run

See ["Free Run " on page 537](#)

Video

See ["Video \(IF Envelope\) " on page 538](#)

Trigger Level

See ["Trigger Level" on page 538](#)

Trig Slope

See ["Trig Slope" on page 539](#)

Trig Delay

See ["Trig Delay" on page 540](#)

X Axis Relative to Trigger

See ["X Axis Relative to Trigger" on page 583](#)

Line

See ["Line" on page 2814](#)

Trig Slope

See ["Trig Slope" on page 2814](#)

Trig Delay

See ["Trig Delay" on page 543](#)

X Axis Relative to Trigger

See ["X Axis Relative to Trigger" on page 583](#)

External 1

See ["External 1" on page 2828](#)

Trigger Level

See ["Trigger Level" on page 2828](#)

Trig Slope

See ["Trig Slope" on page 2829](#)

Trig Delay

See ["Trig Delay" on page 546](#)

X Axis Relative to Trigger

See ["X Axis Relative to Trigger" on page 583](#)

Zero Span Delay Comp

See ["Zero Span Delay Comp On/Off " on page 2816](#)

External 2

See ["External 2 " on page 2829](#)

Trigger Level

See ["Trigger Level" on page 2830](#)

Trig Slope

See ["Trig Slope" on page 2831](#)

Trig Delay

See ["Trig Delay " on page 549](#)

X Axis Relative to Trigger

See ["X Axis Relative to Trigger" on page 583](#)

Zero Span Delay Comp

See ["Zero Span Delay Comp On/Off" on page 2818](#)

RF Burst

See ["RF Burst" on page 2831](#)

Absolute Trigger

See ["Absolute Trigger Level" on page 2832](#)

Relative Trigger

See ["Relative Trigger Level" on page 2833](#)

Trig Slope

See ["Trigger Slope" on page 2834](#)

Trig Delay

See ["Trig Delay" on page 554](#)

X Axis Relative to Trigger

See ["X Axis Relative to Trigger" on page 583](#)

Zero Span Delay Comp

See ["Zero Span Delay Comp On/Off" on page 2834](#)

Periodic Timer

See ["Periodic Timer \(Frame Trigger\)" on page 2823](#)

Period

See ["Period" on page 2824](#)

Offset

See ["Offset" on page 2825](#)

Offset Adjust (Remote Command Only)

See ["Offset Adjust \(Remote Command Only\)" on page 2826](#)

Reset Offset Display

See ["Reset Offset Display" on page 2827](#)

Sync Source

See ["Sync Source" on page 2827](#)

Off

See ["Off" on page 2828](#)

External 1

See ["External 1" on page 2828](#)

Trigger Level

See ["Trigger Level" on page 2828](#)

Trig Slope

See ["Trig Slope" on page 2829](#)

External 2

See ["External 2 " on page 2829](#)

Trigger Level

See ["Trigger Level" on page 2830](#)

Trig Slope

See ["Trig Slope" on page 2831](#)

RF Burst

See ["RF Burst" on page 2831](#)

Absolute Trigger

See ["Absolute Trigger Level" on page 2832](#)

Relative Trigger

See ["Relative Trigger Level" on page 2833](#)

Trig Slope

See ["Trigger Slope" on page 2834](#)

Zero Span Delay Comp

See ["Zero Span Delay Comp On/Off" on page 2834](#)

Trig Delay

See ["Trig Delay" on page 568](#)

X Axis Relative to Trigger

See ["X Axis Relative to Trigger" on page 583](#)

Sync Holdoff

See ["Sync Holdoff" on page 1289](#)

Baseband I/Q

See ["Baseband I/Q " on page 570](#)

I/Q Mag

See ["I/Q Mag" on page 570](#)

Trigger Level

See ["Trigger Level" on page 570](#)

Trig Slope

See ["Trig Slope" on page 571](#)

Trig Delay

See ["Trig Delay" on page 571](#)

X Axis Relative to Trigger

See ["X Axis Relative to Trigger" on page 583](#)

I (Demodulated)

See ["I \(Demodulated\)" on page 572](#)

Trigger Level

See ["Trigger Level" on page 573](#)

Trig Slope

See ["Trig Slope" on page 573](#)

Trig Delay

See ["Trig Delay" on page 573](#)

X Axis Relative to Trigger

See ["X Axis Relative to Trigger" on page 583](#)

Q (Demodulated)

See ["Q \(Demodulated\)" on page 575](#)

Trigger Level

See ["Trigger Level" on page 575](#)

Trig Slope

See ["Trig Slope" on page 575](#)

Trig Delay

See ["Trig Delay" on page 576](#)

X Axis Relative to Trigger

See ["X Axis Relative to Trigger" on page 583](#)

Input I

See ["Input I" on page 577](#)

Trigger Level

See ["Trigger Level" on page 577](#)

Trig Slope

See ["Trig Slope" on page 578](#)

Trig Delay

See ["Trig Delay" on page 578](#)

X Axis Relative to Trigger

See ["X Axis Relative to Trigger" on page 583](#)

Input Q

See ["Input Q" on page 579](#)

Trigger Level

See ["Trigger Level" on page 579](#)

Trig Slope

See ["Trig Slope" on page 580](#)

Trig Delay

See ["Trig Delay" on page 580](#)

X Axis Relative to Trigger

See ["X Axis Relative to Trigger" on page 583](#)

Auxiliary Channel I/Q Mag

See ["Auxiliary Channel I/Q Mag" on page 581](#)

Trigger Level

See ["Trigger Level" on page 582](#)

Trig Slope

See ["Trig Slope" on page 582](#)

Trig Delay

See ["Trig Delay" on page 582](#)

X Axis Relative to Trigger

See ["X Axis Relative to Trigger" on page 583](#)

Trigger Center Frequency

See ["Trigger Center Frequency" on page 583](#)

Trigger Bandwidth

See ["Trigger Bandwidth" on page 584](#)

TV

See ["TV" on page 2835](#)

TV Line

See ["TV Line" on page 2836](#)

Field

See ["Field" on page 2836](#)

Entire Frame

See ["Entire Frame" on page 2837](#)

Field One

See ["Field One" on page 2837](#)

Field Two

See ["Field Two" on page 2837](#)

Standard

See ["Standard" on page 2838](#)

NTSC-M

See ["NTSC-M" on page 2838](#)

NTSC-Japan

See ["NTSC-Japan" on page 2839](#)

NTSC-4.43

See ["NTSC-4.43" on page 2839](#)

PAL-M

See ["PAL-M" on page 2839](#)

PAL-N

See ["PAL-N" on page 2839](#)

PAL-N Combin

See ["PAL-N-Combin" on page 2839](#)

PAL-B,D,G,H,I

See ["PAL-B,D,G,H,I" on page 2839](#)

PAL-60

See "PAL-60" on page 2840

SECAM-L

See "SECAM-L" on page 2840

Auto/Holdoff

See "Auto/Holdoff" on page 590

Auto Trig

See "Auto Trig" on page 590

Trig Holdoff

See "Trig Holdoff" on page 591

Holdoff Type

See "Holdoff Type" on page 591

User Preset

Accesses a menu that gives you the following three choices:

- **User Preset** – recalls a state previously saved using the Save User Preset function.
- **User Preset All Modes** – presets all of the modes in the analyzer
- **Save User Preset**– saves the current state for the current mode

Key Path	Front-panel key
Backwards Compatibility Notes	<p>User Preset is actually loading a state, and in legacy analyzers, it was possible to load a state without affecting the trace data, limit lines or correction data. Similarly it was possible to do a User Preset without affecting the trace data, limit lines or correction data.</p> <p>In the X-Series, “state” always includes all of this data; so whenever state is loaded, or User Preset is executed, all of the traces, limit lines and corrections are affected. Although this differs from previous behavior, it is desirable behavior, and should not cause adverse issues for users.</p> <p>On ESA and PSA, User Preset affected the entire instrument’s state. In the X-Series, User Preset only recalls the state for the active mode. There is a User Preset file for each mode. User Preset can never cause a mode switch as it can in legacy analyzers. If you want to recall all modes to their user preset file state, you will need to do a User Preset after mode switching into each mode.</p> <p>User Preset recalls mode state which can now include data like traces; whereas on ESA and PSA, User Preset did not affect data.</p>
Initial S/W Revision	Prior to A.02.00

User Preset

User Preset sets the state of the currently active mode back to the state that was previously saved for this mode using the Save User Preset menu key or the SCPI command, **SYST:PRES:USER:SAV**. **It not only recalls the** Mode Preset settings, but it also recalls all of the mode persistent settings, and the Input/Output system setting that existed at the time Save User Preset was executed.

If a Save User Preset has not been done at any time, User Preset recalls the default user preset file for the currently active mode. The default user preset files are created if, at power-on, a mode detects there is no user preset file. There will never be a scenario when there is no user preset file to restore. For each mode, the default user preset state is the same state that would be saved if a Save User Preset is performed in each mode right after doing a Restore Mode Default and after a Restore Input/Output Defaults.

The User Preset function does the following:

- Aborts the currently running measurement.
- Sets the mode State to the values defined by Save User Preset.

- Makes the saved measurement for the currently running mode the active measurement.
- Brings up the saved menu for the power-on mode.
- Clears the input and output buffers.
- Sets the Status Byte to 0.

Key Path	User Preset
Remote Command	:SYSTem:PRESet:USER
Example	:SYST:PRES:USER
Notes	:SYST:PRES:USER:SAVE is used to save the current state as the user preset state. Clears all pending OPC bits. The Status Byte is set to 0. Pressing the User Preset front-panel key while already in the User Preset menu will cause the User Preset to get executed
Couplings	A user preset will cause the currently running measurement to be aborted and cause the saved measurement to be active. Recalling a User Preset file has the same issues that recalling a Save State file has. Some settings may need to be limited and therefore re-coupled, since the capabilities of the mode may have changes when the User Preset file was last saved.
Initial S/W Revision	Prior to A.02.00

User Preset All Modes

Recalls all of the User Preset files for each mode, switches to the power-on mode, and activates the saved measurement from the power-on mode User Preset file.

NOTE

When the instrument is secured, all of the user preset files are converted back to their default user preset files.

The User Preset function does the following:

- Aborts the currently running measurement.
- Switches the Mode to the power-on mode.
- Restores the User Preset files for each mode.
- Makes the saved measurement for the power-on mode the active measurement.
- Brings up the saved menu for the power-on mode.
- Clears the input and output buffers.
- Sets the Status Byte to 0.

Key Path	User Preset
----------	--------------------

Remote Command	:SYSTem:PRESet:USER:ALL
Example	:SYST:PRES:USER:SAVE :SYST:PRES:USER:ALL
Notes	Clears all pending OPC bits. The Status Byte is set to 0. :SYST:PRES:USER:SAVE is used to save the current state as the user preset state.
Couplings	A user preset will cause the currently running measurement to be aborted, cause a mode switch to the power-on mode, and cause the saved measurement to be active in the power-on mode. Recalling a User Preset file has the same issues that recalling a Save State file has. Some settings may need to be limited and therefore re-coupled, since the capabilities of the mode may have changes when the User Preset file was last saved.
Initial S/W Revision	Prior to A.02.00

Save User Preset

Saves the currently active mode and its State. You can recall this User Preset file by pressing the User Preset menu key or sending the SYST:PRES:USER remote command. This same state is also saved by the Save State function.

Key Path	User Preset
Remote Command	:SYSTem:PRESet:USER:SAVE
Example	:SYST:PRES:USER:SAVE
Notes	:SYST:PRES:SAVE creates the same file as if the user requested a *SAV or a MMEM:STOR:STAT, except User Preset Save does not allow the user to specify the filename or the location of the file.
Initial S/W Revision	Prior to A.02.00

View/Display

Accesses a menu of functions that enable you to control the instrument display as well as turn the bar graph On and Off.

If current mode is NOT MSR and LTE-Advanced FDD/TDD mode, the front panel views only contain one view: Spectrum View.

The results of the measurement can be displayed as a single spectrum trace view or displayed with a Bar Graph trace on the spectrum trace.

The display consists of the following two windows:

"Spectrum Window" on page 1894

"Results Window" on page 1894

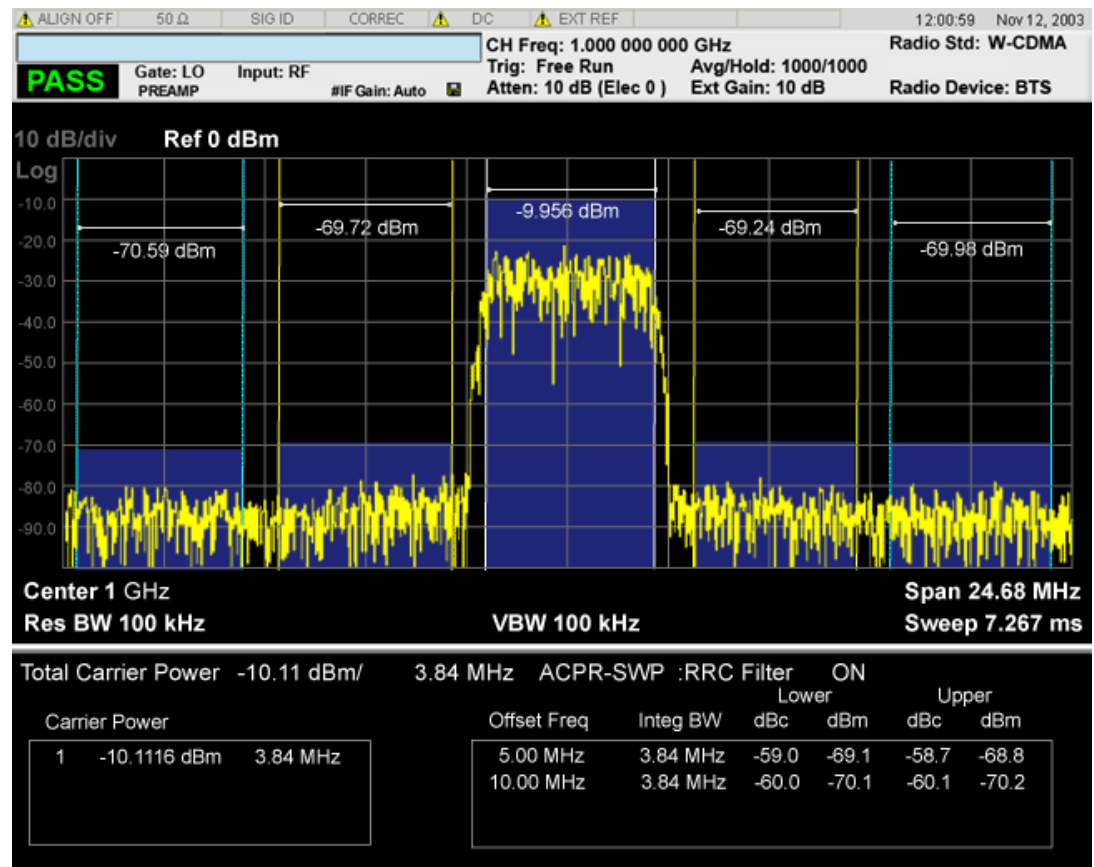

The following two views are only for DTMB (CTTB) and CMMB:

DTMB and CMMB Transmitter:

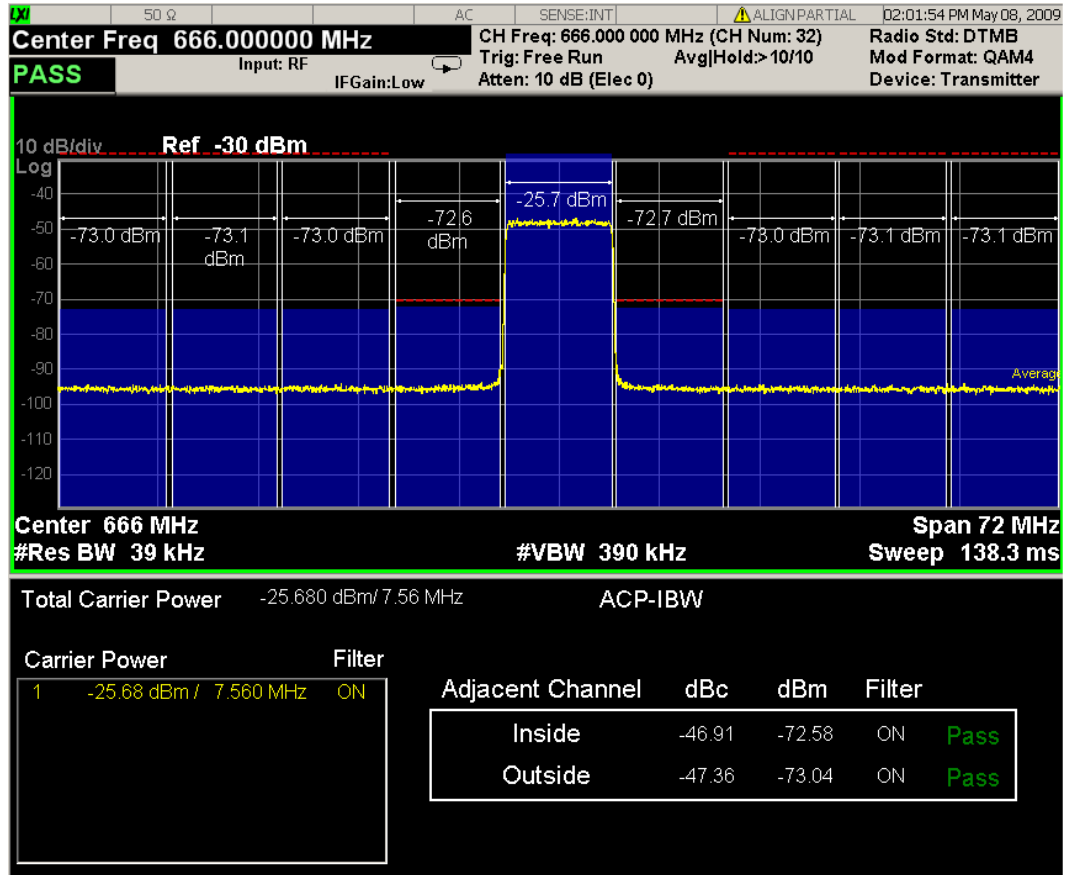

DTMB and CMMB Exciter:

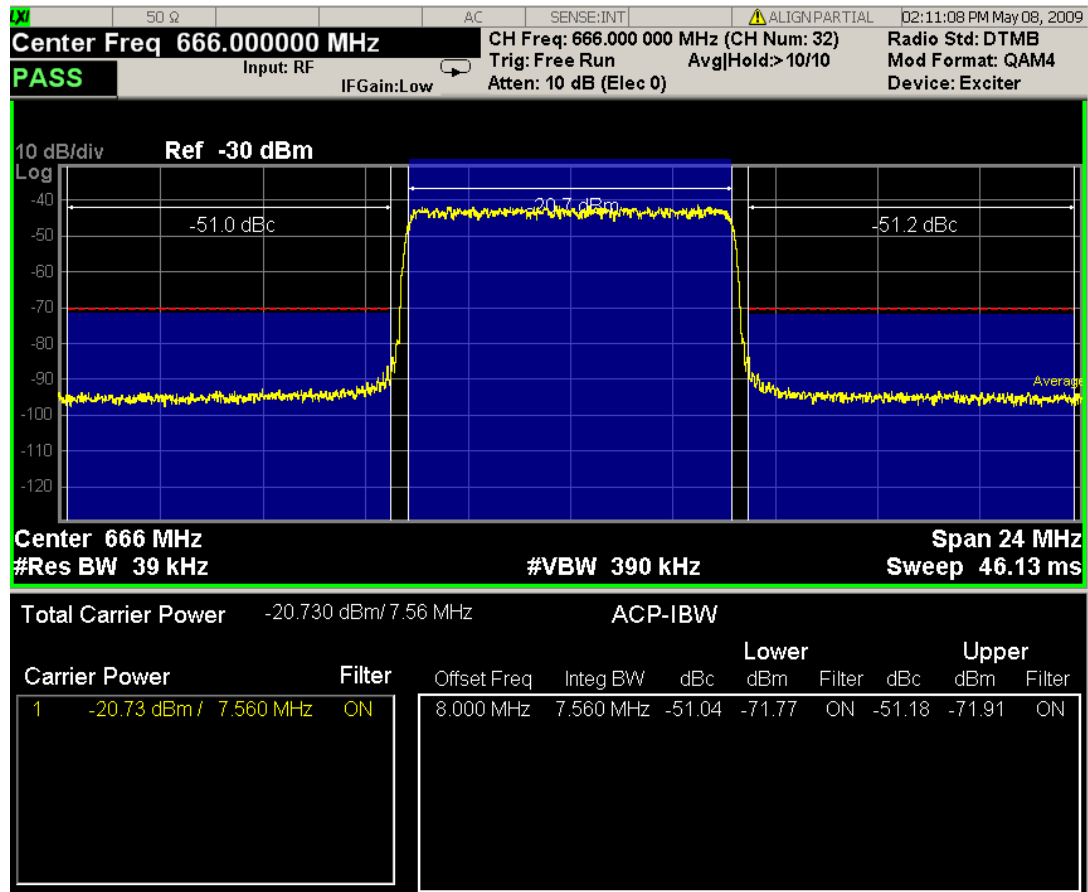

Spectrum Window

When the Bar Graph is On and Limit Test is On, the color of each bar graph reflects the limit test result. When the limit test fails, the bar color is red, and when limit test passes, the bar color is blue.

When RBW is selected as the measurement method, the spectrum trace is not displayed, only the bar graph is displayed. In addition, the Bar Graph key (under the View/Display front-panel key) is set to ON and is grayed out.

The RRC Filter display item is only displayed when RRC filter is on.

Results Window

The text window displays the following results:

Total Carrier Power

This is the total power of all the carriers with carrier power present set to yes. The power is calculated by integrating across the bandwidth declared by the Carrier Integ Bw parameter for each carrier and then totaling the sums. The total integration bandwidth is shown as part of the result. This will be the total of the Carrier Integ Bw of the carriers used in calculating the total carrier power. If the RRC Filter is on, then the integration bandwidth used is $(1 + \alpha)/T$ where $T = 1/(\text{Carrier Integ Bw})$ multiplied by the number of carriers with carrier power present set to yes.

Ref Carrier Power

This is the power in the reference carrier. The power is calculated by integrating across the bandwidth declared by the Carrier Integ Bw parameter for that carrier. The integration bandwidth is shown as part of the result. This is the value of the Carrier Integ Bw for that carrier unless the RRC Filter is on, then the integration bandwidth used is the displayed value, which is $(1 + \alpha)/T$ where $T = 1/(\text{Carrier Integ Bw})$.

Carrier Power

This is the power in all the currently defined carriers. If the carrier has carrier power present, the power will be absolute. If the carrier is defined as not having power present, the power will be relative to the reference carrier. The power is calculated by integrating across the bandwidth declared by the Carrier Integ Bw parameter. The integration bandwidth is shown as part of the result. This is the value of the Carrier Integ Bw for the carrier unless the RRC Filter is on, then the integration bandwidth used is the displayed value, which is $(1 + \alpha)/T$ where $T = 1/(\text{Carrier Integ Bw})$.

As there are potentially more results than can be easily viewed on the display, a scrollable list is used to display all results. The Carrier Results menu key is used to index the carrier amplitude results. This key is grayed out unless the measurement is in single mode (as in continual measurement mode). The display is continuously updating and will not need to be accessed. The currently selected Carrier Result is displayed on the last line of the carrier power result list unless:

- The selected Carrier Result is 4 or less in normal multi carrier power results view. In this case the first 4 carrier power results will be displayed.
- The selected Carrier Result is 9 or greater in normal multi carrier power results view. In this case the last 4 carrier power results will be displayed.
- The zoom mode is selected. In this case all carrier power ranges can be displayed.

Offset Relative Power

This is the power in the offsets relative to the reference carrier. The power is calculated by integrating across the bandwidth declared by the Offset Integ Bw parameter. The offset integration bandwidth is shown as part of the result. This is the value on the Offset Integ Bw menu key unless the RRC Filter is on, then the integration bandwidth used is the displayed value, which is $(1 + \alpha)/T$ where $T = 1/(\text{Offset Integ Bw})$.

Offset Absolute Power

This is the absolute power in the offsets. The power is calculated by integrating across the bandwidth declared by the Offset Integ Bw parameter. The offset integration bandwidth is shown as part of the result. This is the value on the Offset Integ Bw menu key unless the RRC Filter is on, then the integration bandwidth used is the displayed value, which is $(1 + \alpha)/T$ where $T = 1/(\text{Offset Integ Bw})$.

Inside Adjacent Channel Power (DTMB (CTTB) and CMMB only)

This result is only valid for DTMB (CTTB) transmitter and CMMB transmitter. It contains two parts: Relative Power and Absolute Power. The power is calculated by integrating across the bandwidth (Integ Bw) at the frequency Offset A.

Inside Absolute Power = MAX (P_{Lower Offset A}, P_{Upper Offset A});

Inside Relative Power = Inside Absolute Power – Carrier Power;

Outside Adjacent Channel Absolute Power (DTMB (CTTB) and CMMB only)

This result is only valid for DTMB (CTTB) transmitter and CMMB transmitter. It contains two parts: Relative Power and Absolute Power. The power is the Root-Mean-Square of the power calculated by integrating across the bandwidth (Integ Bw) at frequency Offset B, C and D.

$$\text{Outside Absolute Power} = \sqrt{\frac{P_{\text{Lower OffsetB}}^2 + P_{\text{Upper OffsetB}}^2 + P_{\text{Lower OffsetC}}^2 + P_{\text{Upper OffsetC}}^2 + P_{\text{Lower OffsetD}}^2 + P_{\text{Upper OffsetD}}^2}{6}}$$

Outside Relative Power = Outside Absolute Power – Carrier Power;

If current mode is MSR, there are two views, Result Trace and Carrier Info.

NOTE

Y Scale/Div, Y Ref Position, Y Auto Scale, Y Ref Value and Bar Graph affect both views. For example, power bars on the traces in both views appear or disappear when Bar Graph is toggled.

View Selection by Name (MSR and LTE-Advanced FDD/TDD Only)

Selects the results view. The following SCPI command allows you to select the desired measurement view by enumeration.

Key Path	No equivalent front-panel key
Mode	MSR, LTEAFDD,LTEATDD
Remote Command	:DISPlay:ACPower:VIEW[:SElect] PRESult CINformation :DISPlay:ACPower:VIEW[:SElect]?
Example	DISP:ACP:VIEW PRES DISP:ACP:VIEW?
Notes	This SCPI is only available in MSR and LTE-Advanced FDD/TDD.
Preset	PRESult
State Saved	Saved in instrument state
Range	Power Results Carrier Info
Initial S/W Revision	A.10.00

Key Path	No equivalent front-panel key
Mode	MSR, LTEAFDD,LTEATDD
Remote Command	:DISPlay:ACPower:VIEW:NSElect <integer> :DISPlay:ACPower:VIEW:NSElect?
Example	DISP:ACP:VIEW:NSEL 1 DISP:ACP:VIEW:NSEL?
Notes	This SCPI is only available in MSR and LTE-Advanced FDD/TDD.

Preset	1
State Saved	Saved in instrument state
Min	1
Max	2
Initial S/W Revision	A.10.00

Key Path	Front-panel key
Initial S/W Revision	Prior to A.02.00

Display

The Display menu is common to most measurements, and is used for configuring items on the display. Some Display menu settings apply to all the measurements in a mode, and some only to the current measurement. Those under the **System Display Settings** key apply to all measurements in all modes.

Key Path	Display
Key Path	View/Display
Initial S/W Revision	Prior to A.02.00

Annotation

Turns on and off various parts of the display annotation. The annotation is divided up into four categories:

13. Meas Bar: This is the measurement bar at the top of the screen. It does not include the settings panel or the Active Function. Turning off the Meas Bar turns off the settings panel and the Active Function. When the Meas Bar is off, the graticule area expands to fill the area formerly occupied by the Meas Bar.
14. Screen Annotation: this is the annotation and annunciation around the graticule, including any annotation on lines (such as the display line, the threshold line, etc.) This does NOT include the marker number or the N dB result. When off, the graticule expands to fill the entire graticule area.
15. Trace annotation: these are the labels on the traces, showing their detector (or their math mode).
16. Active Function annotation: this is the active function display in the meas bar, and all of the active function values displayed on softkeys.

See the figure below. Each type of annotation can be turned on and off individually.

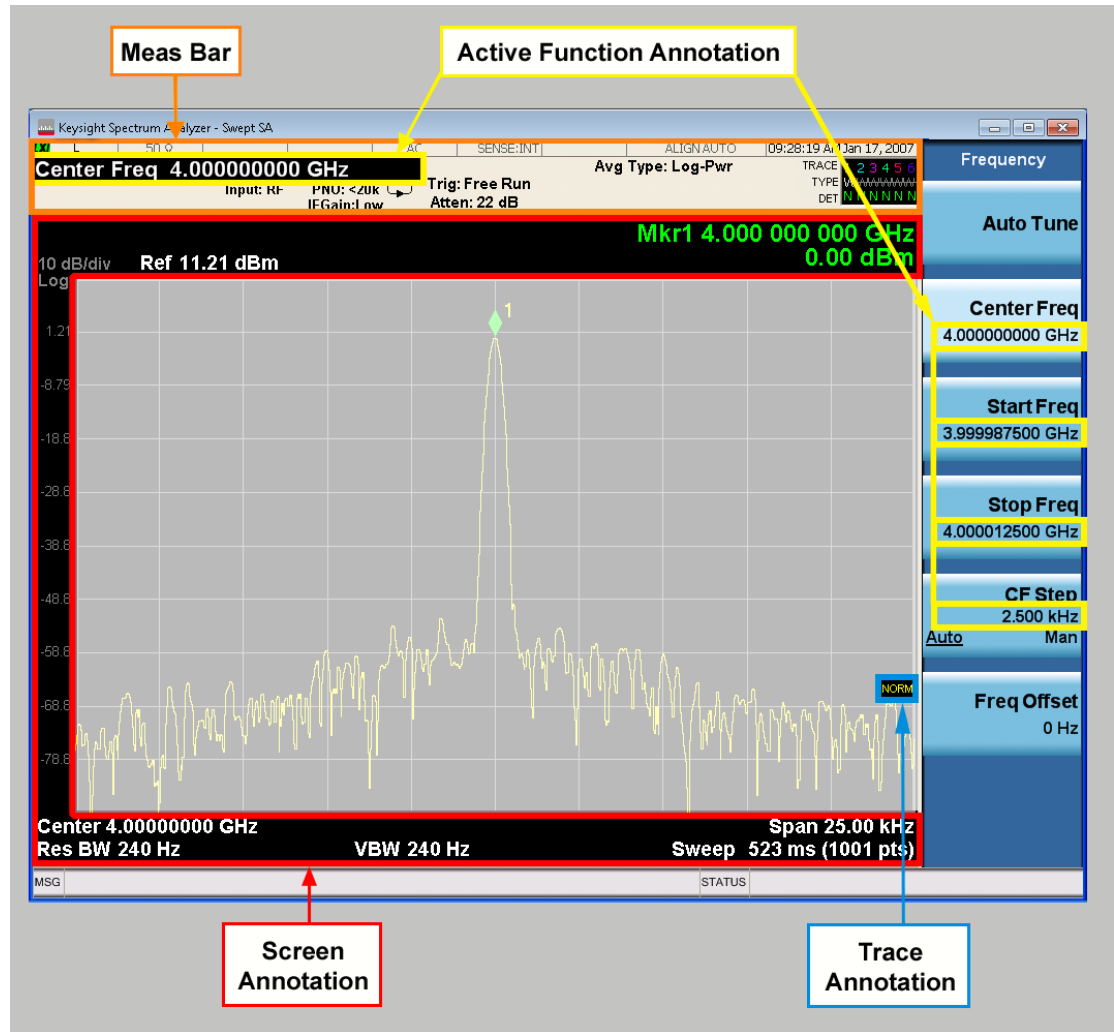

Key Path	View/Display, Display
Initial S/W Revision	Prior to A.02.00

Meas Bar On/Off

This function turns the Measurement Bar on and off, including the settings panel. When off, the graticule area expands to fill the area formerly occupied by the Measurement Bar.

Key Path	View/Display, Display, Annotation
Remote Command	:DISPlay:ANNotation:MBAR[:STATe] OFF ON 0 1 :DISPlay:ANNotation:MBAR[:STATe]?
Example	DISP:ANN:MBAR OFF
Dependencies	Grayed out and forced to OFF when System Display Settings, Annotation is set to Off.

Preset	On This should remain Off through a Preset when System DisplaySettings, Annotation is set to Off.
State Saved	Saved in instrument state.
Initial S/W Revision	Prior to A.02.00

Screen

This controls the display of the annunciation and annotation around the graticule, including any annotation on lines (such as the display line, the threshold line, etc.) and the y-axis annotation. This does NOT include marker annotation (or the N dB result). When off, the graticule expands to fill the entire graticule area, leaving only the 1.5% gap above the graticule as described in the Trace/Detector chapter.

Key Path	View/Display, Display, Annotation
Remote Command	:DISPlay:ANNotation:SCReen[:STATe] OFF ON 0 1 :DISPlay:ANNotation:SCReen[:STATe]?
Example	DISP:ANN:SCR OFF
Dependencies	Grayed-out and forced to OFF when System Display Settings, Annotation is set to Off.
Preset	On This should remain Off through a Preset when System DisplaySettings, Annotation is set to Off
State Saved	Saved in instrument state.
Initial S/W Revision	Prior to A.02.00

Trace

Turns on and off the labels on the traces, showing their detector (or their math mode) as described in the Trace/Detector section.

If trace math is being performed with a trace, then the trace math annotation will replace the detector annotation.

Key Path	View/Display, Display, Annotation
Remote Command	:DISPlay:ANNotation:TRACe[:STATe] ON OFF 1 0 :DISPlay:ANNotation:TRACe[:STATe]?
Example	DISP:ANN:TRAC OFF
Preset	Off
State Saved	Saved in instrument state.
Initial S/W Revision	Prior to A.02.00

Active Function Values On/Off

Turns on and off the active function display in the Meas Bar, and all of the active function values displayed on the softkeys.

Note that all of the softkeys that have active functions have these numeric values blanked when this function is on. This is a security feature..

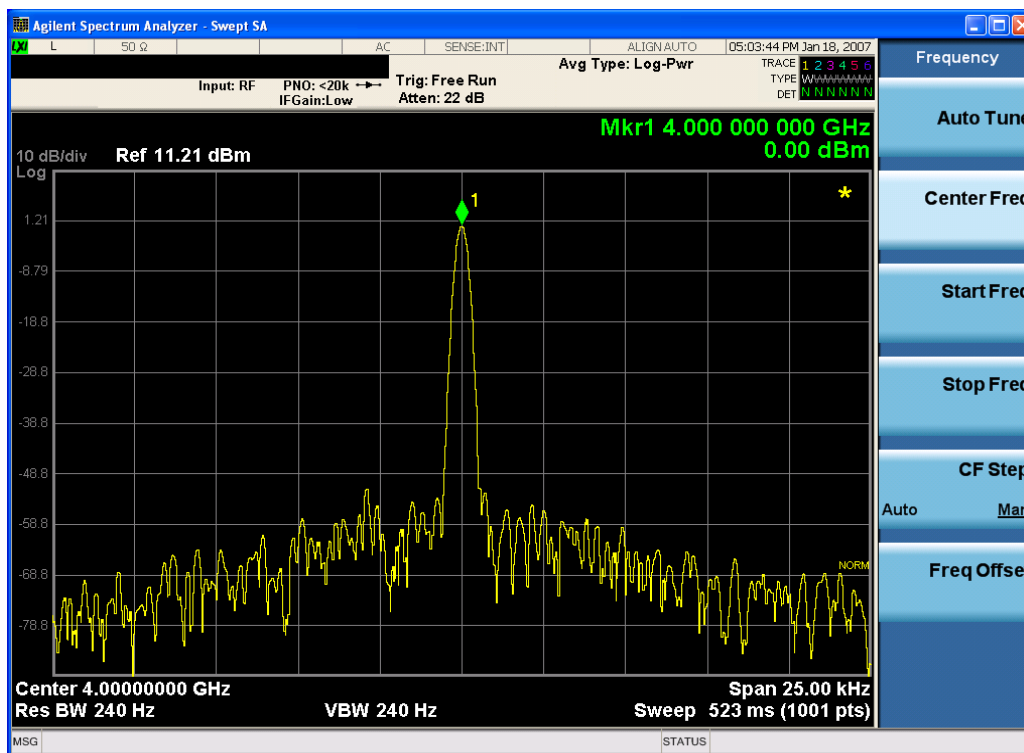

Key Path	View/Display, Display, Annotation
Remote Command	:DISPlay:ACTivefunc[:STATe] ON OFF 1 0 :DISPlay:ACTivefunc[:STATe]?
Example	DISP:ACT OFF
Dependencies	Grayed out and forced to OFF when System Display Settings, Annotation is set to Off.
Preset	On This should remain Off through a Preset when System DisplaySettings, Annotation is set to Off
State Saved	Saved in instrument state.
Initial S/W Revision	Prior to A.02.00

Title

Displays menu keys that enable you to change or clear a title on your display.

Key Path	View/Display, Display
Initial S/W Revision	Prior to A.02.00

Change Title

Writes a title into the "measurement name" field in the banner, for example, "Swept SA".

Press Change Title to enter a new title through the alpha editor. Press Enter or Return to complete the entry. Press ESC to cancel the entry and preserve your existing title.

The display title will replace the measurement name. It remains for this measurement until you press **Change Title** again, or you recall a state, or a Preset is performed. A title can also be cleared by pressing **Title, Clear Title**.

NOTE

Notice the inclusion of the <measurement> parameter in the command below. Because each measurement remembers the Display Title, the command must be qualified with the measurement name. For the Swept SA measurement this is not the case; no <measurement> parameter is used when changing the Display Title for the Swept SA measurement.

Key Path	View/Display, Display, Title
Mode	All
Remote Command	:DISPlay:<measurement>:ANNotation:TITLe:DATA <string> :DISPlay:<measurement>:ANNotation:TITLe:DATA?
Example	DISP:ANN:TITL:DATA "This Is My Title" This example is for the Swept SA measurement in the Spectrum Analyzer mode. The SANalyzer <measurement> name is not used. DISP:ACP:ANN:TITL:DATA "This Is My Title" This example is for Measurements other than Swept SA. Both set the title to: This Is My Title
Notes	Pressing this key cancels any active function. When a title is edited the previous title remains intact (it is not cleared) and the cursor goes at the end so that characters can be added or BKSP can be used to go back over previous characters.
Preset	No title (measurement name instead)
State Saved	Saved in instrument state.
Initial S/W Revision	Prior to A.02.00

Clear Title

Clears a title from the front-panel display. Once cleared, the title cannot be retrieved. After the title is cleared, the current Measurement Name replaces it in the

title bar.

Key Path	View/Display, Display, Title
Example	The following commands clear the title and restore the measurement's original title: DISP:ANN:TITL:DATA "" This example is for the Swept SA measurement in the Spectrum Analyzer mode. The SANalyzer <measurement> name is not used. DISP:ACP:ANN:TITL:DATA "" This example is for ACP; in measurements other than Swept SA the measurement name is required.
Notes	Uses the :DISPlay:<measurement>:ANNotation:TITLe:DATA <string> command with an empty string (in the Swept SA, the <measurement> is omitted).
Preset	Performed on Preset.
Initial S/W Revision	Prior to A.02.00

Graticule

Pressing Graticule turns the display graticule On or Off. It also turns the graticule y-axis annotation on and off.

Key Path	View/Display, Display
Remote Command	:DISPlay:WINDow[1]:TRACe:GRATicule:GRID[:STATe] OFF ON 0 1 :DISPlay:WINDow[1]:TRACe:GRATicule:GRID[:STATe]?
Example	DISP:WIND:TRAC:GRAT:GRID OFF
Notes	The graticule is the set of horizontal and vertical lines that make up the grid/divisions for the x-axis and y-axis.
Preset	On
State Saved	Saved in instrument state
Initial S/W Revision	Prior to A.02.00

System Display Settings

These settings are "Mode Global" – they affect all modes and measurements and are reset only by **Restore Misc Defaults** or **Restore System Defaults** under System.

Key Path	View/Display, Display
Initial S/W Revision	Prior to A.02.00

Annotation Local Settings

This is a Mode Global override of the meas local annotation settings. When it is **All Off**, it forces **ScreenAnnotation, Meas Bar, Trace, and Active Function Values** settings to be **OFF** for all measurements in all modes. This provides the security based "annotation off" function of previous analyzers; hence it uses the legacy SCPI command.

When it is **All Off**, the **Screen, Meas Bar, Trace, and Active Function Values** keys under the **Display, Annotation** menu are grayed out and forced to **Off**. When **Local Settings** is selected, you are able to set the local annotation settings on a measurement by measurement basis.

Key Path	View/Display, Display, System Display Settings
Remote Command	:DISPlay:WINDow[1]:ANNotation[:ALL] OFF ON 0 1 :DISPlay:WINDow[1]:ANNotation[:ALL]?
Example	:DISP:WIND:ANN OFF
Preset	On (Set by Restore Misc Defaults)
State Saved	Not saved in instrument state.
Backwards Compatibility Notes	The WINDow parameter and optional subopcode is included for backwards compatibility but ignored – all windows are equally affected.
Initial S/W Revision	Prior to A.02.00

Themes

Accesses a menu of functions that enable you to choose the theme to be used when saving the screen image.

The **Themes** option is the same as the **Themes** option under the **Display** and **Page Setup** dialogs. It allows you to choose between themes to be used when saving the screen image.

Key Path	Save, Screen Image
Remote Command	:MMEMory:STORe:SCReem:THEMe TDColor TDMonochrome FCOLor FMONochrome :MMEMory:STORe:SCReem:THEMe?
Example	:MMEM:STOR:SCR:THEM TDM
Preset	3D Color; Is not part of Preset, but is reset by Restore Misc Defaults or Restore System Defaults All and survives subsequent running of the modes.
Readback	3D Color 3D Mono Flat Color Flat Mono
Backwards Compatibility Notes	In ESA and PSA we offer the choice of "Reverse Bitmap" or "Reverse Metafile" when saving screen images. This is much like the "Flat Color" theme available in X-Series. Also, if you selected Reverse Bitmap AND a black & white screen image, that would be much like "Flat Monochrome". In other words, each of the X-Series themes has a similar screen image type in ESA/PSA. But they are not identical.
Initial S/W Revision	Prior to A.02.00

3D Color

Selects a standard color theme with each object filled, shaded and colored as designed.

Key Path	Save, Screen Image, Themes
Example	MMEM:STOR:SCR:THEM TDC
Readback	3D Color
Initial S/W Revision	Prior to A.02.00

3D Monochrome

Selects a format that is like 3D color but shades of gray are used instead of colors.

Key Path	Save, Screen Image, Themes
Example	MMEM:STOR:SCR:THEM TDM
Readback	3D Mono
Initial S/W Revision	Prior to A.02.00

Flat Color

Selects a format that is best when the screen is to be printed on an ink printer.

Key Path	Save, Screen Image, Themes
Example	MMEM:STOR:SCR:THEM FCOL
Readback	Flat Color
Initial S/W Revision	Prior to A.02.00

Flat Monochrome

Selects a format that is like Flat Color. But only black is used (no colors, not even gray), and no fill.

Key Path	Save, Screen Image, Themes
Example	MMEM:STOR:SCR:THEM FMON
Readback	Flat Mono
Initial S/W Revision	Prior to A.02.00

Backlight

Accesses the display backlight on/off keys. This setting may interact with settings under the Windows "Power" menu.

When the backlight is off, pressing ESC, TAB, SPACE, ENTER, UP, DOWN, LEFT, RIGHT, DEL, BKSP, CTRL, or ALT turns the backlight on without affecting the application. Pressing any other key will turn backlight on and could potentially perform the action as well.

Key Path	View/Display, Display, System Display Settings
Remote Command	:DISPlay:BACKlight ON OFF :DISPlay:BACKlight?
Preset	ON (Set by Restore Misc Defaults)
Initial S/W Revision	Prior to A.02.00

Backlight Intensity

An active function used to set the backlight intensity. It goes from 0 to 100 where 100 is full on and 0 is off. This value is independent of the values set under the Backlight on/off key.

Key Path	View/Display, Display, System Display Settings
Remote Command	:DISPlay:BACKlight:INTensity <integer> :DISPlay:BACKlight:INTensity?
Example	DISP:BACK:INT 50
Preset	100 (Set by Restore Misc Defaults)
Min	0
Max	100
Initial S/W Revision	Prior to A.02.00

Bar Graph

Turns the Bar Graph On and Off.

Key Path	View/Display
Mode	SA, WCDMA, C2K, WIMAX OFDMA, TD-SCDMA, 1xEVDO, DVB-T/H, DTMB (CTTB), ISDB-T, CMMB, LTE, LTEFDD, Digital Cable TV, MSR, LTEAFDD, LTEATDD
Remote Command	:DISPlay:ACPower:VIEW[1]:WINDow[1]:BGRaph OFF ON 0 1 :DISPlay:ACPower:VIEW[1]:WINDow[1]:BGRaph?
Example	DISP:ACP:VIEW:WIND:BGR OFF DISP:ACP:VIEW:WIND:BGR?
Notes	You must be in the mode that includes ACP measurements to use this command. Use :INSTrument:SElect to set the mode.
Dependencies	When the method is RBW, this key is always set to On and grayed out.
Preset	ON
State Saved	Saved in instrument state.
Range	On Off
Initial S/W Revision	Prior to A.02.00

Modified at S/W	A.02.00, A.03.00
Revision	

12 Power Stat CCDF Measurement

Many of the digitally modulated signals now look noise-like in the time and frequency domain. This means that statistical measurements of the signals can be a useful characterization. The Power Complementary Cumulative Distribution Function (CCDF) curves characterize the higher level power statistics of a digitally modulated signal. The curves can be useful in determining design parameters for digital communications systems.

For more details, see ["Power Stat CCDF Measurement Description" on page 1911](#).

For measurement results and views, see ["View/Display" on page 2069](#).

This topic contains the following sections:

["Measurement Commands for Power Stat CCDF" on page 1908](#)

["Remote Command Results for Power Stat CCDF" on page 1909](#)

["Power Stat CCDF Measurement Description" on page 1911](#)

Measurement Commands for Power Stat CCDF

The following commands and queries can be used to retrieve the measurement results:

```
:CONFigure:PStatistic  
:CONFigure:PStatistic:NDEFault  
:INITiate:PStatistic  
:FETCh:PStatistic[n]?  
:READ:PStatistic[n]?  
:MEASure:PStatistic[n]?
```

For more measurement related commands, see the SENSE subsystem, and the section ["Remote Measurement Functions" on page 3140](#).

Remote Command Results for Power Stat CCDF

The following table describes the results returned by the FETCH, MEASURE, and READ queries listed above, according to the index value n.

n	Results Returned
0	Returns unprocessed I/Q trace data, as a series of trace point values, in volts. The I values are listed first in each pair, using the 0 through even-indexed values. The Q values are the odd-indexed values,
not specified or 1	Returns 10 scalar results: 1. Average input power (in dBm) 2. Probability at the average input power level (in %) 3. Power level that has 10% of the power 4. Power level that has 1% of the power 5. Power level that has 0.1% of the power 6. Power level that has 0.01% of the power 7. Power level that has 0.001% of the power 8. Power level that has 0.0001% of the power 9. Peak power (in dB) 10.Count
2	Returns a series of 5001 floating point numbers (in percent) that represent the current measured power stat trace. This is the probability at particular power levels (average power), in the following order: 1. Probability at 0.0 dB power 2. Probability at 0.01 dB power 3. Probability at 0.02 dB power ... 5000. Probability at 49.9 dB power 5001. Probability at 50.0 dB power
3	Returns a series of 5001 floating point numbers (in percent) that represent the Gaussian trace. This is the probability at particular power levels (average power), in the following order: 1. Probability at 0.0 dB power 2. Probability at 0.01 dB power 3. Probability at 0.02 dB power ... 5000. Probability at 49.9 dB power 5001. Probability at 50.0 dB power
4	Returns a series of 5001 floating point numbers (in percent) that represent the user-definable reference trace. This is the probability at particular power levels (average power), in the following order: 1. Probability at 0.0 dB power 2. Probability at 0.01 dB power

n	Results Returned
	3. Probability at 0.02 dB power
	...
	5000. Probability at 49.9 dB power
	5001. Probability at 50.0 dB power

Power Stat CCDF Measurement Description

The power statistics CCDF measurement can be affected by many factors. For example, modulation filtering, modulation format, combining the multiple signals at different frequencies, number of active codes, and correlation between symbols on different codes with spread spectrum systems will all affect measurement results. These factors are all related to modulation and signal parameters. External factors such as signal compression and expansion by nonlinear components, group delay distortion from filtering, and power control within the observation interval also affect the measurement.

The power measured in power statistics CCDF curves is actually instantaneous envelope power defined by the equation:

$$P = (I^2 + Q^2) / Z_0$$

where I & Q are the quadrature voltage components of the waveform, and Z_0 is the characteristic impedance.

A CCDF curve is defined by how much time the waveform spends at or above a given power level. The percent of time the signal spends at or above the level defines the probability for that particular power level. For capturing a lower probability down to 0.0001%, this measurement is made in the single mode by pressing Single. To make the power statistics CCDF measurement, the instrument uses digital signal processing (DSP) to sample the input signal in the channel bandwidth. The Gaussian distribution line as the band-limited Gaussian noise CCDF reference line, the user-definable reference trace, and the currently measured trace can be displayed on a semi-log graph. If the currently measured trace is above the user reference trace, it means that the higher peak power levels against the average power are included in the input signal.

Key Path	Meas
Initial S/W Revision	Prior to A.02.00

AMPTD Y Scale

Accesses a menu of functions that enable you to set the vertical scale parameters. The parameter values are measurement independent except all Attenuation values, and the Internal Preamp selection, which are the same across all measurements.

Key Path	Front-panel key
Initial S/W Revision	Prior to A.02.00

Attenuation

This menu controls the attenuator functions and interactions between the attenuation system components.

There are two attenuator configurations in the X-Series. One is a dual attenuator configuration consisting of a mechanical attenuator and an optional electronic attenuator. The other configuration uses a single attenuator with combined mechanical and electronic sections that controls all the attenuation functions. Different models in the X-Series come with different configurations.

See ["Dual Attenuator Configurations:" on page 1912](#)

See ["Single Attenuator Configuration:" on page 1913](#)

Most Attenuation settings are the same for all measurements – they do not change as you change measurements. Settings like these are called “Meas Global” and are unaffected by Meas Preset.

Key Path	AMPTD Y Scale
Scope	Meas Global
Dependencies	In measurements that support the I/Q inputs, this key is unavailable when I/Q is the selected input, and is replaced by the Range key in that case.
Readback Line	Contains a summary in [] brackets of the current total attenuation. See the descriptions of the , " (Mech) Atten " on page 3103, and " Enable Elec Atten " on page 3105 keys for more detail on the contributors to the total attenuation. Note that when "Pre-Adjust for Min Clip" is on, this value can change at the start of every measurement.
Initial S/W Revision	Prior to A.02.00
Modified at S/W Revision	A.03.00

Dual Attenuator Configurations:

Configuration 1: Mechanical attenuator + optional electronic attenuator

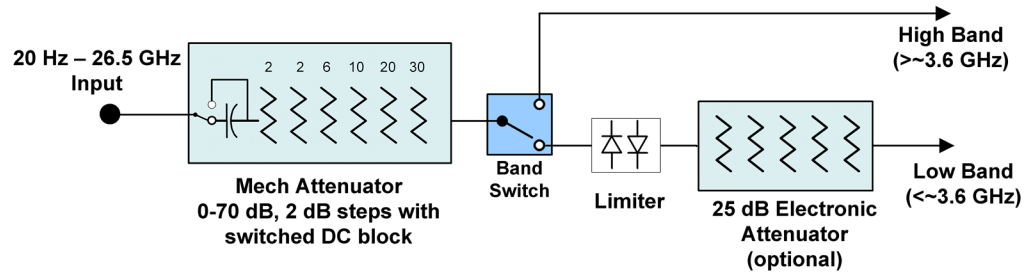

Configuration 2: Mechanical attenuator, no optional electronic attenuator

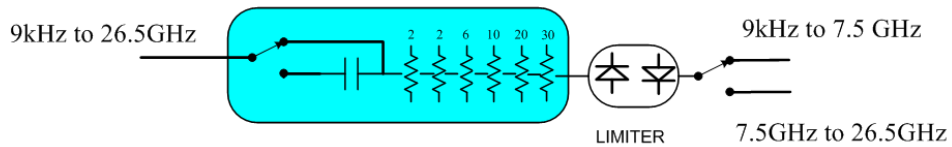

(note that Configuration 2 is not strictly speaking a dual-section attenuator, since there is no electronic section available. However, it behaves exactly like Configuration 1 without the Electronic Attenuator option EA3, therefore for the sake of this document it is grouped into the “Dual Attenuator” configuration)

Single Attenuator Configuration:

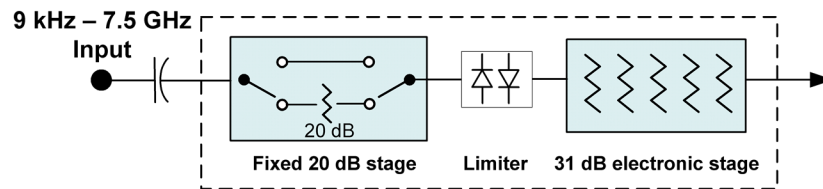

You can tell which attenuator configuration you have by pressing the Attenuation key, which (in most Modes) opens the Attenuation menu. If the first key in the Attenuation menu says **Mech Atten** you have the dual attenuator configuration. If the first key says **Atten** you have the single attenuator configuration.



Dual Attenuator

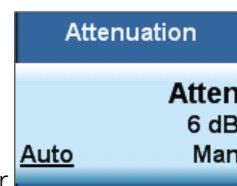

In the single attenuator configuration, you control the attenuation with a single control, as the fixed stage has only two states. In the dual attenuator configuration, both stages have significant range so you are given separate control of the mechanical and electronic attenuator stages.

When you have the dual attenuator configuration, you may still have only a single attenuator, because unless option EA3 (the Electronic Attenuator option) is available, and you purchase it, you will have only the mechanical attenuator.

(Mech) Atten

This key is labeled **Mech Atten** in dual attenuator models and **Atten** in single attenuator models. In the dual attenuator configuration, this key only affects the mechanical attenuator.

This key lets you modify the attenuation applied to the RF input signal path. This value is normally auto coupled to the Ref Level, the Internal Preamp Gain, any External Gain that is entered, and the Max Mixer Level, as described in the table below.

See ["Attenuator Configurations and Auto/Man" on page 1915](#)

Key Path	AMPTD Y Scale, Attenuation
Remote Command	[:SENSE]:POWer[:RF]:ATTenuation <rel_amp1> [:SENSe]:POWer[:RF]:ATTenuation? [:SENSE]:POWer[:RF]:ATTenuation:AUTO OFF ON 0 1 [:SENSE]:POWer[:RF]:ATTenuation:AUTO?
Example	POW:ATT 20 Dual attenuator configuration: sets the mechanical attenuator to 20 dB Single attenuator mode: sets the main attenuation to 20 dB (see below for definition of "main" attenuation). If the attenuator was in Auto, it sets it to Manual.
Dependencies	Some measurements do not support the Auto setting of (Mech) Atten . In these measurements, the Auto/Man selection is not available, and the Auto/Man line on the key disappears. In dual attenuator configurations, when the electronic attenuator is enabled, the mechanical attenuator has no auto setting and the Auto/Man line on the key disappears. The state of Auto/Man is remembered and restored when the electronic attenuator is once again disabled. This is described in more detail in the "Enable Elec Atten" on page 3105 key description. See "Attenuator Configurations and Auto/Man" on page 1915 for more information on the Auto/Man functionality of Attenuation.
Couplings	When (Mech) Atten is in Auto, it uses the following algorithm to determine a value: If the USB Preamp is connected to USB, use 0 dB. Otherwise, $Atten = ReferenceLevel + PreAmpGain + ExternalGain - RefLevelOffset - MaxMixerLevel + IF\ Gain$. Limit this value to be between 6 dB and the Max value. No value below 6 dB can ever be chosen by Auto. The resulting value is rounded up to the largest value possible given the attenuation step setting. That is, 50.01 dB would change to 60 dB (for a 10 dB attenuation step). The "IF Gain" term in the equation above is either 0 dB or +10 dB, depending on the settings of FFT IF Gain, Swept IF Gain, max Ref Level and the Auto/Man setting of Mech Atten. In External Mixing and BBIQ, where the Attenuator is not in the signal path, the Attenuator setting changes as described above when (Mech) Atten is in Auto, but no changes are made to the actual attenuator hardware setting until the input is changed back to the RF Input.
Preset	The preset for Mech Attenuation is "Auto." The Auto value of attenuation is: CXA, EXA, MXA and PXA: 10 dB

State Saved	Saved in instrument state
Min	0 dB The attenuation set by this key cannot be decreased below 6 dB with the knob or step keys. To get to a value below 6 dB it has to be directly entered from the keypad or via SCPI. This protects from adjusting the attenuation to a dangerously small value which can put the instrument at risk of damage to input circuitry. However, if the current mechanical attenuation is below 6 dB it can be increased with the knob and step keys, but not decreased.
Max	CXA N9000A-503/507: 50 dB CXA N9000A-513/526: 70dB EXA: 60 dB MXA and PXA: 70 dB In the single attenuator configuration, the total of ATT and EATT cannot exceed 50 dB, so if the EATT is set to 24 dB first, the main attenuation cannot be greater than 26 dB and will be reduced accordingly; if the main attenuator is set to 40 dB first, EATT cannot be greater than 10 dB.
Initial S/W Revision	Prior to A.02.00
Modified at S/W Revision	A.03.00

Attenuator Configurations and Auto/Man

As described in the Attenuation key description, there are two distinct attenuator configurations available in the X-Series, the single attenuator and dual attenuator configurations. In dual attenuator configurations, we have the mechanical attenuation and the electronic attenuation, and the current total attenuation is the sum of the electronic + mechanical attenuation. In single attenuator configurations, we refer to the attenuation set using the **(Mech) Atten** key (or POW:ATT SCPI) as the “main” attenuation; and the attenuation that is set by the SCPI command POW:EATT as the “soft” attenuation (the POW:EATT command is honored even in the single attenuator configuration, for compatibility purposes). Then the current total attenuation is the sum of the main + soft attenuation. See the **Elec Atten** key description for more on “soft” attenuation.

In the dual attenuator configuration, when the electronic attenuator is enabled, there is no Auto/Man functionality for the mechanical attenuator, and the third line of the key label (the Auto/Man line) disappears:

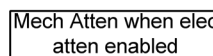
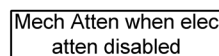
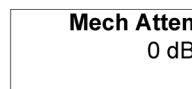
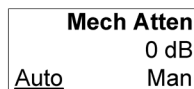

vsd05

Enable Elec Atten

Enables the Electronic Attenuator.

The electronic attenuator offers finer steps than the mechanical attenuator, has no acoustical noise, is faster, and is less subject to wear. These advantages primarily

aid in remote operation and are negligible for front panel use. See ["Using the Electronic Attenuator: Pros and Cons" on page 1918](#) for a detailed discussion of the pros and cons of using the electronic attenuator.

For the single attenuator configuration, for SCPI backwards compatibility, the “soft” attenuation feature replaces the dual attenuator configuration’s electronic attenuator. All the same couplings and limitations apply. See ["Attenuator Configurations and Auto/Man" on page 3105](#)

See [Error! Reference source not found.](#)

Key Path	AMPTD Y Scale, Attenuation
Remote Command	[:SENSe]:POWer[:RF]:EATTenuation:STATe OFF ON 0 1 [:SENSe]:POWer[:RF]:EATTenuation:STATe?
Example	POW:EATT:STAT ON
Dependencies	<p>This key only appears in Dual Attenuator models with an Electronic Attenuator installed. It does not appear in models with the Single Attenuator configuration, as in the single attenuator configuration there is no “electronic attenuator” there is only a single integrated attenuator (which has both a mechanical and electronic stage). However, in the single attenuator configuration, EATT SCPI commands are accepted for compatibility with other X-series instruments and set a “soft” attenuation as described in "Attenuator Configurations and Auto/Man" on page 3105.</p> <p>The electronic attenuator (and the “soft” attenuation function provided in single attenuator configurations) is unavailable above 3.6 GHz. Therefore, if the Stop Frequency of the analyzer is > 3.6 GHz then the Enable Elec Atten key will be OFF and grayed out.</p> <p>If the Internal Preamp is on, meaning it is set to Low Band or Full, the electronic attenuator (and the “soft” attenuation function provided in single attenuator configurations) is unavailable. In this case the Enable Elec Atten key will be OFF and grayed out.</p> <p>If either of the above is true, if the SCPI command is sent, an error indicating that the electronic attenuator is unavailable will be sent.</p> <p>If the electronic/soft Attenuator is enabled, then the Stop Freq of the analyzer is limited to 3.6 GHz and the Internal Preamp is unavailable.</p> <p>The SCPI-only “soft” electronic attenuation for the single-attenuator configuration is not available in all measurements; in particular, it is not available in the Swept SA measurement.</p>
Couplings	Enabling and disabling the Electronic Attenuator affects the setting of the Mechanical Attenuator (in dual attenuator configurations). This is described in more detail below this table.
Preset	OFF for Swept SA measurement; ON for all other measurements that support the electronic attenuator
State Saved	Saved in instrument state
Initial S/W Revision	Prior to A.02.00
Modified at S/W Revision	A.03.00

Mechanical Attenuator Transition Rules

When the Electronic Attenuator is enabled, the Mechanical Attenuator transitions to a state that has no Auto function. Below are the rules for transitioning the

Mechanical Attenuator. NOTE that the information below ONLY applies to the dual attenuator configurations, and ONLY when the Electronic Attenuator is installed:

When the Electronic Attenuation is enabled from a disabled state:

- The Mechanical Attenuator is initialized to 10 dB (this is its optimal performance setting). You can then set it as desired with SCPI, numeric keypad, step keys, or knob, and it behaves as it normally would in manual mode
- The Auto/Man state of (Mech) Atten is saved
- The Auto/Man line on the (Mech) Atten key disappears and the auto rules are disabled
- The Electronic Attenuator is set to 10 dB less than the previous value of the Mechanical Attenuator, within the limitation that it must stay within the range of 0 to 24 dB of attenuation.

Examples in the dual attenuator configuration:

- Mech Atten at 20 dB. Elec Atten enabled, Mech Atten set to 10 dB, and Elec Atten set to 10 dB. New total attenuation equals the value before Elec Atten enabled.
- Mech Atten at 0 dB. Elec Atten enabled, Mech Atten set to 10 dB, and Elec Atten set to 0 dB. New total attenuation does not equal the value before Elec Atten enabled.
- Mech Atten at 40 dB. Elec Atten enabled, Mech Atten set to 10 dB, and Elec Atten set to 24 dB. New total attenuation does not equal the value before Elec Atten enabled.

When the Electronic Attenuation is disabled from an enabled state:

- The Elec Atten key is grayed out
- The Auto/Man state of (Mech) Atten is restored
- If now in Auto, (Mech) Atten recouples
- If now in Man, (Mech) Atten is set to the value of total attenuation that existed before the Elec Atten was disabled. The resulting value is rounded up to the smallest value possible given the (Mech) Atten Step setting - (That is, 57 dB changes to 58 dB when (Mech) Atten Step is 2 dB.)

Using the Electronic Attenuator: Pros and Cons

The electronic attenuator offers finer steps than the mechanical attenuator, has no acoustical noise, is faster, and is less subject to wear.

The “finer steps” advantage of the electronic attenuator is beneficial in optimizing the alignment of the analyzer dynamic range to the signal power in the front panel as well as remote use. Thus, you can achieve improved relative signal measurement accuracy. Compared to a mechanical attenuator with 2 dB steps, the 1 dB resolution of the electronic attenuator only gives better resolution when the odd-decibel steps are used. Those odd-decibel steps are less accurately calibrated than the even-decibel steps, so one tradeoff for this superior relative accuracy is reduced absolute amplitude accuracy.

Another disadvantage of the electronic attenuator is that the spectrum analyzer loses its “Auto” setting, making operation less convenient.

Also, the relationship between the dynamic range specifications (TOI, SHI, compression and noise) and instrument performance are less well-known with the electrical attenuator. With the mechanical attenuator, TOI, SHI and compression threshold levels increase dB-for-dB with increasing attenuation, and the noise floor does as well. With the electronic attenuator, there is an excess attenuation of about 1 to 3 dB between 0 and 3.6 GHz, making the effective TOI, SHI, and so forth, less well known. Excess attenuation is the actual attenuation relative to stated attenuation. Excess attenuation is accounted for in the analyzer calibration

Elec Atten

Controls the Electronic Attenuator in dual attenuator configurations. This key does not appear in single attenuator configurations, as the control of both the mechanical and electronic stages of the single attenuator is integrated into the single **Atten** key.

Key Path	AMPTD Y Scale, Attenuation
Remote Command	<code>[:SENSe] :POWer [:RF] :EATTenuation <rel_amp1></code> <code>[:SENSe] :POWer [:RF] :EATTenuation?</code>
Notes	Electronic Attenuation's specification is defined only when Mechanical Attenuation is 6 dB.
Dependencies	This key only appears in Dual Attenuator models with an Electronic Attenuator installed. It does not appear in models with the Single Attenuator configuration, as in the single attenuator configuration there is no “electronic attenuator” there is only a single integrated attenuator (which has both a mechanical and electronic stage). However, in the single attenuator configuration, EATT SCPI commands are accepted for compatibility with other X-series instruments and set a “soft” attenuation as described in "Attenuator Configurations and Auto/Man" on page 3105 . The “soft” attenuation is treated as an addition to the “main” attenuation value set by the Atten softkey or the POW:ATT SCPI command and affects the total attenuation displayed on the Attenuation key and the Meas Bar. When Enable Elec Atten is off or grayed out, the Elec Atten key is grayed out.
Preset	0 dB
State Saved	Saved in instrument state
Min	0 dB

Max	Dual attenuator configuration: 24 dB Single attenuator configuration: the total of ATT and EATT cannot exceed 50 dB, so if the EATT is set to 24 dB first, the main attenuation cannot be greater than 26 dB and will be reduced accordingly; if the main attenuator is set to 40 dB first, EATT cannot be greater than 10 dB
Initial S/W Revision	Prior to A.02.00
Modified at S/W Revision	A.03.00

Adjust Atten for Min Clip

Sets the combination of mechanical and electronic attenuation and gain based on the current measured signal level so that clipping will be at a minimum.

This is an "immediate action" function, that is, it executes once, when the key is pressed.

This key does not appear in measurements that do not support this functionality. The spectrum analyzer measurement, Swept SA, does not support this functionality.

Key Path	AMPTD Y Scale, Attenuation
Remote Command	<code>[:SENSe] : POWer [:RF] : RANGe : OPTimize IMMEDIATE</code>
Initial S/W Revision	Prior to A.02.00
Modified at S/W Revision	A.03.00

Pre-Adjust for Min Clip

If this function is on, it does the adjustment described under "[Adjust Atten for Min Clip](#)" on page 3108 each time a measurement restarts. Therefore, in Continuous measurement mode, it only executes before the first measurement.

In dual attenuator models, you can set **Elec+Mech Atten**, in which case both attenuators participate in the autoranging, or **Elec Atten Only**, in which case the mechanical attenuator does not participate in the autoranging. This latter case results in less wear on the mechanical attenuator and is usually faster.

This key is grayed out in measurements that do not support this functionality. The spectrum analyzer measurement, Swept SA, does not support this functionality.

Key Path	AMPTD Y Scale, Attenuation
Remote Command	<code>[:SENSe] : POWer [:RF] : RANGe : OPTimize : ATTenuation OFF ELECTrical COMBined</code> <code>[:SENSe] : POWer [:RF] : RANGe : OPTimize : ATTenuation ?</code>
Notes	The SCPI parameter ELECTrical sets this function to On in single attenuator models. The SCPI parameter COMBined is mapped to ELECTrical in single attenuator models; if you send COMBined, it sets the function to On and returns ELEC to a query.
Dependencies	This key only appears in Dual Attenuator models with an Electronic Attenuator installed. In instruments with Dual Attenuator model, when Enable Elec Atten is off or grayed out, the Pre-

	Adjust for Min Clip key is grayed out.
Preset	OFF for Swept SA measurement; ON for all other measurements that support Pre-Adjust for Min Clip
State Saved	Saved in instrument state
Range	Dual attenuator models: Off Elec Atten Only Mech + Elec Atten Single attenuator models: Off On
Initial S/W Revision	Prior to A.02.00
Modified at S/W Revision	A.03.00

Remote Command	<code>[:SENSe] :POWer [:RF] :RANGe :AUTO ON OFF 1 0</code> <code>[:SENSe] :POWer [:RF] :RANGe :AUTO ?</code>
Notes	ON aliases to "Elec Atten Only" (:POW:RANG:OPT:ATT ELEC) OFF aliases to "Off" (:POW:RANG:OPT:ATT OFF) The query :POW:RANG:AUTO? returns true if :POW:RANG:OPT:ATT is not "Off"
Initial S/W Revision	Prior to A.02.00

Off

Turns **Pre-Adjust for Min Clip** off. This is the default setting.

This key is grayed out in measurements that do not support this functionality. The spectrum analyzer measurement, Swept SA, does not support this functionality.

Key Path	AMPTD Y Scale, Attenuation, Pre-Adjust for Min Clip
Example	:POW:RANGe:OPT:ATT OFF
Initial S/W Revision	Prior to A.02.00

Elec Atten Only

Selects only the electric attenuator to participate in auto ranging. This offers less wear on the mechanical attenuator and is usually faster.

This key is grayed out in measurements that do not support this functionality. The spectrum analyzer measurement, Swept SA, does not support this functionality.

Key Path	AMPTD Y Scale, Attenuation, Pre-Adjust for Min Clip
Example	:POW:RANGe:OPT:ATT ELEC
Initial S/W Revision	Prior to A.02.00

Mech + Elec Atten

In dual attenuator models, this selects both attenuators participate in the autoranging.

This key is grayed out in measurements that do not support this functionality. The spectrum analyzer measurement, Swept SA, does not support this functionality.

Key Path	AMPTD Y Scale, Attenuation, Pre-Adjust for Min Clip
Example	:POW:RANGe:OPT:ATT COMB
Initial S/W Revision	Prior to A.02.00

(Mech) Atten Step

This controls the step size used when making adjustments to the input attenuation.

This key is labeled **Mech Atten Step** in dual attenuator models and **Atten Step** in single attenuator models. In the dual attenuator configuration, this key only affects the step size of the mechanical attenuator.

Key Path	AMPTD Y Scale, Attenuation
Remote Command	[:SENSe]:POWer[:RF]:ATTenuation:STEP[:INCRement] 10 dB 2 dB [:SENSe]:POWer[:RF]:ATTenuation:STEP[:INCRement]?
Example	POW:ATT:STEP 2
Notes	Note this feature works like a 1-N choice from the front panel, but it takes a specific value (in dB) when used remotely. The only valid values are 2 and 10.
Dependencies	Blanked in CXA and EXA if option FSA (2 dB steps) is not present. If blanked, attempts to set it via SCPI will yield an error.
Couplings	When the attenuation step size changes, the current mechanical attenuation value is adjusted (if necessary) to be quantized to the new step size. That is, if step is set to 10 dB, mech atten is increased if necessary so it is a multiple of 10 dB
Preset	PXA and MXA: 2 dB EXA and CXA: 10 dB (2 dB with option FSA)
State Saved	Saved in instrument state
Initial S/W Revision	Prior to A.02.00
Modified at S/W Revision	A.03.00

Max Mixer Level

Controls the limitation on the Ref Level for a given attenuation setting, and therefore also interacts with the Auto rules for selecting the attenuation as a coupling from the reference level.

Key Path	AMPTD Y Scale, Attenuation
Remote Command	[:SENSe]:POWer[:RF]:MIXer:RANGe[:UPPer] <real> [:SENSe]:POWer[:RF]:MIXer:RANGe[:UPPer]?

Example	POW:MIX:RANG -15 dBm
Preset	-10 dBm
State Saved	Saved in instrument state
Min	-50 dBm
Max	0 dBm
Default Unit	Depends on the current selected Y axis unit, see Swept SA discussion of Y Axis Unit
Initial S/W Revision	Prior to A.02.00

Range

Accesses the Range menu to change baseband I/Q gain settings. This key has a readback text that describes gain range value. Refer to ["Range" on page 610](#) for more information.

Key Path	AMPTD Y Scale
Initial S/W Revision	Prior to A.02.00

Presel Center

When this key is pressed, the centering of the preselector filter is adjusted to optimize the amplitude accuracy at the frequency of the selected marker. If the selected marker is not on when Presel Center is pressed, the analyzer will turn on the selected marker, perform a peak search, and then perform centering on the marker's center frequency. If the selected marker is already on and between the start and stop frequencies of the analyzer, the analyzer performs the preselector calibration on that marker's frequency. If the selected marker is already on, but outside the frequency range between Start Freq and Stop Freq, the analyzer will first perform a peak search, and then perform centering on the marker's center frequency.

The value displayed on the **Presel Adjust** key will change to reflect the new preselector tuning (see **Presel Adjust**).

A number of considerations should be observed to ensure proper operation. See ["Proper Preselector Operation" on page 1923](#).

Key Path	AMPTD Y Scale
Remote Command	[:SENSe] :POWer [:RF] :PCENter
Example	POW:PCEN
Notes	Note that the rules outlined above under the key description apply for the remote command as well as the key. The result of the command is dependent on marker position, and so forth. Any message shown by the key press is also shown in response to the remote command.
Dependencies	<ul style="list-style-type: none"> - Grayed out if the microwave preselector is off.) - If the selected marker's frequency is below Band 1, advisory message 0.5001 is generated and no action is taken.

	<ul style="list-style-type: none"> - Grayed out if entirely in Band 0. - Blank in models that do not include a preselector, such as option 503. If the SCPI is sent in these instruments, it is accepted without error, and the query always returns 0. - Grayed out in the Spectrogram View.
Couplings	<p>The active marker position determines where the centering will be attempted.</p> <p>If the analyzer is in a measurement such as averaging when centering is initiated, the act of centering the preselector will restart averaging but the first average trace will not be taken until the centering is completed.</p>
Status Bits/OPC dependencies	<p>When centering the preselector, *OPC will not return true until the process is complete and a subsequent measurement has completed, nor will results be returned to a READ or MEASure command.</p> <p>The Measuring bit should remain set while this command is operating and should not go false until the subsequent sweep/measurement has completed.</p>
Initial S/W Revision	Prior to A.02.00
Modified at S/W Revision	A.03.00

Proper Preselector Operation

A number of considerations should be observed to ensure proper operation:

3. If the selected marker is off, the analyzer will turn on a marker, perform a peak search, and adjust the preselector using the selected marker's frequency. It uses the "highest peak" peak search method unqualified by threshold or excursion, so that there is no chance of a 'no peak found' error. It continues with that peak, even if it is the peak of just noise. Therefore, for this operation to work properly, there should be a signal on screen in a preselected range for the peak search to find.
4. If the selected marker is already on, the analyzer will attempt the centering at that marker's frequency. There is no preselector for signals below about 3.6 GHz, therefore if the marker is on a signal below 3.6 GHz, no centering will be attempted and an advisory message generated
5. In some models, the preselector can be bypassed. If it is bypassed, no centering will be attempted in that range and a message will be generated.

Preselector Adjust

Allows you to manually adjust the preselector filter frequency to optimize its response to the signal of interest. This function is only available when "[Presel Center](#)" on page 3111 is available.

For general purpose signal analysis, using Presel Center is recommended. Centering the filter minimizes the impact of long-term preselector drift. Presel Adjust

can be used instead to manually optimize the preselector. One application of manual optimization would be to peak the preselector response, which both optimizes the signal-to-noise ratio and minimizes amplitude variations due to small (short-term) preselector drifting.

Key Path	AMPTD Y Scale
Scope	Meas Global
Remote Command	[:SENSE]:POWER[:RF]:PADJust <freq> [:SENSE]:POWER[:RF]:PADJust?
Example	POW:PADJ 100KHz POW:PADJ?
Notes	The value on the key reads out to 0.1 MHz resolution.
Dependencies	<ul style="list-style-type: none"> - Grayed out if microwave preselector is off.) - Grayed out if entirely in Band 0. - Blank in models that do not include a preselector, such as option 503. If the SCPI is sent in these instruments, it is accepted without error, and the query always returns 0. - Grayed out in the Spectrogram View.
Preset	0 MHz
State Saved	The Presel Adjust value set by Presel Center , or by manually adjusting Presel Adjust , is not saved in instrument state, and does not survive a Preset or power cycle.
Min	-500 MHz
Max	500 MHz
Default Unit	Hz
Backwards Compatibility SCPI	[:SENSE]:POWER[:RF]:MW:PADJust [:SENSE]:POWER[:RF]:MMW:PADJust PSA had multiple preselectors, but the X-Series has only one. These commands simply alias to [:SENSE]:POWER[:RF]:PADJust
Initial S/W Revision	Prior to A.02.00
Modified at S/W Revision	A.03.00
Remote Command	[:SENSE]:POWER[:RF]:PADJust:PRESelector MWAVE MMWave EXTERNAL [:SENSE]:POWER[:RF]:PADJust:PRESelector?
Notes	PSA had multiple preselectors, and you could select which preselector to adjust. Since the X-Series has only one mm/uW preselector, the preselector selection softkey is no longer available. However, to provide backward compatibility, we accept the legacy remote commands. The command form has no effect, the query always returns MWAVE
Initial S/W Revision	Prior to A.02.00

Reference Level Offset

Adds an offset value to the displayed reference level. The reference level is the absolute amplitude represented by the top graticule line on the display.

See ["More Information" on page 1925](#)

Key Path	AMPTD Y Scale
Mode	SA
Scope	Meas Global
Remote Command	:DISPlay:WINDow[1]:TRACe:Y[:SCALe]:RLEVe1:OFFSet <rel_amp1> :DISPlay:WINDow[1]:TRACe:Y[:SCALe]:RLEVe1:OFFSet?
Example	DISP:WIND:TRAC:Y:RLEV:OFFS 12.7 Sets the Ref Level Offset to 12.7 dB. The only valid suffix is dB. If no suffix is sent, dB will be assumed.
Preset	0 dBm
State Saved	Saved in instrument state
Min	The range for Ref Lvl Offset is variable. It is limited to values that keep the reference level within the range of -327.6 dB to 327.6 dB.
Max	327.6 dB
Backwards Compatibility Notes	<p>6. In pre-X-Series instruments, Ref Level Offset could not be adjusted by the knob or step keys. That is no longer the case.</p> <p>7. In ESA and PSA, Ref Level Offset was applied to the data as it was acquired; thus if the Offset changed the new offset was not applied until new trace data was taken. In X-Series, the offset is applied as the data is displayed/queried, so if you change the offset, it will change the data immediately.</p>
Initial S/W Revision	Prior to A.02.00
Modified at S/W Revision	A.04.00

More Information

Offsets are used when gain or loss occurs between a device under test and the analyzer input. Thus, the signal level measured by the analyzer may be thought of as the level at the input of an external amplitude conversion device. Entering an offset does not affect the trace position or attenuation value, just the value of the top line of the display and the values represented by the trace data. Thus, the values of exported trace data, queried trace data, marker amplitudes, trace data used in calculations such as N dB points, trace math, peak threshold, and so forth, are all affected by Ref Level Offset.

NOTE

Changing the offset causes the analyzer to immediately stop the current sweep and prepare to begin a new sweep, but the data will not change until the trace data updates, because the offset is applied to the data as it is taken. If a trace is exported with a nonzero Ref Level Offset, the exported data will contain the trace data with the offset applied.

The maximum reference level available is dependent on the reference level offset. That is, Ref Level - Ref Level Offset must be in the range -170 to +30 dBm. For example, the reference level value range can be initially set to values from -170 dBm to 30 dBm with no reference level offset. If the reference level is first set to -20 dBm, then the reference level offset can be set to values of -150 to +50 dB.

If the reference level offset is first set to -30 dB, then the reference level can be set to values of -200 dBm to 0 dBm. In this case, the reference level is “clamped” at 0 dBm because the maximum limit of +30 dBm is reached with a reference level setting of 0 dBm with an offset of -30 dB. If instead, the reference level offset is first set to 30 dB, then the reference level can be set to values of -140 to +60 dBm.

μ W Path Control

The **μ W Path Control** functions include the **μ W Preselector Bypass** (Option MPB) and **Low Noise Path** (Option LNP) controls in the High Band path circuits.

When the μ W Preselector is bypassed, the user has better flatness, but will be subject to spurs from out of band interfering signals. When the Low Noise Path is enabled, the analyzer automatically switches around certain circuitry in the high frequency bands which can contribute to noise, when it is appropriate based on other analyzer settings.

For most applications, the preset state is Standard Path, which gives the best remote-control throughput, minimizes acoustic noise from switching and minimizes the risk of wear out in the hardware switches. For applications that utilize the wideband IF paths, the preset state is the μ W Preselector Bypass path, if option MPB is present. This is because, when using a wideband IF such as the 140 MHz IF, the μ W Preselector’s bandwidth can be narrower than the available IF bandwidth, causing degraded amplitude flatness and phase linearity, so it is desirable to bypass the preselector in the default case.

Users may choose Low Noise Path Enable. It gives a lower noise floor, especially in the 21-26.5 GHz region, though without improving many measures of dynamic range, and without giving the best possible noise floor. The preamp, if purchased and used, gives better noise floor than does the Low Noise Path, however its compression threshold and third-order intercept are much poorer than that of the non-preamp Low Noise Path. There are some applications, typically for signals around -30 dBm, for which the third-order dynamic range of the standard path is good enough, but the noise floor is not low enough even with 0 dB input attenuation. When the third-order dynamic range of the preamp path is too little and the noise floor of the standard path is too high, the Low Noise Path can provide the best dynamic range.

Mode	SA, BASIC, PNOISE, VSA , LTE, LTETDD
Scope	Meas Global
Remote Command	[:SENSe] :POWer [:RF] :MW:PATH STD LNPath MPBypass FULL [:SENSe] :POWer [:RF] :MW:PATH?
Example	:POW:MW:PATH LNP Enables the Low Noise path
Notes	If a Presel Center is performed, the analyzer will momentarily switch to the Standard Path, regardless of the setting of μW Path Control The DC Block will always be switched in when the low noise path is switched in, to protect succeeding circuitry from DC. Note that this does not mean “when the low noise path is enabled” but when, based on the Low Noise Path rules, the path is actually switched in. This can happen when the selection is Low Noise Path Enable . In the case where the DC Block is switched in the analyzer is now AC coupled. However, if the user has selected DC coupling, the UI will still behave as though it were DC coupled, including all annunciation, warnings, status bits, and responses to SCPI queries. This is because, based on other settings, the analyzer could switch out the low noise path at any time and hence go back to being DC coupled. Alignment switching ignores the settings in this menu, and restores them when finished.
Dependencies	Unavailable in BBIQ and External Mixing
Preset	All modes other than IQ Analyzer mode and VXA: STD IQ Analyzer, VXA and WLAN mode: MPB option present and licensed: MPB MPB option not present and licensed: STD
State Saved	Save in instrument state
Readback	Value selected in the submenu
Initial S/W Revision	A.04.00
Modified at S/W Revision	A.10.00

Standard Path

This path gives the best remote-control throughput, minimizes acoustic noise from switching and minimizes the risk of wear in the hardware switches, particularly in remote test scenarios where both low band and high band setups will follow in rapid succession.

In this path, the bypass of the low band/high band switch and microwave preamp is never activated, which can cause some noise degradation but preserves the life of the bypass switch.

Key Path	AMPTD Y Scale, μW Path Control
Example	:POW:MW:PATH STD
Readback Text	Standard Path
Initial S/W Revision	A.04.00

μW Preselector Bypass

This key toggles the preselector bypass switch for band 1 and higher. When the microwave preselector is on, the signal path is preselected. When the microwave preselector is off, the signal path is not preselected. The preselected path is the normal path for the analyzer.

The preselector is a tunable bandpass filter which prevents signals away from the frequency of interest from combining in the mixer to generate in-band spurious signals (images). The consequences of using a preselector filter are its limited bandwidth, the amplitude and phase ripple in its passband, and any amplitude and phase instability due to center frequency drift.

Option MPB or pre-selector bypass provides an unpreselected input mixer path for certain X-Series signal analyzers with frequency ranges above 3.6 GHz. This signal path allows a wider bandwidth and less amplitude variability, which is an advantage when doing modulation analysis and broadband signal analysis. The disadvantage is that, without the preselector, image signals will be displayed. Another disadvantage of bypassing the preselector is increased LO emission levels at the front panel input port.

Image responses are separated from the real signal by twice the 1st IF. For IF Paths of 10 MHz and 25 MHz, the 1st IF is 322.5 MHz, so the image response and the real signal will be separated by 645 MHz. The 1st IF will be different for other IF Path settings. When viewing a real signal and its corresponding image response in internal mixing, the image response will be to the left of the real signal.

Also, the image response and the real signal typically have the same amplitude and exhibit the same shape factor.

However, if Option FS1, Fast Sweep Capability, is enabled, the image response in the Swept SA measurement will appear lower in amplitude and have a much wider shape factor compared to the real signal.

Key Path	AMPTD Y Scale, μW Path Control
Example	:POW:MW:PATH MPB
Dependencies	Key is blanked if current mode does not support it. Key is grayed out if mode supports it but current measurement does not support it. Key is blank unless Option MPB is present and licensed. If SCPI command sent when MPB not present, error -241, "Hardware missing; Option not installed" is generated.
Readback Text	μW Preselector Bypass
Initial S/W Revision	A.04.00

Remote Command	[:SENSe] :POWer [:RF] :MW:PRESelector [:STATe] ON OFF 0 1 [:SENSe] :POWer [:RF] :MW:PRESelector [:STATe] ?
Example	:POW:MW:PRES OFF Bypasses the microwave preselector
Notes	The ON parameter sets the STD path (:POW:MW:PATH STD)

	The OFF parameter sets path MPB (:POW:MW:PATH MPB)
Preset	ON

Internal Preamp

Accesses a menu of keys that control the internal preamps. Turning on the preamp gives a better noise figure, but a poorer TOI to noise floor dynamic range. You can optimize this setting for your particular measurement.

The instrument takes the preamp gain into account as it sweeps. If you sweep outside of the range of the preamp the instrument will also account for that. The displayed result will always reflect the correct gain.

For some measurements, when the preamp is on and any part of the displayed frequency range is below the lowest frequency for which the preamp has specifications, a warning condition message appears in the status line. For example ,for a preamp with a 9 kHz lowest specified frequency: "Preamp: Accy unspec'd below 9 kHz".

Key Path	AMPTD Y Scale
Scope	Meas Global
Remote Command	[:SENSe] :POWer [:RF] :GAIN [:STATe] OFF ON 0 1 [:SENSe] :POWer [:RF] :GAIN [:STATe] ?
Dependencies	Preamp is not available on all hardware platforms. If the preamp is not present or is unlicensed, the key is not shown. The preamp is not available when the electronic/soft attenuator is enabled.
Couplings	The act of connecting the U7227A USB Preamplifier to one of the analyzer's USB ports will cause the Internal Preamp to be switched on. When this happens an informational message will be generated: "Internal Preamp turned on for optimal operation with USB Preamp." Note that if the Internal Preamp was already on, there will be no change to the setting, but if it was Off it will be switched On, to Full Range. Note that this same action occurs when the SA mode is selected while the USB Preamp is connected to one of the analyzer's USB ports, if it is the first time that the SA mode has run since powerup, or if the last time the SA mode was running the USB Preamp was NOT connected. Subsequently disconnecting the USB Preamp from USB does not change the Internal Preamp setting nor restore the previous setting.
Preset	OFF
State Saved	Saved in instrument state
Initial S/W Revision	Prior to A.02.00
Modified at S/W Revision	A.14.00

Key Path	AMPTD Y Scale, Internal Preamp
----------	---------------------------------------

Scope	Meas Global
Remote Command	[:SENSe] :POWer [:RF] :GAIN :BAND LOW FULL [:SENSe] :POWer [:RF] :GAIN :BAND ?
Dependencies	Preamp is not available on all hardware platforms. If the preamp is not present or is unlicensed, the key is not shown. If a POW:GAIN:BAND FULL command is sent when a low band preamp is available, the preamp band parameter is to LOW instead of FULL, and an "Option not installed" message is generated.
Preset	LOW
State Saved	Saved in instrument state
Initial S/W Revision	Prior to A.02.00

Off

Turns the internal preamp off

Key Path	AMPTD Y Scale, Internal Preamp
Example	:POW:GAIN OFF
Readback	Off
Initial S/W Revision	Prior to A.02.00

Low Band

Sets the internal preamp to use only the low band.

The frequency range of the installed (optional) low-band preamp is displayed in square brackets on the **Low Band** key label.

Key Path	AMPTD Y Scale, Internal Preamp
Example	:POW:GAIN ON :POW:GAIN:BAND LOW
Readback	Low Band
Initial S/W Revision	Prior to A.02.00

Full Range

Sets the internal preamp to use its full range. The low band (0-3.6 GHz or 0-3GHz, depending on the model) is supplied by the low band preamp and the frequencies above low band are supplied by the high band preamp.

The frequency range of the installed (optional) preamp is displayed in square brackets on the **Full Range** key label. If the high band option is not installed the Full Range key does not appear.

Key Path	AMPTD Y Scale, Internal Preamp
Example	:POW:GAIN ON :POW:GAIN:BAND FULL

Readback	Full Range
Initial S/W Revision	Prior to A.02.00

Presel Center

When this key is pressed, the centering of the preselector filter is adjusted to optimize the amplitude accuracy at the frequency of the selected marker.

See AMPTD Y Scale, "[Presel Center](#)" on page 3111 for more information.

This is only available when the selected input is RF.

Key Path	AMPTD Y Scale
Initial S/W Revision	Prior to A.02.00

Auto Couple

The Auto Couple feature provides a quick and convenient way to automatically couple multiple instrument settings. This helps ensure accurate measurements and optimum dynamic range. When the Auto Couple feature is activated, either from the front panel or remotely, all parameters of the current measurement that have an Auto/Manual mode are set to Auto mode and all measurement settings dependent on (or coupled to) the Auto/Man parameters are automatically adjusted for optimal performance.

However, the Auto Couple keyactions are confined to the current measurement only. It does not affect other measurements in the mode, and it does not affect markers, marker functions, or trace or display attributes.

See "[More Information](#)" on page 1932

Key Path	Front-panel key
Remote Command	:COUPle ALL NONE
Example	:COUP ALL
Notes	:COUPle ALL puts all Auto/Man parameters in Auto mode (equivalent to pressing the Auto Couple key). :COUPLE NONE puts all Auto/Man parameters in manual mode. It decouples all the coupled instrument parameters and is not recommended for making measurements.
Initial S/W Revision	Prior to A.02.00

More Information

There are two types of functions that have Auto/Manual modes.

Auto/Man Active Function keys

An Auto/Man toggle key controls the binary state associated with an instrument parameter by toggling between **Auto** (where the parameter is automatically coupled to the other parameters it is dependent upon) and **Man** (where the parameter is controlled independent of the other parameters), as well as making the parameter the active function. The current mode is indicated on the softkey with either **Auto** or **Man** underlined as illustrated below.

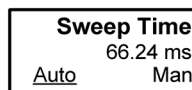

vsd07

Auto/Man 1-of-N keys

An Auto/Man 1-of-N key allows you to manually pick from a list of parameter values, or place the function in Auto, in which case the value is automatically selected (and indicated).

- If in Auto, Auto is underlined on the calling key.

- If in manual operation, manual is indicated on the calling key, but note that the calling key simply opens the menu and does **not** actually toggle the function.

BW

Opens the BW menu, which contains keys to control the information bandwidth functions of the instrument.

Key Path	Front-panel key
Initial S/W Revision	Prior to A.02.00

Info BW

Allows you to enter a frequency value to set the channel bandwidth that will be used for data acquisition.

Key Path	BW
Mode	SA, WCDMA, C2K, WIMAXOFDMA, TD-SCDMA, 1xEV-DO, DVB-T/H, DTMB (CTTB), ISDB-T, CMMB, LTE, LTETDD, Digital Cable TV, WLAN, MSR, LTEATDD, LTEAFDD
Remote Command	<code>[:SENSe]:PStatistic:BAWdwidth <freq></code> <code>[:SENSe]:PStatistic:BAWdwidth?</code>
Example	PST:BAW 8 MHz PST:BAW?
Couplings	WiMAX OFDMA: The default value depends on the Radio Standard selection..
Preset	SA, WCDM: 5 MHz C2K:1.5 MHz 1xEV-DO:1.3 MHz WiMAX OFDMA: Hardware Dependent No Option = 10 MHz WB (25 MHz or wider) = 25 MHz TD-SCDMA: 1.3 MHz DVB-T/H, DTMB (CTTB): 8 MHz ISDB-T: 6 MHz CMMB: 8 MHz LTE, LTETDD, LTEATDD, LTEAFDD: 6 MHz Digital Cable TV: 8MHz WLAN: Hardware Dependent if Radio Std is 802.11a/b/g/n(20MHz) = 25 MHz if Radio Std is 802.11n(40MHz) = 40 MHz if Radio Std is 802.11ac(20MHz) = 25 MHz if Radio Std is 802.11ac(40MHz) = 40 MHz if Radio Std is 802.11ac(80MHz) = 80 MHz if Radio Std is 802.11ac(160MHz) = 160 MHz if Radio Std is 802.11ah(1MHz) = 3 MHz if Radio Std is 802.11ah(2MHz) = 3 MHz if Radio Std is 802.11ah(4MHz) = 4 MHz

	if Radio Std is 802.11ah(8MHz) = 8 MHz if Radio Std is 802.11ah(16MHz) = 16 MHz if Radio Std is 802.11j/p(10MHz) =10 MHz if Radio Std is 802.11p(5MHz) =5 MHz MSR: same as max value
State Saved	Saved in instrument state.
Min	10.0 kHz
Max	Hardware Dependent: RF Input: No Option = 10 MHz WB (25MHz or wider) = Hardware Option Limit I/Q Input (for I+jQ): No Option = 20 MHz Option B25 = 50 MHz
Backwards Compatibility SCPI	[:SENSe] :PStatistic:BWIDth
Initial S/W Revision	Prior to A.02.00
Modified at S/W Revision	A.02.00, A.03.00, A.06.00

Cont (Continuous Measurement/Sweep)

Sets the analyzer for Continuous measurement operation. The single/continuous state is Meas Global so the setting will affect all measurements. If you are Paused, pressing **Cont** does a Resume.

Key Path	Front-panel key
Remote Command	:INITiate:CONTinuous OFF ON 0 1 :INITiate:CONTinuous?
Example	:INIT:CONT 0 puts analyzer in Single measurement operation. :INIT:CONT 1 puts analyzer in Continuous measurement operation
Preset	ON (Note that SYST:PRESet sets INIT:CONT to ON but *RST sets INIT:CONT to OFF)
State Saved	Saved in instrument state
Backwards Compatibility Notes	For Spectrum Analysis mode in ESA and PSA, there is no Cont hardkey, instead there is a Sweep Single/Cont key. In these analyzers, switching the Sweep Single/Cont key from Single to Cont restarts averages (displayed average count reset to 1), but does not restart Max Hold and Min Hold . The X-Series has Single and Cont keys in place of the SweepSingleCont key. In the X-Series, if in single measurement, the Cont key (and INIT:CONT ON) switches to continuous measurement, but never restarts a measurement and never resets a sweep.
Initial S/W Revision	Prior to A.02.00

In Swept SA Measurement (Spectrum Analysis Mode):

The analyzer takes repetitive sweeps, averages, measurements, etc., when in Continuous mode. When the average count reaches the Average/Hold Number the count stops incrementing, but the analyzer keeps sweeping. See the Trace/Detector section for the averaging formula used both before and after the Average/Hold Number is reached. The trigger condition must be met prior to each sweep. The type of trace processing for multiple sweeps, is set under the Trace/Detector key, with choices of **Trace Average**, **Max Hold**, or **Min Hold**.

In Other Measurements/Modes:

With **Avg/Hold Num** (in the **Meas Setup** menu) set to **Off** or set to **On** with a value of 1, a sweep is taken after the trigger condition is met; and the analyzer continues to take new sweeps after the current sweep has completed and the trigger condition is again met. However, with **Avg/Hold Num** set to On with a value >1, multiple sweeps (data acquisitions) are taken for the measurement. The trigger condition must be met prior to each sweep. The sweep is not stopped when the average count k equals the number N set for Avg/Hold Num is reached, but the number k stops incrementing. A measurement average usually applies to all traces, marker results, and numeric results. But sometimes it only applies to the numeric results.

If the analyzer is in Single measurement, pressing the **Cont** key does not change k and does not cause the sweep to be reset; the only action is to put the analyzer into Continuous measurement operation.

If it is already in continuous sweep:

the INIT:CONT 1 command has no effect

the INIT:CONT 0 command will place the analyzer in Single Sweep but will have no effect on the current sequence until $k = N$, at which point the current sequence will stop and the instrument will go to the idle state.

File

See "File" on page 426

FREQ Channel

Accesses a menu of keys that allow you to control the Frequency and Channel parameters of the instrument.

Some features in the Frequency menu are the same for all measurements – they do not change as you change measurements. Settings like these are called “Meas Global” and are unaffected by Meas Preset. For example, the Center Freq setting is the same for all measurements – it does not change as you change measurements.

Key Path	Front-panel key
Initial S/W Revision	Prior to A.02.00

Center Freq

Sets the frequency that corresponds to the horizontal center of the graticule (when frequency Scale Type is set to linear). While adjusting the Center Frequency the Span is held constant, which means that both Start Frequency and Stop Frequency will change.

Pressing Center Freq also sets the frequency entry mode to Center/Span. In Center/Span mode, the center frequency and span values are displayed below the graticule, and the default active function in the Frequency menu is **Center Freq**.

The center frequency setting is the same for all measurements within a mode, that is, it is Meas Global. Some modes are also able to share a Mode Global center frequency value. If this is the case, the Mode will have a **Global Settings** key in its **Mode Setup** menu.

The **Center Freq** function sets (and queries) the Center Frequency for the currently selected input. If your analyzer has multiple inputs, and you select another input, the Center Freq changes to the value for that input. SCPI commands are available to directly set the Center Freq for a specific input.

Center Freq is remembered as you go from input to input. Thus you can set a Center Freq of 10 GHz with the RF Input selected, change to BBIQ and set a Center Freq of 20 MHz, then switch to External Mixing and set a Center Freq of 60 GHz, and when you go back to the RF Input the Center Freq will go back to 10 GHz; back to BBIQ and it is 20 MHz; back to External Mixing and it is 60 GHz.

See ["RF Center Freq" on page 1943](#)

See [Ext Mix Center Freq](#)

See ["I/Q Center Freq" on page 1944](#)

See ["Center Frequency Presets" on page 1940](#)

Key Path	FREQ Channel
Scope	Meas Global
Remote Command	[:SENSE] :FREQuency:CENTer <freq>

[:SENSe] :FREQuency :CENTer ?	
Example	FREQ:CENT 50 MHz FREQ:CENT UP changes the center frequency to 150 MHz if you use FREQ:CENT:STEP 100 MHz to set the center frequency step size to 100 MHz FREQ:CENT?
Notes	This command sets either the RF or I/Q Center Frequency depending on the selected input. For RF input it is equivalent to FREQ:RF:CENT For I/Q input it is equivalent to FREQ:IQ:CENT Preset and Max values are dependent on Hardware Options (5xx) If no terminator (e.g. MHz) is sent the terminator Hz is used. If a terminator with unit other than Frequency is used, an invalid suffix error message is generated.
Dependencies	The Center Frequency can be limited by Start or Stop Freq limits, if the Span is so large that Start or Stop reach their limit.
Couplings	When operating in "swept span", any value of the Center Frequency or Span that is within the frequency range of the analyzer is allowed when the value is being set through the front panel numeric key pad or the SCPI command. The other parameter is forced to a different value if needed, to keep the Start and the Stop Frequencies within the analyzer's frequency range
Preset	Depends on instrument maximum frequency, mode, measurement, and selected input. See "Center Frequency Presets" on page 1940 and "RF Center Freq" on page 1943 and Ext Mix Center Freq and "I/Q Center Freq" on page 1944 .
State Saved	Saved in instrument state
Min	Depends on instrument maximum frequency, mode, measurement, and selected input.. See "Center Frequency Presets" on page 1940 and "RF Center Freq" on page 1943 and "I/Q Center Freq" on page 1944 .
Max	Depends on instrument maximum frequency, mode, measurement, and selected input.. See "Center Frequency Presets" on page 1940 and "RF Center Freq" on page 1943 and "I/Q Center Freq" on page 1944 .
Default Unit	Hz
Status Bits/OPC Dependencies	Non-overlapped
Initial S/W Revision	Prior to A.02.00

Center Frequency Presets

The following table provides the Center Frequency Presets for the Spectrum Analyzer mode, and the Max Freq, for the various frequency options:

Freq Option	CF after Mode Preset	Stop Freq after Mode Preset	Max Freq (can't tune above)
503 (all but N9000A)		1.805 GHz	3.6 GHz 3.7 GHz

Freq Optio n	CF after Mode Prese t	Stop Freq after Mode Prese t	Max Freq (can't tune abov e)	
503 (N9000A)		1.505 GHz	3.0 GHz	3.08 GHz
504 (M9420A)		1 GHz	3.8GHz	3.88 GHz
506 (M9420A)		1 GHz	6.0GHz	6.08 GHz
507 (all but N9000A)		3.505 GHz	7.0 GHz	7.1 GHz
507 (N9000A)		3.755 GHz	7.5 GHz	7.58 GHz
508 (all but N9038A)		1.805 GHz	3.6 GHz	8.5 GHz
508 (N9038A)		4.205 GHz	8.4 GHz	8.5 GHz
513		6.805 GHz	13.6 GHz	13.8 GHz
526 (all but N9000A and N9038A)		13.255 GHz	26.5 GHz	27.0 GHz
526 (N9000A)		13.255 GHz	26.5 GHz	26.5 5 GHz
526 (N9038A)		1.805 GHz	3.6 GHz	27.0 GHz
532	16.005 GHz		32.0 GHz	32.5 GHz
543	21.505 GHz		43.0 GHz	TBD
544	22.005 GHz		44.0 GHz	44.5 GHz
550	25.005 GHz		50.0 GHz	51 GHz

Input 2:

Model	CF after Mode Preset	Stop Freq after Mode Preset	Max Freq (can't tune above)
N9000A opt C75	0.7505GHz	1.5 GHz	1.58 GHz
N9038A	505 MHz	1 GHz	1.000025 GHz

Tracking Generator Frequency Limits (N9000A only):

Tracking Generator Option	Min Freq (clips to this freq when turn TG on and can't tune below while TG on)	If above this Freq, Stop Freq clipped to this Freq when TG turned on	Max Freq (can't tune above) while TG on
T03	9 kHz	3.0 GHz	3.08 GHz
T06	9 kHz	6.0 GHz	6.05 GHz

Tracking Generator Frequency Limits(M9290A only):

Tracking Generator Option	Min Freq (clips to this freq when turn TG on and can't tune below while TG on)	If above this Freq, Stop Freq clipped to this Freq when TG turned on	Max Freq (can't tune above) while TG on
T03	2 MHz	3.08 GHz	3.08 GHz
T07	2 MHz	7.575 GHz	7.575 GHz
T13	2 MHz	13.8 GHz	13.8 GHz
T26	2 MHz	26.55 GHz	26.55 GHz

The following table shows the Center Frequency Presets for modes other than Spectrum Analyzer:

Mode	CF Preset for RF
WCDMA	1 GHz
WIMAXOFDMA,	1 GHz
BASIC	1 GHz
ADEMOD	1 GHz
VSA	1 GHz
TDSCDMA	1 GHz
PNOISE	1 GHz

Mode	CF Preset for RF
LTE	1 GHz
LTETDD	1 GHz
MSR	1 GHz
GSM	935.2 MHz
NFIGURE	1.505 GHz

RF Center Freq

SCPI command for specifying the RF Center Frequency. This command will set the Center Frequency to be used when the RF input is selected, even if the RF input is not the input that is selected at the time the command is sent. Note that the **Center Freq** function in the **Frequency** menu on the front panel always applies to the currently selected input.

Scope	Meas Global
Remote Command	[:SENSe] :FREQuency:RF:CENTer <freq> [:SENSe] :FREQuency:RF:CENTer?
Example	FREQ:RF:CENT 30 MHz
Notes	This command is the same in all modes, but the parameter is Measurement Global. So the value is independent in each mode and common across all the measurements in the mode.
Dependencies	If the electronic/soft attenuator is enabled, any attempt to set Center Frequency such that the Stop Frequency would be >3.6 GHz fails and results in an advisory message. If the equivalent SCPI command is sent, this same message is generated as part of a “-221, Settings conflict” warning. If Source Mode is set to Tracking, and the Max or Min Center Freq is therefore limited by the limits of the source, a warning message is generated, “Data out of range;clipped to source max/min” if these limits are exceeded. Note that for an external source, these limits can be affected by the settings of Source Numerator, Source Denominator and Power Sweep.
Preset	See table above
State Saved	Saved in instrument state.
Min	-79.999995 MHz, unless Source Mode is set to Tracking, in which case it is limited by the minimum frequency of the Source
Max	See table above. Basically instrument maximum frequency - 5 Hz. Note that, if the Source Mode is set to Tracking, the effective instrument maximum frequency may be limited by the source maximum frequency. If the knob or step keys are being used, also depends on the value of the other three interdependent parameters Span, Start Frequency and Stop Frequency
Initial S/W Revision	Prior to A.02.00
Modified at S/W Revision	A.03.00

Ext Mix Center Freq

SCPI command for specifying the External Mixer Center Frequency. This command will set the Center Frequency to be used when the External Mixer is selected, even if the External Mixer input is not the input which is selected at the time the command is sent. Note that the **Center Freq** function in the **Frequency** menu on the front panel always applies to the currently selected input.

Scope	Meas Global
Remote Command	[:SENSe] :FREQuency:EMIXer:CENTer <freq> [:SENSe] :FREQuency:EMIXer:CENTer?
Example	:FREQ:EMIX:CENT 60 GHz :FREQ:EMIX:CENT?
Notes	This command is the same in all modes, but the parameter is Measurement Global. So the value is independent in each mode and common across all the measurements in the mode.
Couplings	When returning to External Mixing after having been switched to one of the other inputs (e.g., RF), you will come back into the settings that you had when you left External Mixing. So you will come back to the band you were in with the Center Frequency that you had. However, Span is not an input-dependent parameter, therefore you will bring the span over from the other input. Therefore, the analyzer comes back with the span from the previous input, limited as necessary by the current mixer setup.
Preset	When a Mode Preset is performed while in External Mixing, the Start frequency of the current Mode is set to the nominal Min Freq of the lowest harmonic range in the Harmonic Table for the current mixer setup. Similarly, the Stop frequency of the current Mode is set to the nominal Max Freq of the highest harmonic range in the Harmonic Table. The Center Freq thus presets to the point arithmetically equidistant from these two frequencies. If the current measurement has a limited Span available to it, and cannot achieve the Span shown in the table (Span=Stop Freq – Start Freq), the analyzer uses the maximum Span the measurement allows, and still sets the Center Freq to the midpoint of the Start and Stop Freq values in the Harmonic Table. When Restore Input/Output Defaults is performed, the mixer presets to the 11970A, whose Start and Stop frequencies are 26.5 and 40 GHz respectively. The center of these two frequencies is 33.25 GHz. Therefore, after a Restore Input/Output Defaults, if you go into External Mixing and do a Mode Preset while in the Spectrum Analyzer Mode, the resulting Center Freq is 33.25 GHz.
State Saved	Saved in instrument state.
Min	The minimum frequency in the currently selected mixer band + 5 Hz
Max	The maximum frequency in the currently selected mixer band - 5 Hz If the knob or step keys are being used, also depends on the value of the other three interdependent parameters Span, Start Frequency and Stop Frequency
Initial S/W Revision	A.08.01

I/Q Center Freq

SCPI command for specifying the I/Q Center Frequency. This command will set the Center Frequency to be used when the I/Q input is selected, even if the I/Q input is not the input which is selected at the time the command is sent. Note that the

Center Freq function in the **Frequency** menu on the front panel always applies to the currently selected input.

Scope	Meas Global
Remote Command	<code>[:SENSe] :FREQuency:IQ:CENTer <freq></code> <code>[:SENSe] :FREQuency:IQ:CENTer?</code>
Example	FREQ:IQ:CENt: 30 MHz
Notes	This command is the same in all modes, but the parameter is Measurement Global. So the value is independent in each mode and common across all the measurements in the mode.
Preset	0 Hz
State Saved	Saved in instrument state.
Min	-40.049995 MHz
Max	40.049995 MHz
Initial S/W Revision	Prior to A.02.00

CF Step

Changes the step size for the center frequency and start and stop frequency functions. Once a step size has been selected and the center frequency function is active, the step keys (and the UP|DOWN parameters for Center Frequency from remote commands) change the center frequency by the step-size value. The step size function is useful for finding harmonics and sidebands beyond the current frequency span of the analyzer.

Note that the start and stop frequencies also step by the CF Step value.

Key Path	FREQ Channel
Remote Command	<code>[:SENSe] :FREQuency:CENTer:STEP [:INCRement] <freq></code> <code>[:SENSe] :FREQuency:CENTer:STEP [:INCRement]?</code> <code>[:SENSe] :FREQuency:CENTer:STEP:AUTO OFF ON 0 1</code> <code>[:SENSe] :FREQuency:CENTer:STEP:AUTO?</code>
Example	FREQ:CENt:STEP:AUTO ON FREQ:CENt:STEP 500 MHz FREQ:CENt UP increases the current center frequency value by 500 MHz FREQ:CENt:STEP? FREQ:CENt:STEP:AUTO?
Notes	Preset and Max values are depending on Hardware Options (503, 507, 508, 513, 526)
Notes	Preset and Max values are dependent on Hardware Options (5xx)
Dependencies	Freq Offset is not available in External Mixing. In this case the Freq Offset key is grayed out and shows a value of zero. It will once again be available, and show the previously set value, when you return to the RF Input.
Dependencies	Span, RBW, Center frequency If the electronic/soft attenuator is enabled, any attempt to change the value of the center

	frequency >3.6 GHz by pressing the Up-arrow key, fails and results in an advisory message. If the equivalent SCPI command is sent, this same message is generated as part of a “-221, Settings conflict” warning.
Couplings	When auto-coupled in a non-zero span, the center frequency step size is set to 10% of the span. When auto-coupled in zero span, the center frequency step size is set to the equivalent -3 dB RBW value.
Preset	Auto ADEM0D: 1 MHz ON
State Saved	Saved in instrument state
Min	– (the maximum frequency of the instrument). That is, 27 GHz max freq instrument has a CF step range of +/- 27 GHz. Note that this is the maximum frequency given the current settings of the instrument, so in External Mixing, for example, it is the maximum frequency of the current mixer band.
Max	The maximum frequency of the instrument. That is, 27 GHz max freq instrument has a CF step range of +/- 27 GHz. Note that this is the maximum frequency given the current settings of the instrument, so in External Mixing, for example, it is the maximum frequency of the current mixer band.
Default Unit	Hz
Status Bits/OPC dependencies	non-overlapped
Initial S/W Revision	Prior to A.02.00
Modified at S/W Revision	A.03.00

Freq Offset

Enables you to set a frequency offset value to account for frequency conversions outside of the analyzer. This value is added to the display readout of the marker frequency, center frequency, start frequency, stop frequency, and all other absolute frequency settings in the analyzer including frequency count. When a frequency offset is entered, the value appears below the center of the graticule. To eliminate an offset, perform a Mode Preset or set the frequency offset to 0 Hz.

See ["More Information" on page 1947](#).

Key Path	FREQ Channel
Scope	Meas Global
Remote Command	[:SENSe] :FREQuency:OFFSet <freq> [:SENSe] :FREQuency:OFFSet?
Example	FREQ:OFFS 10 MHz
Notes	Preset and Max values are dependent on Hardware Options (503, 507, 508, 513, 526)
Dependencies	Freq Offset is not available in External Mixing. In this case the Freq Offset key is grayed out and shows a value of zero. However, the value of CF Offset that was set for the RF Input is retained and restored when the user switches back to the RF Input.

Preset	See " Center Frequency Presets " on page 2932
State Saved	Saved in instrument state
Min	-500 GHz
Max	500 GHz
Default Unit	Hz
Status Bits/OPC dependencies	Non-overlapped
Backwards Compatibility SCPI	DISPlay:WINDow[1]:TRACe:X[:SCALE]:OFFSet
	The DISPlay version of the command is in the instrument for compatibility across platforms and is not recommended for new development.
Backwards Compatibility Notes	<ol style="list-style-type: none"> 1. In pre-X-Series instruments, Frequency Offset could not be adjusted by the knob or step keys. That is no longer the case. 2. Some previous spectrum analyzers did not adjust frequency counter results for the Frequency Offset. The X-Series does adjust the frequency counter for the offset.
Initial S/W Revision	Prior to A.02.00
Modified at S/W Revision	A.04.00, A.08.50

More Information

This command does not affect any bandwidths or the settings of relative frequency parameters such as delta markers or span. It does not affect the current hardware settings of the analyzer, but only the displayed frequency values. Entering an offset does not affect the trace position or display, just the value of the start and stop frequency and the values represented by the trace data. The frequency values of exported trace data, queried trace data, markers, trace data used in calculations such as N dB points, trace math, etc., are all affected by Freq Offset. Changing the offset, even on a trace that is not updating will immediately change all of the above, without taking new data.

NOTE

If a trace is exported with a nonzero Freq Offset, the exported data will contain the trace data with the offset applied. Therefore, if that trace were to be imported back into the analyzer, you would want Freq Offset to be 0, or the offset would be applied again to data which is already offset. No such care need be taken when saving a State+Trace file because the data and state are saved together.

Input/Output

See ["Input/Output" on page 241](#)

Marker

Accesses a menu that enables you to select, set up and control the markers for the current measurement.

Key Path	Front-panel key
Initial S/W Revision	Prior to A.02.00

Select Marker

Accesses a menu that allows you to select one of 12 markers for control and function

Key Path	Marker
Initial S/W Revision	Prior to A.02.00

Marker Type

Sets the marker control mode to **Normal**, **Delta**, **Fixed** or **Off**.

If the selected marker is **Off**, pressing **Marker** sets it to **Normal** and places it at the center of the screen on the trace determined by the Marker Trace rules. At the same time, Marker X Axis Value appears on the Active Function area.

The Active function for the selected marker's current control mode is the default active function. If the current control mode is **Off**, there is no active function and the active function is turned off. The active function display is the marker X axis value entered in the active function area, which displays the marker value to its full entered precision.

All interactions and dependencies detailed under the key description are enforced when the remote command is sent.

Key Path	Marker
Mode	SA, WCDMA, C2K, WiMAX OFDMA, TD-SCDMA, 1xEV-DO, DVB-T/H, DTMB (CTTB), ISDB-T, CMMB, LTE, LTETDD, Digital Cable TV, WLAN, MSR, LTEATDD, LTEAFDD
Remote Command	:CALCulate:PStatistic:MARKer[1] 2 ... 12:MODE POSition DELTa OFF :CALCulate:PStatistic:MARKer[1] 2 ... 12:MODE?
Example	CALC:PST:MARK:MODE POS CALC:PST:MARK:MODE?
Notes	If the selected marker is Off, pressing Marker sets it to Normal and places it at the center of the screen on the trace determined by the Marker Trace rules. At the same time, Marker X Axis Value appears on the Active Function area. Default Active Function: the active function for the selected marker's current control mode. If the current control mode is Off, there is no active function and the active function is turned off. Active Function Display: the marker X axis value entered in the active function area displays the marker value to its full entered precision.

Preset	OFF
State Saved	Saved in instrument state.
Range	Normal Delta Off
Initial S/W Revision	Prior to A.02.00
Modified at S/W Revision	A.02.00, A.03.00

Properties

Accesses the marker properties menu.

Key Path	Marker
Initial S/W Revision	Prior to A.02.00

Select Marker

Accesses a menu that allows you to select one of 12 markers for control and function

Key Path	Marker
Initial S/W Revision	Prior to A.02.00

Relative To

Sets the reference marker that the selected marker will be relative to.

Key Path	Marker, Properties
Mode	SA, WCDMA, C2K, WIMAXOFDMA, TD-SCDMA, 1xEV-DO, DVB-T/H, DTMB (CTTB), ISDB-T, CMMB, LTE, LTETDD, Digital Cable TV, WLAN, MSR, LTEATDD, LTEAFDD
Remote Command	:CALCulate:PSTatistic:MARKer[1] 2 ... 12:REFerence <integer> :CALCulate:PSTatistic:MARKer[1] 2 ... 12:REFerence?
Example	CALC:PST:MARK:REF 3 CALC:PST:MARK:REF?
Notes	A marker cannot be relative to itself so that choice is grayed out, and if sent from SCPI generates error -221: "Settings conflict; marker cannot be relative to itself." When queried a single value will be returned (the specified marker numbers relative marker).
Preset	2 3 4 5 6 7 8 9 10 11 12 1
State Saved	Saved in instrument state.
Min	1
Max	12
Initial S/W Revision	Prior to A.02.00
Modified at S/W Revision	A.02.00, A.03.00

Marker Trace

Assigns the specified marker to the designated trace. The trace choices are:

- Measured
- Gaussian
- Reference

Key Path	Marker
Mode	SA, WCDMA, C2K, WIMAXOFDMA, TD-SCDMA, 1xEV-DO, DVB-T/H, DTMB (CTTB), ISDB-T, CMMB, LTE, LTETDD, Digital Cable TV, WLAN, MSR, LTEATDD, LTEAFDD
Remote Command	:CALCulate:PStatistic:MARKer[1] 2 ... 12:TRACe MEASured GAUSSian REFERENCE :CALCulate:PStatistic:MARKer[1] 2 ... 12:TRACe?
Example	CALC:PST:MARK3:TRAC MEAS CALC:PST:MARK:TRACe?
Preset	MEASured
State Saved	Saved in instrument state.
Range	Measured Gaussian Reference
Initial S/W Revision	Prior to A.02.00
Modified at S/W Revision	A.02.00, A.03.00

Couple Markers

When this function is on, moving any marker causes an equal X axis movement of every other marker that is not off. By “equal X axis movement” we mean that we preserve the difference between each marker’s X axis value (in the fundamental x-axis units of the trace that marker is on) and the X axis value of the marker being moved (in the same fundamental x-axis units).

Key Path	Marker
Initial S/W Revision	Prior to A.02.00

All Markers Off

Turns off all markers.

Key Path	Marker, More
Mode	SA, WCDMA, C2K, WIMAXOFDMA, TD-SCDMA, 1xEV-DO, DVB-T/H, DTMB (CTTB), ISDB-T, CMMB, LTE, LTETDD, Digital Cable TV, WLAN, MSR, LTEATDD, LTEAFDD
Remote Command	:CALCulate:PStatistic:MARKer:AOFF
Example	CALC:PST:MARK:AOFF

Initial S/W Revision	Prior to A.02.00
Modified at S/W Revision	A.02.00, A.03.00

Marker X Axis Value (Remote Command Only)

Sets the marker X Axis value in the current marker X Axis Scale unit. This function has no effect if the control mode is **Off**, but is the remote command equivalent of entering an X value if the control mode is **Normal** or **Delta**.

Mode	SA, WCDMA, C2K, WIMAXOFDMA, TD-SCDMA, 1xEV-DO, DVB-T/H, DTMB (CTTB), ISDB-T, CMMB, LTE, LTETDD, Digital Cable TV, WLAN, MSR, LTEATDD, LTEAFDD
Remote Command	:CALCulate:PSTatistic:MARKer[1] 2 ... 12:X <rel_amp1> :CALCulate:PSTatistic:MARKer[1] 2 ... 12:X?
Example	CALC:PST:MARK3:X 0 CALC:PST:MARK3:X?
Notes	If no suffix is sent, it will use the fundamental units for the current marker X Axis Scale. If a suffix is sent that does not match the current marker X Axis Scale unit, an error "Invalid suffix" will be generated. If the specified marker is Fixed and a Marker Function is on, error -221 "Settings conflict; cannot adjust Fixed marker while Marker Function is on" is generated. The query returns the marker's absolute X Axis value if the control mode is Normal , or the offset from the marker's reference marker if the control mode is Delta . The query is returned in the fundamental units for the current marker X Axis scale: Hz for Frequency and Inverse Time , seconds for Period and Time . If the marker is Off the response is not a number.
Preset	After a preset, all Markers are turned OFF, so Marker X Axis Value query will return a not a number (NAN).
State Saved	No
Min	-9.9E+37
Max	9.9E+37
Initial S/W Revision	Prior to A.02.00
Modified at S/W Revision	A.02.00, A.03.00

Marker Y Axis Value (Remote Command Only)

Queries the marker Y Axis value in the current marker Y Axis unit.

Mode	SA, WCDMA, C2K, WIMAXOFDMA, TD-SCDMA, 1xEV-DO, DVB-T/H, DTMB (CTTB), ISDB-T, CMMB, LTE, LTETDD, Digital Cable TV, WLAN, MSR, LTEATDD, LTEAFDD
Remote Command	:CALCulate:PSTatistic:MARKer[1] 2 ... 12:Y?
Example	CALC:PST:MARK11:Y?
Notes	The query returns the marker Y-axis result, if the control mode is Normal , or Delta . If the marker is Off the response is not a number.
Preset	0

State Saved	No
Backwards Compatibility SCPI	:CALCulate:PStAtistic:MARKer[1] 2 ... 12:FUNCTion:RESuIt?
Initial S/W Revision	Prior to A.02.00
Modified at S/W Revision	A.02.00, A.03.00

Marker Function

There are no ‘Marker Functions’ supported in Power Stat CCDF measurement. The front-panel key displays a blank menu when pressed.

Key Path	Front-panel key
Initial S/W Revision	Prior to A.02.00

Marker To

There is no 'Marker To' functionality supported in Power Stat CCDF measurement. The front-panel key displays a blank menu when pressed.

Key Path	Front-panel key
Initial S/W Revision	Prior to A.02.00

Meas

The information in this section is common to all measurements. For key and remote command information for a specific measurement, refer to the section that describes the measurement of interest.

Measurements available under the Meas key are specific to the current Mode.

When viewing Help for measurements, note the following:

NOTE

Operation for some keys differs between measurements. The information displayed in Help pertains to the current measurement. To see how a key operates in a different measurement, exit Help (press the Cancel Esc key), select the measurement, then reenter Help (press the Help key) and press that key.

Key Path	Front-panel key
Initial S/W Revision	Prior to A.02.00

Remote Measurement Functions

This section contains the following topics:

["Measurement Group of Commands" on page 3141](#)

["Current Measurement Query \(Remote Command Only\)" on page 3144](#)

["Limit Test Current Results \(Remote Command Only\)" on page 3144](#)

["Data Query \(Remote Command Only\)" on page 3144](#)

["Calculate/Compress Trace Data Query \(Remote Command Only\)" on page 3144](#)

["Calculate Peaks of Trace Data \(Remote Command Only\)" on page 3150](#)

["Hardware-Accelerated Fast Power Measurement \(Remote Command Only\)" on page 3151](#)

["Format Data: Numeric Data \(Remote Command Only\)" on page 3165](#)

["Format Data: Byte Order \(Remote Command Only\)" on page 3166](#)

Initial S/W Revision	Prior to A.02.00
----------------------	------------------

Measurement Group of Commands

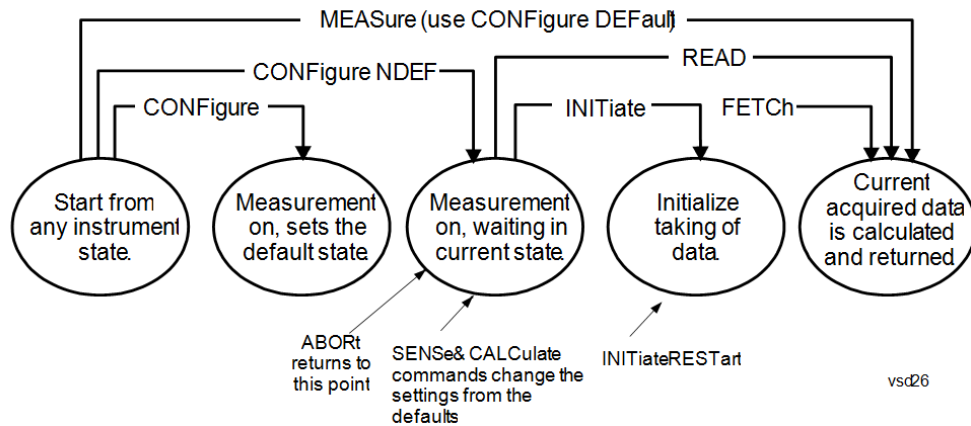

Measure Commands:

:MEASure:<measurement>[n]?

This is a fast single-command way to make a measurement using the factory default instrument settings. These are the settings and units that conform to the Mode Setup settings (e.g. radio standard) that you have currently selected.

- Stops the current measurement (if any) and sets up the instrument for the specified measurement using the factory defaults
- Initiates the data acquisition for the measurement
- Blocks other SCPI communication, waiting until the measurement is complete before returning results.
- If the function does averaging, it is turned on and the number of averages is set to 10.
- After the data is valid it returns the scalar results, or the trace data, for the specified measurement. The type of data returned may be defined by an [n] value that is sent with the command.
- The scalar measurement results will be returned if the optional [n] value is not included, or is set to 1. If the [n] value is set to a value other than 1, the selected trace data results will be returned. See each command for details of what types of scalar results or trace data results are available.
- ASCII is the default format for the data output. (Older versions of Spectrum Analysis and Phase Noise mode measurements only use ASCII.) The binary data formats should be used for handling large blocks of data since they are smaller and faster than the ASCII format. Refer to the FORMat:DATA command for more information.

If you need to change some of the measurement parameters from the factory default settings you can set up the measurement with the CONFIGure command. Use the commands in the SENSE:<measurement> and CALCulate:<measurement> subsystems to change the settings. Then you can use the READ? command to initiate the measurement and query the results.

If you need to repeatedly make a given measurement with settings other than the factory defaults, you can use the commands in the SENSE:<measurement> and CALCulate:<measurement> subsystems to set up the measurement. Then use the READ? command to initiate the measurement and query results.

Measurement settings persist if you initiate a different measurement and then return to a previous one. Use READ:<measurement>? if you want to use those persistent settings. If you want to go back to the default settings, use MEASure:<measurement>?.

Configure Commands:

:CONFigure:<measurement>

This command stops the current measurement (if any) and sets up the instrument for the specified measurement using the factory default instrument settings. It does not initiate the taking of measurement data unless INIT:CONTinuous is ON. If you change any measurement settings after using the CONFigure command, the READ command can be used to initiate a measurement without changing the settings back to their defaults.

In the Swept SA measurement in Spectrum Analyzer mode the CONFigure command also turns the averaging function on and sets the number of averages to 10 for all measurements.

:CONFigure: <measurement>: NDEFault stops the current measurement and changes to the specified measurement. It does not change the settings to the defaults. It does not initiate the taking of measurement data unless INIT:CONTinuous is ON.

The CONFigure? query returns the current measurement name.

The CONFigure:CATalog? query returns a quoted string of all licensed measurement names in the current mode. For example, "SAN, CHP, OBW, ACP, PST, TXP, SPUR, SEM, LIST".

Fetch Commands:

:FETCh:<measurement>[n]?

This command puts selected data from the most recent measurement into the output buffer. Use FETCh if you have already made a good measurement and you want to return several types of data (different [n] values, for example, both scalars and trace data) from a single measurement. FETCh saves you the time of re-making the measurement. You can only FETCh results from the measurement that is currently active, it will not change to a different measurement. An error message is reported if a measurement other than the current one is specified.

If you need to get new measurement data, use the READ command, which is equivalent to an INITiate followed by a FETCh.

The scalar measurement results will be returned if the optional [n] value is not included, or is set to 1. If the [n] value is set to a value other than 1, the selected trace data results will be returned. See each command for details of what types of scalar results or trace data results are available. The binary data formats should be used for handling large blocks of data since they are smaller and transfer faster than the ASCII format. (FORMat:DATA)

FETCh may be used to return results other than those specified with the original READ or MEASure command that you sent.

INITiate Commands:

:INITiate:<measurement>

This command is not available for measurements in all the instrument modes:

- Initiates a trigger cycle for the specified measurement, but does not output any data. You must then use the FETCh<meas> command to return data. If a

measurement other than the current one is specified, the instrument will switch to that measurement and then initiate it.

- For example, suppose you have previously initiated the ACP measurement, but now you are running the channel power measurement. If you send INIT:ACP? it will change from channel power to ACP and will initiate an ACP measurement.
- Does not change any of the measurement settings. For example, if you have previously started the ACP measurement and you send INIT:ACP? it will initiate a new ACP measurement using the same instrument settings as the last time ACP was run.
- If your selected measurement is currently active (in the idle state) it triggers the measurement, assuming the trigger conditions are met. Then it completes one trigger cycle. Depending upon the measurement and the number of averages, there may be multiple data acquisitions, with multiple trigger events, for one full trigger cycle. It also holds off additional commands on GPIB until the acquisition is complete.

READ Commands:

:READ:<measurement>[n]?

- Does not preset the measurement to the factory default settings. For example, if you have previously initiated the ACP measurement and you send READ:ACP? it will initiate a new measurement using the same instrument settings.
 - Initiates the measurement and puts valid data into the output buffer. If a measurement other than the current one is specified, the instrument will switch to that measurement before it initiates the measurement and returns results.
 - For example, suppose you have previously initiated the ACP measurement, but now you are running the channel power measurement. Then you send READ:ACP? It will change from channel power back to ACP and, using the previous ACP settings, will initiate the measurement and return results.
 - Blocks other SCPI communication, waiting until the measurement is complete before returning the results
 - If the optional [n] value is not included, or is set to 1, the scalar measurement results will be returned. If the [n] value is set to a value other than 1, the selected trace data results will be returned. See each command for details of what types of scalar results or trace data results are available. The binary data formats should be used when handling large blocks of data since they are smaller and faster than the ASCII format. (FORMat:DATA)
-

Current Measurement Query (Remote Command Only)

This command returns the name of the measurement that is currently running.

Remote Command	:CONFiGure?
Example	CONF?
Initial S/W Revision	Prior to A.02.00

Limit Test Current Results (Remote Command Only)

Queries the status of the current measurement limit testing. It returns a 0 if the measured results pass when compared with the current limits. It returns a 1 if the measured results fail any limit tests.

Remote Command	:CALCuLate:CLIMits:FAIL?
Example	CALC:CLIM:FAIL? queries the current measurement to see if it fails the defined limits. Returns a 0 or 1: 0 it passes, 1 it fails.
Initial S/W Revision	Prior to A.02.00

Data Query (Remote Command Only)

Returns the designated measurement data for the currently selected measurement and subopcode.

n = any valid subopcode for the current measurement. See the measurement command results table for your current measurement, for information about what data is returned for the subopcodes.

This command uses the data setting specified by the FORMat:BORDER and FORMat:DATA commands and can return real or ASCII data. (See the format command descriptions under Input/Output in the Analyzer Setup section.)

Remote Command	:CALCuLate:DATA[n]?
Notes	The return trace depends on the measurement. In CALCulate:<meas>:DATA[n], n is any valid subopcode for the current measurement. It returns the same data as the FETCh:<measurement>? query where <measurement> is the current measurement.
Initial S/W Revision	Prior to A.02.00

Calculate/Compress Trace Data Query (Remote Command Only)

Returns compressed data for the currently selected measurement and sub-opcode [n].

n = any valid sub-opcode for that measurement. See the MEASure:<measurement>? command description of your specific measurement for information on the data that can be returned.

The data is returned in the current Y Axis Unit of the analyzer. The command is used with a sub-opcode <n> (default=1) to specify the trace. With trace queries, it is best if the analyzer is not sweeping during the query. Therefore, it is generally advisable to be in Single Sweep, or Update=Off.

This command is used to compress or decimate a long trace to extract and return only the desired data. A typical example would be to acquire N frames of GSM data and return the mean power of the first burst in each frame. The command can also be used to identify the best curve fit for the data.

Remote Command	:CALCulate:DATA<n>:COMPRESS? BLOCK CFIT MAXimum MINimum MEAN DMEan RMS RMSCubed SAMPLE SDEVIation PPHase [,<soffset> [,<length>[,<roffset>[,<rlimit>]]]]
Example	To query the mean power of a set of GSM bursts: Supply a signal that is a set of GSM bursts. Select the IQ Waveform measurement (in IQ Analyzer Mode). Set the sweep time to acquire at least one burst. Set the triggers such that acquisition happens at a known position relative to a burst. Then query the mean burst levels using, CALC:DATA2:COMP? MEAN, 24e-6, 526e-6 (These parameter values correspond to GSM signals, where 526e-6 is the length of the burst in the slot and you just want 1 burst.)
Notes	The command supports 5 parameters. Note that the last 4 (<soffset>, <length>, <roffset>, <rlimit>) are optional. But these optional parameters must be entered in the specified order. For example, if you want to specify <length>, then you must also specify <soffset>. See details below for a definition of each of these parameters. This command uses the data in the format specified by FORMat:DATA, returning either binary or ASCII data.
Initial S/W Revision	Prior to A.02.00

- BLOCK or block data - returns all the data points from the region of the trace data that you specify. For example, it could be used to return the data points of an input signal over several timeslots, excluding the portions of the trace data that you do not want. (This is x,y pairs for trace data and I,Q pairs for complex data.)
- CFIT or curve fit - applies curve fitting routines to the data. <soffset> and <length> are required to define the data that you want. <roffset> is an optional parameter for the desired order of the curve equation. The query will return the following values: the x-offset (in seconds) and the curve coefficients ((order + 1) values).

MIN, MAX, MEAN, DME, RMS, RMSC, SAMP, SDEV and PPH return one data value for each specified region (or <length>) of trace data, for as many regions as possible until you run out of trace data (using <roffset> to specify regions). Or they return the number of regions you specify (using <rlimit>) ignoring any data beyond that.

- MINimum - returns the minimum data point (y value) for the specified region (s) of trace data. For I/Q trace data, the minimum magnitude of the I/Q pairs is returned.
- MAXimum - returns the maximum data point (y value) for the specified region(s) of trace data. For I/Q trace data, the maximum magnitude of the I/Q pairs is returned.
- MEAN - returns a single value that is the arithmetic mean of the data point values (in dB/ dBm) for the specified region(s) of trace data. For I/Q trace data, the mean of the magnitudes of the I/Q pairs is returned. See the following equations.

NOTE

If the original trace data is in dB, this function returns the arithmetic mean of those log values, not log of the mean power which is a more useful value. The mean of the log is the better measurement technique when measuring CW signals in the presence of noise. The mean of the power, expressed in dB, is useful in power measurements such as Channel Power. To achieve the mean of the power, use the RMS option.

Equation 1

Mean Value of Data Points for Specified Region(s)

$$MEAN = \frac{1}{n} \sum_{X_i \in \text{region}(s)} X_i$$

where X_i is a data point value, and n is the number of data points in the specified region(s).

Equation 2

Mean Value of I/Q Data Pairs for Specified Region(s)

$$MEAN = \frac{1}{n} \sum_{X_i \in \text{region}(s)} |X_i|$$

where $|X_i|$ is the magnitude of an I/Q pair, and n is the number of I/Q pairs in the specified region(s).

- DMEan - returns a single value that is the mean power (in dB/ dBm) of the data point values for the specified region(s) of trace data. See the following

equation:

Equation 3

DMEan Value of Data Points for Specified Region(s)

$$\text{DME} = 10 \times \log_{10} \left(\frac{1}{n} \sum_{X_i \in \text{region}(s)} 10^{\frac{X_i}{10}} \right)$$

- RMS - returns a single value that is the average power on a root-mean-squared voltage scale (arithmetic rms) of the data point values for the specified region(s) of trace data. See the following equation.

NOTE

For I/Q trace data, the rms of the magnitudes of the I/Q pairs is returned. See the following equation.

This function is very useful for I/Q trace data. However, if the original trace data is in dB, this function returns the rms of the log values which is not usually needed.

Equation 4

RMS Value of Data Points for Specified Region(s)

$$\text{RMS} = \sqrt{\frac{1}{n} \sum_{X_i \in \text{region}(s)} X_i^2}$$

where X_i is a data point value, and n is the number of data points in the specified region(s).

Equation 5

RMS Value of I/Q Data Pairs for Specified Region(s)

$$\text{RMS} = \sqrt{\frac{1}{n} \sum_{X_i \in \text{region}(s)} X_i X_i^*}$$

where X_i is the complex value representation of an I/Q pair, X_i^* its conjugate complex number, and n is the number of I/Q pairs in the specified region(s).

Once you have the rms value for a region of trace data (linear or I/Q), you may want to calculate the mean power. You must convert this rms value (peak volts) to power in dBm:

$$10 \times \log[10 \times (\text{rms value})^2]$$

- SAMPlE - returns the first data value (x,y pair) for the specified region(s) of trace data. For I/Q trace data, the first I/Q pair is returned.
- SDEVIation - returns a single value that is the arithmetic standard deviation for the data point values for the specified region(s) of trace data. See the following equation.
- For I/Q trace data, the standard deviation of the magnitudes of the I/Q pairs is returned. See the following equation.

Equation 6

Standard Deviation of Data Point Values for Specified Region(s)

$$SDEV = \sqrt{\frac{1}{n} \sum_{X_i \in \text{region}(s)} (X_i - \bar{X})^2}$$

where X_i is a data point value, \bar{X} is the arithmetic mean of the data point values for the specified region(s), and n is the number of data points in the specified region(s).

$$SDEV = \sqrt{\frac{1}{n} \sum_{X_i \in \text{region}(s)} (|X_i| - \bar{X})^2}$$

where $|X_i|$ is the magnitude of an I/Q pair, \bar{X} is the mean of the magnitudes for the specified region(s), and n is the number of data points in the specified region(s).

- PPHase - returns the x,y pairs of both rms power (dBm) and arithmetic mean phase (radian) for every specified region and frequency offset (Hz). The number of pairs is defined by the specified number of regions. This parameter can be used for I/Q vector (n=0) in Waveform (time domain) measurement and all parameters are specified by data point in PPHase.

The rms power of the specified region may be expressed as:

$$\text{Power} = 10 \times \log [10 \times (\text{RMS I/Q value})] + 10.$$

The RMS I/Q value (peak volts) is:

$$\sqrt{\frac{1}{n} \sum_{X_i \in \text{region}} X_i X_i^*}$$

where X_i is the complex value representation of an I/Q pair, X_i^* its conjugate complex number, and n is the number of I/Q pairs in the specified region.

The arithmetic mean phase of the specified region may be expressed as:

$$\frac{1}{n} \sum_{Y_i \in \text{region}} Y_i$$

where Y_i is the unwrapped phase of I/Q pair with applying frequency correction and n is the number of I/Q pairs in the specified region.

The frequency correction is made by the frequency offset calculated by the arithmetic mean of every specified region's frequency offset. Each frequency offset is calculated by the least square method against the unwrapped phase of I/Q pair.

Sample Trace Data - Constant Envelope

(See below for explanation of variables.)

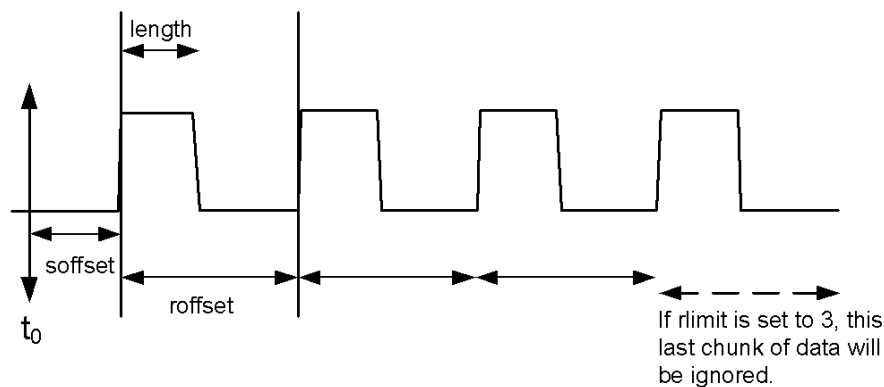

Sample Trace Data - Not Constant Envelope

(See below for explanation of variables.)

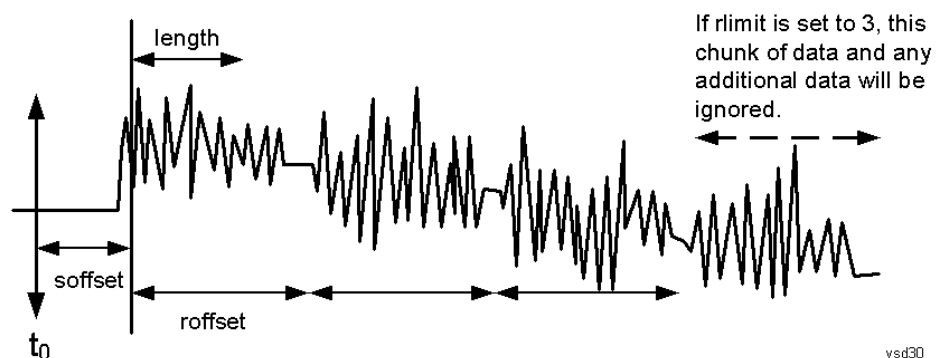

<soffset> - start offset is an optional real number. (It is in seconds for time-domain traces, and is a dimensionless index 0 to Npoints - 1, for frequency-domain traces). It specifies the amount of data at the beginning of the trace that will be ignored before the decimation process starts. It is the time or frequency change from the start of the trace to the point where you want to start using the data. The default value is zero.

<length> - is an optional real number. (It is in seconds for time-domain traces, and is a dimensionless index 0 to Npoints - 1, for frequency-domain traces). It defines how much data will be compressed into one value. This parameter has a default value equal to the current trace length.

<roffset> - repeat offset is an optional real number. (It is in seconds for time-domain traces, and is a dimensionless index 0 to Npoints - 1, for frequency-domain traces). It defines the beginning of the next field of trace elements to be compressed. This is relative to the beginning of the previous field. This parameter has a default value equal to the <length> variable. Note that this parameter is used for a completely different purpose when curve fitting (see CFIT above).

<rlimit> - repeat limit is an optional integer. It specifies the number of data items that you want returned. It will ignore any additional items beyond that number. You can use the Start offset and the Repeat limit to pick out exactly what part of the data you want to use. The default value is all the data.

Calculate Peaks of Trace Data (Remote Command Only)

Returns a list of all the peaks for the currently selected measurement and sub-opcode [n]. The peaks must meet the requirements of the peak threshold and excursion values.

n = any valid sub-opcode for the current measurement. See the MEASure:<measurement> command description of your specific measurement for information on the data that can be returned.

The command can only be used with specific sub-opcodes with measurement results that are trace data. Both real and complex traces can be searched, but complex traces are converted to magnitude in dBm. In many measurements the sub-opcode n=0, is the raw trace data which cannot be searched for peaks. And Sub-opcode n=1, is often calculated results values which also cannot be searched for peaks.

This command uses the data setting specified by the FORMat:BORDER and FORMat:DATA commands and can return real or ASCII data. If the format is set to INT,32, it returns REAL,32 data.

The command has four types of parameters:

- Threshold (in dBm)
- Excursion (in dB)
- Sorting order (amplitude, frequency, time)
- Optional in some measurements: Display line use (all, > display line, < display line)

Remote Command

For Swept SA measurement:

```
:CALCulate:DATA[1]|2|...|6:PEAKS? <threshold>,<excursion>[,AMPLitude  
| FREQuency | TIME[,ALL | GTDLine | LTDLine]]
```

For most other measurements:

	<pre>:CALCulate:DATA[1] 2 ... 6:PEAKs? <threshold>,<excursion>[,AMPLitude FREQUENCY TIME]</pre>
Example	<p>Example for Swept SA measurement in Spectrum Analyzer Mode:</p> <p>CALC:DATA4:PEAK? -40, 10, FREQ, GTDL This will identify the peaks of trace 4 that are above -40 dBm, with excursions of at least 10 dB. The peaks are returned in order of increasing frequency, starting with the lowest frequency. Only the peaks that are above the display line are returned.</p> <p>Query Results 1:</p> <p>With FORMat:DATA REAL, 32 selected, it returns a list of floating-point numbers. The first value in the list is the number of peak points that are in the following list. A peak point consists of two values: a peak amplitude followed by its corresponding frequency (or time).</p> <p>If no peaks are found the peak list will consist of only the number of peaks, (0).</p>
Notes	<p><n> - is the trace that will be used</p> <p><threshold> - is the level below which trace data peaks are ignored. Note that the threshold value is required and is always used as a peak criterion. To effectively disable the threshold criterion for this command, provide a substantially low threshold value such as -200 dBm. Also note that the threshold value used in this command is independent of and has no effect on the threshold value stored under the Peak Criteria menu.</p> <p><excursion> - is the minimum amplitude variation (rise and fall) required for a signal to be identified as peak. Note that the excursion value is required and is always used as a peak criterion. To effectively disable the excursion criterion for this command, provide the minimum value of 0.0 dB. Also note that the excursion value used in this command is independent of and has no effect on the excursion value stored under the Peak Criteria menu.</p> <p>Values must be provided for threshold and excursion. The sorting and display line parameters are optional (defaults are AMPLitude and ALL).</p> <p>Note that there is always a Y-axis value for the display line, regardless of whether the display line state is on or off. It is the current Y-axis value of the display line which is used by this command to determine whether a peak should be reported</p> <p>Sorting order:</p> <p>AMPLitude - lists the peaks in order of descending amplitude, with the highest peak first (default if optional parameter not sent)</p> <p>FREQUENCY - lists the peaks in order of occurrence, left to right across the x-axis.</p> <p>TIME - lists the peaks in order of occurrence, left to right across the x-axis.</p> <p>Peaks vs. Display Line:</p> <p>ALL - lists all of the peaks found (default if optional parameter not sent).</p> <p>GTDLLine (greater than display line) - lists all of the peaks found above the display line.</p> <p>LTDLine (less than display line) - lists all of the peaks found below the display line.</p>
Initial S/W Revision	Prior to A.02.00

Hardware-Accelerated Fast Power Measurement (Remote Command Only)

The Fast Power option (FP2) enables very fast channel power measurements for instruments with the prerequisite hardware (DP2 and/or B40). It accomplishes this by performing real-time overlapped FFTs at the hardware layer, using software for basic post-processing before returning the result to the user. The upshot of this

approach is improved throughput for user applications that require many sequential power measurements.

The analysis bandwidth of FP2 is limited by the licenses in the instrument, but its maximum overall analysis bandwidth per acquisition is 40 MHz.

FP2 is remote-only, which means the instrument does not switch to any particular mode or measurement. FP2 commands can be sent while another application is in use on the front panel.

Each Fast Power measurement can be predefined using an array index, and up to 1,000 measurements can be stored. In the following documentation, instances of [1,2,...,999] can be substituted with a particular measurement index, e.g. CALC:FPOW:POW1?, CALC:FPOW:POW2?, CALC:FPOW:POW134?. In this way, power measurements can be defined one time in a batch, and then executed multiple times without having to redefine them, similar to “list mode” on other measurements.

In addition to basic channel power measurements, there are a number of other measurement “functions” for each channel, including peak power, peak frequency, and power spectral density. See the Function parameter for more information.

Reset Fast Power Measurement (Remote Command Only)

Resets the measurement configuration to the defaults.

Mode	All
Remote Command	:CALCulate:FPOWer:POWer[1,2,...,999]:RESet
Example	:CALC:FPOW:POW1:RES
Notes	Option FP2 is required.
Initial S/W Revision	A.14.00

Define Fast Power Measurement (Remote Command Only)

Fast Power acquisitions are configured using the DEFine command. This command accepts a comma-delimited string of configuration parameters and their appropriate values, which are all specified in the subsection below.

Mode	All
Remote Command	:CALCulate:FPOWer:POWer[1,2,...,999]:DEFine "configuration string"
Example	:CALC:FPOW:POW1:DEF "CenterFrequency=2e9, AcquisitionTime=0.005"
Notes	See below for a list of measurement variables that can be defined in the configuration string.
Initial S/W Revision	A.14.00

Acquisition Time

Example	CALC:FPOW:POW1:DEF "AcquisitionTime=0.002"
Notes	The acquisition time parameter sets the time in which the entire spectrum is measured. An increase in the acquisition time yields an improvement in measurement repeatability.
Preset	0.001 s
Range	0 s to 1 s
Default Unit	Time (s)
Initial S/W Revision	A.14.00

Center Frequency

Example	CALC:FPOW:POW1:DEF "CenterFrequency=2e9"
Notes	The center frequency parameter sets the frequency in which the measurement is centered around. The OffsetFrequency parameter is calculated relative to the center frequency.
Preset	1 GHz
Range	0 Hz to maximum instrument frequency
Default Unit	Frequency (Hz)
Initial S/W Revision	A.14.00

DC Coupled

Example	CALC:FPOW:POW1:DEF "DCCoupled=True"
Notes	The DC coupled parameter allows the user to specify whether the DC blocking capacitor is utilized. Set parameter to true when measuring frequencies below 10 MHz.
Preset	False
Range	True (DC Coupled) or False (AC Coupled)
Default Unit	Boolean
Initial S/W Revision	A.14.00

DetectorType

Example	CALC:FPOW:POW1:DEF "DetectorType=Peak"
Notes	Option FP2 is required. The detector type parameter allows the user to choose whether a RMS average or peak value is used during the measurement.
Preset	RmsAverage
Range	RmsAverage, Peak
Initial S/W Revision	A.14.00

Do Noise Correction

Example	CALC:FPOW:POW1:DEF "DoNoiseCorrection=True"
Notes	<p>When noise correction is enabled, the linear noise power contributed by the analyzer is subtracted from all measurements. This effectively lowers the noise floor of the analyzer.</p> <p>When noise correction is enabled, the first measurement for a given set of input parameters will take extra time. This is because the analyzer takes an extra acquisition with the RF input disconnected from the analyzer's front end to measure the noise of just the analyzer. The measured noise floor is stored in a cache so the noise acquisition will occur only once for the same state settings. In other words, if noise correction was turned on and the analyzer made an acquisition at frequency A, then frequency B, and back again to frequency A, the hidden initial noise floor acquisition would only occur for the first acquisition at frequency A and the cached noise floor would be used the second time frequency A was measured.</p>
Preset	False
Range	True (enable noise correction) or False (disable noise correction)
Default Unit	Boolean
Initial S/W Revision	A.14.00

Do Spur Suppression

Example	CALC:FPOW:POW1:DEF "DoSpurSuppression=True"
Notes	<p>When measuring very low level signals, or when large out-of-band inputs are input into the analyzer, sometimes unwanted spurs and residuals can appear in the measured spectrum. Spur suppression is a method to help minimize the levels of these internally generated spurs and residuals.</p> <p>When spur suppression is enabled, the analyzer will automatically take two acquisitions using two different internal analog LO frequencies. The FFT spectrums from both acquisitions are combined by taking the minimum power between both traces on a per FFT bin basis. External signals will have the same amplitude for both traces and therefore will return the expected amplitudes. However, low level spurs and residuals generated internally to the analyzer tend to move to different FFT bins depending on the internal analog LO frequency used, and therefore tend to be suppressed using this spur suppression method.</p> <p>Because two acquisitions, rather than a single acquisition, are made when spur suppression is enabled, the measurement time will always be slower when spur suppression is enabled.</p>
Preset	False
Range	True (enable spur suppression) or False (disable spur suppression)
Default Unit	Boolean
Initial S/W Revision	A.14.00

Electronic Attenuator Bypass

Example	CALC:FPOW:POW1:DEF "ElecAttBypass =False"
---------	---

Notes	The electronic attenuation bypass parameter allows the user to either utilize or bypass the electronic attenuator. The electronic attenuator is only available for frequencies up to 3.6 GHz. Set parameter to true when using frequencies above 3.6 GHz and set the parameter to false when using the preamp.
Preset	True
Range	True (bypass electronic attenuator) or False (use electronic attenuator)
Default Unit	Boolean
Initial S/W Revision	A.14.00

Electronic Attenuation

Example	CALC:FPOW:POW1:DEF "ElecAttenuation=10"
Notes	Option EA3 is required. The electronic attenuation value parameter sets the amount of electrical attenuation from 0 to 24 dB (1 dB steps). Set "ElecAttBypass=False" to make sure the electronic attenuator path is enabled.
Preset	0 dB
Range	0 – 24 dB (1 dB steps)
Default Unit	dB
Initial S/W Revision	A.14.00

IF Gain

Example	CALC:FPOW:POW1:DEF "IFGain=10"
Notes	The IF gain parameter allows the user to specify the gain at the IF stage anywhere from -6 to 16 dB (1 dB steps). This is an advanced feature, and for most cases this should remain at its default value of 0 dB.
Preset	0 dB
Range	-6 – 16 dB (1 dB steps)
Default Unit	dB
Initial S/W Revision	A.14.00

IF Type

Example	CALC:FPOW:POW1:DEF "IFType=B25M"
Notes	The IF type parameter allows the user to select between different IF paths. For example, if the signal is less than 25 MHz wide, then the user can select the B25M path to take advantage of additional filtering on this analog IF path.

Preset	B40M
Range	B10M, B25M, B40M
Initial S/W Revision	A.14.00

Include Power Spectrum

Example	CALC:FPOW:POW1:DEF "IncludePowerSpectrum=True"
Notes	The power spectrum parameter allows the user to read data on the entire spectrum for diagnostic purposes. It is not recommended for production use. See CALC:FPOW:POW[n]:READ2? for details on the binary format of the response.
Preset	False
Range	True (return both channel power and full power spectrum) or False (returns only channel power)
Default Unit	Boolean
Initial S/W Revision	A.14.00

Mechanical Attenuation

Example	CALC:FPOW:POW1:DEF "MechAttenuation=10"
Notes	The mechanical attenuation value parameter sets the amount of mechanical attenuation anywhere from 0 to 70 dB (2 dB steps).
Preset	0 dB
Range	0 – 70 dB (2 dB steps)
Default Unit	dB
Initial S/W Revision	A.14.00

Preamp Mode

Example	CALC:FPOW:POW1:DEF "PreAmpMode=Low"
Notes	The license for the appropriate preamp is required. The preamp mode parameter specifies whether the preamps are being utilized. Low allows any preamps up to 3.6 GHz, and Full allows all licensed preamps. Set "ElecAttBypass=True" in order to utilize any preamps.
Preset	Off
Range	Off, Low, Full
Initial S/W Revision	A.14.00

Resolution Bandwidth Mode

Example	CALC:FPOW:POW1:DEF "PreAmpMode=Low"
Notes	The resolution bandwidth mode parameter allows the user to choose whether the RBW filter is automatically or manually set. The BestSpeed value minimizes measurement time, while the Narrowest value minimizes RBW size (minimum of two FFT bins per RBW). To manually specify an RBW, set this parameter to Explicit, and set the ResolutionBW parameter to the desired value.
Preset	BestSpeed
Range	BestSpeed, Narrowest, Explicit
Initial S/W Revision	A.14.00

Resolution Bandwidth

Example	CALC:FPOW:POW1:DEF "ResolutionBW=25e3"
Notes	The resolution bandwidth parameter sets the 3-dB bandwidth of the RBW filter. The ResolutionBWMode parameter must be set to Explicit in order to manually set the RBW.
Preset	0 Hz
Default Unit	Hz
Initial S/W Revision	A.14.00

Trigger Delay

Example	CALC:FPOW:POW1:DEF "TriggerDelay=0.025"
Notes	The trigger delay parameter sets the time after an external trigger is detected until the measurement is performed.
Preset	0 s
Range	0 – 1 s
Default Unit	Seconds
Initial S/W Revision	A.14.00

Trigger Level

Example	CALC:FPOW:POW1:DEF "TriggerLevel=2"
Notes	The trigger level parameter sets the voltage value at which an external trigger is detected.
Preset	1.2 V
Range	-5 to 5 V
Default Unit	Volts
Initial S/W Revision	A.14.00

Trigger Slope

Example	CALC:FPOW:POW1:DEF "TriggerSlope=Negative"
Notes	The trigger slope parameter indicates the direction of the edge trigger voltage for detection.
Preset	Positive
Range	Positive, Negative
Initial S/W Revision	A.14.00

Trigger Source

Example	CALC:FPOW:POW1:DEF "TriggerSource=Ext1"
Notes	The trigger source parameter allows the user to choose between measurement's triggering freely or controlled by an external input. Ext1 and Ext2 correspond to Trigger 1 In and Trigger 2 In, respectively.
Preset	Free
Range	Free, Ext1, Ext2
Initial S/W Revision	A.14.00

Trigger Timeout

Example	CALC:FPOW:POW1:DEF "TriggerTimeout=0.1"
Notes	The trigger timeout parameter sets the time in which the analyzer will wait for a trigger before automatically performing the measurement.
Preset	1 s
Range	0 – 1 s
Default Unit	Seconds
Initial S/W Revision	A.14.00

Signal Input

Example	CALC:FPOW:POW1:DEF "SignalInput=Fp50MHzCW"
Notes	The signal input parameter allows the user to select between using the main RF input or the internal analyzer reference CW signal of 50 MHz.
Preset	FpMainRf
Range	FpMainRf, Fp50MHzCW
Initial S/W Revision	A.14.00

Use Preselector

Example	CALC:FPOW:POW1:DEF "UsePreSelector=True"
Notes	The preselector parameter allows the user to either utilize or bypass the front end tunable filter at frequencies above 3.6 GHz. For frequencies below 3.6 GHz, the preselector is automatically bypassed, so you do not need to set this parameter to False in those cases.
Preset	False
Range	True (use preselector above 3.6 GHz), or False (preselector bypassed)
Default Unit	Boolean
Initial S/W Revision	A.14.00

Channel Bandwidth Array

Example	CALC:FPOW:POW1:DEF "Bandwidth=[3.84e6, 5e6, 3.84e6]"
Notes	The bandwidth parameter array defines the bandwidth of each channel that will be measured. All array parameters should have the same number of elements. Alternatively, if all the elements are the same value, a single number with no square brackets can be used to define the parameter.
Preset	[1e6]
Range	0 to 40 MHz
Default Unit	Hz
Initial S/W Revision	A.14.00

Channel Filter Type Array

Example	CALC:FPOW:POW1:DEF "FilterType=[RRC, IBW, RRC]"
Notes	The filter type parameter allows the user to choose between an integration bandwidth (IBW) filter or a root-raised-cosine (RRC) filter. The integration bandwidth filter weighs all frequencies within the bandwidth equally. The root-raised-cosine filter has an associated shape parameter, defined by the FilterAlpha parameter. All array parameters should have the same number of elements. Alternatively, if all the elements are the same value, a single value with no square brackets can be used to define the parameter.
Preset	[IBW]
Range	IBW, RRC
Initial S/W Revision	A.14.00

Channel Filter Alpha Array

Example	CALC:FPOW:POW1:DEF "FilterAlpha=[0.5, 0.0, 0.5]"
Notes	The filter alpha parameter allows the user to adjust the alpha value associated with the root-

	raised-cosine (RRC) filter type. Set FilterType to RRC in order to utilize this parameter. All array parameters should have the same number of elements. Alternatively, if all the elements are the same value, a single number with no square brackets can be used to define the parameter.
Preset	[0.22]
Range	0.0 – 1.0
Initial S/W Revision	A.14.00

Channel Measurement Function Array

Example	CALC:FPOW:POW1:DEF "Function=[BandPower, PeakPower, BandPower]"
Notes	This parameter array defines what measurement is being made for each individually-specified channel: BandPower: Total power within the specified bandwidth of the channel (dBm) BandDensity: Total power density within the specified bandwidth of the channel (dBm/Hz) PeakPower: The peak power value within the specified bandwidth of the channel (dBm) PeakFrequency: The frequency which corresponds to the peak power value within the specified bandwidth of the channel. This frequency is relative to the center frequency (Hz) XdBBandwidth: The half power (-3.01 dB) bandwidth of the highest amplitude signal that resides within the channel (Hz), dB is configurable using XdBBandwidth parameter OccupiedBandwidth: The bandwidth at which 99% of the total power resides within the channel (Hz), percentage configurable using OccupiedBandwidthPercent parameter All array parameters should have the same number of elements. Alternatively, if all the elements are the same value, a single value with no square brackets can be used to define the parameter.
Preset	[BandPower]
Range	BandPower, BandDensity, PeakPower, PeakFrequency, XdBBandwidth, OccupiedBandwidth
Initial S/W Revision	A.14.00

Channel Offset Frequency Array

Example	CALC:FPOW:POW1:DEF "OffsetFrequency=[-5e6, 0, 5e6]"
Notes	The offset frequency parameter array defines the difference between the center frequency to the center frequency of each channel. All array parameters should have the same number of elements.
Preset	[0]
Range	0 to 20 MHz
Default Unit	Hz
Initial S/W Revision	A.14.00

Channel Occupied Bandwidth Percent Array

Example	CALC:FPOW:POW1:DEF "OccupiedBandwidthPercent =[0.95, 0.95, 0.95]"
Notes	This parameter only applies for channels whose Function is set to OccupiedBandwidth. The occupied bandwidth percent parameter specifies the percent of total power in these channels. The valid range for this parameter is 0.0 to 1.0, where 1.0 represents 100%. The default for this parameter is 0.99, which will return the bandwidth that contains 99% of the total channel power.
Preset	[0.99]
Range	0 – 1.0
Initial S/W Revision	A.14.00

Channel x-dB Bandwidth Array

Example	CALC:FPOW:POW1:DEF "XdBBandwidth =[-6.02, -3.01, -1.0]"
Notes	This parameter only applies for channels whose Function is set to XdBBandwidth. The X dB bandwidth parameter is used to specify the power relative to the peak channel power over which the bandwidth is calculated. The parameter value must be a negative number.
Preset	[-3.01]
Range	-200 to 0 dB
Default Unit	dB
Initial S/W Revision	A.14.00

Define Fast Power Measurement Query (Remote Command Only)

The DEFine? command is used to retrieve a list of all defined parameters in an ASCII string format

```

M All
o
d
e
R :CALCulate:FPOwer:POWer[1,2,...,999]:DEFine?
e
m
o
t
e
C
o
m
m
a
n

```

d

E :CALC:FPOW:POW1:DEF?

**x
a
m
p
l
e**

N This command query is used to retrieve a list of all defined parameters in an ASCII format.

O The following is an example of the returned results:

t "DCCoupled=False,ElecAttBypass=True,ElecAttenuation=0,IFGain=0,MechAttenuation=0,PreAmpMode=Off,PreSelectorOf
e fset=0,UsePreSelector=False,ExternalReferenceFrequency=10000000,FrequencyReferenceSource=AutoExternalFrequenc
s yReference,IFType=B40M,LOMode=SLW,SignalInput=FpMainRf,AcquisitionTime=0.001,CenterFrequency=1000000000,Re
solutionBW=0,ResolutionBWMode=BestSpeed,DetectorType=RmsAverage,Bandwidth=[1000000],OffsetFrequency=
[0],Function=[BandPower],FilterType=[BW],FilterAlpha=[0.22],OccupiedBandwidthPercent=[0.99],XdBBandwidth=[-
3.01],DoNoiseCorrection=False,DoSpurSuppression=False,MeasurementMethod=HardwareFFT,IncludePowerSpectrum=F
alse,TriggerDelay=0,TriggerLevel=1.2,TriggerSlope=Positive,TriggerSource=Free,TriggerTimeout=1"

I A.14.00

**n
i
t
i
a
l**

**S
/
W**

**R
e
v
i
s
i
o
n**

Configure Fast Power Measurement (Remote Command Only)

The configure command begins hardware setup and returns immediately, with no acquisition made. This can be used in parallel with other hardware operations to effectively hide the hardware setup time.

Mode	All
Remote Command	:CALCulate:FPOWer:POWer[1,2,...,999]:CONFigure
Example	:CALC:FPOW:POW1:CONF

Notes	Option FP2 is required.
Initial S/W Revision	A.14.00

Initiate Fast Power Measurement (Remote Command Only)

The INITiate command begins an acquisition and returns immediately. The results of the measurement can be retrieved using FETCh.

Mode	All
Remote Command	:CALCulate:FPOWer:POWer[1,2,...,999]:INITiate
Example	:CALC:FPOW:POW1:INIT
Notes	Option FP2 is required.
Initial S/W Revision	A.14.00

Fetch Fast Power Measurement (Remote Command Only)

The FETCh command query is used to retrieve the results of an acquisition initiated by the INIT command. The returned results are in ASCII string format. The string begins and ends with quotation marks.

Mode	All
Remote Command	:CALCulate:FPOWer:POWer[1,2,...,999]:FETCh?
Example	:CALC:FPOW:POW1:FETC?
Notes	Option FP2 is required. Returns m comma-separated ASCII values, where m corresponds to the number of bandwidths defined. 1. Declared function return in the 1st specified channel 2. Declared function return in the 2nd specified channel ... m. Declared function return in the last specified channel The INIT and FETC? command sequence performs the same functionality of a single CALC:FPOW:POW[n]? query. Units of the returned values are dependent on the Function parameter for each channel.
Initial S/W Revision	A.14.00

Execute Fast Power Measurement (Remote Command Only)

This command query is used as shorthand for an INIT command immediately followed by a FETC? command. The returned results are in ASCII string format. The string begins and ends with quotation marks.

Mode	All
Remote Command	:CALCulate:FPOWer:POWer[1,2,...,999]?
Example	:CALC:FPOW:POW1?
Notes	Option FP2 is required. See notes for Fast Power Fetch for return format.
Initial S/W Revision	A.14.00

Binary Read Fast Power Measurement (Remote Command Only)

This command query is used as shorthand for an INIT command immediately followed by a FETC? command. The returned results are in a binary format.

Mode	All
Remote Command	:CALCulate:FPOWer:POWer[1,2,...,999]:READ? :CALCulate:FPOWer:POWer[1,2,...,999]:READ1?
Example	:CALC:FPOW:POW1:READ? :CALC:FPOW:POW1:READ1?
Notes	Option FP2 is required. Returns m 4 byte floating point binary values (Little-Endian), where m corresponds to the number of bandwidths defined.
Initial S/W Revision	A.14.00

Diagnostic Binary Read Fast Power Measurement (Remote Command Only)

This command query is used as shorthand for an INIT command immediately followed by a FETC? command. The returned results are in a binary format. This command is used primarily for diagnostic purposes to test for ADC overloads and to visibly inspect the spectrum.

Mode	All
Remote Command	:CALCulate:FPOWer:POWer[1,2,...,999]:READ2?
Example	:CALC:FPOW:POW1:READ2?
Notes	Option FP2 is required. <div style="display: flex; align-items: flex-start; margin-top: 10px;"> <div style="background-color: #cccccc; padding: 2px 5px; margin-right: 10px;">NOTE</div> <div> <p>Spectrum data is only returned if the IncludePowerSpectrum parameter is set to True. If IncludePowerSpectrum is False, the number of spectrum points will be zero (0).</p> <p>Units of the returned values are dependent on the Function parameter per channel (e.g. dBm for BandPower, Hz for PeakFrequency). Returns binary data (Little-Endian) that contains information on m amount of channels, along with ADC over range and full spectrum data.</p> </div> </div>

The following is the binary format of the response.

Bandwidth Return Value

1. Number of channels specified, m [4 byte int]
2. Declared function result for the 1st specified channel [4 byte float]
3. Declared function result for the 2nd specified channel [4 byte float]
- ...
- (m + 1). Declared function result for the last (mth) specified channel [4 byte float]

ADC Over Range

1. ADC over-range occurred (1: true, 0: false) [2 byte short]

Spectrum Data

1. Number of points in the spectrum data, k [4 byte int]
2. Start frequency of spectrum data (Hz) [8 byte double]
3. Step frequency of spectrum data (Hz) [8 byte double]
4. FFT bin at 1st point (dBm) [4 byte float]
5. FFT bin at 2nd point (dBm) [4 byte float]
- ...
- (k + 3). FFT bin at last (kth) point (dBm) [4 byte float]

Initial S/W Revision A.14.00

Format Data: Numeric Data (Remote Command Only)

This command specifies the format of the trace data input and output. It specifies the formats used for trace data during data transfer across any remote port. It affects only the data format for setting and querying trace data for the :TRACe[:DATA], TRACe[:DATA]?, :CALCulate:DATA[n]? and FETCh:SANalyzer[n]? commands and queries.

Remote Command	:FORMat[:TRACe][:DATA] ASCii INTEger,32 REAL,32 REAL,64 :FORMat[:TRACe][:DATA]?
Notes	<p>The query response is:</p> <p>ASCii: ASC,8 REAL,32: REAL,32 REAL,64: REAL,64 INTEger,32: INT,32</p> <p>When the numeric data format is REAL or ASCii, data is output in the current Y Axis unit. When the data format is INTEger, data is output in units of m dBm (.001 dBm).</p> <p>The INT,32 format returns binary 32-bit integer values in internal units (m dBm), in a definite length block.</p>
Dependencies	<p>Sending a data format spec with an invalid number (for example, INT,48) generates no error. The analyzer simply uses the default (8 for ASCii, 32 for INTEger, 32 for REAL).</p> <p>Sending data to the analyzer which does not conform to the current FORMat specified, results in an error. Sending ASCII data when a definite block is expected generates message -161 "Invalid</p>

	Block Data" and sending a definite block when ASCII data is expected generates message -121 "Invalid Character in Number".
Preset	AScii
Backwards Compatibility Notes	Note that the INT,32 format is only applicable to the command, TRACe:DATA. This preserves backwards compatibility for the Swept SA measurement. For all other commands/queries which honor FORMat:DATA, if INT,32 is sent the analyzer will behave as though it were set to REAL,32.
Initial S/W Revision	Prior to A.02.00

The specs for each output type follow:

AScii - Amplitude values are in ASCII, in the current Y Axis Unit, one ASCII character per digit, values separated by commas, each value in the form:

SX.YYYYEsZZ

Where:

S = sign (+ or -)

X = one digit to left of decimal point

Y = 5 digits to right of decimal point

E = E, exponent header

s = sign of exponent (+ or -)

ZZ = two digit exponent

REAL,32 - Binary 32-bit real values in the current Y Axis Unit, in a definite length block.

REAL,64 - Binary 64-bit real values in the current Y Axis Unit, in a definite length block.

Format Data: Byte Order (Remote Command Only)

This command selects the binary data byte order for data transfer and other queries. It controls whether binary data is transferred in normal or swapped mode. This command affects only the byte order for setting and querying trace data for the :TRACe[:DATA], TRACe[:DATA]? , :CALCulate:DATA[n]? and FETCh:SANalyzer[n]? commands and queries.

By definition any command that says it uses FORMat:DATA uses any format supported by FORMat:DATA.

The NORMal order is a byte sequence that begins with the most significant byte (MSB) first, and ends with the least significant byte (LSB) last in the sequence: 1|2|3|4. SWAPped order is when the byte sequence begins with the LSB first, and ends with the MSB last in the sequence: 4|3|2|1.

Remote Command	:FORMat:BORDER NORMa1 SWAPped
-----------------------	--

	:FORMat:BORDER?
Preset	NORMal
Initial S/W Revision	Prior to A.02.00

Meas Setup

Accesses the functions that allow you to change the settings for your measurement requirements.

Key Path	Front-panel key
Initial S/W Revision	Prior to A.02.00

Counts

Sets the accumulated number of sampling points for data acquisition. The range is 1.000 kpt (k point) to 2.00000 Gpt (G point) with 1 kpt resolution. Counts couples to Meas Cycles. When the value for counts is changed, the Meas Cycles value will be (Counts / SamplingFrequency * MeasInterval).

Key Path	Meas Setup
Mode	SA, WCDMA, C2K, WIMAXOFDMA, TD-SCDMA, 1xEV-DO, DVB-T/H, DTMB (CTTB), ISDB-T, CMMB, LTE, LTETDD, Digital Cable TV, WLAN, MSR, LTEATDD, LTEAFDD
Remote Command	[:SENSe]:PStatistic:COUNTs <integer> [:SENSe]:PStatistic:COUNTs?
Example	PST:COUN 5001 PST:COUN?
Couplings	This value is coupled to Meas Cycles. When Counts is changed, the MeasCycles value will be (Counts / SamplingFrequency * MeasInterval). TD-SCDMA: When Counts is changed, the MeasCycles value will be (Counts / (Sampling Frequency * Time duration of measured time slots / 5 msec)), Time duration of measured time slots is determined by Analysis Time Slot and Measure Interval.
Preset	10000000
State Saved	Saved in instrument state.
Min	1000
Max	2000000000
Default Unit	Kpt
Initial S/W Revision	Prior to A.02.00
Modified at S/W Revision	A.02.00, A.03.00

Meas Cycles

Set the number of measurement cycles to calculate power statistic data. This number couples to Counts. The Counts value is (MeasCycles * Sampling Frequency * MeasInterval).

When the counts value cannot be divided by (Sampling Frequency * MeasInterval), this value is displayed as a decimal fraction.

Key Path	Meas Setup
Mode	SA, WCDMA, C2K, WiMAX OFDMA, TD-SCDMA, 1xEV-DO, DVB-T/H, DTMB (CTTB), ISDB-T, CMMB, LTE, LTETDD, Digital Cable TV, WLAN, MSR, LTEATDD, LTEAFDD
Remote Command	[:SENSE]:PStatistic:SWEep:CYCLes <integer> [:SENSe]:PStatistic:SWEep:CYCLes?
Example	PST:SWE:CYCL 1001 PST:SWE:CYCL?
Couplings	The Counts value will be (MeasCycles * Sampling Frequency * MeasInterval). TD-SCDMA: The Counts value will be (MeasCycles * Sampling Frequency * Time duration of measured time slots / 5 msec), Time duration of measured time slots is determined by Analysis Time Slot and Measure Interval.
Preset	Depends on the sampling frequency.
Min	1
Max	Depends on the sampling frequency.
Initial S/W Revision	Prior to A.02.00
Modified at S/W Revision	A.02.00, A.03.00

Meas Interval (Not 1xEVDO)

Sets the number of data points to be used as the measurement interval. This value couples to Counts. The Counts value is (MeasCycles * Sampling Frequency * MeasInterval).

Key Path	Meas Setup
Mode	SA, WCDMA, C2K, WiMAX OFDMA, TD-SCDMA, DVB-T/H, DTMB (CTTB), ISDB-T, CMMB, LTE, LTETDD, Digital Cable TV, WLAN, MSR, LTEATDD, LTEAFDD
Remote Command	[:SENSE]:PStatistic:SWEep:TIME <time> [:SENSe]:PStatistic:SWEep:TIME?
Example	PST:SWE:TIME 2 ms PST:SWE:TIME?
Couplings	The Counts value will be (MeasCycles * Sampling Frequency * MeasInterval). WiMAX OFDMA: The default value depends on Radio Device status. TD-SCDMA: The Counts value will be (MeasCycles * Sampling Frequency * Time duration of measured time slots / 5 msec), Time duration of measured time slots is determined by Analysis Time Slot and Measure Interval. When TriggerSource is RFBurst, this button is grayed.
Preset	Others: 1.0 ms TD-SCDMA: 1 slot LTETDD, LTEATDD: 500 us
Min	Others: 50.0 us TD-SCDMA: 1 slot

Max	Others: 10.0 ms TD-SCDMA: 9 slot
Initial S/W Revision	Prior to A.02.00
Modified at S/W Revision	A.02.00, A.03.00

IF Gain

Sets the IF Gain function to Auto, Low Gain or High Gain. These settings affect sensitivity and IF overloads.

This only applies to the RF input. It does not apply to baseband I/Q input.

Key Path	Meas Setup
Dependencies	The IF Gain keys (FFT IF Gain and Swept IF Gain) have no effect when the U7227A USB Preamp is connected. This is not annotated or reflected on any softkey; there are no keys grayed out nor any SCPI locked out. The analyzer simply behaves as though both FFT IF Gain and Swept IF Gain are set to Low regardless of the setting on the keys.
Initial S/W Revision	Prior to A.02.00

IF Gain Auto

Activates the Auto Rules for IF Gain. When Auto is active, the IF Gain is set to High Gain under any of the following conditions:

- the input attenuator is set to 0 dB
- the preamp is turned On
- the Max Mixer Level is -20 dBm or lower

For other settings, Auto sets IF Gain to Off.

Key Path	Meas Setup, IF Gain
Mode	SA, WCDMA, C2K, WiMAX OFDMA, TD-SCDMA, 1xEV-DO, DVB-T/H, DTMB (CTTB), ISDB-T, CMMB, LTE, LTE-TDD, Digital Cable TV, WLAN, MSR, LTE-TDD, LTE-AFDD
Remote Command	<code>[:SENSe]:PStatistic:IF:GAIN:AUTO[:STATE] ON OFF 1 0</code> <code>[:SENSe]:PStatistic:IF:GAIN:AUTO[:STATE]?</code>
Example	PST:IF:GAIN:AUTO ON PST:IF:GAIN:AUTO?
Notes	IF Gain only applies to the RF input. It does not apply to baseband I/Q input.
Couplings	When either the auto attenuation is active (for example, with electrical attenuator), or the optimize mechanical attenuator range is requested, the IF Gain setting is changed using the following rule. The Auto selection sets IF Gain On under any of the following conditions: <ul style="list-style-type: none"> - the input attenuator is set to 0 dB

- the preamp is turned on,
- the Max Mixer Level is -20 dBm or lower.

For other settings, Auto sets IF Gain to Off.

Preset	OFF
State Saved	Saved in instrument state.
Range	Auto Man
Initial S/W Revision	Prior to A.02.00
Modified at S/W Revision	A.02.00, A.03.00

IF Gain State

Selects the range of IF gain. On sets the high gain option, which allows for better noise level measurements and Off sets low gain when measuring large signals.

Key Path	Meas Setup, IF Gain
Mode	SA, WCDMA, C2K, WIMAXOFDMA, TD-SCDMA, 1xEV-DO, DVB-T/H, DTMB (CTTB), ISDB-T, CMMB, LTE, LTETDD, Digital Cable TV, WLAN, MSR, LTEATDD, LTEAFDD
Remote Command	<code>[:SENSe]:PStatistic:IF:GAIN[:STATe] ON OFF 1 0</code> <code>[:SENSe]:PStatistic:IF:GAIN[:STATe]?</code>
Example	PST:IF:GAIN ON PST:IF:GAIN?
Notes	IF Gain only applies to the RF input. It does not apply to baseband I/Q input. ON = high gain OFF = low gain
Preset	OFF
State Saved	Saved in instrument state.
Range	Low Gain (Best for Large Signals) High Gain (Best Noise Level)
Readback Text	Low Gain High Gain
Initial S/W Revision	Prior to A.02.00
Modified at S/W Revision	A.02.00, A.03.00

Meas Preset

Restores all measurement settings to their default values.

Key Path	Meas Setup
Mode	SA, WCDMA, C2K, WIMAXOFDMA, TD-SCDMA, 1xEV-DO, DVB-T/H, DTMB (CTTB), ISDB-T, CMMB, LTE, LTETDD, Digital Cable TV, WLAN, MSR, LTEATDD, LTEAFDD
Remote Command	<code>:CONFigure:PStatistic</code>

Example	CONF:PST
Notes	You must be in the Spectrum Analysis mode, W-CDMA mode, cdma2000 mode, TD-SCDMA mode, DVB-T/H mode, DTMB (CTTB) mode, ISDB-T mode, CMMB mode, Digital Cable TV mode or WIMAXOFDMA mode to use this command. Use :INSTrument:SElect to set the mode.
Couplings	Selecting Meas Preset will restore all measurement parameters to their default values.
Initial S/W Revision	Prior to A.02.00
Modified at S/W Revision	A.02.00, A.03.00

Mode

See ["Mode" on page 353](#)

Mode Preset

Returns the active mode to a known state.

Mode Preset does the following for the currently active mode:

- Aborts the currently running measurement.
- Brings up the default menu for the mode, with no active function.
- Sets measurement Global settings to their preset values for the active mode only.
- Activates the default measurement.
- Brings up the default menu for the mode.
- Clears the input and output buffers.
- Sets Status Byte to 0.

Mode Preset does not:

- Cause a mode switch
- Affect mode persistent settings
- Affect system settings
- See "[How-To Preset](#)" on page 1991 for more information.

Key Path	Front-panel key
Remote Command	:SYSTem:PRESet
Example	:SYST:PRES
Notes	<p>*RST is preferred over :SYST:PRES for remote operation. *RST does a Mode Preset, as done by the :SYST:PRES command, and it sets the measurement mode to Single measurement rather than Continuous for optimal remote control throughput.</p> <p>Clears all pending OPC bits. The Status Byte is set to 0.</p>
Couplings	A Mode Preset aborts the currently running measurement, activates the default measurement, and gets the mode to a consistent state with all of the default couplings set.
Backwards Compatibility Notes	<p>In the X-Series, the legacy "Factory Preset" has been replaced with Mode Preset, which only presets the currently active mode, not the entire instrument. In the X-Series, the way to preset the entire instrument is by using System, Restore System Defaults All, which behaves essentially the same way as restore System Defaults does on ESA and PSA.</p> <p>There is also no "Preset Type" as there is on the PSA. There is a green Mode Preset front-panel key that does a Mode Preset and a white-with-green-letters User Preset front-panel key that does a User Preset. The old PRESet:TYPE command is ignored (without generating an error), and SYST:PRES without a parameter does a Mode Preset, which should cover most backward code compatibility issues.</p> <p>The settings and correction data under the Input/Output front-panel key (examples: Input Z Corr,</p>

Ext Amp Gain, etc.) are no longer part of any Mode, so they will not be preset by a Mode Preset. They are preset using Restore Input/Output Defaults, Restore System Defaults All. Note that because User Preset does a Recall State, and all of these settings are saved in State, they ARE recalled when using User Preset.

Initial S/W Revision Prior to A.02.00

How-To Preset

The table below shows all possible presets, their corresponding SCPI commands and front-panel access (key paths). Instrument settings depend on the current measurement context. Some settings are local to the current measurement, some are global (common) across all the measurements in the current mode, and some are global to all the available modes. In a similar way, restoring the settings to their preset state can be done within the different contexts.

Auto Couple - is a measurement local key. It sets all Auto/Man parameter couplings in the measurement to Auto. Any Auto/Man selection that is local to other measurements in the mode will not be affected.

Meas Preset - is a measurement local key. Meas Preset resets all the variables local to the current measurement except the persistent ones.

Mode Preset - resets all the current mode's measurement local and measurement global variables except the persistent ones.

Restore Mode Defaults - resets ALL the Mode variables (and all the Meas global and Meas local variables), including the persistent ones.

Type Of Preset	SCPI Command	Front Panel Access
Auto Couple	:COUPle ALL	Auto Couple front-panel key
Meas Preset	:CONFigure: <Measurement>	Meas Setup Menu
Mode Preset	:SYSTem:PRESet	Mode Preset (green key)
Restore Mode Defaults	:INSTrument:DEFault	Mode Setup Menu
Restore All Mode Defaults	:SYSTem:DEFault MODes	System Menu; Restore System Default Menu
*RST	*RST	not possible (Mode Preset with Single)
Restore Input/Output Defaults	:SYSTem:DEFault INPut	System Menu; Restore System Default Menu
Restore Power On Defaults	:SYSTem:DEFault PON	System Menu; Restore System Default Menu
Restore Alignment Defaults	:SYSTem:DEFault ALIGn	System Menu; Restore System Default Menu
Restore Miscellaneous Defaults	:SYSTem:DEFault MISC	System Menu; Restore System Default Menu

Restore All System Defaults	:SYSTem:DEFault [ALL] :SYSTem:PRESet:PERSistent	System Menu; Restore System Default Menu
User Preset	:SYSTem:PRESet:USER	User Preset Menu
User Preset All Modes	:SYSTem:PRESet:USER:ALL	User Preset Menu
Power On Mode Preset	:SYSTem:PON:TYPE MODE	System Menu
Power On User Preset	:SYSTem:PON:TYPE USER	System Menu
Power On Last State	:SYSTem:PON:TYPE LAST	System Menu

Mode Setup

See ["Mode Setup" on page 388](#)

Peak Search

There is no 'Peak Search' functionality supported in Power Stat CCDF measurement. The front-panel key displays a blank menu when pressed.

Key Path	Front-panel key
Initial S/W Revision	Prior to A.02.00

Print

See "Print " on page 430

Quick Save

The Quick Save front-panel key repeats the most recent save that was performed from the Save menu, with the following exceptions:

- Register saves are not remembered as Saves for the purpose of the Quick Save function
- If the current measurement does not support the last non-register save that was performed, an informational message is generated, “File type not supported for this measurement”

Quick Save repeats the last type of qualified save (that is, a save qualified by the above criteria) in the last save directory by creating a unique filename using the Auto File Naming algorithm described below.

If Quick Save is pressed after startup and before any qualified Save has been performed, the Quick Save function performs a Screen Image save using the current settings for Screen Image saves (current theme, current directory), which then becomes the “last save” for the purpose of subsequent Quick Saves.

The Auto File Naming feature automatically generates a file name for use when saving a file. The filename consists of a prefix and suffix separated by a dot, as is standard for the Windows® file system. A default prefix exists for each of the available file types:

Type	Default Prefix	Menu
State	State_	(Save/Recall)
Trace + State	State_	(Save/Recall)
Screen	Screen_	(Save/Recall)
Amplitude Corrections	Ampcor_	(Import/Export)
Traces	Trace_	(Import/Export)
Limit Lines	LLine_	(Import/Export)
Measurement Result	MeasR_	(Import/Export)
Capture Buffer	CapBuf_	(Import/Export)

A four digit number is appended to the prefix to create a unique file name. The numbering sequence starts at 0000 within each Mode for each file type and updates incrementally to 9999, then wraps to 0000 again. It remembers where it was through a Mode Preset and when leaving and returning to the Mode. It is reset by Restore Misc Defaults and Restore System Defaults and subsequent running of the instrument application. So, for example, the first auto file name generated for State files is State_0000.state. The next is State_0001, and so forth.

One of the key features of Auto File Name is that we guarantee that the Auto File Name will never conflict with an existing file. The algorithm looks for the next

available number. If it gets to 9999, then it looks for holes. If it find no holes, that is no more numbers are available, it gives an error.

For example, if when we get to State_0010.state there is already a State_0010.state file in the current directory, it advances the counter to State_0011.state to ensure that no conflict will exist (and then it verifies that State_0011.state also does not exist in the current directory and advances again if it does, and so forth).

If you enter a file name for a given file type, then the prefix becomes the filename you entered instead of the default prefix, followed by an underscore. The last four letters (the suffix) are the 4-digit number.

For example, if you save a measurement results file as “fred.csv”, then the next auto file name chosen for a measurement results save will be fred_0000.csv.

NOTE

Although 0000 is used in the example above, the number that is used is actually the current number in the Meas Results sequence, that is, the number that would have been used if you had not entered your own file name.

If the filename you entered ends with _dddd, where d=any number, making it look just like an auto file name, then the next auto file name picks up where you left off with the suffix being dddd + 1.

Key Path	Front-panel key
Notes	No remote command for this key specifically.
Initial S/W Revision	Prior to A.02.00

Recall

The **Recall** menu lets you choose what you want to recall, and where you want to recall it from. Among the types of files you can recall are **States and Traces**. In addition, an **Import (Data)** option lets you recall a number of data types stored in CSV files (as used by Excel and other spreadsheet programs).

The default paths for Recall are data type dependent and are the same as for the Save key.

Key Path	Front-panel key
Notes	<p>No remote command for this key specifically, but the :MMEM:LOAD command is available for specific file types. An example is :MMEM:LOAD:STATe <filename>.</p> <p>If you try to recall a State file for a mode that is not licensed or not available in the instrument, an error message will occur and the state will not change.</p>
Backwards Compatibility Notes	<p>In legacy analyzers, it was possible to load a state without affecting the trace data, limit lines or correction data. Similarly (since User Preset is actually loading a state), it was possible to do a User Preset without affecting the trace data, limit lines or correction data.</p> <p>In the X-Series, "state" always includes all of this data; so whenever state is loaded, all of the traces, limit lines and corrections are affected. Although this differs from previous behavior, it is desirable behavior, and should not cause adverse issues for users.</p>
Backwards Compatibility Notes	<p>Recall for the X-Series supports backward compatibility in the sense that you can recall a state file from any X-Series model number and any version of X-Series software. This is only possible if part of the recalling process goes through a limiting step after recalling the mode settings, at least for settings that may vary with version number, model number, option and license differences. If you try to recall a state file onto an instrument with less capability than what was available on the instrument during the save, the recall will ignore the state it doesn't support and it will limit the recalled setting to what it allows.</p> <p>Example: if the saved state includes preamp ON, but the recalling instrument does not have a preamp; the preamp is limited to OFF. Conversely, if you save a state without a preamp, the preamp is OFF in the state file. When this saved file is recalled on an instrument with a licensed preamp, the preamp is changed to OFF. Another example is if the saved state has center frequency set to 20 GHz, but the instrument recalling the saved state is a different model and only supports 13.5 GHz. In this case, the center frequency is limited along with any other frequency based settings. Since the center frequency can't be preserved in this case, the recall limiting tries to at least preserve span to keep the measurement setup as intact as possible.</p> <p>It may be appropriate to issue a warning if the state is limited on the recall; warnings do not go out to SCPI so this would only affect the manual user.</p> <p>Note that there is no state file compatibility outside of the X-Series. For example, you cannot recall a state file from ESA or PSA.</p>
Initial S/W Revision	Prior to A.02.00

State

The **Recall State** menu lets you choose a register or file from which to recall the state.

The content of a state file includes all of the settings and data required to return the analyzer as closely as possible to the Mode it was in, with the exact settings that

were in place, when the save occurred. The Mode settings in each state file include the settings that are affected by Mode Preset, as well as the additional settings affected by Restore Mode Defaults; all of the Mode's settings. In addition, all of the settings of the **Input/Output** system are included, even though they are outside of the Mode's state, because they are needed to restore the complete setup. Persistent System settings (for example, GPIB address) are not affected by either a Mode Preset or Restore Mode Defaults, nor are they included in a saved State file.

Since each state file is only for one Mode, the settings for other Modes are unaffected when it is loaded. **Recall State** will cause a mode switch if the state being recalled is not from the current active mode.

After the recall completes, the message "File <filename> recalled" or "Recalled State Register <register number>" is displayed.

For rapid recalls, the State menu lists 16 registers that you can choose from to recall. Pressing a Register key initiates the recall. You can also select a file from which to recall.

The default path for all State Files is:

My Documents\<<mode name>\state

where <mode name> is the parameter used to select the mode with the INST:SEL command (for example, SA for the Spectrum Analyzer).

See ["More Information" on page 2000](#).

Key Path	Recall
Mode	All
Remote Command	:MMEMory:LOAD:STATe <filename>
Example	:MMEM:LOAD:STAT "myState.state" This recalls the file myState.state on the default path
Example	MMEM:LOAD:STAT "MyStateFile.state" This loads the state file data (on the default file directory path) into the instrument state.
Notes	When you pick a file to recall, the analyzer first verifies that the file is recallable in the current instrument by checking the software version and model number of the instrument. If everything matches, a full recall proceeds by aborting the currently running measurement, clearing any pending operations, and then loading the State from the saved state file. You can open state files from any mode, so recalling a State file switches to the mode that was active when the save occurred. After switching to the mode of the saved state file, mode settings and data (if any for the mode) are loaded with values from the saved file. The saved measurement of the mode becomes the newly active measurement and the data relevant to the measurement (if there is any) is recalled. <ul style="list-style-type: none"> - If there is a mismatch between file version or model number or instrument version or model number, the recall function tries to recall as much as possible and returns a warning message. It may limit settings that differ based on model number, licensing or version number. <p>After recalling the state, the Recall State function does the following:</p>

- Makes the saved measurement for the mode the active measurement.
- Clears the input and output buffers.
- Status Byte is set to 0.
- Executes a *CLS

If the file specified is empty an error is generated. If the specified file does not exist, another error is generated. If there is a mismatch between the file and the proper file type, an error is generated. If there is a mismatch between file version or model number or instrument version or model number, a warning is displayed. Then it returns to the State menu and File Open dialog goes away.

After the Recall, the analyzer exits the Recall menu and returns to the previous menu.

Backwards Compatibility SCPI :MMEMory:LOAD:STATE 1,<filename>
For backwards compatibility, the above syntax is supported. The "1" is simply ignored.

Initial S/W Revision Prior to A.02.00

More Information

In measurements that support saving Traces, for example, Swept SA, the Trace data is saved along with the State in the State file. When recalling the State, the Trace data is recalled as well. Traces are recalled exactly as they were stored, including the writing mode and update and display modes. If a Trace was updating and visible when the State was saved, it will come back updating and visible, and its data will be rewritten right away. When you use State to save and recall traces, any trace whose data must be preserved should be placed in View or Blank mode before saving.

The following table describes the Trace Save and Recall possibilities:

You want to recall state and one trace's data, leaving other traces unaffected.	Save Trace+State from 1 trace. Make sure that no other traces are updating (they should all be in View or Blank mode) when the save is performed.	On Recall, specify the trace you want to load the one trace's data into. This trace will load in View. All other traces' data will be unaffected, although their trace mode will be as it was when the state save was performed.
You want to recall all traces	Save Trace+State from ALL traces.	On Recall, all traces will come back in View (or Blank if they were in Blank or Background when saved)
You want all traces to load exactly as they were when saved.	Save State	On recall, all traces' mode and data will be exactly as they were when saved. Any traces that were updating will have their data immediately overwritten.

From File...

When you press “From File”, the analyzer brings up a Windows dialog and a menu entitled “File Open.” This menu allows you to navigate to the various fields in the Windows dialog without using a keyboard or mouse. The **Tab** and **Arrow** keys can also be used for dialog navigation.

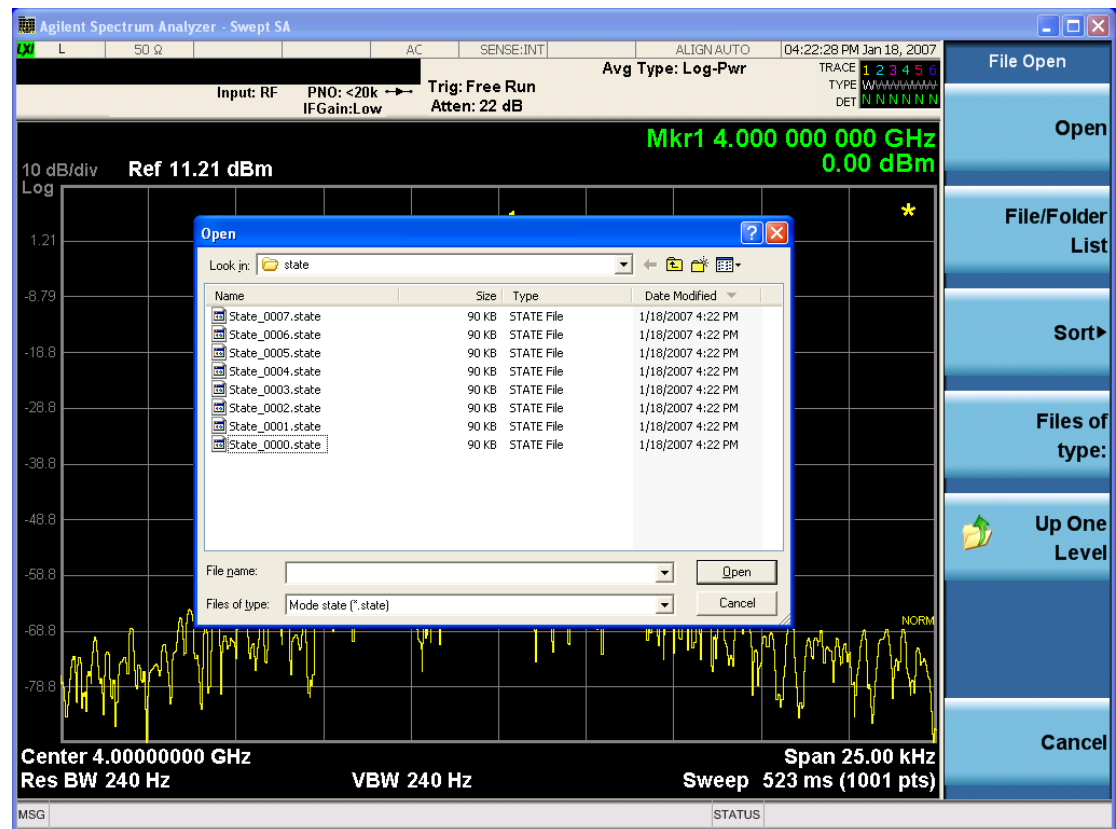

Listed below are the functions of the various fields in the dialog, and the corresponding softkeys:

Open

Performs the recall of the specified file. While the recall is being performed, the floppy icon appears briefly in the Meas bar.

File/Folder List

Enables you to navigate to the center of the dialog that contains the list of files and folders. Once here you can get information about the file and use the tab keys to navigate to the other fields in the dialog, such as Look In.

Look In

The **Look In** field shows the path from which the file will be recalled and allows you to change the path using the up and down arrow keys to navigate to other paths; the Enter key to open a directory; and the Backspace key to go back one directory. The **Look In** field first uses the last path from the Save As dialog **Save In:** path for that

same file type. There is no softkey for directly navigating to the Look In field, but you can use the left tab to get here from the File/Folder List.

User specified paths are remembered when you leave and return to a Mode and are reset back to the default using **Restore Mode Defaults**.

Sort

Accesses a menu that enables you to sort the files within the File Open dialog. Only one sorting type can be selected at a time and the sorting happens immediately. The sorting types are **By Date**, **By Name**, **By extension**, and **By Size**.

Files of Type

This field shows the file suffix for the type of file you have selected to recall. For example, if you navigated here while recalling State, "Mode state (*.state)" is in the field. If you navigated here while recalling Trace, "Mode state (*.trace)" is in the field. If you navigated here while importing a trace data file, "Trace Data (*.csv)" is in the field. For some file types, there is more than one choice in the dropdown menu, which you can select by using the up and down arrow keys and Enter.

Up One Level

This key corresponds to the icon of a folder with the up arrow that is in the tool bar of the dialog. When pressed, it causes the file and folder list to navigate up one level in the directory structure. The Backspace key does the same thing.

Cancel

This key corresponds to the **Cancel** selection in the dialog. It causes the current **Open** request to be cancelled. The ESC key does the same thing.

Key Path	Recall, State
Notes	Brings up the Open dialog for recalling a State Save Type
Initial S/W Revision	Prior to A.02.00

Edit Register Names

You may enter a custom name on any of the Register keys, to help you remember what you are using that state to save. To do this, press the **Edit Register Names** key, choose the register whose name you wish to edit, and then enter the desired label using the Alpha Editor or an external PC keyboard.

The maximum number of characters that can be added is 30. In most cases, 30 characters will fit on two lines of the key.

For more information and the SCPI command, see Edit Register Names under the **Save, State** function.

Key Path	Recall, State
Mode	All
Dependencies	N9060A-7FP or N9060B-2FP license required to edit the register names. When the feature is not licensed, sending the SCPI command generates an error, -221,"Settings conflict;Option not

	available"
Initial S/W Revision	A.11.00

Register 1 thru Register 16

Selecting any one of these register keys causes the State of the mode from the specified Register to be recalled. Each of the register keys annotates whether it is empty or at what date and time it was last modified. In addition, you can use the **Edit Register Names** key under **Save, State** to enter custom names for each register.

Registers are shared by all modes, so recalling from any one of the registers will cause a mode switch to the mode that was active when the save to the Register occurred.

Although these 16 registers are the only registers available from the front panel, there are 128 state registers available in the instrument. Registers 17-128 are only available from the SCPI interface, using the *RCL command.

After the recall completes, the message "Register <register number> recalled" appears in the message bar. If you are in the Spectrum Analyzer Mode, and you are recalling a register that was saved in the Spectrum Analyzer Mode, then after the recall, you will still be in the Recall Register menu. If the Recall causes you to switch modes, then after the Recall, you will be in the Frequency menu.

If a requested register is empty an error is generated.

Key Path	Recall, State
Example	*RCL 1
Range	1-16 from front panel, 1-128 from SCPI
Readback	Date and time with seconds resolution are displayed on the key OR A custom name of up to 30 characters entered using the Save, State,Edit Register Names key OR “(empty)” if no prior save operation has been performed to this register.
Initial S/W Revision	Prior to A.02.00
Modified at S/W Revision	Prior to A.11.00

Register 1 thru Register 16

Selecting any one of these register keys causes the State of the mode from the specified Register to be recalled. Each of the register keys annotates whether it is empty or at what date and time it was last modified. In addition, you can use the **Edit Register Names** key under **Save, State** to enter custom names for each register.

Registers are shared by all modes, so recalling from any one of the registers will cause a mode switch to the mode that was active when the save to the Register occurred.

Although these 16 registers are the only registers available from the front panel, there are 128 state registers available in the instrument. Registers 17-128 are only available from the SCPI interface, using the *RCL command.

After the recall completes, the message "Register <register number> recalled" appears in the message bar. If you are in the Spectrum Analyzer Mode, and you are recalling a register that was saved in the Spectrum Analyzer Mode, then after the recall, you will still be in the Recall Register menu. If the Recall causes you to switch modes, then after the Recall, you will be in the Frequency menu.

If a requested register is empty an error is generated.

Key Path	Recall, State
Example	*RCL 1
Range	1-16 from front panel, 1-128 from SCPI
Readback	Date and time with seconds resolution are displayed on the key OR A custom name of up to 30 characters entered using the Save, State,Edit Register Names key OR “(empty)” if no prior save operation has been performed to this register.
Initial S/W Revision	Prior to A.02.00
Modified at S/W Revision	Prior to A.11.00

Trace (+State)

The Recall Trace (+State) menu lets you choose a register or file from which to recall the Trace+State state file.

A saved state contains all of the settings and data required to return the analyzer as closely as possible to the exact setup it had when the save occurred. This includes the Input/Output settings, even though they are outside of the Mode’s state, because they are needed to restore the complete setup. A Trace+State file also includes trace data from one trace or all traces, which will load in View mode when the Trace+State file is recalled. Recall Trace (+State) will also cause a mode switch if the state being recalled is not for the current active mode.

After the recall completes, the message "File <filename> recalled" or “Recalled Trace Register <register number>” is displayed.

For rapid recalls, the Trace (+State) menu lists 5 registers to choose from to recall. Pressing a Register key initiates the recall. You can also select a file from which to recall.

The default path for all State Files including .trace files is:

My Documents\<<mode name>\state

where <mode name> is the parameter used to select the mode with the INST:SEL command (for example, SA for the Spectrum Analyzer).

Key Path	Recall
Mode	SA
Remote Command	<pre>:MMEMory:LOAD:TRACe TRACE1 TRACE2 TRACE3 TRACE4 TRACE5 TRACE6,<filename> :MMEMory:LOAD:TRACe:REGister TRACE1 TRACE2 TRACE3 TRACE4 TRACE5 TRACE6,<integer></pre>
Example	<pre>MMEM:LOAD:TRAC TRACE2, "MyTraceFile.trace"</pre> <p>This loads the trace file data (on the default file directory path) into the specified trace; if it is a "single trace" save file, that trace is loaded to trace 2, and is set to be not updating.</p> <pre>:MMEM:LOAD:TRAC:REG TRACE1,2</pre> <p>restores the trace data in register 2 to Trace 1</p>
Notes	<p>When you perform the recall, the recalling Trace function must first verify the file is recallable in this instrument by checking instrument software version and model number, since it includes State. If everything matches, a full recall proceeds by aborting the currently running measurement, and loading the state from the saved state file to as close as possible to the context in which the save occurred. You can open .trace files from any mode that supports them, so recalling a Trace file switches to the mode that was active when the save occurred. After switching to the mode of the saved state file, mode settings and data (if any for the mode) are loaded with values from the saved file and the saved measurement of the mode becomes the newly active measurement, and the data relevant to the measurement (if there is any) is recalled.</p> <p>Once the state is loaded, the trace data must be loaded. The internal flags are consulted to see which trace to load and the "To Trace" setting to see where to load it. Trace data is always loaded with the specified trace set to View, so that the data is visible and not updating (so as not to erase the recalled data). If the file is an "all trace" file, all traces are loaded with the saved data (to the original trace the data was saved from) and set to View. Traces whose data is not loaded are restored to the update state that existed when they were saved.</p> <p>After the Recall the analyzer exits the Recall menu and returns to the previous menu.</p> <p>Some modes and measurements do not have available all 6 traces. Phase Noise mode command, for example, is: <code>MMEMory:LOAD:TRACe TRACE1 TRACE2 TRACE3,<filename></code></p> <p>Some modes and measurements have more than 6 traces available. The Realtime SA mode command, for example, is: <code>MMEMory:STORe:TRACe TRACE1 TRACE2 TRACE3 TRACE4 TRACE5 TRACE6 TRACE7 TRACE8 TRACE9 TRACE10 TRACE11 TRACE12 ALL,<filename></code></p>
Initial S/W Revision	Prior to A.02.00

To Trace

These menu selections let you choose the Trace where the recalled saved trace will go. Not all modes have the full 6 traces available. The default is the currently selected trace, selected in this menu or in the Trace/Detector, Export Data, Import Data, or Save Trace menus, except if you have chosen All, then it remains chosen until you specifically change it to a single trace.

If the .trace file is an "all trace" file, "**To Trace**" is ignored and the traces each go back to the trace from which they were saved.

Once selected, the key returns back to the Recall Trace menu and the selected Trace number is annotated on the key. Now you have selected exactly where the

trace needs to be recalled. To trigger a recall of the selected Trace, you must select the **Open** key in the Recall Trace menu.

When you select a trace, it makes that trace the current trace, so it displays on top of all of the other traces.

Key Path	Save, Data, Trace
Mode	SA
Initial S/W Revision	Prior to A.02.00

Register 1 thru Register 16

Selecting any one of these register keys causes the State of the mode from the specified Register to be recalled. Each of the register keys annotates whether it is empty or at what date and time it was last modified. In addition, you can use the **Edit Register Names** key under **Save, State** to enter custom names for each register.

Registers are shared by all modes, so recalling from any one of the registers will cause a mode switch to the mode that was active when the save to the Register occurred.

Although these 16 registers are the only registers available from the front panel, there are 128 state registers available in the instrument. Registers 17-128 are only available from the SCPI interface, using the *RCL command.

After the recall completes, the message "Register <register number> recalled" appears in the message bar. If you are in the Spectrum Analyzer Mode, and you are recalling a register that was saved in the Spectrum Analyzer Mode, then after the recall, you will still be in the Recall Register menu. If the Recall causes you to switch modes, then after the Recall, you will be in the Frequency menu.

If a requested register is empty an error is generated.

Key Path	Recall, State
Example	*RCL 1
Range	1-16 from front panel, 1-128 from SCPI
Readback	Date and time with seconds resolution are displayed on the key OR A custom name of up to 30 characters entered using the Save, State, Edit Register Names key OR “(empty)” if no prior save operation has been performed to this register.
Initial S/W Revision	Prior to A.02.00
Modified at S/W Revision	Prior to A.11.00

From File...

When you press “From File”, the analyzer brings up a Windows dialog and a menu entitled “**File Open.**” This menu allows you to navigate to the various fields in the

Windows dialog without using a keyboard or mouse. The **Tab** and **Arrow** keys can also be used for dialog navigation.

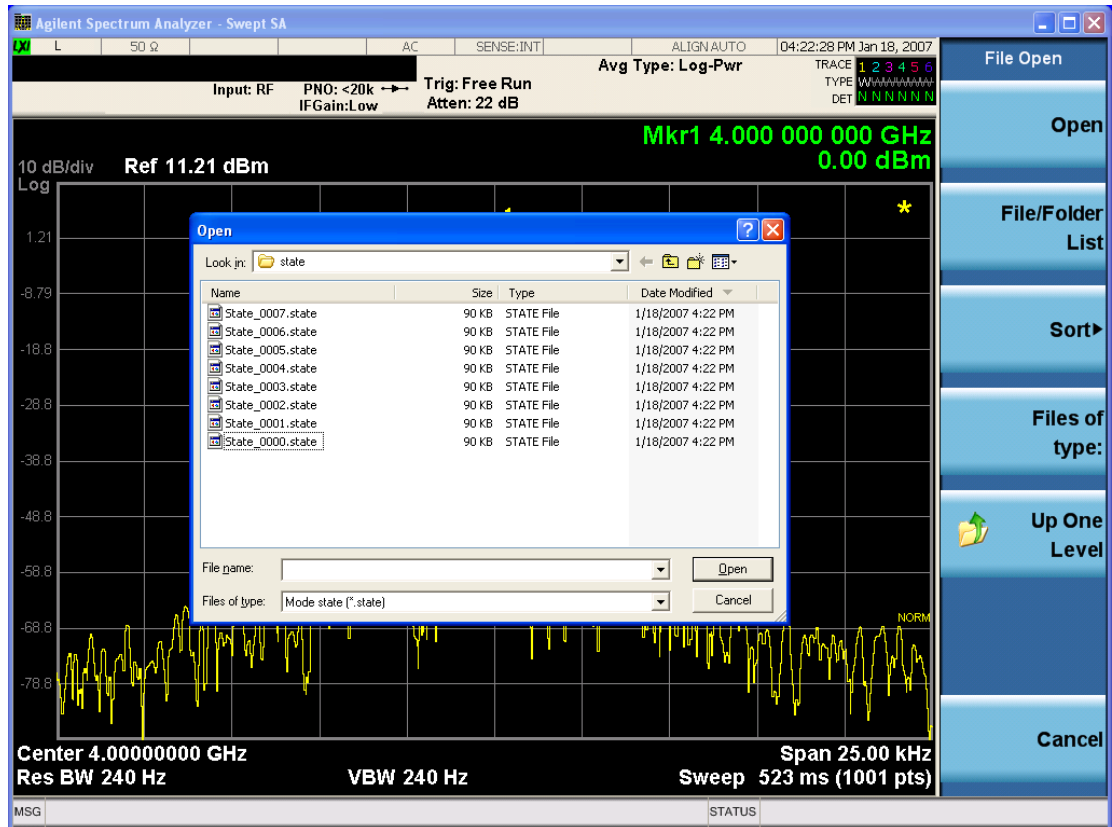

Listed below are the functions of the various fields in the dialog, and the corresponding softkeys:

Open

Performs the recall of the specified file. While the recall is being performed, the floppy icon appears briefly in the Meas bar.

File/Folder List

Enables you to navigate to the center of the dialog that contains the list of files and folders. Once here you can get information about the file and use the tab keys to navigate to the other fields in the dialog, such as Look In.

Look In

The **Look In** field shows the path from which the file will be recalled and allows you to change the path using the up and down arrow keys to navigate to other paths; the Enter key to open a directory; and the Backspace key to go back one directory. The **Look In** field first uses the last path from the Save As dialog **Save In**: path for that same file type. There is no softkey for directly navigating to the Look In field, but you can use the left tab to get here from the File/Folder List.

User specified paths are remembered when you leave and return to a Mode and are reset back to the default using **Restore Mode Defaults**.

Sort

Accesses a menu that enables you to sort the files within the File Open dialog. Only one sorting type can be selected at a time and the sorting happens immediately. The sorting types are **By Date, By Name, By extension, and By Size**.

Files of Type

This field shows the file suffix for the type of file you have selected to recall. For example, if you navigated here while recalling State, "Mode state (*.state)" is in the field. If you navigated here while recalling Trace, "Mode state (*.trace)" is in the field. If you navigated here while importing a trace data file, "Trace Data (*.csv)" is in the field. For some file types, there is more than one choice in the dropdown menu, which you can select by using the up and down arrow keys and Enter.

Up One Level

This key corresponds to the icon of a folder with the up arrow that is in the tool bar of the dialog. When pressed, it causes the file and folder list to navigate up one level in the directory structure. The Backspace key does the same thing.

Cancel

This key corresponds to the **Cancel** selection in the dialog. It causes the current **Open** request to be cancelled. The ESC key does the same thing.

Key Path	Recall, State
Notes	Brings up the Open dialog for recalling a State Save Type
Initial S/W Revision	Prior to A.02.00

Data (Import)

Importing a data file loads data that was previously saved from the current measurement or from other measurements and/or modes that produce compatible data files. The Import Menu only contains Data Types that are supported by the current measurement.

Since the commonly exported data files are in .csv format, the data can be edited by the user prior to importing. This allows you to export a data file, manipulate the data in Excel (the most common PC Application for manipulating .csv files) and then import it.

Importing Data loads measurement data from the specified file into the specified or default destination, depending on the data type selected. Selecting an Import Data menu key will not actually cause the importing to occur, since the analyzer still needs to know from where to get the data. Pressing the Open key in this menu brings up the Open dialog and Open menu that provides you with the options from where to recall the data. Once a filename has been selected or entered in the Open menu, the recall occurs as soon as the Open button is pressed.

Key Path	Recall
Mode	All
Notes	The menu is built from whatever data types are available for the mode. Some keys will be missing completely, so the key locations in the sub-menu will vary. No SCPI command directly controls the Data Type that this key controls. The Data Type is included in the MMEM:LOAD commands.
Dependencies	If a file type is not used by a certain measurement, it is grayed out for that measurement. The key for a file type will not show at all if there are no measurements in the Mode that support it.
Preset	Is not affected by Preset or shutdown, but is reset during Restore Mode Defaults
Readback	The data type that is currently selected
Initial S/W Revision	Prior to A.02.00

Amplitude Correction

This key selects the Amplitude Corrections as the data type to be imported. When pressed a second time, it brings up the Select Menu, which lets you select the Correction into which the data will be imported.

Amplitude Corrections are fully discussed in the documentation of the Input/Output key, under the Corrections key.

A set of preloaded Corrections files can be found in the directory

/My Documents/ EMC Limits and Ampcor.

When the Amplitude Correction is an Antenna correction and the Antenna Unit in the file is not **None**, the Y Axis Unit setting will change to match the Antenna Unit in the file.

Key Path	Recall
Mode	SA EDGE GSM PN
Remote Command	:MMEMory:LOAD:CORRection 1 2 3 4 5 6 7 8, <filename>
Example	:MMEM:LOAD:CORR 2, "myAmpcor.csv" recalls the Amplitude Correction data from the file myAmpcor.csv in the current directory to the 2nd Amplitude Correction table, and turns on Correction 2. The default path is D:\Users\Instrument\My Documents\amplitudeCorrections\
Dependencies	Only the first correction array (Correction 1) supports antenna units. This means that a correction file with an Antenna Unit can only be loaded into the Corrections 1 register. Consequently only for Correction 1 does the dropdown in the Recall dialog include ant, and if an attempt is made to load a correction file into any other Correction register which DOES contain an antenna unit, a Mass Storage error is generated. Corrections are not supported by all Measurements. If in a Mode in which some Measurements support it, this key will be grayed out in measurements that do not. The key will not show at all if no measurements in the Mode support it. Errors are reported if the file is empty or missing, or if the file type does not match, or if there is a mismatch between the file type and the destination data type. If any of these occur during manual operation, the analyzer returns to the Import Data menu and the File Open dialog goes away.

	This key does not appear unless you have the proper option installed in your instrument. This command will generate an "Option not available" error unless you have the proper option installed in your instrument.
Couplings	When a correction file is loaded from mass storage, it is automatically turned on (Correction ON) and ApplyCorrections is set to On. This allows you to see its effect, thus confirming the load.
Readback	selected Correction
Backwards Compatibility SCPI	:MMEMory:LOAD:CORRection ANTenna CABLE OTHER USER, <filename> For backwards compatibility, ANTenna maps to 1, CABLE maps to 2, OTHER maps to 3 and USER maps to 4
Initial S/W Revision	A.02.00

Amplitude Correction

These keys let you select which Correction to import the data into. Once selected, the key returns back to the Import Data menu and the selected Correction number is annotated on the key. The next step is to select the Open key in the Import Data menu.

Antenna corrections are a particular kind of Amplitude Corrections – they are distinguished in the corrections file by having the Antenna Unit set to a value other than None. Only Correction 1 supports Antenna Units.

Key Path	Recall, Data, Amplitude Correction
Notes	auto return
Dependencies	Only Correction 1 may be used to load a Correction that contains an Antenna Unit other than None
Preset	Not part of Preset, but is reset to Correction 1 by Restore Input/Output Defaults; survives shutdown.
State Saved	The current Correction number is saved in instrument state
Initial S/W Revision	A.02.00

Trace

This key selects Trace as the data type to be imported. When pressed a second time, it brings up the Trace Menu, which lets you select the Trace into which the data will be imported.

The trace file contains "meta" data which describes the state of the analyzer when the trace was exported (see "[Trace File Contents](#)" on page 3216). If the meta data in the file does not match the current SA state, the "invalid data indicator" (*) is displayed.

Key Path	Recall, Data
Remote Command	:MMEMory:LOAD:TRACe:DATA TRACE1 TRACE2 TRACE3 TRACE4 TRACE5 TRACE6,<filename>
Example	:MMEM:LOAD:TRAC DATA TRACE2, "myTrace2.csv" Imports the 2nd trace from the file myTrace2.csv in the current path. The default path is My Documents\SA\data\traces
Dependencies	<p>For SA measurements, a trace cannot be recalled from a trace file that was exported with ALL traces selected.</p> <p>A trace cannot be imported if the number of trace points in the file do not match the number of sweep points currently set for the measurement. If this happens, an error message is generated.</p> <p>Errors are reported if the file is empty or missing, or if the file type does not match, or if there is a mismatch between the file type and the destination data type.</p> <p>If any error occurs while trying to load a file manually (as opposed to during remote operation), the analyzer returns to the Import Data menu and the File Open dialog goes away.</p>
Couplings	When a trace is imported, Trace Update is always turned OFF for that trace and Trace Display is always turned ON.
Readback	Selected Trace
Status Bits/OPC dependencies	Sequential - aborts the current measurement.
Initial S/W Revision	Prior to A.02.00

Select Trace

These keys let you pick the Trace into which to import the data; either 1, 2, 3, 4, 5 or 6. The default is the currently selected trace, selected in this menu or in the Trace/Det, Export Data, Recall Trace, or Save Trace menus; except if you have chosen **All** then **All** remains chosen until you specifically change it to a single trace.

Once selected, the key returns back to the Import Data menu and the selected Trace number is annotated on the key. The next step is to select the Open key in the Import Data menu.

Key Path	Recall, Data, Trace
Notes	Auto return
Couplings	When you select the trace into which to import the data, it makes that trace the current trace, so it displays on top of all of the other traces.
Preset	Not part of Preset, but is reset to TRACE1 by Restore Mode Defaults; survives shutdown
State Saved	The current trace number is saved in State
Initial S/W Revision	Prior to A.02.00

Limit

This key selects Limit Lines as the data type to be imported. When pressed a second time, it brings up the Limits Menu, which lets you select into which Limit the data will be imported.

A set of preloaded Limits files can be found in the directory

/My Documents/ EMC Limits and Ampcor.

Under this directory, the directory called Limits (Legacy Naming) contains a set of legacy limits, generally the same files that were supplied with older Agilent EMC analyzers, that use the legacy suffix .lim, and the old 8-character file names. In the directory called Limits, the same files can be found, with the same suffix, but with longer, more descriptive filenames.

Key Path	Recall, Data
Remote Command	:MMEMory:LOAD:LIMit LLINE1 LLINE2,<filename>
Example	:MMEM:LOAD:LIM LLINE2, "myLimitLine2.csv" Imports the 2nd Limit Line from the file myLimitLine2.csv in the current path. The default path is My Documents\SA\data\limits
Dependencies	Errors are reported if the file is empty or missing, or if the file type does not match, or if there is a mismatch between the file type and the destination data type. If any of these occur during manual operation, the analyzer returns to the Import Data menu and the File Open dialog goes away. This key will only appear if you have the proper option installed in your instrument.
Couplings	When a limit line is loaded from mass storage, it is automatically turned on. This allows the user to see it, thus confirming the load. The Margin settings will match those when the limit was saved The instrument cannot mix Limits domains (X Axis Unit must be Frequency or Time for both Limits). So when a Limits file is loaded, the analyzer will set the Limits domain (X Axis Unit) to match that of the file. If this changes the Limits domain from what it was before the file was loaded, all Limits data in all Limits sets will be erased before the data loads. If this operation is over the remote interface there will be no warning if this occurs, so care should be taken to know the domain of the file you are loading.
Readback	Selected Limit Line
Status Bits/OPC dependencies	Sequential - aborts the current measurement
Initial S/W Revision	A.02.00

Limit Selection

These keys let you pick which Limit Line to import the data into; either 1, 2, 3, 4, 5 or 6. The default is the currently selected limit. Once selected, the key returns back to the Import Data menu and the selected Limit Line number is annotated on the key. Now you have selected exactly what needs to be imported. In order to trigger an import of the selected Limit Line, you must select the Open key in the Import Data menu.

An example of using this menu is: If you select 2 and continue to the File Open menu, Limit Line 2 will be imported from the file selected or entered in File Name option in the File Open dialog.

Key Path	Recall, Data, Limit Line
Notes	Auto return
Preset	Not part of Preset, but is reset to LLINE1 by Restore Mode Defaults; survives a shutdown.
State Saved	The selected limit number is saved in instrument state
Initial S/W Revision	A.02.00

Open...

When you press “Open”, the analyzer brings up a Windows dialog and a menu entitled “**File Open.**” This menu allows you to navigate to the various fields in the Windows dialog without using a keyboard or mouse. The **Tab** and **Arrow** keys can also be used for dialog navigation.

See "[From File...](#)" on page 3210 in **Recall, State**, for a full description of this dialog and menu.

Key Path	Recall, Data
Notes	The key location is mode-dependent and will vary. Brings up Open dialog for recalling a <mode specific> Save Type
Initial S/W Revision	Prior to A.02.00

Restart

The Restart function restarts the current sweep, or measurement, or set of averaged/held sweeps or measurements. If you are Paused, pressing Restart does a Resume.

The Restart function is accessed in several ways:

- Pressing the Restart key
- Sending the remote command INIT:IMMEDIATE
- Sending the remote command INIT:RESTART

See ["More Information" on page 2014](#)

Key Path	Front-panel key
Remote Command	:INITiate[:IMMEDIATE] :INITiate:RESTART
Example	:INIT:IMM :INIT:REST
Notes	:INITiate:RESTART and :INITiate:IMMEDIATE perform exactly the same function.
Couplings	Resets average/hold count k. For the first sweep overwrites all active (update=on) traces with new current data. For application modes, it resets other parameters as required by the measurement.
Status Bits/OPC dependencies	This is an Overlapped command. The STATus:OPERation register bits 0 through 8 are cleared. The STATus:QUESTionable register bit 9 (INTEgrity sum) is cleared. The SWEEPING bit is set. The MEASURING bit is set.
Backwards Compatibility Notes	For Spectrum Analysis mode in ESA and PSA, the Restart hardkey and the INITiate:RESTART command restart trace averages (displayed average count reset to 1) for a trace in Clear Write , but did not restart Max Hold and Min Hold . In the X-Series, the Restart hardkey and the INITiate:RESTART command restart not only Trace Average , but MaxHold and MinHold traces as well. For wireless comms modes in ESA and PSA, the Restart hardkey and the INITiate:RESTART command restart every measurement, which includes all traces and numeric results. There is no change to this operation.
Initial S/W Revision	Prior to A.02.00

More Information

The **Restart** function first aborts the current sweep/measurement as quickly as possible. It then resets the sweep and trigger systems, sets up the measurement and initiates a new data measurement sequence with a new data acquisition (sweep) taken once the trigger condition is met.

If the analyzer is in the process of aligning when **Restart** is executed, the alignment finishes before the restart function is performed.

Even when set for Single operation, multiple sweeps may be taken when Restart is pressed (for example, when averaging/holding is on). Thus when we say that **Restart** "restarts a measurement," we may mean:

- It restarts the current sweep
- It restarts the current measurement
- It restarts the current set of sweeps if any trace is in Trace Average, Max Hold or Min Hold
- It restarts the current set of measurements if Averaging, or Max Hold, or Min Hold is on for the measurement
- depending on the current settings.

With **Average/Hold Number** (in **Meas Setup** menu) set to 1, or Averaging off, or no trace in Trace Average or Hold, a single sweep is equivalent to a single measurement. A single sweep is taken after the trigger condition is met; and the analyzer stops sweeping once that sweep has completed. However, with **Average/Hold Number** > 1 and at least one trace set to **Trace Average, Max Hold, or Min Hold (SA Measurement)** or **Averaging on (most other measurements)**, multiple sweeps/data acquisitions are taken for a single measurement. The trigger condition must be met prior to each sweep. The sweep is stopped when the average count k equals the number N set for **Average/Hold Number**. A measurement average usually applies to all traces, marker results, and numeric results; but sometimes it only applies to the numeric results.

Once the full set of sweeps has been taken, the analyzer will go to idle state. To take one more sweep without resetting the average count, increment the average count by 1, by pressing the step up key while **Average/Hold Number** is the active function, or sending the remote command `CALC: AVER: TCON UP`.

Save

The **Save** menu lets you choose what you want to save and where you want to save it. Among the types of files you can save are **States**, **Traces**, and **Screen Images**. In addition, an **Export (Data)** option lets you save a number of data types as CSV files for easy import into Excel and other spreadsheet programs.

Key Path	Front-panel key
Mode	All
Notes	No remote command for this key specifically, but the :MMEM:STORe command is available for specific file types. An example is :MMEM:STOR:STATe <filename>.
Initial S/W Revision	Prior to A.02.00

State

The Save State menu lets you choose a register or file for saving the state.

The content of a state file includes all of the settings and data required to return the analyzer as closely as possible to the Mode it was in, with the exact settings which were in place, when the save occurred. The Mode settings in each state file include the settings that are affected by Mode Preset, as well as the additional settings affected by Restore Mode Defaults; all of the Mode's settings. In addition, all of the settings of the **Input/Output** system are included, even though they are outside of the Mode's state, because they are needed to restore the complete setup. Persistent **System** settings (for example, Verbose SCPI) are not affected by either Mode Preset or Restore Mode Defaults, nor are they included in a saved State file.

After the save completes, the message "File <filename> saved" or "State Register <register number> saved" is displayed.

For rapid saving, the State menu lists 16 registers to save to. Pressing a Register key initiates the save. You can also select a file to save to.

The default path for all State Files is:

My Documents\<<mode name>\state

where <mode name> is the parameter used to select the mode with the INST:SEL command (for example, SA for the Spectrum Analyzer).

Key Path	Save
Mode	All
Remote Command	:MMEMory:STORe:STATe <filename>
Example	MMEM:STOR:STATe "MyStateFile.state" This stores the current instrument state data in the file MyStateFile.state in the default directory.
Notes	Both single and double quotes are supported for any filename parameter over remote. After saving to a register, that register's menu key is updated with the date the time, unless a custom label has been entered for that key. After saving to a register, you remain in the Save State menu, so that you can see the Register

	key update. After saving to a file, the analyzer automatically returns to the previous menu and any Save As dialog goes away.
Backwards Compatibility SCPI	:MMEMory:STORe:STATe 1,<filename> For backwards compatibility, the above syntax is supported. The "1" is simply ignored. The command is sequential.
Initial S/W Revision	Prior to A.02.00

To File . . .

When you press "To File", the analyzer brings up a Windows dialog and a menu entitled "**Save As.**" This menu allows you to navigate to the various fields in the Windows dialog without using a keyboard or mouse. The **Tab** and **Arrow** keys can also be used for dialog navigation.

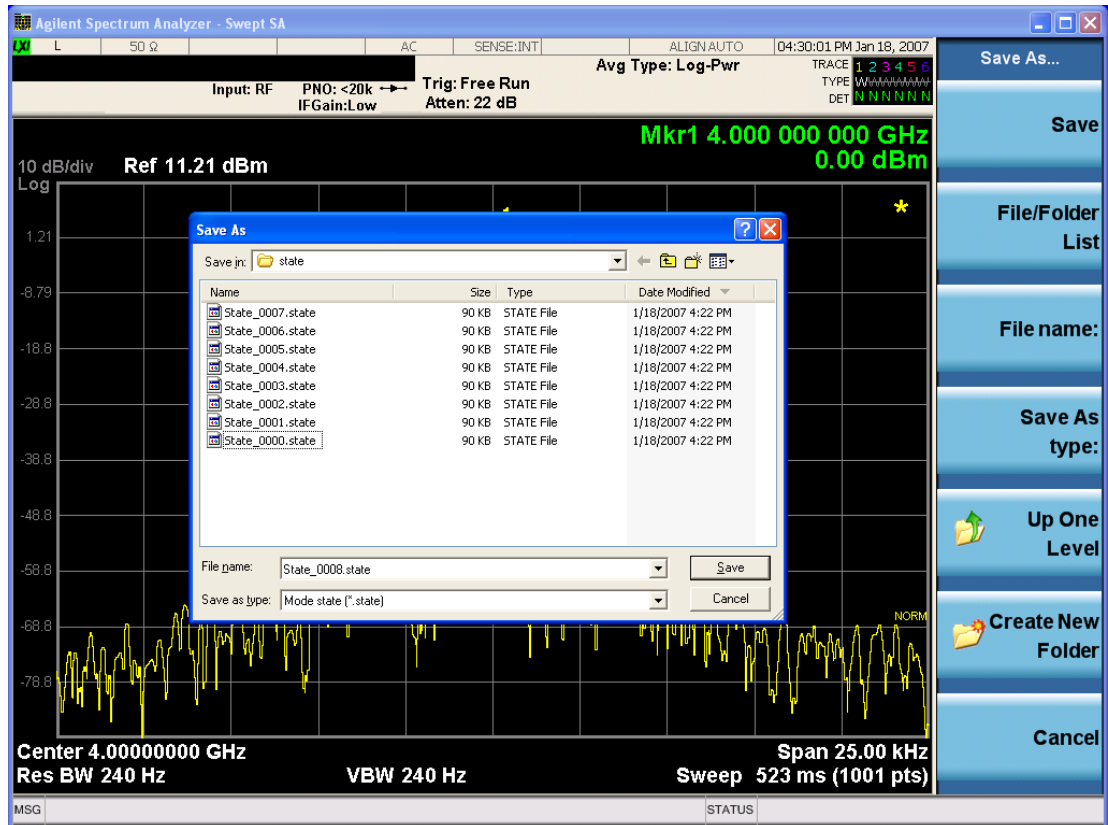

The Listed below are the functions of the various fields in the dialog, and the corresponding softkeys:

Save

Performs the save to the specified file of the selected type. If the file already exists, a dialog will appear that allows you to replace the existing file by selecting **OK**, or you can Cancel the request. If you select OK, the file will be overwritten. Using the C: drive is strongly discouraged, since it runs the risk of being overwritten during an instrument software upgrade.

While the save is being performed, the floppy icon appears briefly in the Meas bar.

File/Folder List

Enables you to navigate to the center of the dialog that contains the list of files and folders. Once here you can get information about the file and use the tab keys to navigate to the other fields in the dialog, such as Save In.

Save In

The Save In field shows the path to which the file will be saved and allows you to change the path using the up and down arrow keys to navigate to other paths; the Enter key to open a directory; and the Backspace key to go back one directory. The **Save In field** defaults to the default path for this type of file and remembers the last path you used to save this type of file. There is no softkey for directly navigating to the Save In field but you can use left tab to get here from the File/Folder List.

User specified paths are remembered when you leave and return to a Mode and are reset back to the default using **Restore Mode Defaults**.

File Name

The **File Name** field is initially loaded with an automatically generated filename specific to the appropriate Save Type. The automatically generated filename is guaranteed not to conflict with any filename currently in the directory. You may replace or modify this filename using the File Name key. See the ["Quick Save " on page 3181](#) documentation for more on the automatic file naming algorithm.

When you press the **File Name** key the analyzer displays the Alpha Editor. Use the knob to choose the letter to add and the front-panel Enter key to add the letter to the file name. The BK character moves you back and the FW character moves you forward in the filename. The Select key on the front panel generates a space character. When you are done entering the filename press the **Done** softkey. This returns back to the **File Open** dialog and menu, but does not cause the save to occur.

Save As Type

This field shows the file suffix for the type of file you have selected to save. For example, if you navigated here while saving State, "Mode state (*.state)" is in the field. If you navigated here from saving Trace, "Mode state (*.trace)" is in the field. If you navigated here while exporting a trace data file, "Trace Data (*.csv)" is in the field. For some file types, there is more than one choice in the dropdown, which you can select by using the up and down arrow keys and Enter.

Up One Level

This key corresponds to the icon of a folder with the up arrow that is in the tool bar of the dialog. When pressed, it causes the file and folder list to navigate up one level in the directory structure. The Backspace key does the same thing.

Create New Folder

This key corresponds to the icon of a folder with the "*" that is in the tool bar of the dialog. When pressed, a new folder is created in the current directory with the name **New Folder** and you can enter a new folder name using the Alpha Editor.

Cancel

This key corresponds to the **Cancel** selection in the dialog. It causes the current **Save As** request to be cancelled. The ESC key does the same thing.

Key Path	Save, State
Mode	All
Notes	Brings up Save As dialog for saving a State Save Type
Initial S/W Revision	Prior to A.02.00

Edit Register Names

You may enter a custom name on any of the Register keys, to help you remember what you are using that state to save. To do this, press the **Edit Register Names** key,

choose the register whose name you wish to edit, and then enter the desired label using the Alpha Editor or an external PC keyboard.

The maximum number of characters that can be added is 30. In most cases, 30 characters will fit on two lines of the key.

See ["More Information" on page 2020](#)

Key Path	Save, State
Mode	All
Remote Command	:MMEMory:REGister:STATe:LABe1 <reg number>,"label" :MMEMory:REGister:STATe:LABe1? <reg number>
Example	:MMEM:REG:STAT:LAB 1,"my label"
Notes	<reg number> is an integer from 1 to 16. If the SCPI specifies an invalid register number an error message is generated, -222,"Data out of range;Invalid register label number" "label" is a string from 0 to 30 characters in length. If a label exceeds 30 characters, an error message is generated, -150,"String data error;Label clipped to 30 characters" "label" of length 0 erases the custom label and restores the default (time and date) label. E.g.: :MMEM:REG:STAT:LAB 1,""
Dependencies	N9060A-7FP or N9060B-2FP license required to edit the register names. When the feature is not licensed, sending this command generates an error, -221,"Settings conflict;Option not available"
Preset	The names are unaffected by Preset or power cycle but are set to the default label (time and date) on a "Restore System Defaults->Misc"
Initial S/W Revision	A.11.00

More Information

When you edit one of the register names, the time and date field will be replaced by the custom name.

If you delete all the characters in the custom name, it restores the default (time and date).

The register names are stored within the state files, but they are not part of the instrument state; that is, once you have edited a register name, loading a new state will not change that register name. Another consequence of this is that the names will be persistent through a power cycle. Also, if a named state file is transferred to another analyzer, it will bring its custom name along with it.

If you try to edit the name of an empty register, the analyzer will first save the state to have a file to put the name in. If you load a named state file into an analyzer with older firmware it will ignore the metadata.

The *SAV and *RCL commands will not be affected by the custom register names, nor will the MMEM commands.

Register 1 thru Register 16

Selecting any one of these register menu keys causes the State of the currently active mode to be saved to the specified Register. The registers are provided for rapid saving and recalling, since you do not need to specify a filename or navigate to

a file. Each of the register menu keys annotates whether it is empty or at what date and time it was last modified. In addition, you can use the **Edit Register Names** key to enter custom names for each register.

Although these 16 registers are the only registers available from the front panel, there are 128 state registers available in the instrument. Registers 17-128 are only available from the SCPI interface, using the *SAV command.

There is one set of 128 state registers in the instrument, not one set for each Mode. When a state is saved, the Mode it was saved from is saved with it; then when it is recalled, the instrument switches to that Mode.

After the save completes, the corresponding register menu key annotation is updated with the date and time and the message "Register <register number> saved" is displayed.

Key Path	Save, State
Mode	All
Example	*SAV 1
Range	1-16 from front panel, 1-128 from SCPI
Readback	Date and time with seconds resolution are displayed on the key OR A custom name of up to 30 characters entered using the Edit Register Names key OR “(empty)” if no prior save operation has been performed to this register.
Initial S/W Revision	Prior to A.02.00
Modified at S/W Revision	A.11.00

Register 1 thru Register 16

Selecting any one of these register menu keys causes the State of the currently active mode to be saved to the specified Register. The registers are provided for rapid saving and recalling, since you do not need to specify a filename or navigate to a file. Each of the register menu keys annotates whether it is empty or at what date and time it was last modified. In addition, you can use the **Edit Register Names** key to enter custom names for each register.

Although these 16 registers are the only registers available from the front panel, there are 128 state registers available in the instrument. Registers 17-128 are only available from the SCPI interface, using the *SAV command.

There is one set of 128 state registers in the instrument, not one set for each Mode. When a state is saved, the Mode it was saved from is saved with it; then when it is recalled, the instrument switches to that Mode.

After the save completes, the corresponding register menu key annotation is updated with the date and time and the message "Register <register number> saved" is displayed.

Key Path	Save, State
Mode	All
Example	*SAV 1
Range	1-16 from front panel, 1-128 from SCPI
Readback	Date and time with seconds resolution are displayed on the key OR A custom name of up to 30 characters entered using the Edit Register Names key OR “(empty)” if no prior save operation has been performed to this register.
Initial S/W Revision	Prior to A.02.00
Modified at S/W Revision	A.11.00

Trace (+State)

The **Save Trace (+State)** menu lets you choose a register or file specifying where to save the Trace+State state file.

A saved state contains all of the settings and data required to return the analyzer as closely as possible to the exact setup it had when the save occurred. This includes the Input/Output settings, even though they are outside of the Mode’s state, because they are needed to restore the complete setup. A Trace+State file also includes trace data from one trace or all traces, which will load in View mode when the Trace+State file is recalled.

After the save completes, the message "File <filename> saved" or "Trace Register <register number> saved" is displayed.

For rapid saves, the Trace (+State) menu lists 5 registers to save to. Pressing a Register key initiates the save. You can also select a file to save to.

The default path for all State Files including .trace files is:

My Documents\<mode name>\state

where <mode name> is the parameter used to select the mode with the INST:SEL command (for example, Basic for the IQAnalyzer).

This key is grayed out for measurements that do not support trace saves. It is blanked for modes that do not support trace saves. Saving **Trace** is identical to saving State except a .trace extension is used on the file instead of .state, and internal flags are set in the file indicating which trace was saved. You may select to save one trace or ALL traces.

Key Path	Save
Mode	SA
Remote Command	:MMEMory:STORe:TRACe TRACE1 TRACE2 TRACE3 TRACE4 TRACE5 TRACE6 ALL,<filename>

	<code>:MMEMory:STORe:TRACe:REGister TRACE1 TRACE2 TRACE3 TRACE4 TRACE5 TRACE6 ALL,<integer></code>
Example	<p>:MMEM:STOR:TRAC TRACE1, "myState.trace" saves the file myState.trace on the default path and flags it as a "single trace" file with Trace 1 as the single trace (even though all of the traces are in fact stored).</p> <p>:MMEM:STOR:TRAC ALL, "myState.trace" saves the file myState.trace on the default path and flags it as an "all traces" file</p> <p>:MMEM:STOR:TRAC:REG TRACE1, 2 stores trace 1 data in trace register 2</p>
Notes	<p>This command actually performs a save state, which in the Swept SA measurement includes the trace data. However it flags it (in the file) as a "save trace" file of the specified trace (or all traces).</p> <p>Some modes and measurements do not have available all 6 traces. The Phase Noise mode command, for example, is: <code>MMEMory:STORe:TRACe TRACE1 TRACE2 TRACE3 ALL,<filename></code></p> <p>Some modes and measurements have more than 6 traces available. The Realtime SA mode command, for example, is: <code>MMEMory:STORe:TRACe TRACE1 TRACE2 TRACE3 TRACE4 TRACE5 TRACE6 TRACE7 TRACE8 TRACE9 TRACE10 TRACE11 TRACE12 ALL,<filename></code></p> <p>The range for the register parameter is 1-5</p> <p>When you initiate a save, if the file already exists, a dialog will appear that allows you to replace the existing file by selecting OK or you can Cancel the request. If you select OK, the file will be overwritten. Using the C: drive is strongly discouraged, since it runs the risk of being overwritten during an instrument software upgrade.</p> <p>Both single and double quotes are supported for any filename parameter over remote.</p> <p>After saving to a register, that register's menu key is updated with the date and time of the save.</p> <p>After saving to a register, you remain in the Save Trace menu, so that you can see the Register key update. After saving to a file, the analyzer automatically returns to the previous menu and any Save As dialog goes away.</p>
Initial S/W Revision	Prior to A.02.00

Register 1 thru Register 16

Selecting any one of these register menu keys causes the State of the currently active mode to be saved to the specified Register. The registers are provided for rapid saving and recalling, since you do not need to specify a filename or navigate to a file. Each of the register menu keys annotates whether it is empty or at what date and time it was last modified. In addition, you can use the **Edit Register Names** key to enter custom names for each register.

Although these 16 registers are the only registers available from the front panel, there are 128 state registers available in the instrument. Registers 17-128 are only available from the SCPI interface, using the *SAV command.

There is one set of 128 state registers in the instrument, not one set for each Mode. When a state is saved, the Mode it was saved from is saved with it; then when it is recalled, the instrument switches to that Mode.

After the save completes, the corresponding register menu key annotation is updated with the date and time and the message "Register <register number> saved" is displayed.

Key Path	Save, State
Mode	All
Example	*SAV 1
Range	1-16 from front panel, 1-128 from SCPI
Readback	Date and time with seconds resolution are displayed on the key OR A custom name of up to 30 characters entered using the Edit Register Names key OR "(empty)" if no prior save operation has been performed to this register.
Initial S/W Revision	Prior to A.02.00
Modified at S/W Revision	A.11.00

From Trace

Accesses a menu that enables you to select the trace to be saved. Once a trace is selected, the key returns to the Save Trace menu and the selected trace number is annotated on the key. The default is the currently selected trace, selected in this menu or in the Trace/Det, Export Data, Import Data or Recall Trace menus, except if you have chosen All then it remains chosen until you specifically change it to a single trace. To save the Trace you must select the **Save As** key in the Save Trace menu.

When you select a trace, it makes that trace the current trace, so it displays on top of all of the other traces.

Key Path	Save, Trace + State
Mode	SA
Initial S/W Revision	Prior to A.02.00

From File...

When you press "From File", the analyzer brings up a Windows dialog and a menu entitled "**File Open.**" This menu allows you to navigate to the various fields in the Windows dialog without using a keyboard or mouse. The **Tab** and **Arrow** keys can also be used for dialog navigation.

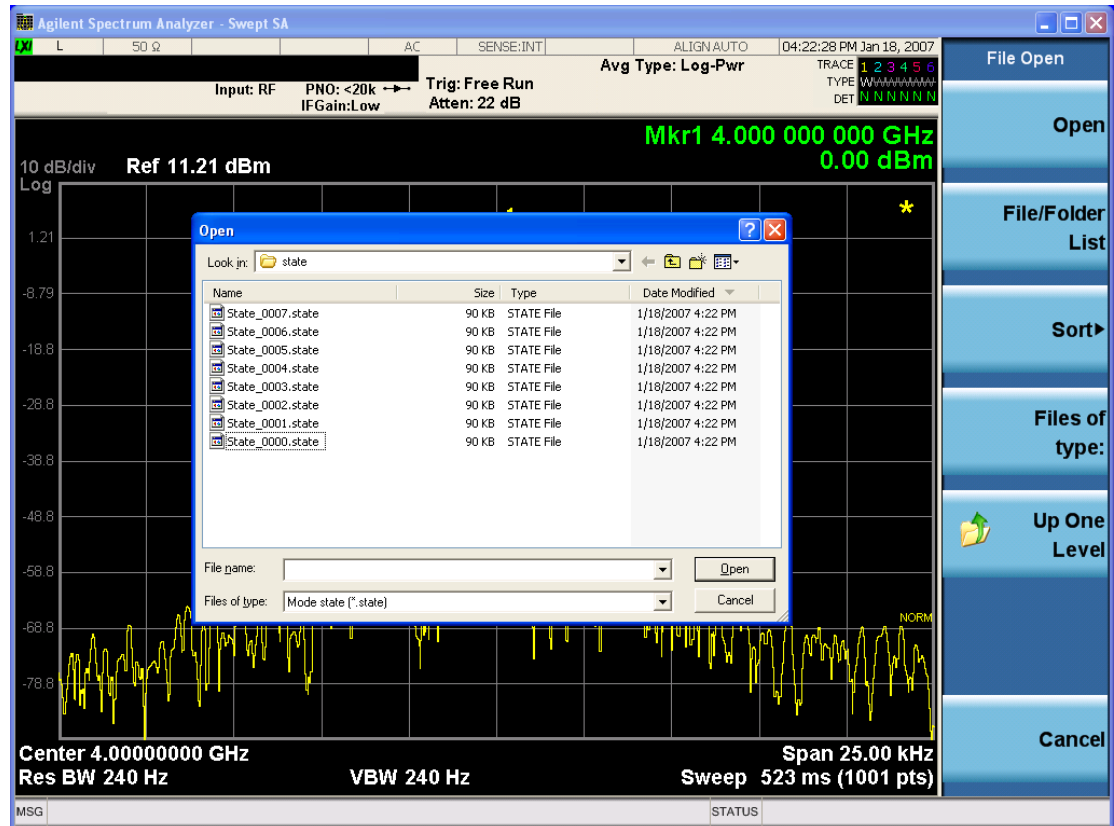

Listed below are the functions of the various fields in the dialog, and the corresponding softkeys:

Open

Performs the recall of the specified file. While the recall is being performed, the floppy icon appears briefly in the Meas bar.

File/Folder List

Enables you to navigate to the center of the dialog that contains the list of files and folders. Once here you can get information about the file and use the tab keys to navigate to the other fields in the dialog, such as Look In.

Look In

The **Look In** field shows the path from which the file will be recalled and allows you to change the path using the up and down arrow keys to navigate to other paths; the Enter key to open a directory; and the Backspace key to go back one directory. The **Look In** field first uses the last path from the Save As dialog **Save In:** path for that same file type. There is no softkey for directly navigating to the Look In field, but you can use the left tab to get here from the File/Folder List.

User specified paths are remembered when you leave and return to a Mode and are reset back to the default using **Restore Mode Defaults**.

Sort

Accesses a menu that enables you to sort the files within the File Open dialog. Only one sorting type can be selected at a time and the sorting happens immediately. The sorting types are **By Date**, **By Name**, **By extension**, and **By Size**.

Files of Type

This field shows the file suffix for the type of file you have selected to recall. For example, if you navigated here while recalling State, "Mode state (*.state)" is in the field. If you navigated here while recalling Trace, "Mode state (*.trace)" is in the field. If you navigated here while importing a trace data file, "Trace Data (*.csv)" is in the field. For some file types, there is more than one choice in the dropdown menu, which you can select by using the up and down arrow keys and Enter.

Up One Level

This key corresponds to the icon of a folder with the up arrow that is in the tool bar of the dialog. When pressed, it causes the file and folder list to navigate up one level in the directory structure. The Backspace key does the same thing.

Cancel

This key corresponds to the **Cancel** selection in the dialog. It causes the current **Open** request to be cancelled. The ESC key does the same thing.

Key Path	Recall, State
Notes	Brings up the Open dialog for recalling a State Save Type
Initial S/W Revision	Prior to A.02.00

Data (Export)

Exporting a data file stores data from the current measurement to mass storage files. The Export Menu only contains data types that are supported by the current measurement.

Since the commonly exported data files are in .csv format, the data can be edited by you prior to importing. This allows you to export a data file, manipulate the data in Excel (the most common PC Application for manipulating .csv files) and then import it.

Selecting an Export Data menu key will not actually cause the exporting to occur, since the analyzer still needs to know where you wish to save the data. Pressing the Save As key in this menu brings up the Save As dialog and Save As menu that allows you to specify the destination file and directory. Once a filename has been selected or entered in the Open menu, the export will occur as soon as the Save key is pressed.

Key Path	Save
Mode	All
Notes	The menu is built from whatever data types are available for the mode. So the key locations in the sub menu will vary. No SCPI command directly controls the Data Type that this key controls. The Data Type is included in the MMEM:STORe commands.

Dependencies	If a file type is not used by a certain measurement, that type is grayed out for that measurement. The key for a file type will not show at all if there are no measurements in the Mode that support it.
Preset	Is not affected by a Preset or shutdown, but is reset during Restore Mode Defaults
Readback	The data type that is currently selected
Initial S/W Revision	Prior to A.02.00

Amplitude Correction

Pressing this key selects **Amplitude Corrections** as the data type to be exported. Pressing this key again brings up the Select Menu, which allows the user to select which **Amplitude Correction** to save.

Amplitude Corrections are fully discussed in the documentation of the Input/Output key, under the Corrections softkey.

See "[Correction Data File](#)" on page 2027

Key Path	Save
Remote Command	:MMEMory:STORe:CORRection 1 2 3 4 5 6, <filename>
Example	:MMEM:STOR:CORR 2 "myAmpcor.csv" saves Correction 2 to the file myAmpcor.csv on the current path. The default path is My Documents\amplitudeCorrections.
Notes	If the save is initiated via SCPI, and the file already exists, the file will be overwritten. Using the C: drive is strongly discouraged, since it runs the risk of being overwritten during an instrument software upgrade. Both single and double quotes are supported for any filename parameter over SCPI.
Dependencies	Corrections are not supported by all Measurements. If in a Mode in which some Measurements support it, this key will be grayed out in measurements that do not. The key will not show at all if no measurements in the Mode support it. This key will not appear unless you have the proper option installed in your instrument.
Readback	Selected Correction
Backwards Compatibility SCPI	:MMEMory:STORe:CORRection ANTenna CABLe OTHer USER, <filename> For backwards compatibility, ANTenna maps to 1, CABLe maps to 2, OTHer maps to 3 and USER maps to 4
Initial S/W Revision	A.02.00

Correction Data File

A Corrections Data File contains a copy of one of the analyzer correction tables. Corrections provide a way to adjust the trace display for predetermined gain curves (such as for cable loss).

Corrections files are text files in .csv (comma separated values) form, to make them importable into Excel or other spreadsheet programs. The format for Corrections files is as follows.

Line #	Type of field	Example	Notes
1	File type, must be "Amplitude Correction"	Amplitude Correction	May not be omitted
2	File Description (in quotes)	"Correction Factors for 11966E"	60 characters max; may be empty but may not be omitted. If exceeds 60 characters, error -233 Too much data reported
3	Comment (in quotes)	"Class B Radiated"	60 characters max; may be empty but may not be omitted. . If exceeds 60 characters, error -233 Too much data reported
4	Instrument Version, Model #	A.02.06,N9020A	May be empty but may not be omitted
5	Option List, File Format Version	K03 LFE EXM ,01	May be empty but may not be omitted
6	Freq Unit to be used for all frequency values in the file	Frequency Unit,MHz	assumed to be Hz if omitted
7	Antenna Unit	Antenna Unit,None	If omitted leaves the Antenna unit unchanged. The amplitude unit in the Antenna Unit field is a conversion factor that is used to adjust the Y Axis Units of the current mode, if the mode supports Antenna Units. For more details on antenna correction data, refer to the Input/Output,Corrections key description. Allowable values: dBuv/m, dBuA/m, dBG, dBpT, None
8	Freq Interpolation	Frequency Interpolation,Linear	if omitted leaves the Freq Interpolation unchanged. Allowable values: Linear, Logarithmic
9	Bias value in mA	Bias,0.00	If omitted leaves the Bias value unchanged (added as of A.08.50)
10	Bias State	Bias State,On	If omitted leaves the Bias State unchanged. Allowable values: On, Off (added as of A.08.50)

Line #	Type of field	Example	Notes
11	Overlap, two values, Freq1 and Freq2, separated by commas.	Overlap,33500,40000	Uses Freq Unit from line 6. Thus, in this example Freq1=33.5 GHz, Freq2= 40.0 GHz (see note below). If omitted leaves the overlap unchanged (added as of A.08.50)
12	DATA marker	DATA	Corrections data begins in the next line

Lines 2 through 5 can be empty but must appear in the file. Lines 6 through 11 are optional, the lines can be left out of the file altogether.

The Overlap row and the two Bias rows apply only to external mixing. Both are read-only, they are never written by the analyzer. The only way to insert or modify these rows is to edit the file with a text editor or a spreadsheet editor. These rows are intended for use by mixer manufacturers, as they allow the manufacturer to insert data about how the mixer corrections were generated and how they should be applied. The Bias rows allow you to specify whether to turn Bias on or off when the Correction is turned on and to specify a Bias value (turning off the Correction does not change the Bias, but turning it back on again sets it to the value specified in the file). The Overlap row allows you to specify an overlap region in which two different corrections may be applied. It is expected that in the corrections data itself, there will be TWO corrections values exactly at Max Freq, otherwise Overlap is ignored. The way the overlap is processed is as follows: if at any given time the current analyzer Start Freq is greater than Freq 1 and lower than Freq 2, and the current Stop Freq is greater than Freq 2, extend the first correction point at or above Freq 2 down to Freq 1, rather than using the correction data between Freq1 and Freq2.

The Antenna Unit row can only be used in Correction register 1, because there can only be one setting for Antenna Unit at any given time. If a Correction whose Antenna Unit is set to anything but None is loaded into any Correction register but 1, an error is generated (Mass storage error; Can only load an Antenna Unit into Correction 1). When a correction file is saved from any Correction register but 1, Antenna Unit is always written as None.

Similarly, the Bias rows can only be used in Correction register 1, because there can only be one setting for Bias at any given time. If a Correction file with a Bias or Bias State row is loaded into any Correction register but 1, an error is generated: Mass storage error; Can only load Bias Settings into Correction 1

The data follows the DATA row, as comma separated X, Y pairs; one pair per line.

For example, suppose you have an Antenna to correct for on an N9020A version A.02.06 and the correction data is:

- 0 dB at 200 MHz

- 17 dB at 210 MHz
- 14.8 dB at 225 MHz

Then the file will look like:

- Amplitude Correction
- "Correction Factors for 11966E"
- "Class B Radiated"
- A.02.06,N9020A
- P13 EA3 UK6,01
- Frequency Unit,MHz
- Antenna Unit,dBuV/m
- Frequency Interpolation,Linear
- DATA
- 200.000000,0.00
- 210.000000,17.00
- 225.000000,14.80

The choices for the 1 of N fields in the metadata are as follows:

- Frequency Unit: Hz, kHz, MHz, GHz
- Antenna Unit: dBuv/m, dBuA/m, dBG, dBpT, None
- Frequency Interpolation: Logarithmic, Linear

Amplitude Correction

These keys let you choose which Correction to save. Once selected, the key returns back to the Export Data menu and the selected Correction number is annotated on the key.

The next step in the Save process is to select the Save As key in the Export Data menu.

Key Path	Save, Data, Amplitude Correction
Preset	Not part of a Preset, but is reset to Correction 1 by Restore Input/Output Defaults. Survives a shutdown.
Readback	1
Initial S/W Revision	A.02.00

Trace

Pressing this key selects Traces as the data type to be exported. Pressing this key when it is already selected brings up the Trace Menu, which allows you to select which Trace to save.

The trace file contains “meta” data which describes the current state of the analyzer. The metadata is detailed in ["Trace File Contents" on page 2031](#) below.

Key Path	Save, Data
Remote Command	:MMEMory:STORe:TRACe:DATA TRACE1 TRACE2 TRACE3 TRACE4 TRACE5 TRACE6 ALL,<filename>
Example	:MMEM:STOR:TRAC:DATA TRACE2, "myTrace2.csv" Exports the 2nd trace to the file myTrace2.csv in the current path. The default path is My Documents\SA\data\traces
Notes	If the save is initiated via SCPI, and the file already exists, the file will be overwritten. Using the C: drive is strongly discouraged, since it runs the risk of being overwritten during an instrument software upgrade. Both single and double quotes are supported for any filename parameter over SCPI.
Dependencies	For SA measurements, traces cannot be recalled from a trace file that was saved with ALL traces selected.
Couplings	When you select which trace to save, it makes that trace the current trace, so it displays on top of all of the other traces.
Readback	selected Trace
Status Bits/OPC dependencies	Sequential - waits for previous measurement to complete
Initial S/W Revision	Prior to A.02.00

Trace File Contents

A Trace Data File contains the data for one trace.

Metadata: Trace Specific

Besides the trace data, there is metadata describing the context by which the trace was produced. Some of the metadata is trace specific:

- Trace Type
- Detector
- Trace math (function, operand1, operand2, offset, reference)
- Trace name/number

When importing a trace, the detector and/or trace math function specified in the metadata is imported with the trace, so that the annotation correctly shows the detector and/or math type that was used to generate the data

Metadata: Display Specific

There is also some display-related metadata:

- Ref Level Offset
- External Gain
- X-Axis Unit
- Y-Axis Unit

Metadata: Measurement Related

The rest of the metadata is measurement specific and reflects the state of the measurement the last time the trace was updated. These are the “measurement-related instrument settings” which, if changed, cause a measurement restart.

- Number of Points
- Sweep Time
- Start Frequency
- Stop Frequency
- Average Count (actual; not the limit for the instrument)
- Average Type
- RBW
- RBW Filter Type
- RBW Filter BW Type
- VBW
- Sweep Type (FFT vs. Swept)
- Log/Lin X Scale (sometimes called Log Sweep)
- Preamp (on/off, band)
- Trigger (source, level, slope, delay)
- Phase Noise optimization setting
- Swept IF Gain
- FFT IF Gain
- AC/DC setting (RF Coupling)

- FFT Width
- External Reference setting
- Input (which input is in use)
- RF calibrator on/off
- Attenuation

Because any inactive trace can have a value that does not match the rest of the measurement, when performing a Save the metadata for each trace is pulled from the individual trace, not from the measurement.

A revision number is also included in the trace database, to allow for future changes.

The choices for the various 1 of N and binary fields are as follows:

- Average Type: Power(RMS), Voltage, LogPower(Video)
- RBW Filter Type: Flattop, EMI, Gaussian
- RBW Filter BW: 3dB, 6dB, Noise, Impulse
- Sweep Type: Swept, FFT
- PreAmp State: On, Off
- PreAmp Band: Low, Full
- Trigger Source: Free, RFBurst, Video, Line, Periodic, Ext1, Ext2, TV
- Trigger Slope: Positive, Negative
- Phase Noise Optimization: Fast, Narrow, Wide
- Swept IF Gain: Low, High
- FFT If Gain: Autorange, Low, High
- Input: RF, BBIQ
- RF Calibrator: 50M, 400G, Comb, Off
- Trace Type: ClearWrite, TraceAverage, MaxHold, MinHold
- Detector: Normal, Average, Peak, NegPeak, Sample
- Trace Math: Off, PowerDifference, PowerSum, LogOffset, LogDifference
- Y Axis Unit: dBm, dBmV, dBmA, W, V, A, dBuV, dBuA, dBuV/m, dBuA/m, dBuV, dBpT, dBG, dB

After the header, just before the trace data, a line with just the word DATA on it is inserted to flag the start of the trace data.

The following file example shows the first lines of a Trace 1 file with X Axis Unit = Hz and Y Axis Unit = dBuV, after importing into Excel (the second row contains the Title):

Trace	
"AS/NZS 1044; Conducted >1000 W, Motors, Average"	
A.01.00	E4410A
526 EA3 B25 P26 PFR	1
Segment	0
Number of Points	1001
Sweep Time	0.066266667
Start Frequency	18827440
Stop Frequency	24463718
Average Count	0
Average Type	Power(RMS)
RBW	51000
RBW Filter	Gaussian
RBW Filter BW	3dB
VBW	51000
Sweep Type	Swept
X Axis Scale	Lin
PreAmp State	Off
PreAmp Band	Low
Trigger Source	Video
Trigger Level	1.2
Trigger Slope	Positive
Trigger Delay	1.00E-06
Phase Noise Optimization	Fast
Swept IF Gain	Low
FFT IF Gain	Autorange
RF Coupling	AC
FFT Width	411900
Ext Ref	10000000
Input	RF
RF Calibrator	Off

Attenuation	10
Ref Level Offset	0
External Gain	0
Trace Type	ClearWrite
Detector	Normal
Trace Math	Off
Trace Math Oper1	Trace5
Trace Math Oper2	Trace6
Trace Math Offset	0
Trace Name	Trace1
X Axis Unit	Hz
Y Axis Unit	dBm
DATA	
1.6009301E+07	4.82047E+01
1.6018694E+07	4.69737E+01
1.6028087E+07	4.81207E+01
1.6037480E+07	4.72487E+01
1.6046873E+07	4.66437E+01
1.6056266E+07	4.66237E+01
1.6065659E+07	4.66967E+01
1.6075052E+07	4.77117E+01
1.6084445E+07	4.75787E+01
1.6093838E+07	4.83297E+01
1.6103231E+07	4.71327E+01
1.6112624E+07	4.78957E+01
1.6122017E+07	4.67507E+01
1.6131410E+07	4.81137E+01

Limit

Pressing this key selects Limit Lines as the data type to be exported. Pressing the key a second time brings up the Limit Menu that allows you to select which **Limit Line** to save.

- See ["Limits File Contents" on page 2036](#).
- See [".csv file format" on page 2036](#)
- See [".lim file format" on page 2037](#)

Key Path	Save, Data
Remote Command	:MMEMory:STORe:LIMit LLINE1 LLINE2,<filename>
Example	:MMEM:STOR:LIM LLINE2, "myLimitLine2.csv" Saves the 2nd Limit Line to the file myLimitLine2.csv in the current path. The default path is My Documents\SA\data\limits
Notes	If the save is initiated via SCPI, and the file already exists, the file will be overwritten. Using the C: drive is strongly discouraged, since it runs the risk of being overwritten during an instrument software upgrade. Both single and double quotes are supported for any filename parameter over SCPI.
Dependencies	This key will only appear if you have the proper option installed in your instrument.
Preset	1; not part of Preset, but is reset by Restore Mode Defaults and survives power cycles
State Saved	The selected Limit number is saved in instrument state.
Readback	selected Limit Line
Status Bits/OPC dependencies	Sequential - waits for previous measurement to complete
Initial S/W Revision	A.02.00

Limits File Contents

Limits may be exported into a data file with a .csv extension. They may be imported from that data file; they may also be imported from a legacy limit file with a .lim extension. The .lim files meet the specification for limit files contained in the EMI measurement guide, HP E7415A.

.csv file format

Except for information in quotes, limit line files are not case sensitive. Information in bold is required verbatim; other text is example text, and italic text is commentary which should not be present in the file.

The first five lines are system-required header lines, and must be in the correct order.

Limit	<i>Data file type name</i>
"FCC Part 15"	<i>File Description</i>
"Class B Radiated"	<i>Comment</i>
A.01.00.R0001,N9020A	<i>Instrument Version, Model Number</i>
P13 EA3 UK6 ,01	<i>Option List, File Format Version</i>

The next few lines describe the parameters; on export they will be in the order shown, on import they can be in any order. If some parameters are missing, they will revert to the default.

Type, Upper	Upper Lower
X Axis Unit, MHz	MHz S; other units should be converted; this also specifies the domain
Amplitude Unit, dBm	dBm V; all other units should be converted appropriately
Frequency Interpolation, Linear	Logarithmic Linear
Amplitude Interpolation, Logarithmic	Logarithmic Linear
X Control, Fixed	Fixed Relative; on input we consider only the first three characters
Y Control, Fixed	Fixed Relative; on input we consider only the first three characters
Margin, 0	Always in dB. A 0 margin is equivalent to margin off
X Offset, 10	Expressed in the X axis units
Y Offset, 5	Expressed in the Amplitude units

The Amplitude Unit line in the limits file may contain an antenna factor unit, for example:

Amplitude Unit=dBuV/m

Antenna factor units are dBuV/m, dBuA/m, dBpT, and dBG. In this case, the unit is treated exactly as though it were dBuV, meaning that all of the limits are interpreted to have units of dBuV. The box does NOT change Y Axis Units when such a limit is loaded in.

The X axis unit also specifies the domain (time or frequency). It is not possible to have both time-domain lines and frequency-domain lines at the same time; if a time-domain line is imported while the other lines are in the frequency domain (or vice-versa), all limit lines will be deleted prior to import.

If the sign of the margin is inappropriate for the limit type (for example a positive margin for an upper limit), the sign of the margin will be changed internally so that it is appropriate.

The remaining lines describe the data. Each line in the file represents an X-Y pair. The X values should be monotonically non-decreasing, although adjacent lines in the file can have the same X value as an aid to building a stair-stepped limit line. To specify a region over which there is no limit, use +1000 dBm for upper limits or -1000 dBm for lower limits.

The data region begins with the keyword DATA:

DATA
200.000000,-10.00
300.000000,-10.00
300.000000,-20.00
500.000000,-20.00

.lim file format

This is a legacy format which allows files saved from older analyzers to be loaded into the X-Series. Design of files in this format is not recommended.

Limit Selection

These keys let you pick which Limit Line to save. Once selected, the key returns back to the **Export Data** menu and the selected Limit Line number is annotated on the key.

The next step in the Save process is to select the Save As key in the Export Data menu.

Key Path	Save, Data, Limit Line
Notes	auto return
Preset	Not part of Preset, but is reset to LLINE1 by Restore Mode Defaults; survives shutdown
Initial S/W Revision	A.02.00

Measurement Results

Pressing this key selects Meas Results as the data type to be exported.

The Meas Results file contains measurement result sets, plus information describing the current state of the analyzer, as detailed in ["Meas Results File Definition" on page 2038](#) and ["Meas Results File Example" on page 2040](#) below.

Key Path	Save, Data
Remote Command	:MMEMory:STORe:RESuLts <string>
Example	:MMEM:STOR:RES "MeasR_0000.csv"
Notes	<p>If the save is initiated via SCPI and the file already exists, the file will be overwritten.</p> <p>The SCPI command exports Power Stat CCDF measurement results to the file specified as the parameter in the current path. The default path is My Documents\<current mode>\data\pst\results.<="" p=""> <p>Using the C: drive is strongly discouraged, since it runs the risk of being overwritten during an instrument software upgrade.</p> <p>The SCPI parameter is a quoted string that specifies the filename. Both single and double quotes are supported for any filename parameter over SCPI.</p> </current></p>
Dependencies	The current active measurement must be the Power Stat CCDF measurement to use this command.
Status Bits/OPC dependencies	Sequential – waits for the previous measurement to complete
Initial S/W Revision	Prior to A.02.00

Meas Results File Definition

The content of a Meas Results File is defined in this section.

The first lines in the file consist of identification and instrument configuration details, as follows.

- File ID string, which is “MeasResult”
- Measurement ID following Mode ID, which is “SA:PST” for example.
- Firmware rev and model number
- Option string
- Automatic Trigger Time
- Automatic Trigger Time State

- CcdfCurrentCounts
- Center Frequency
- Center Frequency Step
- Center Frequency Step State
- Counts
- Electrical Atten
- Electrical Atten State
- External Array Trigger Delay
- External Array Trigger Delay State
- External Array Trigger Level
- External Array Trigger Slope
- Gaussian Line
- IF Gain Auto
- IF Gain State
- Info BW
- Internal Preamp
- Internal Preamp Band
- Line Trigger Delay
- Line Trigger Delay State
- Line Trigger Slope
- Meas Cycles
- MeasInterval
- Mechanical Atten
- MechanicalAttenStepEnum
- Periodic Timer Period
- Periodic Timer Sync Source
- Periodic Timer Trigger Delay

- Periodic Timer Trigger Delay State
- Preselector Adjust
- Ref Trace
- RFBurst Trigger Delay
- RFBurst Trigger Delay State
- RFBurst Trigger Level Abs
- RFBurst Trigger Level Rel
- RFBurst Trigger Level Type
- RFBurst Trigger Slope
- Scale/Div
- Trigger Holdoff
- Trigger Holdoff State
- TriggerSource

The data above is followed in the file by a line containing “MeasResult1” to “MeasResult4”. This line forms a header for each set of measurement results, which appear in subsequent lines. Each line of Measurement Results consists of 4 comma-separated values, from the MeasResult1 value to the MeasResult4 value.

The MeasResult1 set in the file corresponds to the data returned by MEAS|READ|FETCh:PStatistic1; the MeasResult2 set corresponds to the data returned by MEAS|READ|FETCh:PStatistic2, and so on.

The exported file is in CSV format, with a .csv extension.

Meas Results File Example

When imported into Microsoft Excel, a typical Meas Results CSV file appears as shown in the example below.

MeasResult	
SA:PST	
A.10.53	N9030A
526 ALV ATP B1X B1Y B25	1
B40 BBA CR3 CRP DCF	
DDA DP2 DRD EA3 EDP	
EMC EP1 ERC ESC ESP	
EXM FSA LFE LNP MAT	
MPB NFE NUL P26 PFR	
PNC RTL RTS S40 SB1 SEC	

SM1 TVT YAS YAV		
Automatic Trigger Time	0.1	
Automatic Trigger Time State	FALSE	
CcdfCurrentCounts	6087500	
Center Frequency	1.33E+10	
Center Frequency Step	5000000	
Center Frequency Step State	TRUE	
Counts	10000000	
Electrical Atten	0	
Electrical Atten State	FALSE	
External Array Trigger Delay	1.00E-06	1.00E-06
External Array Trigger Delay State	FALSE	FALSE
External Array Trigger Level	1.2	1.2
External Array Trigger Slope	Positive	Positive
Gaussian Line	TRUE	
IF Gain AUto	FALSE	
IF Gain State	FALSE	
Info BW	5000000	
Internal Preamp	FALSE	
Internal Preamp Band	Low	
Line Trigger Delay	1.00E-06	
Line Trigger Delay State	FALSE	
Line Trigger Slope	Positive	
Meas Cycles	1600	
MeasInterval	0.001	
Mechanical Atten	10	
MechanicalAttenStepEnum	S2dB	
Periodic Timer Period	0.02	
Periodic Timer Sync Source	None	
Periodic Timer Trigger Delay	1.00E-06	
Periodic Timer Trigger	FALSE	

Delay State			
Preselector Adjust	0		
Ref Trace	FALSE		
RFBurst Trigger Delay	1.00E-06		
RFBurst Trigger Delay State	FALSE		
RFBurst Trigger Level Abs	-20		
RFBurst Trigger Level Rel	-6		
RFBurst Trigger Level Type	Absolute		
RFBurst Trigger Slope	Positive		
Scale/Div	2		
Trigger Holdoff	0.1		
Trigger Holdoff State	FALSE		
TriggerSource	Free		
MeasResult1	MeasResult2	MeasResult3	MeasResult4
-73.0651058869747	36.9712197125257	36.7879441171442	
36.9712197125257	36.8850431211499	36.7032368203129	

Save As . . .

When you press “Save As”, the analyzer brings up a Windows dialog and a menu entitled “**Save As.**” This menu allows you to navigate to the various fields in the Windows dialog without using a keyboard or mouse. The **Tab** and **Arrow** keys can also be used for dialog navigation.

See "[To File . . .](#)" on page 3202 in **Save, State** for a full description of this dialog and menu.

The default path for saving files is:

For all of the Trace Data Files:

- My Documents\<<mode name>\data\traces

For all of the Limit Data Files:

- My Documents\<<mode name>\data\limits

For all of the Measurement Results Data Files:

- My Documents\<<mode name>\data\<<measurement name>\results

For all of the Capture Buffer Data Files:

- My Documents\<<mode name>\data\captureBuffer

Key Path	Save, Data
----------	-------------------

Mode	All
Notes	The key location is mode-dependent and will vary. Brings up the Save As dialog for saving a <mode specific> Save Type. The save is performed immediately and does not wait until the measurement is complete.
Initial S/W Revision	Prior to A.02.00

Screen Image

Pressing Screen Image accesses a menu of functions that enable you to specify a format and location for the saved screen image. It brings up a menu that allows you to specify the color scheme of the Screen Image (Themes) or navigate to the Save As dialog to perform the actual save.

Screen Image files contain an exact representation of the analyzer display. They cannot be loaded back onto the analyzer, but they can be loaded into your PC for use in many popular applications.

The image to be saved is actually captured when the **Save** front panel key is pressed, and kept in temporary storage to be used if you ask for a Screen Image save. When the Screen Image key is pressed, a "thumbnail" of the captured image is displayed, as shown below:

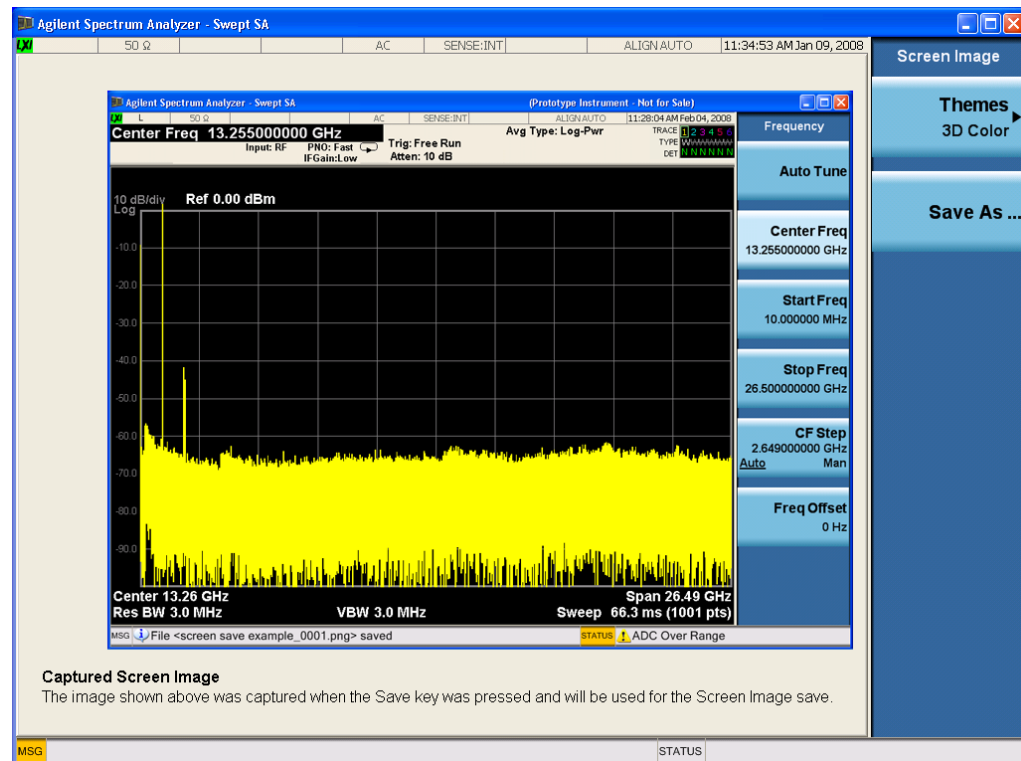

When you continue on into the **Save As** menu and complete the Screen Image save, the image depicted in the thumbnail is the one that gets saved, showing the menus

that were on the screen before going into the **Save** menus. The save is performed immediately and does not wait until the measurement is complete.

After you have completed the save, the **Quick Save** front-panel key lets you quickly repeat the last save performed, using an auto-named file, with the current screen data.

NOTE

For versions previous to A.01.55, if you initiate a screen image save by navigating through the Save menus, the image that is saved will contain the Save menu softkeys, not the menus and the active function that were on the screen when you first pressed the Save front panel key.

Key Path	Save
Mode	All
Remote Command	:MMEMory:STORe:SCReen <filename>
Example	:MMEM:STOR:SCR "myScreen.png" This stores the current screen image in the file MyScreenFile.png in the default directory.
Backwards Compatibility SCPI	HCOPY:SDUMp:DATA? returns the screen image in a <DEFINITE LENGTH ARBITRARY RESPONSE DATA> element. The response data is IEEE Block format; the controlling computer can strip the header and store the result as a .png file.
Initial S/W Revision	Prior to A.02.00

Themes

Accesses a menu of functions that enable you to choose the theme to be used when saving the screen image.

The **Themes** option is the same as the **Themes** option under the **Display** and **Page Setup** dialogs. It allows you to choose between themes to be used when saving the screen image.

Key Path	Save, Screen Image
Remote Command	:MMEMory:STORe:SCReen:THEMe TDCoLor TDMonochrome FCOLor FMONochrome :MMEMory:STORe:SCReen:THEMe?
Example	:MMEM:STOR:SCR:THEM TDM
Preset	3D Color; Is not part of Preset, but is reset by Restore Misc Defaults or Restore System Defaults All and survives subsequent running of the modes.
Readback	3D Color 3D Mono Flat Color Flat Mono
Backwards Compatibility Notes	In ESA and PSA we offer the choice of "Reverse Bitmap" or "Reverse Metafile" when saving screen images. This is much like the "Flat Color" theme available in X-Series. Also, if you selected Reverse Bitmap AND a black & white screen image, that would be much like "Flat Monochrome". In other words, each of the X-Series themes has a similar screen image type in ESA/PSA. But they are not identical.
Initial S/W Revision	Prior to A.02.00

3D Color

Selects a standard color theme with each object filled, shaded and colored as designed.

Key Path	Save, Screen Image, Themes
Example	MMEM:STOR:SCR:THEM TDC
Readback	3D Color
Initial S/W Revision	Prior to A.02.00

3D Monochrome

Selects a format that is like 3D color but shades of gray are used instead of colors.

Key Path	Save, Screen Image, Themes
Example	MMEM:STOR:SCR:THEM TDM
Readback	3D Mono
Initial S/W Revision	Prior to A.02.00

Flat Color

Selects a format that is best when the screen is to be printed on an ink printer.

Key Path	Save, Screen Image, Themes
Example	MMEM:STOR:SCR:THEM FCOL
Readback	Flat Color
Initial S/W Revision	Prior to A.02.00

Flat Monochrome

Selects a format that is like Flat Color. But only black is used (no colors, not even gray), and no fill.

Key Path	Save, Screen Image, Themes
Example	MMEM:STOR:SCR:THEM FMON
Readback	Flat Mono
Initial S/W Revision	Prior to A.02.00

Save As...

When you press "Save As", the analyzer brings up a Windows dialog and a menu entitled "**Save As.**" This menu allows you to navigate to the various fields in the Windows dialog without using a keyboard or mouse. The **Tab** and **Arrow** keys can also be used for dialog navigation.

See "[To File . . .](#)" on page 3202 in **Save, State** for a full description of this dialog and menu.

The default path for Screen Images is

- My Documents\<<mode name>\screen.

where <mode name> is the parameter used to select the mode with the INST:SEL command (for example, SA for the Spectrum Analyzer).

Key Path	Save, Screen Image
Notes	Brings up Save As dialog for saving a Screen Image Save Type
Initial S/W Revision	Prior to A.02.00

Mass Storage Catalog (Remote Command Only)

Key path	SCPI Only
Remote Command	:MMEMory:CATalog? [<directory_name>]
Notes	<p>The string must be a valid logical path.</p> <p>Queries disk usage information (drive capacity, free space available) and obtains a list of files and directories in a specified directory in the following format: <numeric_value>,<numeric_value>,{<file_entry>}</p> <p>It returns two numeric parameters and as many strings as there are files and directories. The first parameter indicates the total amount of storage currently used in bytes. The second parameter indicates the total amount of storage available, also in bytes. The <file_entry> is a string. Each <file_entry> indicates the name, type, and size of one file in the directory list: <file_name>,<file_type>,<file_size></p> <p>As the windows file system has an extension that indicates file type, <file_type> is always empty. <file_size> provides the size of the file in bytes. For directories, <file_entry> is surrounded by square brackets and both <file_type> and <file_size> are empty</p>
Initial S/W Revision	Prior to A.02.00

Mass Storage Change Directory (Remote Command Only)

Key path	SCPI Only
Remote Command	:MMEMory:CDIRectory [<directory_name>] :MMEMory:CDIRectory?
Notes	<p>The string must be a valid logical path.</p> <p>Changes the default directory for a mass memory file system. The <directory_name> parameter is a string. If no parameter is specified, the directory is set to the *RST value.</p> <p>At *RST, this value is set to the default user data storage area, that is defined as System.Environment.SpecialFolder.Personal.</p> <p>Query returns full path of the default directory.</p>
Initial S/W Revision	Prior to A.02.00

Mass Storage Copy (Remote Command Only)

Key path	SCPI Only
----------	------------------

Remote Command	:MMEMory:COpy <string>,<string>[,<string>,<string>]
Notes	<p>The string must be a valid logical path.</p> <p>Copies an existing file to a new file or an existing directory to a new directory.</p> <p>Two forms of parameters are allowed. The first form has two parameters. In this form, the first parameter specifies the source, and the second parameter specifies the destination.</p> <p>The second form has four parameters. In this form, the first and third parameters specify the source. The second and fourth parameters specify the directories. The first pair of parameters specifies the source. The second pair specifies the destination. An error is generated if the source doesn't exist or the destination file already exists.</p> <p>This command will generate an "access denied" error if the destination is a restricted folder (e.g., C:\Windows) and the current user does not have Power User or Administrator privileges.</p>

Mass Storage Device Copy (Remote Command Only)

This command transfers data to/from a file and a peripheral device.

Key path	SCPI Only
Remote Command	:MMEMory:COpy:DEvice <source_string>,<dest_string>
Notes	<p>The strings must be a valid logical path or a valid device keyword. If the dest_string is a device keyword, the data is copied from the source file to the device. If the source_string is a device keyword, the data is copied to the source file from the device.</p> <p>Valid device keywords are:</p> <ul style="list-style-type: none"> SNS (smart noise source) <p>An error is generated if the file or device is not found.</p>

Mass Storage Delete (Remote Command Only)

Key path	SCPI Only
Remote Command	:MMEMory:DELeTe <file_name>[,<directory_name>]
Notes	<p>The string must be a valid logical path.</p> <p>Removes a file from the specified directory. The <file_name> parameter specifies the file name to be removed. This command will generate an "access denied" error if the file is in a restricted folder (e.g., C:\Windows) and the current user does not have Power User or Administrator privileges.</p>
Initial S/W Revision	Prior to A.02.00

Mass Storage Data (Remote Command Only)

Creates a file containing the specified data OR queries the data from an existing file.

Key path	SCPI Only
Remote Command	:MMEMory:DATA <file_name>, <data> :MMEMory:DATA? <file_name>
Notes	The string must be a valid logical path.

	The command form is MMEemory:DATA <file_name>, <data>. It loads <data> into the file <file_name>. <data> is in 488.2 block format. <file_name> is string data.
	The query form is MMEemory:DATA? <file_name> with the response being the associated <data> in block format.

Initial S/W Revision	Prior to A.02.00
----------------------	------------------

Mass Storage Make Directory (Remote Command Only)

Key path	SCPI Only
Remote Command	:MMEemory:MDIRectory <directory_name>
Notes	<p>The string must be a valid logical path.</p> <p>Creates a new directory. The <directory_name> parameter specifies the name to be created.</p> <p>This command will generate an “access denied” error if the new directory would be in a restricted folder (e.g., C:\Windows) and the current user does not have Power User or Administrator privileges.</p>
Initial S/W Revision	Prior to A.02.00

Mass Storage Move (Remote Command Only)

Key path	SCPI Only
Remote Command	:MMEemory:MOVE <string>, <string>[, <string>, <string>]
Notes	<p>The string must be a valid logical path.</p> <p>Moves an existing file to a new file or an existing directory to a new directory.</p> <p>Two forms of parameters are allowed. The first form has two parameters. In this form, the first parameter specifies the source, and the second parameter specifies the destination.</p> <p>The second form has four parameters. In this form, the first and third parameters specify the source. The second and fourth parameters specify the directories. The first pair of parameters specifies the source. The second pair specifies the destination. An error is generated if the source doesn't exist or the destination file already exists.</p> <p>This command will generate an “access denied” error if the destination is a restricted folder (e.g., C:\Windows) and the current user does not have Power User or Administrator privileges.</p>
Initial S/W Revision	Prior to A.02.00

Mass Storage Remove Directory (Remote Command Only)

Key path	SCPI Only
Remote Command	:MMEemory:RDIRectory <directory_name>
Notes	<p>The string must be a valid logical path.</p> <p>Removes a directory. The <directory_name> parameter specifies the directory name to be removed. All files and directories under the specified directory shall also be removed.</p> <p>This command will generate an “access denied” error if the folder is a restricted folder (e.g., C:\Windows) or is in a restricted folder and the current user does not have Power User or Administrator privileges.</p>
Initial S/W Revision	Prior to A.02.00

Mass Storage Determine Removable Media (Remote Command Only)

This command is used to determine if any removable media devices are connected to the instrument. Primarily, these are USB memory devices plugged-in to the front panel or rear panel USB ports. On instruments with PC6 or PC7 CPU's, one SD card slot is available for removable media. The instrument's primary disk drive is not a removable media device.

Key Path	SCPI Only
Remote Command	:MMEMory:RMEDia:LIST?
Notes	<p>The return value is a string containing a list of partition identifiers that are removable media devices. Each identifier is separated by a comma. If no removable media is present, an empty string is returned.</p> <p>Examples:</p> <ul style="list-style-type: none"> - One removable device present results in a return string of "F:". - Two removable devices present results in a return string of "F:,G:". - No removable devices present results in a return string of "".
Initial S/W Revision	x.15.00

Mass Storage Determine Removable Media Label (Remote Command Only)

This command is used to set or query a removable media device's label.

Key Path	SCPI Only
Remote Command	:MMEMory:RMEDia:LABel <partition>,<string> :MMEMory:RMEDia:LABel? <partition>
Example	MMEM:RMED:LAB "F:","My Device"
Notes	<p>If the <partition> specified does not exist or is not a removable media device, the error -252,"Missing Media" is generated.</p> <p>Setting the removable media label requires Administrative privileges. If the currently logged in user does not have appropriate privileges the error "-221.9900,Settings conflict;Administrator privileges required" is generated.</p>
Initial S/W Revision	x.15.00

Mass Storage Determine Removable Media Write-protect status (Remote Command Only)

This command is used to query a removable media device's write-protect status.

Key Path	SCPI Only
----------	-----------

Remote Command	:MMEMory:RMEDia:WPRotect? <partition>
Example	MMEM:RMED:WPR? "F:"
Notes	The return value is 1 if the device is write-protected, or 0 if the device is write-enabled. If the <partition> specified does not exist or is not a removable media device the error - 252,"Missing Media" is generated.
Preset	The return value will be depending on SD card installed.
Initial S/W Revision	x.15.00

Mass Storage Determine Removable Media size (Remote Command Only)

This command is used to query a removable media device's total memory size (not available memory size).

Key Path	SCPI Only
Remote Command	:MMEMory:RMEDia:SIZE? <partition>
Example	MMEM:RMED:SIZE? "F:"
Notes	The return value is integer value in GBytes. Any device that is less than 1 GB returns 0 GB. If the <partition> specified does not exist or is not a removable media device, the error - 252,"Missing Media" is generated.
Initial S/W Revision	x.15.00

:SYSTem:SET (Remote Command Only)

Remote command that allows the user to obtain the state of the currently active mode in a form that can then be loaded back into the instrument quickly.

Remote Command	SYSTem:SET <instrument state in IEEE Block> SYSTem:SET?
Notes	SYST:SET? returns current instrument state of the active mode in IEEE Block data format. The state is in a machine readable format only. Sending the query returns the following format: <syst set preamble><state block data> Where: <syst set preamble> is the format: #NMMM N=number of digits that comprise MMM MMM=length in bytes of following data <state block data> is machine readable state data Example response: #42016<state data> The state is recalled by sending the SYST:SET? Response data to the instrument. From example above: SYST:SET #42016<state data>
Initial S/W Revision	x.17.00

Single (Single Measurement/Sweep)

Sets the analyzer for Single measurement operation. The single/continuous state is Meas Global, so the setting will affect all the measurements. If you are Paused, pressing **Single** does a Resume.

See "[More Information](#)" on page 2051

Key Path	Front-panel key
Example	:INIT:CONT OFF
Notes	See Cont key description.
Backwards Compatibility Notes	<p>For Spectrum Analysis mode in ESA and PSA, the Single hardkey and the INITiate:IMM switched from continuous measurement to single measurement and restarted sweeps and averages (displayed average count reset to 1), but did not restart Max Hold and Min Hold. In the X-Series, the Single hardkey and the INITiate:IMM command initiate a sweep/ measurement/ average sequence/hold sequence including MaxHold and MinHold.</p> <p>For Spectrum Analysis mode in ESA and PSA, the Single hardkey restarted the sweep regardless of whether or not you were in an active sweep or sweep sequence. In the X-Series, Restart does this but Single only restarts the sweep or sweep sequence if you are in the idle state.</p> <p>INIT[:IMM] in ESA & PSA Spectrum Analysis Mode does an implied ABORT. In some other PSA Modes, INIT[:IMM] is ignored if not in the idle state. . The X-Series follows the ESA/PSA SA Mode model, which may cause some Modes to have compatibility problems.</p>
Initial S/W Revision	Prior to A.02.00

More Information

See "[Restart](#)" on page 3199 for details on the INIT:IMMEDIATE (Restart) function.

If you are already in single sweep, the INIT:CONT OFF command has no effect.

If you are already in Single Sweep, then pressing the **Single** key in the middle of a sweep does not restart the sweep or sequence. Similarly, pressing the **Single** key does not restart the sweep or sequence if the sweep is not in the idle state (for example, if you are taking a very slow sweep, or the analyzer is waiting for a trigger). Instead, it results in a message. "Already in Single, press Restart to initiate a new sweep or sequence". Even though pressing the **Single** key in the middle of a sweep does not restart the sweep, sending INIT:IMMEDIATE does reset it.

To take one more sweep without resetting the average count, increment the average count by 1, by pressing the step up key while **Average/Hold Number** is the active function, or sending the remote command CALC:AVER:TCON UP.

Source

There is no Source control functionality for this measurement. When this key is pressed, the screen either displays a blank menu, or the previously-selected menu remains unchanged.

Key Path

Front-panel key

Span X Scale

The SPAN X Scale key accesses the menu to set the desired horizontal scale.

Key Path	Front-panel key
Initial S/W Revision	Prior to A.02.00

Scale/Div

Enables you to enter a time value to change the horizontal scale.

Key Path	Span X Scale
Mode	SA, WCDMA, C2K, WIMAXOFDMA, TD-SCDMA, 1xEV-DO, DVB-T/H, DTMB (CTTB), ISDB-T, CMMB, LTE, LTE-TDD, Digital Cable TV, WLAN, MSR,, LTE-TDD, LTEAFDD
Remote Command	:DISPlay:PStatistic:VIEW[1]:WINDow2:TRACe:X[:SCALe]:PDIVision <rel_ ampl> :DISPlay:PStatistic:VIEW[1]:WINDow2:TRACe:X[:SCALe]:PDIVision?
Example	DISP:PST:VIEW:WIND2:TRAC:X:PDIV 10 DISP:PST:VIEW:WIND2:TRAC:X:PDIV?
Notes	CCDF measurement has the trace display only at Window 2.
Couplings	See Notes
Preset	2.00
State Saved	Saved in instrument state.
Min	0.1
Max	20
Backwards Compatibility SCPI	:DISPlay:PStatistic:XSCale
Initial S/W Revision	Prior to A.02.00
Modified at S/W Revision	A.02.00, A.03.00

Sweep/Control

Enables you to pause the power statistics CCDF measurement after the current data acquisition is complete. When Paused, the label on the menu key changes to **Resume**. Press **Resume** to resume the measurement where it was when it was paused.

Key Path	Front-panel key
Initial S/W Revision	Prior to A.02.00

Pause/Resume

Pauses a measurement after the current data acquisition is complete. When Paused, the label on the key changes to **Resume**. Press **Resume** to resume the measurement where it was when it was paused. See "[Pause/Resume](#)" on page 2263 for details.

Key Path	Sweep/Control
Initial S/W Revision	Prior to A.02.00

System

See "System" on page 431

Trace/Detector

Accesses a menu of functions that enable you to control the storage and manipulation of the reference trace, as well as controls the display of the trace data.

Key Path	Front-panel key
Initial S/W Revision	Prior to A.02.00

Store Ref Trace

Copies the currently measured curve as the user-definable reference trace. The captured data remains until the other mode is chosen. Pressing this key also refreshes the reference trace.

No query command is available.

Key Path	Trace/Detector
Mode	SA, WCDMA, C2K, WIMAXOFDMA, TD-SCDMA, 1xEV-DO, DVB-T/H, DTMB (CTTB), ISDB-T, CMMB, LTE, LTETDD, Digital Cable TV, WLAN, MSR, LTEATDD, LTEAFDD
Remote Command	:CALCulate:PStatistic:STORe:REFeRence
Example	CALC:PST:STOR:REF
Backwards Compatibility SCPI	[:SENSe]:PStatistic:SRTRace
Initial S/W Revision	Prior to A.02.00
Modified at S/W Revision	A.02.00, A.03.00

Ref Trace

Toggles the reference trace display between On and Off.

Key Path	Trace/Detector
Mode	SA, WCDMA, C2K, WIMAXOFDMA, TD-SCDMA, 1xEV-DO, DVB-T/H, DTMB (CTTB), ISDB-T, CMMB, LTE, LTETDD, Digital Cable TV, WLAN, MSR, LTEATDD, LTEAFDD
Remote Command	:DISPlay:PStatistic:RTRace[:STATe] OFF ON 0 1 :DISPlay:PStatistic:RTRace[:STATe]?
Example	DISP:PST:RTR OFF DISP:PST:RTR?
Preset	OFF
State Saved	Saved in instrument state.
Range	On Off
Backwards Compatibility SCPI	[:SENSe]:PStatistic:RTRace[:STATe]
Initial S/W Revision	Prior to A.02.00
Modified at S/W Revision	A.02.00, A.03.00, A.04.00

Revision

Gaussian Line

Toggles the Gaussian trace display between On and Off.

Key Path	Trace/Detector
Mode	SA, WCDMA, C2K, WIMAXOFDMA, TD-SCDMA, 1xEV-DO, DVB-T/H, DTMB (CTTB), ISDB-T, CMMB, LTE, LTE-TDD, Digital Cable TV, WLAN, MSR, LTE-TDD, LTE-FDD
Remote Command	:DISPlay:PSTatistic:GAUSSian[:STATe] OFF ON 0 1 :DISPlay:PSTatistic:GAUSSian[:STATe]?
Example	DISP:PST:GAUS OFF DISP:PST:GAUS?
Preset	ON
State Saved	Saved in instrument state.
Range	On Off
Backwards Compatibility SCPI	[:SENSe]:PSTatistic:GAUSSian[:STATe]
Initial S/W Revision	Prior to A.02.00
Modified at S/W Revision	A.02.00, A.03.00, A.04.00

Trigger

See ["Trigger" on page 529](#)

Free Run

See ["Free Run " on page 537](#)

Video

See ["Video \(IF Envelope\) " on page 538](#)

Trigger Level

See ["Trigger Level" on page 538](#)

Trig Slope

See ["Trig Slope" on page 539](#)

Trig Delay

See ["Trig Delay" on page 540](#)

X Axis Relative to Trigger

See ["X Axis Relative to Trigger" on page 583](#)

Line

See ["Line" on page 2814](#)

Trig Slope

See ["Trig Slope" on page 2814](#)

Trig Delay

See ["Trig Delay" on page 543](#)

X Axis Relative to Trigger

See ["X Axis Relative to Trigger" on page 583](#)

External 1

See ["External 1" on page 2828](#)

Trigger Level

See ["Trigger Level" on page 2828](#)

Trig Slope

See ["Trig Slope" on page 2829](#)

Trig Delay

See ["Trig Delay" on page 546](#)

X Axis Relative to Trigger

See ["X Axis Relative to Trigger" on page 583](#)

Zero Span Delay Comp

See ["Zero Span Delay Comp On/Off " on page 2816](#)

External 2

See ["External 2 " on page 2829](#)

Trigger Level

See ["Trigger Level" on page 2830](#)

Trig Slope

See ["Trig Slope" on page 2831](#)

Trig Delay

See ["Trig Delay " on page 549](#)

X Axis Relative to Trigger

See ["X Axis Relative to Trigger" on page 583](#)

Zero Span Delay Comp

See ["Zero Span Delay Comp On/Off" on page 2818](#)

RF Burst

See ["RF Burst" on page 2831](#)

Absolute Trigger

See ["Absolute Trigger Level" on page 2832](#)

Relative Trigger

See ["Relative Trigger Level" on page 2833](#)

Trig Slope

See ["Trigger Slope" on page 2834](#)

Trig Delay

See ["Trig Delay" on page 554](#)

X Axis Relative to Trigger

See ["X Axis Relative to Trigger" on page 583](#)

Zero Span Delay Comp

See ["Zero Span Delay Comp On/Off" on page 2834](#)

Periodic Timer

See ["Periodic Timer \(Frame Trigger\)" on page 2823](#)

Period

See ["Period" on page 2824](#)

Offset

See ["Offset" on page 2825](#)

Offset Adjust (Remote Command Only)

See ["Offset Adjust \(Remote Command Only\)" on page 2826](#)

Reset Offset Display

See ["Reset Offset Display" on page 2827](#)

Sync Source

See ["Sync Source" on page 2827](#)

Off

See ["Off" on page 2828](#)

External 1

See ["External 1" on page 2828](#)

Trigger Level

See ["Trigger Level" on page 2828](#)

Trig Slope

See ["Trig Slope" on page 2829](#)

External 2

See ["External 2 " on page 2829](#)

Trigger Level

See ["Trigger Level" on page 2830](#)

Trig Slope

See ["Trig Slope" on page 2831](#)

RF Burst

See ["RF Burst" on page 2831](#)

Absolute Trigger

See ["Absolute Trigger Level" on page 2832](#)

Relative Trigger

See ["Relative Trigger Level" on page 2833](#)

Trig Slope

See ["Trigger Slope" on page 2834](#)

Zero Span Delay Comp

See ["Zero Span Delay Comp On/Off" on page 2834](#)

Trig Delay

See ["Trig Delay" on page 568](#)

X Axis Relative to Trigger

See ["X Axis Relative to Trigger" on page 583](#)

Sync Holdoff

See ["Sync Holdoff" on page 1289](#)

Baseband I/Q

See ["Baseband I/Q " on page 570](#)

I/Q Mag

See ["I/Q Mag" on page 570](#)

Trigger Level

See ["Trigger Level" on page 570](#)

Trig Slope

See ["Trig Slope" on page 571](#)

Trig Delay

See ["Trig Delay" on page 571](#)

X Axis Relative to Trigger

See ["X Axis Relative to Trigger" on page 583](#)

I (Demodulated)

See ["I \(Demodulated\)" on page 572](#)

Trigger Level

See ["Trigger Level" on page 573](#)

Trig Slope

See ["Trig Slope" on page 573](#)

Trig Delay

See ["Trig Delay" on page 573](#)

X Axis Relative to Trigger

See ["X Axis Relative to Trigger" on page 583](#)

Q (Demodulated)

See ["Q \(Demodulated\)" on page 575](#)

Trigger Level

See ["Trigger Level" on page 575](#)

Trig Slope

See ["Trig Slope" on page 575](#)

Trig Delay

See ["Trig Delay" on page 576](#)

X Axis Relative to Trigger

See ["X Axis Relative to Trigger" on page 583](#)

Input I

See ["Input I" on page 577](#)

Trigger Level

See ["Trigger Level" on page 577](#)

Trig Slope

See ["Trig Slope" on page 578](#)

Trig Delay

See ["Trig Delay" on page 578](#)

X Axis Relative to Trigger

See ["X Axis Relative to Trigger" on page 583](#)

Input Q

See ["Input Q" on page 579](#)

Trigger Level

See ["Trigger Level" on page 579](#)

Trig Slope

See ["Trig Slope" on page 580](#)

Trig Delay

See ["Trig Delay" on page 580](#)

X Axis Relative to Trigger

See ["X Axis Relative to Trigger" on page 583](#)

Auxiliary Channel I/Q Mag

See ["Auxiliary Channel I/Q Mag" on page 581](#)

Trigger Level

See ["Trigger Level" on page 582](#)

Trig Slope

See ["Trig Slope" on page 582](#)

Trig Delay

See ["Trig Delay" on page 582](#)

X Axis Relative to Trigger

See ["X Axis Relative to Trigger" on page 583](#)

Trigger Center Frequency

See ["Trigger Center Frequency" on page 583](#)

Trigger Bandwidth

See ["Trigger Bandwidth" on page 584](#)

TV

See ["TV" on page 2835](#)

TV Line

See ["TV Line" on page 2836](#)

Field

See ["Field" on page 2836](#)

Entire Frame

See ["Entire Frame" on page 2837](#)

Field One

See ["Field One" on page 2837](#)

Field Two

See ["Field Two" on page 2837](#)

Standard

See ["Standard" on page 2838](#)

NTSC-M

See ["NTSC-M" on page 2838](#)

NTSC-Japan

See ["NTSC-Japan" on page 2839](#)

NTSC-4.43

See ["NTSC-4.43" on page 2839](#)

PAL-M

See ["PAL-M" on page 2839](#)

PAL-N

See ["PAL-N" on page 2839](#)

PAL-N Combin

See ["PAL-N-Combin" on page 2839](#)

PAL-B,D,G,H,I

See ["PAL-B,D,G,H,I" on page 2839](#)

PAL-60

See ["PAL-60" on page 2840](#)

SECAM-L

See ["SECAM-L" on page 2840](#)

Auto/Holdoff

See ["Auto/Holdoff" on page 590](#)

Auto Trig

See ["Auto Trig" on page 590](#)

Trig Holdoff

See ["Trig Holdoff" on page 591](#)

Holdoff Type

See ["Holdoff Type" on page 591](#)

User Preset

Accesses a menu that gives you the following three choices:

- **User Preset** – recalls a state previously saved using the Save User Preset function.
- **User Preset All Modes** – presets all of the modes in the analyzer
- **Save User Preset**– saves the current state for the current mode

Key Path	Front-panel key
Backwards Compatibility Notes	<p>User Preset is actually loading a state, and in legacy analyzers, it was possible to load a state without affecting the trace data, limit lines or correction data. Similarly it was possible to do a User Preset without affecting the trace data, limit lines or correction data.</p> <p>In the X-Series, “state” always includes all of this data; so whenever state is loaded, or User Preset is executed, all of the traces, limit lines and corrections are affected. Although this differs from previous behavior, it is desirable behavior, and should not cause adverse issues for users.</p> <p>On ESA and PSA, User Preset affected the entire instrument’s state. In the X-Series, User Preset only recalls the state for the active mode. There is a User Preset file for each mode. User Preset can never cause a mode switch as it can in legacy analyzers. If you want to recall all modes to their user preset file state, you will need to do a User Preset after mode switching into each mode.</p> <p>User Preset recalls mode state which can now include data like traces; whereas on ESA and PSA, User Preset did not affect data.</p>
Initial S/W Revision	Prior to A.02.00

User Preset

User Preset sets the state of the currently active mode back to the state that was previously saved for this mode using the Save User Preset menu key or the SCPI command, **SYST:PRES:USER:SAV**. **It not only recalls the** Mode Preset settings, but it also recalls all of the mode persistent settings, and the Input/Output system setting that existed at the time Save User Preset was executed.

If a Save User Preset has not been done at any time, User Preset recalls the default user preset file for the currently active mode. The default user preset files are created if, at power-on, a mode detects there is no user preset file. There will never be a scenario when there is no user preset file to restore. For each mode, the default user preset state is the same state that would be saved if a Save User Preset is performed in each mode right after doing a Restore Mode Default and after a Restore Input/Output Defaults.

The User Preset function does the following:

- Aborts the currently running measurement.
- Sets the mode State to the values defined by Save User Preset.

- Makes the saved measurement for the currently running mode the active measurement.
- Brings up the saved menu for the power-on mode.
- Clears the input and output buffers.
- Sets the Status Byte to 0.

Key Path	User Preset
Remote Command	:SYSTem:PRESet:USER
Example	:SYST:PRES:USER
Notes	:SYST:PRES:USER:SAVE is used to save the current state as the user preset state. Clears all pending OPC bits. The Status Byte is set to 0. Pressing the User Preset front-panel key while already in the User Preset menu will cause the User Preset to get executed
Couplings	A user preset will cause the currently running measurement to be aborted and cause the saved measurement to be active. Recalling a User Preset file has the same issues that recalling a Save State file has. Some settings may need to be limited and therefore re-coupled, since the capabilities of the mode may have changes when the User Preset file was last saved.
Initial S/W Revision	Prior to A.02.00

User Preset All Modes

Recalls all of the User Preset files for each mode, switches to the power-on mode, and activates the saved measurement from the power-on mode User Preset file.

NOTE

When the instrument is secured, all of the user preset files are converted back to their default user preset files.

The User Preset function does the following:

- Aborts the currently running measurement.
- Switches the Mode to the power-on mode.
- Restores the User Preset files for each mode.
- Makes the saved measurement for the power-on mode the active measurement.
- Brings up the saved menu for the power-on mode.
- Clears the input and output buffers.
- Sets the Status Byte to 0.

Key Path	User Preset
----------	-------------

Remote Command	:SYSTem:PRESet:USER:ALL
Example	:SYST:PRES:USER:SAVE :SYST:PRES:USER:ALL
Notes	Clears all pending OPC bits. The Status Byte is set to 0. :SYST:PRES:USER:SAVE is used to save the current state as the user preset state.
Couplings	A user preset will cause the currently running measurement to be aborted, cause a mode switch to the power-on mode, and cause the saved measurement to be active in the power-on mode. Recalling a User Preset file has the same issues that recalling a Save State file has. Some settings may need to be limited and therefore re-coupled, since the capabilities of the mode may have changes when the User Preset file was last saved.
Initial S/W Revision	Prior to A.02.00

Save User Preset

Saves the currently active mode and its State. You can recall this User Preset file by pressing the User Preset menu key or sending the SYST:PRES:USER remote command. This same state is also saved by the Save State function.

Key Path	User Preset
Remote Command	:SYSTem:PRESet:USER:SAVE
Example	:SYST:PRES:USER:SAVE
Notes	:SYST:PRES:SAVE creates the same file as if the user requested a *SAV or a MMEM:STOR:STAT, except User Preset Save does not allow the user to specify the filename or the location of the file.
Initial S/W Revision	Prior to A.02.00

View/Display

Accesses a menu of functions that enable you to control the instrument display as well as turn the bar graph On and Off.

The Power Stat CCDF measurement provides a single view. This is common for both Uplink (MS) and Downlink (BTS). The view consists of the following windows:

- "Metrics window" on page 2071
- "Graph window" on page 2072
- "Wave window (TD-SCDMA and LTE TDD only)" on page 2072

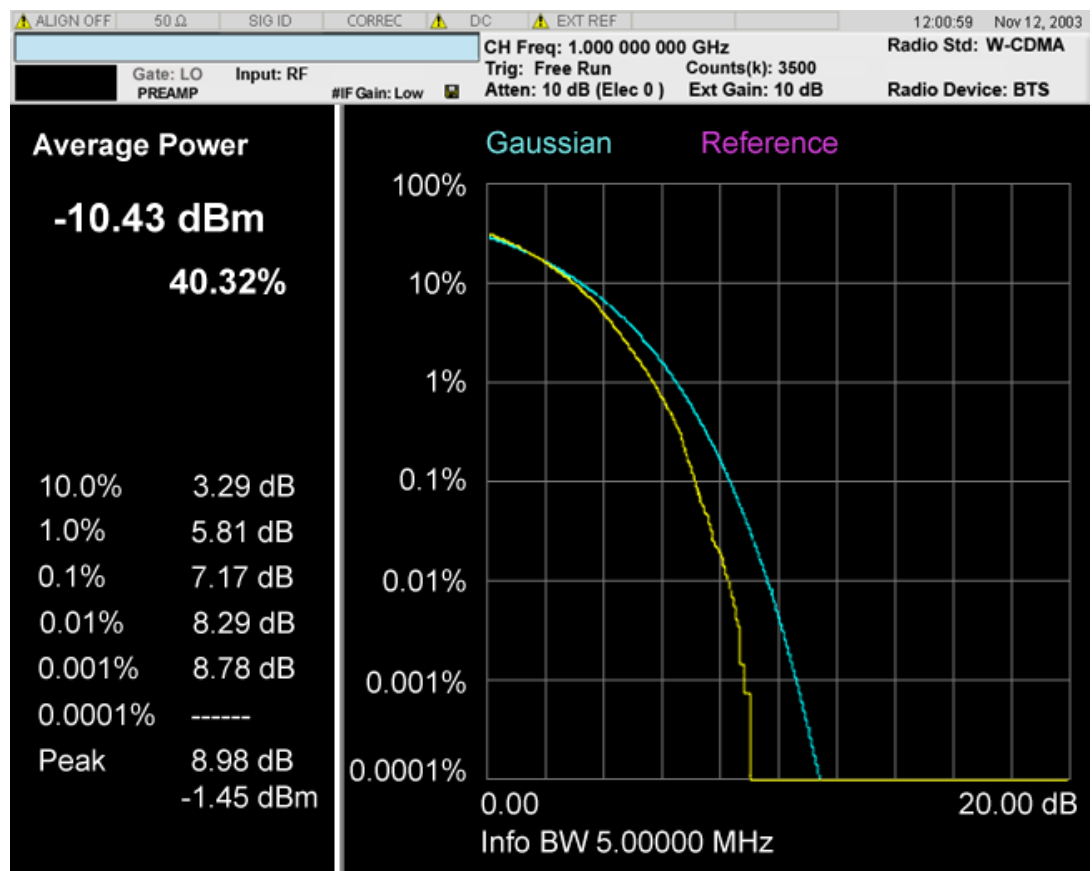

Above: View for Power Stat CCDF Measurement.

12 Power Stat CCDF Measurement
View/Display

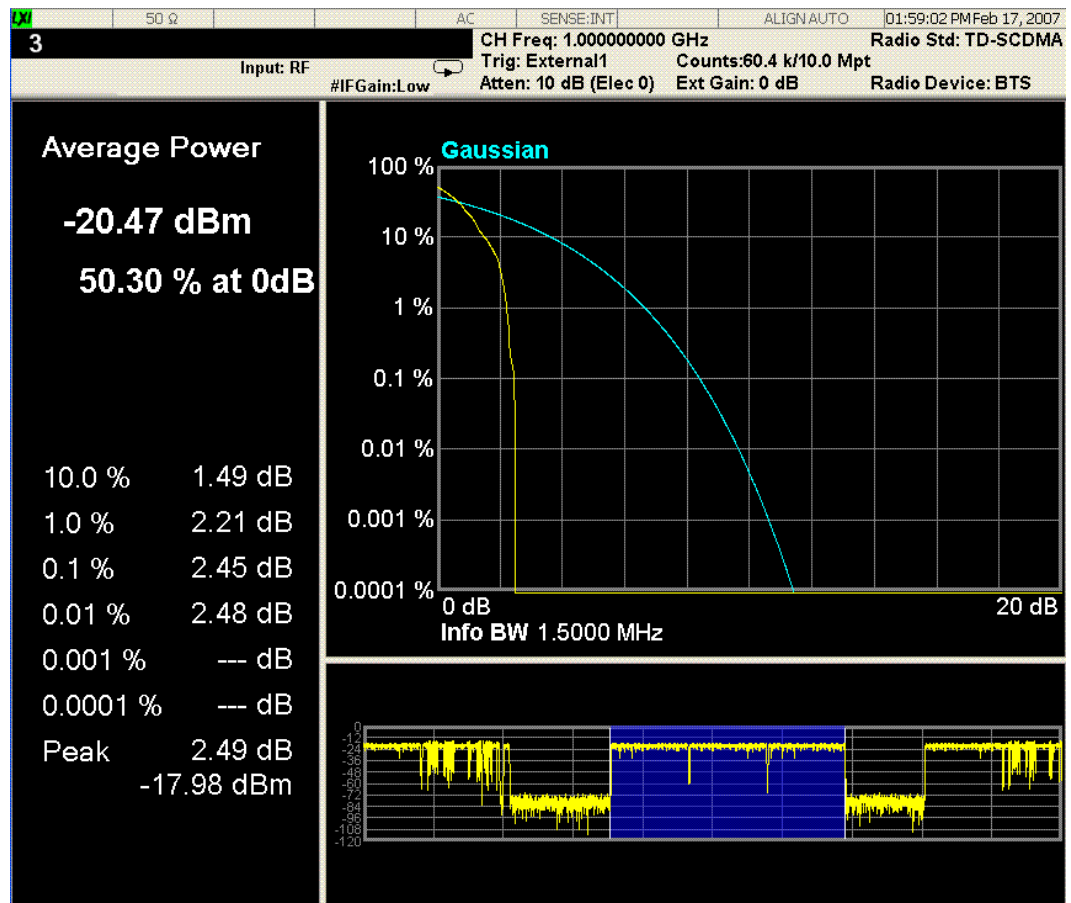

Above: Slot View for Power Stat CCDF Measurement in TD-SCDMA mode.

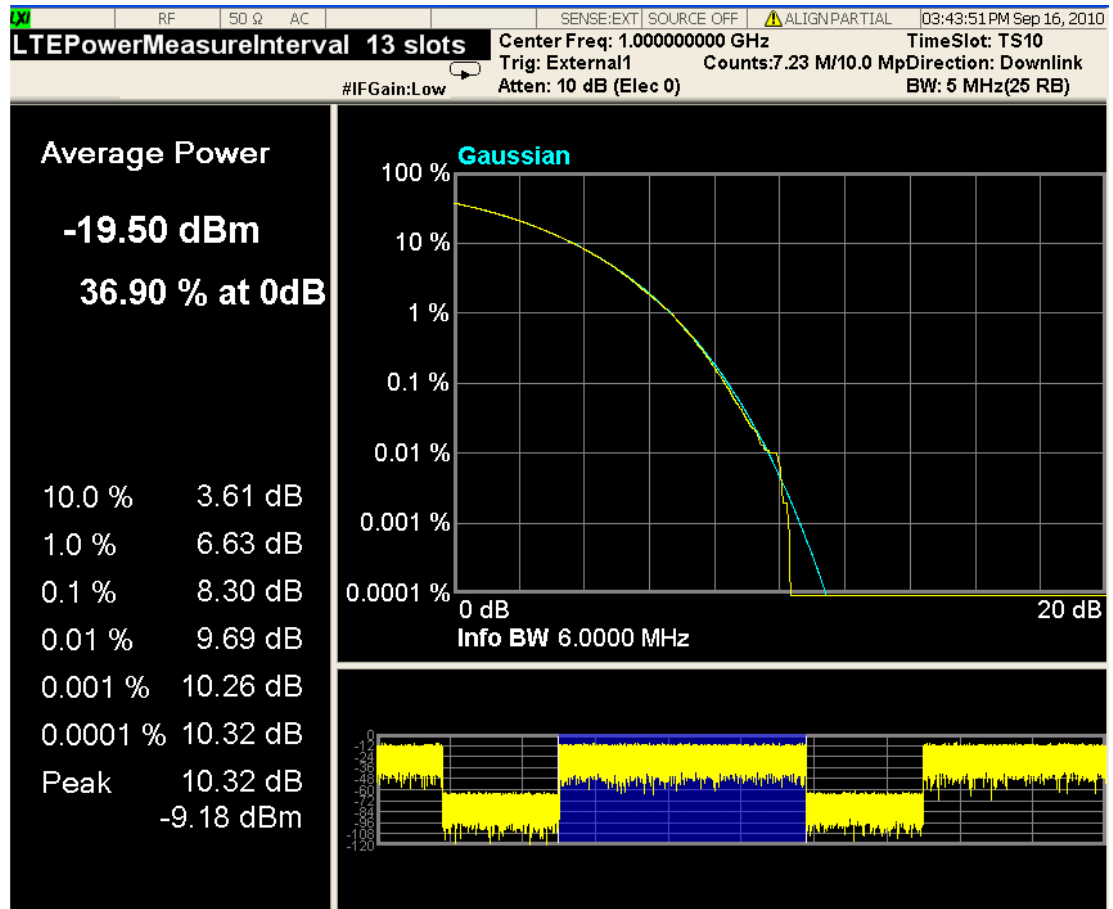

Above: View for Power Stat CCDF Measurement in LTE TDD mode.

Metrics window

Name	Corresponding Results	Explanation
Average Power [dBm]	n=1 1st Average input power	99.99 dBm
Average Power [%]	n=1 2nd Probability at the average input power level	99.99 %
10.0% [dB]	n=1 3rd Power level that has 10% of the power	99.99 dB
1.0% [dB]	n=1 4th Power level that has 1% of the power	99.99 dB
0.1% [dB]	n=1 5th Power level that has 0.1% of the power	99.99 dB
0.01% [dB]	n=1 6th Power level that has 0.01% of the power	99.99 dB
0.001% [dB]	n=1 7th	99.99 dB

Name	Corresponding Results	Explanation
	Power level that has 0.001% of the power	
0.0001% [dB]	n=1 8th	99.99 dB
	Power level that has 0.0001% of the power	
Peak [dB]	n=1 9th Peak power	99.99 dB
Peak[dBm]	This is not available from SCPI using remote commands.	99.99 dBm

Graph window

Marker Operation	Yes
Corresponding Trace	<p>Yellow: Series of 5001 floating the current measured power stat trace. (n=2) Initially all markers refer this trace.</p> <p>Light Blue: Series of 5001 floating point numbers (in percent) that represent the Gaussian trace. (n=3)</p> <p>Violet: series of 5001 floating point numbers (in percent) that represent the user-definable reference trace. (n=4)</p> <p>The Gaussian and Reference trace/line can be removed using the functions under the Trace/Detector key</p>

Wave window (TD-SCDMA and LTE TDD only)

This window is only available under TD-SCDMA mode and LTE TDD mode, and by default this window is closed, it can be turned on or off by using the softkey "Slot View". For more details, refer to the section [Slot View](#).

Marker Operation	No
Corresponding Trace	<p>Yellow: For TD-SCDMA, Waveform of entire TD-SCDMA frame. If measurement range specified by Analysis Time Slot and Measured Time Slot is out of the first frame, the display range extends to two TD-SCDMA frames. For LTETDD, Waveform of 2 continuous LTE type2 frames.</p> <p>Blue: Indicates current measurement range</p>

Key Path	Front-panel key
Initial S/W Revision	Prior to A.02.00

Display

The Display menu is common to most measurements, and is used for configuring items on the display. Some Display menu settings apply to all the measurements in

a mode, and some only to the current measurement. Those under the **System Display Settings** key apply to all measurements in all modes.

Key Path	Display
Key Path	View/Display
Initial S/W Revision	Prior to A.02.00

Annotation

Turns on and off various parts of the display annotation. The annotation is divided up into four categories:

13. Meas Bar: This is the measurement bar at the top of the screen. It does not include the settings panel or the Active Function. Turning off the Meas Bar turns off the settings panel and the Active Function. When the Meas Bar is off, the graticule area expands to fill the area formerly occupied by the Meas Bar.
14. Screen Annotation: this is the annotation and annunciation around the graticule, including any annotation on lines (such as the display line, the threshold line, etc.) This does NOT include the marker number or the N dB result. When off, the graticule expands to fill the entire graticule area.
15. Trace annotation: these are the labels on the traces, showing their detector (or their math mode).
16. Active Function annotation: this is the active function display in the meas bar, and all of the active function values displayed on softkeys.

See the figure below. Each type of annotation can be turned on and off individually.

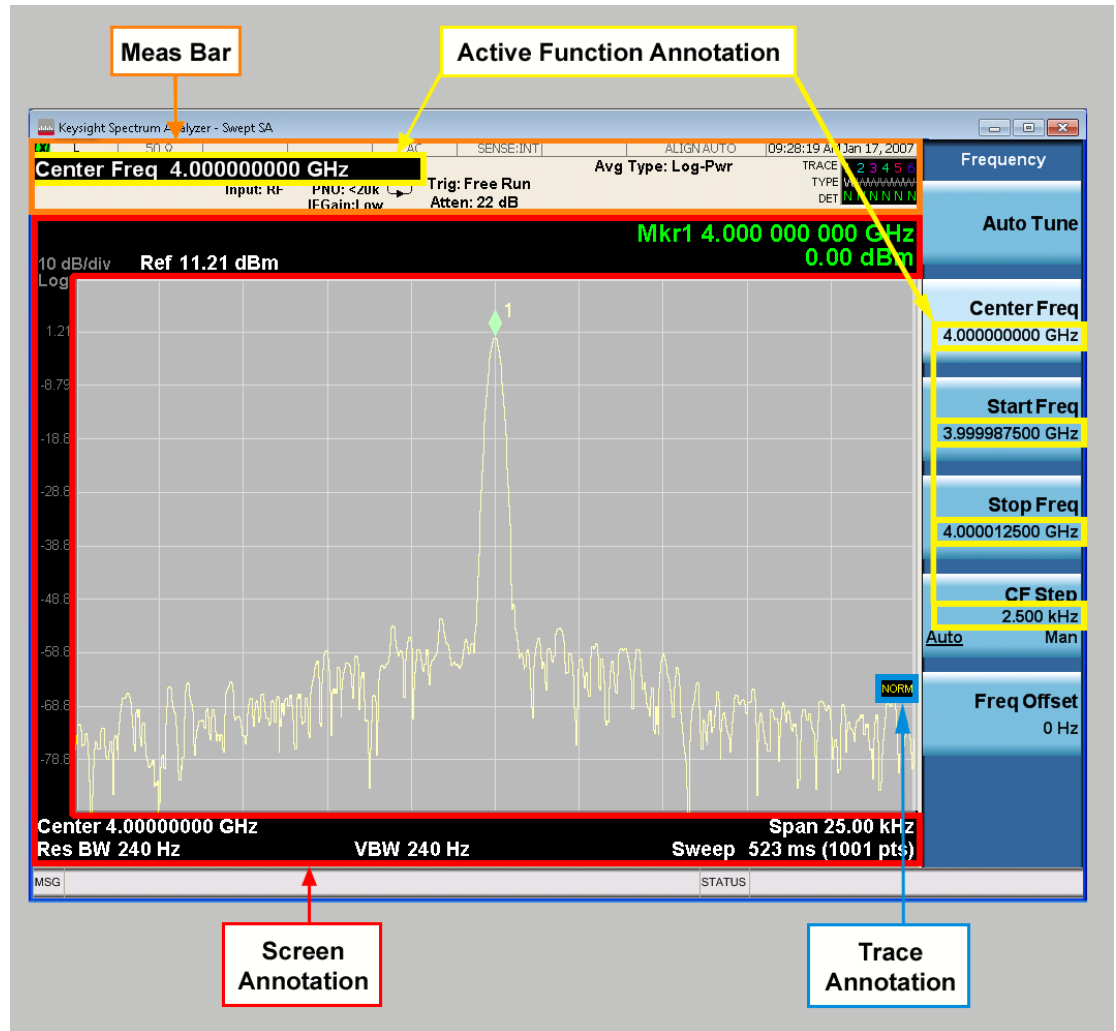

Key Path	View/Display, Display
Initial S/W Revision	Prior to A.02.00

Meas Bar On/Off

This function turns the Measurement Bar on and off, including the settings panel. When off, the graticule area expands to fill the area formerly occupied by the Measurement Bar.

Key Path	View/Display, Display, Annotation
Remote Command	:DISPlay:ANNotation:MBAR[:STATE] OFF ON 0 1 :DISPlay:ANNotation:MBAR[:STATE]?
Example	DISP:ANN:MBAR OFF
Dependencies	Grayed out and forced to OFF when System Display Settings, Annotation is set to Off.
Preset	On

	This should remain Off through a Preset when System DisplaySettings, Annotation is set to Off.
State Saved	Saved in instrument state.
Initial S/W Revision	Prior to A.02.00

Screen

This controls the display of the annunciation and annotation around the graticule, including any annotation on lines (such as the display line, the threshold line, etc.) and the y-axis annotation. This does NOT include marker annotation (or the N dB result). When off, the graticule expands to fill the entire graticule area, leaving only the 1.5% gap above the graticule as described in the Trace/Detector chapter.

Key Path	View/Display, Display, Annotation
Remote Command	:DISPlay:ANNotation:SCReen[:STATe] OFF ON 0 1 :DISPlay:ANNotation:SCReen[:STATe]?
Example	DISP:ANN:SCR OFF
Dependencies	Grayed-out and forced to OFF when System Display Settings, Annotation is set to Off.
Preset	On This should remain Off through a Preset when System DisplaySettings, Annotation is set to Off
State Saved	Saved in instrument state.
Initial S/W Revision	Prior to A.02.00

Trace

Turns on and off the labels on the traces, showing their detector (or their math mode) as described in the Trace/Detector section.

If trace math is being performed with a trace, then the trace math annotation will replace the detector annotation.

Key Path	View/Display, Display, Annotation
Remote Command	:DISPlay:ANNotation:TRACe[:STATe] ON OFF 1 0 :DISPlay:ANNotation:TRACe[:STATe]?
Example	DISP:ANN:TRAC OFF
Preset	Off
State Saved	Saved in instrument state.
Initial S/W Revision	Prior to A.02.00

Active Function Values On/Off

Turns on and off the active function display in the Meas Bar, and all of the active function values displayed on the softkeys.

Note that all of the softkeys that have active functions have these numeric values blanked when this function is on. This is a security feature..

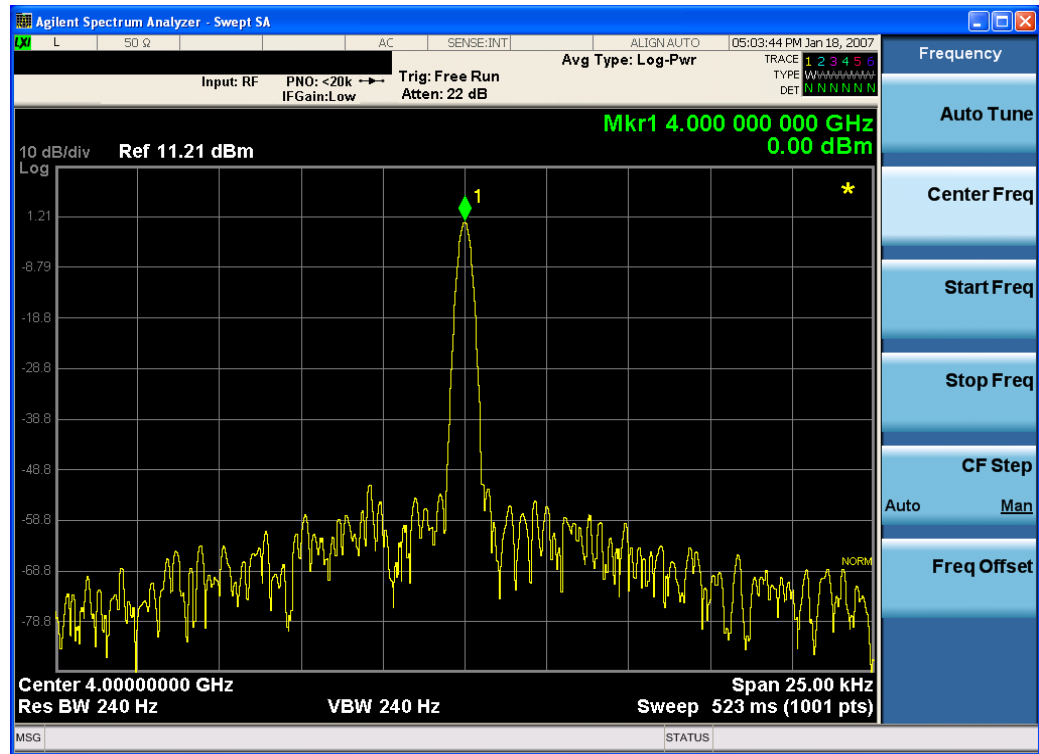

Key Path	View/Display, Display, Annotation
Remote Command	:DISPlay:ACTivefunc[:STATe] ON OFF 1 0 :DISPlay:ACTivefunc[:STATe]?
Example	DISP:ACT OFF
Dependencies	Grayed out and forced to OFF when System Display Settings, Annotation is set to Off.
Preset	On This should remain Off through a Preset when System DisplaySettings, Annotation is set to Off
State Saved	Saved in instrument state.
Initial S/W Revision	Prior to A.02.00

Title

Displays menu keys that enable you to change or clear a title on your display.

Key Path	View/Display, Display
Initial S/W Revision	Prior to A.02.00

Change Title

Writes a title into the "measurement name" field in the banner, for example, "Swept SA".

Press Change Title to enter a new title through the alpha editor. Press Enter or Return to complete the entry. Press ESC to cancel the entry and preserve your existing title.

The display title will replace the measurement name. It remains for this measurement until you press **Change Title** again, or you recall a state, or a Preset is performed. A title can also be cleared by pressing **Title**, **Clear Title**.

NOTE

Notice the inclusion of the <measurement> parameter in the command below. Because each measurement remembers the Display Title, the command must be qualified with the measurement name. For the Swept SA measurement this is not the case; no <measurement> parameter is used when changing the Display Title for the Swept SA measurement.

Key Path	View/Display, Display, Title
Mode	All
Remote Command	:DISPlay:<measurement>:ANNotation:TITLe:DATA <string> :DISPlay:<measurement>:ANNotation:TITLe:DATA?
Example	DISP:ANN:TITL:DATA "This Is My Title" This example is for the Swept SA measurement in the Spectrum Analyzer mode. The SANalyzer <measurement> name is not used. DISP:ACP:ANN:TITL:DATA "This Is My Title" This example is for Measurements other than Swept SA. Both set the title to: This Is My Title
Notes	Pressing this key cancels any active function. When a title is edited the previous title remains intact (it is not cleared) and the cursor goes at the end so that characters can be added or BKSP can be used to go back over previous characters.
Preset	No title (measurement name instead)
State Saved	Saved in instrument state.
Initial S/W Revision	Prior to A.02.00

Clear Title

Clears a title from the front-panel display. Once cleared, the title cannot be retrieved. After the title is cleared, the current Measurement Name replaces it in the title bar.

Key Path	View/Display, Display, Title
Example	<p>The following commands clear the title and restore the measurement's original title:</p> <pre>DISP:ANN:TITL:DATA ""</pre> <p>This example is for the Swept SA measurement in the Spectrum Analyzer mode. The SANalyzer <measurement> name is not used.</p> <pre>DISP:ACP:ANN:TITL:DATA ""</pre> <p>This example is for ACP; in measurements other than Swept SA the measurement name is required.</p>
Notes	Uses the :DISPlay:<measurement>:ANNotation:TITLe:DATA <string> command with an empty string (in the Swept SA, the <measurement> is omitted).
Preset	Performed on Preset.
Initial S/W Revision	Prior to A.02.00

Graticule

Pressing Graticule turns the display graticule On or Off. It also turns the graticule y-axis annotation on and off.

Key Path	View/Display, Display
Remote Command	<pre>:DISPlay:WINDow[1]:TRACe:GRATicule:GRID[:STATe] OFF ON 0 1</pre> <pre>:DISPlay:WINDow[1]:TRACe:GRATicule:GRID[:STATe]?</pre>
Example	DISP:WIND:TRAC:GRAT:GRID OFF
Notes	The graticule is the set of horizontal and vertical lines that make up the grid/divisions for the x-axis and y-axis.
Preset	On
State Saved	Saved in instrument state
Initial S/W Revision	Prior to A.02.00

System Display Settings

These settings are "Mode Global" – they affect all modes and measurements and are reset only by **Restore Misc Defaults** or **Restore System Defaults** under System.

Key Path	View/Display, Display
Initial S/W Revision	Prior to A.02.00

Annotation Local Settings

This is a Mode Global override of the meas local annotation settings. When it is **All Off**, it forces **ScreenAnnotation, Meas Bar, Trace, and Active Function Values** settings to be **OFF** for all measurements in all modes. This provides the security

based "annotation off" function of previous analyzers; hence it uses the legacy SCPI command.

When it is **All Off**, the **Screen, Meas Bar, Trace**, and **Active Function Values** keys under the **Display, Annotation** menu are grayed out and forced to **Off**. When **Local Settings** is selected, you are able to set the local annotation settings on a measurement by measurement basis.

Key Path	View/Display, Display, System Display Settings
Remote Command	:DISPlay:WINDow[1]:ANNotation[:ALL] OFF ON 0 1 :DISPlay:WINDow[1]:ANNotation[:ALL]?
Example	:DISP:WIND:ANN OFF
Preset	On (Set by Restore Misc Defaults)
State Saved	Not saved in instrument state.
Backwards Compatibility Notes	The WINDow parameter and optional subopcode is included for backwards compatibility but ignored – all windows are equally affected.
Initial S/W Revision	Prior to A.02.00

Themes

Accesses a menu of functions that enable you to choose the theme to be used when saving the screen image.

The **Themes** option is the same as the **Themes** option under the **Display** and **Page Setup** dialogs. It allows you to choose between themes to be used when saving the screen image.

Key Path	Save, Screen Image
Remote Command	:MMEMory:STORe:SCReEn:THEMe TDCoLor TDMonochrome FCOLor FMONochrome :MMEMory:STORe:SCReEn:THEMe?
Example	:MMEM:STOR:SCR:THEM TDM
Preset	3D Color; Is not part of Preset, but is reset by Restore Misc Defaults or Restore System Defaults All and survives subsequent running of the modes.
Readback	3D Color 3D Mono Flat Color Flat Mono
Backwards Compatibility Notes	In ESA and PSA we offer the choice of "Reverse Bitmap" or "Reverse Metafile" when saving screen images. This is much like the "Flat Color" theme available in X-Series. Also, if you selected Reverse Bitmap AND a black & white screen image, that would be much like "Flat Monochrome". In other words, each of the X-Series themes has a similar screen image type in ESA/PSA. But they are not identical.
Initial S/W Revision	Prior to A.02.00

3D Color

Selects a standard color theme with each object filled, shaded and colored as designed.

Key Path	Save, Screen Image, Themes
Example	MMEM:STOR:SCR:THEM TDC
Readback	3D Color
Initial S/W Revision	Prior to A.02.00

3D Monochrome

Selects a format that is like 3D color but shades of gray are used instead of colors.

Key Path	Save, Screen Image, Themes
Example	MMEM:STOR:SCR:THEM TDM
Readback	3D Mono
Initial S/W Revision	Prior to A.02.00

Flat Color

Selects a format that is best when the screen is to be printed on an ink printer.

Key Path	Save, Screen Image, Themes
Example	MMEM:STOR:SCR:THEM FCOL
Readback	Flat Color
Initial S/W Revision	Prior to A.02.00

Flat Monochrome

Selects a format that is like Flat Color. But only black is used (no colors, not even gray), and no fill.

Key Path	Save, Screen Image, Themes
Example	MMEM:STOR:SCR:THEM FMON
Readback	Flat Mono
Initial S/W Revision	Prior to A.02.00

Backlight

Accesses the display backlight on/off keys. This setting may interact with settings under the Windows "Power" menu.

When the backlight is off, pressing ESC, TAB, SPACE, ENTER, UP, DOWN, LEFT, RIGHT, DEL, BKSP, CTRL, or ALT turns the backlight on without affecting the application. Pressing any other key will turn backlight on and could potentially perform the action as well.

Key Path	View/Display, Display, System Display Settings
Remote Command	:DISPlay:BACKlight ON OFF :DISPlay:BACKlight?

Preset	ON (Set by Restore Misc Defaults)
Initial S/W Revision	Prior to A.02.00

Backlight Intensity

An active function used to set the backlight intensity. It goes from 0 to 100 where 100 is full on and 0 is off. This value is independent of the values set under the Backlight on/off key.

Key Path	View/Display, Display, System Display Settings
Remote Command	:DISPlay:BACKlight:INTensity <integer> :DISPlay:BACKlight:INTensity?
Example	DISP:BACK:INT 50
Preset	100 (Set by Restore Misc Defaults)
Min	0
Max	100
Initial S/W Revision	Prior to A.02.00

13 Burst Power (Transmit Power)

The Burst Power (Transmit Power) measurement (at the base transceiver station) is used to determine the power delivered to the antenna system on the radio-frequency channel under test. The Burst Power measurement verifies the accuracy of the mean transmitted RF carrier power. This can be done across the frequency range and at each power step. For more information, see ["Transmit Power \(Burst Power\) Measurement Description" on page 2086](#). For measurement results and views, see ["View/Display" on page 2279](#).

This topic contains the following sections.

["Measurement Commands for Burst Power \(Transmit Power\)" on page 2083](#)

["Remote Command Results for Burst Power \(Transmit Power\)" on page 2084](#)

Measurement Commands for Burst Power (Transmit Power)

The general functionality of CONFigure, FETCh, MEASure, and READ are described at the beginning of this section. See the SENSE:TXPower|BPOWer commands for more measurement related commands.

NOTE

The BPOWer form of the commands is included for backward compatibility only. They are not recommended for use in new designs. Use the TXPower keyword.

The following commands and queries are used to retrieve the measurement results:

:CONFigure:TXPower|BPOWer

:CONFigure:TXPower|BPOWer:NDEFault

:INITiate:TXPower|BPOWer

:FETCh:TXPower|BPOWer[n]?

:READ:TXPower|BPOWer[n]?

:MEASure:TXPower|BPOWer[n]?

For more remote command information, see SENSE:TXPower|BPOWer commands and the section, ["Remote Measurement Functions" on page 3140](#).

Remote Command Results for Burst Power (Transmit Power)

For the queries listed above, the results returned depend on the value of n, as follows.

n	Results Returned
0	Returns unprocessed I/Q trace data, as a series of comma-separated trace points, in volts. The I values are listed first in each pair, using the 0 through even-indexed values. The Q values are the odd-indexed values.
not specified or n = 1	<p>Returns the following comma-separated scalar results:</p> <ol style="list-style-type: none"> 1. Sample time is a floating point number representing the time between samples when using the trace queries (n=0, 2, etc.). 2. Power is the mean power (in dBm) of the power value that calculated by specified method: above the threshold or measured burst width. If averaging is on, the power is for the latest acquisition. 3. Power averaged is the power (in dBm) for N averages, if averaging is on. An average consists of N acquisitions of data which represents the current trace. If averaging is off, the value of Power averaged is the same as the Power value. 4. Number of samples is the number of data points in the captured signal. This number is useful when performing a query on the signal (i.e. when n=0, 2, etc.). 5. Threshold value is the absolute threshold level (in dBm) above which the power is calculated when Meas Method is set to Above Threshold. 6. Threshold points is the number of points that were above the threshold and were used to calculate Mean Transmit Power when Meas Method is set to Above Threshold. If Meas Method is set to Measured Burst Width, Measured Pts is returned. 7. Maximum value is the maximum peak level of the most recently acquired trace data (in dBm). 8. Minimum value is the minimum peak level of the most recently acquired trace data (in dBm). <p>Full Burst width is the burst width of this signal regardless of the parameter value set for the current Measured width. The Burst width is determined by the Threshold Lvl when Meas Method is set to Measured Burst Width. If Meas Method is set to Above Threshold Lvl, this value is 0.</p> <ol style="list-style-type: none"> 9. Full Burst width is the burst width of this signal regardless of the parameter value set for the current Measured width. The Burst width is determined by the Threshold Lvl when Meas Method is set to Measured

n	Results Returned
	Burst Width. If Meas Method is set to Above Threshold Lvl, this value is zero.
10.	Measured width is the time length that is used to calculate Mean Transmit Power when Meas Method is set to Measured Burst Width. If Meas Method is set to Above Threshold, this value is zero.
11.	Measured points is the number of points used to calculate Mean Transmit Power when Meas Method is set to Measured Burst Width. If Meas Method is set to Above Threshold, this value is 0.
2	Returns comma-separated trace points of the Measure Trace data. These data points are floating point numbers representing the power of the signal (in dBm). There are N data points, where N is the number of samples. The period between the samples is defined by the sample time.
3	Returns comma-separated trace points of the Max Hold Trace data. These data points are floating point numbers representing the power of the signal (in dBm). There are N data points, where N is the number of samples. The period between the samples is defined by the sample time. * This is not available in TD-SCDMA.
4	Returns comma-separated trace points of the Min Hold Trace data. These data points are floating point numbers representing the power of the signal (in dBm). There are N data points, where N is the number of samples. The period between the samples is defined by the sample time. * This is not available in TD-SCDMA.

Transmit Power (Burst Power) Measurement Description

Mobile stations and base transceiver stations must transmit enough power, with sufficient modulation accuracy, to maintain a call of acceptable quality without leaking power into frequency channels or timeslots allocated for others. The Burst Power measurement determines the average power for an RF signal burst at or above a specified threshold value or during the detected burst width. The threshold value may be absolute, or relative to the peak value of the signal. Burst width can be set automatically or manually.

Key Path	Front-panel key
Initial S/W Revision	Prior to A.02.00

AMPTD Y Scale

Accesses a menu of functions that enable you to set the vertical scale parameters. Many of the parameter values are measurement dependent. Attenuation values, and the Internal Preamp selection are measurement global, so they are common across all measurements. Functions with operation unique to this measurement are described below. See ["AMPTD Y Scale" on page 598](#) for more information.

Key Path	Front-panel key
Initial S/W Revision	Prior to A.02.00

Y Ref Value

Sets the absolute power reference.

Key Path	AMPTD Y Scale
Mode	SA, GSM, TD-SCDMA
Remote Command	<code>:DISP:TXPower:VIEW[1]:WINDow[1]:TRACe:Y[:SCALe]:RLEVel <real></code> <code>:DISP:TXPower:VIEW[1]:WINDow[1]:TRACe:Y[:SCALe]:RLEVel?</code>
Example	DISP:TXP:VIEW:WIND:TRAC:Y:RLEV 5dbm DISP:TXP:VIEW:WIND:TRAC:Y:RLEV?
Notes	You must be in the Spectrum Analyzer mode, TD-SCDMA mode or GSM mode to use this command. Use INSTRUMENT:SElect to set the mode.
Couplings	When Y Auto Scaling is On, this value is automatically determined by the measurement result. When the user sets this value manually, Y Auto Scaling automatically changes to Off.
Preset	10.00
State Saved	Saved in instrument state.
Min	-250.0
Max	250.0
Initial S/W Revision	Prior to A.02.00

Attenuation

This menu controls the attenuator functions and interactions between the attenuation system components.

There are two attenuator configurations in the X-Series. One is a dual attenuator configuration consisting of a mechanical attenuator and an optional electronic attenuator. The other configuration uses a single attenuator with combined mechanical and electronic sections that controls all the attenuation functions. Different models in the X-Series come with different configurations.

See ["Dual Attenuator Configurations:" on page 2088](#)

See ["Single Attenuator Configuration:" on page 2089](#)

Most Attenuation settings are the same for all measurements – they do not change as you change measurements. Settings like these are called “Meas Global” and are unaffected by Meas Preset.

Key Path	AMPTD Y Scale
Scope	Meas Global
Dependencies	In measurements that support the I/Q inputs, this key is unavailable when I/Q is the selected input, and is replaced by the Range key in that case.
Readback Line	Contains a summary in [] brackets of the current total attenuation. See the descriptions of the , " (Mech) Atten " on page 3103, and "Enable Elec Atten" on page 3105 keys for more detail on the contributors to the total attenuation. Note that when "Pre-Adjust for Min Clip" is on, this value can change at the start of every measurement.
Initial S/W Revision	Prior to A.02.00
Modified at S/W Revision	A.03.00

Dual Attenuator Configurations:

Configuration 1: Mechanical attenuator + optional electronic attenuator

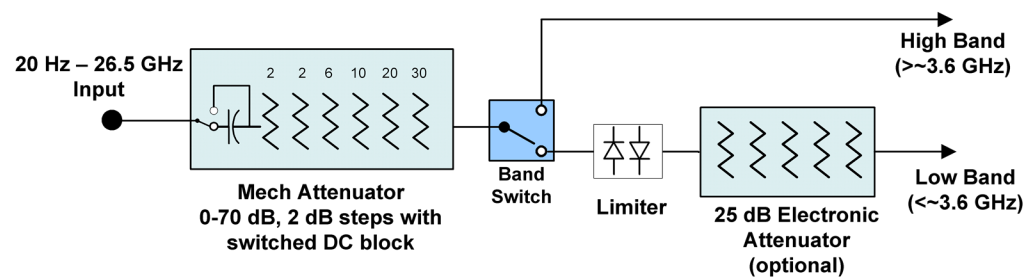

Configuration 2: Mechanical attenuator, no optional electronic attenuator

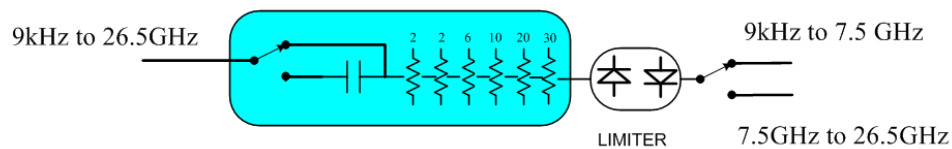

(note that Configuration 2 is not strictly speaking a dual-section attenuator, since there is no electronic section available. However, it behaves exactly like Configuration 1 without the Electronic Attenuator option EA3, therefore for the sake of this document it is grouped into the “Dual Attenuator” configuration)

Single Attenuator Configuration:

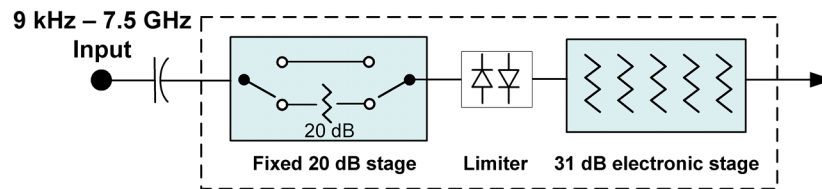

You can tell which attenuator configuration you have by pressing the Attenuation key, which (in most Modes) opens the Attenuation menu. If the first key in the Attenuation menu says **Mech Atten** you have the dual attenuator configuration. If the first key says **Atten** you have the single attenuator configuration.

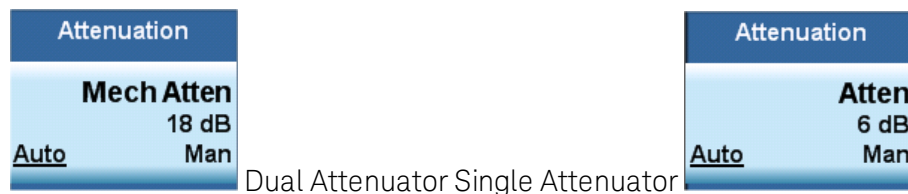

In the single attenuator configuration, you control the attenuation with a single control, as the fixed stage has only two states. In the dual attenuator configuration, both stages have significant range so you are given separate control of the mechanical and electronic attenuator stages.

When you have the dual attenuator configuration, you may still have only a single attenuator, because unless option EA3 (the Electronic Attenuator option) is available, and you purchase it, you will have only the mechanical attenuator.

(Mech) Atten

This key is labeled **Mech Atten** in dual attenuator models and **Atten** in single attenuator models. In the dual attenuator configuration, this key only affects the mechanical attenuator.

This key lets you modify the attenuation applied to the RF input signal path. This value is normally auto coupled to the Ref Level, the Internal Preamp Gain, any External Gain that is entered, and the Max Mixer Level, as described in the table below.

See "[Attenuator Configurations and Auto/Man](#)" on page 2091

Key Path	AMPTD Y Scale, Attenuation
Remote Command	[:SENSe]:POWer[:RF]:ATTenuation <rel_amp1> [:SENSe]:POWer[:RF]:ATTenuation? [:SENSe]:POWer[:RF]:ATTenuation:AUTO OFF ON 0 1 [:SENSe]:POWer[:RF]:ATTenuation:AUTO?
Example	POW:ATT 20 Dual attenuator configuration: sets the mechanical attenuator to 20 dB Single attenuator mode: sets the main attenuation to 20 dB (see below for definition of "main" attenuation).

	If the attenuator was in Auto, it sets it to Manual.
Dependencies	<p>Some measurements do not support the Auto setting of (Mech) Atten. In these measurements, the Auto/Man selection is not available, and the Auto/Man line on the key disappears.</p> <p>In dual attenuator configurations, when the electronic attenuator is enabled, the mechanical attenuator has no auto setting and the Auto/Man line on the key disappears. The state of Auto/Man is remembered and restored when the electronic attenuator is once again disabled. This is described in more detail in the "Enable Elec Atten" on page 3105 key description.</p> <p>See "Attenuator Configurations and Auto/Man" on page 2091 for more information on the Auto/Man functionality of Attenuation.</p>
Couplings	<p>When (Mech) Atten is in Auto, it uses the following algorithm to determine a value:</p> <p>If the USB Preamp is connected to USB, use 0 dB.</p> <p>Otherwise, $Atten = ReferenceLevel + PreAmpGain + ExternalGain - RefLevelOffset - MaxMixerLevel + IF\ Gain$.</p> <p>Limit this value to be between 6 dB and the Max value. No value below 6 dB can ever be chosen by Auto.</p> <p>The resulting value is rounded up to the largest value possible given the attenuation step setting. That is, 50.01 dB would change to 60 dB (for a 10 dB attenuation step).</p> <p>The "IF Gain" term in the equation above is either 0 dB or +10 dB, depending on the settings of FFT IF Gain, Swept IF Gain, max Ref Level and the Auto/Man setting of Mech Atten.</p> <p>In External Mixing and BBIQ, where the Attenuator is not in the signal path, the Attenuator setting changes as described above when (Mech) Atten is in Auto, but no changes are made to the actual attenuator hardware setting until the input is changed back to the RF Input.</p>
Preset	<p>The preset for Mech Attenuation is "Auto."</p> <p>The Auto value of attenuation is:</p> <p>CXA, EXA, MXA and PXA: 10 dB</p>
State Saved	Saved in instrument state
Min	<p>0 dB</p> <p>The attenuation set by this key cannot be decreased below 6 dB with the knob or step keys. To get to a value below 6 dB it has to be directly entered from the keypad or via SCPI. This protects from adjusting the attenuation to a dangerously small value which can put the instrument at risk of damage to input circuitry. However, if the current mechanical attenuation is below 6 dB it can be increased with the knob and step keys, but not decreased.</p>
Max	<p>CXA N9000A-503/507: 50 dB</p> <p>CXA N9000A-513/526: 70dB</p> <p>EXA: 60 dB</p> <p>MXA and PXA: 70 dB</p> <p>In the single attenuator configuration, the total of ATT and EATT cannot exceed 50 dB, so if the EATT is set to 24 dB first, the main attenuation cannot be greater than 26 dB and will be reduced accordingly; if the main attenuator is set to 40 dB first, EATT cannot be greater than 10 dB.</p>
Initial S/W Revision	Prior to A.02.00
Modified at S/W Revision	A.03.00

Attenuator Configurations and Auto/Man

As described in the Attenuation key description, there are two distinct attenuator configurations available in the X-Series, the single attenuator and dual attenuator configurations. In dual attenuator configurations, we have the mechanical attenuation and the electronic attenuation, and the current total attenuation is the sum of the electronic + mechanical attenuation. In single attenuator configurations, we refer to the attenuation set using the **(Mech) Atten** key (or POW:ATT SCPI) as the “main” attenuation; and the attenuation that is set by the SCPI command POW:EATT as the “soft” attenuation (the POW:EATT command is honored even in the single attenuator configuration, for compatibility purposes). Then the current total attenuation is the sum of the main + soft attenuation. See the **Elec Atten** key description for more on “soft” attenuation.

In the dual attenuator configuration, when the electronic attenuator is enabled, there is no Auto/Man functionality for the mechanical attenuator, and the third line of the key label (the Auto/Man line) disappears:

Mech Atten
0 dB
<u>Auto</u> Man

Mech Atten
0 dB

Mech Atten when elec atten disabled
--

Mech Atten when elec atten enabled

vsd05

Enable Elec Atten

Enables the Electronic Attenuator.

The electronic attenuator offers finer steps than the mechanical attenuator, has no acoustical noise, is faster, and is less subject to wear. These advantages primarily aid in remote operation and are negligible for front panel use. See ["Using the Electronic Attenuator: Pros and Cons" on page 2093](#) for a detailed discussion of the pros and cons of using the electronic attenuator.

For the single attenuator configuration, for SCPI backwards compatibility, the “soft” attenuation feature replaces the dual attenuator configuration’s electronic attenuator. All the same couplings and limitations apply. See ["Attenuator Configurations and Auto/Man" on page 3105](#)

See [Error! Reference source not found.](#)

Key Path	AMPTD Y Scale, Attenuation
Remote Command	[:SENSe] : POWer [:RF] : EATTenuation : STATe OFF ON 0 1 [:SENSe] : POWer [:RF] : EATTenuation : STATe ?
Example	POW:EATT:STAT ON
Dependencies	This key only appears in Dual Attenuator models with an Electronic Attenuator installed. It does not appear in models with the Single Attenuator configuration, as in the single attenuator configuration there is no “electronic attenuator” there is only a single integrated attenuator (which has both a mechanical and electronic stage). However, in the single attenuator configuration, EATT SCPI commands are accepted for compatibility with other X-series

instruments and set a “soft” attenuation as described in "[Attenuator Configurations and Auto/Man](#)" on page 3105.

The electronic attenuator (and the “soft” attenuation function provided in single attenuator configurations) is unavailable above 3.6 GHz. Therefore, if the Stop Frequency of the analyzer is > 3.6 GHz then the **Enable Elec Atten** key will be OFF and grayed out.

If the Internal Preamp is on, meaning it is set to Low Band or Full, the electronic attenuator (and the “soft” attenuation function provided in single attenuator configurations) is unavailable. In this case the **Enable Elec Atten** key will be OFF and grayed out.

If either of the above is true, if the SCPI command is sent, an error indicating that the electronic attenuator is unavailable will be sent.

If the electronic/soft Attenuator is enabled, then the Stop Freq of the analyzer is limited to 3.6 GHz and the Internal Preamp is unavailable.

The SCPI-only “soft” electronic attenuation for the single-attenuator configuration is not available in all measurements; in particular, it is not available in the Swept SA measurement.

Couplings	Enabling and disabling the Electronic Attenuator affects the setting of the Mechanical Attenuator (in dual attenuator configurations). This is described in more detail below this table.
Preset	OFF for Swept SA measurement; ON for all other measurements that support the electronic attenuator
State Saved	Saved in instrument state
Initial S/W Revision	Prior to A.02.00
Modified at S/W Revision	A.03.00

Mechanical Attenuator Transition Rules

When the Electronic Attenuator is enabled, the Mechanical Attenuator transitions to a state that has no Auto function. Below are the rules for transitioning the Mechanical Attenuator. NOTE that the information below ONLY applies to the dual attenuator configurations, and ONLY when the Electronic Attenuator is installed:

When the Electronic Attenuation is enabled from a disabled state:

- The Mechanical Attenuator is initialized to 10 dB (this is its optimal performance setting). You can then set it as desired with SCPI, numeric keypad, step keys, or knob, and it behaves as it normally would in manual mode
- The Auto/Man state of (Mech) Atten is saved
- The Auto/Man line on the (Mech) Atten key disappears and the auto rules are disabled
- The Electronic Attenuator is set to 10 dB less than the previous value of the Mechanical Attenuator, within the limitation that it must stay within the range of 0 to 24 dB of attenuation.

Examples in the dual attenuator configuration:

- Mech Atten at 20 dB. Elec Atten enabled, Mech Atten set to 10 dB, and Elec Atten set to 10 dB. New total attenuation equals the value before Elec Atten enabled.
- Mech Atten at 0 dB. Elec Atten enabled, Mech Atten set to 10 dB, and Elec Atten set to 0 dB. New total attenuation does not equal the value before Elec Atten enabled.
- Mech Atten at 40 dB. Elec Atten enabled, Mech Atten set to 10 dB, and Elec Atten set to 24 dB. New total attenuation does not equal the value before Elec Atten enabled.

When the Electronic Attenuation is disabled from an enabled state:

- The Elec Atten key is grayed out
- The Auto/Man state of (Mech) Atten is restored
- If now in Auto, (Mech) Atten recouples
- If now in Man, (Mech) Atten is set to the value of total attenuation that existed before the Elec Atten was disabled. The resulting value is rounded up to the smallest value possible given the (Mech) Atten Step setting - (That is, 57 dB changes to 58 dB when (Mech) Atten Step is 2 dB.)

Using the Electronic Attenuator: Pros and Cons

The electronic attenuator offers finer steps than the mechanical attenuator, has no acoustical noise, is faster, and is less subject to wear.

The “finer steps” advantage of the electronic attenuator is beneficial in optimizing the alignment of the analyzer dynamic range to the signal power in the front panel as well as remote use. Thus, you can achieve improved relative signal measurement accuracy. Compared to a mechanical attenuator with 2 dB steps, the 1 dB resolution of the electronic attenuator only gives better resolution when the odd-decibel steps are used. Those odd-decibel steps are less accurately calibrated than the even-decibel steps, so one tradeoff for this superior relative accuracy is reduced absolute amplitude accuracy.

Another disadvantage of the electronic attenuator is that the spectrum analyzer loses its “Auto” setting, making operation less convenient.

Also, the relationship between the dynamic range specifications (TOI, SHI, compression and noise) and instrument performance are less well-known with the electrical attenuator. With the mechanical attenuator, TOI, SHI and compression threshold levels increase dB-for-dB with increasing attenuation, and the noise floor does as well. With the electronic attenuator, there is an excess attenuation of about 1 to 3 dB between 0 and 3.6 GHz, making the effective TOI, SHI, and so forth, less

well known. Excess attenuation is the actual attenuation relative to stated attenuation. Excess attenuation is accounted for in the analyzer calibration

Elec Atten

Controls the Electronic Attenuator in dual attenuator configurations. This key does not appear in single attenuator configurations, as the control of both the mechanical and electronic stages of the single attenuator is integrated into the single **Atten** key.

Key Path	AMPTD Y Scale, Attenuation
Remote Command	[:SENSe] : POWer [:RF] : EATTenuation <rel_amp1> [:SENSe] : POWer [:RF] : EATTenuation?
Notes	Electronic Attenuation's specification is defined only when Mechanical Attenuation is 6 dB.
Dependencies	This key only appears in Dual Attenuator models with an Electronic Attenuator installed. It does not appear in models with the Single Attenuator configuration, as in the single attenuator configuration there is no "electronic attenuator" there is only a single integrated attenuator (which has both a mechanical and electronic stage). However, in the single attenuator configuration, EATT SCPI commands are accepted for compatibility with other X-series instruments and set a "soft" attenuation as described in " Attenuator Configurations and Auto/Man " on page 3105. The "soft" attenuation is treated as an addition to the "main" attenuation value set by the Atten softkey or the POW:ATT SCPI command and affects the total attenuation displayed on the Attenuation key and the Meas Bar. When Enable Elec Atten is off or grayed out, the Elec Atten key is grayed out.
Preset	0 dB
State Saved	Saved in instrument state
Min	0 dB
Max	Dual attenuator configuration: 24 dB Single attenuator configuration: the total of ATT and EATT cannot exceed 50 dB, so if the EATT is set to 24 dB first, the main attenuation cannot be greater than 26 dB and will be reduced accordingly; if the main attenuator is set to 40 dB first, EATT cannot be greater than 10 dB
Initial S/W Revision	Prior to A.02.00
Modified at S/W Revision	A.03.00

Adjust Atten for Min Clip

Sets the combination of mechanical and electronic attenuation and gain based on the current measured signal level so that clipping will be at a minimum.

This is an "immediate action" function, that is, it executes once, when the key is pressed.

This key does not appear in measurements that do not support this functionality. The spectrum analyzer measurement, Swept SA, does not support this functionality.

Key Path	AMPTD Y Scale, Attenuation
Remote Command	[:SENSe] : POWer [:RF] : RANGE:OPTimize IMMEDIATE

Initial S/W Revision	Prior to A.02.00
Modified at S/W Revision	A.03.00

Pre-Adjust for Min Clip

If this function is on, it does the adjustment described under "[Adjust Atten for Min Clip](#)" on page 3108 each time a measurement restarts. Therefore, in Continuous measurement mode, it only executes before the first measurement.

In dual attenuator models, you can set **Elec+Mech Atten**, in which case both attenuators participate in the autoranging, or **Elec Atten Only**, in which case the mechanical attenuator does not participate in the autoranging. This latter case results in less wear on the mechanical attenuator and is usually faster.

This key is grayed out in measurements that do not support this functionality. The spectrum analyzer measurement, Swept SA, does not support this functionality.

Key Path	AMPTD Y Scale, Attenuation
Remote Command	<code>[:SENSe]:POWer[:RF]:RANGe:OPTimize:ATTenuation OFF ELECtrical COMBined</code> <code>[:SENSe]:POWer[:RF]:RANGe:OPTimize:ATTenuation?</code>
Notes	The SCPI parameter ELECtrical sets this function to On in single attenuator models. The SCPI parameter COMBined is mapped to ELECtrical in single attenuator models; if you send COMBined, it sets the function to On and returns ELEC to a query.
Dependencies	This key only appears in Dual Attenuator models with an Electronic Attenuator installed. In instruments with Dual Attenuator model, when Enable Elec Atten is off or grayed out, the Pre-Adjust for Min Clip key is grayed out.
Preset	OFF for Swept SA measurement; ON for all other measurements that support Pre-Adjust for Min Clip
State Saved	Saved in instrument state
Range	Dual attenuator models: Off Elec Atten Only Mech + Elec Atten Single attenuator models: Off On
Initial S/W Revision	Prior to A.02.00
Modified at S/W Revision	A.03.00

Remote Command	<code>[:SENSe]:POWer[:RF]:RANGe:AUTO ON OFF 1 0</code> <code>[:SENSe]:POWer[:RF]:RANGe:AUTO?</code>
Notes	ON aliases to "Elec Atten Only" (:POW:RANG:OPT:ATT ELEC) OFF aliases to "Off" (:POW:RANG:OPT:ATT OFF) The query :POW:RANG:AUTO? returns true if :POW:RANG:OPT:ATT is not "Off"
Initial S/W Revision	Prior to A.02.00

Off

Turns **Pre-Adjust for Min Clip** off. This is the default setting.

This key is grayed out in measurements that do not support this functionality. The spectrum analyzer measurement, Swept SA, does not support this functionality.

Key Path	AMPTD Y Scale, Attenuation, Pre-Adjust for Min Clip
Example	:POW:RANGe:OPT:ATT OFF
Initial S/W Revision	Prior to A.02.00

Elec Atten Only

Selects only the electric attenuator to participate in auto ranging. This offers less wear on the mechanical attenuator and is usually faster.

This key is grayed out in measurements that do not support this functionality. The spectrum analyzer measurement, Swept SA, does not support this functionality.

Key Path	AMPTD Y Scale, Attenuation, Pre-Adjust for Min Clip
Example	:POW:RANGe:OPT:ATT ELEC
Initial S/W Revision	Prior to A.02.00

Mech + Elec Atten

In dual attenuator models, this selects both attenuators participate in the autoranging.

This key is grayed out in measurements that do not support this functionality. The spectrum analyzer measurement, Swept SA, does not support this functionality.

Key Path	AMPTD Y Scale, Attenuation, Pre-Adjust for Min Clip
Example	:POW:RANGe:OPT:ATT COMB
Initial S/W Revision	Prior to A.02.00

(Mech) Atten Step

This controls the step size used when making adjustments to the input attenuation.

This key is labeled **Mech Atten Step** in dual attenuator models and **Atten Step** in single attenuator models. In the dual attenuator configuration, this key only affects the step size of the mechanical attenuator.

Key Path	AMPTD Y Scale, Attenuation
Remote Command	[:SENSe]:POWer[:RF]:ATTenuation:STEP[:INCRement] 10 dB 2 dB [:SENSe]:POWer[:RF]:ATTenuation:STEP[:INCRement]?
Example	POW:ATT:STEP 2
Notes	Note this feature works like a 1-N choice from the front panel, but it takes a specific value (in dB) when used remotely. The only valid values are 2 and 10.

Dependencies	Blanked in CXA and EXA if option FSA (2 dB steps) is not present. If blanked, attempts to set it via SCPI will yield an error.
Couplings	When the attenuation step size changes, the current mechanical attenuation value is adjusted (if necessary) to be quantized to the new step size. That is, if step is set to 10 dB, mech atten is increased if necessary so it is a multiple of 10 dB
Preset	PXA and MXA: 2 dB EXA and CXA: 10 dB (2 dB with option FSA)
State Saved	Saved in instrument state
Initial S/W Revision	Prior to A.02.00
Modified at S/W Revision	A.03.00

Max Mixer Level

Controls the limitation on the Ref Level for a given attenuation setting, and therefore also interacts with the Auto rules for selecting the attenuation as a coupling from the reference level.

Key Path	AMPTD Y Scale, Attenuation
Remote Command	[:SENSe] :POWer [:RF] :MIXer :RANGe [:UPPer] <real> [:SENSe] :POWer [:RF] :MIXer :RANGe [:UPPer] ?
Example	POW:MIX:RANG -15 dBm
Preset	-10 dBm
State Saved	Saved in instrument state
Min	-50 dBm
Max	0 dBm
Default Unit	Depends on the current selected Y axis unit, see Swept SA discussion of Y Axis Unit
Initial S/W Revision	Prior to A.02.00

Scale/Division

Enables you to enter a numeric value to change the vertical display sensitivity.

Key Path	AMPTD Y Scale
Mode	SA, GSM, TD-SCDMA
Remote Command	:DISPlay:TXPower:VIEW[1]:WINDow[1]:TRACe:Y[:SCALE]:PDIVision <rel_ ampl> :DISPlay:TXPower:VIEW[1]:WINDow[1]:TRACe:Y[:SCALE]:PDIVision?
Example	DISP:TXP:VIEW:WIND:TRAC:Y:PDIV 10dB DISP:TXP:VIEW:WIND:TRAC:Y:PDIV?
Notes	You must be in the Spectrum Analyzer mode, TD-SCDMA mode or GSM mode to use this command. Use INSTRument:SElect to set the mode.
Couplings	When the Y Auto Scaling is On, this value is automatically determined by the measurement

	result. When the user sets a value manually, Y Auto Scaling automatically changes to Off.
Preset	10.00 dB
State Saved	Saved in instrument state.
Min	0.1 dB
Max	20.00 dB
Initial S/W Revision	Prior to A.02.00

Presel Center

When this key is pressed, the centering of the preselector filter is adjusted to optimize the amplitude accuracy at the frequency of the selected marker. If the selected marker is not on when Presel Center is pressed, the analyzer will turn on the selected marker, perform a peak search, and then perform centering on the marker's center frequency. If the selected marker is already on and between the start and stop frequencies of the analyzer, the analyzer performs the preselector calibration on that marker's frequency. If the selected marker is already on, but outside the frequency range between Start Freq and Stop Freq, the analyzer will first perform a peak search, and then perform centering on the marker's center frequency.

The value displayed on the **Presel Adjust** key will change to reflect the new preselector tuning (see **Presel Adjust**).

A number of considerations should be observed to ensure proper operation. See ["Proper Preselector Operation" on page 2099](#).

Key Path	AMPTD Y Scale
Remote Command	[:SENSE] :POWer [:RF] :PCENter
Example	POW:PCEN
Notes	Note that the rules outlined above under the key description apply for the remote command as well as the key. The result of the command is dependent on marker position, and so forth. Any message shown by the key press is also shown in response to the remote command.
Dependencies	<ul style="list-style-type: none"> - Grayed out if the microwave preselector is off.) - If the selected marker's frequency is below Band 1, advisory message 0.5001 is generated and no action is taken. - Grayed out if entirely in Band 0. - Blank in models that do not include a preselector, such as option 503. If the SCPI is sent in these instruments, it is accepted without error, and the query always returns 0. - Grayed out in the Spectrogram View.
Couplings	The active marker position determines where the centering will be attempted. If the analyzer is in a measurement such as averaging when centering is initiated, the act of centering the preselector will restart averaging but the first average trace will not be taken until

	the centering is completed.
Status Bits/OPC dependencies	When centering the preselector, *OPC will not return true until the process is complete and a subsequent measurement has completed, nor will results be returned to a READ or MEASure command. The Measuring bit should remain set while this command is operating and should not go false until the subsequent sweep/measurement has completed.
Initial S/W Revision	Prior to A.02.00
Modified at S/W Revision	A.03.00

Proper Preselector Operation

A number of considerations should be observed to ensure proper operation:

3. If the selected marker is off, the analyzer will turn on a marker, perform a peak search, and adjust the preselector using the selected marker's frequency. It uses the "highest peak" peak search method unqualified by threshold or excursion, so that there is no chance of a 'no peak found' error. It continues with that peak, even if it is the peak of just noise. Therefore, for this operation to work properly, there should be a signal on screen in a preselected range for the peak search to find.
4. If the selected marker is already on, the analyzer will attempt the centering at that marker's frequency. There is no preselector for signals below about 3.6 GHz, therefore if the marker is on a signal below 3.6 GHz, no centering will be attempted and an advisory message generated
5. In some models, the preselector can be bypassed. If it is bypassed, no centering will be attempted in that range and a message will be generated.

Preselector Adjust

Allows you to manually adjust the preselector filter frequency to optimize its response to the signal of interest. This function is only available when "Presel Center" on page 3111 is available.

For general purpose signal analysis, using Presel Center is recommended. Centering the filter minimizes the impact of long-term preselector drift. Presel Adjust can be used instead to manually optimize the preselector. One application of manual optimization would be to peak the preselector response, which both optimizes the signal-to-noise ratio and minimizes amplitude variations due to small (short-term) preselector drifting.

Key Path	AMPTD Y Scale
Scope	Meas Global
Remote Command	[:SENSe] : POWer [:RF] : PADJust <freq> [:SENSe] : POWer [:RF] : PADJust?

Example	POW:PADJ 100KHz POW:PADJ?
Notes	The value on the key reads out to 0.1 MHz resolution.
Dependencies	<ul style="list-style-type: none"> - Grayed out if microwave preselector is off.) - Grayed out if entirely in Band 0. - Blank in models that do not include a preselector, such as option 503. If the SCPI is sent in these instruments, it is accepted without error, and the query always returns 0. - Grayed out in the Spectrogram View.
Preset	0 MHz
State Saved	The Presel Adjust value set by Presel Center , or by manually adjusting Presel Adjust , is not saved in instrument state, and does not survive a Preset or power cycle.
Min	-500 MHz
Max	500 MHz
Default Unit	Hz
Backwards Compatibility SCPI	<p><code>[:SENSe] :POWer [:RF] :MW :PADJ ust</code> <code>[:SENSe] :POWer [:RF] :MMW :PADJ ust</code></p> <p>PSA had multiple preselectors, but the X-Series has only one. These commands simply alias to <code>[:SENSe] :POWer [:RF] :PADJ ust</code></p>
Initial S/W Revision	Prior to A.02.00
Modified at S/W Revision	A.03.00

Remote Command	<code>[:SENSe] :POWer [:RF] :PADJ ust :PRESelector MWAVE MMWave EXTERNAL</code> <code>[:SENSe] :POWer [:RF] :PADJ ust :PRESelector ?</code>
Notes	<p>PSA had multiple preselectors, and you could select which preselector to adjust. Since the X-Series has only one mm/uW preselector, the preselector selection softkey is no longer available. However, to provide backward compatibility, we accept the legacy remote commands.</p> <p>The command form has no effect, the query always returns MWAVE</p>
Initial S/W Revision	Prior to A.02.00

Y Axis Unit

Displays the menu keys that enable you to change the vertical (Y) axis amplitude unit. The analyzer retains the entered Y Axis Unit separately for both Log and Lin amplitude scale types. For example, if Scale Type has been set to Log, and you set Y Axis Unit to dBm, pressing Scale Type (Log) sets the Y Axis Unit to dBm. If Scale Type has been set to Lin and you set Y Axis Unit to V, pressing Scale Type (Lin) sets the Y Axis Unit to V. Pressing Scale Type (Log) again sets the Y axis unit back to dBm.

NOTE

The units of current (A, dBmA, dBuA) are calculated based on 50 ohms input impedance.

All four of the EMI units (dB μ A/m, dB μ V/m, dBG, dBpT) are treated by the instrument exactly as though they were dBuV. The user must load an appropriate correction factor using Amplitude Corrections for accurate and meaningful results.

If a SCPI command is sent to the analyzer that uses one of the EMI units as a terminator, the analyzer treats it as though DBUV had been sent as the terminator.

Key Path	AMPTD Y Scale
Mode	SA
Scope	Meas Global
Remote Command	:UNIT:POWer DBM DBMV DBMA V W A DBUV DBUA DBPW DBUVM DBUAM DBPT DBG :UNIT:POWer?
Example	UNIT:POW dBmV UNIT:POW?
Notes	The Y axis unit has either logarithmic or linear characteristics. The set of units that is logarithmic consists of dBm, dBmV, dBmA, dB μ V, dB μ A, dB μ V/m, dB μ A/m, dBpT, and dBG. The set of units that are linear consists of V, W, and A. The chosen unit will determine how the reference level and all the amplitude-related outputs like trace data, marker data, etc. read out.
Notes	The settings of Y Axis Unit and Scale Type, affect how the data is read over the remote interface. When using the remote interface no unit is returned, so you must know what the Y axis unit is to interpret the results: Example 1, set the following: Scale Type (Log) Y Axis Unit, dBm Scale/Div, 1 dB Ref Level, 10 dBm This sets the top line to 10 dBm with each vertical division representing 1 dB. Thus, if a point on trace 1 is on the fifth graticule line from the top, it represents 5 dBm and will read out remotely as 5. Example 2, set the following: Scale Type (Lin) Y Axis Unit, Volts Ref Level, 100 mV (10 mV/div) This sets the top line to 100 mV and the bottom line to 0 V, so each vertical division represents 10 mV. Thus, if a point on trace 1 is on the fifth graticule line from the top, it represents 50 mV and will read out remotely as 50.
Dependencies	If an amplitude correction with an Antenna Unit other than None is applied and enabled, then that antenna unit is forced and the key with that unit is the only Y Axis Unit available. All other Y Axis Unit keys are grayed out. If an amplitude correction with an Antenna Unit other than None is applied and enabled, and you then turn off that correction or set Apply Corrections to No , the Y Axis Unit that existed before the Antenna Unit was applied is restored.

Couplings	The analyzer retains the entered Y Axis Unit separately for both Log and Lin amplitude scale types
Preset	dBm for log scale, V for linear. The true 'preset' value is dBm, since at preset the Y Scale type is set to logarithmic.
State Saved	Saved in instrument state
Readback line	1-of-N selection
Initial S/W Revision	Prior to A.02.00
Modified at S/W Revision	A.02.00, A.04.00, A.11.00

dBm

Sets the amplitude unit for the selected amplitude scale (log/lin) to dBm.

Key Path	AMPTD Y Scale, Y Axis Unit
Example	UNIT:POW DBM
Dependencies	Grayed out if an Amplitude Correction with an Antenna Unit is ON.
Readback	dBm
Initial S/W Revision	Prior to A.02.00
Modified at S/W Revision	A.02.00

dBmV

Sets the amplitude unit for the selected amplitude scale (log/lin) to dBmV.

Key Path	AMPTD Y Scale, Y Axis Unit
Example	UNIT:POW DBMV
Dependencies	Grayed out if an Amplitude Correction with an Antenna Unit is ON.
Readback	dBmV
Initial S/W Revision	Prior to A.02.00
Modified at S/W Revision	A.02.00

dBmA

Sets the amplitude unit for the selected amplitude scale (log/lin) to dBmA.

Key Path	AMPTD Y Scale, Y Axis Unit
Example	UNIT:POW DBMA
Dependencies	Grayed out if an Amplitude Correction with an Antenna Unit is ON.
Readback	dBmA
Initial S/W Revision	Prior to A.02.00
Modified at S/W Revision	A.02.00

W

Sets the amplitude unit for the selected amplitude scale (log/lin) to watt.

Key Path	AMPTD Y Scale, Y Axis Unit
Example	UNIT:POW W
Dependencies	Grayed out if an Amplitude Correction with an Antenna Unit is ON.
Readback	W
Initial S/W Revision	Prior to A.02.00
Modified at S/W Revision	A.02.00

V

Sets the amplitude unit for the selected amplitude scale (log/lin) to volt.

Key Path	AMPTD Y Scale, Y Axis Unit
Example	UNIT:POW V
Dependencies	Grayed out if an Amplitude Correction with an Antenna Unit is ON.
Readback	V
Initial S/W Revision	Prior to A.02.00
Modified at S/W Revision	A.02.00

A

Sets the amplitude unit for the selected amplitude scale (log/lin) to Ampere.

Key Path	AMPTD Y Scale, Y Axis Unit
Example	UNIT:POW A
Dependencies	Grayed out if an Amplitude Correction with an Antenna Unit is ON.
Readback	A
Initial S/W Revision	Prior to A.02.00
Modified at S/W Revision	A.02.00

dB μ V

Sets the amplitude unit for the selected amplitude scale (log/lin) to dB μ V.

Key Path	AMPTD Y Scale, Y Axis Unit
Example	UNIT:POW DBUV
Dependencies	Grayed out if an Amplitude Correction with an Antenna Unit is ON.
Readback	dB μ V
Initial S/W Revision	Prior to A.02.00

Modified at S/W Revision	A.02.00
--------------------------	---------

dB μ A

Sets the amplitude unit for the selected amplitude scale (log/lin) to dB μ A.

NOTE

The unit dBuA can also appear as an Antenna Unit. This will be used by customers using current probes, because current probes are often supplied with conversion tables that provide the transducer factors. When dBuA is used as an Antenna Unit the normal conversion from power to amps for dBuA (based on the analyzer input impedance) is not done, but instead the conversion is based solely on the Correction that contains the transducer factors. This is what distinguishes dBuA as a normal unit from dBuA as an antenna unit. When querying the Y-Axis unit, you can query the Antenna Unit to distinguish between regular dBuA and the dBuA antenna unit. If :CORR:CSET:ANT? returns NOC (for No Conversion), you are using a normal Y Axis dBuA. If it returns UA you are using an Antenna Unit dBuA.

Key Path	AMPTD Y Scale, Y Axis Unit
Example	UNIT:POW DBUA
Dependencies	Grayed out if an Amplitude Correction with an Antenna Unit is ON.
Readback	dB μ A
Initial S/W Revision	Prior to A.02.00
Modified at S/W Revision	A.02.00

Antenna Unit

When a Correction is turned on that uses an Antenna Unit, the Y Axis Unit changes to that Antenna Unit. All of the keys in the Y-Axis Unit menu are then greyed out, except the Antenna Unit key. The unit being used is shown on this key and is shown as selected in the submenu.

Key Path	AMPTD Y Scale, Y Axis Unit
Dependencies	Grayed out if no Amplitude Correction with an Antenna Unit is on.
Readback line	Currently selected unit
Initial S/W Revision	A.11.00

dB μ V/m

Sets the amplitude unit for the selected amplitude scale (log/lin) to dB μ V/m. This is an antenna unit, and this key is grayed out unless a Correction with this Antenna Unit selected is ON. If this is the case, all of the other Antenna Units are grayed out.

Key Path	AMPTD Y Scale, Y Axis Unit, Antenna Unit
Example	UNIT:POW DBUVM

Dependencies	Grayed out if no Amplitude Correction with an Antenna Unit is on.
Readback	dB μ V/m
Initial S/W Revision	A.02.00

dB μ A/m

Sets the amplitude unit for the selected amplitude scale (log/lin) to dB μ A/m. This is an antenna unit, and this key is grayed out unless a Correction with this Antenna Unit selected is ON. If this is the case, all of the other Antenna Units are grayed out.

Key Path	AMPTD Y Scale, Y Axis Unit, Antenna Unit
Example	UNIT:POW DBUAM
Dependencies	Grayed out if no Amplitude Correction with an Antenna Unit is on.
Readback	dB μ A/m
Initial S/W Revision	A.02.00

dB μ A

Sets the amplitude unit for the selected amplitude scale (log/lin) to dB μ A. This is an antenna unit, and this key is grayed out unless a Correction with this Antenna Unit selected is ON. If this is the case, all of the other Antenna Units are grayed out.

Key Path	AMPTD Y Scale, Y Axis Unit, Antenna Unit
Example	UNIT:POW DBUAM
Dependencies	Grayed out if no Amplitude Correction with an Antenna Unit is on.
Readback	dB μ A
Initial S/W Revision	A.11.00

dBpT

Sets the amplitude unit for the selected amplitude scale (log/lin) to dBpT. This is an antenna unit, and this key is grayed out unless a Correction with this Antenna Unit selected is ON. If this is the case, all of the other Antenna Units are grayed out.

Key Path	AMPTD Y Scale, Y Axis Unit, Antenna Unit
Example	UNIT:POW DBPT
Dependencies	Grayed out if no Amplitude Correction with an Antenna Unit is on.
Readback	dBpT
Initial S/W Revision	A.02.00

DBG

Sets the amplitude unit for the selected amplitude scale (log/lin) to DBG. This is an antenna unit, and this key is grayed out unless a Correction with this Antenna Unit selected is ON. If this is the case, all of the other Antenna Units are grayed out.

Key Path	AMPTD Y Scale, Y Axis Unit, Antenna Unit
Example	UNIT:POW DBG
Dependencies	Grayed out if no Amplitude Correction with an Antenna Unit is on.
Readback	dBG
Initial S/W Revision	A.02.00

None

This is selected if no Antenna Unit is currently on, however you cannot actually set this value, since it is always grayed out. The key is included simply to provide an indication on the Readback line of the Antenna Unit key when there is no Antenna Unit selected.

Key Path	AMPTD Y Scale, Y Axis Unit, Antenna Unit
Readback	"None"
Initial S/W Revision	A.11.00

Reference Level Offset

Adds an offset value to the displayed reference level. The reference level is the absolute amplitude represented by the top graticule line on the display.

See ["More Information" on page 2107](#)

Key Path	AMPTD Y Scale
Mode	SA
Scope	Meas Global
Remote Command	:DISPlay:WINDow[1]:TRACe:Y[:SCALE]:RLEVel:OFFSet <rel_amp1> :DISPlay:WINDow[1]:TRACe:Y[:SCALE]:RLEVel:OFFSet?
Example	DISP:WIND:TRAC:Y:RLEV:OFFS 12.7 Sets the Ref Level Offset to 12.7 dB. The only valid suffix is dB. If no suffix is sent, dB will be assumed.
Preset	0 dBm
State Saved	Saved in instrument state
Min	The range for Ref Lvl Offset is variable. It is limited to values that keep the reference level within the range of -327.6 dB to 327.6 dB.
Max	327.6 dB
Backwards Compatibility Notes	<ol style="list-style-type: none"> In pre-X-Series instruments, Ref Level Offset could not be adjusted by the knob or step keys. That is no longer the case. In ESA and PSA, Ref Level Offset was applied to the data as it was acquired; thus if the Offset changed the new offset was not applied until new trace data was taken. In X-Series, the offset is applied as the data is displayed/queried, so if you change the offset, it will change the data immediately.

Initial S/W Revision	Prior to A.02.00
Modified at S/W Revision	A.04.00

More Information

Offsets are used when gain or loss occurs between a device under test and the analyzer input. Thus, the signal level measured by the analyzer may be thought of as the level at the input of an external amplitude conversion device. Entering an offset does not affect the trace position or attenuation value, just the value of the top line of the display and the values represented by the trace data. Thus, the values of exported trace data, queried trace data, marker amplitudes, trace data used in calculations such as N dB points, trace math, peak threshold, and so forth, are all affected by Ref Level Offset.

NOTE

Changing the offset causes the analyzer to immediately stop the current sweep and prepare to begin a new sweep, but the data will not change until the trace data updates, because the offset is applied to the data as it is taken. If a trace is exported with a nonzero Ref Level Offset, the exported data will contain the trace data with the offset applied.

The maximum reference level available is dependent on the reference level offset. That is, Ref Level - Ref Level Offset must be in the range -170 to +30 dBm. For example, the reference level value range can be initially set to values from -170 dBm to 30 dBm with no reference level offset. If the reference level is first set to -20 dBm, then the reference level offset can be set to values of -150 to +50 dB.

If the reference level offset is first set to -30 dB, then the reference level can be set to values of -200 dBm to 0 dBm. In this case, the reference level is “clamped” at 0 dBm because the maximum limit of +30 dBm is reached with a reference level setting of 0 dBm with an offset of -30 dB. If instead, the reference level offset is first set to 30 dB, then the reference level can be set to values of -140 to +60 dBm.

μ W Path Control

The **μ W Path Control** functions include the **μ W Preselector Bypass** (Option MPB) and **Low Noise Path** (Option LNP) controls in the High Band path circuits.

When the μ W Preselector is bypassed, the user has better flatness, but will be subject to spurs from out of band interfering signals. When the Low Noise Path is enabled, the analyzer automatically switches around certain circuitry in the high frequency bands which can contribute to noise, when it is appropriate based on other analyzer settings.

For most applications, the preset state is Standard Path, which gives the best remote-control throughput, minimizes acoustic noise from switching and minimizes the risk of wear out in the hardware switches. For applications that utilize the wideband IF paths, the preset state is the μ W Preselector Bypass path, if option MPB is present. This is because, when using a wideband IF such as the 140 MHz IF, the μ W Preselector's bandwidth can be narrower than the available IF bandwidth,

causing degraded amplitude flatness and phase linearity, so it is desirable to bypass the preselector in the default case.

Users may choose Low Noise Path Enable. It gives a lower noise floor, especially in the 21-26.5 GHz region, though without improving many measures of dynamic range, and without giving the best possible noise floor. The preamp, if purchased and used, gives better noise floor than does the Low Noise Path, however its compression threshold and third-order intercept are much poorer than that of the non-preamp Low Noise Path. There are some applications, typically for signals around -30 dBm, for which the third-order dynamic range of the standard path is good enough, but the noise floor is not low enough even with 0 dB input attenuation. When the third-order dynamic range of the preamp path is too little and the noise floor of the standard path is too high, the Low Noise Path can provide the best dynamic range.

Key Path	AMPTD Y Scale
Mode	SA, BASIC, PNOISE, VSA , LTE, LTETDD
Scope	Meas Global
Remote Command	[:SENSe] :POWer [:RF] :MW:PATH STD LNPPath MPBypass FULL [:SENSe] :POWer [:RF] :MW:PATH?
Example	:POW:MW:PATH LNP Enables the Low Noise path
Notes	If a Presel Center is performed, the analyzer will momentarily switch to the Standard Path, regardless of the setting of μW Path Control The DC Block will always be switched in when the low noise path is switched in, to protect succeeding circuitry from DC. Note that this does not mean “when the low noise path is enabled” but when, based on the Low Noise Path rules, the path is actually switched in. This can happen when the selection is Low Noise Path Enable . In the case where the DC Block is switched in the analyzer is now AC coupled. However, if the user has selected DC coupling, the UI will still behave as though it were DC coupled, including all annunciation, warnings, status bits, and responses to SCPI queries. This is because, based on other settings, the analyzer could switch out the low noise path at any time and hence go back to being DC coupled. Alignment switching ignores the settings in this menu, and restores them when finished.
Dependencies	Unavailable in BBIQ and External Mixing
Preset	All modes other than IQ Analyzer mode and VXA: STD IQ Analyzer, VXA and WLAN mode: MPB option present and licensed: MPB MPB option not present and licensed: STD
State Saved	Save in instrument state
Readback	Value selected in the submenu
Initial S/W Revision	A.04.00
Modified at S/W Revision	A.10.00

Standard Path

This path gives the best remote-control throughput, minimizes acoustic noise from switching and minimizes the risk of wear in the hardware switches, particularly in remote test scenarios where both low band and high band setups will follow in rapid succession.

In this path, the bypass of the low band/high band switch and microwave preamp is never activated, which can cause some noise degradation but preserves the life of the bypass switch.

Key Path	AMPTD Y Scale, μW Path Control
Example	:POW:MW:PATH STD
Readback Text	Standard Path
Initial S/W Revision	A.04.00

μ W Preselector Bypass

This key toggles the preselector bypass switch for band 1 and higher. When the microwave preselect is on, the signal path is preselected. When the microwave preselector is off, the signal path is not preselected. The preselected path is the normal path for the analyzer.

The preselector is a tunable bandpass filter which prevents signals away from the frequency of interest from combining in the mixer to generate in-band spurious signals (images). The consequences of using a preselector filter are its limited bandwidth, the amplitude and phase ripple in its passband, and any amplitude and phase instability due to center frequency drift.

Option MPB or pre-selector bypass provides an unpreselected input mixer path for certain X-Series signal analyzers with frequency ranges above 3.6 GHz. This signal path allows a wider bandwidth and less amplitude variability, which is an advantage when doing modulation analysis and broadband signal analysis. The disadvantage is that, without the preselector, image signals will be displayed. Another disadvantage of bypassing the preselector is increased LO emission levels at the front panel input port.

Image responses are separated from the real signal by twice the 1st IF. For IF Paths of 10 MHz and 25 MHz, the 1st IF is 322.5 MHz, so the image response and the real signal will be separated by 645 MHz. The 1st IF will be different for other IF Path settings. When viewing a real signal and its corresponding image response in internal mixing, the image response will be to the left of the real signal.

Also, the image response and the real signal typically have the same amplitude and exhibit the same shape factor.

However, if Option FS1, Fast Sweep Capability, is enabled, the image response in the Swept SA measurement will appear lower in amplitude and have a much wider shape factor compared to the real signal.

Key Path	AMPTD Y Scale, μW Path Control
----------	--

Example	:POW:MW:PATH MPB
Dependencies	Key is blanked if current mode does not support it. Key is grayed out if mode supports it but current measurement does not support it. Key is blank unless Option MPB is present and licensed. If SCPI command sent when MPB not present, error -241, "Hardware missing; Option not installed" is generated.
Readback Text	μW Preselector Bypass
Initial S/W Revision	A.04.00

Remote Command	[:SENSe]:POWer[:RF]:MW:PRESelector[:STATe] ON OFF 0 1 [:SENSe]:POWer[:RF]:MW:PRESelector[:STATe]?
Example	:POW:MW:PRES OFF Bypasses the microwave preselector
Notes	The ON parameter sets the STD path (:POW:MW:PATH STD) The OFF parameter sets path MPB (:POW:MW:PATH MPB)
Preset	ON

Internal Preamp

Accesses a menu of keys that control the internal preamps. Turning on the preamp gives a better noise figure, but a poorer TOI to noise floor dynamic range. You can optimize this setting for your particular measurement.

The instrument takes the preamp gain into account as it sweeps. If you sweep outside of the range of the preamp the instrument will also account for that. The displayed result will always reflect the correct gain.

For some measurements, when the preamp is on and any part of the displayed frequency range is below the lowest frequency for which the preamp has specifications, a warning condition message appears in the status line. For example ,for a preamp with a 9 kHz lowest specified frequency: "Preamp: Accy unspec'd below 9 kHz".

Key Path	AMPTD Y Scale
Scope	Meas Global
Remote Command	[:SENSe]:POWer[:RF]:GAIN[:STATe] OFF ON 0 1 [:SENSe]:POWer[:RF]:GAIN[:STATe]?
Dependencies	Preamp is not available on all hardware platforms. If the preamp is not present or is unlicensed, the key is not shown. The preamp is not available when the electronic/soft attenuator is enabled.
Couplings	The act of connecting the U7227A USB Preamplifier to one of the analyzer's USB ports will cause the Internal Preamp to be switched on. When this happens an informational message will be generated: "Internal Preamp turned on for optimal operation with USB Preamp." Note that if the Internal Preamp was already on, there will be no change to the setting, but if it was Off it will be

	switched On, to Full Range. Note that this same action occurs when the SA mode is selected while the USB Preamp is connected to one of the analyzer's USB ports, if it is the first time that the SA mode has run since powerup, or if the last time the SA mode was running the USB Preamp was NOT connected. Subsequently disconnecting the USB Preamp from USB does not change the Internal Preamp setting nor restore the previous setting.
Preset	OFF
State Saved	Saved in instrument state
Initial S/W Revision	Prior to A.02.00
Modified at S/W Revision	A.14.00

Key Path	AMPTD Y Scale, Internal Preamp
Scope	Meas Global
Remote Command	[:SENSe] :POWer [:RF] :GAIN :BAND LOW FULL [:SENSe] :POWer [:RF] :GAIN :BAND ?
Dependencies	Preamp is not available on all hardware platforms. If the preamp is not present or is unlicensed, the key is not shown. If a POW:GAIN:BAND FULL command is sent when a low band preamp is available, the preamp band parameter is to LOW instead of FULL, and an "Option not installed" message is generated.
Preset	LOW
State Saved	Saved in instrument state
Initial S/W Revision	Prior to A.02.00

Off

Turns the internal preamp off

Key Path	AMPTD Y Scale, Internal Preamp
Example	:POW:GAIN OFF
Readback	Off
Initial S/W Revision	Prior to A.02.00

Low Band

Sets the internal preamp to use only the low band.

The frequency range of the installed (optional) low-band preamp is displayed in square brackets on the **Low Band** key label.

Key Path	AMPTD Y Scale, Internal Preamp
Example	:POW:GAIN ON :POW:GAIN:BAND LOW

Readback	Low Band
Initial S/W Revision	Prior to A.02.00

Full Range

Sets the internal preamp to use its full range. The low band (0-3.6 GHz or 0-3GHz, depending on the model) is supplied by the low band preamp and the frequencies above low band are supplied by the high band preamp.

The frequency range of the installed (optional) preamp is displayed in square brackets on the **Full Range** key label. If the high band option is not installed the Full Range key does not appear.

Key Path	AMPTD Y Scale, Internal Preamp
Example	:POW:GAIN ON :POW:GAIN:BAND FULL
Readback	Full Range
Initial S/W Revision	Prior to A.02.00

Ref Position

Enables you to set the display reference position to either, Top, Center or Bottom.

Key Path	AMPTD Y Scale
Mode	SA, GSM, TD-SCDMA
Remote Command	:DISPlay:TXPower:VIEW[1]:WINDow[1]:TRACe:Y[:SCALE]:RPOsition TOP CENTER BOTTOm :DISPlay:TXPower:VIEW[1]:WINDow[1]:TRACe:Y[:SCALE]:RPOsition?
Example	DISP:TXP:VIEW:WIND:TRAC:Y:RPOS CENT DISP:TXP:VIEW:WIND:TRAC:Y:RPOS?
Notes	You must be in the Spectrum Analyzer mode, TD-SCDMA mode or GSM mode to use this command. Use INSTRument:SElect to set the mode.
Preset	TOP
State Saved	Saved in instrument state.
Range	Top Ctr Bot
Initial S/W Revision	Prior to A.02.00

Auto Scaling

Allows you to toggle the Y axis auto scaling function between On and Off.

Key Path	AMPTD Y Scale
Mode	SA, GSM, TD-SCDMA
Remote Command	:DISPlay:TXPower:VIEW[1]:WINDow[1]:TRACe:Y[:SCALE]:COUPlE 0 1 OFF ON

	<code>:DISPlay:TXPower:VIEW[1]:WINDow[1]:TRACe:Y[:SCALE]:COUPle?</code>
Example	DISP:TXP:VIEW:WIND:TRAC:Y:COUP 0 DISP:TXP:VIEW:WIND:TRAC:Y:COUP?
Notes	You must be in the Spectrum Analyzer mode, TD-SCDMA mode or GSM mode to use this command. Use INSTRument:SElect to set the mode.
Couplings	When Auto Scaling is On, upon pressing the Restart front-panel key, this function automatically determines the scale per division and reference values based on the measurement results. When the user sets a value either Y Rel Value or Y Scale/Div manually, this parameter automatically is set to 'Off'.
Preset	ON
State Saved	Saved in instrument state.
Range	On Off
Initial S/W Revision	Prior to A.02.00

Auto Couple

The Auto Couple feature provides a quick and convenient way to automatically couple multiple instrument settings. This helps ensure accurate measurements and optimum dynamic range. When the Auto Couple feature is activated, either from the front panel or remotely, all parameters of the current measurement that have an Auto/Manual mode are set to Auto mode and all measurement settings dependent on (or coupled to) the Auto/Man parameters are automatically adjusted for optimal performance.

However, the Auto Couple key actions are confined to the current measurement only. It does not affect other measurements in the mode, and it does not affect markers, marker functions, or trace or display attributes.

See "[More Information](#)" on page 2114

Key Path	Front-panel key
Remote Command	:COUPlE ALL NONE
Example	:COUP ALL
Notes	:COUPlE ALL puts all Auto/Man parameters in Auto mode (equivalent to pressing the Auto Couple key). :COUPLE NONE puts all Auto/Man parameters in manual mode. It decouples all the coupled instrument parameters and is not recommended for making measurements.
Initial S/W Revision	Prior to A.02.00

More Information

There are two types of functions that have Auto/Manual modes.

Auto/Man Active Function keys

An Auto/Man toggle key controls the binary state associated with an instrument parameter by toggling between **Auto** (where the parameter is automatically coupled to the other parameters it is dependent upon) and **Man** (where the parameter is controlled independent of the other parameters), as well as making the parameter the active function. The current mode is indicated on the softkey with either **Auto** or **Man** underlined as illustrated below.

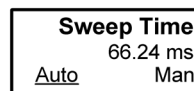

vsd07

Auto/Man 1-of-N keys

An Auto/Man 1-of-N key allows you to manually pick from a list of parameter values, or place the function in Auto, in which case the value is automatically selected (and indicated).

- If in Auto, Auto is underlined on the calling key.

13 Burst Power (Transmit Power)
Auto Couple

- If in manual operation, manual is indicated on the calling key, but note that the calling key simply opens the menu and does **not** actually toggle the function.

BW

Accesses a menu of functions that enable you to specify and control the video and resolution bandwidths. You can also select the type of filter for the measurement and set the filter bandwidth.

NOTE

If the selected mode is TD-SCDMA, this function is **not** available.

Key Path	Front-panel key
Mode	SA, EDGE/GSM
Initial S/W Revision	Prior to A.02.00

Res BW

Sets the resolution bandwidth. This is the bandwidth used for the power measurement. The bandwidth is ideally wide enough to pass all the power of the burst signal, while not being so wide that it passes noise that reduces dynamic range and the accuracy of low level measurements.

Key Path	BW
Mode	SA, GSM
Remote Command	<code>[:SENSe]:TXPower:BANDwidth[:RESolution] <bandwidth></code> <code>[:SENSe]:TXPower:BANDwidth[:RESolution]?</code>
Example	TXP:BAND 1000 TXP:BAND?
Notes	You must be in the Spectrum Analyzer mode or GSM mode to use this command. Use INSTRUMENT:SElect to set the mode.
Preset	GSM: 510 kHz SA: 3 MHz
State Saved	Saved in instrument state.
Min	1 kHz
Max	Hardware Dependent: RF Input: No Option = 10 MHz WB (25 MHz or wider) = Hardware Option Limit I/Q Input (for I+jQ): No Option = 20 MHz Option B25 = 50 MHz
Backwards Compatibility SCPI	<code>[:SENSe]:TXPower:BWIDth[:RESolution]</code>
Initial S/W Revision	Prior to A.02.00
Modified at S/W Revision	A.06.00

Filter Type

Besides the familiar Gaussian filter shape, there are certain special filter types, such as Flat Top, that are desirable under certain conditions.

Key Path	BW
Mode	SA, GSM
Remote Command	<code>[:SENSe]:TXPower:BAWdwidth:TYPE GAUSSian FLATtop</code> <code>[:SENSe]:TXPower:BAWdwidth:TYPE?</code>
Example	TXP:BAWd:TYPE GAUS TXP:BAWd:TYPE?
Notes	Selects the type of filter: either Gaussian or Flat (Flattop). Gaussian is the best choice when looking at the overall burst or the rising and falling edges, as it has excellent pulse response. This measurement does not trade off time domain accuracy vs. noise, just total power accuracy vs. noise level. If you want to precisely examine just the useful part of the burst, choose Flat. This is an advanced control that normally does not need to be changed. Setting this to a value other than the factory default may cause invalid measurement results. FLATtop – a filter with a flat amplitude response, which provides the best amplitude accuracy. GAUSSian – a filter with Gaussian characteristics, which provides the best pulse response. You must be in the Spectrum Analyzer mode or GSM mode to use this command. Use INSTRument:SElect to set the mode.
Preset	GAUSSian
State Saved	Saved in instrument state.
Range	Gaussian (Normal) Flattop
Backwards Compatibility SCPI	<code>[:SENSe]:TXPower:BWIDth:TYPE</code>
Initial S/W Revision	Prior to A.02.00

Cont (Continuous Measurement/Sweep)

Sets the analyzer for Continuous measurement operation. The single/continuous state is Meas Global so the setting will affect all measurements. If you are Paused, pressing **Cont** does a Resume.

Key Path	Front-panel key
Remote Command	:INITiate:CONTinuous OFF ON 0 1 :INITiate:CONTinuous?
Example	:INIT:CONT 0 puts analyzer in Single measurement operation. :INIT:CONT 1 puts analyzer in Continuous measurement operation
Preset	ON (Note that SYST:PRESet sets INIT:CONT to ON but *RST sets INIT:CONT to OFF)
State Saved	Saved in instrument state
Backwards Compatibility Notes	For Spectrum Analysis mode in ESA and PSA, there is no Cont hardkey, instead there is a Sweep Single/Cont key. In these analyzers, switching the Sweep Single/Cont key from Single to Cont restarts averages (displayed average count reset to 1), but does not restart Max Hold and Min Hold . The X-Series has Single and Cont keys in place of the SweepSingleCont key. In the X-Series, if in single measurement, the Cont key (and INIT:CONT ON) switches to continuous measurement, but never restarts a measurement and never resets a sweep.
Initial S/W Revision	Prior to A.02.00

In Swept SA Measurement (Spectrum Analysis Mode):

The analyzer takes repetitive sweeps, averages, measurements, etc., when in Continuous mode. When the average count reaches the Average/Hold Number the count stops incrementing, but the analyzer keeps sweeping. See the Trace/Detector section for the averaging formula used both before and after the Average/Hold Number is reached. The trigger condition must be met prior to each sweep. The type of trace processing for multiple sweeps, is set under the Trace/Detector key, with choices of **Trace Average**, **Max Hold**, or **Min Hold**.

In Other Measurements/Modes:

With **Avg/Hold Num** (in the **Meas Setup** menu) set to **Off** or set to **On** with a value of 1, a sweep is taken after the trigger condition is met; and the analyzer continues to take new sweeps after the current sweep has completed and the trigger condition is again met. However, with **Avg/Hold Num** set to On with a value >1, multiple sweeps (data acquisitions) are taken for the measurement. The trigger condition must be met prior to each sweep. The sweep is not stopped when the average count k equals the number N set for Avg/Hold Num is reached, but the number k stops incrementing. A measurement average usually applies to all traces, marker results, and numeric results. But sometimes it only applies to the numeric results.

13 Burst Power (Transmit Power)
Cont (Continuous Measurement/Sweep)

If the analyzer is in Single measurement, pressing the **Cont** key does not change k and does not cause the sweep to be reset; the only action is to put the analyzer into Continuous measurement operation.

If it is already in continuous sweep:

the INIT:CONT 1 command has no effect

the INIT:CONT 0 command will place the analyzer in Single Sweep but will have no effect on the current sequence until $k = N$, at which point the current sequence will stop and the instrument will go to the idle state.

File

See "File" on page 426

FREQ Channel

Accesses a menu of keys that allow you to control the Frequency and Channel parameters of the instrument.

Some features in the Frequency menu are the same for all measurements – they do not change as you change measurements. Settings like these are called “Meas Global” and are unaffected by Meas Preset. For example, the Center Freq setting is the same for all measurements – it does not change as you change measurements.

Key Path	Front-panel key
Initial S/W Revision	Prior to A.02.00

Center Freq

Sets the frequency that corresponds to the horizontal center of the graticule (when frequency Scale Type is set to linear). While adjusting the Center Frequency the Span is held constant, which means that both Start Frequency and Stop Frequency will change.

Pressing Center Freq also sets the frequency entry mode to Center/Span. In Center/Span mode, the center frequency and span values are displayed below the graticule, and the default active function in the Frequency menu is **Center Freq**.

The center frequency setting is the same for all measurements within a mode, that is, it is Meas Global. Some modes are also able to share a Mode Global center frequency value. If this is the case, the Mode will have a **Global Settings** key in its **Mode Setup** menu.

The **Center Freq** function sets (and queries) the Center Frequency for the currently selected input. If your analyzer has multiple inputs, and you select another input, the Center Freq changes to the value for that input. SCPI commands are available to directly set the Center Freq for a specific input.

Center Freq is remembered as you go from input to input. Thus you can set a Center Freq of 10 GHz with the RF Input selected, change to BBIQ and set a Center Freq of 20 MHz, then switch to External Mixing and set a Center Freq of 60 GHz, and when you go back to the RF Input the Center Freq will go back to 10 GHz; back to BBIQ and it is 20 MHz; back to External Mixing and it is 60 GHz.

See ["RF Center Freq" on page 2125](#)

See [Ext Mix Center Freq](#)

See ["I/Q Center Freq" on page 2126](#)

See ["Center Frequency Presets" on page 2122](#)

Key Path	FREQ Channel
Scope	Meas Global
Remote Command	[:SENSe] :FREQuency :CENTer <freq> [:SENSe] :FREQuency :CENTer ?

Example	FREQ:CENT 50 MHz FREQ:CENT UP changes the center frequency to 150 MHz if you use FREQ:CENT:STEP 100 MHz to set the center frequency step size to 100 MHz FREQ:CENT?
Notes	This command sets either the RF or I/Q Center Frequency depending on the selected input. For RF input it is equivalent to FREQ:RF:CENT For I/Q input it is equivalent to FREQ:IQ:CENT Preset and Max values are dependent on Hardware Options (5xx) If no terminator (e.g. MHz) is sent the terminator Hz is used. If a terminator with unit other than Frequency is used, an invalid suffix error message is generated.
Dependencies	The Center Frequency can be limited by Start or Stop Freq limits, if the Span is so large that Start or Stop reach their limit.
Couplings	When operating in "swept span", any value of the Center Frequency or Span that is within the frequency range of the analyzer is allowed when the value is being set through the front panel numeric key pad or the SCPI command. The other parameter is forced to a different value if needed, to keep the Start and the Stop Frequencies within the analyzer's frequency range
Preset	Depends on instrument maximum frequency, mode, measurement, and selected input. See "Center Frequency Presets" on page 2122 and "RF Center Freq" on page 2125 and Ext Mix Center Freq and "I/Q Center Freq" on page 2126 .
State Saved	Saved in instrument state
Min	Depends on instrument maximum frequency, mode, measurement, and selected input.. See "Center Frequency Presets" on page 2122 and "RF Center Freq" on page 2125 and "I/Q Center Freq" on page 2126 .
Max	Depends on instrument maximum frequency, mode, measurement, and selected input.. See "Center Frequency Presets" on page 2122 and "RF Center Freq" on page 2125 and "I/Q Center Freq" on page 2126 .
Default Unit	Hz
Status Bits/OPC Dependencies	Non-overlapped
Initial S/W Revision	Prior to A.02.00

Center Frequency Presets

The following table provides the Center Frequency Presets for the Spectrum Analyzer mode, and the Max Freq, for the various frequency options:

Freq Option	CF after Mode Preset	Stop Freq after Mode Preset	Max Freq (can't tune above)	
503 (all but N9000A)		1.805 GHz	3.6 GHz	3.7 GHz

13 Burst Power (Transmit Power)
FREQ Channel

Freq Optio n	CF after Mode Prese t	Stop Freq after Mode Prese t	Max Freq (can't tune abov e)	
503 (N9000A)		1.505 GHz	3.0 GHz	3.08 GHz
504 (M9420A)		1 GHz	3.8GHz	3.88 GHz
506 (M9420A)		1 GHz	6.0GHz	6.08 GHz
507 (all but N9000A)		3.505 GHz	7.0 GHz	7.1 GHz
507 (N9000A)		3.755 GHz	7.5 GHz	7.58 GHz
508 (all but N9038A)		1.805 GHz	3.6 GHz	8.5 GHz
508 (N9038A)		4.205 GHz	8.4 GHz	8.5 GHz
513		6.805 GHz	13.6 GHz	13.8 GHz
526 (all but N9000A and N9038A)		13.255 GHz	26.5 GHz	27.0 GHz
526 (N9000A)		13.255 GHz	26.5 GHz z	26.5 5 GHz
526 (N9038A)		1.805 GHz	3.6 GHz	27.0 GHz
532	16.005 GHz		32.0 GHz	32.5 GHz
543	21.505 GHz		43.0 GHz	TBD
544	22.005 GHz		44.0 GHz	44.5 GHz
550	25.005 GHz		50.0 GHz	51 GHz

Input 2:

Model	CF after Mode Preset	Stop Freq after Mode Preset	Max Freq (can't tune above)
N9000A opt C75	0.7505GHz	1.5 GHz	1.58 GHz
N9038A	505 MHz	1 GHz	1.000025 GHz

Tracking Generator Frequency Limits (N9000A only):

Tracking Generator Option	Min Freq (clips to this freq when turn TG on and can't tune below while TG on)	If above this Freq, Stop Freq clipped to this Freq when TG turned on	Max Freq (can't tune above) while TG on
T03	9 kHz	3.0 GHz	3.08 GHz
T06	9 kHz	6.0 GHz	6.05 GHz

Tracking Generator Frequency Limits(M9290A only):

Tracking Generator Option	Min Freq (clips to this freq when turn TG on and can't tune below while TG on)	If above this Freq, Stop Freq clipped to this Freq when TG turned on	Max Freq (can't tune above) while TG on
T03	2 MHz	3.08 GHz	3.08 GHz
T07	2 MHz	7.575 GHz	7.575 GHz
T13	2 MHz	13.8 GHz	13.8 GHz
T26	2 MHz	26.55 GHz	26.55 GHz

The following table shows the Center Frequency Presets for modes other than Spectrum Analyzer:

Mode	CF Preset for RF
WCDMA	1 GHz
WIMAXOFDMA,	1 GHz
BASIC	1 GHz
ADEMOD	1 GHz
VSA	1 GHz
TDSCDMA	1 GHz

Mode	CF Preset for RF
PNOISE	1 GHz
LTE	1 GHz
LTETDD	1 GHz
MSR	1 GHz
GSM	935.2 MHz
NFIGURE	1.505 GHz

RF Center Freq

SCPI command for specifying the RF Center Frequency. This command will set the Center Frequency to be used when the RF input is selected, even if the RF input is not the input that is selected at the time the command is sent. Note that the **Center Freq** function in the **Frequency** menu on the front panel always applies to the currently selected input.

Scope	Meas Global
Remote Command	[:SENSe] :FREQuency:RF:CENTer <freq> [:SENSe] :FREQuency:RF:CENTer?
Example	FREQ:RF:CENT 30 MHz
Notes	This command is the same in all modes, but the parameter is Measurement Global. So the value is independent in each mode and common across all the measurements in the mode.
Dependencies	If the electronic/soft attenuator is enabled, any attempt to set Center Frequency such that the Stop Frequency would be >3.6 GHz fails and results in an advisory message. If the equivalent SCPI command is sent, this same message is generated as part of a “-221, Settings conflict” warning. If Source Mode is set to Tracking, and the Max or Min Center Freq is therefore limited by the limits of the source, a warning message is generated, “Data out of range;clipped to source max/min” if these limits are exceeded. Note that for an external source, these limits can be affected by the settings of Source Numerator, Source Denominator and Power Sweep.
Preset	See table above
State Saved	Saved in instrument state.
Min	-79.999995 MHz, unless Source Mode is set to Tracking, in which case it is limited by the minimum frequency of the Source
Max	See table above. Basically instrument maximum frequency - 5 Hz. Note that, if the Source Mode is set to Tracking, the effective instrument maximum frequency may be limited by the source maximum frequency. If the knob or step keys are being used, also depends on the value of the other three interdependent parameters Span, Start Frequency and Stop Frequency
Initial S/W Revision	Prior to A.02.00
Modified at S/W Revision	A.03.00

Ext Mix Center Freq

SCPI command for specifying the External Mixer Center Frequency. This command will set the Center Frequency to be used when the External Mixer is selected, even if the External Mixer input is not the input which is selected at the time the command is sent. Note that the **Center Freq** function in the **Frequency** menu on the front panel always applies to the currently selected input.

Scope	Meas Global
Remote Command	[:SENSe] :FREQuency:EMIXer:CENTer <freq> [:SENSe] :FREQuency:EMIXer:CENTer?
Example	:FREQ:EMIX:CENt 60 GHz :FREQ:EMIX:CENt?
Notes	This command is the same in all modes, but the parameter is Measurement Global. So the value is independent in each mode and common across all the measurements in the mode.
Couplings	When returning to External Mixing after having been switched to one of the other inputs (e.g., RF), you will come back into the settings that you had when you left External Mixing. So you will come back to the band you were in with the Center Frequency that you had. However, Span is not an input-dependent parameter, therefore you will bring the span over from the other input. Therefore, the analyzer comes back with the span from the previous input, limited as necessary by the current mixer setup.
Preset	When a Mode Preset is performed while in External Mixing, the Start frequency of the current Mode is set to the nominal Min Freq of the lowest harmonic range in the Harmonic Table for the current mixer setup. Similarly, the Stop frequency of the current Mode is set to the nominal Max Freq of the highest harmonic range in the Harmonic Table. The Center Freq thus presets to the point arithmetically equidistant from these two frequencies. If the current measurement has a limited Span available to it, and cannot achieve the Span shown in the table (Span=Stop Freq – Start Freq), the analyzer uses the maximum Span the measurement allows, and still sets the Center Freq to the midpoint of the Start and Stop Freq values in the Harmonic Table. When Restore Input/Output Defaults is performed, the mixer presets to the 11970A, whose Start and Stop frequencies are 26.5 and 40 GHz respectively. The center of these two frequencies is 33.25 GHz. Therefore, after a Restore Input/Output Defaults, if you go into External Mixing and do a Mode Preset while in the Spectrum Analyzer Mode, the resulting Center Freq is 33.25 GHz.
State Saved	Saved in instrument state.
Min	The minimum frequency in the currently selected mixer band + 5 Hz
Max	The maximum frequency in the currently selected mixer band - 5 Hz If the knob or step keys are being used, also depends on the value of the other three interdependent parameters Span, Start Frequency and Stop Frequency
Initial S/W Revision	A.08.01

I/Q Center Freq

SCPI command for specifying the I/Q Center Frequency. This command will set the Center Frequency to be used when the I/Q input is selected, even if the I/Q input is not the input which is selected at the time the command is sent. Note that the

Center Freq function in the **Frequency** menu on the front panel always applies to the currently selected input.

Scope	Meas Global
Remote Command	[:SENSe] :FREQuency :IQ :CENTer <freq> [:SENSe] :FREQuency :IQ :CENTer ?
Example	FREQ:IQ:CENT: 30 MHz
Notes	This command is the same in all modes, but the parameter is Measurement Global. So the value is independent in each mode and common across all the measurements in the mode.
Preset	0 Hz
State Saved	Saved in instrument state.
Min	-40.049995 MHz
Max	40.049995 MHz
Initial S/W Revision	Prior to A.02.00

CF Step

Changes the step size for the center frequency and start and stop frequency functions. Once a step size has been selected and the center frequency function is active, the step keys (and the UP|DOWN parameters for Center Frequency from remote commands) change the center frequency by the step-size value. The step size function is useful for finding harmonics and sidebands beyond the current frequency span of the analyzer.

Note that the start and stop frequencies also step by the CF Step value.

Key Path	FREQ Channel
Remote Command	[:SENSe] :FREQuency :CENTer :STEP [:INCRement] <freq> [:SENSe] :FREQuency :CENTer :STEP [:INCRement] ? [:SENSe] :FREQuency :CENTer :STEP :AUTO OFF ON 0 1 [:SENSe] :FREQuency :CENTer :STEP :AUTO ?
Example	FREQ:CENT:STEP:AUTO ON FREQ:CENT:STEP 500 MHz FREQ:CENT UP increases the current center frequency value by 500 MHz FREQ:CENT:STEP? FREQ:CENT:STEP:AUTO?
Notes	Preset and Max values are depending on Hardware Options (503, 507, 508, 513, 526)
Notes	Preset and Max values are dependent on Hardware Options (5xx)
Dependencies	Freq Offset is not available in External Mixing. In this case the Freq Offset key is grayed out and shows a value of zero. It will once again be available, and show the previously set value, when you return to the RF Input.
Dependencies	Span, RBW, Center frequency If the electronic/soft attenuator is enabled, any attempt to change the value of the center frequency >3.6 GHz by pressing the Up-arrow key, fails and results in an advisory message. If the

	equivalent SCPI command is sent, this same message is generated as part of a “-221, Settings conflict” warning.
Couplings	When auto-coupled in a non-zero span, the center frequency step size is set to 10% of the span. When auto-coupled in zero span, the center frequency step size is set to the equivalent -3 dB RBW value.
Preset	Auto ADEMOD: 1 MHz ON
State Saved	Saved in instrument state
Min	– (the maximum frequency of the instrument). That is, 27 GHz max freq instrument has a CF step range of +/- 27 GHz. Note that this is the maximum frequency given the current settings of the instrument, so in External Mixing, for example, it is the maximum frequency of the current mixer band.
Max	The maximum frequency of the instrument. That is, 27 GHz max freq instrument has a CF step range of +/- 27 GHz. Note that this is the maximum frequency given the current settings of the instrument, so in External Mixing, for example, it is the maximum frequency of the current mixer band.
Default Unit	Hz
Status Bits/OPC dependencies	non-overlapped
Initial S/W Revision	Prior to A.02.00
Modified at S/W Revision	A.03.00

Freq Offset

Enables you to set a frequency offset value to account for frequency conversions outside of the analyzer. This value is added to the display readout of the marker frequency, center frequency, start frequency, stop frequency, and all other absolute frequency settings in the analyzer including frequency count. When a frequency offset is entered, the value appears below the center of the graticule. To eliminate an offset, perform a Mode Preset or set the frequency offset to 0 Hz.

See ["More Information" on page 2129](#).

Key Path	FREQ Channel
Scope	Meas Global
Remote Command	[:SENSe] :FREQuency:OFFSet <freq> [:SENSe] :FREQuency:OFFSet?
Example	FREQ:OFFS 10 MHz
Notes	Preset and Max values are dependent on Hardware Options (503, 507, 508, 513, 526)
Dependencies	Freq Offset is not available in External Mixing. In this case the Freq Offset key is grayed out and shows a value of zero. However, the value of CF Offset that was set for the RF Input is retained and restored when the user switches back to the RF Input.

Preset	See " Center Frequency Presets " on page 2932
State Saved	Saved in instrument state
Min	-500 GHz
Max	500 GHz
Default Unit	Hz
Status Bits/OPC dependencies	Non-overlapped
Backwards Compatibility SCPI	DISPlay:WINDow[1]:TRACe:X[:SCALE]:OFFSet
	The DISPlay version of the command is in the instrument for compatibility across platforms and is not recommended for new development.
Backwards Compatibility Notes	<ol style="list-style-type: none"> 1. In pre-X-Series instruments, Frequency Offset could not be adjusted by the knob or step keys. That is no longer the case. 2. Some previous spectrum analyzers did not adjust frequency counter results for the Frequency Offset. The X-Series does adjust the frequency counter for the offset.
Initial S/W Revision	Prior to A.02.00
Modified at S/W Revision	A.04.00, A.08.50

More Information

This command does not affect any bandwidths or the settings of relative frequency parameters such as delta markers or span. It does not affect the current hardware settings of the analyzer, but only the displayed frequency values. Entering an offset does not affect the trace position or display, just the value of the start and stop frequency and the values represented by the trace data. The frequency values of exported trace data, queried trace data, markers, trace data used in calculations such as N dB points, trace math, etc., are all affected by Freq Offset. Changing the offset, even on a trace that is not updating will immediately change all of the above, without taking new data.

NOTE

If a trace is exported with a nonzero Freq Offset, the exported data will contain the trace data with the offset applied. Therefore, if that trace were to be imported back into the analyzer, you would want Freq Offset to be 0, or the offset would be applied again to data which is already offset. No such care need be taken when saving a State+Trace file because the data and state are saved together.

Input/Output

See ["Input/Output" on page 241](#)

Marker

Accesses a menu that enables you to select, set up and control the markers for the current measurement.

Key Path	Front-panel key
Initial S/W Revision	Prior to A.02.00

Select Marker

Displays 12 markers available for selection.

Key Path	Marker
Initial S/W Revision	Prior to A.02.00

Marker Type

Sets the marker control mode as described under **Normal**, **Delta**, **Fixed** and **Off**, below. All interactions and dependencies detailed under the key description are enforced when the remote command is sent.

Key Path	Marker
Mode	GSM, SA, TD-SCDMA
Remote Command	:CALCulate:TXPower:MARKer[1] 2 ... 12:MODE POSITION DELTA OFF :CALCulate:TXPower:MARKer[1] 2 ... 12:MODE?
Example	CALC:TXP:MARK:MODE OFF CALC:TXP:MARK:MODE?
Notes	If the selected marker is Off, pressing Marker sets it to Normal and places it at the center of the screen on the trace determined by the Marker Trace rules. At the same time, Marker X Axis Value appears on the Active Function area. Default Active Function: the active function for the selected marker's current control mode. If the current control mode is Off, there is no active function and the active function is turned off. Active Function Display: the marker X axis value entered in the active function area will display the marker value to its full entered precision. You must be in the Spectrum Analyzer mode, TD-SCDMA mode or GSM mode to use this command. Use INSTRument:SElect to set the mode.
Preset	OFF
State Saved	Saved in instrument state.
Range	Normal Delta Off
Backwards Compatibility SCPI	:CALCulate:BPOWER:MARKer[1] 2 ... 12:MODE
Initial S/W Revision	Prior to A.02.00

Properties

Accesses a menu that enables you to set marker properties and to access the marker trace menu.

Key Path	Marker
Initial S/W Revision	Prior to A.02.00

Select Marker

Displays 12 markers available for selection.

Key Path	Marker
Initial S/W Revision	Prior to A.02.00

Relative To

Selects the marker that the selected marker will be relative to (its reference marker).

Key Path	Marker, Properties
Mode	GSM, SA, TD-SCDMA
Remote Command	:CALCulate:TXPower:MARKer[1] 2 ... 12:REFerence <integer> :CALCulate:TXPower:MARKer[1] 2 ... 12:REFerence?
Example	CALC:TXP:MARK:REF 10 CALC:TXP:MARK:REF?
Notes	A marker cannot be relative to itself, so that choice is grayed out, and if sent from SCPI generates error -221: "Settings conflict; marker cannot be relative to itself." You must be in the Spectrum Analyzer mode, TD-SCDMA mode or GSM mode to use this command. Use INSTRument:SElect to set the mode. When queried a single value will be returned (the specified marker numbers relative marker).
Preset	2 3 4 5 6 7 8 9 10 11 12 1
State Saved	Saved in instrument state.
Min	1
Max	12
Initial S/W Revision	Prior to A.02.00

Marker Trace

Assigns the specified marker to the designated trace.

Key Path	Marker, Properties
Mode	GSM, SA, TD-SCDMA
Remote Command	:CALCulate:TXPower:MARKer[1] 2 ... 12:TRACe RFENvelope MAXHold MINHold :CALCulate:TXPower:MARKer[1] 2 ... 12:TRACe?

Example	CALC:TXP:MARK:TRAC MAXH CALC:TXP:MARK:TRAC?
Notes	You must be in the Spectrum Analyzer mode, TD-SCDMA mode or GSM mode to use this command. Use INSTRUMENT:SElect to set the mode.
Dependencies	If Detector/Max Hold Trace is Off, Max Hold is grayed out and MAXHold parameter is not available. If Detector/Min Hold Trace is Off, Min Hold is grayed out and MINHold parameter is not available.
Preset	RFENvelope
State Saved	Saved in instrument state.
Range	RF Envelope Max Hold RF Envelope Min Hold RF Envelope
Backwards Compatibility SCPI	:CALCulate:BPowEr:MARKer[1] 2 ... 12:TRACe
Initial S/W Revision	Prior to A.02.00

Couple Markers

When this function is true, moving any marker causes an equal X Axis movement of every other marker which is not **Off**. By “equal X Axis movement” we mean that we preserve the difference between each marker’s X Axis value (in the fundamental x-axis units of the trace that marker is on) and the X Axis value of the marker being moved (in the same fundamental x-axis units).

This may result in markers going off screen.

Key Path	Marker
Mode	GSM, SA, TD-SCDMA
Remote Command	:CALCulate:TXPower:MARKer:COUple[:STATe] ON OFF 1 0 :CALCulate:TXPower:MARKer:COUple[:STATe]?
Example	CALC:TXP:MARK:COUP ON CALC:TXP:MARK:COUP?
Notes	You must be in the Spectrum Analyzer mode, TD-SCDMA mode or GSM mode to use this command. Use INSTRUMENT:SElect to set the mode.
Preset	OFF
State Saved	Saved in instrument state.
Range	On Off
Initial S/W Revision	Prior to A.02.00

All Markers Off

Turns off all markers.

Key Path	Marker
----------	---------------

Mode	GSM, SA, TD-SCDMA
Remote Command	:CALCulate:TXPower:MARKer:AOff
Example	CALC:TXP:MARK:AOff
Notes	You must be in the Spectrum Analyzer mode, TDSDMA mode or GSM mode to use this command. Use INSTRument:SElect to set the mode.
Backwards Compatibility SCPI	:CALCulate:BPOwer:MARKer:AOff
Initial S/W Revision	Prior to A.02.00

Marker X Axis Position (Remote Command Only)

Sets the marker X position in trace points. It has no effect if the control mode is **Off**, but is the SCPI equivalent of entering a value if the control mode is **Normal** or **Delta** except in trace points rather than X Axis Scale units. The entered value is immediately translated into the current X Axis Scale units for setting the value of the marker.

Mode	GSM, SA, TD-SCDMA
Remote Command	:CALCulate:TXPower:MARKer[1] 2 ... 12:X:POsition <real> :CALCulate:TXPower:MARKer[1] 2 ... 12:X:POsition?
Example	CALC:TXP:MARK10:X:POS 500 CALC:TXP:MARK10:X:POS?
Notes	The query returns the marker's absolute X Axis value in trace points if the control mode is Normal , or the offset from the marker's reference marker in trace points if the control mode is Delta . If the marker is Off the response is not a number. You must be in the Spectrum Analyzer mode, TDSCMA mode or GSM mode to use this command. Use INSTRument:SElect to set the mode.
Couplings	Max value would be changed by Sweep/Meas Time parameter value.
Preset	Markers are turned OFF, so Marker X Axis Value query will return a not a number (NAN).
State Saved	No
Min	-9.9E+37
Max	9.9E+37
Backwards Compatibility SCPI	:CALCulate:BPOwer:MARKer[1] 2 ... 12:X:POsition
Initial S/W Revision	Prior to A.02.00

Marker Y Axis Value (Remote Command Only)

Returns the marker Y Axis value in the current marker Y Axis unit.

The "result" of a marker is the value which is displayed on the second line of the Marker Result block. To properly interpret the returned value the remote programmer must also know what the analyzer's Y-Axis Unit is set to as described below.

A marker can have up to two results, only one of which is displayed or returned on a query, as follows:

- Absolute result: every marker has an absolute result:
 - For Normal and Delta markers, the Y Axis value of the trace point the marker is currently on.
 - The absolute result is displayed in the result block or returned on a query unless the marker control mode is **Delta**.
- Relative result: if a marker’s control mode is **Delta**, the relative result is displayed in the result block or returned on a query. This is the ratio of the Absolute Result of a delta marker to the Absolute Result of its reference marker. The ratio is expressed in dB.

Mode	GSM, SA, TD-SCDMA
Remote Command	:CALCulate:TXPower:MARKer[1] 2 ... 12:Y?
Example	CALC:TXP:MARK11:Y?
Notes	The query returns the marker Y Axis result. If the marker is Off the response is not a number. You must be in the Spectrum Analyzer mode, TD-SCDMA mode or GSM mode to use this command. Use INSTRument:SElect to set the mode.
Preset	0
State Saved	No
Backwards Compatibility SCPI	:CALCulate:TXPower:MARKer[1] 2 ... 12:FUNCTION:RESult? :CALCulate:BPOwer:MARKer[1] 2 ... 12:FUNCTION:RESult? :CALCulate:BPOwer:MARKer[1] 2 ... 12:Y?
Initial S/W Revision	Prior to A.02.00

Marker Function

There is no 'Marker Function' supported in Burst (Tx) Power, so this front-panel key displays a blank menu key when pressed.

Key Path	Front-panel key
Initial S/W Revision	Prior to A.02.00

Marker To

There is no 'Marker To' functionality supported in Burst (Tx) Power, so this front-panel key displays a blank menu key when pressed.

Key Path	Front-panel key
Initial S/W Revision	Prior to A.02.00

Meas

The information in this section is common to all measurements. For key and remote command information for a specific measurement, refer to the section that describes the measurement of interest.

Measurements available under the Meas key are specific to the current Mode.

When viewing Help for measurements, note the following:

NOTE

Operation for some keys differs between measurements. The information displayed in Help pertains to the current measurement. To see how a key operates in a different measurement, exit Help (press the Cancel Esc key), select the measurement, then reenter Help (press the Help key) and press that key.

Key Path	Front-panel key
Initial S/W Revision	Prior to A.02.00

Remote Measurement Functions

This section contains the following topics:

["Measurement Group of Commands" on page 3141](#)

["Current Measurement Query \(Remote Command Only\)" on page 3144](#)

["Limit Test Current Results \(Remote Command Only\)" on page 3144](#)

["Data Query \(Remote Command Only\)" on page 3144](#)

["Calculate/Compress Trace Data Query \(Remote Command Only\)" on page 3144](#)

["Calculate Peaks of Trace Data \(Remote Command Only\)" on page 3150](#)

["Hardware-Accelerated Fast Power Measurement \(Remote Command Only\)" on page 3151](#)

["Format Data: Numeric Data \(Remote Command Only\)" on page 3165](#)

["Format Data: Byte Order \(Remote Command Only\)" on page 3166](#)

Initial S/W Revision	Prior to A.02.00
----------------------	------------------

Measurement Group of Commands

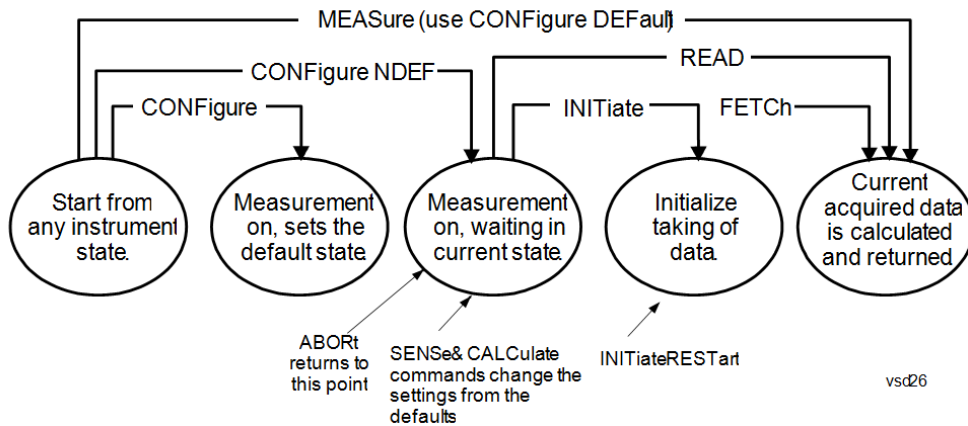

Measure Commands:

:MEASure:<measurement>[n]?

This is a fast single-command way to make a measurement using the factory default instrument settings. These are the settings and units that conform to the Mode Setup settings (e.g. radio standard) that you have currently selected.

- Stops the current measurement (if any) and sets up the instrument for the specified measurement using the factory defaults
- Initiates the data acquisition for the measurement
- Blocks other SCPI communication, waiting until the measurement is complete before returning results.
- If the function does averaging, it is turned on and the number of averages is set to 10.
- After the data is valid it returns the scalar results, or the trace data, for the specified measurement. The type of data returned may be defined by an [n] value that is sent with the command.
- The scalar measurement results will be returned if the optional [n] value is not included, or is set to 1. If the [n] value is set to a value other than 1, the selected trace data results will be returned. See each command for details of what types of scalar results or trace data results are available.
- ASCII is the default format for the data output. (Older versions of Spectrum Analysis and Phase Noise mode measurements only use ASCII.) The binary data formats should be used for handling large blocks of data since they are smaller and faster than the ASCII format. Refer to the FORMat:DATA command for more information.

If you need to change some of the measurement parameters from the factory default settings you can set up the measurement with the CONFIGure command. Use the commands in the SENSE:<measurement> and CALCulate:<measurement> subsystems to change the settings. Then you can use the READ? command to initiate the measurement and query the results.

If you need to repeatedly make a given measurement with settings other than the factory defaults, you can use the commands in the SENSE:<measurement> and CALCulate:<measurement> subsystems to set up the measurement. Then use the READ? command to initiate the measurement and query results.

Measurement settings persist if you initiate a different measurement and then return to a previous one. Use READ:<measurement>? if you want to use those persistent settings. If you want to go back to the default settings, use MEASure:<measurement>?.

Configure Commands:

:CONFigure:<measurement>

This command stops the current measurement (if any) and sets up the instrument for the specified measurement using the factory default instrument settings. It does not initiate the taking of measurement data unless INIT:CONTinuous is ON. If you change any measurement settings after using the CONFigure command, the READ command can be used to initiate a measurement without changing the settings back to their defaults.

In the Swept SA measurement in Spectrum Analyzer mode the CONFigure command also turns the averaging function on and sets the number of averages to 10 for all measurements.

:CONFigure: <measurement>: NDEFault stops the current measurement and changes to the specified measurement. It does not change the settings to the defaults. It does not initiate the taking of measurement data unless INIT:CONTinuous is ON.

The CONFigure? query returns the current measurement name.

The CONFigure:CATalog? query returns a quoted string of all licensed measurement names in the current mode. For example, "SAN, CHP, OBW, ACP, PST, TXP, SPUR, SEM, LIST".

Fetch Commands:

:FETCh:<measurement>[n]?

This command puts selected data from the most recent measurement into the output buffer. Use FETCh if you have already made a good measurement and you want to return several types of data (different [n] values, for example, both scalars and trace data) from a single measurement. FETCh saves you the time of re-making the measurement. You can only FETCh results from the measurement that is currently active, it will not change to a different measurement. An error message is reported if a measurement other than the current one is specified.

If you need to get new measurement data, use the READ command, which is equivalent to an INITiate followed by a FETCh.

The scalar measurement results will be returned if the optional [n] value is not included, or is set to 1. If the [n] value is set to a value other than 1, the selected trace data results will be returned. See each command for details of what types of scalar results or trace data results are available. The binary data formats should be used for handling large blocks of data since they are smaller and transfer faster than the ASCII format. (FORMat:DATA)

FETCh may be used to return results other than those specified with the original READ or MEASure command that you sent.

INITiate Commands:

:INITiate:<measurement>

This command is not available for measurements in all the instrument modes:

- Initiates a trigger cycle for the specified measurement, but does not output any data. You must then use the FETCh<meas> command to return data. If a
-

measurement other than the current one is specified, the instrument will switch to that measurement and then initiate it.

- For example, suppose you have previously initiated the ACP measurement, but now you are running the channel power measurement. If you send INIT:ACP? it will change from channel power to ACP and will initiate an ACP measurement.
- Does not change any of the measurement settings. For example, if you have previously started the ACP measurement and you send INIT:ACP? it will initiate a new ACP measurement using the same instrument settings as the last time ACP was run.
- If your selected measurement is currently active (in the idle state) it triggers the measurement, assuming the trigger conditions are met. Then it completes one trigger cycle. Depending upon the measurement and the number of averages, there may be multiple data acquisitions, with multiple trigger events, for one full trigger cycle. It also holds off additional commands on GPIB until the acquisition is complete.

READ Commands:

:READ:<measurement>[n]?

- Does not preset the measurement to the factory default settings. For example, if you have previously initiated the ACP measurement and you send READ:ACP? it will initiate a new measurement using the same instrument settings.
 - Initiates the measurement and puts valid data into the output buffer. If a measurement other than the current one is specified, the instrument will switch to that measurement before it initiates the measurement and returns results.
 - For example, suppose you have previously initiated the ACP measurement, but now you are running the channel power measurement. Then you send READ:ACP? It will change from channel power back to ACP and, using the previous ACP settings, will initiate the measurement and return results.
 - Blocks other SCPI communication, waiting until the measurement is complete before returning the results
 - If the optional [n] value is not included, or is set to 1, the scalar measurement results will be returned. If the [n] value is set to a value other than 1, the selected trace data results will be returned. See each command for details of what types of scalar results or trace data results are available. The binary data formats should be used when handling large blocks of data since they are smaller and faster than the ASCII format. (FORMat:DATA)
-

Current Measurement Query (Remote Command Only)

This command returns the name of the measurement that is currently running.

Remote Command	:CONFigure?
Example	CONF?
Initial S/W Revision	Prior to A.02.00

Limit Test Current Results (Remote Command Only)

Queries the status of the current measurement limit testing. It returns a 0 if the measured results pass when compared with the current limits. It returns a 1 if the measured results fail any limit tests.

Remote Command	:CALCulate:CLIMits:FAIL?
Example	CALC:CLIM:FAIL? queries the current measurement to see if it fails the defined limits. Returns a 0 or 1: 0 it passes, 1 it fails.
Initial S/W Revision	Prior to A.02.00

Data Query (Remote Command Only)

Returns the designated measurement data for the currently selected measurement and subopcode.

n = any valid subopcode for the current measurement. See the measurement command results table for your current measurement, for information about what data is returned for the subopcodes.

This command uses the data setting specified by the FORMat:BORDER and FORMat:DATA commands and can return real or ASCII data. (See the format command descriptions under Input/Output in the Analyzer Setup section.)

Remote Command	:CALCulate:DATA[n]?
Notes	The return trace depends on the measurement. In CALCulate:<meas>:DATA[n], n is any valid subopcode for the current measurement. It returns the same data as the FETCH:<measurement>? query where <measurement> is the current measurement.
Initial S/W Revision	Prior to A.02.00

Calculate/Compress Trace Data Query (Remote Command Only)

Returns compressed data for the currently selected measurement and sub-opcode [n].

n = any valid sub-opcode for that measurement. See the MEASure:<measurement>? command description of your specific measurement for information on the data that can be returned.

The data is returned in the current Y Axis Unit of the analyzer. The command is used with a sub-opcode <n> (default=1) to specify the trace. With trace queries, it is best if the analyzer is not sweeping during the query. Therefore, it is generally advisable to be in Single Sweep, or Update=Off.

This command is used to compress or decimate a long trace to extract and return only the desired data. A typical example would be to acquire N frames of GSM data and return the mean power of the first burst in each frame. The command can also be used to identify the best curve fit for the data.

Remote Command	:CALCulate:DATA<n>:COMPRESS? BLOCK CFIT MAXimum MINimum MEAN DMEan RMS RMSCubed SAMPLE SDEVIation PPHase [,<soffset> [,<length>[,<roffset>[,<rlimit>]]]]
Example	To query the mean power of a set of GSM bursts: Supply a signal that is a set of GSM bursts. Select the IQ Waveform measurement (in IQ Analyzer Mode). Set the sweep time to acquire at least one burst. Set the triggers such that acquisition happens at a known position relative to a burst. Then query the mean burst levels using, CALC:DATA2:COMP? MEAN, 24e-6, 526e-6 (These parameter values correspond to GSM signals, where 526e-6 is the length of the burst in the slot and you just want 1 burst.)
Notes	The command supports 5 parameters. Note that the last 4 (<soffset>, <length>, <roffset>, <rlimit>) are optional. But these optional parameters must be entered in the specified order. For example, if you want to specify <length>, then you must also specify <soffset>. See details below for a definition of each of these parameters. This command uses the data in the format specified by FORMat:DATA, returning either binary or ASCII data.
Initial S/W Revision	Prior to A.02.00

- BLOCK or block data - returns all the data points from the region of the trace data that you specify. For example, it could be used to return the data points of an input signal over several timeslots, excluding the portions of the trace data that you do not want. (This is x,y pairs for trace data and I,Q pairs for complex data.)
- CFIT or curve fit - applies curve fitting routines to the data. <soffset> and <length> are required to define the data that you want. <roffset> is an optional parameter for the desired order of the curve equation. The query will return the following values: the x-offset (in seconds) and the curve coefficients ((order + 1) values).

MIN, MAX, MEAN, DME, RMS, RMSC, SAMP, SDEV and PPH return one data value for each specified region (or <length>) of trace data, for as many regions as possible

until you run out of trace data (using <roffset> to specify regions). Or they return the number of regions you specify (using <rlimit>) ignoring any data beyond that.

- MINimum - returns the minimum data point (y value) for the specified region (s) of trace data. For I/Q trace data, the minimum magnitude of the I/Q pairs is returned.
- MAXimum - returns the maximum data point (y value) for the specified region(s) of trace data. For I/Q trace data, the maximum magnitude of the I/Q pairs is returned.
- MEAN - returns a single value that is the arithmetic mean of the data point values (in dB/ dBm) for the specified region(s) of trace data. For I/Q trace data, the mean of the magnitudes of the I/Q pairs is returned. See the following equations.

NOTE

If the original trace data is in dB, this function returns the arithmetic mean of those log values, not log of the mean power which is a more useful value. The mean of the log is the better measurement technique when measuring CW signals in the presence of noise. The mean of the power, expressed in dB, is useful in power measurements such as Channel Power. To achieve the mean of the power, use the RMS option.

Equation 1

Mean Value of Data Points for Specified Region(s)

$$\text{MEAN} = \frac{1}{n} \sum_{X_i \in \text{region}(s)} X_i$$

where X_i is a data point value, and n is the number of data points in the specified region(s).

Equation 2

Mean Value of I/Q Data Pairs for Specified Region(s)

$$\text{MEAN} = \frac{1}{n} \sum_{X_i \in \text{region}(s)} |X_i|$$

where $|X_i|$ is the magnitude of an I/Q pair, and n is the number of I/Q pairs in the specified region(s).

- DMEan - returns a single value that is the mean power (in dB/ dBm) of the data point values for the specified region(s) of trace data. See the following equation:

Equation 3

DMEan Value of Data Points for Specified Region(s)

$$DME = 10 \times \log_{10} \left(\frac{1}{n} \sum_{X_i \in \text{region}(s)} 10^{\frac{X_i}{10}} \right)$$

- RMS - returns a single value that is the average power on a root-mean-squared voltage scale (arithmetic rms) of the data point values for the specified region(s) of trace data. See the following equation.

NOTE

For I/Q trace data, the rms of the magnitudes of the I/Q pairs is returned. See the following equation.

This function is very useful for I/Q trace data. However, if the original trace data is in dB, this function returns the rms of the log values which is not usually needed.

Equation 4

RMS Value of Data Points for Specified Region(s)

$$RMS = \sqrt{\frac{1}{n} \sum_{X_i \in \text{region}(s)} X_i^2}$$

where X_i is a data point value, and n is the number of data points in the specified region(s).

Equation 5

RMS Value of I/Q Data Pairs for Specified Region(s)

$$RMS = \sqrt{\frac{1}{n} \sum_{X_i \in \text{region}(s)} X_i X_i^*}$$

where X_i is the complex value representation of an I/Q pair, X_i^* its conjugate complex number, and n is the number of I/Q pairs in the specified region(s).

Once you have the rms value for a region of trace data (linear or I/Q), you may want to calculate the mean power. You must convert this rms value (peak volts) to power in dBm:

$$10 \times \log[10 \times (\text{rms value})^2]$$

- SAMPLE - returns the first data value (x,y pair) for the specified region(s) of trace data. For I/Q trace data, the first I/Q pair is returned.

- SDEViation - returns a single value that is the arithmetic standard deviation for the data point values for the specified region(s) of trace data. See the following equation.
- For I/Q trace data, the standard deviation of the magnitudes of the I/Q pairs is returned. See the following equation.

Equation 6

Standard Deviation of Data Point Values for Specified Region(s)

$$\text{SDEV} = \sqrt{\frac{1}{n} \sum_{X_i \in \text{region}(s)} (X_i - \bar{X})^2}$$

where X_i is a data point value, \bar{X} is the arithmetic mean of the data point values for the specified region(s), and n is the number of data points in the specified region(s).

$$\text{SDEV} = \sqrt{\frac{1}{n} \sum_{X_i \in \text{region}(s)} (|X_i| - \bar{X})^2}$$

where $|X_i|$ is the magnitude of an I/Q pair, \bar{X} is the mean of the magnitudes for the specified region(s), and n is the number of data points in the specified region(s).

- PPHase - returns the x,y pairs of both rms power (dBm) and arithmetic mean phase (radian) for every specified region and frequency offset (Hz). The number of pairs is defined by the specified number of regions. This parameter can be used for I/Q vector ($n=0$) in Waveform (time domain) measurement and all parameters are specified by data point in PPHase.

The rms power of the specified region may be expressed as:

$$\text{Power} = 10 \times \log [10 \times (\text{RMS I/Q value})] + 10.$$

The RMS I/Q value (peak volts) is:

$$\sqrt{\frac{1}{n} \sum_{X_i \in \text{region}} X_i X_i^*}$$

where X_i is the complex value representation of an I/Q pair, X_i^* its conjugate complex number, and n is the number of I/Q pairs in the specified region.

The arithmetic mean phase of the specified region may be expressed as:

$$\frac{1}{n} \sum_{Y_i \in \text{region}} Y_i$$

where Y_i is the unwrapped phase of I/Q pair with applying frequency correction and n is the number of I/Q pairs in the specified region.

The frequency correction is made by the frequency offset calculated by the arithmetic mean of every specified region's frequency offset. Each frequency offset is calculated by the least square method against the unwrapped phase of I/Q pair.

Sample Trace Data - Constant Envelope

(See below for explanation of variables.)

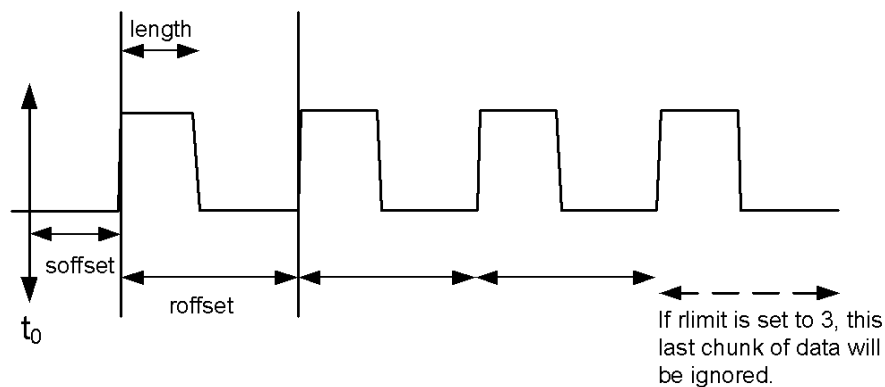

Sample Trace Data - Not Constant Envelope

(See below for explanation of variables.)

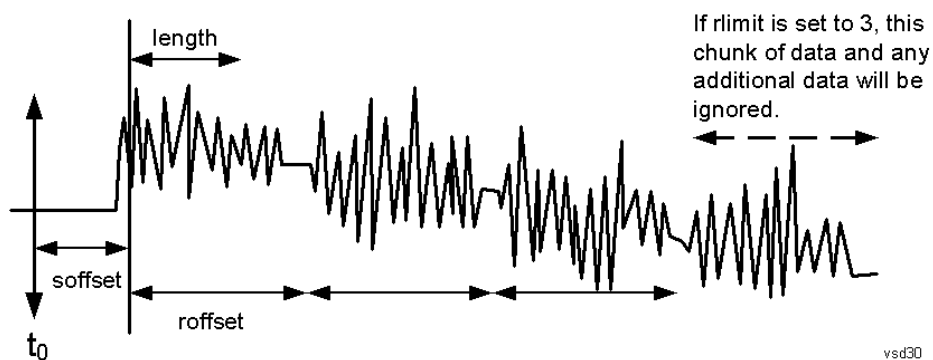

<soffset> - start offset is an optional real number. (It is in seconds for time-domain traces, and is a dimensionless index 0 to Npoints - 1, for frequency-domain traces). It specifies the amount of data at the beginning of the trace that will be ignored before the decimation process starts. It is the time or frequency change from the start of the trace to the point where you want to start using the data. The default value is zero.

<length> - is an optional real number. (It is in seconds for time-domain traces, and is a dimensionless index 0 to Npoints - 1, for frequency-domain traces). It defines how much data will be compressed into one value. This parameter has a default value equal to the current trace length.

<roffset> - repeat offset is an optional real number. (It is in seconds for time-domain traces, and is a dimensionless index 0 to Npoints - 1, for frequency-domain traces). It defines the beginning of the next field of trace elements to be compressed. This is relative to the beginning of the previous field. This parameter has a default value equal to the <length> variable. Note that this parameter is used for a completely different purpose when curve fitting (see CFIT above).

<rlimit> - repeat limit is an optional integer. It specifies the number of data items that you want returned. It will ignore any additional items beyond that number. You can use the Start offset and the Repeat limit to pick out exactly what part of the data you want to use. The default value is all the data.

Calculate Peaks of Trace Data (Remote Command Only)

Returns a list of all the peaks for the currently selected measurement and sub-opcode [n]. The peaks must meet the requirements of the peak threshold and excursion values.

n = any valid sub-opcode for the current measurement. See the MEASure:<measurement> command description of your specific measurement for information on the data that can be returned.

The command can only be used with specific sub-opcodes with measurement results that are trace data. Both real and complex traces can be searched, but complex traces are converted to magnitude in dBm. In many measurements the sub-opcode n=0, is the raw trace data which cannot be searched for peaks. And Sub-opcode n=1, is often calculated results values which also cannot be searched for peaks.

This command uses the data setting specified by the FORMat:BORDER and FORMat:DATA commands and can return real or ASCII data. If the format is set to INT,32, it returns REAL,32 data.

The command has four types of parameters:

- Threshold (in dBm)
- Excursion (in dB)
- Sorting order (amplitude, frequency, time)
- Optional in some measurements: Display line use (all, > display line, < display line)

Remote Command

For Swept SA measurement:

```
:CALCulate:DATA[1]|2|...|6:PEAKS? <threshold>,<excursion>[,AMPLitude
| FREQuency | TIME[,ALL | GTDLine | LTDLine]]
```

	<p>For most other measurements: <code>:CALCulate:DATA[1] 2 ... 6:PEAKs? <threshold>,<excursion>[,AMPLitude FREQuency TIME]</code></p>
Example	<p>Example for Swept SA measurement in Spectrum Analyzer Mode: CALC:DATA4:PEAK? -40, 10, FREQ, GTDL This will identify the peaks of trace 4 that are above -40 dBm, with excursions of at least 10 dB. The peaks are returned in order of increasing frequency, starting with the lowest frequency. Only the peaks that are above the display line are returned.</p> <p>Query Results 1: With FORMat:DATA REAL, 32 selected, it returns a list of floating-point numbers. The first value in the list is the number of peak points that are in the following list. A peak point consists of two values: a peak amplitude followed by its corresponding frequency (or time). If no peaks are found the peak list will consist of only the number of peaks, (0).</p>
Notes	<p><n> - is the trace that will be used</p> <p><threshold> - is the level below which trace data peaks are ignored. Note that the threshold value is required and is always used as a peak criterion. To effectively disable the threshold criterion for this command, provide a substantially low threshold value such as -200 dBm. Also note that the threshold value used in this command is independent of and has no effect on the threshold value stored under the Peak Criteria menu.</p> <p><excursion> - is the minimum amplitude variation (rise and fall) required for a signal to be identified as peak. Note that the excursion value is required and is always used as a peak criterion. To effectively disable the excursion criterion for this command, provide the minimum value of 0.0 dB. Also note that the excursion value used in this command is independent of and has no effect on the excursion value stored under the Peak Criteria menu.</p> <p>Values must be provided for threshold and excursion. The sorting and display line parameters are optional (defaults are AMPLitude and ALL).</p> <p>Note that there is always a Y-axis value for the display line, regardless of whether the display line state is on or off. It is the current Y-axis value of the display line which is used by this command to determine whether a peak should be reported</p> <p>Sorting order: AMPLitude - lists the peaks in order of descending amplitude, with the highest peak first (default if optional parameter not sent) FREQuency - lists the peaks in order of occurrence, left to right across the x-axis. TIME - lists the peaks in order of occurrence, left to right across the x-axis.</p> <p>Peaks vs. Display Line: ALL - lists all of the peaks found (default if optional parameter not sent). GTDLLine (greater than display line) - lists all of the peaks found above the display line. LTDLine (less than display line) - lists all of the peaks found below the display line.</p>
Initial S/W Revision	Prior to A.02.00

Hardware-Accelerated Fast Power Measurement (Remote Command Only)

The Fast Power option (FP2) enables very fast channel power measurements for instruments with the prerequisite hardware (DP2 and/or B40). It accomplishes this by performing real-time overlapped FFTs at the hardware layer, using software for basic post-processing before returning the result to the user. The upshot of this

approach is improved throughput for user applications that require many sequential power measurements.

The analysis bandwidth of FP2 is limited by the licenses in the instrument, but its maximum overall analysis bandwidth per acquisition is 40 MHz.

FP2 is remote-only, which means the instrument does not switch to any particular mode or measurement. FP2 commands can be sent while another application is in use on the front panel.

Each Fast Power measurement can be predefined using an array index, and up to 1,000 measurements can be stored. In the following documentation, instances of [1,2,...,999] can be substituted with a particular measurement index, e.g. CALC:FPOW:POW1?, CALC:FPOW:POW2?, CALC:FPOW:POW134?. In this way, power measurements can be defined one time in a batch, and then executed multiple times without having to redefine them, similar to “list mode” on other measurements.

In addition to basic channel power measurements, there are a number of other measurement “functions” for each channel, including peak power, peak frequency, and power spectral density. See the Function parameter for more information.

Reset Fast Power Measurement (Remote Command Only)

Resets the measurement configuration to the defaults.

Mode	All
Remote Command	:CALCulate:FPOWer:POWer[1,2,...,999]:RESet
Example	:CALC:FPOW:POW1:RES
Notes	Option FP2 is required.
Initial S/W Revision	A.14.00

Define Fast Power Measurement (Remote Command Only)

Fast Power acquisitions are configured using the DEFine command. This command accepts a comma-delimited string of configuration parameters and their appropriate values, which are all specified in the subsection below.

Mode	All
Remote Command	:CALCulate:FPOWer:POWer[1,2,...,999]:DEFine "configuration string"
Example	:CALC:FPOW:POW1:DEF "CenterFrequency=2e9, AcquisitionTime=0.005"
Notes	See below for a list of measurement variables that can be defined in the configuration string.
Initial S/W Revision	A.14.00

Acquisition Time

Example	CALC:FPOW:POW1:DEF "AcquisitionTime=0.002"
Notes	The acquisition time parameter sets the time in which the entire spectrum is measured. An increase in the acquisition time yields an improvement in measurement repeatability.
Preset	0.001 s
Range	0 s to 1 s
Default Unit	Time (s)
Initial S/W Revision	A.14.00

Center Frequency

Example	CALC:FPOW:POW1:DEF "CenterFrequency=2e9"
Notes	The center frequency parameter sets the frequency in which the measurement is centered around. The OffsetFrequency parameter is calculated relative to the center frequency.
Preset	1 GHz
Range	0 Hz to maximum instrument frequency
Default Unit	Frequency (Hz)
Initial S/W Revision	A.14.00

DC Coupled

Example	CALC:FPOW:POW1:DEF "DCCoupled=True"
Notes	The DC coupled parameter allows the user to specify whether the DC blocking capacitor is utilized. Set parameter to true when measuring frequencies below 10 MHz.
Preset	False
Range	True (DC Coupled) or False (AC Coupled)
Default Unit	Boolean
Initial S/W Revision	A.14.00

DetectorType

Example	CALC:FPOW:POW1:DEF "DetectorType=Peak"
Notes	Option FP2 is required. The detector type parameter allows the user to choose whether a RMS average or peak value is used during the measurement.
Preset	RmsAverage
Range	RmsAverage, Peak
Initial S/W Revision	A.14.00

Do Noise Correction

Example	CALC:FPOW:POW1:DEF "DoNoiseCorrection=True"
Notes	<p>When noise correction is enabled, the linear noise power contributed by the analyzer is subtracted from all measurements. This effectively lowers the noise floor of the analyzer.</p> <p>When noise correction is enabled, the first measurement for a given set of input parameters will take extra time. This is because the analyzer takes an extra acquisition with the RF input disconnected from the analyzer's front end to measure the noise of just the analyzer. The measured noise floor is stored in a cache so the noise acquisition will occur only once for the same state settings. In other words, if noise correction was turned on and the analyzer made an acquisition at frequency A, then frequency B, and back again to frequency A, the hidden initial noise floor acquisition would only occur for the first acquisition at frequency A and the cached noise floor would be used the second time frequency A was measured.</p>
Preset	False
Range	True (enable noise correction) or False (disable noise correction)
Default Unit	Boolean
Initial S/W Revision	A.14.00

Do Spur Suppression

Example	CALC:FPOW:POW1:DEF "DoSpurSuppression=True"
Notes	<p>When measuring very low level signals, or when large out-of-band inputs are input into the analyzer, sometimes unwanted spurs and residuals can appear in the measured spectrum. Spur suppression is a method to help minimize the levels of these internally generated spurs and residuals.</p> <p>When spur suppression is enabled, the analyzer will automatically take two acquisitions using two different internal analog LO frequencies. The FFT spectrums from both acquisitions are combined by taking the minimum power between both traces on a per FFT bin basis. External signals will have the same amplitude for both traces and therefore will return the expected amplitudes. However, low level spurs and residuals generated internally to the analyzer tend to move to different FFT bins depending on the internal analog LO frequency used, and therefore tend to be suppressed using this spur suppression method.</p> <p>Because two acquisitions, rather than a single acquisition, are made when spur suppression is enabled, the measurement time will always be slower when spur suppression is enabled.</p>
Preset	False
Range	True (enable spur suppression) or False (disable spur suppression)
Default Unit	Boolean
Initial S/W Revision	A.14.00

Electronic Attenuator Bypass

Example	CALC:FPOW:POW1:DEF "ElecAttBypass =False"
Notes	The electronic attenuation bypass parameter allows the user to either utilize or bypass the electronic attenuator. The electronic attenuator is only available for frequencies up to 3.6 GHz. Set parameter to true when using frequencies above 3.6 GHz and set the parameter to false when using the preamp.
Preset	True
Range	True (bypass electronic attenuator) or False (use electronic attenuator)
Default Unit	Boolean
Initial S/W Revision	A.14.00

Electronic Attenuation

Example	CALC:FPOW:POW1:DEF "ElecAttenuation=10"
Notes	Option EA3 is required. The electronic attenuation value parameter sets the amount of electrical attenuation from 0 to 24 dB (1 dB steps). Set "ElecAttBypass=False" to make sure the electronic attenuator path is enabled.
Preset	0 dB
Range	0 – 24 dB (1 dB steps)
Default Unit	dB
Initial S/W Revision	A.14.00

IF Gain

Example	CALC:FPOW:POW1:DEF "IFGain=10"
Notes	The IF gain parameter allows the user to specify the gain at the IF stage anywhere from -6 to 16 dB (1 dB steps). This is an advanced feature, and for most cases this should remain at its default value of 0 dB.
Preset	0 dB
Range	-6 – 16 dB (1 dB steps)
Default Unit	dB
Initial S/W Revision	A.14.00

IF Type

Example	CALC:FPOW:POW1:DEF "IFType=B25M"
Notes	The IF type parameter allows the user to select between different IF paths. For example, if the signal is less than 25 MHz wide, then the user can select the B25M path to take advantage of

	additional filtering on this analog IF path.
Preset	B40M
Range	B10M, B25M, B40M
Initial S/W Revision	A.14.00

Include Power Spectrum

Example	CALC:FPOW:POW1:DEF "IncludePowerSpectrum=True"
Notes	The power spectrum parameter allows the user to read data on the entire spectrum for diagnostic purposes. It is not recommended for production use. See CALC:FPOW:POW[n]:READ2? for details on the binary format of the response.
Preset	False
Range	True (return both channel power and full power spectrum) or False (returns only channel power)
Default Unit	Boolean
Initial S/W Revision	A.14.00

Mechanical Attenuation

Example	CALC:FPOW:POW1:DEF "MechAttenuation=10"
Notes	The mechanical attenuation value parameter sets the amount of mechanical attenuation anywhere from 0 to 70 dB (2 dB steps).
Preset	0 dB
Range	0 – 70 dB (2 dB steps)
Default Unit	dB
Initial S/W Revision	A.14.00

Preamp Mode

Example	CALC:FPOW:POW1:DEF "PreAmpMode=Low"
Notes	The license for the appropriate preamp is required. The preamp mode parameter specifies whether the preamps are being utilized. Low allows any preamps up to 3.6 GHz, and Full allows all licensed preamps. Set "ElecAttBypass=True" in order to utilize any preamps.
Preset	Off
Range	Off, Low, Full
Initial S/W Revision	A.14.00

Resolution Bandwidth Mode

Example	CALC:FPOW:POW1:DEF "PreAmpMode=Low"
Notes	The resolution bandwidth mode parameter allows the user to choose whether the RBW filter is automatically or manually set. The BestSpeed value minimizes measurement time, while the Narrowest value minimizes RBW size (minimum of two FFT bins per RBW). To manually specify an RBW, set this parameter to Explicit, and set the ResolutionBW parameter to the desired value.
Preset	BestSpeed
Range	BestSpeed, Narrowest, Explicit
Initial S/W Revision	A.14.00

Resolution Bandwidth

Example	CALC:FPOW:POW1:DEF "ResolutionBW=25e3"
Notes	The resolution bandwidth parameter sets the 3-dB bandwidth of the RBW filter. The ResolutionBWMode parameter must be set to Explicit in order to manually set the RBW.
Preset	0 Hz
Default Unit	Hz
Initial S/W Revision	A.14.00

Trigger Delay

Example	CALC:FPOW:POW1:DEF "TriggerDelay=0.025"
Notes	The trigger delay parameter sets the time after an external trigger is detected until the measurement is performed.
Preset	0 s
Range	0 – 1 s
Default Unit	Seconds
Initial S/W Revision	A.14.00

Trigger Level

Example	CALC:FPOW:POW1:DEF "TriggerLevel=2"
Notes	The trigger level parameter sets the voltage value at which an external trigger is detected.
Preset	1.2 V
Range	-5 to 5 V
Default Unit	Volts
Initial S/W Revision	A.14.00

Trigger Slope

Example	CALC:FPOW:POW1:DEF "TriggerSlope=Negative"
Notes	The trigger slope parameter indicates the direction of the edge trigger voltage for detection.
Preset	Positive
Range	Positive, Negative
Initial S/W Revision	A.14.00

Trigger Source

Example	CALC:FPOW:POW1:DEF "TriggerSource=Ext1"
Notes	The trigger source parameter allows the user to choose between measurement's triggering freely or controlled by an external input. Ext1 and Ext2 correspond to Trigger 1 In and Trigger 2 In, respectively.
Preset	Free
Range	Free, Ext1, Ext2
Initial S/W Revision	A.14.00

Trigger Timeout

Example	CALC:FPOW:POW1:DEF "TriggerTimeout=0.1"
Notes	The trigger timeout parameter sets the time in which the analyzer will wait for a trigger before automatically performing the measurement.
Preset	1 s
Range	0 – 1 s
Default Unit	Seconds
Initial S/W Revision	A.14.00

Signal Input

Example	CALC:FPOW:POW1:DEF "SignalInput=Fp50MHzCW"
Notes	The signal input parameter allows the user to select between using the main RF input or the internal analyzer reference CW signal of 50 MHz.
Preset	FpMainRf
Range	FpMainRf, Fp50MHzCW
Initial S/W Revision	A.14.00

Use Preselector

Example	CALC:FPOW:POW1:DEF "UsePreSelector=True"
Notes	The preselector parameter allows the user to either utilize or bypass the front end tunable filter at frequencies above 3.6 GHz. For frequencies below 3.6 GHz, the preselector is automatically bypassed, so you do not need to set this parameter to False in those cases.
Preset	False
Range	True (use preselector above 3.6 GHz), or False (preselector bypassed)
Default Unit	Boolean
Initial S/W Revision	A.14.00

Channel Bandwidth Array

Example	CALC:FPOW:POW1:DEF "Bandwidth=[3.84e6, 5e6, 3.84e6]"
Notes	The bandwidth parameter array defines the bandwidth of each channel that will be measured. All array parameters should have the same number of elements. Alternatively, if all the elements are the same value, a single number with no square brackets can be used to define the parameter.
Preset	[1e6]
Range	0 to 40 MHz
Default Unit	Hz
Initial S/W Revision	A.14.00

Channel Filter Type Array

Example	CALC:FPOW:POW1:DEF "FilterType=[RRC, IBW, RRC]"
Notes	The filter type parameter allows the user to choose between an integration bandwidth (IBW) filter or a root-raised-cosine (RRC) filter. The integration bandwidth filter weighs all frequencies within the bandwidth equally. The root-raised-cosine filter has an associated shape parameter, defined by the FilterAlpha parameter. All array parameters should have the same number of elements. Alternatively, if all the elements are the same value, a single value with no square brackets can be used to define the parameter.
Preset	[IBW]
Range	IBW, RRC
Initial S/W Revision	A.14.00

Channel Filter Alpha Array

Example	CALC:FPOW:POW1:DEF "FilterAlpha=[0.5, 0.0, 0.5]"
Notes	The filter alpha parameter allows the user to adjust the alpha value associated with the root-

	raised-cosine (RRC) filter type. Set FilterType to RRC in order to utilize this parameter. All array parameters should have the same number of elements. Alternatively, if all the elements are the same value, a single number with no square brackets can be used to define the parameter.
Preset	[0.22]
Range	0.0 – 1.0
Initial S/W Revision	A.14.00

Channel Measurement Function Array

Example	CALC:FPOW:POW1:DEF "Function=[BandPower, PeakPower, BandPower]"
Notes	This parameter array defines what measurement is being made for each individually-specified channel: BandPower: Total power within the specified bandwidth of the channel (dBm) BandDensity: Total power density within the specified bandwidth of the channel (dBm/Hz) PeakPower: The peak power value within the specified bandwidth of the channel (dBm) PeakFrequency: The frequency which corresponds to the peak power value within the specified bandwidth of the channel. This frequency is relative to the center frequency (Hz) XdBBandwidth: The half power (-3.01 dB) bandwidth of the highest amplitude signal that resides within the channel (Hz), dB is configurable using XdBBandwidth parameter OccupiedBandwidth: The bandwidth at which 99% of the total power resides within the channel (Hz), percentage configurable using OccupiedBandwidthPercent parameter All array parameters should have the same number of elements. Alternatively, if all the elements are the same value, a single value with no square brackets can be used to define the parameter.
Preset	[BandPower]
Range	BandPower, BandDensity, PeakPower, PeakFrequency, XdBBandwidth, OccupiedBandwidth
Initial S/W Revision	A.14.00

Channel Offset Frequency Array

Example	CALC:FPOW:POW1:DEF "OffsetFrequency=[-5e6, 0, 5e6]"
Notes	The offset frequency parameter array defines the difference between the center frequency to the center frequency of each channel. All array parameters should have the same number of elements.
Preset	[0]
Range	0 to 20 MHz
Default Unit	Hz
Initial S/W Revision	A.14.00

Channel Occupied Bandwidth Percent Array

Example	CALC:FPOW:POW1:DEF "OccupiedBandwidthPercent =[0.95, 0.95, 0.95]"
Notes	This parameter only applies for channels whose Function is set to OccupiedBandwidth. The occupied bandwidth percent parameter specifies the percent of total power in these channels. The valid range for this parameter is 0.0 to 1.0, where 1.0 represents 100%. The default for this parameter is 0.99, which will return the bandwidth that contains 99% of the total channel power.
Preset	[0.99]
Range	0 – 1.0
Initial S/W Revision	A.14.00

Channel x-dB Bandwidth Array

Example	CALC:FPOW:POW1:DEF "XdBBandwidth =[-6.02, -3.01, -1.0]"
Notes	This parameter only applies for channels whose Function is set to XdBBandwidth. The X dB bandwidth parameter is used to specify the power relative to the peak channel power over which the bandwidth is calculated. The parameter value must be a negative number.
Preset	[-3.01]
Range	-200 to 0 dB
Default Unit	dB
Initial S/W Revision	A.14.00

Define Fast Power Measurement Query (Remote Command Only)

The DEFine? command is used to retrieve a list of all defined parameters in an ASCII string format

```

M All
o
d
e
R :CALCulate:FPOwer:POWer[1,2,...,999]:DEFine?
e
m
o
t
e
C
o
m
m
a
n
d

```

E :CALC:FPOW:POW1:DEF?
x
a
m
p
l
e

N This command query is used to retrieve a list of all defined parameters in an ASCII format.

o The following is an example of the returned results:

s "DCCoupled=False,ElecAttBypass=True,ElecAttenuation=0,IFGain=0,MechAttenuation=0,PreAmpMode=Off,PreSelectorOf
fset=0,UsePreSelector=False,ExternalReferenceFrequency=10000000,FrequencyReferenceSource=AutoExternalFrequenc
yReference,IFType=B40M,LOMode=SLW,SignalInput=FpMainRf,AcquisitionTime=0.001,CenterFrequency=1000000000,Re
solutionBW=0,ResolutionBWMode=BestSpeed,DetectorType=RmsAverage,Bandwidth=[1000000],OffsetFrequency=
[0],Function=[BandPower],FilterType=[IBW],FilterAlpha=[0.22],OccupiedBandwidthPercent=[0.99],XdBBandwidth=[-
3.01],DoNoiseCorrection=False,DoSpurSuppression=False,MeasurementMethod=HardwareFFT,IncludePowerSpectrum=F
alse,TriggerDelay=0,TriggerLevel=1.2,TriggerSlope=Positive,TriggerSource=Free,TriggerTimeout=1"

l A.14.00

n
i
t
i
a
l

S
/
W

R
e
v
i
s
i
o
n

Configure Fast Power Measurement (Remote Command Only)

The configure command begins hardware setup and returns immediately, with no acquisition made. This can be used in parallel with other hardware operations to effectively hide the hardware setup time.

Mode	All
Remote Command	:CALCulate:FPOwer:POWer[1,2,...,999]:CONFigure
Example	:CALC:FPOW:POW1:CONF

Notes	Option FP2 is required.
Initial S/W Revision	A.14.00

Initiate Fast Power Measurement (Remote Command Only)

The INITiate command begins an acquisition and returns immediately. The results of the measurement can be retrieved using FETCh.

Mode	All
Remote Command	:CALCulate:FPOWer:POWer[1,2,...,999]:INITiate
Example	:CALC:FPOW:POW1:INIT
Notes	Option FP2 is required.
Initial S/W Revision	A.14.00

Fetch Fast Power Measurement (Remote Command Only)

The FETCh command query is used to retrieve the results of an acquisition initiated by the INIT command. The returned results are in ASCII string format. The string begins and ends with quotation marks.

Mode	All
Remote Command	:CALCulate:FPOWer:POWer[1,2,...,999]:FETCh?
Example	:CALC:FPOW:POW1:FETC?
Notes	Option FP2 is required. Returns m comma-separated ASCII values, where m corresponds to the number of bandwidths defined. 1. Declared function return in the 1st specified channel 2. Declared function return in the 2nd specified channel ... m. Declared function return in the last specified channel The INIT and FETC? command sequence performs the same functionality of a single CALC:FPOW:POW[n]? query. Units of the returned values are dependent on the Function parameter for each channel.
Initial S/W Revision	A.14.00

Execute Fast Power Measurement (Remote Command Only)

This command query is used as shorthand for an INIT command immediately followed by a FETC? command. The returned results are in ASCII string format. The string begins and ends with quotation marks.

Mode	All
Remote Command	:CALCulate:FPOwer:POWer[1,2,...,999]?
Example	:CALC:FPOW:POW1?
Notes	Option FP2 is required. See notes for Fast Power Fetch for return format.
Initial S/W Revision	A.14.00

Binary Read Fast Power Measurement (Remote Command Only)

This command query is used as shorthand for an INIT command immediately followed by a FETC? command. The returned results are in a binary format.

Mode	All
Remote Command	:CALCulate:FPOwer:POWer[1,2,...,999]:READ? :CALCulate:FPOwer:POWer[1,2,...,999]:READ1?
Example	:CALC:FPOW:POW1:READ? :CALC:FPOW:POW1:READ1?
Notes	Option FP2 is required. Returns m 4 byte floating point binary values (Little-Endian), where m corresponds to the number of bandwidths defined.
Initial S/W Revision	A.14.00

Diagnostic Binary Read Fast Power Measurement (Remote Command Only)

This command query is used as shorthand for an INIT command immediately followed by a FETC? command. The returned results are in a binary format. This command is used primarily for diagnostic purposes to test for ADC overloads and to visibly inspect the spectrum.

Mode	All
Remote Command	:CALCulate:FPOwer:POWer[1,2,...,999]:READ2?
Example	:CALC:FPOW:POW1:READ2?
Notes	Option FP2 is required. <div style="display: flex; align-items: flex-start; margin-top: 10px;"> <div style="background-color: #cccccc; padding: 2px 5px; margin-right: 10px;">NOTE</div> <div> <p>Spectrum data is only returned if the IncludePowerSpectrum parameter is set to True. If IncludePowerSpectrum is False, the number of spectrum points will be zero (0).</p> </div> </div> <p>Units of the returned values are dependent on the Function parameter per channel (e.g. dBm for BandPower, Hz for PeakFrequency). Returns binary data (Little-Endian) that contains information on m amount of channels, along with ADC over range and full spectrum data.</p>

	The following is the binary format of the response.
	Bandwidth Return Value
	1. Number of channels specified, m [4 byte int]
	2. Declared function result for the 1st specified channel [4 byte float]
	3. Declared function result for the 2nd specified channel [4 byte float]
	...
	(m + 1). Declared function result for the last (mth) specified channel [4 byte float]
	ADC Over Range
	1. ADC over-range occurred (1: true, 0: false) [2 byte short]
	Spectrum Data
	1. Number of points in the spectrum data, k [4 byte int]
	2. Start frequency of spectrum data (Hz) [8 byte double]
	3. Step frequency of spectrum data (Hz) [8 byte double]
	4. FFT bin at 1st point (dBm) [4 byte float]
	5. FFT bin at 2nd point (dBm) [4 byte float]
	...
	(k + 3). FFT bin at last (kth) point (dBm) [4 byte float]

Initial S/W Revision	A.14.00
----------------------	---------

Format Data: Numeric Data (Remote Command Only)

This command specifies the format of the trace data input and output. It specifies the formats used for trace data during data transfer across any remote port. It affects only the data format for setting and querying trace data for the :TRACe[:DATA], TRACe[:DATA]?, :CALCulate:DATA[n]?, and FETCh:SANalyzer[n]? commands and queries.

Remote Command	:FORMat[:TRACe][:DATA] ASCii INTeger,32 REAL,32 REAL,64 :FORMat[:TRACe][:DATA]?
-----------------------	---

Notes	<p>The query response is:</p> <p>ASCii: ASC,8</p> <p>REAL,32: REAL,32</p> <p>REAL,64: REAL,64</p> <p>INTeger,32: INT,32</p> <p>When the numeric data format is REAL or ASCii, data is output in the current Y Axis unit. When the data format is INTeger, data is output in units of m dBm (.001 dBm).</p> <p>The INT,32 format returns binary 32-bit integer values in internal units (m dBm), in a definite length block.</p>
-------	---

Dependencies	<p>Sending a data format spec with an invalid number (for example, INT,48) generates no error. The analyzer simply uses the default (8 for ASCii, 32 for INTeger, 32 for REAL).</p> <p>Sending data to the analyzer which does not conform to the current FORMat specified, results in an error. Sending ASCII data when a definite block is expected generates message -161 "Invalid</p>
--------------	---

	Block Data" and sending a definite block when ASCII data is expected generates message -121 "Invalid Character in Number".
Preset	ASCIi
Backwards Compatibility Notes	Note that the INT,32 format is only applicable to the command, TRACe:DATA. This preserves backwards compatibility for the Swept SA measurement. For all other commands/queries which honor FORMat:DATA, if INT,32 is sent the analyzer will behave as though it were set to REAL,32.
Initial S/W Revision	Prior to A.02.00

The specs for each output type follow:

ASCIi - Amplitude values are in ASCII, in the current Y Axis Unit, one ASCII character per digit, values separated by commas, each value in the form:

SX.YYYYYEsZZ

Where:

S = sign (+ or -)

X = one digit to left of decimal point

Y = 5 digits to right of decimal point

E = E, exponent header

s = sign of exponent (+ or -)

ZZ = two digit exponent

REAL,32 - Binary 32-bit real values in the current Y Axis Unit, in a definite length block.

REAL,64 - Binary 64-bit real values in the current Y Axis Unit, in a definite length block.

Format Data: Byte Order (Remote Command Only)

This command selects the binary data byte order for data transfer and other queries. It controls whether binary data is transferred in normal or swapped mode. This command affects only the byte order for setting and querying trace data for the :TRACe[:DATA], TRACe[:DATA]? , :CALCulate:DATA[n]? and FETCh:SANalyzer[n]? commands and queries.

By definition any command that says it uses FORMat:DATA uses any format supported by FORMat:DATA.

The NORMal order is a byte sequence that begins with the most significant byte (MSB) first, and ends with the least significant byte (LSB) last in the sequence: 1|2|3|4. SWAPped order is when the byte sequence begins with the LSB first, and ends with the MSB last in the sequence: 4|3|2|1.

Remote Command	:FORMat:BORDER NORMal SWAPped
-----------------------	---------------------------------

13 Burst Power (Transmit Power)
Meas

	:FORMat:BORDER?
Preset	NORMal
Initial S/W Revision	Prior to A.02.00

Meas Setup

Displays the setup menu for the currently selected measurement. Many of the lower-level menu keys operate the same in all measurements. Unique functions are described below.

Key Path	Front-panel key
Initial S/W Revision	Prior to A.02.00

Avg/Hold Num

Specifies the number of data acquisition that will be averaged. After the specified number of average counts, the averaging mode (terminal control) setting determines the averaging action.

- On - Sets measurement averaging on.
- Off - Sets measurement averaging off.

Key Path	Meas Setup
Mode	SA, GSM, TD-SCDMA
Remote Command	[:SENSe] :TXPower :AVERage :COUNT <integer> [:SENSe] :TXPower :AVERage :COUNT? [:SENSe] :TXPower :AVERage [:STATE] OFF ON 0 1 [:SENSe] :TXPower :AVERage [:STATE] ?
Example	TXP:AVER:COUN 100 TXP:AVER:COUN? TXP:AVER:0 TXP:AVER?
Notes	You must be in the Spectrum Analyzer mode or GSM mode to use this command. Use INSTRument:SElect to set the mode.
Preset	50 ON
State Saved	Saved in instrument state.
Min	1
Max	10000
Backwards Compatibility SCPI	[:SENSe] :BPOwer :AVERage :COUNT
Initial S/W Revision	Prior to A.02.00

Avg Mode

Selects the type of termination control used for the averaging function. This determines the averaging action after the specified number of data acquisitions

(average count) is reached.

Key	SCPI	Mode
Exponential	EXponential	After the average count is reached, each successive data acquisition is exponentially weighted and combined with the existing average.
Repeat	REPeat	After reaching the average count, the averaging is reset and a new average is started.

Key Path	Meas Setup
Mode	SA, GSM, TD-SCDMA
Remote Command	[:SENSe] :TXPower :AVERage :TCONtrol EXPonential REPeat [:SENSe] :TXPower :AVERage :TCONtrol ?
Example	TXP:AVER:TCON REP TXP:AVER:TCON?
Notes	You must be in the Spectrum Analyzer mode or GSM mode to use this command. Use INSTRument:SElect to set the mode.
Preset	EXponential
State Saved	Saved in instrument state.
Range	Exp Repeat
Backwards Compatibility SCPI	[:SENSe] :BPOwer :AVERage :TCONtrol
Initial S/W Revision	Prior to A.02.00

Avg Type

Specifies the type of trace and result averaging to use.

Key	SCPI	Type
Pwr Avg (RMS)	RMS	True power averaging that is equivalent to taking the RMS value of the voltage. It is the most accurate type of averaging.
Log-Pwr Avg (Video)	LOG	Simulates the traditional spectrum analyzer type of averaging by averaging the log of the power.
None	MAXimum	The maximum values are retained during the averaging cycle.
None	MINimum	The minimum values are retained during the averaging cycle.

SA, GSM Mode

Key Path	Meas Setup
Mode	SA, GSM

Remote Command	[:SENSe] :TXPower :AVERage :TYPE LOG MAXimum MINimum RMS [:SENSe] :TXPower :AVERage :TYPE?
Example	TXP:AVER:TYPE LOG TXP:AVER:TYPE?
Notes	Maximum Minimum are selected only via SCPI. You must be in the Spectrum Analyzer or GSM mode to use this command. Use INSTRument:SElect to set the mode.
Couplings	Selecting MAXimum MINimum force to visible Max Hold Trace or and Min Hold Trace . Measure Trace stays in RMS or Video average state.
Preset	RMS
State Saved	Saved in instrument state.
Range	Pwr Avg (RMS) Log-Pwr Avg(Video) Maximum Minimum
Backwards Compatibility SCPI	[:SENSe] :BPOwer :AVERage :TYPE
Initial S/W Revision	Prior to A.02.00

Key Path	Meas Setup
Mode	TD-SCDMA
Remote Command	[:SENSe] :TXPower :AVERage :TYPE LOG RMS [:SENSe] :TXPower :AVERage :TYPE?
Example	TXP:AVER:TYPE LOG TXP:AVER:TYPE?
Notes	You must be in the TD-SCDMA mode. Use INSTRument:SElect to set the mode.
Preset	RMS
State Saved	Saved in instrument state.
Range	Pwr Avg (RMS) Log-Pwr Avg(Video)
Initial S/W Revision	Prior to A.02.00

Threshold Lvl

When Meas Method is set to Above Threshold Lvl, the mean carrier power is calculated based on the trace above the threshold level. The threshold level is displayed in dB (relative to the measured carrier) or dBm (absolute).

A green line in the grid is displayed at the y-position associated with the current threshold level value. Its state is controlled by the On/Off state of the 'Display Line' under the View/Display menu.

Key Path	Meas Setup
Mode	SA, GSM, TD-SCDMA

Remote Command	[:SENSe]:TXPower:THReshold <real> [:SENSe]:TXPower:THReshold? [:SENSe]:TXPower:THReshold:TYPE ABSolute RELative [:SENSe]:TXPower:THReshold:TYPE?
Example	TXP:THR 0 TXP:THR?
Example	TXP:THR:TYPE ABS TXP:THR:TYPE?
Notes	You must be in the TD-SCDMA mode, Spectrum Analyzer mode or GSM mode to use this command. Use INSTRument:SElect to set the mode. BAF SCPI Command determines whether this command is setting an absolute or a relative power level. Suffix dB and dBm are allowed, but it does not change the state of Threshold Type. Suffix may not be send. If Threshold Type is set to Relative, the positive value of Threshold level was allowed to +100dB and it treated as a negative value. Now max value of Threshold level is changed to 0dB. To keep the backward compatibility, the input from SCPI command allows to +100dB.
Preset	GSM: -20.0 SA: -30.0 TD-SCDMA : -60.0 RELative
State Saved	Saved in instrument state.
Min	-100
Max	GSM, SA: Relative : 0dB Absolute : 100dBm TD-SCDMA: Relative : 0dB Absolute : 60dBm
Backwards Compatibility SCPI	[:SENSe]:BPOWer:THReshold
Initial S/W Revision	Prior to A.02.00

Meas Method

When the selected mode is SA or GSM, there are two options for this parameter: .

- **Above Threshold Level** measurement algorithm is used to capture a time record, and average only those points in the time record that exceed the user-specified threshold level. No attempt is made to position the burst, or to calculate/display burst widths. This can be used to measure continuous signals, or bursted signals where the Measured Burst Width algorithm is too restrictive.

- **Measured Burst Width** measurement algorithm uses the threshold level to calculate the burst center, and average those points that lie within a user-specified burst width that is centered upon the burst. The burst width parameter is described in more detail below.

When the selected mode is TD-SCDMA, there is a third option:

- **Single Time Slot** measurement algorithm is to capture a single time slot record, and calculate the start and stop position of the time slot in terms of the trigger position theoretically. No attempt is made to position the burst, or to calculate/display burst widths. The burst width drawn in the screen is considered to be the theoretical width of the slot. This method is recommended to measure the mean transmit power in a single slot when trigger source is External Front/Rear while the Measured Burst Width algorithm is too restrictive.

SA, GSM mode

Key Path	Meas Setup
Mode	SA, GSM
Remote Command	[:SENSe] :TXPower :METHod THReshold BWIDth [:SENSe] :TXPower :METHod ?
Example	TXP:METH BWID TXP:METH?
Preset	THReshold
State Saved	Saved in instrument state.
Range	Above Threshold Lvl Measured Burst Width
Backwards Compatibility SCPI	[:SENSe] :BPOwer :METHod
Initial S/W Revision	Prior to A.02.00

Key Path	Meas Setup
Mode	TD-SCDMA
Remote Command	[:SENSe] :TXPower :METHod THReshold BWIDth SINGle [:SENSe] :TXPower :METHod ?
Example	TXP:METH BWID TXP:METH?
Preset	SINGle
State Saved	Saved in instrument state.
Range	Threshold Lvl Measured Burst Width Single TimeSlot
Initial S/W Revision	Prior to A.02.00

Burst Width

When Burst Width Mode is set to manual, the user may enter a fixed-time value in seconds, or alternatively specify the burst width as a percentage of the last measured burst width (result in bottom-left corner of second window).

Key Path	Meas Setup
Mode	SA, GSM, TD-SCDMA
Remote Command	<pre>[:SENSe]:TXPower:BURSt:WIDTh <time> [:SENSe]:TXPower:BURSt:WIDTh? [:SENSe]:TXPower:BURSt:AUTO ON OFF 1 0 [:SENSe]:TXPower:BURSt:AUTO?</pre>
Example	<pre>TXP:BURS:WIDT 10 TXP:BURS:WIDT? TXP:BURS:AUTO 1 TXP:BURS:AUTO?</pre>
Example	<pre>TXP:BURS:AUTO 0 TXP:BURS:AUTO? TXP:BURS:AUTO 1 TXP:BURS:AUTO?</pre>
Notes	You must be in the Spectrum Analyzer mode, TD-SCDMA mode or GSM mode to use this command. Use INSTRument:SElect to set the mode.
Dependencies	Burst Width will be grayed out if " Meas Method " on page 2169 is set to 'Above Threshold Lvl'.
Couplings	SA, GSM, TD-SCDMA Max value depends on Sweep Time, Res BW and RBW filter type. If the measure method is not "Measured Burst Width", this key will be grayed out.
Preset	SA, GSM: 255.6 us TD-SCDMA: 662.5us ON
State Saved	Saved in instrument state.
Min	100.0 ns
Max	50 s
Initial S/W Revision	Prior to A.02.00

IF Gain

The **IF Gain** key can be used to set the IF Gain function to Auto, or to On (the extra 10 dB) or Off. These settings affect sensitivity and IF overloads.

This only applies to the RF input. It does not apply to baseband I/Q input.

If the selected mode is TD-SCDMA, this function is not available and the front-panel key displays a blank menu key when pressed.

Key Path	Meas Setup
Mode	SA
Dependencies	The IF Gain keys (FFT IF Gain and Swept IF Gain) have no effect when the U7227A USB Preamplifier is connected. This is not annotated or reflected on any softkey; there are no keys grayed out nor any SCPI locked out. The analyzer simply behaves as though both FFT IF Gain and Swept IF Gain are set to Low regardless of the setting on the keys.
Initial S/W Revision	Prior to A.02.00

IF Gain Auto

Activates the auto rules for IF Gain.

Key Path	Meas Setup, IF Gain
Mode	SA, GSM
Remote Command	[:SENSe] :TXPower :IF :GAIN :AUTO [:STATe] OFF ON 0 1 [:SENSe] :TXPower :IF :GAIN :AUTO [:STATe] ?
Example	TXP : IF : GAIN : AUTO ON TXP : IF : GAIN : AUTO ?
Notes	You must be in the Spectrum Analyzer mode, GSM mode to use this command. Use INSTRument:SElect to set the mode.
Dependencies	IF Gain is not available when IQ Input is selected (the menu key is blank).
Couplings	When either the auto attenuation works (for example, with electrical attenuator), or the optimize mechanical attenuator range is requested, the IF Gain setting is changed according to the following rule. 'auto' sets IF Gain High under any of the following conditions: the input attenuator is set to 0 dB, the preamp is turned on, or the Max Mixer Level is -20 dBm or lower. For other settings, auto sets IF Gain to Low.
Preset	ON
State Saved	Saved in instrument state.
Range	Auto Man
Initial S/W Revision	Prior to A.02.00

IF Gain State

Selects the range of the IF Gain.

Key Path	Meas Setup, IF Gain
Mode	SA, GSM
Remote Command	[:SENSe] :TXPower :IF :GAIN [:STATe] ON OFF 1 0 [:SENSe] :TXPower :IF :GAIN [:STATe] ?
Example	TXP : IF : GAIN ON TXP : IF : GAIN ?
Notes	You must be in the Spectrum Analyzer mode, GSM mode to use this command. Use INSTRument:SElect to set the mode.

13 Burst Power (Transmit Power)
Meas Setup

	ON = high gain OFF = low gain
Dependencies	IF Gain is not available when IQ Input is selected (the menu key is blank)
Couplings	Sending this command forces IF Gain Auto to OFF (Man).
Preset	OFF
State Saved	Saved in instrument state.
Range	Low Gain (Best for Large Signals) High Gain (Best Noise Level)
Initial S/W Revision	Prior to A.02.00

Meas Preset

Returns parameters for this measurement to those set by the factory.

Key Path	Meas Setup
Mode	SA, GSM, TD-SCDMA
Remote Command	:CONFigure:TXPower
Example	CONF:TXP
Notes	You must be in the Spectrum Analyzer mode, TD-SCDMA mode or GSM mode to use this command. Use INSTRument:SElect to set the mode.
Initial S/W Revision	Prior to A.02.00

Mode

See ["Mode" on page 353](#)

Mode Preset

Returns the active mode to a known state.

Mode Preset does the following for the currently active mode:

- Aborts the currently running measurement.
- Brings up the default menu for the mode, with no active function.
- Sets measurement Global settings to their preset values for the active mode only.
- Activates the default measurement.
- Brings up the default menu for the mode.
- Clears the input and output buffers.
- Sets Status Byte to 0.

Mode Preset does not:

- Cause a mode switch
- Affect mode persistent settings
- Affect system settings
- See "[How-To Preset](#)" on page 2176 for more information.

Key Path	Front-panel key
Remote Command	:SYSTem:PRESet
Example	:SYST:PRES
Notes	<p>*RST is preferred over :SYST:PRES for remote operation. *RST does a Mode Preset, as done by the :SYST:PRES command, and it sets the measurement mode to Single measurement rather than Continuous for optimal remote control throughput.</p> <p>Clears all pending OPC bits. The Status Byte is set to 0.</p>
Couplings	A Mode Preset aborts the currently running measurement, activates the default measurement, and gets the mode to a consistent state with all of the default couplings set.
Backwards Compatibility Notes	<p>In the X-Series, the legacy "Factory Preset" has been replaced with Mode Preset, which only presets the currently active mode, not the entire instrument. In the X-Series, the way to preset the entire instrument is by using System, Restore System Defaults All, which behaves essentially the same way as restore System Defaults does on ESA and PSA.</p> <p>There is also no "Preset Type" as there is on the PSA. There is a green Mode Preset front-panel key that does a Mode Preset and a white-with-green-letters User Preset front-panel key that does a User Preset. The old PRESet:TYPE command is ignored (without generating an error), and SYST:PRES without a parameter does a Mode Preset, which should cover most backward code compatibility issues.</p> <p>The settings and correction data under the Input/Output front-panel key (examples: Input Z Corr,</p>

Ext Amp Gain, etc.) are no longer part of any Mode, so they will not be preset by a Mode Preset. They are preset using Restore Input/Output Defaults, Restore System Defaults All. Note that because User Preset does a Recall State, and all of these settings are saved in State, they ARE recalled when using User Preset.

Initial S/W Revision Prior to A.02.00

How-To Preset

The table below shows all possible presets, their corresponding SCPI commands and front-panel access (key paths). Instrument settings depend on the current measurement context. Some settings are local to the current measurement, some are global (common) across all the measurements in the current mode, and some are global to all the available modes. In a similar way, restoring the settings to their preset state can be done within the different contexts.

Auto Couple - is a measurement local key. It sets all Auto/Man parameter couplings in the measurement to Auto. Any Auto/Man selection that is local to other measurements in the mode will not be affected.

Meas Preset - is a measurement local key. Meas Preset resets all the variables local to the current measurement except the persistent ones.

Mode Preset - resets all the current mode's measurement local and measurement global variables except the persistent ones.

Restore Mode Defaults - resets ALL the Mode variables (and all the Meas global and Meas local variables), including the persistent ones.

Type Of Preset	SCPI Command	Front Panel Access
Auto Couple	:COUPle ALL	Auto Couple front-panel key
Meas Preset	:CONFigure:<Measurement>	Meas Setup Menu
Mode Preset	:SYSTem:PRESet	Mode Preset (green key)
Restore Mode Defaults	:INSTrument:DEFAult	Mode Setup Menu
Restore All Mode Defaults	:SYSTem:DEFAult MODes	System Menu; Restore System Default Menu
*RST	*RST	not possible (Mode Preset with Single)
Restore Input/Output Defaults	:SYSTem:DEFAult INPut	System Menu; Restore System Default Menu
Restore Power On Defaults	:SYSTem:DEFAult PON	System Menu; Restore System Default Menu
Restore Alignment Defaults	:SYSTem:DEFAult ALIGn	System Menu; Restore System Default Menu
Restore Miscellaneous Defaults	:SYSTem:DEFAult MISC	System Menu; Restore System Default Menu

13 Burst Power (Transmit Power)
Mode Preset

Restore All System Defaults	:SYSTem:DEFault [ALL] :SYSTem:PRESet:PERSistent	System Menu; Restore System Default Menu
User Preset	:SYSTem:PRESet:USER	User Preset Menu
User Preset All Modes	:SYSTem:PRESet:USER:ALL	User Preset Menu
Power On Mode Preset	:SYSTem:PON:TYPE MODE	System Menu
Power On User Preset	:SYSTem:PON:TYPE USER	System Menu
Power On Last State	:SYSTem:PON:TYPE LAST	System Menu

Mode Setup

See ["Mode Setup" on page 388](#)

Peak Search

Places the selected marker on the trace point with the maximum y-axis value for that marker's trace. Pressing Peak Search with the selected marker off causes the selected marker to be set to Normal, then a peak search is immediately performed.

Key Path	Front-panel key
Mode	GSM, SA, TD-SCDMA
Remote Command	:CALCulate:TXPower:MARKer[1] 2 ... 12:MAXimum
Example	CALC:TXP:MARK2:MAX
Initial S/W Revision	Prior to A.02.00

Print

See "Print " on page 430

Quick Save

The Quick Save front-panel key repeats the most recent save that was performed from the Save menu, with the following exceptions:

- Register saves are not remembered as Saves for the purpose of the Quick Save function
- If the current measurement does not support the last non-register save that was performed, an informational message is generated, “File type not supported for this measurement”

Quick Save repeats the last type of qualified save (that is, a save qualified by the above criteria) in the last save directory by creating a unique filename using the Auto File Naming algorithm described below.

If Quick Save is pressed after startup and before any qualified Save has been performed, the Quick Save function performs a Screen Image save using the current settings for Screen Image saves (current theme, current directory), which then becomes the “last save” for the purpose of subsequent Quick Saves.

The Auto File Naming feature automatically generates a file name for use when saving a file. The filename consists of a prefix and suffix separated by a dot, as is standard for the Windows® file system. A default prefix exists for each of the available file types:

Type	Default Prefix	Menu
State	State_	(Save/Recall)
Trace + State	State_	(Save/Recall)
Screen	Screen_	(Save/Recall)
Amplitude Corrections	Ampcor_	(Import/Export)
Traces	Trace_	(Import/Export)
Limit Lines	LLine_	(Import/Export)
Measurement Result	MeasR_	(Import/Export)
Capture Buffer	CapBuf_	(Import/Export)

A four digit number is appended to the prefix to create a unique file name. The numbering sequence starts at 0000 within each Mode for each file type and updates incrementally to 9999, then wraps to 0000 again. It remembers where it was through a Mode Preset and when leaving and returning to the Mode. It is reset by Restore Misc Defaults and Restore System Defaults and subsequent running of the instrument application. So, for example, the first auto file name generated for State files is State_0000.state. The next is State_0001, and so forth.

One of the key features of Auto File Name is that we guarantee that the Auto File Name will never conflict with an existing file. The algorithm looks for the next

available number. If it gets to 9999, then it looks for holes. If it find no holes, that is no more numbers are available, it gives an error.

For example, if when we get to State_0010.state there is already a State_0010.state file in the current directory, it advances the counter to State_0011.state to ensure that no conflict will exist (and then it verifies that State_0011.state also does not exist in the current directory and advances again if it does, and so forth).

If you enter a file name for a given file type, then the prefix becomes the filename you entered instead of the default prefix, followed by an underscore. The last four letters (the suffix) are the 4-digit number.

For example, if you save a measurement results file as “fred.csv”, then the next auto file name chosen for a measurement results save will be fred_0000.csv.

NOTE

Although 0000 is used in the example above, the number that is used is actually the current number in the Meas Results sequence, that is, the number that would have been used if you had not entered your own file name.

If the filename you entered ends with _dddd, where d=any number, making it look just like an auto file name, then the next auto file name picks up where you left off with the suffix being dddd + 1.

Key Path	Front-panel key
Notes	No remote command for this key specifically.
Initial S/W Revision	Prior to A.02.00

Recall

The **Recall** menu lets you choose what you want to recall, and where you want to recall it from. Among the types of files you can recall are **States and Traces**. In addition, an **Import (Data)** option lets you recall a number of data types stored in CSV files (as used by Excel and other spreadsheet programs).

The default paths for Recall are data type dependent and are the same as for the Save key.

Key Path	Front-panel key
Notes	<p>No remote command for this key specifically, but the :MMEM:LOAD command is available for specific file types. An example is :MMEM:LOAD:STATe <filename>.</p> <p>If you try to recall a State file for a mode that is not licensed or not available in the instrument, an error message will occur and the state will not change.</p>
Backwards Compatibility Notes	<p>In legacy analyzers, it was possible to load a state without affecting the trace data, limit lines or correction data. Similarly (since User Preset is actually loading a state), it was possible to do a User Preset without affecting the trace data, limit lines or correction data.</p> <p>In the X-Series, “state” always includes all of this data; so whenever state is loaded, all of the traces, limit lines and corrections are affected. Although this differs from previous behavior, it is desirable behavior, and should not cause adverse issues for users.</p>
Backwards Compatibility Notes	<p>Recall for the X-Series supports backward compatibility in the sense that you can recall a state file from any X-Series model number and any version of X-Series software. This is only possible if part of the recalling process goes through a limiting step after recalling the mode settings, at least for settings that may vary with version number, model number, option and license differences. If you try to recall a state file onto an instrument with less capability than what was available on the instrument during the save, the recall will ignore the state it doesn't support and it will limit the recalled setting to what it allows.</p> <p>Example: if the saved state includes preamp ON, but the recalling instrument does not have a preamp; the preamp is limited to OFF. Conversely, if you save a state without a preamp, the preamp is OFF in the state file. When this saved file is recalled on an instrument with a licensed preamp, the preamp is changed to OFF. Another example is if the saved state has center frequency set to 20 GHz, but the instrument recalling the saved state is a different model and only supports 13.5 GHz. In this case, the center frequency is limited along with any other frequency based settings. Since the center frequency can't be preserved in this case, the recall limiting tries to at least preserve span to keep the measurement setup as intact as possible.</p> <p>It may be appropriate to issue a warning if the state is limited on the recall; warnings do not go out to SCPI so this would only affect the manual user.</p> <p>Note that there is no state file compatibility outside of the X-Series. For example, you cannot recall a state file from ESA or PSA.</p>
Initial S/W Revision	Prior to A.02.00

State

The **Recall State** menu lets you choose a register or file from which to recall the state.

The content of a state file includes all of the settings and data required to return the analyzer as closely as possible to the Mode it was in, with the exact settings that

were in place, when the save occurred. The Mode settings in each state file include the settings that are affected by Mode Preset, as well as the additional settings affected by Restore Mode Defaults; all of the Mode's settings. In addition, all of the settings of the **Input/Output** system are included, even though they are outside of the Mode's state, because they are needed to restore the complete setup. Persistent System settings (for example, GPIB address) are not affected by either a Mode Preset or Restore Mode Defaults, nor are they included in a saved State file.

Since each state file is only for one Mode, the settings for other Modes are unaffected when it is loaded. **Recall State** will cause a mode switch if the state being recalled is not from the current active mode.

After the recall completes, the message "File <filename> recalled" or "Recalled State Register <register number>" is displayed.

For rapid recalls, the State menu lists 16 registers that you can choose from to recall. Pressing a Register key initiates the recall. You can also select a file from which to recall.

The default path for all State Files is:

My Documents\<<mode name>\state

where <mode name> is the parameter used to select the mode with the INST:SEL command (for example, SA for the Spectrum Analyzer).

See ["More Information" on page 2185](#).

Key Path	Recall
Mode	All
Remote Command	:MMEMory:LOAD:STATe <filename>
Example	:MMEM:LOAD:STAT "myState.state" This recalls the file myState.state on the default path
Example	MMEM:LOAD:STAT "MyStateFile.state" This loads the state file data (on the default file directory path) into the instrument state.
Notes	When you pick a file to recall, the analyzer first verifies that the file is recallable in the current instrument by checking the software version and model number of the instrument. If everything matches, a full recall proceeds by aborting the currently running measurement, clearing any pending operations, and then loading the State from the saved state file. You can open state files from any mode, so recalling a State file switches to the mode that was active when the save occurred. After switching to the mode of the saved state file, mode settings and data (if any for the mode) are loaded with values from the saved file. The saved measurement of the mode becomes the newly active measurement and the data relevant to the measurement (if there is any) is recalled. <ul style="list-style-type: none"> - If there is a mismatch between file version or model number or instrument version or model number, the recall function tries to recall as much as possible and returns a warning message. It may limit settings that differ based on model number, licensing or version number. <p>After recalling the state, the Recall State function does the following:</p>

-
- Makes the saved measurement for the mode the active measurement.
 - Clears the input and output buffers.
 - Status Byte is set to 0.
 - Executes a *CLS

If the file specified is empty an error is generated. If the specified file does not exist, another error is generated. If there is a mismatch between the file and the proper file type, an error is generated. If there is a mismatch between file version or model number or instrument version or model number, a warning is displayed. Then it returns to the State menu and File Open dialog goes away.

After the Recall, the analyzer exits the Recall menu and returns to the previous menu.

Backwards Compatibility SCPI :MMEMory:LOAD:STATE 1,<filename>
For backwards compatibility, the above syntax is supported. The "1" is simply ignored.

Initial S/W Revision Prior to A.02.00

More Information

In measurements that support saving Traces, for example, Swept SA, the Trace data is saved along with the State in the State file. When recalling the State, the Trace data is recalled as well. Traces are recalled exactly as they were stored, including the writing mode and update and display modes. If a Trace was updating and visible when the State was saved, it will come back updating and visible, and its data will be rewritten right away. When you use State to save and recall traces, any trace whose data must be preserved should be placed in View or Blank mode before saving.

The following table describes the Trace Save and Recall possibilities:

You want to recall state and one trace's data, leaving other traces unaffected.	Save Trace+State from 1 trace. Make sure that no other traces are updating (they should all be in View or Blank mode) when the save is performed.	On Recall, specify the trace you want to load the one trace's data into. This trace will load in View. All other traces' data will be unaffected, although their trace mode will be as it was when the state save was performed.
You want to recall all traces	Save Trace+State from ALL traces.	On Recall, all traces will come back in View (or Blank if they were in Blank or Background when saved)
You want all traces to load exactly as they were when saved.	Save State	On recall, all traces' mode and data will be exactly as they were when saved. Any traces that were updating will have their data immediately overwritten.

From File...

When you press “From File”, the analyzer brings up a Windows dialog and a menu entitled “File Open.” This menu allows you to navigate to the various fields in the Windows dialog without using a keyboard or mouse. The **Tab** and **Arrow** keys can also be used for dialog navigation.

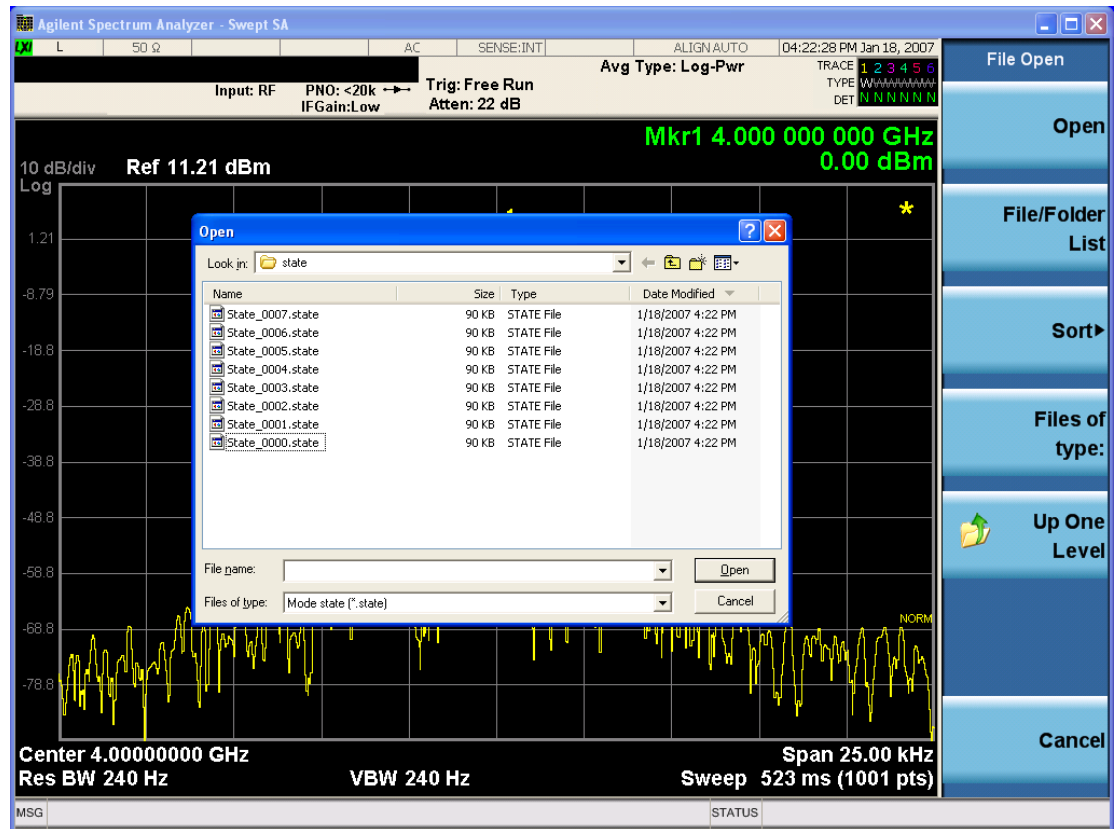

Listed below are the functions of the various fields in the dialog, and the corresponding softkeys:

Open

Performs the recall of the specified file. While the recall is being performed, the floppy icon appears briefly in the Meas bar.

File/Folder List

Enables you to navigate to the center of the dialog that contains the list of files and folders. Once here you can get information about the file and use the tab keys to navigate to the other fields in the dialog, such as Look In.

Look In

The **Look In** field shows the path from which the file will be recalled and allows you to change the path using the up and down arrow keys to navigate to other paths; the Enter key to open a directory; and the Backspace key to go back one directory. The **Look In** field first uses the last path from the Save As dialog **Save In:** path for that

same file type. There is no softkey for directly navigating to the Look In field, but you can use the left tab to get here from the File/Folder List.

User specified paths are remembered when you leave and return to a Mode and are reset back to the default using **Restore Mode Defaults**.

Sort

Accesses a menu that enables you to sort the files within the File Open dialog. Only one sorting type can be selected at a time and the sorting happens immediately. The sorting types are **By Date**, **By Name**, **By extension**, and **By Size**.

Files of Type

This field shows the file suffix for the type of file you have selected to recall. For example, if you navigated here while recalling State, "Mode state (*.state)" is in the field. If you navigated here while recalling Trace, "Mode state (*.trace)" is in the field. If you navigated here while importing a trace data file, "Trace Data (*.csv)" is in the field. For some file types, there is more than one choice in the dropdown menu, which you can select by using the up and down arrow keys and Enter.

Up One Level

This key corresponds to the icon of a folder with the up arrow that is in the tool bar of the dialog. When pressed, it causes the file and folder list to navigate up one level in the directory structure. The Backspace key does the same thing.

Cancel

This key corresponds to the **Cancel** selection in the dialog. It causes the current **Open** request to be cancelled. The ESC key does the same thing.

Key Path	Recall, State
Notes	Brings up the Open dialog for recalling a State Save Type
Initial S/W Revision	Prior to A.02.00

Edit Register Names

You may enter a custom name on any of the Register keys, to help you remember what you are using that state to save. To do this, press the **Edit Register Names** key, choose the register whose name you wish to edit, and then enter the desired label using the Alpha Editor or an external PC keyboard.

The maximum number of characters that can be added is 30. In most cases, 30 characters will fit on two lines of the key.

For more information and the SCPI command, see Edit Register Names under the **Save, State** function.

Key Path	Recall, State
Mode	All
Dependencies	N9060A-7FP or N9060B-2FP license required to edit the register names. When the feature is not licensed, sending the SCPI command generates an error, -221,"Settings conflict;Option not

	available"
Initial S/W Revision	A.11.00

Register 1 thru Register 16

Selecting any one of these register keys causes the State of the mode from the specified Register to be recalled. Each of the register keys annotates whether it is empty or at what date and time it was last modified. In addition, you can use the **Edit Register Names** key under **Save, State** to enter custom names for each register.

Registers are shared by all modes, so recalling from any one of the registers will cause a mode switch to the mode that was active when the save to the Register occurred.

Although these 16 registers are the only registers available from the front panel, there are 128 state registers available in the instrument. Registers 17-128 are only available from the SCPI interface, using the *RCL command.

After the recall completes, the message "Register <register number> recalled" appears in the message bar. If you are in the Spectrum Analyzer Mode, and you are recalling a register that was saved in the Spectrum Analyzer Mode, then after the recall, you will still be in the Recall Register menu. If the Recall causes you to switch modes, then after the Recall, you will be in the Frequency menu.

If a requested register is empty an error is generated.

Key Path	Recall, State
Example	*RCL 1
Range	1-16 from front panel, 1-128 from SCPI
Readback	Date and time with seconds resolution are displayed on the key OR A custom name of up to 30 characters entered using the Save, State,Edit Register Names key OR “(empty)” if no prior save operation has been performed to this register.
Initial S/W Revision	Prior to A.02.00
Modified at S/W Revision	Prior to A.11.00

Register 1 thru Register 16

Selecting any one of these register keys causes the State of the mode from the specified Register to be recalled. Each of the register keys annotates whether it is empty or at what date and time it was last modified. In addition, you can use the **Edit Register Names** key under **Save, State** to enter custom names for each register.

Registers are shared by all modes, so recalling from any one of the registers will cause a mode switch to the mode that was active when the save to the Register occurred.

Although these 16 registers are the only registers available from the front panel, there are 128 state registers available in the instrument. Registers 17-128 are only available from the SCPI interface, using the *RCL command.

After the recall completes, the message "Register <register number> recalled" appears in the message bar. If you are in the Spectrum Analyzer Mode, and you are recalling a register that was saved in the Spectrum Analyzer Mode, then after the recall, you will still be in the Recall Register menu. If the Recall causes you to switch modes, then after the Recall, you will be in the Frequency menu.

If a requested register is empty an error is generated.

Key Path	Recall, State
Example	*RCL 1
Range	1-16 from front panel, 1-128 from SCPI
Readback	Date and time with seconds resolution are displayed on the key OR A custom name of up to 30 characters entered using the Save, State,Edit Register Names key OR "(empty)" if no prior save operation has been performed to this register.
Initial S/W Revision	Prior to A.02.00
Modified at S/W Revision	Prior to A.11.00

Trace (+State)

The Recall Trace (+State) menu lets you choose a register or file from which to recall the Trace+State state file.

A saved state contains all of the settings and data required to return the analyzer as closely as possible to the exact setup it had when the save occurred. This includes the Input/Output settings, even though they are outside of the Mode's state, because they are needed to restore the complete setup. A Trace+State file also includes trace data from one trace or all traces, which will load in View mode when the Trace+State file is recalled. Recall Trace (+State) will also cause a mode switch if the state being recalled is not for the current active mode.

After the recall completes, the message "File <filename> recalled" or "Recalled Trace Register <register number>" is displayed.

For rapid recalls, the Trace (+State) menu lists 5 registers to choose from to recall. Pressing a Register key initiates the recall. You can also select a file from which to recall.

The default path for all State Files including .trace files is:

My Documents\<<mode name>\state

where <mode name> is the parameter used to select the mode with the INST:SEL command (for example, SA for the Spectrum Analyzer).

Key Path	Recall
Mode	SA
Remote Command	<pre>:MMEMory:LOAD:TRACe TRACE1 TRACE2 TRACE3 TRACE4 TRACE5 TRACE6,<filename> :MMEMory:LOAD:TRACe:REGister TRACE1 TRACE2 TRACE3 TRACE4 TRACE5 TRACE6,<integer></pre>
Example	<pre>MMEM:LOAD:TRAC TRACE2, "MyTraceFile.trace"</pre> <p>This loads the trace file data (on the default file directory path) into the specified trace; if it is a "single trace" save file, that trace is loaded to trace 2, and is set to be not updating.</p> <pre>:MMEM:LOAD:TRAC:REG TRACE1,2</pre> <p>restores the trace data in register 2 to Trace 1</p>
Notes	<p>When you perform the recall, the recalling Trace function must first verify the file is recallable in this instrument by checking instrument software version and model number, since it includes State. If everything matches, a full recall proceeds by aborting the currently running measurement, and loading the state from the saved state file to as close as possible to the context in which the save occurred. You can open .trace files from any mode that supports them, so recalling a Trace file switches to the mode that was active when the save occurred. After switching to the mode of the saved state file, mode settings and data (if any for the mode) are loaded with values from the saved file and the saved measurement of the mode becomes the newly active measurement, and the data relevant to the measurement (if there is any) is recalled.</p> <p>Once the state is loaded, the trace data must be loaded. The internal flags are consulted to see which trace to load and the "To Trace" setting to see where to load it. Trace data is always loaded with the specified trace set to View, so that the data is visible and not updating (so as not to erase the recalled data). If the file is an "all trace" file, all traces are loaded with the saved data (to the original trace the data was saved from) and set to View. Traces whose data is not loaded are restored to the update state that existed when they were saved.</p> <p>After the Recall the analyzer exits the Recall menu and returns to the previous menu.</p> <p>Some modes and measurements do not have available all 6 traces. Phase Noise mode command, for example, is: <code>MMEMory:LOAD:TRACe TRACE1 TRACE2 TRACE3,<filename></code></p> <p>Some modes and measurements have more than 6 traces available. The Realtime SA mode command, for example, is: <code>MMEMory:STORe:TRACe TRACE1 TRACE2 TRACE3 TRACE4 TRACE5 TRACE6 TRACE7 TRACE8 TRACE9 TRACE10 TRACE11 TRACE12 ALL,<filename></code></p>
Initial S/W Revision	Prior to A.02.00

To Trace

These menu selections let you choose the Trace where the recalled saved trace will go. Not all modes have the full 6 traces available. The default is the currently selected trace, selected in this menu or in the Trace/Detector, Export Data, Import Data, or Save Trace menus, except if you have chosen All, then it remains chosen until you specifically change it to a single trace.

If the .trace file is an "all trace" file, "**To Trace**" is ignored and the traces each go back to the trace from which they were saved.

Once selected, the key returns back to the Recall Trace menu and the selected Trace number is annotated on the key. Now you have selected exactly where the

trace needs to be recalled. To trigger a recall of the selected Trace, you must select the **Open** key in the Recall Trace menu.

When you select a trace, it makes that trace the current trace, so it displays on top of all of the other traces.

Key Path	Save, Data, Trace
Mode	SA
Initial S/W Revision	Prior to A.02.00

Register 1 thru Register 16

Selecting any one of these register keys causes the State of the mode from the specified Register to be recalled. Each of the register keys annotates whether it is empty or at what date and time it was last modified. In addition, you can use the **Edit Register Names** key under **Save, State** to enter custom names for each register.

Registers are shared by all modes, so recalling from any one of the registers will cause a mode switch to the mode that was active when the save to the Register occurred.

Although these 16 registers are the only registers available from the front panel, there are 128 state registers available in the instrument. Registers 17-128 are only available from the SCPI interface, using the *RCL command.

After the recall completes, the message "Register <register number> recalled" appears in the message bar. If you are in the Spectrum Analyzer Mode, and you are recalling a register that was saved in the Spectrum Analyzer Mode, then after the recall, you will still be in the Recall Register menu. If the Recall causes you to switch modes, then after the Recall, you will be in the Frequency menu.

If a requested register is empty an error is generated.

Key Path	Recall, State
Example	*RCL 1
Range	1-16 from front panel, 1-128 from SCPI
Readback	Date and time with seconds resolution are displayed on the key OR A custom name of up to 30 characters entered using the Save, State, Edit Register Names key OR “(empty)” if no prior save operation has been performed to this register.
Initial S/W Revision	Prior to A.02.00
Modified at S/W Revision	Prior to A.11.00

From File...

When you press “From File”, the analyzer brings up a Windows dialog and a menu entitled “**File Open.**” This menu allows you to navigate to the various fields in the

Windows dialog without using a keyboard or mouse. The **Tab** and **Arrow** keys can also be used for dialog navigation.

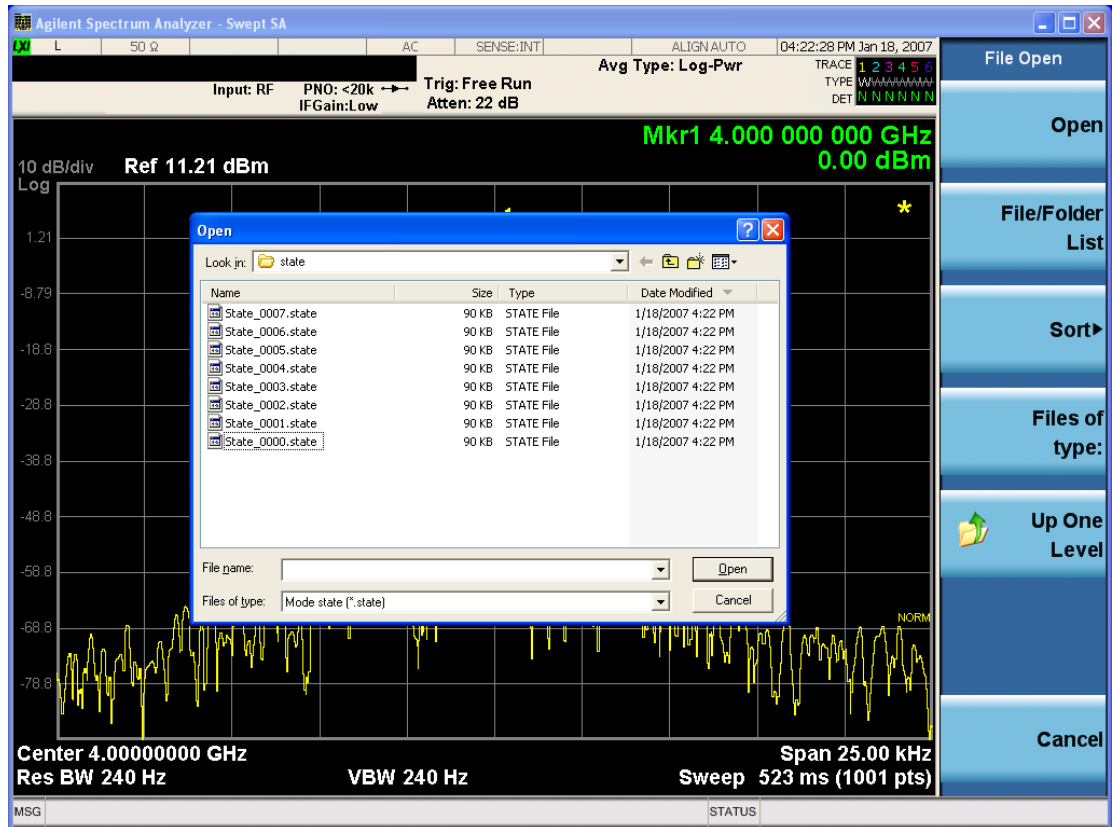

Listed below are the functions of the various fields in the dialog, and the corresponding softkeys:

Open

Performs the recall of the specified file. While the recall is being performed, the floppy icon appears briefly in the Meas bar.

File/Folder List

Enables you to navigate to the center of the dialog that contains the list of files and folders. Once here you can get information about the file and use the tab keys to navigate to the other fields in the dialog, such as Look In.

Look In

The **Look In** field shows the path from which the file will be recalled and allows you to change the path using the up and down arrow keys to navigate to other paths; the Enter key to open a directory; and the Backspace key to go back one directory. The **Look In** field first uses the last path from the Save As dialog **Save In:** path for that same file type. There is no softkey for directly navigating to the Look In field, but you can use the left tab to get here from the File/Folder List.

User specified paths are remembered when you leave and return to a Mode and are reset back to the default using **Restore Mode Defaults**.

Sort

Accesses a menu that enables you to sort the files within the File Open dialog. Only one sorting type can be selected at a time and the sorting happens immediately. The sorting types are **By Date, By Name, By extension, and By Size**.

Files of Type

This field shows the file suffix for the type of file you have selected to recall. For example, if you navigated here while recalling State, "Mode state (*.state)" is in the field. If you navigated here while recalling Trace, "Mode state (*.trace)" is in the field. If you navigated here while importing a trace data file, "Trace Data (*.csv)" is in the field. For some file types, there is more than one choice in the dropdown menu, which you can select by using the up and down arrow keys and Enter.

Up One Level

This key corresponds to the icon of a folder with the up arrow that is in the tool bar of the dialog. When pressed, it causes the file and folder list to navigate up one level in the directory structure. The Backspace key does the same thing.

Cancel

This key corresponds to the **Cancel** selection in the dialog. It causes the current **Open** request to be cancelled. The ESC key does the same thing.

Key Path	Recall, State
Notes	Brings up the Open dialog for recalling a State Save Type
Initial S/W Revision	Prior to A.02.00

Data (Import)

Importing a data file loads data that was previously saved from the current measurement or from other measurements and/or modes that produce compatible data files. The Import Menu only contains Data Types that are supported by the current measurement.

Since the commonly exported data files are in .csv format, the data can be edited by the user prior to importing. This allows you to export a data file, manipulate the data in Excel (the most common PC Application for manipulating .csv files) and then import it.

Importing Data loads measurement data from the specified file into the specified or default destination, depending on the data type selected. Selecting an Import Data menu key will not actually cause the importing to occur, since the analyzer still needs to know from where to get the data. Pressing the Open key in this menu brings up the Open dialog and Open menu that provides you with the options from where to recall the data. Once a filename has been selected or entered in the Open menu, the recall occurs as soon as the Open button is pressed.

Key Path	Recall
Mode	All
Notes	The menu is built from whatever data types are available for the mode. Some keys will be missing completely, so the key locations in the sub-menu will vary. No SCPI command directly controls the Data Type that this key controls. The Data Type is included in the MMEM:LOAD commands.
Dependencies	If a file type is not used by a certain measurement, it is grayed out for that measurement. The key for a file type will not show at all if there are no measurements in the Mode that support it.
Preset	Is not affected by Preset or shutdown, but is reset during Restore Mode Defaults
Readback	The data type that is currently selected
Initial S/W Revision	Prior to A.02.00

Amplitude Correction

This key selects the Amplitude Corrections as the data type to be imported. When pressed a second time, it brings up the Select Menu, which lets you select the Correction into which the data will be imported.

Amplitude Corrections are fully discussed in the documentation of the Input/Output key, under the Corrections key.

A set of preloaded Corrections files can be found in the directory

/My Documents/ EMC Limits and Ampcor.

When the Amplitude Correction is an Antenna correction and the Antenna Unit in the file is not **None**, the Y Axis Unit setting will change to match the Antenna Unit in the file.

Key Path	Recall
Mode	SA EDGE GSM PN
Remote Command	:MMEMory:LOAD:CORRection 1 2 3 4 5 6 7 8, <filename>
Example	:MMEM:LOAD:CORR 2, "myAmpcor.csv" recalls the Amplitude Correction data from the file myAmpcor.csv in the current directory to the 2nd Amplitude Correction table, and turns on Correction 2. The default path is D:\Users\Instrument\My Documents\amplitudeCorrections\
Dependencies	Only the first correction array (Correction 1) supports antenna units. This means that a correction file with an Antenna Unit can only be loaded into the Corrections 1 register. Consequently only for Correction 1 does the dropdown in the Recall dialog include ant, and if an attempt is made to load a correction file into any other Correction register which DOES contain an antenna unit, a Mass Storage error is generated. Corrections are not supported by all Measurements. If in a Mode in which some Measurements support it, this key will be grayed out in measurements that do not. The key will not show at all if no measurements in the Mode support it. Errors are reported if the file is empty or missing, or if the file type does not match, or if there is a mismatch between the file type and the destination data type. If any of these occur during manual operation, the analyzer returns to the Import Data menu and the File Open dialog goes away.

	This key does not appear unless you have the proper option installed in your instrument. This command will generate an “Option not available” error unless you have the proper option installed in your instrument.
Couplings	When a correction file is loaded from mass storage, it is automatically turned on (Correction ON) and ApplyCorrections is set to On. This allows you to see its effect, thus confirming the load.
Readback	selected Correction
Backwards Compatibility SCPI	:MMEMory:LOAD:CORRection ANTenna CABLE OTHER USER, <filename> For backwards compatibility, ANTenna maps to 1, CABLE maps to 2, OTHER maps to 3 and USER maps to 4
Initial S/W Revision	A.02.00

Amplitude Correction

These keys let you select which Correction to import the data into. Once selected, the key returns back to the Import Data menu and the selected Correction number is annotated on the key. The next step is to select the Open key in the Import Data menu.

Antenna corrections are a particular kind of Amplitude Corrections – they are distinguished in the corrections file by having the Antenna Unit set to a value other than None. Only Correction 1 supports Antenna Units.

Key Path	Recall, Data, Amplitude Correction
Notes	auto return
Dependencies	Only Correction 1 may be used to load a Correction that contains an Antenna Unit other than None
Preset	Not part of Preset, but is reset to Correction 1 by Restore Input/Output Defaults; survives shutdown.
State Saved	The current Correction number is saved in instrument state
Initial S/W Revision	A.02.00

Trace

This key selects Trace as the data type to be imported. When pressed a second time, it brings up the Trace Menu, which lets you select the Trace into which the data will be imported.

The trace file contains “meta” data which describes the state of the analyzer when the trace was exported (see ["Trace File Contents" on page 3216](#)). If the meta data in the file does not match the current SA state, the “invalid data indicator” (*) is displayed.

Key Path	Recall, Data
Remote Command	:MMEMory:LOAD:TRACe:DATA TRACE1 TRACE2 TRACE3 TRACE4 TRACE5 TRACE6,<filename>
Example	:MMEM:LOAD:TRAC DATA TRACE2, "myTrace2.csv" Imports the 2nd trace from the file myTrace2.csv in the current path. The default path is My Documents\SA\data\traces
Dependencies	For SA measurements, a trace cannot be recalled from a trace file that was exported with ALL traces selected. A trace cannot be imported if the number of trace points in the file do not match the number of sweep points currently set for the measurement. If this happens, an error message is generated. Errors are reported if the file is empty or missing, or if the file type does not match, or if there is a mismatch between the file type and the destination data type. If any error occurs while trying to load a file manually (as opposed to during remote operation), the analyzer returns to the Import Data menu and the File Open dialog goes away.
Couplings	When a trace is imported, Trace Update is always turned OFF for that trace and Trace Display is always turned ON.
Readback	Selected Trace
Status Bits/OPC dependencies	Sequential - aborts the current measurement.
Initial S/W Revision	Prior to A.02.00

Select Trace

These keys let you pick the Trace into which to import the data; either 1, 2, 3, 4, 5 or 6. The default is the currently selected trace, selected in this menu or in the Trace/Det, Export Data, Recall Trace, or Save Trace menus; except if you have chosen **All** then **All** remains chosen until you specifically change it to a single trace.

Once selected, the key returns back to the Import Data menu and the selected Trace number is annotated on the key. The next step is to select the Open key in the Import Data menu.

Key Path	Recall, Data, Trace
Notes	Auto return
Couplings	When you select the trace into which to import the data, it makes that trace the current trace, so it displays on top of all of the other traces.
Preset	Not part of Preset, but is reset to TRACE1 by Restore Mode Defaults; survives shutdown
State Saved	The current trace number is saved in State
Initial S/W Revision	Prior to A.02.00

Limit

This key selects Limit Lines as the data type to be imported. When pressed a second time, it brings up the Limits Menu, which lets you select into which Limit the data will be imported.

A set of preloaded Limits files can be found in the directory

/My Documents/ EMC Limits and Ampcor.

Under this directory, the directory called Limits (Legacy Naming) contains a set of legacy limits, generally the same files that were supplied with older Agilent EMC analyzers, that use the legacy suffix .lim, and the old 8-character file names. In the directory called Limits, the same files can be found, with the same suffix, but with longer, more descriptive filenames.

Key Path	Recall, Data
Remote Command	:MMEMory:LOAD:LIMit LLINE1 LLINE2,<filename>
Example	:MMEM:LOAD:LIM LLINE2, "myLimitLine2.csv" Imports the 2nd Limit Line from the file myLimitLine2.csv in the current path. The default path is My Documents\SA\data\limits
Dependencies	Errors are reported if the file is empty or missing, or if the file type does not match, or if there is a mismatch between the file type and the destination data type. If any of these occur during manual operation, the analyzer returns to the Import Data menu and the File Open dialog goes away. This key will only appear if you have the proper option installed in your instrument.
Couplings	When a limit line is loaded from mass storage, it is automatically turned on. This allows the user to see it, thus confirming the load. The Margin settings will match those when the limit was saved The instrument cannot mix Limits domains (X Axis Unit must be Frequency or Time for both Limits). So when a Limits file is loaded, the analyzer will set the Limits domain (X Axis Unit) to match that of the file. If this changes the Limits domain from what it was before the file was loaded, all Limits data in all Limits sets will be erased before the data loads. If this operation is over the remote interface there will be no warning if this occurs, so care should be taken to know the domain of the file you are loading.
Readback	Selected Limit Line
Status Bits/OPC dependencies	Sequential - aborts the current measurement
Initial S/W Revision	A.02.00

Limit Selection

These keys let you pick which Limit Line to import the data into; either 1, 2, 3, 4, 5 or 6. The default is the currently selected limit. Once selected, the key returns back to the Import Data menu and the selected Limit Line number is annotated on the key. Now you have selected exactly what needs to be imported. In order to trigger an import of the selected Limit Line, you must select the Open key in the Import Data menu.

An example of using this menu is: If you select 2 and continue to the File Open menu, Limit Line 2 will be imported from the file selected or entered in File Name option in the File Open dialog.

Key Path	Recall, Data, Limit Line
Notes	Auto return
Preset	Not part of Preset, but is reset to LLINE1 by Restore Mode Defaults; survives a shutdown.
State Saved	The selected limit number is saved in instrument state
Initial S/W Revision	A.02.00

Open...

When you press “Open”, the analyzer brings up a Windows dialog and a menu entitled “**File Open.**” This menu allows you to navigate to the various fields in the Windows dialog without using a keyboard or mouse. The **Tab** and **Arrow** keys can also be used for dialog navigation.

See "[From File...](#)" on page 3210 in **Recall, State**, for a full description of this dialog and menu.

Key Path	Recall, Data
Notes	The key location is mode-dependent and will vary. Brings up Open dialog for recalling a <mode specific> Save Type
Initial S/W Revision	Prior to A.02.00

Restart

The Restart function restarts the current sweep, or measurement, or set of averaged/held sweeps or measurements. If you are Paused, pressing Restart does a Resume.

The Restart function is accessed in several ways:

- Pressing the Restart key
- Sending the remote command INIT:IMMEDIATE
- Sending the remote command INIT:RESTART

See ["More Information" on page 2199](#)

Key Path	Front-panel key
Remote Command	:INITiate[:IMMEDIATE] :INITiate:RESTART
Example	:INIT:IMM :INIT:REST
Notes	:INITiate:RESTART and :INITiate:IMMEDIATE perform exactly the same function.
Couplings	Resets average/hold count k. For the first sweep overwrites all active (update=on) traces with new current data. For application modes, it resets other parameters as required by the measurement.
Status Bits/OPC dependencies	This is an Overlapped command. The STATus:OPERation register bits 0 through 8 are cleared. The STATus:QUESTionable register bit 9 (INTegrity sum) is cleared. The SWEEPING bit is set. The MEASURING bit is set.
Backwards Compatibility Notes	For Spectrum Analysis mode in ESA and PSA, the Restart hardkey and the INITiate:RESTART command restart trace averages (displayed average count reset to 1) for a trace in Clear Write , but did not restart Max Hold and Min Hold . In the X-Series, the Restart hardkey and the INITiate:RESTART command restart not only Trace Average , but MaxHold and MinHold traces as well. For wireless comms modes in ESA and PSA, the Restart hardkey and the INITiate:RESTART command restart every measurement, which includes all traces and numeric results. There is no change to this operation.
Initial S/W Revision	Prior to A.02.00

More Information

The **Restart** function first aborts the current sweep/measurement as quickly as possible. It then resets the sweep and trigger systems, sets up the measurement and initiates a new data measurement sequence with a new data acquisition (sweep) taken once the trigger condition is met.

If the analyzer is in the process of aligning when **Restart** is executed, the alignment finishes before the restart function is performed.

Even when set for Single operation, multiple sweeps may be taken when Restart is pressed (for example, when averaging/holding is on). Thus when we say that **Restart** "restarts a measurement," we may mean:

- It restarts the current sweep
- It restarts the current measurement
- It restarts the current set of sweeps if any trace is in Trace Average, Max Hold or Min Hold
- It restarts the current set of measurements if Averaging, or Max Hold, or Min Hold is on for the measurement
- depending on the current settings.

With **Average/Hold Number** (in **Meas Setup** menu) set to 1, or Averaging off, or no trace in Trace Average or Hold, a single sweep is equivalent to a single measurement. A single sweep is taken after the trigger condition is met; and the analyzer stops sweeping once that sweep has completed. However, with **Average/Hold Number** > 1 and at least one trace set to **Trace Average, Max Hold, or Min Hold (SA Measurement)** or **Averaging on (most other measurements)**, multiple sweeps/data acquisitions are taken for a single measurement. The trigger condition must be met prior to each sweep. The sweep is stopped when the average count k equals the number N set for **Average/Hold Number**. A measurement average usually applies to all traces, marker results, and numeric results; but sometimes it only applies to the numeric results.

Once the full set of sweeps has been taken, the analyzer will go to idle state. To take one more sweep without resetting the average count, increment the average count by 1, by pressing the step up key while **Average/Hold Number** is the active function, or sending the remote command `CALC: AVER: TCON UP`.

Save

The **Save** menu lets you choose what you want to save and where you want to save it. Among the types of files you can save are **States**, **Traces**, and **Screen Images**. In addition, an **Export (Data)** option lets you save a number of data types as CSV files for easy import into Excel and other spreadsheet programs.

Key Path	Front-panel key
Mode	All
Notes	No remote command for this key specifically, but the :MMEM:STORe command is available for specific file types. An example is :MMEM:STOR:STATe <filename>.
Initial S/W Revision	Prior to A.02.00

State

The Save State menu lets you choose a register or file for saving the state.

The content of a state file includes all of the settings and data required to return the analyzer as closely as possible to the Mode it was in, with the exact settings which were in place, when the save occurred. The Mode settings in each state file include the settings that are affected by Mode Preset, as well as the additional settings affected by Restore Mode Defaults; all of the Mode's settings. In addition, all of the settings of the **Input/Output** system are included, even though they are outside of the Mode's state, because they are needed to restore the complete setup. Persistent **System** settings (for example, Verbose SCPI) are not affected by either Mode Preset or Restore Mode Defaults, nor are they included in a saved State file.

After the save completes, the message "File <filename> saved" or "State Register <register number> saved" is displayed.

For rapid saving, the State menu lists 16 registers to save to. Pressing a Register key initiates the save. You can also select a file to save to.

The default path for all State Files is:

My Documents\<<mode name>\state

where <mode name> is the parameter used to select the mode with the INST:SEL command (for example, SA for the Spectrum Analyzer).

Key Path	Save
Mode	All
Remote Command	:MMEMory:STORe:STATe <filename>
Example	MMEM:STOR:STATe "MyStateFile.state" This stores the current instrument state data in the file MyStateFile.state in the default directory.
Notes	Both single and double quotes are supported for any filename parameter over remote. After saving to a register, that register's menu key is updated with the date the time, unless a custom label has been entered for that key. After saving to a register, you remain in the Save State menu, so that you can see the Register

	key update. After saving to a file, the analyzer automatically returns to the previous menu and any Save As dialog goes away.
Backwards Compatibility SCPI	:MMEMory:STORe:STATe 1,<filename> For backwards compatibility, the above syntax is supported. The "1" is simply ignored. The command is sequential.
Initial S/W Revision	Prior to A.02.00

To File . . .

When you press "To File", the analyzer brings up a Windows dialog and a menu entitled "**Save As.**" This menu allows you to navigate to the various fields in the Windows dialog without using a keyboard or mouse. The **Tab** and **Arrow** keys can also be used for dialog navigation.

13 Burst Power (Transmit Power) Save

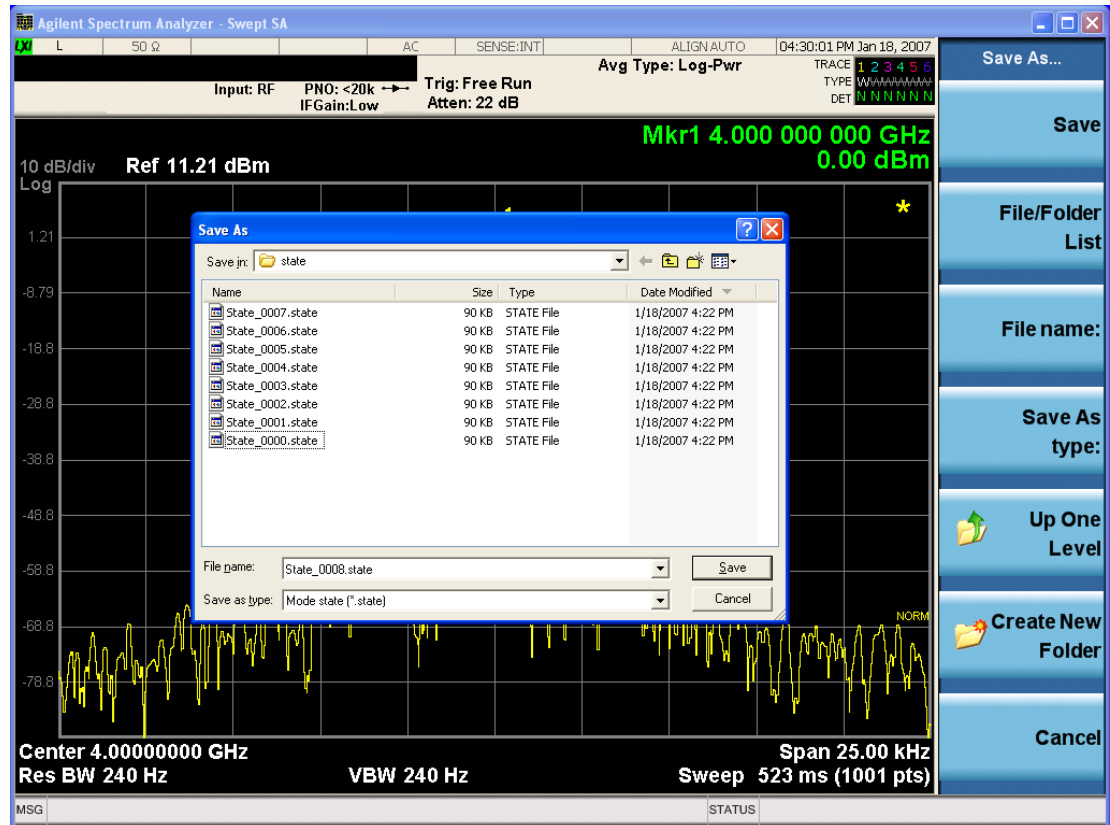

The Listed below are the functions of the various fields in the dialog, and the corresponding softkeys:

Save

Performs the save to the specified file of the selected type. If the file already exists, a dialog will appear that allows you to replace the existing file by selecting **OK**, or you can Cancel the request. If you select OK, the file will be overwritten. Using the C: drive is strongly discouraged, since it runs the risk of being overwritten during an instrument software upgrade.

While the save is being performed, the floppy icon appears briefly in the Meas bar.

File/Folder List

Enables you to navigate to the center of the dialog that contains the list of files and folders. Once here you can get information about the file and use the tab keys to navigate to the other fields in the dialog, such as Save In.

Save In

The Save In field shows the path to which the file will be saved and allows you to change the path using the up and down arrow keys to navigate to other paths; the Enter key to open a directory; and the Backspace key to go back one directory. The **Save In field** defaults to the default path for this type of file and remembers the last path you used to save this type of file. There is no softkey for directly navigating to the Save In field but you can use left tab to get here from the File/Folder List.

User specified paths are remembered when you leave and return to a Mode and are reset back to the default using **Restore Mode Defaults**.

File Name

The **File Name** field is initially loaded with an automatically generated filename specific to the appropriate Save Type. The automatically generated filename is guaranteed not to conflict with any filename currently in the directory. You may replace or modify this filename using the File Name key. See the ["Quick Save " on page 3181](#) documentation for more on the automatic file naming algorithm.

When you press the **File Name** key the analyzer displays the Alpha Editor. Use the knob to choose the letter to add and the front-panel Enter key to add the letter to the file name. The BK character moves you back and the FW character moves you forward in the filename. The Select key on the front panel generates a space character. When you are done entering the filename press the **Done** softkey. This returns back to the **File Open** dialog and menu, but does not cause the save to occur.

Save As Type

This field shows the file suffix for the type of file you have selected to save. For example, if you navigated here while saving State, "Mode state (*.state)" is in the field. If you navigated here from saving Trace, "Mode state (*.trace)" is in the field. If you navigated here while exporting a trace data file, "Trace Data (*.csv)" is in the field. For some file types, there is more than one choice in the dropdown, which you can select by using the up and down arrow keys and Enter.

Up One Level

This key corresponds to the icon of a folder with the up arrow that is in the tool bar of the dialog. When pressed, it causes the file and folder list to navigate up one level in the directory structure. The Backspace key does the same thing.

Create New Folder

This key corresponds to the icon of a folder with the "*" that is in the tool bar of the dialog. When pressed, a new folder is created in the current directory with the name **New Folder** and you can enter a new folder name using the Alpha Editor.

Cancel

This key corresponds to the **Cancel** selection in the dialog. It causes the current **Save As** request to be cancelled. The ESC key does the same thing.

Key Path	Save, State
Mode	All
Notes	Brings up Save As dialog for saving a State Save Type
Initial S/W Revision	Prior to A.02.00

Edit Register Names

You may enter a custom name on any of the Register keys, to help you remember what you are using that state to save. To do this, press the **Edit Register Names** key,

choose the register whose name you wish to edit, and then enter the desired label using the Alpha Editor or an external PC keyboard.

The maximum number of characters that can be added is 30. In most cases, 30 characters will fit on two lines of the key.

See ["More Information" on page 2205](#)

Key Path	Save, State
Mode	All
Remote Command	:MMEMory:REGister:STATe:LABel <reg number>,"label" :MMEMory:REGister:STATe:LABel? <reg number>
Example	:MMEM:REG:STAT:LAB 1,"my label"
Notes	<reg number> is an integer from 1 to 16. If the SCPI specifies an invalid register number an error message is generated, -222,"Data out of range;Invalid register label number" "label" is a string from 0 to 30 characters in length. If a label exceeds 30 characters, an error message is generated, -150,"String data error;Label clipped to 30 characters" "label" of length 0 erases the custom label and restores the default (time and date) label. E.g.: :MMEM:REG:STAT:LAB 1,""
Dependencies	N9060A-7FP or N9060B-2FP license required to edit the register names. When the feature is not licensed, sending this command generates an error, -221,"Settings conflict;Option not available"
Preset	The names are unaffected by Preset or power cycle but are set to the default label (time and date) on a "Restore System Defaults->Misc"
Initial S/W Revision	A.11.00

More Information

When you edit one of the register names, the time and date field will be replaced by the custom name.

If you delete all the characters in the custom name, it restores the default (time and date).

The register names are stored within the state files, but they are not part of the instrument state; that is, once you have edited a register name, loading a new state will not change that register name. Another consequence of this is that the names will be persistent through a power cycle. Also, if a named state file is transferred to another analyzer, it will bring its custom name along with it.

If you try to edit the name of an empty register, the analyzer will first save the state to have a file to put the name in. If you load a named state file into an analyzer with older firmware it will ignore the metadata.

The *SAV and *RCL commands will not be affected by the custom register names, nor will the MMEM commands.

Register 1 thru Register 16

Selecting any one of these register menu keys causes the State of the currently active mode to be saved to the specified Register. The registers are provided for rapid saving and recalling, since you do not need to specify a filename or navigate to

a file. Each of the register menu keys annotates whether it is empty or at what date and time it was last modified. In addition, you can use the **Edit Register Names** key to enter custom names for each register.

Although these 16 registers are the only registers available from the front panel, there are 128 state registers available in the instrument. Registers 17-128 are only available from the SCPI interface, using the *SAV command.

There is one set of 128 state registers in the instrument, not one set for each Mode. When a state is saved, the Mode it was saved from is saved with it; then when it is recalled, the instrument switches to that Mode.

After the save completes, the corresponding register menu key annotation is updated with the date and time and the message "Register <register number> saved" is displayed.

Key Path	Save, State
Mode	All
Example	*SAV 1
Range	1-16 from front panel, 1-128 from SCPI
Readback	Date and time with seconds resolution are displayed on the key OR A custom name of up to 30 characters entered using the Edit Register Names key OR “(empty)” if no prior save operation has been performed to this register.
Initial S/W Revision	Prior to A.02.00
Modified at S/W Revision	A.11.00

Register 1 thru Register 16

Selecting any one of these register menu keys causes the State of the currently active mode to be saved to the specified Register. The registers are provided for rapid saving and recalling, since you do not need to specify a filename or navigate to a file. Each of the register menu keys annotates whether it is empty or at what date and time it was last modified. In addition, you can use the **Edit Register Names** key to enter custom names for each register.

Although these 16 registers are the only registers available from the front panel, there are 128 state registers available in the instrument. Registers 17-128 are only available from the SCPI interface, using the *SAV command.

There is one set of 128 state registers in the instrument, not one set for each Mode. When a state is saved, the Mode it was saved from is saved with it; then when it is recalled, the instrument switches to that Mode.

After the save completes, the corresponding register menu key annotation is updated with the date and time and the message "Register <register number> saved" is displayed.

Key Path	Save, State
Mode	All
Example	*SAV 1
Range	1-16 from front panel, 1-128 from SCPI
Readback	Date and time with seconds resolution are displayed on the key OR A custom name of up to 30 characters entered using the Edit Register Names key OR “(empty)” if no prior save operation has been performed to this register.
Initial S/W Revision	Prior to A.02.00
Modified at S/W Revision	A.11.00

Trace (+State)

The **Save Trace (+State)** menu lets you choose a register or file specifying where to save the Trace+State state file.

A saved state contains all of the settings and data required to return the analyzer as closely as possible to the exact setup it had when the save occurred. This includes the Input/Output settings, even though they are outside of the Mode's state, because they are needed to restore the complete setup. A Trace+State file also includes trace data from one trace or all traces, which will load in View mode when the Trace+State file is recalled.

After the save completes, the message "File <filename> saved" or "Trace Register <register number> saved" is displayed.

For rapid saves, the Trace (+State) menu lists 5 registers to save to. Pressing a Register key initiates the save. You can also select a file to save to.

The default path for all State Files including .trace files is:

My Documents\<<mode name>\state

where <mode name> is the parameter used to select the mode with the INST:SEL command (for example, Basic for the IQAnalyzer).

This key is grayed out for measurements that do not support trace saves. It is blanked for modes that do not support trace saves. Saving **Trace** is identical to saving State except a .trace extension is used on the file instead of .state, and internal flags are set in the file indicating which trace was saved. You may select to save one trace or ALL traces.

Key Path	Save
Mode	SA
Remote Command	:MMEMory:STORe:TRACe TRACE1 TRACE2 TRACE3 TRACE4 TRACE5 TRACE6 ALL,<filename>

	<code>:MMEMory:STORe:TRACe:REGister TRACE1 TRACE2 TRACE3 TRACE4 TRACE5 TRACE6 ALL,<integer></code>
Example	<p><code>:MMEM:STOR:TRAC TRACE1</code>, "myState.trace" saves the file myState.trace on the default path and flags it as a "single trace" file with Trace 1 as the single trace (even though all of the traces are in fact stored).</p> <p><code>:MMEM:STOR:TRAC ALL</code>, "myState.trace" saves the file myState.trace on the default path and flags it as an "all traces" file</p> <p><code>:MMEM:STOR:TRAC:REG TRACE1, 2</code> stores trace 1 data in trace register 2</p>
Notes	<p>This command actually performs a save state, which in the Swept SA measurement includes the trace data. However it flags it (in the file) as a "save trace" file of the specified trace (or all traces).</p> <p>Some modes and measurements do not have available all 6 traces. The Phase Noise mode command, for example, is: <code>MMEMory:STORe:TRACe TRACE1 TRACE2 TRACE3 ALL,<filename></code></p> <p>Some modes and measurements have more than 6 traces available. The Realtime SA mode command, for example, is: <code>MMEMory:STORe:TRACe TRACE1 TRACE2 TRACE3 TRACE4 TRACE5 TRACE6 TRACE7 TRACE8 TRACE9 TRACE10 TRACE11 TRACE12 ALL,<filename></code></p> <p>The range for the register parameter is 1-5</p> <p>When you initiate a save, if the file already exists, a dialog will appear that allows you to replace the existing file by selecting OK or you can Cancel the request. If you select OK, the file will be overwritten. Using the C: drive is strongly discouraged, since it runs the risk of being overwritten during an instrument software upgrade.</p> <p>Both single and double quotes are supported for any filename parameter over remote.</p> <p>After saving to a register, that register's menu key is updated with the date and time of the save.</p> <p>After saving to a register, you remain in the Save Trace menu, so that you can see the Register key update. After saving to a file, the analyzer automatically returns to the previous menu and any Save As dialog goes away.</p>
Initial S/W Revision	Prior to A.02.00

Register 1 thru Register 16

Selecting any one of these register menu keys causes the State of the currently active mode to be saved to the specified Register. The registers are provided for rapid saving and recalling, since you do not need to specify a filename or navigate to a file. Each of the register menu keys annotates whether it is empty or at what date and time it was last modified. In addition, you can use the **Edit Register Names** key to enter custom names for each register.

Although these 16 registers are the only registers available from the front panel, there are 128 state registers available in the instrument. Registers 17-128 are only available from the SCPI interface, using the *SAV command.

There is one set of 128 state registers in the instrument, not one set for each Mode. When a state is saved, the Mode it was saved from is saved with it; then when it is recalled, the instrument switches to that Mode.

After the save completes, the corresponding register menu key annotation is updated with the date and time and the message "Register <register number> saved" is displayed.

Key Path	Save, State
Mode	All
Example	*SAV 1
Range	1-16 from front panel, 1-128 from SCPI
Readback	Date and time with seconds resolution are displayed on the key OR A custom name of up to 30 characters entered using the Edit Register Names key OR “(empty)” if no prior save operation has been performed to this register.
Initial S/W Revision	Prior to A.02.00
Modified at S/W Revision	A.11.00

From Trace

Accesses a menu that enables you to select the trace to be saved. Once a trace is selected, the key returns to the Save Trace menu and the selected trace number is annotated on the key. The default is the currently selected trace, selected in this menu or in the Trace/Det, Export Data, Import Data or Recall Trace menus, except if you have chosen All then it remains chosen until you specifically change it to a single trace. To save the Trace you must select the **Save As** key in the Save Trace menu.

When you select a trace, it makes that trace the current trace, so it displays on top of all of the other traces.

Key Path	Save, Trace + State
Mode	SA
Initial S/W Revision	Prior to A.02.00

From File...

When you press “From File”, the analyzer brings up a Windows dialog and a menu entitled “**File Open.**” This menu allows you to navigate to the various fields in the Windows dialog without using a keyboard or mouse. The **Tab** and **Arrow** keys can also be used for dialog navigation.

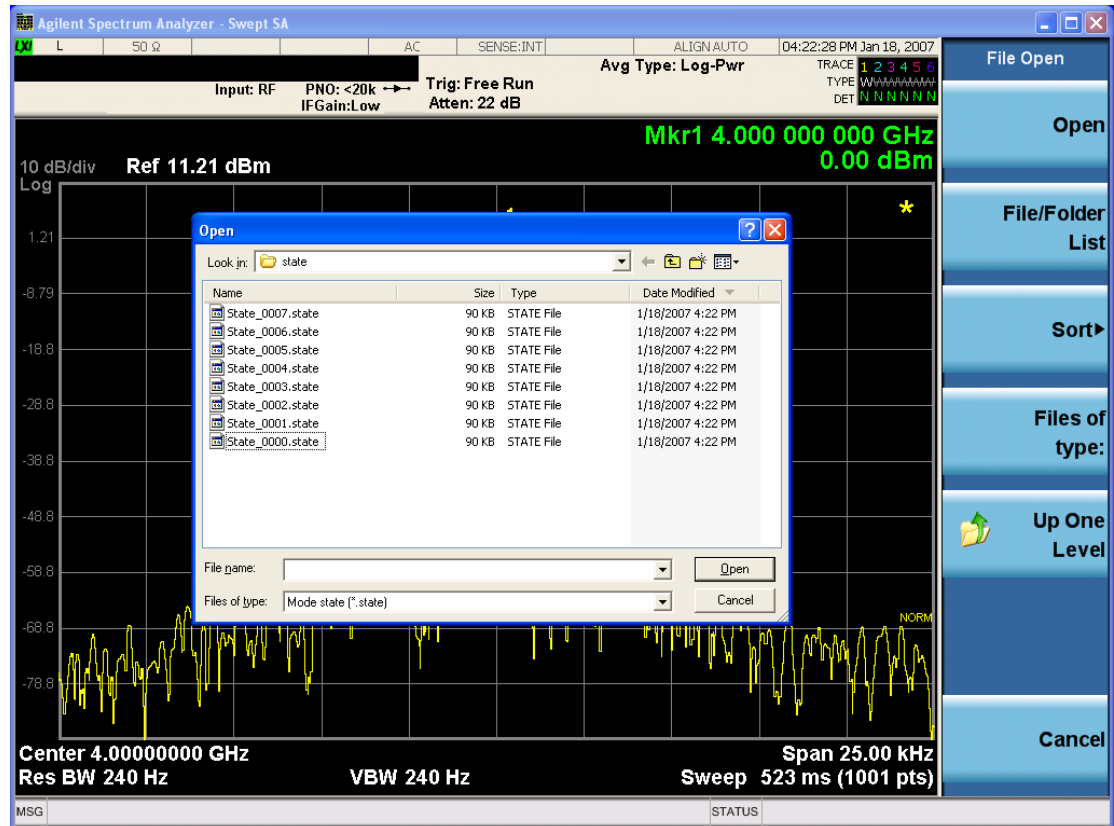

Listed below are the functions of the various fields in the dialog, and the corresponding softkeys:

Open

Performs the recall of the specified file. While the recall is being performed, the floppy icon appears briefly in the Meas bar.

File/Folder List

Enables you to navigate to the center of the dialog that contains the list of files and folders. Once here you can get information about the file and use the tab keys to navigate to the other fields in the dialog, such as Look In.

Look In

The **Look In** field shows the path from which the file will be recalled and allows you to change the path using the up and down arrow keys to navigate to other paths; the Enter key to open a directory; and the Backspace key to go back one directory. The **Look In** field first uses the last path from the Save As dialog **Save In:** path for that same file type. There is no softkey for directly navigating to the Look In field, but you can use the left tab to get here from the File/Folder List.

User specified paths are remembered when you leave and return to a Mode and are reset back to the default using **Restore Mode Defaults**.

Sort

Accesses a menu that enables you to sort the files within the File Open dialog. Only one sorting type can be selected at a time and the sorting happens immediately. The sorting types are **By Date**, **By Name**, **By extension**, and **By Size**.

Files of Type

This field shows the file suffix for the type of file you have selected to recall. For example, if you navigated here while recalling State, "Mode state (*.state)" is in the field. If you navigated here while recalling Trace, "Mode state (*.trace)" is in the field. If you navigated here while importing a trace data file, "Trace Data (*.csv)" is in the field. For some file types, there is more than one choice in the dropdown menu, which you can select by using the up and down arrow keys and Enter.

Up One Level

This key corresponds to the icon of a folder with the up arrow that is in the tool bar of the dialog. When pressed, it causes the file and folder list to navigate up one level in the directory structure. The Backspace key does the same thing.

Cancel

This key corresponds to the **Cancel** selection in the dialog. It causes the current **Open** request to be cancelled. The ESC key does the same thing.

Key Path	Recall, State
Notes	Brings up the Open dialog for recalling a State Save Type
Initial S/W Revision	Prior to A.02.00

Data (Export)

Exporting a data file stores data from the current measurement to mass storage files. The Export Menu only contains data types that are supported by the current measurement.

Since the commonly exported data files are in .csv format, the data can be edited by you prior to importing. This allows you to export a data file, manipulate the data in Excel (the most common PC Application for manipulating .csv files) and then import it.

Selecting an Export Data menu key will not actually cause the exporting to occur, since the analyzer still needs to know where you wish to save the data. Pressing the Save As key in this menu brings up the Save As dialog and Save As menu that allows you to specify the destination file and directory. Once a filename has been selected or entered in the Open menu, the export will occur as soon as the Save key is pressed.

Key Path	Save
Mode	All
Notes	The menu is built from whatever data types are available for the mode. So the key locations in the sub menu will vary. No SCPI command directly controls the Data Type that this key controls. The Data Type is included in the MMEM:STORe commands.

Dependencies	If a file type is not used by a certain measurement, that type is grayed out for that measurement. The key for a file type will not show at all if there are no measurements in the Mode that support it.
Preset	Is not affected by a Preset or shutdown, but is reset during Restore Mode Defaults
Readback	The data type that is currently selected
Initial S/W Revision	Prior to A.02.00

Amplitude Correction

Pressing this key selects **Amplitude Corrections** as the data type to be exported. Pressing this key again brings up the Select Menu, which allows the user to select which **Amplitude Correction** to save.

Amplitude Corrections are fully discussed in the documentation of the Input/Output key, under the Corrections softkey.

See "[Correction Data File](#)" on page 2212

Key Path	Save
Remote Command	:MMEMory:STORe:CORRection 1 2 3 4 5 6, <filename>
Example	:MMEM:STOR:CORR 2 "myAmpcor.csv" saves Correction 2 to the file myAmpcor.csv on the current path. The default path is My Documents\amplitudeCorrections.
Notes	If the save is initiated via SCPI, and the file already exists, the file will be overwritten. Using the C: drive is strongly discouraged, since it runs the risk of being overwritten during an instrument software upgrade. Both single and double quotes are supported for any filename parameter over SCPI.
Dependencies	Corrections are not supported by all Measurements. If in a Mode in which some Measurements support it, this key will be grayed out in measurements that do not. The key will not show at all if no measurements in the Mode support it. This key will not appear unless you have the proper option installed in your instrument.
Readback	Selected Correction
Backwards Compatibility SCPI	:MMEMory:STORe:CORRection ANTenna CABLe OTHer USER, <filename> For backwards compatibility, ANTenna maps to 1, CABLe maps to 2, OTHer maps to 3 and USER maps to 4
Initial S/W Revision	A.02.00

Correction Data File

A Corrections Data File contains a copy of one of the analyzer correction tables. Corrections provide a way to adjust the trace display for predetermined gain curves (such as for cable loss).

Corrections files are text files in .csv (comma separated values) form, to make them importable into Excel or other spreadsheet programs. The format for Corrections files is as follows.

Line #	Type of field	Example	Notes
1	File type, must be "Amplitude Correction"	Amplitude Correction	May not be omitted
2	File Description (in quotes)	"Correction Factors for 11966E"	60 characters max; may be empty but may not be omitted. If exceeds 60 characters, error -233 Too much data reported
3	Comment (in quotes)	"Class B Radiated"	60 characters max; may be empty but may not be omitted. . If exceeds 60 characters, error -233 Too much data reported
4	Instrument Version, Model #	A.02.06,N9020A	May be empty but may not be omitted
5	Option List, File Format Version	K03 LFE EXM ,01	May be empty but may not be omitted
6	Freq Unit to be used for all frequency values in the file	Frequency Unit,MHz	assumed to be Hz if omitted
7	Antenna Unit	Antenna Unit,None	If omitted leaves the Antenna unit unchanged. The amplitude unit in the Antenna Unit field is a conversion factor that is used to adjust the Y Axis Units of the current mode, if the mode supports Antenna Units. For more details on antenna correction data, refer to the Input/Output,Corrections key description. Allowable values: dBuv/m, dBuA/m, dBG, dBpT, None
8	Freq Interpolation	Frequency Interpolation,Linear	if omitted leaves the Freq Interpolation unchanged. Allowable values: Linear, Logarithmic
9	Bias value in mA	Bias,0.00	If omitted leaves the Bias value unchanged (added as of A.08.50)
10	Bias State	Bias State,On	If omitted leaves the Bias State unchanged. Allowable values: On, Off (added as of A.08.50)

Line #	Type of field	Example	Notes
11	Overlap, two values, Freq1 and Freq2, separated by commas.	Overlap,33500,40000	Uses Freq Unit from line 6. Thus, in this example Freq1=33.5 GHz, Freq2= 40.0 GHz (see note below). If omitted leaves the overlap unchanged (added as of A.08.50)
12	DATA marker	DATA	Corrections data begins in the next line

Lines 2 through 5 can be empty but must appear in the file. Lines 6 through 11 are optional, the lines can be left out of the file altogether.

The Overlap row and the two Bias rows apply only to external mixing. Both are read-only, they are never written by the analyzer. The only way to insert or modify these rows is to edit the file with a text editor or a spreadsheet editor. These rows are intended for use by mixer manufacturers, as they allow the manufacturer to insert data about how the mixer corrections were generated and how they should be applied. The Bias rows allow you to specify whether to turn Bias on or off when the Correction is turned on and to specify a Bias value (turning off the Correction does not change the Bias, but turning it back on again sets it to the value specified in the file). The Overlap row allows you to specify an overlap region in which two different corrections may be applied. It is expected that in the corrections data itself, there will be TWO corrections values exactly at Max Freq, otherwise Overlap is ignored. The way the overlap is processed is as follows: if at any given time the current analyzer Start Freq is greater than Freq 1 and lower than Freq 2, and the current Stop Freq is greater than Freq 2, extend the first correction point at or above Freq 2 down to Freq 1, rather than using the correction data between Freq1 and Freq2.

The Antenna Unit row can only be used in Correction register 1, because there can only be one setting for Antenna Unit at any given time. If a Correction whose Antenna Unit is set to anything but None is loaded into any Correction register but 1, an error is generated (Mass storage error; Can only load an Antenna Unit into Correction 1). When a correction file is saved from any Correction register but 1, Antenna Unit is always written as None.

Similarly, the Bias rows can only be used in Correction register 1, because there can only be one setting for Bias at any given time. If a Correction file with a Bias or Bias State row is loaded into any Correction register but 1, an error is generated: Mass storage error; Can only load Bias Settings into Correction 1

The data follows the DATA row, as comma separated X, Y pairs; one pair per line.

For example, suppose you have an Antenna to correct for on an N9020A version A.02.06 and the correction data is:

- 0 dB at 200 MHz

- 17 dB at 210 MHz
- 14.8 dB at 225 MHz

Then the file will look like:

- Amplitude Correction
- "Correction Factors for 11966E"
- "Class B Radiated"
- A.02.06,N9020A
- P13 EA3 UK6,01
- Frequency Unit,MHz
- Antenna Unit,dBuV/m
- Frequency Interpolation,Linear
- DATA
- 200.000000,0.00
- 210.000000,17.00
- 225.000000,14.80

The choices for the 1 of N fields in the metadata are as follows:

- Frequency Unit: Hz, kHz, MHz, GHz
- Antenna Unit: dBuv/m, dBuA/m, dBG, dBpT, None
- Frequency Interpolation: Logarithmic, Linear

Amplitude Correction

These keys let you choose which Correction to save. Once selected, the key returns back to the Export Data menu and the selected Correction number is annotated on the key.

The next step in the Save process is to select the Save As key in the Export Data menu.

Key Path	Save, Data, Amplitude Correction
Preset	Not part of a Preset, but is reset to Correction 1 by Restore Input/Output Defaults. Survives a shutdown.
Readback	1
Initial S/W Revision	A.02.00

Trace

Pressing this key selects Traces as the data type to be exported. Pressing this key when it is already selected brings up the Trace Menu, which allows you to select which Trace to save.

The trace file contains “meta” data which describes the current state of the analyzer. The metadata is detailed in ["Trace File Contents" on page 2216](#) below.

Key Path	Save, Data
Remote Command	:MMEMory:STORe:TRACe:DATA TRACE1 TRACE2 TRACE3 TRACE4 TRACE5 TRACE6 ALL,<filename>
Example	:MMEM:STOR:TRAC:DATA TRACE2, "myTrace2.csv" Exports the 2nd trace to the file myTrace2.csv in the current path. The default path is My Documents\SA\data\traces
Notes	If the save is initiated via SCPI, and the file already exists, the file will be overwritten. Using the C: drive is strongly discouraged, since it runs the risk of being overwritten during an instrument software upgrade. Both single and double quotes are supported for any filename parameter over SCPI.
Dependencies	For SA measurements, traces cannot be recalled from a trace file that was saved with ALL traces selected.
Couplings	When you select which trace to save, it makes that trace the current trace, so it displays on top of all of the other traces.
Readback	selected Trace
Status Bits/OPC dependencies	Sequential - waits for previous measurement to complete
Initial S/W Revision	Prior to A.02.00

Trace File Contents

A Trace Data File contains the data for one trace.

Metadata: Trace Specific

Besides the trace data, there is metadata describing the context by which the trace was produced. Some of the metadata is trace specific:

- Trace Type
- Detector
- Trace math (function, operand1, operand2, offset, reference)
- Trace name/number

When importing a trace, the detector and/or trace math function specified in the metadata is imported with the trace, so that the annotation correctly shows the detector and/or math type that was used to generate the data

Metadata: Display Specific

There is also some display-related metadata:

- Ref Level Offset
- External Gain
- X-Axis Unit
- Y-Axis Unit

Metadata: Measurement Related

The rest of the metadata is measurement specific and reflects the state of the measurement the last time the trace was updated. These are the “measurement-related instrument settings” which, if changed, cause a measurement restart.

- Number of Points
- Sweep Time
- Start Frequency
- Stop Frequency
- Average Count (actual; not the limit for the instrument)
- Average Type
- RBW
- RBW Filter Type
- RBW Filter BW Type
- VBW
- Sweep Type (FFT vs. Swept)
- Log/Lin X Scale (sometimes called Log Sweep)
- Preamp (on/off, band)
- Trigger (source, level, slope, delay)
- Phase Noise optimization setting
- Swept IF Gain
- FFT IF Gain
- AC/DC setting (RF Coupling)

- FFT Width
- External Reference setting
- Input (which input is in use)
- RF calibrator on/off
- Attenuation

Because any inactive trace can have a value that does not match the rest of the measurement, when performing a Save the metadata for each trace is pulled from the individual trace, not from the measurement.

A revision number is also included in the trace database, to allow for future changes.

The choices for the various 1 of N and binary fields are as follows:

- Average Type: Power(RMS), Voltage, LogPower(Video)
- RBW Filter Type: Flattop, EMI, Gaussian
- RBW Filter BW: 3dB, 6dB, Noise, Impulse
- Sweep Type: Swept, FFT
- PreAmp State: On, Off
- PreAmp Band: Low, Full
- Trigger Source: Free, RFBurst, Video, Line, Periodic, Ext1, Ext2, TV
- Trigger Slope: Positive, Negative
- Phase Noise Optimization: Fast, Narrow, Wide
- Swept IF Gain: Low, High
- FFT If Gain: Autorange, Low, High
- Input: RF, BBIQ
- RF Calibrator: 50M, 400G, Comb, Off
- Trace Type: ClearWrite, TraceAverage, MaxHold, MinHold
- Detector: Normal, Average, Peak, NegPeak, Sample
- Trace Math: Off, PowerDifference, PowerSum, LogOffset, LogDifference
- Y Axis Unit: dBm, dBmV, dBmA, W, V, A, dBuV, dBuA, dBuV/m, dBuA/m, dBuV, dBpT, dBG, dB

After the header, just before the trace data, a line with just the word DATA on it is inserted to flag the start of the trace data.

The following file example shows the first lines of a Trace 1 file with X Axis Unit = Hz and Y Axis Unit = dBuV, after importing into Excel (the second row contains the Title):

Trace	
"AS/NZS 1044; Conducted >1000 W, Motors, Average"	
A.01.00	E4410A
526 EA3 B25 P26 PFR	1
Segment	0
Number of Points	1001
Sweep Time	0.066266667
Start Frequency	18827440
Stop Frequency	24463718
Average Count	0
Average Type	Power(RMS)
RBW	51000
RBW Filter	Gaussian
RBW Filter BW	3dB
VBW	51000
Sweep Type	Swept
X Axis Scale	Lin
PreAmp State	Off
PreAmp Band	Low
Trigger Source	Video
Trigger Level	1.2
Trigger Slope	Positive
Trigger Delay	1.00E-06
Phase Noise Optimization	Fast
Swept IF Gain	Low
FFT IF Gain	Autorange
RF Coupling	AC
FFT Width	411900
Ext Ref	10000000
Input	RF
RF Calibrator	Off

Attenuation	10
Ref Level Offset	0
External Gain	0
Trace Type	ClearWrite
Detector	Normal
Trace Math	Off
Trace Math Oper1	Trace5
Trace Math Oper2	Trace6
Trace Math Offset	0
Trace Name	Trace1
X Axis Unit	Hz
Y Axis Unit	dBm
DATA	
1.6009301E+07	4.82047E+01
1.6018694E+07	4.69737E+01
1.6028087E+07	4.81207E+01
1.6037480E+07	4.72487E+01
1.6046873E+07	4.66437E+01
1.6056266E+07	4.66237E+01
1.6065659E+07	4.66967E+01
1.6075052E+07	4.77117E+01
1.6084445E+07	4.75787E+01
1.6093838E+07	4.83297E+01
1.6103231E+07	4.71327E+01
1.6112624E+07	4.78957E+01
1.6122017E+07	4.67507E+01
1.6131410E+07	4.81137E+01

Limit

Pressing this key selects Limit Lines as the data type to be exported. Pressing the key a second time brings up the Limit Menu that allows you to select which **Limit Line** to save.

- See "[Limits File Contents](#)" on page 2221.
- See "[.csv file format](#)" on page 2221
- See "[.lim file format](#)" on page 2222

Key Path	Save, Data
Remote Command	:MMEMory:STORe:LIMit LLINE1 LLINE2,<filename>
Example	:MMEM:STOR:LIM LLINE2, "myLimitLine2.csv" Saves the 2nd Limit Line to the file myLimitLine2.csv in the current path. The default path is My Documents\SA\data\limits
Notes	If the save is initiated via SCPI, and the file already exists, the file will be overwritten. Using the C: drive is strongly discouraged, since it runs the risk of being overwritten during an instrument software upgrade. Both single and double quotes are supported for any filename parameter over SCPI.
Dependencies	This key will only appear if you have the proper option installed in your instrument.
Preset	1; not part of Preset, but is reset by Restore Mode Defaults and survives power cycles
State Saved	The selected Limit number is saved in instrument state.
Readback	selected Limit Line
Status Bits/OPC dependencies	Sequential - waits for previous measurement to complete
Initial S/W Revision	A.02.00

Limits File Contents

Limits may be exported into a data file with a .csv extension. They may be imported from that data file; they may also be imported from a legacy limit file with a .lim extension. The .lim files meet the specification for limit files contained in the EMI measurement guide, HP E7415A.

.csv file format

Except for information in quotes, limit line files are not case sensitive. Information in bold is required verbatim; other text is example text, and italic text is commentary which should not be present in the file.

The first five lines are system-required header lines, and must be in the correct order.

Limit	<i>Data file type name</i>
"FCC Part 15"	<i>File Description</i>
"Class B Radiated"	<i>Comment</i>
A.01.00.R0001,N9020A	<i>Instrument Version, Model Number</i>
P13 EA3 UK6 ,01	<i>Option List, File Format Version</i>

The next few lines describe the parameters; on export they will be in the order shown, on import they can be in any order. If some parameters are missing, they will revert to the default.

Type, Upper	Upper Lower
X Axis Unit, MHz	MHz S; other units should be converted; this also specifies the domain
Amplitude Unit, dBm	dBm V; all other units should be converted appropriately
Frequency Interpolation, Linear	Logarithmic Linear
Amplitude Interpolation, Logarithmic	Logarithmic Linear
X Control, Fixed	Fixed Relative; on input we consider only the first three characters
Y Control, Fixed	Fixed Relative; on input we consider only the first three characters
Margin, 0	Always in dB. A 0 margin is equivalent to margin off
X Offset, 10	Expressed in the X axis units
Y Offset, 5	Expressed in the Amplitude units

The Amplitude Unit line in the limits file may contain an antenna factor unit, for example:

Amplitude Unit=dBuV/m

Antenna factor units are dBuV/m, dBuA/m, dBpT, and dBG. In this case, the unit is treated exactly as though it were dBuV, meaning that all of the limits are interpreted to have units of dBuV. The box does NOT change Y Axis Units when such a limit is loaded in.

The X axis unit also specifies the domain (time or frequency). It is not possible to have both time-domain lines and frequency-domain lines at the same time; if a time-domain line is imported while the other lines are in the frequency domain (or vice-versa), all limit lines will be deleted prior to import.

If the sign of the margin is inappropriate for the limit type (for example a positive margin for an upper limit), the sign of the margin will be changed internally so that it is appropriate.

The remaining lines describe the data. Each line in the file represents an X-Y pair. The X values should be monotonically non-decreasing, although adjacent lines in the file can have the same X value as an aid to building a stair-stepped limit line. To specify a region over which there is no limit, use +1000 dBm for upper limits or -1000 dBm for lower limits.

The data region begins with the keyword DATA:

DATA
200.000000,-10.00
300.000000,-10.00
300.000000,-20.00
500.000000,-20.00

.lim file format

This is a legacy format which allows files saved from older analyzers to be loaded into the X-Series. Design of files in this format is not recommended.

Limit Selection

These keys let you pick which Limit Line to save. Once selected, the key returns back to the **Export Data** menu and the selected Limit Line number is annotated on the key.

The next step in the Save process is to select the Save As key in the Export Data menu.

Key Path	Save, Data, Limit Line
Notes	auto return
Preset	Not part of Preset, but is reset to LLINE1 by Restore Mode Defaults; survives shutdown
Initial S/W Revision	A.02.00

Measurement Results

Pressing this key selects Meas Results as the data type to be exported.

The Meas Results file contains information that describes the current state of the instrument. It is detailed in "[Meas Results File Contents](#)" on page 2223 below.

Key Path	Save, Data
Remote Command	:MMEMory:STORe:RESults <string>
Example	:MMEM:STOR:RES "MeasR_0000.csv"
Notes	<p>If the save is initiated via SCPI and the file already exists, the file will be overwritten.</p> <p>The SCPI command exports Burst Power (Transmit Power) measurement results to the file specified as the parameter in the current path. The default path is My Documents\<current mode>\data\txp\results.<="" p=""> <p>Using the C: drive is strongly discouraged, since it runs the risk of being overwritten during an instrument software upgrade.</p> <p>The SCPI parameter is a quoted string that specifies the filename. Both single and double quotes are supported for any filename parameter over SCPI.</p> </current></p>
Dependencies	The current active measurement must be the Burst Power (Transmit Power) measurement to use this command.
Status Bits/OPC dependencies	Sequential – waits for the previous measurement to complete
Initial S/W Revision	Prior to A.02.00

Meas Results File Contents

A Meas Results File contains measurement results with the following information.

- File ID string, which is "MeasResult"
- Measurement ID following Mode ID, which is "SA:TXP" for example.
- Firmware rev and model number
- Option string
- Center Frequency
- TXP_InfoBw
- TXP_Used_CaptureTime

The file contains these data followed by MeasResult1 to MeasResult4 that flag the start of the measurement results. Each line of Measurement Results consists of four comma separated values from MeasResult1 value to MeasResult4 value. MeasResult1 contains the same results as MEAS/READ/FETCH:TXPower|BPOWer1; MeasResult2, MEAS/READ/FETCH:TXPower|BPOWer2;...(continues in the same manner)

Exported file is .csv file. The Meas Results file, when imported into Excel, will show the following data:

MeasResult			
SA:TXP			
A.10.53	N9030A		
526 ALV ATP B1X B1Y	1		
B25 B40 BBA CR3			
CRP DCF DDA DP2			
DRD EA3 EDP EMC			
EP1 ERC ESC ESP			
EXM FSA LFE LNP			
MAT MPB NFE NUL			
P26 PFR PNC RTL			
RTS S40 SB1 SEC			
SM1 TVT YAS YAV			
Center Frequency	1.33E+10		
TXP_InfoBw	3000000		
TXP_Used_CaptureTime	0.00064		
MeasResult1	MeasResult2	MeasResult3	MeasResult4
0			
-999			

Save As . . .

When you press “Save As”, the analyzer brings up a Windows dialog and a menu entitled “**Save As.**” This menu allows you to navigate to the various fields in the Windows dialog without using a keyboard or mouse. The **Tab** and **Arrow** keys can also be used for dialog navigation.

See "[To File . . .](#)" on page 3202 in **Save, State** for a full description of this dialog and menu.

The default path for saving files is:

For all of the Trace Data Files:

- My Documents\<<mode name>\data\traces

For all of the Limit Data Files:

- My Documents\<<mode name>\data\limits

For all of the Measurement Results Data Files:

- My Documents\<<mode name>\data\<<measurement name>\results

For all of the Capture Buffer Data Files:

- My Documents\<<mode name>\data\captureBuffer

Key Path	Save, Data
Mode	All
Notes	The key location is mode-dependent and will vary. Brings up the Save As dialog for saving a <mode specific> Save Type. The save is performed immediately and does not wait until the measurement is complete.
Initial S/W Revision	Prior to A.02.00

Screen Image

Pressing Screen Image accesses a menu of functions that enable you to specify a format and location for the saved screen image. It brings up a menu that allows you to specify the color scheme of the Screen Image (Themes) or navigate to the Save As dialog to perform the actual save.

Screen Image files contain an exact representation of the analyzer display. They cannot be loaded back onto the analyzer, but they can be loaded into your PC for use in many popular applications.

The image to be saved is actually captured when the **Save** front panel key is pressed, and kept in temporary storage to be used if you ask for a Screen Image save. When the Screen Image key is pressed, a "thumbnail" of the captured image is displayed, as shown below:

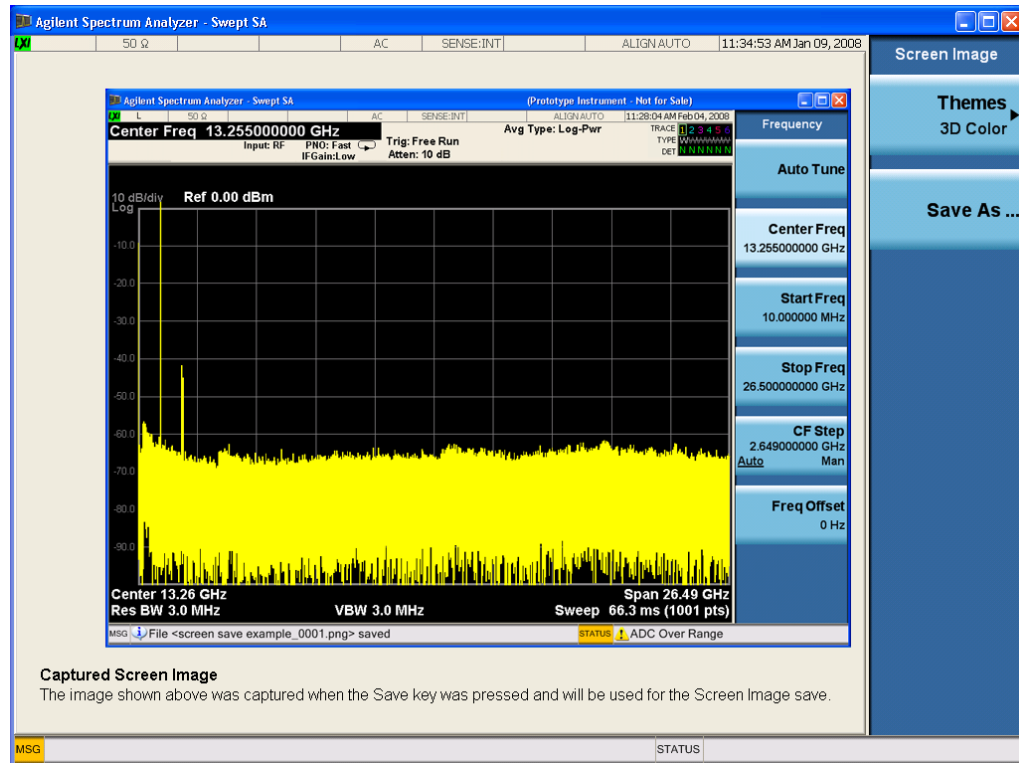

When you continue on into the **Save As** menu and complete the Screen Image save, the image depicted in the thumbnail is the one that gets saved, showing the menus that were on the screen before going into the **Save** menus. The save is performed immediately and does not wait until the measurement is complete.

After you have completed the save, the **Quick Save** front-panel key lets you quickly repeat the last save performed, using an auto-named file, with the current screen data.

NOTE

For versions previous to A.01.55, if you initiate a screen image save by navigating through the Save menus, the image that is saved will contain the Save menu softkeys, not the menus and the active function that were on the screen when you first pressed the Save front panel key.

Key Path	Save
Mode	All
Remote Command	:MMEMoRY:STORe:SCReen <filename>
Example	:MMEM:STOR:SCR "myScreen.png" This stores the current screen image in the file MyScreenFile.png in the default directory.
Backwards Compatibility SCPI	HCOpy:SDUMp:DATA? returns the screen image in a <DEFINITE LENGTH ARBITRARY RESPONSE DATA> element. The response data is IEEE Block format; the controlling computer can strip the header and store the result as a .png file.
Initial S/W Revision	Prior to A.02.00

Themes

Accesses a menu of functions that enable you to choose the theme to be used when saving the screen image.

The **Themes** option is the same as the **Themes** option under the **Display and Page Setup** dialogs. It allows you to choose between themes to be used when saving the screen image.

Key Path	Save, Screen Image
Remote Command	:MMEMory:STORe:SCReen:THEMe TDCoLor TDMonochrome FCOLor FMONochrome :MMEMory:STORe:SCReen:THEMe?
Example	:MMEM:STOR:SCR:THEM TDM
Preset	3D Color; Is not part of Preset, but is reset by Restore Misc Defaults or Restore System Defaults All and survives subsequent running of the modes.
Readback	3D Color 3D Mono Flat Color Flat Mono
Backwards Compatibility Notes	In ESA and PSA we offer the choice of "Reverse Bitmap" or "Reverse Metafile" when saving screen images. This is much like the "Flat Color" theme available in X-Series. Also, if you selected Reverse Bitmap AND a black & white screen image, that would be much like "Flat Monochrome". In other words, each of the X-Series themes has a similar screen image type in ESA/PSA. But they are not identical.
Initial S/W Revision	Prior to A.02.00

3D Color

Selects a standard color theme with each object filled, shaded and colored as designed.

Key Path	Save, Screen Image, Themes
Example	MMEM:STOR:SCR:THEM TDC
Readback	3D Color
Initial S/W Revision	Prior to A.02.00

3D Monochrome

Selects a format that is like 3D color but shades of gray are used instead of colors.

Key Path	Save, Screen Image, Themes
Example	MMEM:STOR:SCR:THEM TDM
Readback	3D Mono
Initial S/W Revision	Prior to A.02.00

Flat Color

Selects a format that is best when the screen is to be printed on an ink printer.

Key Path	Save, Screen Image, Themes
Example	MMEM:STOR:SCR:THEM FCOL
Readback	Flat Color
Initial S/W Revision	Prior to A.02.00

Flat Monochrome

Selects a format that is like Flat Color. But only black is used (no colors, not even gray), and no fill.

Key Path	Save, Screen Image, Themes
Example	MMEM:STOR:SCR:THEM FMON
Readback	Flat Mono
Initial S/W Revision	Prior to A.02.00

Save As...

When you press “Save As”, the analyzer brings up a Windows dialog and a menu entitled “**Save As.**” This menu allows you to navigate to the various fields in the Windows dialog without using a keyboard or mouse. The **Tab** and **Arrow** keys can also be used for dialog navigation.

See "[To File . . .](#)" on page 3202 in **Save, State** for a full description of this dialog and menu.

The default path for Screen Images is

– My Documents\`<mode name>`\screen.

where `<mode name>` is the parameter used to select the mode with the INST:SEL command (for example, SA for the Spectrum Analyzer).

Key Path	Save, Screen Image
Notes	Brings up Save As dialog for saving a Screen Image Save Type
Initial S/W Revision	Prior to A.02.00

Mass Storage Catalog (Remote Command Only)

Key path	SCPI Only
Remote Command	:MMEMory:CATalog? [<code><directory_name></code>]
Notes	<p>The string must be a valid logical path.</p> <p>Queries disk usage information (drive capacity, free space available) and obtains a list of files and directories in a specified directory in the following format:</p> <p><code><numeric_value>,<numeric_value>,{<file_entry>}</code></p> <p>It returns two numeric parameters and as many strings as there are files and directories. The first parameter indicates the total amount of storage currently used in bytes. The second parameter</p>

indicates the total amount of storage available, also in bytes. The <file_entry> is a string. Each <file_entry> indicates the name, type, and size of one file in the directory list:

<file_name>,<file_type>,<file_size>

As the windows file system has an extension that indicates file type, <file_type> is always empty. <file_size> provides the size of the file in bytes. For directories, <file_entry> is surrounded by square brackets and both <file_type> and <file_size> are empty

Initial S/W Revision Prior to A.02.00

Mass Storage Change Directory (Remote Command Only)

Key path **SCPI Only**

Remote Command :MMEMory:CDIRectory [<directory_name>]

:MMEMory:CDIRectory?

Notes

The string must be a valid logical path.

Changes the default directory for a mass memory file system. The <directory_name> parameter is a string. If no parameter is specified, the directory is set to the *RST value.

At *RST, this value is set to the default user data storage area, that is defined as System.Environment.SpecialFolder.Personal.

Query returns full path of the default directory.

Initial S/W Revision Prior to A.02.00

Mass Storage Copy (Remote Command Only)

Key path **SCPI Only**

Remote Command :MMEMory:COpy <string>,<string>[,<string>,<string>]

Notes

The string must be a valid logical path.

Copies an existing file to a new file or an existing directory to a new directory.

Two forms of parameters are allowed. The first form has two parameters. In this form, the first parameter specifies the source, and the second parameter specifies the destination.

The second form has four parameters. In this form, the first and third parameters specify the source. The second and fourth parameters specify the directories. The first pair of parameters specifies the source. The second pair specifies the destination. An error is generated if the source doesn't exist or the destination file already exists.

This command will generate an "access denied" error if the destination is a restricted folder (e.g., C:\Windows) and the current user does not have Power User or Administrator privileges.

Mass Storage Device Copy (Remote Command Only)

This command transfers data to/from a file and a peripheral device.

Key path **SCPI Only**

Remote Command :MMEMory:COpy:DEvice <source_string>,<dest_string>

Notes

The strings must be a valid logical path or a valid device keyword. If the dest_string is a device keyword, the data is copied from the source file to the device. If the source_string is a device

keyword, the data is copied to the source file from the device.

Valid device keywords are:

SNS (smart noise source)

An error is generated if the file or device is not found.

Mass Storage Delete (Remote Command Only)

Key path	SCPI Only
Remote Command	:MMEMory:DELeTe <file_name>[,<directory_name>]
Notes	<p>The string must be a valid logical path.</p> <p>Removes a file from the specified directory. The <file_name> parameter specifies the file name to be removed. This command will generate an “access denied” error if the file is in a restricted folder (e.g., C:\Windows) and the current user does not have Power User or Administrator privileges.</p>
Initial S/W Revision	Prior to A.02.00

Mass Storage Data (Remote Command Only)

Creates a file containing the specified data OR queries the data from an existing file.

Key path	SCPI Only
Remote Command	:MMEMory:DATA <file_name>, <data> :MMEMory:DATA? <file_name>
Notes	<p>The string must be a valid logical path.</p> <p>The command form is MMEMory:DATA <file_name>,<data>. It loads <data> into the file <file_name>. <data> is in 488.2 block format. <file_name> is string data.</p> <p>The query form is MMEMory:DATA? <file_name> with the response being the associated <data> in block format.</p>
Initial S/W Revision	Prior to A.02.00

Mass Storage Make Directory (Remote Command Only)

Key path	SCPI Only
Remote Command	:MMEMory:MDIRectory <directory_name>
Notes	<p>The string must be a valid logical path.</p> <p>Creates a new directory. The <directory_name> parameter specifies the name to be created. This command will generate an “access denied” error if the new directory would be in a restricted folder (e.g., C:\Windows) and the current user does not have Power User or Administrator privileges.</p>
Initial S/W Revision	Prior to A.02.00

Mass Storage Move (Remote Command Only)

Key path	SCPI Only
Remote Command	:MMEMory:MOVE <string>,<string>[,<string>,<string>]
Notes	<p>The string must be a valid logical path.</p> <p>Moves an existing file to a new file or an existing directory to a new directory.</p> <p>Two forms of parameters are allowed. The first form has two parameters. In this form, the first parameter specifies the source, and the second parameter specifies the destination.</p> <p>The second form has four parameters. In this form, the first and third parameters specify the source. The second and fourth parameters specify the directories. The first pair of parameters specifies the source. The second pair specifies the destination. An error is generated if the source doesn't exist or the destination file already exists.</p> <p>This command will generate an "access denied" error if the destination is a restricted folder (e.g., C:\Windows) and the current user does not have Power User or Administrator privileges.</p>
Initial S/W Revision	Prior to A.02.00

Mass Storage Remove Directory (Remote Command Only)

Key path	SCPI Only
Remote Command	:MMEMory:RDIRECTory <directory_name>
Notes	<p>The string must be a valid logical path.</p> <p>Removes a directory. The <directory_name> parameter specifies the directory name to be removed. All files and directories under the specified directory shall also be removed.</p> <p>This command will generate an "access denied" error if the folder is a restricted folder (e.g., C:\Windows) or is in a restricted folder and the current user does not have Power User or Administrator privileges.</p>
Initial S/W Revision	Prior to A.02.00

Mass Storage Determine Removable Media (Remote Command Only)

This command is used to determine if any removable media devices are connected to the instrument. Primarily, these are USB memory devices plugged-in to the front panel or rear panel USB ports. On instruments with PC6 or PC7 CPU's, one SD card slot is available for removable media. The instrument's primary disk drive is not a removable media device.

Key Path	SCPI Only
Remote Command	:MMEMory:RMEDIA:LIST?
Notes	<p>The return value is a string containing a list of partition identifiers that are removable media devices. Each identifier is separated by a comma. If no removable media is present, an empty string is returned.</p> <p>Examples:</p> <ul style="list-style-type: none">– One removable device present results in a return string of "F:".

- Two removable devices present results in a return string of "F:,G:".
- No removable devices present results in a return string of "".

Initial S/W Revision x.15.00

Mass Storage Determine Removable Media Label (Remote Command Only)

This command is used to set or query a removable media device's label.

Key Path	SCPI Only
Remote Command	:MMEMory:RMEDia:LABel <partition>,<string> :MMEMory:RMEDia:LABel? <partition>
Example	MMEM:RMED:LAB "F:","My Device"
Notes	If the <partition> specified does not exist or is not a removable media device, the error - 252,"Missing Media" is generated. Setting the removable media label requires Administrative privileges. If the currently logged in user does not have appropriate privileges the error "-221.9900,Settings conflict;Administrator privileges required" is generated.
Initial S/W Revision	x.15.00

Mass Storage Determine Removable Media Write-protect status (Remote Command Only)

This command is used to query a removable media device's write-protect status.

Key Path	SCPI Only
Remote Command	:MMEMory:RMEDia:WPRotect? <partition>
Example	MMEM:RMED:WPR? "F:"
Notes	The return value is 1 if the device is write-protected, or 0 if the device is write-enabled. If the <partition> specified does not exist or is not a removable media device the error - 252,"Missing Media" is generated.
Preset	The return value will be depending on SD card installed.
Initial S/W Revision	x.15.00

Mass Storage Determine Removable Media size (Remote Command Only)

This command is used to query a removable media device's total memory size (not available memory size).

Key Path	SCPI Only
Remote Command	:MMEMory:RMEDia:SIZE? <partition>

Example	MMEM:RMED:SIZE? "F:"
Notes	The return value is integer value in GBytes. Any device that is less than 1 GB returns 0 GB. If the <partition> specified does not exist or is not a removable media device, the error - 252, "Missing Media" is generated.
Initial S/W Revision	x.15.00

:SYSTem:SET (Remote Command Only)

Remote command that allows the user to obtain the state of the currently active mode in a form that can then be loaded back into the instrument quickly.

Remote Command	SYSTem:SET <instrument state in IEEE Block> SYSTem:SET?
Notes	SYST:SET? returns current instrument state of the active mode in IEEE Block data format. The state is in a machine readable format only. Sending the query returns the following format: <syst set preamble><state block data> Where: <syst set preamble> is the format: #NMMM N=number of digits that comprise MMM MMM=length in bytes of following data <state block data> is machine readable state data Example response: #42016<state data> The state is recalled by sending the SYST:SET? Response data to the instrument. From example above: SYST:SET #42016<state data>
Initial S/W Revision	x.17.00

Single (Single Measurement/Sweep)

Sets the analyzer for Single measurement operation. The single/continuous state is Meas Global, so the setting will affect all the measurements. If you are Paused, pressing **Single** does a Resume.

See "[More Information](#)" on page 2234

Key Path	Front-panel key
Example	:INIT:CONT OFF
Notes	See Cont key description.
Backwards Compatibility Notes	<p>For Spectrum Analysis mode in ESA and PSA, the Single hardkey and the INITiate:IMM switched from continuous measurement to single measurement and restarted sweeps and averages (displayed average count reset to 1), but did not restart Max Hold and Min Hold. In the X-Series, the Single hardkey and the INITiate:IMM command initiate a sweep/ measurement/ average sequence/hold sequence including MaxHold and MinHold.</p> <p>For Spectrum Analysis mode in ESA and PSA, the Single hardkey restarted the sweep regardless of whether or not you were in an active sweep or sweep sequence. In the X-Series, Restart does this but Single only restarts the sweep or sweep sequence if you are in the idle state.</p> <p>INIT[:IMM] in ESA & PSA Spectrum Analysis Mode does an implied ABORT. In some other PSA Modes, INIT[:IMM] is ignored if not in the idle state. . The X-Series follows the ESA/PSA SA Mode model, which may cause some Modes to have compatibility problems.</p>
Initial S/W Revision	Prior to A.02.00

More Information

See "[Restart](#)" on page 3199 for details on the INIT:IMMEDIATE (Restart) function.

If you are already in single sweep, the INIT:CONT OFF command has no effect.

If you are already in Single Sweep, then pressing the **Single** key in the middle of a sweep does not restart the sweep or sequence. Similarly, pressing the **Single** key does not restart the sweep or sequence if the sweep is not in the idle state (for example, if you are taking a very slow sweep, or the analyzer is waiting for a trigger). Instead, it results in a message. "Already in Single, press Restart to initiate a new sweep or sequence". Even though pressing the **Single** key in the middle of a sweep does not restart the sweep, sending INIT:IMMEDIATE does reset it.

To take one more sweep without resetting the average count, increment the average count by 1, by pressing the step up key while **Average/Hold Number** is the active function, or sending the remote command CALC:AVER:TCON UP.

Source

The Source key accesses menus for controlling a Source in Tracking Source mode

Key Path	Front-panel key
Dependencies	Operation with a source requires a license. If the proper license is not installed, the following occurs: <ul style="list-style-type: none"> - When the Source key is pressed the user sees an informational message, "Option not installed" - If any SCPI command in the :SOURce subsystem is sent it generates a message, "Settings conflict;option not installed"
Initial S/W Revision	A.06.01

NOTE

Option T03 or T06 is required for the Tracking Generator function in CXA. Option T03, T07, T13 or T26 is required for the Tracking Generator function in CXA-m.

When using the CXA-m Tracking Generator, if the Source Frequency is in the frequency range of the below table, and the Source Amplitude is in the corresponding amplitude range of the below table, a warning status message is generated, +313 "Source Uncal". This is also true if Power Sweep is on and any amplitude in the Power Sweep (as calculated by Amplitude, Power Sweep, and Amptd Offset) is in that range.

CXA-m TG Un-calibrated Amplitude Range

Frequency Range	Amplitude Range
$2 \text{ MHz} \leq \text{frequency} < 10 \text{ GHz}$	$-40 \text{ dBm} \leq \text{amplitude} < -35 \text{ dBm}$
$10 \text{ GHz} \leq \text{frequency} < 20 \text{ GHz}$	$-40 \text{ dBm} \leq \text{amplitude} < -35 \text{ dBm}$ or $-5 \text{ dBm} < \text{amplitude} \leq 0 \text{ dBm}$
$20 \text{ GHz} \leq \text{frequency} \leq 26.55 \text{ GHz}$	$-12 \text{ dBm} < \text{amplitude} \leq 0 \text{ dBm}$

RF Output

Allows you to turn the source RF Power on or off.

NOTE

When the RF Output is turned on, the Source Mode is set to Tracking. See the Source Mode key description for special considerations concerning how to configure your N5172B or N5182B source for use with External Source Control.

Key Path	Source
Scope	Meas Global
Remote Command	:OUTPut[:EXTerna1] [:STATe] ON OFF 1 0 :OUTPut[:EXTerna1] [:STATe]?

Example	:OUTP ON :OUTP?
Dependencies	Grayed out in measurements that do not support a source. If you go to such a measurement the output will be forced to Off. Grayed out if there is no valid source selection, in this case go to the Select Source menu to choose, configure and/or verify your source When there is no available Source Mode (other than Off), due to other couplings, then the RF Output key is grayed out.
Couplings	When RF Output is turned On, Source Mode is set to Tracking When Source Mode is turned Off, RF Output is turned Off. When Source Mode is turned Off (or forced to Off by another coupling), RF Output is turned Off. Turning RF Output Off does not affect Source Mode or other settings.
Preset	OFF (on either a Mode Preset, a Source Preset, or Restore Input/Output Defaults)
State Saved	Part of the Input/Output system, which means it is Loaded and Saved with state.
Range	On Off
Initial S/W Revision	A.06.01
Modified at S/W Revision	A.10.01

Amplitude

Allows you to access the Amplitude sub-menu to control various amplitude parameters of the Source. The resolution of the Source amplitude parameters is coupled to match the minimum resolution of the source when the source is acquired. When the source is released, the amplitude parameter resolution reverts to default values.

Key Path	Source
Readback	In square brackets, the amplitude value from Amplitude key in the next menu level down
Initial S/W Revision	A.06.01

Amplitude

Allows you to adjust the power level of the selected source. Note that the actual amplitude is also affected by the Amplitude Offset and Power Sweep parameters.

Key Path	Source, Amplitude
Scope	Mode Global
Remote Command	:SOURce[:EXTernal]:POWer[:LEVel][:IMMediate][:AMPLitude] <amp1> :SOURce[:EXTernal]:POWer[:LEVel][:IMMediate][:AMPLitude]?
Example	:OUTP ON :SOUR:POW -10dBm
Dependencies	If the requested setting of Source Amplitude causes the calculated external source start or stop

	Amplitude to exceed the external source capability, a warning status message is generated, "Data out of Range; clipped to source max/min" The "Show Source Capabilities and Settings" menu can then be examined to check the source capabilities. This parameter test and clip is also performed at source acquisition.
Preset	-10.00 dBm (On Source Preset and Restore Input/Output Defaults) Not affected by Mode Preset
State Saved	Part of the Input/Output system, which means it is Loaded and Saved with state.
Min	The range of the amplitude parameter is dependent on the amplitude range of the source that is selected, and the settings of Amplitude Offset and Power Sweep.
Max	The range of the amplitude parameter is dependent on the amplitude range of the source that is selected, and the settings of Amplitude Offset and Power Sweep.
Backwards Compatibility SCPI	:SOURce:POWer:START <amp1> :SOURce:POWer:START? This alias is for the ESA tracking generator. It specifies the source output power level at the start of the power sweep, just as does :SOURce:POWer.
Initial S/W Revision	A.06.01
Modified at S/W Revision	A.10.01

Power Sweep

Allows you to set up a Power Sweep. Power Sweep is useful for measuring saturation behavior in a test device, such as a power amplifier.

Pressing the key sets the power-sweep function to On or Off. The value of the power-sweep range is displayed in the active function block, and can be adjusted, when set to On.

The source will sweep the power between the start power defined by the Amplitude function and the stop power = start power + power sweep value:

Source (start) amplitude = Amplitude – Amplitude Offset

Source (stop) amplitude = Amplitude – Amplitude Offset + Power Sweep

In Stepped Tracking, such as is used with an external source or the CXA-m TG, the analyzer controls the source with step sweep mode, which provides a linear progression from one selected frequency, amplitude, or both, to another, pausing at linearly spaced points (steps) along the sweep. The analyzer continues to sweep the specified frequency range when power sweep is on, although generally Power Sweep is performed in Zero Span.

With CXA options T03, T06, the hardware is capable of continuous power sweeps. This makes it possible to use the swept sweep time rules and should be employed for faster sweeps. Care should be taken to limit the sweep time you use as there are no sweep time couplings to Power Sweep settings. The recommended minimum sweep time depends on the RBW and power-sweep range. Start by computing $(1.28/\text{RBW}) * (\text{abs}(\text{startPower} - \text{stopPower}) / (5 \text{ dB}))$. The recommended minimum sweep time is the larger of this value and 50 ms.

Some external Sources have mechanical attenuators, which are not used in Power Sweep in order to save wear on the attenuators. To allow an acceptable range of Power Sweep without changing the mechanical attenuation, the Sources are put in a mode that allows the Source to handle a wide amplitude range without switching the attenuators. When the Power Sweep settings put the Source in an amplitude range that requires the mechanical attenuators, the analyzer displays a condition warning message:

Settings Alert;Src pwr ramp>ALC range

Key Path	Source, Amplitude
Mode	SA
Scope	Mode Global
Remote Command	:SOURce:POWer:SWEEp <rel_amp1> :SOURce:POWer:SWEEp? :SOURce:POWer:SWEEp:STATe ON OFF 1 0 :SOURce:POWer:SWEEp:STATe?
Example	:SOUR:POW -5 :SOUR:POW:SWE:STAT ON :SOUR:POW:SWE 10 Set source start power to - 5 dBm and stop power + 5dBm (-5 + 10).
Example	:SOUR:POW:SWE:STAT ON
Dependencies	If the requested setting of Power Sweep causes the calculated external source start or stop Amplitude to exceed the external source capability, a warning status message is generated, "Data out of Range; clipped to source max/min". The Show Source Capabilities and Settings menu can then be examined to check the source capabilities. This parameter test and clip is also performed at source acquisition.
Preset	This is unaffected by "Mode Preset" but is set to 0dB on a "Source Preset" or "Restore Input/Output Defaults".
State Saved	Part of the Input/Output system, which means it is Loaded and Saved with state.
Min	-500 dB
Max	+500 dB
Backwards Compatibility SCPI	:SOURce[:EXTErnal][:SWEEp]:POWer:SPAN <rel_amp1> :SOURce[:EXTErnal][:SWEEp]:POWer:SPAN? This alias is for the ESA tracking generator and PSA option 215. It specifies the range of power levels through which the source output will sweep just as does :SOURce:POWer:SWEEp.
Initial S/W Revision	A.06.01
Remote Command	:SOURce[:EXTErnal]:POWer:MODE FIXEd SWEEp :SOURce[:EXTErnal]:POWer:MODE?
Notes	The ESA tracking generator and the PSA option 215 support this SCPI command. It sets the source output to be at a single amplitude (fixed) or to sweep through a range of power levels

	SOURce:POWer:MODE FIXed is equivalent to :SOURce:POWer:SWEEp:STATe OFF
	SOURce:POWer:MODE SWEEp is equivalent to :SOURce:POWer:SWEEp:STATe ON
Preset	This is unaffected by "Mode Preset" but is set to FIXed on a "Source Preset" or "Restore Input/Output Defaults".
Initial S/W Revision	A.06.01
Modified at S/W Revision	A.10.01

Amptd Offset

Offsets the displayed power of the source in the Amplitude parameter. Using the amplitude offset allows you to take into account any system losses or gains (for example, due to cable loss), thereby displaying the actual power delivered to the device under test. See the equations under the Source, Amplitude, Power Sweep key.

Key Path	Source, Amplitude
Mode	SA
Scope	Mode Global
Remote Command	:SOURce:CORRection:OFFSet <rel_ampl> :SOURce:CORRection:OFFSet?
Example	:SOUR:CORR:OFFS 5 Sets the displayed source offset power to 5 dB.
Dependencies	If the requested setting of Amptd Offset causes the calculated external source start or stop Amplitude to exceed the external source capability, a warning status message is generated, "Data out of Range; clipped to source max/min". The Show Source Capabilities and Settings menu can then be examined to check the source capabilities. This parameter test and clip is also performed at source acquisition.
Preset	This is unaffected by Mode Preset but is set to 0.00dBm on a Source Preset or Restore Input/Output Defaults.
State Saved	Part of the Input/Output system, which means it is Loaded and Saved with state.
Min	-1000 dB
Max	+1000 dB
Initial S/W Revision	A.06.01

Amptd Step Auto/Man

Allows you to set the step size associated with the Source Amplitude key. When auto-coupled, the step size is the current Scale/Div setting under the Amplitude hardkey (note that this is true even if the analyzer is currently in Linear amplitude scale).

Once a step size has been selected and the Source Amplitude function is active, the step keys (and the UP|DOWN parameters for Source Amplitude from remote commands) change the Source Amplitude by the step-size value.

You may change the step size manually by pressing Amptd Step and entering a value. The function (and the step size) will return to Auto when a Mode Preset or Auto Couple is performed.

Key Path	Source, Amplitude
Scope	Mode Global
Remote Command	:SOURce:POWer:STEP[:INCRement] <amp1> :SOURce:POWer:STEP[:INCRement]? :SOURce:POWer:STEP:AUTO OFF ON 0 1 :SOURce:POWer:STEP:AUTO?
Example	:SOUR:POW:STEP 0.1 Set amplitude step to 0.1 dB :SOUR:POW:STEP:AUTO ON
Couplings	In Auto, coupled to the size of one logarithmic vertical graticule division
Preset	Auto
State Saved	Part of the Input/Output system, which means it is Loaded and Saved with state.
Min	0.1 dB
Max	20 dB
Initial S/W Revision	A.06.01

Frequency

Allows a you to access the Frequency sub-menu. This menu lets you use a stepped tracking source for stimulus/response measurements for some added flexibility. Because with such a source, the source frequency does not need to track 1:1 with the analyzer LO frequency, it is possible to measure scalar harmonic and subharmonic responses of devices. For example, the second harmonic response is measured by stepping the analyzer and source so that the analyzer is always at twice the source frequency. In addition, the frequency offset capability allows the measurement of frequency conversion devices (like mixers).

In tracking mode, the source frequency tracks the analyzer frequency according to the source frequency equation:

$$\text{Source Frequency} = (\text{Analyzer Frequency} * \text{Multiplier Numerator} / \text{Multiplier Denominator}) + \text{Source Frequency Offset}$$

NOTE

Analyzer Frequency is the frequency to which the analyzer is set, which is the analyzer's displayed frequency, offset by any Freq Offset set under the Frequency hardkey. **Source Frequency Offset** is the value set under **Source, Frequency, Freq Offset**.

Key Path	Source
----------	--------

Readback	none in Tracking Source mode
Initial S/W Revision	A.06.01

Multiplier Numerator

The multiplier numerator parameter offsets the source frequency from the analyzer frequency. The source frequency tracks the SA frequency according to the source frequency equation shown under the **Source, Frequency** key description.

The multiplier numerator must be restricted to operate within the range of the source minimum and maximum frequencies.

Key Path	Source, Frequency
Mode	SA
Scope	Mode Global
Remote Command	:SOURCE:FREQUENCY[:MULTIPLIER]:NUMERATOR <integer> :SOURCE:FREQUENCY[:MULTIPLIER]:NUMERATOR?
Example	:SOUR:FREQ:NUM 3 Sets the source frequency multiplier numerator to 3.
Dependencies	If the currently selected source does not support this capability (for example, an internal Tracking Generator which must track the LO), this key is forced to its Preset value and grayed out
Preset	This is unaffected by Mode Preset but is set to 1 on a Source Preset or Restore Input/Output Defaults.
State Saved	Part of the Input/Output system, which means it is Loaded and Saved with state.
Min	1
Max	1000
Initial S/W Revision	A.06.01

Multiplier Denominator

The multiplier denominator parameter offsets the source frequency from the analyzer frequency. The source frequency tracks the SA frequency according to the source frequency equation shown under the **Source, Frequency** key description.

The multiplier denominator must be restricted to operate within the range of the source minimum and maximum frequencies.

Key Path	Source, Frequency
Mode	SA
Scope	Mode Global
Remote Command	:SOURCE:FREQUENCY[:MULTIPLIER]:DENOMINATOR <integer> :SOURCE:FREQUENCY[:MULTIPLIER]:DENOMINATOR?
Example	:SOUR:FREQ:DEN 3 Sets the source frequency multiplier denominator to 3
Dependencies	If the currently selected source does not support this capability (for example, an internal Tracking

	Generator which must track the LO), this key is forced to its Preset value and grayed out
Preset	This is unaffected by Mode Preset but is set to 1 on a Source Preset or Restore Input/Output Defaults.
State Saved	Part of the Input/Output system, which means it is Loaded and Saved with state
Min	1
Max	1000
Initial S/W Revision	A.06.01

Source Sweep Reverse

Allows you to reverse the source sweep direction

Normally, the source will sweep from a lower frequency to a higher frequency. However, there are test scenarios in which the source sweep needs to be “reversed”. In this case, it sweeps from a higher frequency to a lower frequency. For example, when the DUT is a frequency converter and a measurement of the Lower Side Band characteristics is desired, a reverse sweep is employed. Reverse sweeps are supported for such scenarios, but two cautions are in order:

4. Reverse Sweep only reverses the direction of the source’s sweep, not the analyzer’s sweep. Unless you are actually using a device like a frequency converter and looking at the lower sideband, thus effectively reversing the direction of the source’s sweep, the source will be sweeping in the opposite direction from the analyzer, and it will not be possible track the desired device output frequency.
5. Any time you are using a frequency converter, care must be taken in setting up all of the sweep parameters, including analyzer start/stop frequency and source multiplier, to make sure that the analyzer’s sweep tracks the output of the converter device.

Key Path	Source, Frequency
Mode	SA
Scope	Mode Global
Remote Command	:SOURce:FREQuency:SSReverse:ON OFF 0 1 :SOURce:FREQuency:SSReverse?
Example	SOUR:FREQ:SSR:OFF SOUR:FREQ:SSR?
Notes	You must be in Spectrum Analyzer mode to use this command. Use INSTRument:SElect to set the mode.
Dependencies	If the currently selected source does not support this capability (for example, an internal Tracking Generator which must track the LO), this key is forced to its Preset value and grayed out
Preset	This is unaffected by Mode Preset but is set to OFF on a Source Preset or Restore Input/Output Defaults.

State Saved	Part of the Input/Output system, which means it is Loaded and Saved with state
Range	On Off
Initial S/W Revision	A.06.01

Freq Offset

The frequency offset parameter offsets the source frequency from the analyzer frequency. The source frequency tracks the SA frequency according to the equations under the **Source, Frequency** key.

Pressing the key sets the Freq Offset function to On or Off. The value of Freq Offset is displayed in the active function block, and can be adjusted, when set to On.

The frequency offset must be restricted to operate within the range of the source minimum and maximum frequencies.

Key Path	Source, Frequency
Mode	SA
Scope	Mode Global
Remote Command	:SOURce:FREQuency:OFFSet <freq> :SOURce:FREQuency:OFFSet? :SOURce:FREQuency:OFFSet:STATe ON OFF 1 0 :SOURce:FREQuency:OFFSet:STATe?
Example	:SOUR:FREQ:OFFS 10MHz Sets the source frequency offset to 10MHz.
Dependencies	If the currently selected source does not support this capability (for example, an internal Tracking Generator which must track the LO), this key is forced to its Preset value and grayed out
Preset	This is unaffected by Mode Preset but is set to 0.00Hz on a Source Preset or Restore Input/Output Defaults.
State Saved	Part of the Input/Output system, which means it is loaded and saved with state
Min	-500 GHz
Max	500 GHz
Backwards Compatibility SCPI	:SOURce:EXTernal:SWEEP:OFFSet:FREQuency <freq> :SOURce:EXTernal:SWEEP:OFFSet:FREQuency? The PSA option 215 supports this SCPI command. This command is equivalent to :SOURce:FREQuency:OFFSet
Initial S/W Revision	A.06.01
Modified at S/W Revision	A.10.01

Source Mode

Accesses the Source Mode softkey menu. This menu lets you select Tracking mode for the Source, and also allows you to set the Source Mode to OFF.

The Source Mode can be set to Tracking without the user setting it directly. There are several couplings that cause Source Mode to be automatically set to Tracking (detailed in the table below). One important coupling is that Source Mode is forced to Tracking when the RF Output is turned on if the measurement supports Tracking. Since Source Mode is set to Off on a Mode Preset, this means that you will rarely need to change the Source Mode setting directly.

NOTE

When the Source Mode is set to Tracking, the analyzer acquires control of the source. When this happens the source is told to save its state and then perform a preset. Usually both of these operations take very little time; however, on an N5172B or an N5182B, if many Source real-time apps are in use, both save and preset can take many seconds. If it takes longer than the analyzer expects to acquire control, you will see an error: “Source connection lost, check interface connection”. If you see this error, and you are using an N5172B or an N5182B, you can shorten the acquire time by presetting your MXG before attempting to use External Source Control.

Key Path	Source
Scope	Meas Global
Remote Command	:INSTrument:SOURce[:SElect] TRACKing OFF :INSTrument:SOURce[:SElect]?
Example	:INST:SOUR TRAC
Dependencies	<p>Grayed out if no Source is selected, in this case go to the Select Source menu to choose, configure and/or verify your source</p> <p>Grayed out and forced to Off if either BBIQ or External Mixing are selected</p> <p>Blanked in Modes that do not support a source</p> <p>Grayed out in Measurements that do not support a source</p> <p>Tracking is grayed out when Manual FFT is selected</p> <p>Tracking is grayed out when the RF Preselector is on (in models which support the RF Preselector).</p>
Couplings	<p>When RF Output is turned On, Source Mode is set to Tracking. When Source Mode is turned Off, RF Output is turned Off.</p> <p>Whenever you switch to an application (Mode) in which the Source Mode was previously set to Tracking, it is again set to Tracking. That is, the last setting of the Source Mode is remembered when you leave an application (Mode) and restored when you return</p> <p>Source Mode is forced to Tracking when the RF Output is turned on if the measurement supports Tracking</p> <p>If Source Mode is set to Tracking, then it is forced to Off when you select a measurement that does not support Tracking.</p> <p>If Source Mode is set to Tracking, then it is forced to Off when you turn on the RF Preselector (in models which support the RF Preselector).</p> <p>Whenever the Source Mode is set to Tracking, the analyzer acquires the Source. Similarly, the Source is released whenever the Source Mode is set to Off. This is true whether the Source Mode was set directly by you, was set indirectly through a coupling, if you switched to an application (Mode) that had previously been set to Tracking, or if you switched to an application (Mode) in which the Source Mode is not set to Tracking.</p>

For an external source, “acquiring the source” involves contacting the external instrument over the remote interface (which puts it into Remote) and taking control of it.

When you set the Source Mode to OFF, it releases the Source (and puts it into Local). For an external source, this means you are now free to operate the source for other purposes.

When the Source is acquired, its previous state is saved, and when it is released, that state is restored, so that you can acquire and then release the source and it will return to the state it was in before you acquired it.

Preset	OFF
State Saved	Saved in instrument state
Initial S/W Revision	A.06.01
Modified at S/W Revision	A.10.01

Select Source

The Select Source menu allows you to maintain a list of available external Sources, and choose the Source that you want to use from the list. It shows the currently selected source at the bottom of the screen.

While in the Select Source menu, you can see, and select from, a list of the currently available sources. The sources listed in this table are as follows:

- Any internal sources which are installed and licensed

NOTE

Only one internal source can be installed, displayed at address “INTERNAL”

- Any external sources which you have previously configured, whether or not they are currently connected, displayed with their VISA address

Note that only external sources that are supported by the Tracking Source Mode are displayed in the Available Source List. Here are the Keysight/Agilent sources currently supported:

Source	PXA	MXA	EXA	CXA	MXE (Presel off)
MXG N5181A	X	X	X	X	X
MXG N5182A	X	X	X	X	X
MXG N5183A	X	X	X		X
EXG N5171B	X	X	X	X	X
MXG N5181B	X	X	X	X	X
EXG	X	X	X	X	X

N5172B					
EXG	X	X	X	X	X
N5173B					
MXG	X	X	X	X	X
N5182B					
MXG	X	X	X	X	X
N5183B					
PSG	X	X	X		
E8257D					
PSG	X	X	X		
E8267D					

NOTE

For X-Series software versions earlier than A.10.01, option UNZ (Fast switching) was required on the MXG for some use cases. This is no longer the case, option ESC now works without MXG option UNZ for all use cases. (Note that you will get better performance if your MXG has option UNZ, because without option UNZ your sweep speeds will be noticeably slower.)

While in the Select Source menu and its submenus, detailed instructions are presented that tell you how to operate the Select Source functions. Basically they tell you to first use the up and down arrow keys to move the selection highlighted in the “Available Source List” to the source that you want to use. The list of available sources includes any sources that you have previously used (unless you have deleted them) and any found while in the “Add Source to List” menu.

When the source you want to use is highlighted, press “Select Highlighted Source” or “Enter”. The source you have selected shows up at the bottom of the screen as the “Current Source”. Press “Verify Current Source Connection” to make sure that the interface connection to the Source is still functional.

At any time you may use the “Add Source to List” or “Delete Highlighted Source” keys to find new sources or remove a source from the list of available sources.

Key Path	Source
Readback Text	Two lines of readback give the type information and serial number of the current source, in square brackets
Initial S/W Revision	A.06.01

Select Highlighted Source

You can navigate up and down in the list with the up and down arrow keys, and can select any entry by pressing the Select Highlighted Source key (or by double-clicking on the entry in the table with a mouse). The highlighted source becomes the Current Source and is prominently displayed at the bottom of the screen.

At any given time there is only one selected Source for the entire system; once a Source is selected, it becomes the Current Source and will be used by all applications that support Source Control.

For example, if no Source has yet been selected, the statement at the bottom of the screen would say

Current Source

None

If an N5182A connected via USB were the Current Source, the statement at the bottom of the screen might say:

Current Source

Agilent N5182A US00000258 at USB0::2931::7937::US00000258::0::INSTR

The SCPI command defined below allows the programmatic user to directly define the VISA address via a string parameter. The parameter is checked for proper syntax, the connection to the instrument is verified, and the source is added to the Available Source List if it verifies. If it does not verify or no source is found at that address, an error message is generated.

Normally the source selection activities should be performed only when the user changes the hardware connection configuration or activates/deactivates a source option license; shutdown and startup of the application will not cause source re-selection.

The Agilent IO Libraries Suite provides an “Agilent VISA Help” document that has a section that shows the proper syntax for valid VISA address strings, in the ViOpen function definition.

Key Path	Source, Select Source
Mode	SA
Remote Command	:SYSTem:COMMunicate:SOURce[1]:ADDRess <address string> :SYSTem:COMMunicate:SOURce[1]:ADDRess?
Example	Different examples for setting external source address :SYST:COMM:SOUR:ADDR "TCPIP0::MyHostName::INSTR" :SYST:COMM:SOUR:ADDR "TCPIP0::123.121.100.210::INSTR" :SYST:COMM:SOUR:ADDR "USB0::12212::32145::US1234567A::INSTR" :SYST:COMM:SOUR:ADDR "GPIB1::19::INSTR"
Notes	Empty string is allowed and means no source is defined or selected.
Remote Command Notes	The address string is the VISA address for external sources and "INTERNAL" for an internal source
Dependencies	Operation with a source requires a license. If the proper license is not installed, the SCPI command generates an error message, "Settings conflict;option not installed" If no supported source, or no source at all, is found at the specified address, the SCPI command generates an error message
Preset	The current source selection is unaffected by a Mode Preset and Source Preset but reverts to

	[None] on a Restore Input/Output Defaults. If an internal Tracking Generator is installed, then instead of None, the default selection will be INTERNAL.
State Saved	Selected Source is <ul style="list-style-type: none"> - Power On Persistent (survives power cycle) - Part of the Input/Output system, which means it is Loaded and Saved with state.
Readback	Two lines of readback give the type information and serial number of the current source on the Select Source key in the form [<source type>] [<serial number>] [None] shows in the type area and blank in the serial number area if a source has not been configured. [Internal TG] shows in type area and serial number in the serial number area if an internal Tracking Generator has been selected. For example: [MXG]/n, [US01020022]. This indicates an MXG of serial number US01020022.
Backwards Compatibility SCPI	:SYSTem:COMMunicate:LAN:SOURce[:EXTernal]:IP <address string> :SYSTem:COMMunicate:LAN:SOURce[:EXTernal]:IP? This command is provided for compatibility with PSA Option 215. The address string is reformatted for the X-Series. For example, if the customer sends :SYSTem:COMMunicate:LAN:SOURce:EXTernal:IP 146.208.172.111 The analyzer turns this into :SYSTem:COMMunicate:SOURce:ADDRess "TCPIP0::146.208.172.111::INSTR"
Initial S/W Revision	A.06.01
Modified at S/W Revision	A.10.01

Delete Highlighted Source

Deletes the highlighted source from the list of available sources. You will be prompted with a dialog box to make sure you REALLY want to do this. The prompt says "The highlighted source will be permanently deleted from the list. Are you sure you want to do this? Press Enter to proceed, or Cancel (ESC) to cancel."

Key Path	Source, Select Source
Initial S/W Revision	A.06.01

Add Source To List

This menu allows you to add to the list of available sources from various interfaces.

Key Path	Source, Select Source
Initial S/W Revision	A.06.01

USB

Sources on USB (once installed) can be added to the list by pressing “Add Installed USB Sources.” Any supported source found will be added to the list.

See ["Add Installed USB Sources" on page 3259](#) for information on connecting and installing USB devices.

Key Path	Source, Select Source, Add Source to List
Initial S/W Revision	A.06.01

Add Installed USB Sources

Press this key to add USB sources to the Available Source List. Note that this function will ONLY find sources that have previously been installed onto the USB. For information on how to install a USB source, see ["Installing a USB source" on page 2250](#)

Key Path	Source, Select Source, Add Source to List, USB
Notes	If no installed USB device is found which is a supported source, an error message is generated
Initial S/W Revision	A.06.01

Installing a USB source

USB is the only interface which requires no runtime action by the user in the Select Source menu, but does require “installation” when a source is plugged in.

You start by connecting the USB source to the analyzer. You will get a series of messages indicating that the analyzer is installing required device software.

When the installation is complete, you will get a message to that effect. You can then use the “Add Installed USB Sources” function (above) to add the source to the list of sources in the Available Source List.

GPIB

Lets you add GPIB sources to the Available Source List.

For the GPIB interface to work properly, it must be configured as a Controller. You can find this setting in the System menu under System, I/O Config, GPIB. Set the GPIB Controller function to Enabled.

Note that you must also make sure that the GPIB interface is not set to “Ignore” in the Agilent Connection Expert. If it is set to **Ignore**, then even if the GPIB Controller is set to **Enabled**, it is not possible for the analyzer to find a GPIB connected source. See ["More Information" on page 2250](#).

Key Path	Source, Select Source, Add Source to List
Initial S/W Revision	A.06.01

More Information

If you suspect that the GPIB interface is not set to Ignore, run the Agilent Connection Expert (ACE). To run ACE, press Source, Select Source, Add Source to List, LAN, Run Connection Expert. Look for the GPIB branch on the interface tree:

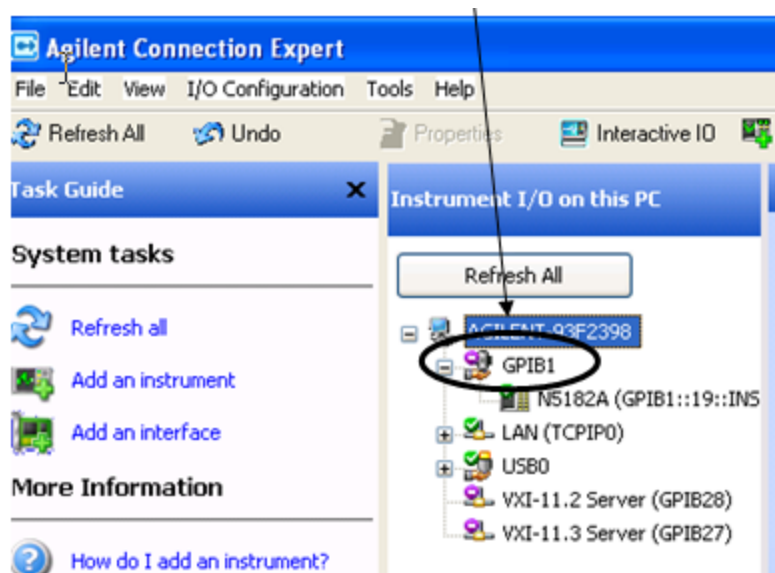

Right click on the GPIB branch (you will have to plug in a mouse to do this). You should see a dialog like the one below. If this dialog says **Stop Ignoring**, select **Stop Ignoring** and close ACE.

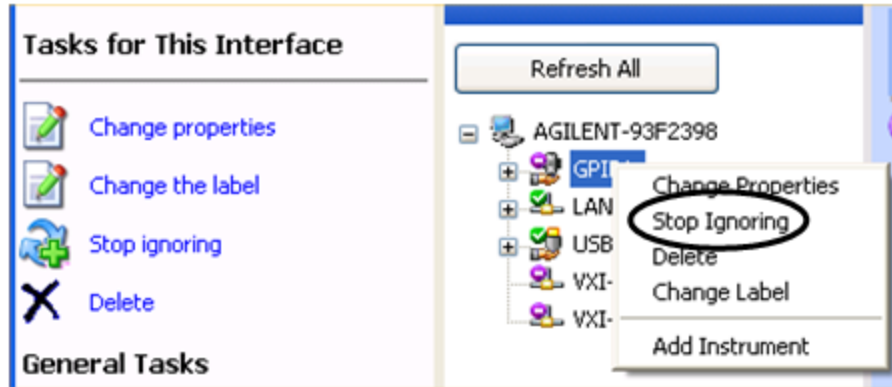

Scan & Add GPIB Sources

Sources on GPIB can be added by pressing **Scan & Add GPIB Sources**. Any supported source found will be added to the Available Source List.

NOTE

This will cause any older, non-SCPI compatible devices on your GPIB to generate error messages.

Key Path	Source, Select Source, Add Source to List, GPIB
Notes	If the GPIB controller mode is not enabled, an error message is generated If no GPIB device is found which is a supported source, an error message is generated
Initial S/W Revision	A.06.01

Enter GPIB Address

Opens a menu that lets you enter the GPIB address of the desired source directly.

NOTE

For this to work properly, the GPIB interface must be configured as GPIB1. This is the default state and should normally be the case. To see how to verify this, see **"More Information"** on page 2252.

Key Path	Source, Select Source, Add Source to List, GPIB
Initial S/W Revision	A.06.01

More Information

If you suspect that the GPIB interface is not set to GPIB1, run the Agilent Connection Expert (ACE). To run ACE, press Source, Select Source, Add Source to List, LAN, Run Connection Expert. Look for the GPIB branch on the interface tree:

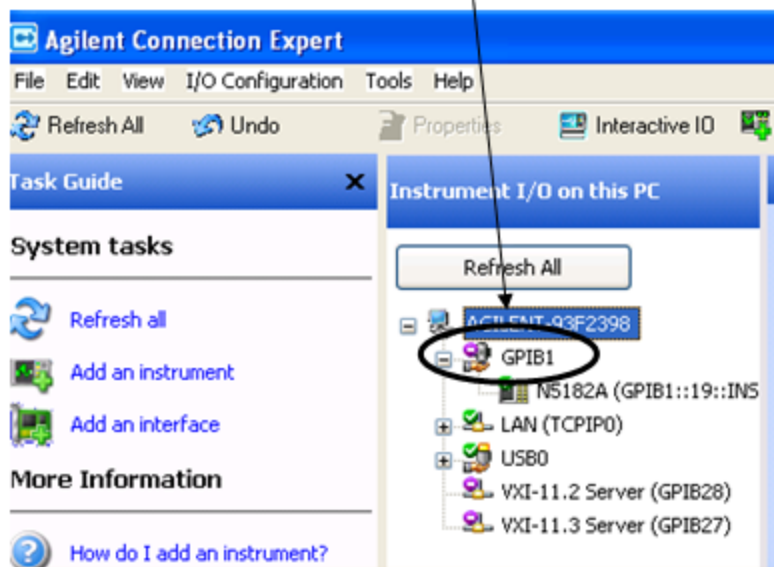

If this branch is not labeled **GPIB1**, right click on the GPIB branch (you will have to plug in a mouse to do this) and select **Change Properties**.

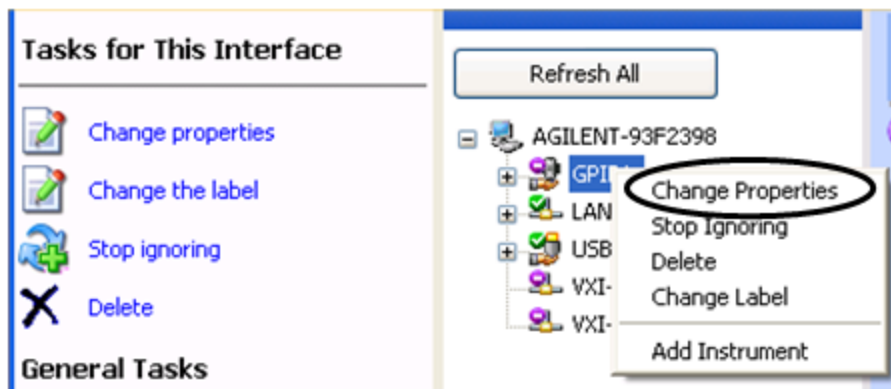

You should see a dialog like the one below. Click on the drop-down arrow under **VISA Interface ID**, select **GPIB1** and click **OK**

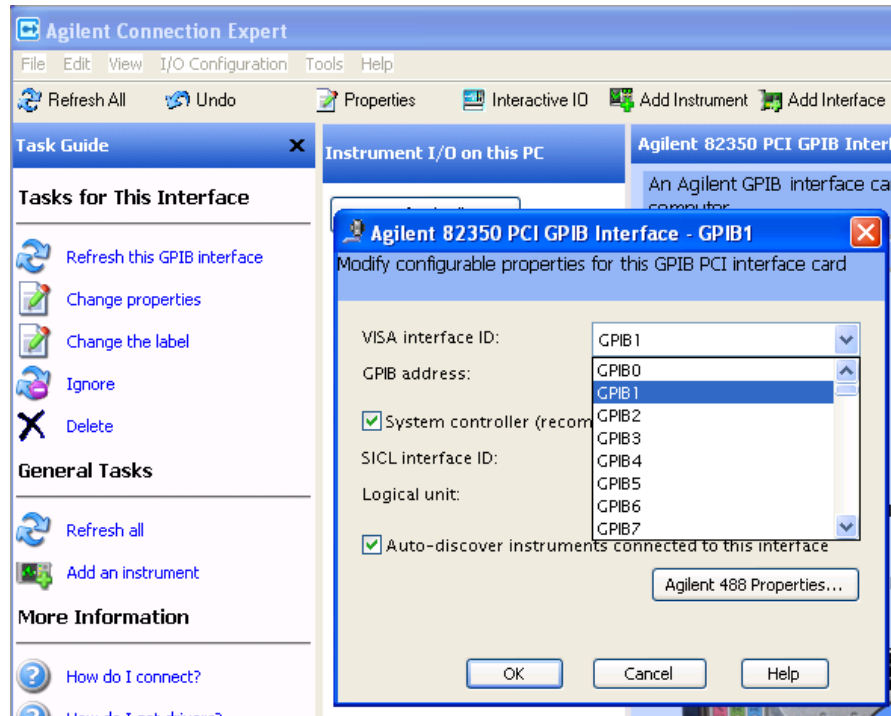

GPIB Address

Lets you enter the GPIB address. After you enter the address press **Add** to add the source at that address to the Available Source List.

Key Path	Source, Select Source, Add Source to List, GPIB, Enter GPIB Address
Preset	Unaffected by Mode Preset but set to 19 by "Restore Input/Output defaults"
State Saved	No
Min	0
Max	30
Initial S/W Revision	A.06.01

Add

Add the source at the entered GPIB address to the Available Source List. If a supported source is found at that address it will be added to the list.

Key Path	Source, Select Source, Add Source to List, GPIB, Enter GPIB Address
Notes	If GPIB controller mode is not enabled, an error message is generated If no supported source is found at the specified address, an error message is generated
Initial S/W Revision	A.06.01

LAN

The LAN cannot be scanned directly from the analyzer software, but you can import the list of currently configured devices from Agilent Connection Expert by pressing

“Add From Connection Expert List.” The Connection Expert list depends on which instruments have already been discovered by the Agilent Connection Expert application. Any connected, supported sources in that list will be added.

You can also enter the IP address and press “Add”. If a supported source is found at that address it will be added.

If you want to discover sources on the LAN, you can open Connection Expert by pressing the “Run Connection Expert...” softkey.

Key Path	Source, Select Source, Add Source to List
Initial S/W Revision	A.06.01

Enter LAN Address

Opens up a menu which lets you enter the IP address of the desired source directly.

Key Path	Source, Select Source, Add Source to List, LAN
Initial S/W Revision	A.06.01

IP Address

Lets you enter the IP address of the desired source. After you enter the address you should press “Add” to add the source at that address to the Available Source List.

Key Path	Source
Preset	Unaffected by Mode Preset but set to 0.0.0.0 by Restore Input/Output defaults
State Saved	No
Initial S/W Revision	A.06.01

Add

Adds the source at the entered IP address to the Available Source List. If a supported source is found at that address it will be added to the list.

Key Path	Source
Notes	If no supported source is found at the specified address, an error message is generated
Initial S/W Revision	A.06.01

Run Connection Expert...

Runs the Agilent Connection Expert so that you can scan the LAN for sources.

Key Path	Source, Select Source, Add Source to List, LAN
Initial S/W Revision	A.06.01

Add From Connection Expert List

You can import the list of currently configured devices from Agilent Connection Expert by pressing **Add From Connection Expert List**. The Connection Expert list depends on which instruments have already been discovered by the Agilent Connection Expert application. Any connected, supported sources in that list will be added.

Key Path	Source, Select Source, Add Source to List, LAN
Notes	If no supported source is found in the Connection Expert list, an error message is generated
Initial S/W Revision	A.06.01

Verify Current Source Connection

This key verifies the interface connection to the Current Source (it does NOT verify any signal connections!)

Until the selected source is verified, a statement appears at the bottom of the screen which says (in red):

This Source has not been verified. Press "Verify Source" to check the interface connection.

When you press this key, the connection is checked to the selected source. If all is well, the statement is changed to (in green):

This connection to this source has been verified.

If the verification fails, the statement at the bottom will change to (in red):

Verification of this source failed. Check the interface connection

The selected source is also verified whenever it is acquired. If a Source's connection has been verified by any means, then that Source is considered to have been verified until either the analyzer software is shut down or if, in attempting to use the Source, communication with it fails.

Key Path	Source, Select Source
Initial S/W Revision	A.06.01

Source Setup

This menu is used to set up miscellaneous source functions, including trigger settings. For more on triggering in Tracking Mode, see ["Tracking Setup Details" on page 2256](#). For information on bypassing the Microwave Preselector, see ["Use of the YTF \(Microwave or mm Preselector\) with External Source Control" on page 2257](#)

Key Path	Source
Mode	SA
Initial S/W Revision	A.06.01

Tracking Setup Details

When an external source is operating in Tracking Mode, operation can be greatly enhanced by using hardware triggers. Below is a typical connection diagram showing a hardware handshake using Trigger 1 inputs and outputs on the analyzer (trigger 2 in and out is also a valid connection).

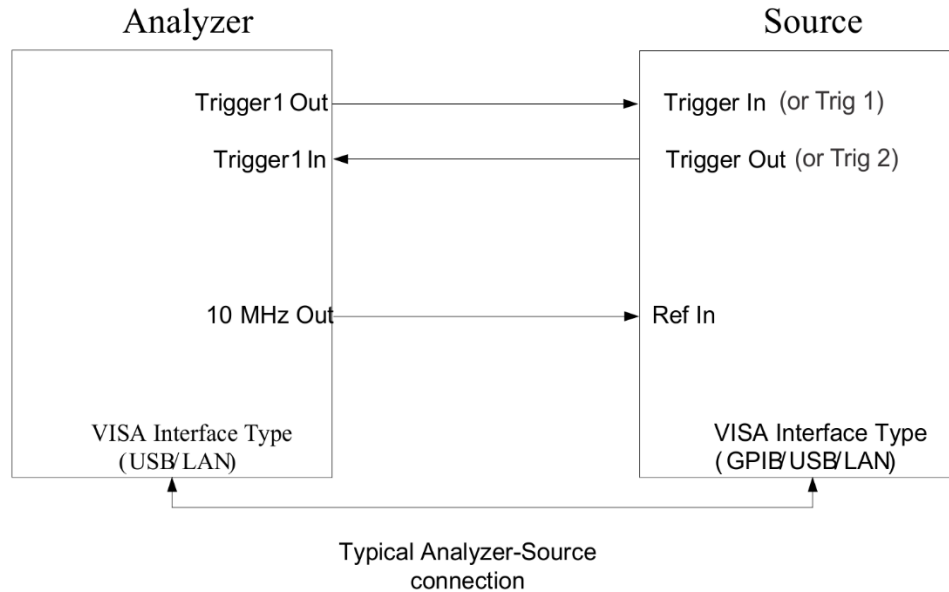

Analyzer Trigger 1 Out: Triggers the external source to step to next point in the frequency step/list.

Analyzer Trigger 1 In: Triggers the analyzer to make a measurement on this point

Source Trigger In (or “Trig 1” at default setting for N5181B/82B, N5183B MXG or N5171B/72B, N5173B EXG):

Triggers the source to step to the next point.

Source Trigger Out (or “Trig 2” at default setting for N5181B/82B, N5183B MXG or N5171B/72B, N5173B EXG): Indicates that the source has settled.

IO interface Connection: analyzer can connect to sources with its GPIB, USB or LAN interface.

Notes:

- Trigger sync connections are optional – synchronization can be done via remote commands if Bus Trigger is enabled in the Source Setup menu.
- Connection from the SA external frequency reference output to the source frequency reference input (10 MHz Out to Ref In) is not required, but may improve the measurement accuracy.

Use of the YTF (Microwave or mm Preselector) with External Source Control

In most stimulus/response measurements that utilize External Source Control, the source exactly tracks the tuned analyzer frequency. Consequently, preselection is not needed, and you can achieve greatly superior amplitude accuracy and repeatability by bypassing the YTF (Preselector) using the Microwave Preselector Bypass control in the Amplitude, μ W Path Control menu.

NOTE

This control is only available if option MPB is installed.

There are rare but important cases, however, where the source is tuned to a different frequency than the analyzer, using the Multiplier and Reverse controls in the Source, Frequency menu. For example, you might be tuning the source to $\frac{1}{2}$ of the analyzer frequency when looking at second harmonic distortion in a DUT. In these cases, it would be commonplace for there to be an undesired signal at the analyzer input that is at an image frequency that you will want to reject with the YTF.

Understanding these cases is important for proper operation of the Microwave Preselector with External Source Control, so that you only bypass it when it will improve accuracy but not hinder the measurement.

Point Trigger

Shows point trigger type selected and navigates to the Point Trigger menu.

The Point Trigger menu lists all analyzer point trigger types. The analyzer and source point trigger synchronization can be done using SCPI bus commands or by using external trigger output and input lines.

NOTE

For X-Series software versions earlier than A.10.01, hardware triggering was unavailable in stepped tracking at frequencies above 3.6 GHz, so above 3.6 GHz, software triggering was always used. This is no longer the case.

Key Path	Source, Source Setup
Mode	SA
Scope	Mode Global
Remote Command	:SOURce:TRIGger:TYPE BUS EXTernal[1] EXTernal2 :SOURce:TRIGger:TYPE?
Example	:SOUR:TRIG:TYPE EXT1 Selects analyzer external trigger 1 in and out for point trigger synchronization with selected source
Dependencies	If an internal Tracking Generator is selected, then this menu is unavailable, Additionally, the External 1 and External 2 Trigger keys on the Spectrum Analyzer are released from any grayout that may have been forced on them by the external source Point Trigger selection. In some models, there is no second External input. In these models, the External 2 key is blanked and the EXTernal2 parameter will generate a "Hardware missing; Not available for this model number" message.
Couplings	The source control point trigger selection can select external trigger 1 or 2 in for synchronized point triggering. This can conflict with the selection under the Trigger hardkey, if it has External 1 or 2 selected. If there is a conflict when the selection is made under the Point Trigger menu, the

	Trigger selection under the Trigger hardkey will be changed to Free Run.
Preset	This is unaffected by "Mode Preset" but is set to EXTERNAL1 on a "Source Preset" or "Restore Input/Output Defaults".
State Saved	Part of the Input/Output system, which means it is Loaded and Saved with state
Readback	1-of-N selection
Initial S/W Revision	A.06.01

SW Trigger

Analyzer and source point trigger synchronization is setup using the SCPI commands. Source is stepped via SCPI commands. Analyzer waits for source to settle by polling source.

Key Path	Source, Source Setup, Point Trigger
Mode	SA
Example	:SOUR:TRIG:TYPE BUS
Readback	SW Trigger
Initial S/W Revision	A.06.01

Ext Trigger 1

Analyzer and source point trigger synchronization is setup using the analyzer Trigger 1 Output and Trigger 1 Input. The Source is stepped via Trigger 1 Output. The Analyzer waits for source to settle via Trigger 1 Input.

Key Path	Source, Source Setup, Point Trigger
Mode	SA
Example	:SOUR:TRIG:TYP EXT1
Couplings	<p>With an acquired source, selecting this point trigger mode overrides existing external trigger 1 output level, slope, and delay, and external trigger 1 type and polarity.</p> <p>External trigger 1 input level = 1.20 V</p> <p>External trigger 1 input slope = Positive</p> <p>External trigger 1 input delay = Off</p> <p>External trigger 1 output type = Source Point Trigger</p> <p>External trigger 1 output polarity = Positive</p> <p>When this selection is made:</p> <ul style="list-style-type: none"> - The External 1 key in the Trigger menu (under the Trigger hardkey) is grayed out and, if External 1 was previously selected, it will be changed to Free Run. - Trig 1 Out selected under Output Config in the Input/Output menu will be changed to Source Point Trigger <p>If the user subsequently goes into the Trig 1 Out menu and selects a different Trigger Output, the Point Trigger will revert to SW Trigger.</p>

Readback	Ext Trigger 1
Initial S/W Revision	A.06.01

Ext Trigger 2

Analyzer and source point trigger synchronization is setup using the analyzer Trigger 2 Output and Trigger 2 Input. The Source is stepped via Trigger 2 Output. The Analyzer waits for source to settle via Trigger 2 Input.

Key Path	Source, Source Setup, Point Trigger
Mode	SA
Example	:SOUR:TRIG:TYP EXT2
Dependencies	This key is blanked out on CXA as there is only one trigger input
Couplings	<p>With an acquired source, selecting this point trigger mode overrides existing external trigger 2 output level, slope, and delay, and external trigger 2 type and polarity.</p> <p>External trigger 2 input level = 1.20 V</p> <p>External trigger 2 input slope = Positive</p> <p>External trigger 2 input delay = Off</p> <p>External trigger 2 output type = Source Point Trigger</p> <p>External trigger 2 output polarity = Positive</p> <p>When this selection is made:</p> <ul style="list-style-type: none"> - The External 2 key in the Trigger menu (under the Trigger hardkey) is grayed out and, if External 2 was previously selected, it will be changed to Free Run. - Trig 2 Out selected under Output Config in the Input/Output menu will be changed to Source Point Trigger - If the user subsequently goes into the Trig 2 Out menu and selects a different Trigger Output, the Point Trigger will revert to SW Trigger.
Readback	Ext Trigger 2
Initial S/W Revision	A.06.01

Show Source Capabilities & Settings

Shows the capabilities of the currently selected Source. The menu is useful for displaying source capabilities such as frequency and amplitude ranges. In addition, the results of the source control sweep algorithms can be viewed. This gives information of the source range required for a given analyzer sweep range. This can be used dynamically as a way of configuring the sweep settings.

Key Path	Source, Source Setup
Mode	SA
Dependencies	If no source is selected this key is grayed out.
Initial S/W Revision	A.06.01

Source Preset

The Source Preset key forces all the settings in the analyzer's Source State to their preset condition.

The Source State is the set of Source settings that is maintained and remembered by the analyzer for use in the Tracking Source Mode. The Source State variables are controlled and set in the menus under the Source front panel key. These settings include:

- RF Output Off
- Amplitude = - 10 dBm
- Amplitude Step = Auto
- Power Sweep = 0 dB
- Amplitude Offset = 0 dB
- Source Sweep Reverse = Off
- Multiplier Numerator = 1
- Multiplier Denominator = 1
- Freq Offset = 0 Hz
- Point trigger is set to "Ext1"

The Source State is saved along with the state of the current Mode when you save a State, and is recalled when that Mode State is recalled.

When the analyzer first starts up, a Source Preset is performed. In the Input/Output menu, Restore Input/Output Defaults will also perform a Source Preset.

A Mode Preset, from modes that support the External Source, will turn the RF Off but will **not** perform a Source Preset. By the same token, Source Preset does **not** perform a Mode Preset.

Source Preset does **not** change the Source Mode nor the selection of which physical source is being used, nor does it release the current source (the source remains under the control of the analyzer) nor exit the Source menu.

Key Path	Source
Mode	SA
Remote Command	:SOURce:PRESet
Example	:SOUR:PRES
Preset	Initiates a Source Preset
State Saved	No
Initial S/W Revision	A.06.01

SPAN X Scale

Accesses a menu of functions that enable you set the horizontal scale parameters.

Key Path	Front-panel key
Initial S/W Revision	Prior to A.02.00

Ref Value

Enables you to set the display X reference value.

Key Path	SPAN X Scale
Mode	SA, GSM, TD-SCDMA
Remote Command	:DISPlay:TXPower:VIEW[1]:WINDow[1]:TRACe:X[:SCALe]:RLEVel <time> :DISPlay:TXPower:VIEW[1]:WINDow[1]:TRACe:X[:SCALe]:RLEVel?
Example	DISP:TXP:VIEW:WIND:TRAC:X:RLEV 1s DISP:TXP:VIEW:WIND:TRAC:X:RLEV?
Notes	You must be in the Spectrum Analyzer mode, TD-SCDMA mode or GSM mode to use this command. Use INSTRUMENT:SElect to set the mode.
Couplings	If the X Auto Scaling is On, this value is automatically determined by the measurement result. When you set a value manually, X Auto Scaling automatically changes to Off.
Preset	0 s
State Saved	Saved in instrument state.
Min	-10.0 s
Max	10.00 s
Initial S/W Revision	Prior to A.02.00

Scale/Div

Enables you to set the display X scale/division value.

Key Path	SPAN X Scale
Mode	SA, GSM, TD-SCDMA
Remote Command	:DISPlay:TXPower:VIEW[1]:WINDow[1]:TRACe:X[:SCALe]:PDIVision <time> :DISPlay:TXPower:VIEW[1]:WINDow[1]:TRACe:X[:SCALe]:PDIVision?
Example	DISP:TXP:VIEW:WIND:TRAC:X:PDIV 1ms DISP:TXP:VIEW:WIND:TRAC:X:PDIV?
Notes	You must be in the Spectrum Analyzer mode, TD-SCDMA mode or GSM mode to use this command. Use INSTRUMENT:SElect to set the mode.
Couplings	If the X Auto Scaling is On, this value is automatically determined by the measurement result. When you set a value manually, X Auto Scaling automatically changes to Off.
Preset	64.0 us
State Saved	Saved in instrument state.

Min	1.00 ns
Max	1.00 s
Initial S/W Revision	Prior to A.02.00

Ref Position

Enables you to set the display X reference position to Left, Center or Right.

Key Path	SPAN X Scale
Mode	SA, GSM, TD-SCDMA
Remote Command	:DISPlay:TXPower:VIEW[1]:WINDow[1]:TRACe:X[:SCALE]:RPOsition LEFT CENTER RIGHT :DISPlay:TXPower:VIEW[1]:WINDow[1]:TRACe:X[:SCALE]:RPOsition?
Example	DISP:TXP:VIEW:WIND:TRAC:X:RPOS LEFT DISP:TXP:VIEW:WIND:TRAC:X:RPOS?
Notes	You must be in the Spectrum Analyzer mode, TD-SCDMA mode or GSM mode to use this command. Use INSTRument:SElect to set the mode.
Preset	LEFT
State Saved	Saved in instrument state.
Range	Left Ctr Right
Initial S/W Revision	Prior to A.02.00

Auto Scaling

Enables you to toggle the X auto scaling function between On and Off.

Key Path	SPAN X Scale
Mode	SA, GSM, TD-SCDMA
Remote Command	:DISPlay:TXPower:VIEW[1]:WINDow[1]:TRACe:X[:SCALE]:COUPlE 0 1 OFF ON :DISPlay:TXPower:VIEW[1]:WINDow[1]:TRACe:X[:SCALE]:COUPlE?
Example	DISP:TXP:VIEW:WIND:TRAC:X:COUP OFF DISP:TXP:VIEW:WIND:TRAC:X:COUP?
Notes	You must be in the Spectrum Analyzer mode, TD-SCDMA mode or GSM mode to use this command. Use INSTRument:SElect to set the mode.
Couplings	Upon pressing the Restart front-panel key, the scale coupling function automatically determines the scale per division and reference values based on the measurement results if this parameter is set to On. When you set a value to either X Rel Value or X Scale/Div manually, X Auto Scaling automatically changes to Off.
Preset	ON
State Saved	Saved in instrument state.
Range	On Off
Initial S/W Revision	Prior to A.02.00

Sweep/Control

Accesses a menu of functions that enable you to set up and control the sweep for the current measurement. For details about this key, see ["Sweep/Control" on page 927](#).

Key Path	Front-panel key
Mode	SA, EDGE GSM, TDSCDMA
Initial S/W Revision	Prior to A.02.00

Sweep Time (for SAmode)

Sets the sweep time to capture and show on screen.

Key Path	Sweep/Control
Mode	SA
Remote Command	<code>[:SENSe] :TXPower :SWEep :TIME <time></code> <code>[:SENSe] :TXPower :SWEep :TIME ?</code>
Example	TXP:SWE:TIME 10 TXP:SWE:TIME?
Notes	You must be in the Spectrum Analyzer mode to use this command. Use INSTRument:SElect to set the mode.
Preset	640 us
State Saved	Saved in instrument state.
Min	1.0e-6
Max	50
Initial S/W Revision	Prior to A.02.00

Pause/Resume

Pauses a measurement after the current data acquisition is complete.

When Paused, the label on the key changes to Resume. Pressing Resume unpauses the measurement. When you are Paused, pressing **Restart**, **Single** or **Cont** does a Resume.

Key Path	Sweep/Control
Remote Command	<code>:INITiate :PAUSE</code>
Dependencies	Grayed out in Measurements that do not support Pausing. Blanked in Modes that do not support Pausing.
Initial S/W Revision	Prior to A.02.00

Key Path	Sweep/Control
Remote Command	:INITiate:RESume
Dependencies	Grayed out in Measurements that do not support Pausing. Blanked in Modes that do not support Pausing.
Initial S/W Revision	Prior to A.02.00

Abort (Remote Command Only)

This command is used to stop the current measurement. It aborts the current measurement as quickly as possible, resets the sweep and trigger systems, and puts the measurement into an "idle" state. If the analyzer is in the process of aligning when ABORt is sent, the alignment finishes before the abort function is performed. So ABORt does not abort an alignment.

If the analyzer is set for Continuous measurement, it sets up the measurement and initiates a new data measurement sequence with a new data acquisition (sweep) taken once the trigger condition is met.

If the analyzer is set for Single measurement, it remains in the "idle" state until an :INIT:IMM command is received.

Remote Command	:ABORt
Example	:ABOR
Notes	If :INITiate:CONTInuous is ON, then a new continuous measurement will start immediately; with sweep (data acquisition) occurring once the trigger condition has been met. If :INITiate:CONTInuous is OFF, then :INITiate:IMMEDIATE is used to start a single measurement; with sweep (data acquisition) occurring once the trigger condition has been met.
Dependencies	For continuous measurement, ABORt is equivalent to the Restart key. Not all measurements support the abort command.
Status Bits/OPC dependencies	The STATus:OPERation register bits 0 through 8 are cleared. The STATus:QUESTionable register bit 9 (INTEgrity sum) is cleared. Since all the bits that feed into OPC are cleared by the ABORt, the ABORt will cause the *OPC query to return true.
Initial S/W Revision	Prior to A.02.00

System

See "[System](#)" on page 431

Trace/Detector

Accesses a menu of functions that enable you to control the detectors for the current measurement.

Key Path	Front-panel key
Initial S/W Revision	Prior to A.02.00

Max Hold Trace

This key enables you to select visible/invisible Max Hold Trace.

Key Path	Trace/Detector
Mode	SA, GSM, TD-SCDMA
Remote Command	:DISPlay:TXPower:VIEW[1]:WINDow[1]:TRACe:MAXHold[:STATe] ON OFF 1 0 :DISPlay:TXPower:VIEW[1]:WINDow[1]:TRACe:MAXHold[:STATe]?
Example	:DISP:TXP:VIEW:WIND:TRAC:MAXH ON :DISP:TXP:VIEW:WIND:TRAC:MAXH?
Notes	You must be in the Spectrum Analyzer mode, TD-SCDMA mode or GSM mode to use this command. Use INSTRument:SElect to set the mode.
Couplings	Selecting [:SENSe]:TXPower:AVERage:TYPE MAXimum forces this parameter to ON.
Preset	OFF
State Saved	Saved in instrument state.
Range	On Off
Initial S/W Revision	Prior to A.02.00

Min Hold Trace

This key enables you to select visible/invisible Min Hold Trace.

Key Path	Trace/Detector
Mode	SA, GSM, TD-SCDMA
Remote Command	:DISPlay:TXPower:VIEW[1]:WINDow[1]:TRACe:MINHold[:STATe] ON OFF 1 0 :DISPlay:TXPower:VIEW[1]:WINDow[1]:TRACe:MINHold[:STATe]?
Example	:DISP:TXP:VIEW:WIND:TRAC:MINH ON :DISP:TXP:VIEW:WIND:TRAC:MINH?
Notes	You must be in the Spectrum Analyzer mode, TD-SCDMA mode or GSM mode to use this command. Use INSTRument:SElect to set the mode.
Couplings	Selecting [:SENSe]:TXPower:AVERage:TYPE MINimum forces this parameter to ON.
Preset	OFF

13 Burst Power (Transmit Power)
Trace/Detector

State Saved	Saved in instrument state.
Range	On Off
Initial S/W Revision	Prior to A.02.00

Trigger

See ["Trigger" on page 529](#)

Free Run

See ["Free Run " on page 537](#)

Video

See ["Video \(IF Envelope\) " on page 538](#)

Trigger Level

See ["Trigger Level" on page 538](#)

Trig Slope

See ["Trig Slope" on page 539](#)

Trig Delay

See ["Trig Delay" on page 540](#)

X Axis Relative to Trigger

See ["X Axis Relative to Trigger" on page 583](#)

Line

See ["Line" on page 2814](#)

Trig Slope

See ["Trig Slope" on page 2814](#)

Trig Delay

See ["Trig Delay" on page 543](#)

X Axis Relative to Trigger

See ["X Axis Relative to Trigger" on page 583](#)

External 1

See ["External 1" on page 2828](#)

Trigger Level

See ["Trigger Level" on page 2828](#)

Trig Slope

See ["Trig Slope" on page 2829](#)

Trig Delay

See ["Trig Delay" on page 546](#)

X Axis Relative to Trigger

See ["X Axis Relative to Trigger" on page 583](#)

Zero Span Delay Comp

See ["Zero Span Delay Comp On/Off " on page 2816](#)

External 2

See ["External 2 " on page 2829](#)

Trigger Level

See ["Trigger Level" on page 2830](#)

Trig Slope

See ["Trig Slope" on page 2831](#)

Trig Delay

See ["Trig Delay " on page 549](#)

X Axis Relative to Trigger

See ["X Axis Relative to Trigger" on page 583](#)

Zero Span Delay Comp

See ["Zero Span Delay Comp On/Off" on page 2818](#)

RF Burst

See ["RF Burst" on page 2831](#)

Absolute Trigger

See ["Absolute Trigger Level" on page 2832](#)

Relative Trigger

See ["Relative Trigger Level" on page 2833](#)

Trig Slope

See ["Trigger Slope" on page 2834](#)

Trig Delay

See ["Trig Delay" on page 554](#)

X Axis Relative to Trigger

See ["X Axis Relative to Trigger" on page 583](#)

Zero Span Delay Comp

See ["Zero Span Delay Comp On/Off" on page 2834](#)

Periodic Timer

See ["Periodic Timer \(Frame Trigger\)" on page 2823](#)

Period

See ["Period" on page 2824](#)

Offset

See ["Offset" on page 2825](#)

Offset Adjust (Remote Command Only)

See ["Offset Adjust \(Remote Command Only\)" on page 2826](#)

Reset Offset Display

See ["Reset Offset Display" on page 2827](#)

Sync Source

See ["Sync Source" on page 2827](#)

Off

See ["Off" on page 2828](#)

External 1

See ["External 1" on page 2828](#)

Trigger Level

See ["Trigger Level" on page 2828](#)

Trig Slope

See ["Trig Slope" on page 2829](#)

External 2

See ["External 2 " on page 2829](#)

Trigger Level

See ["Trigger Level" on page 2830](#)

Trig Slope

See ["Trig Slope" on page 2831](#)

RF Burst

See ["RF Burst" on page 2831](#)

Absolute Trigger

See ["Absolute Trigger Level" on page 2832](#)

Relative Trigger

See ["Relative Trigger Level" on page 2833](#)

Trig Slope

See ["Trigger Slope" on page 2834](#)

Zero Span Delay Comp

See ["Zero Span Delay Comp On/Off" on page 2834](#)

Trig Delay

See ["Trig Delay" on page 568](#)

X Axis Relative to Trigger

See ["X Axis Relative to Trigger" on page 583](#)

Sync Holdoff

See ["Sync Holdoff" on page 1289](#)

Baseband I/Q

See ["Baseband I/Q " on page 570](#)

I/Q Mag

See ["I/Q Mag" on page 570](#)

Trigger Level

See ["Trigger Level" on page 570](#)

Trig Slope

See ["Trig Slope" on page 571](#)

Trig Delay

See ["Trig Delay" on page 571](#)

X Axis Relative to Trigger

See ["X Axis Relative to Trigger" on page 583](#)

I (Demodulated)

See ["I \(Demodulated\)" on page 572](#)

Trigger Level

See ["Trigger Level" on page 573](#)

Trig Slope

See ["Trig Slope" on page 573](#)

Trig Delay

See ["Trig Delay" on page 573](#)

X Axis Relative to Trigger

See ["X Axis Relative to Trigger" on page 583](#)

Q (Demodulated)

See ["Q \(Demodulated\)" on page 575](#)

Trigger Level

See ["Trigger Level" on page 575](#)

Trig Slope

See ["Trig Slope" on page 575](#)

Trig Delay

See ["Trig Delay" on page 576](#)

X Axis Relative to Trigger

See ["X Axis Relative to Trigger" on page 583](#)

Input I

See ["Input I" on page 577](#)

Trigger Level

See ["Trigger Level" on page 577](#)

Trig Slope

See ["Trig Slope" on page 578](#)

Trig Delay

See ["Trig Delay" on page 578](#)

X Axis Relative to Trigger

See ["X Axis Relative to Trigger" on page 583](#)

Input Q

See ["Input Q" on page 579](#)

Trigger Level

See ["Trigger Level" on page 579](#)

Trig Slope

See ["Trig Slope" on page 580](#)

Trig Delay

See ["Trig Delay" on page 580](#)

X Axis Relative to Trigger

See ["X Axis Relative to Trigger" on page 583](#)

Auxiliary Channel I/Q Mag

See ["Auxiliary Channel I/Q Mag" on page 581](#)

Trigger Level

See ["Trigger Level" on page 582](#)

Trig Slope

See ["Trig Slope" on page 582](#)

Trig Delay

See ["Trig Delay" on page 582](#)

X Axis Relative to Trigger

See ["X Axis Relative to Trigger" on page 583](#)

Trigger Center Frequency

See ["Trigger Center Frequency" on page 583](#)

Trigger Bandwidth

See ["Trigger Bandwidth" on page 584](#)

TV

See ["TV" on page 2835](#)

TV Line

See ["TV Line" on page 2836](#)

Field

See ["Field" on page 2836](#)

Entire Frame

See ["Entire Frame" on page 2837](#)

Field One

See ["Field One" on page 2837](#)

Field Two

See ["Field Two" on page 2837](#)

Standard

See ["Standard" on page 2838](#)

NTSC-M

See ["NTSC-M" on page 2838](#)

NTSC-Japan

See ["NTSC-Japan" on page 2839](#)

NTSC-4.43

See ["NTSC-4.43" on page 2839](#)

PAL-M

See ["PAL-M" on page 2839](#)

PAL-N

See ["PAL-N" on page 2839](#)

PAL-N Combin

See ["PAL-N-Combin" on page 2839](#)

PAL-B,D,G,H,I

See ["PAL-B,D,G,H,I" on page 2839](#)

PAL-60

See ["PAL-60" on page 2840](#)

SECAM-L

See ["SECAM-L" on page 2840](#)

Auto/Holdoff

See ["Auto/Holdoff" on page 590](#)

Auto Trig

See ["Auto Trig" on page 590](#)

Trig Holdoff

See ["Trig Holdoff" on page 591](#)

Holdoff Type

See ["Holdoff Type" on page 591](#)

User Preset

Accesses a menu that gives you the following three choices:

- **User Preset** – recalls a state previously saved using the Save User Preset function.
- **User Preset All Modes** – presets all of the modes in the analyzer
- **Save User Preset**– saves the current state for the current mode

Key Path	Front-panel key
Backwards Compatibility Notes	<p>User Preset is actually loading a state, and in legacy analyzers, it was possible to load a state without affecting the trace data, limit lines or correction data. Similarly it was possible to do a User Preset without affecting the trace data, limit lines or correction data.</p> <p>In the X-Series, “state” always includes all of this data; so whenever state is loaded, or User Preset is executed, all of the traces, limit lines and corrections are affected. Although this differs from previous behavior, it is desirable behavior, and should not cause adverse issues for users.</p> <p>On ESA and PSA, User Preset affected the entire instrument’s state. In the X-Series, User Preset only recalls the state for the active mode. There is a User Preset file for each mode. User Preset can never cause a mode switch as it can in legacy analyzers. If you want to recall all modes to their user preset file state, you will need to do a User Preset after mode switching into each mode.</p> <p>User Preset recalls mode state which can now include data like traces; whereas on ESA and PSA, User Preset did not affect data.</p>
Initial S/W Revision	Prior to A.02.00

User Preset

User Preset sets the state of the currently active mode back to the state that was previously saved for this mode using the Save User Preset menu key or the SCPI command, **SYST:PRES:USER:SAV**. **It not only recalls the** Mode Preset settings, but it also recalls all of the mode persistent settings, and the Input/Output system setting that existed at the time Save User Preset was executed.

If a Save User Preset has not been done at any time, User Preset recalls the default user preset file for the currently active mode. The default user preset files are created if, at power-on, a mode detects there is no user preset file. There will never be a scenario when there is no user preset file to restore. For each mode, the default user preset state is the same state that would be saved if a Save User Preset is performed in each mode right after doing a Restore Mode Default and after a Restore Input/Output Defaults.

The User Preset function does the following:

- Aborts the currently running measurement.
- Sets the mode State to the values defined by Save User Preset.

- Makes the saved measurement for the currently running mode the active measurement.
- Brings up the saved menu for the power-on mode.
- Clears the input and output buffers.
- Sets the Status Byte to 0.

Key Path	User Preset
Remote Command	:SYSTem:PRESet:USER
Example	:SYST:PRES:USER
Notes	:SYST:PRES:USER:SAVE is used to save the current state as the user preset state. Clears all pending OPC bits. The Status Byte is set to 0. Pressing the User Preset front-panel key while already in the User Preset menu will cause the User Preset to get executed
Couplings	A user preset will cause the currently running measurement to be aborted and cause the saved measurement to be active. Recalling a User Preset file has the same issues that recalling a Save State file has. Some settings may need to be limited and therefore re-coupled, since the capabilities of the mode may have changes when the User Preset file was last saved.
Initial S/W Revision	Prior to A.02.00

User Preset All Modes

Recalls all of the User Preset files for each mode, switches to the power-on mode, and activates the saved measurement from the power-on mode User Preset file.

NOTE

When the instrument is secured, all of the user preset files are converted back to their default user preset files.

The User Preset function does the following:

- Aborts the currently running measurement.
- Switches the Mode to the power-on mode.
- Restores the User Preset files for each mode.
- Makes the saved measurement for the power-on mode the active measurement.
- Brings up the saved menu for the power-on mode.
- Clears the input and output buffers.
- Sets the Status Byte to 0.

Key Path	User Preset
----------	-------------

Remote Command	:SYSTem:PRESet:USER:ALL
Example	:SYST:PRES:USER:SAVE :SYST:PRES:USER:ALL
Notes	Clears all pending OPC bits. The Status Byte is set to 0. :SYST:PRES:USER:SAVE is used to save the current state as the user preset state.
Couplings	A user preset will cause the currently running measurement to be aborted, cause a mode switch to the power-on mode, and cause the saved measurement to be active in the power-on mode. Recalling a User Preset file has the same issues that recalling a Save State file has. Some settings may need to be limited and therefore re-coupled, since the capabilities of the mode may have changes when the User Preset file was last saved.
Initial S/W Revision	Prior to A.02.00

Save User Preset

Saves the currently active mode and its State. You can recall this User Preset file by pressing the User Preset menu key or sending the SYST:PRES:USER remote command. This same state is also saved by the Save State function.

Key Path	User Preset
Remote Command	:SYSTem:PRESet:USER:SAVE
Example	:SYST:PRES:USER:SAVE
Notes	:SYST:PRES:SAVE creates the same file as if the user requested a *SAV or a MMEM:STOR:STAT, except User Preset Save does not allow the user to specify the filename or the location of the file.
Initial S/W Revision	Prior to A.02.00

View/Display

The View/Display key opens up the View menu for the current measurement. The views that are available are specific to the current measurement selected under the **Meas** key. Many of the lower-level menu keys are also the same across all measurements. Unique functions are described below.

This measurement has one view, which consists of two windows.

"RF Envelope view for TX Power Measurement(Above Threshold)" on page 2279

"RF Envelope view with Bar Graph for TX Power Measurement (Measured Burst Width)" on page 2280

"RF Envelope view with Bar Graph for TX Power Measurement (Single TimeSlot)" on page 2281

RF Envelope view for TX Power Measurement(Above Threshold)

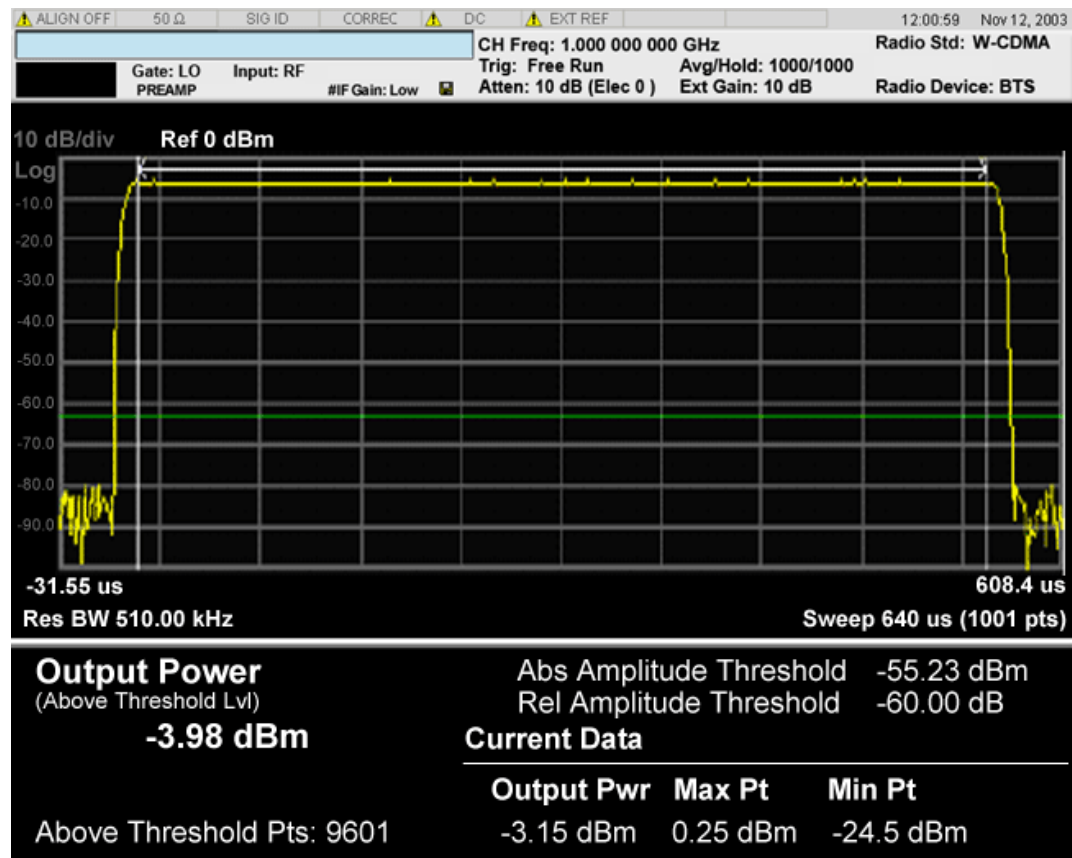

RF Envelope view with Bar Graph for TX Power Measurement
(Measured Burst Width)

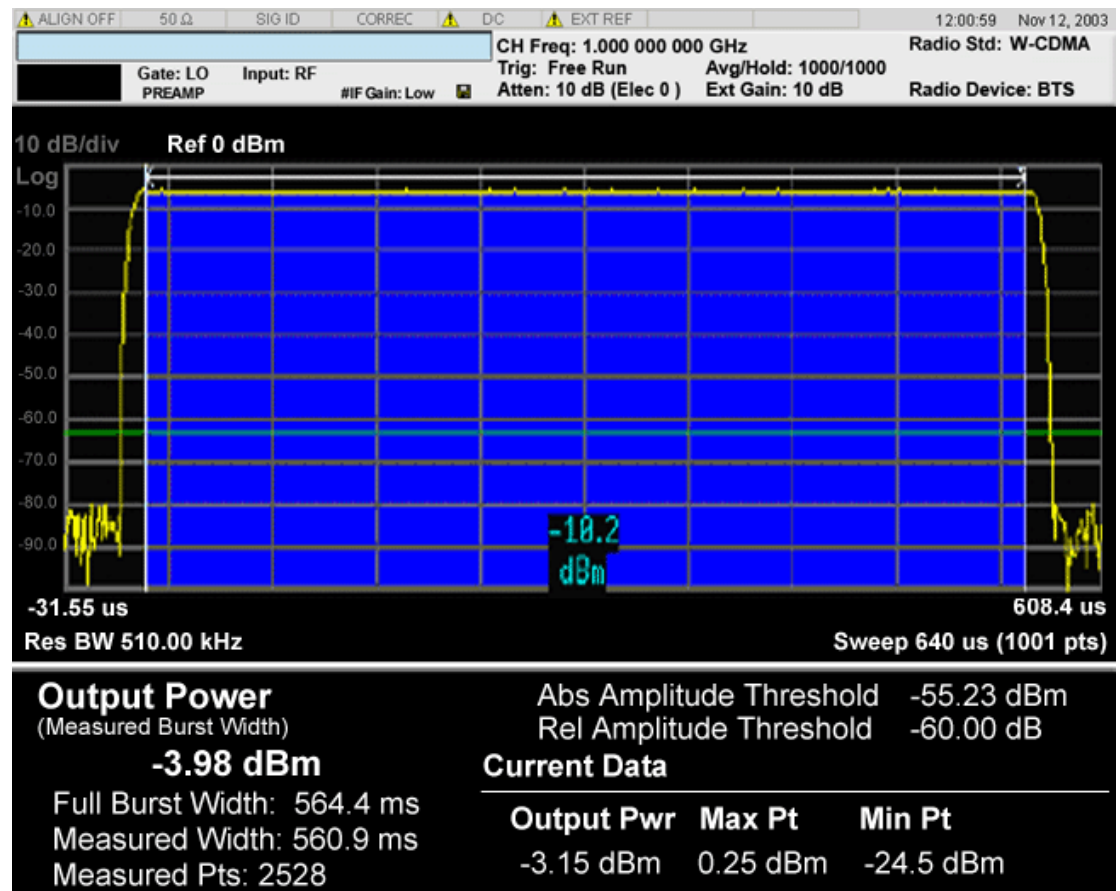

RF Envelope view with Bar Graph for TX Power Measurement (Single TimeSlot)

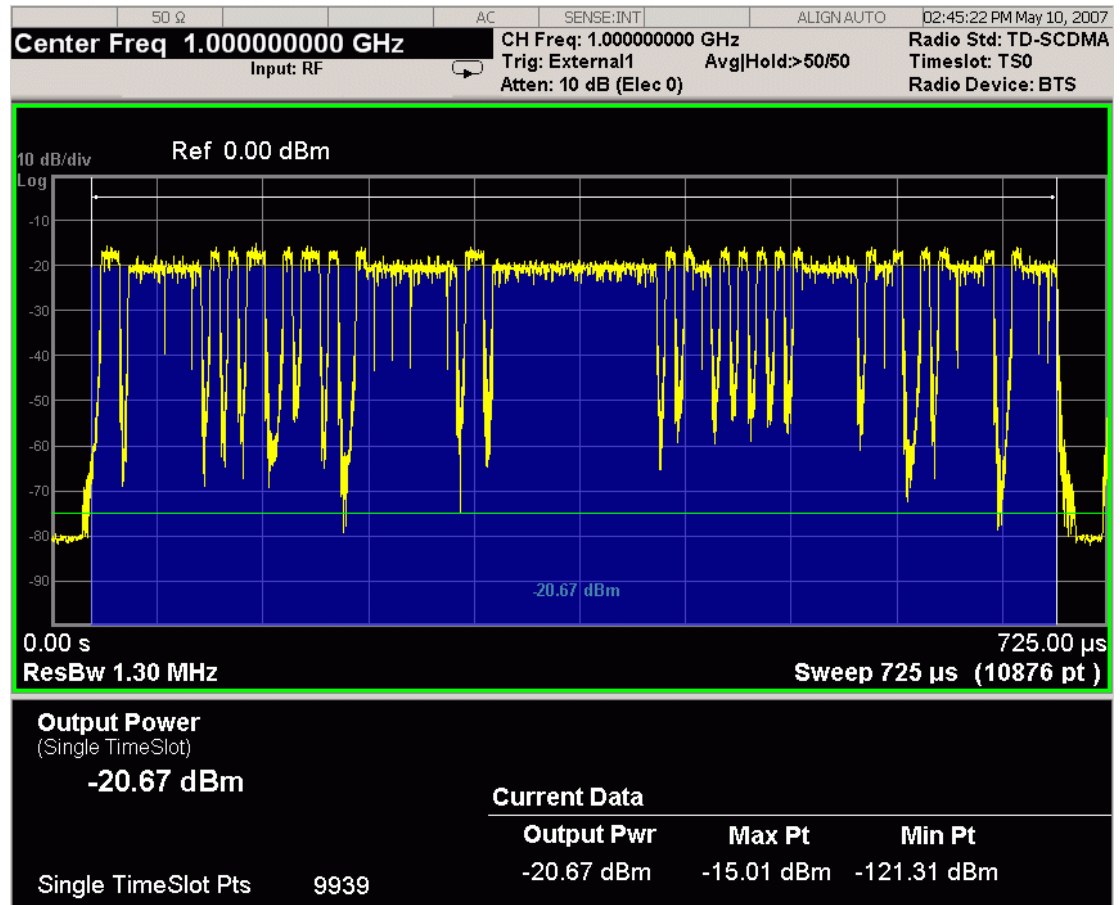

The bar graph represents the measured portion of the trace. It is the blue bar in the second figure. Its state (On/Off) is controlled by the **Bar Graph** key under the View/Display key.

RF Envelope window

Marker Operation	Yes
Corresponding Trace	Corrected measured trace (n=2,3,4)

Metrics window

Name	Corresponding Results	Display Format
Mean Transmit Power	n=1 3rd	99.99 dBm
Above Threshold or Measured Burst Width	Power Value above the threshold or measured burst width for N averages, if averaging is on. An average consists of N acquisitions of data which represents the current trace. If averaging is off, the value of power averaged is the same as the	

Name	Corresponding Results	Display Format
	Mean Transmit Power of Current Data.	
Full Burst Width	n=1 9th Burst width that is determined by the Threshold Lvl.	999.9 us
Measured Width	n=1 10th Time length that is used to calculate Mean Transmit Power when Meas Method is Measured Burst Width. If Meas Method is set to Above Threshold, disappear from the window.	999.9 us
Above Thresh Pts	n=1 6th Number of points that were above the threshold level and were used for the power calculation when Meas Method is Above Threshold Level.	9999
Thresh Pts	N=1 6th Number of points that were used for the power calculation when Meas Method is Measured Burst Width.	9999
Abs Amplitude Threshold	n=1 5th Threshold value is the threshold (in dBm) above which the power is calculated.	99.99 dBm
Rel Amplitude Threshold	Threshold (in dB) relative to the peak carrier level above which the power is calculated	99.99 dB
Mean Transmit power (Current data)	n=1 2nd Power value above the threshold or measured burst width. If averaging is on, the power is for the latest acquisition.	99.99 dBm
Max Pt	n=1 7th Maximum peak level of the most recently acquired trace data.	99.99 dBm
Min Pt	n=1 8th Minimum peak level of the most recently acquired trace data.	99.99 dBm

Key Path	Front-panel key
Mode	SA, EDGE, GSM, TDSCDMA
Initial S/W Revision	Prior to A.02.00

Display

The Display menu is common to most measurements, and is used for configuring items on the display. Some Display menu settings apply to all the measurements in

a mode, and some only to the current measurement. Those under the **System Display Settings** key apply to all measurements in all modes.

Key Path	Display
Key Path	View/Display
Initial S/W Revision	Prior to A.02.00

Annotation

Turns on and off various parts of the display annotation. The annotation is divided up into four categories:

13. Meas Bar: This is the measurement bar at the top of the screen. It does not include the settings panel or the Active Function. Turning off the Meas Bar turns off the settings panel and the Active Function. When the Meas Bar is off, the graticule area expands to fill the area formerly occupied by the Meas Bar.
14. Screen Annotation: this is the annotation and annunciation around the graticule, including any annotation on lines (such as the display line, the threshold line, etc.) This does NOT include the marker number or the N dB result. When off, the graticule expands to fill the entire graticule area.
15. Trace annotation: these are the labels on the traces, showing their detector (or their math mode).
16. Active Function annotation: this is the active function display in the meas bar, and all of the active function values displayed on softkeys.

See the figure below. Each type of annotation can be turned on and off individually.

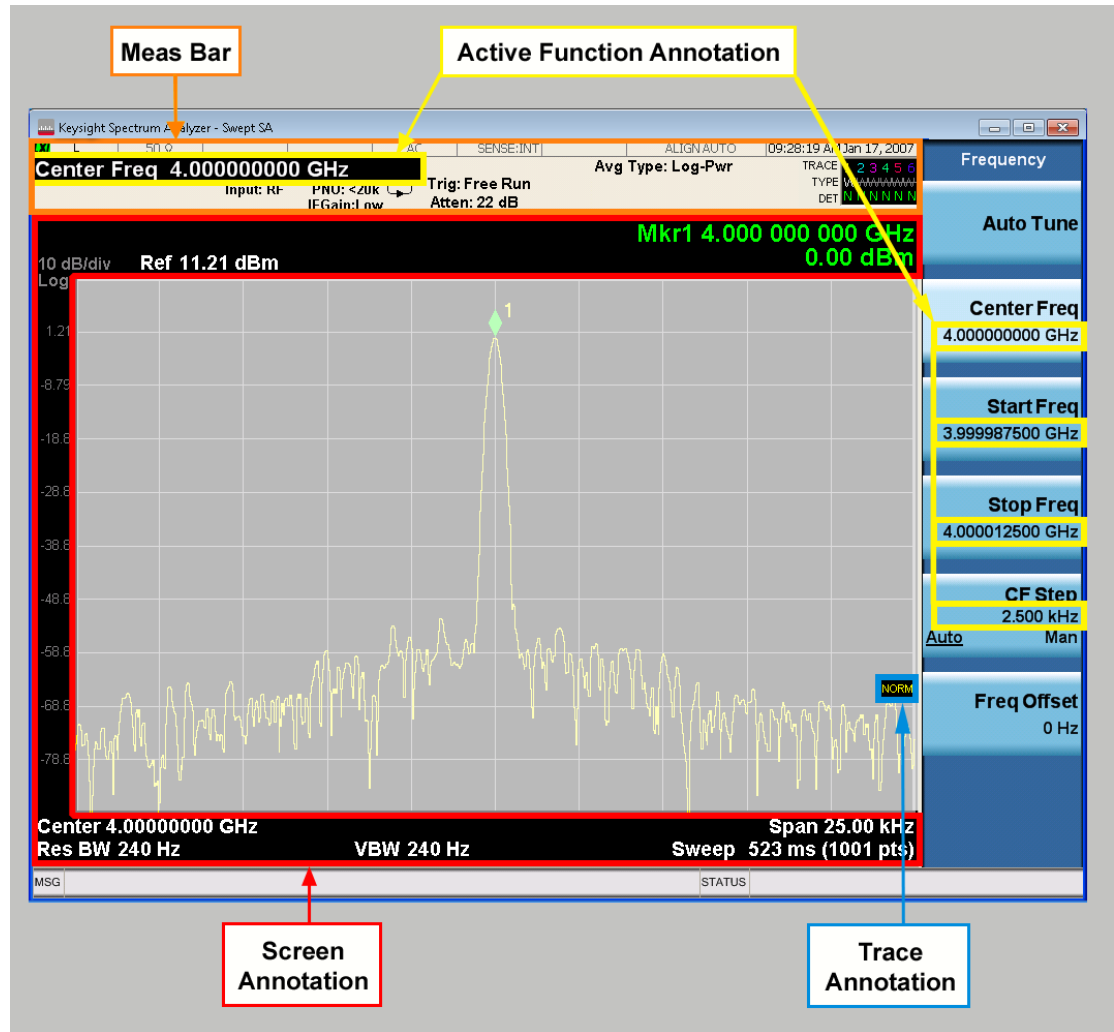

Key Path	View/Display, Display
Initial S/W Revision	Prior to A.02.00

Meas Bar On/Off

This function turns the Measurement Bar on and off, including the settings panel. When off, the graticule area expands to fill the area formerly occupied by the Measurement Bar.

Key Path	View/Display, Display, Annotation
Remote Command	:DISPlay:ANNotation:MBAR[:STATe] OFF ON 0 1 :DISPlay:ANNotation:MBAR[:STATe]?
Example	DISP:ANN:MBAR OFF
Dependencies	Grayed out and forced to OFF when System Display Settings, Annotation is set to Off.

Preset	On This should remain Off through a Preset when System DisplaySettings, Annotation is set to Off.
State Saved	Saved in instrument state.
Initial S/W Revision	Prior to A.02.00

Screen

This controls the display of the annunciation and annotation around the graticule, including any annotation on lines (such as the display line, the threshold line, etc.) and the y-axis annotation. This does NOT include marker annotation (or the N dB result). When off, the graticule expands to fill the entire graticule area, leaving only the 1.5% gap above the graticule as described in the Trace/Detector chapter.

Key Path	View/Display, Display, Annotation
Remote Command	:DISP:ANNOtation:SCReen[:STATe] OFF ON 0 1 :DISP:ANNOtation:SCReen[:STATe]?
Example	DISP:ANN:SCR OFF
Dependencies	Grayed-out and forced to OFF when System Display Settings, Annotation is set to Off.
Preset	On This should remain Off through a Preset when System DisplaySettings, Annotation is set to Off
State Saved	Saved in instrument state.
Initial S/W Revision	Prior to A.02.00

Trace

Turns on and off the labels on the traces, showing their detector (or their math mode) as described in the Trace/Detector section.

If trace math is being performed with a trace, then the trace math annotation will replace the detector annotation.

Key Path	View/Display, Display, Annotation
Remote Command	:DISP:ANNOtation:TRACe[:STATe] ON OFF 1 0 :DISP:ANNOtation:TRACe[:STATe]?
Example	DISP:ANN:TRAC OFF
Preset	Off
State Saved	Saved in instrument state.
Initial S/W Revision	Prior to A.02.00

Active Function Values On/Off

Turns on and off the active function display in the Meas Bar, and all of the active function values displayed on the softkeys.

Note that all of the softkeys that have active functions have these numeric values blanked when this function is on. This is a security feature..

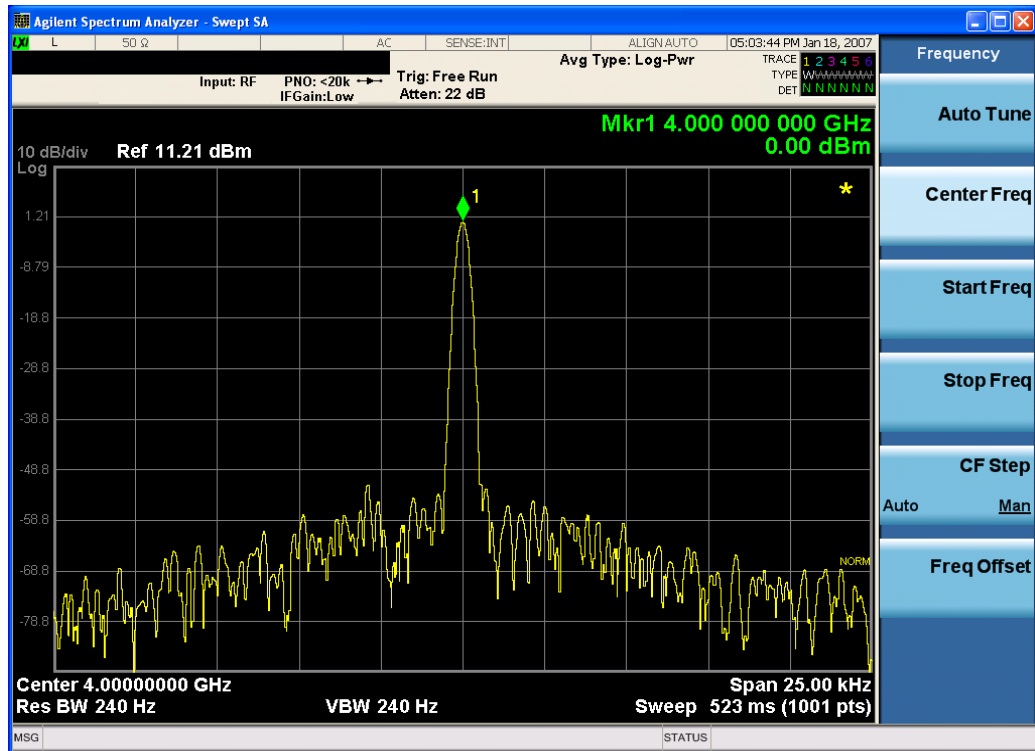

Key Path	View/Display, Display, Annotation
Remote Command	:DISPlay:ACTivefunc[:STATe] ON OFF 1 0 :DISPlay:ACTivefunc[:STATe]?
Example	DISP:ACT OFF
Dependencies	Grayed out and forced to OFF when System Display Settings, Annotation is set to Off.
Preset	On This should remain Off through a Preset when System DisplaySettings, Annotation is set to Off
State Saved	Saved in instrument state.
Initial S/W Revision	Prior to A.02.00

Title

Displays menu keys that enable you to change or clear a title on your display.

Key Path	View/Display, Display
Initial S/W Revision	Prior to A.02.00

Change Title

Writes a title into the "measurement name" field in the banner, for example, "Swept SA".

Press Change Title to enter a new title through the alpha editor. Press Enter or Return to complete the entry. Press ESC to cancel the entry and preserve your existing title.

The display title will replace the measurement name. It remains for this measurement until you press **Change Title** again, or you recall a state, or a Preset is performed. A title can also be cleared by pressing **Title, Clear Title**.

NOTE

Notice the inclusion of the <measurement> parameter in the command below. Because each measurement remembers the Display Title, the command must be qualified with the measurement name. For the Swept SA measurement this is not the case; no <measurement> parameter is used when changing the Display Title for the Swept SA measurement.

Key Path	View/Display, Display, Title
Mode	All
Remote Command	:DISPlay:<measurement>:ANNotation:TITLe:DATA <string> :DISPlay:<measurement>:ANNotation:TITLe:DATA?
Example	DISP:ANN:TITL:DATA "This Is My Title" This example is for the Swept SA measurement in the Spectrum Analyzer mode. The SANalyzer <measurement> name is not used. DISP:ACP:ANN:TITL:DATA "This Is My Title" This example is for Measurements other than Swept SA. Both set the title to: This Is My Title
Notes	Pressing this key cancels any active function. When a title is edited the previous title remains intact (it is not cleared) and the cursor goes at the end so that characters can be added or BKSP can be used to go back over previous characters.
Preset	No title (measurement name instead)
State Saved	Saved in instrument state.
Initial S/W Revision	Prior to A.02.00

Clear Title

Clears a title from the front-panel display. Once cleared, the title cannot be retrieved. After the title is cleared, the current Measurement Name replaces it in the

title bar.

Key Path	View/Display, Display, Title
Example	The following commands clear the title and restore the measurement's original title: DISP:ANN:TITL:DATA "" This example is for the Swept SA measurement in the Spectrum Analyzer mode. The SANalyzer <measurement> name is not used. DISP:ACP:ANN:TITL:DATA "" This example is for ACP; in measurements other than Swept SA the measurement name is required.
Notes	Uses the :DISPlay:<measurement>:ANNotation:TITLe:DATA <string> command with an empty string (in the Swept SA, the <measurement> is omitted).
Preset	Performed on Preset.
Initial S/W Revision	Prior to A.02.00

Graticule

Pressing Graticule turns the display graticule On or Off. It also turns the graticule y-axis annotation on and off.

Key Path	View/Display, Display
Remote Command	:DISPlay:WINDow[1]:TRACe:GRATicule:GRID[:STATe] OFF ON 0 1 :DISPlay:WINDow[1]:TRACe:GRATicule:GRID[:STATe]?
Example	DISP:WIND:TRAC:GRAT:GRID OFF
Notes	The graticule is the set of horizontal and vertical lines that make up the grid/divisions for the x-axis and y-axis.
Preset	On
State Saved	Saved in instrument state
Initial S/W Revision	Prior to A.02.00

System Display Settings

These settings are "Mode Global" – they affect all modes and measurements and are reset only by **Restore Misc Defaults** or **Restore System Defaults** under System.

Key Path	View/Display, Display
Initial S/W Revision	Prior to A.02.00

Annotation Local Settings

This is a Mode Global override of the meas local annotation settings. When it is **All Off**, it forces **ScreenAnnotation, Meas Bar, Trace, and Active Function Values** settings to be **OFF** for all measurements in all modes. This provides the security based "annotation off" function of previous analyzers; hence it uses the legacy SCPI command.

When it is **All Off**, the **Screen, Meas Bar, Trace, and Active Function Values** keys under the **Display, Annotation** menu are grayed out and forced to **Off**. When **Local Settings** is selected, you are able to set the local annotation settings on a measurement by measurement basis.

Key Path	View/Display, Display, System Display Settings
Remote Command	:DISPlay:WINDow[1]:ANNotation[:ALL] OFF ON 0 1 :DISPlay:WINDow[1]:ANNotation[:ALL]?
Example	:DISP:WIND:ANN OFF
Preset	On (Set by Restore Misc Defaults)
State Saved	Not saved in instrument state.
Backwards Compatibility Notes	The WINDow parameter and optional subopcode is included for backwards compatibility but ignored – all windows are equally affected.
Initial S/W Revision	Prior to A.02.00

Themes

Accesses a menu of functions that enable you to choose the theme to be used when saving the screen image.

The **Themes** option is the same as the **Themes** option under the **Display and Page Setup** dialogs. It allows you to choose between themes to be used when saving the screen image.

Key Path	Save, Screen Image
Remote Command	:MMEMory:STORe:SCReem:THEMe TDColor TDMonochrome FCOLor FMONochrome :MMEMory:STORe:SCReem:THEMe?
Example	:MMEM:STOR:SCR:THEM TDM
Preset	3D Color; Is not part of Preset, but is reset by Restore Misc Defaults or Restore System Defaults All and survives subsequent running of the modes.
Readback	3D Color 3D Mono Flat Color Flat Mono
Backwards Compatibility Notes	In ESA and PSA we offer the choice of "Reverse Bitmap" or "Reverse Metafile" when saving screen images. This is much like the "Flat Color" theme available in X-Series. Also, if you selected Reverse Bitmap AND a black & white screen image, that would be much like "Flat Monochrome". In other words, each of the X-Series themes has a similar screen image type in ESA/PSA. But they are not identical.
Initial S/W Revision	Prior to A.02.00

3D Color

Selects a standard color theme with each object filled, shaded and colored as designed.

Key Path	Save, Screen Image, Themes
Example	MMEM:STOR:SCR:THEM TDC
Readback	3D Color
Initial S/W Revision	Prior to A.02.00

3D Monochrome

Selects a format that is like 3D color but shades of gray are used instead of colors.

Key Path	Save, Screen Image, Themes
Example	MMEM:STOR:SCR:THEM TDM
Readback	3D Mono
Initial S/W Revision	Prior to A.02.00

Flat Color

Selects a format that is best when the screen is to be printed on an ink printer.

Key Path	Save, Screen Image, Themes
Example	MMEM:STOR:SCR:THEM FCOL
Readback	Flat Color
Initial S/W Revision	Prior to A.02.00

Flat Monochrome

Selects a format that is like Flat Color. But only black is used (no colors, not even gray), and no fill.

Key Path	Save, Screen Image, Themes
Example	MMEM:STOR:SCR:THEM FMON
Readback	Flat Mono
Initial S/W Revision	Prior to A.02.00

Backlight

Accesses the display backlight on/off keys. This setting may interact with settings under the Windows "Power" menu.

When the backlight is off, pressing ESC, TAB, SPACE, ENTER, UP, DOWN, LEFT, RIGHT, DEL, BKSP, CTRL, or ALT turns the backlight on without affecting the application. Pressing any other key will turn backlight on and could potentially perform the action as well.

Key Path	View/Display, Display, System Display Settings
Remote Command	:DISPlay:BACKlight ON OFF :DISPlay:BACKlight?
Preset	ON (Set by Restore Misc Defaults)
Initial S/W Revision	Prior to A.02.00

Backlight Intensity

An active function used to set the backlight intensity. It goes from 0 to 100 where 100 is full on and 0 is off. This value is independent of the values set under the Backlight on/off key.

Key Path	View/Display, Display, System Display Settings
Remote Command	:DISPlay:BACKlight:INTensity <integer> :DISPlay:BACKlight:INTensity?
Example	DISP:BACK:INT 50
Preset	100 (Set by Restore Misc Defaults)
Min	0
Max	100
Initial S/W Revision	Prior to A.02.00

Bar Graph

Enables you to select visible/invisible Bar Graph.

Key Path	View/Display
Mode	SA, GSM, TD-SCDMA
Remote Command	:DISPlay:TXPower:BARGraph[:STATe] ON OFF 1 0 :DISPlay:TXPower:BARGraph[:STATe]?
Example	DISP:TXP:BARG ON DISP:TXP:BARG?
Preset	OFF
State Saved	Saved in instrument state.
Range	On Off
Initial S/W Revision	Prior to A.02.00

14 Spurious Emissions Measurement

The Spurious Emissions measurement identifies and determines the power level of spurious emissions in certain frequency bands. For measurement results and views, see ["View/Display" on page 2541](#).

This topic contains the following sections:

- ["Measurement Commands for Spurious Emissions" on page 2293](#)
- ["Remote Command Results for Spurious Emissions Measurement" on page 2294](#)

Measurement Commands for Spurious Emissions

The following commands can be used to retrieve the measurement results:

```
:CONFigure:SPURious  
:CONFigure:SPURious:NDEFault  
:INITiate:SPURious  
:FETCh:SPURious[n]?  
:READ:SPURious[n]?  
:MEASure:SPURious[n]?
```

For more measurement related commands, see the SENSE subsystem, and the section ["Remote Measurement Functions" on page 3140](#).

Remote Command Results for Spurious Emissions Measurement

The following table describes the results returned by the FETCh, MEASure, and READ queries listed above, according to the index value n. Note that the queries are not available when viewing the Range Table.

n	Return Value
1 (or not supplied)	Returns a variable-length (1+6*Spurs – up to 1201 entries) comma separated list containing detailed information in the following format: <ol style="list-style-type: none"> 1. Number of spurs in following list (Integer) <p style="margin-left: 40px;"><i>[Repeat the following for each spur]</i></p> <ol style="list-style-type: none"> a. Spur # b. Range # Spur was located (Integer) c. Frequency of Spur (Hz, Float64) d. Amplitude of Spur (dBm, Float32) e. Absolute Limit (dBm, Float32) f. Pass or Fail (1 0, Boolean)
2 – 21	Returns a comma separated list of the trace data for the selected range (where range number = n – 1) using Detector 1. If selected range is not active SCPI_NAN is returned for each trace data element where SCPI_NAN = 9.91E37.
22	Returns the number of spurs found.
23 – 42	Returns a comma separated list of the trace data for the selected range (where range number = n – 22) using Detector 2. If selected range is not active or Detector 2 selection is off, SCPI_NAN is returned for each trace data element where SCPI_NAN = 9.91E37.

Key Path	Meas
Initial S/W Revision	Prior to A.02.00

AMPTD Y Scale

AMPTD Y Scale opens a menu of functions that enable you to modify the Amplitude parameters.

Key Path	Front-panel key
Initial S/W Revision	Prior to A.02.00

Ref Value

Sets the value for the absolute power reference. When Auto Scaling for the Y-axis is off, the measurement uses the current reference level settings. When Auto Scaling for the Y-axis is on, the analyzer will set the reference level such that the absolute limit will be positioned two divisions down from the top of the display.

Key Path	AMPTD Y Scale
Mode	SA, WCDMA, WIMAX OFDMA, TD-SCDMA,C2k, 1xEV-DO, DVB-T/H, LTE, LTETDD, WLAN, MSR, LTEAFDD, LTEATDD
Remote Command	:DISPlay:SPURious:VIEW[1]:WINDow[1]:TRACe:Y[:SCALE]:RLEVel < real> :DISPlay:SPURious:VIEW[1]:WINDow[1]:TRACe:Y[:SCALE]:RLEVel?
Example	DISP:SPUR:VIEW:WIND:TRAC:Y:RLEV -50 dBm DISP:SPUR:VIEW:WIND:TRAC:Y:RLEV?
Notes	You must be in the Spectrum Analysis mode, W-CDMA mode, cdma2000 mode, DVB-T/H mode, TD-SCDMA mode, LTE mode, LTETDD mode, WLAN mode, MSR, LTE-Advanced FDD/TDD mode or WiMAX mode to use this command. Use INSTRument:SElect to set the mode.
Couplings	When the Y Auto Scaling is off, the measurement uses the current reference level settings. When the Y Auto Scaling is on, the analyzer automatically sets the reference level such that the absolute limit is positioned two divisions down from the top of the display. This is the most useful setting when searching for spurs. The algorithm used for determining the ref level is Ref Level = Absolute Limit + (2 * Scale/Div). All other reference level settings are left as the current base instrument settings.
Preset	0.00 dBm
State Saved	Saved in instrument state.
Min	-250.0 dBm
Max	250.0 dBm
Initial S/W Revision	Prior to A.02.00
Modified at S/W Revision	A.03.00

Attenuation

This menu controls the attenuator functions and interactions between the attenuation system components.

There are two attenuator configurations in the X-Series. One is a dual attenuator configuration consisting of a mechanical attenuator and an optional electronic

attenuator. The other configuration uses a single attenuator with combined mechanical and electronic sections that controls all the attenuation functions. Different models in the X-Series come with different configurations.

See ["Dual Attenuator Configurations:" on page 2296](#)

See ["Single Attenuator Configuration:" on page 2297](#)

Most Attenuation settings are the same for all measurements – they do not change as you change measurements. Settings like these are called “Meas Global” and are unaffected by Meas Preset.

Key Path	AMPTD Y Scale
Scope	Meas Global
Dependencies	In measurements that support the I/Q inputs, this key is unavailable when I/Q is the selected input, and is replaced by the Range key in that case.
Readback Line	Contains a summary in [] brackets of the current total attenuation. See the descriptions of the , " (Mech) Atten " on page 3103, and " Enable Elec Atten " on page 3105 keys for more detail on the contributors to the total attenuation. Note that when "Pre-Adjust for Min Clip" is on, this value can change at the start of every measurement.
Initial S/W Revision	Prior to A.02.00
Modified at S/W Revision	A.03.00

Dual Attenuator Configurations:

Configuration 1: Mechanical attenuator + optional electronic attenuator

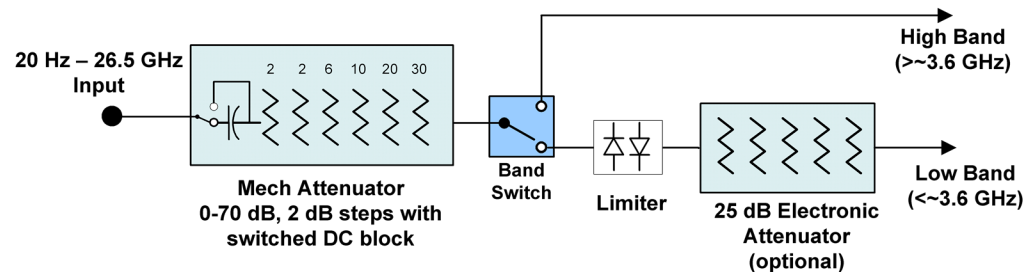

Configuration 2: Mechanical attenuator, no optional electronic attenuator

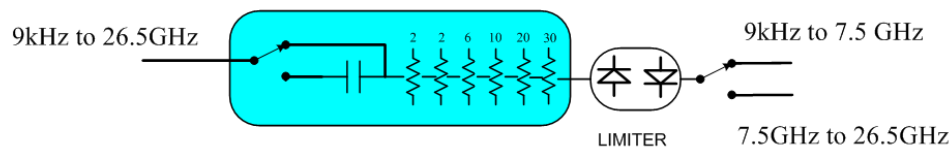

(note that Configuration 2 is not strictly speaking a dual-section attenuator, since there is no electronic section available. However, it behaves exactly like

Configuration 1 without the Electronic Attenuator option EA3, therefore for the sake of this document it is grouped into the “Dual Attenuator” configuration)

Single Attenuator Configuration:

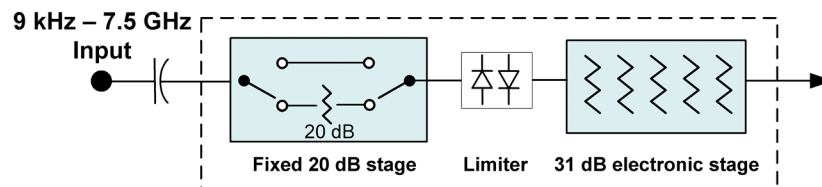

You can tell which attenuator configuration you have by pressing the Attenuation key, which (in most Modes) opens the Attenuation menu. If the first key in the Attenuation menu says **Mech Atten** you have the dual attenuator configuration. If the first key says **Atten** you have the single attenuator configuration.



In the single attenuator configuration, you control the attenuation with a single control, as the fixed stage has only two states. In the dual attenuator configuration, both stages have significant range so you are given separate control of the mechanical and electronic attenuator stages.

When you have the dual attenuator configuration, you may still have only a single attenuator, because unless option EA3 (the Electronic Attenuator option) is available, and you purchase it, you will have only the mechanical attenuator.

(Mech) Atten

This key is labeled **Mech Atten** in dual attenuator models and **Atten** in single attenuator models. In the dual attenuator configuration, this key only affects the mechanical attenuator.

This key lets you modify the attenuation applied to the RF input signal path. This value is normally auto coupled to the Ref Level, the Internal Preamp Gain, any External Gain that is entered, and the Max Mixer Level, as described in the table below.

See "[Attenuator Configurations and Auto/Man](#)" on page 2299

Key Path	AMPTD Y Scale, Attenuation
Remote Command	[:SENSe]:POWer[:RF]:ATTenuation <rel_amp1> [:SENSe]:POWer[:RF]:ATTenuation? [:SENSe]:POWer[:RF]:ATTenuation:AUTO OFF ON 0 1 [:SENSe]:POWer[:RF]:ATTenuation:AUTO?
Example	POW:ATT 20

	<p>Dual attenuator configuration: sets the mechanical attenuator to 20 dB</p> <p>Single attenuator mode: sets the main attenuation to 20 dB (see below for definition of “main” attenuation).</p> <p>If the attenuator was in Auto, it sets it to Manual.</p>
Dependencies	<p>Some measurements do not support the Auto setting of (Mech) Atten. In these measurements, the Auto/Man selection is not available, and the Auto/Man line on the key disappears.</p> <p>In dual attenuator configurations, when the electronic attenuator is enabled, the mechanical attenuator has no auto setting and the Auto/Man line on the key disappears. The state of Auto/Man is remembered and restored when the electronic attenuator is once again disabled. This is described in more detail in the "Enable Elec Atten" on page 3105 key description.</p> <p>See "Attenuator Configurations and Auto/Man" on page 2299 for more information on the Auto/Man functionality of Attenuation.</p>
Couplings	<p>When (Mech) Atten is in Auto, it uses the following algorithm to determine a value:</p> <p>If the USB Preamp is connected to USB, use 0 dB.</p> <p>Otherwise, $Atten = ReferenceLevel + PreAmpGain + ExternalGain - RefLevelOffset - MaxMixerLevel + IF\ Gain$.</p> <p>Limit this value to be between 6 dB and the Max value. No value below 6 dB can ever be chosen by Auto.</p> <p>The resulting value is rounded up to the largest value possible given the attenuation step setting. That is, 50.01 dB would change to 60 dB (for a 10 dB attenuation step).</p> <p>The “IF Gain” term in the equation above is either 0 dB or +10 dB, depending on the settings of FFT IF Gain, Swept IF Gain, max Ref Level and the Auto/Man setting of Mech Atten.</p> <p>In External Mixing and BBIQ, where the Attenuator is not in the signal path, the Attenuator setting changes as described above when (Mech) Atten is in Auto, but no changes are made to the actual attenuator hardware setting until the input is changed back to the RF Input.</p>
Preset	<p>The preset for Mech Attenuation is “Auto.”</p> <p>The Auto value of attenuation is:</p> <p>CXA, EXA, MXA and PXA: 10 dB</p>
State Saved	<p>Saved in instrument state</p>
Min	<p>0 dB</p> <p>The attenuation set by this key cannot be decreased below 6 dB with the knob or step keys. To get to a value below 6 dB it has to be directly entered from the keypad or via SCPI. This protects from adjusting the attenuation to a dangerously small value which can put the instrument at risk of damage to input circuitry. However, if the current mechanical attenuation is below 6 dB it can be increased with the knob and step keys, but not decreased.</p>
Max	<p>CXA N9000A-503/507: 50 dB</p> <p>CXA N9000A-513/526: 70dB</p> <p>EXA: 60 dB</p> <p>MXA and PXA: 70 dB</p> <p>In the single attenuator configuration, the total of ATT and EATT cannot exceed 50 dB, so if the EATT is set to 24 dB first, the main attenuation cannot be greater than 26 dB and will be reduced accordingly; if the main attenuator is set to 40 dB first, EATT cannot be greater than 10 dB.</p>
Initial S/W Revision	<p>Prior to A.02.00</p>

Modified at S/W A.03.00
 Revision

Attenuator Configurations and Auto/Man

As described in the Attenuation key description, there are two distinct attenuator configurations available in the X-Series, the single attenuator and dual attenuator configurations. In dual attenuator configurations, we have the mechanical attenuation and the electronic attenuation, and the current total attenuation is the sum of the electronic + mechanical attenuation. In single attenuator configurations, we refer to the attenuation set using the **(Mech) Atten** key (or POW:ATT SCPI) as the “main” attenuation; and the attenuation that is set by the SCPI command POW:EATT as the “soft” attenuation (the POW:EATT command is honored even in the single attenuator configuration, for compatibility purposes). Then the current total attenuation is the sum of the main + soft attenuation. See the **Elec Atten** key description for more on “soft” attenuation.

In the dual attenuator configuration, when the electronic attenuator is enabled, there is no Auto/Man functionality for the mechanical attenuator, and the third line of the key label (the Auto/Man line) disappears:

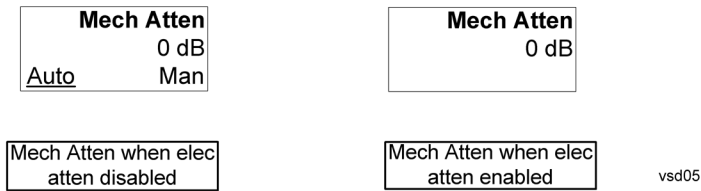

Enable Elec Atten

Enables the Electronic Attenuator.

The electronic attenuator offers finer steps than the mechanical attenuator, has no acoustical noise, is faster, and is less subject to wear. These advantages primarily aid in remote operation and are negligible for front panel use. See ["Using the Electronic Attenuator: Pros and Cons" on page 2301](#) for a detailed discussion of the pros and cons of using the electronic attenuator.

For the single attenuator configuration, for SCPI backwards compatibility, the “soft” attenuation feature replaces the dual attenuator configuration’s electronic attenuator. All the same couplings and limitations apply. See ["Attenuator Configurations and Auto/Man" on page 3105](#)

See [Error! Reference source not found.](#)

Key Path	AMPTD Y Scale, Attenuation
Remote Command	[:SENSe]:POWer[:RF]:EATTenuation:STATe OFF ON 0 1 [:SENSe]:POWer[:RF]:EATTenuation:STATe?
Example	POW:EATT:STAT ON
Dependencies	This key only appears in Dual Attenuator models with an Electronic Attenuator installed. It does

not appear in models with the Single Attenuator configuration, as in the single attenuator configuration there is no “electronic attenuator” there is only a single integrated attenuator (which has both a mechanical and electronic stage). However, in the single attenuator configuration, EATT SCPI commands are accepted for compatibility with other X-series instruments and set a “soft” attenuation as described in ["Attenuator Configurations and Auto/Man" on page 3105](#).

The electronic attenuator (and the “soft” attenuation function provided in single attenuator configurations) is unavailable above 3.6 GHz. Therefore, if the Stop Frequency of the analyzer is > 3.6 GHz then the **Enable Elec Atten** key will be OFF and grayed out.

If the Internal Preamp is on, meaning it is set to Low Band or Full, the electronic attenuator (and the “soft” attenuation function provided in single attenuator configurations) is unavailable. In this case the **Enable Elec Atten** key will be OFF and grayed out.

If either of the above is true, if the SCPI command is sent, an error indicating that the electronic attenuator is unavailable will be sent.

If the electronic/soft Attenuator is enabled, then the Stop Freq of the analyzer is limited to 3.6 GHz and the Internal Preamp is unavailable.

The SCPI-only “soft” electronic attenuation for the single-attenuator configuration is not available in all measurements; in particular, it is not available in the Swept SA measurement.

Couplings	Enabling and disabling the Electronic Attenuator affects the setting of the Mechanical Attenuator (in dual attenuator configurations). This is described in more detail below this table.
Preset	OFF for Swept SA measurement; ON for all other measurements that support the electronic attenuator
State Saved	Saved in instrument state
Initial S/W Revision	Prior to A.02.00
Modified at S/W Revision	A.03.00

Mechanical Attenuator Transition Rules

When the Electronic Attenuator is enabled, the Mechanical Attenuator transitions to a state that has no Auto function. Below are the rules for transitioning the Mechanical Attenuator. NOTE that the information below ONLY applies to the dual attenuator configurations, and ONLY when the Electronic Attenuator is installed:

When the Electronic Attenuation is enabled from a disabled state:

- The Mechanical Attenuator is initialized to 10 dB (this is its optimal performance setting). You can then set it as desired with SCPI, numeric keypad, step keys, or knob, and it behaves as it normally would in manual mode
- The Auto/Man state of (Mech) Atten is saved
- The Auto/Man line on the (Mech) Atten key disappears and the auto rules are disabled

- The Electronic Attenuator is set to 10 dB less than the previous value of the Mechanical Attenuator, within the limitation that it must stay within the range of 0 to 24 dB of attenuation.

Examples in the dual attenuator configuration:

- Mech Atten at 20 dB. Elec Atten enabled, Mech Atten set to 10 dB, and Elec Atten set to 10 dB. New total attenuation equals the value before Elec Atten enabled.
- Mech Atten at 0 dB. Elec Atten enabled, Mech Atten set to 10 dB, and Elec Atten set to 0 dB. New total attenuation does not equal the value before Elec Atten enabled.
- Mech Atten at 40 dB. Elec Atten enabled, Mech Atten set to 10 dB, and Elec Atten set to 24 dB. New total attenuation does not equal the value before Elec Atten enabled.

When the Electronic Attenuation is disabled from an enabled state:

- The Elec Atten key is grayed out
- The Auto/Man state of (Mech) Atten is restored
- If now in Auto, (Mech) Atten recouples
- If now in Man, (Mech) Atten is set to the value of total attenuation that existed before the Elec Atten was disabled. The resulting value is rounded up to the smallest value possible given the (Mech) Atten Step setting - (That is, 57 dB changes to 58 dB when (Mech) Atten Step is 2 dB.)

Using the Electronic Attenuator: Pros and Cons

The electronic attenuator offers finer steps than the mechanical attenuator, has no acoustical noise, is faster, and is less subject to wear.

The “finer steps” advantage of the electronic attenuator is beneficial in optimizing the alignment of the analyzer dynamic range to the signal power in the front panel as well as remote use. Thus, you can achieve improved relative signal measurement accuracy. Compared to a mechanical attenuator with 2 dB steps, the 1 dB resolution of the electronic attenuator only gives better resolution when the odd-decibel steps are used. Those odd-decibel steps are less accurately calibrated than the even-decibel steps, so one tradeoff for this superior relative accuracy is reduced absolute amplitude accuracy.

Another disadvantage of the electronic attenuator is that the spectrum analyzer loses its “Auto” setting, making operation less convenient.

Also, the relationship between the dynamic range specifications (TOI, SHI, compression and noise) and instrument performance are less well-known with the

electrical attenuator. With the mechanical attenuator, TOI, SHI and compression threshold levels increase dB-for-dB with increasing attenuation, and the noise floor does as well. With the electronic attenuator, there is an excess attenuation of about 1 to 3 dB between 0 and 3.6 GHz, making the effective TOI, SHI, and so forth, less well known. Excess attenuation is the actual attenuation relative to stated attenuation. Excess attenuation is accounted for in the analyzer calibration

Elec Atten

Controls the Electronic Attenuator in dual attenuator configurations. This key does not appear in single attenuator configurations, as the control of both the mechanical and electronic stages of the single attenuator is integrated into the single **Atten** key.

Key Path	AMPTD Y Scale, Attenuation
Remote Command	<code>[:SENSe] :POWer [:RF] :EATTenuation <rel_amp1></code> <code>[:SENSe] :POWer [:RF] :EATTenuation?</code>
Notes	Electronic Attenuation's specification is defined only when Mechanical Attenuation is 6 dB.
Dependencies	This key only appears in Dual Attenuator models with an Electronic Attenuator installed. It does not appear in models with the Single Attenuator configuration, as in the single attenuator configuration there is no "electronic attenuator" there is only a single integrated attenuator (which has both a mechanical and electronic stage). However, in the single attenuator configuration, EATT SCPI commands are accepted for compatibility with other X-series instruments and set a "soft" attenuation as described in "Attenuator Configurations and Auto/Man" on page 3105 . The "soft" attenuation is treated as an addition to the "main" attenuation value set by the Atten softkey or the POW:ATT SCPI command and affects the total attenuation displayed on the Attenuation key and the Meas Bar. When Enable Elec Atten is off or grayed out, the Elec Atten key is grayed out.
Preset	0 dB
State Saved	Saved in instrument state
Min	0 dB
Max	Dual attenuator configuration: 24 dB Single attenuator configuration: the total of ATT and EATT cannot exceed 50 dB, so if the EATT is set to 24 dB first, the main attenuation cannot be greater than 26 dB and will be reduced accordingly; if the main attenuator is set to 40 dB first, EATT cannot be greater than 10 dB
Initial S/W Revision	Prior to A.02.00
Modified at S/W Revision	A.03.00

Adjust Atten for Min Clip

Sets the combination of mechanical and electronic attenuation and gain based on the current measured signal level so that clipping will be at a minimum.

This is an "immediate action" function, that is, it executes once, when the key is pressed.

This key does not appear in measurements that do not support this functionality. The spectrum analyzer measurement, Swept SA, does not support this functionality.

Key Path	AMPTD Y Scale, Attenuation
Remote Command	[:SENSe]:POWer[:RF]:RANGe:OPTimize IMMEDIATE
Initial S/W Revision	Prior to A.02.00
Modified at S/W Revision	A.03.00

Pre-Adjust for Min Clip

If this function is on, it does the adjustment described under "[Adjust Atten for Min Clip](#)" on page 3108 each time a measurement restarts. Therefore, in Continuous measurement mode, it only executes before the first measurement.

In dual attenuator models, you can set **Elec+Mech Atten**, in which case both attenuators participate in the autoranging, or **Elec Atten Only**, in which case the mechanical attenuator does not participate in the autoranging. This latter case results in less wear on the mechanical attenuator and is usually faster.

This key is grayed out in measurements that do not support this functionality. The spectrum analyzer measurement, Swept SA, does not support this functionality.

Key Path	AMPTD Y Scale, Attenuation
Remote Command	[:SENSe]:POWer[:RF]:RANGe:OPTimize:ATTenuation OFF ELECTrical COMBined [:SENSe]:POWer[:RF]:RANGe:OPTimize:ATTenuation?
Notes	The SCPI parameter ELECTrical sets this function to On in single attenuator models. The SCPI parameter COMBined is mapped to ELECTrical in single attenuator models; if you send COMBined, it sets the function to On and returns ELEC to a query.
Dependencies	This key only appears in Dual Attenuator models with an Electronic Attenuator installed. In instruments with Dual Attenuator model, when Enable Elec Atten is off or grayed out, the Pre-Adjust for Min Clip key is grayed out.
Preset	OFF for Swept SA measurement; ON for all other measurements that support Pre-Adjust for Min Clip
State Saved	Saved in instrument state
Range	Dual attenuator models: Off Elec Atten Only Mech + Elec Atten Single attenuator models: Off On
Initial S/W Revision	Prior to A.02.00
Modified at S/W Revision	A.03.00

Remote Command	[:SENSe]:POWer[:RF]:RANGe:AUTO ON OFF 1 0 [:SENSe]:POWer[:RF]:RANGe:AUTO?
Notes	ON aliases to "Elec Atten Only" (:POW:RANG:OPT:ATT ELEC)

	OFF aliases to "Off" (:POW:RANG:OPT:ATT OFF) The query :POW:RANG:AUTO? returns true if :POW:RANG:OPT:ATT is not "Off"
Initial S/W Revision	Prior to A.02.00

Off

Turns **Pre-Adjust for Min Clip** off. This is the default setting.

This key is grayed out in measurements that do not support this functionality. The spectrum analyzer measurement, Swept SA, does not support this functionality.

Key Path	AMPTD Y Scale, Attenuation, Pre-Adjust for Min Clip
Example	:POW:RANGe:OPT:ATT OFF
Initial S/W Revision	Prior to A.02.00

Elec Atten Only

Selects only the electric attenuator to participate in auto ranging. This offers less wear on the mechanical attenuator and is usually faster.

This key is grayed out in measurements that do not support this functionality. The spectrum analyzer measurement, Swept SA, does not support this functionality.

Key Path	AMPTD Y Scale, Attenuation, Pre-Adjust for Min Clip
Example	:POW:RANGe:OPT:ATT ELEC
Initial S/W Revision	Prior to A.02.00

Mech + Elec Atten

In dual attenuator models, this selects both attenuators participate in the autoranging.

This key is grayed out in measurements that do not support this functionality. The spectrum analyzer measurement, Swept SA, does not support this functionality.

Key Path	AMPTD Y Scale, Attenuation, Pre-Adjust for Min Clip
Example	:POW:RANGe:OPT:ATT COMB
Initial S/W Revision	Prior to A.02.00

(Mech) Atten Step

This controls the step size used when making adjustments to the input attenuation.

This key is labeled **Mech Atten Step** in dual attenuator models and **Atten Step** in single attenuator models. In the dual attenuator configuration, this key only affects the step size of the mechanical attenuator.

Key Path	AMPTD Y Scale, Attenuation
----------	-----------------------------------

Remote Command	<code>[:SENSe]:POWer[:RF]:ATTenuation:STEP[:INCRement] 10 dB 2 dB</code> <code>[:SENSe]:POWer[:RF]:ATTenuation:STEP[:INCRement]?</code>
Example	POW:ATT:STEP 2
Notes	Note this feature works like a 1-N choice from the front panel, but it takes a specific value (in dB) when used remotely. The only valid values are 2 and 10.
Dependencies	Blanked in CXA and EXA if option FSA (2 dB steps) is not present. If blanked, attempts to set it via SCPI will yield an error.
Couplings	When the attenuation step size changes, the current mechanical attenuation value is adjusted (if necessary) to be quantized to the new step size. That is, if step is set to 10 dB, mech atten is increased if necessary so it is a multiple of 10 dB
Preset	PXA and MXA: 2 dB EXA and CXA: 10 dB (2 dB with option FSA)
State Saved	Saved in instrument state
Initial S/W Revision	Prior to A.02.00
Modified at S/W Revision	A.03.00

Max Mixer Level

Controls the limitation on the Ref Level for a given attenuation setting, and therefore also interacts with the Auto rules for selecting the attenuation as a coupling from the reference level.

Key Path	AMPTD Y Scale, Attenuation
Remote Command	<code>[:SENSe]:POWer[:RF]:MIXer:RANGe[:UPPer] <real></code> <code>[:SENSe]:POWer[:RF]:MIXer:RANGe[:UPPer]?</code>
Example	POW:MIX:RANG -15 dBm
Preset	-10 dBm
State Saved	Saved in instrument state
Min	-50 dBm
Max	0 dBm
Default Unit	Depends on the current selected Y axis unit, see Swept SA discussion of Y Axis Unit
Initial S/W Revision	Prior to A.02.00

Scale/Div

Sets the units per division of the vertical scale in the logarithmic display. However, since the Auto Scaling is defaulted to On, this value is automatically determined by the measurement result. When you set a value manually, Auto Scaling automatically changes to Off.

Key Path	AMPTD Y Scale
Mode	SA, WCDMA, C2K, WIMAX OFDMA, TD-SCDMA, DVB-T/H, LTE, LTETDD, WLAN, MSR, LTEAFDD, LTEATDD

Remote Command	:DISPlay:SPURious:VIEW[1]:WINDow[1]:TRACe:Y[:SCALe]:PDIVision <rel_aml> :DISPlay:SPURious:VIEW[1]:WINDow[1]:TRACe:Y[:SCALe]:PDIVision?
Example	DISP:SPUR:VIEW:WIND:TRAC:Y:PDIV 10 dB DISP:SPUR:VIEW:WIND:TRAC:Y:PDIV?
Notes	You must be in the Spectrum Analysis mode, W-CDMA mode, cdma2000 mode, DVB-T/H mode, TD-SCDMA, LTE mode, LTE TDD mode, WLAN mode, MSR, LTE-Advanced FDD/TDD mode or WiMAX mode to use this command. Use INSTRument:SElect to set the mode.
Couplings	When Auto Scaling is On, this value is automatically determined by the measurement result. When you set a value manually, Auto Scaling automatically changes to Off.
Preset	10.00 dB
State Saved	Saved in instrument state.
Range	0.10 dB to 20.00 dB
Min	0.10 dB
Max	20.00 dB
Initial S/W Revision	Prior to A.02.00
Modified at S/W Revision	A.03.00

Presel Center

When this key is pressed, the centering of the preselector filter is adjusted to optimize the amplitude accuracy at the frequency of the selected marker. If the selected marker is not on when Presel Center is pressed, the analyzer will turn on the selected marker, perform a peak search, and then perform centering on the marker's center frequency. If the selected marker is already on and between the start and stop frequencies of the analyzer, the analyzer performs the preselector calibration on that marker's frequency. If the selected marker is already on, but outside the frequency range between Start Freq and Stop Freq, the analyzer will first perform a peak search, and then perform centering on the marker's center frequency.

The value displayed on the **Presel Adjust** key will change to reflect the new preselector tuning (see **Presel Adjust**).

A number of considerations should be observed to ensure proper operation. See ["Proper Preselector Operation" on page 2307](#).

Key Path	AMPTD Y Scale
Remote Command	[:SENSe] :POWer [:RF] :PCENter
Example	POW:PCEN
Notes	Note that the rules outlined above under the key description apply for the remote command as well as the key. The result of the command is dependent on marker position, and so forth. Any message shown by the key press is also shown in response to the remote command.

Dependencies	<ul style="list-style-type: none"> - Grayed out if the microwave preselector is off.) - If the selected marker's frequency is below Band 1, advisory message 0.5001 is generated and no action is taken. - Grayed out if entirely in Band 0. - Blank in models that do not include a preselector, such as option 503. If the SCPI is sent in these instruments, it is accepted without error, and the query always returns 0. - Grayed out in the Spectrogram View.
Couplings	<p>The active marker position determines where the centering will be attempted.</p> <p>If the analyzer is in a measurement such as averaging when centering is initiated, the act of centering the preselector will restart averaging but the first average trace will not be taken until the centering is completed.</p>
Status Bits/OPC dependencies	<p>When centering the preselector, *OPC will not return true until the process is complete and a subsequent measurement has completed, nor will results be returned to a READ or MEASure command.</p> <p>The Measuring bit should remain set while this command is operating and should not go false until the subsequent sweep/measurement has completed.</p>
Initial S/W Revision	Prior to A.02.00
Modified at S/W Revision	A.03.00

Proper Preselector Operation

A number of considerations should be observed to ensure proper operation:

3. If the selected marker is off, the analyzer will turn on a marker, perform a peak search, and adjust the preselector using the selected marker's frequency. It uses the "highest peak" peak search method unqualified by threshold or excursion, so that there is no chance of a 'no peak found' error. It continues with that peak, even if it is the peak of just noise. Therefore, for this operation to work properly, there should be a signal on screen in a preselected range for the peak search to find.
4. If the selected marker is already on, the analyzer will attempt the centering at that marker's frequency. There is no preselector for signals below about 3.6 GHz, therefore if the marker is on a signal below 3.6 GHz, no centering will be attempted and an advisory message generated
5. In some models, the preselector can be bypassed. If it is bypassed, no centering will be attempted in that range and a message will be generated.

Preselector Adjust

Allows you to manually adjust the preselector filter frequency to optimize its response to the signal of interest. This function is only available when "[Presel Center](#)" on page 3111 is available.

For general purpose signal analysis, using Presel Center is recommended. Centering the filter minimizes the impact of long-term preselector drift. Presel Adjust can be used instead to manually optimize the preselector. One application of manual optimization would be to peak the preselector response, which both optimizes the signal-to-noise ratio and minimizes amplitude variations due to small (short-term) preselector drifting.

Key Path	AMPTD Y Scale
Scope	Meas Global
Remote Command	[:SENSe] :POWer [:RF] :PADJust <freq> [:SENSe] :POWer [:RF] :PADJust?
Example	POW:PADJ 100kHz POW:PADJ?
Notes	The value on the key reads out to 0.1 MHz resolution.
Dependencies	<ul style="list-style-type: none"> - Grayed out if microwave preselector is off.) - Grayed out if entirely in Band 0. - Blank in models that do not include a preselector, such as option 503. If the SCPI is sent in these instruments, it is accepted without error, and the query always returns 0. - Grayed out in the Spectrogram View.
Preset	0 MHz
State Saved	The Presel Adjust value set by Presel Center , or by manually adjusting Presel Adjust , is not saved in instrument state, and does not survive a Preset or power cycle.
Min	-500 MHz
Max	500 MHz
Default Unit	Hz
Backwards Compatibility SCPI	[:SENSe] :POWer [:RF] :MW:PADJust [:SENSe] :POWer [:RF] :MMW:PADJust PSA had multiple preselectors, but the X-Series has only one. These commands simply alias to [:SENSe] :POWer [:RF] :PADJust
Initial S/W Revision	Prior to A.02.00
Modified at S/W Revision	A.03.00

Remote Command	<code>[:SENSe] :POWer [:RF] :PADJust :PRESelector MWAVE MMWave EXTERNAL</code> <code>[:SENSe] :POWer [:RF] :PADJust :PRESelector?</code>
Notes	PSA had multiple preselectors, and you could select which preselector to adjust. Since the X-Series has only one mm/uW preselector, the preselector selection softkey is no longer available. However, to provide backward compatibility, we accept the legacy remote commands. The command form has no effect, the query always returns MWAVE
Initial S/W Revision	Prior to A.02.00

Y Axis Unit

Displays the menu keys that enable you to change the vertical (Y) axis amplitude unit. The analyzer retains the entered Y Axis Unit separately for both Log and Lin amplitude scale types. For example, if Scale Type has been set to Log, and you set Y Axis Unit to dBm, pressing Scale Type (Log) sets the Y Axis Unit to dBm. If Scale Type has been set to Lin and you set Y Axis Unit to V, pressing Scale Type (Lin) sets the Y Axis Unit to V. Pressing Scale Type (Log) again sets the Y axis unit back to dBm.

NOTE

The units of current (A, dBmA, dBuA) are calculated based on 50 ohms input impedance.

All four of the EMI units (dB μ A/m, dB μ V/m, dBG, dBpT) are treated by the instrument exactly as though they were dBuV. The user must load an appropriate correction factor using Amplitude Corrections for accurate and meaningful results.

If a SCPI command is sent to the analyzer that uses one of the EMI units as a terminator, the analyzer treats it as though DBUV had been sent as the terminator.

Key Path	AMPTD Y Scale
Mode	SA
Scope	Meas Global
Remote Command	<code>:UNIT:POWer DBM DBMV DBMA V W A DBUV DBUA DBPW DBUVM DBUAM DBPT DBG</code> <code>:UNIT:POWer?</code>
Example	UNIT:POW dBmV UNIT:POW?
Notes	The Y axis unit has either logarithmic or linear characteristics. The set of units that is logarithmic consists of dBm, dBmV, dBmA, dB μ V, dB μ A, dB μ V/m, dB μ A/m, dBpT, and dBG. The set of units that are linear consists of V, W, and A. The chosen unit will determine how the reference level and all the amplitude-related outputs like trace data, marker data, etc. read out.
Notes	The settings of Y Axis Unit and Scale Type, affect how the data is read over the remote interface. When using the remote interface no unit is returned, so you must know what the Y axis unit is to interpret the results: Example 1, set the following: Scale Type (Log) Y Axis Unit, dBm Scale/Div, 1 dB Ref Level, 10 dBm

	<p>This sets the top line to 10 dBm with each vertical division representing 1 dB. Thus, if a point on trace 1 is on the fifth graticule line from the top, it represents 5 dBm and will read out remotely as 5.</p> <p>Example 2, set the following: Scale Type (Lin) Y Axis Unit, Volts Ref Level, 100 mV (10 mV/div)</p> <p>This sets the top line to 100 mV and the bottom line to 0 V, so each vertical division represents 10 mV. Thus, if a point on trace 1 is on the fifth graticule line from the top, it represents 50 mV and will read out remotely as 50.</p>
Dependencies	<p>If an amplitude correction with an Antenna Unit other than None is applied and enabled, then that antenna unit is forced and the key with that unit is the only Y Axis Unit available. All other Y Axis Unit keys are grayed out.</p> <p>If an amplitude correction with an Antenna Unit other than None is applied and enabled, and you then turn off that correction or set Apply Corrections to No, the Y Axis Unit that existed before the Antenna Unit was applied is restored.</p>
Couplings	The analyzer retains the entered Y Axis Unit separately for both Log and Lin amplitude scale types
Preset	dBm for log scale, V for linear. The true 'preset' value is dBm, since at preset the Y Scale type is set to logarithmic.
State Saved	Saved in instrument state
Readback line	1-of-N selection
Initial S/W Revision	Prior to A.02.00
Modified at S/W Revision	A.02.00, A.04.00, A.11.00

dBm

Sets the amplitude unit for the selected amplitude scale (log/lin) to dBm.

Key Path	AMPTD Y Scale, Y Axis Unit
Example	UNIT:POW DBM
Dependencies	Grayed out if an Amplitude Correction with an Antenna Unit is ON.
Readback	dBm
Initial S/W Revision	Prior to A.02.00
Modified at S/W Revision	A.02.00

dBmV

Sets the amplitude unit for the selected amplitude scale (log/lin) to dBmV.

Key Path	AMPTD Y Scale, Y Axis Unit
Example	UNIT:POW DBMV

Dependencies	Grayed out if an Amplitude Correction with an Antenna Unit is ON.
Readback	dBmV
Initial S/W Revision	Prior to A.02.00
Modified at S/W Revision	A.02.00

dBmA

Sets the amplitude unit for the selected amplitude scale (log/lin) to dBmA.

Key Path	AMPTD Y Scale, Y Axis Unit
Example	UNIT:POW DBMA
Dependencies	Grayed out if an Amplitude Correction with an Antenna Unit is ON.
Readback	dBmA
Initial S/W Revision	Prior to A.02.00
Modified at S/W Revision	A.02.00

W

Sets the amplitude unit for the selected amplitude scale (log/lin) to watt.

Key Path	AMPTD Y Scale, Y Axis Unit
Example	UNIT:POW W
Dependencies	Grayed out if an Amplitude Correction with an Antenna Unit is ON.
Readback	W
Initial S/W Revision	Prior to A.02.00
Modified at S/W Revision	A.02.00

V

Sets the amplitude unit for the selected amplitude scale (log/lin) to volt.

Key Path	AMPTD Y Scale, Y Axis Unit
Example	UNIT:POW V
Dependencies	Grayed out if an Amplitude Correction with an Antenna Unit is ON.
Readback	V
Initial S/W Revision	Prior to A.02.00
Modified at S/W Revision	A.02.00

A

Sets the amplitude unit for the selected amplitude scale (log/lin) to Ampere.

Key Path	AMPTD Y Scale, Y Axis Unit
Example	UNIT:POW A
Dependencies	Grayed out if an Amplitude Correction with an Antenna Unit is ON.
Readback	A
Initial S/W Revision	Prior to A.02.00
Modified at S/W Revision	A.02.00

dB μ V

Sets the amplitude unit for the selected amplitude scale (log/lin) to dB μ V.

Key Path	AMPTD Y Scale, Y Axis Unit
Example	UNIT:POW DBUV
Dependencies	Grayed out if an Amplitude Correction with an Antenna Unit is ON.
Readback	dB μ V
Initial S/W Revision	Prior to A.02.00
Modified at S/W Revision	A.02.00

dB μ A

Sets the amplitude unit for the selected amplitude scale (log/lin) to dB μ A.

NOTE

The unit dB μ A can also appear as an Antenna Unit. This will be used by customers using current probes, because current probes are often supplied with conversion tables that provide the transducer factors. When dB μ A is used as an Antenna Unit the normal conversion from power to amps for dB μ A (based on the analyzer input impedance) is not done, but instead the conversion is based solely on the Correction that contains the transducer factors. This is what distinguishes dB μ A as a normal unit from dB μ A as an antenna unit. When querying the Y-Axis unit, you can query the Antenna Unit to distinguish between regular dB μ A and the dB μ A antenna unit. If :CORR:CSET:ANT? returns NOC (for No Conversion), you are using a normal Y Axis dB μ A. If it returns UA you are using an Antenna Unit dB μ A.

Key Path	AMPTD Y Scale, Y Axis Unit
Example	UNIT:POW DBUA
Dependencies	Grayed out if an Amplitude Correction with an Antenna Unit is ON.
Readback	dB μ A
Initial S/W Revision	Prior to A.02.00
Modified at S/W Revision	A.02.00

Antenna Unit

When a Correction is turned on that uses an Antenna Unit, the Y Axis Unit changes to that Antenna Unit. All of the keys in the Y-Axis Unit menu are then greyed out, except the Antenna Unit key. The unit being used is shown on this key and is shown as selected in the submenu.

Key Path	AMPTD Y Scale, Y Axis Unit
Dependencies	Grayed out if no Amplitude Correction with an Antenna Unit is on.
Readback line	Currently selected unit
Initial S/W Revision	A.11.00

dB μ V/m

Sets the amplitude unit for the selected amplitude scale (log/lin) to dB μ V/m. This is an antenna unit, and this key is grayed out unless a Correction with this Antenna Unit selected is ON. If this is the case, all of the other Antenna Units are grayed out.

Key Path	AMPTD Y Scale, Y Axis Unit, Antenna Unit
Example	UNIT:POW DBUVM
Dependencies	Grayed out if no Amplitude Correction with an Antenna Unit is on.
Readback	dB μ V/m
Initial S/W Revision	A.02.00

dB μ A/m

Sets the amplitude unit for the selected amplitude scale (log/lin) to dB μ A/m. This is an antenna unit, and this key is grayed out unless a Correction with this Antenna Unit selected is ON. If this is the case, all of the other Antenna Units are grayed out.

Key Path	AMPTD Y Scale, Y Axis Unit, Antenna Unit
Example	UNIT:POW DBUAM
Dependencies	Grayed out if no Amplitude Correction with an Antenna Unit is on.
Readback	dB μ A/m
Initial S/W Revision	A.02.00

dB μ A

Sets the amplitude unit for the selected amplitude scale (log/lin) to dB μ A. This is an antenna unit, and this key is grayed out unless a Correction with this Antenna Unit selected is ON. If this is the case, all of the other Antenna Units are grayed out.

Key Path	AMPTD Y Scale, Y Axis Unit, Antenna Unit
Example	UNIT:POW DBUAM
Dependencies	Grayed out if no Amplitude Correction with an Antenna Unit is on.
Readback	dB μ A
Initial S/W Revision	A.11.00

dBpT

Sets the amplitude unit for the selected amplitude scale (log/lin) to dBpT. This is an antenna unit, and this key is grayed out unless a Correction with this Antenna Unit selected is ON. If this is the case, all of the other Antenna Units are grayed out.

Key Path	AMPTD Y Scale, Y Axis Unit, Antenna Unit
Example	UNIT:POW DBPT
Dependencies	Grayed out if no Amplitude Correction with an Antenna Unit is on.
Readback	dBpT
Initial S/W Revision	A.02.00

dBG

Sets the amplitude unit for the selected amplitude scale (log/lin) to dBG. This is an antenna unit, and this key is grayed out unless a Correction with this Antenna Unit selected is ON. If this is the case, all of the other Antenna Units are grayed out.

Key Path	AMPTD Y Scale, Y Axis Unit, Antenna Unit
Example	UNIT:POW DBG
Dependencies	Grayed out if no Amplitude Correction with an Antenna Unit is on.
Readback	dBG
Initial S/W Revision	A.02.00

None

This is selected if no Antenna Unit is currently on, however you cannot actually set this value, since it is always grayed out. The key is included simply to provide an indication on the Readback line of the Antenna Unit key when there is no Antenna Unit selected.

Key Path	AMPTD Y Scale, Y Axis Unit, Antenna Unit
Readback	"None"
Initial S/W Revision	A.11.00

Reference Level Offset

Adds an offset value to the displayed reference level. The reference level is the absolute amplitude represented by the top graticule line on the display.

See ["More Information" on page 2315](#)

Key Path	AMPTD Y Scale
Mode	SA
Scope	Meas Global
Remote Command	:DISPlay:WINDow[1]:TRACe:Y[:SCALe]:RLEVe1:OFFSet <rel_amp1>

:DISPlay:WINDow[1]:TRACe:Y[:SCALe]:RLEVel:OFFSet?	
Example	DISP:WIND:TRAC:Y:RLEV:OFFS 12.7 Sets the Ref Level Offset to 12.7 dB. The only valid suffix is dB. If no suffix is sent, dB will be assumed.
Preset	0 dBm
State Saved	Saved in instrument state
Min	The range for Ref Lvl Offset is variable. It is limited to values that keep the reference level within the range of -327.6 dB to 327.6 dB.
Max	327.6 dB
Backwards Compatibility Notes	<p>6. In pre-X-Series instruments, Ref Level Offset could not be adjusted by the knob or step keys. That is no longer the case.</p> <p>7. In ESA and PSA, Ref Level Offset was applied to the data as it was acquired; thus if the Offset changed the new offset was not applied until new trace data was taken. In X-Series, the offset is applied as the data is displayed/queried, so if you change the offset, it will change the data immediately.</p>
Initial S/W Revision	Prior to A.02.00
Modified at S/W Revision	A.04.00

More Information

Offsets are used when gain or loss occurs between a device under test and the analyzer input. Thus, the signal level measured by the analyzer may be thought of as the level at the input of an external amplitude conversion device. Entering an offset does not affect the trace position or attenuation value, just the value of the top line of the display and the values represented by the trace data. Thus, the values of exported trace data, queried trace data, marker amplitudes, trace data used in calculations such as N dB points, trace math, peak threshold, and so forth, are all affected by Ref Level Offset.

NOTE

Changing the offset causes the analyzer to immediately stop the current sweep and prepare to begin a new sweep, but the data will not change until the trace data updates, because the offset is applied to the data as it is taken. If a trace is exported with a nonzero Ref Level Offset, the exported data will contain the trace data with the offset applied.

The maximum reference level available is dependent on the reference level offset. That is, Ref Level - Ref Level Offset must be in the range -170 to +30 dBm. For example, the reference level value range can be initially set to values from -170 dBm to 30 dBm with no reference level offset. If the reference level is first set to -20 dBm, then the reference level offset can be set to values of -150 to +50 dB.

If the reference level offset is first set to -30 dB, then the reference level can be set to values of -200 dBm to 0 dBm. In this case, the reference level is “clamped” at 0 dBm because the maximum limit of +30 dBm is reached with a reference level setting of 0 dBm with an offset of -30 dB. If instead, the reference level offset is first set to 30 dB, then the reference level can be set to values of -140 to +60 dBm.

μW Path Control

The **μW Path Control** functions include the **μW Preselector Bypass** (Option MPB) and **Low Noise Path** (Option LNP) controls in the High Band path circuits.

When the μW Preselector is bypassed, the user has better flatness, but will be subject to spurs from out of band interfering signals. When the Low Noise Path is enabled, the analyzer automatically switches around certain circuitry in the high frequency bands which can contribute to noise, when it is appropriate based on other analyzer settings.

For most applications, the preset state is Standard Path, which gives the best remote-control throughput, minimizes acoustic noise from switching and minimizes the risk of wear out in the hardware switches. For applications that utilize the wideband IF paths, the preset state is the μW Preselector Bypass path, if option MPB is present. This is because, when using a wideband IF such as the 140 MHz IF, the μW Preselector's bandwidth can be narrower than the available IF bandwidth, causing degraded amplitude flatness and phase linearity, so it is desirable to bypass the preselector in the default case.

Users may choose Low Noise Path Enable. It gives a lower noise floor, especially in the 21-26.5 GHz region, though without improving many measures of dynamic range, and without giving the best possible noise floor. The preamp, if purchased and used, gives better noise floor than does the Low Noise Path, however its compression threshold and third-order intercept are much poorer than that of the non-preamp Low Noise Path. There are some applications, typically for signals around -30 dBm, for which the third-order dynamic range of the standard path is good enough, but the noise floor is not low enough even with 0 dB input attenuation. When the third-order dynamic range of the preamp path is too little and the noise floor of the standard path is too high, the Low Noise Path can provide the best dynamic range.

Key Path	AMPTD Y Scale
Mode	SA, BASIC, PNOISE, VSA , LTE, LTETDD
Scope	Meas Global
Remote Command	[:SENSe] :POWer [:RF] :MW:PATH STD LNPath MPBypass FULL [:SENSe] :POWer [:RF] :MW:PATH?
Example	:POW:MW:PATH LNP Enables the Low Noise path
Notes	If a Presel Center is performed, the analyzer will momentarily switch to the Standard Path, regardless of the setting of μW Path Control The DC Block will always be switched in when the low noise path is switched in, to protect succeeding circuitry from DC. Note that this does not mean “when the low noise path is enabled” but when, based on the Low Noise Path rules, the path is actually switched in. This can happen when the selection is Low Noise Path Enable . In the case where the DC Block is switched in the analyzer is now AC coupled. However, if the user has selected DC coupling, the UI will still behave as though it were DC coupled, including all annunciation, warnings, status bits, and responses to SCPI queries. This is because, based on other settings, the analyzer could switch out the low noise path at any time and hence go back to being DC coupled.

	Alignment switching ignores the settings in this menu, and restores them when finished.
Dependencies	Unavailable in BBIQ and External Mixing
Preset	All modes other than IQ Analyzer mode and VXA: STD IQ Analyzer, VXA and WLAN mode: MPB option present and licensed: MPB MPB option not present and licensed: STD
State Saved	Save in instrument state
Readback	Value selected in the submenu
Initial S/W Revision	A.04.00
Modified at S/W Revision	A.10.00

Standard Path

This path gives the best remote-control throughput, minimizes acoustic noise from switching and minimizes the risk of wear in the hardware switches, particularly in remote test scenarios where both low band and high band setups will follow in rapid succession.

In this path, the bypass of the low band/high band switch and microwave preamp is never activated, which can cause some noise degradation but preserves the life of the bypass switch.

Key Path	AMPTD Y Scale, μW Path Control
Example	:POW:MW:PATH STD
Readback Text	Standard Path
Initial S/W Revision	A.04.00

μ W Preselector Bypass

This key toggles the preselector bypass switch for band 1 and higher. When the microwave preselect is on, the signal path is preselected. When the microwave preselector is off, the signal path is not preselected. The preselected path is the normal path for the analyzer.

The preselector is a tunable bandpass filter which prevents signals away from the frequency of interest from combining in the mixer to generate in-band spurious signals (images). The consequences of using a preselector filter are its limited bandwidth, the amplitude and phase ripple in its passband, and any amplitude and phase instability due to center frequency drift.

Option MPB or pre-selector bypass provides an unpreselected input mixer path for certain X-Series signal analyzers with frequency ranges above 3.6 GHz. This signal path allows a wider bandwidth and less amplitude variability, which is an advantage when doing modulation analysis and broadband signal analysis. The disadvantage is that, without the preselector, image signals will be displayed. Another disadvantage of bypassing the preselector is increased LO emission levels at the front panel input port.

Image responses are separated from the real signal by twice the 1st IF. For IF Paths of 10 MHz and 25 MHz, the 1st IF is 322.5 MHz, so the image response and the real signal will be separated by 645 MHz. The 1st IF will be different for other IF Path settings. When viewing a real signal and its corresponding image response in internal mixing, the image response will be to the left of the real signal.

Also, the image response and the real signal typically have the same amplitude and exhibit the same shape factor.

However, if Option FS1, Fast Sweep Capability, is enabled, the image response in the Swept SA measurement will appear lower in amplitude and have a much wider shape factor compared to the real signal.

Key Path	AMPTD Y Scale, μW Path Control
Example	:POW:MW:PATH MPB
Dependencies	Key is blanked if current mode does not support it. Key is grayed out if mode supports it but current measurement does not support it. Key is blank unless Option MPB is present and licensed. If SCPI command sent when MPB not present, error -241, "Hardware missing; Option not installed" is generated.
Readback Text	μ W Preselector Bypass
Initial S/W Revision	A.04.00

Remote Command	[:SENSe]:POWer[:RF]:MW:PRESelector[:STATe] ON OFF 0 1 [:SENSe]:POWer[:RF]:MW:PRESelector[:STATe]?
Example	:POW:MW:PRES OFF Bypasses the microwave preselector
Notes	The ON parameter sets the STD path (:POW:MW:PATH STD) The OFF parameter sets path MPB (:POW:MW:PATH MPB)
Preset	ON

Internal Preamp

Accesses a menu of keys that control the internal preamps. Turning on the preamp gives a better noise figure, but a poorer TOI to noise floor dynamic range. You can optimize this setting for your particular measurement.

The instrument takes the preamp gain into account as it sweeps. If you sweep outside of the range of the preamp the instrument will also account for that. The displayed result will always reflect the correct gain.

For some measurements, when the preamp is on and any part of the displayed frequency range is below the lowest frequency for which the preamp has specifications, a warning condition message appears in the status line. For example ,for a preamp with a 9 kHz lowest specified frequency: "Preamp: Accy unspec'd below 9 kHz".

Key Path	AMPTD Y Scale
Scope	Meas Global
Remote Command	[:SENSe] :POWer[:RF] :GAIN[:STATe] OFF ON 0 1 [:SENSe] :POWer[:RF] :GAIN[:STATe] ?
Dependencies	Preamp is not available on all hardware platforms. If the preamp is not present or is unlicensed, the key is not shown. The preamp is not available when the electronic/soft attenuator is enabled.
Couplings	The act of connecting the U7227A USB Preamplifier to one of the analyzer's USB ports will cause the Internal Preamp to be switched on. When this happens an informational message will be generated: "Internal Preamp turned on for optimal operation with USB Preamp." Note that if the Internal Preamp was already on, there will be no change to the setting, but if it was Off it will be switched On, to Full Range. Note that this same action occurs when the SA mode is selected while the USB Preamp is connected to one of the analyzer's USB ports, if it is the first time that the SA mode has run since powerup, or if the last time the SA mode was running the USB Preamp was NOT connected. Subsequently disconnecting the USB Preamp from USB does not change the Internal Preamp setting nor restore the previous setting.
Preset	OFF
State Saved	Saved in instrument state
Initial S/W Revision	Prior to A.02.00
Modified at S/W Revision	A.14.00

Key Path	AMPTD Y Scale, Internal Preamp
Scope	Meas Global
Remote Command	[:SENSe] :POWer[:RF] :GAIN :BAND LOW FULL [:SENSe] :POWer[:RF] :GAIN :BAND ?
Dependencies	Preamp is not available on all hardware platforms. If the preamp is not present or is unlicensed, the key is not shown. If a POW:GAIN:BAND FULL command is sent when a low band preamp is available, the preamp band parameter is to LOW instead of FULL, and an "Option not installed" message is generated.
Preset	LOW
State Saved	Saved in instrument state
Initial S/W Revision	Prior to A.02.00

Off

Turns the internal preamp off

Key Path	AMPTD Y Scale, Internal Preamp
Example	:POW:GAIN OFF

Readback	Off
Initial S/W Revision	Prior to A.02.00

Low Band

Sets the internal preamp to use only the low band.

The frequency range of the installed (optional) low-band preamp is displayed in square brackets on the **Low Band** key label.

Key Path	AMPTD Y Scale, Internal Preamp
Example	:POW:GAIN ON :POW:GAIN:BAND LOW
Readback	Low Band
Initial S/W Revision	Prior to A.02.00

Full Range

Sets the internal preamp to use its full range. The low band (0-3.6 GHz or 0-3GHz, depending on the model) is supplied by the low band preamp and the frequencies above low band are supplied by the high band preamp.

The frequency range of the installed (optional) preamp is displayed in square brackets on the **Full Range** key label. If the high band option is not installed the Full Range key does not appear.

Key Path	AMPTD Y Scale, Internal Preamp
Example	:POW:GAIN ON :POW:GAIN:BAND FULL
Readback	Full Range
Initial S/W Revision	Prior to A.02.00

Auto Scaling

Toggles the Auto Scaling function between On and Off.

Key Path	AMPTD Y Scale
Mode	SA, WCDMA, C2K, WIMAX OFDMA, TD-SCDMA, DVB-T/H, LTE, LTETDD, WLAN, MSR, LTEAFDD, LTEATDD
Remote Command	:DISPlay:SPURious:VIEW[1]:WINDow[1]:TRACe:Y[:SCALE]:COUPle 0 1 OFF ON :DISPlay:SPURious:VIEW[1]:WINDow[1]:TRACe:Y[:SCALE]:COUPle?
Example	DISP:SPUR:VIEW:WIND:TRAC:Y:COUP OFF DISP:SPUR:VIEW:WIND:TRAC:Y:COUP?
Couplings	When Auto Scaling is On and the Restart front-panel key is pressed, this function automatically determines the scale per division and reference values based on the measurement results.

When you set a value to either Scale/Div or Ref Value manually, Auto Scaling automatically changes to Off.

When the Y Auto Scaling is off, the measurement uses the current reference level settings. When the Y Auto Scaling is on, the analyzer automatically sets the reference level such that the absolute limit is positioned two divisions down from the top of the display. This is the most useful setting when searching for spurs. The algorithm used for determining the ref level is $\text{Ref Level} = \text{Absolute Limit} + (2 * \text{Scale/Div})$. All other reference level settings are left as the current base instrument settings.

Preset	1
State Saved	Saved in instrument state.
Range	On Off
Backwards Compatibility SCPI	[:SENSe] : SPURious : POWer [: RF] : RANGe : AUTO
Initial S/W Revision	Prior to A.02.00
Modified at S/W Revision	A.03.00

Auto Couple

The Auto Couple feature provides a quick and convenient way to automatically couple multiple instrument settings. This helps ensure accurate measurements and optimum dynamic range. When the Auto Couple feature is activated, either from the front panel or remotely, all parameters of the current measurement that have an Auto/Manual mode are set to Auto mode and all measurement settings dependent on (or coupled to) the Auto/Man parameters are automatically adjusted for optimal performance.

However, the Auto Couple key actions are confined to the current measurement only. It does not affect other measurements in the mode, and it does not affect markers, marker functions, or trace or display attributes.

See "[More Information](#)" on page 2322

Key Path	Front-panel key
Remote Command	:COUPlE ALL NONE
Example	:COUP ALL
Notes	:COUPlE ALL puts all Auto/Man parameters in Auto mode (equivalent to pressing the Auto Couple key). :COUPLE NONE puts all Auto/Man parameters in manual mode. It decouples all the coupled instrument parameters and is not recommended for making measurements.
Initial S/W Revision	Prior to A.02.00

More Information

There are two types of functions that have Auto/Manual modes.

Auto/Man Active Function keys

An Auto/Man toggle key controls the binary state associated with an instrument parameter by toggling between **Auto** (where the parameter is automatically coupled to the other parameters it is dependent upon) and **Man** (where the parameter is controlled independent of the other parameters), as well as making the parameter the active function. The current mode is indicated on the softkey with either **Auto** or **Man** underlined as illustrated below.

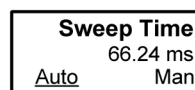

vsd07

Auto/Man 1-of-N keys

An Auto/Man 1-of-N key allows you to manually pick from a list of parameter values, or place the function in Auto, in which case the value is automatically selected (and indicated).

- If in Auto, Auto is underlined on the calling key.

- If in manual operation, manual is indicated on the calling key, but note that the calling key simply opens the menu and does **not** actually toggle the function.

BW

BW is unavailable in the Spurious Emissions measurement. When pressed, this key displays a blank menu.

Key Path	Front-panel key
Initial S/W Revision	Prior to A.02.00

Cont (Continuous Measurement/Sweep)

Sets the analyzer for Continuous measurement operation. The single/continuous state is Meas Global so the setting will affect all measurements. If you are Paused, pressing **Cont** does a Resume.

Key Path	Front-panel key
Remote Command	:INITiate:CONTinuous OFF ON 0 1 :INITiate:CONTinuous?
Example	:INIT:CONT 0 puts analyzer in Single measurement operation. :INIT:CONT 1 puts analyzer in Continuous measurement operation
Preset	ON (Note that SYST:PRESet sets INIT:CONT to ON but *RST sets INIT:CONT to OFF)
State Saved	Saved in instrument state
Backwards Compatibility Notes	For Spectrum Analysis mode in ESA and PSA, there is no Cont hardkey, instead there is a Sweep Single/Cont key. In these analyzers, switching the Sweep Single/Cont key from Single to Cont restarts averages (displayed average count reset to 1), but does not restart Max Hold and Min Hold . The X-Series has Single and Cont keys in place of the SweepSingleCont key. In the X-Series, if in single measurement, the Cont key (and INIT:CONT ON) switches to continuous measurement, but never restarts a measurement and never resets a sweep.
Initial S/W Revision	Prior to A.02.00

In Swept SA Measurement (Spectrum Analysis Mode):

The analyzer takes repetitive sweeps, averages, measurements, etc., when in Continuous mode. When the average count reaches the Average/Hold Number the count stops incrementing, but the analyzer keeps sweeping. See the Trace/Detector section for the averaging formula used both before and after the Average/Hold Number is reached. The trigger condition must be met prior to each sweep. The type of trace processing for multiple sweeps, is set under the Trace/Detector key, with choices of **Trace Average**, **Max Hold**, or **Min Hold**.

In Other Measurements/Modes:

With **Avg/Hold Num** (in the **Meas Setup** menu) set to **Off** or set to **On** with a value of 1, a sweep is taken after the trigger condition is met; and the analyzer continues to take new sweeps after the current sweep has completed and the trigger condition is again met. However, with **Avg/Hold Num** set to On with a value >1, multiple sweeps (data acquisitions) are taken for the measurement. The trigger condition must be met prior to each sweep. The sweep is not stopped when the average count k equals the number N set for Avg/Hold Num is reached, but the number k stops incrementing. A measurement average usually applies to all traces, marker results, and numeric results. But sometimes it only applies to the numeric results.

If the analyzer is in Single measurement, pressing the **Cont** key does not change k and does not cause the sweep to be reset; the only action is to put the analyzer into Continuous measurement operation.

If it is already in continuous sweep:

the INIT:CONT 1 command has no effect

the INIT:CONT 0 command will place the analyzer in Single Sweep but will have no effect on the current sequence until $k = N$, at which point the current sequence will stop and the instrument will go to the idle state.

File

See "File" on page 426

FREQ Channel

Accesses a menu of keys that allow you to control the Frequency and Channel parameters of the instrument.

Some features in the Frequency menu are the same for all measurements – they do not change as you change measurements. Settings like these are called “Meas Global” and are unaffected by Meas Preset. For example, the Center Freq setting is the same for all measurements – it does not change as you change measurements.

Key Path	Front-panel key
Initial S/W Revision	Prior to A.02.00

Center Freq

Sets the frequency that corresponds to the horizontal center of the graticule (when frequency Scale Type is set to linear). While adjusting the Center Frequency the Span is held constant, which means that both Start Frequency and Stop Frequency will change.

Pressing Center Freq also sets the frequency entry mode to Center/Span. In Center/Span mode, the center frequency and span values are displayed below the graticule, and the default active function in the Frequency menu is **Center Freq**.

The center frequency setting is the same for all measurements within a mode, that is, it is Meas Global. Some modes are also able to share a Mode Global center frequency value. If this is the case, the Mode will have a **Global Settings** key in its **Mode Setup** menu.

The **Center Freq** function sets (and queries) the Center Frequency for the currently selected input. If your analyzer has multiple inputs, and you select another input, the Center Freq changes to the value for that input. SCPI commands are available to directly set the Center Freq for a specific input.

Center Freq is remembered as you go from input to input. Thus you can set a Center Freq of 10 GHz with the RF Input selected, change to BBIQ and set a Center Freq of 20 MHz, then switch to External Mixing and set a Center Freq of 60 GHz, and when you go back to the RF Input the Center Freq will go back to 10 GHz; back to BBIQ and it is 20 MHz; back to External Mixing and it is 60 GHz.

See ["RF Center Freq" on page 2332](#)

See [Ext Mix Center Freq](#)

See ["I/Q Center Freq" on page 2333](#)

See ["Center Frequency Presets" on page 2329](#)

Key Path	FREQ Channel
Scope	Meas Global
Remote Command	[:SENSE] :FREQuency:CENTer <freq>

[:SENSe] :FREQuency :CENTer ?	
Example	FREQ:CENT 50 MHz FREQ:CENT UP changes the center frequency to 150 MHz if you use FREQ:CENT:STEP 100 MHz to set the center frequency step size to 100 MHz FREQ:CENT?
Notes	This command sets either the RF or I/Q Center Frequency depending on the selected input. For RF input it is equivalent to FREQ:RF:CENT For I/Q input it is equivalent to FREQ:IQ:CENT Preset and Max values are dependent on Hardware Options (5xx) If no terminator (e.g. MHz) is sent the terminator Hz is used. If a terminator with unit other than Frequency is used, an invalid suffix error message is generated.
Dependencies	The Center Frequency can be limited by Start or Stop Freq limits, if the Span is so large that Start or Stop reach their limit.
Couplings	When operating in "swept span", any value of the Center Frequency or Span that is within the frequency range of the analyzer is allowed when the value is being set through the front panel numeric key pad or the SCPI command. The other parameter is forced to a different value if needed, to keep the Start and the Stop Frequencies within the analyzer's frequency range
Preset	Depends on instrument maximum frequency, mode, measurement, and selected input. See "Center Frequency Presets" on page 2329 and "RF Center Freq" on page 2332 and Ext Mix Center Freq and "I/Q Center Freq" on page 2333 .
State Saved	Saved in instrument state
Min	Depends on instrument maximum frequency, mode, measurement, and selected input.. See "Center Frequency Presets" on page 2329 and "RF Center Freq" on page 2332 and "I/Q Center Freq" on page 2333 .
Max	Depends on instrument maximum frequency, mode, measurement, and selected input.. See "Center Frequency Presets" on page 2329 and "RF Center Freq" on page 2332 and "I/Q Center Freq" on page 2333 .
Default Unit	Hz
Status Bits/OPC Dependencies	Non-overlapped
Initial S/W Revision	Prior to A.02.00

Center Frequency Presets

The following table provides the Center Frequency Presets for the Spectrum Analyzer mode, and the Max Freq, for the various frequency options:

Freq Option	CF after Mode Preset	Stop Freq after Mode Preset	Max Freq (can't tune above)
503 (all but N9000A)		1.805 GHz	3.6 GHz 3.7 GHz

Freq Option	CF after Mode Preset	Stop Freq after Mode Preset	Max Freq (can't tune above)	
503 (N9000A)		1.505 GHz	3.0 GHz	3.08 GHz
504 (M9420A)		1 GHz	3.8GHz	3.88 GHz
506 (M9420A)		1 GHz	6.0GHz	6.08 GHz
507 (all but N9000A)		3.505 GHz	7.0 GHz	7.1 GHz
507 (N9000A)		3.755 GHz	7.5 GHz	7.58 GHz
508 (all but N9038A)		1.805 GHz	3.6 GHz	8.5 GHz
508 (N9038A)		4.205 GHz	8.4 GHz	8.5 GHz
513		6.805 GHz	13.6 GHz	13.8 GHz
526 (all but N9000A and N9038A)		13.255 GHz	26.5 GHz	27.0 GHz
526 (N9000A)		13.255 GHz	26.5 GHz	26.5 5 GHz
526 (N9038A)		1.805 GHz	3.6 GHz	27.0 GHz
532	16.005 GHz		32.0 GHz	32.5 GHz
543	21.505 GHz		43.0 GHz	TBD
544	22.005 GHz		44.0 GHz	44.5 GHz
550	25.005 GHz		50.0 GHz	51 GHz

Input 2:

Model	CF after Mode Preset	Stop Freq after Mode Preset	Max Freq (can't tune above)
N9000A opt C75	0.7505GHz	1.5 GHz	1.58 GHz
N9038A	505 MHz	1 GHz	1.000025 GHz

Tracking Generator Frequency Limits (N9000A only):

Tracking Generator Option	Min Freq (clips to this freq when turn TG on and can't tune below while TG on)	If above this Freq, Stop Freq clipped to this Freq when TG turned on	Max Freq (can't tune above) while TG on
T03	9 kHz	3.0 GHz	3.08 GHz
T06	9 kHz	6.0 GHz	6.05 GHz

Tracking Generator Frequency Limits(M9290A only):

Tracking Generator Option	Min Freq (clips to this freq when turn TG on and can't tune below while TG on)	If above this Freq, Stop Freq clipped to this Freq when TG turned on	Max Freq (can't tune above) while TG on
T03	2 MHz	3.08 GHz	3.08 GHz
T07	2 MHz	7.575 GHz	7.575 GHz
T13	2 MHz	13.8 GHz	13.8 GHz
T26	2 MHz	26.55 GHz	26.55 GHz

The following table shows the Center Frequency Presets for modes other than Spectrum Analyzer:

Mode	CF Preset for RF
WCDMA	1 GHz
WIMAXOFDMA,	1 GHz
BASIC	1 GHz
ADEMOD	1 GHz
VSA	1 GHz
TDSCDMA	1 GHz
PNOISE	1 GHz

Mode	CF Preset for RF
LTE	1 GHz
LTETDD	1 GHz
MSR	1 GHz
GSM	935.2 MHz
NFIGURE	1.505 GHz

RF Center Freq

SCPI command for specifying the RF Center Frequency. This command will set the Center Frequency to be used when the RF input is selected, even if the RF input is not the input that is selected at the time the command is sent. Note that the **Center Freq** function in the **Frequency** menu on the front panel always applies to the currently selected input.

Scope	Meas Global
Remote Command	[:SENSe] :FREQuency:RF:CENTer <freq> [:SENSe] :FREQuency:RF:CENTer?
Example	FREQ:RF:CENT 30 MHz
Notes	This command is the same in all modes, but the parameter is Measurement Global. So the value is independent in each mode and common across all the measurements in the mode.
Dependencies	If the electronic/soft attenuator is enabled, any attempt to set Center Frequency such that the Stop Frequency would be >3.6 GHz fails and results in an advisory message. If the equivalent SCPI command is sent, this same message is generated as part of a “-221, Settings conflict” warning. If Source Mode is set to Tracking, and the Max or Min Center Freq is therefore limited by the limits of the source, a warning message is generated, “Data out of range;clipped to source max/min” if these limits are exceeded. Note that for an external source, these limits can be affected by the settings of Source Numerator, Source Denominator and Power Sweep.
Preset	See table above
State Saved	Saved in instrument state.
Min	-79.999995 MHz, unless Source Mode is set to Tracking, in which case it is limited by the minimum frequency of the Source
Max	See table above. Basically instrument maximum frequency - 5 Hz. Note that, if the Source Mode is set to Tracking, the effective instrument maximum frequency may be limited by the source maximum frequency. If the knob or step keys are being used, also depends on the value of the other three interdependent parameters Span, Start Frequency and Stop Frequency
Initial S/W Revision	Prior to A.02.00
Modified at S/W Revision	A.03.00

Ext Mix Center Freq

SCPI command for specifying the External Mixer Center Frequency. This command will set the Center Frequency to be used when the External Mixer is selected, even if the External Mixer input is not the input which is selected at the time the command is sent. Note that the **Center Freq** function in the **Frequency** menu on the front panel always applies to the currently selected input.

Scope	Meas Global
Remote Command	[:SENSe] :FREQuency:EMIXer:CENTer <freq> [:SENSe] :FREQuency:EMIXer:CENTer?
Example	:FREQ:EMIX:CENT 60 GHz :FREQ:EMIX:CENT?
Notes	This command is the same in all modes, but the parameter is Measurement Global. So the value is independent in each mode and common across all the measurements in the mode.
Couplings	When returning to External Mixing after having been switched to one of the other inputs (e.g., RF), you will come back into the settings that you had when you left External Mixing. So you will come back to the band you were in with the Center Frequency that you had. However, Span is not an input-dependent parameter, therefore you will bring the span over from the other input. Therefore, the analyzer comes back with the span from the previous input, limited as necessary by the current mixer setup.
Preset	When a Mode Preset is performed while in External Mixing, the Start frequency of the current Mode is set to the nominal Min Freq of the lowest harmonic range in the Harmonic Table for the current mixer setup. Similarly, the Stop frequency of the current Mode is set to the nominal Max Freq of the highest harmonic range in the Harmonic Table. The Center Freq thus presets to the point arithmetically equidistant from these two frequencies. If the current measurement has a limited Span available to it, and cannot achieve the Span shown in the table (Span=Stop Freq – Start Freq), the analyzer uses the maximum Span the measurement allows, and still sets the Center Freq to the midpoint of the Start and Stop Freq values in the Harmonic Table. When Restore Input/Output Defaults is performed, the mixer presets to the 11970A, whose Start and Stop frequencies are 26.5 and 40 GHz respectively. The center of these two frequencies is 33.25 GHz. Therefore, after a Restore Input/Output Defaults, if you go into External Mixing and do a Mode Preset while in the Spectrum Analyzer Mode, the resulting Center Freq is 33.25 GHz.
State Saved	Saved in instrument state.
Min	The minimum frequency in the currently selected mixer band + 5 Hz
Max	The maximum frequency in the currently selected mixer band - 5 Hz If the knob or step keys are being used, also depends on the value of the other three interdependent parameters Span, Start Frequency and Stop Frequency
Initial S/W Revision	A.08.01

I/Q Center Freq

SCPI command for specifying the I/Q Center Frequency. This command will set the Center Frequency to be used when the I/Q input is selected, even if the I/Q input is not the input which is selected at the time the command is sent. Note that the

Center Freq function in the **Frequency** menu on the front panel always applies to the currently selected input.

Scope	Meas Global
Remote Command	[:SENSe] :FREQuency:IQ:CENTer <freq> [:SENSe] :FREQuency:IQ:CENTer?
Example	FREQ:IQ:CENT: 30 MHz
Notes	This command is the same in all modes, but the parameter is Measurement Global. So the value is independent in each mode and common across all the measurements in the mode.
Preset	0 Hz
State Saved	Saved in instrument state.
Min	-40.049995 MHz
Max	40.049995 MHz
Initial S/W Revision	Prior to A.02.00

CF Step

Changes the step size for the center frequency and start and stop frequency functions. Once a step size has been selected and the center frequency function is active, the step keys (and the UP|DOWN parameters for Center Frequency from remote commands) change the center frequency by the step-size value. The step size function is useful for finding harmonics and sidebands beyond the current frequency span of the analyzer.

Note that the start and stop frequencies also step by the CF Step value.

Key Path	FREQ Channel
Remote Command	[:SENSe] :FREQuency:CENTer:STEP [:INCRement] <freq> [:SENSe] :FREQuency:CENTer:STEP [:INCRement] ? [:SENSe] :FREQuency:CENTer:STEP:AUTO OFF ON 0 1 [:SENSe] :FREQuency:CENTer:STEP:AUTO?
Example	FREQ:CENT:STEP:AUTO ON FREQ:CENT:STEP 500 MHz FREQ:CENT UP increases the current center frequency value by 500 MHz FREQ:CENT:STEP? FREQ:CENT:STEP:AUTO?
Notes	Preset and Max values are depending on Hardware Options (503, 507, 508, 513, 526)
Notes	Preset and Max values are dependent on Hardware Options (5xx)
Dependencies	Freq Offset is not available in External Mixing. In this case the Freq Offset key is grayed out and shows a value of zero. It will once again be available, and show the previously set value, when you return to the RF Input.
Dependencies	Span, RBW, Center frequency If the electronic/soft attenuator is enabled, any attempt to change the value of the center

	frequency >3.6 GHz by pressing the Up-arrow key, fails and results in an advisory message. If the equivalent SCPI command is sent, this same message is generated as part of a “-221, Settings conflict” warning.
Couplings	When auto-coupled in a non-zero span, the center frequency step size is set to 10% of the span. When auto-coupled in zero span, the center frequency step size is set to the equivalent -3 dB RBW value.
Preset	Auto ADEM0D: 1 MHz ON
State Saved	Saved in instrument state
Min	– (the maximum frequency of the instrument). That is, 27 GHz max freq instrument has a CF step range of +/- 27 GHz. Note that this is the maximum frequency given the current settings of the instrument, so in External Mixing, for example, it is the maximum frequency of the current mixer band.
Max	The maximum frequency of the instrument. That is, 27 GHz max freq instrument has a CF step range of +/- 27 GHz. Note that this is the maximum frequency given the current settings of the instrument, so in External Mixing, for example, it is the maximum frequency of the current mixer band.
Default Unit	Hz
Status Bits/OPC dependencies	non-overlapped
Initial S/W Revision	Prior to A.02.00
Modified at S/W Revision	A.03.00

Freq Offset

Enables you to set a frequency offset value to account for frequency conversions outside of the analyzer. This value is added to the display readout of the marker frequency, center frequency, start frequency, stop frequency, and all other absolute frequency settings in the analyzer including frequency count. When a frequency offset is entered, the value appears below the center of the graticule. To eliminate an offset, perform a Mode Preset or set the frequency offset to 0 Hz.

See ["More Information" on page 2336](#).

Key Path	FREQ Channel
Scope	Meas Global
Remote Command	[:SENSe] :FREQuency:OFFSet <freq> [:SENSe] :FREQuency:OFFSet?
Example	FREQ:OFFS 10 MHz
Notes	Preset and Max values are dependent on Hardware Options (503, 507, 508, 513, 526)
Dependencies	Freq Offset is not available in External Mixing. In this case the Freq Offset key is grayed out and shows a value of zero. However, the value of CF Offset that was set for the RF Input is retained and restored when the user switches back to the RF Input.

Preset	See " Center Frequency Presets " on page 2932
State Saved	Saved in instrument state
Min	-500 GHz
Max	500 GHz
Default Unit	Hz
Status Bits/OPC dependencies	Non-overlapped
Backwards Compatibility SCPI	DISPlay:WINDow[1]:TRACe:X[:SCALE]:OFFSet
	The DISPlay version of the command is in the instrument for compatibility across platforms and is not recommended for new development.
Backwards Compatibility Notes	<ol style="list-style-type: none"> 1. In pre-X-Series instruments, Frequency Offset could not be adjusted by the knob or step keys. That is no longer the case. 2. Some previous spectrum analyzers did not adjust frequency counter results for the Frequency Offset. The X-Series does adjust the frequency counter for the offset.
Initial S/W Revision	Prior to A.02.00
Modified at S/W Revision	A.04.00, A.08.50

More Information

This command does not affect any bandwidths or the settings of relative frequency parameters such as delta markers or span. It does not affect the current hardware settings of the analyzer, but only the displayed frequency values. Entering an offset does not affect the trace position or display, just the value of the start and stop frequency and the values represented by the trace data. The frequency values of exported trace data, queried trace data, markers, trace data used in calculations such as N dB points, trace math, etc., are all affected by Freq Offset. Changing the offset, even on a trace that is not updating will immediately change all of the above, without taking new data.

NOTE

If a trace is exported with a nonzero Freq Offset, the exported data will contain the trace data with the offset applied. Therefore, if that trace were to be imported back into the analyzer, you would want Freq Offset to be 0, or the offset would be applied again to data which is already offset. No such care need be taken when saving a State+Trace file because the data and state are saved together.

Input/Output

See ["Input/Output" on page 241](#)

Marker

Displays the menu keys that enable you to select, set up and control the markers for the current measurement.

Key Path	Front-panel key
Initial S/W Revision	Prior to A.02.00

Select Marker

Displays 12 markers available for selection.

Key Path	Marker
Initial S/W Revision	Prior to A.02.00

Marker Type

Sets the marker control mode to **Normal**, **Delta** and **Off**. Normal enables you to activate the selected marker to read the power level and time. Delta enables you to read the differences in the power levels and time scales between the selected marker and the next marker. Off enables you to turn off the selected marker.

All interactions and dependencies detailed under the key description are enforced when the remote command is sent.

Key Path	Marker
Mode	SA, WCDMA, C2K, WIMAX OFDMA, TD-SCDMA, 1xEV-DO, DVB-T/H, LTE, LTETDD, WLAN, MSR, LTEAFDD, LTEATDD
Remote Command	:CALCulate:SPURious:MARKer[1] 2 ... 12:MODE POSition DELTa OFF :CALCulate:SPURious:MARKer[1] 2 ... 12:MODE?
Example	CALC:SPUR:MARK:MODE POS CALC:SPUR:MARK:MODE?
Notes	If the selected marker is Off, pressing Marker sets it to Normal and places it at the center of the screen on the trace determined by the Marker Trace rules. At the same time, Marker X Axis Value appears on the Active Function area. Default Active Function: the active function for the selected marker's current control mode. If the current control mode is Off, there is no active function and the active function is turned off. Active Function Display: the marker X axis value entered in the active function area will display the marker value to its full entered precision.
Preset	OFF
State Saved	Saved in instrument state.
Range	Normal Delta Off
Initial S/W Revision	Prior to A.02.00
Modified at S/W Revision	A.03.00

Properties

Accesses the Properties menu to set certain properties of the selected marker.

Key Path	Marker
Initial S/W Revision	Prior to A.02.00

Select Marker

Displays 12 markers available for selection.

Key Path	Marker
Initial S/W Revision	Prior to A.02.00

Relative To

Selects the marker the selected marker will be relative to (its reference marker).

Every marker has another marker to which it is relative. This marker is referred to as the "reference marker" for that marker. This attribute is set by the **Marker, Properties, Relative To** key. The marker must be a **Delta** marker to make this attribute relevant. If it is a **Delta** marker, the reference marker determines how the marker is controlled and how its value is displayed. A marker cannot be relative to itself.

Key Path	Marker, Properties
Mode	SA, WCDMA, C2K, WIMAX OFDMA, TD-SCDMA, 1xEV-DO, DVB-T/H, LTE, LTETDD, WLAN, MSR, LTEAFDD, LTEATDD
Remote Command	:CALCulate:SPURious:MARKer[1] 2 ... 12:REFerence <integer> :CALCulate:SPURious:MARKer[1] 2 ... 12:REFerence?
Example	CALC:SPUR:MARK3:REF 5 CALC:SPUR:MARK:REF?
Notes	A marker cannot be relative to itself so that choice is grayed out, and if sent from SCPI generates error -221: "Settings conflict; marker cannot be relative to itself." When queried a single value will be returned (the specified marker numbers relative marker).
Preset	2 3 4 5 6 7 8 9 10 11 12 1
State Saved	Saved in instrument state.
Min	1
Max	12
Initial S/W Revision	Prior to A.02.00
Modified at S/W Revision	A.03.00

Couple Markers

When this function is true, moving any marker causes an equal X Axis movement of every other marker which is not **Off**. By "equal X Axis movement" we mean that we

preserve the difference between each marker's X Axis value (in the fundamental x-axis units of the trace that marker is on) and the X Axis value of the marker being moved (in the same fundamental x-axis units).

Key Path	Marker
Mode	SA, WCDMA, C2K, WIMAX OFDMA, TD-SCDMA, 1xEV-DO, DVB-T/H, LTE, LTETDD, WLAN, MSR, LTEAFDD, LTEATDD
Remote Command	:CALCulate:SPURious:MARKer:COUPlE[:STATe] ON OFF 1 0 :CALCulate:SPURious:MARKer:COUPlE[:STATe]?
Example	CALC:SPUR:MARK:COUP ON CALC:SPUR:MARK:COUP?
Preset	OFF
State Saved	Saved in instrument state.
Range	On Off
Initial S/W Revision	Prior to A.02.00
Modified at S/W Revision	A.03.00

All Markers Off

Turns off all markers.

Key Path	Marker
Mode	SA, WCDMA, C2K, WIMAX OFDMA, TD-SCDMA, 1xEV-DO, DVB-T/H, LTE, LTETDD, WLAN, MSR, LTEAFDD, LTEATDD
Remote Command	:CALCulate:SPURious:MARKer:AOff
Example	CALC:SPUR:MARK:AOff
Initial S/W Revision	Prior to A.02.00
Modified at S/W Revision	A.03.00

Marker X Axis Value (Remote Command only)

Sets the Marker X Axis value in the current marker X Axis Scale unit. It has no effect if the control mode is **Off**, but is the SCPI equivalent of entering an X value if the control mode is **Normal** or **Delta**.

Mode	SA, WCDMA, C2K, WIMAX OFDMA, TD-SCDMA, DVB-T/H, LTE, LTETDD, WLAN, MSR, LTEAFDD, LTEATDD
Remote Command	:CALCulate:SPURious:MARKer[1] 2 ... 12:X <freq> :CALCulate:SPURious:MARKer[1] 2 ... 12:X?
Example	CALC:SPUR:MARK2:X 25 kHz CALC:SPUR:MARK3:X?
Notes	If no suffix is sent it will use the fundamental units for the current marker X Axis Scale. If a suffix is

	sent that does not match the current marker X Axis Scale unit, an error “Invalid suffix” will be generated. The query returns the absolute X Axis marker value if the control mode is Normal, or the offset from the reference marker if the control mode is Delta. The query is returned in the fundamental units for the current marker X Axis scale: Hz for Frequency and Inverse Time, seconds for Period and Time. If the marker is Off, the response is not a number.
Preset	1 GHz
State Saved	No
Min	-9.9E+37
Max	9.9E+37
Initial S/W Revision	Prior to A.02.00
Modified at S/W Revision	A.03.00

Marker X Axis Position (Remote Command only)

Sets the Marker X position in trace points. It has no effect if the control mode is **Off**, but is the SCPI equivalent of entering a value if the control mode is **Normal** or **Delta** – except in trace points rather than X Axis Scale units. The entered value is immediately translated into the current X Axis Scale units for setting the value of the marker.

Mode	SA, WCDMA, C2K, WIMAX OFDMA, TD-SCDMA, 1xEV-DO, DVB-T/H, LTE, LTETDD, WLAN, MSR, LTEAFDD, LTEATDD
Remote Command	:CALCulate:SPURious:MARKer[1] 2 ... 12:X:POsition <integer> :CALCulate:SPURious:MARKer[1] 2 ... 12:X:POsition?
Example	CALC:SPUR:MARK10:X:POS 300 CALC:SPUR:MARK10:X:POS?
Notes	The query returns the absolute X Axis marker value in trace points if the control mode is Normal , or the offset from the reference marker in trace points if the control mode is Delta . The value is returned as a real number, not an integer, corresponding to the translation from X Axis Scale units to trace points. If the marker is Off the response is not a number.
Preset	300
State Saved	No
Min	-9.9E+37
Max	9.9E+37
Initial S/W Revision	Prior to A.02.00
Modified at S/W Revision	A.03.00

Marker Y Axis Value (Remote Command only)

Returns the marker Y Axis value in the current marker Y Axis unit.

Mode	SA, WCDMA, C2K, WIMAX OFDMA, TD-SCDMA, 1xEV-DO, DVB-T/H, LTE, LTETDD, WLAN, MSR, LTEAFDD, LTEATDD
Remote Command	:CALCulate:SPURious:MARKer[1] 2 ... 12:Y?
Example	CALC:SPUR:MARK11:Y?
Notes	If no suffix is sent, it will use the current Y Axis unit. If a suffix is sent that does not have units of absolute amplitude, an error "Invalid suffix" will be generated.
Preset	Depends on Y axis range of selected Trace.
State Saved	No
Initial S/W Revision	Prior to A.02.00
Modified at S/W Revision	A.03.00

Backward Compatibility SCPI Commands

Sets or queries the state of a marker. Setting a marker which is OFF to state ON or 1 puts it in Normal mode and places it at the center of the screen.

Key Path	SCPI Only
Mode	SA, WCDMA, CDMA2K, WIMAX OFDMA, TDSCDMA, CDMA1XEV, DVB, LTE, LTETDD, WLAN, MSR, LTEAFDD, LTEATDD
Remote Command	:CALCulate:SPURious:MARKer[1] 2 ... 12:STATE OFF ON 0 1 :CALCulate:SPURious:MARKer[1] 2 ... 12:STATE?
Example	CALC:SPUR:MARK3:STAT 1 CALC:SPUR:MARK3:STAT?
Preset	OFF
State Saved	Saved in instrument state.
Initial S/W Revision	Prior to A.02.00
Modified at S/W Revision	A.03.00

Marker Function

There are no 'Marker Functions' supported in Spurious Emissions so this front-panel key displays a blank menu when pressed.

Key Path	Front-panel key
Initial S/W Revision	Prior to A.02.00

Marker To

There is no 'Marker To' functionality supported in Spurious Emissions, so this front-panel key displays a blank menu when pressed.

Key Path	Front-panel key
Initial S/W Revision	Prior to A.02.00

Meas

The information in this section is common to all measurements. For key and remote command information for a specific measurement, refer to the section that describes the measurement of interest.

Measurements available under the Meas key are specific to the current Mode.

When viewing Help for measurements, note the following:

NOTE

Operation for some keys differs between measurements. The information displayed in Help pertains to the current measurement. To see how a key operates in a different measurement, exit Help (press the Cancel Esc key), select the measurement, then reenter Help (press the Help key) and press that key.

Key Path	Front-panel key
Initial S/W Revision	Prior to A.02.00

Remote Measurement Functions

This section contains the following topics:

["Measurement Group of Commands" on page 3141](#)

["Current Measurement Query \(Remote Command Only\)" on page 3144](#)

["Limit Test Current Results \(Remote Command Only\)" on page 3144](#)

["Data Query \(Remote Command Only\)" on page 3144](#)

["Calculate/Compress Trace Data Query \(Remote Command Only\)" on page 3144](#)

["Calculate Peaks of Trace Data \(Remote Command Only\)" on page 3150](#)

["Hardware-Accelerated Fast Power Measurement \(Remote Command Only\)" on page 3151](#)

["Format Data: Numeric Data \(Remote Command Only\)" on page 3165](#)

["Format Data: Byte Order \(Remote Command Only\)" on page 3166](#)

Initial S/W Revision	Prior to A.02.00
----------------------	------------------

Measurement Group of Commands

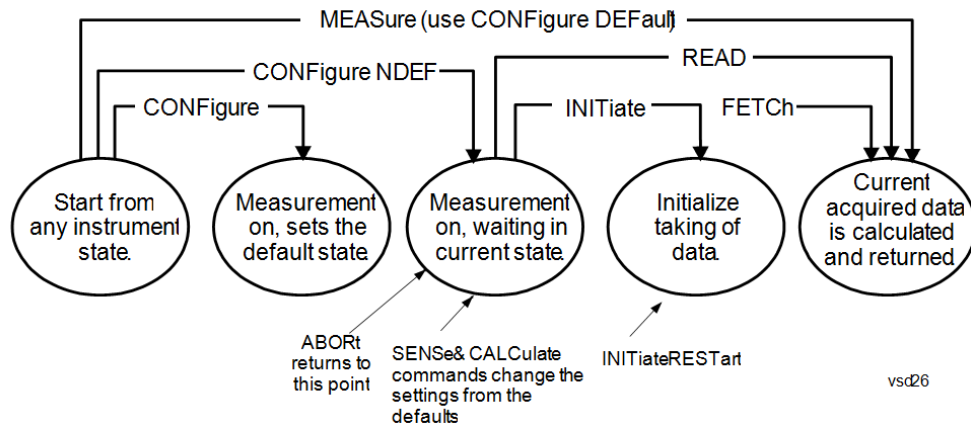

Measure Commands:

:MEASure:<measurement>[n]?

This is a fast single-command way to make a measurement using the factory default instrument settings. These are the settings and units that conform to the Mode Setup settings (e.g. radio standard) that you have currently selected.

- Stops the current measurement (if any) and sets up the instrument for the specified measurement using the factory defaults
- Initiates the data acquisition for the measurement
- Blocks other SCPI communication, waiting until the measurement is complete before returning results.
- If the function does averaging, it is turned on and the number of averages is set to 10.
- After the data is valid it returns the scalar results, or the trace data, for the specified measurement. The type of data returned may be defined by an [n] value that is sent with the command.
- The scalar measurement results will be returned if the optional [n] value is not included, or is set to 1. If the [n] value is set to a value other than 1, the selected trace data results will be returned. See each command for details of what types of scalar results or trace data results are available.
- ASCII is the default format for the data output. (Older versions of Spectrum Analysis and Phase Noise mode measurements only use ASCII.) The binary data formats should be used for handling large blocks of data since they are smaller and faster than the ASCII format. Refer to the FORMat:DATA command for more information.

If you need to change some of the measurement parameters from the factory default settings you can set up the measurement with the CONFIGure command. Use the commands in the SENSE:<measurement> and CALCulate:<measurement> subsystems to change the settings. Then you can use the READ? command to initiate the measurement and query the results.

If you need to repeatedly make a given measurement with settings other than the factory defaults, you can use the commands in the SENSE:<measurement> and CALCulate:<measurement> subsystems to set up the measurement. Then use the READ? command to initiate the measurement and query results.

Measurement settings persist if you initiate a different measurement and then return to a previous one. Use READ:<measurement>? if you want to use those persistent settings. If you want to go back to the default settings, use MEASure:<measurement>?.

Configure Commands:

:CONFigure:<measurement>

This command stops the current measurement (if any) and sets up the instrument for the specified measurement using the factory default instrument settings. It does not initiate the taking of measurement data unless INIT:CONTinuous is ON. If you change any measurement settings after using the CONFigure command, the READ command can be used to initiate a measurement without changing the settings back to their defaults.

In the Swept SA measurement in Spectrum Analyzer mode the CONFigure command also turns the averaging function on and sets the number of averages to 10 for all measurements.

:CONFigure: <measurement>: NDEFault stops the current measurement and changes to the specified measurement. It does not change the settings to the defaults. It does not initiate the taking of measurement data unless INIT:CONTinuous is ON.

The CONFigure? query returns the current measurement name.

The CONFigure:CATalog? query returns a quoted string of all licensed measurement names in the current mode. For example, "SAN, CHP, OBW, ACP, PST, TXP, SPUR, SEM, LIST".

Fetch Commands:

:FETCh:<measurement>[n]?

This command puts selected data from the most recent measurement into the output buffer. Use FETCh if you have already made a good measurement and you want to return several types of data (different [n] values, for example, both scalars and trace data) from a single measurement. FETCh saves you the time of re-making the measurement. You can only FETCh results from the measurement that is currently active, it will not change to a different measurement. An error message is reported if a measurement other than the current one is specified.

If you need to get new measurement data, use the READ command, which is equivalent to an INITiate followed by a FETCh.

The scalar measurement results will be returned if the optional [n] value is not included, or is set to 1. If the [n] value is set to a value other than 1, the selected trace data results will be returned. See each command for details of what types of scalar results or trace data results are available. The binary data formats should be used for handling large blocks of data since they are smaller and transfer faster than the ASCII format. (FORMat:DATA)

FETCh may be used to return results other than those specified with the original READ or MEASure command that you sent.

INITiate Commands:

:INITiate:<measurement>

This command is not available for measurements in all the instrument modes:

- Initiates a trigger cycle for the specified measurement, but does not output any data. You must then use the FETCh<meas> command to return data. If a

measurement other than the current one is specified, the instrument will switch to that measurement and then initiate it.

- For example, suppose you have previously initiated the ACP measurement, but now you are running the channel power measurement. If you send INIT:ACP? it will change from channel power to ACP and will initiate an ACP measurement.
- Does not change any of the measurement settings. For example, if you have previously started the ACP measurement and you send INIT:ACP? it will initiate a new ACP measurement using the same instrument settings as the last time ACP was run.
- If your selected measurement is currently active (in the idle state) it triggers the measurement, assuming the trigger conditions are met. Then it completes one trigger cycle. Depending upon the measurement and the number of averages, there may be multiple data acquisitions, with multiple trigger events, for one full trigger cycle. It also holds off additional commands on GPIB until the acquisition is complete.

READ Commands:

:READ:<measurement>[n]?

- Does not preset the measurement to the factory default settings. For example, if you have previously initiated the ACP measurement and you send READ:ACP? it will initiate a new measurement using the same instrument settings.
 - Initiates the measurement and puts valid data into the output buffer. If a measurement other than the current one is specified, the instrument will switch to that measurement before it initiates the measurement and returns results.
 - For example, suppose you have previously initiated the ACP measurement, but now you are running the channel power measurement. Then you send READ:ACP? It will change from channel power back to ACP and, using the previous ACP settings, will initiate the measurement and return results.
 - Blocks other SCPI communication, waiting until the measurement is complete before returning the results
 - If the optional [n] value is not included, or is set to 1, the scalar measurement results will be returned. If the [n] value is set to a value other than 1, the selected trace data results will be returned. See each command for details of what types of scalar results or trace data results are available. The binary data formats should be used when handling large blocks of data since they are smaller and faster than the ASCII format. (FORMat:DATA)
-

Current Measurement Query (Remote Command Only)

This command returns the name of the measurement that is currently running.

Remote Command	:CONFiGure?
Example	CONF?
Initial S/W Revision	Prior to A.02.00

Limit Test Current Results (Remote Command Only)

Queries the status of the current measurement limit testing. It returns a 0 if the measured results pass when compared with the current limits. It returns a 1 if the measured results fail any limit tests.

Remote Command	:CALCuLate:CLIMits:FAIL?
Example	CALC:CLIM:FAIL? queries the current measurement to see if it fails the defined limits. Returns a 0 or 1: 0 it passes, 1 it fails.
Initial S/W Revision	Prior to A.02.00

Data Query (Remote Command Only)

Returns the designated measurement data for the currently selected measurement and subopcode.

n = any valid subopcode for the current measurement. See the measurement command results table for your current measurement, for information about what data is returned for the subopcodes.

This command uses the data setting specified by the FORMat:BORDER and FORMat:DATA commands and can return real or ASCII data. (See the format command descriptions under Input/Output in the Analyzer Setup section.)

Remote Command	:CALCuLate:DATA[n]?
Notes	The return trace depends on the measurement. In CALCulate:<meas>:DATA[n], n is any valid subopcode for the current measurement. It returns the same data as the FETCh:<measurement>? query where <measurement> is the current measurement.
Initial S/W Revision	Prior to A.02.00

Calculate/Compress Trace Data Query (Remote Command Only)

Returns compressed data for the currently selected measurement and sub-opcode [n].

n = any valid sub-opcode for that measurement. See the MEASure:<measurement>? command description of your specific measurement for information on the data that can be returned.

The data is returned in the current Y Axis Unit of the analyzer. The command is used with a sub-opcode <n> (default=1) to specify the trace. With trace queries, it is best if the analyzer is not sweeping during the query. Therefore, it is generally advisable to be in Single Sweep, or Update=Off.

This command is used to compress or decimate a long trace to extract and return only the desired data. A typical example would be to acquire N frames of GSM data and return the mean power of the first burst in each frame. The command can also be used to identify the best curve fit for the data.

Remote Command	:CALCulate:DATA<n>:COMPRESS? BLOCK CFIT MAXimum MINimum MEAN DMEan RMS RMSCubed SAMPLE SDEVIation PPHase [,<soffset> [,<length>[,<roffset>[,<rlimit>]]]]
Example	To query the mean power of a set of GSM bursts: Supply a signal that is a set of GSM bursts. Select the IQ Waveform measurement (in IQ Analyzer Mode). Set the sweep time to acquire at least one burst. Set the triggers such that acquisition happens at a known position relative to a burst. Then query the mean burst levels using, CALC:DATA2:COMP? MEAN, 24e-6, 526e-6 (These parameter values correspond to GSM signals, where 526e-6 is the length of the burst in the slot and you just want 1 burst.)
Notes	The command supports 5 parameters. Note that the last 4 (<soffset>, <length>, <roffset>, <rlimit>) are optional. But these optional parameters must be entered in the specified order. For example, if you want to specify <length>, then you must also specify <soffset>. See details below for a definition of each of these parameters. This command uses the data in the format specified by FORMat:DATA, returning either binary or ASCII data.
Initial S/W Revision	Prior to A.02.00

- BLOCK or block data - returns all the data points from the region of the trace data that you specify. For example, it could be used to return the data points of an input signal over several timeslots, excluding the portions of the trace data that you do not want. (This is x,y pairs for trace data and I,Q pairs for complex data.)
- CFIT or curve fit - applies curve fitting routines to the data. <soffset> and <length> are required to define the data that you want. <roffset> is an optional parameter for the desired order of the curve equation. The query will return the following values: the x-offset (in seconds) and the curve coefficients ((order + 1) values).

MIN, MAX, MEAN, DME, RMS, RMSC, SAMP, SDEV and PPH return one data value for each specified region (or <length>) of trace data, for as many regions as possible until you run out of trace data (using <roffset> to specify regions). Or they return the number of regions you specify (using <rlimit>) ignoring any data beyond that.

- MINimum - returns the minimum data point (y value) for the specified region (s) of trace data. For I/Q trace data, the minimum magnitude of the I/Q pairs is returned.
- MAXimum - returns the maximum data point (y value) for the specified region(s) of trace data. For I/Q trace data, the maximum magnitude of the I/Q pairs is returned.
- MEAN - returns a single value that is the arithmetic mean of the data point values (in dB/ dBm) for the specified region(s) of trace data. For I/Q trace data, the mean of the magnitudes of the I/Q pairs is returned. See the following equations.

NOTE

If the original trace data is in dB, this function returns the arithmetic mean of those log values, not log of the mean power which is a more useful value. The mean of the log is the better measurement technique when measuring CW signals in the presence of noise. The mean of the power, expressed in dB, is useful in power measurements such as Channel Power. To achieve the mean of the power, use the RMS option.

Equation 1

Mean Value of Data Points for Specified Region(s)

$$MEAN = \frac{1}{n} \sum_{X_i \in \text{region}(s)} X_i$$

where X_i is a data point value, and n is the number of data points in the specified region(s).

Equation 2

Mean Value of I/Q Data Pairs for Specified Region(s)

$$MEAN = \frac{1}{n} \sum_{X_i \in \text{region}(s)} |X_i|$$

where $|X_i|$ is the magnitude of an I/Q pair, and n is the number of I/Q pairs in the specified region(s).

- DMEan - returns a single value that is the mean power (in dB/ dBm) of the data point values for the specified region(s) of trace data. See the following

equation:

Equation 3

DMEan Value of Data Points for Specified Region(s)

$$\text{DME} = 10 \times \log_{10} \left(\frac{1}{n} \sum_{X_i \in \text{region}(s)} 10^{\frac{X_i}{10}} \right)$$

- RMS - returns a single value that is the average power on a root-mean-squared voltage scale (arithmetic rms) of the data point values for the specified region(s) of trace data. See the following equation.

NOTE

For I/Q trace data, the rms of the magnitudes of the I/Q pairs is returned. See the following equation.

This function is very useful for I/Q trace data. However, if the original trace data is in dB, this function returns the rms of the log values which is not usually needed.

Equation 4

RMS Value of Data Points for Specified Region(s)

$$\text{RMS} = \sqrt{\frac{1}{n} \sum_{X_i \in \text{region}(s)} X_i^2}$$

where X_i is a data point value, and n is the number of data points in the specified region(s).

Equation 5

RMS Value of I/Q Data Pairs for Specified Region(s)

$$\text{RMS} = \sqrt{\frac{1}{n} \sum_{X_i \in \text{region}(s)} X_i X_i^*}$$

where X_i is the complex value representation of an I/Q pair, X_i^* its conjugate complex number, and n is the number of I/Q pairs in the specified region(s).

Once you have the rms value for a region of trace data (linear or I/Q), you may want to calculate the mean power. You must convert this rms value (peak volts) to power in dBm:

$$10 \times \log[10 \times (\text{rms value})^2]$$

- SAMPlE - returns the first data value (x,y pair) for the specified region(s) of trace data. For I/Q trace data, the first I/Q pair is returned.
- SDEViation - returns a single value that is the arithmetic standard deviation for the data point values for the specified region(s) of trace data. See the following equation.
- For I/Q trace data, the standard deviation of the magnitudes of the I/Q pairs is returned. See the following equation.

Equation 6

Standard Deviation of Data Point Values for Specified Region(s)

$$SDEV = \sqrt{\frac{1}{n} \sum_{X_i \in \text{region}(s)} (X_i - \bar{X})^2}$$

where X_i is a data point value, \bar{X} is the arithmetic mean of the data point values for the specified region(s), and n is the number of data points in the specified region(s).

$$SDEV = \sqrt{\frac{1}{n} \sum_{X_i \in \text{region}(s)} (|X_i| - \bar{X})^2}$$

where $|X_i|$ is the magnitude of an I/Q pair, \bar{X} is the mean of the magnitudes for the specified region(s), and n is the number of data points in the specified region(s).

- PPHase - returns the x,y pairs of both rms power (dBm) and arithmetic mean phase (radian) for every specified region and frequency offset (Hz). The number of pairs is defined by the specified number of regions. This parameter can be used for I/Q vector (n=0) in Waveform (time domain) measurement and all parameters are specified by data point in PPHase.

The rms power of the specified region may be expressed as:

$$\text{Power} = 10 \times \log [10 \times (\text{RMS I/Q value})] + 10.$$

The RMS I/Q value (peak volts) is:

$$\sqrt{\frac{1}{n} \sum_{X_i \in \text{region}} X_i X_i^*}$$

where X_i is the complex value representation of an I/Q pair, X_i^* its conjugate complex number, and n is the number of I/Q pairs in the specified region.

The arithmetic mean phase of the specified region may be expressed as:

$$\frac{1}{n} \sum_{Y_i \in \text{region}} Y_i$$

where Y_i is the unwrapped phase of I/Q pair with applying frequency correction and n is the number of I/Q pairs in the specified region.

The frequency correction is made by the frequency offset calculated by the arithmetic mean of every specified region's frequency offset. Each frequency offset is calculated by the least square method against the unwrapped phase of I/Q pair.

Sample Trace Data - Constant Envelope

(See below for explanation of variables.)

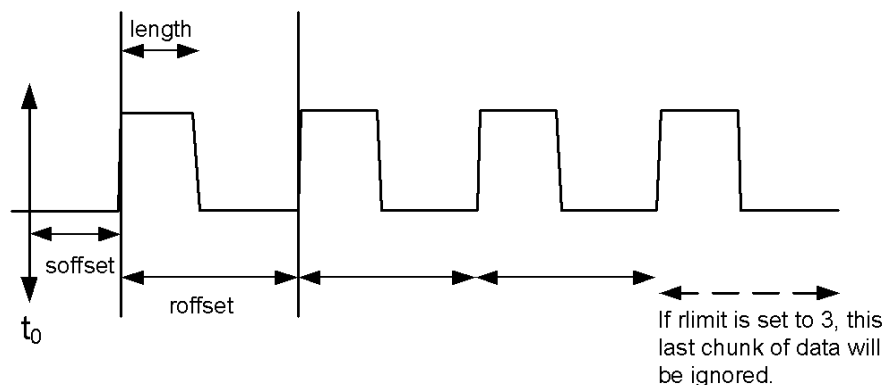

Sample Trace Data - Not Constant Envelope

(See below for explanation of variables.)

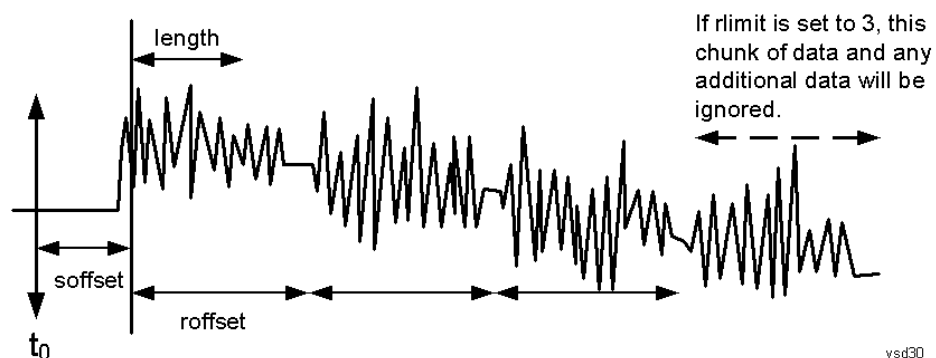

<soffset> - start offset is an optional real number. (It is in seconds for time-domain traces, and is a dimensionless index 0 to Npoints - 1, for frequency-domain traces). It specifies the amount of data at the beginning of the trace that will be ignored before the decimation process starts. It is the time or frequency change from the start of the trace to the point where you want to start using the data. The default value is zero.

<length> - is an optional real number. (It is in seconds for time-domain traces, and is a dimensionless index 0 to Npoints - 1, for frequency-domain traces). It defines how much data will be compressed into one value. This parameter has a default value equal to the current trace length.

<roffset> - repeat offset is an optional real number. (It is in seconds for time-domain traces, and is a dimensionless index 0 to Npoints - 1, for frequency-domain traces). It defines the beginning of the next field of trace elements to be compressed. This is relative to the beginning of the previous field. This parameter has a default value equal to the <length> variable. Note that this parameter is used for a completely different purpose when curve fitting (see CFIT above).

<rlimit> - repeat limit is an optional integer. It specifies the number of data items that you want returned. It will ignore any additional items beyond that number. You can use the Start offset and the Repeat limit to pick out exactly what part of the data you want to use. The default value is all the data.

Calculate Peaks of Trace Data (Remote Command Only)

Returns a list of all the peaks for the currently selected measurement and sub-opcode [n]. The peaks must meet the requirements of the peak threshold and excursion values.

n = any valid sub-opcode for the current measurement. See the MEASure:<measurement> command description of your specific measurement for information on the data that can be returned.

The command can only be used with specific sub-opcodes with measurement results that are trace data. Both real and complex traces can be searched, but complex traces are converted to magnitude in dBm. In many measurements the sub-opcode n=0, is the raw trace data which cannot be searched for peaks. And Sub-opcode n=1, is often calculated results values which also cannot be searched for peaks.

This command uses the data setting specified by the FORMat:BORDER and FORMat:DATA commands and can return real or ASCII data. If the format is set to INT,32, it returns REAL,32 data.

The command has four types of parameters:

- Threshold (in dBm)
- Excursion (in dB)
- Sorting order (amplitude, frequency, time)
- Optional in some measurements: Display line use (all, > display line, < display line)

Remote Command

For Swept SA measurement:

```
:CALCulate:DATA[1]|2|...|6:PEAKS? <threshold>,<excursion>[,AMPLitude  
| FREQuency | TIME[,ALL | GTDLine | LTDLine]]
```

For most other measurements:

	:CALCulate:DATA[1] 2 ... 6:PEAKs? <threshold>,<excursion>[,AMPLitude FREQUENCY TIME]
Example	<p>Example for Swept SA measurement in Spectrum Analyzer Mode:</p> <p>CALC:DATA4:PEAK? -40, 10, FREQ, GTDL This will identify the peaks of trace 4 that are above -40 dBm, with excursions of at least 10 dB. The peaks are returned in order of increasing frequency, starting with the lowest frequency. Only the peaks that are above the display line are returned.</p> <p>Query Results 1:</p> <p>With FORMat:DATA REAL, 32 selected, it returns a list of floating-point numbers. The first value in the list is the number of peak points that are in the following list. A peak point consists of two values: a peak amplitude followed by its corresponding frequency (or time).</p> <p>If no peaks are found the peak list will consist of only the number of peaks, (0).</p>
Notes	<p><n> - is the trace that will be used</p> <p><threshold> - is the level below which trace data peaks are ignored. Note that the threshold value is required and is always used as a peak criterion. To effectively disable the threshold criterion for this command, provide a substantially low threshold value such as -200 dBm. Also note that the threshold value used in this command is independent of and has no effect on the threshold value stored under the Peak Criteria menu.</p> <p><excursion> - is the minimum amplitude variation (rise and fall) required for a signal to be identified as peak. Note that the excursion value is required and is always used as a peak criterion. To effectively disable the excursion criterion for this command, provide the minimum value of 0.0 dB. Also note that the excursion value used in this command is independent of and has no effect on the excursion value stored under the Peak Criteria menu.</p> <p>Values must be provided for threshold and excursion. The sorting and display line parameters are optional (defaults are AMPLitude and ALL).</p> <p>Note that there is always a Y-axis value for the display line, regardless of whether the display line state is on or off. It is the current Y-axis value of the display line which is used by this command to determine whether a peak should be reported</p> <p>Sorting order:</p> <p>AMPLitude - lists the peaks in order of descending amplitude, with the highest peak first (default if optional parameter not sent)</p> <p>FREQUENCY - lists the peaks in order of occurrence, left to right across the x-axis.</p> <p>TIME - lists the peaks in order of occurrence, left to right across the x-axis.</p> <p>Peaks vs. Display Line:</p> <p>ALL - lists all of the peaks found (default if optional parameter not sent).</p> <p>GTDLLine (greater than display line) - lists all of the peaks found above the display line.</p> <p>LTDLine (less than display line) - lists all of the peaks found below the display line.</p>
Initial S/W Revision	Prior to A.02.00

Hardware-Accelerated Fast Power Measurement (Remote Command Only)

The Fast Power option (FP2) enables very fast channel power measurements for instruments with the prerequisite hardware (DP2 and/or B40). It accomplishes this by performing real-time overlapped FFTs at the hardware layer, using software for basic post-processing before returning the result to the user. The upshot of this

approach is improved throughput for user applications that require many sequential power measurements.

The analysis bandwidth of FP2 is limited by the licenses in the instrument, but its maximum overall analysis bandwidth per acquisition is 40 MHz.

FP2 is remote-only, which means the instrument does not switch to any particular mode or measurement. FP2 commands can be sent while another application is in use on the front panel.

Each Fast Power measurement can be predefined using an array index, and up to 1,000 measurements can be stored. In the following documentation, instances of [1,2,...,999] can be substituted with a particular measurement index, e.g. CALC:FPOW:POW1?, CALC:FPOW:POW2?, CALC:FPOW:POW134?. In this way, power measurements can be defined one time in a batch, and then executed multiple times without having to redefine them, similar to “list mode” on other measurements.

In addition to basic channel power measurements, there are a number of other measurement “functions” for each channel, including peak power, peak frequency, and power spectral density. See the Function parameter for more information.

Reset Fast Power Measurement (Remote Command Only)

Resets the measurement configuration to the defaults.

Mode	All
Remote Command	:CALCulate:FPOWer:POWer[1,2,...,999]:RESet
Example	:CALC:FPOW:POW1:RES
Notes	Option FP2 is required.
Initial S/W Revision	A.14.00

Define Fast Power Measurement (Remote Command Only)

Fast Power acquisitions are configured using the DEFine command. This command accepts a comma-delimited string of configuration parameters and their appropriate values, which are all specified in the subsection below.

Mode	All
Remote Command	:CALCulate:FPOWer:POWer[1,2,...,999]:DEFine "configuration string"
Example	:CALC:FPOW:POW1:DEF "CenterFrequency=2e9, AcquisitionTime=0.005"
Notes	See below for a list of measurement variables that can be defined in the configuration string.
Initial S/W Revision	A.14.00

Acquisition Time

Example	CALC:FPOW:POW1:DEF "AcquisitionTime=0.002"
Notes	The acquisition time parameter sets the time in which the entire spectrum is measured. An increase in the acquisition time yields an improvement in measurement repeatability.
Preset	0.001 s
Range	0 s to 1 s
Default Unit	Time (s)
Initial S/W Revision	A.14.00

Center Frequency

Example	CALC:FPOW:POW1:DEF "CenterFrequency=2e9"
Notes	The center frequency parameter sets the frequency in which the measurement is centered around. The OffsetFrequency parameter is calculated relative to the center frequency.
Preset	1 GHz
Range	0 Hz to maximum instrument frequency
Default Unit	Frequency (Hz)
Initial S/W Revision	A.14.00

DC Coupled

Example	CALC:FPOW:POW1:DEF "DCCoupled=True"
Notes	The DC coupled parameter allows the user to specify whether the DC blocking capacitor is utilized. Set parameter to true when measuring frequencies below 10 MHz.
Preset	False
Range	True (DC Coupled) or False (AC Coupled)
Default Unit	Boolean
Initial S/W Revision	A.14.00

DetectorType

Example	CALC:FPOW:POW1:DEF "DetectorType=Peak"
Notes	Option FP2 is required. The detector type parameter allows the user to choose whether a RMS average or peak value is used during the measurement.
Preset	RmsAverage
Range	RmsAverage, Peak
Initial S/W Revision	A.14.00

Do Noise Correction

Example	CALC:FPOW:POW1:DEF "DoNoiseCorrection=True"
Notes	<p>When noise correction is enabled, the linear noise power contributed by the analyzer is subtracted from all measurements. This effectively lowers the noise floor of the analyzer.</p> <p>When noise correction is enabled, the first measurement for a given set of input parameters will take extra time. This is because the analyzer takes an extra acquisition with the RF input disconnected from the analyzer's front end to measure the noise of just the analyzer. The measured noise floor is stored in a cache so the noise acquisition will occur only once for the same state settings. In other words, if noise correction was turned on and the analyzer made an acquisition at frequency A, then frequency B, and back again to frequency A, the hidden initial noise floor acquisition would only occur for the first acquisition at frequency A and the cached noise floor would be used the second time frequency A was measured.</p>
Preset	False
Range	True (enable noise correction) or False (disable noise correction)
Default Unit	Boolean
Initial S/W Revision	A.14.00

Do Spur Suppression

Example	CALC:FPOW:POW1:DEF "DoSpurSuppression=True"
Notes	<p>When measuring very low level signals, or when large out-of-band inputs are input into the analyzer, sometimes unwanted spurs and residuals can appear in the measured spectrum. Spur suppression is a method to help minimize the levels of these internally generated spurs and residuals.</p> <p>When spur suppression is enabled, the analyzer will automatically take two acquisitions using two different internal analog LO frequencies. The FFT spectrums from both acquisitions are combined by taking the minimum power between both traces on a per FFT bin basis. External signals will have the same amplitude for both traces and therefore will return the expected amplitudes. However, low level spurs and residuals generated internally to the analyzer tend to move to different FFT bins depending on the internal analog LO frequency used, and therefore tend to be suppressed using this spur suppression method.</p> <p>Because two acquisitions, rather than a single acquisition, are made when spur suppression is enabled, the measurement time will always be slower when spur suppression is enabled.</p>
Preset	False
Range	True (enable spur suppression) or False (disable spur suppression)
Default Unit	Boolean
Initial S/W Revision	A.14.00

Electronic Attenuator Bypass

Example	CALC:FPOW:POW1:DEF "ElecAttBypass =False"
---------	---

Notes	The electronic attenuation bypass parameter allows the user to either utilize or bypass the electronic attenuator. The electronic attenuator is only available for frequencies up to 3.6 GHz. Set parameter to true when using frequencies above 3.6 GHz and set the parameter to false when using the preamp.
Preset	True
Range	True (bypass electronic attenuator) or False (use electronic attenuator)
Default Unit	Boolean
Initial S/W Revision	A.14.00

Electronic Attenuation

Example	CALC:FPOW:POW1:DEF "ElecAttenuation=10"
Notes	Option EA3 is required. The electronic attenuation value parameter sets the amount of electrical attenuation from 0 to 24 dB (1 dB steps). Set "ElecAttBypass=False" to make sure the electronic attenuator path is enabled.
Preset	0 dB
Range	0 – 24 dB (1 dB steps)
Default Unit	dB
Initial S/W Revision	A.14.00

IF Gain

Example	CALC:FPOW:POW1:DEF "IFGain=10"
Notes	The IF gain parameter allows the user to specify the gain at the IF stage anywhere from -6 to 16 dB (1 dB steps). This is an advanced feature, and for most cases this should remain at its default value of 0 dB.
Preset	0 dB
Range	-6 – 16 dB (1 dB steps)
Default Unit	dB
Initial S/W Revision	A.14.00

IF Type

Example	CALC:FPOW:POW1:DEF "IFType=B25M"
Notes	The IF type parameter allows the user to select between different IF paths. For example, if the signal is less than 25 MHz wide, then the user can select the B25M path to take advantage of additional filtering on this analog IF path.

Preset	B40M
Range	B10M, B25M, B40M
Initial S/W Revision	A.14.00

Include Power Spectrum

Example	CALC:FPOW:POW1:DEF "IncludePowerSpectrum=True"
Notes	The power spectrum parameter allows the user to read data on the entire spectrum for diagnostic purposes. It is not recommended for production use. See CALC:FPOW:POW[n]:READ2? for details on the binary format of the response.
Preset	False
Range	True (return both channel power and full power spectrum) or False (returns only channel power)
Default Unit	Boolean
Initial S/W Revision	A.14.00

Mechanical Attenuation

Example	CALC:FPOW:POW1:DEF "MechAttenuation=10"
Notes	The mechanical attenuation value parameter sets the amount of mechanical attenuation anywhere from 0 to 70 dB (2 dB steps).
Preset	0 dB
Range	0 – 70 dB (2 dB steps)
Default Unit	dB
Initial S/W Revision	A.14.00

Preamp Mode

Example	CALC:FPOW:POW1:DEF "PreAmpMode=Low"
Notes	The license for the appropriate preamp is required. The preamp mode parameter specifies whether the preamps are being utilized. Low allows any preamps up to 3.6 GHz, and Full allows all licensed preamps. Set "ElecAttBypass=True" in order to utilize any preamps.
Preset	Off
Range	Off, Low, Full
Initial S/W Revision	A.14.00

Resolution Bandwidth Mode

Example	CALC:FPOW:POW1:DEF "PreAmpMode=Low"
Notes	The resolution bandwidth mode parameter allows the user to choose whether the RBW filter is automatically or manually set. The BestSpeed value minimizes measurement time, while the Narrowest value minimizes RBW size (minimum of two FFT bins per RBW). To manually specify an RBW, set this parameter to Explicit, and set the ResolutionBW parameter to the desired value.
Preset	BestSpeed
Range	BestSpeed, Narrowest, Explicit
Initial S/W Revision	A.14.00

Resolution Bandwidth

Example	CALC:FPOW:POW1:DEF "ResolutionBW=25e3"
Notes	The resolution bandwidth parameter sets the 3-dB bandwidth of the RBW filter. The ResolutionBWMode parameter must be set to Explicit in order to manually set the RBW.
Preset	0 Hz
Default Unit	Hz
Initial S/W Revision	A.14.00

Trigger Delay

Example	CALC:FPOW:POW1:DEF "TriggerDelay=0.025"
Notes	The trigger delay parameter sets the time after an external trigger is detected until the measurement is performed.
Preset	0 s
Range	0 – 1 s
Default Unit	Seconds
Initial S/W Revision	A.14.00

Trigger Level

Example	CALC:FPOW:POW1:DEF "TriggerLevel=2"
Notes	The trigger level parameter sets the voltage value at which an external trigger is detected.
Preset	1.2 V
Range	-5 to 5 V
Default Unit	Volts
Initial S/W Revision	A.14.00

Trigger Slope

Example	CALC:FPOW:POW1:DEF "TriggerSlope=Negative"
Notes	The trigger slope parameter indicates the direction of the edge trigger voltage for detection.
Preset	Positive
Range	Positive, Negative
Initial S/W Revision	A.14.00

Trigger Source

Example	CALC:FPOW:POW1:DEF "TriggerSource=Ext1"
Notes	The trigger source parameter allows the user to choose between measurement's triggering freely or controlled by an external input. Ext1 and Ext2 correspond to Trigger 1 In and Trigger 2 In, respectively.
Preset	Free
Range	Free, Ext1, Ext2
Initial S/W Revision	A.14.00

Trigger Timeout

Example	CALC:FPOW:POW1:DEF "TriggerTimeout=0.1"
Notes	The trigger timeout parameter sets the time in which the analyzer will wait for a trigger before automatically performing the measurement.
Preset	1 s
Range	0 – 1 s
Default Unit	Seconds
Initial S/W Revision	A.14.00

Signal Input

Example	CALC:FPOW:POW1:DEF "SignalInput=Fp50MHzCW"
Notes	The signal input parameter allows the user to select between using the main RF input or the internal analyzer reference CW signal of 50 MHz.
Preset	FpMainRf
Range	FpMainRf, Fp50MHzCW
Initial S/W Revision	A.14.00

Use Preselector

Example	CALC:FPOW:POW1:DEF "UsePreSelector=True"
Notes	The preselector parameter allows the user to either utilize or bypass the front end tunable filter at frequencies above 3.6 GHz. For frequencies below 3.6 GHz, the preselector is automatically bypassed, so you do not need to set this parameter to False in those cases.
Preset	False
Range	True (use preselector above 3.6 GHz), or False (preselector bypassed)
Default Unit	Boolean
Initial S/W Revision	A.14.00

Channel Bandwidth Array

Example	CALC:FPOW:POW1:DEF "Bandwidth=[3.84e6, 5e6, 3.84e6]"
Notes	The bandwidth parameter array defines the bandwidth of each channel that will be measured. All array parameters should have the same number of elements. Alternatively, if all the elements are the same value, a single number with no square brackets can be used to define the parameter.
Preset	[1e6]
Range	0 to 40 MHz
Default Unit	Hz
Initial S/W Revision	A.14.00

Channel Filter Type Array

Example	CALC:FPOW:POW1:DEF "FilterType=[RRC, IBW, RRC]"
Notes	The filter type parameter allows the user to choose between an integration bandwidth (IBW) filter or a root-raised-cosine (RRC) filter. The integration bandwidth filter weighs all frequencies within the bandwidth equally. The root-raised-cosine filter has an associated shape parameter, defined by the FilterAlpha parameter. All array parameters should have the same number of elements. Alternatively, if all the elements are the same value, a single value with no square brackets can be used to define the parameter.
Preset	[IBW]
Range	IBW, RRC
Initial S/W Revision	A.14.00

Channel Filter Alpha Array

Example	CALC:FPOW:POW1:DEF "FilterAlpha=[0.5, 0.0, 0.5]"
Notes	The filter alpha parameter allows the user to adjust the alpha value associated with the root-

	raised-cosine (RRC) filter type. Set FilterType to RRC in order to utilize this parameter. All array parameters should have the same number of elements. Alternatively, if all the elements are the same value, a single number with no square brackets can be used to define the parameter.
Preset	[0.22]
Range	0.0 – 1.0
Initial S/W Revision	A.14.00

Channel Measurement Function Array

Example	CALC:FPOW:POW1:DEF "Function=[BandPower, PeakPower, BandPower]"
Notes	This parameter array defines what measurement is being made for each individually-specified channel: BandPower: Total power within the specified bandwidth of the channel (dBm) BandDensity: Total power density within the specified bandwidth of the channel (dBm/Hz) PeakPower: The peak power value within the specified bandwidth of the channel (dBm) PeakFrequency: The frequency which corresponds to the peak power value within the specified bandwidth of the channel. This frequency is relative to the center frequency (Hz) XdBBandwidth: The half power (-3.01 dB) bandwidth of the highest amplitude signal that resides within the channel (Hz), dB is configurable using XdBBandwidth parameter OccupiedBandwidth: The bandwidth at which 99% of the total power resides within the channel (Hz), percentage configurable using OccupiedBandwidthPercent parameter All array parameters should have the same number of elements. Alternatively, if all the elements are the same value, a single value with no square brackets can be used to define the parameter.
Preset	[BandPower]
Range	BandPower, BandDensity, PeakPower, PeakFrequency, XdBBandwidth, OccupiedBandwidth
Initial S/W Revision	A.14.00

Channel Offset Frequency Array

Example	CALC:FPOW:POW1:DEF "OffsetFrequency=[-5e6, 0, 5e6]"
Notes	The offset frequency parameter array defines the difference between the center frequency to the center frequency of each channel. All array parameters should have the same number of elements.
Preset	[0]
Range	0 to 20 MHz
Default Unit	Hz
Initial S/W Revision	A.14.00

Channel Occupied Bandwidth Percent Array

Example	CALC:FPOW:POW1:DEF "OccupiedBandwidthPercent =[0.95, 0.95, 0.95]"
Notes	This parameter only applies for channels whose Function is set to OccupiedBandwidth. The occupied bandwidth percent parameter specifies the percent of total power in these channels. The valid range for this parameter is 0.0 to 1.0, where 1.0 represents 100%. The default for this parameter is 0.99, which will return the bandwidth that contains 99% of the total channel power.
Preset	[0.99]
Range	0 – 1.0
Initial S/W Revision	A.14.00

Channel x-dB Bandwidth Array

Example	CALC:FPOW:POW1:DEF "XdBBandwidth =[-6.02, -3.01, -1.0]"
Notes	This parameter only applies for channels whose Function is set to XdBBandwidth. The X dB bandwidth parameter is used to specify the power relative to the peak channel power over which the bandwidth is calculated. The parameter value must be a negative number.
Preset	[-3.01]
Range	-200 to 0 dB
Default Unit	dB
Initial S/W Revision	A.14.00

Define Fast Power Measurement Query (Remote Command Only)

The DEFine? command is used to retrieve a list of all defined parameters in an ASCII string format

```

M All
o
d
e
R :CALCulate:FPOWer:POWer[1,2,...,999]:DEFine?
e
m
o
t
e
C
o
m
m
a
n

```

d

E :CALC:FPOW:POW1:DEF?

**x
a
m
p
l
e**

N This command query is used to retrieve a list of all defined parameters in an ASCII format.

O The following is an example of the returned results:

t "DCCoupled=False,ElecAttBypass=True,ElecAttenuation=0,IFGain=0,MechAttenuation=0,PreAmpMode=Off,PreSelectorOf
e fset=0,UsePreSelector=False,ExternalReferenceFrequency=10000000,FrequencyReferenceSource=AutoExternalFrequenc
s yReference,IFType=B40M,LOMode=SLW,SignalInput=FpMainRf,AcquisitionTime=0.001,CenterFrequency=1000000000,Re
solutionBW=0,ResolutionBWMode=BestSpeed,DetectorType=RmsAverage,Bandwidth=[1000000],OffsetFrequency=
[0],Function=[BandPower],FilterType=[BW],FilterAlpha=[0.22],OccupiedBandwidthPercent=[0.99],XdBBandwidth=[-
3.01],DoNoiseCorrection=False,DoSpurSuppression=False,MeasurementMethod=HardwareFFT,IncludePowerSpectrum=F
alse,TriggerDelay=0,TriggerLevel=1.2,TriggerSlope=Positive,TriggerSource=Free,TriggerTimeout=1"

I A.14.00

**n
i
t
i
a
l**

**S
/
W**

**R
e
v
i
s
i
o
n**

Configure Fast Power Measurement (Remote Command Only)

The configure command begins hardware setup and returns immediately, with no acquisition made. This can be used in parallel with other hardware operations to effectively hide the hardware setup time.

Mode	All
Remote Command	:CALCulate:FPOWer:POWer[1,2,...,999]:CONFigure
Example	:CALC:FPOW:POW1:CONF

Notes	Option FP2 is required.
Initial S/W Revision	A.14.00

Initiate Fast Power Measurement (Remote Command Only)

The INITiate command begins an acquisition and returns immediately. The results of the measurement can be retrieved using FETCh.

Mode	All
Remote Command	:CALCulate:FPOWer:POWer[1,2,...,999]:INITiate
Example	:CALC:FPOW:POW1:INIT
Notes	Option FP2 is required.
Initial S/W Revision	A.14.00

Fetch Fast Power Measurement (Remote Command Only)

The FETCh command query is used to retrieve the results of an acquisition initiated by the INIT command. The returned results are in ASCII string format. The string begins and ends with quotation marks.

Mode	All
Remote Command	:CALCulate:FPOWer:POWer[1,2,...,999]:FETCh?
Example	:CALC:FPOW:POW1:FETC?
Notes	Option FP2 is required. Returns m comma-separated ASCII values, where m corresponds to the number of bandwidths defined. 1. Declared function return in the 1st specified channel 2. Declared function return in the 2nd specified channel ... m. Declared function return in the last specified channel The INIT and FETC? command sequence performs the same functionality of a single CALC:FPOW:POW[n]? query. Units of the returned values are dependent on the Function parameter for each channel.
Initial S/W Revision	A.14.00

Execute Fast Power Measurement (Remote Command Only)

This command query is used as shorthand for an INIT command immediately followed by a FETC? command. The returned results are in ASCII string format. The string begins and ends with quotation marks.

Mode	All
Remote Command	:CALCulate:FPOWer:POWer[1,2,...,999]?
Example	:CALC:FPOW:POW1?
Notes	Option FP2 is required. See notes for Fast Power Fetch for return format.
Initial S/W Revision	A.14.00

Binary Read Fast Power Measurement (Remote Command Only)

This command query is used as shorthand for an INIT command immediately followed by a FETC? command. The returned results are in a binary format.

Mode	All
Remote Command	:CALCulate:FPOWer:POWer[1,2,...,999]:READ? :CALCulate:FPOWer:POWer[1,2,...,999]:READ1?
Example	:CALC:FPOW:POW1:READ? :CALC:FPOW:POW1:READ1?
Notes	Option FP2 is required. Returns m 4 byte floating point binary values (Little-Endian), where m corresponds to the number of bandwidths defined.
Initial S/W Revision	A.14.00

Diagnostic Binary Read Fast Power Measurement (Remote Command Only)

This command query is used as shorthand for an INIT command immediately followed by a FETC? command. The returned results are in a binary format. This command is used primarily for diagnostic purposes to test for ADC overloads and to visibly inspect the spectrum.

Mode	All
Remote Command	:CALCulate:FPOWer:POWer[1,2,...,999]:READ2?
Example	:CALC:FPOW:POW1:READ2?
Notes	Option FP2 is required. <div style="display: flex; align-items: flex-start;"> <div style="background-color: #cccccc; padding: 2px 5px; margin-right: 10px;">NOTE</div> <div> <p>Spectrum data is only returned if the IncludePowerSpectrum parameter is set to True. If IncludePowerSpectrum is False, the number of spectrum points will be zero (0).</p> </div> </div> <p>Units of the returned values are dependent on the Function parameter per channel (e.g. dBm for BandPower, Hz for PeakFrequency). Returns binary data (Little-Endian) that contains information on m amount of channels, along with ADC over range and full spectrum data.</p>

The following is the binary format of the response.

Bandwidth Return Value

1. Number of channels specified, m [4 byte int]
2. Declared function result for the 1st specified channel [4 byte float]
3. Declared function result for the 2nd specified channel [4 byte float]
- ...
- (m + 1). Declared function result for the last (mth) specified channel [4 byte float]

ADC Over Range

1. ADC over-range occurred (1: true, 0: false) [2 byte short]

Spectrum Data

1. Number of points in the spectrum data, k [4 byte int]
2. Start frequency of spectrum data (Hz) [8 byte double]
3. Step frequency of spectrum data (Hz) [8 byte double]
4. FFT bin at 1st point (dBm) [4 byte float]
5. FFT bin at 2nd point (dBm) [4 byte float]
- ...
- (k + 3). FFT bin at last (kth) point (dBm) [4 byte float]

Initial S/W Revision A.14.00

Format Data: Numeric Data (Remote Command Only)

This command specifies the format of the trace data input and output. It specifies the formats used for trace data during data transfer across any remote port. It affects only the data format for setting and querying trace data for the :TRACe[:DATA], TRACe[:DATA]?, :CALCulate:DATA[n]? and FETCh:SANalyzer[n]? commands and queries.

Remote Command	:FORMat[:TRACe][:DATA] ASCii INTeger,32 REAL,32 REAL,64 :FORMat[:TRACe][:DATA]?
-----------------------	---

Notes	<p>The query response is:</p> <p>ASCii: ASC,8</p> <p>REAL,32: REAL,32</p> <p>REAL,64: REAL,64</p> <p>INTeger,32: INT,32</p> <p>When the numeric data format is REAL or ASCii, data is output in the current Y Axis unit. When the data format is INTeger, data is output in units of m dBm (.001 dBm).</p> <p>The INT,32 format returns binary 32-bit integer values in internal units (m dBm), in a definite length block.</p>
-------	---

Dependencies	<p>Sending a data format spec with an invalid number (for example, INT,48) generates no error. The analyzer simply uses the default (8 for ASCii, 32 for INTeger, 32 for REAL).</p> <p>Sending data to the analyzer which does not conform to the current FORMat specified, results in an error. Sending ASCII data when a definite block is expected generates message -161 "Invalid</p>
--------------	---

	Block Data" and sending a definite block when ASCII data is expected generates message -121 "Invalid Character in Number".
Preset	AScii
Backwards Compatibility Notes	Note that the INT,32 format is only applicable to the command, TRACe:DATA. This preserves backwards compatibility for the Swept SA measurement. For all other commands/queries which honor FORMat:DATA, if INT,32 is sent the analyzer will behave as though it were set to REAL,32.
Initial S/W Revision	Prior to A.02.00

The specs for each output type follow:

AScii - Amplitude values are in ASCII, in the current Y Axis Unit, one ASCII character per digit, values separated by commas, each value in the form:

SX.YYYYYEsZZ

Where:

S = sign (+ or -)

X = one digit to left of decimal point

Y = 5 digits to right of decimal point

E = E, exponent header

s = sign of exponent (+ or -)

ZZ = two digit exponent

REAL,32 - Binary 32-bit real values in the current Y Axis Unit, in a definite length block.

REAL,64 - Binary 64-bit real values in the current Y Axis Unit, in a definite length block.

Format Data: Byte Order (Remote Command Only)

This command selects the binary data byte order for data transfer and other queries. It controls whether binary data is transferred in normal or swapped mode. This command affects only the byte order for setting and querying trace data for the :TRACe[:DATA], TRACe[:DATA]? , :CALCulate:DATA[n]? and FETCh:SANalyzer[n]? commands and queries.

By definition any command that says it uses FORMat:DATA uses any format supported by FORMat:DATA.

The NORMal order is a byte sequence that begins with the most significant byte (MSB) first, and ends with the least significant byte (LSB) last in the sequence: 1|2|3|4. SWAPped order is when the byte sequence begins with the LSB first, and ends with the MSB last in the sequence: 4|3|2|1.

Remote Command :FORMat:BORDER NORMa1 | SWAPped

	:FORMat:BORDER?
Preset	NORMal
Initial S/W Revision	Prior to A.02.00

Meas Setup

Displays the measurement setup menu for the currently selected measurement.

Key Path	Front-panel key
Initial S/W Revision	Prior to A.02.00

Avg/Hold Num

Specifies the number of measurement averages used to calculate the measurement result. The average is displayed at the end of each sweep.

Average State allows you to turn averaging on or off.

Key Path	Meas Setup
Mode	SA, WCDMA, C2K, WiMAX OFDMA, CDMA1xEVDO, TD-SCDMA, DVB-T/H, LTE, LTE-TDD, WLAN, MSR, LTE-FDD, LTE-TDD
Remote Command	<pre>[:SENSe]:SPURious:AVERage:COUnT <integer> [:SENSe]:SPURious:AVERage:COUnT? [:SENSe]:SPURious:AVERage[:STATe] ON OFF 1 0 [:SENSe]:SPURious:AVERage[:STATe]?</pre>
Example	<pre>SPUR:AVER:COUn 2500 SPUR:AVER:COUn? SPUR:AVER ON SPUR:AVER?</pre>
Notes	You must be in the Spectrum Analysis mode, W-CDMA mode, cdma2000 mode, DVB-T/H mode, TD-SCDMA mode, LTE mode, LTE TDD mode, WLAN mode, MSR, LTE-Advanced FDD/TDD mode or WiMAX mode to use this command. Use INSTRument:SElect to set the mode.
Preset	10 OFF
State Saved	Saved in instrument state.
Min	1
Max	10000
Initial S/W Revision	Prior to A.02.00
Modified at S/W Revision	A.03.00

Avg Mode

Enables you to set the averaging mode.

- When set to Exponential (Exp) the measurement averaging continues using the specified number of averages to compute each averaged value. The average will be displayed at the end of each sweep.

- When set to Repeat, the measurement resets the average counter each time the specified number of averages is reached.

Key Path	Meas Setup
Mode	SA, WCDMA, WIMAX OFDMA, TD-SCDMA, DVB-T/H, LTE, LTE-TDD, WLAN, MSR, LTEAFDD, LTEATDD
Remote Command	[:SENSe]:SPURious:AVERage:TCONtrol EXPonential REPeat [:SENSe]:SPURious:AVERage:TCONtrol?
Example	SPUR:AVER:TCON REP SPUR:AVER:TCON?
Notes	You must be in the cdma2000 mode, TD-SCDMA mode, W-CDMA mode, DVB-T/H mode, GSM/EDGE mode, LTE mode, LTE TDD mode, WLAN mode, MSR, LTE-Advanced FDD/TDD mode or WiMAX mode to use this command. Use INSTRument:SElect to set the mode.
Preset	EXPonential
State Saved	Saved in instrument state.
Range	Exp Repeat
Initial S/W Revision	Prior to A.02.00
Modified at S/W Revision	A.03.00

Range Table

Enables you to set range parameters.

To change a parameter, select the appropriate menu softkey and enter the value using the numeric keypad or the knob. The analyzer settings will be updated with the new parameter values.

When the current view is the Range Table view, the selected range is highlighted and displayed in the Range Table automatically. With the normal window arrangement, up to five ranges are displayed. In the zoom mode, all 20 ranges can be displayed.

In the Range Table window, there are three tables corresponding to each page of the Range Table menu. When the Range Table key is pressed, the table of the first menu page is displayed.

The Displayed table is changed by changing the Range Table menu page. It can also be changed by a remote command. When the Range Table is changed by the command, the menu page changes accordingly if the Range Table menu is displayed.

Key Path	Meas Setup
Initial S/W Revision	Prior to A.02.00

Min	1
Max	20
Initial S/W Revision	Prior to A.02.00
Modified at S/W Revision	A.03.00, A.10.00

Start Freq

Sets the start frequency of the analyzer. This parameter can send up to 20 values. The location where the start frequency occurs in the list sent to the measurement corresponds to the range the value is associated with.

Missing values are not permitted. If you want to change values 2 and 6 you must send all values up to 6. Subsequent values will remain as they were. The query for this parameter always returns 20 values.

Key Path	Meas Setup, Range Table
Mode	SA, WCDMA, C2K, WIMAX OFDMA, TD-SCDMA, 1xEV-DO, DVB-T/H, LTE, LTETDD, WLAN
Remote Command	[:SENSE]:SPURious[:RANGe][:LIST]:FREQuency:STARt <freq>, <freq>, <freq>, <freq>, <freq>, <freq>, <freq>, <freq>, <freq>, <freq>, <freq>, <freq>, <freq>, <freq>, <freq>, <freq>, <freq>, <freq> [:SENSE]:SPURious[:RANGe][:LIST]:FREQuency:STARt?
Example	SPUR:FREQ:STAR 9 kHz, 150 kHz, 30 MHz, 1GHz, 1.5 GHz, 1.5 GHz, 1.5 GHz, 1.5 GHz, 1.5 GHz, 1.5 GHz, 1.5 GHz, 1.5 GHz, 1.5 GHz, 1.5 GHz, 1.5 GHz, 1.5 GHz, 1.5 GHz, 1.5 GHz SPUR:FREQ:STAR?
Notes	You must be in cdma2000 mode, TD-SCDMA mode, W-CDMA mode, DVB-T/H, GSM/EDGE mode, LTE mode, LTE TDD mode, WLAN mode, MSR or WiMAX mode to use this command. Use INSTRument:SElect to set the mode.
Preset	SA, WIMAX OFDMA: +1.92000000E+009, +1.89350000E+009, +2.10000000E+009, +2.17500000E+009, +8.00000000E+008, +1.50000000E+009, +1.50000000E+009, +1.50000000E+009, +1.50000000E+009, +1.50000000E+009, +1.50000000E+009, +1.50000000E+009, +1.50000000E+009, +1.50000000E+009, +1.50000000E+009, +1.50000000E+009, +1.50000000E+009, +1.50000000E+009 WCDMA: 9kHz, 150kHz, 30MHz, 1GHz, 2.1GHz, 2.1GHz, 2.1774GHz, 2.18GHz, 1.5GHz, 1.5GHz, 1.5GHz, 1.5GHz, 1.5GHz, 1.5GHz, 1.5GHz, 1.5GHz, 1.5GHz, 1.5GHz, 1.5GHz C2K, 1xEV-DO: 9kHz, 150kHz, 30 MHz, 1GHz, 2.5GHz, 2.5GHz, 2.5GHz, 2.5 GHz, 2.5 GHz, 2.5 GHz, 2.5 GHz, 2.5 GHz, 2.5 GHz, 2.5 GHz, 2.5 GHz, 2.5 GHz, 2.5 GHz, 2.5 GHz, 2.5 GHz TD-SCDMA: 9 kHz, 150 kHz, 30 MHz, 1GHz, 1.5 GHz, 1.5 GHz, 1.5 GHz, 1.5 GHz, 1.5 GHz, 1.5 GHz, 1.5 GHz, 1.5 GHz, 1.5 GHz, 1.5 GHz, 1.5 GHz, 1.5 GHz DVB-T/H: 9kHz, 174MHz, 400MHz, 790MHz, 862MHz, 1GHz, 1.5GHz, 1.5GHz, 1.5GHz, 1.5GHz, 1.5GHz, 1.5GHz, 1.5GHz, 1.5GHz, 1.5GHz, 1.5GHz LTE, MSR: 9 kHz, 150 kHz, 30 MHz, 1 GHz, 1.92GHz, 1.98 GHz, 2.18 GHz, 1.5 GHz, 1.5 GHz, 1.5

	GHz, 1.5 GHz, 1.5 GHz, 1.5 GHz, 1.5 GHz, 1.5 GHz, 1.5 GHz, 1.5 GHz, 1.5 GHz, 1.5 GHz, 1.5 GHz, 1.5 GHz LTETDD: 9 kHz, 150 kHz, 30 MHz, 1 GHz, 1.90GHz, 2.01 GHz, 2.025 GHz, 1.5 GHz, 1.5 GHz, 1.5 GHz, 1.5 GHz, 1.5 GHz, 1.5 GHz, 1.5 GHz, 1.5 GHz, 1.5 GHz, 1.5 GHz WLAN: 9 kHz, 150 kHz, 30 MHz, 1 GHz, 1.5 GHz, 1.5 GHz, 1.5 GHz, 1.5 GHz, 1.5 GHz, 1.5 GHz, 1.5 GHz, 1.5 GHz, 1.5 GHz, 1.5 GHz, 1.5 GHz, 1.5 GHz
State Saved	Saved in instrument state.
Min	-80 MHz
Max	Hardware Dependent: Option 503: 3699999990 Option 508: 8499999990 Option 513: 13799999990 Option 526: 26999999990
Initial S/W Revision	Prior to A.02.00
Modified at S/W Revision	A.03.00

Stop Freq

Sets the stop frequency of the analyzer. This parameter can send up to 20 values.

The location of where the stop frequency occurs in the list sent to the measurement corresponds to the range the value is associated with.

Missing values are not permitted. If you want to change values 2 and 6 you must send all values up to 6. Subsequent values will remain as they were. The query for this parameter always returns 20 values.

Key Path	Meas Setup, Range Table
Mode	SA, WCDMA, C2K, WIMAX OFDMA, TD-SCDMA, 1xEV-DO, DVB-T/H, WLAN
Remote Command	<pre>[:SENSe]:SPURious[:RANGe][:LIST]:FREQuency:STOP <freq>, <freq>, <freq>, <freq>, <freq>, <freq>, <freq>, <freq>, <freq>, <freq>, <freq>, <freq>, <freq>, <freq>, <freq>, <freq>, <freq>, <freq>, <freq>, <freq> [:SENSe]:SPURious[:RANGe][:LIST]:FREQuency:STOP?</pre>
Example	<pre>SPUR:FREQ:STOP 150kHz, 30MHz, 1GHz, 2.1GHz, 2.1GHz, 2.1774GHz, 2.18GHz, 12.75GHz, 2.5GHz, 2.5GHz, 2.5GHz, 2.5GHz, 2.5GHz, 2.5GHz, 2.5GHz, 2.5GHz, 2.5GHz, 2.5GHz, 2.5GHz SPUR:FREQ:STOP?</pre>
Notes	You must be in cdma2000 mode, TD-SCDMA mode, W-CDMA mode, DVB-T/H, GSM/EDGE mode, LTE mode, LTE TDD mode, WLAN mode, MSR or WiMAX mode to use this command. Use INSTRument:SElect to set the mode.
Preset	SA, WIMAX OFDMA:+1.98000000E+009, +1.91960000E+009, +2.10150000E+009, +2.18000000E+009, +1.00000000E+009, +2.50000000E+009, +2.50000000E+009, +2.50000000E+009, +2.50000000E+009, +2.50000000E+009, +2.50000000E+009, +2.50000000E+009, +2.50000000E+009, +2.50000000E+009, +2.50000000E+009,

	+2.50000000E+009, +2.50000000E+009, +2.50000000E+009, +2.50000000E+009, +2.50000000E+009 WCDMA:150kHz, 30MHz, 1GHz, 2.1GHz, 2.1GHz, 2.1774GHz, 2.18GHz, 12.75GHz, 2.5GHz, 2.5GHz, 2.5GHz, 2.5GHz, 2.5GHz, 2.5GHz, 2.5GHz, 2.5GHz, 2.5GHz, 2.5GHz, 2.5GHz C2K, 1xEV-DO: 150kHz, 30 MHz, 1GHz, 5GHz, 2.5GHz, 2.5GHz, 2.5GHz, 2.5 GHz, 2.5 GHz, 2.5 GHz, 2.5 GHz, 2.5 GHz, 2.5 GHz, 2.5 GHz, 2.5 GHz, 2.5 GHz, 2.5 GHz, 2.5 GHz TD-SCDMA: 150kHz, 30 MHz, 1GHz, 12.75GHz, 2.5 GHz, 2.5 GHz, 2.5 GHz, 2.5 GHz, 2.5 GHz, 2.5 GHz, 2.5 GHz, 2.5 GHz, 2.5 GHz, 2.5 GHz, 2.5 GHz, 2.5 GHz, 2.5 GHz, 2.5 GHz DVB-T/H: 174MHz, 400MHz, 790MHz, 862MHz, 1GHz, 4.5GHz, 2.5GHz, 2.5GHz, 2.5GHz, 2.5GHz, 2.5GHz, 2.5GHz, 2.5GHz, 2.5GHz, 2.5GHz, 2.5GHz, 2.5GHz, 2.5GHz, 2.5GHz LTE, MSR: 150kHz, 30MHz, 1GHz, 1.92GHz, 1.98GHz, 2.1GHz, 12.75GHz, 2.5GHz, 2.5GHz, 2.5GHz, 2.5GHz, 2.5GHz, 2.5GHz, 2.5GHz, 2.5GHz, 2.5GHz, 2.5GHz, 2.5GHz, 2.5GHz LTETDD: 150kHz, 30MHz, 1GHz, 1.90GHz, 2.01GHz, 2.025GHz, 12.75GHz, 2.5GHz, 2.5GHz, 2.5GHz, 2.5GHz, 2.5GHz, 2.5GHz, 2.5GHz, 2.5GHz, 2.5GHz, 2.5GHz, 2.5GHz, 2.5GHz WLAN: 150 kHz, 30 MHz, 1 GHz, 12.75 GHz, 2.5 GHz, 2.5 GHz, 2.5 GHz, 2.5 GHz, 2.5 GHz, 2.5 GHz, 2.5 GHz, 2.5 GHz, 2.5 GHz, 2.5 GHz, 2.5 GHz, 2.5 GHz, 2.5 GHz, 2.5 GHz, 2.5 GHz
State Saved	Saved in instrument state.
Min	-799999990
Max	Hardware Dependent: Option 503: 3.7 GHz Option 508: 8.5 GHz Option 513: 13.8 GHz Option 526: 27.0 GHz
Initial S/W Revision	Prior to A.02.00
Modified at S/W Revision	A.03.00

Res BW

Sets the resolution bandwidth of the analyzer. This parameter can send up to 20 values.

The location of where the resolution bandwidth occurs in the list sent to the measurement corresponds to the range the value is associated with.

Missing values are not permitted. In other words, if you want to change values 2 and 6 you must send all values up to 6. Subsequent values will remain as they were. The query for this parameter always returns 20 values.

Key Path	Meas Setup, Range Table
Mode	SA, WCDMA, C2K, WIMAX OFDMA, TD-SCDMA, 1xEV-DO, DVB-T/H, LTE, LTETDD, WLAN, MSR, LTEAFDD, LTEATDD
Remote Command	[:SENSe] : SPURious [:RANGe] [:LIST] : BANDwidth [:RESolution] <freq>, <freq>, <freq>, <freq>, <freq>, <freq>, <freq>, <freq>, <freq>, <freq>, <freq>, <freq>, <freq>, <freq>, <freq>, <freq>, <freq>

	<pre> <freq>, <freq>, <freq> [:SENSE]:SPURious[:RANGe][:LIST]:BANDwidth[:RESolution]? [:SENSE]:SPURious[:RANGe][:LIST]:BANDwidth[:RESolution]:AUTO OFF ON 0 1, OFF ON 0 1, OFF ON 0 1, OFF ON 0 1, OFF ON 0 1, OFF ON 0 1, OFF ON 0 1, OFF ON 0 1, OFF ON 0 1, OFF ON 0 1, OFF ON 0 1, OFF ON 0 1, OFF ON 0 1, OFF ON 0 1, OFF ON 0 1, OFF ON 0 1, OFF ON 0 1, OFF ON 0 1, OFF ON 0 1, OFF ON 0 1 [:SENSE]:SPURious[:RANGe][:LIST]:BANDwidth[:RESolution]:AUTO? </pre>
Example	<pre> SPUR:BAND 1kHz, 10kHz, 100kHz, 1MHz, 1MHz, 1MHz, 1MHz, 3MHz, 3MHz, 3MHz, 3MHz, 3MHz, 3MHz, 3MHz, 3MHz, 3MHz, 3MHz, 3MHz, 3MHz, 3MHz SPUR:BAND? SPUR:BWID:AUTO ON, ON, ON, OFF, OFF, OFF, OFF, OFF, ON, ON, ON, ON, OFF, OFF, OFF, OFF, OFF, OFF, ON, ON SPUR:BWID:AUTO? </pre>
Notes	<p>You must be in cdma2000 mode, TD-SCDMA mode, W-CDMA mode, DVB-T/H, GSM/EDGE mode, LTE mode, LTE TDD mode, WLAN mode, MSR, LTE-Advanced FDD/TDD mode or WiMAX mode to use this command. Use INSTRument:SElect to set the mode.</p>
Preset	<pre> SA, WIMAX OFDMA:1.2MHz, 0.51MHz, 0.1MHz, 0.1MHz, 4MHz, 3MHz, 3MHz, 3MHz, 3MHz, 3MHz, 3MHz, 3MHz, 3MHz, 3MHz, 3MHz, 3MHz, 3MHz, 3MHz, 3MHz, 3MHz WCDMA:1kHz, 10kHz, 100kHz, 1MHz, 1MHz, 1MHz, 1MHz, 1MHz, 3MHz, 3MHz, 3MHz, 3MHz, 3MHz, 3MHz, 3MHz, 3MHz, 3MHz, 3MHz, 3MHz, 3MHz C2k, 1xEV-DO: 1kHz, 10kHz, 100kHz, 1MHz, 1MHz, 1MHz, 1MHz, 3MHz, 3MHz, 3MHz, 3MHz, 3MHz, 3MHz, 3MHz, 3MHz, 3MHz, 3MHz, 3MHz, 3MHz TD-SCDMA: 1kHz, 10kHz, 100kHz, 1MHz, 3MHz, 3MHz, 3MHz, 3MHz, 3MHz, 3MHz, 3MHz, 3MHz, 3MHz, 3MHz, 3MHz, 3MHz, 3MHz, 3MHz, 3MHz, 3MHz DVB-T/H: 100kHz, 3.9kHz, 100kHz, 3.9kHz, 100kHz, 100kHz, 3MHz, 3MHz, 3MHz, 3MHz, 3MHz, 3MHz, 3MHz, 3MHz, 3MHz, 3MHz, 3MHz, 3MHz, 3MHz LTE, MSR, LTEAFDD: 1kHz, 10kHz, 100kHz, 1MHz, 100kHz, 1MHz, 1MHz, 3MHz, 3MHz, 3MHz, 3MHz, 3MHz, 3MHz, 3MHz, 3MHz, 3MHz, 3MHz, 3MHz LTETDD, LTEATDD: 1kHz, 10kHz, 100kHz, 1MHz, 1MHz, 1MHz, 1MHz, 3MHz, 3MHz, 3MHz, 3MHz, 3MHz, 3MHz, 3MHz, 3MHz, 3MHz, 3MHz, 3MHz WLAN: 1kHz, 10kHz, 100kHz, 1MHz, 3MHz, 3MHz, 3MHz, 3MHz, 3MHz, 3MHz, 3MHz, 3MHz, 3MHz, 3MHz, 3MHz, 3MHz, 3MHz, 3MHz, 3MHz SA, WIMAX OFDMA:OFF, OFF, OFF, OFF, OFF, ON, ON, ON, ON, ON, ON, ON, ON, ON, ON, ON, ON, ON, ON, ON WCDMA:OFF, OFF, OFF, OFF, OFF, OFF, OFF, OFF, ON, ON, ON, ON, ON, ON, ON, ON, ON, ON, ON C2k, 1xEV-DO:OFF, OFF, OFF, OFF, OFF, OFF, OFF, ON, ON, ON, ON, ON,ON,ON,ON,ON,ON,ON,ON,ON TD-SCDMA: OFF, OFF, OFF, OFF, ON, ON, ON, ON, ON, ON, ON, ON, ON, ON, ON, ON, ON, ON, ON DVB-T/H: OFF, OFF, OFF, OFF, OFF, OFF, ON, ON, ON, ON, ON, ON, ON, ON, ON, ON, ON, ON </pre>

	GAUS, GAUS, GAUS, GAUS, GAUS, GAUS, GAUS
State Saved	Saved in instrument state.
Range	Gaussian (Normal) Flattop
Backwards Compatibility SCPI	[:SENSe] : SPURious [:RANGe] [:LIST] : BWIDth : SHAPE
Initial S/W Revision	Prior to A.02.00
Modified at S/W Revision	A.03.00

Abs Start Limit

Determines the limit above which spurs will report a failing. If Abs Stop Limit Mode is set to Auto, this is coupled to Abs Stop Limit to make a flat limit line. If set to Man, Abs Start Limit and Abs Stop Limit can take different values to make a sloped limit line.

If the Limit Line Test parameter is off then any spurs which are found to be above the current 'Peak Excursion' will be added to the results table. From these spurs, the amplitude will be checked using the abs limit start and abs limit stop parameters and then calculate the limit. An 'F' will be appended to the amplitude value of the spur if the measured amplitude is above the limit. If the Limit Line Test is on, only the spurs whose amplitudes exceed the limit will be reported.

This parameter can send up to 20 values. The location in the list sent corresponds to the range of the associated value. Missing values are not permitted. If you want to change values 2 and 6 you must send all values up to 6. Subsequent values will remain as they were. The query for this parameter always returns 20 values.

Key Path	Meas Setup, Range Table
Mode	SA, WCDMA, C2K, WIMAX OFDMA, TD-SCDMA, 1xEV-DO, DVB-T/H, LTE, LTE-TDD, WLAN, MSR, LTEAFDD, LTEATDD
Remote Command	:CALCulate:SPURious[:RANGe][:LIST]:LIMit:ABSolute[:UPPer]:DATA [:START] <ampl>, <ampl>, <ampl>, <ampl>, <ampl>, <ampl>, <ampl>, <ampl>, <ampl>, <ampl>, <ampl>, <ampl>, <ampl>, <ampl>, <ampl>, <ampl>, <ampl>, <ampl>, <ampl>, <ampl> :CALCulate:SPURious[:RANGe][:LIST]:LIMit:ABSolute[:UPPer]:DATA [:START]?
Example	CALC:SPUR:LIM:ABS:DATA 0, 0, 0, 0, 0, 0, 0, 0, 0, 0, 0, 0, 0, 0, 0, 0, 0, 0, 0, 0 CALC:SPUR:LIM:ABS:DATA?
Preset	SA, WIMAX OFDMA: -5.00000000E+001, -5.00000000E+001, -5.00000000E+001, -5.00000000E+001, -5.00000000E+001, -5.00000000E+001, -5.00000000E+001, -5.00000000E+001, -5.00000000E+001, -5.00000000E+001, -5.00000000E+001, -5.00000000E+001, -5.00000000E+001, -5.00000000E+001, -5.00000000E+001, -5.00000000E+001, -5.00000000E+001, -5.00000000E+001, -5.00000000E+001, -5.00000000E+001 WCDMA: -36dBm, -36dBm, -36dBm, -30dBm, -25dBm, -15dBm, -25dBm, -30dBm, -50dBm, -50dBm, -50dBm, -50dBm, -50dBm, -50dBm, -50dBm, -50dBm, -50dBm, -50dBm, -50dBm, -50dBm, -50dBm

	50dBm
	C2K, 1xEV-DO: -13 dBm, -13dBm, -13 dBm, -13 dBm, -50 dBm, -50 dBm, -50 dBm, -50 dBm, -50 dBm, -50 dBm, -50 dBm, -50 dBm, -50 dBm, -50 dBm, -50 dBm, -50 dBm, -50 dBm, -50 dBm, -50 dBm, -50 dBm
	TD-SCDMA: -13 dBm, -13dBm, -13 dBm, -13 dBm, -50 dBm, -50 dBm, -50 dBm, -50 dBm, -50 dBm, -50 dBm, -50 dBm, -50 dBm, -50 dBm, -50 dBm, -50 dBm, -50 dBm, -50 dBm, -50 dBm, -50 dBm, -50 dBm
	DVB-T/H: -36dBm, -82dBm, -36dBm, -76dBm, -36dBm, -30dBm, -50dBm, -50dBm, -50dBm, -50dBm, -50dBm, -50dBm, -50dBm, -50dBm, -50dBm, -50dBm, -50dBm, -50dBm, -50dBm, -50dBm, -50dBm
	LTE, MSR, LTEAFDD: -36dBm, -36dBm, -36dBm, -30dBm, -96dBm, -30dBm, -30dBm, -50dBm, -50dBm, -50dBm, -50dBm, -50dBm, -50dBm, -50dBm, -50dBm, -50dBm, -50dBm, -50dBm, -50dBm, -50dBm, -50dBm
	LTETDD, LTEATDD: -36dBm, -36dBm, -36dBm, -30dBm, -96dBm, -30dBm, -30dBm, -50dBm, -50dBm, -50dBm, -50dBm, -50dBm, -50dBm, -50dBm, -50dBm, -50dBm, -50dBm, -50dBm, -50dBm, -50dBm, -50dBm
	WLAN: -36dBm, -36dBm, -36dBm, -30dBm, -50dBm, -50dBm, -50dBm, -50dBm, -50dBm, -50dBm, -50dBm, -50dBm, -50dBm, -50dBm, -50dBm, -50dBm, -50dBm, -50dBm, -50dBm, -50dBm, -50dBm

State Saved	Saved in instrument state.
Min	-200 dBm
Max	50.0 dBm
Initial S/W Revision	Prior to A.02.00
Modified at S/W Revision	A.03.00

Abs Stop Limit

Abs Stop Limit is used to determine the limit above which spurs will report a failing. If Abs Stop Limit Mode is set to Auto, this is coupled to Abs Start Limit to make a flat limit line. If set to Man, Abs Start Limit and Abs Stop Limit can take different values to make a sloped limit line.

Abs Stop Limit Mode, when set to Couple, couples Abs Start Limit and Abs Stop Limit to make a flat limit line. If set to Man, Abs Start and Abs Stop can take different values to make a sloped limit line.

This parameter can send up to 20 values. The location in the list sent corresponds to the range of the associated value. Missing values are not permitted; that is, if you want to change values 2 and 6 you must send all values up to 6. Subsequent values will remain as they were. The query for this parameter always returns 20 values.

Key Path	Meas Setup, Range Table
Mode	SA, WCDMA, C2K, WIMAX OFDMA, TD-SCDMA, 1xEV-DO, DVB-T/H, LTE, LTETDD, WLAN, MSR, LTEAFDD, LTEATDD

Remote Command	<pre> :CALCulate:SPURious[:RANGe][:LIST]:LIMit:ABSolute[:UPPer]:DATA:STOP <ampl>, <ampl>, <ampl>, <ampl>, <ampl>, <ampl>, <ampl>, <ampl>, <ampl>, <ampl>, <ampl>, <ampl>, <ampl>, <ampl>, <ampl>, <ampl>, <ampl>, <ampl>, <ampl>, <ampl> :CALCulate:SPURious[:RANGe][:LIST]:LIMit:ABSolute[:UPPer]:DATA:STOP? :CALCulate:SPURious[:RANGe][:LIST]:LIMit:ABSolute [:UPPer]:DATA:STOP:AUTO OFF ON 0 1, OFF ON 0 1 :CALCulate:SPURious[:RANGe][:LIST]:LIMit:ABSolute [:UPPer]:DATA:STOP:AUTO? </pre>
Example	<pre> CALC:SPUR:LIM:ABS:DATA:STOP -25, -25, -25, -25, -25, -25, -25, -25, -25, -25, -25, -25, -25, - 25, -25, -25, -25, -25, -25 CALC:SPUR:LIM:ABS:DATA:STOP? CALC:SPUR:LIM:ABS:DATA:STOP:AUTO ON, ON CALC:SPUR:LIM:ABS:DATA:STOP:AUTO? </pre>
Preset	<pre> SA, WIMAX OFDMA: -5.00000000E+001, -5.00000000E+001, -5.00000000E+001, - 5.00000000E+001, -5.00000000E+001, -5.00000000E+001, -5.00000000E+001, - 5.00000000E+001, -5.00000000E+001, -5.00000000E+001, -5.00000000E+001, - 5.00000000E+001, -5.00000000E+001, -5.00000000E+001, -5.00000000E+001, - 5.00000000E+001, -5.00000000E+001, -5.00000000E+001, -5.00000000E+001, - 5.00000000E+001 WCDMA: -36dBm, -36dBm, -36dBm, -30dBm, -25dBm, -15dBm, -25dBm, -30dBm, -50dBm, - 50dBm, -50dBm, -50dBm, -50dBm, -50dBm, -50dBm, -50dBm, -50dBm, -50dBm, - 50dBm C2K, 1xEV-DO: -13 dBm, -13dBm, -13 dBm, -13 dBm, -50 dBm, -50 dBm, -50 dBm, -50 dBm, -50 dBm, -50 dBm, -50 dBm, -50 dBm, -50 dBm, -50 dBm, -50 dBm, -50 dBm, -50 dBm, -50 dBm, -50 dBm, -50 dBm TD-SCDMA: -13 dBm, -13dBm, -13 dBm, -13 dBm, -50 dBm, -50 dBm, -50 dBm, -50 dBm, -50 dBm, -50 dBm, -50 dBm, -50 dBm, -50 dBm, -50 dBm, -50 dBm, -50 dBm, -50 dBm, -50 dBm, -50 dBm DVB-T/H: -36dBm, -82dBm, -36dBm, -76dBm, -36dBm, -30dBm, -50dBm, -50dBm, -50dBm, -50dBm, - 50dBm, -50dBm, -50dBm, -50dBm, -50dBm, -50dBm, -50dBm, -50dBm, -50dBm, -50dBm LTE, MSR, LTEAFDD: -36dBm, -36dBm, -36dBm, -30dBm, -96dBm, -30dBm, -30dBm, -50dBm, -50dBm, -50dBm, -50dBm, -50dBm, -50dBm, -50dBm, -50dBm, -50dBm, -50dBm, -50dBm, -50dBm, -50dBm LTETDD, LTEATDD: -36dBm, -36dBm, -36dBm, -52dBm, -52dBm, -30dBm, -30dBm, -50dBm, - 50dBm, -50dBm, -50dBm, -50dBm, -50dBm, -50dBm, -50dBm, -50dBm, -50dBm, -50dBm, - 50dBm, -50dBm WLAN: </pre>

Pk Threshold

Sets the minimum amplitude of signals that can be identified as peaks. For example, if a value of -90 dBm is selected, only peaks that rise and fall more than the peak excursion value which are above -90 dBm are identified.

This parameter can send up to 20 values. The location in the list sent corresponds to the range of the associated value. Missing values are not permitted. If you want to change values 2 and 6 you must send all values up to 6. Subsequent values will remain as they were. The query for this parameter always returns 20 values.

Key Path	Meas Setup, Range Table
Mode	SA, WCDMA, C2K, WIMAX OFDMA, TD-SCDMA, 1xEV-DO, DVB-T/H, LTE, LTETDD, WLAN, MSR, LTEAFDD, LTEATDD
Remote Command	[:SENSE]:SPURious[:RANGe][:LIST]:PEAK:THReshold <real>, <real>, <real>, <real>, <real>, <real>, <real>, <real>, <real>, <real>, <real>, <real>, <real>, <real>, <real>, <real>, <real>, <real>, <real>, <real> [:SENSE]:SPURious[:RANGe][:LIST]:PEAK:THReshold?
Example	SPUR:PEAK:THR 0,0,0 SPUR:PEAK:THR?
Preset	-9.00000000E+001, -9.00000000E+001, -9.00000000E+001, -9.00000000E+001, -9.00000000E+001, -9.00000000E+001, -9.00000000E+001, -9.00000000E+001, -9.00000000E+001, -9.00000000E+001, -9.00000000E+001, -9.00000000E+001, -9.00000000E+001, -9.00000000E+001, -9.00000000E+001, -9.00000000E+001, -9.00000000E+001, -9.00000000E+001, -9.00000000E+001, -9.00000000E+001
State Saved	Saved in instrument state.
Min	-200
Max	0
Initial S/W Revision	Prior to A.02.00
Modified at S/W Revision	A.03.00, A.07.00

Attenuation

Defines attenuation value for each range.

- When Auto state is ON, attenuation value under AMPTD Y Scale is used.
- When Auto state is OFF, this value is used as mechanical attenuation value without electric attenuation.

Key Path	Meas Setup, Range Table
Mode	SA, WCDMA, C2K, WIMAX OFDMA, TD-SCDMA, 1xEV-DO, DVB-T/H, LTE, LTETDD, WLAN, MSR, LTEAFDD, LTEATDD
Remote Command	[:SENSE]:SPURious[:RANGe][:LIST]:ATTenuation <rel_ampl>, <rel_ampl>, <rel_ampl>, <rel_ampl>, <rel_ampl>, <rel_

	<pre> ampl>, <rel_ampl>, <rel_ampl>, <rel_ampl>, <rel_ampl>, <rel_ampl>, <rel_ampl>, <rel_ampl>, <rel_ampl>, <rel_ampl>, <rel_ampl>, <rel_ ampl>, <rel_ampl> [:SENSE]:SPURious[:RANGe][:LIST]:ATTenuation? [:SENSE]:SPURious[:RANGe][:LIST]:ATTenuation:AUTO OFF ON 0 1, OFF ON 0 1, OFF ON 0 1, OFF ON 0 1, OFF ON 0 1, OFF ON 0 1, OFF ON 0 1, OFF ON 0 1, OFF ON 0 1, OFF ON 0 1, OFF ON 0 1, OFF ON 0 1, OFF ON 0 1, OFF ON 0 1, OFF ON 0 1, OFF ON 0 1, OFF ON 0 1, OFF ON 0 1, OFF ON 0 1, OFF ON 0 1 [:SENSE]:SPURious[:RANGe][:LIST]:ATTenuation:AUTO? </pre>
Example	<pre> SPUR:ATT 10dB, 10dB, 10dB, 10dB, 10dB, 10dB, 10dB, 10dB, 10dB, 10dB, 10dB, 10dB, 10dB, 10dB, 10dB, 10dB, 10dB, 10dB, 10dB SPUR:ATT? SPUR:ATT:AUTO 0, 0, 0, 0, 0, 0, 0, 0, 0, 0, 0, 0, 0, 0, 0, 0, 0, 0, 0 SPUR:ATT:AUTO? </pre>
Notes	You must be in cdma2000 mode, 1xEV-DO mode, TD-SCDMA mode, W-CDMA mode, DVB-T/H, SA mode, LTE mode, LTE TDD mode, WLAN mode, MSR, LTE-Advanced FDD/TDD or WiMAX mode to use this command. Use INSTRUMENT:SElect to set the mode.
Couplings	“---” is displayed as value when Auto state is ON, to indicate attenuation value under AMPTD Y Scale is being used.
Preset	<pre> 10dB, 10dB, 10dB, 10dB, 10dB, 10dB, 10dB, 10dB, 10dB, 10dB, 10dB, 10dB, 10dB, 10dB, 10dB, 10dB, 10dB, 10dB, 10dB ON, ON, ON, ON, ON, ON, ON, ON, ON, ON, ON, ON, ON, ON, ON, ON, ON, ON, ON </pre>
State Saved	Saved in instrument state.
Min	0 dB
Max	70 dB
Initial S/W Revision	Prior to A.02.00
Modified at S/W Revision	A.03.00

Detector 1

Sets the detector to be used by the trace for spur detection and limit line testing.

Key Path	Meas Setup, Range Table
Mode	SA, WCDMA, C2K, WIMAX OFDMA, TD-SCDMA, 1xEV-DO, DVB-T/H, LTE, LTETDD, WLAN, MSR, LTEAFDD, LTEATDD
Remote Command	<pre> [:SENSE]:SPURious[:RANGe][:LIST]:DETEctor[1][:FUNctIon] AVERAge NEGAtive NORMAl POSitive SAMPlE RMS, AVERAge NEGAtive NORMAl POSitive SAMPlE RMS, AVERAge NEGAtive NORMAl POSitive SAMPlE RMS, AVERAge NEGAtive NORMAl POSitive SAMPlE RMS, AVERAge NEGAtive NORMAl POSitive SAMPlE RMS, AVERAge NEGAtive NORMAl POSitive SAMPlE RMS, AVERAge NEGAtive NORMAl POSitive SAMPlE RMS, AVERAge NEGAtive NORMAl POSitive SAMPlE RMS, AVERAge NEGAtive NORMAl </pre>

	POSitive SAMPlE RMS, AVERAge NEGative NORMal POSitive SAMPlE RMS, AVERAge NEGative NORMal POSitive SAMPlE RMS, AVERAge NEGative NORMal POSitive SAMPlE RMS, AVERAge NEGative NORMal POSitive SAMPlE RMS, AVERAge NEGative NORMal POSitive SAMPlE RMS, AVERAge NEGative NORMal POSitive SAMPlE RMS, AVERAge NEGative NORMal POSitive SAMPlE RMS, AVERAge NEGative NORMal POSitive SAMPlE RMS, AVERAge NEGative NORMal POSitive SAMPlE RMS, AVERAge NEGative NORMal POSitive SAMPlE RMS, AVERAge NEGative NORMal POSitive SAMPlE RMS [:SENSe]:SPURious[:RANGe][:LIST]:DETEctor[1][:FUNction]?
Example	SPUR:DET NORM, NORM, NORM, NORM, NORM, NORM, NORM, NORM, NORM, NORM, NORM, NORM, NORM, NORM, NORM, NORM, NORM, NORM, NORM SPUR:DET?
Notes	For backward compatibility, "NORMal" is available as a SCPI command parameter. However this is treated the same as "RMS" internally, so the query never returns "NORMal" as its results.
Preset	POS, POS, POS, POS, POS, POS, POS, POS, POS, POS, POS, POS, POS, POS, POS, POS, POS, POS, POS
State Saved	Saved in instrument state.
Range	Normal Average Peak Sample Negative Peak
Initial S/W Revision	Prior to A.02.00
Modified at S/W Revision	A.03.00

Detector 2

Sets the detector to be used by the trace for display purposes only.

Key Path	Meas Setup, Range Table
Mode	SA, WCDMA, C2K, WIMAX OFDMA, TD-SCDMA, 1xEV-DO, DVB-T/H, LTE, LTETDD, WLAN, MSR, LTEAFDD, LTEATDD
Remote Command	[:SENSe]:SPURious[:RANGe][:LIST]:DETEctor2[:FUNction] OFF AVERAge NEGative NORMal POSitive SAMPlE RMS, OFF AVERAge NEGative NORMal POSitive SAMPlE RMS, OFF AVERAge NEGative NORMal POSitive SAMPlE RMS, OFF AVERAge NEGative NORMal POSitive SAMPlE RMS, OFF AVERAge NEGative NORMal POSitive SAMPlE RMS, OFF AVERAge NEGative NORMal POSitive SAMPlE RMS, OFF AVERAge NEGative NORMal POSitive SAMPlE RMS, OFF AVERAge NEGative NORMal POSitive SAMPlE RMS, OFF AVERAge NEGative NORMal POSitive SAMPlE RMS, OFF AVERAge NEGative NORMal POSitive SAMPlE RMS, OFF AVERAge NEGative NORMal POSitive SAMPlE RMS, OFF AVERAge NEGative NORMal POSitive SAMPlE RMS, OFF AVERAge NEGative NORMal POSitive SAMPlE RMS, OFF AVERAge NEGative NORMal POSitive SAMPlE RMS, OFF AVERAge NEGative NORMal POSitive SAMPlE RMS, OFF AVERAge NEGative NORMal POSitive SAMPlE RMS, OFF AVERAge NEGative NORMal POSitive SAMPlE RMS, OFF AVERAge NEGative NORMal POSitive SAMPlE RMS, OFF AVERAge

	<pre> NEGative NORMal POSitive SAMPlE RMS, OFF AVERage NEGative NORMal POSitive SAMPlE RMS [:SENSe]:SPURious[:RANGe][:LIST]:DETEctor2[:FUNction]? </pre>
Example	<pre> SPUR:DET2 AVER, AVER, AVER, AVER, AVER, AVER, AVER, AVER, AVER, AVER, AVER, AVER, AVER, AVER, AVER, AVER, AVER, AVER, AVER, AVER SPUR:DET2? </pre>
Notes	For backward compatibility, "NORMal" is available as a SCPI command parameter. However this is treated same as "RMS" internally, so the query never returns "NORMal" as its results.
Preset	OFF, OFF, OFF, OFF, OFF, OFF, OFF, OFF, OFF, OFF, OFF, OFF, OFF, OFF, OFF, OFF, OFF, OFF
State Saved	Saved in instrument state.
Range	Off Normal Average Peak Sample Negative Peak
Initial S/W Revision	Prior to A.02.00
Modified at S/W Revision	A.03.00

Sweep Time

Sets the sweep time mode of the analyzer. This can be Auto, where the analyzer determines the optimum setting, or Manual, where you determine the setting.

This parameter can send up to 20 values. The location in the list sent corresponds to the range of the associated value. Missing values are not permitted. If you want to change values 2 and 6 you must send all values up to 6. Subsequent values will remain as they were. The query for this parameter always returns 20 values.

Key Path	Meas Setup, Range Table
Mode	SA, WCDMA, C2K, WIMAX OFDMA, TD-SCDMA, 1xEV-DO, DVB-T/H, LTE, LTETDD, WLAN, MSR, LTEAFDD, LTEATDD
Remote Command	<pre> [:SENSe]:SPURious[:RANGe][:LIST]:SWEep:TIME <time>, <time>, <time>, <time>, <time>, <time>, <time>, <time>, <time>, <time>, <time>, <time>, <time>, <time>, <time>, <time>, <time>, <time> [:SENSe]:SPURious[:RANGe][:LIST]:SWEep:TIME? [:SENSe]:SPURious[:RANGe][:LIST]:SWEep:TIME:AUTO OFF ON 0 1,OFF ON 0 1,OFF ON 0 1,OFF ON 0 1,OFF ON 0 1,OFF ON 0 1,OFF ON 0 1,OFF ON 0 1,OFF ON 0 1,OFF ON 0 1,OFF ON 0 1,OFF ON 0 1,OFF ON 0 1,OFF ON 0 1,OFF ON 0 1,OFF ON 0 1 [:SENSe]:SPURious[:RANGe][:LIST]:SWEep:TIME:AUTO? </pre>
Example	<pre> SPUR:SWE:TIME 10, 10, 10, 10, 10, 10, 10, 10, 10, 10, 10, 10, 10, 10, 10, 10, 10, 10 SPUR:SWE:TIME? SPUR:SWE:TIME:AUTO ON, ON SPUR:SWE:TIME:AUTO? </pre>

	SPUR:SWE:POIN:AUTO ON,ON,ON SPUR:SWE:POIN:AUTO?
Preset	SA, WIMAX OFDMA, DVB-T/H, WLAN: +601, +601, +601, +601, +601, +601, +601, +601, +601, +601, +601, +601, +601, +601, +601 WCDMA: 601, 2985, 9700, 1100, 601, 601, 601, 10570, 601, 601, 601, 601, 601, 601, 601, 601 C2K: 601, 601, 9970, 11750, , 601, 601, 601, 601, 601, 601, 601, 601, 601, 601, 601, 601, 601, 601, 601 CDMA1xEVDO: 601, 601, 9970, 11750, 601, 601, 601, 10570, 601, 601, 601, 601, 601, 601, 601, 601 TD-SCDMA: 601, 5970, 19400, 20001, 601, 601, 601, 601, 601, 601, 601, 601, 601, 601, 601, 601, 601, 601 LTE, LTETDD, MSR, LTEAFDD, LTEATDD : Automatically calculated. WLAN: Automatically calculated. OFF, OFF, OFF, OFF, OFF, OFF, OFF, OFF, OFF, OFF, OFF, OFF, OFF, OFF, OFF, OFF, OFF, OFF, OFF, OFF LTE, LTETDD, WLAN, MSR, LTEAFDD, LTEATDD: ON, ON, ON, ON, ON, ON, ON, ON, ON, ON, ON, ON, ON, ON, ON, ON, ON, ON, ON, ON
State Saved	Saved in instrument state.
Min	101
Max	20001
Initial S/W Revision	Prior to A.02.00
Modified at S/W Revision	A.03.00

IF Gain

Sets the IF Gain function to Auto, On (the extra 10 dB) or Off. These settings affect sensitivity and IF overloads. A switched IF amplifier with approximately 10 dB of gain is available. This amplifier takes full advantage of the RF dynamic range of the analyzer. When it can be turned on without an overload, the dynamic range is always better with the amplifier on than off.

Key Path	Meas Setup, Range Table
Dependencies	The IF Gain keys (FFT IF Gain and Swept IF Gain) have no effect when the U7227A USB Preamp is connected. This is not annotated or reflected on any softkey; there are no keys grayed out nor any SCPI locked out. The analyzer simply behaves as though both FFT IF Gain and Swept IF Gain are set to Low regardless of the setting on the keys.
Initial S/W Revision	Prior to A.02.00

IF Gain Auto

Activates the rules for auto IF Gain.

Mode	SA, WCDMA, C2K, WIMAX OFDMA, TD-SCDMA, 1xEV-DO, DVB-T/H, LTE, LTETDD, WLAN, MSR, LTEAFDD, LTEATDD
------	---

selected, the measurement sets the average mode to repeat. The behavior of each measurement type is described in the table below. When averaging is on, trace averaging is used as each active range is measured. Averaging is not used at any other time.

Type	Single	Continuous		
	No Spurs Found	No Spurs Found	Spurs Found	
Examine	All active ranges are measured. On completion the measurement is set to the idle state and the 'No Spurs' happening is displayed.	All active ranges are measured and the spurs found reported. On completion the measurement is set to the idle state and the trace containing the worst spur restored. The spur menu key is enabled. A marker is also added which is set to the frequency of the worst spur.	All active ranges are measured. On completion the SA remains set to last range checked with an active trace and the 'No Spurs' happening is displayed.	All active ranges are measured and the spurs found reported. On completion the SA is set to the range containing the worst spur found and continually sweeps this range. Note that the trace is continually updated but the metrics results aren't updated until restart to keep the initial results as references. Use marker readouts to refer the latest results. The spur menu key is enabled. A marker is also added which is set to the frequency of the worst spur.
Full	All active ranges are measured. On completion measurement is set to idle state and the 'No Spurs' happening is displayed.	All active ranges are measured and spurs found reported. On completion the measurement is set to the idle state, displaying the trace of the last active range.	Measurement continually cycles through all active ranges.	All active ranges are measured and spurs found reported. On each cycle of the active ranges the spurs found are reset. This ensures any remote queries retrieve the trace data that matches the currently displayed results.

Key Path	Meas Setup
Mode	SA, WCDMA, C2K, WIMAX OFDMA, TD-SCDMA, 1xEV-DO, DVB-T/H, LTE, LTETDD, WLAN, MSR, LTEAFDD, LTEATDD
Remote Command	[:SENSe] : SPURious : TYPE EXAMine FULL [:SENSe] : SPURious : TYPE ?
Example	SPUR:TYPE FULL

	SPUR:TYPE?
Preset	EXAMine
State Saved	Saved in instrument state.
Range	Examine Full
Initial S/W Revision	Prior to A.02.00
Modified at S/W Revision	A.03.00

Spur

Displays any spurs found. It is only enabled when the measurement type is set to examine and will turn on upon completion of a measurement. Once the Spur menu key has been enabled, you can view any spur. The measurement sets the analyzer to the range in which the currently selected spur was found. The range settings only changes if the spur selected is in a range which is different from the current range settings. A marker is used to identify the currently selected spur on the trace.

Key Path	Meas Setup
Mode	SA, WCDMA, C2K, WIMAX OFDMA, CDMA1xEVDO, TD-SCDMA, DVB-T/H, LTE, LTETDD, WLAN, MSR, LTEAFDD, LTEATDD
Remote Command	[:SENSe]:SPURious:SPUR <integer> [:SENSe]:SPURious:SPUR?
Example	SPUR:SPUR 55 SPUR:SPUR?
Preset	1
State Saved	No
Min	1
Max	200
Initial S/W Revision	Prior to A.02.00
Modified at S/W Revision	A.03.00

Spurious Report Mode

Selects the spurious report mode.

- Select Limit Line Test (LIMTest) to report only spurs above the limit line. Any spurs reported will cause the measurement to fail. See Abs Start Limit for more information.
- Select All Spurs (ALL) to report all spurs detected by Peak Threshold and Peak Excursion.

- Select Minimum Margin (MMARgin) to report only the spur with the minimum margin from the limit line. For the spur above the limit, its margin is defined as the negative margin. If there are more than one spurs above the limit, only one spur with the largest negative margin is reported.

Key Path	Meas Setup
Mode	SA, WCDMA, C2K, WIMAX OFDMA, TD-SCDMA, 1xEV-DO, DVB-T/H, LTE, LTETDD, WLAN, MSR, LTEAFDD, LTEATDD
Remote Command	[:SENSe] :SPURious:REPT:MODE ALL LIMTest MMARgin [:SENSe] :SPURious:REPT:MODE?
Example	SPUR:REPT:MODE LIMIT SPUR:REPT:MODE?
Dependencies	MMARgin is available only when option N9060A-7FP is installed.
Preset	ALL
State Saved	Saved in instrument state.
Range	All Spurs Limit Test Minimum Margin
Initial S/W Revision	Prior to A.02.00
Modified at S/W Revision	A.03.00, A.11.00

Meas Preset

Restores all measurement parameters to their default values.

Key Path	Meas Setup
Mode	SA, WCDMA, C2K, WIMAX OFDMA, TD-SCDMA, 1xEV-DO, DVB-T/H, LTE, LTETDD, WLAN, MSR, LTEAFDD, LTEATDD
Remote Command	:CONFigure:SPURious
Example	CONF:SPUR
Initial S/W Revision	Prior to A.02.00
Modified at S/W Revision	A.03.00

Fast Spurious Meas (Remote Command only)

This command is provided as the backward compatibility SCPI command of the Fast Spurious Measurement. Since this command is another representation of Spurious Report Mode, this command is coupled with the command.

When set to ON, only spurs above the limit line are reported. This is the same as Spurious Report Mode “LIMTest”.

When set to OFF, all detected spurs are reported. This is the same as Spurious Report Mode “ALL.”

Mode	SA, WCDMA, C2K, WIMAX OFDMA, TD-SCDMA, 1xEV-DO, DVB-T/H, WLAN, MSR, LTEAFDD, LTEATDD
Remote Command	[:SENSe] :SPURious:FSMeas ON OFF 1 0 [:SENSe] :SPURious:FSMeas?
Example	SPUR:FSM ON SPUR:FSM?
Couplings	If SPUR:REPT:MODE is ALL, this parameter is OFF. If SPUR:REPT:MODE is LIMTest, this parameter is ON.
Preset	OFF
State Saved	Saved in instrument state.
Initial S/W Revision	A.04.00

Mode

See ["Mode" on page 353](#)

Mode Preset

Returns the active mode to a known state.

Mode Preset does the following for the currently active mode:

- Aborts the currently running measurement.
- Brings up the default menu for the mode, with no active function.
- Sets measurement Global settings to their preset values for the active mode only.
- Activates the default measurement.
- Brings up the default menu for the mode.
- Clears the input and output buffers.
- Sets Status Byte to 0.

Mode Preset does not:

- Cause a mode switch
- Affect mode persistent settings
- Affect system settings
- See "[How-To Preset](#)" on page 2399 for more information.

Key Path	Front-panel key
Remote Command	:SYSTem:PRESet
Example	:SYST:PRES
Notes	<p>*RST is preferred over :SYST:PRES for remote operation. *RST does a Mode Preset, as done by the :SYST:PRES command, and it sets the measurement mode to Single measurement rather than Continuous for optimal remote control throughput.</p> <p>Clears all pending OPC bits. The Status Byte is set to 0.</p>
Couplings	A Mode Preset aborts the currently running measurement, activates the default measurement, and gets the mode to a consistent state with all of the default couplings set.
Backwards Compatibility Notes	<p>In the X-Series, the legacy "Factory Preset" has been replaced with Mode Preset, which only presets the currently active mode, not the entire instrument. In the X-Series, the way to preset the entire instrument is by using System, Restore System Defaults All, which behaves essentially the same way as restore System Defaults does on ESA and PSA.</p> <p>There is also no "Preset Type" as there is on the PSA. There is a green Mode Preset front-panel key that does a Mode Preset and a white-with-green-letters User Preset front-panel key that does a User Preset. The old PRESet:TYPE command is ignored (without generating an error), and SYST:PRES without a parameter does a Mode Preset, which should cover most backward code compatibility issues.</p>

The settings and correction data under the Input/Output front-panel key (examples: Input Z Corr, Ext Amp Gain, etc.) are no longer part of any Mode, so they will not be preset by a Mode Preset. They are preset using Restore Input/Output Defaults, Restore System Defaults All. Note that because User Preset does a Recall State, and all of these settings are saved in State, they ARE recalled when using User Preset.

Initial S/W Revision Prior to A.02.00

How-To Preset

The table below shows all possible presets, their corresponding SCPI commands and front-panel access (key paths). Instrument settings depend on the current measurement context. Some settings are local to the current measurement, some are global (common) across all the measurements in the current mode, and some are global to all the available modes. In a similar way, restoring the settings to their preset state can be done within the different contexts.

Auto Couple - is a measurement local key. It sets all Auto/Man parameter couplings in the measurement to Auto. Any Auto/Man selection that is local to other measurements in the mode will not be affected.

Meas Preset - is a measurement local key. Meas Preset resets all the variables local to the current measurement except the persistent ones.

Mode Preset - resets all the current mode's measurement local and measurement global variables except the persistent ones.

Restore Mode Defaults - resets ALL the Mode variables (and all the Meas global and Meas local variables), including the persistent ones.

Type Of Preset	SCPI Command	Front Panel Access
Auto Couple	:COUPle ALL	Auto Couple front-panel key
Meas Preset	:CONFigure:<Measurement>	Meas Setup Menu
Mode Preset	:SYSTem:PRESet	Mode Preset (green key)
Restore Mode Defaults	:INSTrument:DEFault	Mode Setup Menu
Restore All Mode Defaults	:SYSTem:DEFault MODes	System Menu; Restore System Default Menu
*RST	*RST	not possible (Mode Preset with Single)
Restore Input/Output Defaults	:SYSTem:DEFault INPUt	System Menu; Restore System Default Menu
Restore Power On Defaults	:SYSTem:DEFault PON	System Menu; Restore System Default Menu
Restore Alignment Defaults	:SYSTem:DEFault ALIGN	System Menu; Restore System Default Menu
Restore Miscellaneous Defaults	:SYSTem:DEFault MISC	System Menu; Restore System Default Menu

Restore All System Defaults	:SYSTem:DEFault [ALL] :SYSTem:PRESet:PERSistent	System Menu; Restore System Default Menu
User Preset	:SYSTem:PRESet:USER	User Preset Menu
User Preset All Modes	:SYSTem:PRESet:USER:ALL	User Preset Menu
Power On Mode Preset	:SYSTem:PON:TYPE MODE	System Menu
Power On User Preset	:SYSTem:PON:TYPE USER	System Menu
Power On Last State	:SYSTem:PON:TYPE LAST	System Menu

Mode Setup

See "[Mode Setup](#)" on page 388

Peak Search

Performs a peak search and opens the Peak Search menu. The Peak Search functions allow you to define specific search criteria to determine which signals can be considered peaks, excluding unwanted signals from the search.

Places the selected marker on the trace point with the maximum y-axis value for that marker's trace.

Key Path	Front-panel key
Mode	SA, WCDMA, C2K, WIMAX OFDMA, 1xEV-DO, DVB-T/H, LTE, LTETDD, WLAN, MSR, LTEAFDD, LTEATDD
Remote Command	:CALCulate:SPURious:MARKer[1] 2 ... 12:MAXimum
Example	CALC:SPUR:MARK2:MAX
Initial S/W Revision	Prior to A.02.00
Modified at S/W Revision	A.03.00

Next Peak

Moves the selected marker to the peak that has the next highest amplitude less than the current marker value.

Key Path	Peak Search
Mode	SA, WCDMA, C2K, WIMAX OFDMA, TD-SCDMA, 1xEV-DO, DVB-T/H, LTE, LTETDD, WLAN, MSR, LTEAFDD, LTEATDD
Remote Command	:CALCulate:SPURious:MARKer[1] 2 ... 12:MAXimum:NEXT
Example	CALC:SPUR:MARK2:MAX:NEXT
Initial S/W Revision	Prior to A.02.00
Modified at S/W Revision	A.03.00

Next Pk Right

Moves the selected marker to the nearest peak to the right of the current marker which meets all enabled peak criteria.

Key Path	Peak Search
Mode	SA, WCDMA, C2K, WIMAX OFDMA, TD-SCDMA, 1xEV-DO, DVB-T/H, LTE, LTETDD, WLAN
Remote Command	:CALCulate:SPURious:MARKer[1] 2 ... 12:MAXimum:RIGHT
Example	CALC:SPUR:MARK2:MAX:RIGH
Initial S/W Revision	Prior to A.02.00
Modified at S/W Revision	A.03.00

Next Pk Left

Moves the selected marker to the nearest peak to the left of the current marker which meets all enabled peak criteria.

Key Path	Peak Search
Mode	SA, WCDMA, C2K, WIMAX OFDMA, TD-SCDMA, 1xEV-DO, DVB-T/H, LTE, LTETDD, WLAN, MSR, LTEAFDD, LTEATDD
Remote Command	:CALCulate:SPURious:MARKer[1] 2 ... 12:MAXimum:LEFT
Example	CALC:SPUR:MARK2:MAX:LEFT
Initial S/W Revision	Prior to A.02.00
Modified at S/W Revision	A.03.00

Marker Delta

Performs the same function as the Delta 1-of-N selection key in the Marker menu. This sets the control mode for the selected marker to Delta mode. See the Marker section for the complete description of this function. The key is duplicated here in the Peak Search Menu to allow you to conveniently perform a peak search and change the control of the Marker mode to Delta without having to access two separate menus.

Key Path	Peak Search
Initial S/W Revision	Prior to A.02.00

Pk-Pk Search

Finds and displays the amplitude and frequency (or time, if in zero span) differences between the highest and lowest y-axis value.

Key Path	Peak Search
Mode	SA, WCDMA, C2K, WIMAX OFDMA, TD-SCDMA, 1xEV-DO, DVB-T/H, LTE, LTETDD, WLAN, MSR, LTEAFDD, LTEATDD
Remote Command	:CALCulate:SPURious:MARKer[1] 2 ... 12:PTPeak
Example	CALC:SPUR:MARK:PTP
Notes	Turns on the Marker Δ
Dependencies	This key is not available (key is grayed-out) when Coupled Markers is on.
Initial S/W Revision	Prior to A.02.00
Modified at S/W Revision	A.03.00

Min Search

Moves the selected marker to the minimum y-axis value on the current trace.

Key Path	Peak Search
Mode	SA, WCDMA, C2K, WIMAX OFDMA, TD-SCDMA, 1xEV-DO, DVB-T/H, LTE, LTE-TDD, WLAN, MSR, LTEAFDD, LTEATDD
Remote Command	:CALCulate:SPURious:MARKer[1] 2 ... 12:MINimum
Example	CALC:SPUR:MARK:MIN
Initial S/W Revision	Prior to A.02.00
Modified at S/W Revision	A.03.00

Print

See "Print " on page 430

Quick Save

The Quick Save front-panel key repeats the most recent save that was performed from the Save menu, with the following exceptions:

- Register saves are not remembered as Saves for the purpose of the Quick Save function
- If the current measurement does not support the last non-register save that was performed, an informational message is generated, “File type not supported for this measurement”

Quick Save repeats the last type of qualified save (that is, a save qualified by the above criteria) in the last save directory by creating a unique filename using the Auto File Naming algorithm described below.

If Quick Save is pressed after startup and before any qualified Save has been performed, the Quick Save function performs a Screen Image save using the current settings for Screen Image saves (current theme, current directory), which then becomes the “last save” for the purpose of subsequent Quick Saves.

The Auto File Naming feature automatically generates a file name for use when saving a file. The filename consists of a prefix and suffix separated by a dot, as is standard for the Windows® file system. A default prefix exists for each of the available file types:

Type	Default Prefix	Menu
State	State_	(Save/Recall)
Trace + State	State_	(Save/Recall)
Screen	Screen_	(Save/Recall)
Amplitude Corrections	Ampcor_	(Import/Export)
Traces	Trace_	(Import/Export)
Limit Lines	LLine_	(Import/Export)
Measurement Result	MeasR_	(Import/Export)
Capture Buffer	CapBuf_	(Import/Export)

A four digit number is appended to the prefix to create a unique file name. The numbering sequence starts at 0000 within each Mode for each file type and updates incrementally to 9999, then wraps to 0000 again. It remembers where it was through a Mode Preset and when leaving and returning to the Mode. It is reset by Restore Misc Defaults and Restore System Defaults and subsequent running of the instrument application. So, for example, the first auto file name generated for State files is State_0000.state. The next is State_0001, and so forth.

One of the key features of Auto File Name is that we guarantee that the Auto File Name will never conflict with an existing file. The algorithm looks for the next available number. If it gets to 9999, then it looks for holes. If it find no holes, that is no more numbers are available, it gives an error.

For example, if when we get to State_0010.state there is already a State_0010.state file in the current directory, it advances the counter to State_0011.state to ensure that no conflict will exist (and then it verifies that State_0011.state also does not exist in the current directory and advances again if it does, and so forth).

If you enter a file name for a given file type, then the prefix becomes the filename you entered instead of the default prefix, followed by an underscore. The last four letters (the suffix) are the 4-digit number.

For example, if you save a measurement results file as "fred.csv", then the next auto file name chosen for a measurement results save will be fred_0000.csv.

NOTE

Although 0000 is used in the example above, the number that is used is actually the current number in the Meas Results sequence, that is, the number that would have been used if you had not entered your own file name.

If the filename you entered ends with _dddd, where d=any number, making it look just like an auto file name, then the next auto file name picks up where you left off with the suffix being dddd + 1.

Key Path	Front-panel key
Notes	No remote command for this key specifically.
Initial S/W Revision	Prior to A.02.00

Recall

The **Recall** menu lets you choose what you want to recall, and where you want to recall it from. Among the types of files you can recall are **States and Traces**. In addition, an **Import (Data)** option lets you recall a number of data types stored in CSV files (as used by Excel and other spreadsheet programs).

The default paths for Recall are data type dependent and are the same as for the Save key.

Key Path	Front-panel key
Notes	<p>No remote command for this key specifically, but the :MMEM:LOAD command is available for specific file types. An example is :MMEM:LOAD:STATe <filename>.</p> <p>If you try to recall a State file for a mode that is not licensed or not available in the instrument, an error message will occur and the state will not change.</p>
Backwards Compatibility Notes	<p>In legacy analyzers, it was possible to load a state without affecting the trace data, limit lines or correction data. Similarly (since User Preset is actually loading a state), it was possible to do a User Preset without affecting the trace data, limit lines or correction data.</p> <p>In the X-Series, "state" always includes all of this data; so whenever state is loaded, all of the traces, limit lines and corrections are affected. Although this differs from previous behavior, it is desirable behavior, and should not cause adverse issues for users.</p>
Backwards Compatibility Notes	<p>Recall for the X-Series supports backward compatibility in the sense that you can recall a state file from any X-Series model number and any version of X-Series software. This is only possible if part of the recalling process goes through a limiting step after recalling the mode settings, at least for settings that may vary with version number, model number, option and license differences. If you try to recall a state file onto an instrument with less capability than what was available on the instrument during the save, the recall will ignore the state it doesn't support and it will limit the recalled setting to what it allows.</p> <p>Example: if the saved state includes preamp ON, but the recalling instrument does not have a preamp; the preamp is limited to OFF. Conversely, if you save a state without a preamp, the preamp is OFF in the state file. When this saved file is recalled on an instrument with a licensed preamp, the preamp is changed to OFF. Another example is if the saved state has center frequency set to 20 GHz, but the instrument recalling the saved state is a different model and only supports 13.5 GHz. In this case, the center frequency is limited along with any other frequency based settings. Since the center frequency can't be preserved in this case, the recall limiting tries to at least preserve span to keep the measurement setup as intact as possible.</p> <p>It may be appropriate to issue a warning if the state is limited on the recall; warnings do not go out to SCPI so this would only affect the manual user.</p> <p>Note that there is no state file compatibility outside of the X-Series. For example, you cannot recall a state file from ESA or PSA.</p>
Initial S/W Revision	Prior to A.02.00

State

The **Recall State** menu lets you choose a register or file from which to recall the state.

The content of a state file includes all of the settings and data required to return the analyzer as closely as possible to the Mode it was in, with the exact settings that were in place, when the save occurred. The Mode settings in each state file include the settings that are affected by Mode Preset, as well as the additional settings affected by Restore Mode Defaults; all of the Mode's settings. In addition, all of the settings of the **Input/Output** system are included, even though they are outside of the Mode's state, because they are needed to restore the complete setup. Persistent System settings (for example, GPIB address) are not affected by either a Mode Preset or Restore Mode Defaults, nor are they included in a saved State file.

Since each state file is only for one Mode, the settings for other Modes are unaffected when it is loaded. **Recall State** will cause a mode switch if the state being recalled is not from the current active mode.

After the recall completes, the message "File <filename> recalled" or "Recalled State Register <register number>" is displayed.

For rapid recalls, the State menu lists 16 registers that you can choose from to recall. Pressing a Register key initiates the recall. You can also select a file from which to recall.

The default path for all State Files is:

My Documents\<<mode name>\state

where <mode name> is the parameter used to select the mode with the INST:SEL command (for example, SA for the Spectrum Analyzer).

See ["More Information" on page 2410](#).

Key Path	Recall
Mode	All
Remote Command	:MMEMory:LOAD:STATe <filename>
Example	:MMEM:LOAD:STAT "myState.state" This recalls the file myState.state on the default path
Example	MMEM:LOAD:STAT "MyStateFile.state" This loads the state file data (on the default file directory path) into the instrument state.
Notes	When you pick a file to recall, the analyzer first verifies that the file is recallable in the current instrument by checking the software version and model number of the instrument. If everything matches, a full recall proceeds by aborting the currently running measurement, clearing any pending operations, and then loading the State from the saved state file. You can open state files from any mode, so recalling a State file switches to the mode that was active when the save occurred. After switching to the mode of the saved state file, mode settings and data (if any for the mode) are loaded with values from the saved file. The saved measurement of the mode becomes the newly active measurement and the data relevant to the measurement (if there is any) is recalled. <ul style="list-style-type: none"> - If there is a mismatch between file version or model number or instrument version or model number, the recall function tries to recall as much as possible and returns a warning message. It may limit settings that differ based on model number, licensing or version number.

After recalling the state, the Recall State function does the following:

- Makes the saved measurement for the mode the active measurement.
- Clears the input and output buffers.
- Status Byte is set to 0.
- Executes a *CLS

If the file specified is empty an error is generated. If the specified file does not exist, another error is generated. If there is a mismatch between the file and the proper file type, an error is generated. If there is a mismatch between file version or model number or instrument version or model number, a warning is displayed. Then it returns to the State menu and File Open dialog goes away.

After the Recall, the analyzer exits the Recall menu and returns to the previous menu.

**Backwards
Compatibility SCPI**

:MMEMory:LOAD:STATE 1,<filename>

For backwards compatibility, the above syntax is supported. The "1" is simply ignored.

Initial S/W Revision

Prior to A.02.00

More Information

In measurements that support saving Traces, for example, Swept SA, the Trace data is saved along with the State in the State file. When recalling the State, the Trace data is recalled as well. Traces are recalled exactly as they were stored, including the writing mode and update and display modes. If a Trace was updating and visible when the State was saved, it will come back updating and visible, and its data will be rewritten right away. When you use State to save and recall traces, any trace whose data must be preserved should be placed in View or Blank mode before saving.

The following table describes the Trace Save and Recall possibilities:

You want to recall state and one trace's data, leaving other traces unaffected.	Save Trace+State from 1 trace. Make sure that no other traces are updating (they should all be in View or Blank mode) when the save is performed.	On Recall, specify the trace you want to load the one trace's data into. This trace will load in View. All other traces' data will be unaffected, although their trace mode will be as it was when the state save was performed.
You want to recall all traces	Save Trace+State from ALL traces.	On Recall, all traces will come back in View (or Blank if they were in Blank or Background when saved)
You want all traces to load exactly as they were when saved.	Save State	On recall, all traces' mode and data will be exactly as they were when saved. Any traces that were updating will have their data immediately overwritten.

From File...

When you press “From File”, the analyzer brings up a Windows dialog and a menu entitled “File Open.” This menu allows you to navigate to the various fields in the Windows dialog without using a keyboard or mouse. The **Tab** and **Arrow** keys can also be used for dialog navigation.

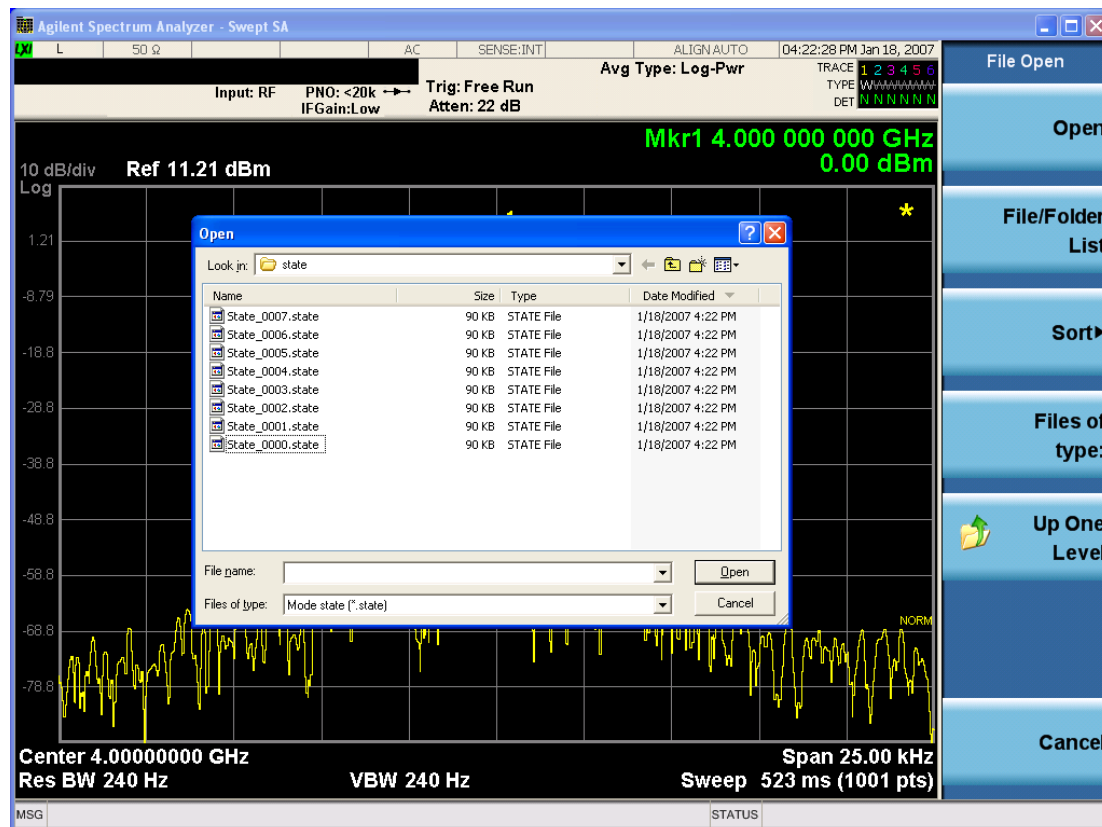

Listed below are the functions of the various fields in the dialog, and the corresponding softkeys:

Open

Performs the recall of the specified file. While the recall is being performed, the floppy icon appears briefly in the Meas bar.

File/Folder List

Enables you to navigate to the center of the dialog that contains the list of files and folders. Once here you can get information about the file and use the tab keys to navigate to the other fields in the dialog, such as Look In.

Look In

The **Look In** field shows the path from which the file will be recalled and allows you to change the path using the up and down arrow keys to navigate to other paths; the Enter key to open a directory; and the Backspace key to go back one directory. The **Look In** field first uses the last path from the Save As dialog **Save In:** path for that

same file type. There is no softkey for directly navigating to the Look In field, but you can use the left tab to get here from the File/Folder List.

User specified paths are remembered when you leave and return to a Mode and are reset back to the default using **Restore Mode Defaults**.

Sort

Accesses a menu that enables you to sort the files within the File Open dialog. Only one sorting type can be selected at a time and the sorting happens immediately. The sorting types are **By Date**, **By Name**, **By extension**, and **By Size**.

Files of Type

This field shows the file suffix for the type of file you have selected to recall. For example, if you navigated here while recalling State, "Mode state (*.state)" is in the field. If you navigated here while recalling Trace, "Mode state (*.trace)" is in the field. If you navigated here while importing a trace data file, "Trace Data (*.csv)" is in the field. For some file types, there is more than one choice in the dropdown menu, which you can select by using the up and down arrow keys and Enter.

Up One Level

This key corresponds to the icon of a folder with the up arrow that is in the tool bar of the dialog. When pressed, it causes the file and folder list to navigate up one level in the directory structure. The Backspace key does the same thing.

Cancel

This key corresponds to the **Cancel** selection in the dialog. It causes the current **Open** request to be cancelled. The ESC key does the same thing.

Key Path	Recall, State
Notes	Brings up the Open dialog for recalling a State Save Type
Initial S/W Revision	Prior to A.02.00

Edit Register Names

You may enter a custom name on any of the Register keys, to help you remember what you are using that state to save. To do this, press the **Edit Register Names** key, choose the register whose name you wish to edit, and then enter the desired label using the Alpha Editor or an external PC keyboard.

The maximum number of characters that can be added is 30. In most cases, 30 characters will fit on two lines of the key.

For more information and the SCPI command, see Edit Register Names under the **Save, State** function.

Key Path	Recall, State
Mode	All
Dependencies	N9060A-7FP or N9060B-2FP license required to edit the register names. When the feature is not

	licensed, sending the SCPI command generates an error, -221, "Settings conflict;Option not available"
Initial S/W Revision	A.11.00

Register 1 thru Register 16

Selecting any one of these register keys causes the State of the mode from the specified Register to be recalled. Each of the register keys annotates whether it is empty or at what date and time it was last modified. In addition, you can use the **Edit Register Names** key under **Save, State** to enter custom names for each register.

Registers are shared by all modes, so recalling from any one of the registers will cause a mode switch to the mode that was active when the save to the Register occurred.

Although these 16 registers are the only registers available from the front panel, there are 128 state registers available in the instrument. Registers 17-128 are only available from the SCPI interface, using the *RCL command.

After the recall completes, the message "Register <register number> recalled" appears in the message bar. If you are in the Spectrum Analyzer Mode, and you are recalling a register that was saved in the Spectrum Analyzer Mode, then after the recall, you will still be in the Recall Register menu. If the Recall causes you to switch modes, then after the Recall, you will be in the Frequency menu.

If a requested register is empty an error is generated.

Key Path	Recall, State
Example	*RCL 1
Range	1-16 from front panel, 1-128 from SCPI
Readback	Date and time with seconds resolution are displayed on the key OR A custom name of up to 30 characters entered using the Save, State,Edit Register Names key OR “(empty)” if no prior save operation has been performed to this register.
Initial S/W Revision	Prior to A.02.00
Modified at S/W Revision	Prior to A.11.00

Register 1 thru Register 16

Selecting any one of these register keys causes the State of the mode from the specified Register to be recalled. Each of the register keys annotates whether it is empty or at what date and time it was last modified. In addition, you can use the **Edit Register Names** key under **Save, State** to enter custom names for each register.

Registers are shared by all modes, so recalling from any one of the registers will cause a mode switch to the mode that was active when the save to the Register occurred.

Although these 16 registers are the only registers available from the front panel, there are 128 state registers available in the instrument. Registers 17-128 are only available from the SCPI interface, using the *RCL command.

After the recall completes, the message "Register <register number> recalled" appears in the message bar. If you are in the Spectrum Analyzer Mode, and you are recalling a register that was saved in the Spectrum Analyzer Mode, then after the recall, you will still be in the Recall Register menu. If the Recall causes you to switch modes, then after the Recall, you will be in the Frequency menu.

If a requested register is empty an error is generated.

Key Path	Recall, State
Example	*RCL 1
Range	1-16 from front panel, 1-128 from SCPI
Readback	Date and time with seconds resolution are displayed on the key OR A custom name of up to 30 characters entered using the Save, State,Edit Register Names key OR “(empty)” if no prior save operation has been performed to this register.
Initial S/W Revision	Prior to A.02.00
Modified at S/W Revision	Prior to A.11.00

Trace (+State)

The Recall Trace (+State) menu lets you choose a register or file from which to recall the Trace+State state file.

A saved state contains all of the settings and data required to return the analyzer as closely as possible to the exact setup it had when the save occurred. This includes the Input/Output settings, even though they are outside of the Mode’s state, because they are needed to restore the complete setup. A Trace+State file also includes trace data from one trace or all traces, which will load in View mode when the Trace+State file is recalled. Recall Trace (+State) will also cause a mode switch if the state being recalled is not for the current active mode.

After the recall completes, the message "File <filename> recalled" or “Recalled Trace Register <register number>” is displayed.

For rapid recalls, the Trace (+State) menu lists 5 registers to choose from to recall. Pressing a Register key initiates the recall. You can also select a file from which to recall.

The default path for all State Files including .trace files is:

My Documents\<<mode name>\state

where <mode name> is the parameter used to select the mode with the INST:SEL command (for example, SA for the Spectrum Analyzer).

Key Path	Recall
Mode	SA
Remote Command	:MMEMory:LOAD:TRACe TRACE1 TRACE2 TRACE3 TRACE4 TRACE5 TRACE6,<filename> :MMEMory:LOAD:TRACe:REGister TRACE1 TRACE2 TRACE3 TRACE4 TRACE5 TRACE6,<integer>
Example	MMEM:LOAD:TRAC TRACE2, "MyTraceFile.trace" This loads the trace file data (on the default file directory path) into the specified trace; if it is a "single trace" save file, that trace is loaded to trace 2, and is set to be not updating. :MMEM:LOAD:TRAC:REG TRACE1,2 restores the trace data in register 2 to Trace 1
Notes	When you perform the recall, the recalling Trace function must first verify the file is recallable in this instrument by checking instrument software version and model number, since it includes State. If everything matches, a full recall proceeds by aborting the currently running measurement, and loading the state from the saved state file to as close as possible to the context in which the save occurred. You can open .trace files from any mode that supports them, so recalling a Trace file switches to the mode that was active when the save occurred. After switching to the mode of the saved state file, mode settings and data (if any for the mode) are loaded with values from the saved file and the saved measurement of the mode becomes the newly active measurement, and the data relevant to the measurement (if there is any) is recalled. Once the state is loaded, the trace data must be loaded. The internal flags are consulted to see which trace to load and the "To Trace" setting to see where to load it. Trace data is always loaded with the specified trace set to View, so that the data is visible and not updating (so as not to erase the recalled data). If the file is an "all trace" file, all traces are loaded with the saved data (to the original trace the data was saved from) and set to View. Traces whose data is not loaded are restored to the update state that existed when they were saved. After the Recall the analyzer exits the Recall menu and returns to the previous menu. Some modes and measurements do not have available all 6 traces. Phase Noise mode command, for example, is: MMEMory:LOAD:TRACe TRACE1 TRACE2 TRACE3,<filename> Some modes and measurements have more than 6 traces available. The Realtime SA mode command, for example, is: MMEMory:STORe:TRACe TRACE1 TRACE2 TRACE3 TRACE4 TRACE5 TRACE6 TRACE7 TRACE8 TRACE9 TRACE10 TRACE11 TRACE12 ALL,<filename>
Initial S/W Revision	Prior to A.02.00

To Trace

These menu selections let you choose the Trace where the recalled saved trace will go. Not all modes have the full 6 traces available. The default is the currently selected trace, selected in this menu or in the Trace/Detector, Export Data, Import Data, or Save Trace menus, except if you have chosen All, then it remains chosen until you specifically change it to a single trace.

If the .trace file is an "all trace" file, "To Trace" is ignored and the traces each go back to the trace from which they were saved.

Once selected, the key returns back to the Recall Trace menu and the selected Trace number is annotated on the key. Now you have selected exactly where the

trace needs to be recalled. To trigger a recall of the selected Trace, you must select the **Open** key in the Recall Trace menu.

When you select a trace, it makes that trace the current trace, so it displays on top of all of the other traces.

Key Path	Save, Data, Trace
Mode	SA
Initial S/W Revision	Prior to A.02.00

Register 1 thru Register 16

Selecting any one of these register keys causes the State of the mode from the specified Register to be recalled. Each of the register keys annotates whether it is empty or at what date and time it was last modified. In addition, you can use the **Edit Register Names** key under **Save, State** to enter custom names for each register.

Registers are shared by all modes, so recalling from any one of the registers will cause a mode switch to the mode that was active when the save to the Register occurred.

Although these 16 registers are the only registers available from the front panel, there are 128 state registers available in the instrument. Registers 17-128 are only available from the SCPI interface, using the *RCL command.

After the recall completes, the message "Register <register number> recalled" appears in the message bar. If you are in the Spectrum Analyzer Mode, and you are recalling a register that was saved in the Spectrum Analyzer Mode, then after the recall, you will still be in the Recall Register menu. If the Recall causes you to switch modes, then after the Recall, you will be in the Frequency menu.

If a requested register is empty an error is generated.

Key Path	Recall, State
Example	*RCL 1
Range	1-16 from front panel, 1-128 from SCPI
Readback	Date and time with seconds resolution are displayed on the key OR A custom name of up to 30 characters entered using the Save, State, Edit Register Names key OR “(empty)” if no prior save operation has been performed to this register.
Initial S/W Revision	Prior to A.02.00
Modified at S/W Revision	Prior to A.11.00

From File...

When you press “From File”, the analyzer brings up a Windows dialog and a menu entitled “**File Open.**” This menu allows you to navigate to the various fields in the

Windows dialog without using a keyboard or mouse. The **Tab** and **Arrow** keys can also be used for dialog navigation.

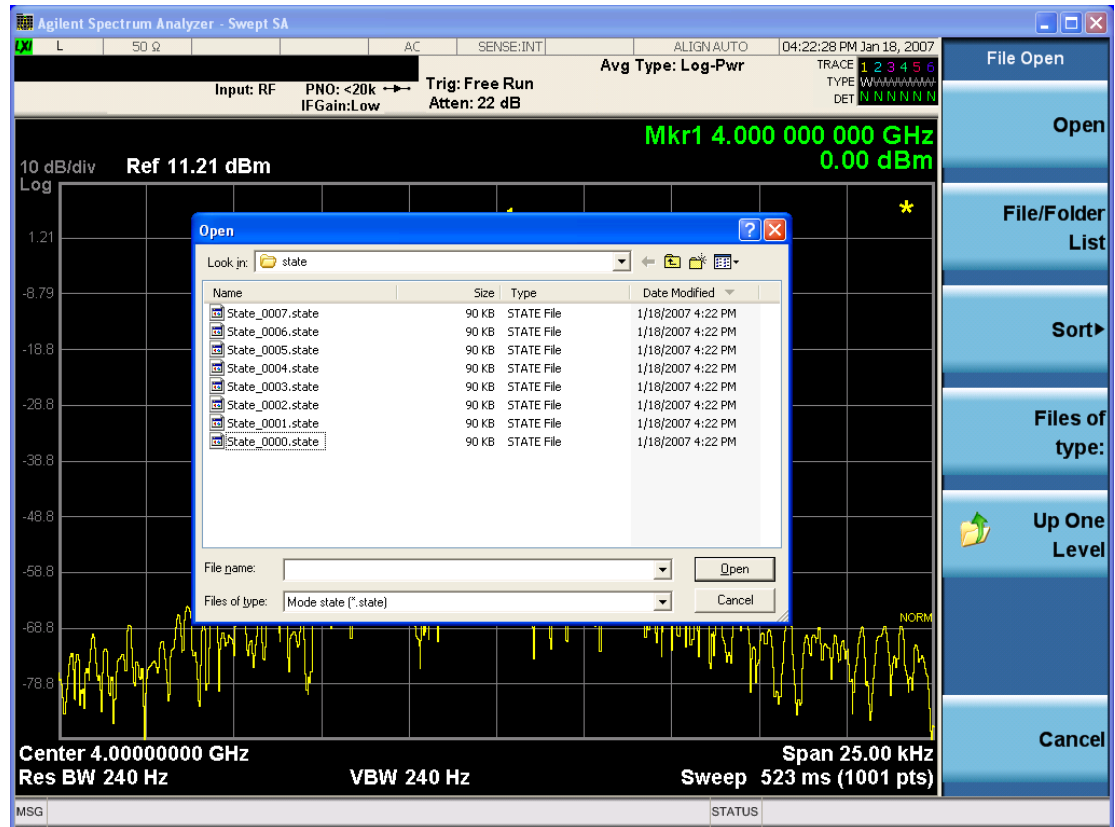

Listed below are the functions of the various fields in the dialog, and the corresponding softkeys:

Open

Performs the recall of the specified file. While the recall is being performed, the floppy icon appears briefly in the Meas bar.

File/Folder List

Enables you to navigate to the center of the dialog that contains the list of files and folders. Once here you can get information about the file and use the tab keys to navigate to the other fields in the dialog, such as Look In.

Look In

The **Look In** field shows the path from which the file will be recalled and allows you to change the path using the up and down arrow keys to navigate to other paths; the Enter key to open a directory; and the Backspace key to go back one directory. The **Look In** field first uses the last path from the Save As dialog **Save In**: path for that same file type. There is no softkey for directly navigating to the Look In field, but you can use the left tab to get here from the File/Folder List.

User specified paths are remembered when you leave and return to a Mode and are reset back to the default using **Restore Mode Defaults**.

Sort

Accesses a menu that enables you to sort the files within the File Open dialog. Only one sorting type can be selected at a time and the sorting happens immediately. The sorting types are **By Date, By Name, By extension, and By Size.**

Files of Type

This field shows the file suffix for the type of file you have selected to recall. For example, if you navigated here while recalling State, "Mode state (*.state)" is in the field. If you navigated here while recalling Trace, "Mode state (*.trace)" is in the field. If you navigated here while importing a trace data file, "Trace Data (*.csv)" is in the field. For some file types, there is more than one choice in the dropdown menu, which you can select by using the up and down arrow keys and Enter.

Up One Level

This key corresponds to the icon of a folder with the up arrow that is in the tool bar of the dialog. When pressed, it causes the file and folder list to navigate up one level in the directory structure. The Backspace key does the same thing.

Cancel

This key corresponds to the **Cancel** selection in the dialog. It causes the current **Open** request to be cancelled. The ESC key does the same thing.

Key Path	Recall, State
Notes	Brings up the Open dialog for recalling a State Save Type
Initial S/W Revision	Prior to A.02.00

Data (Import)

Importing a data file loads data that was previously saved from the current measurement or from other measurements and/or modes that produce compatible data files. The Import Menu only contains Data Types that are supported by the current measurement.

Since the commonly exported data files are in .csv format, the data can be edited by the user prior to importing. This allows you to export a data file, manipulate the data in Excel (the most common PC Application for manipulating .csv files) and then import it.

Importing Data loads measurement data from the specified file into the specified or default destination, depending on the data type selected. Selecting an Import Data menu key will not actually cause the importing to occur, since the analyzer still needs to know from where to get the data. Pressing the Open key in this menu brings up the Open dialog and Open menu that provides you with the options from where to recall the data. Once a filename has been selected or entered in the Open menu, the recall occurs as soon as the Open button is pressed.

Key Path	Recall
----------	---------------

Mode	All
Notes	The menu is built from whatever data types are available for the mode. Some keys will be missing completely, so the key locations in the sub-menu will vary. No SCPI command directly controls the Data Type that this key controls. The Data Type is included in the MMEM:LOAD commands.
Dependencies	If a file type is not used by a certain measurement, it is grayed out for that measurement. The key for a file type will not show at all if there are no measurements in the Mode that support it.
Preset	Is not affected by Preset or shutdown, but is reset during Restore Mode Defaults
Readback	The data type that is currently selected
Initial S/W Revision	Prior to A.02.00

Amplitude Correction

This key selects the Amplitude Corrections as the data type to be imported. When pressed a second time, it brings up the Select Menu, which lets you select the Correction into which the data will be imported.

Amplitude Corrections are fully discussed in the documentation of the Input/Output key, under the Corrections key.

A set of preloaded Corrections files can be found in the directory

/My Documents/ EMC Limits and Ampcor.

When the Amplitude Correction is an Antenna correction and the Antenna Unit in the file is not **None**, the Y Axis Unit setting will change to match the Antenna Unit in the file.

Key Path	Recall
Mode	SA EDGE GSM PN
Remote Command	:MMEMory:LOAD:CORRection 1 2 3 4 5 6 7 8, <filename>
Example	:MMEM:LOAD:CORR 2, "myAmpcor.csv" recalls the Amplitude Correction data from the file myAmpcor.csv in the current directory to the 2nd Amplitude Correction table, and turns on Correction 2. The default path is D:\Users\Instrument\My Documents\amplitudeCorrections\
Dependencies	Only the first correction array (Correction 1) supports antenna units. This means that a correction file with an Antenna Unit can only be loaded into the Corrections 1 register. Consequently only for Correction 1 does the dropdown in the Recall dialog include.ant, and if an attempt is made to load a correction file into any other Correction register which DOES contain an antenna unit, a Mass Storage error is generated. Corrections are not supported by all Measurements. If in a Mode in which some Measurements support it, this key will be grayed out in measurements that do not. The key will not show at all if no measurements in the Mode support it. Errors are reported if the file is empty or missing, or if the file type does not match, or if there is a mismatch between the file type and the destination data type. If any of these occur during manual operation, the analyzer returns to the Import Data menu and the File Open dialog goes away. This key does not appear unless you have the proper option installed in your instrument.

	This command will generate an “Option not available” error unless you have the proper option installed in your instrument.
Couplings	When a correction file is loaded from mass storage, it is automatically turned on (Correction ON) and ApplyCorrections is set to On. This allows you to see its effect, thus confirming the load.
Readback	selected Correction
Backwards Compatibility SCPI	:MMEMory:LOAD:CORRection ANTenna CABLe OTHer USER, <filename> For backwards compatibility, ANTenna maps to 1, CABLe maps to 2, OTHer maps to 3 and USER maps to 4
Initial S/W Revision	A.02.00

Amplitude Correction

These keys let you select which Correction to import the data into. Once selected, the key returns back to the Import Data menu and the selected Correction number is annotated on the key. The next step is to select the Open key in the Import Data menu.

Antenna corrections are a particular kind of Amplitude Corrections – they are distinguished in the corrections file by having the Antenna Unit set to a value other than None. Only Correction 1 supports Antenna Units.

Key Path	Recall, Data, Amplitude Correction
Notes	auto return
Dependencies	Only Correction 1 may be used to load a Correction that contains an Antenna Unit other than None
Preset	Not part of Preset, but is reset to Correction 1 by Restore Input/Output Defaults; survives shutdown.
State Saved	The current Correction number is saved in instrument state
Initial S/W Revision	A.02.00

Trace

This key selects Trace as the data type to be imported. When pressed a second time, it brings up the Trace Menu, which lets you select the Trace into which the data will be imported.

The trace file contains “meta” data which describes the state of the analyzer when the trace was exported (see ["Trace File Contents" on page 3216](#)). If the meta data in the file does not match the current SA state, the “invalid data indicator” (*) is displayed.

Key Path	Recall, Data
----------	---------------------

Remote Command	:MMEMory:LOAD:TRACe:DATA TRACE1 TRACE2 TRACE3 TRACE4 TRACE5 TRACE6,<filename>
Example	:MMEM:LOAD:TRAC DATA TRACE2, "myTrace2.csv" Imports the 2nd trace from the file myTrace2.csv in the current path. The default path is My Documents\SA\data\traces
Dependencies	For SA measurements, a trace cannot be recalled from a trace file that was exported with ALL traces selected. A trace cannot be imported if the number of trace points in the file do not match the number of sweep points currently set for the measurement. If this happens, an error message is generated. Errors are reported if the file is empty or missing, or if the file type does not match, or if there is a mismatch between the file type and the destination data type. If any error occurs while trying to load a file manually (as opposed to during remote operation), the analyzer returns to the Import Data menu and the File Open dialog goes away.
Couplings	When a trace is imported, Trace Update is always turned OFF for that trace and Trace Display is always turned ON.
Readback	Selected Trace
Status Bits/OPC dependencies	Sequential - aborts the current measurement.
Initial S/W Revision	Prior to A.02.00

Select Trace

These keys let you pick the Trace into which to import the data; either 1, 2, 3, 4, 5 or 6. The default is the currently selected trace, selected in this menu or in the Trace/Det, Export Data, Recall Trace, or Save Trace menus; except if you have chosen **All** then **All** remains chosen until you specifically change it to a single trace.

Once selected, the key returns back to the Import Data menu and the selected Trace number is annotated on the key. The next step is to select the Open key in the Import Data menu.

Key Path	Recall, Data, Trace
Notes	Auto return
Couplings	When you select the trace into which to import the data, it makes that trace the current trace, so it displays on top of all of the other traces.
Preset	Not part of Preset, but is reset to TRACE1 by Restore Mode Defaults; survives shutdown
State Saved	The current trace number is saved in State
Initial S/W Revision	Prior to A.02.00

Limit

This key selects Limit Lines as the data type to be imported. When pressed a second time, it brings up the Limits Menu, which lets you select into which Limit the data will be imported.

A set of preloaded Limits files can be found in the directory
/My Documents/ EMC Limits and Ampcor.

Under this directory, the directory called Limits (Legacy Naming) contains a set of legacy limits, generally the same files that were supplied with older Agilent EMC analyzers, that use the legacy suffix .lim, and the old 8-character file names. In the directory called Limits, the same files can be found, with the same suffix, but with longer, more descriptive filenames.

Key Path	Recall, Data
Remote Command	:MMEMory:LOAD:LIMit LLINE1 LLINE2,<filename>
Example	:MMEM:LOAD:LIM LLINE2, "myLimitLine2.csv" Imports the 2nd Limit Line from the file myLimitLine2.csv in the current path. The default path is My Documents\SA\data\limits
Dependencies	Errors are reported if the file is empty or missing, or if the file type does not match, or if there is a mismatch between the file type and the destination data type. If any of these occur during manual operation, the analyzer returns to the Import Data menu and the File Open dialog goes away. This key will only appear if you have the proper option installed in your instrument.
Couplings	When a limit line is loaded from mass storage, it is automatically turned on. This allows the user to see it, thus confirming the load. The Margin settings will match those when the limit was saved The instrument cannot mix Limits domains (X Axis Unit must be Frequency or Time for both Limits). So when a Limits file is loaded, the analyzer will set the Limits domain (X Axis Unit) to match that of the file. If this changes the Limits domain from what it was before the file was loaded, all Limits data in all Limits sets will be erased before the data loads. If this operation is over the remote interface there will be no warning if this occurs, so care should be taken to know the domain of the file you are loading.
Readback	Selected Limit Line
Status Bits/OPC dependencies	Sequential - aborts the current measurement
Initial S/W Revision	A.02.00

Limit Selection

These keys let you pick which Limit Line to import the data into; either 1, 2, 3, 4, 5 or 6. The default is the currently selected limit. Once selected, the key returns back to the Import Data menu and the selected Limit Line number is annotated on the key. Now you have selected exactly what needs to be imported. In order to trigger an import of the selected Limit Line, you must select the Open key in the Import Data menu.

An example of using this menu is: If you select 2 and continue to the File Open menu, Limit Line 2 will be imported from the file selected or entered in File Name option in the File Open dialog.

Key Path	Recall, Data, Limit Line
Notes	Auto return
Preset	Not part of Preset, but is reset to LLINE1 by Restore Mode Defaults; survives a shutdown.
State Saved	The selected limit number is saved in instrument state
Initial S/W Revision	A.02.00

Open...

When you press “Open”, the analyzer brings up a Windows dialog and a menu entitled “**File Open.**” This menu allows you to navigate to the various fields in the Windows dialog without using a keyboard or mouse. The **Tab** and **Arrow** keys can also be used for dialog navigation.

See "[From File...](#)" on page 3210 in **Recall, State**, for a full description of this dialog and menu.

Key Path	Recall, Data
Notes	The key location is mode-dependent and will vary. Brings up Open dialog for recalling a <mode specific> Save Type
Initial S/W Revision	Prior to A.02.00

Restart

The Restart function restarts the current sweep, or measurement, or set of averaged/held sweeps or measurements. If you are Paused, pressing Restart does a Resume.

The Restart function is accessed in several ways:

- Pressing the Restart key
- Sending the remote command INIT:IMMEDIATE
- Sending the remote command INIT:RESTART

See ["More Information" on page 2424](#)

Key Path	Front-panel key
Remote Command	:INITiate[:IMMEDIATE] :INITiate:RESTART
Example	:INIT:IMM :INIT:REST
Notes	:INITiate:RESTART and :INITiate:IMMEDIATE perform exactly the same function.
Couplings	Resets average/hold count k. For the first sweep overwrites all active (update=on) traces with new current data. For application modes, it resets other parameters as required by the measurement.
Status Bits/OPC dependencies	This is an Overlapped command. The STATus:OPERation register bits 0 through 8 are cleared. The STATus:QUESTionable register bit 9 (INTegrity sum) is cleared. The SWEEPING bit is set. The MEASURING bit is set.
Backwards Compatibility Notes	For Spectrum Analysis mode in ESA and PSA, the Restart hardkey and the INITiate:RESTART command restart trace averages (displayed average count reset to 1) for a trace in Clear Write , but did not restart Max Hold and Min Hold . In the X-Series, the Restart hardkey and the INITiate:RESTART command restart not only Trace Average , but MaxHold and MinHold traces as well. For wireless comms modes in ESA and PSA, the Restart hardkey and the INITiate:RESTART command restart every measurement, which includes all traces and numeric results. There is no change to this operation.
Initial S/W Revision	Prior to A.02.00

More Information

The **Restart** function first aborts the current sweep/measurement as quickly as possible. It then resets the sweep and trigger systems, sets up the measurement

and initiates a new data measurement sequence with a new data acquisition (sweep) taken once the trigger condition is met.

If the analyzer is in the process of aligning when **Restart** is executed, the alignment finishes before the restart function is performed.

Even when set for Single operation, multiple sweeps may be taken when Restart is pressed (for example, when averaging/holding is on). Thus when we say that **Restart** "restarts a measurement," we may mean:

- It restarts the current sweep
- It restarts the current measurement
- It restarts the current set of sweeps if any trace is in Trace Average, Max Hold or Min Hold
- It restarts the current set of measurements if Averaging, or Max Hold, or Min Hold is on for the measurement
- depending on the current settings.

With **Average/Hold Number** (in **Meas Setup** menu) set to 1, or Averaging off, or no trace in Trace Average or Hold, a single sweep is equivalent to a single measurement. A single sweep is taken after the trigger condition is met; and the analyzer stops sweeping once that sweep has completed. However, with **Average/Hold Number** > 1 and at least one trace set to **Trace Average**, **Max Hold**, or **Min Hold (SA Measurement)** or **Averaging on (most other measurements)**, multiple sweeps/data acquisitions are taken for a single measurement. The trigger condition must be met prior to each sweep. The sweep is stopped when the average count k equals the number N set for **Average/Hold Number**. A measurement average usually applies to all traces, marker results, and numeric results; but sometimes it only applies to the numeric results.

Once the full set of sweeps has been taken, the analyzer will go to idle state. To take one more sweep without resetting the average count, increment the average count by 1, by pressing the step up key while **Average/Hold Number** is the active function, or sending the remote command `CALC:AVER:TCON UP`.

Save

The **Save** menu lets you choose what you want to save and where you want to save it. Among the types of files you can save are **States**, **Traces**, and **Screen Images**. In addition, an **Export (Data)** option lets you save a number of data types as CSV files for easy import into Excel and other spreadsheet programs.

Key Path	Front-panel key
Mode	All
Notes	No remote command for this key specifically, but the :MMEM:STOR:STATe command is available for specific file types. An example is :MMEM:STOR:STATe <filename>.
Initial S/W Revision	Prior to A.02.00

State

The Save State menu lets you choose a register or file for saving the state.

The content of a state file includes all of the settings and data required to return the analyzer as closely as possible to the Mode it was in, with the exact settings which were in place, when the save occurred. The Mode settings in each state file include the settings that are affected by Mode Preset, as well as the additional settings affected by Restore Mode Defaults; all of the Mode's settings. In addition, all of the settings of the **Input/Output** system are included, even though they are outside of the Mode's state, because they are needed to restore the complete setup. Persistent **System** settings (for example, Verbose SCPI) are not affected by either Mode Preset or Restore Mode Defaults, nor are they included in a saved State file.

After the save completes, the message "File <filename> saved" or "State Register <register number> saved" is displayed.

For rapid saving, the State menu lists 16 registers to save to. Pressing a Register key initiates the save. You can also select a file to save to.

The default path for all State Files is:

My Documents\<<mode name>\state

where <mode name> is the parameter used to select the mode with the INST:SEL command (for example, SA for the Spectrum Analyzer).

Key Path	Save
Mode	All
Remote Command	:MMEMory:STORe:STATe <filename>
Example	MMEM:STOR:STATe "MyStateFile.state" This stores the current instrument state data in the file MyStateFile.state in the default directory.
Notes	Both single and double quotes are supported for any filename parameter over remote. After saving to a register, that register's menu key is updated with the date the time, unless a

	custom label has been entered for that key. After saving to a register, you remain in the Save State menu, so that you can see the Register key update. After saving to a file, the analyzer automatically returns to the previous menu and any Save As dialog goes away.
Backwards Compatibility SCPI	:MMEMory:STORe:STATe 1,<filename> For backwards compatibility, the above syntax is supported. The "1" is simply ignored. The command is sequential.
Initial S/W Revision	Prior to A.02.00

To File . . .

When you press "To File", the analyzer brings up a Windows dialog and a menu entitled "**Save As.**" This menu allows you to navigate to the various fields in the Windows dialog without using a keyboard or mouse. The **Tab** and **Arrow** keys can also be used for dialog navigation.

corresponding softkeys:

Save

Performs the save to the specified file of the selected type. If the file already exists, a dialog will appear that allows you to replace the existing file by selecting **OK**, or you can Cancel the request. If you select OK, the file will be overwritten. Using the C: drive is strongly discouraged, since it runs the risk of being overwritten during an instrument software upgrade.

While the save is being performed, the floppy icon appears briefly in the Meas bar.

File/Folder List

Enables you to navigate to the center of the dialog that contains the list of files and folders. Once here you can get information about the file and use the tab keys to navigate to the other fields in the dialog, such as Save In.

Save In

The Save In field shows the path to which the file will be saved and allows you to change the path using the up and down arrow keys to navigate to other paths; the Enter key to open a directory; and the Backspace key to go back one directory. The **Save In field** defaults to the default path for this type of file and remembers the last path you used to save this type of file. There is no softkey for directly navigating to the Save In field but you can use left tab to get here from the File/Folder List.

User specified paths are remembered when you leave and return to a Mode and are reset back to the default using **Restore Mode Defaults**.

File Name

The **File Name** field is initially loaded with an automatically generated filename specific to the appropriate Save Type. The automatically generated filename is guaranteed not to conflict with any filename currently in the directory. You may replace or modify this filename using the File Name key. See the ["Quick Save " on page 3181](#) documentation for more on the automatic file naming algorithm.

When you press the **File Name** key the analyzer displays the Alpha Editor. Use the knob to choose the letter to add and the front-panel Enter key to add the letter to the file name. The BK character moves you back and the FW character moves you forward in the filename. The Select key on the front panel generates a space character. When you are done entering the filename press the **Done** softkey. This returns back to the **File Open** dialog and menu, but does not cause the save to occur.

Save As Type

This field shows the file suffix for the type of file you have selected to save. For example, if you navigated here while saving State, "Mode state (*.state)" is in the field. If you navigated here from saving Trace, ""Mode state (*.trace)" is in the field. If you navigated here while exporting a trace data file, "Trace Data (*.csv)" is in the field. For some file types, there is more than one choice in the dropdown, which you can select by using the up and down arrow keys and Enter.

Up One Level

This key corresponds to the icon of a folder with the up arrow that is in the tool bar of the dialog. When pressed, it causes the file and folder list to navigate up one level in the directory structure. The Backspace key does the same thing.

Create New Folder

This key corresponds to the icon of a folder with the "*" that is in the tool bar of the dialog. When pressed, a new folder is created in the current directory with the name **New Folder** and you can enter a new folder name using the Alpha Editor.

Cancel

This key corresponds to the **Cancel** selection in the dialog. It causes the current **Save As** request to be cancelled. The ESC key does the same thing.

Key Path	Save, State
Mode	All
Notes	Brings up Save As dialog for saving a State Save Type
Initial S/W Revision	Prior to A.02.00

Edit Register Names

You may enter a custom name on any of the Register keys, to help you remember what you are using that state to save. To do this, press the **Edit Register Names** key, choose the register whose name you wish to edit, and then enter the desired label using the Alpha Editor or an external PC keyboard.

The maximum number of characters that can be added is 30. In most cases, 30 characters will fit on two lines of the key.

See ["More Information" on page 2431](#)

Key Path	Save, State
Mode	All
Remote Command	:MMEMory:REGiSTER:STATe:LABeL <reg number>,"label" :MMEMory:REGiSTER:STATe:LABeL? <reg number>
Example	:MMEM:REG:STAT:LAB 1,"my label"
Notes	<reg number> is an integer from 1 to 16. If the SCPI specifies an invalid register number an error message is generated, -222,"Data out of range;Invalid register label number" "label" is a string from 0 to 30 characters in length. If a label exceeds 30 characters, an error message is generated, -150,"String data error;Label clipped to 30 characters" "label" of length 0 erases the custom label and restores the default (time and date) label. E.g.: :MMEM:REG:STAT:LAB 1,""
Dependencies	N9060A-7FP or N9060B-2FP license required to edit the register names. When the feature is not licensed, sending this command generates an error, -221,"Settings conflict;Option not available"
Preset	The names are unaffected by Preset or power cycle but are set to the default label (time and date) on a "Restore System Defaults->Misc"
Initial S/W Revision	A.11.00

More Information

When you edit one of the register names, the time and date field will be replaced by the custom name.

If you delete all the characters in the custom name, it restores the default (time and date).

The register names are stored within the state files, but they are not part of the instrument state; that is, once you have edited a register name, loading a new state will not change that register name. Another consequence of this is that the names will be persistent through a power cycle. Also, if a named state file is transferred to another analyzer, it will bring its custom name along with it.

If you try to edit the name of an empty register, the analyzer will first save the state to have a file to put the name in. If you load a named state file into an analyzer with older firmware it will ignore the metadata.

The *SAV and *RCL commands will not be affected by the custom register names, nor will the MMEM commands.

Register 1 thru Register 16

Selecting any one of these register menu keys causes the State of the currently active mode to be saved to the specified Register. The registers are provided for rapid saving and recalling, since you do not need to specify a filename or navigate to a file. Each of the register menu keys annotates whether it is empty or at what date and time it was last modified. In addition, you can use the **Edit Register Names** key to enter custom names for each register.

Although these 16 registers are the only registers available from the front panel, there are 128 state registers available in the instrument. Registers 17-128 are only available from the SCPI interface, using the *SAV command.

There is one set of 128 state registers in the instrument, not one set for each Mode. When a state is saved, the Mode it was saved from is saved with it; then when it is recalled, the instrument switches to that Mode.

After the save completes, the corresponding register menu key annotation is updated with the date and time and the message "Register <register number> saved" is displayed.

Key Path	Save, State
Mode	All
Example	*SAV 1
Range	1-16 from front panel, 1-128 from SCPI
Readback	Date and time with seconds resolution are displayed on the key OR A custom name of up to 30 characters entered using the Edit Register Names key OR "(empty)" if no prior save operation has been performed to this register.

Initial S/W Revision	Prior to A.02.00
Modified at S/W Revision	A.11.00

Register 1 thru Register 16

Selecting any one of these register menu keys causes the State of the currently active mode to be saved to the specified Register. The registers are provided for rapid saving and recalling, since you do not need to specify a filename or navigate to a file. Each of the register menu keys annotates whether it is empty or at what date and time it was last modified. In addition, you can use the **Edit Register Names** key to enter custom names for each register.

Although these 16 registers are the only registers available from the front panel, there are 128 state registers available in the instrument. Registers 17-128 are only available from the SCPI interface, using the *SAV command.

There is one set of 128 state registers in the instrument, not one set for each Mode. When a state is saved, the Mode it was saved from is saved with it; then when it is recalled, the instrument switches to that Mode.

After the save completes, the corresponding register menu key annotation is updated with the date and time and the message "Register <register number> saved" is displayed.

Key Path	Save, State
Mode	All
Example	*SAV 1
Range	1-16 from front panel, 1-128 from SCPI
Readback	Date and time with seconds resolution are displayed on the key OR A custom name of up to 30 characters entered using the Edit Register Names key OR “(empty)” if no prior save operation has been performed to this register.
Initial S/W Revision	Prior to A.02.00
Modified at S/W Revision	A.11.00

Trace (+State)

The **Save Trace (+State)** menu lets you choose a register or file specifying where to save the Trace+State state file.

A saved state contains all of the settings and data required to return the analyzer as closely as possible to the exact setup it had when the save occurred. This includes the Input/Output settings, even though they are outside of the Mode’s state, because they are needed to restore the complete setup. A Trace+State file also

includes trace data from one trace or all traces, which will load in View mode when the Trace+State file is recalled.

After the save completes, the message "File <filename> saved" or "Trace Register <register number> saved" is displayed.

For rapid saves, the Trace (+State) menu lists 5 registers to save to. Pressing a Register key initiates the save. You can also select a file to save to.

The default path for all State Files including .trace files is:

My Documents\<mode name>\state

where <mode name> is the parameter used to select the mode with the INST:SEL command (for example, Basic for the IQAnalyzer).

This key is grayed out for measurements that do not support trace saves. It is blanked for modes that do not support trace saves. Saving **Trace** is identical to saving State except a .trace extension is used on the file instead of .state, and internal flags are set in the file indicating which trace was saved. You may select to save one trace or ALL traces.

Key Path	Save
Mode	SA
Remote Command	:MMEMory:STORe:TRACe TRACE1 TRACE2 TRACE3 TRACE4 TRACE5 TRACE6 ALL,<filename> :MMEMory:STORe:TRACe:REGister TRACE1 TRACE2 TRACE3 TRACE4 TRACE5 TRACE6 ALL,<integer>
Example	:MMEM:STOR:TRAC TRACE1, "myState.trace" saves the file myState.trace on the default path and flags it as a "single trace" file with Trace 1 as the single trace (even though all of the traces are in fact stored). :MMEM:STOR:TRAC ALL, "myState.trace" saves the file myState.trace on the default path and flags it as an "all traces" file :MMEM:STOR:TRAC:REG TRACE1, 2 stores trace 1 data in trace register 2
Notes	This command actually performs a save state, which in the Swept SA measurement includes the trace data. However it flags it (in the file) as a "save trace" file of the specified trace (or all traces). Some modes and measurements do not have available all 6 traces. The Phase Noise mode command, for example, is: MMEMory:STORe:TRACe TRACE1 TRACE2 TRACE3 ALL,<filename> Some modes and measurements have more than 6 traces available. The Realtime SA mode command, for example, is: MMEMory:STORe:TRACe TRACE1 TRACE2 TRACE3 TRACE4 TRACE5 TRACE6 TRACE7 TRACE8 TRACE9 TRACE10 TRACE11 TRACE12 ALL,<filename> The range for the register parameter is 1-5 When you initiate a save, if the file already exists, a dialog will appear that allows you to replace the existing file by selecting OK or you can Cancel the request. If you select OK, the file will be overwritten. Using the C: drive is strongly discouraged, since it runs the risk of being overwritten during an instrument software upgrade. Both single and double quotes are supported for any filename parameter over remote. After saving to a register, that register's menu key is updated with the date and time of the save. After saving to a register, you remain in the Save Trace menu, so that you can see the Register

	key update. After saving to a file, the analyzer automatically returns to the previous menu and any Save As dialog goes away.
--	---

Initial S/W Revision	Prior to A.02.00
----------------------	------------------

Register 1 thru Register 16

Selecting any one of these register menu keys causes the State of the currently active mode to be saved to the specified Register. The registers are provided for rapid saving and recalling, since you do not need to specify a filename or navigate to a file. Each of the register menu keys annotates whether it is empty or at what date and time it was last modified. In addition, you can use the **Edit Register Names** key to enter custom names for each register.

Although these 16 registers are the only registers available from the front panel, there are 128 state registers available in the instrument. Registers 17-128 are only available from the SCPI interface, using the *SAV command.

There is one set of 128 state registers in the instrument, not one set for each Mode. When a state is saved, the Mode it was saved from is saved with it; then when it is recalled, the instrument switches to that Mode.

After the save completes, the corresponding register menu key annotation is updated with the date and time and the message "Register <register number> saved" is displayed.

Key Path	Save, State
Mode	All
Example	*SAV 1
Range	1-16 from front panel, 1-128 from SCPI
Readback	Date and time with seconds resolution are displayed on the key OR A custom name of up to 30 characters entered using the Edit Register Names key OR “(empty)” if no prior save operation has been performed to this register.
Initial S/W Revision	Prior to A.02.00
Modified at S/W Revision	A.11.00

From Trace

Accesses a menu that enables you to select the trace to be saved. Once a trace is selected, the key returns to the Save Trace menu and the selected trace number is annotated on the key. The default is the currently selected trace, selected in this menu or in the Trace/Det, Export Data, Import Data or Recall Trace menus, except if you have chosen All then it remains chosen until you specifically change it to a single trace. To save the Trace you must select the **Save As** key in the Save Trace menu.

When you select a trace, it makes that trace the current trace, so it displays on top of all of the other traces.

Key Path	Save, Trace + State
Mode	SA
Initial S/W Revision	Prior to A.02.00

From File...

When you press “From File”, the analyzer brings up a Windows dialog and a menu entitled “File Open.” This menu allows you to navigate to the various fields in the Windows dialog without using a keyboard or mouse. The **Tab** and **Arrow** keys can also be used for dialog navigation.

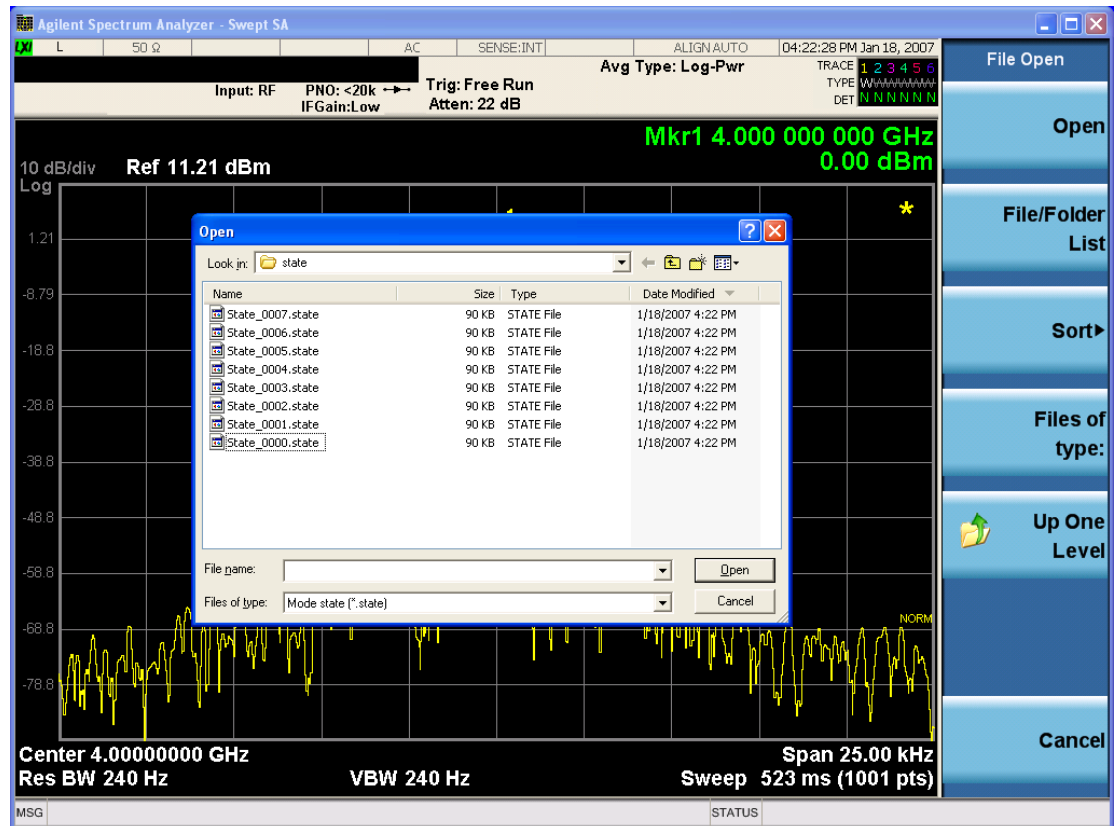

Listed below are the functions of the various fields in the dialog, and the corresponding softkeys:

Open

Performs the recall of the specified file. While the recall is being performed, the floppy icon appears briefly in the Meas bar.

File/Folder List

Enables you to navigate to the center of the dialog that contains the list of files and folders. Once here you can get information about the file and use the tab keys to navigate to the other fields in the dialog, such as Look In.

Look In

The **Look In** field shows the path from which the file will be recalled and allows you to change the path using the up and down arrow keys to navigate to other paths; the Enter key to open a directory; and the Backspace key to go back one directory. The **Look In field** first uses the last path from the Save As dialog **Save In:** path for that same file type. There is no softkey for directly navigating to the Look In field, but you can use the left tab to get here from the File/Folder List.

User specified paths are remembered when you leave and return to a Mode and are reset back to the default using **Restore Mode Defaults**.

Sort

Accesses a menu that enables you to sort the files within the File Open dialog. Only one sorting type can be selected at a time and the sorting happens immediately. The sorting types are **By Date, By Name, By extension, and By Size**.

Files of Type

This field shows the file suffix for the type of file you have selected to recall. For example, if you navigated here while recalling State, "Mode state (*.state)" is in the field. If you navigated here while recalling Trace, "Mode state (*.trace)" is in the field. If you navigated here while importing a trace data file, "Trace Data (*.csv)" is in the field. For some file types, there is more than one choice in the dropdown menu, which you can select by using the up and down arrow keys and Enter.

Up One Level

This key corresponds to the icon of a folder with the up arrow that is in the tool bar of the dialog. When pressed, it causes the file and folder list to navigate up one level in the directory structure. The Backspace key does the same thing.

Cancel

This key corresponds to the **Cancel** selection in the dialog. It causes the current **Open** request to be cancelled. The ESC key does the same thing.

Key Path	Recall, State
Notes	Brings up the Open dialog for recalling a State Save Type
Initial S/W Revision	Prior to A.02.00

Data (Export)

Exporting a data file stores data from the current measurement to mass storage files. The Export Menu only contains data types that are supported by the current measurement.

Since the commonly exported data files are in .csv format, the data can be edited by you prior to importing. This allows you to export a data file, manipulate the data in Excel (the most common PC Application for manipulating .csv files) and then import it.

Selecting an Export Data menu key will not actually cause the exporting to occur, since the analyzer still needs to know where you wish to save the data. Pressing the Save As key in this menu brings up the Save As dialog and Save As menu that allows you to specify the destination file and directory. Once a filename has been selected or entered in the Open menu, the export will occur as soon as the Save key is pressed.

Key Path	Save
Mode	All
Notes	The menu is built from whatever data types are available for the mode. So the key locations in the sub menu will vary. No SCPI command directly controls the Data Type that this key controls. The Data Type is included in the MMEM:STORe commands.
Dependencies	If a file type is not used by a certain measurement, that type is grayed out for that measurement. The key for a file type will not show at all if there are no measurements in the Mode that support it.
Preset	Is not affected by a Preset or shutdown, but is reset during Restore Mode Defaults
Readback	The data type that is currently selected
Initial S/W Revision	Prior to A.02.00

Amplitude Correction

Pressing this key selects **Amplitude Corrections** as the data type to be exported. Pressing this key again brings up the Select Menu, which allows the user to select which **Amplitude Correction** to save.

Amplitude Corrections are fully discussed in the documentation of the Input/Output key, under the Corrections softkey.

See "[Correction Data File](#)" on page 2438

Key Path	Save
Remote Command	:MMEMory:STORe:CORRection 1 2 3 4 5 6, <filename>
Example	:MMEM:STOR:CORR 2 "myAmpcor.csv" saves Correction 2 to the file myAmpcor.csv on the current path. The default path is My Documents\amplitudeCorrections.
Notes	If the save is initiated via SCPI, and the file already exists, the file will be overwritten. Using the C: drive is strongly discouraged, since it runs the risk of being overwritten during an instrument software upgrade. Both single and double quotes are supported for any filename parameter over SCPI.
Dependencies	Corrections are not supported by all Measurements. If in a Mode in which some Measurements support it, this key will be grayed out in measurements that do not. The key will not show at all if no measurements in the Mode support it.

	This key will not appear unless you have the proper option installed in your instrument.
Readback	Selected Correction
Backwards Compatibility SCPI	:MMEMory:STORE:CORRection ANTenna CABLe OTHer USER, <filename> For backwards compatibility, ANTenna maps to 1, CABLe maps to 2, OTHer maps to 3 and USER maps to 4
Initial S/W Revision	A.02.00

Correction Data File

A Corrections Data File contains a copy of one of the analyzer correction tables. Corrections provide a way to adjust the trace display for predetermined gain curves (such as for cable loss).

Corrections files are text files in .csv (comma separated values) form, to make them importable into Excel or other spreadsheet programs. The format for Corrections files is as follows.

Line #	Type of field	Example	Notes
1	File type, must be "Amplitude Correction"	Amplitude Correction	May not be omitted
2	File Description (in quotes)	"Correction Factors for 11966E"	60 characters max; may be empty but may not be omitted. If exceeds 60 characters, error -233 Too much data reported
3	Comment (in quotes)	"Class B Radiated"	60 characters max; may be empty but may not be omitted. . If exceeds 60 characters, error -233 Too much data reported
4	Instrument Version, Model #	A.02.06,N9020A	May be empty but may not be omitted
5	Option List, File Format Version	K03 LFE EXM ,01	May be empty but may not be omitted
6	Freq Unit to be used for all frequency values in the file	Frequency Unit,MHz	assumed to be Hz if omitted
7	Antenna Unit	Antenna Unit,None	If omitted leaves the Antenna unit unchanged. The amplitude unit in the Antenna Unit field is a conversion factor that is used to adjust the Y Axis Units of the current mode, if the mode supports Antenna Units.

Line #	Type of field	Example	Notes
			For more details on antenna correction data, refer to the Input/Output, Corrections key description. Allowable values: dBuv/m, dBuA/m, DBG, dBpT, None
8	Freq Interpolation	Frequency Interpolation, Linear	if omitted leaves the Freq Interpolation unchanged. Allowable values: Linear, Logarithmic
9	Bias value in mA	Bias, 0.00	If omitted leaves the Bias value unchanged (added as of A.08.50)
10	Bias State	Bias State, On	If omitted leaves the Bias State unchanged. Allowable values: On, Off (added as of A.08.50)
11	Overlap, two values, Freq1 and Freq2, separated by commas.	Overlap, 33500, 40000	Uses Freq Unit from line 6. Thus, in this example Freq1=33.5 GHz, Freq2= 40.0 GHz (see note below). If omitted leaves the overlap unchanged (added as of A.08.50)
12	DATA marker	DATA	Corrections data begins in the next line

Lines 2 through 5 can be empty but must appear in the file. Lines 6 through 11 are optional, the lines can be left out of the file altogether.

The Overlap row and the two Bias rows apply only to external mixing. Both are read-only, they are never written by the analyzer. The only way to insert or modify these rows is to edit the file with a text editor or a spreadsheet editor. These rows are intended for use by mixer manufacturers, as they allow the manufacturer to insert data about how the mixer corrections were generated and how they should be applied. The Bias rows allow you to specify whether to turn Bias on or off when the Correction is turned on and to specify a Bias value (turning off the Correction does not change the Bias, but turning it back on again sets it to the value specified in the file). The Overlap row allows you to specify an overlap region in which two different corrections may be applied. It is expected that in the corrections data itself, there will be TWO corrections values exactly at Max Freq, otherwise Overlap is ignored. The way the overlap is processed is as follows: if at any given time the current analyzer Start Freq is greater than Freq 1 and lower than Freq 2, and the current Stop Freq is greater than Freq 2, extend the first correction point at or above Freq 2 down to Freq 1, rather than using the correction data between Freq1 and Freq2.

The Antenna Unit row can only be used in Correction register 1, because there can only be one setting for Antenna Unit at any given time. If a Correction whose Antenna Unit is set to anything but None is loaded into any Correction register but 1, an error is generated (Mass storage error; Can only load an Antenna Unit into Correction 1). When a correction file is saved from any Correction register but 1, Antenna Unit is always written as None.

Similarly, the Bias rows can only be used in Correction register 1, because there can only be one setting for Bias at any given time. If a Correction file with a Bias or Bias State row is loaded into any Correction register but 1, an error is generated: Mass storage error; Can only load Bias Settings into Correction 1

The data follows the DATA row, as comma separated X, Y pairs; one pair per line.

For example, suppose you have an Antenna to correct for on an N9020A version A.02.06 and the correction data is:

- 0 dB at 200 MHz
- 17 dB at 210 MHz
- 14.8 dB at 225 MHz

Then the file will look like:

- Amplitude Correction
- "Correction Factors for 11966E"
- "Class B Radiated"
- A.02.06,N9020A
- P13 EA3 UK6,01
- Frequency Unit,MHz
- Antenna Unit,dBuV/m
- Frequency Interpolation,Linear
- DATA
- 200.000000,0.00
- 210.000000,17.00
- 225.000000,14.80

The choices for the 1 of N fields in the metadata are as follows:

- Frequency Unit: Hz, kHz, MHz, GHz
- Antenna Unit: dBuV/m, dBuA/m, dBG, dBpT, None

- Frequency Interpolation: Logarithmic, Linear

Amplitude Correction

These keys let you choose which Correction to save. Once selected, the key returns back to the Export Data menu and the selected Correction number is annotated on the key.

The next step in the Save process is to select the Save As key in the Export Data menu.

Key Path	Save, Data, Amplitude Correction
Preset	Not part of a Preset, but is reset to Correction 1 by Restore Input/Output Defaults. Survives a shutdown.
Readback	1
Initial S/W Revision	A.02.00

Trace

Pressing this key selects Traces as the data type to be exported. Pressing this key when it is already selected brings up the Trace Menu, which allows you to select which Trace to save.

The trace file contains “meta” data which describes the current state of the analyzer. The metadata is detailed in ["Trace File Contents" on page 2441](#) below.

Key Path	Save, Data
Remote Command	<code>:MMEMory:STORe:TRACe:DATA TRACE1 TRACE2 TRACE3 TRACE4 TRACE5 TRACE6 ALL,<filename></code>
Example	:MMEM:STOR:TRAC:DATA TRACE2, "myTrace2.csv" Exports the 2nd trace to the file myTrace2.csv in the current path. The default path is My Documents\SA\data\traces
Notes	If the save is initiated via SCPI, and the file already exists, the file will be overwritten. Using the C: drive is strongly discouraged, since it runs the risk of being overwritten during an instrument software upgrade. Both single and double quotes are supported for any filename parameter over SCPI.
Dependencies	For SA measurements, traces cannot be recalled from a trace file that was saved with ALL traces selected.
Couplings	When you select which trace to save, it makes that trace the current trace, so it displays on top of all of the other traces.
Readback	selected Trace
Status Bits/OPC dependencies	Sequential - waits for previous measurement to complete
Initial S/W Revision	Prior to A.02.00

Trace File Contents

A Trace Data File contains the data for one trace.

Metadata: Trace Specific

Besides the trace data, there is metadata describing the context by which the trace was produced. Some of the metadata is trace specific:

- Trace Type
- Detector
- Trace math (function, operand1, operand2, offset, reference)
- Trace name/number

When importing a trace, the detector and/or trace math function specified in the metadata is imported with the trace, so that the annotation correctly shows the detector and/or math type that was used to generate the data

Metadata: Display Specific

There is also some display-related metadata:

- Ref Level Offset
- External Gain
- X-Axis Unit
- Y-Axis Unit

Metadata: Measurement Related

The rest of the metadata is measurement specific and reflects the state of the measurement the last time the trace was updated. These are the “measurement-related instrument settings” which, if changed, cause a measurement restart.

- Number of Points
- Sweep Time
- Start Frequency
- Stop Frequency
- Average Count (actual; not the limit for the instrument)
- Average Type
- RBW
- RBW Filter Type
- RBW Filter BW Type
- VBW

- Sweep Type (FFT vs. Swept)
- Log/Lin X Scale (sometimes called Log Sweep)
- Preamp (on/off, band)
- Trigger (source, level, slope, delay)
- Phase Noise optimization setting
- Swept IF Gain
- FFT IF Gain
- AC/DC setting (RF Coupling)
- FFT Width
- External Reference setting
- Input (which input is in use)
- RF calibrator on/off
- Attenuation

Because any inactive trace can have a value that does not match the rest of the measurement, when performing a Save the metadata for each trace is pulled from the individual trace, not from the measurement.

A revision number is also included in the trace database, to allow for future changes.

The choices for the various 1 of N and binary fields are as follows:

- Average Type: Power(RMS), Voltage, LogPower(Video)
- RBW Filter Type: Flattop, EMI, Gaussian
- RBW Filter BW: 3dB, 6dB, Noise, Impulse
- Sweep Type: Swept, FFT
- PreAmp State: On, Off
- PreAmp Band: Low, Full
- Trigger Source: Free, RFBurst, Video, Line, Periodic, Ext1, Ext2, TV
- Trigger Slope: Positive, Negative
- Phase Noise Optimization: Fast, Narrow, Wide
- Swept IF Gain: Low, High

- FFT If Gain: Autorange, Low, High
- Input: RF, BBIQ
- RF Calibrator: 50M, 400G, Comb, Off
- Trace Type: ClearWrite, TraceAverage, MaxHold, MinHold
- Detector: Normal, Average, Peak, NegPeak, Sample
- Trace Math: Off, PowerDifference, PowerSum, LogOffset, LogDifference
- Y Axis Unit: dBm, dBmV, dBmA, W, V, A, dBuV, dBuA, dBuV/m, dBuA/m, dBuV, dBpT, dBG, dB

After the header, just before the trace data, a line with just the word DATA on it is inserted to flag the start of the trace data.

The following file example shows the first lines of a Trace 1 file with X Axis Unit = Hz and Y Axis Unit = dBuV, after importing into Excel (the second row contains the Title):

Trace	
"AS/NZS 1044; Conducted >1000 W, Motors, Average"	
A.01.00	E4410A
526 EA3 B25 P26 PFR	1
Segment	0
Number of Points	1001
Sweep Time	0.066266667
Start Frequency	18827440
Stop Frequency	24463718
Average Count	0
Average Type	Power(RMS)
RBW	51000
RBW Filter	Gaussian
RBW Filter BW	3dB
VBW	51000
Sweep Type	Swept
X Axis Scale	Lin
PreAmp State	Off
PreAmp Band	Low
Trigger Source	Video

Trigger Level	1.2
Trigger Slope	Positive
Trigger Delay	1.00E-06
Phase Noise Optimization	Fast
Swept IF Gain	Low
FFT IF Gain	Autorange
RF Coupling	AC
FFT Width	411900
Ext Ref	10000000
Input	RF
RF Calibrator	Off
Attenuation	10
Ref Level Offset	0
External Gain	0
Trace Type	ClearWrite
Detector	Normal
Trace Math	Off
Trace Math Oper1	Trace5
Trace Math Oper2	Trace6
Trace Math Offset	0
Trace Name	Trace1
X Axis Unit	Hz
Y Axis Unit	dBm
DATA	
1.6009301E+07	4.82047E+01
1.6018694E+07	4.69737E+01
1.6028087E+07	4.81207E+01
1.6037480E+07	4.72487E+01
1.6046873E+07	4.66437E+01
1.6056266E+07	4.66237E+01
1.6065659E+07	4.66967E+01
1.6075052E+07	4.77117E+01
1.6084445E+07	4.75787E+01
1.6093838E+07	4.83297E+01
1.6103231E+07	4.71327E+01
1.6112624E+07	4.78957E+01

1.6122017E+07	4.67507E+01
1.6131410E+07	4.81137E+01

Limit

Pressing this key selects Limit Lines as the data type to be exported. Pressing the key a second time brings up the Limit Menu that allows you to select which **Limit Line** to save.

- See ["Limits File Contents" on page 2446](#).
- See [".csv file format" on page 2446](#)
- See [".lim file format" on page 2448](#)

Key Path	Save, Data
Remote Command	:MMEMory:STORe:LIMit LLINE1 LLINE2,<filename>
Example	:MMEM:STOR:LIM LLINE2, "myLimitLine2.csv" Saves the 2nd Limit Line to the file myLimitLine2.csv in the current path. The default path is My Documents\SA\data\limits
Notes	If the save is initiated via SCPI, and the file already exists, the file will be overwritten. Using the C: drive is strongly discouraged, since it runs the risk of being overwritten during an instrument software upgrade. Both single and double quotes are supported for any filename parameter over SCPI.
Dependencies	This key will only appear if you have the proper option installed in your instrument.
Preset	1; not part of Preset, but is reset by Restore Mode Defaults and survives power cycles
State Saved	The selected Limit number is saved in instrument state.
Readback	selected Limit Line
Status Bits/OPC dependencies	Sequential - waits for previous measurement to complete
Initial S/W Revision	A.02.00

Limits File Contents

Limits may be exported into a data file with a .csv extension. They may be imported from that data file; they may also be imported from a legacy limit file with a .lim extension. The .lim files meet the specification for limit files contained in the EMI measurement guide, HP E7415A.

.csv file format

Except for information in quotes, limit line files are not case sensitive. Information in bold is required verbatim; other text is example text, and italic text is commentary which should not be present in the file.

The first five lines are system-required header lines, and must be in the correct order.

Limit	<i>Data file type name</i>
"FCC Part 15"	<i>File Description</i>
"Class B Radiated"	<i>Comment</i>
A.01.00.R0001,N9020A	<i>Instrument Version, Model Number</i>
P13 EA3 UK6 ,01	<i>Option List, File Format Version</i>

The next few lines describe the parameters; on export they will be in the order shown, on import they can be in any order. If some parameters are missing, they will revert to the default.

Type, Upper	<i>Upper Lower</i>
X Axis Unit, MHz	<i>MHz S; other units should be converted; this also specifies the domain</i>
Amplitude Unit, dBm	<i>dBm V; all other units should be converted appropriately</i>
Frequency Interpolation, Linear	<i>Logarithmic Linear</i>
Amplitude Interpolation, Logarithmic	<i>Logarithmic Linear</i>
X Control, Fixed	<i>Fixed Relative; on input we consider only the first three characters</i>
Y Control, Fixed	<i>Fixed Relative; on input we consider only the first three characters</i>
Margin, 0	<i>Always in dB. A 0 margin is equivalent to margin off</i>
X Offset, 10	<i>Expressed in the X axis units</i>
Y Offset, 5	<i>Expressed in the Amplitude units</i>

The Amplitude Unit line in the limits file may contain an antenna factor unit, for example:

Amplitude Unit=dBuV/m

Antenna factor units are dBuV/m, dBuA/m, dBpT, and dBG. In this case, the unit is treated exactly as though it were dBuV, meaning that all of the limits are interpreted to have units of dBuV. The box does NOT change Y Axis Units when such a limit is loaded in.

The X axis unit also specifies the domain (time or frequency). It is not possible to have both time-domain lines and frequency-domain lines at the same time; if a time-domain line is imported while the other lines are in the frequency domain (or vice-versa), all limit lines will be deleted prior to import.

If the sign of the margin is inappropriate for the limit type (for example a positive margin for an upper limit), the sign of the margin will be changed internally so that it is appropriate.

The remaining lines describe the data. Each line in the file represents an X-Y pair. The X values should be monotonically non-decreasing, although adjacent lines in the file can have the same X value as an aid to building a stair-stepped limit line. To specify a region over which there is no limit, use +1000 dBm for upper limits or -1000 dBm for lower limits.

The data region begins with the keyword DATA:

DATA
200.000000,-10.00
300.000000,-10.00
300.000000,-20.00
500.000000,-20.00

.lim file format

This is a legacy format which allows files saved from older analyzers to be loaded into the X-Series. Design of files in this format is not recommended.

Limit Selection

These keys let you pick which Limit Line to save. Once selected, the key returns back to the **Export Data** menu and the selected Limit Line number is annotated on the key.

The next step in the Save process is to select the Save As key in the Export Data menu.

Key Path	Save, Data, Limit Line
Notes	auto return
Preset	Not part of Preset, but is reset to LLINE1 by Restore Mode Defaults; survives shutdown
Initial S/W Revision	A.02.00

Save As . . .

When you press “Save As”, the analyzer brings up a Windows dialog and a menu entitled “**Save As.**” This menu allows you to navigate to the various fields in the Windows dialog without using a keyboard or mouse. The **Tab** and **Arrow** keys can also be used for dialog navigation.

See "[To File . . .](#)" on page 3202 in **Save, State** for a full description of this dialog and menu.

The default path for saving files is:

For all of the Trace Data Files:

- My Documents\<<mode name>\data\traces

For all of the Limit Data Files:

- My Documents\<<mode name>\data\limits

For all of the Measurement Results Data Files:

- My Documents\<<mode name>\data\<<measurement name>\results

For all of the Capture Buffer Data Files:

- My Documents\<<mode name>\data\captureBuffer

Key Path	Save, Data
Mode	All
Notes	The key location is mode-dependent and will vary. Brings up the Save As dialog for saving a <mode specific> Save Type. The save is performed immediately and does not wait until the measurement is complete.
Initial S/W Revision	Prior to A.02.00

Screen Image

Pressing Screen Image accesses a menu of functions that enable you to specify a format and location for the saved screen image. It brings up a menu that allows you to specify the color scheme of the Screen Image (Themes) or navigate to the Save As dialog to perform the actual save.

Screen Image files contain an exact representation of the analyzer display. They cannot be loaded back onto the analyzer, but they can be loaded into your PC for use in many popular applications.

The image to be saved is actually captured when the **Save** front panel key is pressed, and kept in temporary storage to be used if you ask for a Screen Image save. When the Screen Image key is pressed, a "thumbnail" of the captured image is displayed, as shown below:

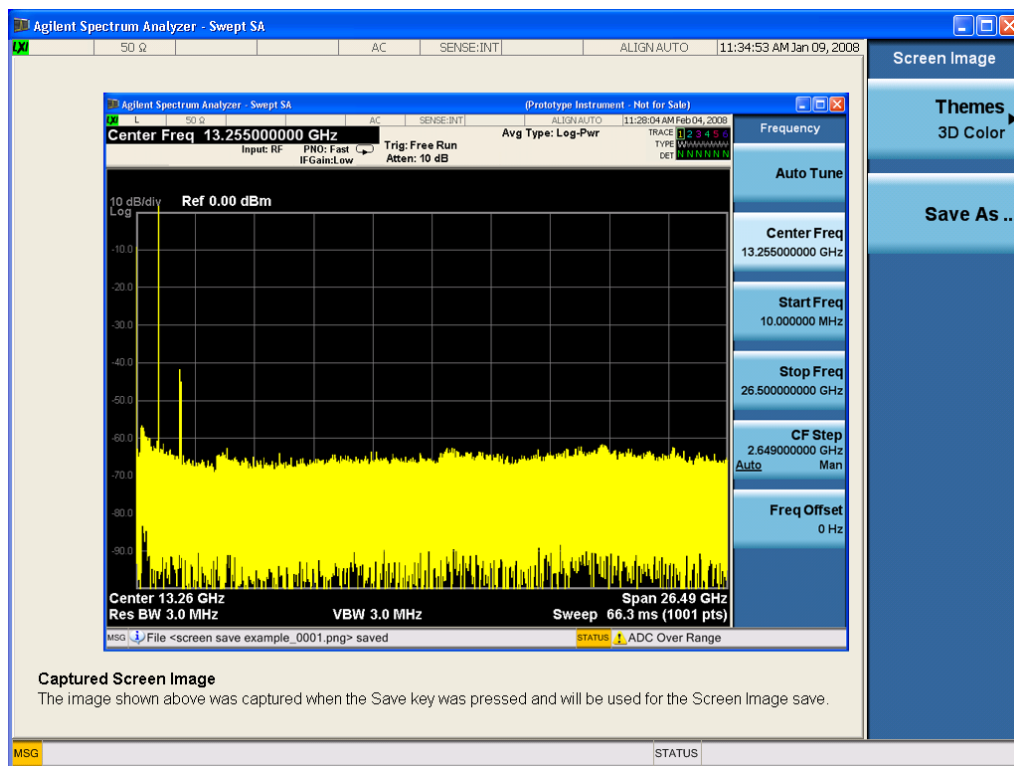

When you continue on into the **Save As** menu and complete the Screen Image save, the image depicted in the thumbnail is the one that gets saved, showing the menus that were on the screen before going into the **Save** menus. The save is performed immediately and does not wait until the measurement is complete.

After you have completed the save, the **Quick Save** front-panel key lets you quickly repeat the last save performed, using an auto-named file, with the current screen data.

NOTE

For versions previous to A.01.55, if you initiate a screen image save by navigating through the Save menus, the image that is saved will contain the Save menu softkeys, not the menus and the active function that were on the screen when you first pressed the Save front panel key.

Key Path	Save
Mode	All
Remote Command	:MMEMory:STORe:SCReem <filename>
Example	:MMEM:STOR:SCR "myScreen.png" This stores the current screen image in the file MyScreenFile.png in the default directory.
Backwards Compatibility SCPI	HCOPy:SDUMp:DATA? returns the screen image in a <DEFINITE LENGTH ARBITRARY RESPONSE DATA> element. The response data is IEEE Block format; the controlling computer can strip the header and store the result as a .png file.
Initial S/W Revision	Prior to A.02.00

Themes

Accesses a menu of functions that enable you to choose the theme to be used when saving the screen image.

The **Themes** option is the same as the **Themes** option under the **Display and Page Setup** dialogs. It allows you to choose between themes to be used when saving the screen image.

Key Path	Save, Screen Image
Remote Command	:MMEMory:STORe:SCReem:THEMe TDColor TDMonochrome FCOLOR FMONochrome :MMEMory:STORe:SCReem:THEMe?
Example	:MMEM:STOR:SCR:THEM TDM
Preset	3D Color; Is not part of Preset, but is reset by Restore Misc Defaults or Restore System Defaults All and survives subsequent running of the modes.
Readback	3D Color 3D Mono Flat Color Flat Mono
Backwards Compatibility Notes	In ESA and PSA we offer the choice of "Reverse Bitmap" or "Reverse Metafile" when saving screen images. This is much like the "Flat Color" theme available in X-Series. Also, if you selected Reverse Bitmap AND a black & white screen image, that would be much like "Flat Monochrome". In other words, each of the X-Series themes has a similar screen image type in ESA/PSA. But they are not identical.
Initial S/W Revision	Prior to A.02.00

3D Color

Selects a standard color theme with each object filled, shaded and colored as designed.

Key Path	Save, Screen Image, Themes
----------	----------------------------

Example	MMEM:STOR:SCR:THEM TDC
Readback	3D Color
Initial S/W Revision	Prior to A.02.00

3D Monochrome

Selects a format that is like 3D color but shades of gray are used instead of colors.

Key Path	Save, Screen Image, Themes
Example	MMEM:STOR:SCR:THEM TDM
Readback	3D Mono
Initial S/W Revision	Prior to A.02.00

Flat Color

Selects a format that is best when the screen is to be printed on an ink printer.

Key Path	Save, Screen Image, Themes
Example	MMEM:STOR:SCR:THEM FCOL
Readback	Flat Color
Initial S/W Revision	Prior to A.02.00

Flat Monochrome

Selects a format that is like Flat Color. But only black is used (no colors, not even gray), and no fill.

Key Path	Save, Screen Image, Themes
Example	MMEM:STOR:SCR:THEM FMON
Readback	Flat Mono
Initial S/W Revision	Prior to A.02.00

Save As...

When you press “Save As”, the analyzer brings up a Windows dialog and a menu entitled “**Save As.**” This menu allows you to navigate to the various fields in the Windows dialog without using a keyboard or mouse. The **Tab** and **Arrow** keys can also be used for dialog navigation.

See "[To File . . .](#)" on page 3202 in **Save, State** for a full description of this dialog and menu.

The default path for Screen Images is

- My Documents\`<mode name>`\screen.

where `<mode name>` is the parameter used to select the mode with the INST:SEL command (for example, SA for the Spectrum Analyzer).

Key Path	Save, Screen Image
Notes	Brings up Save As dialog for saving a Screen Image Save Type
Initial S/W Revision	Prior to A.02.00

Mass Storage Catalog (Remote Command Only)

Key path	SCPI Only
Remote Command	:MMEMory:CATaLog? [<directory_name>]
Notes	<p>The string must be a valid logical path.</p> <p>Queries disk usage information (drive capacity, free space available) and obtains a list of files and directories in a specified directory in the following format: <numeric_value>,<numeric_value>,{<file_entry>}</p> <p>It returns two numeric parameters and as many strings as there are files and directories. The first parameter indicates the total amount of storage currently used in bytes. The second parameter indicates the total amount of storage available, also in bytes. The <file_entry> is a string. Each <file_entry> indicates the name, type, and size of one file in the directory list: <file_name>,<file_type>,<file_size></p> <p>As the windows file system has an extension that indicates file type, <file_type> is always empty. <file_size> provides the size of the file in bytes. For directories, <file_entry> is surrounded by square brackets and both <file_type> and <file_size> are empty</p>
Initial S/W Revision	Prior to A.02.00

Mass Storage Change Directory (Remote Command Only)

Key path	SCPI Only
Remote Command	:MMEMory:CDIRectory [<directory_name>] :MMEMory:CDIRectory?
Notes	<p>The string must be a valid logical path.</p> <p>Changes the default directory for a mass memory file system. The <directory_name> parameter is a string. If no parameter is specified, the directory is set to the *RST value.</p> <p>At *RST, this value is set to the default user data storage area, that is defined as System.Environment.SpecialFolder.Personal.</p> <p>Query returns full path of the default directory.</p>
Initial S/W Revision	Prior to A.02.00

Mass Storage Copy (Remote Command Only)

Key path	SCPI Only
Remote Command	:MMEMory:COpy <string>,<string>[,<string>,<string>]
Notes	<p>The string must be a valid logical path.</p> <p>Copies an existing file to a new file or an existing directory to a new directory.</p> <p>Two forms of parameters are allowed. The first form has two parameters. In this form, the first</p>

parameter specifies the source, and the second parameter specifies the destination.
 The second form has four parameters. In this form, the first and third parameters specify the source. The second and fourth parameters specify the directories. The first pair of parameters specifies the source. The second pair specifies the destination. An error is generated if the source doesn't exist or the destination file already exists.
 This command will generate an "access denied" error if the destination is a restricted folder (e.g., C:\Windows) and the current user does not have Power User or Administrator privileges.

Mass Storage Device Copy (Remote Command Only)

This command transfers data to/from a file and a peripheral device.

Key path	SCPI Only
Remote Command	:MMEMory:COpy:DEvIce <source_string>,<dest_string>
Notes	The strings must be a valid logical path or a valid device keyword. If the dest_string is a device keyword, the data is copied from the source file to the device. If the source_string is a device keyword, the data is copied to the source file from the device. Valid device keywords are: SNS (smart noise source) An error is generated if the file or device is not found.

Mass Storage Delete (Remote Command Only)

Key path	SCPI Only
Remote Command	:MMEMory:DELEte <file_name>[,<directory_name>]
Notes	The string must be a valid logical path. Removes a file from the specified directory. The <file_name> parameter specifies the file name to be removed. This command will generate an "access denied" error if the file is in a restricted folder (e.g., C:\Windows) and the current user does not have Power User or Administrator privileges.
Initial S/W Revision	Prior to A.02.00

Mass Storage Data (Remote Command Only)

Creates a file containing the specified data OR queries the data from an existing file.

Key path	SCPI Only
Remote Command	:MMEMory:DATA <file_name>, <data> :MMEMory:DATA? <file_name>
Notes	The string must be a valid logical path. The command form is MMEMory:DATA <file_name>,<data>. It loads <data> into the file <file_name>. <data> is in 488.2 block format. <file_name> is string data. The query form is MMEMory:DATA? <file_name> with the response being the associated <data> in block format.
Initial S/W Revision	Prior to A.02.00

Mass Storage Make Directory (Remote Command Only)

Key path	SCPI Only
Remote Command	:MMEMory:MDIRectory <directory_name>
Notes	<p>The string must be a valid logical path.</p> <p>Creates a new directory. The <directory_name> parameter specifies the name to be created.</p> <p>This command will generate an “access denied” error if the new directory would be in a restricted folder (e.g., C:\Windows) and the current user does not have Power User or Administrator privileges.</p>
Initial S/W Revision	Prior to A.02.00

Mass Storage Move (Remote Command Only)

Key path	SCPI Only
Remote Command	:MMEMory:MOVE <string>,<string>[,<string>,<string>]
Notes	<p>The string must be a valid logical path.</p> <p>Moves an existing file to a new file or an existing directory to a new directory.</p> <p>Two forms of parameters are allowed. The first form has two parameters. In this form, the first parameter specifies the source, and the second parameter specifies the destination.</p> <p>The second form has four parameters. In this form, the first and third parameters specify the source. The second and fourth parameters specify the directories. The first pair of parameters specifies the source. The second pair specifies the destination. An error is generated if the source doesn't exist or the destination file already exists.</p> <p>This command will generate an “access denied” error if the destination is a restricted folder (e.g., C:\Windows) and the current user does not have Power User or Administrator privileges.</p>
Initial S/W Revision	Prior to A.02.00

Mass Storage Remove Directory (Remote Command Only)

Key path	SCPI Only
Remote Command	:MMEMory:RDIRectory <directory_name>
Notes	<p>The string must be a valid logical path.</p> <p>Removes a directory. The <directory_name> parameter specifies the directory name to be removed. All files and directories under the specified directory shall also be removed.</p> <p>This command will generate an “access denied” error if the folder is a restricted folder (e.g., C:\Windows) or is in a restricted folder and the current user does not have Power User or Administrator privileges.</p>
Initial S/W Revision	Prior to A.02.00

Mass Storage Determine Removable Media (Remote Command Only)

This command is used to determine if any removable media devices are connected to the instrument. Primarily, these are USB memory devices plugged-in to the front

panel or rear panel USB ports. On instruments with PC6 or PC7 CPU's, one SD card slot is available for removable media. The instrument's primary disk drive is not a removable media device.

Key Path	SCPI Only
Remote Command	:MMEMory:RMEDia:LIST?
Notes	The return value is a string containing a list of partition identifiers that are removable media devices. Each identifier is separated by a comma. If no removable media is present, an empty string is returned. Examples: <ul style="list-style-type: none"> - One removable device present results in a return string of "F:". - Two removable devices present results in a return string of "F:,G:". - No removable devices present results in a return string of "".
Initial S/W Revision	x.15.00

Mass Storage Determine Removable Media Label (Remote Command Only)

This command is used to set or query a removable media device's label.

Key Path	SCPI Only
Remote Command	:MMEMory:RMEDia:LABel <partition>,<string> :MMEMory:RMEDia:LABel? <partition>
Example	MMEM:RMED:LAB "F:","My Device"
Notes	If the <partition> specified does not exist or is not a removable media device, the error - 252,"Missing Media" is generated. Setting the removable media label requires Administrative privileges. If the currently logged in user does not have appropriate privileges the error "-221.9900,Settings conflict;Administrator privileges required" is generated.
Initial S/W Revision	x.15.00

Mass Storage Determine Removable Media Write-protect status (Remote Command Only)

This command is used to query a removable media device's write-protect status.

Key Path	SCPI Only
Remote Command	:MMEMory:RMEDia:WPRotect? <partition>
Example	MMEM:RMED:WPR? "F:"
Notes	The return value is 1 if the device is write-protected, or 0 if the device is write-enabled. If the <partition> specified does not exist or is not a removable media device the error - 252,"Missing Media" is generated.
Preset	The return value will be depending on SD card installed.
Initial S/W Revision	x.15.00

Mass Storage Determine Removable Media size (Remote Command Only)

This command is used to query a removable media device's total memory size (not available memory size).

Key Path	SCPI Only
Remote Command	:MMEMory:RMEDia:SIZE? <partition>
Example	MMEM:RMED:SIZE? "F:"
Notes	The return value is integer value in GBytes. Any device that is less than 1 GB returns 0 GB. If the <partition> specified does not exist or is not a removable media device, the error - 252, "Missing Media" is generated.
Initial S/W Revision	x.15.00

:SYSTem:SET (Remote Command Only)

Remote command that allows the user to obtain the state of the currently active mode in a form that can then be loaded back into the instrument quickly.

Remote Command	SYSTem:SET <instrument state in IEEE Block> SYSTem:SET?
Notes	SYST:SET? returns current instrument state of the active mode in IEEE Block data format. The state is in a machine readable format only. Sending the query returns the following format: <syst set preamble><state block data> Where: <syst set preamble> is the format: #NMMM N=number of digits that comprise MMM MMM=length in bytes of following data <state block data> is machine readable state data Example response: #42016<state data> The state is recalled by sending the SYST:SET? Response data to the instrument. From example above: SYST:SET #42016<state data>
Initial S/W Revision	x.17.00

Single (Single Measurement/Sweep)

Sets the analyzer for Single measurement operation. The single/continuous state is Meas Global, so the setting will affect all the measurements. If you are Paused, pressing **Single** does a Resume.

See "[More Information](#)" on page 2457

Key Path	Front-panel key
Example	:INIT:CONT OFF
Notes	See Cont key description.
Backwards Compatibility Notes	<p>For Spectrum Analysis mode in ESA and PSA, the Single hardkey and the INITiate:IMM switched from continuous measurement to single measurement and restarted sweeps and averages (displayed average count reset to 1), but did not restart Max Hold and Min Hold. In the X-Series, the Single hardkey and the INITiate:IMM command initiate a sweep/ measurement/ average sequence/hold sequence including MaxHold and MinHold.</p> <p>For Spectrum Analysis mode in ESA and PSA, the Single hardkey restarted the sweep regardless of whether or not you were in an active sweep or sweep sequence. In the X-Series, Restart does this but Single only restarts the sweep or sweep sequence if you are in the idle state.</p> <p>INIT[:IMM] in ESA & PSA Spectrum Analysis Mode does an implied ABORT. In some other PSA Modes, INIT[:IMM] is ignored if not in the idle state. . The X-Series follows the ESA/PSA SA Mode model, which may cause some Modes to have compatibility problems.</p>
Initial S/W Revision	Prior to A.02.00

More Information

See "[Restart](#)" on page 3199 for details on the INIT:IMMEDIATE (Restart) function.

If you are already in single sweep, the INIT:CONT OFF command has no effect.

If you are already in Single Sweep, then pressing the **Single** key in the middle of a sweep does not restart the sweep or sequence. Similarly, pressing the **Single** key does not restart the sweep or sequence if the sweep is not in the idle state (for example, if you are taking a very slow sweep, or the analyzer is waiting for a trigger). Instead, it results in a message. "Already in Single, press Restart to initiate a new sweep or sequence". Even though pressing the **Single** key in the middle of a sweep does not restart the sweep, sending INIT:IMMEDIATE does reset it.

To take one more sweep without resetting the average count, increment the average count by 1, by pressing the step up key while **Average/Hold Number** is the active function, or sending the remote command CALC:AVER:TCON UP.

Source

The Source key accesses menus for controlling a Source in Tracking Source mode

Key Path	Front-panel key
Dependencies	<p>Operation with a source requires a license. If the proper license is not installed, the following occurs:</p> <ul style="list-style-type: none"> - When the Source key is pressed the user sees an informational message, "Option not installed" - If any SCPI command in the :SOURce subsystem is sent it generates a message, "Settings conflict;option not installed"
Initial S/W Revision	A.06.01

NOTE

Option T03 or T06 is required for the Tracking Generator function in CXA. Option T03, T07, T13 or T26 is required for the Tracking Generator function in CXA-m.

When using the CXA-m Tracking Generator, if the Source Frequency is in the frequency range of the below table, and the Source Amplitude is in the corresponding amplitude range of the below table, a warning status message is generated, +313 "Source Uncal". This is also true if Power Sweep is on and any amplitude in the Power Sweep (as calculated by Amplitude, Power Sweep, and Amptd Offset) is in that range.

CXA-m TG Un-calibrated Amplitude Range

Frequency Range	Amplitude Range
$2 \text{ MHz} \leq \text{frequency} < 10 \text{ GHz}$	$-40 \text{ dBm} \leq \text{amplitude} < -35 \text{ dBm}$
$10 \text{ GHz} \leq \text{frequency} < 20 \text{ GHz}$	$-40 \text{ dBm} \leq \text{amplitude} < -35 \text{ dBm}$ or $-5 \text{ dBm} < \text{amplitude} \leq 0 \text{ dBm}$
$20 \text{ GHz} \leq \text{frequency} \leq 26.55 \text{ GHz}$	$-12 \text{ dBm} < \text{amplitude} \leq 0 \text{ dBm}$

RF Output

Allows you to turn the source RF Power on or off.

NOTE

When the RF Output is turned on, the Source Mode is set to Tracking. See the Source Mode key description for special considerations concerning how to configure your N5172B or N5182B source for use with External Source Control.

Key Path	Source
Scope	Meas Global
Remote Command	:OUTPut[:EXTErnal] [:STATe] ON OFF 1 0 :OUTPut[:EXTErnal] [:STATe]?

Example	:OUTP ON :OUTP?
Dependencies	Grayed out in measurements that do not support a source. If you go to such a measurement the output will be forced to Off. Grayed out if there is no valid source selection, in this case go to the Select Source menu to choose, configure and/or verify your source When there is no available Source Mode (other than Off), due to other couplings, then the RF Output key is grayed out.
Couplings	When RF Output is turned On, Source Mode is set to Tracking When Source Mode is turned Off, RF Output is turned Off. When Source Mode is turned Off (or forced to Off by another coupling), RF Output is turned Off. Turning RF Output Off does not affect Source Mode or other settings.
Preset	OFF (on either a Mode Preset, a Source Preset, or Restore Input/Output Defaults)
State Saved	Part of the Input/Output system, which means it is Loaded and Saved with state.
Range	On Off
Initial S/W Revision	A.06.01
Modified at S/W Revision	A.10.01

Amplitude

Allows you to access the Amplitude sub-menu to control various amplitude parameters of the Source. The resolution of the Source amplitude parameters is coupled to match the minimum resolution of the source when the source is acquired. When the source is released, the amplitude parameter resolution reverts to default values.

Key Path	Source
Readback	In square brackets, the amplitude value from Amplitude key in the next menu level down
Initial S/W Revision	A.06.01

Amplitude

Allows you to adjust the power level of the selected source. Note that the actual amplitude is also affected by the Amplitude Offset and Power Sweep parameters.

Key Path	Source, Amplitude
Scope	Mode Global
Remote Command	:SOURce[:EXTeRna1]:POWer[:LEVel][:IMMediate][:AMPLitude] <amp1> :SOURce[:EXTeRna1]:POWer[:LEVel][:IMMediate][:AMPLitude]?
Example	:OUTP ON :SOUR:POW -10dBm
Dependencies	If the requested setting of Source Amplitude causes the calculated external source start or stop Amplitude to exceed the external source capability, a warning status message is generated,

	<p>“Data out of Range; clipped to source max/min” The “Show Source Capabilities and Settings” menu can then be examined to check the source capabilities.</p> <p>This parameter test and clip is also performed at source acquisition.</p>
Preset	<p>-10.00 dBm (On Source Preset and Restore Input/Output Defaults)</p> <p>Not affected by Mode Preset</p>
State Saved	Part of the Input/Output system, which means it is Loaded and Saved with state.
Min	The range of the amplitude parameter is dependent on the amplitude range of the source that is selected, and the settings of Amplitude Offset and Power Sweep.
Max	The range of the amplitude parameter is dependent on the amplitude range of the source that is selected, and the settings of Amplitude Offset and Power Sweep.
Backwards Compatibility SCPI	<p>:SOURce:POWer:STARt <amp1></p> <p>:SOURce:POWer:STARt?</p> <p>This alias is for the ESA tracking generator. It specifies the source output power level at the start of the power sweep, just as does :SOURce:POWer.</p>
Initial S/W Revision	A.06.01
Modified at S/W Revision	A.10.01

Power Sweep

Allows you to set up a Power Sweep. Power Sweep is useful for measuring saturation behavior in a test device, such as a power amplifier.

Pressing the key sets the power-sweep function to On or Off. The value of the power-sweep range is displayed in the active function block, and can be adjusted, when set to On.

The source will sweep the power between the start power defined by the Amplitude function and the stop power = start power + power sweep value:

Source (start) amplitude = Amplitude – Amplitude Offset

Source (stop) amplitude = Amplitude – Amplitude Offset + Power Sweep

In Stepped Tracking, such as is used with an external source or the CXA-m TG, the analyzer controls the source with step sweep mode, which provides a linear progression from one selected frequency, amplitude, or both, to another, pausing at linearly spaced points (steps) along the sweep. The analyzer continues to sweep the specified frequency range when power sweep is on, although generally Power Sweep is performed in Zero Span.

With CXA options T03, T06, the hardware is capable of continuous power sweeps. This makes it possible to use the swept sweep time rules and should be employed for faster sweeps. Care should be taken to limit the sweep time you use as there are no sweep time couplings to Power Sweep settings. The recommended minimum sweep time depends on the RBW and power-sweep range. Start by computing $(1.28/\text{RBW}) * (\text{abs}(\text{startPower} - \text{stopPower}) / (5 \text{ dB}))$. The recommended minimum sweep time is the larger of this value and 50 ms.

Some external Sources have mechanical attenuators, which are not used in Power Sweep in order to save wear on the attenuators. To allow an acceptable range of Power Sweep without changing the mechanical attenuation, the Sources are put in a mode that allows the Source to handle a wide amplitude range without switching the attenuators. When the Power Sweep settings put the Source in an amplitude range that requires the mechanical attenuators, the analyzer displays a condition warning message:

Settings Alert;Src pwr ramp>ALC range

Key Path	Source, Amplitude
Mode	SA
Scope	Mode Global
Remote Command	:SOURce:POWer:SWEep <rel_amp1> :SOURce:POWer:SWEep? :SOURce:POWer:SWEep:STATe ON OFF 1 0 :SOURce:POWer:SWEep:STATe?
Example	:SOUR:POW -5 :SOUR:POW:SWE:STAT ON :SOUR:POW:SWE 10 Set source start power to - 5 dBm and stop power + 5dBm (-5 + 10).
Example	:SOUR:POW:SWE:STAT ON
Dependencies	If the requested setting of Power Sweep causes the calculated external source start or stop Amplitude to exceed the external source capability, a warning status message is generated, "Data out of Range; clipped to source max/min". The Show Source Capabilities and Settings menu can then be examined to check the source capabilities. This parameter test and clip is also performed at source acquisition.
Preset	This is unaffected by "Mode Preset" but is set to 0dB on a "Source Preset" or "Restore Input/Output Defaults".
State Saved	Part of the Input/Output system, which means it is Loaded and Saved with state.
Min	-500 dB
Max	+500 dB
Backwards Compatibility SCPI	:SOURce[:EXTeRnAl][:SWEep]:POWer:SPAN <rel_amp1> :SOURce[:EXTeRnAl][:SWEep]:POWer:SPAN? This alias is for the ESA tracking generator and PSA option 215. It specifies the range of power levels through which the source output will sweep just as does :SOURce:POWer:SWEep.
Initial S/W Revision	A.06.01
Remote Command	:SOURce[:EXTeRnAl]:POWer:MODE FIXed SWEep :SOURce[:EXTeRnAl]:POWer:MODE?
Notes	The ESA tracking generator and the PSA option 215 support this SCPI command. It sets the source output to be at a single amplitude (fixed) or to sweep through a range of power levels

	SOURce:POWer:MODE FIXed is equivalent to :SOURce:POWer:SWEEP:STATe OFF
	SOURce:POWer:MODE SWEEP is equivalent to :SOURce:POWer:SWEEP:STATe ON
Preset	This is unaffected by "Mode Preset" but is set to FIXed on a "Source Preset" or "Restore Input/Output Defaults".
Initial S/W Revision	A.06.01
Modified at S/W Revision	A.10.01

Amptd Offset

Offsets the displayed power of the source in the Amplitude parameter. Using the amplitude offset allows you to take into account any system losses or gains (for example, due to cable loss), thereby displaying the actual power delivered to the device under test. See the equations under the Source, Amplitude, Power Sweep key.

Key Path	Source, Amplitude
Mode	SA
Scope	Mode Global
Remote Command	:SOURce:CORRection:OFFSet <rel_amp1> :SOURce:CORRection:OFFSet?
Example	:SOUR:CORR:OFFS 5 Sets the displayed source offset power to 5 dB.
Dependencies	If the requested setting of Amptd Offset causes the calculated external source start or stop Amplitude to exceed the external source capability, a warning status message is generated, "Data out of Range; clipped to source max/min". The Show Source Capabilities and Settings menu can then be examined to check the source capabilities. This parameter test and clip is also performed at source acquisition.
Preset	This is unaffected by Mode Preset but is set to 0.00dBm on a Source Preset or Restore Input/Output Defaults.
State Saved	Part of the Input/Output system, which means it is Loaded and Saved with state.
Min	-1000 dB
Max	+1000 dB
Initial S/W Revision	A.06.01

Amptd Step Auto/Man

Allows you to set the step size associated with the Source Amplitude key. When auto-coupled, the step size is the current Scale/Div setting under the Amplitude hardkey (note that this is true even if the analyzer is currently in Linear amplitude scale).

Once a step size has been selected and the Source Amplitude function is active, the step keys (and the UP|DOWN parameters for Source Amplitude from remote commands) change the Source Amplitude by the step-size value.

You may change the step size manually by pressing Amptd Step and entering a value. The function (and the step size) will return to Auto when a Mode Preset or Auto Couple is performed.

Key Path	Source, Amplitude
Scope	Mode Global
Remote Command	<pre>:SOURce:POWer:STEP[:INCRement] <amp1> :SOURce:POWer:STEP[:INCRement]? :SOURce:POWer:STEP:AUTO OFF ON 0 1 :SOURce:POWer:STEP:AUTO?</pre>
Example	<pre>:SOUR:POW:STEP 0.1 Set amplitude step to 0.1 dB :SOUR:POW:STEP:AUTO ON</pre>
Couplings	In Auto, coupled to the size of one logarithmic vertical graticule division
Preset	Auto
State Saved	Part of the Input/Output system, which means it is Loaded and Saved with state.
Min	0.1 dB
Max	20 dB
Initial S/W Revision	A.06.01

Frequency

Allows a you to access the Frequency sub-menu. This menu lets you use a stepped tracking source for stimulus/response measurements for some added flexibility. Because with such a source, the source frequency does not need to track 1:1 with the analyzer LO frequency, it is possible to measure scalar harmonic and subharmonic responses of devices. For example, the second harmonic response is measured by stepping the analyzer and source so that the analyzer is always at twice the source frequency. In addition, the frequency offset capability allows the measurement of frequency conversion devices (like mixers).

In tracking mode, the source frequency tracks the analyzer frequency according to the source frequency equation:

$$\text{Source Frequency} = (\text{Analyzer Frequency} * \text{Multiplier Numerator} / \text{Multiplier Denominator}) + \text{Source Frequency Offset}$$

NOTE

Analyzer Frequency is the frequency to which the analyzer is set, which is the analyzer's displayed frequency, offset by any Freq Offset set under the Frequency hardkey. Source Frequency Offset is the value set under **Source, Frequency, Freq Offset.**

Key Path	Source
----------	---------------

Readback	none in Tracking Source mode
Initial S/W Revision	A.06.01

Multiplier Numerator

The multiplier numerator parameter offsets the source frequency from the analyzer frequency. The source frequency tracks the SA frequency according to the source frequency equation shown under the **Source, Frequency** key description.

The multiplier numerator must be restricted to operate within the range of the source minimum and maximum frequencies.

Key Path	Source, Frequency
Mode	SA
Scope	Mode Global
Remote Command	:SOURce:FREQuency[:MULTIplier]:NUMerator <integer> :SOURce:FREQuency[:MULTIplier]:NUMerator?
Example	:SOUR:FREQ:NUM 3 Sets the source frequency multiplier numerator to 3.
Dependencies	If the currently selected source does not support this capability (for example, an internal Tracking Generator which must track the LO), this key is forced to its Preset value and grayed out
Preset	This is unaffected by Mode Preset but is set to 1 on a Source Preset or Restore Input/Output Defaults.
State Saved	Part of the Input/Output system, which means it is Loaded and Saved with state.
Min	1
Max	1000
Initial S/W Revision	A.06.01

Multiplier Denominator

The multiplier denominator parameter offsets the source frequency from the analyzer frequency. The source frequency tracks the SA frequency according to the source frequency equation shown under the **Source, Frequency** key description.

The multiplier denominator must be restricted to operate within the range of the source minimum and maximum frequencies.

Key Path	Source, Frequency
Mode	SA
Scope	Mode Global
Remote Command	:SOURce:FREQuency[:MULTIplier]:DENominator <integer> :SOURce:FREQuency[:MULTIplier]:DENominator?
Example	:SOUR:FREQ:DEN 3 Sets the source frequency multiplier denominator to 3

Dependencies	If the currently selected source does not support this capability (for example, an internal Tracking Generator which must track the LO), this key is forced to its Preset value and grayed out
Preset	This is unaffected by Mode Preset but is set to 1 on a Source Preset or Restore Input/Output Defaults.
State Saved	Part of the Input/Output system, which means it is Loaded and Saved with state
Min	1
Max	1000
Initial S/W Revision	A.06.01

Source Sweep Reverse

Allows you to reverse the source sweep direction

Normally, the source will sweep from a lower frequency to a higher frequency. However, there are test scenarios in which the source sweep needs to be “reversed”. In this case, it sweeps from a higher frequency to a lower frequency. For example, when the DUT is a frequency converter and a measurement of the Lower Side Band characteristics is desired, a reverse sweep is employed. Reverse sweeps are supported for such scenarios, but two cautions are in order:

4. Reverse Sweep only reverses the direction of the source’s sweep, not the analyzer’s sweep. Unless you are actually using a device like a frequency converter and looking at the lower sideband, thus effectively reversing the direction of the source’s sweep, the source will be sweeping in the opposite direction from the analyzer, and it will not be possible track the desired device output frequency.
5. Any time you are using a frequency converter, care must be taken in setting up all of the sweep parameters, including analyzer start/stop frequency and source multiplier, to make sure that the analyzer’s sweep tracks the output of the converter device.

Key Path	Source, Frequency
Mode	SA
Scope	Mode Global
Remote Command	:SOURce:FREQuency:SSReverse:ON OFF 0 1 :SOURce:FREQuency:SSReverse?
Example	SOUR:FREQ:SSR:OFF SOUR:FREQ:SSR?
Notes	You must be in Spectrum Analyzer mode to use this command. Use INSTRument:SElect to set the mode.
Dependencies	If the currently selected source does not support this capability (for example, an internal Tracking Generator which must track the LO), this key is forced to its Preset value and grayed out
Preset	This is unaffected by Mode Preset but is set to OFF on a Source Preset or Restore Input/Output Defaults.

State Saved	Part of the Input/Output system, which means it is Loaded and Saved with state
Range	On Off
Initial S/W Revision	A.06.01

Freq Offset

The frequency offset parameter offsets the source frequency from the analyzer frequency. The source frequency tracks the SA frequency according to the equations under the **Source, Frequency** key.

Pressing the key sets the Freq Offset function to On or Off. The value of Freq Offset is displayed in the active function block, and can be adjusted, when set to On.

The frequency offset must be restricted to operate within the range of the source minimum and maximum frequencies.

Key Path	Source, Frequency
Mode	SA
Scope	Mode Global
Remote Command	:SOURce:FREQuency:OFFSet <freq> :SOURce:FREQuency:OFFSet? :SOURce:FREQuency:OFFSet:STATe ON OFF 1 0 :SOURce:FREQuency:OFFSet:STATe?
Example	:SOUR:FREQ:OFFS 10MHz Sets the source frequency offset to 10MHz.
Dependencies	If the currently selected source does not support this capability (for example, an internal Tracking Generator which must track the LO), this key is forced to its Preset value and grayed out
Preset	This is unaffected by Mode Preset but is set to 0.00Hz on a Source Preset or Restore Input/Output Defaults.
State Saved	Part of the Input/Output system, which means it is loaded and saved with state
Min	-500 GHz
Max	500 GHz
Backwards Compatibility SCPI	:SOURce:EXTernal:SWEep:OFFSet:FREQuency <freq> :SOURce:EXTernal:SWEep:OFFSet:FREQuency? The PSA option 215 supports this SCPI command. This command is equivalent to :SOURce:FREQuency:OFFSet
Initial S/W Revision	A.06.01
Modified at S/W Revision	A.10.01

Source Mode

Accesses the Source Mode softkey menu. This menu lets you select Tracking mode for the Source, and also allows you to set the Source Mode to OFF.

The Source Mode can be set to Tracking without the user setting it directly. There are several couplings that cause Source Mode to be automatically set to Tracking (detailed in the table below). One important coupling is that Source Mode is forced to Tracking when the RF Output is turned on if the measurement supports Tracking. Since Source Mode is set to Off on a Mode Preset, this means that you will rarely need to change the Source Mode setting directly.

NOTE

When the Source Mode is set to Tracking, the analyzer acquires control of the source. When this happens the source is told to save its state and then perform a preset. Usually both of these operations take very little time; however, on an N5172B or an N5182B, if many Source real-time apps are in use, both save and preset can take many seconds. If it takes longer than the analyzer expects to acquire control, you will see an error: “Source connection lost, check interface connection”. If you see this error, and you are using an N5172B or an N5182B, you can shorten the acquire time by presetting your MXG before attempting to use External Source Control.

Key Path	Source
Scope	Meas Global
Remote Command	:INSTrument:SOURce[:SElect] TRACKing OFF :INSTrument:SOURce[:SElect]?
Example	:INST:SOUR TRAC
Dependencies	<p>Grayed out if no Source is selected, in this case go to the Select Source menu to choose, configure and/or verify your source</p> <p>Grayed out and forced to Off if either BBIQ or External Mixing are selected</p> <p>Blanked in Modes that do not support a source</p> <p>Grayed out in Measurements that do not support a source</p> <p>Tracking is grayed out when Manual FFT is selected</p> <p>Tracking is grayed out when the RF Preselector is on (in models which support the RF Preselector).</p>
Couplings	<p>When RF Output is turned On, Source Mode is set to Tracking. When Source Mode is turned Off, RF Output is turned Off.</p> <p>Whenever you switch to an application (Mode) in which the Source Mode was previously set to Tracking, it is again set to Tracking. That is, the last setting of the Source Mode is remembered when you leave an application (Mode) and restored when you return</p> <p>Source Mode is forced to Tracking when the RF Output is turned on if the measurement supports Tracking</p> <p>If Source Mode is set to Tracking, then it is forced to Off when you select a measurement that does not support Tracking.</p> <p>If Source Mode is set to Tracking, then it is forced to Off when you turn on the RF Preselector (in models which support the RF Preselector).</p> <p>Whenever the Source Mode is set to Tracking, the analyzer acquires the Source. Similarly, the Source is released whenever the Source Mode is set to Off. This is true whether the Source Mode was set directly by you, was set indirectly through a coupling, if you switched to an application (Mode) that had previously been set to Tracking, or if you switched to an application (Mode) in which the Source Mode is not set to Tracking.</p> <p>For an external source, “acquiring the source” involves contacting the external instrument over</p>

the remote interface (which puts it into Remote) and taking control of it.
When you set the Source Mode to OFF, it releases the Source (and puts it into Local). For an external source, this means you are now free to operate the source for other purposes.
When the Source is acquired, its previous state is saved, and when it is released, that state is restored, so that you can acquire and then release the source and it will return to the state it was in before you acquired it.

Preset	OFF
State Saved	Saved in instrument state
Initial S/W Revision	A.06.01
Modified at S/W Revision	A.10.01

Select Source

The Select Source menu allows you to maintain a list of available external Sources, and choose the Source that you want to use from the list. It shows the currently selected source at the bottom of the screen.

While in the Select Source menu, you can see, and select from, a list of the currently available sources. The sources listed in this table are as follows:

- Any internal sources which are installed and licensed

NOTE

Only one internal source can be installed, displayed at address “INTERNAL”

- Any external sources which you have previously configured, whether or not they are currently connected, displayed with their VISA address

Note that only external sources that are supported by the Tracking Source Mode are displayed in the Available Source List. Here are the Keysight/Agilent sources currently supported:

Source	PXA	MXA	EXA	CXA	MXE (Presel off)
MXG N5181A	X	X	X	X	X
MXG N5182A	X	X	X	X	X
MXG N5183A	X	X	X		X
EXG N5171B	X	X	X	X	X
MXG N5181B	X	X	X	X	X
EXG	X	X	X	X	X

N5172B					
EXG	X	X	X	X	X
N5173B					
MXG	X	X	X	X	X
N5182B					
MXG	X	X	X	X	X
N5183B					
PSG	X	X	X		
E8257D					
PSG	X	X	X		
E8267D					

NOTE

For X-Series software versions earlier than A.10.01, option UNZ (Fast switching) was required on the MXG for some use cases. This is no longer the case, option ESC now works without MXG option UNZ for all use cases. (Note that you will get better performance if your MXG has option UNZ, because without option UNZ your sweep speeds will be noticeably slower.)

While in the Select Source menu and its submenus, detailed instructions are presented that tell you how to operate the Select Source functions. Basically they tell you to first use the up and down arrow keys to move the selection highlighted in the “Available Source List” to the source that you want to use. The list of available sources includes any sources that you have previously used (unless you have deleted them) and any found while in the “Add Source to List” menu.

When the source you want to use is highlighted, press “Select Highlighted Source” or “Enter”. The source you have selected shows up at the bottom of the screen as the “Current Source”. Press “Verify Current Source Connection” to make sure that the interface connection to the Source is still functional.

At any time you may use the “Add Source to List” or “Delete Highlighted Source” keys to find new sources or remove a source from the list of available sources.

Key Path	Source
Readback Text	Two lines of readback give the type information and serial number of the current source, in square brackets
Initial S/W Revision	A.06.01

Select Highlighted Source

You can navigate up and down in the list with the up and down arrow keys, and can select any entry by pressing the Select Highlighted Source key (or by double-clicking on the entry in the table with a mouse). The highlighted source becomes the Current Source and is prominently displayed at the bottom of the screen.

At any given time there is only one selected Source for the entire system; once a Source is selected, it becomes the Current Source and will be used by all applications that support Source Control.

For example, if no Source has yet been selected, the statement at the bottom of the screen would say

Current Source

None

If an N5182A connected via USB were the Current Source, the statement at the bottom of the screen might say:

Current Source

Agilent N5182A US00000258 at USB0::2931::7937::US00000258::0::INSTR

The SCPI command defined below allows the programmatic user to directly define the VISA address via a string parameter. The parameter is checked for proper syntax, the connection to the instrument is verified, and the source is added to the Available Source List if it verifies. If it does not verify or no source is found at that address, an error message is generated.

Normally the source selection activities should be performed only when the user changes the hardware connection configuration or activates/deactivates a source option license; shutdown and startup of the application will not cause source re-selection.

The Agilent IO Libraries Suite provides an “Agilent VISA Help” document that has a section that shows the proper syntax for valid VISA address strings, in the ViOpen function definition.

Key Path	Source, Select Source
Mode	SA
Remote Command	:SYSTem:COMMunicate:SOURce[1]:ADDRess <address string> :SYSTem:COMMunicate:SOURce[1]:ADDRess?
Example	Different examples for setting external source address :SYST:COMM:SOUR:ADDR "TCPIP0::MyHostName::INSTR" :SYST:COMM:SOUR:ADDR "TCPIP0::123.121.100.210::INSTR" :SYST:COMM:SOUR:ADDR "USB0::12212::32145::US1234567A::INSTR" :SYST:COMM:SOUR:ADDR "GPIB1::19::INSTR"
Notes	Empty string is allowed and means no source is defined or selected.
Remote Command Notes	The address string is the VISA address for external sources and "INTERNAL" for an internal source
Dependencies	Operation with a source requires a license. If the proper license is not installed, the SCPI command generates an error message, "Settings conflict;option not installed" If no supported source, or no source at all, is found at the specified address, the SCPI command generates an error message
Preset	The current source selection is unaffected by a Mode Preset and Source Preset but reverts to [None] on a Restore Input/Output Defaults. If an internal Tracking Generator is installed, then instead of None, the default selection will be INTERNAL.

State Saved	<p>Selected Source is</p> <ul style="list-style-type: none"> - Power On Persistent (survives power cycle) - Part of the Input/Output system, which means it is Loaded and Saved with state.
Readback	<p>Two lines of readback give the type information and serial number of the current source on the Select Source key in the form</p> <p>[<source type>] [<serial number>]</p> <p>[None] shows in the type area and blank in the serial number area if a source has not been configured.</p> <p>[Internal TG] shows in type area and serial number in the serial number area if an internal Tracking Generator has been selected.</p> <p>For example: [MXG]/n, [US01020022]. This indicates an MXG of serial number US01020022.</p>
Backwards Compatibility SCPI	<p>:SYSTem:COMMunicate:LAN:SOURce[:EXTernal]:IP <address string></p> <p>:SYSTem:COMMunicate:LAN:SOURce[:EXTernal]:IP?</p> <p>This command is provided for compatibility with PSA Option 215. The address string is reformatted for the X-Series. For example, if the customer sends</p> <p>:SYSTem:COMMunicate:LAN:SOURce:EXTernal:IP 146.208.172.111</p> <p>The analyzer turns this into</p> <p>:SYSTem:COMMunicate:SOURce:ADDRes "TCPIP0::146.208.172.111::INSTR"</p>
Initial S/W Revision	A.06.01
Modified at S/W Revision	A.10.01

Delete Highlighted Source

Deletes the highlighted source from the list of available sources. You will be prompted with a dialog box to make sure you REALLY want to do this. The prompt says "The highlighted source will be permanently deleted from the list. Are you sure you want to do this? Press Enter to proceed, or Cancel (ESC) to cancel."

Key Path	Source, Select Source
Initial S/W Revision	A.06.01

Add Source To List

This menu allows you to add to the list of available sources from various interfaces.

Key Path	Source, Select Source
Initial S/W Revision	A.06.01

USB

Sources on USB (once installed) can be added to the list by pressing "Add Installed USB Sources." Any supported source found will be added to the list.

See ["Add Installed USB Sources" on page 3259](#) for information on connecting and installing USB devices.

Key Path	Source, Select Source, Add Source to List
Initial S/W Revision	A.06.01

Add Installed USB Sources

Press this key to add USB sources to the Available Source List. Note that this function will ONLY find sources that have previously been installed onto the USB. For information on how to install a USB source, see ["Installing a USB source" on page 2473](#)

Key Path	Source, Select Source, Add Source to List, USB
Notes	If no installed USB device is found which is a supported source, an error message is generated
Initial S/W Revision	A.06.01

Installing a USB source

USB is the only interface which requires no runtime action by the user in the Select Source menu, but does require “installation” when a source is plugged in.

You start by connecting the USB source to the analyzer. You will get a series of messages indicating that the analyzer is installing required device software.

When the installation is complete, you will get a message to that effect. You can then use the “Add Installed USB Sources” function (above) to add the source to the list of sources in the Available Source List.

GPIB

Lets you add GPIB sources to the Available Source List.

For the GPIB interface to work properly, it must be configured as a Controller. You can find this setting in the System menu under System, I/O Config, GPIB. Set the GPIB Controller function to Enabled.

Note that you must also make sure that the GPIB interface is not set to “Ignore” in the Agilent Connection Expert. If it is set to **Ignore**, then even if the GPIB Controller is set to **Enabled**, it is not possible for the analyzer to find a GPIB connected source. See ["More Information" on page 2473](#).

Key Path	Source, Select Source, Add Source to List
Initial S/W Revision	A.06.01

More Information

If you suspect that the GPIB interface is not set to Ignore, run the Agilent Connection Expert (ACE). To run ACE, press Source, Select Source, Add Source to List, LAN, Run Connection Expert. Look for the GPIB branch on the interface tree:

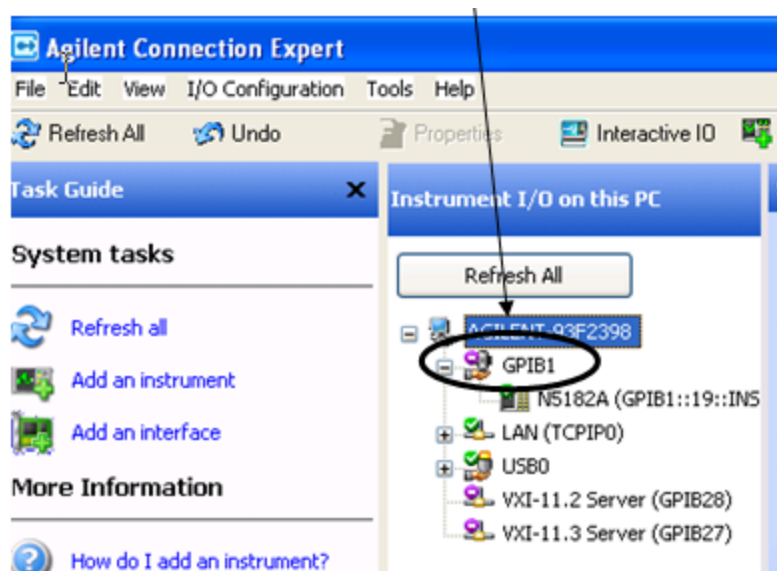

Right click on the GPIB branch (you will have to plug in a mouse to do this). You should see a dialog like the one below. If this dialog says **Stop Ignoring**, select **Stop Ignoring** and close ACE.

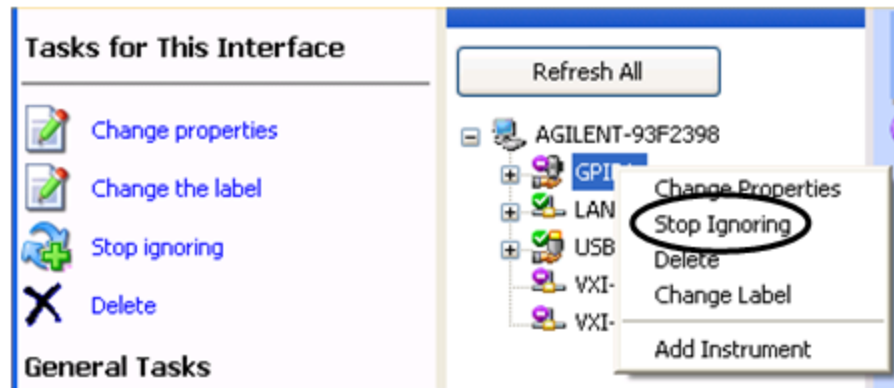

Scan & Add GPIB Sources

Sources on GPIB can be added by pressing **Scan & Add GPIB Sources**. Any supported source found will be added to the Available Source List.

NOTE

This will cause any older, non-SCPI compatible devices on your GPIB to generate error messages.

Key Path	Source, Select Source, Add Source to List, GPIB
Notes	If the GPIB controller mode is not enabled, an error message is generated If no GPIB device is found which is a supported source, an error message is generated
Initial S/W Revision	A.06.01

Enter GPIB Address

Opens a menu that lets you enter the GPIB address of the desired source directly.

NOTE

For this to work properly, the GPIB interface must be configured as GPIB1. This is the default state and should normally be the case. To see how to verify this, see **"More Information" on page 2475**.

Key Path	Source, Select Source, Add Source to List, GPIB
Initial S/W Revision	A.06.01

More Information

If you suspect that the GPIB interface is not set to GPIB1, run the Agilent Connection Expert (ACE). To run ACE, press Source, Select Source, Add Source to List, LAN, Run Connection Expert. Look for the GPIB branch on the interface tree:

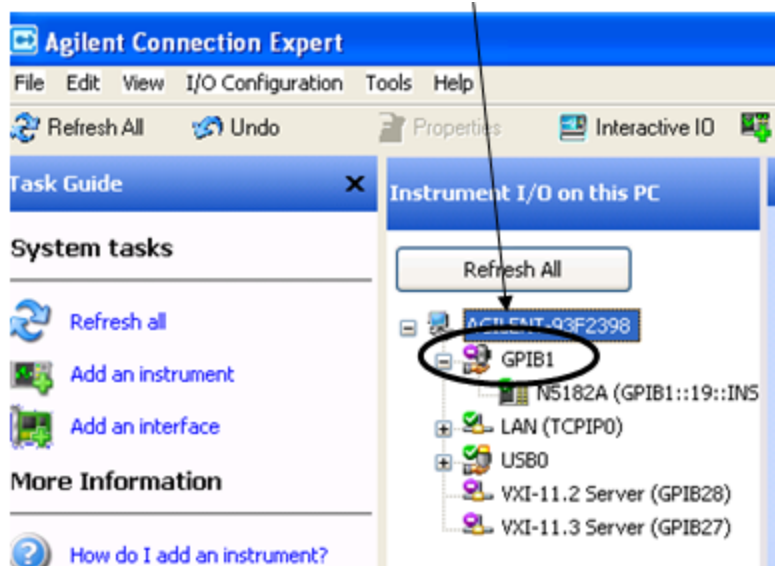

If this branch is not labeled **GPIB1**, right click on the GPIB branch (you will have to plug in a mouse to do this) and select **Change Properties**.

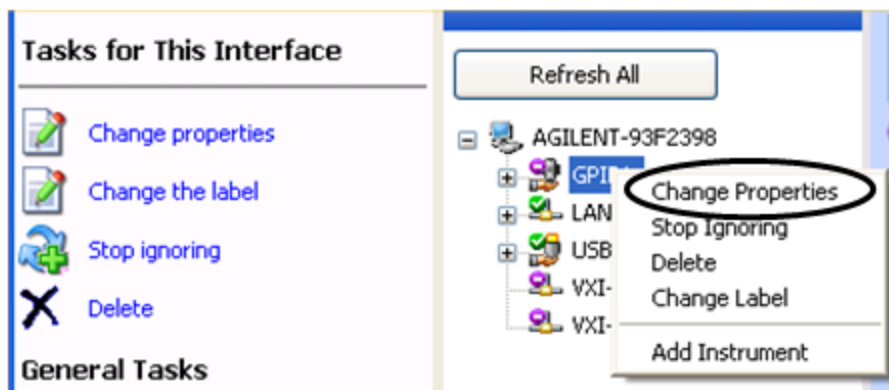

You should see a dialog like the one below. Click on the drop-down arrow under VISA Interface ID, select GPIB1 and click OK

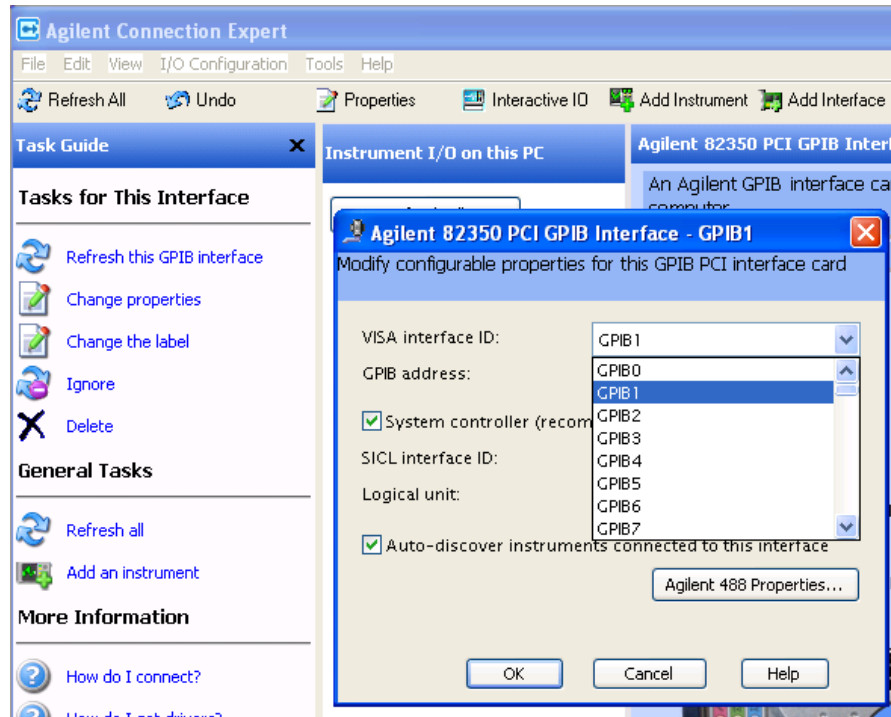

GPIB Address

Lets you enter the GPIB address. After you enter the address press **Add** to add the source at that address to the Available Source List.

Key Path	Source, Select Source, Add Source to List, GPIB, Enter GPIB Address
Preset	Unaffected by Mode Preset but set to 19 by "Restore Input/Output defaults"
State Saved	No
Min	0
Max	30
Initial S/W Revision	A.06.01

Add

Add the source at the entered GPIB address to the Available Source List. If a supported source is found at that address it will be added to the list.

Key Path	Source, Select Source, Add Source to List, GPIB, Enter GPIB Address
Notes	If GPIB controller mode is not enabled, an error message is generated If no supported source is found at the specified address, an error message is generated
Initial S/W Revision	A.06.01

LAN

The LAN cannot be scanned directly from the analyzer software, but you can import the list of currently configured devices from Agilent Connection Expert by pressing

“Add From Connection Expert List.” The Connection Expert list depends on which instruments have already been discovered by the Agilent Connection Expert application. Any connected, supported sources in that list will be added.

You can also enter the IP address and press “Add”. If a supported source is found at that address it will be added.

If you want to discover sources on the LAN, you can open Connection Expert by pressing the “Run Connection Expert...” softkey.

Key Path	Source, Select Source, Add Source to List
Initial S/W Revision	A.06.01

Enter LAN Address

Opens up a menu which lets you enter the IP address of the desired source directly.

Key Path	Source, Select Source, Add Source to List, LAN
Initial S/W Revision	A.06.01

IP Address

Lets you enter the IP address of the desired source. After you enter the address you should press “Add” to add the source at that address to the Available Source List.

Key Path	Source
Preset	Unaffected by Mode Preset but set to 0.0.0.0 by Restore Input/Output defaults
State Saved	No
Initial S/W Revision	A.06.01

Add

Adds the source at the entered IP address to the Available Source List. If a supported source is found at that address it will be added to the list.

Key Path	Source
Notes	If no supported source is found at the specified address, an error message is generated
Initial S/W Revision	A.06.01

Run Connection Expert...

Runs the Agilent Connection Expert so that you can scan the LAN for sources.

Key Path	Source, Select Source, Add Source to List, LAN
Initial S/W Revision	A.06.01

Add From Connection Expert List

You can import the list of currently configured devices from Agilent Connection Expert by pressing **Add From Connection Expert List**. The Connection Expert list

depends on which instruments have already been discovered by the Agilent Connection Expert application. Any connected, supported sources in that list will be added.

Key Path	Source, Select Source, Add Source to List, LAN
Notes	If no supported source is found in the Connection Expert list, an error message is generated
Initial S/W Revision	A.06.01

Verify Current Source Connection

This key verifies the interface connection to the Current Source (it does NOT verify any signal connections!)

Until the selected source is verified, a statement appears at the bottom of the screen which says (in red):

This Source has not been verified. Press "Verify Source" to check the interface connection.

When you press this key, the connection is checked to the selected source. If all is well, the statement is changed to (in green):

This connection to this source has been verified.

If the verification fails, the statement at the bottom will change to (in red):

Verification of this source failed. Check the interface connection

The selected source is also verified whenever it is acquired. If a Source's connection has been verified by any means, then that Source is considered to have been verified until either the analyzer software is shut down or if, in attempting to use the Source, communication with it fails.

Key Path	Source, Select Source
Initial S/W Revision	A.06.01

Source Setup

This menu is used to set up miscellaneous source functions, including trigger settings. For more on triggering in Tracking Mode, see ["Tracking Setup Details" on page 2478](#). For information on bypassing the Microwave Preselector, see ["Use of the YTF \(Microwave or mm Preselector\) with External Source Control" on page 2479](#)

Key Path	Source
Mode	SA
Initial S/W Revision	A.06.01

Tracking Setup Details

When an external source is operating in Tracking Mode, operation can be greatly enhanced by using hardware triggers. Below is a typical connection diagram showing

a hardware handshake using Trigger 1 inputs and outputs on the analyzer (trigger 2 in and out is also a valid connection).

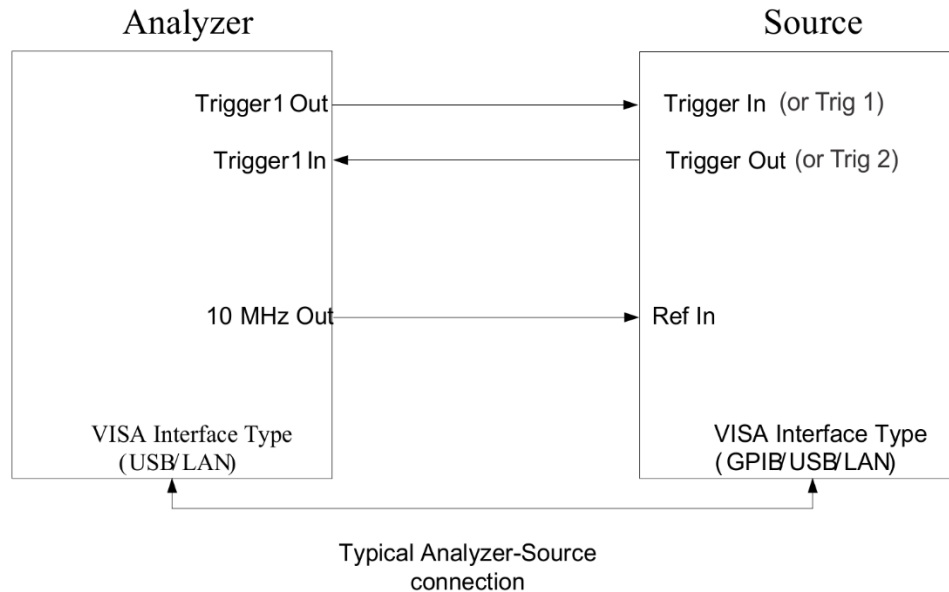

Analyzer Trigger 1 Out: Triggers the external source to step to next point in the frequency step/list.

Analyzer Trigger 1 In: Triggers the analyzer to make a measurement on this point

Source Trigger In (or “Trig 1” at default setting for N5181B/82B, N5183B MXG or N5171B/72B, N5173B EXG):

Triggers the source to step to the next point.

Source Trigger Out (or “Trig 2” at default setting for N5181B/82B, N5183B MXG or N5171B/72B, N5173B EXG): Indicates that the source has settled.

IO interface Connection: analyzer can connect to sources with its GPIB, USB or LAN interface.

Notes:

- Trigger sync connections are optional – synchronization can be done via remote commands if Bus Trigger is enabled in the Source Setup menu.
- Connection from the SA external frequency reference output to the source frequency reference input (10 MHz Out to Ref In) is not required, but may improve the measurement accuracy.

Use of the YTF (Microwave or mm Preselector) with External Source Control

In most stimulus/response measurements that utilize External Source Control, the source exactly tracks the tuned analyzer frequency. Consequently, preselection is not needed, and you can achieve greatly superior amplitude accuracy and

repeatability by bypassing the YTF (Preselector) using the Microwave Preselector Bypass control in the Amplitude, μ W Path Control menu.

NOTE

This control is only available if option MPB is installed.

There are rare but important cases, however, where the source is tuned to a different frequency than the analyzer, using the Multiplier and Reverse controls in the Source, Frequency menu. For example, you might be tuning the source to $\frac{1}{2}$ of the analyzer frequency when looking at second harmonic distortion in a DUT. In these cases, it would be commonplace for there to be an undesired signal at the analyzer input that is at an image frequency that you will want to reject with the YTF.

Understanding these cases is important for proper operation of the Microwave Preselector with External Source Control, so that you only bypass it when it will improve accuracy but not hinder the measurement.

Point Trigger

Shows point trigger type selected and navigates to the Point Trigger menu.

The Point Trigger menu lists all analyzer point trigger types. The analyzer and source point trigger synchronization can be done using SCPI bus commands or by using external trigger output and input lines.

NOTE

For X-Series software versions earlier than A.10.01, hardware triggering was unavailable in stepped tracking at frequencies above 3.6 GHz, so above 3.6 GHz, software triggering was always used. This is no longer the case.

Key Path	Source, Source Setup
Mode	SA
Scope	Mode Global
Remote Command	:SOURCE:TRIGGER:TYPE BUS EXTERNAL[1] EXTERNAL2 :SOURCE:TRIGGER:TYPE?
Example	:SOUR:TRIG:TYPE EXT1 Selects analyzer external trigger 1 in and out for point trigger synchronization with selected source
Dependencies	If an internal Tracking Generator is selected, then this menu is unavailable. Additionally, the External 1 and External 2 Trigger keys on the Spectrum Analyzer are released from any grayout that may have been forced on them by the external source Point Trigger selection. In some models, there is no second External input. In these models, the External 2 key is blanked and the EXTERNAL2 parameter will generate a "Hardware missing; Not available for this model number" message.
Couplings	The source control point trigger selection can select external trigger 1 or 2 in for synchronized point triggering. This can conflict with the selection under the Trigger hardkey, if it has External 1 or 2 selected. If there is a conflict when the selection is made under the Point Trigger menu, the Trigger selection under the Trigger hardkey will be changed to Free Run.
Preset	This is unaffected by "Mode Preset" but is set to EXTERNAL1 on a "Source Preset" or "Restore Input/Output Defaults".

State Saved	Part of the Input/Output system, which means it is Loaded and Saved with state
Readback	1-of-N selection
Initial S/W Revision	A.06.01

SW Trigger

Analyzer and source point trigger synchronization is setup using the SCPI commands. Source is stepped via SCPI commands. Analyzer waits for source to settle by polling source.

Key Path	Source, Source Setup, Point Trigger
Mode	SA
Example	:SOUR:TRIG:TYPE BUS
Readback	SW Trigger
Initial S/W Revision	A.06.01

Ext Trigger 1

Analyzer and source point trigger synchronization is setup using the analyzer Trigger 1 Output and Trigger 1 Input. The Source is stepped via Trigger 1 Output. The Analyzer waits for source to settle via Trigger 1 Input.

Key Path	Source, Source Setup, Point Trigger
Mode	SA
Example	:SOUR:TRIG:TYP EXT1
Couplings	<p>With an acquired source, selecting this point trigger mode overrides existing external trigger 1 output level, slope, and delay, and external trigger 1 type and polarity.</p> <p>External trigger 1 input level = 1.20 V</p> <p>External trigger 1 input slope = Positive</p> <p>External trigger 1 input delay = Off</p> <p>External trigger 1 output type = Source Point Trigger</p> <p>External trigger 1 output polarity = Positive</p> <p>When this selection is made:</p> <ul style="list-style-type: none"> - The External 1 key in the Trigger menu (under the Trigger hardkey) is grayed out and, if External 1 was previously selected, it will be changed to Free Run. - Trig 1 Out selected under Output Config in the Input/Output menu will be changed to Source Point Trigger <p>If the user subsequently goes into the Trig 1 Out menu and selects a different Trigger Output, the Point Trigger will revert to SW Trigger.</p>
Readback	Ext Trigger 1
Initial S/W Revision	A.06.01

Ext Trigger 2

Analyzer and source point trigger synchronization is setup using the analyzer Trigger 2 Output and Trigger 2 Input. The Source is stepped via Trigger 2 Output. The Analyzer waits for source to settle via Trigger 2 Input.

Key Path	Source, Source Setup, Point Trigger
Mode	SA
Example	:SOUR:TRIG:TYP EXT2
Dependencies	This key is blanked out on CXA as there is only one trigger input
Couplings	<p>With an acquired source, selecting this point trigger mode overrides existing external trigger 2 output level, slope, and delay, and external trigger 2 type and polarity.</p> <p>External trigger 2 input level = 1.20 V</p> <p>External trigger 2 input slope = Positive</p> <p>External trigger 2 input delay = Off</p> <p>External trigger 2 output type = Source Point Trigger</p> <p>External trigger 2 output polarity = Positive</p> <p>When this selection is made:</p> <ul style="list-style-type: none"> - The External 2 key in the Trigger menu (under the Trigger hardkey) is grayed out and, if External 2 was previously selected, it will be changed to Free Run. - Trig 2 Out selected under Output Config in the Input/Output menu will be changed to Source Point Trigger - If the user subsequently goes into the Trig 2 Out menu and selects a different Trigger Output, the Point Trigger will revert to SW Trigger.
Readback	Ext Trigger 2
Initial S/W Revision	A.06.01

Show Source Capabilities & Settings

Shows the capabilities of the currently selected Source. The menu is useful for displaying source capabilities such as frequency and amplitude ranges. In addition, the results of the source control sweep algorithms can be viewed. This gives information of the source range required for a given analyzer sweep range. This can be used dynamically as a way of configuring the sweep settings.

Key Path	Source, Source Setup
Mode	SA
Dependencies	If no source is selected this key is grayed out.
Initial S/W Revision	A.06.01

Source Preset

The Source Preset key forces all the settings in the analyzer's Source State to their preset condition.

The Source State is the set of Source settings that is maintained and remembered by the analyzer for use in the Tracking Source Mode. The Source State variables are controlled and set in the menus under the Source front panel key. These settings include:

- RF Output Off
- Amplitude = - 10 dBm
- Amplitude Step = Auto
- Power Sweep = 0 dB
- Amplitude Offset = 0 dB
- Source Sweep Reverse = Off
- Multiplier Numerator = 1
- Multiplier Denominator = 1
- Freq Offset = 0 Hz
- Point trigger is set to "Ext1"

The Source State is saved along with the state of the current Mode when you save a State, and is recalled when that Mode State is recalled.

When the analyzer first starts up, a Source Preset is performed. In the Input/Output menu, Restore Input/Output Defaults will also perform a Source Preset.

A Mode Preset, from modes that support the External Source, will turn the RF Off but will **not** perform a Source Preset. By the same token, Source Preset does **not** perform a Mode Preset.

Source Preset does **not** change the Source Mode nor the selection of which physical source is being used, nor does it release the current source (the source remains under the control of the analyzer) nor exit the Source menu.

Key Path	Source
Mode	SA
Remote Command	:SOURce:PRESet
Example	:SOUR:PRES
Preset	Initiates a Source Preset
State Saved	No
Initial S/W Revision	A.06.01

Span X Scale

Span X Scale is unavailable in the Spurious Emissions measurement. When pressed, this key displays a blank menu.

Key Path	Front-panel key
Initial S/W Revision	Prior to A.02.00

Sweep/Control

Accesses the Sweep/Control menu keys used to set up and control the sweep time and source.

Key Path	Front-panel key
Initial S/W Revision	Prior to A.02.00

Sweep Setup

Sets the sweep functions that control the sweep state and time.

Key Path	Sweep/Control
Initial S/W Revision	Prior to A.02.00

Auto Sweep Time Rules

Switches the analyzer between normal and accuracy sweep states. Setting **Auto Sweep Time** to **Accy** will result in slower sweep times, usually about three times as long, but better amplitude accuracy for CW signals. The instrument amplitude accuracy specifications only apply when **Auto Sweep Time** is set to **Accy**.

Additional amplitude errors which occur when **Auto Sweep Time** is set to **Norm** are usually well under 0.1 dB, though this is not guaranteed. Because of the faster sweep times and still low errors, **Norm** is the preferred setting of **Auto Sweep Time**. **Auto Sweep Time** is set to **Norm** on a **Preset** or **Auto Couple**. This means that in the Preset or Auto Coupled state, instrument amplitude accuracy specifications do not apply.

Key Path	Sweep/Control, Sweep Setup
Mode	SA, WCDMA, C2K, WIMAX OFDMA, TD-SCDMA, 1xEV-DO, DVB-T/H, LTE, LTETDD, WLAN, MSR, LTEAFDD, LTEATDD
Remote Command	[:SENSe]:SPURious:SWEep:TIME:AUTO:RULEs NORMal ACCuracy [:SENSe]:SPURious:SWEep:TIME:AUTO:RULEs?
Example	SPUR:SWE:TIME:AUTO:RUL ACC SPUR:SWE:TIME:AUTO:RUL?
Notes	In Zero Span, this key is irrelevant and inaccessible (because the whole Sweep Setup menu is grayed out), however, Sweep Setup settings can be changed remotely with no error indication.
Preset	NORMal
State Saved	Saved in instrument state.
Range	Norm Accy
Initial S/W Revision	Prior to A.02.00
Modified at S/W Revision	A.03.00

Sweep Type

Sets the sweep type of the spurious measurement to either Auto or Swept. When in Auto, the selections of swept type of ranges are governed by the Best Speed Sweep Type Rule, and FFT analysis might be chosen for some ranges if it speeds up the measurement.

Key Path	Sweep/Control, Sweep Setup
Mode	SA, WCDMA, C2K, WIMAX OFDMA, TD-SCDMA, 1xEV-DO, DVB-T/H, LTE, LTE-TDD, WLAN, MSR, LTEAFDD, LTEATDD
Remote Command	[:SENSe] :SPURious [:RANGe] :ALL :SWEep :TYPE :AUTO OFF ON 0 1 [:SENSe] :SPURious [:RANGe] :ALL :SWEep :TYPE :AUTO?
Example	SPUR:ALL:SWE:TYPE:AUTO 1 SPUR:ALL:SWE:TYPE:AUTO?
Dependencies	This parameter is available only when option N9060A-7FP is installed.
Preset	ON
State Saved	Saved in instrument state.
Range	Auto Swept
Initial S/W Revision	A.11.00

Pause

Pauses a measurement after the current data acquisition is complete.

When paused, the label on the key changes to **Resume**. Pressing **Resume** resumes the measurement at the point it was at when paused.

See "[Pause/Resume](#)" on page 2263 for more information.

Key Path	Sweep/Control
Initial S/W Revision	Prior to A.02.00

Gate

Accesses a menu that enables you to control the gating function. The Gate functionality is used to view signals best viewed by qualifying them with other events.

Gate setup parameters are the same for all measurements – they do not change as you change measurements. Settings like these are called “Meas Global” and are unaffected by Meas Preset.

Note that Sweep Time autocoupling rules and annotation are changed by Gate being on.

Key Path	Sweep/Control
Scope	Meas Global

Readback	The state and method of Gate, as [Off, LO] or [On, Video]. Note that for measurements that only support gated LO, the method is nonetheless read back, but always as LO.
Initial S/W Revision	Prior to A.02.00

Gate On/Off

Turns the gate function on and off.

When the Gate Function is on, the selected Gate Method is used along with the gate settings and the signal at the gate source to control the sweep and video system with the gate signal. Not all measurements allow every type of Gate Methods.

When Gate is on, the annunciation in the measurement bar reflects that it is on and what method is used, as seen in the following "Gate: LO" annunciator graphic.

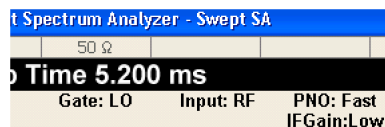

Key Path	Sweep/Control, Gate
Remote Command	[:SENSe] :SWEep:EGATe [:STATe] OFF ON 0 1 [:SENSe] :SWEep:EGATe [:STATe] ?
Example	SWE:EGAT ON SWE:EGAT?

Dependencies	The function is unavailable (grayed out) and Off when: <ul style="list-style-type: none"> – Gate Method is LO or Video and FFT Sweep Type is manually selected. – Gate Method is FFT and Swept Sweep Type is manually selected. – Marker Count is ON.
--------------	--

The following are unavailable whenever Gate is on:

- FFT under Sweep Type when Method=LO or Video or Swept under Sweep Type when Method=FFT

Marker Count

While Gate is on, the Auto Rules for Sweep Type are modified so that the choice agrees with the Gate Method: i.e., FFT for Method = FFT and Swept for Method = LO or Video.

The Gate softkey and all SCPI under the [:SENSe]:SWEep:EGATe SCPI node are grayed out when Source Mode is Tracking with an external source. This is because the Gate circuitry is used to sync the external source. If the Tracking Source is turned on, the Gate is turned off.

When in the ACP measurement:

- When Meas Method is RBW or FAST, this function is unavailable and the key is grayed out.
- Whenever Gate is on, Meas Method, RBW or FAST is unavailable and keys for those are grayed out.

	<ul style="list-style-type: none"> When Gate is on, Offset Res BW and Offset Video BW are ignored (if you set these values) and the measurement works as if all Offset Res BW and all Offset Video BW are coupled with the Res BW and the Video BW under the BW menu. When Gate is on, the Offset BW key in the Offset/Limit menu is grayed out.
Preset	Off LTETDD: On
State Saved	Saved in instrument state
Range	On Off
Backwards Compatibility SCPI	[:SENSe]:SWEep:TIME:GATE[:STATe] ESA compatibility
Backwards Compatibility Notes	In ESA, Trig Delay (On) and Gate (On) could not be active at the same time.. This dependency does not exist in PSA or in the X-Series.
Initial S/W Revision	Prior to A.02.00

Gate View On/Off

Turning on Gate View in the Swept SA measurement provides a single-window gate view display..

Turning on Gate View in other measurements shows the split-screen Gate View. In these measurements, when the Gate View is on, the regular view of the current measurement traces and results are reduced vertically to about 70% of the regular height. The Zero Span window, showing the positions of the Gate, is shown between the Measurement Bar and the reduced measurement window. By reducing the height of the measurement window, some of the annotation on the Data Display may not fit and is not shown.

Key Path	Sweep/Control, Gate
Remote Command	[:SENSe] :SWEep:EGATe:VIEW ON OFF 1 0 [:SENSe] :SWEep:EGATe:VIEW?
Example	SWE:EGAT:VIEW ON turns on the gate view.
Dependencies	In the Swept SA measurement: In Gate View, the regular Sweep Time key is grayed out . When pressed, the grayed out key puts up the informational message "Use Gate View Sweep Time in the Gate menu." In the other measurements: When you turn Gate View on, the lower window takes on the current state of the instrument. Upon leaving Gate View, the instrument takes on the state of the lower window. When you turn Gate View on, the upper window Sweep Time is set to the gate view sweep time.
Couplings	These couplings apply to the Swept SA measurement: <ul style="list-style-type: none"> When Gate View is turned on, the instrument is set to Zero Span. Gate View automatically turns off whenever a Span other than Zero is selected. Gate View automatically turns off if you press the Last Span key while in Gate View,

and the instrument returns to the Span it was in before entering Gate View (even if that is Zero Span).

- When Gate View is turned on, the sweep time used is the gate view sweep time. This is set according to the rules in section "Gate View Setup " on page 2809
- When Gate View is turned off, Sweep Time is set to the normal Swept SA measurement sweep time.
- If Gate View is on and Gate is off, then turning on Gate turns off Gate View.

Preset	OFF
State Saved	Saved in instrument state
Range	On Off
Initial S/W Revision	Prior to A.02.00

A sample of the Gate View screen in the Swept SA measurement is shown in the following graphic :

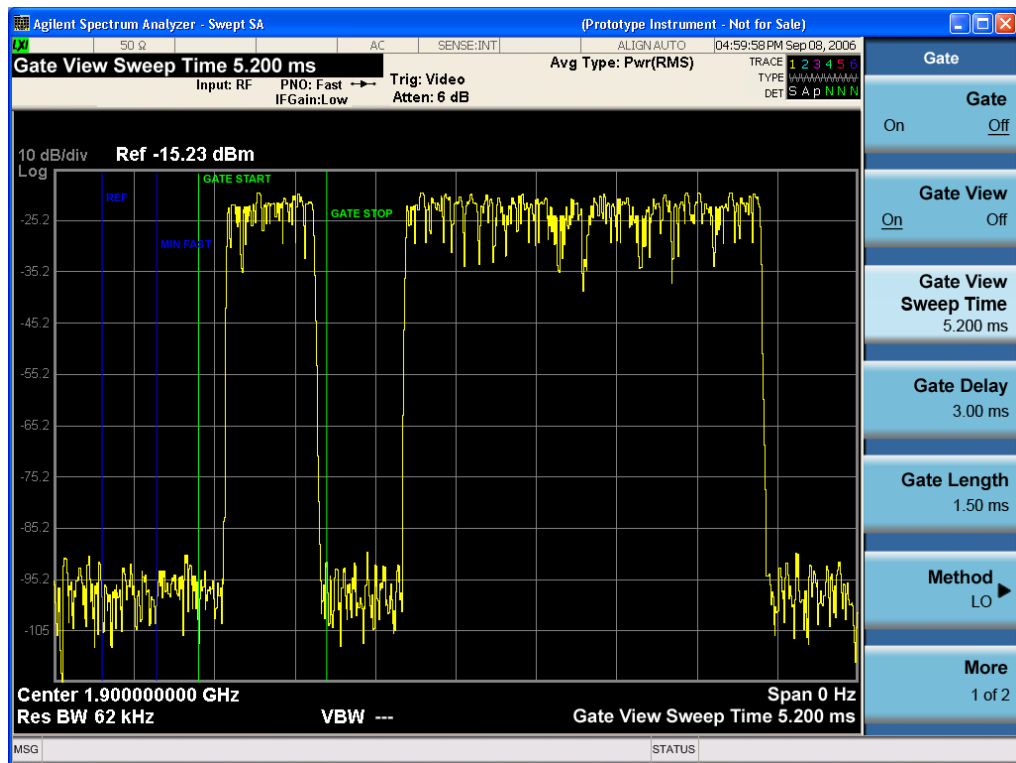

A sample of the Gate View screen in other measurements is shown in the following graphic . This example is for the ACP measurement:

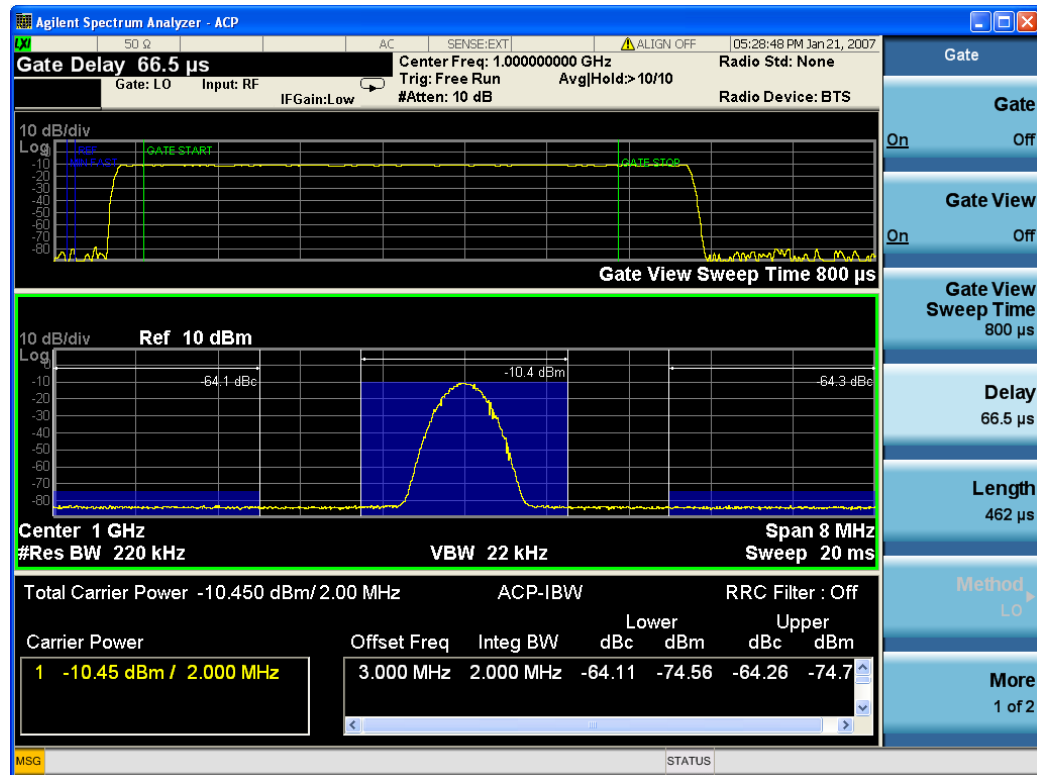

Turning Gate View off returns the analyzer to the Normal measurement view.

In the Swept SA, the normal measurement view is the single-window Swept SA view. When returning to this view, the Swept SA measurement returns to the Span it was in before entering **Gate View** (even if that is Zero Span).

The **Gate View** window is triggered from the Gate Source, with zero trigger delay. Also, when updating the **Gate View** window, the Gate itself must not operate. So it is internally shut off while the gate view window is being updated. For the Swept SA measurement, this means that the Gate is internally shut off whenever the gate view window is displayed. The measurement bar and softkeys continue to show the Trigger source for the main sweep window and give no indication that the Gate is shut off or that the Gate View window is triggered from the Gate Source.

When in **Gate View**, vertical lines are displayed in the Gate View window as follows:

- Green lines are displayed at the gate edges as follows: in Edge Gate, a line is shown for Delay and one for the end of the Gate period, defined by Length. In Level Gate a line is shown only for Delay. You can adjust the position of the green lines by adjusting the gate length and the gate delay. These lines update in the Gate View window as the active function changes, even if the window is not being updated. In Gated LO and Gated Video, these lines are positioned relative to the delay reference line (not relative to 0 time). In Gated FFT, their location is relative to the left edge of the screen.

- A blue line is displayed showing the delay reference, that is, the reference point for the Gate Delay within the Zero Span window. The blue line represents where (in time) the effective location of the gate start would be if the gate were programmed to zero delay.
-
- The second blue line is labeled "MIN FAST" as shown in the figure above because it represents the minimum Gate Delay for fast Gated LO operation. This line is only displayed in Gated LO. You cannot scroll (knob) or decrement (down key) the Gate Delay to less than that represented by the position of this line, it can only be set below this position manually, although once there it can be moved freely with the knob while below the line.
- A yellow line in the Gated Video case only, is displayed at Blength, where Blength is the display point (bucket) length for the swept trace, which is given by the sweep time for that trace divided by number of Points - 1. So it is referenced to 0 time, not to the delay reference. This line is labeled NEXT PT (it is not shown in the figure above because the figure above is for Gated LO).
- The yellow line represents the edge of a display point (bucket). Normally in Gated Video, the bucket length must be selected so that it exceeds the off time of the burst. There is another way to use the analyzer in Gated Video measurements, and that is to set the bucket width much shorter than the off time of the burst. Then use the Max Hold trace function to fill in "missing" buckets more slowly. This allows you to see some of the patterns of the Gated Video results earlier, though seeing a completely filled-in spectrum later.

Gate View Setup

Accesses a menu that enables you to setup parameters relevant to the Gate View

Key Path	Sweep/Control, Gate
Scope	Meas Global
Initial S/W Revision	A.10.00

Gate View Sweep Time

Controls the sweep time in the Gate View window. To provide an optimal view of the gate signal, the analyzer initializes Gate View Sweep Time based on the current settings of Gate Delay and Gate Length.

Key Path	Sweep/Control, Gate, Gate View Setup
Remote Command	[:SENSe] :SWEep:EGATe:TIME <time>

	[:SENSe] :SWEep:EGATe:TIME?
Example	SWE:EGAT:TIME 500 ms
Dependencies	Gate View Sweep Time is initialized: <ul style="list-style-type: none"> - On Preset (after initializing delay and length). - Every time the Gate Method is set/changed. <p>Additionally, in the Swept SA measurement, whenever you do a Preset, or leave Gate View, the analyzer remembers the Gate Delay and Gate Length settings. Then, when returning to Gate View, if the current Gate Delay and/or Gate Length do not match the remembered values Gate View Sweep Time is re-initialized.</p>
Preset	519.3 μ s WiMAX OFDMA: 5 ms GSM/EDGE: 1 ms
State Saved	Saved in instrument state
Max	6000 s
Initial S/W Revision	Prior to A.02.00

Gate View Start Time

Controls the time at the left edge of the Gate View.

Key Path	Sweep/Control, Gate, Gate View Setup
Remote Command	[:SENSe] :SWEep:EGATe:VIEW:STARt <time> [:SENSe] :SWEep:EGATe:VIEW:STARt?
Example	SWE:EGAT:VIEW:STAR 10ms
Notes	Units of time are required or no units; otherwise an invalid suffix error message will be generated. See error -131.
Preset	0 ms
State Saved	Saved in instrument state
Min	0
Max	500 ms
Initial S/W Revision	A.10.00

Gate Delay

Controls the length of time from the time the gate condition goes True until the gate is turned on.

Key Path	Sweep/Control, Gate
Remote Command	[:SENSe] :SWEep:EGATe:DELay <time> [:SENSe] :SWEep:EGATe:DELay?
Example	SWE:EGAT:DELay 500ms

	SWE:EGAT:DElAY?
Notes	Units of time are required or no units; otherwise an invalid suffix error message will be generated.
Preset	57.7 us WiMAX OFDMA: 71 us GSM/EDGE: 600 us WLAN: 500 us
State Saved	Saved in instrument state
Min	0.0 us
Max	100 s
Backwards Compatibility SCPI	[:SENSe] :SWEep :TIME :GATE :DElAY ESA compatibility
Initial S/W Revision	Prior to A.02.00

Gate Length

Controls the length of time that the gate is on after it opens.

Key Path	Sweep/Control, Gate
Remote Command	[:SENSe] :SWEep :EGATe :LENGth <time> [:SENSe] :SWEep :EGATe :LENGth?
Example	SWE:EGAT:LENG 1 SWE:EGAT:LENG?
Notes	Units of time are required or no units; otherwise an invalid suffix error message will be generated.
Dependencies	Grayed out when Gate Method is set to FFT in which case the label changes to that shown below. <div style="border: 1px solid gray; padding: 5px; display: inline-block; margin-bottom: 10px;"> Gate Length (=1.83/RBW) 2.8 ms </div> <small>vsd 39-1</small> The key is also grayed out if Gate Control = Level.
Preset	461.6 us WiMAX OFDMA: 50 us GSM/EDGE: 200 us WLAN: 1.54 ms
State Saved	Saved in instrument state
Min	100 ns
Max	5 s
Backwards Compatibility SCPI	[:SENSe] :SWEep :TIME :GATE :LENGth ESA compatibility
Initial S/W Revision	Prior to A.02.00

Method

This lets you choose one of the three different types of gating.

Not all types of gating are available for all measurements.

Key Path	Sweep/Control, Gate
Remote Command	[:SENSe] :SWEep:EGATe:METhod LO VIDeo FFT [:SENSe] :SWEep:EGATe:METhod?
Example	SWE:EGAT:METh FFT
Preset	LO
State Saved	Saved in instrument state
Initial S/W Revision	Prior to A.02.00

LO

When Gate is set to On, the LO sweeps whenever the gate conditions as specified in the Gate menu are satisfied by the signal at the Gate Source.

This form of gating is more sophisticated, and results in faster measurements. With Gated LO, the analyzer only sweeps while the gate conditions are satisfied. This means that a sweep could take place over several gate events. It would start when the gate signal goes true and stop when it goes false, and then continue when it goes true again. But since the LO is sweeping as long as the gate conditions are satisfied, the sweep typically finishes much more quickly than with Gated Video.

When in zero span, there is no actual sweep performed. But data is only taken while the gate conditions are satisfied. So even though there is no sweep, the gate settings will impact when data is acquired.

Key Path	Sweep/Control, Gate, Method
Dependencies	Key is unavailable when Gate is On and FFT Sweep Type manually selected. When selected, Sweep Type is forced to Swept and the FFT key in Sweep Type is grayed out.
Readback	LO
Initial S/W Revision	Prior to A.02.00

Video

When Gate is set to On, the video signal is allowed to pass through whenever the gate conditions as specified in the Gate menu are satisfied by the signal at the Gate Source.

This form of gating may be thought of as a simple switch, which connects the signal to the input of the spectrum analyzer. When the gate conditions are satisfied, the switch is closed, and when the gate conditions are not satisfied, the switch is open. So we only look at the signal while the gate conditions are satisfied.

With this type of gating, you usually set the analyzer to sweep very slowly. In fact, a general rule is to sweep slowly enough that the gate is guaranteed to be closed at

least once per data measurement interval (bucket). Then if the peak detector is used, each bucket will represent the peak signal as it looks with the gate closed.

Key Path	Sweep/Control, Gate, Method
Dependencies	Key is unavailable when Gate is On and FFT Sweep Type manually selected. When selected, Sweep Type is forced to Swept and the FFT key in Sweep Type is grayed out
Readback	Video
Initial S/W Revision	Prior to A.02.00

FFT

When Gate is set to On, an FFT is performed whenever the gate conditions as specified in the Gate menu are satisfied by the signal at the Gate Source. This is an FFT measurement which begins when the gate conditions are satisfied. Since the time period of an FFT is approximately $1.83/\text{RBW}$, you get a measurement that starts under predefined conditions and takes place over a predefined period. So, in essence, this is a gated measurement. You have limited control over the gate length but it works in FFT sweeps, which the other two methods do not.

Gated FFT cannot be done in zero span since the instrument is not sweeping. So in zero span the Gated LO method is used. Data is still only taken while the gate conditions are satisfied, so the gate settings do impact when data is acquired.

The Gate Length will be $1.83/\text{RBW}$.

This is a convenient way to make a triggered FFT measurement under control of an external gating signal.

Key Path	Sweep/Control, Gate
Dependencies	Key is unavailable when Gate is On and Swept Sweep Type is manually selected. When selected, Sweep Type is forced to FFT and the Swept key in Sweep Type is grayed out Key is unavailable when gate Control is set to Level. Forces Gate Length to $1.83/\text{RBW}$
Readback	FFT
Initial S/W Revision	Prior to A.02.00

Gate Source

The menus under the **Gate Source** key are the same as those under the **Trigger key**, with the exception that neither **Free Run** nor **Video** are available as Gate Source selections. However, a different SCPI command is used to select the Gate Source (see table below) because you may independently set the Gate Source and the Trigger Source.

Any changes to the settings in the setup menus under each Gate Source selection key (for example: Trigger Level, Trigger Delay, etc.) also affect the corresponding settings under the Trigger menu keys. The SCPI commands used for these are the same for Trigger and Gate, since there is only one setting which affects both Gate and Trigger. Example: to set the Trigger Level for External 1 you use the command

:TRIG:EXT1:LEV regardless of whether you are using External 1 as a Trigger Source or a Gate Source.

Key Path	Sweep/Control, Gate
Remote Command	[:SENSe] :SWEep :EGATe :SOURce EXTerna11 EXTerna12 LINE FRAME RFBurst TV PXI [:SENSe] :SWEep :EGATe :SOURce?
Dependencies	In some models, there is no second External input. In these models, the External 2 key is blanked and the EXTerna12 parameter will generate a "Hardware missing; Not available for this model number" error. PXI trigger is only supported in PXI (modular) instruments.
Preset	EXTerna1 GSM/EDGE, MSR: FRAME LTETDD: EXTerna1When Direction is Downlink, FRAME when Direction is Uplink.
Backwards Compatibility Notes	In ESA, there is a single Gate input port. In PSA, the Gate Source may be taken from one of two specified input ports. In the X-Series, any Trigger Source can be a Gate Source.
Initial S/W Revision	Prior to A.02.00
Modified at S/W Revision	A.03.00, A.14.00

Line

Pressing this key, when it is not selected, selects the line signal as the trigger. A new sweep/measurement will start synchronized with the next cycle of the line voltage. Pressing this key, when it is already selected, access the line trigger setup menu.

Key Path	Trigger
Example	TRIG:SOUR LINE Swept SA measurement TRIG:<meas>:SOUR LINE Measurements other than Swept SA
Dependencies	Line trigger is not available when operating from a "dc power source", for example, when the instrument is powered from batteries.
State Saved	Saved in instrument state
Status Bits/OPC dependencies	The Status Operation Register bit 5 "Waiting for Trigger" is set at the same time as the Sweeping or Measuring bit is set. It is cleared when the trigger actually occurs (that is, after the trigger event occurs and all the applicable trigger criteria have been met). A corresponding pop-up message ("Waiting for trigger") is generated if no trigger signal appears after approximately 2 sec. This message goes away when a trigger signal appears.
Initial S/W Revision	Prior to A.02.00

Trig Slope

Controls the trigger polarity. It is set positive to trigger on a rising edge and negative to trigger on a falling edge.

Key Path	Trigger, Line
Remote Command	:TRIGger [:SEquence] :LINE :SLOPe POSitive NEGative

	:TRIGger[:SEQuence]:LINE:SLOPe?
Example	TRIG:LINE:SLOP NEG
Preset	POSitive
State Saved	Saved in instrument state
Backwards Compatibility Notes	The legacy :TRIGger[:SEQuence]:SLOPe command affects the slopes for the VID, LINE, EXT1, EXT2, and RFB triggers.
Initial S/W Revision	Prior to A.02.00

External 1

Pressing this key, when it is not selected, selects an external input signal as the trigger. A new sweep/measurement will start when the external trigger condition is met using the external 1 input connector on the rear panel.

Pressing this key, when it is already selected, accesses the external 1 trigger setup menu.

Key Path	Trigger
Example	TRIG:SOUR EXT1 Swept SA measurement TRIG:<meas>:SOUR EXT1 Measurements other than Swept SA
Dependencies	Grayed out if in use by Point Trigger in the Source Setup menu. Forced to Free Run if already selected and Point Trigger is set to External 1.
State Saved	Saved in instrument state
Status Bits/OPC dependencies	The Status Operation Register bit 5 "Waiting for Trigger" is set at the same time as the Sweeping or Measuring bit is set. It is cleared when the trigger actually occurs (that is, after the trigger event occurs and all the applicable trigger criteria have been met). A corresponding pop-up message ("Waiting for trigger") is generated if no trigger signal appears after approximately 2 sec. This message goes away when a trigger signal appears.
Initial S/W Revision	Prior to A.02.00

Trigger Level

Sets the value where the external 1 trigger input will trigger a new sweep/measurement.

Key Path	Trigger, External 1
Remote Command	:TRIGger[:SEQuence]:EXTErnal1:LEVel <level> :TRIGger[:SEQuence]:EXTErnal1:LEVel?
Example	TRIG:EXT1:LEV 0.4 V
Couplings	This same level is used for the Ext1 trigger source in the Trigger menu, for the Ext1 selection in the Periodic Timer sync source (in the Trigger menu and in the Gate Source menu), and also for the Ext1 selection in the Gate Source menu.
Preset	1.2 V
State Saved	Saved in instrument state

Min	-5 V
Max	5 V
Default Unit	V
Backwards Compatibility SCPI	:TRIGger[:SEquence]:EXTernal:LEVel
	For backward compatibility, the parameter EXTernal is mapped to EXTernal1
Backwards Compatibility SCPI	:TRIGger[:SEquence]:FRAME:EXTernal1:LEVel
Initial S/W Revision	Prior to A.02.00

Trig Slope

Controls the trigger polarity. It is set positive to trigger on a rising edge and negative to trigger on a falling edge.

Key Path	Trigger, External 1
Remote Command	:TRIGger[:SEquence]:EXTernal1:SLOPe POSitive NEGative :TRIGger[:SEquence]:EXTernal1:SLOPe?
Example	TRIG:EXT1:SLOP NEG
Couplings	This same slope is used in the Ext1 selection for the trigger source in the Trigger menu and for the period timer sync source (in the Trigger menu and in the Gate Source menu).
Preset	POSitive
State Saved	Saved in instrument state
Backwards Compatibility SCPI	:TRIGger[:SEquence]:EXTernal:SLOPe
	For backward compatibility, the parameter EXTernal is mapped to EXTernal1
Backwards Compatibility SCPI	:TRIGger[:SEquence]:FRAME:EXTernal1:SLOPe
Backwards Compatibility Notes	The legacy :TRIGger[:SEquence]:SLOPe command affects the slopes for the VID, LINE, EXT1, EXT2, and RFB triggers.
Initial S/W Revision	Prior to A.02.00

Zero Span Delay Comp On/Off

In zero span, there is a natural delay in the signal path, which comes from the RBW filter. This is usually desirable, as it allows you to trigger on events and also see those events, because the signal is delayed from the trigger event. However, in some cases it is desirable to eliminate this delay, so that trigger events line up exactly with the zero time point in zero span. You can use the **Zero Span Delay Comp On/Off** feature to enable or disable zero span delay compensation.

Key Path	Trigger, External 1
Remote Command	:TRIGger[:SEquence]:EXTernal1:DELay:COMPensation OFF ON 0 1 :TRIGger[:SEquence]:EXTernal1:DELay:COMPensation?

Example	TRIG:EXT1:DEL:COMP ON
Dependencies	No effect except in zero-span, but not locked out in nonzero spans. Blanked in modes that do not support zero-span measurements. If the SCPI command is sent when the key is blanked, an error is returned: -221, "Settings conflict; Feature not supported for this measurement" In analyzers shipping N9060A, this feature requires N9060A-7FP.
Preset	OFF
State Saved	Saved in instrument state
Initial S/W Revision	A.11.00

External 2

Pressing this key, when it is not selected, selects an external input signal as the trigger. A new sweep/measurement will start when the external trigger condition is met using the external 2 input connector. The external trigger 2 input connector is on the rear panel.

Pressing this key, when it is already selected, accesses the external 2 trigger setup menu.

Key Path	Trigger
Example	TRIG:SOUR EXT2 Swept SA measurement TRIG:<meas>:SOUR EXT2 Measurements other than Swept SA
Dependencies	In some models, there is no second External input. In these models, the External 2 key is blanked and the EXTernal2 parameter will generate a "Hardware missing; Not available for this model number" message. Grayed out if in use by Point Trigger in the Source Setup menu. Forced to Free Run if already selected and Point Trigger is set to External 2.
State Saved	Saved in instrument state
Status Bits/OPC dependencies	The Status Operation Register bit 5 "Waiting for Trigger" is set at the same time as the Sweeping or Measuring bit is set. It is cleared when the trigger actually occurs (that is, after the trigger event occurs and all the applicable trigger criteria have been met). A corresponding pop-up message ("Waiting for trigger") is generated if no trigger signal appears after approximately 2 sec. This message goes away when a trigger signal appears.
Initial S/W Revision	Prior to A.02.00
Modified at S/W Revision	A.03.00

Trigger Level

Sets the value where the external 2 trigger input will trigger a new sweep/measurement.

Key Path	Trigger, External 2
Remote Command	:TRIGger[:SEquence]:EXTernal2:LEVel :TRIGger[:SEquence]:EXTernal2:LEVel?

Example	TRIG:EXT2:LEV 1.1 V
Couplings	This same level is used for the Ext2 trigger source in the Trigger menu, for the Ext2 selection in the Periodic Timer sync source (in the Trigger menu and in the Gate Source menu), and also for the Ext2 selection in the Gate Source menu.
Preset	1.2 V
State Saved	Saved in instrument state
Min	-5 V
Max	5 V
Default Unit	V
Backwards Compatibility SCPI	:TRIGger[:SEQuence]:FRAME:EXTerna12:LEVe1
Initial S/W Revision	Prior to A.02.00

Trig Slope

Controls the trigger polarity. It is set positive to trigger on a rising edge and negative to trigger on a falling edge.

Key Path	Trigger, External 2
Remote Command	:TRIGger[:SEQuence]:EXTerna12:SLOPe POSitive NEGative :TRIGger[:SEQuence]:EXTerna12:SLOPe?
Example	TRIG:EXT2:SLOP NEG
Couplings	This same slope is used in the Ext2 selection for the trigger source in the Trigger menu and for the period timer sync source (in the Trigger menu and in the Gate Source menu).
Preset	POSitive
State Saved	Saved in instrument state
Backwards Compatibility SCPI	:TRIGger[:SEQuence]:FRAME:EXTerna12:SLOPe
Backwards Compatibility Notes	The legacy :TRIGger[:SEQuence]:SLOPe command affects the slopes for the VID, LINE, EXT1, EXT2, and RFB triggers.
Initial S/W Revision	Prior to A.02.00

Zero Span Delay Comp On/Off

In zero span, there is a natural delay in the signal path, which comes from the RBW filter. This is usually desirable, as it allows you to trigger on events and also see those events, because the signal is delayed from the trigger event. However, in some cases it is desirable to eliminate this delay, so that trigger events line up exactly with the zero time point in zero span. You can use the **Zero Span Delay Comp On/Off** feature to enable or disable zero span delay compensation.

Key Path	Trigger, External 2
Remote Command	:TRIGger[:SEQuence]:EXTerna12:DELAy:COMPensation OFF ON 0 1

:TRIGger[:SEquence]:EXternal2:DElay:COMPensation?	
Example	TRIG:EXT2:DEL:COMP ON
Dependencies	No effect except in zero-span, but not locked out in nonzero spans. Blanked in modes that do not support zero-span measurements. If the SCPI command is sent when the key is blanked, an error is returned: -221, "Settings conflict; Feature not supported for this measurement" In analyzers shipping N9060A, this feature requires N9060A-7FP.
Preset	OFF
State Saved	Saved in instrument state
Initial S/W Revision	A.11.00

RF Burst

Pressing this key, when it is not selected, selects the RF Burst as the trigger. A new sweep/measurement will start when an RF burst envelope signal is identified from the signal at the RF Input connector. Pressing this key, when it is already selected, accesses the RF Burst trigger setup menu.

In some models, a variety of burst trigger circuitry is available, resulting in various available burst trigger bandwidths. The analyzer automatically chooses the appropriate trigger path based on the hardware configuration and other settings of the analyzer.

Key Path	Trigger
Example	TRIG:SOUR RFB Swept SA measurement TRIG:<meas>:SOUR RFB Measurements other than Swept SA
State Saved	Saved in instrument state
Status Bits/OPC dependencies	The Status Operation Register bit 5 "Waiting for Trigger" is set at the same time as the Sweeping or Measuring bit is set. It is cleared when the trigger actually occurs (that is, after the trigger event occurs and all the applicable trigger criteria have been met). A corresponding pop-up message ("Waiting for trigger") is generated if no trigger signal appears after approximately 2 sec. This message goes away when a trigger signal appears.
Backwards Compatibility Notes	The legacy command: :TRIGger[:SEquence]:RFBurst:FSElectivity[:STATe] OFF ON 0 1 is not supported in the X-Series, as the hardware to do Frequency Selective burst triggers does not exist in X-Series.
Initial S/W Revision	Prior to A.02.00
Modified at S/W Revision	A.04.00

Absolute Trigger Level

Sets the absolute trigger level for the RF burst envelope.

When using the External Mixing path, the Absolute Trigger Level is uncalibrated because the factory default was set to accommodate the expected IF levels for the RF path.

Key Path	Trigger, RF Burst
Scope	Meas Global
Remote Command	:TRIGger[:SEquence]:RFBurst:LEVel:ABSolute <aml> :TRIGger[:SEquence]:RFBurst:LEVel:ABSolute?
Example	TRIG:RFB:LEV:ABS 10 dBm sets the trigger level of the RF burst envelope signal to the absolute level of 10 dBm
Notes	Sending this command does not switch the setting from relative to absolute; to switch it you need to send the :TRIGger[:SEquence]:RFBurst:LEVel:TYPE command, below. Amplitude Corrections are not taken into account by the Absolute Trigger Level. For example, if you have given yourself effective gain with an amplitude correction factor, the Absolute Trigger will not fire until you have set the trigger level that far below the displayed signal level, rather than simply to the displayed signal level. This is only true for Amplitude Corrections, not External Gain or Ref Level Offset functions. If mode is Bluetooth, the default value is -50 dBm.
Couplings	This same level is used for the RF Burst trigger source in the Trigger menu, for the RF Burst selection in the Periodic Timer sync source (in the Trigger menu and in the Gate Source menu), and also for the RF Burst selection in the Gate Source menu
Preset	-20 dBm
State Saved	Saved in instrument state
Min	-200 dBm
Max	100 dBm
Default Unit	depends on the current selected Y-Axis unit
Backwards Compatibility SCPI	:TRIGger[:SEquence]:FRAMe:RFBurst:LEVel:ABSolute
Initial S/W Revision	Prior to A.02.00
Modified at S/W Revision	A.04.00

Key Path	Trigger, RF Burst
Remote Command	:TRIGger[:SEquence]:RFBurst:LEVel:TYPE ABSolute RELative :TRIGger[:SEquence]:RFBurst:LEVel:TYPE?
Example	TRIG:RFB:LEV:TYPE REL sets the trigger level type of the RF burst trigger to Relative.
Preset	ABSolute
State Saved	Saved in instrument state
Initial S/W Revision	Prior to A.02.00
Modified at S/W Revision	A.04.00

Relative Trigger Level

Sets the relative trigger level for the RF burst envelope.

In some models, the relative burst trigger function is implemented in hardware. In other models, without the advanced triggering hardware required, the relative burst trigger function is implemented in software in some measurements, and is unavailable in other measurements.

When implemented in software, the relative RF Burst trigger function is implemented as follows:

5. The measurement starts with the absolute RF Burst trigger setting. If it cannot get a trigger with that level, auto trigger fires and the acquisition starts anyway. After the acquisition, the measurement searches for the peak in the acquired waveform and saves it.
6. Now, in the next cycle of the measurement, the measurement determines a new absolute RF Burst level based on the peak value from the first measurement and the Relative RF Burst Trigger Level (always 0 or negative dB) set by the user. The following formula is used:
7. absolute RF Burst level = peak level of the previous acquisition + relative RF Burst level
8. If the new absolute RF Burst level differs from the previous by more than 0.5 dB, the new level is sent to the hardware; otherwise it is not updated (to avoid slowing down the acquisition)

Steps 2 and 3 repeat for subsequent measurements.

Key Path	Trigger, RF Burst
Scope	Meas Global
Remote Command	:TRIGger[:SEquence]:RFBurst:LEVel:RELative <rel_amp1> :TRIGger[:SEquence]:RFBurst:LEVel:RELative?
Example	TRIG:RFB:LEV:REL -10 dB sets the trigger level of the RF burst envelope signal to the relative level of -10 dB
Notes	Sending this command does not switch the setting from absolute to relative; to switch it you need to send the :TRIGger[:SEquence]:RFBurst:LEVel:TYPE command, above. The relative trigger level is not available in some measurements. In those measurements the RELative parameter, and the :TRIGger[:SEquence]:RFBurst:LEVel:TYPE command (above), will generate an error if sent.
Dependencies	This key is grayed out and Absolute Trigger Level selected if the required hardware is not present in your analyzer and the current measurement does not support Relative triggering.
Preset	-6 dB GSM: -25 dB

State Saved	Saved in instrument state
Min	-45 dB
Max	0 dB
Default Unit	dB or dBc
Backwards Compatibility SCPI	:TRIGger[:SEquence]:RFBurst:LEVel This legacy command is aliased to :TRIGger[:SEquence]:RFBurst:LEVel:RELative because the PSA had ONLY relative burst triggering
Initial S/W Revision	Prior to A.02.00
Modified at S/W Revision	A.04.00

Trigger Slope

It is set positive to trigger on a rising edge and negative to trigger on a falling edge.

Key Path	Trigger, RF Burst
Remote Command	:TRIGger[:SEquence]:RFBurst:SLOPe POSitive NEGative :TRIGger[:SEquence]:RFBurst:SLOPe?
Example	TRIG:RFB:SLOP NEG
Couplings	This same slope is used in the RF Burst selection for the trigger source in the Trigger menu and for the period timer sync source (in the Trigger menu and in the Gate Source menu).
Preset	POSitive
State Saved	Saved in instrument state
Backwards Compatibility SCPI	:TRIGger[:SEquence]:FRAME:RFBurst:SLOPe
Backwards Compatibility Notes	The legacy :TRIGger[:SEquence]:SLOPe command affects the slopes for the VID, LINE, EXT1, EXT2, and RFB triggers.
Initial S/W Revision	Prior to A.02.00

Zero Span Delay Comp On/Off

In zero span, there is a natural delay in the signal path, which comes from the RBW filter. This is usually desirable, as it allows you to trigger on events and also see those events, because the signal is delayed from the trigger event. However, in some cases it is desirable to eliminate this delay, so that trigger events line up exactly with the zero time point in zero span. You can use the **Zero Span Delay Comp On/Off** feature to enable or disable zero span delay compensation.

Key Path	Trigger, RF Burst
Remote Command	:TRIGger[:SEquence]:RFBurst:DELAy:COMPensation OFF ON 0 1 :TRIGger[:SEquence]:RFBurst:DELAy:COMPensation?
Example	TRIG:RFB:DEL:COMP ON
Dependencies	No effect except in zero-span, but not locked out in nonzero spans.

	Blanked in modes that do not support zero-span measurements. If the SCPI command is sent when the key is blanked, an error is returned: -221, "Settings conflict; Feature not supported for this measurement" In analyzers shipping N9060A, this feature requires N9060A-7FP.
Preset	OFF
State Saved	Saved in instrument state
Initial S/W Revision	A.11.00

Periodic Timer (Frame Trigger)

Pressing this key, when it is not selected, selects the internal periodic timer signal as the trigger. Triggering occurrences are set by the **Period** parameter, which is modified by the **Sync Source** and **Offset**. Pressing this key, when it is already selected, accesses the periodic timer trigger setup functions.

If you do not have a sync source selected (it is Off), then the internal timer will not be synchronized with any external timing events.

Key Path	Trigger
Example	TRIG:SOUR FRAM Swept SA measurement TRIG:<meas>:SOUR FRAM Measurements other than Swept SA
State Saved	Saved in instrument state
Readback	[Sync: <value of Sync Source>], for example, [Sync: External 1]
Status Bits/OPC dependencies	The Status Operation Register bit 5 "Waiting for Trigger" is set at the same time as the Sweeping or Measuring bit is set. It is cleared when the trigger actually occurs (that is, after the trigger event occurs and all the applicable trigger criteria have been met). A corresponding pop-up message ("Waiting for trigger") is generated if no trigger signal appears after approximately 2 sec. This message goes away when a trigger signal appears.
Initial S/W Revision	Prior to A.02.00

Periodic Timer Triggering:

This feature selects the internal periodic timer signal as the trigger. Trigger occurrences are set by the **Periodic Timer** parameter, which is modified by the **Sync Source** and **Offset**.

The figure below shows the action of the periodic timer trigger. Before reviewing the figure, we'll explain some uses for the periodic trigger.

A common application is measuring periodic burst RF signals for which a trigger signal is not easily available. For example, we might be measuring a TDMA radio which bursts every 20 ms. Let's assume that the 20 ms period is very consistent. Let's also assume that we do not have an external trigger source available that is synchronized with the period, and that the signal-to-noise ratio of the signal is not high enough to provide a clean RF burst trigger at all of the analysis frequencies. For example, we might want to measure spurious transmissions at an offset from the carrier that is larger than the bandwidth of the RF burst trigger. In this application, we can set the Periodic Timer to a 20.00 ms period and adjust the offset from that timer to position our trigger just where we want it. If we find that the 20.00 ms is not

exactly right, we can adjust the period slightly to minimize the drift between the period timer and the signal to be measured.

A second way to use this feature would be to use **Sync Source** temporarily, instead of **Offset**. In this case, we might tune to the signal in a narrow span and use the RF Burst trigger to synchronize the periodic timer. Then we would turn the sync source off so that it would not miss-trigger. Miss-triggering can occur when we are tuned so far away from the RF burst trigger that it is no longer reliable.

A third example would be to synchronize to a signal that has a reference time element of much longer period than the period of interest. In some CDMA applications, it is useful to look at signals with a short periodicity, by synchronizing that periodicity to the "even-second clock" edge that happens every two seconds. Thus, we could connect the even-second clock trigger to Ext1 and use then Ext1 as the sync source for the periodic timer.

The figure below illustrates this third example. The top trace represents the even-second clock. It causes the periodic timer to synchronize with the leading edge shown. The analyzer trigger occurs at a time delayed by the accumulated offset from the period trigger event. The periodic timer continues to run, and triggers continue to occur, with a periodicity determined by the analyzer time base. The timer output (labeled "late event") will drift away from its ideal time due to imperfect matching between the time base of the signal being measured and the time base of the analyzer, and also because of imperfect setting of the period parameter. But the synchronization is restored on the next even-second clock event. ("Accumulated offset" is described in the in the **Offset** function section.)

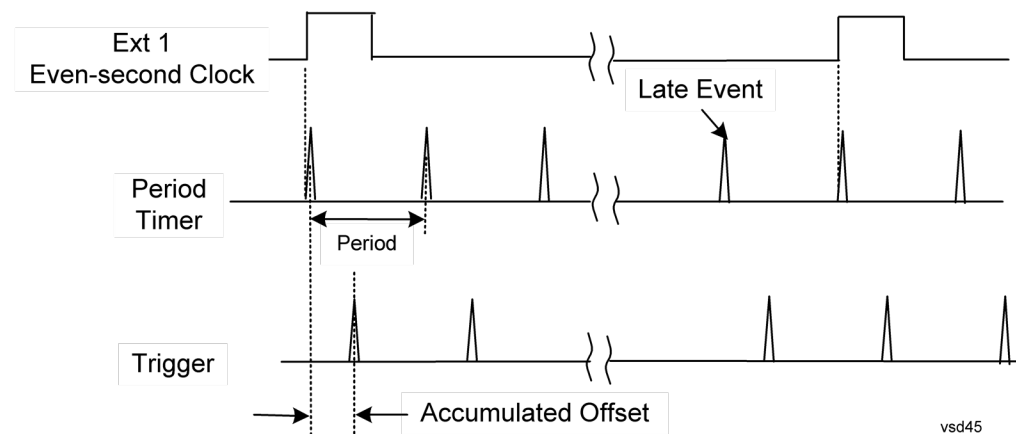

Period

Sets the period of the internal periodic timer clock. For digital communications signals, this is usually set to the frame period of your current input signal. In the case that sync source is not set to OFF, and the external sync source rate is changed for some reason, the periodic timer is synchronized at the every external synchronization pulse by resetting the internal state of the timer circuit.

Key Path	Trigger, Periodic Timer
Remote Command	:TRIGGER[:SEQUENCE]:FRAME:PERIOD <time>

	:TRIGger[:SEQuence]:FRAMe:PERiod?
Example	TRIG:FRAM:PER 100 ms
Dependencies	The invalid data indicator turns on when the period is changed, until the next sweep/measurement completes.
Couplings	The same period is used in the Gate Source selection of the period timer.
Preset	20 ms GSM: 4.615383
State Saved	Saved in instrument state
Min	100.000 ns
Max	559.0000 ms
Default Unit	S
Initial S/W Revision	Prior to A.02.00

Offset

Adjusts the accumulated offset between the periodic timer events and the trigger event. Adjusting the accumulated offset is different than setting an offset, and requires explanation.

The periodic timer is usually not synchronized with any external events, so the timing of its output events has no absolute meaning. Since the timing relative to external events (RF signals) is important, you need to be able to adjust (offset) it. However, you have no direct way to see when the periodic timer events occur. All that you can see is the trigger timing. When you want to adjust the trigger timing, you will be changing the internal offset between the periodic timer events and the trigger event. Because the absolute value of that internal offset is unknown, we will just call that the accumulated offset. Whenever the Offset parameter is changed, you are changing that accumulated offset. You can reset the displayed offset using Reset Offset Display. Changing the display does not change the value of the accumulated offset, and you can still make additional changes to accumulated offset.

To avoid ambiguity, we define that an increase in the "offset" parameter, either from the knob or the SCPI adjust command, serves to delay the timing of the trigger event.

Key Path	Trigger, Periodic Timer
Remote Command	:TRIGger[:SEQuence]:FRAMe:OFFSet <time> :TRIGger[:SEQuence]:FRAMe:OFFSet?
Example	TRIG:FRAM:OFFS 1.2 ms
Notes	The front panel interface (for example, the knob), and this command, adjust the accumulated offset, which is shown on the active function display. However, the actual amount sent to the hardware each time the offset is updated is the delta value, that is, the current accumulated offset value minus the previous accumulated offset value. Note that the accumulated offset value is essentially arbitrary; it represents the accumulated offset from the last time the offset was zeroed (with the Reset Offset Display key). Note that this command does not change the period of the trigger waveform. Note also that Offset

	is used only when the sync source is set to OFF, otherwise delay is used, see section "Trig Delay" on page 568 . An increase in the "offset" parameter, either from the knob or the SCPI adjust command, serves to delay the timing of the trigger event.
Notes	When the SCPI command is sent the value shown on the key (and the Active Function, if this happens to be the active function) is updated with the new value. However, the actual amount sent to the hardware is the delta value, that is, the current accumulated offset value minus the previous accumulated offset value. The SCPI query simply returns the value currently showing on the key.
Dependencies	The invalid data indicator turns on when the offset is changed, until the next sweep/measurement completes.
Couplings	The same offset is used in the Gate Source selection of the period timer.
Preset	0 s
State Saved	Saved in instrument state
Min	-10.000 s
Max	10.000 s
Default Unit	S
Initial S/W Revision	Prior to A.02.00

Offset Adjust (Remote Command Only)

This remote command does not work at all like the related front panel keys. This command lets you advance the phase of the frame trigger by the amount you specify.

It does not change the period of the trigger waveform. If the command is sent multiple times, it advances the phase of the frame trigger an additional amount each time it is sent. Negative numbers are permitted.

Remote Command	:TRIGger[:SEquence]:FRAMe:ADJust <time>
Example	TRIG:FRAM:ADJ 1.2 ms
Notes	Note also that Offset is used only when the sync source is set to OFF, otherwise delay is used, see section "Trig Delay" on page 568 . An increase in the "offset" parameter, either from the knob or the SCPI adjust command, serves to delay the timing of the trigger event.
Notes	The front panel interface (for example, the knob) and the :TRIG:FRAM:OFFS command adjust the accumulated offset, which is shown on the active function display. However, the actual amount sent to the hardware is the delta value, that is, the current offset value minus the previous offset value. When the SCPI command is sent the value shown on the key (and the Active Function, if this happens to be the active function) is updated by increasing it (or decreasing it if the value sent is negative) by the amount specified in the SCPI command. This is a "command only" SCPI command, with no query.
Dependencies	The invalid data indicator turns on when the offset is changed, until the next sweep/measurement completes.

Couplings	The same offset is used in the Gate Source selection of the period timer.
Preset	0 s
State Saved	Saved in instrument state
Min	-10.000 s
Max	10.000 s
Default Unit	S
Initial S/W Revision	Prior to A.02.00

Reset Offset Display

Resets the value of the periodic trigger offset display setting to 0.0 seconds. The current displayed trigger location may include an offset value defined with the **Offset** key. Pressing this key redefines the currently displayed trigger location as the new trigger point that is 0.0 s offset. The **Offset** key can then be used to add offset relative to this new timing.

Key Path	Trigger, Periodic Timer
Remote Command	:TRIGger[:SEquence]:FRAMe:OFFSet:DISPlay:RESet
Example	TRIG:FRAM:OFFS:DISP:RES
Initial S/W Revision	Prior to A.02.00

Sync Source

Selects a signal source for you to synchronize your periodic timer trigger to, otherwise you are triggering at some arbitrary location in the frame. Synchronization reduces the precision requirements on the setting of the period.

For convenience you may adjust the level and slope of the selected sync source in a conditional branch setup menu accessed from the Sync Source menu. Note that these settings match those in the **Trigger** and **Gate Source** menus; that is, each trigger source has only one value of level and slope, regardless of which menu it is accessed from.

Key Path	Trigger, Periodic Timer
Remote Command	:TRIGger[:SEquence]:FRAMe:SYNC EXTerna11 EXTerna12 RFBurst PXI OFF :TRIGger[:SEquence]:FRAMe:SYNC?
Example	TRIG:FRAM:SYNC EXT2
Dependencies	In some models, there is no second External input. In these models, the External 2 key is blanked and the EXTerna12 parameter will generate a "Hardware missing; Not available for this model number" message. PXI trigger is only supported in PXI (modular) instruments.
Preset	Off GSM/EDGE, MSR,LTE,LTETDD: RFBurst
State Saved	Saved in instrument state

Readback	The current setting is read back to this key and it is also Readback to the previous Periodic Timer trigger key.
Backwards Compatibility SCPI	:TRIGger[:SEquence]:FRAMe:SYNC EXTeRnAl
	For backward compatibility, the parameter EXTeRnAl is mapped to EXTeRnAl1
Initial S/W Revision	Prior to A.02.00
Modified at S/W Revision	A.03.00, A.14.00

Off

Turns off the sync source for your periodic trigger. With the sync source off, the timing will drift unless the signal source frequency is locked to the analyzer frequency reference.

Key Path	Trigger, Periodic Timer, Sync Source
Example	TRIG:FRAM:SYNC OFF
Readback	Off
Initial S/W Revision	Prior to A.02.00

External 1

Pressing this key, when it is not selected, selects an external input signal as the trigger. A new sweep/measurement will start when the external trigger condition is met using the external 1 input connector on the rear panel.

Pressing this key, when it is already selected, accesses the external 1 trigger setup menu.

Key Path	Trigger
Example	TRIG:SOUR EXT1 Swept SA measurement TRIG:<meas>:SOUR EXT1 Measurements other than Swept SA
Dependencies	Grayed out if in use by Point Trigger in the Source Setup menu. Forced to Free Run if already selected and Point Trigger is set to External 1.
State Saved	Saved in instrument state
Status Bits/OPC dependencies	The Status Operation Register bit 5 "Waiting for Trigger" is set at the same time as the Sweeping or Measuring bit is set. It is cleared when the trigger actually occurs (that is, after the trigger event occurs and all the applicable trigger criteria have been met). A corresponding pop-up message ("Waiting for trigger") is generated if no trigger signal appears after approximately 2 sec. This message goes away when a trigger signal appears.
Initial S/W Revision	Prior to A.02.00

Trigger Level

Sets the value where the external 1 trigger input will trigger a new sweep/measurement.

Key Path	Trigger, External 1
Remote Command	:TRIGger[:SEquence]:EXTernal1:LEVel <level> :TRIGger[:SEquence]:EXTernal1:LEVel?
Example	TRIG:EXT1:LEV 0.4 V
Couplings	This same level is used for the Ext1 trigger source in the Trigger menu, for the Ext1 selection in the Periodic Timer sync source (in the Trigger menu and in the Gate Source menu), and also for the Ext1 selection in the Gate Source menu.
Preset	1.2 V
State Saved	Saved in instrument state
Min	-5 V
Max	5 V
Default Unit	V
Backwards Compatibility SCPI	:TRIGger[:SEquence]:EXTernal:LEVel For backward compatibility, the parameter EXTernal is mapped to EXTernal1
Backwards Compatibility SCPI	:TRIGger[:SEquence]:FRAME:EXTernal1:LEVel
Initial S/W Revision	Prior to A.02.00

Trig Slope

Controls the trigger polarity. It is set positive to trigger on a rising edge and negative to trigger on a falling edge.

Key Path	Trigger, External 1
Remote Command	:TRIGger[:SEquence]:EXTernal1:SLOPe POSitive NEGative :TRIGger[:SEquence]:EXTernal1:SLOPe?
Example	TRIG:EXT1:SLOP NEG
Couplings	This same slope is used in the Ext1 selection for the trigger source in the Trigger menu and for the period timer sync source (in the Trigger menu and in the Gate Source menu).
Preset	POSitive
State Saved	Saved in instrument state
Backwards Compatibility SCPI	:TRIGger[:SEquence]:EXTernal:SLOPe For backward compatibility, the parameter EXTernal is mapped to EXTernal1
Backwards Compatibility SCPI	:TRIGger[:SEquence]:FRAME:EXTernal1:SLOPe
Backwards Compatibility Notes	The legacy :TRIGger[:SEquence]:SLOPe command affects the slopes for the VID, LINE, EXT1, EXT2, and RFB triggers.
Initial S/W Revision	Prior to A.02.00

External 2

Pressing this key, when it is not selected, selects an external input signal as the trigger. A new sweep/measurement will start when the external trigger condition is

met using the external 2 input connector. The external trigger 2 input connector is on the rear panel.

Pressing this key, when it is already selected, accesses the external 2 trigger setup menu.

Key Path	Trigger
Example	TRIG:SOUR EXT2 Swept SA measurement TRIG:<meas>:SOUR EXT2 Measurements other than Swept SA
Dependencies	In some models, there is no second External input. In these models, the External 2 key is blanked and the EXTernal2 parameter will generate a "Hardware missing; Not available for this model number" message. Grayed out if in use by Point Trigger in the Source Setup menu. Forced to Free Run if already selected and Point Trigger is set to External 2.
State Saved	Saved in instrument state
Status Bits/OPC dependencies	The Status Operation Register bit 5 "Waiting for Trigger" is set at the same time as the Sweeping or Measuring bit is set. It is cleared when the trigger actually occurs (that is, after the trigger event occurs and all the applicable trigger criteria have been met). A corresponding pop-up message ("Waiting for trigger") is generated if no trigger signal appears after approximately 2 sec. This message goes away when a trigger signal appears.
Initial S/W Revision	Prior to A.02.00
Modified at S/W Revision	A.03.00

Trigger Level

Sets the value where the external 2 trigger input will trigger a new sweep/measurement.

Key Path	Trigger, External 2
Remote Command	:TRIGger[:SEquence]:EXTernal2:LEVel :TRIGger[:SEquence]:EXTernal2:LEVel?
Example	TRIG:EXT2:LEV 1.1 V
Couplings	This same level is used for the Ext2 trigger source in the Trigger menu, for the Ext2 selection in the Periodic Timer sync source (in the Trigger menu and in the Gate Source menu), and also for the Ext2 selection in the Gate Source menu.
Preset	1.2 V
State Saved	Saved in instrument state
Min	-5 V
Max	5 V
Default Unit	V
Backwards Compatibility SCPI	:TRIGger[:SEquence]:FRAME:EXTernal2:LEVel
Initial S/W Revision	Prior to A.02.00

Trig Slope

Controls the trigger polarity. It is set positive to trigger on a rising edge and negative to trigger on a falling edge.

Key Path	Trigger, External 2
Remote Command	:TRIGger[:SEquence]:EXTerna12:SLOPe POSitive NEGative :TRIGger[:SEquence]:EXTerna12:SLOPe?
Example	TRIG:EXT2:SLOP NEG
Couplings	This same slope is used in the Ext2 selection for the trigger source in the Trigger menu and for the period timer sync source (in the Trigger menu and in the Gate Source menu).
Preset	POSitive
State Saved	Saved in instrument state
Backwards Compatibility SCPI	:TRIGger[:SEquence]:FRaME:EXTerna12:SLOPe
Backwards Compatibility Notes	The legacy :TRIGger[:SEquence]:SLOPe command affects the slopes for the VID, LINE, EXT1, EXT2, and RFB triggers.
Initial S/W Revision	Prior to A.02.00

RF Burst

Pressing this key, when it is not selected, selects the RF Burst as the trigger. A new sweep/measurement will start when an RF burst envelope signal is identified from the signal at the RF Input connector. Pressing this key, when it is already selected, accesses the RF Burst trigger setup menu.

In some models, a variety of burst trigger circuitry is available, resulting in various available burst trigger bandwidths. The analyzer automatically chooses the appropriate trigger path based on the hardware configuration and other settings of the analyzer.

Key Path	Trigger
Example	TRIG:SOUR RFB Swept SA measurement TRIG:<meas>:SOUR RFB Measurements other than Swept SA
State Saved	Saved in instrument state
Status Bits/OPC dependencies	The Status Operation Register bit 5 "Waiting for Trigger" is set at the same time as the Sweeping or Measuring bit is set. It is cleared when the trigger actually occurs (that is, after the trigger event occurs and all the applicable trigger criteria have been met). A corresponding pop-up message ("Waiting for trigger") is generated if no trigger signal appears after approximately 2 sec. This message goes away when a trigger signal appears.
Backwards Compatibility Notes	The legacy command: :TRIGger[:SEquence]:RFBurst:FSElectivity[:STATe] OFF ON 0 1 is not supported in the X-Series, as the hardware to do Frequency Selective burst triggers does not exist in X-Series.
Initial S/W Revision	Prior to A.02.00
Modified at S/W Revision	A.04.00

Absolute Trigger Level

Sets the absolute trigger level for the RF burst envelope.

When using the External Mixing path, the Absolute Trigger Level is uncalibrated because the factory default was set to accommodate the expected IF levels for the RF path.

Key Path	Trigger, RF Burst
Scope	Meas Global
Remote Command	:TRIGger[:SEquence]:RFBurst:LEVel:ABSolute <ampl> :TRIGger[:SEquence]:RFBurst:LEVel:ABSolute?
Example	TRIG:RFB:LEV:ABS 10 dBm sets the trigger level of the RF burst envelope signal to the absolute level of 10 dBm
Notes	Sending this command does not switch the setting from relative to absolute; to switch it you need to send the :TRIGger[:SEquence]:RFBurst:LEVel:TYPE command, below. Amplitude Corrections are not taken into account by the Absolute Trigger Level. For example, if you have given yourself effective gain with an amplitude correction factor, the Absolute Trigger will not fire until you have set the trigger level that far below the displayed signal level, rather than simply to the displayed signal level. This is only true for Amplitude Corrections, not External Gain or Ref Level Offset functions. If mode is Bluetooth, the default value is -50 dBm.
Couplings	This same level is used for the RF Burst trigger source in the Trigger menu, for the RF Burst selection in the Periodic Timer sync source (in the Trigger menu and in the Gate Source menu), and also for the RF Burst selection in the Gate Source menu
Preset	-20 dBm
State Saved	Saved in instrument state
Min	-200 dBm
Max	100 dBm
Default Unit	depends on the current selected Y-Axis unit
Backwards Compatibility SCPI	:TRIGger[:SEquence]:FRAMe:RFBurst:LEVel:ABSolute
Initial S/W Revision	Prior to A.02.00
Modified at S/W Revision	A.04.00

Key Path	Trigger, RF Burst
Remote Command	:TRIGger[:SEquence]:RFBurst:LEVel:TYPE ABSolute RELative :TRIGger[:SEquence]:RFBurst:LEVel:TYPE?
Example	TRIG:RFB:LEV:TYPE REL sets the trigger level type of the RF burst trigger to Relative.
Preset	ABSolute

State Saved	Saved in instrument state
Initial S/W Revision	Prior to A.02.00
Modified at S/W Revision	A.04.00

Relative Trigger Level

Sets the relative trigger level for the RF burst envelope.

In some models, the relative burst trigger function is implemented in hardware. In other models, without the advanced triggering hardware required, the relative burst trigger function is implemented in software in some measurements, and is unavailable in other measurements.

When implemented in software, the relative RF Burst trigger function is implemented as follows:

5. The measurement starts with the absolute RF Burst trigger setting. If it cannot get a trigger with that level, auto trigger fires and the acquisition starts anyway. After the acquisition, the measurement searches for the peak in the acquired waveform and saves it.
6. Now, in the next cycle of the measurement, the measurement determines a new absolute RF Burst level based on the peak value from the first measurement and the Relative RF Burst Trigger Level (always 0 or negative dB) set by the user. The following formula is used:
7. absolute RF Burst level = peak level of the previous acquisition + relative RF Burst level
8. If the new absolute RF Burst level differs from the previous by more than 0.5 dB, the new level is sent to the hardware; otherwise it is not updated (to avoid slowing down the acquisition)

Steps 2 and 3 repeat for subsequent measurements.

Key Path	Trigger, RF Burst
Scope	Meas Global
Remote Command	<code>:TRIGger[:SEquence]:RFBurst:LEVel:RELative <rel_amp1></code> <code>:TRIGger[:SEquence]:RFBurst:LEVel:RELative?</code>
Example	TRIG:RFB:LEV:REL -10 dB sets the trigger level of the RF burst envelope signal to the relative level of -10 dB
Notes	Sending this command does not switch the setting from absolute to relative; to switch it you need to send the <code>:TRIGger[:SEquence]:RFBurst:LEVel:TYPE</code> command, above. The relative trigger level is not available in some measurements. In those measurements the RELative parameter, and the <code>:TRIGger[:SEquence]:RFBurst:LEVel:TYPE</code> command (above), will generate an error if sent.

Dependencies	This key is grayed out and Absolute Trigger Level selected if the required hardware is not present in your analyzer and the current measurement does not support Relative triggering.
Preset	-6 dB GSM: -25 dB
State Saved	Saved in instrument state
Min	-45 dB
Max	0 dB
Default Unit	dB or dBc
Backwards Compatibility SCPI	:TRIGger[:SEquence]:RFBurst:LEVel This legacy command is aliased to :TRIGger[:SEquence]:RFBurst:LEVel:RELative because the PSA had ONLY relative burst triggering
Initial S/W Revision	Prior to A.02.00
Modified at S/W Revision	A.04.00

Trigger Slope

It is set positive to trigger on a rising edge and negative to trigger on a falling edge.

Key Path	Trigger, RF Burst
Remote Command	:TRIGger[:SEquence]:RFBurst:SLOPe POSitive NEGative :TRIGger[:SEquence]:RFBurst:SLOPe?
Example	TRIG:RFB:SLOP NEG
Couplings	This same slope is used in the RF Burst selection for the trigger source in the Trigger menu and for the period timer sync source (in the Trigger menu and in the Gate Source menu).
Preset	POSitive
State Saved	Saved in instrument state
Backwards Compatibility SCPI	:TRIGger[:SEquence]:FRAME:RFBurst:SLOPe
Backwards Compatibility Notes	The legacy :TRIGger[:SEquence]:SLOPe command affects the slopes for the VID, LINE, EXT1, EXT2, and RFB triggers.
Initial S/W Revision	Prior to A.02.00

Zero Span Delay Comp On/Off

In zero span, there is a natural delay in the signal path, which comes from the RBW filter. This is usually desirable, as it allows you to trigger on events and also see those events, because the signal is delayed from the trigger event. However, in some cases it is desirable to eliminate this delay, so that trigger events line up exactly with the zero time point in zero span. You can use the **Zero Span Delay Comp On/Off** feature to enable or disable zero span delay compensation.

Key Path	Trigger, RF Burst
----------	-------------------

Remote Command	:TRIGger[:SEquence]:RFBurst:DELay:COMPensation OFF ON 0 1 :TRIGger[:SEquence]:RFBurst:DELay:COMPensation?
Example	TRIG:RFB:DEL:COMP ON
Dependencies	No effect except in zero-span, but not locked out in nonzero spans. Blanked in modes that do not support zero-span measurements. If the SCPI command is sent when the key is blanked, an error is returned: -221, "Settings conflict; Feature not supported for this measurement" In analyzers shipping N9060A, this feature requires N9060A-7FP.
Preset	OFF
State Saved	Saved in instrument state
Initial S/W Revision	A.11.00

TV

Pressing this key, when it is not selected, selects the TV input signal as the trigger. A new sweep/measurement will start synchronized with the next occurrence of the synchronizing pulse of the selected TV line number.

Pressing this key, when it is already selected, opens a menu of TV Trigger setup functions. The default active function in this menu is the TV line number on which you want to trigger.

The Frame and Field options enable you to determine how the fields of the TV picture signal will be affected by the trigger system. One complete TV image consists of one frame of 525 or 625 horizontal lines depending on the TV standard being used. Each frame is composed of two fields of interlacing lines, each consisting of 262 1/2 lines (or 312 1/2 lines). The fields are called Field One and Field Two. Field One is viewed as having 263 lines (or 313 lines) and Field Two is viewed as having 262 lines (or 312 lines).

For the 525 line NTSC video standard, we refer to TV lines as follows (these are the Field Modes):

Entire Frame, lines 1 to 525

Field One, lines 1 to 263

Field Two, lines 1 to 262 (note that this really refers to "actual" lines 264 to 525)

For the 625 line PAL and SECAM video standards, we refer to TV lines as follows:

Entire Frame, lines 1 to 625

Field One, lines 1 to 313

Field Two, lines 314 to 625

As the Field is changed, the appropriate value for Line is chosen to keep triggering on the same line as before, or if this is not possible, the corresponding line in the new Field. For example, suppose line 264 is selected while in the NTSC-M standard and the Entire Frame mode. This is the first line in Field Two. If Field Two is then selected, the Line number changes to Line 1, the same actual line in the TV signal. If Field One

is then selected, the line number stays at 1, but now we are triggering in the first line in Field One. The only exception to this is if we are on the last line of Field One and change to Field Two. In this case, we go to the last line in Field Two.

Key Path	Trigger
Example	TRIG:SOUR TV Swept SA measurement TRIG:<meas>:SOUR TV Measurements other than Swept SA
Dependencies	This key only appears in Modes which support TV Trigger, otherwise the key is blanked. If the SCPI command is sent while the key is blanked, an error is returned.
Readback	This key displays the value read back from TV Line
Status Bits/OPC dependencies	The Status Operation Register bit 5 "Waiting for Trigger" is set at the same time as the Sweeping or Measuring bit is set. It is cleared when the trigger actually occurs (that is, after the trigger event occurs and all the applicable trigger criteria have been met). A corresponding pop-up message ("Waiting for trigger") is generated if no trigger signal appears after approximately 2 sec. This message goes away when a trigger signal appears.
Initial S/W Revision	Prior to A.02.00

TV Line

Selects the TV line number to trigger on. Line number range is dependent on the settings of the **Standard** and **Field** menus within the TV trigger setup functions. When the line number is incremented beyond the upper limit, the value will change to the lower limit and continue incrementing from there. When the line number is decremented below the lower limit, the value will change to the upper limit and continue decrementing from there.

Key Path	Trigger, TV
Remote Command	:TRIGger[:SEquence]:TV:LINE <integer> :TRIGger[:SEquence]:TV:LINE?
Example	TRIG:TV:LINE 20 TRIG:TV:LINE?
Notes	The range of the TV line number is dependent on the settings of the Standard and Field menus within the TV trigger setup functions.
Preset	17
State Saved	Saved in instrument state
Min	The minimum value is the minimum line, and rolls over to the maximum value. The minimum line number depends on which Field and standard are selected.
Max	The maximum value is the maximum line, and rolls over to the minimum value. The maximum line number depends on which Field and standard are selected.
Initial S/W Revision	Prior to A.02.00

Field

Accesses the menu to select the field.

Key Path	Trigger, TV
----------	--------------------

Remote Command	:TRIGger[:SEquence]:TV:FMODe ENTire ODD EVEN :TRIGger[:SEquence]:TV:FMODe?
Example	TRIG:TV:FMOD EVEN
Notes	ODD is Field 1 EVEN is Field 2
Dependencies	This command is available only when Option B7B (TV trigger) is installed.
Preset	ENTire
Readback	Displays the Readback value
Initial S/W Revision	Prior to A.02.00

Entire Frame

When you select Entire Frame it causes the selected line number to be viewed as an offset into the entire frame starting with line 1, the first line in Field One.

Key Path	Trigger, TV, Field
Example	TRIG:TV:FMOD ENT
Min	1, for all formats.
Max	525, for formats NTSC-M, NTSC-Japan, NTSC-4.43, PAL-M and PAL-60 625, for formats PAL-B, D, G, H, I, PAL-N, PAL-N Combin, and SECAM-L.
Readback	Entire Frame
Initial S/W Revision	Prior to A.02.00

Field One

When you select Field One it causes the selected line number to be viewed as an offset into the first field starting with Line 1, the first line in Field One.

Key Path	Trigger, TV, Field
Example	TRIG:TV:FMOD ODD
Min	Field 1 (ODD) The minimum line is 1
Max	Field 1 (ODD) Maximum line is 263 for formats NTSC-M, NTSC-Japan, NTSC-4.43, PAL-M and PAL-60 Maximum line is 313 for formats PAL-B, D, G, H, I, PAL-N, PAL-N Combin, and SECAM-L.
Readback	Field 1
Initial S/W Revision	Prior to A.02.00

Field Two

When you select Field Two it causes the selected line number to be viewed as an offset into the second field. If Line 1 is selected, it is the 264th line of the frame (NTSC-M, NTSC-Japan, NTSC-4.43, PAL-M, PAL-60) or the 314th line of the frame (PAL-B,D,G,H,I, PAL-N, PAL-N-Combin, SECAM-L).

Key Path	Trigger, TV, Field
Example	TRIG:TV:FMODEVEN
Min	Field 2 (EVEN) The minimum line is 1
Max	Field 2 (EVEN) The maximum line 262 for formats NTSC-M, NTSC-Japan, NTSC-4.43, PAL-M and PAL-60 The maximum line is 312 for formats PAL-B, D, G, H, I, PAL-N, PAL-N Combin, and SECAM-L
Readback	Field 2
Initial S/W Revision	Prior to A.02.00

Standard

Accesses the Standard menu keys which select from the following TV standards: **NTSC-M, NTSC-Japan, NTSC-4.43, PAL-M, PAL-B,D,G,H,I, PAL-N, PAL-N-Combin, PAL-60, SECAM-L.**

As the TV standard is changed, the current line value is clipped as necessary to keep it valid for the chosen standard and field mode. For example, line 600 is selected in Entire Frame mode in PAL-N; if NTSC-M is selected, the line number is clipped to 525. Or, if line 313 is selected in Field 1 mode in PAL-N and NTSC-M is selected, the line number is clipped to 263. Changing back to the PAL-N standard will leave the line number at 263.

Key Path	Trigger, TV
Remote Command	:TRIGger[:SEquence]:TV:STANdard MNTSc JNTSc NTSC443 MPAL BPAL NPAL CPAL PAL60 LSEC :TRIGger[:SEquence]:TV:STANdard?
Example	TRIG:TV:STAN MPAL TRIG:TV:STAN?
Preset	MNTS
State Saved	Saved in instrument state
Readback	Displays Readback value
Initial S/W Revision	Prior to A.02.00

NTSC-M

Sets the TV standard to NTSC-M.

Key Path	Trigger, TV, Standard
Example	TRIG:TV:STAN MNTS
Readback	NTSC-M
Initial S/W Revision	Prior to A.02.00

NTSC-Japan

Sets the TV standard to **NTSC-Japan**.

Key Path	Trigger, TV, Standard
Example	TRIG:TV:STAN JNTS
Readback	NTSC-Japan
Initial S/W Revision	Prior to A.02.00

NTSC-4.43

Sets the TV standard to **NTSC-4.43**.

Key Path	Trigger, TV, Standard
Example	TRIG:TV:STAN NTSC443
Readback	NTSC-Japan
Initial S/W Revision	Prior to A.02.00

PAL-M

Sets the TV standard to **PAL-M**.

Key Path	Trigger, TV, Standard
Example	TRIG:TV:STAN MPAL
Readback	PAL-M
Initial S/W Revision	Prior to A.02.00

PAL-N

Sets the TV standard to **PAL-N**.

Key Path	Trigger, TV, Standard
Example	TRIG:TV:STAN NPAL
Readback	PAL-N
Initial S/W Revision	Prior to A.02.00

PAL-N-Combin

Sets the TV standard to **PAL-N-Combin**.

Key Path	Trigger, TV, Standard
Example	TRIG:TV:STAN CPAL
Readback	PAL-N-C
Initial S/W Revision	Prior to A.02.00

PAL-B,D,G,H,I

Sets the TV standard to **PAL-B,D,G,H,I**

Key Path	Trigger, TV, Standard
Example	TRIG:TV:STAN BPAL
Readback	PAL-B
Initial S/W Revision	Prior to A.02.00

PAL-60

Sets the TV standard to **PAL-60**.

Key Path	Trigger, TV, Standard
Example	TRIG:TV:STAN PAL60
Readback	PAL-N
Initial S/W Revision	Prior to A.02.00

SECAM-L

Sets the TV standard to **SECAM-L**.

Key Path	Trigger, TV, Standard
Example	TRIG:TV:STAN LSEC
Readback	SECAM-L
Initial S/W Revision	Prior to A.02.00

Control Edge/Level

Sets the method of controlling the gating function from the gating signal.

Edge

In Edge triggering, the gate opens (after the Delay) on the selected edge (for example, positive) of the gate signal and closes on the alternate edge (for example, negative).

Level

In Level triggering, the gate opens (after the Delay) when the gate signal has achieved a certain level and stays open as long as that level is maintained.

Key Path	Sweep/Control, Gate
Remote Command	[:SENSe] :SWEep:EGATe:CONTro1 EDGE LEVe1 [:SENSe] :SWEep:EGATe:CONTro1?
Example	SWE:EGAT:CONT EDGE
Dependencies	If the Gate Method is FFT the Control key is grayed out and Edge is selected. If the Gate Source is TV, Frame or Line, the Control key is grayed out and Edge is selected.
Preset	EDGE
State Saved	Saved in instrument state
Backwards Compatibility SCPI	[:SENSe] :SWEep:TIME:GATE:TYPE ESA Compatibility

Initial S/W Revision Prior to A.02.00

Gate Holdoff

Lets you increase or decrease the wait time after a gate event ends before the analyzer will respond to the next gate signal.

After any Gate event finishes, the analyzer must wait for the sweep system to settle before it can respond to another Gate signal. The analyzer calculates a "wait time," taking into account a number of factors, including RBW and Phase Noise Optimization settings. The goal is to achieve the same accuracy when gated as in ungated operation. The figure below illustrates this concept:

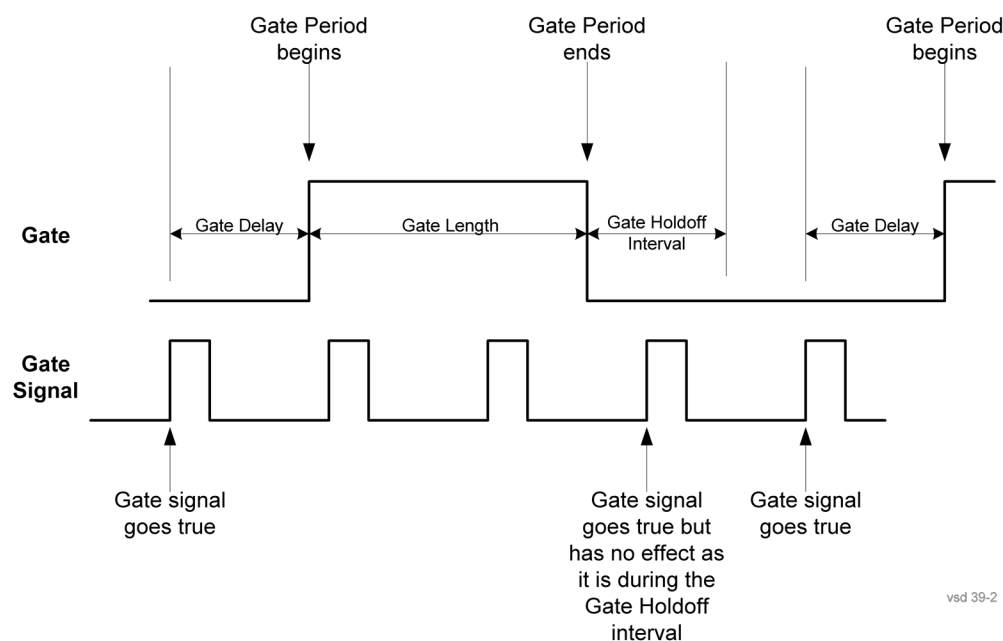

When Gate Holdoff is in Auto, the wait time calculated by the analyzer is used. When Gate Time is in Manual, the user may adjust the wait time, usually decreasing it in order to achieve greater speed, but at the risk of decreasing accuracy.

When the **Method** key is set to **Video** or **FFT**, the **Gate Holdoff** function has no effect.

In measurements that do not support Auto, the value shown when Auto is selected is “---” and the manually set holdoff is returned to a query.

Key Path	Sweep/Control, Gate
Remote Command	[:SENSe]:SWEep:EGATe:HOLDoff <time> [:SENSe]:SWEep:EGATe:HOLDoff? [:SENSe]:SWEep:EGATe:HOLDoff:AUTO OFF ON 0 1 [:SENSe]:SWEep:EGATe:HOLDoff:AUTO?
Example	SWE:EGAT:HOLD 0.0002 SWE:EGAT:HOLD?

	SWE:EGAT:HOLD:AUTO ON SWE:EGAT:HOLD:AUTO?
Couplings	<p>When Gate Holdoff is Auto, the Gate Holdoff key shows the value calculated by the analyzer for the wait time.</p> <p>Pressing the Gate Holdoff key while it is in Auto and not selected, causes the key to become selected and allows the user to adjust the value. If the value is adjusted, the setting changes to Man.</p> <p>Pressing the Gate Holdoff key, while it is in Auto and selected, does not change the value of Gate Holdoff, but causes the setting to change to Man. Now the user can adjust the value.</p> <p>Pressing the key while it is in Man and selected, cause the value to change back to Auto.</p> <p>Pressing the key while it is in Man and not selected, causes the key to become selected and allows the user to adjust the value.</p> <p>When Method is set to Video or FFT, the Gate Holdoff function has no effect.</p>
Preset	Auto Auto/On
State Saved	Saved in instrument state
Min	1 µsec
Max	1 sec
Initial S/W Revision	Prior to A.02.00

Gate Delay Compensation

This function allows you to select an RBW-dependent value by which to adjust the gate delay, to compensate for changes in the delay caused by RBW effects.

You can select between uncompensated operation and two types of compensation, **Delay Until RBW Settled** and **Compensate for RBW Group Delay**.

See "[More Information](#)" on page 2525

Key Path	Sweep/Control, Gate
Scope	Meas Global
Remote Command	[:SENSe] :SWEep:EGATe:DELay:COMPensation:TYPE OFF SETTled GDELay [:SENSe] :SWEep:EGATe:DELay:COMPensation:TYPE?
Example	SWE:EGAT:DEL:COMP:TYPE SETT SWE:EGAT:DEL:COMP:TYPE?
Notes	<p>Although this function is Meas Global, there are some measurements that do not support this function. In those measurements the operation will be Uncompensated. Going into one of those measurements will not change the Meas Global selection; it will simply display the grayed-out menu key with "Uncompensated" showing as the selection. This is a non-forceful grayout, so the SCPI command is still accepted.</p> <p>If Gate Delay Compensation is not supported at all within a particular mode, the key is not displayed, and if the SCPI command is sent while in a measurement within that mode, an "Undefined Header" message is generated.</p> <p>Measurements that do not support this function include:</p>

	Swept SA
Preset	TD-SCDMA mode: Compensate for RBW Group Delay All other modes: Delay Until RBW Settled
State Saved	Saved in instrument state
Range	Uncompensated Delay Until RBW Settled Compensate for RBW Group Delay
Readback text	Uncompensated Settled Group Delay
Initial S/W Revision	Prior to A.02.00
Modified at S/W Revision	A.11.0

More Information

Selecting **Uncompensated** means that the actual gate delay is as you sets it.

Selecting **Delay Until RBW Settled** causes the gate delay to be increased above the user setting by an amount equal to $3.06/\text{RBW}$. This compensated delay causes the GATE START and GATE STOP lines on the display to move by the compensation amount, and the actual hardware gate delay to be increased by the same amount. All the other gate lines (for example, MIN FAST) are unaffected. If the RBW subsequently changes, the compensation is readjusted for the new RBW. The value shown on the **Gate Delay** key does NOT change.

Delay Until RBW Settled allows excellent measurements of gated signals, by allowing the IF to settle following any transient that affects the burst. Excellent measurements also require that the analysis region not extend into the region affected by the falling edge of the burst. Thus, excellent measurements can only be made over a width that declines with narrowing RBWs, which is achieved by decreasing the gate length below the user setting by an amount equal to $2.53/\text{RBW}$. Therefore, for general purpose compensation, you will still want to change the gate length with changes in RBW even if the gate delay is compensated. The compensated Gate Length is limited by the analyzer so that it will never go below 10% of the value shown on the Gate Length key, as otherwise the sweep times could get very long. Anytime the **Gate Length and RBW** values combine in such a way that this limiting takes place, a warning is displayed . For measurements which contain multiple sweeps with different RBW like SEM and SPUR, the smallest RBW is used for this limiting.

Selecting **Compensate for RBW Group Delay** causes the gate delay to be increased above the user setting by an amount equal to $1.81/\text{RBW}$. This compensated delay causes the GATE START, GATE STOP lines on the display to move by the compensation amount, and the actual hardware gate delay to be increased by the same amount. All the other gate lines (for example, MIN FAST) are unaffected. If the RBW subsequently changes, the compensation is readjusted for the new RBW. The value shown on the **Gate Delay** key does NOT change. **Compensate for RBW Group Delay** also includes gate length compensation; the gate length itself is adjusted as necessary to attempt to compensate for delay effects imposed by the RBW.

Compensate for RBW Group Delay is similar to **Delay Until RBW Settled** , but compensates for the group delay of the RBW filter, rather than the filter settling

time. As the RBW gets narrow, this can allow the settling tail of the RBW to affect the beginning part of the gated measurement, and allow the beginning of the RBW settling transient to affect the end of the gated measurement. These two effects are symmetric because the RBW response is symmetric. Because the gate length is not automatically compensated, some users might find this compensation to be more intuitive than compensation for RBW settling.

Min Fast Position Query (Remote Command Only)

This command queries the position of the MIN FAST line, relative to the delay reference (REF) line. See section "Gate View On/Off" on page 2806. If this query is sent while not in gate view, the MinFast calculation is performed based on the current values of the appropriate parameters and the result is returned. Knowing this value lets you set an optimal gate delay value for the current measurement setup.

Remote Command	<code>[:SENSe] :SWEep:EGATe:MINFast?</code>
Example	<code>SWE:EGAT:MIN?</code>
Initial S/W Revision	Prior to A.02.00

Gate Preset (Remote Command Only)

Presets the time-gated spectrum analysis capability.

This command sets gate parameter values to the ESA preset values, as follows:

Gate trigger type = edge

Gate polarity = positive

Gate delay = 1 us

Gate length = 1 us

Remote Command	<code>[:SENSe] :SWEep:TIME:GATE:PRESet ESA Compatibility</code>
Initial S/W Revision	Prior to A.02.00

Gate Level (Remote Command Only)

Sets the gate input transition point level for the external TRIGGER inputs on the front and rear panel. This is a legacy command for PSA compatibility. It is simply an alias to the equivalent trigger level command.

Remote Command	<code>[:SENSe] :SWEep:EGATe:EXTernal[1] 2:LEVel <voltage></code> <code>[:SENSe] :SWEep:EGATe:EXTernal[1] 2:LEVel?</code>
Notes	This command is simply an alias to <code>:TRIGger[:SEQuence]:EXTernal[1]2:LEVel</code>
Initial S/W Revision	Prior to A.02.00

Gate Polarity (Remote Command Only)

Sets the polarity for the gate signal. This setup is now done using the gate trigger's slope setting.

When Positive (Pos) is selected, a positive-going edge (Edge) or a high voltage (Level) will satisfy the gate condition, after the delay set with the Gate Delay key. When Negative (Neg) is selected, a negative-going edge (Edge) or a low voltage (Level) will satisfy the gate condition after the delay.

Remote Command	<code>[:SENSe] :SWEep:EGATe:POLarity NEGative POSitive</code> <code>[:SENSe] :SWEep:EGATe:POLarity?</code>
Example	<code>SWE:EGAT:POL NEG</code> <code>SWE:EGAT:POL?</code>
Preset	POSitive
State Saved	Saved in instrument state
Backwards Compatibility SCPI	<code>[:SENSe] :SWEep:TIME:GATE:POLarity</code> ESA compatibility
Initial S/W Revision	Prior to A.02.00

Remote Command	<code>[:SENSe] :SWEep:TIME:GATE:LEVe1 HIGH LOW</code> <code>[:SENSe] :SWEep:TIME:GATE:LEVe1?</code> ESA compatibility
Preset	HIGH
Initial S/W Revision	Prior to A.02.00

System

See "System" on page 431

Trace/Detector

Trace/Detector is unavailable in the Spurious Emissions measurement. When pressed, this key displays a blank menu.

Key Path	Front-panel key
Initial S/W Revision	Prior to A.02.00

Trigger

See ["Trigger" on page 529](#)

Free Run

See ["Free Run " on page 537](#)

Video

See ["Video \(IF Envelope\) " on page 538](#)

Trigger Level

See ["Trigger Level" on page 538](#)

Trig Slope

See ["Trig Slope" on page 539](#)

Trig Delay

See ["Trig Delay" on page 540](#)

X Axis Relative to Trigger

See ["X Axis Relative to Trigger" on page 583](#)

Line

See ["Line" on page 2814](#)

Trig Slope

See ["Trig Slope" on page 2814](#)

Trig Delay

See ["Trig Delay" on page 543](#)

X Axis Relative to Trigger

See ["X Axis Relative to Trigger" on page 583](#)

External 1

See ["External 1" on page 2828](#)

Trigger Level

See ["Trigger Level" on page 2828](#)

Trig Slope

See ["Trig Slope" on page 2829](#)

Trig Delay

See ["Trig Delay" on page 546](#)

X Axis Relative to Trigger

See ["X Axis Relative to Trigger" on page 583](#)

Zero Span Delay Comp

See ["Zero Span Delay Comp On/Off " on page 2816](#)

External 2

See ["External 2 " on page 2829](#)

Trigger Level

See ["Trigger Level" on page 2830](#)

Trig Slope

See ["Trig Slope" on page 2831](#)

Trig Delay

See ["Trig Delay " on page 549](#)

X Axis Relative to Trigger

See ["X Axis Relative to Trigger" on page 583](#)

Zero Span Delay Comp

See ["Zero Span Delay Comp On/Off" on page 2818](#)

RF Burst

See ["RF Burst" on page 2831](#)

Absolute Trigger

See ["Absolute Trigger Level" on page 2832](#)

Relative Trigger

See ["Relative Trigger Level" on page 2833](#)

Trig Slope

See ["Trigger Slope" on page 2834](#)

Trig Delay

See ["Trig Delay" on page 554](#)

X Axis Relative to Trigger

See ["X Axis Relative to Trigger" on page 583](#)

Zero Span Delay Comp

See ["Zero Span Delay Comp On/Off" on page 2834](#)

Periodic Timer

See ["Periodic Timer \(Frame Trigger\)" on page 2823](#)

Period

See ["Period" on page 2824](#)

Offset

See ["Offset" on page 2825](#)

Offset Adjust (Remote Command Only)

See ["Offset Adjust \(Remote Command Only\)" on page 2826](#)

Reset Offset Display

See ["Reset Offset Display" on page 2827](#)

Sync Source

See ["Sync Source" on page 2827](#)

Off

See ["Off" on page 2828](#)

External 1

See ["External 1" on page 2828](#)

Trigger Level

See ["Trigger Level" on page 2828](#)

Trig Slope

See ["Trig Slope" on page 2829](#)

External 2

See ["External 2 " on page 2829](#)

Trigger Level

See ["Trigger Level" on page 2830](#)

Trig Slope

See ["Trig Slope" on page 2831](#)

RF Burst

See ["RF Burst" on page 2831](#)

Absolute Trigger

See ["Absolute Trigger Level" on page 2832](#)

Relative Trigger

See ["Relative Trigger Level" on page 2833](#)

Trig Slope

See ["Trigger Slope" on page 2834](#)

Zero Span Delay Comp

See ["Zero Span Delay Comp On/Off" on page 2834](#)

Trig Delay

See ["Trig Delay" on page 568](#)

X Axis Relative to Trigger

See ["X Axis Relative to Trigger" on page 583](#)

Sync Holdoff

See ["Sync Holdoff" on page 1289](#)

Baseband I/Q

See ["Baseband I/Q " on page 570](#)

I/Q Mag

See ["I/Q Mag" on page 570](#)

Trigger Level

See ["Trigger Level" on page 570](#)

Trig Slope

See ["Trig Slope" on page 571](#)

Trig Delay

See ["Trig Delay" on page 571](#)

X Axis Relative to Trigger

See ["X Axis Relative to Trigger" on page 583](#)

I (Demodulated)

See ["I \(Demodulated\)" on page 572](#)

Trigger Level

See ["Trigger Level" on page 573](#)

Trig Slope

See ["Trig Slope" on page 573](#)

Trig Delay

See ["Trig Delay" on page 573](#)

X Axis Relative to Trigger

See ["X Axis Relative to Trigger" on page 583](#)

Q (Demodulated)

See ["Q \(Demodulated\)" on page 575](#)

Trigger Level

See ["Trigger Level" on page 575](#)

Trig Slope

See ["Trig Slope" on page 575](#)

Trig Delay

See ["Trig Delay" on page 576](#)

X Axis Relative to Trigger

See ["X Axis Relative to Trigger" on page 583](#)

Input I

See ["Input I" on page 577](#)

Trigger Level

See ["Trigger Level" on page 577](#)

Trig Slope

See ["Trig Slope" on page 578](#)

Trig Delay

See ["Trig Delay" on page 578](#)

X Axis Relative to Trigger

See ["X Axis Relative to Trigger" on page 583](#)

Input Q

See ["Input Q" on page 579](#)

Trigger Level

See ["Trigger Level" on page 579](#)

Trig Slope

See ["Trig Slope" on page 580](#)

Trig Delay

See ["Trig Delay" on page 580](#)

X Axis Relative to Trigger

See ["X Axis Relative to Trigger" on page 583](#)

Auxiliary Channel I/Q Mag

See ["Auxiliary Channel I/Q Mag" on page 581](#)

Trigger Level

See ["Trigger Level" on page 582](#)

Trig Slope

See ["Trig Slope" on page 582](#)

Trig Delay

See ["Trig Delay" on page 582](#)

X Axis Relative to Trigger

See ["X Axis Relative to Trigger" on page 583](#)

Trigger Center Frequency

See ["Trigger Center Frequency" on page 583](#)

Trigger Bandwidth

See ["Trigger Bandwidth" on page 584](#)

TV

See ["TV" on page 2835](#)

TV Line

See ["TV Line" on page 2836](#)

Field

See ["Field" on page 2836](#)

Entire Frame

See ["Entire Frame" on page 2837](#)

Field One

See ["Field One" on page 2837](#)

Field Two

See ["Field Two" on page 2837](#)

Standard

See ["Standard" on page 2838](#)

NTSC-M

See ["NTSC-M" on page 2838](#)

NTSC-Japan

See ["NTSC-Japan" on page 2839](#)

NTSC-4.43

See ["NTSC-4.43" on page 2839](#)

PAL-M

See ["PAL-M" on page 2839](#)

PAL-N

See ["PAL-N" on page 2839](#)

PAL-N Combin

See ["PAL-N-Combin" on page 2839](#)

PAL-B,D,G,H,I

See ["PAL-B,D,G,H,I" on page 2839](#)

PAL-60

See ["PAL-60" on page 2840](#)

SECAM-L

See ["SECAM-L" on page 2840](#)

Auto/Holdoff

See ["Auto/Holdoff" on page 590](#)

Auto Trig

See ["Auto Trig" on page 590](#)

Trig Holdoff

See ["Trig Holdoff" on page 591](#)

Holdoff Type

See ["Holdoff Type" on page 591](#)

User Preset

Accesses a menu that gives you the following three choices:

- **User Preset** – recalls a state previously saved using the Save User Preset function.
- **User Preset All Modes** – presets all of the modes in the analyzer
- **Save User Preset**– saves the current state for the current mode

Key Path	Front-panel key
Backwards Compatibility Notes	<p>User Preset is actually loading a state, and in legacy analyzers, it was possible to load a state without affecting the trace data, limit lines or correction data. Similarly it was possible to do a User Preset without affecting the trace data, limit lines or correction data.</p> <p>In the X-Series, “state” always includes all of this data; so whenever state is loaded, or User Preset is executed, all of the traces, limit lines and corrections are affected. Although this differs from previous behavior, it is desirable behavior, and should not cause adverse issues for users.</p> <p>On ESA and PSA, User Preset affected the entire instrument’s state. In the X-Series, User Preset only recalls the state for the active mode. There is a User Preset file for each mode. User Preset can never cause a mode switch as it can in legacy analyzers. If you want to recall all modes to their user preset file state, you will need to do a User Preset after mode switching into each mode.</p> <p>User Preset recalls mode state which can now include data like traces; whereas on ESA and PSA, User Preset did not affect data.</p>
Initial S/W Revision	Prior to A.02.00

User Preset

User Preset sets the state of the currently active mode back to the state that was previously saved for this mode using the Save User Preset menu key or the SCPI command, **SYST:PRES:USER:SAV**. **It not only recalls the** Mode Preset settings, but it also recalls all of the mode persistent settings, and the Input/Output system setting that existed at the time Save User Preset was executed.

If a Save User Preset has not been done at any time, User Preset recalls the default user preset file for the currently active mode. The default user preset files are created if, at power-on, a mode detects there is no user preset file. There will never be a scenario when there is no user preset file to restore. For each mode, the default user preset state is the same state that would be saved if a Save User Preset is performed in each mode right after doing a Restore Mode Default and after a Restore Input/Output Defaults.

The User Preset function does the following:

- Aborts the currently running measurement.
- Sets the mode State to the values defined by Save User Preset.

- Makes the saved measurement for the currently running mode the active measurement.
- Brings up the saved menu for the power-on mode.
- Clears the input and output buffers.
- Sets the Status Byte to 0.

Key Path	User Preset
Remote Command	:SYSTem:PRESet:USER
Example	:SYST:PRES:USER
Notes	:SYST:PRES:USER:SAVE is used to save the current state as the user preset state. Clears all pending OPC bits. The Status Byte is set to 0. Pressing the User Preset front-panel key while already in the User Preset menu will cause the User Preset to get executed
Couplings	A user preset will cause the currently running measurement to be aborted and cause the saved measurement to be active. Recalling a User Preset file has the same issues that recalling a Save State file has. Some settings may need to be limited and therefore re-coupled, since the capabilities of the mode may have changes when the User Preset file was last saved.
Initial S/W Revision	Prior to A.02.00

User Preset All Modes

Recalls all of the User Preset files for each mode, switches to the power-on mode, and activates the saved measurement from the power-on mode User Preset file.

NOTE

When the instrument is secured, all of the user preset files are converted back to their default user preset files.

The User Preset function does the following:

- Aborts the currently running measurement.
- Switches the Mode to the power-on mode.
- Restores the User Preset files for each mode.
- Makes the saved measurement for the power-on mode the active measurement.
- Brings up the saved menu for the power-on mode.
- Clears the input and output buffers.
- Sets the Status Byte to 0.

Key Path	User Preset
----------	-------------

Remote Command	:SYSTem:PRESet:USER:ALL
Example	:SYST:PRES:USER:SAVE :SYST:PRES:USER:ALL
Notes	Clears all pending OPC bits. The Status Byte is set to 0. :SYST:PRES:USER:SAVE is used to save the current state as the user preset state.
Couplings	A user preset will cause the currently running measurement to be aborted, cause a mode switch to the power-on mode, and cause the saved measurement to be active in the power-on mode. Recalling a User Preset file has the same issues that recalling a Save State file has. Some settings may need to be limited and therefore re-coupled, since the capabilities of the mode may have changes when the User Preset file was last saved.
Initial S/W Revision	Prior to A.02.00

Save User Preset

Saves the currently active mode and its State. You can recall this User Preset file by pressing the User Preset menu key or sending the SYST:PRES:USER remote command. This same state is also saved by the Save State function.

Key Path	User Preset
Remote Command	:SYSTem:PRESet:USER:SAVE
Example	:SYST:PRES:USER:SAVE
Notes	:SYST:PRES:SAVE creates the same file as if the user requested a *SAV or a MMEM:STOR:STAT, except User Preset Save does not allow the user to specify the filename or the location of the file.
Initial S/W Revision	Prior to A.02.00

View/Display

Accesses a menu that includes keys that enables you to control the instrument display.

For details of available views, see [View Selection](#).

For details of remote commands associated with views, see [Range Table Selection \(SCPI only command\)](#).

Key Path	Front-panel key
Initial S/W Revision	Prior to A.02.00

Display

The Display menu is common to most measurements, and is used for configuring items on the display. Some Display menu settings apply to all the measurements in a mode, and some only to the current measurement. Those under the **System Display Settings** key apply to all measurements in all modes.

Key Path	Display
Key Path	View/Display
Initial S/W Revision	Prior to A.02.00

Annotation

Turns on and off various parts of the display annotation. The annotation is divided up into four categories:

13. Meas Bar: This is the measurement bar at the top of the screen. It does not include the settings panel or the Active Function. Turning off the Meas Bar turns off the settings panel and the Active Function. When the Meas Bar is off, the graticule area expands to fill the area formerly occupied by the Meas Bar.
14. Screen Annotation: this is the annotation and annunciation around the graticule, including any annotation on lines (such as the display line, the threshold line, etc.) This does NOT include the marker number or the N dB result. When off, the graticule expands to fill the entire graticule area.
15. Trace annotation: these are the labels on the traces, showing their detector (or their math mode).
16. Active Function annotation: this is the active function display in the meas bar, and all of the active function values displayed on softkeys.

See the figure below. Each type of annotation can be turned on and off individually.

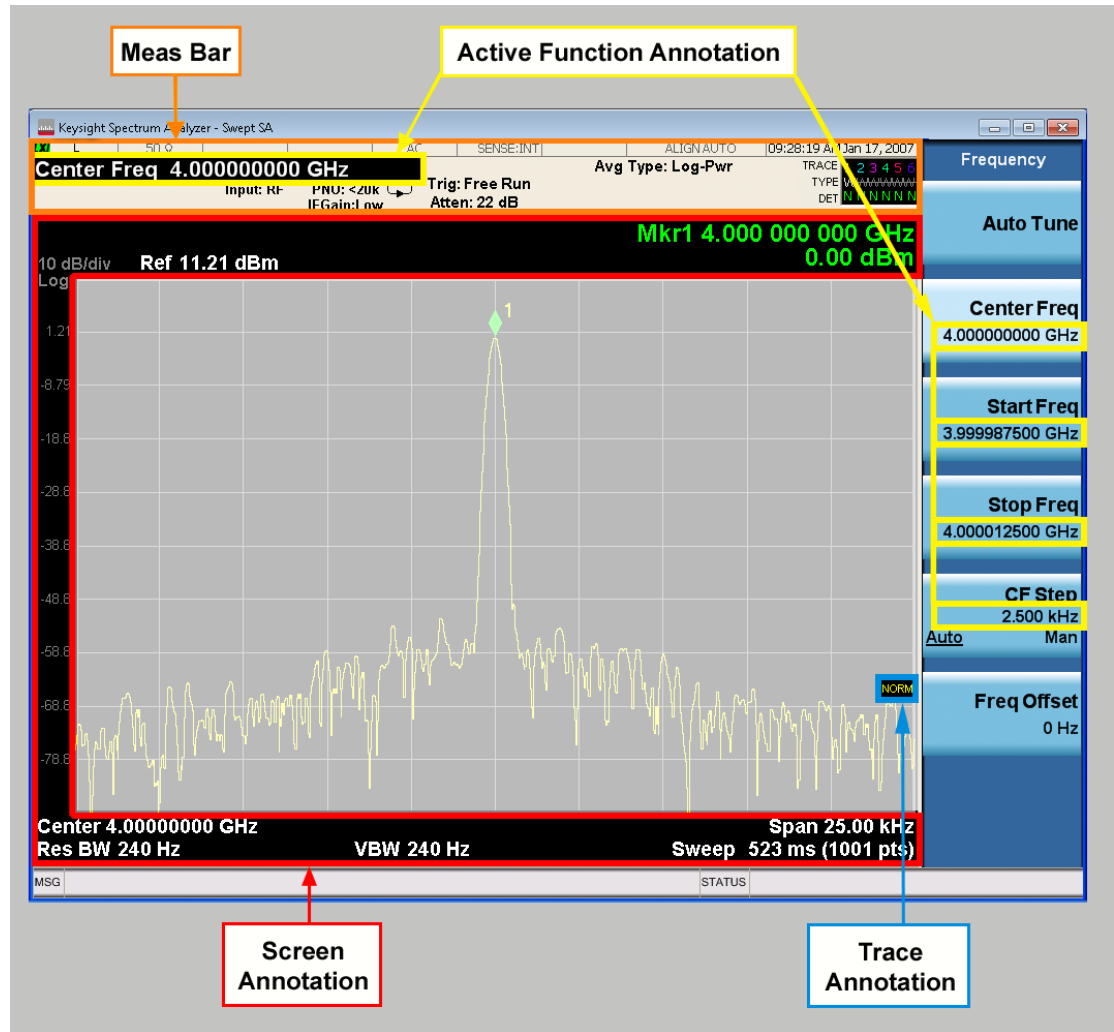

Key Path	View/Display, Display
Initial S/W Revision	Prior to A.02.00

Meas Bar On/Off

This function turns the Measurement Bar on and off, including the settings panel. When off, the graticule area expands to fill the area formerly occupied by the Measurement Bar.

Key Path	View/Display, Display, Annotation
Remote Command	:DISPlay:ANNotation:MBAR[:STATe] OFF ON 0 1 :DISPlay:ANNotation:MBAR[:STATe]?
Example	DISP:ANN:MBAR OFF
Dependencies	Grayed out and forced to OFF when System Display Settings, Annotation is set to Off.

Preset	On This should remain Off through a Preset when System DisplaySettings, Annotation is set to Off.
State Saved	Saved in instrument state.
Initial S/W Revision	Prior to A.02.00

Screen

This controls the display of the annunciation and annotation around the graticule, including any annotation on lines (such as the display line, the threshold line, etc.) and the y-axis annotation. This does NOT include marker annotation (or the N dB result). When off, the graticule expands to fill the entire graticule area, leaving only the 1.5% gap above the graticule as described in the Trace/Detector chapter.

Key Path	View/Display, Display, Annotation
Remote Command	:DISPlay:ANNotation:SCReen[:STATe] OFF ON 0 1 :DISPlay:ANNotation:SCReen[:STATe]?
Example	DISP:ANN:SCR OFF
Dependencies	Grayed-out and forced to OFF when System Display Settings, Annotation is set to Off.
Preset	On This should remain Off through a Preset when System DisplaySettings, Annotation is set to Off
State Saved	Saved in instrument state.
Initial S/W Revision	Prior to A.02.00

Trace

Turns on and off the labels on the traces, showing their detector (or their math mode) as described in the Trace/Detector section.

If trace math is being performed with a trace, then the trace math annotation will replace the detector annotation.

Key Path	View/Display, Display, Annotation
Remote Command	:DISPlay:ANNotation:TRACe[:STATe] ON OFF 1 0 :DISPlay:ANNotation:TRACe[:STATe]?
Example	DISP:ANN:TRAC OFF
Preset	Off
State Saved	Saved in instrument state.
Initial S/W Revision	Prior to A.02.00

Active Function Values On/Off

Turns on and off the active function display in the Meas Bar, and all of the active function values displayed on the softkeys.

Note that all of the softkeys that have active functions have these numeric values blanked when this function is on. This is a security feature..

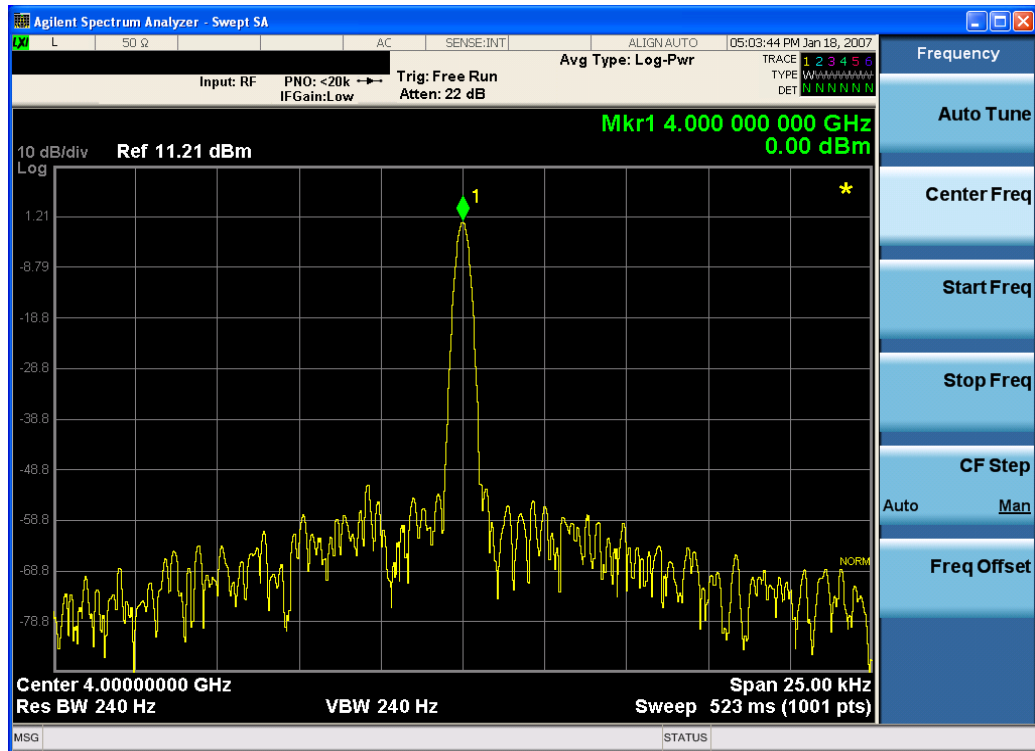

Key Path	View/Display, Display, Annotation
Remote Command	:DISPlay:ACTivefunc[:STATe] ON OFF 1 0 :DISPlay:ACTivefunc[:STATe]?
Example	DISP:ACT OFF
Dependencies	Grayed out and forced to OFF when System Display Settings, Annotation is set to Off.
Preset	On This should remain Off through a Preset when System DisplaySettings, Annotation is set to Off
State Saved	Saved in instrument state.
Initial S/W Revision	Prior to A.02.00

Title

Displays menu keys that enable you to change or clear a title on your display.

Key Path	View/Display, Display
Initial S/W Revision	Prior to A.02.00

Change Title

Writes a title into the "measurement name" field in the banner, for example, "Swept SA".

Press Change Title to enter a new title through the alpha editor. Press Enter or Return to complete the entry. Press ESC to cancel the entry and preserve your existing title.

The display title will replace the measurement name. It remains for this measurement until you press **Change Title** again, or you recall a state, or a Preset is performed. A title can also be cleared by pressing **Title, Clear Title**.

NOTE

Notice the inclusion of the <measurement> parameter in the command below. Because each measurement remembers the Display Title, the command must be qualified with the measurement name. For the Swept SA measurement this is not the case; no <measurement> parameter is used when changing the Display Title for the Swept SA measurement.

Key Path	View/Display, Display, Title
Mode	All
Remote Command	:DISPlay:<measurement>:ANNotation:TITLe:DATA <string> :DISPlay:<measurement>:ANNotation:TITLe:DATA?
Example	DISP:ANN:TITL:DATA "This Is My Title" This example is for the Swept SA measurement in the Spectrum Analyzer mode. The SANalyzer <measurement> name is not used. DISP:ACP:ANN:TITL:DATA "This Is My Title" This example is for Measurements other than Swept SA. Both set the title to: This Is My Title
Notes	Pressing this key cancels any active function. When a title is edited the previous title remains intact (it is not cleared) and the cursor goes at the end so that characters can be added or BKSP can be used to go back over previous characters.
Preset	No title (measurement name instead)
State Saved	Saved in instrument state.
Initial S/W Revision	Prior to A.02.00

Clear Title

Clears a title from the front-panel display. Once cleared, the title cannot be retrieved. After the title is cleared, the current Measurement Name replaces it in the

title bar.

Key Path	View/Display, Display, Title
Example	The following commands clear the title and restore the measurement's original title: DISP:ANN:TITL:DATA "" This example is for the Swept SA measurement in the Spectrum Analyzer mode. The SANalyzer <measurement> name is not used. DISP:ACP:ANN:TITL:DATA "" This example is for ACP; in measurements other than Swept SA the measurement name is required.
Notes	Uses the :DISPlay:<measurement>:ANNotation:TITLe:DATA <string> command with an empty string (in the Swept SA, the <measurement> is omitted).
Preset	Performed on Preset.
Initial S/W Revision	Prior to A.02.00

Graticule

Pressing Graticule turns the display graticule On or Off. It also turns the graticule y-axis annotation on and off.

Key Path	View/Display, Display
Remote Command	:DISPlay:WINDow[1]:TRACe:GRATicule:GRID[:STATe] OFF ON 0 1 :DISPlay:WINDow[1]:TRACe:GRATicule:GRID[:STATe]?
Example	DISP:WIND:TRAC:GRAT:GRID OFF
Notes	The graticule is the set of horizontal and vertical lines that make up the grid/divisions for the x-axis and y-axis.
Preset	On
State Saved	Saved in instrument state
Initial S/W Revision	Prior to A.02.00

System Display Settings

These settings are "Mode Global" – they affect all modes and measurements and are reset only by **Restore Misc Defaults** or **Restore System Defaults** under System.

Key Path	View/Display, Display
Initial S/W Revision	Prior to A.02.00

Annotation Local Settings

This is a Mode Global override of the meas local annotation settings. When it is **All Off**, it forces **ScreenAnnotation, Meas Bar, Trace, and Active Function Values** settings to be **OFF** for all measurements in all modes. This provides the security based "annotation off" function of previous analyzers; hence it uses the legacy SCPI command.

When it is **All Off**, the **Screen, Meas Bar, Trace, and Active Function Values** keys under the **Display, Annotation** menu are grayed out and forced to **Off**. When **Local Settings** is selected, you are able to set the local annotation settings on a measurement by measurement basis.

Key Path	View/Display, Display, System Display Settings
Remote Command	:DISPlay:WINDow[1]:ANNotation[:ALL] OFF ON 0 1 :DISPlay:WINDow[1]:ANNotation[:ALL]?
Example	:DISP:WIND:ANN OFF
Preset	On (Set by Restore Misc Defaults)
State Saved	Not saved in instrument state.
Backwards Compatibility Notes	The WINDow parameter and optional subopcode is included for backwards compatibility but ignored – all windows are equally affected.
Initial S/W Revision	Prior to A.02.00

Themes

Accesses a menu of functions that enable you to choose the theme to be used when saving the screen image.

The **Themes** option is the same as the **Themes** option under the **Display** and **Page Setup** dialogs. It allows you to choose between themes to be used when saving the screen image.

Key Path	Save, Screen Image
Remote Command	:MMEMory:STORe:SCReem:THEMe TDColor TDMonochrome FCOLor FMONochrome :MMEMory:STORe:SCReem:THEMe?
Example	:MMEM:STOR:SCR:THEM TDM
Preset	3D Color; Is not part of Preset, but is reset by Restore Misc Defaults or Restore System Defaults All and survives subsequent running of the modes.
Readback	3D Color 3D Mono Flat Color Flat Mono
Backwards Compatibility Notes	In ESA and PSA we offer the choice of "Reverse Bitmap" or "Reverse Metafile" when saving screen images. This is much like the "Flat Color" theme available in X-Series. Also, if you selected Reverse Bitmap AND a black & white screen image, that would be much like "Flat Monochrome". In other words, each of the X-Series themes has a similar screen image type in ESA/PSA. But they are not identical.
Initial S/W Revision	Prior to A.02.00

3D Color

Selects a standard color theme with each object filled, shaded and colored as designed.

Key Path	Save, Screen Image, Themes
Example	MMEM:STOR:SCR:THEM TDC
Readback	3D Color
Initial S/W Revision	Prior to A.02.00

3D Monochrome

Selects a format that is like 3D color but shades of gray are used instead of colors.

Key Path	Save, Screen Image, Themes
Example	MMEM:STOR:SCR:THEM TDM
Readback	3D Mono
Initial S/W Revision	Prior to A.02.00

Flat Color

Selects a format that is best when the screen is to be printed on an ink printer.

Key Path	Save, Screen Image, Themes
Example	MMEM:STOR:SCR:THEM FCOL
Readback	Flat Color
Initial S/W Revision	Prior to A.02.00

Flat Monochrome

Selects a format that is like Flat Color. But only black is used (no colors, not even gray), and no fill.

Key Path	Save, Screen Image, Themes
Example	MMEM:STOR:SCR:THEM FMON
Readback	Flat Mono
Initial S/W Revision	Prior to A.02.00

Backlight

Accesses the display backlight on/off keys. This setting may interact with settings under the Windows "Power" menu.

When the backlight is off, pressing ESC, TAB, SPACE, ENTER, UP, DOWN, LEFT, RIGHT, DEL, BKSP, CTRL, or ALT turns the backlight on without affecting the application. Pressing any other key will turn backlight on and could potentially perform the action as well.

Key Path	View/Display, Display, System Display Settings
Remote Command	:DISPlay:BACKlight ON OFF :DISPlay:BACKlight?
Preset	ON (Set by Restore Misc Defaults)
Initial S/W Revision	Prior to A.02.00

Backlight Intensity

An active function used to set the backlight intensity. It goes from 0 to 100 where 100 is full on and 0 is off. This value is independent of the values set under the Backlight on/off key.

Key Path	View/Display, Display, System Display Settings
Remote Command	:DISPlay:BACKlight:INTensity <integer> :DISPlay:BACKlight:INTensity?
Example	DISP:BACK:INT 50
Preset	100 (Set by Restore Misc Defaults)
Min	0
Max	100
Initial S/W Revision	Prior to A.02.00

View Selection

Selects the desired view. The following views are available:

- ["Graph + Metrics" on page 2550](#) – The lower window displays a list of spurs detected in a measurement cycle. The upper window displays a trace of the range that contains the currently selected spur.
- ["Range Table" on page 2551](#) – The lower window displays settings of ranges. The upper window displays a trace of the currently selected range.
- ["All Ranges" on page 2554](#) – The lower window displays a list of spurs detected in a measurement cycle. The upper window displays a merged trace of all the ranges.

Key Path	View/Display
Mode	SA, WCDMA, C2K, 1xEV-DO, WIMAX OFDMA, TD-SCDMA, DVB-T/H, LTE, LTEFDD, MSR, LTEAFDD, LTEATDD
Remote Command	:DISPlay:SPURious:VIEW[:SElect] RESult RANGE ALL :DISPlay:SPURious:VIEW[:SElect]?

Example	DISP:SPUR:VIEW RANG DISP:SPUR:VIEW?
Preset	RESult
State Saved	No
Range	Graph + Metrics Range Table All Ranges
Initial S/W Revision	A.10.00
Modified at S/W Revision	A.11.00

Graph + Metrics

Select Graph + Metrics to view measurement results.

- The lower window displays a list of spurs detected in a measurement cycle. The currently selected spur, which is highlighted, can be changed by the Spur softkey in the Meas Setup menu.
- The upper window displays a trace of the range that contains the currently selected spur.

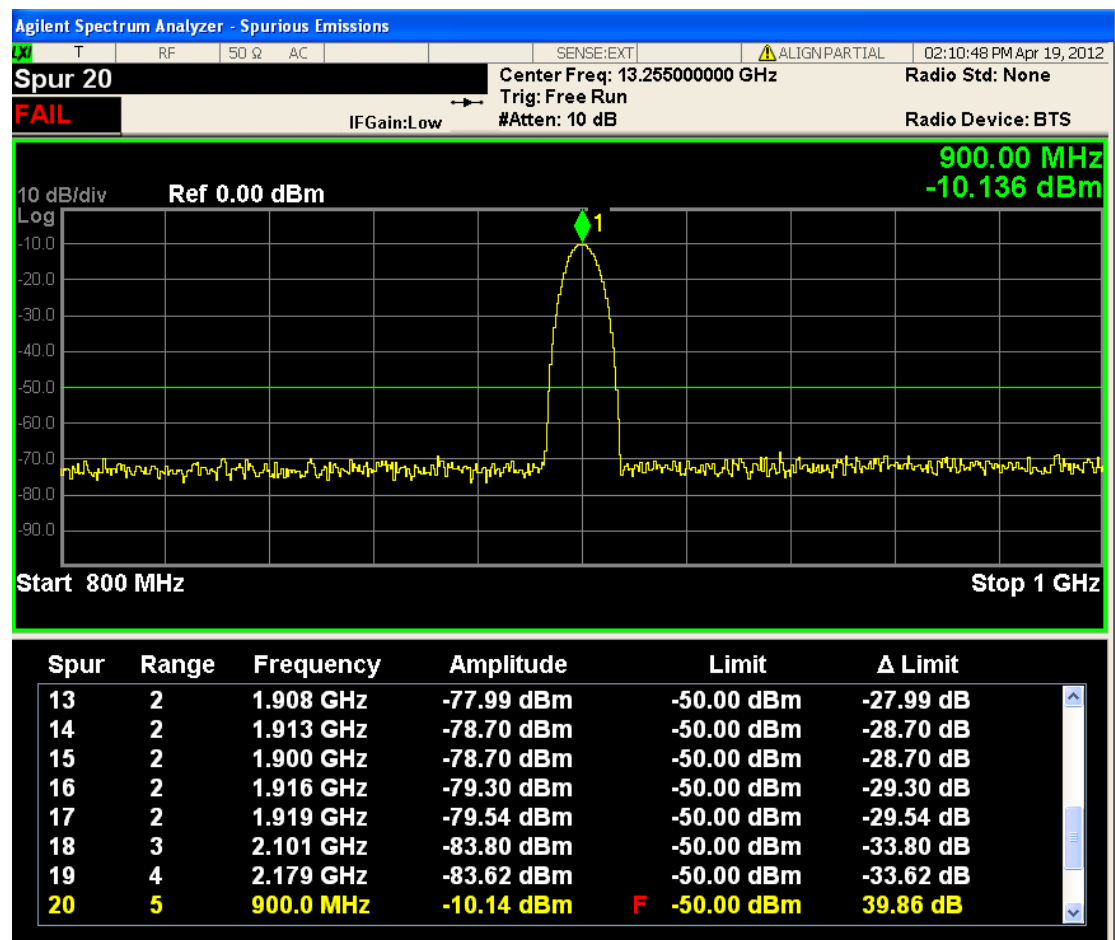

Result	Units	Min	Max
Spur	N/A	0	200
Range	N/A	1	20
Frequency	Hz	Analyzer Min	Analyzer Max
Amplitude	dBm	-150	50
Limit	dBm	-150	50

The spurs listed are within the current value of the Marker Peak Excursion setting of the absolute limit. All of the spurs listed passed. Any spur that has failed the absolute limit will have an 'F' beside it.

Range Table

Select Range Table to view range settings.

- The upper window displays a trace of the range specified by the Range key under Range Table in Meas Setup.
- The lower window displays the range setting.

All enabled range may not be displayed with the normal window arrangement. Even in that case, the instrument always displays the highlighted line in the table. When you zoom the lower window, all 20 ranges can be displayed.

When the range state is OFF, "---" appears, to indicate the range is inactive.

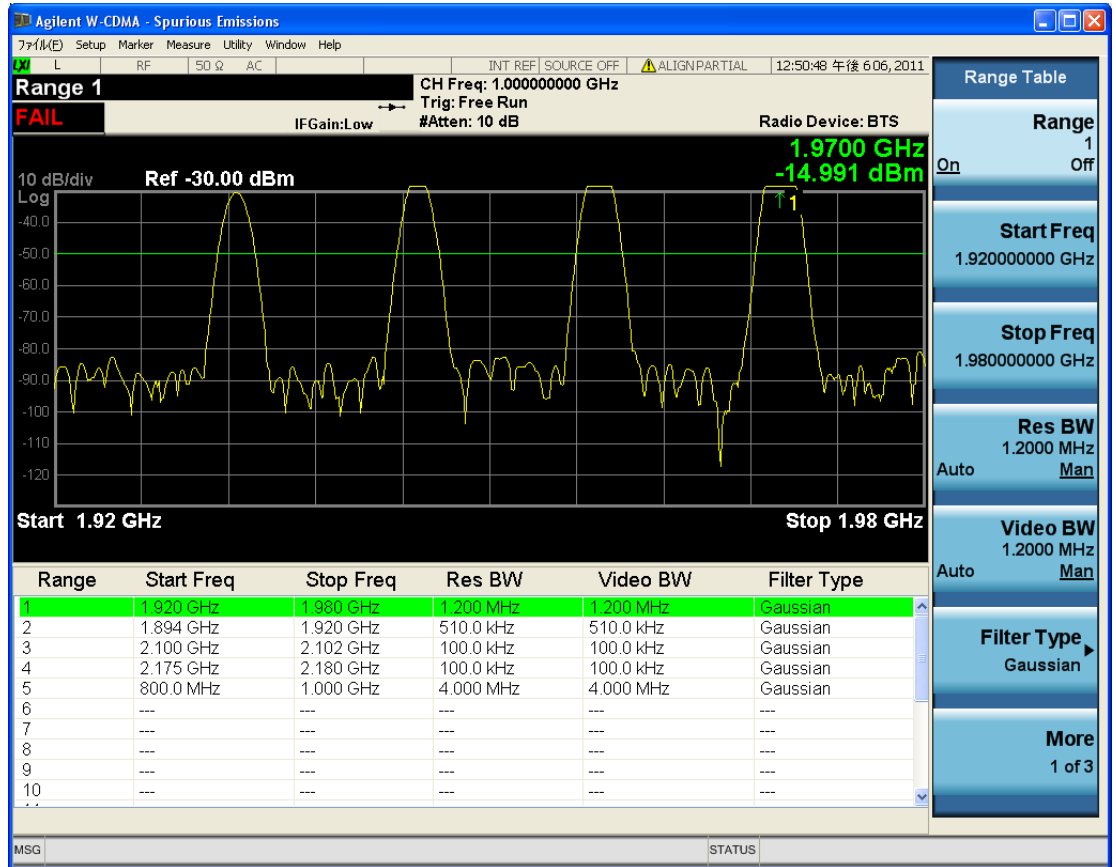

14 Spurious Emissions Measurement
View/Display

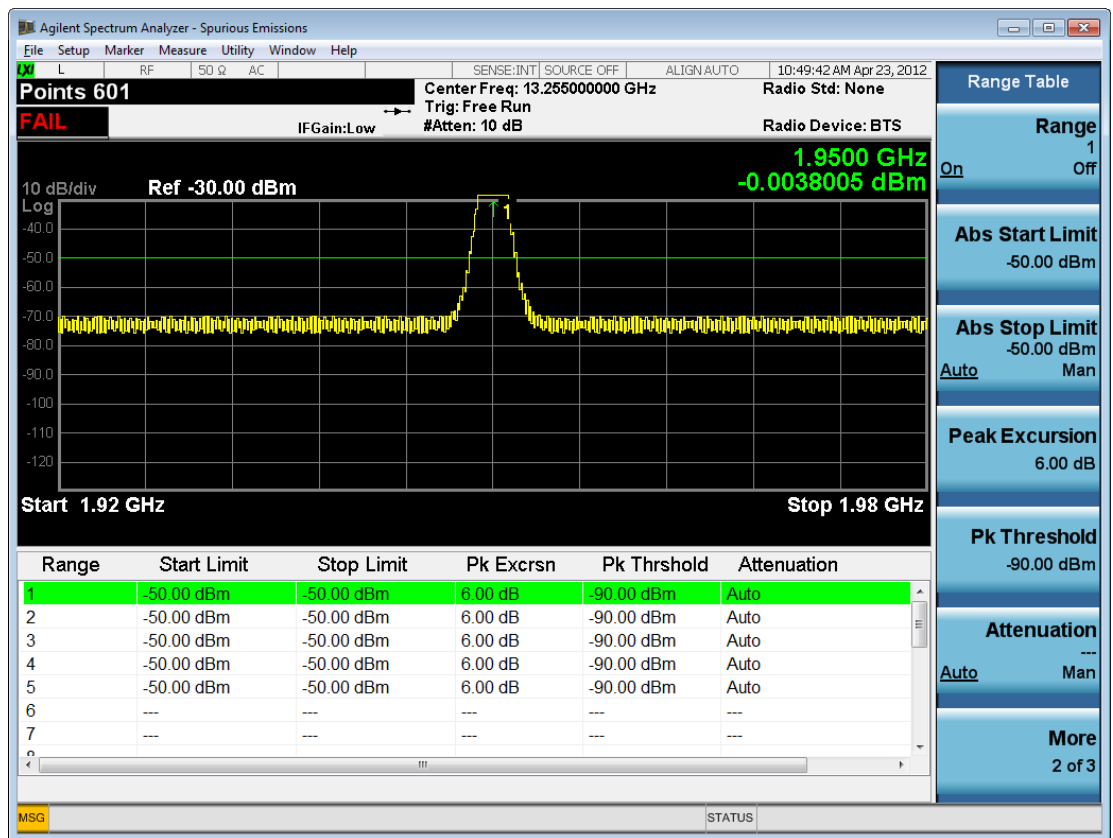

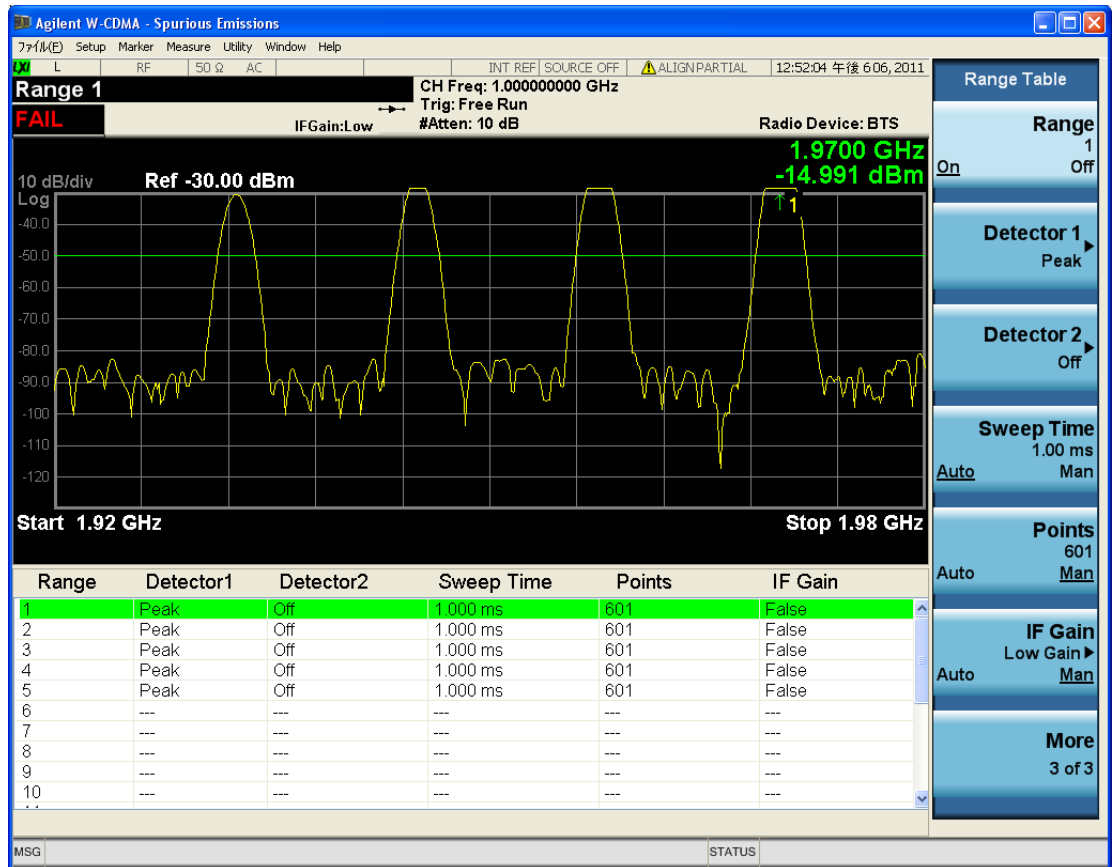

All Ranges

Select All Ranges to view measurement results for all the ranges.

- The upper window displays a merged trace of all the ranges.
- The lower window displays a list of spurs detected in a measurement cycle. The currently selected spur, which is highlighted, can be changed by the Spur softkey in the Meas Setup menu.

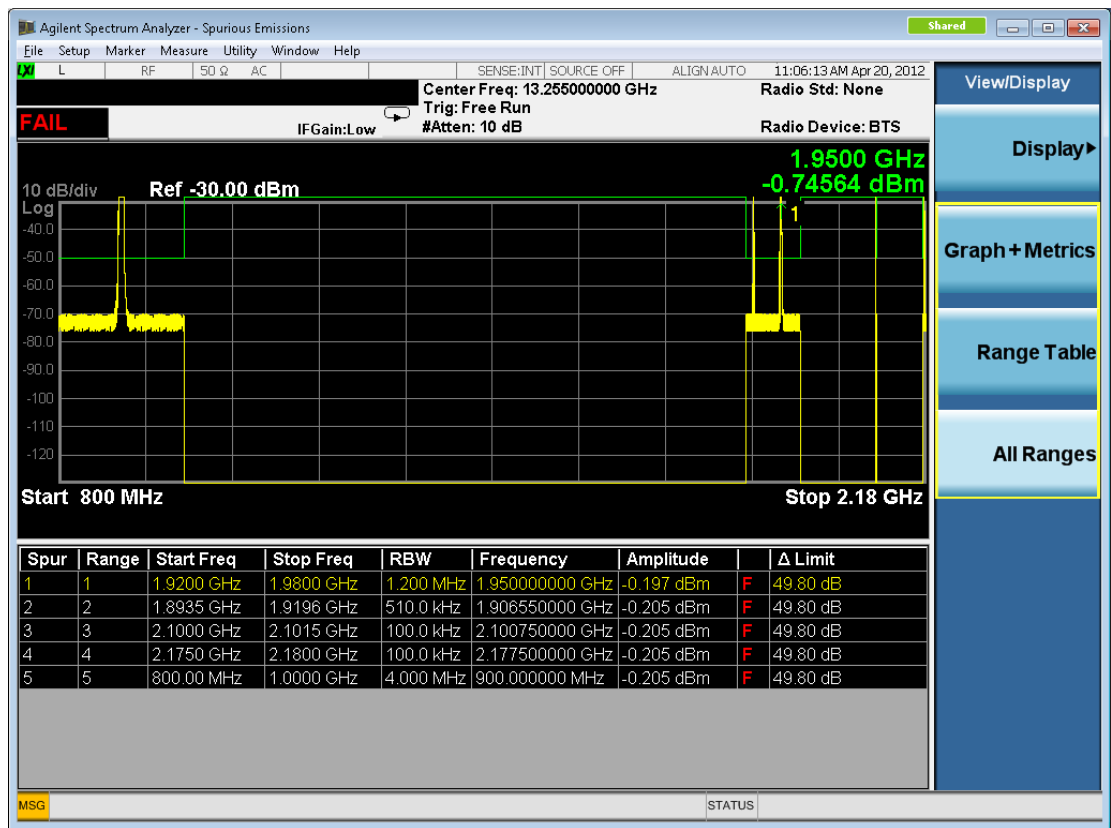

Range Table Selection (SCPI only command)

Switches contents of Range Table.

There are three tables in the Range Table window, corresponding to each page of the Range Table menu. If the Range Table menu is displayed, this command changes the page of the Range Table menu too.

Pressing the Range Table softkey always changes the current Range Table to 1.

Key Path	SCPI only
Mode	SA, WCDMA, C2K, 1xEV-DO, WIMAX OFDMA, TD-SCDMA, DVB-T/H, LTE, LTEFDD, LTEATDD, WLAN, MSR, LTEAFDD, LTEATDD
Remote Command	:DISPlay:SPURious:VIEW:RANGe:TABLE <integer> :DISPlay:SPURious:VIEW:RANGe:TABLE?
Example	DISP:SPUR:VIEW:RANG:TABL 2 DISP:SPUR:VIEW:RANG:TABL?
Preset	1
State Saved	No
Min	1
Max	3
Initial S/W Revision	A.10.00

15 Spectrum Emission Mask Measurement

The spectrum emission mask measures spurious signal levels in up to six pairs of offset frequencies and relates them to the carrier power. For measurement results and views, see ["View/Display" on page 2863](#).

This topic contains the following sections:

["Measurement Commands for Spectrum Emission Mask" on page 2557](#)

["Remote Command Results for Spectrum Emission Mask Measurement" on page 2558](#)

["Number of Offsets" on page 2579](#)

Measurement Commands for Spectrum Emission Mask

Offsets that are turned off (inactive) return -999.0 when their results are queried via SCPI.

```
:CONFigure:SEMask  
:CONFigure:SEMask:NDEFault  
:INITiate:SEMask  
:FETCh:SEMask[n]?  
:MEASure:SEMask[n]?  
:READ:SEMask[n]?
```

For more measurement related commands, see the SENSE subsystem, and the section ["Remote Measurement Functions" on page 3140](#).

Remote Command Results for Spectrum Emission Mask Measurement

The following table describes the results returned by the FETCh, MEASure, and READ queries listed above, according to the index value n:

Modes	n	Return Value
All except MSR, WLAN, LTEAFDD, LTEATDD	1	<p>Meas Type: Total Power Reference</p> <p>Returns 82 comma-separated scalar results, in the following order:</p> <ol style="list-style-type: none"> 1. Reserved for the future use, returns -999.0 2. Absolute power at the center frequency (reference) area (dBm) 3. Reserved for the future use, returns -999.0 4. Reserved for the future use, returns -999.0 5. Peak frequency in the center frequency (reference) area (Hz) 6. Reserved for the future use, returns -999.0 7. Reserved for the future use, returns -999.0 8. Reserved for the future use, returns -999.0 9. Reserved for the future use, returns -999.0 10. Reserved for the future use, returns -999.0 11. Relative integrated power on the negative offset A (dBc) 12. Absolute integrated power on the negative offset A (dBm) 13. Relative peak power on the negative offset A (dBc) 14. Absolute peak power on the negative offset A (dBm) 15. Peak power offset frequency from the center or carrier edge frequency in the negative offset A, depending on Offset Frequency Define settings (Hz) 16. Relative integrated power on the positive offset A (dBc) 17. Absolute integrated power on the positive offset A (dBm) 18. Relative peak power on the positive offset A (dBc) 19. Absolute peak power on the positive offset A (dBm) 20. Peak power offset frequency from the center or carrier edge frequency in the positive offset A, depending on Offset Frequency Define settings (Hz) 21. Relative integrated power on the negative offset B (dBc) --- 69. Absolute peak power on the positive offset F (dBm) 70. Peak power offset frequency from the center or carrier edge frequency in the positive offset F, depending on Offset Frequency Define settings (Hz) 71. Minimum margin from limit line on the negative offset A (dB) 72. Minimum margin from limit line on the positive offset A (dB) 73. Minimum margin from limit line on the negative offset B (dB) 74. Minimum margin from limit line on the positive offset B (dB) 75. Minimum margin from limit line on the negative offset C (dB) 76. Minimum margin from limit line on the positive offset C (dB)

Modes	n	Return Value
		77. Minimum margin from limit line on the negative offset D (dB) 78. Minimum margin from limit line on the positive offset D (dB) 79. Minimum margin from limit line on the negative offset E (dB) 80. Minimum margin from limit line on the positive offset E (dB) 81. Minimum margin from limit line on the negative offset F (dB) 82. Minimum margin from limit line on the positive offset F (dB)
All except MSR, WLAN, LTEAFDD, LTEATDD	1	Meas Type: Power Spectral Density Reference Returns 82 comma-separated scalar results, in the following order: 1. Reserved for the future use, returns -999.0 2. Absolute power at the center frequency (reference) area (dBm/Hz) 3. Reserved for the future use, returns -999.0 4. Reserved for the future use, returns -999.0 5. Peak frequency in the center frequency (reference) area (Hz) 6. Reserved for the future use, returns -999.0 7. Reserved for the future use, returns -999.0 8. Reserved for the future use, returns -999.0 9. Reserved for the future use, returns -999.0 10. Reserved for the future use, returns -999.0 11. Relative integrated power on the negative offset A (dB) 12. Absolute integrated power on the negative offset A (dBm/Hz) 13. Relative peak power on the negative offset A (dB) 14. Absolute peak power on the negative offset A (dBm/Hz) 15. Peak power offset frequency from the center or carrier edge frequency in the negative offset A, depending on Offset Frequency Define settings (Hz) 16. Relative integrated power on the positive offset A (dB) 17. Absolute integrated power on the positive offset A (dBm/Hz) 18. Relative peak power on the positive offset A (dB) 19. Absolute peak power on the positive offset A (dBm/Hz) 20. Peak power offset frequency from the center or carrier edge frequency in the positive offset A, depending on Offset Frequency Define settings (Hz) 21. Relative integrated power on the negative offset B (dB) --- 69. Absolute peak power on the positive offset F (dBm/Hz) 70. Peak power offset frequency from the center or carrier edge frequency in the positive offset F, depending on Offset Frequency Define settings (Hz) 71. Minimum margin from limit line on the negative offset A (dB) 72. Minimum margin from limit line on the positive offset A (dB) 73. Minimum margin from limit line on the negative offset B (dB) 74. Minimum margin from limit line on the positive offset B (dB) 75. Minimum margin from limit line on the negative offset C (dB) 76. Minimum margin from limit line on the positive offset C (dB)

Modes	n	Return Value
		77. Minimum margin from limit line on the negative offset D (dB) 78. Minimum margin from limit line on the positive offset D (dB) 79. Minimum margin from limit line on the negative offset E (dB) 80. Minimum margin from limit line on the positive offset E (dB) 81. Minimum margin from limit line on the negative offset F (dB) 82. Minimum margin from limit line on the positive offset F (dB)
All except MSR, WLAN, LTEAFDD, LTEATDD	1	Meas Type: Spectrum Peak Reference Returns 82 comma-separated scalar results, in the following order: 1. Reserved for the future use, returns -999.0 2. Peak power at the center frequency (reference) area (dBm) 3. Reserved for the future use, returns -999.0 4. Reserved for the future use, returns -999.0 5. Peak frequency in the center frequency (reference) area (Hz) 6. Reserved for the future use, returns -999.0 7. Reserved for the future use, returns -999.0 8. Reserved for the future use, returns -999.0 9. Reserved for the future use, returns -999.0 10. Reserved for the future use, returns -999.0 11. Reserved for the future use, returns -999.0 12. Reserved for the future use, returns -999.0 13. Relative peak power on the negative offset A (dB) 14. Absolute peak power on the negative offset A (dBm) 15. Peak power offset frequency from the center or carrier edge frequency in the negative offset A, depending on Offset Frequency Define settings (Hz) 16. Reserved for the future use, returns -999.0 17. Reserved for the future use, returns -999.0 18. Relative peak power on the positive offset A (dB) 19. Absolute peak power on the positive offset A (dBm) 20. Peak power offset frequency from the center or carrier edge frequency in the positive offset A, depending on Offset Frequency Define settings (Hz) 21. Reserved for the future use, returns -999.0 --- 69. Absolute peak power on the positive offset F (dBm) 70. Peak power offset frequency from the center or carrier edge frequency in the positive offset F, depending on Offset Frequency Define settings (Hz) 71. Minimum margin from limit line on the negative offset A (dB) 72. Minimum margin from limit line on the positive offset A (dB) 73. Minimum margin from limit line on the negative offset B (dB) 74. Minimum margin from limit line on the positive offset B (dB) 75. Minimum margin from limit line on the negative offset C (dB)

Modes	n	Return Value
		76. Minimum margin from limit line on the positive offset C (dB) 77. Minimum margin from limit line on the negative offset D (dB) 78. Minimum margin from limit line on the positive offset D (dB) 79. Minimum margin from limit line on the negative offset E (dB) 80. Minimum margin from limit line on the positive offset E (dB) 81. Minimum margin from limit line on the negative offset F (dB) 82. Minimum margin from limit line on the positive offset F (dB)
MSR, LTEAFDD, LTEATDD	1	Meas Type: Total Power Reference Returns outer offset results when Non-Contiguous Meas Region is set to Outer, and returns inner offset results when it is set to Inner, in the following order. <ol style="list-style-type: none"> 1. Total Absolute power of carriers of Measure Carrier On if available. Otherwise -999.0 is returned. 2. Absolute reference power. Absolute power at the left reference carrier if Power Ref type is "Left & Right Carriers." Absolute power at the reference carrier of the left sub-block if Power Ref type is "Max Power Carrier in Sub-block." (dBm) 3. Absolute power at the right reference carrier if Power Ref type is "Left & Right Carriers." Absolute power at the reference carrier of the right sub-block if Power Ref type is "Max Power Carrier in Sub-block." Otherwise -999.0 is returned. (dBm) 4. Reserved for the future use, returns -999.0 5. Peak frequency in the ref carrier channel spacing frequency range. Peak frequency in the left ref carrier frequency range if Power Ref Type is "Left & Right Carriers." Peak frequency in the ref carrier frequency range of the left sub-block if Power Ref type is "Max Power Carrier in Sub-block." 6. Peak frequency in the right ref carrier channel spacing frequency range if Power Ref type is "Left & Right Carriers." Peak frequency in the ref carrier frequency range of the right sub-block if Power Ref type is "Max Power Carrier in Sub-block." Otherwise -999.0 is returned. 7. Reserved for the future use, returns -999.0 8. Reserved for the future use, returns -999.0 9. Reserved for the future use, returns -999.0 10. Reserved for the future use, returns -999.0 11. Relative integrated power on the negative offset A (dBc) 12. Absolute integrated power on the negative offset A (dBm) 13. Relative peak power on the negative offset A (dBc) 14. Absolute peak power on the negative offset A (dBm) 15. Peak power offset frequency from the center or carrier edge frequency in the negative offset A, depending on Offset Frequency Define settings (Hz) 16. Relative integrated power on the positive offset A (dBc) 17. Absolute integrated power on the positive offset A (dBm) 18. Relative peak power on the positive offset A (dBc) 19. Absolute peak power on the positive offset A (dBm) 20. Peak power offset frequency from the center or carrier edge frequency in the

Modes	n	Return Value
		positive offset A, depending on Offset Frequency Define settings (Hz)
		21. Relative integrated power on the negative offset B (dBc)

		69. Absolute peak power on the positive offset F (dBm)
		70. Peak power offset frequency from the center or carrier edge frequency in the positive offset F, depending on Offset Frequency Define settings (Hz)
		71. Minimum margin from limit line on the negative offset A (dB)
		72. Minimum margin from limit line on the positive offset A (dB)
		73. Minimum margin from limit line on the negative offset B (dB)
		74. Minimum margin from limit line on the positive offset B (dB)
		75. Minimum margin from limit line on the negative offset C (dB)
		76. Minimum margin from limit line on the positive offset C (dB)
		77. Minimum margin from limit line on the negative offset D (dB)
		78. Minimum margin from limit line on the positive offset D (dB)
		79. Minimum margin from limit line on the negative offset E (dB)
		80. Minimum margin from limit line on the positive offset E (dB)
		81. Minimum margin from limit line on the negative offset F (dB)
		82. Minimum margin from limit line on the positive offset F (dB)
MSR, LTEAFDD, LTEATDD	1	<p>Meas Type: Power Spectral Density Reference Returns outer offset results when Non-Contiguous Meas Region is set to Outer, and returns inner offset results when it is set to Inner, in the following order.</p> <ol style="list-style-type: none"> 1. Total Absolute power of carriers of Measure Carrier On if available. Otherwise -999.0 is returned. (dBm) 2. Absolute reference power. Absolute power at the left reference carrier if Power Ref type is "Left & Right Carriers." Absolute power at the reference carrier of the left sub-block if Power Ref type is "Max Power Carrier in Sub-block." (dBm/Hz) 3. Absolute power at the right reference carrier if Power Ref type is "Left & Right Carriers." Absolute power at the reference carrier of the right sub-block if Power Ref type is "Max Power Carrier in Sub-block." Otherwise -999.0 is returned. (dBm/Hz) 4. Reserved for the future use, returns -999.0 5. Peak frequency in the ref carrier channel spacing frequency range . Peak frequency in the left ref carrier frequency range if Power Ref type is "Left & Right Carriers." Peak frequency in the ref carrier frequency range of the left sub-block if Power Ref type is "Max Power Carrier in Sub-block." 6. Peak frequency in the right ref carrier channel spacing frequency range if Power Ref type is "Left & Right Carriers." Peak frequency in the ref carrier frequency range of the right sub-block if Power Ref type is "Max Power Carrier in Sub-block." Otherwise -999.0 is returned. 7. Reserved for the future use, returns -999.0 8. Reserved for the future use, returns -999.0 9. Reserved for the future use, returns -999.0

Modes	n	Return Value
		10. Reserved for the future use, returns -999.0
		11. Relative integrated power on the negative offset A (dBc)
		12. Absolute integrated power on the negative offset A (dBm/Hz)
		13. Relative peak power on the negative offset A (dBc)
		14. Absolute peak power on the negative offset A (dBm/Hz)
		15. Peak power offset frequency from the center or carrier edge frequency in the negative offset A, depending on Offset Frequency Define settings (Hz)
		16. Relative integrated power on the positive offset A (dBc)
		17. Absolute integrated power on the positive offset A (dBm/Hz)
		18. Relative peak power on the positive offset A (dBc)
		19. Absolute peak power on the positive offset A (dBm/Hz)
		20. Peak power offset frequency from the center or carrier edge frequency in the positive offset A, depending on Offset Frequency Define settings (Hz)
		21. Relative integrated power on the negative offset B (dBc)

		69. Absolute peak power on the positive offset F (dBm/Hz)
		70. Peak power offset frequency from the center or carrier edge frequency in the positive offset F, depending on Offset Frequency Define settings (Hz)
		71. Minimum margin from limit line on the negative offset A (dB)
		72. Minimum margin from limit line on the positive offset A (dB)
		73. Minimum margin from limit line on the negative offset B (dB)
		74. Minimum margin from limit line on the positive offset B (dB)
		75. Minimum margin from limit line on the negative offset C (dB)
		76. Minimum margin from limit line on the positive offset C (dB)
		77. Minimum margin from limit line on the negative offset D (dB)
		78. Minimum margin from limit line on the positive offset D (dB)
		79. Minimum margin from limit line on the negative offset E (dB)
		80. Minimum margin from limit line on the positive offset E (dB)
		81. Minimum margin from limit line on the negative offset F (dB)
		82. Minimum margin from limit line on the positive offset F (dB)
MSR, LTEAFDD, LTEATDD	1	<p>Meas Type: Spectrum Peak Reference</p> <p>Returns outer offset results when Non-Contiguous Meas Region is set to Outer, and returns inner offset results when it is set to Inner, in the following order.</p> <ol style="list-style-type: none"> 1. Total Absolute power of carriers of Measure Carrier On if available. Otherwise -999.0 is returned. (dBm) 2. Peak reference power. Peak power at the left reference carrier if Power Ref type is "Left & Right Carriers." Peak power at the reference carrier of the left sub-block if Power Ref type is "Max Power Carrier in Sub-block." (dBm) 3. Peak power at the right reference carrier if Power Ref type is "Left & Right Carriers." Peak power at the reference carrier of the right sub-block if Power Ref type is "Max Power Carrier in Sub-block." Otherwise -999.0 is returned. (dBm) 4. Reserved for the future use, returns -999.0

Modes	n	Return Value
		5. Peak frequency in the ref carrier channel spacing frequency range. Peak frequency in the left ref carrier frequency range if Power Ref type is "Left & Right Carriers." Peak frequency in the ref carrier frequency range of the left sub-block if Power Ref type is "Max Power Carrier in Sub-block."
		6. Peak frequency in the right ref carrier channel spacing frequency range if Power Ref type is "Left & Right Carriers." Peak frequency in the ref carrier frequency range of the right sub-block if Power Ref type is "Max Power Carrier in Sub-block." Otherwise -999.0 is returned.
		7. Reserved for the future use, returns -999.0
		8. Reserved for the future use, returns -999.0
		9. Reserved for the future use, returns -999.0
		10. Reserved for the future use, returns -999.0
		11. Relative integrated power on the negative offset A (dBc)
		12. Absolute integrated power on the negative offset A (dBm)
		13. Relative peak power on the negative offset A (dBc)
		14. Absolute peak power on the negative offset A (dBm)
		15. Peak power offset frequency from the center or carrier edge frequency in the negative offset A, depending on Offset Frequency Define settings (Hz)
		16. Relative integrated power on the positive offset A (dBc)
		17. Absolute integrated power on the positive offset A (dBm)
		18. Relative peak power on the positive offset A (dBc)
		19. Absolute peak power on the positive offset A (dBm)
		20. Peak power offset frequency from the center or carrier edge frequency in the positive offset A, depending on Offset Frequency Define settings (Hz)
		21. Relative integrated power on the negative offset B (dBc)

		69. Absolute peak power on the positive offset F (dBm)
		70. Peak power offset frequency from the center or carrier edge frequency in the positive offset F, depending on Offset Frequency Define settings (Hz)
		71. Minimum margin from limit line on the negative offset A (dB)
		72. Minimum margin from limit line on the positive offset A (dB)
		73. Minimum margin from limit line on the negative offset B (dB)
		74. Minimum margin from limit line on the positive offset B (dB)
		75. Minimum margin from limit line on the negative offset C (dB)
		76. Minimum margin from limit line on the positive offset C (dB)
		77. Minimum margin from limit line on the negative offset D (dB)
		78. Minimum margin from limit line on the positive offset D (dB)
		79. Minimum margin from limit line on the negative offset E (dB)
		80. Minimum margin from limit line on the positive offset E (dB)
		81. Minimum margin from limit line on the negative offset F (dB)
		82. Minimum margin from limit line on the positive offset F (dB)

Modes	n	Return Value
WLAN, with radio standard 802.11 ac (80 MHz + 80 MHz)	1	<p>Meas Type: Total Power Reference Returns 82 comma-separated scalar results, in the following order:</p> <ol style="list-style-type: none"> 1. Reserved for the future use, returns -999.0 2. Absolute reference power (dBm) 3. Absolute power of the carrier of which the frequency is indicated by Freq Segment 1 (dBm) 4. Absolute power of the carrier of which the frequency is indicated by Freq Segment 2 (dBm) 5. Peak frequency in the center frequency (reference) area (Hz) 6. Reserved for the future use, returns -999.0 7. Reserved for the future use, returns -999.0 8. Reserved for the future use, returns -999.0 9. Reserved for the future use, returns -999.0 10. Reserved for the future use, returns -999.0 11. Relative integrated power on the negative offset A (dBc) 12. Absolute integrated power on the negative offset A (dBm) 13. Relative peak power on the negative offset A (dBc) 14. Absolute peak power on the negative offset A (dBm) 15. Peak power offset frequency from the center or carrier edge frequency in the negative offset A, depending on Offset Frequency Define settings (Hz) 16. Relative integrated power on the positive offset A (dBc) 17. Absolute integrated power on the positive offset A (dBm) 18. Relative peak power on the positive offset A (dBc) 19. Absolute peak power on the positive offset A (dBm) 20. Peak power offset frequency from the center or carrier edge frequency in the positive offset A, depending on Offset Frequency Define settings (Hz) 21. Relative integrated power on the negative offset B (dBc) <p>---</p> <ol style="list-style-type: none"> 69. Absolute peak power on the positive offset F (dBm) 70. Peak power offset frequency from the center or carrier edge frequency in the positive offset F, depending on Offset Frequency Define settings (Hz) 71. Minimum margin from limit line on the negative offset A (dB) 72. Minimum margin from limit line on the positive offset A (dB) 73. Minimum margin from limit line on the negative offset B (dB) 74. Minimum margin from limit line on the positive offset B (dB) 75. Minimum margin from limit line on the negative offset C (dB) 76. Minimum margin from limit line on the positive offset C (dB) 77. Minimum margin from limit line on the negative offset D (dB) 78. Minimum margin from limit line on the positive offset D (dB) 79. Minimum margin from limit line on the negative offset E (dB) 80. Minimum margin from limit line on the positive offset E (dB)

Modes	n	Return Value
		81. Minimum margin from limit line on the negative offset F (dB) 82. Minimum margin from limit line on the positive offset F (dB)
WLAN, with radio standard 802.11 ac (80 MHz + 80 MHz)	1	<p>Meas Type: Power Spectral Density Reference Returns 82 comma-separated scalar results, in the following order:</p> <ol style="list-style-type: none"> 1. Reserved for the future use, returns -999.0 2. Absolute reference power (dBm/Hz) 3. Absolute power of the carrier of which the frequency is indicated by Freq Segment 1 (dBm/Hz) 4. Absolute power of the carrier of which the frequency is indicated by Freq Segment 2 (dBm/Hz) 5. Peak frequency in the center frequency (reference) area (Hz) 6. Reserved for the future use, returns -999.0 7. Reserved for the future use, returns -999.0 8. Reserved for the future use, returns -999.0 9. Reserved for the future use, returns -999.0 10. Reserved for the future use, returns -999.0 11. Relative integrated power on the negative offset A (dB) 12. Absolute integrated power on the negative offset A (dBm/Hz) 13. Relative peak power on the negative offset A (dB) 14. Absolute peak power on the negative offset A (dBm/Hz) 15. Peak power offset frequency from the center or carrier edge frequency in the negative offset A, depending on Offset Frequency Define settings (Hz) 16. Relative integrated power on the positive offset A (dB) 17. Absolute integrated power on the positive offset A (dBm/Hz) 18. Relative peak power on the positive offset A (dB) 19. Absolute peak power on the positive offset A (dBm/Hz) 20. Peak power offset frequency from the center or carrier edge frequency in the positive offset A, depending on Offset Frequency Define settings (Hz) 21. Relative integrated power on the negative offset B (dB) --- 69. Absolute peak power on the positive offset F (dBm/Hz) 70. Peak power offset frequency from the center or carrier edge frequency in the positive offset F, depending on Offset Frequency Define settings (Hz) 71. Minimum margin from limit line on the negative offset A (dB) 72. Minimum margin from limit line on the positive offset A (dB) 73. Minimum margin from limit line on the negative offset B (dB) 74. Minimum margin from limit line on the positive offset B (dB) 75. Minimum margin from limit line on the negative offset C (dB) 76. Minimum margin from limit line on the positive offset C (dB) 77. Minimum margin from limit line on the negative offset D (dB) 78. Minimum margin from limit line on the positive offset D (dB)

Modes	n	Return Value
		79. Minimum margin from limit line on the negative offset E (dB)
		80. Minimum margin from limit line on the positive offset E (dB)
		81. Minimum margin from limit line on the negative offset F (dB)
		82. Minimum margin from limit line on the positive offset F (dB)
WLAN, with radio standard 802.11 ac (80 MHz + 80 MHz)	1	<p>Meas Type: Spectrum Peak Reference</p> <p>Returns 82 comma-separated scalar results, in the following order:</p> <ol style="list-style-type: none"> 1. Reserved for the future use, returns -999.0 2. Peak power (dBm) 3. Peak power of the carrier of which the frequency is indicated by Freq Segment 1 (dBm/Hz) 4. Peak power of the carrier of which the frequency is indicated by Freq Segment 2 (dBm/Hz) 5. Peak frequency in the center frequency (reference) area (Hz) 6. Reserved for the future use, returns -999.0 7. Reserved for the future use, returns -999.0 8. Reserved for the future use, returns -999.0 9. Reserved for the future use, returns -999.0 10. Reserved for the future use, returns -999.0 11. Reserved for the future use, returns -999.0 12. Reserved for the future use, returns -999.0 13. Relative peak power on the negative offset A (dB) 14. Absolute peak power on the negative offset A (dBm) 15. Peak power offset frequency from the center or carrier edge frequency in the negative offset A, depending on Offset Frequency Define settings (Hz) 16. Reserved for the future use, returns -999.0 17. Reserved for the future use, returns -999.0 18. Relative peak power on the positive offset A (dB) 19. Absolute peak power on the positive offset A (dBm) 20. Peak power offset frequency from the center or carrier edge frequency in the positive offset A, depending on Offset Frequency Define settings (Hz) 21. Reserved for the future use, returns -999.0 <p>---</p> <ol style="list-style-type: none"> 69. Absolute peak power on the positive offset F (dBm) 70. Peak power offset frequency from the center or carrier edge frequency in the positive offset F, depending on Offset Frequency Define settings (Hz) 71. Minimum margin from limit line on the negative offset A (dB) 72. Minimum margin from limit line on the positive offset A (dB) 73. Minimum margin from limit line on the negative offset B (dB) 74. Minimum margin from limit line on the positive offset B (dB) 75. Minimum margin from limit line on the negative offset C (dB) 76. Minimum margin from limit line on the positive offset C (dB)

Modes	n	Return Value
		77. Minimum margin from limit line on the negative offset D (dB) 78. Minimum margin from limit line on the positive offset D (dB) 79. Minimum margin from limit line on the negative offset E (dB) 80. Minimum margin from limit line on the positive offset E (dB) 81. Minimum margin from limit line on the negative offset F (dB) 82. Minimum margin from limit line on the positive offset F (dB)
All	2	Returns the displayed frequency domain spectrum trace data separated by comma. The number of data points is 2001.
All	3	Returns the displayed frequency domain absolute limit trace data separated by comma. The number of data points is 2001.
All	4	Returns the displayed frequency domain relative limit trace data separated by comma. The number of data points is 2001.
All (see details)	5	<p>Meas Type: Total Power Reference Returns comma-separated scalar values (in dBm) of the absolute integrated power of the segment frequencies. The length of the result depends on the number of available offset (See "Number of Offsets" on page 2579).</p> <ol style="list-style-type: none"> Total power reference (dBm) Reserved for the future use, returns -999.0 Absolute integrated power at negative offset frequency (A) Absolute integrated power at positive offset frequency (A) <p>---</p> <ol style="list-style-type: none"> Absolute integrated power at negative offset frequency (L) Absolute integrated power at positive offset frequency (L) <p>In MSR and LTE-Advanced FDD/TDD mode. Returns outer offset results when Non-Contiguous Meas Region is set to Outer, and returns inner offset results when it is set to Inner, in the following order.</p> <ol style="list-style-type: none"> Ref carrier power. Left ref carrier power if Power Ref type is "Left & Right Carriers." Ref carrier power of the left sub-block if Power Ref type is "Max Power Carrier in Sub-block." (dBm) Right ref carrier power if Ref channel type is "Left & Right Carriers." Ref carrier power of the right sub-block if Power Ref type is "Max Power Carrier in Sub-block." Otherwise -999.0 is returned. (dBm) Absolute integrated power at negative offset frequency (A) Absolute integrated power at positive offset frequency (A) <p>---</p> <ol style="list-style-type: none"> Absolute integrated power at negative offset frequency (L) Absolute integrated power at positive offset frequency (L) <p>In WLAN 802.11ac 80 + 80 MHz: Returns 26 comma-separated scalar values (in dBm) of the absolute integrated power of the segment frequencies:</p> <ol style="list-style-type: none"> Ref carrier power (dBm) Reserved for the future use, returns -999.0

Modes	n	Return Value
		<p>3. Absolute integrated power at negative offset frequency (A)</p> <p>4. Absolute integrated power at positive offset frequency (A)</p> <p>---</p> <p>25. Absolute integrated power at negative offset frequency (L)</p> <p>26. Absolute integrated power at positive offset frequency (L)</p> <p>If the result is not available, -999.0 is returned.</p> <p>The number of values returned is subject to change in future releases.</p>
All (see details)	5	<p>Meas Type: Power Spectral Density Reference</p> <p>Returns comma-separated scalar values (in dBm/Hz) of the absolute integrated power of the segment frequencies. The length of the result depends on the number of available offset (See "Number of Offsets" on page 2579).</p> <p>1. Power spectral density reference (dBm/Hz)</p> <p>2. Reserved for the future use, returns -999.0</p> <p>3. Absolute integrated power at negative offset frequency (A)</p> <p>4. Absolute integrated power at positive offset frequency (A)</p> <p>---</p> <p>25. Absolute integrated power at negative offset frequency (L)</p> <p>26. Absolute integrated power at positive offset frequency (L)</p> <p>In MSR and LTE-Advanced FDD/TDD mode.</p> <p>Returns outer offset results when Non-Contiguous Meas Region is set to Outer, and returns inner offset results when it is set to Inner, in the following order.</p> <p>1. Ref carrier power. Left ref carrier power if Power Ref type is "Left & Right Carriers" Ref carrier power of the left sub-block if Power Ref type is "Max Power Carrier in Sub-block." (dBm/Hz)</p> <p>2. Right ref carrier power if Power Ref type is "Left & Right Carriers." Ref carrier power of the right sub-block if Power Ref type is "Max Power Carrier in Sub-block." Otherwise -999.0 is returned. (dBm/Hz)</p> <p>3. Absolute integrated power at negative offset frequency (A)</p> <p>4. Absolute integrated power at positive offset frequency (A)</p> <p>---</p> <p>25. Absolute integrated power at negative offset frequency (L)</p> <p>26. Absolute integrated power at positive offset frequency (L)</p> <p>In WLAN 802.11ac 80+80 MHz :</p> <p>Returns 26 comma-separated scalar values (in dBm/Hz) of the absolute integrated power of the segment frequencies:</p> <p>1. Ref carrier power (dBm/Hz)</p> <p>2. Reserved for the future use, returns -999.0</p> <p>3. Absolute integrated power at negative offset frequency (A)</p> <p>4. Absolute integrated power at positive offset frequency (A)</p> <p>---</p> <p>25. Absolute integrated power at negative offset frequency (L)</p> <p>26. Absolute integrated power at positive offset frequency (L)</p>

Modes	n	Return Value
All (see details)	5	<p>If the result is not available, -999.0 is returned.</p> <p>The number of values returned is subject to change in future releases.</p> <hr/> <p>Meas Type: Spectrum Peak Reference Returns comma-separated scalar values (in dBm) of the absolute peak power of the segment frequencies. The length of the result depends on the number of available offset (See "Number of Offsets" on page 2579).</p> <ol style="list-style-type: none"> 1. Spectrum Peak Power reference (dBm) 2. Reserved for the future use, returns -999.0 3. Absolute peak power at negative offset frequency (A) 4. Absolute peak power at positive offset frequency (A) <p>---</p> <ol style="list-style-type: none"> 25. Absolute peak power at negative offset frequency (L) 26. Absolute peak power at positive offset frequency (L) <p>In MSR and LTE-Advanced FDD/TDD mode. Returns outer offset results when Non-Contiguous Meas Region is set to Outer, and returns inner offset results when it is set to Inner, in the following order.</p> <ol style="list-style-type: none"> 1. Spectrum Peak Power reference of ref carrier. Spectrum Peak Power reference of left ref carrier if Power Ref type is "Left & Right Carriers." Spectrum Peak Power reference of the left sub-block if Power Ref type is "Max Power Carrier in Sub-block." (dBm) 2. Spectrum Peak Power reference of right ref carrier power if Power Ref type is "Left & Right carriers." Spectrum Peak Power reference of the right sub-block if Power Ref type is "Max Power Carrier in Sub-block." Otherwise -999.0 is returned. (dBm) 3. Absolute peak power at negative offset frequency (A) 4. Absolute peak power at positive offset frequency (A) <p>---</p> <ol style="list-style-type: none"> 25. Absolute peak power at negative offset frequency (L) 26. Absolute peak power at positive offset frequency (L) <p>If the result is not available, -999.0 is returned.</p> <p>The number of values returned is subject to change in future releases.</p> <hr/>
All	6	<p>Meas Type: Total Power Reference Returns comma-separated scalar values (in dBc) of the integrated power relative to the carrier at the segment frequencies. The length of the result depends on the number of available offset (See "Number of Offsets" on page 2579).</p> <p>When in the MSR and LTE-Advanced FDD/TDD mode, returns outer offset results when Non-Contiguous Meas Region is set to Outer, and returns inner offset results when it is set to Inner, in the following order.</p> <ol style="list-style-type: none"> 1. Reserved for the future use, returns -999.0 2. Reserved for the future use, returns -999.0 3. Relative integrated power at negative offset frequency (A) 4. Relative integrated power at positive offset frequency (A) <hr/>

Modes	n	Return Value
		<p>---</p> <p>25. Relative integrated power at negative offset frequency (L)</p> <p>26. Relative integrated power at positive offset frequency (L)</p> <p>If the result is not available, -999.0 is returned.</p> <p>The number of values returned is subject to change in future releases.</p>
All	6	<p>Meas Type: Power Spectral Density Reference</p> <p>Returns comma-separated scalar values (in dBc/Hz) of the integrated power relative to the carrier at the segment frequencies. The length of the result depends on the number of available offset (See "Number of Offsets" on page 2579).</p> <p>When in the MSR and LTE-Advanced FDD/TDD mode, returns outer offset results when Non-Contiguous Meas Region is set to Outer, and returns inner offset results when it is set to Inner, in the following order.</p> <ol style="list-style-type: none"> 1. Reserved for the future use, returns -999.0 2. Reserved for the future use, returns -999.0 3. Relative integrated power at negative offset frequency (A) 4. Relative integrated power at positive offset frequency (A) <p>---</p> <p>25. Relative integrated power at negative offset frequency (L)</p> <p>26. Relative integrated power at positive offset frequency (L)</p> <p>If the result is not available, -999.0 is returned.</p> <p>The number of values returned is subject to change in future releases.</p>
All	6	<p>Meas Type: Spectrum Peak Reference</p> <p>Returns comma-separated scalar values (in dB) of the integrated power relative to the carrier at the segment frequencies. The length of the result depends on the number of available offset (See "Number of Offsets" on page 2579).</p> <p>When in the MSR and LTE-Advanced FDD/TDD mode, returns outer offset results when Non-Contiguous Meas Region is set to Outer, and returns inner offset results when it is set to Inner, in the following order.</p> <ol style="list-style-type: none"> 1. Reserved for the future use, returns -999.0 2. Reserved for the future use, returns -999.0 3. Relative peak power at negative offset frequency (A) 4. Relative peak power at positive offset frequency (A) <p>---</p> <p>25. Relative peak power at negative offset frequency (L)</p> <p>26. Relative peak power at positive offset frequency (L)</p> <p>If the result is not available, -999.0 is returned.</p> <p>The number of values returned is subject to change in future releases.</p>
All	7	<p>Returns comma-separated pass/fail test results (0=passed, or 1=failed) determined by testing the minimum margin point from the limit line that is determined each offset's Limits setting. The length of the result depends on the number of available offset (See "Number of Offsets" on page 2579).</p>

Modes	n	Return Value
		<p>When in the MSR and LTE-Advanced FDD/TDD mode, returns outer offset results when Non-Contiguous Meas Region is set to Outer, and returns inner offset results when it is set to Inner, in the following order.</p> <ol style="list-style-type: none"> 1. Reserved for the future use, returns -999.0 2. Reserved for the future use, returns -999.0 3. At negative offset frequency (A) 4. At positive offset frequency (A) --- 25. At negative offset frequency (L) 26. At positive offset frequency (L) <p>The number of values returned is subject to change in future releases.</p>
All	8	<p>Offset Pass/Fail.</p> <p>Returns comma-separated pass/fail test results (0=passed, or 1=failed) determined by testing the minimum margin point from the limit line that is determined each offset's Limits setting. The length of the result depends on the number of available offset (See "Number of Offsets" on page 2579).</p> <p>When in the MSR and LTE-Advanced FDD/TDD mode, returns outer offset results when Non-Contiguous Meas Region is set to Outer, and returns inner offset results when it is set to Inner, in the following order.</p> <p>NOTE These results (n=8) are the same as n=7 result.</p> <ol style="list-style-type: none"> 1. Reserved for the future use, returns -999.0 2. Reserved for the future use, returns -999.0 3. At negative offset frequency (A) 4. At positive offset frequency (A) --- 25. At negative offset frequency (L) 26. At positive offset frequency (L) <p>The number of values returned is subject to change in future releases.</p>
All	9	<p>Offset Peak Power Freq.</p> <p>Returns comma-separated scalar values of frequency (in Hz) that have peak power from center or carrier edge frequency in each offset, depending on Offset Frequency Define settings. The length of the result depends on the number of available offset (See "Number of Offsets" on page 2579).</p> <p>When in the MSR and LTE-Advanced FDD/TDD mode, returns outer offset results when Non-Contiguous Meas Region is set to Outer, and returns inner offset results when it is set to Inner, in the following order.</p> <ol style="list-style-type: none"> 1. Reserved for the future use, returns -999.0 2. Reserved for the future use, returns -999.0 3. Negative offset frequency (A) 4. Positive offset frequency (A)

Modes	n	Return Value
		<p>---</p> <p>25. Negative offset frequency (L)</p> <p>26. Positive offset frequency (L)</p> <p>If the result is not available, -999.0 is returned.</p> <p>The number of values returned is subject to change in future releases.</p>
All	10	<p>Offset Abs Peak Power.</p> <p>Returns comma-separated scalar values (in dBm) of the absolute peak power of the segment frequencies. The length of the result depends on the number of available offset (See "Number of Offsets" on page 2579).</p> <p>When in the MSR and LTE-Advanced FDD/TDD mode, returns outer offset results when Non-Contiguous Meas Region is set to Outer, and returns inner offset results when it is set to Inner, in the following order.</p> <ol style="list-style-type: none"> 1. Reserved for the future use, returns -999.0 2. Reserved for the future use, returns -999.0 3. At negative offset frequency (A) 4. At positive offset frequency (A) <p>---</p> <p>25. At negative offset frequency (L)</p> <p>26. At positive offset frequency (L)</p> <p>If the result is not available, -999.0 is returned.</p> <p>The number of values returned is subject to change in future releases.</p>
All	11	<p>Offset Rel Peak Power.</p> <p>Returns comma-separated scalar values in dBc (dB if MeasType = PSD) of the peak power relative to the carrier at the segment frequencies. The length of the result depends on the number of available offset (See "Number of Offsets" on page 2579).</p> <p>When in the MSR and LTE-Advanced FDD/TDD mode, returns outer offset results when Non-Contiguous Meas Region is set to Outer, and returns inner offset results when it is set to Inner, in the following order.</p> <ol style="list-style-type: none"> 1. Reserved for the future use, returns -999.0 2. Reserved for the future use, returns -999.0 3. At negative offset frequency (A) 4. At positive offset frequency (A) <p>---</p> <p>25. At negative offset frequency (L)</p> <p>26. At positive offset frequency (L)</p> <p>If the result is not available, -999.0 is returned.</p> <p>The number of values returned is subject to change in future releases.</p>
All	12	<p>Returns the power result (the peak power of the signal in the ref channel) when Meas Type is Spectrum Peak reference. Otherwise, the value returned will be -999.0.</p> <p>When in the MSR and LTE-Advanced FDD/TDD mode, returns outer offset results</p>

Modes	n	Return Value
MSR, LTEAFDD, LTEATDD only	13	<p>when Non-Contiguous Meas Region is set to Outer, and returns inner offset results when it is set to Inner, in the following order.</p> <hr/> <p>Meas Type: Total Power Reference Returns outer offset results when Non-Contiguous Meas Region is set to Outer, and returns inner offset results when it is set to Inner, in the following order.</p> <ol style="list-style-type: none"> 1. Total Absolute power of carriers of Measure Carrier On if Power Ref Type is "Max Power Carrier," "Max Power Carrier in Sub-block," or "RF Bandwidth." Otherwise NaN (9.91E+37) is returned. (dBm) 2. Absolute reference power. Absolute power at the left reference carrier if Power Ref type is "Left & Right Carriers." Absolute power at the reference carrier of the left sub-block if Power Ref type is "Max Power Carrier in Sub-block." (dBm) 3. Absolute power at the right reference carrier if Power Ref type is "Left & Right Carriers." Absolute power at the reference carrier of the right sub-block if Power Ref type is "Max Power Carrier in Sub-block." Otherwise NaN (9.91E+37) is returned. (dBm) 4. Peak frequency in the measured ref carrier frequency range. Peak frequency in the left ref carrier frequency range if Power Ref type is "Left & Right Carriers." Peak frequency in the ref carrier frequency range of the left sub-block if Power Ref type is "Max Power Carrier in Sub-block." (Hz) 5. Peak frequency in the right ref carrier frequency range if Power Ref type is "Left & Right Carriers." Peak frequency in the ref carrier frequency range of the right sub-block if Power Ref type is "Max Power Carrier in Sub-block." Otherwise NaN (9.91E+37) is returned. (Hz) <p>If the result is not available, NaN (9.91E+37) is returned. The number of values returned is subject to change in future releases.</p> <hr/>
MSR, LTEAFDD, LTEATDD only	13	<p>Meas Type: Power Spectral Density Reference Returns outer offset results when Non-Contiguous Meas Region is set to Outer, and returns inner offset results when it is set to Inner, in the following order.</p> <ol style="list-style-type: none"> 1. Total Absolute power of carriers of Measure Carrier On if Power Ref Type is "Max Power Carrier," "Max Power Carrier in Sub-block," or "RF Bandwidth." Otherwise NaN (9.91E+37) is returned. (dBm) 2. Absolute reference power. Absolute power at the left reference carrier if Power Ref type is "Left & Right Carriers." Absolute power at the reference carrier of the left sub-block if Power Ref type is "Max Power Carrier in Sub-block." (dBm/Hz) 3. Absolute power at the right reference carrier if Power Ref type is "Left & Right Carriers." Absolute power at the reference carrier of the right sub-block if Power Ref type is "Max Power Carrier in Sub-block." Otherwise NaN (9.91E+37) is returned. (dBm/Hz) 4. Peak frequency in the measured ref carrier frequency range. Peak frequency in the left ref carrier frequency range if Power Ref type is "Left & Right Carriers." Peak frequency in the ref carrier frequency range of the left sub-block if Power Ref type is "Max Power Carrier in Sub-block." (Hz) 5. Peak frequency in the right ref carrier frequency range if Power Ref type is "Left & Right Carriers." Peak frequency in the ref carrier frequency range of the right sub-block if Power Ref type is "Max Power Carrier in Sub-block." Otherwise <hr/>

Modes	n	Return Value
		<p>NaN (9.91E+37) is returned. (Hz)</p> <p>If the result is not available, NaN (9.91E+37) is returned.</p> <p>The number of values returned is subject to change in future releases.</p>
MSR, LTEAFDD, LTEATDD only	13	<p>Meas Type: Power Spectrum Peak Reference</p> <p>Returns outer offset results when Non-Contiguous Meas Region is set to Outer, and returns inner offset results when it is set to Inner, in the following order.</p> <ol style="list-style-type: none"> 1. Total Absolute power of carriers of Measure Carrier On if Power Ref Type is "Max Power Carrier," "Max Power Carrier in Sub-block," or "RF Bandwidth." Otherwise NaN (9.91E+37) is returned. (dBm) 2. Peak reference power. Peak power at the left reference carrier if Power Ref type is "Left & Right Carriers." Peak power at the reference carrier of the left sub-block if Power Ref type is "Max Power Carrier in Sub-block." (dBm) 3. Peak power at the right reference carrier if Power Ref type is "Left & Right Carriers." Peak power at the reference carrier of the right sub-block if Power Ref type is "Max Power Carrier in Sub-block." Otherwise NaN (9.91E+37) is returned. (dBm) 4. Peak frequency in the measured ref carrier frequency range. Peak frequency in the left ref carrier frequency range if Power Ref type is "Left & Right Carriers." Peak frequency in the ref carrier frequency range of the left sub-block if Power Ref type is "Max Power Carrier in Sub-block." (Hz) 5. Peak frequency in the right ref carrier frequency range if Power Ref type is "Left & Right Carriers." Peak frequency in the ref carrier frequency range of the right sub-block if Power Ref type is "Max Power Carrier in Sub-block." Otherwise NaN (9.91E+37) is returned. (Hz) <p>If the result is not available, NaN (9.91E+37) is returned.</p> <p>The number of values returned is subject to change in future releases.</p>
All	14	<p>Meas Type: Total Power Reference</p> <p>Returns comma-separated scalar results, in the following order:</p> <p>When in the MSR and LTE-Advanced FDD/TDD mode, returns outer offset results when Non-Contiguous Meas Region is set to Outer, and returns inner offset results when it is set to Inner, in the following order.</p> <ol style="list-style-type: none"> 1. Relative integrated power on the negative offset A (dBc) 2. Absolute integrated power on the negative offset A (dBm) 3. Relative peak power on the negative offset A (dBc) 4. Absolute peak power on the negative offset A (dBm) 5. Peak power offset frequency from the center or carrier edge frequency in the negative offset A, depending on Offset Frequency Define settings (Hz) 6. Relative integrated power on the positive offset A (dBc) 7. Absolute integrated power on the positive offset A (dBm) 8. Relative peak power on the positive offset A (dBc) 9. Absolute peak power on the positive offset A (dBm) 10. Peak power offset frequency from the center or carrier edge frequency in the positive offset A, depending on Offset Frequency Define settings (Hz) 11. Relative integrated power on the negative offset B (dBc)

Modes	n	Return Value
		<p>---</p> <p>119. Absolute peak power on the positive offset L (dBm)</p> <p>120. Peak power offset frequency from the center or carrier edge frequency in the positive offset L, depending on Offset Frequency Define settings (Hz)</p> <p>If the result is not available, NaN (9.91E+37) is returned.</p> <p>The length of the result depends on the number of available offset (See "Number of Offsets" on page 2579).</p> <p>The number of values returned is subject to change in future releases.</p>
All	14	<p>Meas Type: Power Spectral Density Reference</p> <p>Returns comma-separated scalar results, in the following order:</p> <p>When in the MSR and LTE-Advanced FDD/TDD mode, returns outer offset results when Non-Contiguous Meas Region is set to Outer, and returns inner offset results when it is set to Inner, in the following order.</p> <ol style="list-style-type: none"> 1. Relative integrated power on the negative offset A (dB) 2. Absolute integrated power on the negative offset A (dBm/Hz) 3. Relative peak power on the negative offset A (dB) 4. Absolute peak power on the negative offset A (dBm/Hz) 5. Peak power offset frequency from the center or carrier edge frequency in the negative offset A, depending on Offset Frequency Define settings (Hz) 6. Relative integrated power on the positive offset A (dB) 7. Absolute integrated power on the positive offset A (dBm/Hz) 8. Relative peak power on the positive offset A (dB) 9. Absolute peak power on the positive offset A (dBm/Hz) 10. Peak power offset frequency from the center or carrier edge frequency in the positive offset A, depending on Offset Frequency Define settings (Hz) 11. Relative integrated power on the negative offset B (dB) <p>---</p> <p>119. Absolute peak power on the positive offset L (dBm/Hz)</p> <p>120. Peak power offset frequency from the center or carrier edge frequency in the positive offset L, depending on Offset Frequency Define settings (Hz)</p> <p>If the result is not available, NaN (9.91E+37) is returned.</p> <p>The length of the result depends on the number of available offset (See "Number of Offsets" on page 2579).</p> <p>The number of values returned is subject to change in future releases.</p>
All	14	<p>Meas Type: Spectrum Peak Reference</p> <p>Returns comma-separated scalar results, in the following order:</p> <p>When in the MSR and LTE-Advanced FDD/TDD mode, returns outer offset results when Non-Contiguous Meas Region is set to Outer, and returns inner offset results when it is set to Inner, in the following order.</p> <ol style="list-style-type: none"> 1. Reserved for the future use, returns NaN (9.91E+37) 2. Reserved for the future use, returns NaN (9.91E+37)

Modes	n	Return Value
		<p>3. Relative peak power on the negative offset A (dB)</p> <p>4. Absolute peak power on the negative offset A (dBm)</p> <p>5. Peak power offset frequency from the center or carrier edge frequency in the negative offset A, depending on Offset Frequency Define settings (Hz)</p> <p>6. Reserved for the future use, returns NaN (9.91E+37)</p> <p>7. Reserved for the future use, returns NaN (9.91E+37)</p> <p>8. Relative peak power on the positive offset A (dB)</p> <p>9. Absolute peak power on the positive offset A (dBm)</p> <p>10. Peak power offset frequency from the center or carrier edge frequency in the positive offset A, depending on Offset Frequency Define settings (Hz)</p> <p>11. Relative integrated power on the negative offset B (dB)</p> <p>---</p> <p>119. Absolute peak power on the positive offset L (dBm)</p> <p>120. Peak power offset frequency from the center or carrier edge frequency in the positive offset L, depending on Offset Frequency Define settings (Hz)</p> <p>If the result is not available, NaN (9.91E+37) is returned.</p> <p>The length of the result depends on the number of available offset (See "Number of Offsets" on page 2579).</p> <p>The number of values returned is subject to change in future releases.</p>
All	15	<p>Meas Type: Total Power Reference</p> <p>Returns comma-separated scalar results, in the following order:</p> <p>When in the MSR and LTE-Advanced FDD/TDD mode, returns outer offset results when Non-Contiguous Meas Region is set to Outer, and returns inner offset results when it is set to Inner, in the following order.</p> <p>1. Minimum margin from limit line on the negative offset A (dB)</p> <p>2. Minimum margin from limit line on the positive offset A (dB)</p> <p>3. Minimum margin from limit line on the negative offset B (dB)</p> <p>4. Minimum margin from limit line on the positive offset B (dB)</p> <p>---</p> <p>23. Minimum margin from limit line on the negative offset L (dB)</p> <p>24. Minimum margin from limit line on the positive offset L (dB)</p> <p>If the result is not available, NaN (9.91E+37) is returned.</p> <p>The length of the result depends on the number of available offset (See "Number of Offsets" on page 2579).</p> <p>The number of values returned is subject to change in future releases.</p>
MSR, LTEAFDD, LTEATDD only	16	<p>Returns number of carriers comma-separated scalar results, in the following order:</p> <p>1. Absolute power of carrier 1 (dBm)</p> <p>2. Absolute power of carrier 2 (dBm)</p> <p>---</p> <p>number of carriers-1. Absolute power of carrier (number of carriers)-1 (dBm)</p> <p>number of carriers. Absolute power of carrier (number of carriers)-1 (dBm)</p>

Modes	n	Return Value
		If Measure Carrier of the corresponding carrier is no, NaN (9.91E+37) is returned.
WLAN 802.11ac 80+80 MHz only	16	Returns two carriers comma-separated scalar results when the radio standard is 802.11ac 80+80 MHz. And returns NaN otherwise. 1. Absolute power of carrier segment 1 (dBm) 2. Absolute power of carrier segment 2 (dBm)
MSR, LTEAFDD, LTEATDD only	17	Returns the displayed frequency domain combined limit trace data separated by comma. Combined trace is a mixed trace of both absolute limit trace and relative limit trace according to the fail mask condition. The number of data points is 2001.

Number of Offsets

The number of available offsets varies depending on the mode and option as below.

Mode	The number of available offsets
MSR, LTEAFDD, LTEATDD	12 (Offset A to L)
WLAN	12 (Offset A to L)
Other modes with option N9060A-7FP	12 (Offset A to L)
Other modes without option N9060A-7FP	6 (Offset A to F)

Key Path	Meas
Initial S/W Revision	Prior to A.02.00
Modified at S/W Revision	A.11.00, A.14.00

AMPTD Y Scale

Accesses a menu of functions that enable you to set the vertical scale parameters. The parameter values are measurement independent except all Attenuation values and Internal Preamp selections that are measurement global.

Key Path	Front-panel key
Initial S/W Revision	Prior to A.02.00

Ref Value

Sets the value for the absolute power reference. However, since Auto Scaling defaults to On, this value is automatically determined by the measurement result. When you set a value manually, Auto Scaling automatically changes to Off.

Key Path	AMPTD Y Scale
Mode	SA, WCDMA, C2K, WIMAX OFDMA, TD-SCDMA, 1xEVDO, DTMB (CTTB), DVB-T/H, ISDB-T, CMMB, LTE, LTETDD, Digital Cable TV, WLAN, MSR, LTEAFDD, LTEATDD
Remote Command	<code>:DISPlay:SEMask:VIEW[1]:WINDow[1]:TRACe:Y[:SCALE]:RLEVel <real></code> <code>:DISPlay:SEMask:VIEW[1]:WINDow[1]:TRACe:Y[:SCALE]:RLEVel?</code>
Example	DISP:SEM:VIEW:WIND:TRAC:Y:RLEV 100 DISP:SEM:VIEW:WIND:TRAC:Y:RLEV?
Notes	You must be in the mode that includes SEM measurement to use this command. Use :INSTrument:SELEct to set the mode.
Couplings	When the Auto Scaling is On, this value is automatically determined by the measurement result. When you set a value manually, Auto Scaling automatically changed to Off.
Preset	10.0 dBm
State Saved	Saved in instrument state.
Min	-250 dBm
Max	250 dBm
Initial S/W Revision	Prior to A.02.00
Modified at S/W Revision	A.02.00, A.03.00

Attenuation

This menu controls the attenuator functions and interactions between the attenuation system components.

There are two attenuator configurations in the X-Series. One is a dual attenuator configuration consisting of a mechanical attenuator and an optional electronic attenuator. The other configuration uses a single attenuator with combined mechanical and electronic sections that controls all the attenuation functions. Different models in the X-Series come with different configurations.

See "[Dual Attenuator Configurations:](#)" on page 2581

See ["Single Attenuator Configuration:" on page 2582](#)

Most Attenuation settings are the same for all measurements – they do not change as you change measurements. Settings like these are called “Meas Global” and are unaffected by Meas Preset.

Key Path	AMPTD Y Scale
Scope	Meas Global
Dependencies	In measurements that support the I/Q inputs, this key is unavailable when I/Q is the selected input, and is replaced by the Range key in that case.
Readback Line	Contains a summary in [] brackets of the current total attenuation. See the descriptions of the , " (Mech) Atten " on page 3103, and " Enable Elec Atten " on page 3105 keys for more detail on the contributors to the total attenuation. Note that when "Pre-Adjust for Min Clip" is on, this value can change at the start of every measurement.
Initial S/W Revision	Prior to A.02.00
Modified at S/W Revision	A.03.00

Dual Attenuator Configurations:

Configuration 1: Mechanical attenuator + optional electronic attenuator

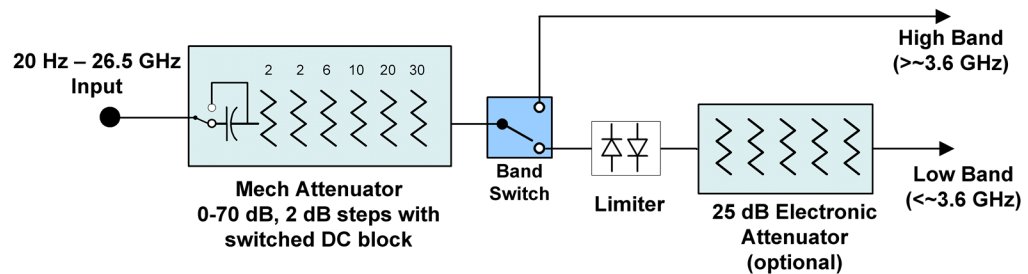

Configuration 2: Mechanical attenuator, no optional electronic attenuator

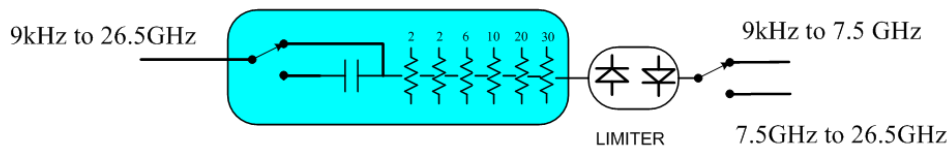

(note that Configuration 2 is not strictly speaking a dual-section attenuator, since there is no electronic section available. However, it behaves exactly like Configuration 1 without the Electronic Attenuator option EA3, therefore for the sake of this document it is grouped into the “Dual Attenuator” configuration)

Single Attenuator Configuration:

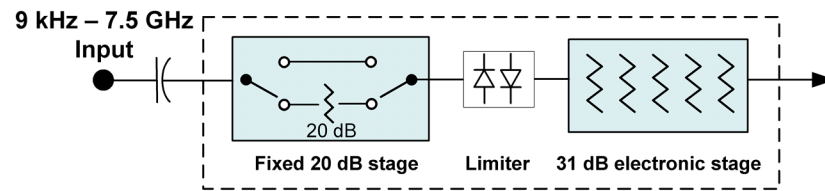

You can tell which attenuator configuration you have by pressing the Attenuation key, which (in most Modes) opens the Attenuation menu. If the first key in the Attenuation menu says **Mech Atten** you have the dual attenuator configuration. If the first key says **Atten** you have the single attenuator configuration.



In the single attenuator configuration, you control the attenuation with a single control, as the fixed stage has only two states. In the dual attenuator configuration, both stages have significant range so you are given separate control of the mechanical and electronic attenuator stages.

When you have the dual attenuator configuration, you may still have only a single attenuator, because unless option EA3 (the Electronic Attenuator option) is available, and you purchase it, you will have only the mechanical attenuator.

(Mech) Atten

This key is labeled **Mech Atten** in dual attenuator models and **Atten** in single attenuator models. In the dual attenuator configuration, this key only affects the mechanical attenuator.

This key lets you modify the attenuation applied to the RF input signal path. This value is normally auto coupled to the Ref Level, the Internal Preamp Gain, any External Gain that is entered, and the Max Mixer Level, as described in the table below.

See "[Attenuator Configurations and Auto/Man](#)" on page 2584

Key Path	AMPTD Y Scale, Attenuation
Remote Command	[:SENSe]:POWer[:RF]:ATTenuation <rel_amp1> [:SENSe]:POWer[:RF]:ATTenuation? [:SENSe]:POWer[:RF]:ATTenuation:AUTO OFF ON 0 1 [:SENSe]:POWer[:RF]:ATTenuation:AUTO?
Example	POW:ATT 20 Dual attenuator configuration: sets the mechanical attenuator to 20 dB Single attenuator mode: sets the main attenuation to 20 dB (see below for definition of "main")

	<p>attenuation).</p> <p>If the attenuator was in Auto, it sets it to Manual.</p>
Dependencies	<p>Some measurements do not support the Auto setting of (Mech) Atten. In these measurements, the Auto/Man selection is not available, and the Auto/Man line on the key disappears.</p> <p>In dual attenuator configurations, when the electronic attenuator is enabled, the mechanical attenuator has no auto setting and the Auto/Man line on the key disappears. The state of Auto/Man is remembered and restored when the electronic attenuator is once again disabled. This is described in more detail in the "Enable Elec Atten" on page 3105 key description.</p> <p>See "Attenuator Configurations and Auto/Man" on page 2584 for more information on the Auto/Man functionality of Attenuation.</p>
Couplings	<p>When (Mech) Atten is in Auto, it uses the following algorithm to determine a value:</p> <p>If the USB Preamp is connected to USB, use 0 dB.</p> <p>Otherwise, $Atten = ReferenceLevel + PreAmpGain + ExternalGain - RefLevelOffset - MaxMixerLevel + IF\ Gain$.</p> <p>Limit this value to be between 6 dB and the Max value. No value below 6 dB can ever be chosen by Auto.</p> <p>The resulting value is rounded up to the largest value possible given the attenuation step setting. That is, 50.01 dB would change to 60 dB (for a 10 dB attenuation step).</p> <p>The "IF Gain" term in the equation above is either 0 dB or +10 dB, depending on the settings of FFT IF Gain, Swept IF Gain, max Ref Level and the Auto/Man setting of Mech Atten.</p> <p>In External Mixing and BBIQ, where the Attenuator is not in the signal path, the Attenuator setting changes as described above when (Mech) Atten is in Auto, but no changes are made to the actual attenuator hardware setting until the input is changed back to the RF Input.</p>
Preset	<p>The preset for Mech Attenuation is "Auto."</p> <p>The Auto value of attenuation is:</p> <p>CXA, EXA, MXA and PXA: 10 dB</p>
State Saved	<p>Saved in instrument state</p>
Min	<p>0 dB</p> <p>The attenuation set by this key cannot be decreased below 6 dB with the knob or step keys. To get to a value below 6 dB it has to be directly entered from the keypad or via SCPI. This protects from adjusting the attenuation to a dangerously small value which can put the instrument at risk of damage to input circuitry. However, if the current mechanical attenuation is below 6 dB it can be increased with the knob and step keys, but not decreased.</p>
Max	<p>CXA N9000A-503/507: 50 dB</p> <p>CXA N9000A-513/526: 70dB</p> <p>EXA: 60 dB</p> <p>MXA and PXA: 70 dB</p> <p>In the single attenuator configuration, the total of ATT and EATT cannot exceed 50 dB, so if the EATT is set to 24 dB first, the main attenuation cannot be greater than 26 dB and will be reduced accordingly; if the main attenuator is set to 40 dB first, EATT cannot be greater than 10 dB.</p>
Initial S/W Revision	<p>Prior to A.02.00</p>
Modified at S/W Revision	<p>A.03.00</p>

Attenuator Configurations and Auto/Man

As described in the Attenuation key description, there are two distinct attenuator configurations available in the X-Series, the single attenuator and dual attenuator configurations. In dual attenuator configurations, we have the mechanical attenuation and the electronic attenuation, and the current total attenuation is the sum of the electronic + mechanical attenuation. In single attenuator configurations, we refer to the attenuation set using the **(Mech) Atten** key (or POW:ATT SCPI) as the “main” attenuation; and the attenuation that is set by the SCPI command POW:EATT as the “soft” attenuation (the POW:EATT command is honored even in the single attenuator configuration, for compatibility purposes). Then the current total attenuation is the sum of the main + soft attenuation. See the **Elec Atten** key description for more on “soft” attenuation.

In the dual attenuator configuration, when the electronic attenuator is enabled, there is no Auto/Man functionality for the mechanical attenuator, and the third line of the key label (the Auto/Man line) disappears:

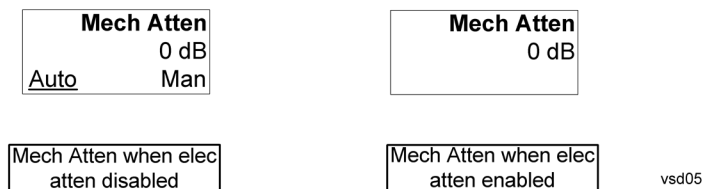

Enable Elec Atten

Enables the Electronic Attenuator.

The electronic attenuator offers finer steps than the mechanical attenuator, has no acoustical noise, is faster, and is less subject to wear. These advantages primarily aid in remote operation and are negligible for front panel use. See ["Using the Electronic Attenuator: Pros and Cons" on page 2586](#) for a detailed discussion of the pros and cons of using the electronic attenuator.

For the single attenuator configuration, for SCPI backwards compatibility, the “soft” attenuation feature replaces the dual attenuator configuration’s electronic attenuator. All the same couplings and limitations apply. See ["Attenuator Configurations and Auto/Man" on page 3105](#)

See [Error! Reference source not found.](#)

Key Path	AMPTD Y Scale, Attenuation
Remote Command	[:SENSe] :POWer [:RF] :EATTenuation :STATe OFF ON 0 1 [:SENSe] :POWer [:RF] :EATTenuation :STATe ?
Example	POW:EATT:STAT ON
Dependencies	This key only appears in Dual Attenuator models with an Electronic Attenuator installed. It does not appear in models with the Single Attenuator configuration, as in the single attenuator configuration there is no “electronic attenuator” there is only a single integrated attenuator (which has both a mechanical and electronic stage). However, in the single attenuator configuration, EATT SCPI commands are accepted for compatibility with other X-series

instruments and set a “soft” attenuation as described in "[Attenuator Configurations and Auto/Man](#)" on page 3105.

The electronic attenuator (and the “soft” attenuation function provided in single attenuator configurations) is unavailable above 3.6 GHz. Therefore, if the Stop Frequency of the analyzer is > 3.6 GHz then the **Enable Elec Atten** key will be OFF and grayed out.

If the Internal Preamp is on, meaning it is set to Low Band or Full, the electronic attenuator (and the “soft” attenuation function provided in single attenuator configurations) is unavailable. In this case the **Enable Elec Atten** key will be OFF and grayed out.

If either of the above is true, if the SCPI command is sent, an error indicating that the electronic attenuator is unavailable will be sent.

If the electronic/soft Attenuator is enabled, then the Stop Freq of the analyzer is limited to 3.6 GHz and the Internal Preamp is unavailable.

The SCPI-only “soft” electronic attenuation for the single-attenuator configuration is not available in all measurements; in particular, it is not available in the Swept SA measurement.

Couplings	Enabling and disabling the Electronic Attenuator affects the setting of the Mechanical Attenuator (in dual attenuator configurations). This is described in more detail below this table.
Preset	OFF for Swept SA measurement; ON for all other measurements that support the electronic attenuator
State Saved	Saved in instrument state
Initial S/W Revision	Prior to A.02.00
Modified at S/W Revision	A.03.00

Mechanical Attenuator Transition Rules

When the Electronic Attenuator is enabled, the Mechanical Attenuator transitions to a state that has no Auto function. Below are the rules for transitioning the Mechanical Attenuator. NOTE that the information below ONLY applies to the dual attenuator configurations, and ONLY when the Electronic Attenuator is installed:

When the Electronic Attenuation is enabled from a disabled state:

- The Mechanical Attenuator is initialized to 10 dB (this is its optimal performance setting). You can then set it as desired with SCPI, numeric keypad, step keys, or knob, and it behaves as it normally would in manual mode
- The Auto/Man state of (Mech) Atten is saved
- The Auto/Man line on the (Mech) Atten key disappears and the auto rules are disabled
- The Electronic Attenuator is set to 10 dB less than the previous value of the Mechanical Attenuator, within the limitation that it must stay within the range of 0 to 24 dB of attenuation.

Examples in the dual attenuator configuration:

- Mech Atten at 20 dB. Elec Atten enabled, Mech Atten set to 10 dB, and Elec Atten set to 10 dB. New total attenuation equals the value before Elec Atten enabled.
- Mech Atten at 0 dB. Elec Atten enabled, Mech Atten set to 10 dB, and Elec Atten set to 0 dB. New total attenuation does not equal the value before Elec Atten enabled.
- Mech Atten at 40 dB. Elec Atten enabled, Mech Atten set to 10 dB, and Elec Atten set to 24 dB. New total attenuation does not equal the value before Elec Atten enabled.

When the Electronic Attenuation is disabled from an enabled state:

- The Elec Atten key is grayed out
- The Auto/Man state of (Mech) Atten is restored
- If now in Auto, (Mech) Atten recouples
- If now in Man, (Mech) Atten is set to the value of total attenuation that existed before the Elec Atten was disabled. The resulting value is rounded up to the smallest value possible given the (Mech) Atten Step setting - (That is, 57 dB changes to 58 dB when (Mech) Atten Step is 2 dB.)

Using the Electronic Attenuator: Pros and Cons

The electronic attenuator offers finer steps than the mechanical attenuator, has no acoustical noise, is faster, and is less subject to wear.

The “finer steps” advantage of the electronic attenuator is beneficial in optimizing the alignment of the analyzer dynamic range to the signal power in the front panel as well as remote use. Thus, you can achieve improved relative signal measurement accuracy. Compared to a mechanical attenuator with 2 dB steps, the 1 dB resolution of the electronic attenuator only gives better resolution when the odd-decibel steps are used. Those odd-decibel steps are less accurately calibrated than the even-decibel steps, so one tradeoff for this superior relative accuracy is reduced absolute amplitude accuracy.

Another disadvantage of the electronic attenuator is that the spectrum analyzer loses its “Auto” setting, making operation less convenient.

Also, the relationship between the dynamic range specifications (TOI, SHI, compression and noise) and instrument performance are less well-known with the electrical attenuator. With the mechanical attenuator, TOI, SHI and compression threshold levels increase dB-for-dB with increasing attenuation, and the noise floor does as well. With the electronic attenuator, there is an excess attenuation of about 1 to 3 dB between 0 and 3.6 GHz, making the effective TOI, SHI, and so forth, less

well known. Excess attenuation is the actual attenuation relative to stated attenuation. Excess attenuation is accounted for in the analyzer calibration

Elec Atten

Controls the Electronic Attenuator in dual attenuator configurations. This key does not appear in single attenuator configurations, as the control of both the mechanical and electronic stages of the single attenuator is integrated into the single **Atten** key.

Key Path	AMPTD Y Scale, Attenuation
Remote Command	[:SENSe]:POWer[:RF]:EATTenuation <rel_amp1> [:SENSe]:POWer[:RF]:EATTenuation?
Notes	Electronic Attenuation's specification is defined only when Mechanical Attenuation is 6 dB.
Dependencies	This key only appears in Dual Attenuator models with an Electronic Attenuator installed. It does not appear in models with the Single Attenuator configuration, as in the single attenuator configuration there is no "electronic attenuator" there is only a single integrated attenuator (which has both a mechanical and electronic stage). However, in the single attenuator configuration, EATT SCPI commands are accepted for compatibility with other X-series instruments and set a "soft" attenuation as described in "Attenuator Configurations and Auto/Man" on page 3105 . The "soft" attenuation is treated as an addition to the "main" attenuation value set by the Atten softkey or the POW:ATT SCPI command and affects the total attenuation displayed on the Attenuation key and the Meas Bar. When Enable Elec Atten is off or grayed out, the Elec Atten key is grayed out.
Preset	0 dB
State Saved	Saved in instrument state
Min	0 dB
Max	Dual attenuator configuration: 24 dB Single attenuator configuration: the total of ATT and EATT cannot exceed 50 dB, so if the EATT is set to 24 dB first, the main attenuation cannot be greater than 26 dB and will be reduced accordingly; if the main attenuator is set to 40 dB first, EATT cannot be greater than 10 dB
Initial S/W Revision	Prior to A.02.00
Modified at S/W Revision	A.03.00

Adjust Atten for Min Clip

Sets the combination of mechanical and electronic attenuation and gain based on the current measured signal level so that clipping will be at a minimum.

This is an "immediate action" function, that is, it executes once, when the key is pressed.

This key does not appear in measurements that do not support this functionality. The spectrum analyzer measurement, Swept SA, does not support this functionality.

Key Path	AMPTD Y Scale, Attenuation
Remote Command	[:SENSe]:POWer[:RF]:RANGe:OPTimize IMMEDIATE

Initial S/W Revision	Prior to A.02.00
Modified at S/W Revision	A.03.00

Pre-Adjust for Min Clip

If this function is on, it does the adjustment described under "[Adjust Atten for Min Clip](#)" on page 3108 each time a measurement restarts. Therefore, in Continuous measurement mode, it only executes before the first measurement.

In dual attenuator models, you can set **Elec+Mech Atten**, in which case both attenuators participate in the autoranging, or **Elec Atten Only**, in which case the mechanical attenuator does not participate in the autoranging. This latter case results in less wear on the mechanical attenuator and is usually faster.

This key is grayed out in measurements that do not support this functionality. The spectrum analyzer measurement, Swept SA, does not support this functionality.

Key Path	AMPTD Y Scale, Attenuation
Remote Command	<code>[:SENSe] :POWer [:RF] :RANGe :OPTimize :ATTenuation OFF ELECtrical COMBined</code> <code>[:SENSe] :POWer [:RF] :RANGe :OPTimize :ATTenuation?</code>
Notes	The SCPI parameter ELECtrical sets this function to On in single attenuator models. The SCPI parameter COMBined is mapped to ELECtrical in single attenuator models; if you send COMBined, it sets the function to On and returns ELEC to a query.
Dependencies	This key only appears in Dual Attenuator models with an Electronic Attenuator installed. In instruments with Dual Attenuator model, when Enable Elec Atten is off or grayed out, the Pre-Adjust for Min Clip key is grayed out.
Preset	OFF for Swept SA measurement; ON for all other measurements that support Pre-Adjust for Min Clip
State Saved	Saved in instrument state
Range	Dual attenuator models: Off Elec Atten Only Mech + Elec Atten Single attenuator models: Off On
Initial S/W Revision	Prior to A.02.00
Modified at S/W Revision	A.03.00

Remote Command	<code>[:SENSe] :POWer [:RF] :RANGe :AUTO ON OFF 1 0</code> <code>[:SENSe] :POWer [:RF] :RANGe :AUTO?</code>
Notes	ON aliases to "Elec Atten Only" (:POW:RANG:OPT:ATT ELEC) OFF aliases to "Off" (:POW:RANG:OPT:ATT OFF)

	The query :POW:RANG:AUTO? returns true if :POW:RANG:OPT:ATT is not "Off"
Initial S/W Revision	Prior to A.02.00

Off

Turns **Pre-Adjust for Min Clip** off. This is the default setting.

This key is grayed out in measurements that do not support this functionality. The spectrum analyzer measurement, Swept SA, does not support this functionality.

Key Path	AMPTD Y Scale, Attenuation, Pre-Adjust for Min Clip
Example	:POW:RANGe:OPT:ATT OFF
Initial S/W Revision	Prior to A.02.00

Elec Atten Only

Selects only the electric attenuator to participate in auto ranging. This offers less wear on the mechanical attenuator and is usually faster.

This key is grayed out in measurements that do not support this functionality. The spectrum analyzer measurement, Swept SA, does not support this functionality.

Key Path	AMPTD Y Scale, Attenuation, Pre-Adjust for Min Clip
Example	:POW:RANGe:OPT:ATT ELEC
Initial S/W Revision	Prior to A.02.00

Mech + Elec Atten

In dual attenuator models, this selects both attenuators participate in the autoranging.

This key is grayed out in measurements that do not support this functionality. The spectrum analyzer measurement, Swept SA, does not support this functionality.

Key Path	AMPTD Y Scale, Attenuation, Pre-Adjust for Min Clip
Example	:POW:RANGe:OPT:ATT COMB
Initial S/W Revision	Prior to A.02.00

(Mech) Atten Step

This controls the step size used when making adjustments to the input attenuation.

This key is labeled **Mech Atten Step** in dual attenuator models and **Atten Step** in single attenuator models. In the dual attenuator configuration, this key only affects the step size of the mechanical attenuator.

Key Path	AMPTD Y Scale, Attenuation
Remote Command	[:SENSe] :POWer [:RF] :ATTenuation :STEP [:INCRe ment] 10 dB 2 dB [:SENSe] :POWer [:RF] :ATTenuation :STEP [:INCRe ment] ?

Example	POW:ATT:STEP 2
Notes	Note this feature works like a 1-N choice from the front panel, but it takes a specific value (in dB) when used remotely. The only valid values are 2 and 10.
Dependencies	Blanked in CXA and EXA if option FSA (2 dB steps) is not present. If blanked, attempts to set it via SCPI will yield an error.
Couplings	When the attenuation step size changes, the current mechanical attenuation value is adjusted (if necessary) to be quantized to the new step size. That is, if step is set to 10 dB, mech atten is increased if necessary so it is a multiple of 10 dB
Preset	PXA and MXA: 2 dB EXA and CXA: 10 dB (2 dB with option FSA)
State Saved	Saved in instrument state
Initial S/W Revision	Prior to A.02.00
Modified at S/W Revision	A.03.00

Max Mixer Level

Controls the limitation on the Ref Level for a given attenuation setting, and therefore also interacts with the Auto rules for selecting the attenuation as a coupling from the reference level.

Key Path	AMPTD Y Scale, Attenuation
Remote Command	[:SENSe] :POWer [:RF] :MIXer :RANGe [:UPPer] <real> [:SENSe] :POWer [:RF] :MIXer :RANGe [:UPPer] ?
Example	POW:MIX:RANG -15 dBm
Preset	-10 dBm
State Saved	Saved in instrument state
Min	-50 dBm
Max	0 dBm
Default Unit	Depends on the current selected Y axis unit, see Swept SA discussion of Y Axis Unit
Initial S/W Revision	Prior to A.02.00

Scale/Div

Sets the units-per-division of the vertical scale in the logarithmic display. When Auto Scaling is On, the scale per division value is automatically determined by the measurement result. When you set a value manually, Auto Scaling automatically changes to Off.

Key Path	AMPTD Y Scale
Mode	SA, WCDMA, C2K, WIMAX OFDMA, TD-SCDMA, 1xEVDO, DTMB (CTTB), DVB-T/H, ISDB-T, CMMB, LTE, LTETDD, Digital Cable TV, WLAN, MSR, LTEAFDD, LTEATDD
Remote Command	:DISPlay:SEMask:VIEW[1]:WINDow[1]:TRAcE:Y[:SCALE]:PDIVision <rel_

	<code>amp1></code>
	<code>:DISP:SEMask:VIEW[1]:WINDow[1]:TRACe:Y[:SCALe]:PDIVision?</code>
Example	DISP:SEM:VIEW:WIND:TRAC:Y:PDIV 15dB DISP:SEM:VIEW:WIND:TRAC:Y:PDIV?
Notes	You must be in the mode that includes SEM measurement to use this command. Use :INSTrument:SElect to set the mode.
Couplings	When the Auto Scaling is On, this value is automatically determined by the measurement result. When you set a value manually, Auto Scaling automatically changes to Off.
Preset	10 dB
State Saved	Saved in instrument state
Min	0.10 dB
Max	20.00 dB
Initial S/W Revision	Prior to A.02.00
Modified at S/W Revision	A.02.00, A.03.00

Presel Center

When this key is pressed, the centering of the preselector filter is adjusted to optimize the amplitude accuracy at the frequency of the selected marker. If the selected marker is not on when Presel Center is pressed, the analyzer will turn on the selected marker, perform a peak search, and then perform centering on the marker's center frequency. If the selected marker is already on and between the start and stop frequencies of the analyzer, the analyzer performs the preselector calibration on that marker's frequency. If the selected marker is already on, but outside the frequency range between Start Freq and Stop Freq, the analyzer will first perform a peak search, and then perform centering on the marker's center frequency.

The value displayed on the **Presel Adjust** key will change to reflect the new preselector tuning (see **Presel Adjust**).

A number of considerations should be observed to ensure proper operation. See ["Proper Preselector Operation" on page 2592](#).

Key Path	AMPTD Y Scale
Remote Command	<code>[:SENSe]:POWer[:RF]:PCENter</code>
Example	POW:PCEN
Notes	Note that the rules outlined above under the key description apply for the remote command as well as the key. The result of the command is dependent on marker position, and so forth. Any message shown by the key press is also shown in response to the remote command.
Dependencies	<ul style="list-style-type: none"> - Grayed out if the microwave preselector is off.) - If the selected marker's frequency is below Band 1, advisory message 0.5001 is generated and no action is taken.

	<ul style="list-style-type: none"> - Grayed out if entirely in Band 0. - Blank in models that do not include a preselector, such as option 503. If the SCPI is sent in these instruments, it is accepted without error, and the query always returns 0. - Grayed out in the Spectrogram View.
Couplings	<p>The active marker position determines where the centering will be attempted.</p> <p>If the analyzer is in a measurement such as averaging when centering is initiated, the act of centering the preselector will restart averaging but the first average trace will not be taken until the centering is completed.</p>
Status Bits/OPC dependencies	<p>When centering the preselector, *OPC will not return true until the process is complete and a subsequent measurement has completed, nor will results be returned to a READ or MEASure command.</p> <p>The Measuring bit should remain set while this command is operating and should not go false until the subsequent sweep/measurement has completed.</p>
Initial S/W Revision	Prior to A.02.00
Modified at S/W Revision	A.03.00

Proper Preselector Operation

A number of considerations should be observed to ensure proper operation:

3. If the selected marker is off, the analyzer will turn on a marker, perform a peak search, and adjust the preselector using the selected marker's frequency. It uses the "highest peak" peak search method unqualified by threshold or excursion, so that there is no chance of a 'no peak found' error. It continues with that peak, even if it is the peak of just noise. Therefore, for this operation to work properly, there should be a signal on screen in a preselected range for the peak search to find.
4. If the selected marker is already on, the analyzer will attempt the centering at that marker's frequency. There is no preselector for signals below about 3.6 GHz, therefore if the marker is on a signal below 3.6 GHz, no centering will be attempted and an advisory message generated
5. In some models, the preselector can be bypassed. If it is bypassed, no centering will be attempted in that range and a message will be generated.

Preselector Adjust

Allows you to manually adjust the preselector filter frequency to optimize its response to the signal of interest. This function is only available when "[Presel Center](#)" on page 3111 is available.

For general purpose signal analysis, using Presel Center is recommended. Centering the filter minimizes the impact of long-term preselector drift. Presel Adjust

can be used instead to manually optimize the preselector. One application of manual optimization would be to peak the preselector response, which both optimizes the signal-to-noise ratio and minimizes amplitude variations due to small (short-term) preselector drifting.

Key Path	AMPTD Y Scale
Scope	Meas Global
Remote Command	[:SENSe]:POWer[:RF]:PADJust <freq> [:SENSe]:POWer[:RF]:PADJust?
Example	POW:PADJ 100KHz POW:PADJ?
Notes	The value on the key reads out to 0.1 MHz resolution.
Dependencies	<ul style="list-style-type: none"> - Grayed out if microwave preselector is off.) - Grayed out if entirely in Band 0. - Blank in models that do not include a preselector, such as option 503. If the SCPI is sent in these instruments, it is accepted without error, and the query always returns 0. - Grayed out in the Spectrogram View.
Preset	0 MHz
State Saved	The Presel Adjust value set by Presel Center , or by manually adjusting Presel Adjust , is not saved in instrument state, and does not survive a Preset or power cycle.
Min	-500 MHz
Max	500 MHz
Default Unit	Hz
Backwards Compatibility SCPI	[:SENSe]:POWer[:RF]:MW:PADJust [:SENSe]:POWer[:RF]:MMW:PADJust PSA had multiple preselectors, but the X-Series has only one. These commands simply alias to [:SENSe]:POWer[:RF]:PADJust
Initial S/W Revision	Prior to A.02.00
Modified at S/W Revision	A.03.00

Remote Command	[:SENSe]:POWer[:RF]:PADJust:PRESelector MWAVE MMWave EXTERNAL [:SENSe]:POWer[:RF]:PADJust:PRESelector?
Notes	PSA had multiple preselectors, and you could select which preselector to adjust. Since the X-Series has only one mm/uW preselector, the preselector selection softkey is no longer available. However, to provide backward compatibility, we accept the legacy remote commands. The command form has no effect, the query always returns MWAVE
Initial S/W Revision	Prior to A.02.00

Y Axis Unit

Displays the menu keys that enable you to change the vertical (Y) axis amplitude unit. The analyzer retains the entered Y Axis Unit separately for both Log and Lin amplitude scale types. For example, if Scale Type has been set to Log, and you set Y Axis Unit to dBm, pressing Scale Type (Log) sets the Y Axis Unit to dBm. If Scale Type has been set to Lin and you set Y Axis Unit to V, pressing Scale Type (Lin) sets the Y Axis Unit to V. Pressing Scale Type (Log) again sets the Y axis unit back to dBm.

NOTE

The units of current (A, dBmA, dBuA) are calculated based on 50 ohms input impedance.

All four of the EMI units (dB μ A/m, dB μ V/m, dBG, dBpT) are treated by the instrument exactly as though they were dBuV. The user must load an appropriate correction factor using Amplitude Corrections for accurate and meaningful results.

If a SCPI command is sent to the analyzer that uses one of the EMI units as a terminator, the analyzer treats it as though DBUV had been sent as the terminator.

Key Path	AMPTD Y Scale
Mode	SA
Scope	Meas Global
Remote Command	:UNIT:POWer DBM DBMV DBMA V W A DBUV DBUA DBPW DBUVM DBUAM DBPT DBG :UNIT:POWer?
Example	UNIT:POW dBmV UNIT:POW?
Notes	The Y axis unit has either logarithmic or linear characteristics. The set of units that is logarithmic consists of dBm, dBmV, dBmA, dB μ V, dB μ A, dB μ V/m, dB μ A/m, dBpT, and dBG. The set of units that are linear consists of V, W, and A. The chosen unit will determine how the reference level and all the amplitude-related outputs like trace data, marker data, etc. read out.
Notes	The settings of Y Axis Unit and Scale Type, affect how the data is read over the remote interface. When using the remote interface no unit is returned, so you must know what the Y axis unit is to interpret the results: Example 1, set the following: Scale Type (Log) Y Axis Unit, dBm Scale/Div, 1 dB Ref Level, 10 dBm This sets the top line to 10 dBm with each vertical division representing 1 dB. Thus, if a point on trace 1 is on the fifth graticule line from the top, it represents 5 dBm and will read out remotely as 5. Example 2, set the following: Scale Type (Lin) Y Axis Unit, Volts Ref Level, 100 mV (10 mV/div)

	This sets the top line to 100 mV and the bottom line to 0 V, so each vertical division represents 10 mV. Thus, if a point on trace 1 is on the fifth graticule line from the top, it represents 50 mV and will read out remotely as 50.
Dependencies	If an amplitude correction with an Antenna Unit other than None is applied and enabled, then that antenna unit is forced and the key with that unit is the only Y Axis Unit available. All other Y Axis Unit keys are grayed out. If an amplitude correction with an Antenna Unit other than None is applied and enabled, and you then turn off that correction or set Apply Corrections to No , the Y Axis Unit that existed before the Antenna Unit was applied is restored.
Couplings	The analyzer retains the entered Y Axis Unit separately for both Log and Lin amplitude scale types
Preset	dBm for log scale, V for linear. The true 'preset' value is dBm, since at preset the Y Scale type is set to logarithmic.
State Saved	Saved in instrument state
Readback line	1-of-N selection
Initial S/W Revision	Prior to A.02.00
Modified at S/W Revision	A.02.00, A.04.00, A.11.00

dBm

Sets the amplitude unit for the selected amplitude scale (log/lin) to dBm.

Key Path	AMPTD Y Scale, Y Axis Unit
Example	UNIT:POW DBM
Dependencies	Grayed out if an Amplitude Correction with an Antenna Unit is ON.
Readback	dBm
Initial S/W Revision	Prior to A.02.00
Modified at S/W Revision	A.02.00

dBmV

Sets the amplitude unit for the selected amplitude scale (log/lin) to dBmV.

Key Path	AMPTD Y Scale, Y Axis Unit
Example	UNIT:POW DBMV
Dependencies	Grayed out if an Amplitude Correction with an Antenna Unit is ON.
Readback	dBmV
Initial S/W Revision	Prior to A.02.00
Modified at S/W Revision	A.02.00

dBmA

Sets the amplitude unit for the selected amplitude scale (log/lin) to dBmA.

Key Path	AMPTD Y Scale, Y Axis Unit
Example	UNIT:POW DBMA
Dependencies	Grayed out if an Amplitude Correction with an Antenna Unit is ON.
Readback	dBmA
Initial S/W Revision	Prior to A.02.00
Modified at S/W Revision	A.02.00

W

Sets the amplitude unit for the selected amplitude scale (log/lin) to watt.

Key Path	AMPTD Y Scale, Y Axis Unit
Example	UNIT:POW W
Dependencies	Grayed out if an Amplitude Correction with an Antenna Unit is ON.
Readback	W
Initial S/W Revision	Prior to A.02.00
Modified at S/W Revision	A.02.00

V

Sets the amplitude unit for the selected amplitude scale (log/lin) to volt.

Key Path	AMPTD Y Scale, Y Axis Unit
Example	UNIT:POW V
Dependencies	Grayed out if an Amplitude Correction with an Antenna Unit is ON.
Readback	V
Initial S/W Revision	Prior to A.02.00
Modified at S/W Revision	A.02.00

A

Sets the amplitude unit for the selected amplitude scale (log/lin) to Ampere.

Key Path	AMPTD Y Scale, Y Axis Unit
Example	UNIT:POW A
Dependencies	Grayed out if an Amplitude Correction with an Antenna Unit is ON.
Readback	A
Initial S/W Revision	Prior to A.02.00
Modified at S/W Revision	A.02.00

dB μ V

Sets the amplitude unit for the selected amplitude scale (log/lin) to dB μ V.

Key Path	AMPTD Y Scale, Y Axis Unit
Example	UNIT:POW DBUV
Dependencies	Grayed out if an Amplitude Correction with an Antenna Unit is ON.
Readback	dB μ V
Initial S/W Revision	Prior to A.02.00
Modified at S/W Revision	A.02.00

dB μ A

Sets the amplitude unit for the selected amplitude scale (log/lin) to dB μ A.

NOTE

The unit dBuA can also appear as an Antenna Unit. This will be used by customers using current probes, because current probes are often supplied with conversion tables that provide the transducer factors. When dBuA is used as an Antenna Unit the normal conversion from power to amps for dBuA (based on the analyzer input impedance) is not done, but instead the conversion is based solely on the Correction that contains the transducer factors. This is what distinguishes dBuA as a normal unit from dBuA as an antenna unit. When querying the Y-Axis unit, you can query the Antenna Unit to distinguish between regular dBuA and the dBuA antenna unit. If :CORR:CSET:ANT? returns NOC (for No Conversion), you are using a normal Y Axis dBuA. If it returns UA you are using an Antenna Unit dBuA.

Key Path	AMPTD Y Scale, Y Axis Unit
Example	UNIT:POW DBUA
Dependencies	Grayed out if an Amplitude Correction with an Antenna Unit is ON.
Readback	dB μ A
Initial S/W Revision	Prior to A.02.00
Modified at S/W Revision	A.02.00

Antenna Unit

When a Correction is turned on that uses an Antenna Unit, the Y Axis Unit changes to that Antenna Unit. All of the keys in the Y-Axis Unit menu are then greyed out, except the Antenna Unit key. The unit being used is shown on this key and is shown as selected in the submenu.

Key Path	AMPTD Y Scale, Y Axis Unit
Dependencies	Grayed out if no Amplitude Correction with an Antenna Unit is on.
Readback line	Currently selected unit
Initial S/W Revision	A.11.00

dB μ V/m

Sets the amplitude unit for the selected amplitude scale (log/lin) to dB μ V/m. This is an antenna unit, and this key is grayed out unless a Correction with this Antenna Unit selected is ON. If this is the case, all of the other Antenna Units are grayed out.

Key Path	AMPTD Y Scale, Y Axis Unit, Antenna Unit
Example	UNIT:POW DBUVM
Dependencies	Grayed out if no Amplitude Correction with an Antenna Unit is on.
Readback	dB μ V/m
Initial S/W Revision	A.02.00

dB μ A/m

Sets the amplitude unit for the selected amplitude scale (log/lin) to dB μ A/m. This is an antenna unit, and this key is grayed out unless a Correction with this Antenna Unit selected is ON. If this is the case, all of the other Antenna Units are grayed out.

Key Path	AMPTD Y Scale, Y Axis Unit, Antenna Unit
Example	UNIT:POW DBUAM
Dependencies	Grayed out if no Amplitude Correction with an Antenna Unit is on.
Readback	dB μ A/m
Initial S/W Revision	A.02.00

dB μ A

Sets the amplitude unit for the selected amplitude scale (log/lin) to dB μ A. This is an antenna unit, and this key is grayed out unless a Correction with this Antenna Unit selected is ON. If this is the case, all of the other Antenna Units are grayed out.

Key Path	AMPTD Y Scale, Y Axis Unit, Antenna Unit
Example	UNIT:POW DBUAM
Dependencies	Grayed out if no Amplitude Correction with an Antenna Unit is on.
Readback	dB μ A
Initial S/W Revision	A.11.00

dBpT

Sets the amplitude unit for the selected amplitude scale (log/lin) to dBpT. This is an antenna unit, and this key is grayed out unless a Correction with this Antenna Unit selected is ON. If this is the case, all of the other Antenna Units are grayed out.

Key Path	AMPTD Y Scale, Y Axis Unit, Antenna Unit
Example	UNIT:POW DBPT
Dependencies	Grayed out if no Amplitude Correction with an Antenna Unit is on.

Readback	dBpT
Initial S/W Revision	A.02.00

dBG

Sets the amplitude unit for the selected amplitude scale (log/lin) to dBG. This is an antenna unit, and this key is grayed out unless a Correction with this Antenna Unit selected is ON. If this is the case, all of the other Antenna Units are grayed out.

Key Path	AMPTD Y Scale, Y Axis Unit, Antenna Unit
Example	UNIT:POW DBG
Dependencies	Grayed out if no Amplitude Correction with an Antenna Unit is on.
Readback	dBG
Initial S/W Revision	A.02.00

None

This is selected if no Antenna Unit is currently on, however you cannot actually set this value, since it is always grayed out. The key is included simply to provide an indication on the Readback line of the Antenna Unit key when there is no Antenna Unit selected.

Key Path	AMPTD Y Scale, Y Axis Unit, Antenna Unit
Readback	"None"
Initial S/W Revision	A.11.00

Reference Level Offset

Adds an offset value to the displayed reference level. The reference level is the absolute amplitude represented by the top graticule line on the display.

See ["More Information" on page 2600](#)

Key Path	AMPTD Y Scale
Mode	SA
Scope	Meas Global
Remote Command	:DISPlay:WINDow[1]:TRACe:Y[:SCALe]:RLEVel:OFFSet <rel_amp1> :DISPlay:WINDow[1]:TRACe:Y[:SCALe]:RLEVel:OFFSet?
Example	DISP:WIND:TRAC:Y:RLEV:OFFS 12.7 Sets the Ref Level Offset to 12.7 dB. The only valid suffix is dB. If no suffix is sent, dB will be assumed.
Preset	0 dBm
State Saved	Saved in instrument state
Min	The range for Ref Lvl Offset is variable. It is limited to values that keep the reference level within the range of -327.6 dB to 327.6 dB.

Max	327.6 dB
Backwards Compatibility Notes	<p>6. In pre-X-Series instruments, Ref Level Offset could not be adjusted by the knob or step keys. That is no longer the case.</p> <p>7. In ESA and PSA, Ref Level Offset was applied to the data as it was acquired; thus if the Offset changed the new offset was not applied until new trace data was taken. In X-Series, the offset is applied as the data is displayed/queried, so if you change the offset, it will change the data immediately.</p>
Initial S/W Revision	Prior to A.02.00
Modified at S/W Revision	A.04.00

More Information

Offsets are used when gain or loss occurs between a device under test and the analyzer input. Thus, the signal level measured by the analyzer may be thought of as the level at the input of an external amplitude conversion device. Entering an offset does not affect the trace position or attenuation value, just the value of the top line of the display and the values represented by the trace data. Thus, the values of exported trace data, queried trace data, marker amplitudes, trace data used in calculations such as N dB points, trace math, peak threshold, and so forth, are all affected by Ref Level Offset.

NOTE

Changing the offset causes the analyzer to immediately stop the current sweep and prepare to begin a new sweep, but the data will not change until the trace data updates, because the offset is applied to the data as it is taken. If a trace is exported with a nonzero Ref Level Offset, the exported data will contain the trace data with the offset applied.

The maximum reference level available is dependent on the reference level offset. That is, Ref Level - Ref Level Offset must be in the range -170 to +30 dBm. For example, the reference level value range can be initially set to values from -170 dBm to 30 dBm with no reference level offset. If the reference level is first set to -20 dBm, then the reference level offset can be set to values of -150 to +50 dB.

If the reference level offset is first set to -30 dB, then the reference level can be set to values of -200 dBm to 0 dBm. In this case, the reference level is “clamped” at 0 dBm because the maximum limit of +30 dBm is reached with a reference level setting of 0 dBm with an offset of -30 dB. If instead, the reference level offset is first set to 30 dB, then the reference level can be set to values of -140 to +60 dBm.

μW Path Control

The **μW Path Control** functions include the **μW Preselector Bypass** (Option MPB) and **Low Noise Path** (Option LNP) controls in the High Band path circuits.

When the μW Preselector is bypassed, the user has better flatness, but will be subject to spurs from out of band interfering signals. When the Low Noise Path is enabled, the analyzer automatically switches around certain circuitry in the high

frequency bands which can contribute to noise, when it is appropriate based on other analyzer settings.

For most applications, the preset state is Standard Path, which gives the best remote-control throughput, minimizes acoustic noise from switching and minimizes the risk of wear out in the hardware switches. For applications that utilize the wideband IF paths, the preset state is the μ W Preselector Bypass path, if option MPB is present. This is because, when using a wideband IF such as the 140 MHz IF, the μ W Preselector's bandwidth can be narrower than the available IF bandwidth, causing degraded amplitude flatness and phase linearity, so it is desirable to bypass the preselector in the default case.

Users may choose Low Noise Path Enable. It gives a lower noise floor, especially in the 21–26.5 GHz region, though without improving many measures of dynamic range, and without giving the best possible noise floor. The preamp, if purchased and used, gives better noise floor than does the Low Noise Path, however its compression threshold and third-order intercept are much poorer than that of the non-preamp Low Noise Path. There are some applications, typically for signals around –30 dBm, for which the third-order dynamic range of the standard path is good enough, but the noise floor is not low enough even with 0 dB input attenuation. When the third-order dynamic range of the preamp path is too little and the noise floor of the standard path is too high, the Low Noise Path can provide the best dynamic range.

Key Path	AMPTD Y Scale
Mode	SA, BASIC, PNOISE, VSA , LTE, LTETDD
Scope	Meas Global
Remote Command	[:SENSe] : POWer [: RF] : MW : PATH STD LNPath MPBypass FULL [:SENSe] : POWer [: RF] : MW : PATH?
Example	:POW:MW:PATH LNP Enables the Low Noise path
Notes	If a Presel Center is performed, the analyzer will momentarily switch to the Standard Path, regardless of the setting of μW Path Control The DC Block will always be switched in when the low noise path is switched in, to protect succeeding circuitry from DC. Note that this does not mean “when the low noise path is enabled” but when, based on the Low Noise Path rules, the path is actually switched in. This can happen when the selection is Low Noise Path Enable . In the case where the DC Block is switched in the analyzer is now AC coupled. However, if the user has selected DC coupling, the UI will still behave as though it were DC coupled, including all annunciation, warnings, status bits, and responses to SCPI queries. This is because, based on other settings, the analyzer could switch out the low noise path at any time and hence go back to being DC coupled. Alignment switching ignores the settings in this menu, and restores them when finished.
Dependencies	Unavailable in BBIQ and External Mixing
Preset	All modes other than IQ Analyzer mode and VXA: STD IQ Analyzer, VXA and WLAN mode: MPB option present and licensed: MPB MPB option not present and licensed: STD
State Saved	Save in instrument state

Readback	Value selected in the submenu
Initial S/W Revision	A.04.00
Modified at S/W Revision	A.10.00

Standard Path

This path gives the best remote-control throughput, minimizes acoustic noise from switching and minimizes the risk of wear in the hardware switches, particularly in remote test scenarios where both low band and high band setups will follow in rapid succession.

In this path, the bypass of the low band/high band switch and microwave preamp is never activated, which can cause some noise degradation but preserves the life of the bypass switch.

Key Path	AMPTD Y Scale, μW Path Control
Example	:POW:MW:PATH STD
Readback Text	Standard Path
Initial S/W Revision	A.04.00

μ W Preselector Bypass

This key toggles the preselector bypass switch for band 1 and higher. When the microwave preselect is on, the signal path is preselected. When the microwave preselector is off, the signal path is not preselected. The preselected path is the normal path for the analyzer.

The preselector is a tunable bandpass filter which prevents signals away from the frequency of interest from combining in the mixer to generate in-band spurious signals (images). The consequences of using a preselector filter are its limited bandwidth, the amplitude and phase ripple in its passband, and any amplitude and phase instability due to center frequency drift.

Option MPB or pre-selector bypass provides an unpreselected input mixer path for certain X-Series signal analyzers with frequency ranges above 3.6 GHz. This signal path allows a wider bandwidth and less amplitude variability, which is an advantage when doing modulation analysis and broadband signal analysis. The disadvantage is that, without the preselector, image signals will be displayed. Another disadvantage of bypassing the preselector is increased LO emission levels at the front panel input port.

Image responses are separated from the real signal by twice the 1st IF. For IF Paths of 10 MHz and 25 MHz, the 1st IF is 322.5 MHz, so the image response and the real signal will be separated by 645 MHz. The 1st IF will be different for other IF Path settings. When viewing a real signal and its corresponding image response in internal mixing, the image response will be to the left of the real signal.

Also, the image response and the real signal typically have the same amplitude and exhibit the same shape factor.

However, if Option FS1, Fast Sweep Capability, is enabled, the image response in the Swept SA measurement will appear lower in amplitude and have a much wider shape factor compared to the real signal.

Key Path	AMPTD Y Scale, μW Path Control
Example	:POW:MW:PATH MPB
Dependencies	Key is blanked if current mode does not support it. Key is grayed out if mode supports it but current measurement does not support it. Key is blank unless Option MPB is present and licensed. If SCPI command sent when MPB not present, error -241, "Hardware missing; Option not installed" is generated.
Readback Text	μ W Preselector Bypass
Initial S/W Revision	A.04.00

Remote Command	[:SENSe]:POWer[:RF]:MW:PRESelector[:STATe] ON OFF 0 1 [:SENSe]:POWer[:RF]:MW:PRESelector[:STATe]?
Example	:POW:MW:PRES OFF Bypasses the microwave preselector
Notes	The ON parameter sets the STD path (:POW:MW:PATH STD) The OFF parameter sets path MPB (:POW:MW:PATH MPB)
Preset	ON

Internal Preamp

Accesses a menu of keys that control the internal preamps. Turning on the preamp gives a better noise figure, but a poorer TOI to noise floor dynamic range. You can optimize this setting for your particular measurement.

The instrument takes the preamp gain into account as it sweeps. If you sweep outside of the range of the preamp the instrument will also account for that. The displayed result will always reflect the correct gain.

For some measurements, when the preamp is on and any part of the displayed frequency range is below the lowest frequency for which the preamp has specifications, a warning condition message appears in the status line. For example ,for a preamp with a 9 kHz lowest specified frequency: "Preamp: Accy unspec'd below 9 kHz".

Key Path	AMPTD Y Scale
Scope	Meas Global
Remote Command	[:SENSe]:POWer[:RF]:GAIN[:STATe] OFF ON 0 1 [:SENSe]:POWer[:RF]:GAIN[:STATe]?
Dependencies	Preamp is not available on all hardware platforms. If the preamp is not present or is unlicensed,

	the key is not shown. The preamp is not available when the electronic/soft attenuator is enabled.
Couplings	The act of connecting the U7227A USB Preamplifier to one of the analyzer's USB ports will cause the Internal Preamp to be switched on. When this happens an informational message will be generated: "Internal Preamp turned on for optimal operation with USB Preamp." Note that if the Internal Preamp was already on, there will be no change to the setting, but if it was Off it will be switched On, to Full Range. Note that this same action occurs when the SA mode is selected while the USB Preamp is connected to one of the analyzer's USB ports, if it is the first time that the SA mode has run since powerup, or if the last time the SA mode was running the USB Preamp was NOT connected. Subsequently disconnecting the USB Preamp from USB does not change the Internal Preamp setting nor restore the previous setting.
Preset	OFF
State Saved	Saved in instrument state
Initial S/W Revision	Prior to A.02.00
Modified at S/W Revision	A.14.00

Key Path	AMPTD Y Scale, Internal Preamp
Scope	Meas Global
Remote Command	[:SENSe] :POWer [:RF] :GAIN :BAND LOW FULL [:SENSe] :POWer [:RF] :GAIN :BAND ?
Dependencies	Preamp is not available on all hardware platforms. If the preamp is not present or is unlicensed, the key is not shown. If a POW:GAIN:BAND FULL command is sent when a low band preamp is available, the preamp band parameter is to LOW instead of FULL, and an "Option not installed" message is generated.
Preset	LOW
State Saved	Saved in instrument state
Initial S/W Revision	Prior to A.02.00

Off

Turns the internal preamp off

Key Path	AMPTD Y Scale, Internal Preamp
Example	:POW:GAIN OFF
Readback	Off
Initial S/W Revision	Prior to A.02.00

Low Band

Sets the internal preamp to use only the low band.

The frequency range of the installed (optional) low-band preamp is displayed in square brackets on the **Low Band** key label.

Key Path	AMPTD Y Scale, Internal Preamp
Example	:POW:GAIN ON :POW:GAIN:BAND LOW
Readback	Low Band
Initial S/W Revision	Prior to A.02.00

Full Range

Sets the internal preamp to use its full range. The low band (0-3.6 GHz or 0-3GHz, depending on the model) is supplied by the low band preamp and the frequencies above low band are supplied by the high band preamp.

The frequency range of the installed (optional) preamp is displayed in square brackets on the **Full Range** key label. If the high band option is not installed the Full Range key does not appear.

Key Path	AMPTD Y Scale, Internal Preamp
Example	:POW:GAIN ON :POW:GAIN:BAND FULL
Readback	Full Range
Initial S/W Revision	Prior to A.02.00

Ref Position

Positions the reference level at the top, center or bottom of the Y scale display. Changing the reference position does not affect the reference level value.

Key Path	AMPTD Y Scale
Mode	SA, WCDMA, C2K, WIMAX OFDMA, TD-SCDMA, 1xEVDO, DTMB (CTTB), DVB-T/H, ISDB-T, CMMB, LTE, LTETDD, Digital Cable TV, WLAN, MSR, LTEAFDD, LTEATDD
Remote Command	:DISPlay:SEMask:VIEW[1]:WINDow[1]:TRACe:Y[:SCALE]:RPOsition TOP CENTER BOTTom :DISPlay:SEMask:VIEW[1]:WINDow[1]:TRACe:Y[:SCALE]:RPOsition?
Example	DISP:SEM:VIEW:WIND:TRAC:Y:RPOS BOTT DISP:SEM:VIEW:WIND:TRAC:Y:RPOS?
Notes	You must be in the mode that includes SEM measurement to use this command. Use :INSTrument:SElect to set the mode.
Preset	TOP
State Saved	Saved in instrument state
Range	Top Ctr Bot
Initial S/W Revision	Prior to A.02.00
Modified at S/W Revision	A.02.00, A.03.00

Auto Scaling

Toggles the Auto Scaling function between On and Off.

When Auto Scaling is On and the Restart front-panel key is pressed, the analyzer automatically determines the scale per division and reference values based on the measurement results. When you set a value to either Scale/Div or Ref Value manually, Auto Scaling automatically changes to Off.

Key Path	AMPTD Y Scale
Mode	SA, WCDMA, C2K, WIMAX OFDMA, TD-SCDMA, 1xEVDO, DTMB (CTTB), DVB-T/H, ISDB-T, CMMB, LTE, LTE-TDD, Digital Cable TV, WLAN, MSR, LTEAFDD, LTEATDD
Remote Command	:DISPlay:SEMask:VIEW[1]:WINDow[1]:TRACe:Y[:SCALE]:COUPle 0 1 ON OFF :DISPlay:SEMask:VIEW[1]:WINDow[1]:TRACe:Y[:SCALE]:COUPle?
Example	DISP:SEM:VIEW:WIND:TRAC:Y:COUP OFF DISP:SEM:VIEW:WIND:TRAC:Y:COUP?
Notes	You must be in the mode that includes SEM measurement to use this command. Use :INSTrument:SElect to set the mode.
Couplings	When Auto Scaling is On, upon pressing the Restart front-panel key, this function automatically determines the scale per division and reference values based on the measurement results. When you set a value to either Scale/Div or Ref Value manually, Auto Scaling automatically changes to Off.
Preset	ON
State Saved	Saved in instrument state
Range	On Off
Initial S/W Revision	Prior to A.02.00
Modified at S/W Revision	A.02.00, A.03.00

Auto Couple

The Auto Couple feature provides a quick and convenient way to automatically couple multiple instrument settings. This helps ensure accurate measurements and optimum dynamic range. When the Auto Couple feature is activated, either from the front panel or remotely, all parameters of the current measurement that have an Auto/Manual mode are set to Auto mode and all measurement settings dependent on (or coupled to) the Auto/Man parameters are automatically adjusted for optimal performance.

However, the Auto Couple keyactions are confined to the current measurement only. It does not affect other measurements in the mode, and it does not affect markers, marker functions, or trace or display attributes.

See "[More Information](#)" on page 2607

Key Path	Front-panel key
Remote Command	:COUPle ALL NONE
Example	:COUP ALL
Notes	:COUPle ALL puts all Auto/Man parameters in Auto mode (equivalent to pressing the Auto Couple key). :COUPLE NONE puts all Auto/Man parameters in manual mode. It decouples all the coupled instrument parameters and is not recommended for making measurements.
Initial S/W Revision	Prior to A.02.00

More Information

There are two types of functions that have Auto/Manual modes.

Auto/Man Active Function keys

An Auto/Man toggle key controls the binary state associated with an instrument parameter by toggling between **Auto** (where the parameter is automatically coupled to the other parameters it is dependent upon) and **Man** (where the parameter is controlled independent of the other parameters), as well as making the parameter the active function. The current mode is indicated on the softkey with either **Auto** or **Man** underlined as illustrated below.

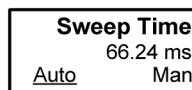

vsd07

Auto/Man 1-of-N keys

An Auto/Man 1-of-N key allows you to manually pick from a list of parameter values, or place the function in Auto, in which case the value is automatically selected (and indicated).

- If in Auto, Auto is underlined on the calling key.

- If in manual operation, manual is indicated on the calling key, but note that the calling key simply opens the menu and does **not** actually toggle the function.

BW

Accesses a menu of functions that enable you to select the type of filter for the measurement.

Key Path	Front-panel key
Initial S/W Revision	Prior to A.02.00
Modified at S/W Revision	A.03.00

Filter Type

Selects the type of bandwidth filter that is used in Carrier and Offsets.

When Gaussian or Flattop is selected, selected filter is applied to carriers and all offsets.

When Auto Sense is selected, filter type is automatically selected for each carriers and offsets, so that measurement speed and accuracy is optimized.

Key Path	BW
Mode	SA, WCDMA, C2K, WIMAX OFDMA, TD-SCDMA, 1xEVDO, DVB-T/H, DTMB (CTTB), ISDB-T, CMMB, LTE, LTETDD, Digital Cable TV, WLAN, MSR, LTEAFDD, LTEATDD
Remote Command	[:SENSe] :SEMAsk :BANDwidth :SHAPE ASEnse GAUSSian FLATtop [:SENSe] :SEMAsk :BANDwidth :SHAPE?
Example	SEM:BAND:SHAP GAUS SEM:BAND:SHAP?
Couplings	See the description above
Preset	ASEnse
State Saved	Saved in instrument state
Range	Auto Sense (each offset and carrier) Gaussian (all offsets and carriers) Flattop (all offsets and carriers)
Initial S/W Revision	A.03.00

Cont (Continuous Measurement/Sweep)

Sets the analyzer for Continuous measurement operation. The single/continuous state is Meas Global so the setting will affect all measurements. If you are Paused, pressing **Cont** does a Resume.

Key Path	Front-panel key
Remote Command	:INITiate:CONTinuous OFF ON 0 1 :INITiate:CONTinuous?
Example	:INIT:CONT 0 puts analyzer in Single measurement operation. :INIT:CONT 1 puts analyzer in Continuous measurement operation
Preset	ON (Note that SYST:PRESet sets INIT:CONT to ON but *RST sets INIT:CONT to OFF)
State Saved	Saved in instrument state
Backwards Compatibility Notes	For Spectrum Analysis mode in ESA and PSA, there is no Cont hardkey, instead there is a Sweep Single/Cont key. In these analyzers, switching the Sweep Single/Cont key from Single to Cont restarts averages (displayed average count reset to 1), but does not restart Max Hold and Min Hold . The X-Series has Single and Cont keys in place of the SweepSingleCont key. In the X-Series, if in single measurement, the Cont key (and INIT:CONT ON) switches to continuous measurement, but never restarts a measurement and never resets a sweep.
Initial S/W Revision	Prior to A.02.00

In Swept SA Measurement (Spectrum Analysis Mode):

The analyzer takes repetitive sweeps, averages, measurements, etc., when in Continuous mode. When the average count reaches the Average/Hold Number the count stops incrementing, but the analyzer keeps sweeping. See the Trace/Detector section for the averaging formula used both before and after the Average/Hold Number is reached. The trigger condition must be met prior to each sweep. The type of trace processing for multiple sweeps, is set under the Trace/Detector key, with choices of **Trace Average**, **Max Hold**, or **Min Hold**.

In Other Measurements/Modes:

With **Avg/Hold Num** (in the **Meas Setup** menu) set to **Off** or set to **On** with a value of 1, a sweep is taken after the trigger condition is met; and the analyzer continues to take new sweeps after the current sweep has completed and the trigger condition is again met. However, with **Avg/Hold Num** set to On with a value >1, multiple sweeps (data acquisitions) are taken for the measurement. The trigger condition must be met prior to each sweep. The sweep is not stopped when the average count k equals the number N set for Avg/Hold Num is reached, but the number k stops incrementing. A measurement average usually applies to all traces, marker results, and numeric results. But sometimes it only applies to the numeric results.

If the analyzer is in Single measurement, pressing the **Cont** key does not change k and does not cause the sweep to be reset; the only action is to put the analyzer into Continuous measurement operation.

If it is already in continuous sweep:

the INIT:CONT 1 command has no effect

the INIT:CONT 0 command will place the analyzer in Single Sweep but will have no effect on the current sequence until $k = N$, at which point the current sequence will stop and the instrument will go to the idle state.

File

See "File" on page 426

FREQ Channel

Accesses a menu of keys that allow you to control the Frequency and Channel parameters of the instrument.

Some features in the Frequency menu are the same for all measurements – they do not change as you change measurements. Settings like these are called “Meas Global” and are unaffected by Meas Preset. For example, the Center Freq setting is the same for all measurements – it does not change as you change measurements.

Key Path	Front-panel key
Initial S/W Revision	Prior to A.02.00

Center Freq

Sets the frequency that corresponds to the horizontal center of the graticule (when frequency Scale Type is set to linear). While adjusting the Center Frequency the Span is held constant, which means that both Start Frequency and Stop Frequency will change.

Pressing Center Freq also sets the frequency entry mode to Center/Span. In Center/Span mode, the center frequency and span values are displayed below the graticule, and the default active function in the Frequency menu is **Center Freq**.

The center frequency setting is the same for all measurements within a mode, that is, it is Meas Global. Some modes are also able to share a Mode Global center frequency value. If this is the case, the Mode will have a **Global Settings** key in its **Mode Setup** menu.

The **Center Freq** function sets (and queries) the Center Frequency for the currently selected input. If your analyzer has multiple inputs, and you select another input, the Center Freq changes to the value for that input. SCPI commands are available to directly set the Center Freq for a specific input.

Center Freq is remembered as you go from input to input. Thus you can set a Center Freq of 10 GHz with the RF Input selected, change to BBIQ and set a Center Freq of 20 MHz, then switch to External Mixing and set a Center Freq of 60 GHz, and when you go back to the RF Input the Center Freq will go back to 10 GHz; back to BBIQ and it is 20 MHz; back to External Mixing and it is 60 GHz.

See ["RF Center Freq" on page 2617](#)

See [Ext Mix Center Freq](#)

See ["I/Q Center Freq" on page 2618](#)

See ["Center Frequency Presets" on page 2614](#)

Key Path	FREQ Channel
Scope	Meas Global
Remote Command	[:SENSe] :FREQuency :CENTer <freq> [:SENSe] :FREQuency :CENTer ?

Example	FREQ:CENT 50 MHz FREQ:CENT UP changes the center frequency to 150 MHz if you use FREQ:CENT:STEP 100 MHz to set the center frequency step size to 100 MHz FREQ:CENT?
Notes	This command sets either the RF or I/Q Center Frequency depending on the selected input. For RF input it is equivalent to FREQ:RF:CENT For I/Q input it is equivalent to FREQ:IQ:CENT Preset and Max values are dependent on Hardware Options (5xx) If no terminator (e.g. MHz) is sent the terminator Hz is used. If a terminator with unit other than Frequency is used, an invalid suffix error message is generated.
Dependencies	The Center Frequency can be limited by Start or Stop Freq limits, if the Span is so large that Start or Stop reach their limit.
Couplings	When operating in "swept span", any value of the Center Frequency or Span that is within the frequency range of the analyzer is allowed when the value is being set through the front panel numeric key pad or the SCPI command. The other parameter is forced to a different value if needed, to keep the Start and the Stop Frequencies within the analyzer's frequency range
Preset	Depends on instrument maximum frequency, mode, measurement, and selected input. See "Center Frequency Presets" on page 2614 and "RF Center Freq" on page 2617 and Ext Mix Center Freq and "I/Q Center Freq" on page 2618.
State Saved	Saved in instrument state
Min	Depends on instrument maximum frequency, mode, measurement, and selected input.. See "Center Frequency Presets" on page 2614 and "RF Center Freq" on page 2617 and "I/Q Center Freq" on page 2618.
Max	Depends on instrument maximum frequency, mode, measurement, and selected input.. See "Center Frequency Presets" on page 2614 and "RF Center Freq" on page 2617 and "I/Q Center Freq" on page 2618.
Default Unit	Hz
Status Bits/OPC Dependencies	Non-overlapped
Initial S/W Revision	Prior to A.02.00

Center Frequency Presets

The following table provides the Center Frequency Presets for the Spectrum Analyzer mode, and the Max Freq, for the various frequency options:

Freq Option	CF after Mode Preset	Stop Freq after Mode Preset	Max Freq (can't tune above)
503 (all but N9000A)		1.805 GHz	3.6 GHz 3.7 GHz

15 Spectrum Emission Mask Measurement
FREQ Channel

Freq Option	CF after Mode Prese t	Stop Freq after Mode Prese t	Max Freq (can't tune abov e)	
503 (N9000A)		1.505 GHz	3.0 GHz	3.08 GHz
504 (M9420A)		1 GHz	3.8GHz	3.88 GHz
506 (M9420A)		1 GHz	6.0GHz	6.08 GHz
507 (all but N9000A)		3.505 GHz	7.0 GHz	7.1 GHz
507 (N9000A)		3.755 GHz	7.5 GHz	7.58 GHz
508 (all but N9038A)		1.805 GHz	3.6 GHz	8.5 GHz
508 (N9038A)		4.205 GHz	8.4 GHz	8.5 GHz
513		6.805 GHz	13.6 GHz	13.8 GHz
526 (all but N9000A and N9038A)		13.255 GHz	26.5 GHz	27.0 GHz
526 (N9000A)		13.255 GHz	26.5 GHz z	26.5 5 GHz
526 (N9038A)		1.805 GHz	3.6 GHz	27.0 GHz
532	16.005 GHz		32.0 GHz	32.5 GHz
543	21.505 GHz		43.0 GHz	TBD
544	22.005 GHz		44.0 GHz	44.5 GHz
550	25.005 GHz		50.0 GHz	51 GHz

Input 2:

Model	CF after Mode Preset	Stop Freq after Mode Preset	Max Freq (can't tune above)
N9000A opt C75	0.7505GHz	1.5 GHz	1.58 GHz
N9038A	505 MHz	1 GHz	1.000025 GHz

Tracking Generator Frequency Limits (N9000A only):

Tracking Generator Option	Min Freq (clips to this freq when turn TG on and can't tune below while TG on)	If above this Freq, Stop Freq clipped to this Freq when TG turned on	Max Freq (can't tune above) while TG on
T03	9 kHz	3.0 GHz	3.08 GHz
T06	9 kHz	6.0 GHz	6.05 GHz

Tracking Generator Frequency Limits(M9290A only):

Tracking Generator Option	Min Freq (clips to this freq when turn TG on and can't tune below while TG on)	If above this Freq, Stop Freq clipped to this Freq when TG turned on	Max Freq (can't tune above) while TG on
T03	2 MHz	3.08 GHz	3.08 GHz
T07	2 MHz	7.575 GHz	7.575 GHz
T13	2 MHz	13.8 GHz	13.8 GHz
T26	2 MHz	26.55 GHz	26.55 GHz

The following table shows the Center Frequency Presets for modes other than Spectrum Analyzer:

Mode	CF Preset for RF
WCDMA	1 GHz
WIMAXOFDMA,	1 GHz
BASIC	1 GHz
ADEMOD	1 GHz
VSA	1 GHz
TDSCDMA	1 GHz

Mode	CF Preset for RF
PNOISE	1 GHz
LTE	1 GHz
LTETDD	1 GHz
MSR	1 GHz
GSM	935.2 MHz
NFIGURE	1.505 GHz

RF Center Freq

SCPI command for specifying the RF Center Frequency. This command will set the Center Frequency to be used when the RF input is selected, even if the RF input is not the input that is selected at the time the command is sent. Note that the **Center Freq** function in the **Frequency** menu on the front panel always applies to the currently selected input.

Scope	Meas Global
Remote Command	[:SENSe] :FREQuency:RF:CENTer <freq> [:SENSe] :FREQuency:RF:CENTer?
Example	FREQ:RF:CENT 30 MHz
Notes	This command is the same in all modes, but the parameter is Measurement Global. So the value is independent in each mode and common across all the measurements in the mode.
Dependencies	If the electronic/soft attenuator is enabled, any attempt to set Center Frequency such that the Stop Frequency would be >3.6 GHz fails and results in an advisory message. If the equivalent SCPI command is sent, this same message is generated as part of a “-221, Settings conflict” warning. If Source Mode is set to Tracking, and the Max or Min Center Freq is therefore limited by the limits of the source, a warning message is generated, “Data out of range;clipped to source max/min” if these limits are exceeded. Note that for an external source, these limits can be affected by the settings of Source Numerator, Source Denominator and Power Sweep.
Preset	See table above
State Saved	Saved in instrument state.
Min	-79.999995 MHz, unless Source Mode is set to Tracking, in which case it is limited by the minimum frequency of the Source
Max	See table above. Basically instrument maximum frequency - 5 Hz. Note that, if the Source Mode is set to Tracking, the effective instrument maximum frequency may be limited by the source maximum frequency. If the knob or step keys are being used, also depends on the value of the other three interdependent parameters Span, Start Frequency and Stop Frequency
Initial S/W Revision	Prior to A.02.00
Modified at S/W Revision	A.03.00

Ext Mix Center Freq

SCPI command for specifying the External Mixer Center Frequency. This command will set the Center Frequency to be used when the External Mixer is selected, even if the External Mixer input is not the input which is selected at the time the command is sent. Note that the **Center Freq** function in the **Frequency** menu on the front panel always applies to the currently selected input.

Scope	Meas Global
Remote Command	[:SENSe] :FREQuency:EMIXer:CENTer <freq> [:SENSe] :FREQuency:EMIXer:CENTer?
Example	:FREQ:EMIX:CENt 60 GHz :FREQ:EMIX:CENt?
Notes	This command is the same in all modes, but the parameter is Measurement Global. So the value is independent in each mode and common across all the measurements in the mode.
Couplings	When returning to External Mixing after having been switched to one of the other inputs (e.g., RF), you will come back into the settings that you had when you left External Mixing. So you will come back to the band you were in with the Center Frequency that you had. However, Span is not an input-dependent parameter, therefore you will bring the span over from the other input. Therefore, the analyzer comes back with the span from the previous input, limited as necessary by the current mixer setup.
Preset	When a Mode Preset is performed while in External Mixing, the Start frequency of the current Mode is set to the nominal Min Freq of the lowest harmonic range in the Harmonic Table for the current mixer setup. Similarly, the Stop frequency of the current Mode is set to the nominal Max Freq of the highest harmonic range in the Harmonic Table. The Center Freq thus presets to the point arithmetically equidistant from these two frequencies. If the current measurement has a limited Span available to it, and cannot achieve the Span shown in the table (Span=Stop Freq – Start Freq), the analyzer uses the maximum Span the measurement allows, and still sets the Center Freq to the midpoint of the Start and Stop Freq values in the Harmonic Table. When Restore Input/Output Defaults is performed, the mixer presets to the 11970A, whose Start and Stop frequencies are 26.5 and 40 GHz respectively. The center of these two frequencies is 33.25 GHz. Therefore, after a Restore Input/Output Defaults, if you go into External Mixing and do a Mode Preset while in the Spectrum Analyzer Mode, the resulting Center Freq is 33.25 GHz.
State Saved	Saved in instrument state.
Min	The minimum frequency in the currently selected mixer band + 5 Hz
Max	The maximum frequency in the currently selected mixer band - 5 Hz If the knob or step keys are being used, also depends on the value of the other three interdependent parameters Span, Start Frequency and Stop Frequency
Initial S/W Revision	A.08.01

I/Q Center Freq

SCPI command for specifying the I/Q Center Frequency. This command will set the Center Frequency to be used when the I/Q input is selected, even if the I/Q input is not the input which is selected at the time the command is sent. Note that the

Center Freq function in the **Frequency** menu on the front panel always applies to the currently selected input.

Scope	Meas Global
Remote Command	[:SENSe] :FREQuency :IQ :CENTer <freq> [:SENSe] :FREQuency :IQ :CENTer?
Example	FREQ:IQ:CENT: 30 MHz
Notes	This command is the same in all modes, but the parameter is Measurement Global. So the value is independent in each mode and common across all the measurements in the mode.
Preset	0 Hz
State Saved	Saved in instrument state.
Min	-40.049995 MHz
Max	40.049995 MHz
Initial S/W Revision	Prior to A.02.00

CF Step

Changes the step size for the center frequency and start and stop frequency functions. Once a step size has been selected and the center frequency function is active, the step keys (and the UP|DOWN parameters for Center Frequency from remote commands) change the center frequency by the step-size value. The step size function is useful for finding harmonics and sidebands beyond the current frequency span of the analyzer.

Note that the start and stop frequencies also step by the CF Step value.

Key Path	FREQ Channel
Remote Command	[:SENSe] :FREQuency :CENTer :STEP [:INCRement] <freq> [:SENSe] :FREQuency :CENTer :STEP [:INCRement]? [:SENSe] :FREQuency :CENTer :STEP :AUTO OFF ON 0 1 [:SENSe] :FREQuency :CENTer :STEP :AUTO?
Example	FREQ:CENT:STEP:AUTO ON FREQ:CENT:STEP 500 MHz FREQ:CENT UP increases the current center frequency value by 500 MHz FREQ:CENT:STEP? FREQ:CENT:STEP:AUTO?
Notes	Preset and Max values are depending on Hardware Options (503, 507, 508, 513, 526)
Notes	Preset and Max values are dependent on Hardware Options (5xx)
Dependencies	Freq Offset is not available in External Mixing. In this case the Freq Offset key is grayed out and shows a value of zero. It will once again be available, and show the previously set value, when you return to the RF Input.
Dependencies	Span, RBW, Center frequency If the electronic/soft attenuator is enabled, any attempt to change the value of the center frequency >3.6 GHz by pressing the Up-arrow key, fails and results in an advisory message. If the

	equivalent SCPI command is sent, this same message is generated as part of a “-221, Settings conflict” warning.
Couplings	When auto-coupled in a non-zero span, the center frequency step size is set to 10% of the span. When auto-coupled in zero span, the center frequency step size is set to the equivalent -3 dB RBW value.
Preset	Auto ADEMOD: 1 MHz ON
State Saved	Saved in instrument state
Min	– (the maximum frequency of the instrument). That is, 27 GHz max freq instrument has a CF step range of +/- 27 GHz. Note that this is the maximum frequency given the current settings of the instrument, so in External Mixing, for example, it is the maximum frequency of the current mixer band.
Max	The maximum frequency of the instrument. That is, 27 GHz max freq instrument has a CF step range of +/- 27 GHz. Note that this is the maximum frequency given the current settings of the instrument, so in External Mixing, for example, it is the maximum frequency of the current mixer band.
Default Unit	Hz
Status Bits/OPC dependencies	non-overlapped
Initial S/W Revision	Prior to A.02.00
Modified at S/W Revision	A.03.00

Freq Offset

Enables you to set a frequency offset value to account for frequency conversions outside of the analyzer. This value is added to the display readout of the marker frequency, center frequency, start frequency, stop frequency, and all other absolute frequency settings in the analyzer including frequency count. When a frequency offset is entered, the value appears below the center of the graticule. To eliminate an offset, perform a Mode Preset or set the frequency offset to 0 Hz.

See ["More Information" on page 2621](#).

Key Path	FREQ Channel
Scope	Meas Global
Remote Command	[:SENSe] :FREQuency:OFFSet <freq> [:SENSe] :FREQuency:OFFSet?
Example	FREQ:OFFS 10 MHz
Notes	Preset and Max values are dependent on Hardware Options (503, 507, 508, 513, 526)
Dependencies	Freq Offset is not available in External Mixing. In this case the Freq Offset key is grayed out and shows a value of zero. However, the value of CF Offset that was set for the RF Input is retained and restored when the user switches back to the RF Input.

Preset	See " Center Frequency Presets " on page 2932
State Saved	Saved in instrument state
Min	-500 GHz
Max	500 GHz
Default Unit	Hz
Status Bits/OPC dependencies	Non-overlapped
Backwards Compatibility SCPI	DISPlay:WINDow[1]:TRACe:X[:SCALE]:OFFSet
	The DISPlay version of the command is in the instrument for compatibility across platforms and is not recommended for new development.
Backwards Compatibility Notes	<ol style="list-style-type: none"> 1. In pre-X-Series instruments, Frequency Offset could not be adjusted by the knob or step keys. That is no longer the case. 2. Some previous spectrum analyzers did not adjust frequency counter results for the Frequency Offset. The X-Series does adjust the frequency counter for the offset.
Initial S/W Revision	Prior to A.02.00
Modified at S/W Revision	A.04.00, A.08.50

More Information

This command does not affect any bandwidths or the settings of relative frequency parameters such as delta markers or span. It does not affect the current hardware settings of the analyzer, but only the displayed frequency values. Entering an offset does not affect the trace position or display, just the value of the start and stop frequency and the values represented by the trace data. The frequency values of exported trace data, queried trace data, markers, trace data used in calculations such as N dB points, trace math, etc., are all affected by Freq Offset. Changing the offset, even on a trace that is not updating will immediately change all of the above, without taking new data.

NOTE

If a trace is exported with a nonzero Freq Offset, the exported data will contain the trace data with the offset applied. Therefore, if that trace were to be imported back into the analyzer, you would want Freq Offset to be 0, or the offset would be applied again to data which is already offset. No such care need be taken when saving a State+Trace file because the data and state are saved together.

Input/Output

See ["Input/Output" on page 241](#)

Marker

Accesses a menu that enables you to select, set up and control the markers for the current measurement. If there are no active markers, **Marker** selects marker 1, sets it to Normal and places it at the center of the display. You can turn on and control up to 12 markers.

Key Path	Front-panel key
Initial S/W Revision	Prior to A.02.00

Select Marker

Displays 12 markers available for selection.

Key Path	Marker
Initial S/W Revision	Prior to A.02.00

Marker Type

Sets the marker control mode to Normal and Off. If the selected marker is Off, pressing Marker sets it to Normal and places it at the center of the screen on the trace determined by the **Marker Trace** rules. At the same time, **Marker X Axis Value** appears on the Active Function area. The marker X axis value entered in the active function area will display the marker value to its full entered precision. If the current control mode for the measurement is Off, there is no active function and the active function is turned off.

Key Path	Marker
Mode	SA, WCDMA, C2K, WIMAX OFDMA, TD-SCDMA, 1xEVDO, DTMB (CTTB), DVB-T/H, ISDB-T, CMMB, LTE, LTETDD, Digital Cable TV, WLAN, MSR, LTEAFDD, LTEATDD
Remote Command	:CALCulate:SEMask:MARKer[1] 2 ... 12:MODE POSition OFF :CALCulate:SEMask:MARKer[1] 2 ... 12:MODE?
Example	CALC:SEM:MARK:MODE POS CALC:SEM:MARK:MODE?
Notes	If the selected marker is Off, pressing Marker sets it to Normal and places it at the center of the screen on the trace determined by the Marker Trace rules. At the same time, Marker X Axis Value appears on the Active Function area. Default Active Function: the active function for the selected marker's current control mode. Note that if the current control mode is Off, there is no active function and the active function is turned off. Active Function Display: the marker X axis value entered in the active function area will display the marker value to its full entered precision.
Preset	OFF OFF OFF OFF OFF OFF OFF OFF OFF OFF OFF OFF
State Saved	Saved in instrument state
Range	Normal Off

Initial S/W Revision	Prior to A.02.00
Modified at S/W Revision	A.02.00, A.03.00

Couple Markers

When this function is true, moving any marker causes an equal X Axis movement of every other marker that is not **Off**. By “equal X Axis movement” we mean that we preserve the difference between each marker’s X Axis value (in the fundamental x-axis units of the trace that marker is on) and the X Axis value of the marker being moved (in the same fundamental x-axis units).

Key Path	Marker
Mode	SA, WCDMA, C2K, WIMAX OFDMA, TD-SCDMA, 1xEVDO, DTMB (CTTB), DVB-T/H, ISDB-T, CMMB, LTE, LTETDD, Digital Cable TV, WLAN, MSR, LTEAFDD, LTEATDD
Remote Command	:CALCulate:SEMask:MARKer:COUPle[:STATe] ON OFF 1 0 :CALCulate:SEMask:MARKer:COUPle[:STATe]?
Example	CALC:SEM:MARK:COUP ON CALC:SEM:MARK:COUP?
Preset	OFF
State Saved	Saved in instrument state
Range	On Off
Initial S/W Revision	Prior to A.02.00
Modified at S/W Revision	A.02.00, A.03.00

All Markers Off

Turns all active markers off in all views.

Key Path	Marker
Mode	SA, WCDMA, C2K, WIMAX OFDMA, TD-SCDMA, 1xEVDO, DTMB (CTTB), DVB-T/H, ISDB-T, CMMB, LTE, LTETDD, Digital Cable TV, WLAN, MSR, LTEAFDD, LTEATDD
Remote Command	:CALCulate:SEMask:MARKer:AOFF
Example	CALC:SEM:MARK:AOFF
Initial S/W Revision	Prior to A.02.00
Modified at S/W Revision	A.02.00, A.03.00

Marker X Axis Value (Remote Command Only)

Sets the marker X Axis value in the current marker X Axis Scale unit. It has no effect if the control mode is Off, but is the SCPI equivalent of entering an X value if the control mode is **Normal**.

Mode	SA, WCDMA, C2K, WIMAX OFDMA, TD-SCDMA, 1xEVDO, DTMB (CTTB), DVB-T/H ISDB-T, CMMB, LTE, LTETDD, Digital Cable TV, WLAN, MSR, LTEAFDD, LTEATDD
Remote Command	:CALCulate:SEMask:MARKer[1] 2 ... 12:X <freq> :CALCulate:SEMask:MARKer[1] 2 ... 12:X?
Example	CALC:SEM:MARK3:X 1.0 GHz CALC:SEM:MARK3:X?
Notes	If no suffix is sent it will use the fundamental units for the current marker X Axis Scale. If a suffix is sent that does not match the current marker X Axis Scale unit, an error "Invalid suffix" will be generated. The query returns the marker's absolute X Axis value if the control mode is Normal . The query is returned in the fundamental units for the current marker X Axis scale. If the marker is Off the response is not a number. When a Marker is turned on, it is placed center of the screen on the trace.
Preset	After a preset, all Markers are turned OFF, so a Marker X Axis Value query will return a not a number (NAN).
State Saved	No
Min	-9.9E+37
Max	9.9E+37
Initial S/W Revision	Prior to A.02.00
Modified at S/W Revision	A.02.00, A.03.00

Marker X Axis Position (Remote Command Only)

Sets the marker X position in trace points. It has no effect if the control mode is **Off**, but is the SCPI equivalent of entering a value if the control mode is **Normal**, except in trace points rather than X Axis Scale units. The entered value is immediately translated into the current X Axis Scale units for setting the value of the marker.

Mode	SA, WCDMA, C2K, WIMAX OFDMA, TD-SCDMA, 1xEVDO, DTMB (CTTB), DVB-T/H, ISDB-T, CMMB, LTE, LTETDD, Digital Cable TV, WLAN, MSR, LTEAFDD, LTEATDD
Remote Command	:CALCulate:SEMask:MARKer[1] 2 ... 12:X:POsition <real> :CALCulate:SEMask:MARKer[1] 2 ... 12:X:POsition?
Example	CALC:SEM:MARK10:X:POS 1001 CALC:SEM:MARK10:X:POS?
Notes	The query returns the marker's absolute X Axis value in trace points if the control mode is Normal . The value is returned as a real number, not an integer, corresponding to the translation from X Axis Scale units to trace points . If the marker is Off the response is not a number. When a Marker is turned on, it is placed center of the screen on the trace.
Preset	After a preset, all Markers are turned OFF, so a Marker X Axis Value query will return a not a number (NAN).
State Saved	No

Min	-9.9E+37
Max	9.9E+37
Initial S/W Revision	Prior to A.02.00
Modified at S/W Revision	A.02.00, A.03.00

Marker Y Axis Value (Remote Command Only)

Returns the marker Y Axis value in the current marker Y Axis unit.

Mode	SA, WCDMA, C2K, WIMAX OFDMA, TD-SCDMA, 1xEVDO, DTMB (CTTB), DVB-T/H, ISDB-T, CMMB, LTE, LTE-TDD, Digital Cable TV, WLAN, MSR, LTEAFDD, LTEATDD
Remote Command	:CALCulate:SEMask:MARKer[1] 2 ... 12:Y?
Example	CALC:SEM:MARK11:Y 10 dBm CALC:SEM:MARK11:Y?
Notes	Since the result value is always calculated from acquisition data, the default value is arbitrary, although the Preset/Default values is defined.
Preset	Result dependent on markers setup and signal source
State Saved	No
Backwards Compatibility SCPI	:CALCulate:SEMask:MARKer[1] 2 ... 12:FUNCTION:RESult?
Initial S/W Revision	Prior to A.02.00
Modified at S/W Revision	A.02.00, A.03.00

Marker Function

There are no 'Marker Functions' supported in Spectrum Emission Mask so this front-panel key displays a blank menu when pressed.

Key Path	Front-panel key
Initial S/W Revision	Prior to A.02.00

Marker To

There is no 'Marker To' functionality supported in Spectrum Emission Mask so this front-panel key displays a blank menu when pressed.

Key Path	Front-panel key
Initial S/W Revision	Prior to A.02.00

Meas

The information in this section is common to all measurements. For key and remote command information for a specific measurement, refer to the section that describes the measurement of interest.

Measurements available under the Meas key are specific to the current Mode.

When viewing Help for measurements, note the following:

NOTE

Operation for some keys differs between measurements. The information displayed in Help pertains to the current measurement. To see how a key operates in a different measurement, exit Help (press the Cancel Esc key), select the measurement, then reenter Help (press the Help key) and press that key.

Key Path	Front-panel key
Initial S/W Revision	Prior to A.02.00

Remote Measurement Functions

This section contains the following topics:

["Measurement Group of Commands" on page 3141](#)

["Current Measurement Query \(Remote Command Only\)" on page 3144](#)

["Limit Test Current Results \(Remote Command Only\)" on page 3144](#)

["Data Query \(Remote Command Only\)" on page 3144](#)

["Calculate/Compress Trace Data Query \(Remote Command Only\)" on page 3144](#)

["Calculate Peaks of Trace Data \(Remote Command Only\)" on page 3150](#)

["Hardware-Accelerated Fast Power Measurement \(Remote Command Only\)" on page 3151](#)

["Format Data: Numeric Data \(Remote Command Only\)" on page 3165](#)

["Format Data: Byte Order \(Remote Command Only\)" on page 3166](#)

Initial S/W Revision	Prior to A.02.00
----------------------	------------------

Measurement Group of Commands

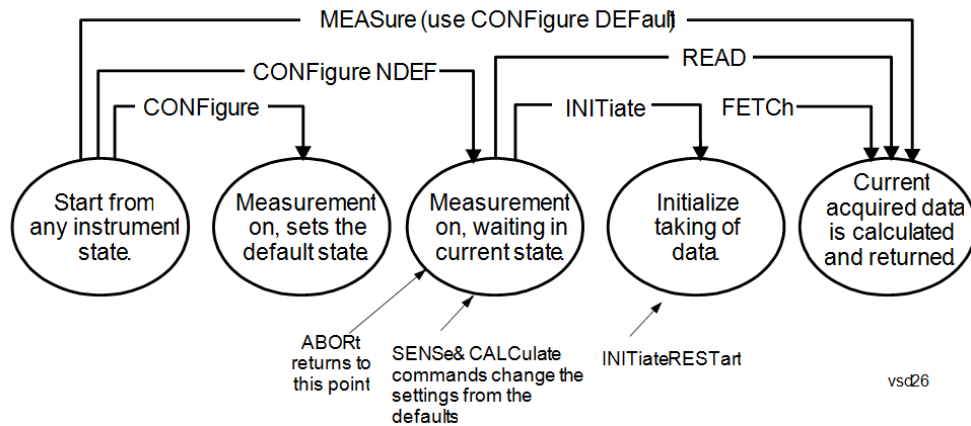

Measure Commands:

```
:MEASure:<measurement>[n]?
```

This is a fast single-command way to make a measurement using the factory default instrument settings. These are the settings and units that conform to the Mode Setup settings (e.g. radio standard) that you have currently selected.

- Stops the current measurement (if any) and sets up the instrument for the specified measurement using the factory defaults
- Initiates the data acquisition for the measurement
- Blocks other SCPI communication, waiting until the measurement is complete before returning results.
- If the function does averaging, it is turned on and the number of averages is set to 10.
- After the data is valid it returns the scalar results, or the trace data, for the specified measurement. The type of data returned may be defined by an [n] value that is sent with the command.
- The scalar measurement results will be returned if the optional [n] value is not included, or is set to 1. If the [n] value is set to a value other than 1, the selected trace data results will be returned. See each command for details of what types of scalar results or trace data results are available.
- ASCII is the default format for the data output. (Older versions of Spectrum Analysis and Phase Noise mode measurements only use ASCII.) The binary data formats should be used for handling large blocks of data since they are smaller and faster than the ASCII format. Refer to the FORMat:DATA command for more information.

If you need to change some of the measurement parameters from the factory default settings you can set up the measurement with the CONFIGure command. Use the commands in the SENSE:<measurement> and CALCulate:<measurement> subsystems to change the settings. Then you can use the READ? command to initiate the measurement and query the results.

If you need to repeatedly make a given measurement with settings other than the factory defaults, you can use the commands in the SENSE:<measurement> and CALCulate:<measurement> subsystems to set up the measurement. Then use the READ? command to initiate the measurement and query results.

Measurement settings persist if you initiate a different measurement and then return to a previous one. Use READ:<measurement>? if you want to use those persistent settings. If you want to go back to the default settings, use MEASure:<measurement>?.

Configure Commands:

:CONFigure:<measurement>

This command stops the current measurement (if any) and sets up the instrument for the specified measurement using the factory default instrument settings. It does not initiate the taking of measurement data unless INIT:CONTinuous is ON. If you change any measurement settings after using the CONFigure command, the READ command can be used to initiate a measurement without changing the settings back to their defaults.

In the Swept SA measurement in Spectrum Analyzer mode the CONFigure command also turns the averaging function on and sets the number of averages to 10 for all measurements.

:CONFigure: <measurement>: NDEFault stops the current measurement and changes to the specified measurement. It does not change the settings to the defaults. It does not initiate the taking of measurement data unless INIT:CONTinuous is ON.

The CONFigure? query returns the current measurement name.

The CONFigure:CATalog? query returns a quoted string of all licensed measurement names in the current mode. For example, "SAN, CHP, OBW, ACP, PST, TXP, SPUR, SEM, LIST".

Fetch Commands:

:FETCh:<measurement>[n]?

This command puts selected data from the most recent measurement into the output buffer. Use FETCh if you have already made a good measurement and you want to return several types of data (different [n] values, for example, both scalars and trace data) from a single measurement. FETCh saves you the time of re-making the measurement. You can only FETCh results from the measurement that is currently active, it will not change to a different measurement. An error message is reported if a measurement other than the current one is specified.

If you need to get new measurement data, use the READ command, which is equivalent to an INITiate followed by a FETCh.

The scalar measurement results will be returned if the optional [n] value is not included, or is set to 1. If the [n] value is set to a value other than 1, the selected trace data results will be returned. See each command for details of what types of scalar results or trace data results are available. The binary data formats should be used for handling large blocks of data since they are smaller and transfer faster than the ASCII format. (FORMat:DATA)

FETCh may be used to return results other than those specified with the original READ or MEASure command that you sent.

INITiate Commands:

:INITiate:<measurement>

This command is not available for measurements in all the instrument modes:

- Initiates a trigger cycle for the specified measurement, but does not output any data. You must then use the FETCh<meas> command to return data. If a

measurement other than the current one is specified, the instrument will switch to that measurement and then initiate it.

- For example, suppose you have previously initiated the ACP measurement, but now you are running the channel power measurement. If you send INIT:ACP? it will change from channel power to ACP and will initiate an ACP measurement.
- Does not change any of the measurement settings. For example, if you have previously started the ACP measurement and you send INIT:ACP? it will initiate a new ACP measurement using the same instrument settings as the last time ACP was run.
- If your selected measurement is currently active (in the idle state) it triggers the measurement, assuming the trigger conditions are met. Then it completes one trigger cycle. Depending upon the measurement and the number of averages, there may be multiple data acquisitions, with multiple trigger events, for one full trigger cycle. It also holds off additional commands on GPIB until the acquisition is complete.

READ Commands:

:READ:<measurement>[n]?

- Does not preset the measurement to the factory default settings. For example, if you have previously initiated the ACP measurement and you send READ:ACP? it will initiate a new measurement using the same instrument settings.
 - Initiates the measurement and puts valid data into the output buffer. If a measurement other than the current one is specified, the instrument will switch to that measurement before it initiates the measurement and returns results.
 - For example, suppose you have previously initiated the ACP measurement, but now you are running the channel power measurement. Then you send READ:ACP? It will change from channel power back to ACP and, using the previous ACP settings, will initiate the measurement and return results.
 - Blocks other SCPI communication, waiting until the measurement is complete before returning the results
 - If the optional [n] value is not included, or is set to 1, the scalar measurement results will be returned. If the [n] value is set to a value other than 1, the selected trace data results will be returned. See each command for details of what types of scalar results or trace data results are available. The binary data formats should be used when handling large blocks of data since they are smaller and faster than the ASCII format. (FORMat:DATA)
-

Current Measurement Query (Remote Command Only)

This command returns the name of the measurement that is currently running.

Remote Command	:CONFigure?
Example	CONF?
Initial S/W Revision	Prior to A.02.00

Limit Test Current Results (Remote Command Only)

Queries the status of the current measurement limit testing. It returns a 0 if the measured results pass when compared with the current limits. It returns a 1 if the measured results fail any limit tests.

Remote Command	:CALCulate:CLIMits:FAIL?
Example	CALC:CLIM:FAIL? queries the current measurement to see if it fails the defined limits. Returns a 0 or 1: 0 it passes, 1 it fails.
Initial S/W Revision	Prior to A.02.00

Data Query (Remote Command Only)

Returns the designated measurement data for the currently selected measurement and subopcode.

n = any valid subopcode for the current measurement. See the measurement command results table for your current measurement, for information about what data is returned for the subopcodes.

This command uses the data setting specified by the FORMat:BORDER and FORMat:DATA commands and can return real or ASCII data. (See the format command descriptions under Input/Output in the Analyzer Setup section.)

Remote Command	:CALCulate:DATA[n]?
Notes	The return trace depends on the measurement. In CALCulate:<meas>:DATA[n], n is any valid subopcode for the current measurement. It returns the same data as the FETCH:<measurement>? query where <measurement> is the current measurement.
Initial S/W Revision	Prior to A.02.00

Calculate/Compress Trace Data Query (Remote Command Only)

Returns compressed data for the currently selected measurement and sub-opcode [n].

n = any valid sub-opcode for that measurement. See the MEASure:<measurement>? command description of your specific measurement for information on the data that can be returned.

The data is returned in the current Y Axis Unit of the analyzer. The command is used with a sub-opcode <n> (default=1) to specify the trace. With trace queries, it is best if the analyzer is not sweeping during the query. Therefore, it is generally advisable to be in Single Sweep, or Update=Off.

This command is used to compress or decimate a long trace to extract and return only the desired data. A typical example would be to acquire N frames of GSM data and return the mean power of the first burst in each frame. The command can also be used to identify the best curve fit for the data.

Remote Command	:CALCulate:DATA<n>:COMPRESS? BLOCK CFIT MAXimum MINimum MEAN DMEan RMS RMSCubed SAMPLE SDEVIation PPHase [,<soffset> [,<length>[,<roffset>[,<rlimit>]]]]
Example	To query the mean power of a set of GSM bursts: Supply a signal that is a set of GSM bursts. Select the IQ Waveform measurement (in IQ Analyzer Mode). Set the sweep time to acquire at least one burst. Set the triggers such that acquisition happens at a known position relative to a burst. Then query the mean burst levels using, CALC:DATA2:COMP? MEAN, 24e-6, 526e-6 (These parameter values correspond to GSM signals, where 526e-6 is the length of the burst in the slot and you just want 1 burst.)
Notes	The command supports 5 parameters. Note that the last 4 (<soffset>, <length>, <roffset>, <rlimit>) are optional. But these optional parameters must be entered in the specified order. For example, if you want to specify <length>, then you must also specify <soffset>. See details below for a definition of each of these parameters. This command uses the data in the format specified by FORMat:DATA, returning either binary or ASCII data.
Initial S/W Revision	Prior to A.02.00

- BLOCK or block data - returns all the data points from the region of the trace data that you specify. For example, it could be used to return the data points of an input signal over several timeslots, excluding the portions of the trace data that you do not want. (This is x,y pairs for trace data and I,Q pairs for complex data.)
- CFIT or curve fit - applies curve fitting routines to the data. <soffset> and <length> are required to define the data that you want. <roffset> is an optional parameter for the desired order of the curve equation. The query will return the following values: the x-offset (in seconds) and the curve coefficients ((order + 1) values).

MIN, MAX, MEAN, DME, RMS, RMSC, SAMP, SDEV and PPH return one data value for each specified region (or <length>) of trace data, for as many regions as possible until you run out of trace data (using <roffset> to specify regions). Or they return the number of regions you specify (using <rlimit>) ignoring any data beyond that.

- MINimum - returns the minimum data point (y value) for the specified region (s) of trace data. For I/Q trace data, the minimum magnitude of the I/Q pairs is returned.
- MAXimum - returns the maximum data point (y value) for the specified region(s) of trace data. For I/Q trace data, the maximum magnitude of the I/Q pairs is returned.
- MEAN - returns a single value that is the arithmetic mean of the data point values (in dB/ dBm) for the specified region(s) of trace data. For I/Q trace data, the mean of the magnitudes of the I/Q pairs is returned. See the following equations.

NOTE

If the original trace data is in dB, this function returns the arithmetic mean of those log values, not log of the mean power which is a more useful value. The mean of the log is the better measurement technique when measuring CW signals in the presence of noise. The mean of the power, expressed in dB, is useful in power measurements such as Channel Power. To achieve the mean of the power, use the RMS option.

Equation 1

Mean Value of Data Points for Specified Region(s)

$$MEAN = \frac{1}{n} \sum_{X_i \in \text{region}(s)} X_i$$

where X_i is a data point value, and n is the number of data points in the specified region(s).

Equation 2

Mean Value of I/Q Data Pairs for Specified Region(s)

$$MEAN = \frac{1}{n} \sum_{X_i \in \text{region}(s)} |X_i|$$

where $|X_i|$ is the magnitude of an I/Q pair, and n is the number of I/Q pairs in the specified region(s).

- DMEan - returns a single value that is the mean power (in dB/ dBm) of the data point values for the specified region(s) of trace data. See the following

equation:

Equation 3

DMEan Value of Data Points for Specified Region(s)

$$\text{DME} = 10 \times \log_{10} \left(\frac{1}{n} \sum_{X_i \in \text{region}(s)} 10^{\frac{X_i}{10}} \right)$$

- RMS - returns a single value that is the average power on a root-mean-squared voltage scale (arithmetic rms) of the data point values for the specified region(s) of trace data. See the following equation.

NOTE

For I/Q trace data, the rms of the magnitudes of the I/Q pairs is returned. See the following equation.

This function is very useful for I/Q trace data. However, if the original trace data is in dB, this function returns the rms of the log values which is not usually needed.

Equation 4

RMS Value of Data Points for Specified Region(s)

$$\text{RMS} = \sqrt{\frac{1}{n} \sum_{X_i \in \text{region}(s)} X_i^2}$$

where X_i is a data point value, and n is the number of data points in the specified region(s).

Equation 5

RMS Value of I/Q Data Pairs for Specified Region(s)

$$\text{RMS} = \sqrt{\frac{1}{n} \sum_{X_i \in \text{region}(s)} X_i X_i^*}$$

where X_i is the complex value representation of an I/Q pair, X_i^* its conjugate complex number, and n is the number of I/Q pairs in the specified region(s).

Once you have the rms value for a region of trace data (linear or I/Q), you may want to calculate the mean power. You must convert this rms value (peak volts) to power in dBm:

$$10 \times \log[10 \times (\text{rms value})^2]$$

- SAMPlE - returns the first data value (x,y pair) for the specified region(s) of trace data. For I/Q trace data, the first I/Q pair is returned.
- SDEViation - returns a single value that is the arithmetic standard deviation for the data point values for the specified region(s) of trace data. See the following equation.
- For I/Q trace data, the standard deviation of the magnitudes of the I/Q pairs is returned. See the following equation.

Equation 6

Standard Deviation of Data Point Values for Specified Region(s)

$$SDEV = \sqrt{\frac{1}{n} \sum_{X_i \in \text{region}(s)} (X_i - \bar{X})^2}$$

where X_i is a data point value, \bar{X} is the arithmetic mean of the data point values for the specified region(s), and n is the number of data points in the specified region(s).

$$SDEV = \sqrt{\frac{1}{n} \sum_{X_i \in \text{region}(s)} (|X_i| - \bar{X})^2}$$

where $|X_i|$ is the magnitude of an I/Q pair, \bar{X} is the mean of the magnitudes for the specified region(s), and n is the number of data points in the specified region(s).

- PPHase - returns the x,y pairs of both rms power (dBm) and arithmetic mean phase (radian) for every specified region and frequency offset (Hz). The number of pairs is defined by the specified number of regions. This parameter can be used for I/Q vector (n=0) in Waveform (time domain) measurement and all parameters are specified by data point in PPHase.

The rms power of the specified region may be expressed as:

$$\text{Power} = 10 \times \log [10 \times (\text{RMS I/Q value})] + 10.$$

The RMS I/Q value (peak volts) is:

$$\sqrt{\frac{1}{n} \sum_{X_i \in \text{region}} X_i X_i^*}$$

where X_i is the complex value representation of an I/Q pair, X_i^* its conjugate complex number, and n is the number of I/Q pairs in the specified region.

The arithmetic mean phase of the specified region may be expressed as:

$$\frac{1}{n} \sum_{Y_i \in \text{region}} Y_i$$

where Y_i is the unwrapped phase of I/Q pair with applying frequency correction and n is the number of I/Q pairs in the specified region.

The frequency correction is made by the frequency offset calculated by the arithmetic mean of every specified region's frequency offset. Each frequency offset is calculated by the least square method against the unwrapped phase of I/Q pair.

Sample Trace Data - Constant Envelope

(See below for explanation of variables.)

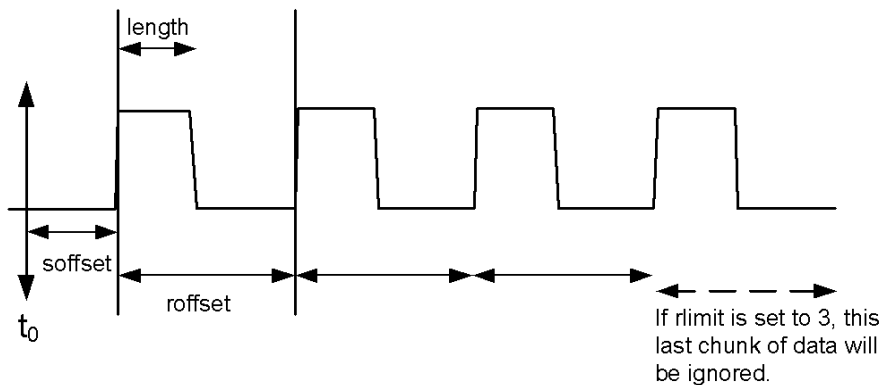

Sample Trace Data - Not Constant Envelope

(See below for explanation of variables.)

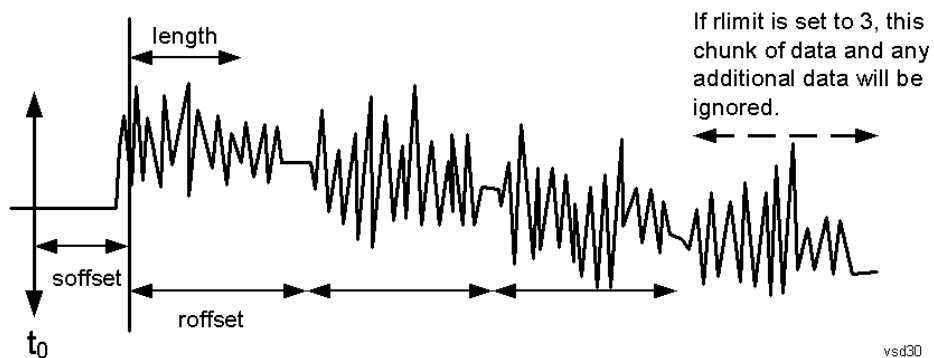

<soffset> - start offset is an optional real number. (It is in seconds for time-domain traces, and is a dimensionless index 0 to Npoints - 1, for frequency-domain traces). It specifies the amount of data at the beginning of the trace that will be ignored before the decimation process starts. It is the time or frequency change from the start of the trace to the point where you want to start using the data. The default value is zero.

<length> - is an optional real number. (It is in seconds for time-domain traces, and is a dimensionless index 0 to Npoints - 1, for frequency-domain traces). It defines how much data will be compressed into one value. This parameter has a default value equal to the current trace length.

<roffset> - repeat offset is an optional real number. (It is in seconds for time-domain traces, and is a dimensionless index 0 to Npoints - 1, for frequency-domain traces). It defines the beginning of the next field of trace elements to be compressed. This is relative to the beginning of the previous field. This parameter has a default value equal to the <length> variable. Note that this parameter is used for a completely different purpose when curve fitting (see CFIT above).

<rlimit> - repeat limit is an optional integer. It specifies the number of data items that you want returned. It will ignore any additional items beyond that number. You can use the Start offset and the Repeat limit to pick out exactly what part of the data you want to use. The default value is all the data.

Calculate Peaks of Trace Data (Remote Command Only)

Returns a list of all the peaks for the currently selected measurement and sub-opcode [n]. The peaks must meet the requirements of the peak threshold and excursion values.

n = any valid sub-opcode for the current measurement. See the MEASure:<measurement> command description of your specific measurement for information on the data that can be returned.

The command can only be used with specific sub-opcodes with measurement results that are trace data. Both real and complex traces can be searched, but complex traces are converted to magnitude in dBm. In many measurements the sub-opcode n=0, is the raw trace data which cannot be searched for peaks. And Sub-opcode n=1, is often calculated results values which also cannot be searched for peaks.

This command uses the data setting specified by the FORMat:BORDER and FORMat:DATA commands and can return real or ASCII data. If the format is set to INT,32, it returns REAL,32 data.

The command has four types of parameters:

- Threshold (in dBm)
- Excursion (in dB)
- Sorting order (amplitude, frequency, time)
- Optional in some measurements: Display line use (all, > display line, < display line)

Remote Command	For Swept SA measurement: :CALCulate:DATA[1] 2 ... 6:PEAKS? <threshold>,<excursion>[,AMPLitude FREQuency TIME[,ALL GTDLine LTDLine]]
	For most other measurements:

	<pre>:CALCulate:DATA[1] 2 ... 6:PEAKs? <threshold>,<excursion>[,AMPLitude FREQuency TIME]</pre>
Example	<p>Example for Swept SA measurement in Spectrum Analyzer Mode:</p> <p>CALC:DATA4:PEAK? -40, 10, FREQ, GTDL This will identify the peaks of trace 4 that are above -40 dBm, with excursions of at least 10 dB. The peaks are returned in order of increasing frequency, starting with the lowest frequency. Only the peaks that are above the display line are returned.</p> <p>Query Results 1:</p> <p>With FORMat:DATA REAL, 32 selected, it returns a list of floating-point numbers. The first value in the list is the number of peak points that are in the following list. A peak point consists of two values: a peak amplitude followed by its corresponding frequency (or time).</p> <p>If no peaks are found the peak list will consist of only the number of peaks, (0).</p>
Notes	<p><n> - is the trace that will be used</p> <p><threshold> - is the level below which trace data peaks are ignored. Note that the threshold value is required and is always used as a peak criterion. To effectively disable the threshold criterion for this command, provide a substantially low threshold value such as -200 dBm. Also note that the threshold value used in this command is independent of and has no effect on the threshold value stored under the Peak Criteria menu.</p> <p><excursion> - is the minimum amplitude variation (rise and fall) required for a signal to be identified as peak. Note that the excursion value is required and is always used as a peak criterion. To effectively disable the excursion criterion for this command, provide the minimum value of 0.0 dB. Also note that the excursion value used in this command is independent of and has no effect on the excursion value stored under the Peak Criteria menu.</p> <p>Values must be provided for threshold and excursion. The sorting and display line parameters are optional (defaults are AMPLitude and ALL).</p> <p>Note that there is always a Y-axis value for the display line, regardless of whether the display line state is on or off. It is the current Y-axis value of the display line which is used by this command to determine whether a peak should be reported</p> <p>Sorting order:</p> <p>AMPLitude - lists the peaks in order of descending amplitude, with the highest peak first (default if optional parameter not sent)</p> <p>FREQuency - lists the peaks in order of occurrence, left to right across the x-axis.</p> <p>TIME - lists the peaks in order of occurrence, left to right across the x-axis.</p> <p>Peaks vs. Display Line:</p> <p>ALL - lists all of the peaks found (default if optional parameter not sent).</p> <p>GTDLLine (greater than display line) - lists all of the peaks found above the display line.</p> <p>LTDLine (less than display line) - lists all of the peaks found below the display line.</p>
Initial S/W Revision	Prior to A.02.00

Hardware-Accelerated Fast Power Measurement (Remote Command Only)

The Fast Power option (FP2) enables very fast channel power measurements for instruments with the prerequisite hardware (DP2 and/or B40). It accomplishes this by performing real-time overlapped FFTs at the hardware layer, using software for basic post-processing before returning the result to the user. The upshot of this

approach is improved throughput for user applications that require many sequential power measurements.

The analysis bandwidth of FP2 is limited by the licenses in the instrument, but its maximum overall analysis bandwidth per acquisition is 40 MHz.

FP2 is remote-only, which means the instrument does not switch to any particular mode or measurement. FP2 commands can be sent while another application is in use on the front panel.

Each Fast Power measurement can be predefined using an array index, and up to 1,000 measurements can be stored. In the following documentation, instances of [1,2,...,999] can be substituted with a particular measurement index, e.g. CALC:FPOW:POW1?, CALC:FPOW:POW2?, CALC:FPOW:POW134?. In this way, power measurements can be defined one time in a batch, and then executed multiple times without having to redefine them, similar to “list mode” on other measurements.

In addition to basic channel power measurements, there are a number of other measurement “functions” for each channel, including peak power, peak frequency, and power spectral density. See the Function parameter for more information.

Reset Fast Power Measurement (Remote Command Only)

Resets the measurement configuration to the defaults.

Mode	All
Remote Command	:CALCulate:FPOWer:POWer[1,2,...,999]:RESet
Example	:CALC:FPOW:POW1:RES
Notes	Option FP2 is required.
Initial S/W Revision	A.14.00

Define Fast Power Measurement (Remote Command Only)

Fast Power acquisitions are configured using the DEFine command. This command accepts a comma-delimited string of configuration parameters and their appropriate values, which are all specified in the subsection below.

Mode	All
Remote Command	:CALCulate:FPOWer:POWer[1,2,...,999]:DEFine "configuration string"
Example	:CALC:FPOW:POW1:DEF "CenterFrequency=2e9, AcquisitionTime=0.005"
Notes	See below for a list of measurement variables that can be defined in the configuration string.
Initial S/W Revision	A.14.00

Acquisition Time

Example	CALC:FPOW:POW1:DEF "AcquisitionTime=0.002"
Notes	The acquisition time parameter sets the time in which the entire spectrum is measured. An increase in the acquisition time yields an improvement in measurement repeatability.
Preset	0.001 s
Range	0 s to 1 s
Default Unit	Time (s)
Initial S/W Revision	A.14.00

Center Frequency

Example	CALC:FPOW:POW1:DEF "CenterFrequency=2e9"
Notes	The center frequency parameter sets the frequency in which the measurement is centered around. The OffsetFrequency parameter is calculated relative to the center frequency.
Preset	1 GHz
Range	0 Hz to maximum instrument frequency
Default Unit	Frequency (Hz)
Initial S/W Revision	A.14.00

DC Coupled

Example	CALC:FPOW:POW1:DEF "DCCoupled=True"
Notes	The DC coupled parameter allows the user to specify whether the DC blocking capacitor is utilized. Set parameter to true when measuring frequencies below 10 MHz.
Preset	False
Range	True (DC Coupled) or False (AC Coupled)
Default Unit	Boolean
Initial S/W Revision	A.14.00

DetectorType

Example	CALC:FPOW:POW1:DEF "DetectorType=Peak"
Notes	Option FP2 is required. The detector type parameter allows the user to choose whether a RMS average or peak value is used during the measurement.
Preset	RmsAverage
Range	RmsAverage, Peak
Initial S/W Revision	A.14.00

Do Noise Correction

Example	CALC:FPOW:POW1:DEF "DoNoiseCorrection=True"
Notes	<p>When noise correction is enabled, the linear noise power contributed by the analyzer is subtracted from all measurements. This effectively lowers the noise floor of the analyzer.</p> <p>When noise correction is enabled, the first measurement for a given set of input parameters will take extra time. This is because the analyzer takes an extra acquisition with the RF input disconnected from the analyzer's front end to measure the noise of just the analyzer. The measured noise floor is stored in a cache so the noise acquisition will occur only once for the same state settings. In other words, if noise correction was turned on and the analyzer made an acquisition at frequency A, then frequency B, and back again to frequency A, the hidden initial noise floor acquisition would only occur for the first acquisition at frequency A and the cached noise floor would be used the second time frequency A was measured.</p>
Preset	False
Range	True (enable noise correction) or False (disable noise correction)
Default Unit	Boolean
Initial S/W Revision	A.14.00

Do Spur Suppression

Example	CALC:FPOW:POW1:DEF "DoSpurSuppression=True"
Notes	<p>When measuring very low level signals, or when large out-of-band inputs are input into the analyzer, sometimes unwanted spurs and residuals can appear in the measured spectrum. Spur suppression is a method to help minimize the levels of these internally generated spurs and residuals.</p> <p>When spur suppression is enabled, the analyzer will automatically take two acquisitions using two different internal analog LO frequencies. The FFT spectrums from both acquisitions are combined by taking the minimum power between both traces on a per FFT bin basis. External signals will have the same amplitude for both traces and therefore will return the expected amplitudes. However, low level spurs and residuals generated internally to the analyzer tend to move to different FFT bins depending on the internal analog LO frequency used, and therefore tend to be suppressed using this spur suppression method.</p> <p>Because two acquisitions, rather than a single acquisition, are made when spur suppression is enabled, the measurement time will always be slower when spur suppression is enabled.</p>
Preset	False
Range	True (enable spur suppression) or False (disable spur suppression)
Default Unit	Boolean
Initial S/W Revision	A.14.00

Electronic Attenuator Bypass

Example	CALC:FPOW:POW1:DEF "ElecAttBypass =False"
---------	---

Notes	The electronic attenuation bypass parameter allows the user to either utilize or bypass the electronic attenuator. The electronic attenuator is only available for frequencies up to 3.6 GHz. Set parameter to true when using frequencies above 3.6 GHz and set the parameter to false when using the preamp.
Preset	True
Range	True (bypass electronic attenuator) or False (use electronic attenuator)
Default Unit	Boolean
Initial S/W Revision	A.14.00

Electronic Attenuation

Example	CALC:FPOW:POW1:DEF "ElecAttenuation=10"
Notes	Option EA3 is required. The electronic attenuation value parameter sets the amount of electrical attenuation from 0 to 24 dB (1 dB steps). Set "ElecAttBypass=False" to make sure the electronic attenuator path is enabled.
Preset	0 dB
Range	0 – 24 dB (1 dB steps)
Default Unit	dB
Initial S/W Revision	A.14.00

IF Gain

Example	CALC:FPOW:POW1:DEF "IFGain=10"
Notes	The IF gain parameter allows the user to specify the gain at the IF stage anywhere from -6 to 16 dB (1 dB steps). This is an advanced feature, and for most cases this should remain at its default value of 0 dB.
Preset	0 dB
Range	-6 – 16 dB (1 dB steps)
Default Unit	dB
Initial S/W Revision	A.14.00

IF Type

Example	CALC:FPOW:POW1:DEF "IFType=B25M"
Notes	The IF type parameter allows the user to select between different IF paths. For example, if the signal is less than 25 MHz wide, then the user can select the B25M path to take advantage of additional filtering on this analog IF path.

Preset	B40M
Range	B10M, B25M, B40M
Initial S/W Revision	A.14.00

Include Power Spectrum

Example	CALC:FPOW:POW1:DEF "IncludePowerSpectrum=True"
Notes	The power spectrum parameter allows the user to read data on the entire spectrum for diagnostic purposes. It is not recommended for production use. See CALC:FPOW:POW[n]:READ2? for details on the binary format of the response.
Preset	False
Range	True (return both channel power and full power spectrum) or False (returns only channel power)
Default Unit	Boolean
Initial S/W Revision	A.14.00

Mechanical Attenuation

Example	CALC:FPOW:POW1:DEF "MechAttenuation=10"
Notes	The mechanical attenuation value parameter sets the amount of mechanical attenuation anywhere from 0 to 70 dB (2 dB steps).
Preset	0 dB
Range	0 – 70 dB (2 dB steps)
Default Unit	dB
Initial S/W Revision	A.14.00

Preamp Mode

Example	CALC:FPOW:POW1:DEF "PreAmpMode=Low"
Notes	The license for the appropriate preamp is required. The preamp mode parameter specifies whether the preamps are being utilized. Low allows any preamps up to 3.6 GHz, and Full allows all licensed preamps. Set "ElecAttBypass=True" in order to utilize any preamps.
Preset	Off
Range	Off, Low, Full
Initial S/W Revision	A.14.00

Resolution Bandwidth Mode

Example	CALC:FPOW:POW1:DEF "PreAmpMode=Low"
Notes	The resolution bandwidth mode parameter allows the user to choose whether the RBW filter is automatically or manually set. The BestSpeed value minimizes measurement time, while the Narrowest value minimizes RBW size (minimum of two FFT bins per RBW). To manually specify an RBW, set this parameter to Explicit, and set the ResolutionBW parameter to the desired value.
Preset	BestSpeed
Range	BestSpeed, Narrowest, Explicit
Initial S/W Revision	A.14.00

Resolution Bandwidth

Example	CALC:FPOW:POW1:DEF "ResolutionBW=25e3"
Notes	The resolution bandwidth parameter sets the 3-dB bandwidth of the RBW filter. The ResolutionBWMode parameter must be set to Explicit in order to manually set the RBW.
Preset	0 Hz
Default Unit	Hz
Initial S/W Revision	A.14.00

Trigger Delay

Example	CALC:FPOW:POW1:DEF "TriggerDelay=0.025"
Notes	The trigger delay parameter sets the time after an external trigger is detected until the measurement is performed.
Preset	0 s
Range	0 – 1 s
Default Unit	Seconds
Initial S/W Revision	A.14.00

Trigger Level

Example	CALC:FPOW:POW1:DEF "TriggerLevel=2"
Notes	The trigger level parameter sets the voltage value at which an external trigger is detected.
Preset	1.2 V
Range	-5 to 5 V
Default Unit	Volts
Initial S/W Revision	A.14.00

Trigger Slope

Example	CALC:FPOW:POW1:DEF "TriggerSlope=Negative"
Notes	The trigger slope parameter indicates the direction of the edge trigger voltage for detection.
Preset	Positive
Range	Positive, Negative
Initial S/W Revision	A.14.00

Trigger Source

Example	CALC:FPOW:POW1:DEF "TriggerSource=Ext1"
Notes	The trigger source parameter allows the user to choose between measurement's triggering freely or controlled by an external input. Ext1 and Ext2 correspond to Trigger 1 In and Trigger 2 In, respectively.
Preset	Free
Range	Free, Ext1, Ext2
Initial S/W Revision	A.14.00

Trigger Timeout

Example	CALC:FPOW:POW1:DEF "TriggerTimeout=0.1"
Notes	The trigger timeout parameter sets the time in which the analyzer will wait for a trigger before automatically performing the measurement.
Preset	1 s
Range	0 – 1 s
Default Unit	Seconds
Initial S/W Revision	A.14.00

Signal Input

Example	CALC:FPOW:POW1:DEF "SignalInput=Fp50MHzCW"
Notes	The signal input parameter allows the user to select between using the main RF input or the internal analyzer reference CW signal of 50 MHz.
Preset	FpMainRf
Range	FpMainRf, Fp50MHzCW
Initial S/W Revision	A.14.00

Use Preselector

Example	CALC:FPOW:POW1:DEF "UsePreSelector=True"
Notes	The preselector parameter allows the user to either utilize or bypass the front end tunable filter at frequencies above 3.6 GHz. For frequencies below 3.6 GHz, the preselector is automatically bypassed, so you do not need to set this parameter to False in those cases.
Preset	False
Range	True (use preselector above 3.6 GHz), or False (preselector bypassed)
Default Unit	Boolean
Initial S/W Revision	A.14.00

Channel Bandwidth Array

Example	CALC:FPOW:POW1:DEF "Bandwidth=[3.84e6, 5e6, 3.84e6]"
Notes	The bandwidth parameter array defines the bandwidth of each channel that will be measured. All array parameters should have the same number of elements. Alternatively, if all the elements are the same value, a single number with no square brackets can be used to define the parameter.
Preset	[1e6]
Range	0 to 40 MHz
Default Unit	Hz
Initial S/W Revision	A.14.00

Channel Filter Type Array

Example	CALC:FPOW:POW1:DEF "FilterType=[RRC, IBW, RRC]"
Notes	The filter type parameter allows the user to choose between an integration bandwidth (IBW) filter or a root-raised-cosine (RRC) filter. The integration bandwidth filter weighs all frequencies within the bandwidth equally. The root-raised-cosine filter has an associated shape parameter, defined by the FilterAlpha parameter. All array parameters should have the same number of elements. Alternatively, if all the elements are the same value, a single value with no square brackets can be used to define the parameter.
Preset	[IBW]
Range	IBW, RRC
Initial S/W Revision	A.14.00

Channel Filter Alpha Array

Example	CALC:FPOW:POW1:DEF "FilterAlpha=[0.5, 0.0, 0.5]"
Notes	The filter alpha parameter allows the user to adjust the alpha value associated with the root-

	raised-cosine (RRC) filter type. Set FilterType to RRC in order to utilize this parameter. All array parameters should have the same number of elements. Alternatively, if all the elements are the same value, a single number with no square brackets can be used to define the parameter.
Preset	[0.22]
Range	0.0 – 1.0
Initial S/W Revision	A.14.00

Channel Measurement Function Array

Example	CALC:FPOW:POW1:DEF "Function=[BandPower, PeakPower, BandPower]"
Notes	This parameter array defines what measurement is being made for each individually-specified channel: BandPower: Total power within the specified bandwidth of the channel (dBm) BandDensity: Total power density within the specified bandwidth of the channel (dBm/Hz) PeakPower: The peak power value within the specified bandwidth of the channel (dBm) PeakFrequency: The frequency which corresponds to the peak power value within the specified bandwidth of the channel. This frequency is relative to the center frequency (Hz) XdBBandwidth: The half power (-3.01 dB) bandwidth of the highest amplitude signal that resides within the channel (Hz), dB is configurable using XdBBandwidth parameter OccupiedBandwidth: The bandwidth at which 99% of the total power resides within the channel (Hz), percentage configurable using OccupiedBandwidthPercent parameter All array parameters should have the same number of elements. Alternatively, if all the elements are the same value, a single value with no square brackets can be used to define the parameter.
Preset	[BandPower]
Range	BandPower, BandDensity, PeakPower, PeakFrequency, XdBBandwidth, OccupiedBandwidth
Initial S/W Revision	A.14.00

Channel Offset Frequency Array

Example	CALC:FPOW:POW1:DEF "OffsetFrequency=[-5e6, 0, 5e6]"
Notes	The offset frequency parameter array defines the difference between the center frequency to the center frequency of each channel. All array parameters should have the same number of elements.
Preset	[0]
Range	0 to 20 MHz
Default Unit	Hz
Initial S/W Revision	A.14.00

Channel Occupied Bandwidth Percent Array

Example	CALC:FPOW:POW1:DEF "OccupiedBandwidthPercent =[0.95, 0.95, 0.95]"
Notes	This parameter only applies for channels whose Function is set to OccupiedBandwidth. The occupied bandwidth percent parameter specifies the percent of total power in these channels. The valid range for this parameter is 0.0 to 1.0, where 1.0 represents 100%. The default for this parameter is 0.99, which will return the bandwidth that contains 99% of the total channel power.
Preset	[0.99]
Range	0 – 1.0
Initial S/W Revision	A.14.00

Channel x-dB Bandwidth Array

Example	CALC:FPOW:POW1:DEF "XdBBandwidth =[-6.02, -3.01, -1.0]"
Notes	This parameter only applies for channels whose Function is set to XdBBandwidth. The X dB bandwidth parameter is used to specify the power relative to the peak channel power over which the bandwidth is calculated. The parameter value must be a negative number.
Preset	[-3.01]
Range	-200 to 0 dB
Default Unit	dB
Initial S/W Revision	A.14.00

Define Fast Power Measurement Query (Remote Command Only)

The DEFine? command is used to retrieve a list of all defined parameters in an ASCII string format

M All
o
d
e

R :CALCulate:FPOWer:POWer[1,2,...,999]:DEFine?

e
m
o
t
e

C
o
m
m
a
n

d

E :CALC:FPOW:POW1:DEF?

**x
a
m
p
l
e**

N This command query is used to retrieve a list of all defined parameters in an ASCII format.

O The following is an example of the returned results:

t "DCCoupled=False,ElecAttBypass=True,ElecAttenuation=0,IFGain=0,MechAttenuation=0,PreAmpMode=Off,PreSelectorOf
e fset=0,UsePreSelector=False,ExternalReferenceFrequency=10000000,FrequencyReferenceSource=AutoExternalFrequenc
s yReference,IFType=B40M,LOMode=SLW,SignalInput=FpMainRf,AcquisitionTime=0.001,CenterFrequency=1000000000,Re
solutionBW=0,ResolutionBWMode=BestSpeed,DetectorType=RmsAverage,Bandwidth=[1000000],OffsetFrequency=
[0],Function=[BandPower],FilterType=[BW],FilterAlpha=[0.22],OccupiedBandwidthPercent=[0.99],XdBBandwidth=[-
3.01],DoNoiseCorrection=False,DoSpurSuppression=False,MeasurementMethod=HardwareFFT,IncludePowerSpectrum=F
alse,TriggerDelay=0,TriggerLevel=1.2,TriggerSlope=Positive,TriggerSource=Free,TriggerTimeout=1"

I A.14.00

**n
i
t
i
a
l**

**S
/
W**

**R
e
v
i
s
i
o
n**

Configure Fast Power Measurement (Remote Command Only)

The configure command begins hardware setup and returns immediately, with no acquisition made. This can be used in parallel with other hardware operations to effectively hide the hardware setup time.

Mode	All
Remote Command	:CALCulate:FPOWer:POWer[1,2,...,999]:CONFigure
Example	:CALC:FPOW:POW1:CONF

Notes	Option FP2 is required.
Initial S/W Revision	A.14.00

Initiate Fast Power Measurement (Remote Command Only)

The INITiate command begins an acquisition and returns immediately. The results of the measurement can be retrieved using FETCh.

Mode	All
Remote Command	:CALCulate:FPOWer:POWer[1,2,...,999]:INITiate
Example	:CALC:FPOW:POW1:INIT
Notes	Option FP2 is required.
Initial S/W Revision	A.14.00

Fetch Fast Power Measurement (Remote Command Only)

The FETCh command query is used to retrieve the results of an acquisition initiated by the INIT command. The returned results are in ASCII string format. The string begins and ends with quotation marks.

Mode	All
Remote Command	:CALCulate:FPOWer:POWer[1,2,...,999]:FETCh?
Example	:CALC:FPOW:POW1:FETC?
Notes	Option FP2 is required. Returns m comma-separated ASCII values, where m corresponds to the number of bandwidths defined. 1. Declared function return in the 1st specified channel 2. Declared function return in the 2nd specified channel ... m. Declared function return in the last specified channel The INIT and FETC? command sequence performs the same functionality of a single CALC:FPOW:POW[n]? query. Units of the returned values are dependent on the Function parameter for each channel.
Initial S/W Revision	A.14.00

Execute Fast Power Measurement (Remote Command Only)

This command query is used as shorthand for an INIT command immediately followed by a FETC? command. The returned results are in ASCII string format. The string begins and ends with quotation marks.

Mode	All
Remote Command	:CALCulate:FPOWer:POWer[1,2,...,999]?
Example	:CALC:FPOW:POW1?
Notes	Option FP2 is required. See notes for Fast Power Fetch for return format.
Initial S/W Revision	A.14.00

Binary Read Fast Power Measurement (Remote Command Only)

This command query is used as shorthand for an INIT command immediately followed by a FETC? command. The returned results are in a binary format.

Mode	All
Remote Command	:CALCulate:FPOWer:POWer[1,2,...,999]:READ? :CALCulate:FPOWer:POWer[1,2,...,999]:READ1?
Example	:CALC:FPOW:POW1:READ? :CALC:FPOW:POW1:READ1?
Notes	Option FP2 is required. Returns m 4 byte floating point binary values (Little-Endian), where m corresponds to the number of bandwidths defined.
Initial S/W Revision	A.14.00

Diagnostic Binary Read Fast Power Measurement (Remote Command Only)

This command query is used as shorthand for an INIT command immediately followed by a FETC? command. The returned results are in a binary format. This command is used primarily for diagnostic purposes to test for ADC overloads and to visibly inspect the spectrum.

Mode	All
Remote Command	:CALCulate:FPOWer:POWer[1,2,...,999]:READ2?
Example	:CALC:FPOW:POW1:READ2?
Notes	Option FP2 is required. <div style="display: flex; align-items: flex-start;"> <div style="background-color: #cccccc; padding: 2px 5px; margin-right: 10px;">NOTE</div> <div> <p>Spectrum data is only returned if the IncludePowerSpectrum parameter is set to True. If IncludePowerSpectrum is False, the number of spectrum points will be zero (0).</p> <p>Units of the returned values are dependent on the Function parameter per channel (e.g. dBm for BandPower, Hz for PeakFrequency). Returns binary data (Little-Endian) that contains information on m amount of channels, along with ADC over range and full spectrum data.</p> </div> </div>

The following is the binary format of the response.

Bandwidth Return Value

1. Number of channels specified, m [4 byte int]
2. Declared function result for the 1st specified channel [4 byte float]
3. Declared function result for the 2nd specified channel [4 byte float]
- ...
- (m + 1). Declared function result for the last (mth) specified channel [4 byte float]

ADC Over Range

1. ADC over-range occurred (1: true, 0: false) [2 byte short]

Spectrum Data

1. Number of points in the spectrum data, k [4 byte int]
2. Start frequency of spectrum data (Hz) [8 byte double]
3. Step frequency of spectrum data (Hz) [8 byte double]
4. FFT bin at 1st point (dBm) [4 byte float]
5. FFT bin at 2nd point (dBm) [4 byte float]
- ...
- (k + 3). FFT bin at last (kth) point (dBm) [4 byte float]

Initial S/W Revision A.14.00

Format Data: Numeric Data (Remote Command Only)

This command specifies the format of the trace data input and output. It specifies the formats used for trace data during data transfer across any remote port. It affects only the data format for setting and querying trace data for the :TRACe[:DATA], TRACe[:DATA]?, :CALCulate:DATA[n]? and FETCh:SANalyzer[n]? commands and queries.

Remote Command	:FORMat[:TRACe][:DATA] ASCii INTeger,32 REAL,32 REAL,64 :FORMat[:TRACe][:DATA]?
Notes	<p>The query response is:</p> <p>ASCii: ASC,8 REAL,32: REAL,32 REAL,64: REAL,64 INTeger,32: INT,32</p> <p>When the numeric data format is REAL or ASCii, data is output in the current Y Axis unit. When the data format is INTeger, data is output in units of m dBm (.001 dBm).</p> <p>The INT,32 format returns binary 32-bit integer values in internal units (m dBm), in a definite length block.</p>
Dependencies	<p>Sending a data format spec with an invalid number (for example, INT,48) generates no error. The analyzer simply uses the default (8 for ASCii, 32 for INTeger, 32 for REAL).</p> <p>Sending data to the analyzer which does not conform to the current FORMat specified, results in an error. Sending ASCII data when a definite block is expected generates message -161 "Invalid</p>

	Block Data" and sending a definite block when ASCII data is expected generates message -121 "Invalid Character in Number".
Preset	AScii
Backwards Compatibility Notes	Note that the INT,32 format is only applicable to the command, TRACe:DATA. This preserves backwards compatibility for the Swept SA measurement. For all other commands/queries which honor FORMat:DATA, if INT,32 is sent the analyzer will behave as though it were set to REAL,32.
Initial S/W Revision	Prior to A.02.00

The specs for each output type follow:

AScii - Amplitude values are in ASCII, in the current Y Axis Unit, one ASCII character per digit, values separated by commas, each value in the form:

SX.YYYYYEsZZ

Where:

S = sign (+ or -)

X = one digit to left of decimal point

Y = 5 digits to right of decimal point

E = E, exponent header

s = sign of exponent (+ or -)

ZZ = two digit exponent

REAL,32 - Binary 32-bit real values in the current Y Axis Unit, in a definite length block.

REAL,64 - Binary 64-bit real values in the current Y Axis Unit, in a definite length block.

Format Data: Byte Order (Remote Command Only)

This command selects the binary data byte order for data transfer and other queries. It controls whether binary data is transferred in normal or swapped mode. This command affects only the byte order for setting and querying trace data for the :TRACe[:DATA], TRACe[:DATA]? , :CALCulate:DATA[n]? and FETCh:SANalyzer[n]? commands and queries.

By definition any command that says it uses FORMat:DATA uses any format supported by FORMat:DATA.

The NORMal order is a byte sequence that begins with the most significant byte (MSB) first, and ends with the least significant byte (LSB) last in the sequence: 1|2|3|4. SWAPped order is when the byte sequence begins with the LSB first, and ends with the MSB last in the sequence: 4|3|2|1.

Remote Command :FORMat:BORDER NORMal | SWAPped

	:FORMat:BORDER?
Preset	NORMal
Initial S/W Revision	Prior to A.02.00

Meas Setup

Displays the setup menu for the currently selected measurement.

Key Path	Front-panel key
Initial S/W Revision	Prior to A.02.00

Avg/Hold Num

Toggles averaging On or Off in addition to enabling you to set the number of measurement averages used to calculate the measurement result. The average is displayed at the end of each sweep. After the specified number of average counts, the average mode (termination control) setting determines the average action.

In the remote mode, use the Average State command to turn averaging on or off.

Key Path	Meas Setup
Mode	SA, WCDMA, C2K, WIMAX OFDMA, TD-SCDMA, 1xEVDO, DTMB (CTTB), DVB-T/H, ISDB-T, CMMB, LTE, LTETDD, Digital Cable TV, WLAN, MSR, LTEAFDD, LTEATDD
Remote Command	<pre>[:SENSe]:SEMAsk:AVERAge:COUNT <integer> [:SENSe]:SEMAsk:AVERAge:COUNT? [:SENSe]:SEMAsk:AVERAge[:STATe] ON OFF 1 0 [:SENSe]:SEMAsk:AVERAge[:STATe]?</pre>
Example	<pre>SEM:AVER:COUN 100 SEM:AVER:COUN? SEM:AVER ON SEM:AVER?</pre>
Notes	You must be in the mode that includes SEM measurement to use this command. Use :INSTRument:SElect to set the mode.
Preset	10 OFF
State Saved	Saved in instrument state.
Min	1
Max	10000
Initial S/W Revision	Prior to A.02.00
Modified at S/W Revision	A.02.00, A.03.00

Meas Type

Accesses a menu that enables you to select one of the following measurement reference types:

- Total Pwr Ref – Sets the reference to the total carrier power and the measured data is shown in dBc and dBm.

- PSD Ref – Sets the reference to the mean power spectral density of the carrier and the measured data is shown in dB and dBm/Hz.
- Spectrum Peak Ref – Sets the reference to the spectrum peak power of the carrier and the measured data is shown in dB and dBm.

Key Path	Meas Setup
Mode	SA, WCDMA, C2K, WIMAX OFDMA, TD-SCDMA, 1xEVDO, DTMB (CTTB), DVB-T/H, ISDB-T, CMMB, LTE, LTETDD, Digital Cable TV, WLAN, MSR, LTEAFDD, LTEATDD
Remote Command	[:SENSe] :SEMAsk :TYPE PSDRef TPreF SPRef [:SENSe] :SEMAsk :TYPE ?
Example	SEM:TYPE PSDR SEM:TYPE?
Notes	You must be in the mode that includes SEM measurement to use this command. Use :INSTrument:SElect to set the mode.
Preset	SA, WCDMA, C2K, TD-SCDMA, 1xEVDO, DTMB (CTTB), DVB-T/H, ISDB-T, CMMB, LTE, LTETDD, Digital Cable TV, MSR, LTEAFDD, LTEATDD: TPreF WIMAX OFDMA, WLAN: SPRef
State Saved	Saved in instrument state.
Range	Total Pwr Ref PSD Ref Spectrum Peak Ref
Initial S/W Revision	Prior to A.02.00
Modified at S/W Revision	A.02.00, A.03.00

Ref Channel

Accesses a menu that enables you to set up the measurement parameters used to calculate the power in the reference channel.

Key Path	Meas Setup
Initial S/W Revision	Prior to A.02.00

Integ BW

Specifies the integration bandwidth used to calculate the power in the reference channel.

Key Path	Meas Setup, Ref Channel
Mode	SA, WCDMA, C2K, WIMAX OFDMA, TD-SCDMA, 1xEVDO, DTMB (CTTB), DVB-T/H, ISDB-T, CMMB, LTE, LTETDD, Digital Cable TV, WLAN, LTEAFDD, LTEATDD
Remote Command	[:SENSe] :SEMAsk :BANDwidth [1] 2 :INTegration <bandwidth> [:SENSe] :SEMAsk :BANDwidth [1] 2 :INTegration ?
Example	SEM:BAND:INT 10 MHz SEM:BAND:INT?

Notes	<p>10% . 100% of Channel Span Parameter Value</p> <p>Bandwidth sub op code, 1 is for BTS, 2 for MS. Default is BTS.</p> <p>Note that Bandwidth sub op code 2 is supported only in Non-SA modes. In the SA mode, Bandwidth sub op code 1 is used for both BTS and MS.</p> <p>If the ref channel is outside of the frequency range, the result spectrum will be invalid.</p> <p>You must be in the mode that includes SEM measurement to use this command. Use :INSTrument:SElect to set the mode.</p>
Dependencies	<p>For MSR and LTE-Advanced FDD/TDD mode, this key is blank.</p> <p>In order to keep backwards compatible with the legacy LTE FDD/TDD, the scpi command is supported in LTE & LTE-A converged application.</p>
Couplings	<p>Cannot be higher than the channel Span. If lower than 1/10 of channel Span, then the channel Span is reduced to be 10 times the Integ BW.</p>
Preset	<p>SA: 3.84 MHz</p> <p>WCDMA: 3.84 MHz 3.84 MHz</p> <p>C2K: 1.23 MHz 1.23 MHz</p> <p>WIMAX OFDMA: 10 MHz 10 MHz</p> <p>TD-SCDMA: 1.28 MHz 1.28 MHz</p> <p>1xEVDO: 1.23MHz</p> <p>DTMB (CTTB): 7.56MHz</p> <p>DVB-T/H: 7.61MHz</p> <p>ISDB-T: 5.6MHz</p> <p>CMMB: 7.512MHz</p> <p>LTE, LTEAFDD: 4.515MHz 4.5MHz</p> <p>LTETDD, LTEATDD: 4.515MHz 4.5MHz</p> <p>Digital Cable TV: 6.9MHz</p> <p>WLAN:</p> <p>if Radio Std is 802.11a/g(OFDM/DSSS-OFDM)/802.11n(20 MHz)/ 802.11ac (20 MHz): 18 MHz</p> <p>if Radio Std is 802.11b/g(DSSS/CCK/PBCC): 22 MHz</p> <p> if Radio Std is 802.11n(40MHz)/ 802.11ac (40 MHz): 38 MHz</p> <p> if Radio Std is 802.11ac (80 MHz): 78 MHz</p> <p> if Radio Std is 802.11ac (160 MHz): 158 MHz</p> <p> if Radio Std is 802.11ac (80 MHz + 80 MHz): 78 MHz</p> <p> if Radio Std is 802.11ah (1 MHz): 0.9 MHz</p> <p> if Radio Std is 802.11ah (2 MHz): 1.8 MHz</p> <p> if Radio Std is 802.11ah (4 MHz): 3.8 MHz</p> <p> if Radio Std is 802.11ah (8 MHz): 7.8 MHz</p> <p> if Radio Std is 802.11ah (16 MHz): 15.8 MHz</p> <p> if Radio Std is 802.11j/p (20 MHz): 18 MHz</p> <p> if Radio Std is 802.11j/p (10 MHz): 9 MHz</p> <p> if Radio Std is 802.11p (5 MHz): 4.5 MHz</p> <p> if Radio Std is 802.11ax (20 MHz): 19.5 MHz</p> <p> if Radio Std is 802.11ax (40 MHz): 39.0 MHz</p>

	<p>if Radio Std is 802.11ax (80 MHz): 79.0 MHz</p> <p>if Radio Std is 802.11ax (160 MHz): 159.0 MHz</p> <p>if Radio Std is 802.11ax (80 MHz + 80 MHz): 79.0 MHz</p> <p>if Radio Std is 802.11af (6 MHz): 5.7 MHz</p> <p>if Radio Std is 802.11af (7 MHz): 6.65 MHz</p> <p>if Radio Std is 802.11af (8 MHz): 7.6 MHz</p>
State Saved	Saved in instrument state.
Min	LTEAFDD, LTEATDD, LTE, LTETDD: 100kHz Others: 1 kHz
Max	Depends on instrument maximum frequency. Same as the Max Span on Swept SA Measurement.
Initial S/W Revision	Prior to A.02.00
Modified at S/W Revision	A.02.00, A.03.00, A.16.00

Span

Specifies the span used to calculate the power in the reference channel.

Key Path	Meas Setup, Ref Channel
Mode	SA, WCDMA, C2K, WIMAX OFDMA, TD-SCDMA, 1xEVDO, DTMB (CTTB), DVB-T/H, ISDB-T, LTE, LTETDD, CMMB, Digital Cable TV, WLAN, LTEAFDD, LTEATDD
Remote Command	<pre>[:SENSe] :SEMask:FREQuency[1] 2:SPAN <freq> [:SENSe] :SEMask:FREQuency[1] 2:SPAN? [:SENSe] :SEMask:FREQuency[1] 2:SPAN:AUTO ON OFF 1 0 [:SENSe] :SEMask:FREQuency[1] 2:SPAN:AUTO?</pre>
Example	<pre>SEM:FREQ:SPAN 3MHz SEM:FREQ:SPAN? :SEM:FREQ:SPAN:AUTO OFF :SEM:FREQ:SPAN:AUTO?</pre>
Notes	<p>Frequency sub op code, 1 is for BTS, 2 for MS. Default is BTS.</p> <p>Note that Frequency sub op code 2 is supported only in Non-SA modes. In the SA mode, Frequency sub op code 1 is used for both BTS and MS.</p> <p>If the ref channel is outside of the frequency range, the result spectrum will be invalid.</p> <p>You must be in the mode that includes SEM measurement to use this command. Use :INSTrument:SElect to set the mode.</p> <p>Span Auto/Man State [:SENSe]:SEMask:FREQuency[1] 2:SPAN:AUTO) is only available in LTE/LTE-Advanced FDD/TDD mode. The BAF SCPI is LTE/LTE-Advanced FDD/TDD only.</p>
Dependencies	<p>For MSR mode, this key is blank.</p> <p>In order to keep backwards compatible with the legacy LTE FDD/TDD, the ref channel span key is supported in LTE & LTE-A converged application. The Auto/Man toggle is added to this key. This key is enabled and can be changed only in single carrier. And the span state is always kept as Auto in Multi-carriers.</p>

Couplings	<p>Range 1 kHz to 50 MHz (although restricted by Integ BW). If you set the channel Span lower than channel Integ BW, they will both track each other. As you increase the channel Span, the Integ BW will also increase if it is less than 1/10 of the channel Span.</p> <p>For WLAN 802.11ac (80 + 80 MHz), the channel span is coupled with the difference between the center frequencies of the two carriers. When the difference is either less than 80 MHz or greater than 565 MHz, a “setting conflict” error message is displayed.</p> <p>Chan Span = Carrier Spacing + Chan IntegBW;</p> <p>When the state of Span is Auto, the span value is automatically determined by multi-carrier configuration. Otherwise, the span value depends on User’s input.</p> <p>When the span value is set manually, the state of span is automatically changes to Man.</p> <p>This key is enabled and can be changed only in single carrier. And the span state is always kept as Auto in Multi-carriers.</p>
Preset	<p>SA: 5.0 MHz</p> <p>WCDMA: 5.0 MHz 5.0 MHz</p> <p>C2K: 1.25 MHz 1.25 MHz</p> <p>WIMAX OFDMA: 10 MHz 10 MHz</p> <p>TD-SCDMA: 1.6 MHz 1.6 MHz</p> <p>1xEVDO: 1.25 MHz</p> <p>DTMB (CTTB): 10 MHz</p> <p>DVB-T/H: 10 MHz</p> <p>ISDB-T: 8 MHz</p> <p>CMMB: 10 MHz</p> <p>LTE, LTEAFDD: 5 MHz</p> <p>LTETDD, LTEATDD: 5 MHz</p> <p>Digital Cable TV: 10 MHz</p> <p>WLAN:</p> <p>if Radio Std is 802.11a/g(OFDM/DSSS-OFDM)/802.11n(20 MHz)/ 802.11ac (20 MHz): 18 MHz</p> <p>if Radio Std is 802.11b/g(DSSS/CCK/PBCC): 22 MHz</p> <p style="padding-left: 20px;">if Radio Std is 802.11n(40MHz)/ 802.11ac (40 MHz): 38 MHz</p> <p style="padding-left: 20px;">if Radio Std is 802.11ac (80 MHz): 78 MHz</p> <p style="padding-left: 20px;">if Radio Std is 802.11ac (160 MHz): 158 MHz</p> <p style="padding-left: 20px;">if Radio Std is 802.11ac (80 MHz + 80 MHz): 240 MHz</p> <p style="padding-left: 20px;">if Radio Std is 802.11ah (1 MHz): 0.9 MHz</p> <p style="padding-left: 20px;">if Radio Std is 802.11ah (2 MHz): 1.8 MHz</p> <p style="padding-left: 20px;">if Radio Std is 802.11ah (4 MHz): 3.8 MHz</p> <p style="padding-left: 20px;">if Radio Std is 802.11ah (8 MHz): 7.8 MHz</p> <p style="padding-left: 20px;">if Radio Std is 802.11ah (16 MHz): 15.8 MHz</p> <p style="padding-left: 20px;">if Radio Std is 802.11j/p (20 MHz): 18 MHz</p> <p style="padding-left: 20px;">if Radio Std is 802.11j/p (10 MHz): 9 MHz</p> <p style="padding-left: 20px;">if Radio Std is 802.11p (5 MHz): 4.5 MHz</p> <p style="padding-left: 20px;">if Radio Std is 802.11ax (20 MHz): 19.5 MHz</p> <p style="padding-left: 20px;">if Radio Std is 802.11ax (40 MHz): 39.0 MHz</p>

	if Radio Std is 802.11ax (80 MHz): 79.0 MHz if Radio Std is 802.11ax (160 MHz): 159.0 MHz if Radio Std is 802.11ax (80 MHz + 80 MHz): 79.0 MHz if Radio Std is 802.11af (6 MHz): 5.7 MHz if Radio Std is 802.11af (7 MHz): 6.65 MHz if Radio Std is 802.11af (8 MHz): 7.6 MHz ON
State Saved	Saved in instrument state.
Min	LTEAFDD, LTEATDD, LTE, LTETDD:100KHz Others: 1 kHz
Max	Depends on instrument maximum frequency. Same as the Max Span on Swept SA Measurement.
Initial S/W Revision	Prior to A.02.00
Modified at S/W Revision	A.02.00, A.03.00, A.16.00

Sweep Time

Sets the sweep time used to calculate the power in the reference channel. Sweep Time can be set manually or put in auto mode.

Key Path	Meas Setup, Ref Channel
Mode	SA, WCDMA, C2K, WIMAX OFDMA, TD-SCDMA, 1xEVDO, DTMB (CTTB), DVB-T/H, ISDB-T, CMMB, LTE, LTETDD, Digital Cable TV, WLAN, MSR, LTEAFDD, LTEATDD
Remote Command	<pre>[:SENSe]:SEMAsk:SWEep[1] 2:TIME <time> [:SENSe]:SEMAsk:SWEep[1] 2:TIME? [:SENSe]:SEMAsk:SWEep[1] 2:TIME:AUTO OFF 0 ON 1 [:SENSe]:SEMAsk:SWEep[1] 2:TIME:AUTO?</pre>
Example	<pre>SEM:SWE:TIME 9ms SEM:SWE:TIME? SEM:SWE:TIME:AUTO OFF SEM:SWE:TIME:AUTO?</pre>
Notes	<p>Sub op code, 1 is for BTS, 2 for MS. Default is BTS.</p> <p>Note that Sweep sub op code 2 is supported only in Non-SA modes.</p> <p>In the SA mode, Sweep sub op code 1 is used for both BTS and MS.</p> <p>You must be in the mode that includes SEM measurement to use this command. Use :INSTrument:SElect to set the mode.</p>
Couplings	<p>When the time is set manually, Auto is set to OFF.</p> <p>Value is coupled with Channel Detector selection, Channel Resolution BW, Channel Video BW if the state is Auto.</p> <p>When set to Auto, the sweep Time is automatically calculated.</p>
Preset	Automatically calculated ON

State Saved	Saved in instrument state.
Min	X-Series HW: Depends on Channel Sweep Type Sweep Type "Swept": 1ms Sweep Type "FFT": 100ns E6630A_E6640A_M90XA:TBD E7515A: 39.2 usec
Max	4000 s
Initial S/W Revision	Prior to A.02.00
Modified at S/W Revision	A.02.00, A.03.00, A.16.00

Chan Sweep Type (except for E6630A/E6640A/M90XA)

Sets the sweep type used to calculate the power in the reference channel. Sweep Type can be set manually or put in auto mode.

How to define Channel Sweep Time and Channel Sweep Type:

- When Channel Sweep Type Mode is Auto, Channel Sweep Type is automatically selected depending on Sweep Type Rules.
- When Channel Sweep Type Mode is Man, Channel Sweep Type is selected by user.
- When Channel Sweep Time Mode is Auto, the channel sweep time is automatically calculated depending on the selected sweep type.

Key Path	Meas Setup, Ref Channel
Mode	SA, WCDMA, C2K, WIMAX OFDMA, TD-SCDMA, 1xEVDO, DTMB (CTTB), DVB-T/H, ISDB-T, CMMB, LTE, LTEFDD, Digital Cable TV, WLAN, MSR, LTEAFDD, LTEATDD
Remote Command	[:SENSe] :SEMAsk :SWEep [1] 2 :TYPE SWEep FFT [:SENSe] :SEMAsk :SWEep [1] 2 :TYPE ? [:SENSe] :SEMAsk :SWEep [1] 2 :TYPE :AUTO OFF 0 ON 1 [:SENSe] :SEMAsk :SWEep [1] 2 :TYPE :AUTO ?
Example	SEM:SWE:TYPE FFT SEM:SWE:TYPE? SEM:SWE:TYPE:AUTO OFF SEM:SWE:TYPE:AUTO?
Notes	Sub op code, 1 is for BTS, 2 for MS. Default is BTS. Note that Sweep sub op code 2 is supported only in Non-SA modes. In the SA mode, Sweep sub op code 1 is used for both BTS and MS. You must be in the mode that includes SEM measurement to use this command. Use :INSTrument:SElect to set the mode.

Couplings	When the sweep type is set manually, Sweep Type Mode is set to MANual. When Channel Sweep Type Mode is Auto, Sweep Type is automatically selected depending on Sweep Type Rules.
Preset	Automatically calculated ON
State Saved	Saved in instrument state.
Initial S/W Revision	A.16.00

Res BW

Sets the resolution bandwidth used to calculate the power in the reference channel. The Channel Resolution BW can be set manually or put in to auto mode.

MSR Auto RBW:

In the MSR resolution bandwidth is predefined for each radio format. When carriers are configured with multiple radio formats, the narrowest RBW is selected.

LTE	1.4 MHz	13
	3 MHz	27
	5 MHz	47
	10 MHz	91
	15 MHz	150
	20 MHz	180
W-CDMA		75
GSM		30

In LTE-Advanced FDD/TDD, the resolution bandwidth is predefined based on the corresponding bandwidth of the single LTE carrier, which is listed above. When ResBW mode is Auto, the narrowest RBW is selected.

Key Path	Meas Setup, Ref Channel
Mode	SA, WCDMA, C2K, WIMAX OFDMA, TD-SCDMA, 1xEVDO, DTMB (CTTB), DVB-T/H, ISDB-T, CMMB, LTE, LTE-TDD, Digital Cable TV, WLAN, MSR, LTEAFDD, LTEATDD
Remote Command	<code>[:SENSe]:SEMAsk:BANDwidth[1] 2[:RESolution] <bandwidth></code> <code>[:SENSe]:SEMAsk:BANDwidth[1] 2[:RESolution]?</code> <code>[:SENSe]:SEMAsk:BANDwidth[1] 2[:RESolution]:AUTO OFF ON 1 0</code> <code>[:SENSe]:SEMAsk:BANDwidth[1] 2[:RESolution]:AUTO?</code>
Example	SEM:BAND 100 kHz SEM:BAND? SEM:BAND:AUTO ON SEM:BAND:AUTO?
Notes	Bandwidth sub op code, 1 is for BTS, 2 for MS. Default is BTS.

	Note that Bandwidth sub op code 2 is supported only in Non-SA modes. In the SA mode, Bandwidth sub op code 1 is used for both BTS and MS. You must be in the mode that includes SEM measurement to use this command. Use :INSTrument:SElect to set the mode.
Couplings	When Res BW is set manually, Channel Resolution BW Mode is set to MANual. Value is coupled with Channel Detector selection, Channel sweep Time, Channel Video BW. When set to Auto, the resolution bandwidth is automatically calculated.
Preset	SA: 100 kHz WCDMA: 75 kHz C2K: 24 kHz WIMAX OFDMA: 100 kHz TD-SCDMA: 30 kHz 1xEVDO: 30.0 KHz DTMB (CTTB): 3.9 kHz DVB-T/H: 3.9 kHz ISDB-T: 10 kHz CMMB: 3.9 kHz LTE, LTEFDD, MSR, LTEAFDD, LTEATDD:Auto (47 kHz) Digital Cable TV: 3.9 kHz WLAN: 100 kHz ON
State Saved	Saved in instrument state.
Min	1 Hz
Max	8 MHz
Backwards Compatibility SCPI	[:SENSe] :SEMAsk :BWIDth [1] 2 [:RESolution]
Initial S/W Revision	Prior to A.02.00
Modified at S/W Revision	A.02.00, A.03.00

Video BW

Sets the video bandwidth used to calculate the power in the reference channel. The Channel Video BW can be set manually or put in to auto mode.

Key Path	Meas Setup, Ref Channel
Mode	SA, WCDMA, C2K, WIMAX OFDMA, TD-SCDMA, 1xEVDO, DTMB (CTTB), DVB-T/H, ISDB-T, CMMB, LTE, LTEFDD, Digital Cable TV, WLAN, MSR, LTEAFDD, LTEATDD
Remote Command	[:SENSe] :SEMAsk :BANDwidth [1] 2 :VIDeo <bandwidth> [:SENSe] :SEMAsk :BANDwidth [1] 2 :VIDeo? [:SENSe] :SEMAsk :BANDwidth [1] 2 :VIDeo :AUTO OFF ON 1 0 [:SENSe] :SEMAsk :BANDwidth [1] 2 :VIDeo :AUTO?

Example	SEM:BAND:VID 100 kHz SEM:BAND:VID? SEM:BAND:VID:AUTO ON SEM:BAND:VID:AUTO?
Notes	Bandwidth sub op code, 1 is for BTS, 2 for MS. Default is BTS. Note that Bandwidth sub op code 2 is supported only in Non-SA modes. In the SA mode, Bandwidth sub op code 1 is used for both BTS and MS. You must be in the mode that includes SEM measurement to use this command. Use :INSTrument:SElect to set the mode.
Couplings	When Video BW is set manually, Channel Video BW Mode is set to MANual Value is coupled with Channel Detector selection, Channel Sweep Time, Channel Resolution BW. When set to Auto, the video bandwidth is automatically calculated.
Preset	SA: 100 kHz WCDMA: 75 kHz C2K: 24 kHz WIMAX OFDMA: 30 kHz TD-SCDMA: 300 kHz 1xEVDO: 300.0 kHz DTMB (CTTB): 39 kHz DVB-T/H: 39 kHz ISDB-T: 1 kHz CMMB: 39 kHz LTE, MSR, LTEAFDD, LTEATDD: Auto LTETDD: Auto Digital Cable TV: 39 kHz WLAN: Auto ON
State Saved	Saved in instrument state.
Min	1 Hz
Max	50 MHz
Backwards Compatibility SCPI	[:SENSe] :SEMAsk :BWIDth [1] 2 :VIDeo
Initial S/W Revision	Prior to A.02.00
Modified at S/W Revision	A.02.00, A.03.00

VBW/RBW

Sets the Video BW/Resolution BW Ratio to calculate the Channel Resolution BW and Channel Video BW. The VBW/RBW Ratio can be set manually or put in to auto mode.

Key Path	Meas Setup, Ref Channel
Mode	SA, WCDMA, C2K, WIMAX OFDMA, TD-SCDMA mode, 1xEVDO, DTMB (CTTB), DVB-T/H, ISDB-T, CMMB, LTE, LTETDD, Digital Cable TV, WLAN, MSR, LTEAFDD, LTEATDD
Remote Command	<pre>[:SENSe]:SEMAsk:BA NDwidth[1] 2:VIDeo:RATio <real> [:SENSe]:SEMAsk:BA NDwidth[1] 2:VIDeo:RATio [:SENSe]:SEMAsk:BA NDwidth[1] 2:VIDeo:RATio:AUTO OFF ON 1 0 [:SENSe]:SEMAsk:BA NDwidth[1] 2:VIDeo:RATio:AUTO?</pre>
Example	<pre>SEM:BA ND:VID:RAT 0.1 SEM:BA ND:VID:RAT? SEM:BA ND:VID:RAT:AUTO ON SEM:BA ND:VID:RAT:AUTO?</pre>
Notes	<p>Bandwidth sub op code, 1 is for BTS, 2 for MS. Default is BTS.</p> <p>Note that Bandwidth sub op code 2 is supported only in Non-SA modes. In the SA mode, Bandwidth sub op code 1 is used for both BTS and MS.</p> <p>You must be in the mode that includes SEM measurement to use this command. Use :INSTrument:SElect to set the mode.</p>
Couplings	<p>When Video BW/Res BW is set manually, Channel VBW/RBW Ratio Mode is set to MANual</p> <p>When set to Auto, the VBW/RBW Ratio is automatically calculated.</p>
Preset	<pre>SA, WCDMA, C2K: 1.0 WIMAX OFDMA: 0.3 TD-SCDMA: 10 1xEVDO: 10.0 DTMB (CTTB): 10 DVB-T/H: 10 ISDB-T: 0.1 CMMB: 10 LTE, MSR: Auto LTEAFDD,LTEATDD:Auto LTETDD: Auto Digital Cable TV: 10 WLAN: Auto ON</pre>
State Saved	Saved in instrument state.
Min	0.00001
Max	3000000
Backwards Compatibility SCPI	<pre>[:SENSe]:SEMAsk:BWIDth[1] 2:VIDeo:RATio</pre>
Initial S/W Revision	Prior to A.02.00
Modified at S/W Revision	A.02.00, A.03.00

Power Ref (for the modes except MSR and LTE-Advanced FDD/TDD)

Sets the power reference in the carrier that will be used to compute the relative values for the offsets.

Key Path	Meas Setup, Ref Channel
Initial S/W Revision	Prior to A.02.00

Total Power

Sets the power in the carrier (ref channel) that is used to compute the relative power values for the offsets. When the state is set to auto, this value is set to the measured carrier reference power. When set to manual, the result takes on the last measured value, or can be manually entered.

For WLAN 802.11ac (80 MHz + 80 MHz), the higher of the power readouts of the two carriers is used for computing the relative power values for the offset.

Key Path	Meas Setup, Ref Channel, Power Ref
Mode	SA, WCDMA, C2K, WIMAX OFDMA, TD-SCDMA, 1xEVDO, DTMB (CTTB), DVB-T/H, ISDB-T, CMMB, LTE, LTEFDD, Digital Cable TV, WLAN, MSR, LTEAFDD, LTEATDD
Remote Command	<pre>[:SENSe]:SEMAsk:CARRier[:POWer] <real> [:SENSe]:SEMAsk:CARRier[:POWer]? [:SENSe]:SEMAsk:CARRier:AUTO[:STATe] OFF ON 1 0 [:SENSe]:SEMAsk:CARRier:AUTO[:STATe]?</pre>
Example	<pre>SEM:CARR 100dBm SEM:CARR? SEM:CARR:AUTO OFF SEM:CARR:AUTO?</pre>
Notes	<p>The min and max values given are for Meas Type = Total Pwr Ref.</p> <p>You must be in the mode that includes SEM measurement to use this command. Use :INSTrument:SElect to set the mode..</p> <p>This BAF SCPI command is available in all the Meas Type case.</p> <p>This BAF SCPI command is not available in MSR and LTE-Advanced FDD/TDD mode.</p>
Dependencies	This "Total Power Ref" parameter is coupled with the "Meas Type" parameter. The softkey is active when Meas Type is set to Total Power Ref. Otherwise, it is grayed out.
Preset	Measured carrier reference power
State Saved	Saved in instrument state.
Min	-200 dBm
Max	200 dBm
Initial S/W Revision	Prior to A.02.00
Modified at S/W Revision	A.02.00, A.03.00

PSD

Sets the power spectral density in the carrier that is used to compute the relative power spectral density values for the offsets when Meas Type is set to PSD Ref. When the state is set to auto, this will be set to the measured carrier power spectral density.

For WLAN 802.11ac (80 MHz + 80 MHz), the higher of the power density readouts of the two carriers is used for computing the relative PSD values for the offset.

Key Path	Meas Setup, Ref Chan, Power Ref
Mode	SA, WCDMA, C2K , WIMAX OFDMA, TD-SCDMA, 1xEVDO, DTMB (CTTB), DVB-T/H, ISDB-T, CMMB, LTE, LTETDD, Digital Cable TV, WLAN, MSR, LTEAFDD, LTEATDD
Remote Command	<code>[:SENSe] :SEMAsk :CARRier :CPSD <real></code> <code>[:SENSe] :SEMAsk :CARRier :CPSD?</code>
Example	SEM:CARR:CPSD -80 SEM:CARR:CPSD?
Notes	Although the default value is defined, the value is recalculated by the measurement result just after completing the measurement. Carrier sub op code. 1 for BTS, 2 for MS. Default is BTS. You must be in the mode that includes SEM measurement to use this command. Use :INSTRument:SElect to set the mode.
Dependencies	See Couplings
Couplings	This "PSD" parameter is coupled with the "Meas Type" parameter. The key will be active if the Meas Type is set to PSD. Otherwise, it is grayed out.
Preset	Measured carrier PSD reference power
State Saved	Saved in instrument state.
Min	-200
Max	200
Initial S/W Revision	Prior to A.02.00
Modified at S/W Revision	A.02.00, A.03.00

Spectrum Peak

Sets the spectrum peak power in the carrier that is used to compute the relative power spectral density values for the offsets when Meas Type is set to Spectrum Peak. When the state is set to auto, this is set to the measured carrier spectrum peak power. When set to manual, the result takes on the last measured value, or can be manually entered

Key Path	Meas Setup, Ref Channel, Power Ref
Mode	SA, WCDMA, C2K , WIMAX OFDMA, TD-SCDMA, 1xEVDO, DTMB (CTTB), DVB-T/H, ISDB-T, CMMB, LTE, LTETDD, Digital Cable TV, WLAN
Remote Command	<code>[:SENSe] :SEMAsk :CARRier :PEAK [:POWer] <real></code> <code>[:SENSe] :SEMAsk :CARRier :PEAK [:POWer]?</code>

Example	SEM:CARR:PEAK -80 SEM:CARR:PEAK:POWER?
Notes	Although the default value is defined, the value is recalculated by the measurement result just after completing the measurement. Carrier sub op code. 1 for BTS, 2 for MS. Default is BTS. You must be in the mode that includes SEM measurement to use this command. Use :INSTrument:SElect to set the mode.
Dependencies	See Couplings
Couplings	This "Spectrum Peak Ref" parameter is coupled with the "Meas Type" parameter. This softkey is active when the "Meas Type" is set to "Spectrum Peak Ref". Otherwise, grayout.
Preset	Measured carrier Spectrum Peak reference power
State Saved	Saved in instrument state.
Min	-200
Max	200
Initial S/W Revision	Prior to A.02.00
Modified at S/W Revision	A.02.00, A.03.00

Offset/Limits

Accesses a menu that enables you to set up the measurement parameters for offset pairs. For example, you can assign the start and stop frequencies, select the resolution bandwidth, and set the sweep time. When in the MSR and LTE-Advanced FDD/TDD mode, the softkey label changes to Outer Offset/Limits.

Key Path	Meas Setup
Initial S/W Revision	Prior to A.02.00
Modified at S/W Revision	A.14.00

Select Offset

Selects the offset (upper and lower) and displays the memory selection menu that enables you to store a set of parameter values for the offset, such as Start Freq, Stop Freq, sweep Time, Res BW, Meas BW, Abs Start, and Abs Stop. Only one selection at a time is shown on this menu key label.

Key Path	Meas Setup, Offset/Limits
Mode	SA, WCDMA, C2K, WIMAX OFDMA, TD-SCDMA, 1xEVDO, DTMB (CTTB), DVB-T/H, ISDB-T, CMMB, LTE, LTETDD, Digital Cable TV, WLAN, MSR, LTEAFDD, LTEATDD
Preset	A
Range	MSR, LTEATDD, LTEAFDD, WLAN: A B C D E F G H J K L Other modes without option N9060A-7FP: A B C D E F Other modes with option N9060A-7FP: A B C D E F G H J K L

Initial S/W Revision	Prior to A.02.00
Modified at S/W Revision	A.02.00, A.03.00, A.10.00, A.11.00, A.14.00

Start Freq

Specifies the start frequency for the currently selected offset. Also enables you to toggle that offset between On and Off.

Missing values are not permitted; that is, if you want to change values 2 and 6, you must send all values up to 6. Subsequent values will remain as they were. The query for this parameter always returns 12 values.

Key Path	Meas Setup, Offset/Limits
Mode	SA, WCDMA, C2K, WIMAX OFDMA, TD-SCDMA, 1xEVDO, DTMB (CTTB), DVB-T/H, ISDB-T, CMMB, LTE, LTETDD, Digital Cable TV, WLAN, MSR, LTEAFDD, LTEATDD
Remote Command	[:SENSe]:SEMAsk:OFFSet[1] 2[:OUTer]:LIST:FREQuency:STARt <freq>, ... [:SENSe]:SEMAsk:OFFSet[1] 2[:OUTer]:LIST:FREQuency:STARt? [:SENSe]:SEMAsk:OFFSet[1] 2[:OUTer]:LIST:STATe ON OFF 1 0, ... [:SENSe]:SEMAsk:OFFSet[1] 2[:OUTer]:LIST:STATe?
Example	SEM:OFFS2:LIST:FREQ:STAR 2.515 MHz, 2.715 MHz, 3.515 MHz, 4.00 MHz, 8.00 MHz, 12.50 MHz SEM:OFFS2:LIST:FREQ:STAR? SEM:OFFS:LIST:STAT ON, ON, ON, OFF, OFF, OFF SEM:OFFS:LIST:STAT?
Notes	Comma separated list of values. OFFSet1 is for BTS, 2 for MS. Default is BTS. Note that Offset sub op code 2 is supported only in Non-SA modes. In the SA mode, Offset sub op code 1 is used for both BTS and MS. If the offset is outside of the frequency range, the result spectrum will be invalid. You must be in the mode that includes SEM measurement to use this command. Use :INSTrument:SElect to set the mode.
Couplings	Coupled to Stop Freq. When the start freq goes above the stop freq, the stop freq is automatically adjusted to the start freq plus 100 Hz. If the current mode is DVB-T/H, this value will be modified automatically according to the limit type and the output power of the transmitter which is less or more than 25 W. If the current mode is ISDB-T, this value will be modified automatically according to the limit type.
Preset	For modes (except MSR, LTEAFDD, LTEATDD and WLAN) without option N9060A-7FP, the preset value is as follows. SA: 2.515 MHz, 2.715 MHz, 3.515 MHz, 4.00 MHz, 8.00 MHz, 12.50 MHz WCDMA: 2.515 MHz, 2.715 MHz, 3.515 MHz, 4.000 MHz, 8.000 MHz, 12.50 MHz 2.515MHz, 4.000 MHz, 7.500 MHz, 8.500 MHz, 12.5 MHz, 15 MHz C2K: 750.0 kHz, 780.0 kHz, 1.980 MHz, 3.25 MHz, 7.0 MHz, 7.0 MHz 885 kHz, 1.980 MHz, 2.250 MHz, 8.0 MHz, 12.0 MHz, 12.0 MHz

WIMAX OFDMA: 4.75 MHz, 5.45 MHz, 9.75 MHz, 14.75 MHz, 19.75 MHz, 24.75 MHz|4.75 MHz, 5.45 MHz, 9.75 MHz, 14.75 MHz, 19.75 MHz, 24.75 MHz

TD-SCDMA:

81 5kHz, 1015 kHz, 1815 kHz, 2.3 MHz, 2.3 MHz, 2.3 MHz, |815 kHz, 1.8 MHz, 2.9 MHz, 2.9 MHz, 2.9 MHz, 2.9 MHz

1xEVDO: 750.0 kHz, 780.0 kHz, 1.98 MHz, 3.25 MHz, 7 MHz, 7 MHz|885.0 kHz, 1.98 MHz, 1.98 MHz, 1.98 MHz, 1.98 MHz, 1.98 MHz

DTMB (CTTB): 3.8 MHz, 4.2 MHz, 6 MHz, 6 MHz, 6 MHz, 6 MHz |6MHz, 6MHz, 6MHz, 6MHz, 6MHz, 6MHz

DVB-T/H: 3.81 MHz, 4.2 MHz, 6 MHz, 6 MHz, 6 MHz, 6 MHz |6MHz, 6MHz, 6MHz, 6MHz, 6MHz, 6MHz

ISDB-T: 2.79 MHz, 2.86 MHz, 3.0 MHz, 4.36 MHz, 6 MHz, 6 MHz |6MHz, 6MHz, 6MHz, 6MHz, 6MHz, 6MHz

CMMB: 3.8 MHz, 4.2 MHz, 8.0 MHz, 6 MHz, 6 MHz, 6 MHz |6MHz, 6MHz, 6MHz, 6MHz, 6MHz, 6MHz

LTE, LTE-TDD: 50 kHz, 5.05 MHz, 10.5 MHz, 15.00 MHz, 30 MHz, 40 MHz|15.00 kHz, 1.5 MHz, 5.5 MHz, 6.5 MHz, 10 MHz, 20MHz

Digital Cable TV: 3.8 MHz, 4.2 MHz, 6 MHz, 6 MHz, 6 MHz, 6 MHz |6MHz, 6MHz, 6MHz, 6MHz, 6MHz, 6MHz

When option N9060A-7FP is installed in these modes, the preset value of Offset G ~ L is the same as the Offset F value.

WLAN:

if Radio Std is 802.11a/g(OFDM/DSSS-OFDM)/802.11n(20MHz): 9 MHz, 11 MHz, 20 MHz, 30 MHz, 50 MHz, 216 MHz, 216 MHz, 216 MHz, 216 MHz, 216 MHz, 216 MHz, 216 MHz

if Radio Std is 802.11b/g(DSSS/CCK/PBCC): 11 MHz, 22 MHz, 50 MHz, 70 MHz, 90 MHz, 100 MHz, 100 MHz, 100 MHz, 100 MHz, 100 MHz, 100 MHz, 100 MHz

if Radio Std is 802.11n(20MHz): 9 MHz, 11 MHz, 20 MHz, 30 MHz, 50 MHz, 100 MHz, 100 MHz, 100 MHz, 100 MHz, 100 MHz, 100 MHz, 100 MHz

if Radio Std is 802.11n(40MHz): 19 MHz, 21 MHz, 40 MHz, 60 MHz, 100 MHz, 200 MHz, 200 MHz, 200 MHz, 200 MHz, 200 MHz, 200 MHz, 200 MHz

if Radio Std is 802.11ac(20MHz): 9 MHz, 11 MHz, 20 MHz, 30 MHz, 30 MHz, 30 MHz, 30 MHz, 30 MHz, 30 MHz, 30 MHz, 30 MHz, 30 MHz

if Radio Std is 802.11ac(40MHz): 19 MHz, 21 MHz, 40 MHz, 60 MHz, 60 MHz, 60 MHz, 60 MHz, 60 MHz, 60 MHz, 60 MHz, 60 MHz, 60 MHz

if Radio Std is 802.11ac(80MHz): 39 MHz, 41 MHz, 80 MHz, 120 MHz, 120 MHz, 120 MHz, 120 MHz, 120 MHz, 120 MHz, 120 MHz, 120 MHz, 120 MHz

if Radio Std is 802.11ac(160MHz): 79 MHz, 81 MHz, 160 MHz, 240 MHz, 240 MHz, 240 MHz, 240 MHz, 240 MHz, 240 MHz, 240 MHz, 240 MHz, 240 MHz

if Radio Std is 802.11ac(80 MHz + 80MHz): 0MHz, 0 MHz, 40 MHz, 79 MHz, 159 MHz, 161 MHz, 200 MHz, 240 MHz, 240 MHz, 240 MHz, 240 MHz, 240 MHz

if Radio Std is 802.11ah(1MHz): 0.45 MHz, 0.6 MHz, 1 MHz, 1.5 MHz, 1.5 MHz, 1.5 MHz, 1.5 MHz, 1.5 MHz, 1.5 MHz, 1.5 MHz, 1.5 MHz, 1.5 MHz

if Radio Std is 802.11ah(2MHz): 0.9 MHz, 1.1 MHz, 2 MHz, 3 MHz, 3 MHz, 3 MHz, 3 MHz, 3 MHz, 3 MHz, 3 MHz, 3 MHz, 3 MHz

if Radio Std is 802.11ah(4MHz): 1.9 MHz, 2.1 MHz, 4 MHz, 6 MHz, 6 MHz, 6 MHz, 6 MHz, 6 MHz, 6 MHz, 6 MHz, 6 MHz, 6 MHz

if Radio Std is 802.11ah(8MHz): 3.9 MHz, 4.1 MHz, 8 MHz, 12 MHz, 12 MHz, 12 MHz, 12 MHz, 12 MHz, 12 MHz, 12 MHz, 120 MHz

if Radio Std is 802.11ah(16MHz): 7.9 MHz, 8.1 MHz, 16 MHz, 24 MHz, 24 MHz, 24 MHz, 24 MHz, 24 MHz, 24 MHz, 24 MHz, 24 MHz, 24 MHz

if Radio Std is 802.11j/p(10MHz): 4.5 MHz, 5MHz, 5.5 MHz, 10 MHz, 15 MHz, 216 MHz, 216MHz, 216 MHz, 216MHz, 216MHz, 216MHz, 216MHz

if Radio Std is 802.11p(5MHz): 2.25 MHz, 2.5MHz, 2.75 MHz, 5 MHz, 7.5 MHz, 216 MHz, 216MHz, 216 MHz, 216MHz, 216MHz, 216MHz, 216MHz

if Radio Std is 802.11ax(20MHz): 9.75 MHz, 10.25 MHz, 20 MHz, 30 MHz, 30 MHz, 30 MHz, 30 MHz, 30 MHz, 30 MHz, 30 MHz, 30 MHz, 30 MHz

if Radio Std is 802.11ax(40MHz): 19.5 MHz, 20.5 MHz, 40 MHz, 60 MHz, 60 MHz, 60 MHz, 60 MHz, 60 MHz, 60 MHz, 60 MHz, 60 MHz, 60 MHz

if Radio Std is 802.11ax(80MHz): 39.5 MHz, 40.5 MHz, 80 MHz, 120 MHz, 120 MHz, 120 MHz, 120 MHz, 120 MHz, 120 MHz, 120 MHz, 120 MHz, 120 MHz

if Radio Std is 802.11ax(160MHz): 79.5 MHz, 80.5 MHz, 160 MHz, 240 MHz, 240 MHz, 240 MHz, 240 MHz, 240 MHz, 240 MHz, 240 MHz, 240 MHz, 240 MHz

if Radio Std is 802.11ax(80 MHz + 80MHz): 0MHz, 0 MHz, 40 MHz, 79 MHz, 159 MHz, 161 MHz, 200 MHz, 240 MHz, 240 MHz, 240 MHz, 240 MHz, 240 MHz

if Radio Std is 802.11af(6MHz): 2.85 MHz, 3.15 MHz, 6 MHz, 9 MHz, 9 MHz, 9 MHz, 9 MHz, 9 MHz, 9 MHz, 9 MHz, 9 MHz, 9 MHz

if Radio Std is 802.11af(7MHz): 3.325 MHz, 3.675 MHz, 7 MHz, 10.5 MHz, 10.5 MHz, 10.5 MHz, 10.5 MHz, 10.5 MHz, 10.5 MHz, 10.5 MHz, 10.5 MHz, 10.5 MHz

if Radio Std is 802.11af(8MHz): 3.8 MHz, 4.2 MHz, 8 MHz, 12 MHz, 12 MHz, 12 MHz, 12 MHz, 12 MHz, 12 MHz, 12 MHz, 12 MHz, 12 MHz

MSR: 15 kHz, 215kHz, 1.015MHz, 1.5MHz, 10.5MHz, 15.00MHz, 30MHz, 30MHz, 30MHz, 30MHz, 30MHz, 30MHz | 15kHz, 215kHz, 1.015MHz, 1.5MHz, 10.5MHz, 15.00MHz, 30MHz, 30MHz, 30MHz, 30MHz, 30MHz, 30MHz

LTEAFDD, LTEATDD: 50 kHz, 5.05 MHz, 10.5 MHz, 15.00 MHz, 30 MHz, 40 MHz, 40 MHz, 40 MHz, 40 MHz, 40 MHz, 40 MHz | 15.00 kHz, 1.5 MHz, 5.5 MHz, 6.5 MHz, 10 MHz, 20MHz, 20MHz, 20MHz, 20MHz, 20MHz, 20MHz, 20MHz

For modes (except MSR, LTEAFDD, LTEATDD and WLAN) without option N9060A-7FP, the preset value is as follows.

SA: ON, ON, ON, ON, ON, OFF

WCDMA: ON, ON, ON, ON, ON, OFF|ON, ON, ON, ON, OFF, OFF

C2K: ON, ON, ON, OFF, OFF, OFF|ON, ON, OFF, OFF, OFF, OFF

WIMAX OFDMA: ON, ON, ON, OFF, OFF, OFF|ON, ON, ON, OFF, OFF, OFF

TD-SCDMA: ON, ON, ON, ON, OFF, OFF|ON, ON, ON, OFF, OFF, OFF

1xEVDO: ON, ON, ON, OFF, OFF, OFF|ON, ON, OFF, OFF, OFF, OFF

DTMB (CTTB), DVB-T/H, CMMB, Digital Cable TV: ON, ON, ON, OFF, OFF, OFF

ISDB-T: ON, ON, ON, ON, OFF, OFF

LTE, LTETDD: ON, ON, ON, OFF, OFF, OFF|ON, ON, ON, ON, OFF, OFF

When option N9060A-7FP is installed in these modes, the preset value of Offset G ~ L is the same as the Offset F value.

WLAN:

if Radio Std is 802.11b/g(DSSS/CCK/PBCC): ON, ON, OFF, OFF, OFF, OFF, OFF, OFF, OFF, OFF, OFF, OFF, OFF, OFF

if Radio Std is 802.11a/g/j/p 20MHz(OFDM/DSSS-OFDM)/802.11j/p 10MHz/ 802.11p 5MHz/802.11n(20MHz/40MHz): ON, ON, ON, ON, OFF, OFF, OFF, OFF, OFF, OFF, OFF, OFF, OFF, OFF

if Radio Std is 802.11ac/802.11ax (20 MHz/ 40 MHz/ 80 MHz/ 160 MHz): ON, ON, ON, ON, OFF, OFF, OFF, OFF, OFF, OFF, OFF, OFF, OFF, OFF

if Radio Std is 802.11ac/802.11ax (80 MHz + 80 MHz): OFF, ON, ON, ON, ON, ON, ON, ON, ON, OFF, OFF, OFF, OFF

if Radio Std is 802.ah (1MHz/2MHz/4MHz/8MHz/16MHz): ON, ON, ON, ON, OFF, OFF, OFF, OFF, OFF, OFF, OFF, OFF, OFF, OFF

if Radio Std is 802.11af (6 MHz/ 7 MHz/ 8 MHz): ON, ON, ON, ON, OFF, OFF, OFF, OFF, OFF, OFF, OFF, OFF, OFF, OFF

MSR:ON, ON, ON, ON, ON, OFF, OFF, OFF, OFF, OFF, OFF, OFF, OFF, OFF|ON, ON, ON, ON, ON, OFF, OFF, OFF, OFF, OFF, OFF, OFF, OFF

LTEAFDD, LTEATDD: ON, ON, ON, OFF, OFF, OFF, OFF, OFF, OFF, OFF, OFF, OFF, OFF, OFF | ON, ON, ON, ON, OFF, OFF, OFF, OFF, OFF, OFF, OFF, OFF, OFF, OFF

State Saved	Saved in instrument state.
Min	0 Hz
Max	Depends on instrument maximum frequency. It's always Offset Stop Freq (100 Hz
Initial S/W Revision	Prior to A.02.00
Modified at S/W Revision	A.02.00, A.03.00, A.10.00, A.11.00, A.14.00, A.16.00

Stop Freq

Specifies the stop frequency for the currently selected offset.

Missing values are not permitted; that is, if you want to change values 2 and 6, you must send all values up to 6. Subsequent values will remain as they were. The query for this parameter always returns 12 values.

Key Path	Meas Setup, Offset/Limits
Mode	SA, WCDMA, C2K, WIMAX OFDMA, TD-SCDMA, 1xEVDO, DTMB (CTTB), DVB-T/H, ISDB-T, CMMB, LTE, LTETDD, Digital Cable TV, WLAN, MSR, LTEAFDD, LTEATDD
Remote Command	[:SENSe] :SEMAsk:OFFSet [1] 2 [:OUTer] :LIST:FREQuency:STOP <freq>, ... [:SENSe] :SEMAsk:OFFSet [1] 2 [:OUTer] :LIST:FREQuency:STOP?
Example	SEM:OFFS:LIST:FREQ:STOP 2.715 MHz, 3.515 MHz, 4.00 MHz, 8.00 MHz, 12.50 MHz, 15.0 MHz SEM:OFFS:LIST:FREQ:STOP?
Notes	Comma separated list of values. OFFSet1 is for BTS, 2 for MS. Default is BTS. Note that Offset sub op code 2 is supported only in Non-SA modes. In the SA mode, Offset sub op code 1 is used for both BTS and MS.

	<p>If the offset is outside of the frequency range, the result spectrum will be invalid.</p> <p>You must be in the mode that includes SEM measurement to use this command. Use :INSTrument:SElect to set the mode.</p>
Couplings	<p>Coupled to Start Freq. When the stop freq goes below the start freq, the start freq is automatically adjusted to the stop freq minus 100 Hz.</p> <p>If the current mode is DVB-T/H, this value will be modified automatically according to the limit type and the output power of the transmitter which is less or more than 25 W.</p> <p>If the current mode is ISDB-T, this value will be modified automatically according to the limit type.</p>
Preset	<p>For modes (except MSR, LTEAFDD, LTEATDD and WLAN) without option N9060A-7FP, the preset value is as follows.</p> <p>SA: 2.715 MHz, 3.515 MHz, 4.00 MHz, 8.00 MHz, 12.50 MHz, 15.0 MHz</p> <p>WCDMA: 2.715 MHz, 3.515 MHz, 4.000 MHz, 8.000 MHz, 12.50 MHz, 15.0 MHz 3.485 MHz, 7.500 MHz, 8.500 MHz, 12.00 MHz, 15.00 MHz, 18.0 MHz</p> <p>C2K: 780.0 kHz, 1.980 MHz, 4.0 MHz, 4.0 MHz, 12.0 MHz, 12.0 MHz 1.980 MHz, 4.0 MHz, 4.0 MHz, 11.5 MHz, 14.5 MHz, 14.5 MHz</p> <p>WIMAX OFDMA: 5.45 MHz, 9.75 MHz, 14.75 MHz, 19.75 MHz, 24.75 MHz, 29.75 MHz 5.45 MHz, 9.75 MHz, 14.75 MHz, 19.75 MHz, 24.75 MHz, 29.75 MHz</p> <p>TD-SCDMA:</p> <p>1015 kHz, 1815 kHz, 2.3 MHz, 4 MHz, 4 MHz, 4 MHz 1.8 MHz, 2385 kHz, 3.5 MHz, 3.5 MHz, 3.5 MHz, 3.5 MHz</p> <p>1xEVDO: 780.0 kHz, 1.98 MHz, 4.0 MHz, 4.0 MHz, 12 MHz, 12 MHz 1.98 MHz, 4.0 MHz, 4.0 MHz, 4.0 MHz, 4.0 MHz, 4.0 MHz</p> <p>DTMB (CTTB): 4.2 MHz, 6 MHz, 12 MHz, 12 MHz, 12 MHz, 12 MHz 12 MHz, 12 MHz, 12 MHz, 12 MHz, 12 MHz, 12 MHz</p> <p>DVB-T/H: 4.2 MHz, 6 MHz, 12 MHz, 12 MHz, 12 MHz, 12 MHz 12 MHz, 12 MHz, 12 MHz, 12 MHz, 12 MHz, 12 MHz</p> <p>ISDB-T: 2.86 MHz, 3.0 MHz, 4.36 MHz, 15.0 MHz, 15.0 MHz, 15.0 MHz 15 MHz, 15 MHz, 15 MHz, 15 MHz, 15 MHz, 15 MHz</p> <p>CMMB: 4.2 MHz, 8.0 MHz, 12.0 MHz, 12.0 MHz, 12.0 MHz, 12.0 MHz 12 MHz, 12 MHz, 12 MHz, 12 MHz, 12 MHz, 12 MHz</p> <p>LTE, LTE TDD: 5.05 MHz, 10.05 MHz, 15 MHz, 30 MHz, 40 MHz, 50 MHz 985.0 kHz, 4.50 MHz, 5.5001 MHz, 9.50 MHz, 20 MHz, 40 MHz</p> <p>Digital Cable TV: 4.2 MHz, 6.0 MHz, 12.0 MHz, 12.0 MHz, 12.0 MHz, 12.0 MHz, 12 MHz, 12 MHz, 12 MHz, 12 MHz, 12 MHz, 12 MHz</p> <p>When option N9060A-7FP is installed in these modes, the preset value of Offset G ~ L is the same as the Offset F value.</p> <p>-----</p> <p>WLAN:</p> <p>if Radio Std is 802.11a/g(OFDM/DSSS-OFDM)/802.11n(20MHz): 11 MHz, 20 MHz, 30 MHz, 50 MHz, 100 MHz, 250 MHz, 250 MHz, 250 MHz, 250 MHz, 250 MHz, 250 MHz, 250 MHz</p> <p>if Radio Std is 802.11b/g(DSSS/CCK/PBCC): 22 MHz, 50 MHz, 70 MHz, 90 MHz, 100 MHz, 120 MHz, 120 MHz, 120 MHz, 120 MHz, 120 MHz, 120 MHz, 120 MHz</p> <p>if Radio Std is 802.11n(20MHz): 11 MHz, 20 MHz, 30 MHz, 50 MHz, 100 MHz, 200 MHz, 200 MHz, 200 MHz, 200 MHz, 200 MHz, 200 MHz, 200 MHz</p>

if Radio Std is 802.11n(40MHz): 21 MHz, 40 MHz, 60 MHz, 100 MHz, 200 MHz, 300 MHz, 300 MHz, 300 MHz, 300 MHz, 300 MHz

if Radio Std is 802.11ac(20MHz): 11 MHz, 20 MHz, 30 MHz, 50 MHz, 50 MHz, 50 MHz, 50 MHz, 50 MHz, 50 MHz, 50 MHz, 50 MHz

if Radio Std is 802.11ac(40MHz): 21 MHz, 40 MHz, 60 MHz, 100 MHz, 100 MHz, 100 MHz, 100 MHz, 100 MHz, 100 MHz, 100 MHz, 100 MHz

if Radio Std is 802.11ac(80MHz): 41 MHz, 80 MHz, 120 MHz, 200 MHz, 200 MHz, 200 MHz, 200 MHz, 200 MHz, 200 MHz, 200 MHz, 200 MHz

if Radio Std is 802.11ac(160MHz): 81 MHz, 160 MHz, 240 MHz, 400 MHz, 400 MHz, 400 MHz, 400 MHz, 400 MHz, 400 MHz, 400 MHz, 400 MHz

if Radio Std is 802.11ac(80 MHz + 80MHz): 100MHz, 40 MHz, 79 MHz, 81 MHz, 161 MHz, 200 MHz, 240 MHz, 260 MHz, 260 MHz, 260 MHz, 260 MHz, 260 MHz

if Radio Std is 802.11ah(1MHz): 0.6MHz, 1 MHz, 1.5 MHz, 2.5MHz, 2.5 MHz, 2.5 MHz, 2.5 MHz, 2.5 MHz, 2.5 MHz, 2.5 MHz, 2.5 MHz

if Radio Std is 802.11ah(2MHz): 1.1 MHz, 2 MHz, 3 MHz, 5MHz, 5 MHz, 5 MHz, 5 MHz, 5 MHz, 5 MHz, 5 MHz, 5 MHz

if Radio Std is 802.11ah(4MHz): 2.1 MHz, 4 MHz, 6 MHz, 10 MHz, 10 MHz, 10 MHz, 10 MHz, 10 MHz, 10 MHz, 10 MHz, 10 MHz

if Radio Std is 802.11ah(8MHz): 4.1 MHz, 8 MHz, 12 MHz, 20 MHz, 20 MHz, 20 MHz, 20 MHz, 20 MHz, 20 MHz, 20 MHz, 20 MHz

if Radio Std is 802.11ah(16MHz): 8.1 MHz, 16 MHz, 24 MHz, 40 MHz, 40 MHz, 40 MHz, 40 MHz, 40 MHz, 40 MHz, 40 MHz, 40 MHz

if Radio Std is 802.11j/p(20MHz): 10MHz, 11 MHz, 20 MHz, 30 MHz, 50MHz, 50 MHz, 50 MHz, 50 MHz, 50 MHz, 50 MHz, 50 MHz

if Radio Std is 802.11j/p(10MHz): 5MHz, 5.5 MHz, 10 MHz, 15 MHz, 25MHz, 250MHz, 250MHz, 250MHz, 250 MHz, 250MHz, 250MHz, 250MHz

if Radio Std is 802.11p(5MHz): 2.5MHz, 2.75MHz, 5 MHz, 7.5 MHz, 12.5MHz, 250MHz, 250MHz, 250MHz, 250 MHz, 250MHz, 250MHz, 250MHz

if Radio Std is 802.11ax(20MHz): 10.25 MHz, 20 MHz, 30 MHz, 50 MHz, 50 MHz, 50 MHz, 50 MHz, 50 MHz, 50 MHz, 50 MHz, 50 MHz

if Radio Std is 802.11ax(40MHz): 20.5 MHz, 40 MHz, 60 MHz, 100 MHz, 100 MHz, 100 MHz, 100 MHz, 100 MHz, 100 MHz, 100 MHz, 100 MHz

if Radio Std is 802.11ax(80MHz): 40.5 MHz, 80 MHz, 120 MHz, 200 MHz, 200 MHz, 200 MHz, 200 MHz, 200 MHz, 200 MHz, 200 MHz, 200 MHz

if Radio Std is 802.11ax(160MHz): 80.5 MHz, 160 MHz, 240 MHz, 400 MHz, 400 MHz, 400 MHz, 400 MHz, 400 MHz, 400 MHz, 400 MHz, 400 MHz

if Radio Std is 802.11ax(80 MHz + 80MHz): 100MHz, 40 MHz, 79 MHz, 81 MHz, 161 MHz, 200 MHz, 240 MHz, 260 MHz, 260 MHz, 260 MHz, 260 MHz, 260 MHz

if Radio Std is 802.11af(6MHz): 3.15MHz, 6 MHz, 9 MHz, 15MHz, 15 MHz, 15 MHz, 15 MHz, 15 MHz, 15 MHz, 15 MHz, 15 MHz

if Radio Std is 802.11af(7MHz): 3.675 MHz, 7 MHz, 10.5 MHz, 17.5MHz, 17.5 MHz, 17.5 MHz, 17.5 MHz, 17.5 MHz, 17.5 MHz, 17.5 MHz, 17.5 MHz

if Radio Std is 802.11af(8MHz): 4.2 MHz, 8 MHz, 12 MHz, 20 MHz, 20 MHz, 20 MHz, 20 MHz, 20 MHz, 20 MHz, 20 MHz, 20 MHz

MSR: 215kHz, 1.015MHz, 1.5MHz, 10.5MHz, 50MHz, 50MHz, 50MHz, 50MHz, 50MHz, 50MHz, 50MHz

	50MHz, 50MHz LTEAFDD, LTEATDD: 5.05 MHz, 10.05 MHz, 15 MHz, 30 MHz, 40 MHz, 50 MHz, 50 MHz, 50 MHz, 50 MHz, 50 MHz 985.0 kHz, 4.50 MHz, 5.5001 MHz, 9.50 MHz, 20 MHz, 40 MHz, 40 MHz, 40 MHz, 40 MHz, 40 MHz, 40 MHz
State Saved	Saved in instrument state.
Min	100 Hz
Max	Depends on instrument maximum frequency. Same as the Max Span on Swept SA Measurement.
Initial S/W Revision	Prior to A.02.00
Modified at S/W Revision	A.02.00, A.03.00, A.10.00, A.11.00, A.14.00, A.16.00

Sweep Time

Specifies the sweep time for the currently selected offset and enables you to toggle the sweep Time mode between Auto and Man.

Missing values are not permitted; that is, if you want to change values 2 and 6, you must send all values up to 6. Subsequent values will remain as they were. The query for this parameter always returns 12 values.

Key Path	Meas Setup, Offset/Limits
Mode	SA, WCDMA, C2K, WIMAX OFDMA, TD-SCDMA, 1xEVDO, DTMB (CTTB), DVB-T/H, ISDB-T, CMMB, LTE, LTETDD, Digital Cable TV, WLAN, MSR, LTEAFDD, LTEATDD
Remote Command	[:SENSe]:SEMAsk:OFFSet[1] 2[:OUTer]:LIST:SWEep:TIME <time>, ... [:SENSe]:SEMAsk:OFFSet[1] 2[:OUTer]:LIST:SWEep:TIME? [:SENSe]:SEMAsk:OFFSet[1] 2[:OUTer]:LIST:SWEep:TIME:AUTO ON OFF 1 0, ... [:SENSe]:SEMAsk:OFFSet[1] 2[:OUTer]:LIST:SWEep:TIME:AUTO?
Example	SEM:OFFS2:LIST:SWE:TIME 1.0 ms, 3.4 ms, 2.08 ms, 1.0 ms, 1.0 ms, 1.0 ms SEM:OFFS2:LIST:SWE:TIME? SEM:OFFS2:LIST:SWE:TIME:AUTO ON, ON, ON, ON, OFF, OFF SEM:OFFS2:LIST:SWE:TIME:AUTO?
Notes	Comma separated list of values. OFFSet1 is for BTS, 2 for MS. Default is BTS. Note that Offset sub op code 2 is supported only in Non-SA modes. In the SA mode, Offset sub op code 1 is used for both BTS and MS. You must be in the mode that includes SEM measurement to use this command. Use :INSTrument:SElect to set the mode.
Couplings	When the sweep time is set manually, sweep Time Mode is set to MANual. If the current mode is DVB-T/H, this value will be modified automatically according to the output power of the transmitter which is less or more than 25W. If the current mode is ISDB-T, this value will be modified automatically according to the limit type.
Preset	Automatically calculated

	Modes (except MSR, LTEAFDD, LTEATDD and WLAN) without option N9060A-7FP: ON, ON, ON, ON, ON, ON Modes (except MSR, LTEAFDD, LTEATDD and WLAN) with option N9060A-7FP: ON, ON, ON, ON, ON, ON, ON, ON, ON, ON, ON, ON WLAN: ON, ON, ON, ON, ON, ON, ON, ON, ON, ON, ON, ON, ON, ON MSR: ON,ON,ON,ON,ON,ON,ON,ON,ON,ON,ON,ON,ON,ON LTEAFDD, LTEATDD: ON, ON, ON, ON, ON, ON, ON, ON, ON, ON, ON, ON, ON, ON ON, ON, ON, ON, ON, ON, ON, ON, ON, ON, ON, ON, ON, ON
State Saved	Saved in instrument state.
Min	X-Series HW: Depends on Sweep Type Sweep Type "Swept": 1ms Sweep Type "FFT": 100ns E6630A_E6640A_M90XA:TBD E7515A: 39.2 usec
Max	4000 s
Backwards Compatibility SCPI	[:SENSe] :SEMAsk :OFFSet [1] 2 :LIST :SWEep [:TIME]
Initial S/W Revision	Prior to A.02.00
Modified at S/W Revision	A.02.00, A.03.00, A.10.00, A.11.00, A.14.00, A.16.00

Sweep Type (except for E6630A/E6640A/M90XA)

Specifies the sweep type for the currently selected offset and enables you to toggle the Sweep Type mode between Auto and Man.

Missing values are not permitted; that is, if you want to change values 2 and 6, you must send all values up to 6. Subsequent values will remain as they were. The query for this parameter always returns 12 values.

How to define Sweep Time and Sweep Type

- When Sweep Type Mode is Auto, Sweep Type is automatically selected depending on Sweep Type Rules.
- When Sweep Type Mode is Man, Sweep Type is selected by user.
- When Sweep Time Mode is Auto, the sweep time is automatically calculated depending on the selected sweep type.

Key Path	Meas Setup, Offset/Limits
Mode	SA, WCDMA, C2K, WIMAX OFDMA, TD-SCDMA, 1xEVDO, DTMB (CTTB), DVB-T/H, ISDB-T, CMMB, LTE, LTEATDD, Digital Cable TV, WLAN, MSR, LTEAFDD, LTEATDD
Remote Command	[:SENSe] :SEMAsk :OFFSet [1] 2 [:OUTer] :LIST :SWEep :TYPE SWEep FFT, ...

	<pre>[:SENSe]:SEMAsk:OFFSet[1] 2[:OUTer]:LIST:SWEEp:TYPE? [:SENSe]:SEMAsk:OFFSet[1] 2[:OUTer]:LIST:SWEEp:TYPE:AUTO ON OFF 1 0, ... [:SENSe]:SEMAsk:OFFSet[1] 2[:OUTer]:LIST:SWEEp:TYPE:AUTO?</pre>
Example	<pre>SEM:OFFS2:LIST:SWE:TYPE FFT,FFT,SWE SEM:OFFS2:LIST:SWE:TYPE? SEM:OFFS2:LIST:SWE:TYPE:AUTO ON, ON, ON, ON, OFF, OFF SEM:OFFS2:LIST:SWE:TYPE:AUTO?</pre>
Notes	<p>Comma separated list of values.</p> <p>OFFSet1 is for BTS, 2 for MS. Default is BTS.</p> <p>Note that Offset sub op code 2 is supported only in Non-SA modes.</p> <p>In the SA mode, Offset sub op code 1 is used for both BTS and MS.</p> <p>You must be in the mode that includes SEM measurement to use this command. Use :INSTrument:SElect to set the mode.</p>
Couplings	<p>When the sweep type is set manually, Sweep Type Mode is set to MANUAL.</p> <p>When Sweep Type Mode is Auto, Sweep Type is automatically selected depending on Sweep Type Rules.</p>
Preset	<p>Automatically calculated</p> <p>X-Series without option N9060A-7FP, except MSR, LTEAFDD, LTEATDD and WLAN modes: ON, ON, ON, ON, ON</p> <p>All others: ON, ON, ON, ON, ON, ON, ON, ON, ON, ON, ON, ON, ON, ON</p>
State Saved	Saved in instrument state.
Initial S/W Revision	A.16.00

Offset Side

Specifies which offset side to measure.

You can turn off (not use) specific offsets with [:SENSe]:SEMAsk:OFFSet[n] [:OUTer]:LIST:STATe.

- BOTH – Both of the negative (lower) and positive (upper) sidebands
- **NEGative** – Negative (lower) sideband only
- **POSitive** – Positive (upper) sideband only

Missing values are not permitted; that is, if you want to change values 2 and 6, you must send all values up to 6. Subsequent values will remain as they were. The query for this parameter always returns 12 values.

The figure below shows the relation between the negative/positive offset side setups and the upper/lower results in the MSR and LTE-Advanced FDD/TDD.

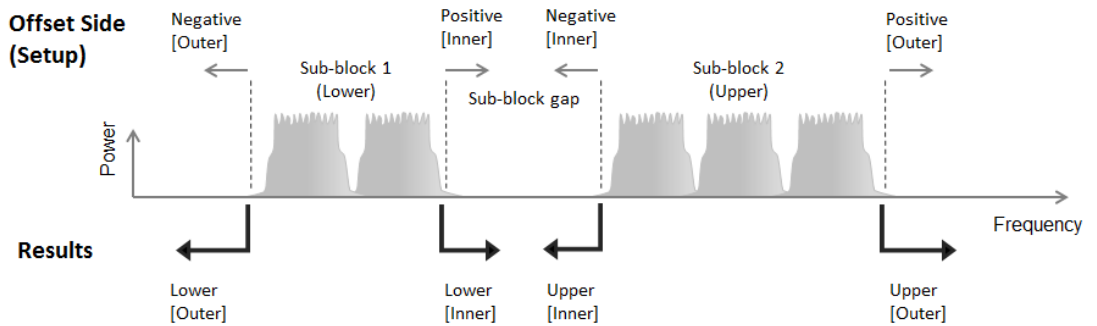

Key Path	Meas Setup, Offset/Limits
Mode	SA, WCDMA, C2K, WIMAX OFDMA, TD-SCDMA, 1xEVDO, DTMB (CTTB), DVB-T/H, ISDB-T, CMMB, LTE, LTEFDD, Digital Cable TV, WLAN, MSR, LTEAFDD, LTEATDD
Remote Command	<code>[:SENSe]:SEMAsk:OFFSet[1] 2[:OUTer]:LIST:SIDE BOTH NEGative POSitive, ...</code> <code>[:SENSe]:SEMAsk:OFFSet[1] 2[:OUTer]:LIST:SIDE?</code>
Example	<code>SEM:OFFS:LIST:SIDE BOTH, NEG, NEG, POS, POS, POS</code> <code>SEM:OFFS:LIST:SIDE?</code>
Notes	Comma separated list of values. OFFSet1 is for BTS, 2 for MS. Default is BTS. Note that Offset sub op code 2 is supported only in Non-SA modes. In the SA mode, Offset sub op code 1 is used for both BTS and MS. You must be in the mode that includes SEM measurement to use this command. Use <code>:INSTrument:SElect</code> to set the mode.
Preset	Modes (except MSR, LTEAFDD, LTEATDD and WLAN) without option N9060A-7FP: BOTH, BOTH, BOTH, BOTH, BOTH, BOTH Modes (except MSR, LTEAFDD, LTEATDD and WLAN) with option N9060A-7FP: BOTH, BOTH, BOTH, BOTH, BOTH, BOTH, BOTH, BOTH, BOTH, BOTH, BOTH, BOTH, BOTH, BOTH, BOTH MSR: BOTH, BOTH, BOTH, BOTH, BOTH, BOTH, BOTH, BOTH, BOTH, BOTH, BOTH, BOTH, BOTH, BOTH, BOTH LTEAFDD, LTEATDD: BOTH, BOTH, BOTH, BOTH, BOTH, BOTH, BOTH, BOTH, BOTH, BOTH, BOTH, BOTH, BOTH, BOTH BOTH, BOTH, BOTH, BOTH, BOTH, BOTH, BOTH, BOTH, BOTH, BOTH, BOTH, BOTH, BOTH, BOTH, BOTH WLAN: BOTH, BOTH, BOTH, BOTH, BOTH, BOTH, BOTH, BOTH, BOTH, BOTH, BOTH, BOTH, BOTH, BOTH, BOTH
State Saved	Saved in instrument state.
Range	Neg Both Pos
Initial S/W Revision	Prior to A.02.00
Modified at S/W Revision	A.02.00, A.03.00, A.10.00, A.11.00, A.14.00

Res BW

Specifies which Resolution BW filter to use when measuring the currently selected offset.

Offset Res BW Mode allows the instrument to determine the optimum Resolution BW filter to use when measuring the currently selected offset.. When changing the Meas BW parameter, if the Res BW needs to be changed to adhere to the rule

$$(N \times \text{Res BW}) \leq (\text{Stop freq of the offset} - \text{Start freq of the offset}),$$

where N is the multiplier, this setting will automatically be changed to manual.

Missing values are not permitted; that is, if you want to change values 2 and 6, you must send all values up to 6. Subsequent values will remain as they were. The query for this parameter always returns 12 values.

Key Path	Meas Setup, Offset/Limits
Mode	SA, WCDMA, C2K, WIMAX OFDMA, TD-SCDMA, 1xEVDO mode, DTMB (CTTB), DVB-T/H, ISDB-T, CMMB, LTE, LTETDD, Digital Cable TV, WLAN, MSR, LTEAFDD, LTEATDD
Remote Command	<pre>[:SENSe]:SEMAsk:OFFSet[1] 2[:OUTer]:LIST:BANDwidth[:RESolution] <bandwidth>, ... [:SENSe]:SEMAsk:OFFSet[1] 2[:OUTer]:LIST:BANDwidth[:RESolution]? [:SENSe]:SEMAsk:OFFSet[1] 2[:OUTer]:LIST:BANDwidth[:RESolution]:AUTO OFF ON 1 0, ... [:SENSe]:SEMAsk:OFFSet[1] 2[:OUTer]:LIST:BANDwidth [:RESolution]:AUTO?</pre>
Example	<pre>SEM:OFFS2:LIST:BAND 30.0 kHz, 30.0 kHz, 30.0 kHz, 1.00 MHz, 1.00 MHz, 1.00 MHz SEM:OFFS2:LIST:BAND? SEM:OFFS:LIST:BAND:AUTO 1,1,1,1,1,1 SEM:OFFS:LIST:BAND:AUTO?</pre>
Notes	<p>Comma separated list of values.</p> <p>OFFSet1 is for BTS, 2 for MS. Default is BTS.</p> <p>Note that Offset sub op code 2 is supported only in Non-SA modes.</p> <p>In the SA mode, Offset sub op code 1 is used for both BTS and MS.</p> <p>You must be in the mode that includes SEM measurement to use this command. Use :INSTrument:SElect to set the mode.</p>
Couplings	<p>Coupled to Start and Stop offset and Meas BW multiplier. This parameter must adhere to the rule $(N \times \text{Res BW}) \leq (\text{Stop freq of the offset} - \text{Start freq of the offset})$, where N is the multiplier. If the multiplier is changed, the Res BW will be changed to ensure this. When set manually, Res BW Coupling is set to manual.</p> <p>The resolution bandwidth is coupled to the offset width determined by the start frequency and stop frequency.</p>
Preset	<p>For modes (except MSR, LTEAFDD, LTEATDD and WLAN) without option N9060A-7FP, the preset value is as follows.</p> <p>SA: 30.0 kHz, 30.0 kHz, 30.0 kHz, 1.00 MHz, 1.00 MHz, 1.00 MHz</p> <p>WCDMA: 30.00 kHz, 30.00 kHz, 30.00 kHz, 100.00 kHz, 1.000 MHz, 1.00 MHz 30.00 kHz, 1.000 MHz, 1.000 MHz, 1.000 MHz, 1.00 MHz</p> <p>C2K: 3.00 kHz, 30.00 kHz, 30.00 kHz, 6.2 kHz, 1.000 MHz, 1.00 MHz 30.00 kHz, 30.00 kHz, 6.2 kHz, 1.000 MHz, 1.000 MHz, 1.00 MHz</p> <p>WIMAX OFDMA: 100 KHz, 100 KHz, 100 KHz, 100 KHz, 100 KHz, 100 KHz 100 KHz, 100 KHz, 100 KHz, 100 KHz, 100 KHz, 100 KHz</p>

TD-SCDMA: 30 kHz, 30 kHz, 30 kHz, 50 kHz, 1 MHz, 1 MHz| 30 kHz, 30 kHz, 50 kHz, 1 MHz, 1 MHz, 1 MHz
 1xEVDO: 30.00 kHz, 30.00 kHz, 30.00 kHz, 6.2 kHz, 1.000 MHz, 1.000 MHz|30.00 kHz, 30.00 kHz, 30.00 kHz, 30.00 kHz, 30.00 kHz, 30.00 kHz
 DTMB (CTTB), DVB-T/H, CMMB, Digital Cable TV: 3.9 kHz, 3.9 kHz, 3.9 kHz, 3.9 kHz, 3.9 kHz, 3.9 kHz |30.00 kHz, 1.000 MHz, 1.000 MHz, 1.000 MHz, 1.000 MHz, 1.00 MHz
 ISDB-T: 10.0 kHz, 10.0 kHz, 10.0 kHz, 10.0 kHz, 10. kHz, 10.0 kHz |30.00 kHz, 1.000 MHz, 1.000 MHz, 1.000 MHz, 1.000 MHz, 1.00 MHz
 LTE, LTE-TDD: 51 kHz, 100 kHz, 1.0 MHz, 1.0 MHz, 1.0 MHz, 1.0 MHz|15.0 kHz, 510 kHz, 1.0 MHz, 1.0 MHz, 1.0 MHz, 1.0 MHz
 When option N9060A-7FP is installed in these modes, the preset value of Offset G ~ L is the same as the Offset F value.

 WLAN:

If radio std is 802.11ah: 10 KHz, 10 KHz, 10 KHz, 10 KHz, 10 KHz, 10 KHz, 10 KHz, 10 KHz, 10 KHz, 10 KHz, 10 KHz, 10 KHz
 For other radio std: 100 KHz, 100 KHz, 100 KHz, 100 KHz, 100 KHz, 100 KHz, 100 KHz, 100 KHz, 100 KHz, 100 KHz, 100 KHz, 100 KHz
 MSR: 30kHz, 30kHz, 30kHz, 1.0MHz, 1.0MHz, 1.0MHz, 1.0MHz, 1.0MHz, 1.0MHz, 1.0MHz, 1.0MHz, 1.0MHz | 30kHz, 30kHz, 30kHz, 1.0MHz, 1.0MHz, 1.0MHz, 1.0MHz, 1.0MHz, 1.0MHz, 1.0MHz, 1.0MHz
 LTEAFDD, LTEATDD: 51 kHz, 100 kHz, 1.0 MHz, 1.0 MHz, 1.0 MHz, 1.0 MHz, 1.0 MHz, 1.0 MHz, 1.0 MHz, 1.0 MHz, 1.0 MHz, 1.0 MHz | 15.0 kHz, 510 kHz, 1.0 MHz, 1.0 MHz, 1.0 MHz, 1.0 MHz, 1.0 MHz, 1.0 MHz, 1.0 MHz, 1.0 MHz, 1.0 MHz
 Modes (except MSR, LTEAFDD, LTEATDD and WLAN) without option N9060A-7FP: OFF, OFF, OFF, OFF, OFF, OFF, OFF, OFF, OFF, OFF, OFF, OFF
 Modes (except MSR, LTEAFDD, LTEATDD and WLAN) with option N9060A-7FP: OFF, OFF
 MSR: OFF, OFF
 LTEAFDD, LTEATDD: OFF, OFF
 WLAN: OFF, OFF

State Saved	Saved in instrument state.
Min	1 Hz
Max	8 MHz
Backwards Compatibility SCPI	[:SENSe] :SEMAsk :OFFSet [1] 2 :LIST :BWIDth [:RESolution]
Initial S/W Revision	Prior to A.02.00
Modified at S/W Revision	A.02.00, A.03.00, A.10.00, A.11.00, A.14.00

Meas BW

Allows you to specify a multiplier of Res BW for the measurement integration bandwidth.

Meas BW is multiplier integer number. It shows a ratio between Integration BW and Resolution BW of the measurement result.

$$\text{Integ BW} = \text{Meas BW} * \text{Resolution BW}$$

Integration BW is desired resolution bandwidth and Resolution BW is actual bandwidth for sweep. Measurement sweeps with Resolution BW and Meas BW compensates sweep resolution bandwidth to Integration BW.

If you set this parameter greater than 1, you can set Resolution BW narrower to avoid carrier power leakage effect to the offset power integration.

Missing values are not permitted; that is, if you want to change values 2 and 6, you must send all values up to 6. Subsequent values will remain as they were. The query for this parameter always returns 12 values.

Key Path	Meas Setup, Offset/Limits
Mode	SA, WCDMA, C2K, WIMAX OFDMA, TD-SCDMA, 1xEVDO, DTMB (CTTB), DVB-T/HISDB-T, CMMB, LTE, LTETDD, Digital Cable TV, WLAN
Remote Command	[:SENSe]:SEMAsk:OFFSet[1] 2[:OUTer]:LIST:BANDwidth:IMULti <integer>, ... [:SENSe]:SEMAsk:OFFSet[1] 2[:OUTer]:LIST:BANDwidth:IMULti?
Example	SEM:OFFS2:LIST:BAND:IMUL 1,1,1,1,1,1 SEM:OFFS2:LIST:BAND:IMUL?
Notes	Comma separated list of values. OFFSet1 is for BTS, 2 for MS. Default is BTS. Note that Offset sub op code 2 is supported only in Non-SA modes. In the SA mode, Offset sub op code 1 is used for both BTS and MS. You must be in the mode that includes SEM measurement to use this command. Use :INSTrument:SElect to set the mode.
Couplings	This parameter must adhere to the rule (N x Res BW) <= (Stop freq of the offset - Start freq of the offset), where N is the multiplier. If the Res Bw is changed, the multiplier will be changed to ensure this.
Preset	For modes (except MSR, LTEAFDD, LTEATDD and WLAN) without option N9060A-7FP, the preset value is as follows. SA: 1, 1, 1, 1, 1, 1 WCDMA: 1, 1, 1, 10, 1, 1 1, 1, 1, 1, 1, 1 C2K: 10, 1, 1, 1, 1, 1 1, 1, 1, 1, 1, 1 WIMAX OFDMA, 1xEVDO: 1, 1, 1, 1, 1, 1 1, 1, 1, 1, 1, 1 TD-SCDMA:1, 1, 1, 20, 1, 1 1, 1, 20, 1, 1, 1 DTMB (CTTB), DVB-T/H, ISDB-T, CMMB, Digital Cable TV: 1, 1, 1, 1, 1, 1 1, 1, 1, 1, 1, 1 LTE, LTETDD: 2, 1, 1, 1, 1, 1 2, 2, 1, 1, 1, 1 When option N9060A-7FP is installed in these modes, the preset value of Offset G ~ L is the

	same as the Offset F value. ----- WLAN: 1, 1, 1, 1, 1, 1, 1, 1, 1, 1, 1, 1 MSR: 1, 1 LTEAFDD, LTEATDD: 2, 1
State Saved	Saved in instrument state.
Min	1
Max	1000
Backwards Compatibility SCPI	[:SENSe] :SEMAsk :OFFSet [1] 2 :LIST :BWiDth :IMULti
Initial S/W Revision	Prior to A.02.00
Modified at S/W Revision	A.02.00, A.03.00, A.10.00, A.11.00, A.14.00

Video BW

Changes the analyzer post-detection filter.

Missing values are not permitted; that is, if you want to change values 2 and 6, you must send all values up to 6. Subsequent values will remain as they were. The query for this parameter always returns 12 values.

Key Path	Meas Setup, Offset/Limits
Mode	SA, WCDMA, C2K, WIMAXOFDMA, TD-SCDMA, 1xEVDO, DTMB (CTTB), DVB-T/H, ISDB-T, CMMB, LTE, LTE-TDD, Digital Cable TV, WLAN, MSR, LTEAFDD, LTEATDD
Remote Command	[:SENSe] :SEMAsk :OFFSet [1] 2 [:OUTer] :LIST :BANDwidth :VIDeo <freq>, ... [:SENSe] :SEMAsk :OFFSet [1] 2 [:OUTer] :LIST :BANDwidth :VIDeo? [:SENSe] :SEMAsk :OFFSet [1] 2 [:OUTer] :LIST :BANDwidth :VIDeo :AUTO OFF ON 0 1, ... [:SENSe] :SEMAsk :OFFSet [1] 2 [:OUTer] :LIST :BANDwidth :VIDeo :AUTO?
Example	SEM:OFFS2:LIST:BAND:VID 3.00 kHz, 3.00 kHz, 3.00 kHz, 100.0 kHz, 100.0 kHz, 100.0 kHz SEM:OFFS2:LIST:BAND:VID? SEM:OFFS2:LIST:BAND:VID:AUTO ON, ON, ON, ON, ON, ON SEM:OFFS2:LIST:BAND:VID:AUTO?
Notes	Comma separated list of values. OFFSet1 is for BTS, 2 for MS. Default is BTS. Note that Offset sub op code 2 is supported only in Non-SA modes. In the SA mode, Offset sub op code 1 is used for both BTS and MS. You must be in the mode that includes SEM measurement to use this command. Use :INSTrument:SElect to set the mode.
Preset	ISDB-T: 1.0kHz, 1.0kHz, 1.0kHz, 1.0kHz, 1.0kHz, 1.0kHz Other than ISDB-T: Automatically Calculated Modes (except MSR, LTEAFDD, LTEATDD, WLAN, ISDB-T) without option N9060A-7FP: ON, ON,

	ON, ON, ON, ON ON, ON, ON, ON, ON, ON Modes (except MSR, LTEAFDD, LTEATDD, WLAN, ISDB-T) with option N9060A-7FP:ON, ON, ON, ON, ON, ON, ON, ON, ON, ON, ON, ON, ON, ON ON, ON, ON, ON, ON, ON, ON, ON, ON, ON, ON ----- MSR, LTEAFDD, LTEATDD: ON, ON, ON, ON, ON, ON, ON, ON, ON, ON, ON, ON, ON, ON, ON ON, ON, ON, ON, ON, ON, ON, ON, ON, ON, ON, ON WLAN: ON, ON, ON, ON, ON, ON, ON, ON, ON, ON, ON, ON, ON, ON ON, ON, ON, ON, ON, ON, ON, ON, ON, ON, ON, ON ISDB-T: OFF, OFF, OFF, OFF, OFF, OFF OFF, OFF, OFF, OFF, OFF, OFF
State Saved	Saved in instrument state.
Min	1 Hz
Max	50 MHz
Backwards Compatibility SCPI	[:SENSe]:SEMAsk:OFFSet[1] 2:LIST:BWIDth:VIDeo
Initial S/W Revision	Prior to A.02.00
Modified at S/W Revision	A.02.00, A.03.00, A.10.00, A.11.00, A.14.00

VBW/RBW

Selects the ratio between the video and resolution bandwidths.

Missing values are not permitted; that is, if you want to change values 2 and 6, you must send all values up to 6. Subsequent values will remain as they were. The query for this parameter always returns 12 values.

Key Path	Meas Setup, Offset/Limits
Mode	SA, WCDMA, C2K, WIMAX OFDMA, TD-SCDMA, 1xEVDO, DTMB (CTTB), DVB-T/H, ISDB-T, CMMB, LTE, LTETDD, Digital Cable TV, WLAN, MSR, LTEAFDD, LTEATDD
Remote Command	[:SENSe]:SEMAsk:OFFSet[1] 2[:OUTer]:LIST:BANDwidth:VIDeo:RATio <real>, ... [:SENSe]:SEMAsk:OFFSet[1] 2[:OUTer]:LIST:BANDwidth:VIDeo:RATio? [:SENSe]:SEMAsk:OFFSet[1] 2[:OUTer]:LIST:BANDwidth:VIDeo:RATio:AUTO OFF ON 0 1, ... [:SENSe]:SEMAsk:OFFSet[1] 2[:OUTer]:LIST:BANDwidth:VIDeo:RATio:AUTO?
Example	SEM:OFFS2:LIST:BAND:VID:RAT 0.1, 0.1, 0.1, 0.1, 0.1, 0.1 SEM:OFFS2:LIST:BAND:VID:RAT? SEM:OFFS2:LIST:BAND:VID:RAT:AUTO ON, ON, ON, ON, ON, ON, ON SEM:OFFS2:LIST:BAND:VID:RAT:AUTO?
Notes	Comma separated list of values. OFFSet1 is for BTS, 2 for MS. Default is BTS. Note that Offset sub op code 2 is supported only in Non-SA modes. In the SA mode, Offset sub op code 1 is used for both BTS and MS.

You must be in the mode that includes SEM measurement to use this command. Use :INSTrument:SELEct to set the mode.

Preset	<p>For modes (except MSR, LTEAFDD, LTEATDD and WLAN) without option N9060A-7FP, the preset value is as follows.</p> <p>SA, WCDMA, C2K, LTE, LTETDD: 0.01, 0.01, 0.01, 0.01, 0.01, 0.01 0.01, 0.01, 0.01, 0.01, 0.01, 0.01</p> <p>WIMAX OFDMA: 0.3, 0.3, 0.3, 0.3, 0.3, 0.3</p> <p>TD-SCDMA: 10, 10, 10, 10, 1, 1 10, 10, 10, 1, 1, 1</p> <p>1xEVDO: 10, 10, 10, 10, 10, 10 10, 10, 10, 10, 10, 10</p> <p>DTMB (CTTB), DVB-T/H, CMMB, Digital Cable TV: 10, 10, 10, 10, 10, 10 10, 10, 10, 10, 10, 10</p> <p>ISDB-T: 0.1, 0.1, 0.1, 0.1, 0.1, 0.1 10, 10, 10, 10, 10, 10</p> <p>When option N9060A-7FP is installed in these modes, the preset value of Offset G ~ L is the same as the Offset F value.</p> <p>-----</p> <p>WLAN:</p> <p>If radio std is 802.11ah: 10, 10, 10, 10, 10, 10, 10, 10, 10, 10, 10, 10</p> <p>For other radio std: 0.3, 0.3, 0.3, 0.3, 0.3, 0.3, 0.3, 0.3, 0.3, 0.3, 0.3, 0.3</p> <p>MSR, LTEAFDD, LTEATDD: 0.01, 0.01, 0.01, 0.01, 0.01, 0.01, 0.01, 0.01, 0.01, 0.01, 0.01, 0.01 0.01, 0.01, 0.01, 0.01, 0.01, 0.01, 0.01, 0.01, 0.01, 0.01</p> <p>Modes (except MSR, LTEAFDD, LTEATDD and WLAN) without option N9060A-7FP: OFF, OFF, OFF, OFF, OFF, OFF OFF, OFF, OFF, OFF, OFF, OFF</p> <p>Modes (except MSR, LTEAFDD, LTEATDD and WLAN) with option N9060A-7FP: OFF, OFF, OFF, OFF, OFF, OFF, OFF, OFF, OFF, OFF, OFF, OFF OFF, OFF, OFF, OFF, OFF, OFF, OFF, OFF, OFF, OFF, OFF, OFF</p> <p>MSR, LTEAFDD, LTEATDD: OFF, OFF, OFF, OFF, OFF, OFF, OFF, OFF, OFF, OFF, OFF, OFF OFF, OFF, OFF, OFF, OFF, OFF, OFF, OFF, OFF, OFF, OFF, OFF</p> <p>WLAN: OFF, OFF, OFF, OFF, OFF, OFF, OFF, OFF, OFF, OFF, OFF, OFF OFF, OFF, OFF, OFF, OFF, OFF, OFF, OFF, OFF, OFF, OFF, OFF</p>
State Saved	Saved in instrument state.
Min	0.00001
Max	3000000
Initial S/W Revision	Prior to A.02.00
Modified at S/W Revision	A.02.00, A.03.00, A.10.00, A.11.00, A.14.00

Limits

Accesses a menu that enables you to set the power limits for start and stop frequencies of the selected offsets.

Key Path	Meas Setup
Initial S/W Revision	Prior to A.02.00

Select Offset

Selects the offset (upper and lower) and displays the memory selection menu that enables you to store a set of parameter values for the offset, such as Start Freq, Stop Freq, sweep Time, Res BW, Meas BW, Abs Start, and Abs Stop. Only one selection at a time is shown on this menu key label.

Key Path	Meas Setup, Offset/Limits
Mode	SA, WCDMA, C2K, WIMAX OFDMA, TD-SCDMA, 1xEVDO, DTMB (CTTB), DVB-T/H, ISDB-T, CMMB, LTE, LTETDD, Digital Cable TV, WLAN, MSR, LTEAFDD, LTEATDD
Preset	A
Range	MSR, LTEATDD, LTEAFDD, WLAN: A B C D E F G H I J K L Other modes without option N9060A-7FP: A B C D E F Other modes with option N9060A-7FP: A B C D E F G H I J K L
Initial S/W Revision	Prior to A.02.00
Modified at S/W Revision	A.02.00, A.03.00, A.10.00, A.11.00, A.14.00

Abs Start

Sets the absolute power level limit at the start frequency for the selected offset. The absolute power level limit ranges from -200 to +50 dBm.

The fail condition for each offset channel is set remotely by
[:SENSe]:SEMAsk:OFFSet[n][:OUTer]:LIST:TEST.

You can turn off (not use) specific offset channels remotely with
[:SENSe]:SEMAsk:OFFSet[n][:OUTer]:LIST:STATE.

The SCPI query returns values currently set to the absolute power test limits.

Missing values are not permitted; that is, if you want to change values 2 and 6, you must send all values up to 6. Subsequent values will remain as they were. The query for this parameter always returns 12 values.

Key Path	Meas Setup, Offset/Limit, Limits
Mode	SA, WCDMA, C2K, WIMAX OFDMA, TD-SCDMA, 1xEVDO, DTMB (CTTB), DVB-T/H, ISDB-T, CMMB, LTE, LTETDD, Digital Cable TV, WLAN, MSR, LTEAFDD, LTEATDD
Remote Command	[:SENSe] : SEMAsk : OFFSet [1] 2 [:OUTer] : LIST : START : ABSolute <real> , ... [:SENSe] : SEMAsk : OFFSet [1] 2 [:OUTer] : LIST : START : ABSolute?
Example	SEM:OFFS2:LIST:STAR:ABS -12.50 dBm, -12.50 dBm, -24.50 dBm, -11.50 dBm, -11.50 dBm, -11.50 dBm SEM:OFFS2:LIST:STAR:ABS?
Notes	Comma separated list of values. OFFSet1 is for BTS, 2 for MS. Default is BTS. Note that Offset sub op code 2 is supported only in Non-SA modes. In the SA mode, Offset sub op code 1 is used for both BTS and MS. You must be in the mode that includes SEM measurement to use this command. Use

	:INSTrument:SElect to set the mode.
Couplings	<p>If the current mode is DVB-T/H, this value will be modified automatically according to the limit type and the output power of the transmitter which is less or more than 25W.</p> <p>If the current mode is ISDB-T, this value will be modified automatically according to the limit type.</p>
Preset	<p>For modes (except MSR, LTEAFDD, LTEATDD and WLAN) without option N9060A-7FP, the preset value is as follows.</p> <p>SA, WIMAX OFDMA: -14.00 dBm , -14.00 dBm , -26.00 dBm , -13.00 dBm , -13.00 dBm, -13.00 dBm</p> <p>WCDMA: -12.50 dBm, -12.50 dBm, -24.50 dBm, -11.50 dBm, -11.50 dBm, -11.50 dBm -69.6 dBm, -54.3 dBm, -54.3 dBm, -54.3 dBm, -54.3 dBm, -54.3 dBm</p> <p>C2K: -27.00 dBm, -27.00 dBm, -27.00 dBm, -46.00 dBm, -13.00 dBm, -13.00 dBm -70.13 dBm, -70.13 dBm, -35.00 dBm, -13.00 dBm, -13.00 dBm, -13.00 dBm</p> <p>TD-SCDMA: -28 dBm, -28 dBm, -36 dBm, -21 dBm, -21 dBm, -21 dBm -71.3 dBm, -71.3 dBm, -56.07 dBm, -56.07 dBm, -56.07 dBm, -56.07 dBm</p> <p>1xEVDO: -27.0dBm, -27.00 dBm, -27.00 dBm, -46.00 dBm, -13.00 dBm, -13.00 dBm -70.13 dBm, -70.13 dBm, -70.13 dBm, -70.13 dBm, -70.13 dBm</p> <p>DTMB (CTTB): -14.0 dBm, -14.0 dBm, -26.0 dBm, -13.0 dBm, -13.0 dBm, -13.0 dBm -13.0 dBm, -13.0 dBm, -13.0 dBm, -13.0 dBm, -13.0 dBm, -13.0 dBm</p> <p>DVB-T/H: 11.2 dBm, -29 dBm, -41 dBm, -66 dBm, -82 dBm, -82 dBm -82 dBm, -82 dBm, -82 dBm, -82 dBm, -82 dBm, -82 dBm</p> <p>ISDB-T, CMMB, Digital Cable TV: 50.0 dBm, 50.0 dBm, 50.0 dBm, 50.0 dBm, 50.0 dBm, 50.0 dBm 50.0 dBm, 50.0 dBm, 50.0 dBm, 50.0 dBm, 50.0 dBm, 50.0 dBm</p> <p>LTE, LTETDD: -5.5 dBm, -12.5 dBm, -15.0 dBm, -15.0 dBm, -15.0 dBm, -15.0 dBm -13.5 dBm, -8.5 dBm, -11.5 dBm, -23.5 dBm, -23.5 dBm, -23.5 dBm</p> <p>When option N9060A-7FP is installed in these modes, the preset value of Offset G ~ L is the same as the Offset F value.</p> <p>-----</p> <p>WLAN:</p> <p>if Radio Std is 802.11b/g(DSSS/CCK/PBCC): -10 dBm, -30 dBm, -30 dBm, -30 dBm, -30 dBm, -30 dBm, -30 dBm, -30 dBm, -30 dBm, -30 dBm, -30 dBm, -30 dBm</p> <p>if Radio Std is 802.11a/g(OFDM/DSSS-OFDM), 802.11n(20MHz) or 802.11ac(20MHz) or 802.11ax(20MHz) : 16.00 dBm, -4.00 dBm, -12.00 dBm, -63.00 dBm, -63.00 dBm, -63.00 dBm, -63.00 dBm, -63.00 dBm, -63.00 dBm, -63.00 dBm, -63.00 dBm, -63.00 dBm</p> <p>if Radio Std is 802.11n(40MHz) or 802.11ac(40MHz) or 802.11ax(40MHz): 16.00 dBm, -4.00 dBm, -12.00 dBm, -66.00 dBm, -66.00 dBm, -66.00 dBm, -66.00 dBm, -66.00 dBm, -66.00 dBm, -66.00 dBm, -66.00 dBm, -66.00 dBm</p> <p>if Radio Std is 802.11ac/802.11ax(80MHz/160MHz): 16.00 dBm, -4.00 dBm, -12.00 dBm, -69.00 dBm, -69.00 dBm, -69.00 dBm, -69.00 dBm, -69.00 dBm, -69.00 dBm, -69.00 dBm, -69.00 dBm, -69.00 dBm</p> <p>if Radio Std is 802.11ac/802.11ax(80 MHz + 80 MHz): -69.00 dBm, -69.00 dBm, -69.00 dBm, -69.00 dBm, -69.00 dBm, -69.00 dBm, -69.00 dBm, -69.00 dBm, -69.00 dBm, -69.00 dBm, -69.00 dBm, -69.00 dBm</p> <p>if Radio Std is 802.11ah(1MHz): 16.00 dBm, -4.00 dBm, -12.00 dBm, -60.00 dBm, -60.00 dBm, -60.00 dBm, -60.00 dBm, -60.00 dBm, -60.00 dBm, -60.00 dBm, -60.00 dBm, -60.00 dBm</p>

Mode	SA, WCDMA, C2K, WIMAX OFDMA, TD-SCDMA, 1xEVDO, DTMB (CTTB), DVB-T/H, ISDB-T, CMMB, LTE, LTETDD, Digital Cable TV, WLAN, MSR, LTEAFDD, LTEATDD
Remote Command	<pre>[:SENSe]:SEMAsk:OFFSet[1] 2[:OUTer]:LIST:STOP:ABSolute <real>, ... [:SENSe]:SEMAsk:OFFSet[1] 2[:OUTer]:LIST:STOP:ABSolute? [:SENSe]:SEMAsk:OFFSet[1] 2[:OUTer]:LIST:STOP:ABSolute:COUple ON OFF 1 0, ... [:SENSe]:SEMAsk:OFFSet[1] 2[:OUTer]:LIST:STOP:ABSolute:COUple?</pre>
Example	<pre>SEM:OFFS:LIST:STOP:ABS -12.50 dBm, -24.50 dBm, -24.50 dBm, -11.50 dBm, -11.50 dBm, -11.50 dBm SEM:OFFS1:LIST:STOP:ABS? SEM:OFFS:LIST:STOP:ABS:COUP ON, OFF, ON, ON, ON, ON SEM:OFFS:LIST:STOP:ABS:COUP?</pre>
Notes	<p>Comma separated list of values.</p> <p>OFFSet1 is for BTS, 2 for MS. Default is BTS.</p> <p>Note that Offset sub op code 2 is supported only in Non-SA modes.</p> <p>In the SA mode, Offset sub op code 1 is used for both BTS and MS.</p> <p>You must be in the mode that includes SEM measurement to use this command. Use :INSTrument:SElect to set the mode.</p>
Couplings	<p>Coupled to Abs Start if "Auto" is selected, that is, the Stop value is equal to the Start value.</p> <p>If the current mode is DVB-T/H, this value will be modified automatically according to the limit type and the output power of the transmitter which is less or more than 25W.</p> <p>If the current mode is ISDB-T, this value will be modified automatically according to the limit type.</p>
Preset	<p>For modes (except MSR, LTEAFDD, LTEATDD and WLAN) without option N9060A-7FP, the preset value is as follows.</p> <p>SA, WIMAX OFDMA: -14.00 dBm, -26.00 dBm, -26.00 dBm, -13.00 dBm, -13.00 dBm, -13.00 dBm</p> <p>WCDMA: -12.50 dBm, -24.50 dBm, -24.50 dBm, -11.50 dBm, -11.50 dBm, -11.50 dBm -69.6 dBm, -54.3 dBm, -54.3 dBm, -54.3 dBm, -54.3 dBm, -54.3 dBm</p> <p>C2K: -27.00 dBm, -27.00 dBm, -27.00 dBm, -46.00 dBm, -13.00 dBm, -13.00 dBm -70.13 dBm, -70.13 dBm, -35.00 dBm, -13.00 dBm, -13.00 dBm, -13.00 dBm</p> <p>TD-SCDMA: -28 dBm, -36 dBm, -36 dBm, -21 dBm, -21 dBm, -21 dBm -71.3 dBm, -71.3 dBm, -56.07 dBm, -56.07 dBm, -56.07 dBm, -56.07 dBm</p> <p>1xEVDO: -27dBm, -27.00 dBm, -27.00 dBm, -46.00 dBm, -13.00 dBm, -13.00 dBm -70.13 dBm, -70.13 dBm, -70.13 dBm, -70.13 dBm, -70.13 dBm</p> <p>DTMB (CTTB): -14.0 dBm, -26.0 dBm, -26.0 dBm, -13.0 dBm, -13.0 dBm, -13.0 dBm -13.0 dBm, -13.0 dBm, -13.0 dBm, -13.0 dBm, -13.0 dBm</p> <p>DVB-T/H: -29 dBm, -41 dBm, -66 dBm, -82 dBm, -82 dBm, -82 dBm -82 dBm, -82 dBm, -82 dBm, -82 dBm, -82 dBm, -82 dBm</p> <p>ISDB-TCMMB, Digital Cable TV: 50.0 dBm, 50.0 dBm, 50.0 dBm, 50.0 dBm, 50.0 dBm 50.0 dBm, 50.0 dBm, 50.0 dBm, 50.0 dBm, 50.0 dBm</p> <p>LTE, LTETDD: -12.5 dBm, -12.5 dBm, -15.0 dBm, -15.0 dBm, -15.0 dBm, -15.0 dBm -13.5 dBm, -8.5 dBm, -11.5 dBm, -23.5 dBm, -23.5 dBm, -23.5 dBm</p> <p>When option N9060A-7FP is installed in these modes, the preset value of Offset G ~ L is the same</p>

C2K: ON, ON, ON, ON, ON, OFF|ON, ON, ON, ON, ON, OFF
 TD-SCDMA: ON, OFF, ON, ON, ON, ON|ON, ON, ON, ON, ON, ON
 1xEVDO: ON, ON, ON, ON, ON, OFF|ON, ON, ON, ON, ON, OFF
 DTMB (CTTB): ON, OFF, ON, ON, ON, ON
 DVB-T/H, ISDB-T, CMMB, Digital Cable TV: OFF, OFF, OFF, OFF, OFF, OFF
 LTE, LTE-TDD: OFF, ON, ON, ON, ON, ON|ON, ON, ON, ON, ON, ON
 When option N9060A-7FP is installed in these modes, the preset value of Offset G ~ L is the same as the Offset F value.

 WLAN:

if Radio Std is 802.11a/g(OFDM/DSSS-OFDM)/802.11n(20MHz/40MHz)/802.11 ac (20MHz/40MHz/80MHz/160MHz) or 802.11ah(1MHz/2MHz/4MHz/8MHz/16MHz) : OFF, OFF, OFF, ON, ON, ON, ON, ON, ON, ON, ON, ON, ON, ON, ON
 if Radio Std is 802.11 ac(80+80 MHz): ON, ON, ON, ON, ON, ON, ON, ON, ON, ON, ON, ON, ON, ON, ON
 if Radio Std is 802.11b/g(DSSS/CCK/PBCC): ON, ON, ON, ON, ON, ON, ON, ON, ON, ON, ON, ON, ON, ON, ON
 if Radio Std is 802.11j/p 20M, j/p 10M, p5M : OFF, OFF, OFF, ON, ON, ON, ON, ON, ON, ON, ON, ON, ON, ON, ON
 MSR: ON, OFF, OFF, OFF, ON, OFF, OFF, OFF, OFF, OFF, OFF, OFF, OFF|ON, OFF, OFF, OFF, ON, OFF, OFF, OFF, OFF, OFF, OFF, OFF
 LTEAFDD, LTEATDD: OFF, ON, ON, ON, ON, ON, ON, ON, ON, ON, ON, ON, ON|ON, ON, ON, ON, ON, ON, ON, ON, ON, ON, ON, ON

State Saved	Saved in instrument state.
Min	-200 dBm
Max	50 dBm
Initial S/W Revision	Prior to A.02.00
Modified at S/W Revision	A.02.00, A.03.00, A.10.00, A.11.00, A.14.00

Rel Start

Sets a relative power level limit at the start frequency for the selected offset. The relative power level limit ranges from -200 to +50 dBc.

The fail condition is set remotely by [:SENSE]:SEMAsk:OFFSet[n][:OUTer]:LIST:TEST for each offset channel test.

You can turn off (not use) specific offset channels remotely with [:SENSE]:SEMAsk:OFFSet[n][:OUTer]:LIST:STATe.

The SCPI query returns values currently set to the relative power test limits.

Missing values are not permitted; that is, if you want to change values 2 and 6, you must send all values up to 6. Subsequent values will remain as they were. The query for this parameter always returns 12 values.

Key Path	Meas Setup, Offset/Limits, Limits
----------	-----------------------------------

Mode	SA, WCDMA, C2K, WIMAX OFDMA, TD-SCDMA, 1xEVDO, DTMB (CTTB), DVB-T/H, ISDB-T, CMMB, LTE, LTETDD, Digital Cable TV, WLAN, MSR, LTEAFDD, LTEATDD
Remote Command	[:SENSe]:SEMAsk:OFFSet[1] 2[:OUTer]:LIST:STARt:RCARrier <rel_amp1>, ... [:SENSe]:SEMAsk:OFFSet[1] 2[:OUTer]:LIST:STARt:RCARrier?
Example	SEM:OFFS:LIST:STAR:RCAR -30, -30, -30, -30, -30, -30 SEM:OFFS:LIST:STAR:RCAR?
Notes	Comma separated list of values. OFFSet1 is for BTS, 2 for MS. Default is BTS. Note that Offset sub op code 2 is supported only in Non-SA modes. In the SA mode, Offset sub op code 1 is used for both BTS and MS. You must be in the mode that includes SEM measurement to use this command. Use :INSTrument:SElect to set the mode.
Couplings	If the current mode is DVB-T/H, this value will be modified automatically according to the limit type the output power of the transmitter which is less or more than 25W. If the current mode is ISDB-T, this value will be modified automatically according to the limit type. If the current mode is WLAN and radio std is 802.11n, Rel Start limits will be set to following values when frequency changed to above 5GHz: 0 dB, -20.00 dB, -28.00 dB, -40.00 dB, -40.00 dB, -40.00 dB, -40.00 dB, -40.00 dB, -40.00 dB, -40.00 dB, -40.00 dB, -40.00 dB
Preset	For modes (except MSR, LTEAFDD, LTEATDD and WLAN) without option N9060A-7FP, the preset value is as follows. SA: -30.00 dB, -30.00 dB, -30.00 dB, -30.00 dB, -30.00 dB, -30.00 dB WCDMA: -30.00 dB, -30.00 dB, -30.00 dB, -30.00 dB, -30.00 dB, -30.00 dB -33.73 dB, -34.00 dB, -37.50 dB, -47.50 dB, -47.50 dB, -47.50 dB C2K: -45.00 dB, -45.00 dB, -55.00 dB, -55.00 dB, -55.00 dB, -55.00 dB -42.00 dB, -54.00 dB, -54.00 dB, -54.00 dB, -54.00 dB WIMAX OFDMA: 0 dB, -25 dB, -32 dB, -50 dB, -50 dB, -50 dB TD-SCDMA: -54.00 dB, -54.00 dB, -62.00 dB, -47.00 dB, -47.00 dB, -47.00 dB -35.21 dB, -49.00 dB, -44.00 dB, -44.00 dB, -44.00 dB, -44.00 dB 1xEVDO: -45dBc, -45.00 dB, -55.00 dB, -55.00 dB, -55.00 dB, -55.00 dB -42dBc, -54.00 dB, -54.00 dB, -54.00 dB, -54.00 dB DTMB (CTTB): -32.8 dB, -83 dB, -95 dB, -120 dB, -120 dB, -120 dB -120 dB, -120 dB, -120 dB, -120 dB, -120 dB DVB-T/H: -30 dB, -30 dB, -30 dB, -30 dB, -30 dB, -30 dB -30 dB, -30 dB, -30 dB, -30 dB, -30 dB, -30 dB ISDB-T: -27.4 dB, -47.4 dB, -54.4 dB, XXX, 50 dB, 50 dB 50 dB, 50 dB, 50 dB, 50 dB, 50 dB, 50 dB; XXX is coupled with the total power reference, it is -57.4 dB when P<=0.025 W, -67.4 dB when P=0.25W, -(73.4 + 10logP) dB when 0.25 W<P<=2.5 W or 0.025 W<P<0.25 W, -77.4 dB when P > 2.5 W. CMMB: -37 dB, -72 dB, -84 dB, -90 dB, -90 dB, -90 dB -90 dB, -90 dB, -90 dB, -90 dB, -90 dB, -90 dB LTE, LTETDD: 0 dB, 0 dB, 0 dB, 0 dB, 0 dB, 0 dB 0 dB, 0 dB, 0 dB, 0 dB, 0 dB, 0 dB

Key Path	Meas Setup, Offset/Limits, Limits
Mode	SA, WCDMA, C2K, WIMAX OFDMA, TD-SCDMA, 1xEVDO, DTMB (CTTB), DVB-T/H, ISDB-T, CMMB, LTE, LTETDD, Digital Cable TV, WLAN, MSR, LTEAFDD, LTEATDD
Remote Command	<pre>[:SENSe]:SEMAsk:OFFSet[1] 2[:OUTer]:LIST:STOP:RCARrier <rel_amp1>, ... [:SENSe]:SEMAsk:OFFSet[1] 2[:OUTer]:LIST:STOP:RCARrier? [:SENSe]:SEMAsk:OFFSet[1] 2[:OUTer]:LIST:STOP:RCARrier:COUPle ON OFF 1 0, ... [:SENSe]:SEMAsk:OFFSet[1] 2[:OUTer]:LIST:STOP:RCARrier:COUPle?</pre>
Example	<pre>SEM:OFFS:LIST:STOP:RCAR -30, -30, -30, -30, -30, -30 SEM:OFFS:LIST:STOP:RCAR? SEM:OFFS:LIST:STOP:RCAR:COUP ON, ON, ON, ON, ON, ON SEM:OFFS:LIST:STOP:RCAR:COUP?</pre>
Notes	<p>Comma separated list of values.</p> <p>OFFSet1 is for BTS, 2 for MS. Default is BTS.</p> <p>Note that Offset sub op code 2 is supported only in Non-SA modes.</p> <p>In the SA mode, Offset sub op code 1 is used for both BTS and MS.</p> <p>You must be in the mode that includes SEM measurement to use this command. Use :INSTrument:SElect to set the mode.</p>
Couplings	<p>Coupled to Rel Start if "Auto" is selected, that is, Start is made the same as Stop.</p> <p>If the current mode is DVB-T/H, this value will be modified automatically according to the limit type and the output power of the transmitter which is less or more than 25W.</p> <p>If the current mode is ISDB-T, this value will be modified automatically according to the limit type.</p> <p>If the current mode is WLAN and radio std is 802.11n, Rel Stop limits will be set to following values when frequency changed to above 5GHz:</p> <p>-20.00 dB, -28.00 dB, -40.00 dB, -40.00 dB, -40.00 dB, -40.00 dB, -40.00 dB, -40.00 dB, -40.00 dB, -40.00 dB, -40.00 dB, -40.00 dB</p>
Preset	<p>For modes (except MSR, LTEAFDD, LTEATDD and WLAN) without option N9060A-7FP, the preset value is as follows.</p> <p>SA: -30.00 dB, -30.00 dB, -30.00 dB, -30.00 dB, -30.00 dB, -30.00 dB</p> <p>WCDMA: -30.00 dB, -30.00 dB, -30.00 dB, -30.00 dB, -30.00 dB, -30.00 dB -48.28 dB, -37.50 dB, -47.50 dB, -47.50 dB, -47.50 dB, -47.50 dB</p> <p>C2K: -45.00 dB, -45.00 dB, -55.00 dB, -55.00 dB, -55.00 dB, -55.00 dB -42.00 dB, -54.00 dB, -54.00 dB, -54.00 dB, -54.00 dB, -54.00 dB</p> <p>WIMAX OFDMA: -25 dB, -32 dB, -50 dB, -50 dB, -50 dB, -50 dB</p> <p>TD-SCDMA: -54.00 dB, -62.00 dB, -62.00 dB, -47.00 dB, -47.00 dB, -47.00 dB -49.00 dB, -58.945 dB, -44.00 dB, -44.00 dB, -44.00 dB, -44.00 dB</p> <p>1xEVDO: -45dB, -45.00 dB, -55.00 dB, -55.00 dB, -55.00 dB, -55.00 dB -42dB, -54.00 dB, -54.00 dB, -54.00 dB, -54.00 dB, -54.00 dB</p> <p>DTMB (CTTB): -83 dB, -95 dB, -120 dB, -120 dB, -120 dB, -120 dB -120 dB, -120 dB, -120 dB, -120 dB, -120 dB, -120 dB</p> <p>DVB-T/H: -73 dB, -85 dB, -110 dB, -126 dB, -126 dB, -126 dB -126 dB, -126 dB, -126 dB, -126 dB, -126 dB, -126 dB</p>

ISDB-T: -47.4 dB, -54.4 dB, XXX, 50 dB, 50 dB, 50 dB | 50 dB, 50 dB, 50 dB, 50 dB, 50 dB, 50 dB;
XXX is coupled with the total power reference P, it is -57.4 dB when $P \leq 0.025$ W, -67.4 dB when
 $P = 0.25$ W, $-(73.4 + 10\log P)$ dB when 0.25 W $< P \leq 2.5$ W or 0.025 W $< P < 0.25$ W, -77.4 dB when $P >$
2.5 W.

CMMB: -72 dB, -84 dB, -90 dB, -90 dB, -90 dB, -90 dB | -90 dB, -90 dB, -90 dB, -90 dB, -90 dB, -
90 dB

LTE, LTE-TDD: 0 dB, 0 dB, 0 dB, 0 dB, 0 dB, 0 dB

Digital Cable TV: 0 dB, 0 dB, 0 dB, 0 dB, 0 dB, 0 dB | 0 dB, 0 dB, 0 dB, 0 dB, 0 dB, 0 dB

When option N9060A-7FP is installed in these modes, the preset value of Offset G ~ L is the same
as the Offset F value.

WLAN:

if Radio Std is 802.11a/g(OFDM/DSSS-OFDM): -20.00 dB, -28.00 dB, -40.00 dB, -40.00 dB, -
47.00 dB, -47.00 dB, -47.00 dB, -47.00 dB, -47.00 dB, -47.00 dB, -47.00 dB, -47.00 dB, -47.00 dB

if Radio Std is 802.11b/g(DSSS/CCK/PBCC): -30 dB, -50 dB, -50 dB, -50 dB, -50 dB, -50 dB, -50
dB, -50 dB, -50 dB, -50 dB, -50 dB, -50 dB

if Radio Std is 802.11n(20MHz/40MHz): -20.00 dB, -28.00 dB, -45.00 dB, -45.00 dB, -45.00 dB, -
45.00 dB, -45.00 dB, -45.00 dB, -45.00 dB, -45.00 dB, -45.00 dB, -45.00 dB

if Radio Std is 802.11ac/802.11ax (20 MHz/ 40 MHz/ 80 MHz/ 160 MHz): -20.00 dB, -28.00 dB, -
40.00 dB, -40.00 dB, -40.00 dB, -40.00 dB, -40.00 dB, -40.00 dB, -40.00 dB, -40.00 dB, -40.00 dB,
-40.00 dB

if Radio Std is 802.11ac/802.11ax(80 MHz + 80MHz): -40dB, -28.00 dB, -20.00 dB, 0 dB, -20.00
dB, -28.00 dB, -40.00 dB, -40.00 dB, -40.00 dB, -40.00 dB, -40.00 dB, -40.00 dB

if Radio Std is 802.11ah (1MHz/2 MHz/ 4 MHz/ 8 MHz/ 16 MHz): -20.00 dB, -28.00 dB, -40.00
dB, -40.00 dB, -40.00 dB, -40.00 dB, -40.00 dB, -40.00 dB, -40.00 dB, -40.00 dB, -40.00 dB, -
40.00 dB

if Radio Std is 802.11 j/p 10M, p5M: -20.00 dB, -28.00 dB, -40.00 dB, -40.00 dB, -40.00 dB, -
47.00 dB, -47.00 dB, -47.00 dB, -47.00 dB, -47.00 dB, -47.00 dB, -47.00 dB

if Radio Std is 802.11af(6MHz/7MHz/8MHz): -20.00 dB, -28.00 dB, -40.00 dB, -40.00 dB, -40.00
dB, -40.00 dB, -40.00 dB, -40.00 dB, -40.00 dB, -40.00 dB, -40.00 dB, -40.00 dB

MSR, LTEAFDD, LTEATDD: 0 dB, 0 dB, 0 dB, 0 dB, 0 dB, 0 dB, 0 dB, 0 dB, 0 dB, 0 dB, 0 dB, 0 dB | 0
dB, 0 dB, 0 dB, 0 dB, 0 dB, 0 dB, 0 dB, 0 dB, 0 dB, 0 dB, 0 dB

For modes (except MSR, LTEAFDD, LTEATDD and WLAN) without option N9060A-7FP, the preset
value is as follows.

For modes (except MSR, LTEAFDD, LTEATDD and WLAN) with option N9060A-7FP, the preset
value of Offset G ~ L is the same as the Offset F value.

SA: ON, ON, ON, ON, ON, ON

WCDMA: ON, ON, ON, ON, ON, ON | OFF, OFF, OFF, ON, ON, ON

C2K: ON, ON, ON, ON, ON, OFF | ON, ON, ON, ON, OFF

WIMAX OFDMA: OFF, OFF, OFF, ON, ON, ON | OFF, OFF, OFF, ON, ON, ON

TD-SCDMA: ON, OFF, ON, ON, ON, ON | OFF, OFF, ON, ON, ON, ON

1xEVDO: ON, ON, ON, ON, ON, OFF | ON, ON, ON, ON, OFF

DTMB (CTTB): OFF, OFF, OFF, OFF, OFF, OFF

DVB-T/H: ON, ON, ON, ON, ON, ON

ISDB-T: OFF, OFF, OFF, OFF, OFF, OFF
 CMMB: OFF, OFF, OFF, OFF, OFF, OFF
 LTE, LTETDD: ON, ON, ON, ON, ON, ON
 Digital Cable TV: OFF, OFF, OFF, OFF, OFF, OFF

 WLAN:
 if Radio Std is 802.11a/g(OFDM/DSSS-OFDM)/802.11n(20MHz/40MHz): OFF, OFF, OFF, ON, ON,
 ON, ON, ON, ON, ON, ON, ON
 if Radio Std is 802.11b/g(DSSS/CCK/PBCC): ON, ON, ON, ON, ON, ON, ON, ON, ON, ON, ON, ON, ON, ON, ON
 if Radio Std is 802.11ac (20 MHz/ 40 MHz/ 80 MHz/ 160 MHz): OFF, OFF, OFF, ON, ON, ON, ON,
 ON, ON, ON, ON, ON
 if Radio Std is 802.11ac(80 MHz + 80MHz): OFF, OFF, OFF, OFF, OFF, OFF, OFF, OFF, OFF, OFF,
 OFF, OFF
 if Radio Std is 802.11ah (1MHz/2 MHz/ 4 MHz/ 8 MHz/ 16 MHz): OFF, OFF, OFF, ON, ON, ON,
 ON, ON, ON, ON, ON, ON
 if Radio Std is 802.11j/p 20M j/p 10M p5M: OFF, OFF, OFF, ON, ON, ON, ON, ON, ON, ON, ON, ON,
 ON
 MSR, LTEAFDD, LTEATDD: ON, ON, ON, ON, ON, ON, ON, ON, ON, ON, ON, ON | ON, ON, ON,
 ON, ON, ON, ON, ON, ON, ON, ON, ON

State Saved	Saved in instrument state.
Min	-200 dB
Max	50 dB
Initial S/W Revision	Prior to A.02.00
Modified at S/W Revision	A.02.00, A.03.00, A.10.00, A.11.00, A.14.00

Fail Mask

Selects one of the logic keys for fail conditions between the measurement results and the test limits:

- **Absolute** and **Relative** both check the results against the respective limit.
- **OR** checks against both limits, failing if either of the limits is broken.
- **AND** will only display a fail if both of the limits are broken.

The absolute or relative power limit value for each offset channel can be set remotely with [:SENSe]:SEMAsk:OFFSet[n][:OUTer]:LIST:ABSolute or [:SENSe]:SEMAsk:OFFSet[n][:OUTer]:LIST:RCARrier.

You can turn off (not use) specific offset channels remotely with [:SENSe]:SEMAsk:OFFSet[n][:OUTer]:LIST:STATe.

Missing values are not permitted; that is, if you want to change values 2 and 6, you must send all values up to 6. Subsequent values will remain as they were. The query for this parameter always returns 12 values.

Key Path	Meas Setup, Offset/Limits, Limits
Mode	SA, WCDMA, C2K, WIMAX OFDMA, TD-SCDMA, 1xEVDO, DTMB (CTTB), DVB-T/H, ISDB-T, CMMB, LTE, LTETDD, Digital Cable TV, WLAN, MSR, LTEAFDD, LTEATDD
Remote Command	[:SENSe]:SEMAsk:OFFSet[1] 2[:OUTer]:LIST:TEST ABSolute AND OR RELative, ... [:SENSe]:SEMAsk:OFFSet[1] 2[:OUTer]:LIST:TEST?
Example	SEM:OFFS:LIST:TEST ABS, ABS, ABS, ABS, ABS, ABS SEM:OFFS:LIST:TEST?
Notes	Comma separated list of values. OFFSet1 is for BTS, 2 for MS. Default is BTS. Note that Offset sub op code 2 is supported only in Non-SA modes. In the SA mode, Offset sub op code 1 is used for both BTS and MS. You must be in the mode that includes SEM measurement to use this command. Use :INSTrument:SElect to set the mode.
Couplings	None If the current mode is DVB-T/H, this value will be modified automatically according to the limit type and the output power of the transmitter which is less or more than 25W.
Preset	For modes (except MSR, LTEAFDD, LTEATDD and WLAN) without option N9060A-7FP, the preset value is as follows. SA: ABS, ABS, ABS, ABS, ABS, ABS WCDMA: ABS, ABS, ABS, ABS, ABS, ABS AND, AND, AND, AND, AND, AND C2K: REL, REL, REL, ABS, REL, REL AND, AND, ABS, REL, REL, REL WIMAX OFDMA: REL, REL, REL, REL, REL, REL REL, REL, REL, REL, REL, REL TD-SCDMA: ABS, ABS, ABS, ABS, ABS, ABS AND, AND, AND, AND, AND, AND 1xEVDO: REL, REL, REL, ABS, REL, REL AND, AND, AND, OR, AND, AND DTMB (CTTB), ISDB-T, CMMB: REL, REL, REL, REL, REL, REL REL, REL, REL, REL, REL, REL DVB-T/H: ABS, ABS, ABS, ABS, ABS, ABS ABS, ABS, ABS, ABS, ABS, ABS LTE, LTDTDD: ABS, ABS, ABS, ABS, ABS, ABS Digital Cable TV: REL, REL, REL, REL, REL, REL REL, REL, REL, REL, REL, REL When option N9060A-7FP is installed in these modes, the preset value of Offset G ~ L is the same as the Offset F value. ----- WLAN: if Radio Std is 802.11b/g(DSSS/CCK/PBCC): REL, REL, REL, REL, REL, REL, REL, REL, REL, REL, REL, REL if Radio Std is 802.11a/g(OFDM/DSSS-OFDM) or 802.11n(20MHz/40MHz): REL, REL, REL, AND, AND, AND, AND, AND, AND, AND, AND, AND if Radio Std is 802.11ac/802.11ax (20 MHz/ 40 MHz/ 80 MHz/ 160 MHz): REL, REL, REL, AND, AND, AND, AND, AND, AND, AND, AND, AND if Radio Std is 802.11ac/802.11ax (80 MHz + 80MHz): AND, REL, REL, REL, REL, REL, REL, AND, AND, AND, AND, AND if Radio Std is 802.11ah (1MHz/2 MHz/ 4 MHz/ 8 MHz/ 16 MHz): REL, REL, REL, AND, AND,

	<p>AND, AND, AND, AND, AND, AND, AND</p> <p>if Radio Std is 802.11j/p 10M, p5M: REL, REL, REL, AND, AND, AND, AND, AND, AND, AND, AND, AND, AND</p> <p>if Radio Std is 802.11af (6 MHz/ 7 MHz/ 8 MHz): REL, REL, REL, AND, AND, AND, AND, AND, AND, AND, AND, AND, AND</p> <p>MSR, LTEAFDD, LTEATDD: ABS, ABS, ABS, ABS, ABS, ABS, ABS, ABS, ABS, ABS, ABS, ABS, ABS</p>
State Saved	Saved in instrument state.
Range	Absolute Relative Abs AND Rel Abs OR Rel
Initial S/W Revision	Prior to A.02.00
Modified at S/W Revision	A.02.00, A.03.00, A.10.00, A.11.00, A.14.00

Offset Freq Define

This key enables you to select “Offset” definition. Each standard defines each “Offset” from Carrier.

Meas BW Edge means the edge of resolution band width that is represented by Meas BW and Res BW settings. Actual center frequency of Meas BW and the limit line have ½ Meas BW offset when the Meas BW Edge is selected.

3GPP2 requires the “Carrier Center to Meas BW Edge” definition. LTE conformance test requires “Carrier Edge to Meas BW Center” and/or “Carrier Edge to Meas BW Edge” definition

- **CTOCenter** – From carrier center to the center of offset measuring filter*
- **CTOEdge** – From carrier center to the nominal -3 dB point of the offset measuring filter* closer to the carrier
- **ETOCenter** – From Center Frequency - Span of Ref Channel / 2 (for lower offset), Center Frequency + Span of Ref Channel / 2 (for upper offset) of the carrier closest to each offset to the center of offset measuring filter*
- **ETOEdge** – From Center Frequency - Span of Ref Channel / 2 (for lower offset), Center Frequency + Span of Ref Channel / 2 (for upper offset) of the carrier closest to each offset to the nominal -3 dB point of the offset measuring filter* closer to the carrier

*Measuring filter = Meas BW (N) x Res BW

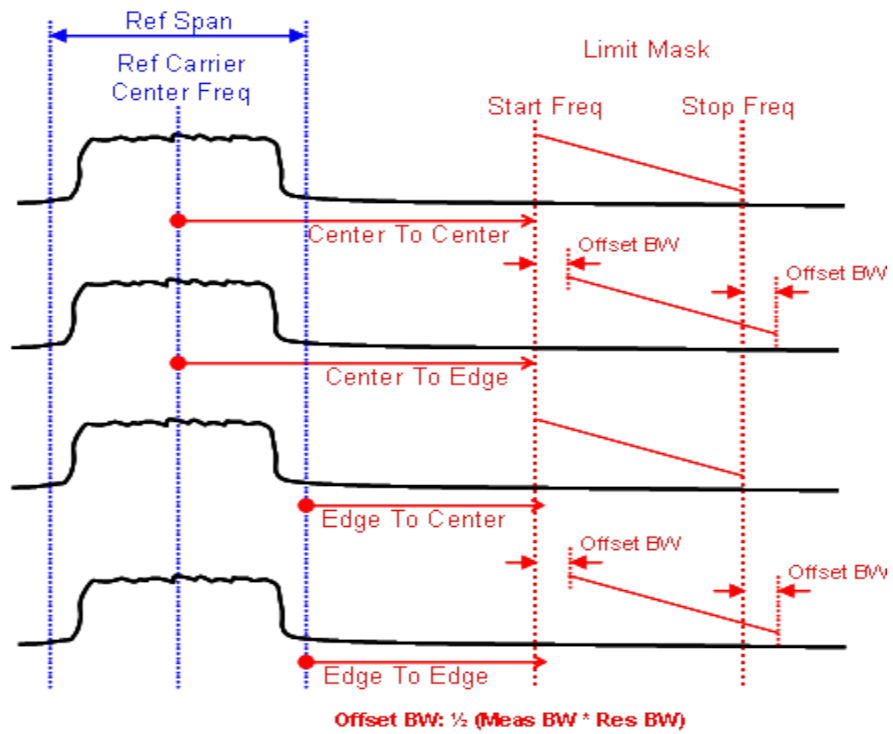
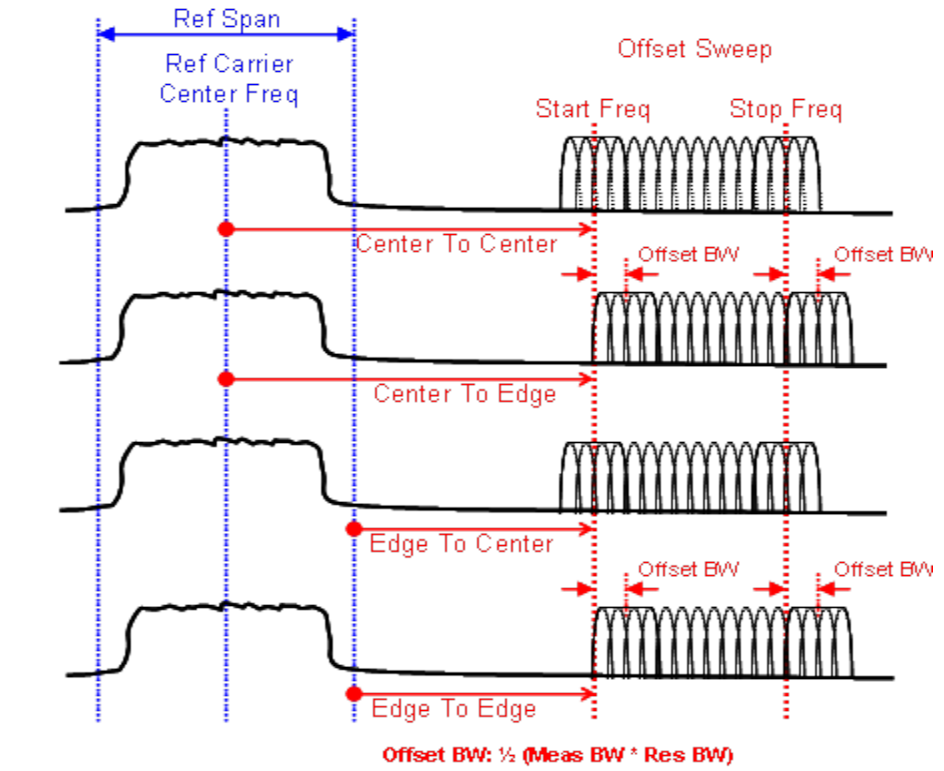

Key Path	Meas Setup, Offset/Limits
Mode	SA, WCDMA, C2K, WIMAX OFDMA, TD-SCDMA, 1xEVDO, DVB-T/H, DTMB (CTTB), ISDB-T, CMMB, LTE, LTETDD, Digital Cable TV, WLAN
Remote Command	[:SENSe] :SEMAsk :OFFSet [1] 2 :TYPE CTOCenter CTOEdge ETOCenter ETOEdge [:SENSe] :SEMAsk :OFFSet [1] 2 :TYPE ?
Example	SEM:OFFS:TYPE ETOC SEM:OFFS:TYPE?
Notes	OFFSet1 is for BTS, 2 for MS. Default is BTS. Note that Offset sub op code 2 is supported only in Non-SA modes. In the SA mode, Offset sub op code 1 is used for both BTS and MS. You must be in the mode that includes SEM measurements to use this command. Use :INSTrument:SElect to set the mode. For the MSR and LTE-Advanced FDD/TDDmode, see Offset Freq Define (Only for MSR and LTE-Advanced FDD/TDD) .
Preset	SA, WCDMA, WIMAX OFDMA, TD-SCDMA, DVB-T/H, DTMB (CTTB), ISDB-T, CMMB, Digital Cable TV: CTOC C2K: CTOE 1xEVDO: CTOE LTE: ETOC LTETDD: ETOC
State Saved	Saved in instrument state.
Range	Carrier Center To Meas BW Center Carrier Center To Meas BW Edge Carrier Edge To Meas BW Center Carrier Edge To Meas BW Edge
Initial S/W Revision	A.03.00

Offset Average Type (SCPI Only)

Select trace average type for the offsets.

Key Path	SCPI Only
Mode	SA, WCDMA, C2K, WIMAX OFDMA, TD-SCDMA, 1xEVDO, DTMB (CTTB), DVB-T/H, ISDB-T, CMMB, LTE, LTETDD, Digital Cable TV, WLAN, MSR, LTEAFDD, LTEATDD
Remote Command	[:SENSe] :SEMAsk :AVERAge :OFFSet :TYPE RMS LOG [:SENSe] :SEMAsk :AVERAge :OFFSet :TYPE ?
Example	SEM:AVER:OFFS:TYPE LOG SEM:AVER:OFFS:TYPE?
Notes	You must be in the mode that includes SEM measurement to use this command. Use :INSTrument:SElect to set the mode.
Preset	RMS
State Saved	Saved in instrument state
Initial S/W Revision	A.18.00

Method

Sets the measurement method:

- **Integ BW**–enables you to set the channel integration bandwidth.
- **RRC Weight**–selects Root Raised Cosine (RRC) filtering of the carriers. The α value (rolloff) for the filter is set to the value of the Filter Alpha parameter.

Key Path	Meas Setup
Mode	SA, WCDMA, WIMAX OFDMA, TD-SCDMA, DTMB (CTTB), DVB-T/H, ISDB-T, CMMB, LTE, LTETDD, Digital Cable TV, WLAN, MSR, LTEAFDD, LTEATDD
Remote Command	[:SENSe] :SEMAsk :FILTer [:RRC] [:STATe] OFF ON 0 1 [:SENSe] :SEMAsk :FILTer [:RRC] [:STATe] ?
Example	SEM:FILT ON SEM:FILT?
Notes	For the C2K and 1xEVDO mode, this key is not available. 1 ON = RRC Weight, 0 OFF = IntegBW You must be in the mode that includes SEM measurement to use this command. Use :INSTrument:SElect to set the mode.
Dependencies	WLAN: RRC Weight is not supported when the radio standard is WLAN 802.11ac (80+80MHz).
Preset	SA, WIMAX OFDMA, DVB-T/H, ISDB-T, CMMB, LTE, LTETDD, WLAN, MSR, LTEAFDD, LTEATDD: OFF WCDMA, TD-SCDMA, DTMB (CTTB), Digital Cable TV: ON
State Saved	Saved in instrument state.
Range	RRCWeight IntegBW
Initial S/W Revision	Prior to A.02.00
Modified at S/W Revision	A.02.00, A.03.00

Filter Alpha

Sets the alpha value for the RRC Filter.

Key Path	Meas Setup
Mode	SA, WCDMA, WIMAX OFDMA, TD-SCDMA, DTMB (CTTB), DVB-T/H, ISDB-T, CMMB, LTE, LTETDD, Digital Cable TV, MSR, LTEAFDD, LTEATDD
Remote Command	[:SENSe] :SEMAsk :FILTer [:RRC] :ALPHa <real> [:SENSe] :SEMAsk :FILTer [:RRC] :ALPHa ?
Example	SEM:FILT:ALPH 0.3 SEM:FILT:ALPH?
Notes	For the C2K and 1xEVDO mode, this key is not available. You must be in the mode that includes SEM measurement to use this command. Use :INSTrument:SElect to set the mode.

Preset	0.22 DTMB (CTTB): 0.05 Digital Cable TV: 0.15
State Saved	Saved in instrument state.
Min	0.01
Max	1.0
Initial S/W Revision	Prior to A.02.00
Modified at S/W Revision	A.02.00, A.03.00

Meas Preset

Restores all the measurement parameters to their default values.

Key Path	Meas Setup
Mode	SA, WCDMA, C2K, WIMAX OFDMA, TD-SCDMA, 1xEVDO, DTMB (CTTB), DVB-T/H, ISDB-T, CMMB, LTE, LTETDD, Digital Cable TV, WLAN, MSR, LTEAFDD, LTEATDD
Remote Command	:CONFigure:SEMAsk
Example	CONF:SEM
Notes	You must be in the mode that includes SEM measurement to use this command. Use :INSTrument:SElect to set the mode.
Couplings	Selecting Meas Preset will restore all measurement parameters to their default values.
Initial S/W Revision	Prior to A.02.00
Modified at S/W Revision	A.02.00, A.03.00

Mode

See ["Mode" on page 353](#)

Mode Preset

Returns the active mode to a known state.

Mode Preset does the following for the currently active mode:

- Aborts the currently running measurement.
- Brings up the default menu for the mode, with no active function.
- Sets measurement Global settings to their preset values for the active mode only.
- Activates the default measurement.
- Brings up the default menu for the mode.
- Clears the input and output buffers.
- Sets Status Byte to 0.

Mode Preset does not:

- Cause a mode switch
- Affect mode persistent settings
- Affect system settings
- See "[How-To Preset](#)" on page 2706 for more information.

Key Path	Front-panel key
Remote Command	:SYSTem:PRESet
Example	:SYST:PRES
Notes	<p>*RST is preferred over :SYST:PRES for remote operation. *RST does a Mode Preset, as done by the :SYST:PRES command, and it sets the measurement mode to Single measurement rather than Continuous for optimal remote control throughput.</p> <p>Clears all pending OPC bits. The Status Byte is set to 0.</p>
Couplings	A Mode Preset aborts the currently running measurement, activates the default measurement, and gets the mode to a consistent state with all of the default couplings set.
Backwards Compatibility Notes	<p>In the X-Series, the legacy "Factory Preset" has been replaced with Mode Preset, which only presets the currently active mode, not the entire instrument. In the X-Series, the way to preset the entire instrument is by using System, Restore System Defaults All, which behaves essentially the same way as restore System Defaults does on ESA and PSA.</p> <p>There is also no "Preset Type" as there is on the PSA. There is a green Mode Preset front-panel key that does a Mode Preset and a white-with-green-letters User Preset front-panel key that does a User Preset. The old PRESet:TYPE command is ignored (without generating an error), and SYST:PRES without a parameter does a Mode Preset, which should cover most backward code compatibility issues.</p> <p>The settings and correction data under the Input/Output front-panel key (examples: Input Z Corr,</p>

Ext Amp Gain, etc.) are no longer part of any Mode, so they will not be preset by a Mode Preset. They are preset using Restore Input/Output Defaults, Restore System Defaults All. Note that because User Preset does a Recall State, and all of these settings are saved in State, they ARE recalled when using User Preset.

Initial S/W Revision Prior to A.02.00

How-To Preset

The table below shows all possible presets, their corresponding SCPI commands and front-panel access (key paths). Instrument settings depend on the current measurement context. Some settings are local to the current measurement, some are global (common) across all the measurements in the current mode, and some are global to all the available modes. In a similar way, restoring the settings to their preset state can be done within the different contexts.

Auto Couple - is a measurement local key. It sets all Auto/Man parameter couplings in the measurement to Auto. Any Auto/Man selection that is local to other measurements in the mode will not be affected.

Meas Preset - is a measurement local key. Meas Preset resets all the variables local to the current measurement except the persistent ones.

Mode Preset - resets all the current mode's measurement local and measurement global variables except the persistent ones.

Restore Mode Defaults - resets ALL the Mode variables (and all the Meas global and Meas local variables), including the persistent ones.

Type Of Preset	SCPI Command	Front Panel Access
Auto Couple	:COUPle ALL	Auto Couple front-panel key
Meas Preset	:CONFigure: <Measurement>	Meas Setup Menu
Mode Preset	:SYSTem:PRESet	Mode Preset (green key)
Restore Mode Defaults	:INSTrument:DEFault	Mode Setup Menu
Restore All Mode Defaults	:SYSTem:DEFault MODes	System Menu; Restore System Default Menu
*RST	*RST	not possible (Mode Preset with Single)
Restore Input/Output Defaults	:SYSTem:DEFault INPut	System Menu; Restore System Default Menu
Restore Power On Defaults	:SYSTem:DEFault PON	System Menu; Restore System Default Menu
Restore Alignment Defaults	:SYSTem:DEFault ALIGn	System Menu; Restore System Default Menu
Restore Miscellaneous Defaults	:SYSTem:DEFault MISC	System Menu; Restore System Default Menu

15 Spectrum Emission Mask Measurement
Mode Preset

Restore All System Defaults	:SYSTem:DEFault [ALL] :SYSTem:PRESet:PERSistent	System Menu; Restore System Default Menu
User Preset	:SYSTem:PRESet:USER	User Preset Menu
User Preset All Modes	:SYSTem:PRESet:USER:ALL	User Preset Menu
Power On Mode Preset	:SYSTem:PON:TYPE MODE	System Menu
Power On User Preset	:SYSTem:PON:TYPE USER	System Menu
Power On Last State	:SYSTem:PON:TYPE LAST	System Menu

Mode Setup

See ["Mode Setup" on page 388](#)

Peak Search

There is no 'Peak Search' supported in Spectrum Emission Mask so this front-panel key displays a blank menu when pressed.

Key Path	Front-panel key
Initial S/W Revision	Prior to A.02.00

Print

See "Print " on page 430

Quick Save

The Quick Save front-panel key repeats the most recent save that was performed from the Save menu, with the following exceptions:

- Register saves are not remembered as Saves for the purpose of the Quick Save function
- If the current measurement does not support the last non-register save that was performed, an informational message is generated, “File type not supported for this measurement”

Quick Save repeats the last type of qualified save (that is, a save qualified by the above criteria) in the last save directory by creating a unique filename using the Auto File Naming algorithm described below.

If Quick Save is pressed after startup and before any qualified Save has been performed, the Quick Save function performs a Screen Image save using the current settings for Screen Image saves (current theme, current directory), which then becomes the “last save” for the purpose of subsequent Quick Saves.

The Auto File Naming feature automatically generates a file name for use when saving a file. The filename consists of a prefix and suffix separated by a dot, as is standard for the Windows® file system. A default prefix exists for each of the available file types:

Type	Default Prefix	Menu
State	State_	(Save/Recall)
Trace + State	State_	(Save/Recall)
Screen	Screen_	(Save/Recall)
Amplitude Corrections	Ampcor_	(Import/Export)
Traces	Trace_	(Import/Export)
Limit Lines	LLine_	(Import/Export)
Measurement Result	MeasR_	(Import/Export)
Capture Buffer	CapBuf_	(Import/Export)

A four digit number is appended to the prefix to create a unique file name. The numbering sequence starts at 0000 within each Mode for each file type and updates incrementally to 9999, then wraps to 0000 again. It remembers where it was through a Mode Preset and when leaving and returning to the Mode. It is reset by Restore Misc Defaults and Restore System Defaults and subsequent running of the instrument application. So, for example, the first auto file name generated for State files is State_0000.state. The next is State_0001, and so forth.

One of the key features of Auto File Name is that we guarantee that the Auto File Name will never conflict with an existing file. The algorithm looks for the next

available number. If it gets to 9999, then it looks for holes. If it find no holes, that is no more numbers are available, it gives an error.

For example, if when we get to State_0010.state there is already a State_0010.state file in the current directory, it advances the counter to State_0011.state to ensure that no conflict will exist (and then it verifies that State_0011.state also does not exist in the current directory and advances again if it does, and so forth).

If you enter a file name for a given file type, then the prefix becomes the filename you entered instead of the default prefix, followed by an underscore. The last four letters (the suffix) are the 4-digit number.

For example, if you save a measurement results file as “fred.csv”, then the next auto file name chosen for a measurement results save will be fred_0000.csv.

NOTE

Although 0000 is used in the example above, the number that is used is actually the current number in the Meas Results sequence, that is, the number that would have been used if you had not entered your own file name.

If the filename you entered ends with _dddd, where d=any number, making it look just like an auto file name, then the next auto file name picks up where you left off with the suffix being dddd + 1.

Key Path	Front-panel key
Notes	No remote command for this key specifically.
Initial S/W Revision	Prior to A.02.00

Recall

The **Recall** menu lets you choose what you want to recall, and where you want to recall it from. Among the types of files you can recall are **States and Traces**. In addition, an **Import (Data)** option lets you recall a number of data types stored in CSV files (as used by Excel and other spreadsheet programs).

The default paths for Recall are data type dependent and are the same as for the Save key.

Key Path	Front-panel key
Notes	<p>No remote command for this key specifically, but the :MMEM:LOAD command is available for specific file types. An example is :MMEM:LOAD:STATe <filename>.</p> <p>If you try to recall a State file for a mode that is not licensed or not available in the instrument, an error message will occur and the state will not change.</p>
Backwards Compatibility Notes	<p>In legacy analyzers, it was possible to load a state without affecting the trace data, limit lines or correction data. Similarly (since User Preset is actually loading a state), it was possible to do a User Preset without affecting the trace data, limit lines or correction data.</p> <p>In the X-Series, “state” always includes all of this data; so whenever state is loaded, all of the traces, limit lines and corrections are affected. Although this differs from previous behavior, it is desirable behavior, and should not cause adverse issues for users.</p>
Backwards Compatibility Notes	<p>Recall for the X-Series supports backward compatibility in the sense that you can recall a state file from any X-Series model number and any version of X-Series software. This is only possible if part of the recalling process goes through a limiting step after recalling the mode settings, at least for settings that may vary with version number, model number, option and license differences. If you try to recall a state file onto an instrument with less capability than what was available on the instrument during the save, the recall will ignore the state it doesn't support and it will limit the recalled setting to what it allows.</p> <p>Example: if the saved state includes preamp ON, but the recalling instrument does not have a preamp; the preamp is limited to OFF. Conversely, if you save a state without a preamp, the preamp is OFF in the state file. When this saved file is recalled on an instrument with a licensed preamp, the preamp is changed to OFF. Another example is if the saved state has center frequency set to 20 GHz, but the instrument recalling the saved state is a different model and only supports 13.5 GHz. In this case, the center frequency is limited along with any other frequency based settings. Since the center frequency can't be preserved in this case, the recall limiting tries to at least preserve span to keep the measurement setup as intact as possible.</p> <p>It may be appropriate to issue a warning if the state is limited on the recall; warnings do not go out to SCPI so this would only affect the manual user.</p> <p>Note that there is no state file compatibility outside of the X-Series. For example, you cannot recall a state file from ESA or PSA.</p>
Initial S/W Revision	Prior to A.02.00

State

The **Recall State** menu lets you choose a register or file from which to recall the state.

The content of a state file includes all of the settings and data required to return the analyzer as closely as possible to the Mode it was in, with the exact settings that

were in place, when the save occurred. The Mode settings in each state file include the settings that are affected by Mode Preset, as well as the additional settings affected by Restore Mode Defaults; all of the Mode's settings. In addition, all of the settings of the **Input/Output** system are included, even though they are outside of the Mode's state, because they are needed to restore the complete setup. Persistent System settings (for example, GPIB address) are not affected by either a Mode Preset or Restore Mode Defaults, nor are they included in a saved State file.

Since each state file is only for one Mode, the settings for other Modes are unaffected when it is loaded. **Recall State** will cause a mode switch if the state being recalled is not from the current active mode.

After the recall completes, the message "File <filename> recalled" or "Recalled State Register <register number>" is displayed.

For rapid recalls, the State menu lists 16 registers that you can choose from to recall. Pressing a Register key initiates the recall. You can also select a file from which to recall.

The default path for all State Files is:

My Documents\<<mode name>\state

where <mode name> is the parameter used to select the mode with the INST:SEL command (for example, SA for the Spectrum Analyzer).

See ["More Information" on page 2715](#).

Key Path	Recall
Mode	All
Remote Command	:MMEMory:LOAD:STATe <filename>
Example	:MMEM:LOAD:STAT "myState.state" This recalls the file myState.state on the default path
Example	MMEM:LOAD:STAT "MyStateFile.state" This loads the state file data (on the default file directory path) into the instrument state.
Notes	When you pick a file to recall, the analyzer first verifies that the file is recallable in the current instrument by checking the software version and model number of the instrument. If everything matches, a full recall proceeds by aborting the currently running measurement, clearing any pending operations, and then loading the State from the saved state file. You can open state files from any mode, so recalling a State file switches to the mode that was active when the save occurred. After switching to the mode of the saved state file, mode settings and data (if any for the mode) are loaded with values from the saved file. The saved measurement of the mode becomes the newly active measurement and the data relevant to the measurement (if there is any) is recalled. <ul style="list-style-type: none"> - If there is a mismatch between file version or model number or instrument version or model number, the recall function tries to recall as much as possible and returns a warning message. It may limit settings that differ based on model number, licensing or version number. <p style="text-align: center;">After recalling the state, the Recall State function does the following:</p>

-
- Makes the saved measurement for the mode the active measurement.
 - Clears the input and output buffers.
 - Status Byte is set to 0.
 - Executes a *CLS

If the file specified is empty an error is generated. If the specified file does not exist, another error is generated. If there is a mismatch between the file and the proper file type, an error is generated. If there is a mismatch between file version or model number or instrument version or model number, a warning is displayed. Then it returns to the State menu and File Open dialog goes away.

After the Recall, the analyzer exits the Recall menu and returns to the previous menu.

Backwards Compatibility SCPI :MMEMory:LOAD:STATE 1,<filename>
For backwards compatibility, the above syntax is supported. The "1" is simply ignored.

Initial S/W Revision Prior to A.02.00

More Information

In measurements that support saving Traces, for example, Swept SA, the Trace data is saved along with the State in the State file. When recalling the State, the Trace data is recalled as well. Traces are recalled exactly as they were stored, including the writing mode and update and display modes. If a Trace was updating and visible when the State was saved, it will come back updating and visible, and its data will be rewritten right away. When you use State to save and recall traces, any trace whose data must be preserved should be placed in View or Blank mode before saving.

The following table describes the Trace Save and Recall possibilities:

You want to recall state and one trace's data, leaving other traces unaffected.	Save Trace+State from 1 trace. Make sure that no other traces are updating (they should all be in View or Blank mode) when the save is performed.	On Recall, specify the trace you want to load the one trace's data into. This trace will load in View. All other traces' data will be unaffected, although their trace mode will be as it was when the state save was performed.
You want to recall all traces	Save Trace+State from ALL traces.	On Recall, all traces will come back in View (or Blank if they were in Blank or Background when saved)
You want all traces to load exactly as they were when saved.	Save State	On recall, all traces' mode and data will be exactly as they were when saved. Any traces that were updating will have their data immediately overwritten.

From File...

When you press “From File”, the analyzer brings up a Windows dialog and a menu entitled “File Open.” This menu allows you to navigate to the various fields in the Windows dialog without using a keyboard or mouse. The **Tab** and **Arrow** keys can also be used for dialog navigation.

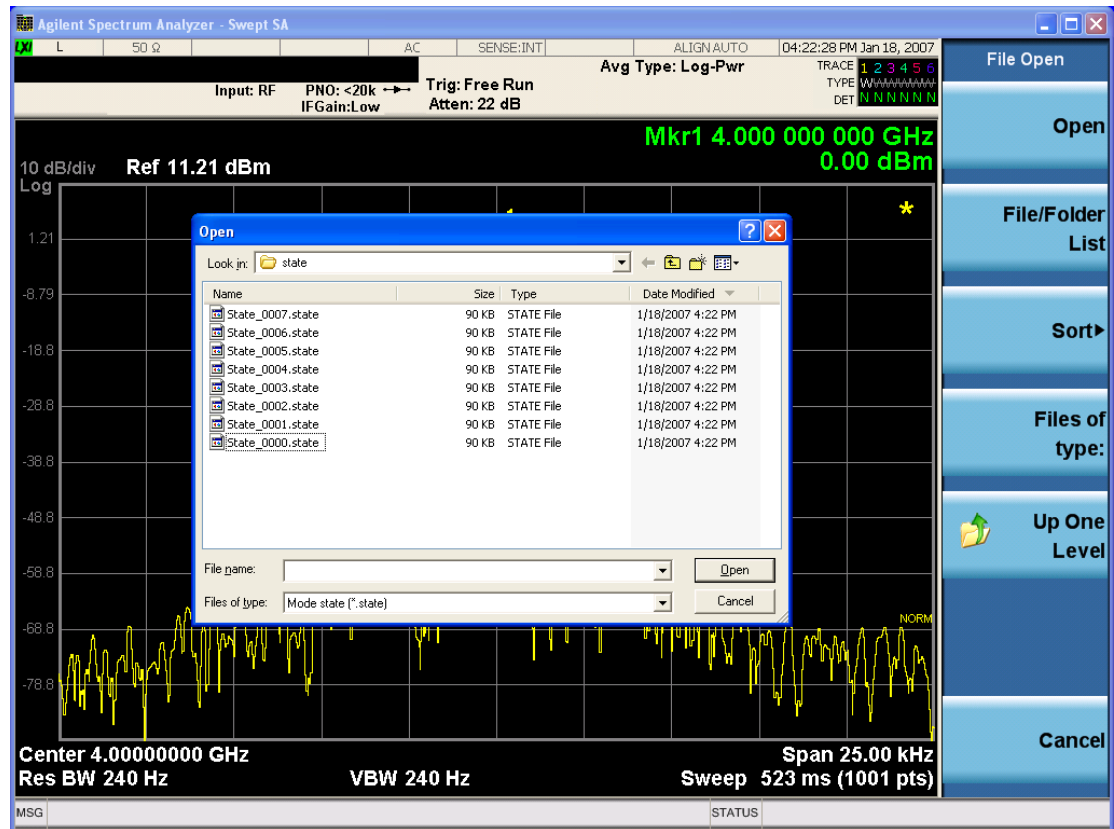

Listed below are the functions of the various fields in the dialog, and the corresponding softkeys:

Open

Performs the recall of the specified file. While the recall is being performed, the floppy icon appears briefly in the Meas bar.

File/Folder List

Enables you to navigate to the center of the dialog that contains the list of files and folders. Once here you can get information about the file and use the tab keys to navigate to the other fields in the dialog, such as Look In.

Look In

The **Look In** field shows the path from which the file will be recalled and allows you to change the path using the up and down arrow keys to navigate to other paths; the Enter key to open a directory; and the Backspace key to go back one directory. The **Look In** field first uses the last path from the Save As dialog **Save In:** path for that

same file type. There is no softkey for directly navigating to the Look In field, but you can use the left tab to get here from the File/Folder List.

User specified paths are remembered when you leave and return to a Mode and are reset back to the default using **Restore Mode Defaults**.

Sort

Accesses a menu that enables you to sort the files within the File Open dialog. Only one sorting type can be selected at a time and the sorting happens immediately. The sorting types are **By Date**, **By Name**, **By extension**, and **By Size**.

Files of Type

This field shows the file suffix for the type of file you have selected to recall. For example, if you navigated here while recalling State, "Mode state (*.state)" is in the field. If you navigated here while recalling Trace, "Mode state (*.trace)" is in the field. If you navigated here while importing a trace data file, "Trace Data (*.csv)" is in the field. For some file types, there is more than one choice in the dropdown menu, which you can select by using the up and down arrow keys and Enter.

Up One Level

This key corresponds to the icon of a folder with the up arrow that is in the tool bar of the dialog. When pressed, it causes the file and folder list to navigate up one level in the directory structure. The Backspace key does the same thing.

Cancel

This key corresponds to the **Cancel** selection in the dialog. It causes the current **Open** request to be cancelled. The ESC key does the same thing.

Key Path	Recall, State
Notes	Brings up the Open dialog for recalling a State Save Type
Initial S/W Revision	Prior to A.02.00

Edit Register Names

You may enter a custom name on any of the Register keys, to help you remember what you are using that state to save. To do this, press the **Edit Register Names** key, choose the register whose name you wish to edit, and then enter the desired label using the Alpha Editor or an external PC keyboard.

The maximum number of characters that can be added is 30. In most cases, 30 characters will fit on two lines of the key.

For more information and the SCPI command, see Edit Register Names under the **Save, State** function.

Key Path	Recall, State
Mode	All
Dependencies	N9060A-7FP or N9060B-2FP license required to edit the register names. When the feature is not licensed, sending the SCPI command generates an error, -221,"Settings conflict;Option not

	available"
Initial S/W Revision	A.11.00

Register 1 thru Register 16

Selecting any one of these register keys causes the State of the mode from the specified Register to be recalled. Each of the register keys annotates whether it is empty or at what date and time it was last modified. In addition, you can use the **Edit Register Names** key under **Save, State** to enter custom names for each register.

Registers are shared by all modes, so recalling from any one of the registers will cause a mode switch to the mode that was active when the save to the Register occurred.

Although these 16 registers are the only registers available from the front panel, there are 128 state registers available in the instrument. Registers 17-128 are only available from the SCPI interface, using the *RCL command.

After the recall completes, the message "Register <register number> recalled" appears in the message bar. If you are in the Spectrum Analyzer Mode, and you are recalling a register that was saved in the Spectrum Analyzer Mode, then after the recall, you will still be in the Recall Register menu. If the Recall causes you to switch modes, then after the Recall, you will be in the Frequency menu.

If a requested register is empty an error is generated.

Key Path	Recall, State
Example	*RCL 1
Range	1-16 from front panel, 1-128 from SCPI
Readback	Date and time with seconds resolution are displayed on the key OR A custom name of up to 30 characters entered using the Save, State,Edit Register Names key OR “(empty)” if no prior save operation has been performed to this register.
Initial S/W Revision	Prior to A.02.00
Modified at S/W Revision	Prior to A.11.00

Register 1 thru Register 16

Selecting any one of these register keys causes the State of the mode from the specified Register to be recalled. Each of the register keys annotates whether it is empty or at what date and time it was last modified. In addition, you can use the **Edit Register Names** key under **Save, State** to enter custom names for each register.

Registers are shared by all modes, so recalling from any one of the registers will cause a mode switch to the mode that was active when the save to the Register occurred.

Although these 16 registers are the only registers available from the front panel, there are 128 state registers available in the instrument. Registers 17-128 are only available from the SCPI interface, using the *RCL command.

After the recall completes, the message "Register <register number> recalled" appears in the message bar. If you are in the Spectrum Analyzer Mode, and you are recalling a register that was saved in the Spectrum Analyzer Mode, then after the recall, you will still be in the Recall Register menu. If the Recall causes you to switch modes, then after the Recall, you will be in the Frequency menu.

If a requested register is empty an error is generated.

Key Path	Recall, State
Example	*RCL 1
Range	1-16 from front panel, 1-128 from SCPI
Readback	Date and time with seconds resolution are displayed on the key OR A custom name of up to 30 characters entered using the Save, State, Edit Register Names key OR “(empty)” if no prior save operation has been performed to this register.
Initial S/W Revision	Prior to A.02.00
Modified at S/W Revision	Prior to A.11.00

Trace (+State)

The Recall Trace (+State) menu lets you choose a register or file from which to recall the Trace+State state file.

A saved state contains all of the settings and data required to return the analyzer as closely as possible to the exact setup it had when the save occurred. This includes the Input/Output settings, even though they are outside of the Mode’s state, because they are needed to restore the complete setup. A Trace+State file also includes trace data from one trace or all traces, which will load in View mode when the Trace+State file is recalled. Recall Trace (+State) will also cause a mode switch if the state being recalled is not for the current active mode.

After the recall completes, the message "File <filename> recalled" or “Recalled Trace Register <register number>” is displayed.

For rapid recalls, the Trace (+State) menu lists 5 registers to choose from to recall. Pressing a Register key initiates the recall. You can also select a file from which to recall.

The default path for all State Files including .trace files is:

My Documents\<mode name>\state

where <mode name> is the parameter used to select the mode with the INST:SEL command (for example, SA for the Spectrum Analyzer).

Key Path	Recall
Mode	SA
Remote Command	:MMEMory:LOAD:TRACe TRACE1 TRACE2 TRACE3 TRACE4 TRACE5 TRACE6,<filename> :MMEMory:LOAD:TRACe:REGister TRACE1 TRACE2 TRACE3 TRACE4 TRACE5 TRACE6,<integer>
Example	MMEM:LOAD:TRAC TRACE2, "MyTraceFile.trace" This loads the trace file data (on the default file directory path) into the specified trace; if it is a "single trace" save file, that trace is loaded to trace 2, and is set to be not updating. :MMEM:LOAD:TRAC:REG TRACE1,2 restores the trace data in register 2 to Trace 1
Notes	When you perform the recall, the recalling Trace function must first verify the file is recallable in this instrument by checking instrument software version and model number, since it includes State. If everything matches, a full recall proceeds by aborting the currently running measurement, and loading the state from the saved state file to as close as possible to the context in which the save occurred. You can open .trace files from any mode that supports them, so recalling a Trace file switches to the mode that was active when the save occurred. After switching to the mode of the saved state file, mode settings and data (if any for the mode) are loaded with values from the saved file and the saved measurement of the mode becomes the newly active measurement, and the data relevant to the measurement (if there is any) is recalled. Once the state is loaded, the trace data must be loaded. The internal flags are consulted to see which trace to load and the "To Trace" setting to see where to load it. Trace data is always loaded with the specified trace set to View, so that the data is visible and not updating (so as not to erase the recalled data). If the file is an "all trace" file, all traces are loaded with the saved data (to the original trace the data was saved from) and set to View. Traces whose data is not loaded are restored to the update state that existed when they were saved. After the Recall the analyzer exits the Recall menu and returns to the previous menu. Some modes and measurements do not have available all 6 traces. Phase Noise mode command, for example, is: MMEMory:LOAD:TRACe TRACE1 TRACE2 TRACE3,<filename> Some modes and measurements have more than 6 traces available. The Realtime SA mode command, for example, is: MMEMory:STORe:TRACe TRACE1 TRACE2 TRACE3 TRACE4 TRACE5 TRACE6 TRACE7 TRACE8 TRACE9 TRACE10 TRACE11 TRACE12 ALL,<filename>
Initial S/W Revision	Prior to A.02.00

To Trace

These menu selections let you choose the Trace where the recalled saved trace will go. Not all modes have the full 6 traces available. The default is the currently selected trace, selected in this menu or in the Trace/Detector, Export Data, Import Data, or Save Trace menus, except if you have chosen All, then it remains chosen until you specifically change it to a single trace.

If the .trace file is an "all trace" file, "**To Trace**" is ignored and the traces each go back to the trace from which they were saved.

Once selected, the key returns back to the Recall Trace menu and the selected Trace number is annotated on the key. Now you have selected exactly where the

trace needs to be recalled. To trigger a recall of the selected Trace, you must select the **Open** key in the Recall Trace menu.

When you select a trace, it makes that trace the current trace, so it displays on top of all of the other traces.

Key Path	Save, Data, Trace
Mode	SA
Initial S/W Revision	Prior to A.02.00

Register 1 thru Register 16

Selecting any one of these register keys causes the State of the mode from the specified Register to be recalled. Each of the register keys annotates whether it is empty or at what date and time it was last modified. In addition, you can use the **Edit Register Names** key under **Save, State** to enter custom names for each register.

Registers are shared by all modes, so recalling from any one of the registers will cause a mode switch to the mode that was active when the save to the Register occurred.

Although these 16 registers are the only registers available from the front panel, there are 128 state registers available in the instrument. Registers 17-128 are only available from the SCPI interface, using the *RCL command.

After the recall completes, the message "Register <register number> recalled" appears in the message bar. If you are in the Spectrum Analyzer Mode, and you are recalling a register that was saved in the Spectrum Analyzer Mode, then after the recall, you will still be in the Recall Register menu. If the Recall causes you to switch modes, then after the Recall, you will be in the Frequency menu.

If a requested register is empty an error is generated.

Key Path	Recall, State
Example	*RCL 1
Range	1-16 from front panel, 1-128 from SCPI
Readback	Date and time with seconds resolution are displayed on the key OR A custom name of up to 30 characters entered using the Save, State, Edit Register Names key OR “(empty)” if no prior save operation has been performed to this register.
Initial S/W Revision	Prior to A.02.00
Modified at S/W Revision	Prior to A.11.00

From File...

When you press “From File”, the analyzer brings up a Windows dialog and a menu entitled “**File Open.**” This menu allows you to navigate to the various fields in the

Windows dialog without using a keyboard or mouse. The **Tab** and **Arrow** keys can also be used for dialog navigation.

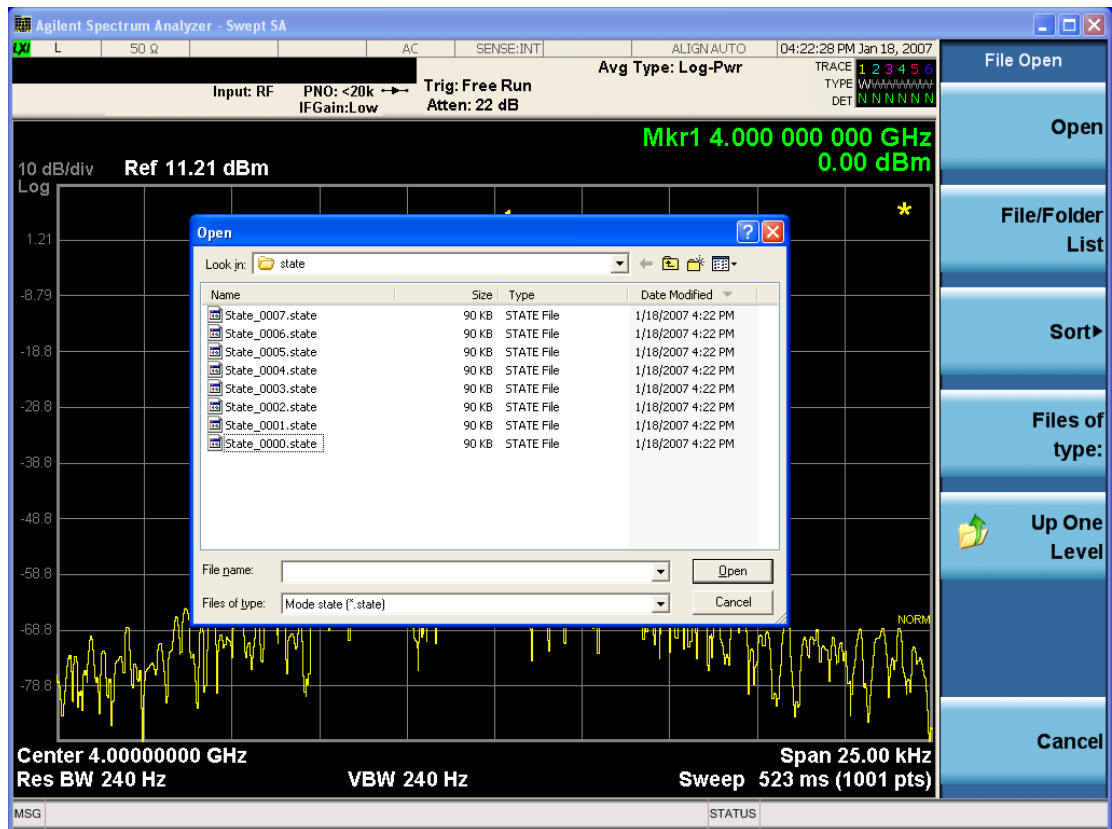

Listed below are the functions of the various fields in the dialog, and the corresponding softkeys:

Open

Performs the recall of the specified file. While the recall is being performed, the floppy icon appears briefly in the Meas bar.

File/Folder List

Enables you to navigate to the center of the dialog that contains the list of files and folders. Once here you can get information about the file and use the tab keys to navigate to the other fields in the dialog, such as Look In.

Look In

The **Look In** field shows the path from which the file will be recalled and allows you to change the path using the up and down arrow keys to navigate to other paths; the Enter key to open a directory; and the Backspace key to go back one directory. The **Look In** field first uses the last path from the Save As dialog **Save In:** path for that same file type. There is no softkey for directly navigating to the Look In field, but you can use the left tab to get here from the File/Folder List.

User specified paths are remembered when you leave and return to a Mode and are reset back to the default using **Restore Mode Defaults**.

Sort

Accesses a menu that enables you to sort the files within the File Open dialog. Only one sorting type can be selected at a time and the sorting happens immediately. The sorting types are **By Date, By Name, By extension, and By Size**.

Files of Type

This field shows the file suffix for the type of file you have selected to recall. For example, if you navigated here while recalling State, "Mode state (*.state)" is in the field. If you navigated here while recalling Trace, "Mode state (*.trace)" is in the field. If you navigated here while importing a trace data file, "Trace Data (*.csv)" is in the field. For some file types, there is more than one choice in the dropdown menu, which you can select by using the up and down arrow keys and Enter.

Up One Level

This key corresponds to the icon of a folder with the up arrow that is in the tool bar of the dialog. When pressed, it causes the file and folder list to navigate up one level in the directory structure. The Backspace key does the same thing.

Cancel

This key corresponds to the **Cancel** selection in the dialog. It causes the current **Open** request to be cancelled. The ESC key does the same thing.

Key Path	Recall, State
Notes	Brings up the Open dialog for recalling a State Save Type
Initial S/W Revision	Prior to A.02.00

Data (Import)

Importing a data file loads data that was previously saved from the current measurement or from other measurements and/or modes that produce compatible data files. The Import Menu only contains Data Types that are supported by the current measurement.

Since the commonly exported data files are in .csv format, the data can be edited by the user prior to importing. This allows you to export a data file, manipulate the data in Excel (the most common PC Application for manipulating .csv files) and then import it.

Importing Data loads measurement data from the specified file into the specified or default destination, depending on the data type selected. Selecting an Import Data menu key will not actually cause the importing to occur, since the analyzer still needs to know from where to get the data. Pressing the Open key in this menu brings up the Open dialog and Open menu that provides you with the options from where to recall the data. Once a filename has been selected or entered in the Open menu, the recall occurs as soon as the Open button is pressed.

Key Path	Recall
Mode	All
Notes	The menu is built from whatever data types are available for the mode. Some keys will be missing completely, so the key locations in the sub-menu will vary. No SCPI command directly controls the Data Type that this key controls. The Data Type is included in the MMEM:LOAD commands.
Dependencies	If a file type is not used by a certain measurement, it is grayed out for that measurement. The key for a file type will not show at all if there are no measurements in the Mode that support it.
Preset	Is not affected by Preset or shutdown, but is reset during Restore Mode Defaults
Readback	The data type that is currently selected
Initial S/W Revision	Prior to A.02.00

Amplitude Correction

This key selects the Amplitude Corrections as the data type to be imported. When pressed a second time, it brings up the Select Menu, which lets you select the Correction into which the data will be imported.

Amplitude Corrections are fully discussed in the documentation of the Input/Output key, under the Corrections key.

A set of preloaded Corrections files can be found in the directory

/My Documents/ EMC Limits and Ampcor.

When the Amplitude Correction is an Antenna correction and the Antenna Unit in the file is not **None**, the Y Axis Unit setting will change to match the Antenna Unit in the file.

Key Path	Recall
Mode	SA EDGE GSM PN
Remote Command	:MMEMory:LOAD:CORRection 1 2 3 4 5 6 7 8, <filename>
Example	:MMEM:LOAD:CORR 2, "myAmpcor.csv" recalls the Amplitude Correction data from the file myAmpcor.csv in the current directory to the 2nd Amplitude Correction table, and turns on Correction 2. The default path is D:\Users\Instrument\My Documents\amplitudeCorrections\
Dependencies	Only the first correction array (Correction 1) supports antenna units. This means that a correction file with an Antenna Unit can only be loaded into the Corrections 1 register. Consequently only for Correction 1 does the dropdown in the Recall dialog include ant, and if an attempt is made to load a correction file into any other Correction register which DOES contain an antenna unit, a Mass Storage error is generated. Corrections are not supported by all Measurements. If in a Mode in which some Measurements support it, this key will be grayed out in measurements that do not. The key will not show at all if no measurements in the Mode support it. Errors are reported if the file is empty or missing, or if the file type does not match, or if there is a mismatch between the file type and the destination data type. If any of these occur during manual operation, the analyzer returns to the Import Data menu and the File Open dialog goes away.

	This key does not appear unless you have the proper option installed in your instrument. This command will generate an "Option not available" error unless you have the proper option installed in your instrument.
Couplings	When a correction file is loaded from mass storage, it is automatically turned on (Correction ON) and ApplyCorrections is set to On. This allows you to see its effect, thus confirming the load.
Readback	selected Correction
Backwards Compatibility SCPI	:MMEMory:LOAD:CORRection ANTenna CABLE OTHER USER, <filename> For backwards compatibility, ANTenna maps to 1, CABLE maps to 2, OTHER maps to 3 and USER maps to 4
Initial S/W Revision	A.02.00

Amplitude Correction

These keys let you select which Correction to import the data into. Once selected, the key returns back to the Import Data menu and the selected Correction number is annotated on the key. The next step is to select the Open key in the Import Data menu.

Antenna corrections are a particular kind of Amplitude Corrections – they are distinguished in the corrections file by having the Antenna Unit set to a value other than None. Only Correction 1 supports Antenna Units.

Key Path	Recall, Data, Amplitude Correction
Notes	auto return
Dependencies	Only Correction 1 may be used to load a Correction that contains an Antenna Unit other than None
Preset	Not part of Preset, but is reset to Correction 1 by Restore Input/Output Defaults; survives shutdown.
State Saved	The current Correction number is saved in instrument state
Initial S/W Revision	A.02.00

Trace

This key selects Trace as the data type to be imported. When pressed a second time, it brings up the Trace Menu, which lets you select the Trace into which the data will be imported.

The trace file contains "meta" data which describes the state of the analyzer when the trace was exported (see "[Trace File Contents](#)" on page 3216). If the meta data in the file does not match the current SA state, the "invalid data indicator" (*) is displayed.

Key Path	Recall, Data
Remote Command	:MMEMory:LOAD:TRACe:DATA TRACE1 TRACE2 TRACE3 TRACE4 TRACE5 TRACE6, <filename>
Example	:MMEM:LOAD:TRAC DATA TRACE2, "myTrace2.csv" Imports the 2nd trace from the file myTrace2.csv in the current path. The default path is My Documents\SA\data\traces
Dependencies	For SA measurements, a trace cannot be recalled from a trace file that was exported with ALL traces selected. A trace cannot be imported if the number of trace points in the file do not match the number of sweep points currently set for the measurement. If this happens, an error message is generated. Errors are reported if the file is empty or missing, or if the file type does not match, or if there is a mismatch between the file type and the destination data type. If any error occurs while trying to load a file manually (as opposed to during remote operation), the analyzer returns to the Import Data menu and the File Open dialog goes away.
Couplings	When a trace is imported, Trace Update is always turned OFF for that trace and Trace Display is always turned ON.
Readback	Selected Trace
Status Bits/OPC dependencies	Sequential - aborts the current measurement.
Initial S/W Revision	Prior to A.02.00

Select Trace

These keys let you pick the Trace into which to import the data; either 1, 2, 3, 4, 5 or 6. The default is the currently selected trace, selected in this menu or in the Trace/Det, Export Data, Recall Trace, or Save Trace menus; except if you have chosen **All** then **All** remains chosen until you specifically change it to a single trace.

Once selected, the key returns back to the Import Data menu and the selected Trace number is annotated on the key. The next step is to select the Open key in the Import Data menu.

Key Path	Recall, Data, Trace
Notes	Auto return
Couplings	When you select the trace into which to import the data, it makes that trace the current trace, so it displays on top of all of the other traces.
Preset	Not part of Preset, but is reset to TRACE1 by Restore Mode Defaults; survives shutdown
State Saved	The current trace number is saved in State
Initial S/W Revision	Prior to A.02.00

Limit

This key selects Limit Lines as the data type to be imported. When pressed a second time, it brings up the Limits Menu, which lets you select into which Limit the data will be imported.

A set of preloaded Limits files can be found in the directory

/My Documents/ EMC Limits and Ampcor.

Under this directory, the directory called Limits (Legacy Naming) contains a set of legacy limits, generally the same files that were supplied with older Agilent EMC analyzers, that use the legacy suffix .lim, and the old 8-character file names. In the directory called Limits, the same files can be found, with the same suffix, but with longer, more descriptive filenames.

Key Path	Recall, Data
Remote Command	:MMEMory:LOAD:LIMit LLINE1 LLINE2,<filename>
Example	:MMEM:LOAD:LIM LLINE2, "myLimitLine2.csv" Imports the 2nd Limit Line from the file myLimitLine2.csv in the current path. The default path is My Documents\SA\data\limits
Dependencies	Errors are reported if the file is empty or missing, or if the file type does not match, or if there is a mismatch between the file type and the destination data type. If any of these occur during manual operation, the analyzer returns to the Import Data menu and the File Open dialog goes away. This key will only appear if you have the proper option installed in your instrument.
Couplings	When a limit line is loaded from mass storage, it is automatically turned on. This allows the user to see it, thus confirming the load. The Margin settings will match those when the limit was saved The instrument cannot mix Limits domains (X Axis Unit must be Frequency or Time for both Limits). So when a Limits file is loaded, the analyzer will set the Limits domain (X Axis Unit) to match that of the file. If this changes the Limits domain from what it was before the file was loaded, all Limits data in all Limits sets will be erased before the data loads. If this operation is over the remote interface there will be no warning if this occurs, so care should be taken to know the domain of the file you are loading.
Readback	Selected Limit Line
Status Bits/OPC dependencies	Sequential - aborts the current measurement
Initial S/W Revision	A.02.00

Limit Selection

These keys let you pick which Limit Line to import the data into; either 1, 2, 3, 4, 5 or 6. The default is the currently selected limit. Once selected, the key returns back to the Import Data menu and the selected Limit Line number is annotated on the key. Now you have selected exactly what needs to be imported. In order to trigger an import of the selected Limit Line, you must select the Open key in the Import Data menu.

An example of using this menu is: If you select 2 and continue to the File Open menu, Limit Line 2 will be imported from the file selected or entered in File Name option in the File Open dialog.

Key Path	Recall, Data, Limit Line
Notes	Auto return
Preset	Not part of Preset, but is reset to LLINE1 by Restore Mode Defaults; survives a shutdown.
State Saved	The selected limit number is saved in instrument state
Initial S/W Revision	A.02.00

Open...

When you press “Open”, the analyzer brings up a Windows dialog and a menu entitled “**File Open.**” This menu allows you to navigate to the various fields in the Windows dialog without using a keyboard or mouse. The **Tab** and **Arrow** keys can also be used for dialog navigation.

See "[From File...](#)" on page 3210 in **Recall, State**, for a full description of this dialog and menu.

Key Path	Recall, Data
Notes	The key location is mode-dependent and will vary. Brings up Open dialog for recalling a <mode specific> Save Type
Initial S/W Revision	Prior to A.02.00

Restart

The Restart function restarts the current sweep, or measurement, or set of averaged/held sweeps or measurements. If you are Paused, pressing Restart does a Resume.

The Restart function is accessed in several ways:

- Pressing the Restart key
- Sending the remote command INIT:IMMEDIATE
- Sending the remote command INIT:RESTART

See ["More Information" on page 2729](#)

Key Path	Front-panel key
Remote Command	:INITiate[:IMMEDIATE] :INITiate:RESTART
Example	:INIT:IMM :INIT:REST
Notes	:INITiate:RESTART and :INITiate:IMMEDIATE perform exactly the same function.
Couplings	Resets average/hold count k. For the first sweep overwrites all active (update=on) traces with new current data. For application modes, it resets other parameters as required by the measurement.
Status Bits/OPC dependencies	This is an Overlapped command. The STATus:OPERation register bits 0 through 8 are cleared. The STATus:QUESTionable register bit 9 (INTegrity sum) is cleared. The SWEEPING bit is set. The MEASURING bit is set.
Backwards Compatibility Notes	For Spectrum Analysis mode in ESA and PSA, the Restart hardkey and the INITiate:RESTART command restart trace averages (displayed average count reset to 1) for a trace in Clear Write , but did not restart Max Hold and Min Hold . In the X-Series, the Restart hardkey and the INITiate:RESTART command restart not only Trace Average , but MaxHold and MinHold traces as well. For wireless comms modes in ESA and PSA, the Restart hardkey and the INITiate:RESTART command restart every measurement, which includes all traces and numeric results. There is no change to this operation.
Initial S/W Revision	Prior to A.02.00

More Information

The **Restart** function first aborts the current sweep/measurement as quickly as possible. It then resets the sweep and trigger systems, sets up the measurement and initiates a new data measurement sequence with a new data acquisition (sweep) taken once the trigger condition is met.

If the analyzer is in the process of aligning when **Restart** is executed, the alignment finishes before the restart function is performed.

Even when set for Single operation, multiple sweeps may be taken when Restart is pressed (for example, when averaging/holding is on). Thus when we say that **Restart** "restarts a measurement," we may mean:

- It restarts the current sweep
- It restarts the current measurement
- It restarts the current set of sweeps if any trace is in Trace Average, Max Hold or Min Hold
- It restarts the current set of measurements if Averaging, or Max Hold, or Min Hold is on for the measurement
- depending on the current settings.

With **Average/Hold Number** (in **Meas Setup** menu) set to 1, or Averaging off, or no trace in Trace Average or Hold, a single sweep is equivalent to a single measurement. A single sweep is taken after the trigger condition is met; and the analyzer stops sweeping once that sweep has completed. However, with **Average/Hold Number** > 1 and at least one trace set to **Trace Average, Max Hold, or Min Hold (SA Measurement)** or **Averaging on (most other measurements)**, multiple sweeps/data acquisitions are taken for a single measurement. The trigger condition must be met prior to each sweep. The sweep is stopped when the average count k equals the number N set for **Average/Hold Number**. A measurement average usually applies to all traces, marker results, and numeric results; but sometimes it only applies to the numeric results.

Once the full set of sweeps has been taken, the analyzer will go to idle state. To take one more sweep without resetting the average count, increment the average count by 1, by pressing the step up key while **Average/Hold Number** is the active function, or sending the remote command `CALC: AVER: TCON UP`.

Save

The **Save** menu lets you choose what you want to save and where you want to save it. Among the types of files you can save are **States**, **Traces**, and **Screen Images**. In addition, an **Export (Data)** option lets you save a number of data types as CSV files for easy import into Excel and other spreadsheet programs.

Key Path	Front-panel key
Mode	All
Notes	No remote command for this key specifically, but the :MMEM:STORe command is available for specific file types. An example is :MMEM:STOR:STATe <filename>.
Initial S/W Revision	Prior to A.02.00

State

The Save State menu lets you choose a register or file for saving the state.

The content of a state file includes all of the settings and data required to return the analyzer as closely as possible to the Mode it was in, with the exact settings which were in place, when the save occurred. The Mode settings in each state file include the settings that are affected by Mode Preset, as well as the additional settings affected by Restore Mode Defaults; all of the Mode's settings. In addition, all of the settings of the **Input/Output** system are included, even though they are outside of the Mode's state, because they are needed to restore the complete setup. Persistent **System** settings (for example, Verbose SCPI) are not affected by either Mode Preset or Restore Mode Defaults, nor are they included in a saved State file.

After the save completes, the message "File <filename> saved" or "State Register <register number> saved" is displayed.

For rapid saving, the State menu lists 16 registers to save to. Pressing a Register key initiates the save. You can also select a file to save to.

The default path for all State Files is:

My Documents\<<mode name>\state

where <mode name> is the parameter used to select the mode with the INST:SEL command (for example, SA for the Spectrum Analyzer).

Key Path	Save
Mode	All
Remote Command	:MMEMory:STORe:STATe <filename>
Example	MMEM:STOR:STATe "MyStateFile.state" This stores the current instrument state data in the file MyStateFile.state in the default directory.
Notes	Both single and double quotes are supported for any filename parameter over remote. After saving to a register, that register's menu key is updated with the date the time, unless a custom label has been entered for that key. After saving to a register, you remain in the Save State menu, so that you can see the Register

	key update. After saving to a file, the analyzer automatically returns to the previous menu and any Save As dialog goes away.
Backwards Compatibility SCPI	:MMEMory:STORe:STATe 1,<filename> For backwards compatibility, the above syntax is supported. The "1" is simply ignored. The command is sequential.
Initial S/W Revision	Prior to A.02.00

To File . . .

When you press "To File", the analyzer brings up a Windows dialog and a menu entitled "**Save As.**" This menu allows you to navigate to the various fields in the Windows dialog without using a keyboard or mouse. The **Tab** and **Arrow** keys can also be used for dialog navigation.

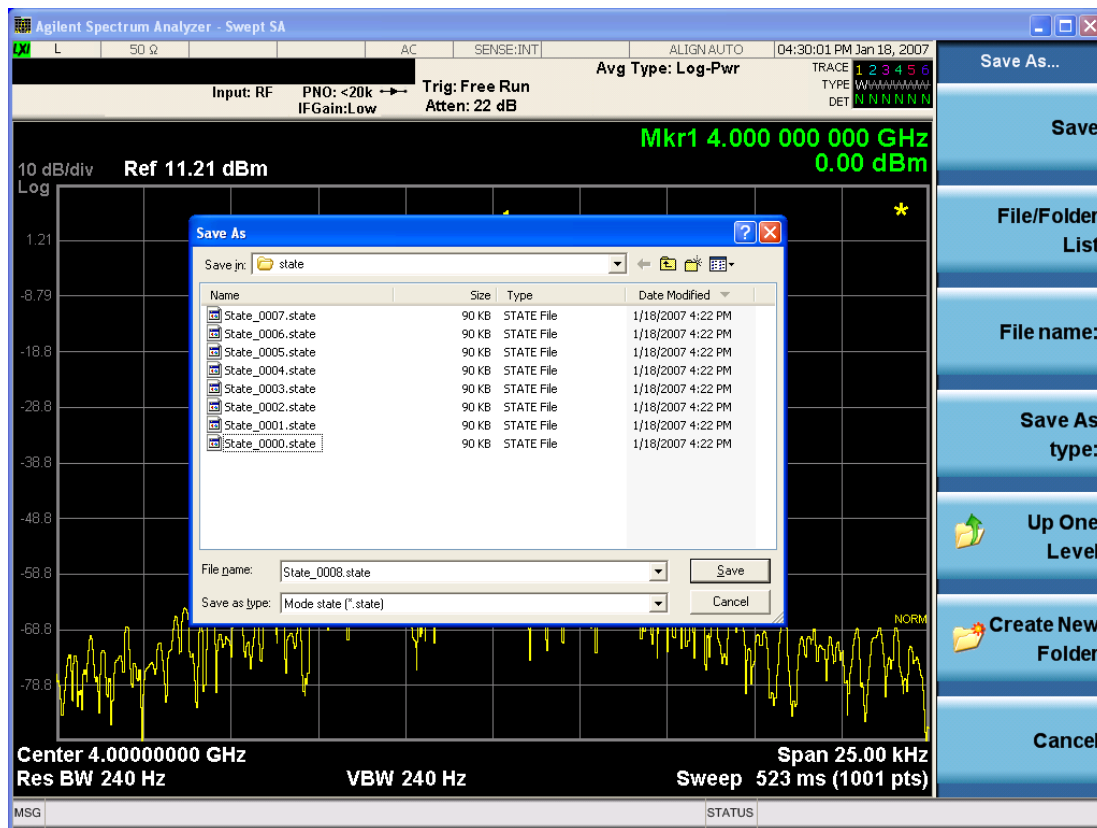

The Listed below are the functions of the various fields in the dialog, and the corresponding softkeys:

Save

Performs the save to the specified file of the selected type. If the file already exists, a dialog will appear that allows you to replace the existing file by selecting **OK**, or you can Cancel the request. If you select OK, the file will be overwritten. Using the C: drive is strongly discouraged, since it runs the risk of being overwritten during an instrument software upgrade.

While the save is being performed, the floppy icon appears briefly in the Meas bar.

File/Folder List

Enables you to navigate to the center of the dialog that contains the list of files and folders. Once here you can get information about the file and use the tab keys to navigate to the other fields in the dialog, such as Save In.

Save In

The Save In field shows the path to which the file will be saved and allows you to change the path using the up and down arrow keys to navigate to other paths; the Enter key to open a directory; and the Backspace key to go back one directory. The **Save In field** defaults to the default path for this type of file and remembers the last path you used to save this type of file. There is no softkey for directly navigating to the Save In field but you can use left tab to get here from the File/Folder List.

User specified paths are remembered when you leave and return to a Mode and are reset back to the default using **Restore Mode Defaults**.

File Name

The **File Name** field is initially loaded with an automatically generated filename specific to the appropriate Save Type. The automatically generated filename is guaranteed not to conflict with any filename currently in the directory. You may replace or modify this filename using the File Name key. See the ["Quick Save " on page 3181](#) documentation for more on the automatic file naming algorithm.

When you press the **File Name** key the analyzer displays the Alpha Editor. Use the knob to choose the letter to add and the front-panel Enter key to add the letter to the file name. The BK character moves you back and the FW character moves you forward in the filename. The Select key on the front panel generates a space character. When you are done entering the filename press the **Done** softkey. This returns back to the **File Open** dialog and menu, but does not cause the save to occur.

Save As Type

This field shows the file suffix for the type of file you have selected to save. For example, if you navigated here while saving State, "Mode state (*.state)" is in the field. If you navigated here from saving Trace, "Mode state (*.trace)" is in the field. If you navigated here while exporting a trace data file, "Trace Data (*.csv)" is in the field. For some file types, there is more than one choice in the dropdown, which you can select by using the up and down arrow keys and Enter.

Up One Level

This key corresponds to the icon of a folder with the up arrow that is in the tool bar of the dialog. When pressed, it causes the file and folder list to navigate up one level in the directory structure. The Backspace key does the same thing.

Create New Folder

This key corresponds to the icon of a folder with the "*" that is in the tool bar of the dialog. When pressed, a new folder is created in the current directory with the name **New Folder** and you can enter a new folder name using the Alpha Editor.

Cancel

This key corresponds to the **Cancel** selection in the dialog. It causes the current **Save As** request to be cancelled. The ESC key does the same thing.

Key Path	Save, State
Mode	All
Notes	Brings up Save As dialog for saving a State Save Type
Initial S/W Revision	Prior to A.02.00

Edit Register Names

You may enter a custom name on any of the Register keys, to help you remember what you are using that state to save. To do this, press the **Edit Register Names** key,

choose the register whose name you wish to edit, and then enter the desired label using the Alpha Editor or an external PC keyboard.

The maximum number of characters that can be added is 30. In most cases, 30 characters will fit on two lines of the key.

See ["More Information" on page 2735](#)

Key Path	Save, State
Mode	All
Remote Command	:MMEMory:REGister:STATe:LABe1 <reg number>,"label" :MMEMory:REGister:STATe:LABe1? <reg number>
Example	:MMEM:REG:STAT:LAB 1,"my label"
Notes	<reg number> is an integer from 1 to 16. If the SCPI specifies an invalid register number an error message is generated, -222,"Data out of range;Invalid register label number" "label" is a string from 0 to 30 characters in length. If a label exceeds 30 characters, an error message is generated, -150,"String data error;Label clipped to 30 characters" "label" of length 0 erases the custom label and restores the default (time and date) label. E.g.: :MMEM:REG:STAT:LAB 1,""
Dependencies	N9060A-7FP or N9060B-2FP license required to edit the register names. When the feature is not licensed, sending this command generates an error, -221,"Settings conflict;Option not available"
Preset	The names are unaffected by Preset or power cycle but are set to the default label (time and date) on a "Restore System Defaults->Misc"
Initial S/W Revision	A.11.00

More Information

When you edit one of the register names, the time and date field will be replaced by the custom name.

If you delete all the characters in the custom name, it restores the default (time and date).

The register names are stored within the state files, but they are not part of the instrument state; that is, once you have edited a register name, loading a new state will not change that register name. Another consequence of this is that the names will be persistent through a power cycle. Also, if a named state file is transferred to another analyzer, it will bring its custom name along with it.

If you try to edit the name of an empty register, the analyzer will first save the state to have a file to put the name in. If you load a named state file into an analyzer with older firmware it will ignore the metadata.

The *SAV and *RCL commands will not be affected by the custom register names, nor will the MMEM commands.

Register 1 thru Register 16

Selecting any one of these register menu keys causes the State of the currently active mode to be saved to the specified Register. The registers are provided for rapid saving and recalling, since you do not need to specify a filename or navigate to

a file. Each of the register menu keys annotates whether it is empty or at what date and time it was last modified. In addition, you can use the **Edit Register Names** key to enter custom names for each register.

Although these 16 registers are the only registers available from the front panel, there are 128 state registers available in the instrument. Registers 17-128 are only available from the SCPI interface, using the *SAV command.

There is one set of 128 state registers in the instrument, not one set for each Mode. When a state is saved, the Mode it was saved from is saved with it; then when it is recalled, the instrument switches to that Mode.

After the save completes, the corresponding register menu key annotation is updated with the date and time and the message "Register <register number> saved" is displayed.

Key Path	Save, State
Mode	All
Example	*SAV 1
Range	1-16 from front panel, 1-128 from SCPI
Readback	Date and time with seconds resolution are displayed on the key OR A custom name of up to 30 characters entered using the Edit Register Names key OR “(empty)” if no prior save operation has been performed to this register.
Initial S/W Revision	Prior to A.02.00
Modified at S/W Revision	A.11.00

Register 1 thru Register 16

Selecting any one of these register menu keys causes the State of the currently active mode to be saved to the specified Register. The registers are provided for rapid saving and recalling, since you do not need to specify a filename or navigate to a file. Each of the register menu keys annotates whether it is empty or at what date and time it was last modified. In addition, you can use the **Edit Register Names** key to enter custom names for each register.

Although these 16 registers are the only registers available from the front panel, there are 128 state registers available in the instrument. Registers 17-128 are only available from the SCPI interface, using the *SAV command.

There is one set of 128 state registers in the instrument, not one set for each Mode. When a state is saved, the Mode it was saved from is saved with it; then when it is recalled, the instrument switches to that Mode.

After the save completes, the corresponding register menu key annotation is updated with the date and time and the message "Register <register number> saved" is displayed.

Key Path	Save, State
Mode	All
Example	*SAV 1
Range	1-16 from front panel, 1-128 from SCPI
Readback	Date and time with seconds resolution are displayed on the key OR A custom name of up to 30 characters entered using the Edit Register Names key OR “(empty)” if no prior save operation has been performed to this register.
Initial S/W Revision	Prior to A.02.00
Modified at S/W Revision	A.11.00

Trace (+State)

The **Save Trace (+State)** menu lets you choose a register or file specifying where to save the Trace+State state file.

A saved state contains all of the settings and data required to return the analyzer as closely as possible to the exact setup it had when the save occurred. This includes the Input/Output settings, even though they are outside of the Mode’s state, because they are needed to restore the complete setup. A Trace+State file also includes trace data from one trace or all traces, which will load in View mode when the Trace+State file is recalled.

After the save completes, the message "File <filename> saved" or "Trace Register <register number> saved" is displayed.

For rapid saves, the Trace (+State) menu lists 5 registers to save to. Pressing a Register key initiates the save. You can also select a file to save to.

The default path for all State Files including .trace files is:

My Documents\<mode name>\state

where <mode name> is the parameter used to select the mode with the INST:SEL command (for example, Basic for the IQAnalyzer).

This key is grayed out for measurements that do not support trace saves. It is blanked for modes that do not support trace saves. Saving **Trace** is identical to saving State except a .trace extension is used on the file instead of .state, and internal flags are set in the file indicating which trace was saved. You may select to save one trace or ALL traces.

Key Path	Save
Mode	SA
Remote Command	:MMEMory:STORe:TRACe TRACE1 TRACE2 TRACE3 TRACE4 TRACE5 TRACE6 ALL,<filename>

	<code>:MMEMory:STORe:TRACe:REGister TRACE1 TRACE2 TRACE3 TRACE4 TRACE5 TRACE6 ALL,<integer></code>
Example	<p>:MMEM:STOR:TRAC TRACE1, "myState.trace" saves the file myState.trace on the default path and flags it as a "single trace" file with Trace 1 as the single trace (even though all of the traces are in fact stored).</p> <p>:MMEM:STOR:TRAC ALL, "myState.trace" saves the file myState.trace on the default path and flags it as an "all traces" file</p> <p>:MMEM:STOR:TRAC:REG TRACE1, 2 stores trace 1 data in trace register 2</p>
Notes	<p>This command actually performs a save state, which in the Swept SA measurement includes the trace data. However it flags it (in the file) as a "save trace" file of the specified trace (or all traces).</p> <p>Some modes and measurements do not have available all 6 traces. The Phase Noise mode command, for example, is: <code>MMEMory:STORe:TRACe TRACE1 TRACE2 TRACE3 ALL,<filename></code></p> <p>Some modes and measurements have more than 6 traces available. The Realtime SA mode command, for example, is: <code>MMEMory:STORe:TRACe TRACE1 TRACE2 TRACE3 TRACE4 TRACE5 TRACE6 TRACE7 TRACE8 TRACE9 TRACE10 TRACE11 TRACE12 ALL,<filename></code></p> <p>The range for the register parameter is 1-5</p> <p>When you initiate a save, if the file already exists, a dialog will appear that allows you to replace the existing file by selecting OK or you can Cancel the request. If you select OK, the file will be overwritten. Using the C: drive is strongly discouraged, since it runs the risk of being overwritten during an instrument software upgrade.</p> <p>Both single and double quotes are supported for any filename parameter over remote.</p> <p>After saving to a register, that register's menu key is updated with the date and time of the save.</p> <p>After saving to a register, you remain in the Save Trace menu, so that you can see the Register key update. After saving to a file, the analyzer automatically returns to the previous menu and any Save As dialog goes away.</p>
Initial S/W Revision	Prior to A.02.00

Register 1 thru Register 16

Selecting any one of these register menu keys causes the State of the currently active mode to be saved to the specified Register. The registers are provided for rapid saving and recalling, since you do not need to specify a filename or navigate to a file. Each of the register menu keys annotates whether it is empty or at what date and time it was last modified. In addition, you can use the **Edit Register Names** key to enter custom names for each register.

Although these 16 registers are the only registers available from the front panel, there are 128 state registers available in the instrument. Registers 17-128 are only available from the SCPI interface, using the *SAV command.

There is one set of 128 state registers in the instrument, not one set for each Mode. When a state is saved, the Mode it was saved from is saved with it; then when it is recalled, the instrument switches to that Mode.

After the save completes, the corresponding register menu key annotation is updated with the date and time and the message "Register <register number> saved" is displayed.

Key Path	Save, State
Mode	All
Example	*SAV 1
Range	1-16 from front panel, 1-128 from SCPI
Readback	Date and time with seconds resolution are displayed on the key OR A custom name of up to 30 characters entered using the Edit Register Names key OR "(empty)" if no prior save operation has been performed to this register.
Initial S/W Revision	Prior to A.02.00
Modified at S/W Revision	A.11.00

From Trace

Accesses a menu that enables you to select the trace to be saved. Once a trace is selected, the key returns to the Save Trace menu and the selected trace number is annotated on the key. The default is the currently selected trace, selected in this menu or in the Trace/Det, Export Data, Import Data or Recall Trace menus, except if you have chosen All then it remains chosen until you specifically change it to a single trace. To save the Trace you must select the **Save As** key in the Save Trace menu.

When you select a trace, it makes that trace the current trace, so it displays on top of all of the other traces.

Key Path	Save, Trace + State
Mode	SA
Initial S/W Revision	Prior to A.02.00

From File...

When you press "From File", the analyzer brings up a Windows dialog and a menu entitled "**File Open.**" This menu allows you to navigate to the various fields in the Windows dialog without using a keyboard or mouse. The **Tab** and **Arrow** keys can also be used for dialog navigation.

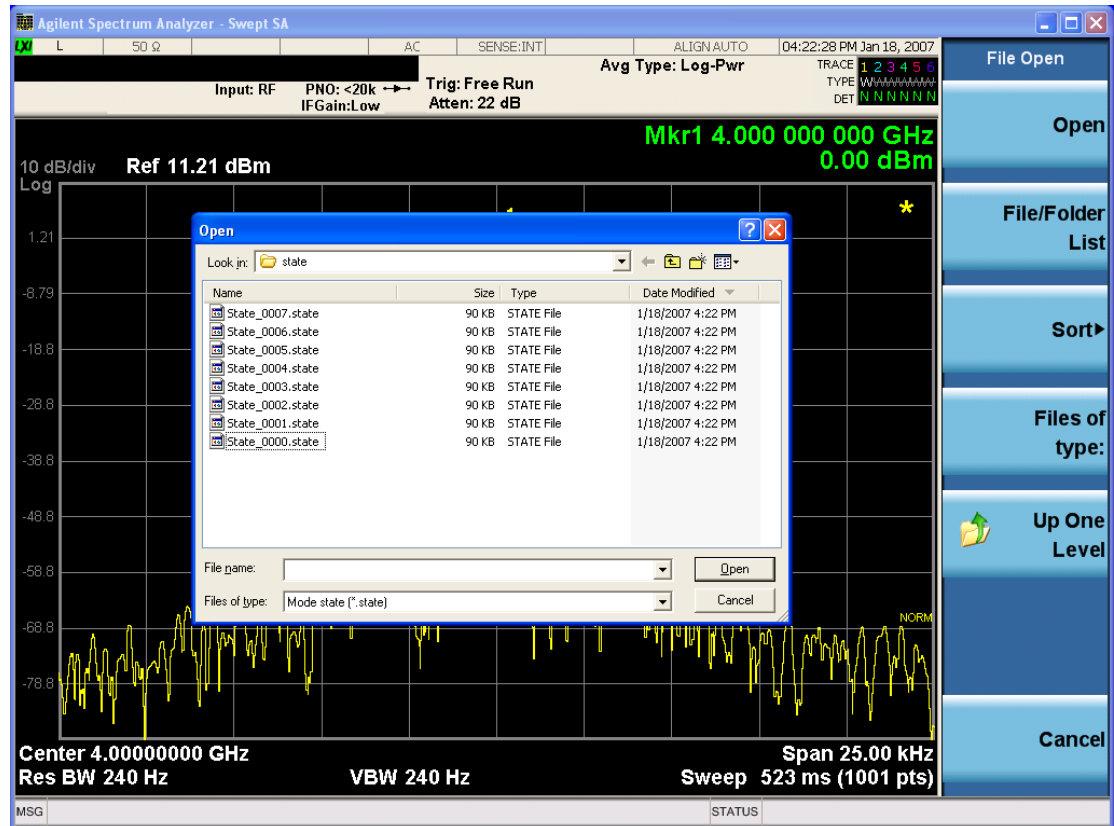

Listed below are the functions of the various fields in the dialog, and the corresponding softkeys:

Open

Performs the recall of the specified file. While the recall is being performed, the floppy icon appears briefly in the Meas bar.

File/Folder List

Enables you to navigate to the center of the dialog that contains the list of files and folders. Once here you can get information about the file and use the tab keys to navigate to the other fields in the dialog, such as Look In.

Look In

The **Look In** field shows the path from which the file will be recalled and allows you to change the path using the up and down arrow keys to navigate to other paths; the Enter key to open a directory; and the Backspace key to go back one directory. The **Look In** field first uses the last path from the Save As dialog **Save In:** path for that same file type. There is no softkey for directly navigating to the Look In field, but you can use the left tab to get here from the File/Folder List.

User specified paths are remembered when you leave and return to a Mode and are reset back to the default using **Restore Mode Defaults**.

Sort

Accesses a menu that enables you to sort the files within the File Open dialog. Only one sorting type can be selected at a time and the sorting happens immediately. The sorting types are **By Date**, **By Name**, **By extension**, and **By Size**.

Files of Type

This field shows the file suffix for the type of file you have selected to recall. For example, if you navigated here while recalling State, "Mode state (*.state)" is in the field. If you navigated here while recalling Trace, "Mode state (*.trace)" is in the field. If you navigated here while importing a trace data file, "Trace Data (*.csv)" is in the field. For some file types, there is more than one choice in the dropdown menu, which you can select by using the up and down arrow keys and Enter.

Up One Level

This key corresponds to the icon of a folder with the up arrow that is in the tool bar of the dialog. When pressed, it causes the file and folder list to navigate up one level in the directory structure. The Backspace key does the same thing.

Cancel

This key corresponds to the **Cancel** selection in the dialog. It causes the current **Open** request to be cancelled. The ESC key does the same thing.

Key Path	Recall, State
Notes	Brings up the Open dialog for recalling a State Save Type
Initial S/W Revision	Prior to A.02.00

Data (Export)

Exporting a data file stores data from the current measurement to mass storage files. The Export Menu only contains data types that are supported by the current measurement.

Since the commonly exported data files are in .csv format, the data can be edited by you prior to importing. This allows you to export a data file, manipulate the data in Excel (the most common PC Application for manipulating .csv files) and then import it.

Selecting an Export Data menu key will not actually cause the exporting to occur, since the analyzer still needs to know where you wish to save the data. Pressing the Save As key in this menu brings up the Save As dialog and Save As menu that allows you to specify the destination file and directory. Once a filename has been selected or entered in the Open menu, the export will occur as soon as the Save key is pressed.

Key Path	Save
Mode	All
Notes	The menu is built from whatever data types are available for the mode. So the key locations in the sub menu will vary. No SCPI command directly controls the Data Type that this key controls. The Data Type is included in the MMEM:STORe commands.

Dependencies	If a file type is not used by a certain measurement, that type is grayed out for that measurement. The key for a file type will not show at all if there are no measurements in the Mode that support it.
Preset	Is not affected by a Preset or shutdown, but is reset during Restore Mode Defaults
Readback	The data type that is currently selected
Initial S/W Revision	Prior to A.02.00

Amplitude Correction

Pressing this key selects **Amplitude Corrections** as the data type to be exported. Pressing this key again brings up the Select Menu, which allows the user to select which **Amplitude Correction** to save.

Amplitude Corrections are fully discussed in the documentation of the Input/Output key, under the Corrections softkey.

See "[Correction Data File](#)" on page 2742

Key Path	Save
Remote Command	:MMEMory:STORe:CORRection 1 2 3 4 5 6, <filename>
Example	:MMEM:STOR:CORR 2 "myAmpcor.csv" saves Correction 2 to the file myAmpcor.csv on the current path. The default path is My Documents\amplitudeCorrections.
Notes	If the save is initiated via SCPI, and the file already exists, the file will be overwritten. Using the C: drive is strongly discouraged, since it runs the risk of being overwritten during an instrument software upgrade. Both single and double quotes are supported for any filename parameter over SCPI.
Dependencies	Corrections are not supported by all Measurements. If in a Mode in which some Measurements support it, this key will be grayed out in measurements that do not. The key will not show at all if no measurements in the Mode support it. This key will not appear unless you have the proper option installed in your instrument.
Readback	Selected Correction
Backwards Compatibility SCPI	:MMEMory:STORe:CORRection ANTenna CABLe OTHer USER, <filename> For backwards compatibility, ANTenna maps to 1, CABLe maps to 2, OTHer maps to 3 and USER maps to 4
Initial S/W Revision	A.02.00

Correction Data File

A Corrections Data File contains a copy of one of the analyzer correction tables. Corrections provide a way to adjust the trace display for predetermined gain curves (such as for cable loss).

Corrections files are text files in .csv (comma separated values) form, to make them importable into Excel or other spreadsheet programs. The format for Corrections files is as follows.

Line #	Type of field	Example	Notes
1	File type, must be "Amplitude Correction"	Amplitude Correction	May not be omitted
2	File Description (in quotes)	"Correction Factors for 11966E"	60 characters max; may be empty but may not be omitted. If exceeds 60 characters, error -233 Too much data reported
3	Comment (in quotes)	"Class B Radiated"	60 characters max; may be empty but may not be omitted. . If exceeds 60 characters, error -233 Too much data reported
4	Instrument Version, Model #	A.02.06,N9020A	May be empty but may not be omitted
5	Option List, File Format Version	K03 LFE EXM ,01	May be empty but may not be omitted
6	Freq Unit to be used for all frequency values in the file	Frequency Unit,MHz	assumed to be Hz if omitted
7	Antenna Unit	Antenna Unit,None	If omitted leaves the Antenna unit unchanged. The amplitude unit in the Antenna Unit field is a conversion factor that is used to adjust the Y Axis Units of the current mode, if the mode supports Antenna Units. For more details on antenna correction data, refer to the Input/Output,Corrections key description. Allowable values: dBuv/m, dBuA/m, dBG, dBpT, None
8	Freq Interpolation	Frequency Interpolation,Linear	if omitted leaves the Freq Interpolation unchanged. Allowable values: Linear, Logarithmic
9	Bias value in mA	Bias,0.00	If omitted leaves the Bias value unchanged (added as of A.08.50)
10	Bias State	Bias State,On	If omitted leaves the Bias State unchanged. Allowable values: On, Off (added as of A.08.50)

Line #	Type of field	Example	Notes
11	Overlap, two values, Freq1 and Freq2, separated by commas.	Overlap,33500,40000	Uses Freq Unit from line 6. Thus, in this example Freq1=33.5 GHz, Freq2= 40.0 GHz (see note below). If omitted leaves the overlap unchanged (added as of A.08.50)
12	DATA marker	DATA	Corrections data begins in the next line

Lines 2 through 5 can be empty but must appear in the file. Lines 6 through 11 are optional, the lines can be left out of the file altogether.

The Overlap row and the two Bias rows apply only to external mixing. Both are read-only, they are never written by the analyzer. The only way to insert or modify these rows is to edit the file with a text editor or a spreadsheet editor. These rows are intended for use by mixer manufacturers, as they allow the manufacturer to insert data about how the mixer corrections were generated and how they should be applied. The Bias rows allow you to specify whether to turn Bias on or off when the Correction is turned on and to specify a Bias value (turning off the Correction does not change the Bias, but turning it back on again sets it to the value specified in the file). The Overlap row allows you to specify an overlap region in which two different corrections may be applied. It is expected that in the corrections data itself, there will be TWO corrections values exactly at Max Freq, otherwise Overlap is ignored. The way the overlap is processed is as follows: if at any given time the current analyzer Start Freq is greater than Freq 1 and lower than Freq 2, and the current Stop Freq is greater than Freq 2, extend the first correction point at or above Freq 2 down to Freq 1, rather than using the correction data between Freq1 and Freq2.

The Antenna Unit row can only be used in Correction register 1, because there can only be one setting for Antenna Unit at any given time. If a Correction whose Antenna Unit is set to anything but None is loaded into any Correction register but 1, an error is generated (Mass storage error; Can only load an Antenna Unit into Correction 1). When a correction file is saved from any Correction register but 1, Antenna Unit is always written as None.

Similarly, the Bias rows can only be used in Correction register 1, because there can only be one setting for Bias at any given time. If a Correction file with a Bias or Bias State row is loaded into any Correction register but 1, an error is generated: Mass storage error; Can only load Bias Settings into Correction 1

The data follows the DATA row, as comma separated X, Y pairs; one pair per line.

For example, suppose you have an Antenna to correct for on an N9020A version A.02.06 and the correction data is:

- 0 dB at 200 MHz

- 17 dB at 210 MHz
- 14.8 dB at 225 MHz

Then the file will look like:

- Amplitude Correction
- "Correction Factors for 11966E"
- "Class B Radiated"
- A.02.06,N9020A
- P13 EA3 UK6,01
- Frequency Unit,MHz
- Antenna Unit,dBuV/m
- Frequency Interpolation,Linear
- DATA
- 200.000000,0.00
- 210.000000,17.00
- 225.000000,14.80

The choices for the 1 of N fields in the metadata are as follows:

- Frequency Unit: Hz, kHz, MHz, GHz
- Antenna Unit: dBuv/m, dBuA/m, dBG, dBpT, None
- Frequency Interpolation: Logarithmic, Linear

Amplitude Correction

These keys let you choose which Correction to save. Once selected, the key returns back to the Export Data menu and the selected Correction number is annotated on the key.

The next step in the Save process is to select the Save As key in the Export Data menu.

Key Path	Save, Data, Amplitude Correction
Preset	Not part of a Preset, but is reset to Correction 1 by Restore Input/Output Defaults. Survives a shutdown.
Readback	1
Initial S/W Revision	A.02.00

Trace

Pressing this key selects Traces as the data type to be exported. Pressing this key when it is already selected brings up the Trace Menu, which allows you to select which Trace to save.

The trace file contains “meta” data which describes the current state of the analyzer. The metadata is detailed in ["Trace File Contents" on page 2746](#) below.

Key Path	Save, Data
Remote Command	:MMEMory:STORe:TRACe:DATA TRACE1 TRACE2 TRACE3 TRACE4 TRACE5 TRACE6 ALL,<filename>
Example	:MMEM:STOR:TRAC:DATA TRACE2, "myTrace2.csv" Exports the 2nd trace to the file myTrace2.csv in the current path. The default path is My Documents\SA\data\traces
Notes	If the save is initiated via SCPI, and the file already exists, the file will be overwritten. Using the C: drive is strongly discouraged, since it runs the risk of being overwritten during an instrument software upgrade. Both single and double quotes are supported for any filename parameter over SCPI.
Dependencies	For SA measurements, traces cannot be recalled from a trace file that was saved with ALL traces selected.
Couplings	When you select which trace to save, it makes that trace the current trace, so it displays on top of all of the other traces.
Readback	selected Trace
Status Bits/OPC dependencies	Sequential - waits for previous measurement to complete
Initial S/W Revision	Prior to A.02.00

Trace File Contents

A Trace Data File contains the data for one trace.

Metadata: Trace Specific

Besides the trace data, there is metadata describing the context by which the trace was produced. Some of the metadata is trace specific:

- Trace Type
- Detector
- Trace math (function, operand1, operand2, offset, reference)
- Trace name/number

When importing a trace, the detector and/or trace math function specified in the metadata is imported with the trace, so that the annotation correctly shows the detector and/or math type that was used to generate the data

Metadata: Display Specific

There is also some display-related metadata:

- Ref Level Offset
- External Gain
- X-Axis Unit
- Y-Axis Unit

Metadata: Measurement Related

The rest of the metadata is measurement specific and reflects the state of the measurement the last time the trace was updated. These are the “measurement-related instrument settings” which, if changed, cause a measurement restart.

- Number of Points
- Sweep Time
- Start Frequency
- Stop Frequency
- Average Count (actual; not the limit for the instrument)
- Average Type
- RBW
- RBW Filter Type
- RBW Filter BW Type
- VBW
- Sweep Type (FFT vs. Swept)
- Log/Lin X Scale (sometimes called Log Sweep)
- Preamp (on/off, band)
- Trigger (source, level, slope, delay)
- Phase Noise optimization setting
- Swept IF Gain
- FFT IF Gain
- AC/DC setting (RF Coupling)

- FFT Width
- External Reference setting
- Input (which input is in use)
- RF calibrator on/off
- Attenuation

Because any inactive trace can have a value that does not match the rest of the measurement, when performing a Save the metadata for each trace is pulled from the individual trace, not from the measurement.

A revision number is also included in the trace database, to allow for future changes.

The choices for the various 1 of N and binary fields are as follows:

- Average Type: Power(RMS), Voltage, LogPower(Video)
- RBW Filter Type: Flattop, EMI, Gaussian
- RBW Filter BW: 3dB, 6dB, Noise, Impulse
- Sweep Type: Swept, FFT
- PreAmp State: On, Off
- PreAmp Band: Low, Full
- Trigger Source: Free, RFBurst, Video, Line, Periodic, Ext1, Ext2, TV
- Trigger Slope: Positive, Negative
- Phase Noise Optimization: Fast, Narrow, Wide
- Swept IF Gain: Low, High
- FFT If Gain: Autorange, Low, High
- Input: RF, BBIQ
- RF Calibrator: 50M, 400G, Comb, Off
- Trace Type: ClearWrite, TraceAverage, MaxHold, MinHold
- Detector: Normal, Average, Peak, NegPeak, Sample
- Trace Math: Off, PowerDifference, PowerSum, LogOffset, LogDifference
- Y Axis Unit: dBm, dBmV, dBmA, W, V, A, dBuV, dBuA, dBuV/m, dBuA/m, dBuV, dBpT, dBG, dB

After the header, just before the trace data, a line with just the word DATA on it is inserted to flag the start of the trace data.

The following file example shows the first lines of a Trace 1 file with X Axis Unit = Hz and Y Axis Unit = dBuV, after importing into Excel (the second row contains the Title):

Trace	
"AS/NZS 1044; Conducted >1000 W, Motors, Average"	
A.01.00	E4410A
526 EA3 B25 P26 PFR	1
Segment	0
Number of Points	1001
Sweep Time	0.066266667
Start Frequency	18827440
Stop Frequency	24463718
Average Count	0
Average Type	Power(RMS)
RBW	51000
RBW Filter	Gaussian
RBW Filter BW	3dB
VBW	51000
Sweep Type	Swept
X Axis Scale	Lin
PreAmp State	Off
PreAmp Band	Low
Trigger Source	Video
Trigger Level	1.2
Trigger Slope	Positive
Trigger Delay	1.00E-06
Phase Noise Optimization	Fast
Swept IF Gain	Low
FFT IF Gain	Autorange
RF Coupling	AC
FFT Width	411900
Ext Ref	10000000
Input	RF
RF Calibrator	Off

Attenuation	10
Ref Level Offset	0
External Gain	0
Trace Type	ClearWrite
Detector	Normal
Trace Math	Off
Trace Math Oper1	Trace5
Trace Math Oper2	Trace6
Trace Math Offset	0
Trace Name	Trace1
X Axis Unit	Hz
Y Axis Unit	dBm
DATA	
1.6009301E+07	4.82047E+01
1.6018694E+07	4.69737E+01
1.6028087E+07	4.81207E+01
1.6037480E+07	4.72487E+01
1.6046873E+07	4.66437E+01
1.6056266E+07	4.66237E+01
1.6065659E+07	4.66967E+01
1.6075052E+07	4.77117E+01
1.6084445E+07	4.75787E+01
1.6093838E+07	4.83297E+01
1.6103231E+07	4.71327E+01
1.6112624E+07	4.78957E+01
1.6122017E+07	4.67507E+01
1.6131410E+07	4.81137E+01

Limit

Pressing this key selects Limit Lines as the data type to be exported. Pressing the key a second time brings up the Limit Menu that allows you to select which **Limit Line** to save.

- See ["Limits File Contents" on page 2751](#).
- See [".csv file format" on page 2751](#)
- See [".lim file format" on page 2752](#)

Key Path	Save, Data
Remote Command	:MMEMory:STORe:LIMit LLINE1 LLINE2,<filename>
Example	:MMEM:STOR:LIM LLINE2, "myLimitLine2.csv" Saves the 2nd Limit Line to the file myLimitLine2.csv in the current path. The default path is My Documents\SA\data\limits
Notes	If the save is initiated via SCPI, and the file already exists, the file will be overwritten. Using the C: drive is strongly discouraged, since it runs the risk of being overwritten during an instrument software upgrade. Both single and double quotes are supported for any filename parameter over SCPI.
Dependencies	This key will only appear if you have the proper option installed in your instrument.
Preset	1; not part of Preset, but is reset by Restore Mode Defaults and survives power cycles
State Saved	The selected Limit number is saved in instrument state.
Readback	selected Limit Line
Status Bits/OPC dependencies	Sequential - waits for previous measurement to complete
Initial S/W Revision	A.02.00

Limits File Contents

Limits may be exported into a data file with a .csv extension. They may be imported from that data file; they may also be imported from a legacy limit file with a .lim extension. The .lim files meet the specification for limit files contained in the EMI measurement guide, HP E7415A.

.csv file format

Except for information in quotes, limit line files are not case sensitive. Information in bold is required verbatim; other text is example text, and italic text is commentary which should not be present in the file.

The first five lines are system-required header lines, and must be in the correct order.

Limit	<i>Data file type name</i>
"FCC Part 15"	<i>File Description</i>
"Class B Radiated"	<i>Comment</i>
A.01.00.R0001,N9020A	<i>Instrument Version, Model Number</i>
P13 EA3 UK6 ,01	<i>Option List, File Format Version</i>

The next few lines describe the parameters; on export they will be in the order shown, on import they can be in any order. If some parameters are missing, they will revert to the default.

Type, Upper	Upper Lower
X Axis Unit, MHz	MHz S; other units should be converted; this also specifies the domain
Amplitude Unit, dBm	dBm V; all other units should be converted appropriately
Frequency Interpolation, Linear	Logarithmic Linear
Amplitude Interpolation, Logarithmic	Logarithmic Linear
X Control, Fixed	Fixed Relative; on input we consider only the first three characters
Y Control, Fixed	Fixed Relative; on input we consider only the first three characters
Margin, 0	Always in dB. A 0 margin is equivalent to margin off
X Offset, 10	Expressed in the X axis units
Y Offset, 5	Expressed in the Amplitude units

The Amplitude Unit line in the limits file may contain an antenna factor unit, for example:

Amplitude Unit=dBuV/m

Antenna factor units are dBuV/m, dBuA/m, dBpT, and dBG. In this case, the unit is treated exactly as though it were dBuV, meaning that all of the limits are interpreted to have units of dBuV. The box does NOT change Y Axis Units when such a limit is loaded in.

The X axis unit also specifies the domain (time or frequency). It is not possible to have both time-domain lines and frequency-domain lines at the same time; if a time-domain line is imported while the other lines are in the frequency domain (or vice-versa), all limit lines will be deleted prior to import.

If the sign of the margin is inappropriate for the limit type (for example a positive margin for an upper limit), the sign of the margin will be changed internally so that it is appropriate.

The remaining lines describe the data. Each line in the file represents an X-Y pair. The X values should be monotonically non-decreasing, although adjacent lines in the file can have the same X value as an aid to building a stair-stepped limit line. To specify a region over which there is no limit, use +1000 dBm for upper limits or -1000 dBm for lower limits.

The data region begins with the keyword DATA:

DATA
200.000000,-10.00
300.000000,-10.00
300.000000,-20.00
500.000000,-20.00

.lim file format

This is a legacy format which allows files saved from older analyzers to be loaded into the X-Series. Design of files in this format is not recommended.

Limit Selection

These keys let you pick which Limit Line to save. Once selected, the key returns back to the **Export Data** menu and the selected Limit Line number is annotated on the key.

The next step in the Save process is to select the Save As key in the Export Data menu.

Key Path	Save, Data, Limit Line
Notes	auto return
Preset	Not part of Preset, but is reset to LLINE1 by Restore Mode Defaults; survives shutdown
Initial S/W Revision	A.02.00

Measurement Results

Pressing this key selects Meas Results as the data type to be exported.

The Meas Results file contains information that describes the current state of the analyzer. It is detailed in "[Meas Results File Contents](#)" on page 2753 below.

Key Path	Save, Data
Remote Command	:MMEMory:STORe:RESults <string>
Example	:MMEM:STOR:RES "MeasR_0000.csv"
Notes	<p>If the save is initiated via SCPI and the file already exists, the file will be overwritten.</p> <p>The SCPI command exports Spectrum Emission Mask measurement results to the file specified as the parameter in the current path. The default path is My Documents\<current mode>\data\sem\results.<="" p=""> <p>Using the C: drive is strongly discouraged, since it runs the risk of being overwritten during an instrument software upgrade.</p> <p>The SCPI parameter is a quoted string that specifies the filename. Both single and double quotes are supported for any filename parameter over SCPI.</p> </current></p>
Dependencies	The current active measurement must be the Spectrum Emission Mask measurement to use this command.
Status Bits/OPC dependencies	Sequential – waits for the previous measurement to complete
Initial S/W Revision	Prior to A.02.00

Meas Results File Contents

A Meas Results File contains measurement results with the following information.

- File ID string, which is "MeasResult"
- Measurement ID following Mode ID, which is "SA:SEM" for example.
- Firmware rev and model number
- Option string
- Automatic Trigger Time
- Automatic Trigger Time State
- Center Frequency
- ChanIntegBW

- ChannelDetector
- ChannelDetectorState
- ChanPwrRefAuto
- ChanResBW
- ChanResBWAuto
- ChanSpan
- ChanSweepTime
- ChanSweepTimeAuto
- ChanVbwRbwRatio
- ChanVbwRbwRatioAuto
- ChanVideoBW
- ChanVideoBWAuto
- Electrical Atten
- Electrical Atten Bypass
- Electrical Atten State
- External1 Trigger Delay
- External1 Trigger Delay State
- External1 Trigger Level
- External1 Trigger Slope
- External2 Trigger Delay
- External2 Trigger Delay State
- External2 Trigger Level
- External2 Trigger Slope
- FilterAlpha
- Internal Preamp
- Internal Preamp Band
- Line Trigger Delay

- Line Trigger Delay State
- Line Trigger Slope
- Mechanical Atten
- Mechanical Atten Auto
- OffsetDetector
- OffsetDetectorState
- OffsetLimitAbsStartBTS
- OffsetLimitAbsStartMS
- OffsetLimitAbsStopBTS
- OffsetLimitAbsStopMS
- OffsetLimitFailMaskBTS
- OffsetLimitFailMaskMS
- OffsetLimitRelStartBTS
- OffsetLimitRelStartMS
- OffsetLimitRelStopBTS
- OffsetLimitRelStopMS
- OffsetMeasBWBTS
- OffsetMeasBWMS
- OffsetResolutionBWAUTOBTS
- OffsetResolutionBWAUTOMS
- OffsetResolutionBWBTS
- OffsetResolutionBWMS
- OffsetSideBTS
- OffsetSideMS
- OffsetStartFrequencyBTS
- OffsetStartFrequencyMS
- OffsetStateBTS

- OffsetStateMS
- OffsetStopFrequencyBTS
- OffsetStopFrequencyMS
- OffsetSweepTimeAutoBTS
- OffsetSweepTimeAutoMS
- OffsetSweepTimeBTS
- OffsetSweepTimeMS
- OffsetVbwRbwRatioAutoBTS
- OffsetVbwRbwRatioAutoMS
- OffsetVbwRbwRatioBTS
- OffsetVbwRbwRatioMS
- OffsetVideoBWAUTOBTS
- OffsetVideoBWAUTOMS
- OffsetVideoBW BTS
- OffsetVideoBW MS
- PeakReference
- Periodic Timer Period
- Periodic Timer Sync Source
- Periodic Timer Trigger Delay
- Periodic Timer Trigger Delay State
- PowerReference
- PSDReference
- Radio Device
- RFBurst Trigger Delay
- RFBurst Trigger Delay State
- RFBurst Trigger Level Abs
- RFBurst Trigger Level Rel

- RFBurst Trigger Level Type
- RFBurst Trigger Slope
- RrcFilter
- SemAverageNumber
- SemAverageState
- TotalAtten
- Trigger Holdoff
- Trigger Holdoff State
- TriggerSource
- Video Trigger Delay
- Video Trigger Delay State
- Video Trigger Level
- Video Trigger Slope
- ViewSelection

The file contains these data followed by MeasResult1 to MeasResult12 that flag the start of the measurement results. Each line of Measurement Results consists of twelve comma separated values from MeasResult1 value to MeasResult12 value. MeasResult1 contains the same results as MEAS/READ/FETCH:SEMask1; MeasResult2, MEAS/READ/FETCH:SEMask2; MeasResult3, MEAS/READ/FETCH:SEMask3;... (continues in the same manner)

The exported file is in CSV format, with a.csv extension. The Meas Results file, when imported into Excel, shows the following data:

MeasResult	
SA:SEM	
A.10.53	N9 03 0A
526 ALV ATP B1X B1Y B25 B40 BBA CR3 CRP DCF DDA DP2 DRD	1

EA3 EDP		
EMC EP1		
ERC ESC		
ESP EXM		
FSA LFE		
LNP MAT		
MPB NFE		
NUL P26		
PFR PNC		
RTL RTS		
S40 SB1		
SEC SM1		
TVT YAS		
YAV		

Automatic Trigger Time	0.1	
------------------------	-----	--

Automatic Trigger Time State	FA	
	LS	
	E	

Center Frequency	1.3	
	3E	
	+10	

ChanInteg BW	38	38
	40	40
	000	000

ChannelDetector	Av	
	era	
	ge	

ChannelDetectorState	TR	
	UE	

ChanPwrRefAuto	TR	
	UE	

ChanResBW	10	10
	00	00
	00	00

ChanResBWAuto	FA	FA
	LS	LS
	E	E

ChanSpan	50	50
	00	00
	000	000

ChanSweepTime	0.0	0.0
	02	02
	507	507

ChanSweepTimeAuto	TR UE	TR UE
ChanVbwRbwRatio	1	1
ChanVbwRbwRatioAuto	FA LS E	FA LS E
ChanVideoBW	10 00 00	10 00 00
ChanVideoBWAuto	TR UE	TR UE
ElectricalAtten	0	
ElectricalAttenBypass	TR UE	
ElectricalAttenState	FA LS E	
External1TriggerDelay	1.0 0E- 06	
External1TriggerDelayState	FA LS E	
External1TriggerLevel	1.2	
External1TriggerSlope	Po siti ve	
External2TriggerDelay	1.0 0E- 06	
External2TriggerDelayState	FA LS E	
External2TriggerLevel	1.2	
External2TriggerSlope	Po siti ve	

FilterAlpha	0.2					
	2					
Internal Preamp	FA					
	LS					
	E					
Internal Preamp Band	Lo					
	w					
Line Trigger Delay	1.0					
	0E-					
	06					
Line Trigger Delay State	FA					
	LS					
	E					
Line Trigger Slope	Posi					
	tive					
Mechanical Atten	10					
Mechanical Atten Auto	TR					
	UE					
OffsetDetector	Peak					
OffsetDetectorState	TR					
	UE					
OffsetLimitAbsStart BTS	-14	-14	-26	-13	-13	-13
OffsetLimitAbsStart MS	-14	-14	-26	-13	-13	-13
OffsetLimitAbsStopBTS	-14	-26	-26	-13	-13	-13
OffsetLimitAbsStop MS	-14	-26	-26	-13	-13	-13
OffsetLimitFailMask BTS	AB	AB	AB	ABSolute	AB	AB
	Solute	Solute	Solute		Solute	Solute
	ute	ute	ute		ute	ute
OffsetLimitFailMask MS	AB	AB	AB	ABSolute	AB	AB
	Solute	Solute	Solute		Solute	Solute
	ute	ute	ute		ute	ute

OffsetLimitRelStartBTS	-30	-30	-30	-30	-30	-30
OffsetLimitRelStartMS	-30	-30	-30	-30	-30	-30
OffsetLimitRelStopBTS	-30	-30	-30	-30	-30	-30
OffsetLimitRelStopMS	-30	-30	-30	-30	-30	-30
OffsetMeasureBWBTs	1	1	1	1	1	1
OffsetMeasureBWMS	1	1	1	1	1	1
OffsetResolutionBWAutoBTS	FA LS E	FA LS E	FA LS E	FALS E	FA LS E	FA LS E
OffsetResolutionBWAutoMS	FA LS E	FA LS E	FA LS E	FALS E	FA LS E	FA LS E
OffsetResolutionBWBTs	30 000	30 000	30 000	10000 00	10 00 000	10 00 000
OffsetResolutionBWMS	30 000	30 000	30 000	10000 00	10 00 000	10 00 000
OffsetSideBTS	Bot h	Bot h	Bot h	Both	Bot h	Bot h
OffsetSideMS	Bot h	Bot h	Bot h	Both	Bot h	Bot h
OffsetStartFrequencyBTS	25 15 000	27 15 000	35 15 000	40000 00	80 00 000	12 50 00 00
OffsetStartFrequencyMS	25 15 000	27 15 000	35 15 000	40000 00	80 00 000	12 50 00 00
OffsetStateBTS	TR UE	TR UE	TR UE	TRUE	TR UE	FA LS E
OffsetStateMS	TR UE	TR UE	TR UE	TRUE	TR UE	FA LS E

OffsetStop	27	35	40	80000	12	15
Frequency	15	15	00	00	50	00
BTS	000	000	000		00	00
					00	00
OffsetStop	27	35	40	80000	12	15
Frequency	15	15	00	00	50	00
MS	000	000	000		00	00
					00	00
OffsetSweepTimeAutoBTS	TR	TR	TR	TRUE	TR	TR
	UE	UE	UE		UE	UE
OffsetSweepTimeAutoMS	TR	TR	TR	TRUE	TR	TR
	UE	UE	UE		UE	UE
OffsetSweepTimeBTS	0.0	0.0	0.0	0.002	0.0	0.0
	17	69	42	053	02	01
	333	32	027		253	253
OffsetSweepTimeMS	0.0	0.0	0.0	0.002	0.0	0.0
	17	69	42	053	02	01
	333	32	027		253	253
OffsetVbwRbwRatioAutoBTS	FA	FA	FA	FALSE	FA	FA
	LS	LS	LS		LS	LS
	E	E	E		E	E
OffsetVbwRbwRatioAutoMS	FA	FA	FA	FALSE	FA	FA
	LS	LS	LS		LS	LS
	E	E	E		E	E
OffsetVbwRbwRatioBTS	0.0	0.0	0.0	0.01	0.0	0.0
	1	1	1		1	1
OffsetVbwRbwRatioMS	0.0	0.0	0.0	0.01	0.0	0.0
	1	1	1		1	1
OffsetVideoBWAutoBTS	TR	TR	TR	TRUE	TR	TR
	UE	UE	UE		UE	UE
OffsetVideoBWAutoMS	TR	TR	TR	TRUE	TR	TR
	UE	UE	UE		UE	UE
OffsetVideoBWAutoBTS	300	300	300	10000	10	10
					000	000
OffsetVideoBWAutoMS	300	300	300	10000	10	10
					000	000
PeakReference	-					
	82.					
	99					

	57
Periodic Timer Period	0.0 2
Periodic Timer Sync Source	No ne
Periodic Timer Trigger Delay	1.0 0E- 06
Periodic Timer Trigger Delay State	FA LS E
PowerRefer ence	- 73. 69 66
PSDRefer ence	- 13 9.5 4
Radio Device	Bts
RFBurst Trigger Delay	1.0 0E- 06
RFBurst Trigger Delay State	FA LS E
RFBurst Trigger Level Abs	-20
RFBurst Trigger Level Rel	-6
RFBurst Trigger Level Type	Ab sol ute
RFBurst Trigger Slope	Po siti ve

RrcFilter	FA LS E											
SemAverageNumber	10											
SemAverageState	FA LS E											
TotalAtten	10											
TriggerHoldoff	0.1											
TriggerHoldoffState	FA LS E											
TriggerSource	Free											
VideoTriggerDelay	1.0 0E- 06											
VideoTriggerDelayState	FA LS E											
VideoTriggerLevel	-25											
VideoTriggerSlope	Positive											
VideoSelection	AbsPwrFreq											
MeasResult1	MeasResult2	MeasResult3	MeasResult4	MeasResult5	MeasResult6	MeasResult7	MeasResult8	MeasResult9	MeasResult10	MeasResult11	MeasResult12	
-999	-78.89359	-13	999	-73.6966334099879	-999	-999	-999	-999	-999	-999	-999	-999
-	-	-13	999	-999	-	-	-	-	-	-	-	-

73.696633	78.	999	999	999	999	999	999
4099879	95						
	235						

Save As . . .

When you press “Save As”, the analyzer brings up a Windows dialog and a menu entitled “**Save As.**” This menu allows you to navigate to the various fields in the Windows dialog without using a keyboard or mouse. The **Tab** and **Arrow** keys can also be used for dialog navigation.

See "[To File . . .](#)" on page 3202 in **Save, State** for a full description of this dialog and menu.

The default path for saving files is:

For all of the Trace Data Files:

- My Documents\<<mode name>\data\traces

For all of the Limit Data Files:

- My Documents\<<mode name>\data\limits

For all of the Measurement Results Data Files:

- My Documents\<<mode name>\data\<<measurement name>\results

For all of the Capture Buffer Data Files:

- My Documents\<<mode name>\data\captureBuffer

Key Path	Save, Data
Mode	All
Notes	The key location is mode-dependent and will vary. Brings up the Save As dialog for saving a <mode specific> Save Type. The save is performed immediately and does not wait until the measurement is complete.
Initial S/W Revision	Prior to A.02.00

Screen Image

Pressing Screen Image accesses a menu of functions that enable you to specify a format and location for the saved screen image. It brings up a menu that allows you to specify the color scheme of the Screen Image (Themes) or navigate to the Save As dialog to perform the actual save.

Screen Image files contain an exact representation of the analyzer display. They cannot be loaded back onto the analyzer, but they can be loaded into your PC for use in many popular applications.

The image to be saved is actually captured when the **Save** front panel key is pressed, and kept in temporary storage to be used if you ask for a Screen Image

save. When the Screen Image key is pressed, a "thumbnail" of the captured image is displayed, as shown below:

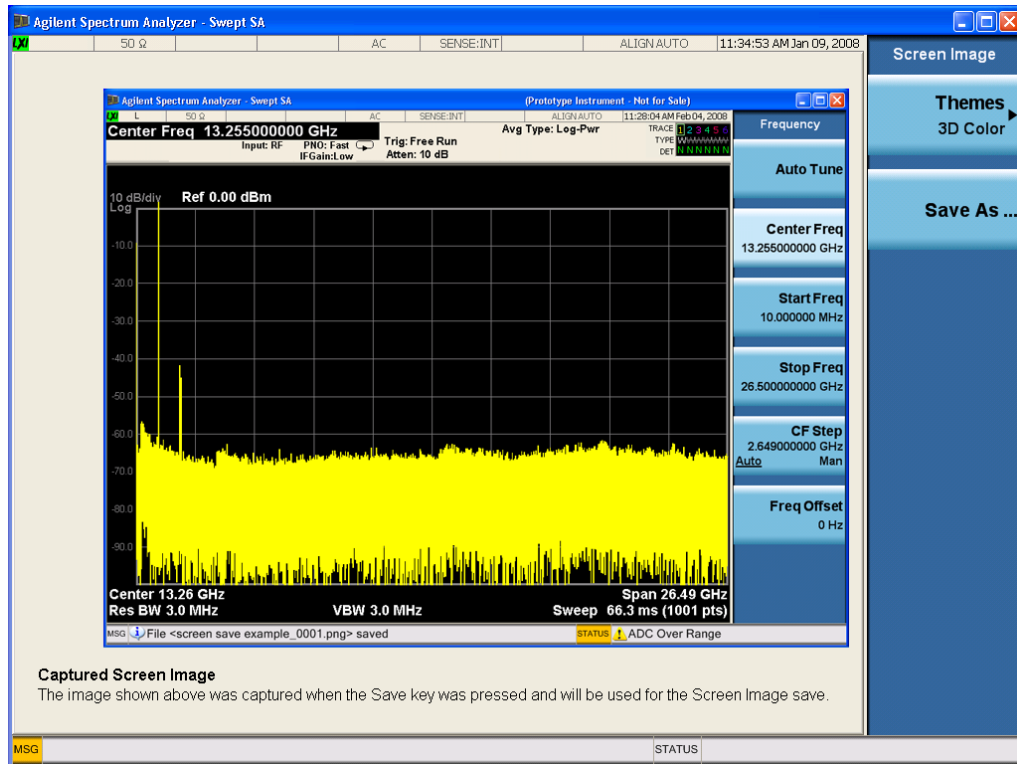

When you continue on into the **Save As** menu and complete the Screen Image save, the image depicted in the thumbnail is the one that gets saved, showing the menus that were on the screen before going into the **Save** menus. The save is performed immediately and does not wait until the measurement is complete.

After you have completed the save, the **Quick Save** front-panel key lets you quickly repeat the last save performed, using an auto-named file, with the current screen data.

NOTE

For versions previous to A.01.55, if you initiate a screen image save by navigating through the Save menus, the image that is saved will contain the Save menu softkeys, not the menus and the active function that were on the screen when you first pressed the Save front panel key.

Key Path	Save
Mode	All
Remote Command	:MMEMory:STORe:SCReen <filename>
Example	:MMEM:STOR:SCR "myScreen.png" This stores the current screen image in the file MyScreenFile.png in the default directory.
Backwards Compatibility SCPI	HCOPy:SDUMp:DATA? returns the screen image in a <DEFINITE LENGTH ARBITRARY RESPONSE DATA> element. The response data is IEEE Block format; the controlling computer can strip the header and store the

	result as a .png file.
Initial S/W Revision	Prior to A.02.00

Themes

Accesses a menu of functions that enable you to choose the theme to be used when saving the screen image.

The **Themes** option is the same as the **Themes** option under the **Display** and **Page Setup** dialogs. It allows you to choose between themes to be used when saving the screen image.

Key Path	Save, Screen Image
Remote Command	:MMEMory:STORe:SCReen:THEMe TDColor TDMonochrome FCOLOR FMONochrome :MMEMory:STORe:SCReen:THEMe?
Example	:MMEM:STOR:SCR:THEM TDM
Preset	3D Color; Is not part of Preset, but is reset by Restore Misc Defaults or Restore System Defaults All and survives subsequent running of the modes.
Readback	3D Color 3D Mono Flat Color Flat Mono
Backwards Compatibility Notes	In ESA and PSA we offer the choice of "Reverse Bitmap" or "Reverse Metafile" when saving screen images. This is much like the "Flat Color" theme available in X-Series. Also, if you selected Reverse Bitmap AND a black & white screen image, that would be much like "Flat Monochrome". In other words, each of the X-Series themes has a similar screen image type in ESA/PSA. But they are not identical.
Initial S/W Revision	Prior to A.02.00

3D Color

Selects a standard color theme with each object filled, shaded and colored as designed.

Key Path	Save, Screen Image, Themes
Example	MMEM:STOR:SCR:THEM TDC
Readback	3D Color
Initial S/W Revision	Prior to A.02.00

3D Monochrome

Selects a format that is like 3D color but shades of gray are used instead of colors.

Key Path	Save, Screen Image, Themes
Example	MMEM:STOR:SCR:THEM TDM
Readback	3D Mono
Initial S/W Revision	Prior to A.02.00

Flat Color

Selects a format that is best when the screen is to be printed on an ink printer.

Key Path	Save, Screen Image, Themes
Example	MMEM:STOR:SCR:THEM FCOL
Readback	Flat Color
Initial S/W Revision	Prior to A.02.00

Flat Monochrome

Selects a format that is like Flat Color. But only black is used (no colors, not even gray), and no fill.

Key Path	Save, Screen Image, Themes
Example	MMEM:STOR:SCR:THEM FMON
Readback	Flat Mono
Initial S/W Revision	Prior to A.02.00

Save As...

When you press “Save As”, the analyzer brings up a Windows dialog and a menu entitled “**Save As.**” This menu allows you to navigate to the various fields in the Windows dialog without using a keyboard or mouse. The **Tab** and **Arrow** keys can also be used for dialog navigation.

See "[To File . . .](#)" on page 3202 in **Save, State** for a full description of this dialog and menu.

The default path for Screen Images is

– My Documents\`<mode name>`\screen.

where `<mode name>` is the parameter used to select the mode with the INST:SEL command (for example, SA for the Spectrum Analyzer).

Key Path	Save, Screen Image
Notes	Brings up Save As dialog for saving a Screen Image Save Type
Initial S/W Revision	Prior to A.02.00

Mass Storage Catalog (Remote Command Only)

Key path	SCPI Only
Remote Command	:MMEMory:CATalog? [<directory_name>]
Notes	The string must be a valid logical path. Queries disk usage information (drive capacity, free space available) and obtains a list of files and directories in a specified directory in the following format:

<numeric_value>, <numeric_value>, {<file_entry>}

It returns two numeric parameters and as many strings as there are files and directories. The first parameter indicates the total amount of storage currently used in bytes. The second parameter indicates the total amount of storage available, also in bytes. The <file_entry> is a string. Each <file_entry> indicates the name, type, and size of one file in the directory list:

<file_name>, <file_type>, <file_size>

As the windows file system has an extension that indicates file type, <file_type> is always empty. <file_size> provides the size of the file in bytes. For directories, <file_entry> is surrounded by square brackets and both <file_type> and <file_size> are empty

Initial S/W Revision Prior to A.02.00

Mass Storage Change Directory (Remote Command Only)

Key path **SCPI Only**

Remote Command :MMEMory:CDIRectory [<directory_name>]
 :MMEMory:CDIRectory?

Notes The string must be a valid logical path.

Changes the default directory for a mass memory file system. The <directory_name> parameter is a string. If no parameter is specified, the directory is set to the *RST value.

At *RST, this value is set to the default user data storage area, that is defined as System.Environment.SpecialFolder.Personal.

Query returns full path of the default directory.

Initial S/W Revision Prior to A.02.00

Mass Storage Copy (Remote Command Only)

Key path **SCPI Only**

Remote Command :MMEMory:COpy <string>, <string>[, <string>, <string>]

Notes The string must be a valid logical path.

Copies an existing file to a new file or an existing directory to a new directory.

Two forms of parameters are allowed. The first form has two parameters. In this form, the first parameter specifies the source, and the second parameter specifies the destination.

The second form has four parameters. In this form, the first and third parameters specify the source. The second and fourth parameters specify the directories. The first pair of parameters specifies the source. The second pair specifies the destination. An error is generated if the source doesn't exist or the destination file already exists.

This command will generate an "access denied" error if the destination is a restricted folder (e.g., C:\Windows) and the current user does not have Power User or Administrator privileges.

Mass Storage Device Copy (Remote Command Only)

This command transfers data to/from a file and a peripheral device.

Key path **SCPI Only**

Remote Command :MMEMory:COpy:DEvice <source_string>, <dest_string>

Notes	<p>The strings must be a valid logical path or a valid device keyword. If the dest_string is a device keyword, the data is copied from the source file to the device. If the source_string is a device keyword, the data is copied to the source file from the device.</p> <p>Valid device keywords are:</p> <p>SNS (smart noise source)</p> <p>An error is generated if the file or device is not found.</p>
-------	---

Mass Storage Delete (Remote Command Only)

Key path	SCPI Only
Remote Command	:MMEMory:DELeTe <file_name>[,<directory_name>]
Notes	<p>The string must be a valid logical path.</p> <p>Removes a file from the specified directory. The <file_name> parameter specifies the file name to be removed. This command will generate an “access denied” error if the file is in a restricted folder (e.g., C:\Windows) and the current user does not have Power User or Administrator privileges.</p>
Initial S/W Revision	Prior to A.02.00

Mass Storage Data (Remote Command Only)

Creates a file containing the specified data OR queries the data from an existing file.

Key path	SCPI Only
Remote Command	:MMEMory:DATA <file_name>, <data> :MMEMory:DATA? <file_name>
Notes	<p>The string must be a valid logical path.</p> <p>The command form is MMEMory:DATA <file_name>,<data>. It loads <data> into the file <file_name>. <data> is in 488.2 block format. <file_name> is string data.</p> <p>The query form is MMEMory:DATA? <file_name> with the response being the associated <data> in block format.</p>
Initial S/W Revision	Prior to A.02.00

Mass Storage Make Directory (Remote Command Only)

Key path	SCPI Only
Remote Command	:MMEMory:MDIRectory <directory_name>
Notes	<p>The string must be a valid logical path.</p> <p>Creates a new directory. The <directory_name> parameter specifies the name to be created. This command will generate an “access denied” error if the new directory would be in a restricted folder (e.g., C:\Windows) and the current user does not have Power User or Administrator privileges.</p>
Initial S/W Revision	Prior to A.02.00

Mass Storage Move (Remote Command Only)

Key path	SCPI Only
Remote Command	:MMEMory:MOVE <string>,<string>[,<string>,<string>]
Notes	<p>The string must be a valid logical path.</p> <p>Moves an existing file to a new file or an existing directory to a new directory.</p> <p>Two forms of parameters are allowed. The first form has two parameters. In this form, the first parameter specifies the source, and the second parameter specifies the destination.</p> <p>The second form has four parameters. In this form, the first and third parameters specify the source. The second and fourth parameters specify the directories. The first pair of parameters specifies the source. The second pair specifies the destination. An error is generated if the source doesn't exist or the destination file already exists.</p> <p>This command will generate an "access denied" error if the destination is a restricted folder (e.g., C:\Windows) and the current user does not have Power User or Administrator privileges.</p>
Initial S/W Revision	Prior to A.02.00

Mass Storage Remove Directory (Remote Command Only)

Key path	SCPI Only
Remote Command	:MMEMory:RDIRECTory <directory_name>
Notes	<p>The string must be a valid logical path.</p> <p>Removes a directory. The <directory_name> parameter specifies the directory name to be removed. All files and directories under the specified directory shall also be removed.</p> <p>This command will generate an "access denied" error if the folder is a restricted folder (e.g., C:\Windows) or is in a restricted folder and the current user does not have Power User or Administrator privileges.</p>
Initial S/W Revision	Prior to A.02.00

Mass Storage Determine Removable Media (Remote Command Only)

This command is used to determine if any removable media devices are connected to the instrument. Primarily, these are USB memory devices plugged-in to the front panel or rear panel USB ports. On instruments with PC6 or PC7 CPU's, one SD card slot is available for removable media. The instrument's primary disk drive is not a removable media device.

Key Path	SCPI Only
Remote Command	:MMEMory:RMEDIA:LIST?
Notes	<p>The return value is a string containing a list of partition identifiers that are removable media devices. Each identifier is separated by a comma. If no removable media is present, an empty string is returned.</p> <p>Examples:</p> <ul style="list-style-type: none"> - One removable device present results in a return string of "F:".

- Two removable devices present results in a return string of "F:,G:".
- No removable devices present results in a return string of "".

Initial S/W Revision x.15.00

Mass Storage Determine Removable Media Label (Remote Command Only)

This command is used to set or query a removable media device's label.

Key Path	SCPI Only
Remote Command	:MMEMory:RMEDia:LABel <partition>,<string> :MMEMory:RMEDia:LABel? <partition>
Example	MMEM:RMED:LAB "F:","My Device"
Notes	If the <partition> specified does not exist or is not a removable media device, the error - 252,"Missing Media" is generated. Setting the removable media label requires Administrative privileges. If the currently logged in user does not have appropriate privileges the error "-221.9900,Settings conflict;Administrator privileges required" is generated.
Initial S/W Revision	x.15.00

Mass Storage Determine Removable Media Write-protect status (Remote Command Only)

This command is used to query a removable media device's write-protect status.

Key Path	SCPI Only
Remote Command	:MMEMory:RMEDia:WPRotect? <partition>
Example	MMEM:RMED:WPR? "F:"
Notes	The return value is 1 if the device is write-protected, or 0 if the device is write-enabled. If the <partition> specified does not exist or is not a removable media device the error - 252,"Missing Media" is generated.
Preset	The return value will be depending on SD card installed.
Initial S/W Revision	x.15.00

Mass Storage Determine Removable Media size (Remote Command Only)

This command is used to query a removable media device's total memory size (not available memory size).

Key Path	SCPI Only
Remote Command	:MMEMory:RMEDia:SIZE? <partition>

Example	MMEM:RMED:SIZE? "F:"
Notes	The return value is integer value in GBytes. Any device that is less than 1 GB returns 0 GB. If the <partition> specified does not exist or is not a removable media device, the error - 252, "Missing Media" is generated.
Initial S/W Revision	x.15.00

:SYSTem:SET (Remote Command Only)

Remote command that allows the user to obtain the state of the currently active mode in a form that can then be loaded back into the instrument quickly.

Remote Command	SYSTem:SET <instrument state in IEEE Block> SYSTem:SET?
Notes	SYST:SET? returns current instrument state of the active mode in IEEE Block data format. The state is in a machine readable format only. Sending the query returns the following format: <syst set preamble><state block data> Where: <syst set preamble> is the format: #NMMM N=number of digits that comprise MMM MMM=length in bytes of following data <state block data> is machine readable state data Example response: #42016<state data> The state is recalled by sending the SYST:SET? Response data to the instrument. From example above: SYST:SET #42016<state data>
Initial S/W Revision	x.17.00

Single (Single Measurement/Sweep)

Sets the analyzer for Single measurement operation. The single/continuous state is Meas Global, so the setting will affect all the measurements. If you are Paused, pressing **Single** does a Resume.

See "[More Information](#)" on page 2774

Key Path	Front-panel key
Example	:INIT:CONT OFF
Notes	See Cont key description.
Backwards Compatibility Notes	<p>For Spectrum Analysis mode in ESA and PSA, the Single hardkey and the INITiate:IMM switched from continuous measurement to single measurement and restarted sweeps and averages (displayed average count reset to 1), but did not restart Max Hold and Min Hold. In the X-Series, the Single hardkey and the INITiate:IMM command initiate a sweep/ measurement/ average sequence/hold sequence including MaxHold and MinHold.</p> <p>For Spectrum Analysis mode in ESA and PSA, the Single hardkey restarted the sweep regardless of whether or not you were in an active sweep or sweep sequence. In the X-Series, Restart does this but Single only restarts the sweep or sweep sequence if you are in the idle state.</p> <p>INIT[:IMM] in ESA & PSA Spectrum Analysis Mode does an implied ABORT. In some other PSA Modes, INIT[:IMM] is ignored if not in the idle state. . The X-Series follows the ESA/PSA SA Mode model, which may cause some Modes to have compatibility problems.</p>
Initial S/W Revision	Prior to A.02.00

More Information

See "[Restart](#)" on page 3199 for details on the INIT:IMMEDIATE (Restart) function.

If you are already in single sweep, the INIT:CONT OFF command has no effect.

If you are already in Single Sweep, then pressing the **Single** key in the middle of a sweep does not restart the sweep or sequence. Similarly, pressing the **Single** key does not restart the sweep or sequence if the sweep is not in the idle state (for example, if you are taking a very slow sweep, or the analyzer is waiting for a trigger). Instead, it results in a message. "Already in Single, press Restart to initiate a new sweep or sequence". Even though pressing the **Single** key in the middle of a sweep does not restart the sweep, sending INIT:IMMEDIATE does reset it.

To take one more sweep without resetting the average count, increment the average count by 1, by pressing the step up key while **Average/Hold Number** is the active function, or sending the remote command CALC:AVER:TCON UP.

Source

The Source key accesses menus for controlling a Source in Tracking Source mode

Key Path	Front-panel key
Dependencies	<p>Operation with a source requires a license. If the proper license is not installed, the following occurs:</p> <ul style="list-style-type: none"> - When the Source key is pressed the user sees an informational message, "Option not installed" - If any SCPI command in the :SOURce subsystem is sent it generates a message, "Settings conflict;option not installed"
Initial S/W Revision	A.06.01

NOTE

Option T03 or T06 is required for the Tracking Generator function in CXA. Option T03, T07, T13 or T26 is required for the Tracking Generator function in CXA-m.

When using the CXA-m Tracking Generator, if the Source Frequency is in the frequency range of the below table, and the Source Amplitude is in the corresponding amplitude range of the below table, a warning status message is generated, +313 "Source Uncal". This is also true if Power Sweep is on and any amplitude in the Power Sweep (as calculated by Amplitude, Power Sweep, and Amptd Offset) is in that range.

CXA-m TG Un-calibrated Amplitude Range

Frequency Range	Amplitude Range
$2 \text{ MHz} \leq \text{frequency} < 10 \text{ GHz}$	$-40 \text{ dBm} \leq \text{amplitude} < -35 \text{ dBm}$
$10 \text{ GHz} \leq \text{frequency} < 20 \text{ GHz}$	$-40 \text{ dBm} \leq \text{amplitude} < -35 \text{ dBm}$ or $-5 \text{ dBm} < \text{amplitude} \leq 0 \text{ dBm}$
$20 \text{ GHz} \leq \text{frequency} \leq 26.55 \text{ GHz}$	$-12 \text{ dBm} < \text{amplitude} \leq 0 \text{ dBm}$

RF Output

Allows you to turn the source RF Power on or off.

NOTE

When the RF Output is turned on, the Source Mode is set to Tracking. See the Source Mode key description for special considerations concerning how to configure your N5172B or N5182B source for use with External Source Control.

Key Path	Source
Scope	Meas Global
Remote Command	:OUTPut[:EXTerna1] [:STATe] ON OFF 1 0 :OUTPut[:EXTerna1] [:STATe]?

Example	:OUTP ON :OUTP?
Dependencies	Grayed out in measurements that do not support a source. If you go to such a measurement the output will be forced to Off. Grayed out if there is no valid source selection, in this case go to the Select Source menu to choose, configure and/or verify your source When there is no available Source Mode (other than Off), due to other couplings, then the RF Output key is grayed out.
Couplings	When RF Output is turned On, Source Mode is set to Tracking When Source Mode is turned Off, RF Output is turned Off. When Source Mode is turned Off (or forced to Off by another coupling), RF Output is turned Off. Turning RF Output Off does not affect Source Mode or other settings.
Preset	OFF (on either a Mode Preset, a Source Preset, or Restore Input/Output Defaults)
State Saved	Part of the Input/Output system, which means it is Loaded and Saved with state.
Range	On Off
Initial S/W Revision	A.06.01
Modified at S/W Revision	A.10.01

Amplitude

Allows you to access the Amplitude sub-menu to control various amplitude parameters of the Source. The resolution of the Source amplitude parameters is coupled to match the minimum resolution of the source when the source is acquired. When the source is released, the amplitude parameter resolution reverts to default values.

Key Path	Source
Readback	In square brackets, the amplitude value from Amplitude key in the next menu level down
Initial S/W Revision	A.06.01

Amplitude

Allows you to adjust the power level of the selected source. Note that the actual amplitude is also affected by the Amplitude Offset and Power Sweep parameters.

Key Path	Source, Amplitude
Scope	Mode Global
Remote Command	:SOURce[:EXTeRnal]:POWer[:LEVe1][:IMMeDiate][:AMPLitude] <amp1> :SOURce[:EXTeRnal]:POWer[:LEVe1][:IMMeDiate][:AMPLitude]?
Example	:OUTP ON :SOUR:POW -10dBm
Dependencies	If the requested setting of Source Amplitude causes the calculated external source start or stop

	Amplitude to exceed the external source capability, a warning status message is generated, "Data out of Range; clipped to source max/min" The "Show Source Capabilities and Settings" menu can then be examined to check the source capabilities. This parameter test and clip is also performed at source acquisition.
Preset	-10.00 dBm (On Source Preset and Restore Input/Output Defaults) Not affected by Mode Preset
State Saved	Part of the Input/Output system, which means it is Loaded and Saved with state.
Min	The range of the amplitude parameter is dependent on the amplitude range of the source that is selected, and the settings of Amplitude Offset and Power Sweep.
Max	The range of the amplitude parameter is dependent on the amplitude range of the source that is selected, and the settings of Amplitude Offset and Power Sweep.
Backwards Compatibility SCPI	:SOURce:POWer:STARt <amp1> :SOURce:POWer:STARt? This alias is for the ESA tracking generator. It specifies the source output power level at the start of the power sweep, just as does :SOURce:POWer.
Initial S/W Revision	A.06.01
Modified at S/W Revision	A.10.01

Power Sweep

Allows you to set up a Power Sweep. Power Sweep is useful for measuring saturation behavior in a test device, such as a power amplifier.

Pressing the key sets the power-sweep function to On or Off. The value of the power-sweep range is displayed in the active function block, and can be adjusted, when set to On.

The source will sweep the power between the start power defined by the Amplitude function and the stop power = start power + power sweep value:

Source (start) amplitude = Amplitude – Amplitude Offset

Source (stop) amplitude = Amplitude – Amplitude Offset + Power Sweep

In Stepped Tracking, such as is used with an external source or the CXA-m TG, the analyzer controls the source with step sweep mode, which provides a linear progression from one selected frequency, amplitude, or both, to another, pausing at linearly spaced points (steps) along the sweep. The analyzer continues to sweep the specified frequency range when power sweep is on, although generally Power Sweep is performed in Zero Span.

With CXA options T03, T06, the hardware is capable of continuous power sweeps. This makes it possible to use the swept sweep time rules and should be employed for faster sweeps. Care should be taken to limit the sweep time you use as there are no sweep time couplings to Power Sweep settings. The recommended minimum sweep time depends on the RBW and power-sweep range. Start by computing $(1.28/RBW) * (abs(startPower - stopPower)/(5 \text{ dB}))$. The recommended minimum sweep time is the larger of this value and 50 ms.

Some external Sources have mechanical attenuators, which are not used in Power Sweep in order to save wear on the attenuators. To allow an acceptable range of Power Sweep without changing the mechanical attenuation, the Sources are put in a mode that allows the Source to handle a wide amplitude range without switching the attenuators. When the Power Sweep settings put the Source in an amplitude range that requires the mechanical attenuators, the analyzer displays a condition warning message:

Settings Alert;Src pwr ramp>ALC range

Key Path	Source, Amplitude
Mode	SA
Scope	Mode Global
Remote Command	:SOURce:POWer:SWEEp <rel_amp1> :SOURce:POWer:SWEEp? :SOURce:POWer:SWEEp:STATe ON OFF 1 0 :SOURce:POWer:SWEEp:STATe?
Example	:SOUR:POW -5 :SOUR:POW:SWE:STAT ON :SOUR:POW:SWE 10 Set source start power to - 5 dBm and stop power + 5dBm (-5 + 10).
Example	:SOUR:POW:SWE:STAT ON
Dependencies	If the requested setting of Power Sweep causes the calculated external source start or stop Amplitude to exceed the external source capability, a warning status message is generated, "Data out of Range; clipped to source max/min". The Show Source Capabilities and Settings menu can then be examined to check the source capabilities. This parameter test and clip is also performed at source acquisition.
Preset	This is unaffected by "Mode Preset" but is set to 0dB on a "Source Preset" or "Restore Input/Output Defaults".
State Saved	Part of the Input/Output system, which means it is Loaded and Saved with state.
Min	-500 dB
Max	+500 dB
Backwards Compatibility SCPI	:SOURce[:EXTErnal][:SWEEp]:POWer:SPAN <rel_amp1> :SOURce[:EXTErnal][:SWEEp]:POWer:SPAN? This alias is for the ESA tracking generator and PSA option 215. It specifies the range of power levels through which the source output will sweep just as does :SOURce:POWer:SWEEp.
Initial S/W Revision	A.06.01
Remote Command	:SOURce[:EXTErnal]:POWer:MODE FIXEd SWEEp :SOURce[:EXTErnal]:POWer:MODE?
Notes	The ESA tracking generator and the PSA option 215 support this SCPI command. It sets the source output to be at a single amplitude (fixed) or to sweep through a range of power levels

	SOURce:POWer:MODE FIXed is equivalent to :SOURce:POWer:SWEEp:STATe OFF
	SOURce:POWer:MODE SWEEp is equivalent to :SOURce:POWer:SWEEp:STATe ON
Preset	This is unaffected by "Mode Preset" but is set to FIXed on a "Source Preset" or "Restore Input/Output Defaults".
Initial S/W Revision	A.06.01
Modified at S/W Revision	A.10.01

Amptd Offset

Offsets the displayed power of the source in the Amplitude parameter. Using the amplitude offset allows you to take into account any system losses or gains (for example, due to cable loss), thereby displaying the actual power delivered to the device under test. See the equations under the Source, Amplitude, Power Sweep key.

Key Path	Source, Amplitude
Mode	SA
Scope	Mode Global
Remote Command	:SOURce:CORRection:OFFSet <rel_ampl> :SOURce:CORRection:OFFSet?
Example	:SOUR:CORR:OFFS 5 Sets the displayed source offset power to 5 dB.
Dependencies	If the requested setting of Amptd Offset causes the calculated external source start or stop Amplitude to exceed the external source capability, a warning status message is generated, "Data out of Range; clipped to source max/min". The Show Source Capabilities and Settings menu can then be examined to check the source capabilities. This parameter test and clip is also performed at source acquisition.
Preset	This is unaffected by Mode Preset but is set to 0.00dBm on a Source Preset or Restore Input/Output Defaults.
State Saved	Part of the Input/Output system, which means it is Loaded and Saved with state.
Min	-1000 dB
Max	+1000 dB
Initial S/W Revision	A.06.01

Amptd Step Auto/Man

Allows you to set the step size associated with the Source Amplitude key. When auto-coupled, the step size is the current Scale/Div setting under the Amplitude hardkey (note that this is true even if the analyzer is currently in Linear amplitude scale).

Once a step size has been selected and the Source Amplitude function is active, the step keys (and the UP|DOWN parameters for Source Amplitude from remote commands) change the Source Amplitude by the step-size value.

You may change the step size manually by pressing Amptd Step and entering a value. The function (and the step size) will return to Auto when a Mode Preset or Auto Couple is performed.

Key Path	Source, Amplitude
Scope	Mode Global
Remote Command	:SOURce:POWer:STEP[:INCRement] <ampl> :SOURce:POWer:STEP[:INCRement]? :SOURce:POWer:STEP:AUTO OFF ON 0 1 :SOURce:POWer:STEP:AUTO?
Example	:SOUR:POW:STEP 0.1 Set amplitude step to 0.1 dB :SOUR:POW:STEP:AUTO ON
Couplings	In Auto, coupled to the size of one logarithmic vertical graticule division
Preset	Auto
State Saved	Part of the Input/Output system, which means it is Loaded and Saved with state.
Min	0.1 dB
Max	20 dB
Initial S/W Revision	A.06.01

Frequency

Allows a you to access the Frequency sub-menu. This menu lets you use a stepped tracking source for stimulus/response measurements for some added flexibility. Because with such a source, the source frequency does not need to track 1:1 with the analyzer LO frequency, it is possible to measure scalar harmonic and subharmonic responses of devices. For example, the second harmonic response is measured by stepping the analyzer and source so that the analyzer is always at twice the source frequency. In addition, the frequency offset capability allows the measurement of frequency conversion devices (like mixers).

In tracking mode, the source frequency tracks the analyzer frequency according to the source frequency equation:

$$\text{Source Frequency} = (\text{Analyzer Frequency} * \text{Multiplier Numerator} / \text{Multiplier Denominator}) + \text{Source Frequency Offset}$$

NOTE

Analyzer Frequency is the frequency to which the analyzer is set, which is the analyzer's displayed frequency, offset by any Freq Offset set under the Frequency hardkey. Source Frequency Offset is the value set under **Source, Frequency, Freq Offset.**

Key Path	Source
----------	---------------

Readback	none in Tracking Source mode
Initial S/W Revision	A.06.01

Multiplier Numerator

The multiplier numerator parameter offsets the source frequency from the analyzer frequency. The source frequency tracks the SA frequency according to the source frequency equation shown under the **Source, Frequency** key description.

The multiplier numerator must be restricted to operate within the range of the source minimum and maximum frequencies.

Key Path	Source, Frequency
Mode	SA
Scope	Mode Global
Remote Command	:SOURCE:FREQUENCY[:MULTIPLIER]:NUMERATOR <integer> :SOURCE:FREQUENCY[:MULTIPLIER]:NUMERATOR?
Example	:SOUR:FREQ:NUM 3 Sets the source frequency multiplier numerator to 3.
Dependencies	If the currently selected source does not support this capability (for example, an internal Tracking Generator which must track the LO), this key is forced to its Preset value and grayed out
Preset	This is unaffected by Mode Preset but is set to 1 on a Source Preset or Restore Input/Output Defaults.
State Saved	Part of the Input/Output system, which means it is Loaded and Saved with state.
Min	1
Max	1000
Initial S/W Revision	A.06.01

Multiplier Denominator

The multiplier denominator parameter offsets the source frequency from the analyzer frequency. The source frequency tracks the SA frequency according to the source frequency equation shown under the **Source, Frequency** key description.

The multiplier denominator must be restricted to operate within the range of the source minimum and maximum frequencies.

Key Path	Source, Frequency
Mode	SA
Scope	Mode Global
Remote Command	:SOURCE:FREQUENCY[:MULTIPLIER]:DENOMINATOR <integer> :SOURCE:FREQUENCY[:MULTIPLIER]:DENOMINATOR?
Example	:SOUR:FREQ:DEN 3 Sets the source frequency multiplier denominator to 3
Dependencies	If the currently selected source does not support this capability (for example, an internal Tracking

	Generator which must track the LO), this key is forced to its Preset value and grayed out
Preset	This is unaffected by Mode Preset but is set to 1 on a Source Preset or Restore Input/Output Defaults.
State Saved	Part of the Input/Output system, which means it is Loaded and Saved with state
Min	1
Max	1000
Initial S/W Revision	A.06.01

Source Sweep Reverse

Allows you to reverse the source sweep direction

Normally, the source will sweep from a lower frequency to a higher frequency. However, there are test scenarios in which the source sweep needs to be “reversed”. In this case, it sweeps from a higher frequency to a lower frequency. For example, when the DUT is a frequency converter and a measurement of the Lower Side Band characteristics is desired, a reverse sweep is employed. Reverse sweeps are supported for such scenarios, but two cautions are in order:

4. Reverse Sweep only reverses the direction of the source’s sweep, not the analyzer’s sweep. Unless you are actually using a device like a frequency converter and looking at the lower sideband, thus effectively reversing the direction of the source’s sweep, the source will be sweeping in the opposite direction from the analyzer, and it will not be possible track the desired device output frequency.
5. Any time you are using a frequency converter, care must be taken in setting up all of the sweep parameters, including analyzer start/stop frequency and source multiplier, to make sure that the analyzer’s sweep tracks the output of the converter device.

Key Path	Source, Frequency
Mode	SA
Scope	Mode Global
Remote Command	:SOURce:FREQuency:SSReverse:ON OFF 0 1 :SOURce:FREQuency:SSReverse?
Example	SOUR:FREQ:SSR:OFF SOUR:FREQ:SSR?
Notes	You must be in Spectrum Analyzer mode to use this command. Use INSTRument:SElect to set the mode.
Dependencies	If the currently selected source does not support this capability (for example, an internal Tracking Generator which must track the LO), this key is forced to its Preset value and grayed out
Preset	This is unaffected by Mode Preset but is set to OFF on a Source Preset or Restore Input/Output Defaults.

State Saved	Part of the Input/Output system, which means it is Loaded and Saved with state
Range	On Off
Initial S/W Revision	A.06.01

Freq Offset

The frequency offset parameter offsets the source frequency from the analyzer frequency. The source frequency tracks the SA frequency according to the equations under the **Source, Frequency** key.

Pressing the key sets the Freq Offset function to On or Off. The value of Freq Offset is displayed in the active function block, and can be adjusted, when set to On.

The frequency offset must be restricted to operate within the range of the source minimum and maximum frequencies.

Key Path	Source, Frequency
Mode	SA
Scope	Mode Global
Remote Command	:SOURce:FREQuency:OFFSet <freq> :SOURce:FREQuency:OFFSet? :SOURce:FREQuency:OFFSet:STATe ON OFF 1 0 :SOURce:FREQuency:OFFSet:STATe?
Example	:SOUR:FREQ:OFFS 10MHz Sets the source frequency offset to 10MHz.
Dependencies	If the currently selected source does not support this capability (for example, an internal Tracking Generator which must track the LO), this key is forced to its Preset value and grayed out
Preset	This is unaffected by Mode Preset but is set to 0.00Hz on a Source Preset or Restore Input/Output Defaults.
State Saved	Part of the Input/Output system, which means it is loaded and saved with state
Min	-500 GHz
Max	500 GHz
Backwards Compatibility SCPI	:SOURce:EXTernal:SWEEP:OFFSet:FREQuency <freq> :SOURce:EXTernal:SWEEP:OFFSet:FREQuency? The PSA option 215 supports this SCPI command. This command is equivalent to :SOURce:FREQuency:OFFSet
Initial S/W Revision	A.06.01
Modified at S/W Revision	A.10.01

Source Mode

Accesses the Source Mode softkey menu. This menu lets you select Tracking mode for the Source, and also allows you to set the Source Mode to OFF.

The Source Mode can be set to Tracking without the user setting it directly. There are several couplings that cause Source Mode to be automatically set to Tracking (detailed in the table below). One important coupling is that Source Mode is forced to Tracking when the RF Output is turned on if the measurement supports Tracking. Since Source Mode is set to Off on a Mode Preset, this means that you will rarely need to change the Source Mode setting directly.

NOTE

When the Source Mode is set to Tracking, the analyzer acquires control of the source. When this happens the source is told to save its state and then perform a preset. Usually both of these operations take very little time; however, on an N5172B or an N5182B, if many Source real-time apps are in use, both save and preset can take many seconds. If it takes longer than the analyzer expects to acquire control, you will see an error: “Source connection lost, check interface connection”. If you see this error, and you are using an N5172B or an N5182B, you can shorten the acquire time by presetting your MXG before attempting to use External Source Control.

Key Path	Source
Scope	Meas Global
Remote Command	:INSTrument:SOURce[:SElect] TRACKing OFF :INSTrument:SOURce[:SElect]?
Example	:INST:SOUR TRAC
Dependencies	<p>Grayed out if no Source is selected, in this case go to the Select Source menu to choose, configure and/or verify your source</p> <p>Grayed out and forced to Off if either BBIQ or External Mixing are selected</p> <p>Blanked in Modes that do not support a source</p> <p>Grayed out in Measurements that do not support a source</p> <p>Tracking is grayed out when Manual FFT is selected</p> <p>Tracking is grayed out when the RF Preselector is on (in models which support the RF Preselector).</p>
Couplings	<p>When RF Output is turned On, Source Mode is set to Tracking. When Source Mode is turned Off, RF Output is turned Off.</p> <p>Whenever you switch to an application (Mode) in which the Source Mode was previously set to Tracking, it is again set to Tracking. That is, the last setting of the Source Mode is remembered when you leave an application (Mode) and restored when you return</p> <p>Source Mode is forced to Tracking when the RF Output is turned on if the measurement supports Tracking</p> <p>If Source Mode is set to Tracking, then it is forced to Off when you select a measurement that does not support Tracking.</p> <p>If Source Mode is set to Tracking, then it is forced to Off when you turn on the RF Preselector (in models which support the RF Preselector).</p> <p>Whenever the Source Mode is set to Tracking, the analyzer acquires the Source. Similarly, the Source is released whenever the Source Mode is set to Off. This is true whether the Source Mode was set directly by you, was set indirectly through a coupling, if you switched to an application (Mode) that had previously been set to Tracking, or if you switched to an application (Mode) in which the Source Mode is not set to Tracking.</p>

For an external source, “acquiring the source” involves contacting the external instrument over the remote interface (which puts it into Remote) and taking control of it.

When you set the Source Mode to OFF, it releases the Source (and puts it into Local). For an external source, this means you are now free to operate the source for other purposes.

When the Source is acquired, its previous state is saved, and when it is released, that state is restored, so that you can acquire and then release the source and it will return to the state it was in before you acquired it.

Preset	OFF
State Saved	Saved in instrument state
Initial S/W Revision	A.06.01
Modified at S/W Revision	A.10.01

Select Source

The Select Source menu allows you to maintain a list of available external Sources, and choose the Source that you want to use from the list. It shows the currently selected source at the bottom of the screen.

While in the Select Source menu, you can see, and select from, a list of the currently available sources. The sources listed in this table are as follows:

- Any internal sources which are installed and licensed

NOTE

Only one internal source can be installed, displayed at address “INTERNAL”

- Any external sources which you have previously configured, whether or not they are currently connected, displayed with their VISA address

Note that only external sources that are supported by the Tracking Source Mode are displayed in the Available Source List. Here are the Keysight/Agilent sources currently supported:

Source	PXA	MXA	EXA	CXA	MXE (Presel off)
MXG N5181A	X	X	X	X	X
MXG N5182A	X	X	X	X	X
MXG N5183A	X	X	X		X
EXG N5171B	X	X	X	X	X
MXG N5181B	X	X	X	X	X
EXG	X	X	X	X	X

N5172B					
EXG	X	X	X	X	X
N5173B					
MXG	X	X	X	X	X
N5182B					
MXG	X	X	X	X	X
N5183B					
PSG	X	X	X		
E8257D					
PSG	X	X	X		
E8267D					

NOTE

For X-Series software versions earlier than A.10.01, option UNZ (Fast switching) was required on the MXG for some use cases. This is no longer the case, option ESC now works without MXG option UNZ for all use cases. (Note that you will get better performance if your MXG has option UNZ, because without option UNZ your sweep speeds will be noticeably slower.)

While in the Select Source menu and its submenus, detailed instructions are presented that tell you how to operate the Select Source functions. Basically they tell you to first use the up and down arrow keys to move the selection highlighted in the “Available Source List” to the source that you want to use. The list of available sources includes any sources that you have previously used (unless you have deleted them) and any found while in the “Add Source to List” menu.

When the source you want to use is highlighted, press “Select Highlighted Source” or “Enter”. The source you have selected shows up at the bottom of the screen as the “Current Source”. Press “Verify Current Source Connection” to make sure that the interface connection to the Source is still functional.

At any time you may use the “Add Source to List” or “Delete Highlighted Source” keys to find new sources or remove a source from the list of available sources.

Key Path	Source
Readback Text	Two lines of readback give the type information and serial number of the current source, in square brackets
Initial S/W Revision	A.06.01

Select Highlighted Source

You can navigate up and down in the list with the up and down arrow keys, and can select any entry by pressing the Select Highlighted Source key (or by double-clicking on the entry in the table with a mouse). The highlighted source becomes the Current Source and is prominently displayed at the bottom of the screen.

At any given time there is only one selected Source for the entire system; once a Source is selected, it becomes the Current Source and will be used by all applications that support Source Control.

For example, if no Source has yet been selected, the statement at the bottom of the screen would say

Current Source

None

If an N5182A connected via USB were the Current Source, the statement at the bottom of the screen might say:

Current Source

Agilent N5182A US00000258 at USB0::2931::7937::US00000258::0::INSTR

The SCPI command defined below allows the programmatic user to directly define the VISA address via a string parameter. The parameter is checked for proper syntax, the connection to the instrument is verified, and the source is added to the Available Source List if it verifies. If it does not verify or no source is found at that address, an error message is generated.

Normally the source selection activities should be performed only when the user changes the hardware connection configuration or activates/deactivates a source option license; shutdown and startup of the application will not cause source re-selection.

The Agilent IO Libraries Suite provides an “Agilent VISA Help” document that has a section that shows the proper syntax for valid VISA address strings, in the ViOpen function definition.

Key Path	Source, Select Source
Mode	SA
Remote Command	:SYSTem:COMMunicate:SOURce[1]:ADDRess <address string> :SYSTem:COMMunicate:SOURce[1]:ADDRess?
Example	Different examples for setting external source address :SYST:COMM:SOUR:ADDR "TCPIP0::MyHostName::INSTR" :SYST:COMM:SOUR:ADDR "TCPIP0::123.121.100.210::INSTR" :SYST:COMM:SOUR:ADDR "USB0::12212::32145::US1234567A::INSTR" :SYST:COMM:SOUR:ADDR "GPIB1::19::INSTR"
Notes	Empty string is allowed and means no source is defined or selected.
Remote Command Notes	The address string is the VISA address for external sources and "INTERNAL" for an internal source
Dependencies	Operation with a source requires a license. If the proper license is not installed, the SCPI command generates an error message, "Settings conflict;option not installed" If no supported source, or no source at all, is found at the specified address, the SCPI command generates an error message
Preset	The current source selection is unaffected by a Mode Preset and Source Preset but reverts to

	<p>[None] on a Restore Input/Output Defaults. If an internal Tracking Generator is installed, then instead of None, the default selection will be INTERNAL.</p>
State Saved	<p>Selected Source is</p> <ul style="list-style-type: none"> - Power On Persistent (survives power cycle) - Part of the Input/Output system, which means it is Loaded and Saved with state.
Readback	<p>Two lines of readback give the type information and serial number of the current source on the Select Source key in the form</p> <p>[<source type>] [<serial number>]</p> <p>[None] shows in the type area and blank in the serial number area if a source has not been configured. [Internal TG] shows in type area and serial number in the serial number area if an internal Tracking Generator has been selected. For example: [MXG]/n, [US01020022]. This indicates an MXG of serial number US01020022.</p>
Backwards Compatibility SCPI	<p>:SYSTem:COMMunicate:LAN:SOURce[:EXTernal]:IP <address string> :SYSTem:COMMunicate:LAN:SOURce[:EXTernal]:IP?</p> <p>This command is provided for compatibility with PSA Option 215. The address string is reformatted for the X-Series. For example, if the customer sends</p> <p>:SYSTem:COMMunicate:LAN:SOURce:EXTernal:IP 146.208.172.111</p> <p>The analyzer turns this into</p> <p>:SYSTem:COMMunicate:SOURce:ADDRess "TCPIP0::146.208.172.111::INSTR"</p>
Initial S/W Revision	A.06.01
Modified at S/W Revision	A.10.01

Delete Highlighted Source

Deletes the highlighted source from the list of available sources. You will be prompted with a dialog box to make sure you REALLY want to do this. The prompt says "The highlighted source will be permanently deleted from the list. Are you sure you want to do this? Press Enter to proceed, or Cancel (ESC) to cancel."

Key Path	Source, Select Source
Initial S/W Revision	A.06.01

Add Source To List

This menu allows you to add to the list of available sources from various interfaces.

Key Path	Source, Select Source
Initial S/W Revision	A.06.01

USB

Sources on USB (once installed) can be added to the list by pressing “Add Installed USB Sources.” Any supported source found will be added to the list.

See ["Add Installed USB Sources" on page 3259](#) for information on connecting and installing USB devices.

Key Path	Source, Select Source, Add Source to List
Initial S/W Revision	A.06.01

Add Installed USB Sources

Press this key to add USB sources to the Available Source List. Note that this function will ONLY find sources that have previously been installed onto the USB. For information on how to install a USB source, see ["Installing a USB source" on page 2790](#)

Key Path	Source, Select Source, Add Source to List, USB
Notes	If no installed USB device is found which is a supported source, an error message is generated
Initial S/W Revision	A.06.01

Installing a USB source

USB is the only interface which requires no runtime action by the user in the Select Source menu, but does require “installation” when a source is plugged in.

You start by connecting the USB source to the analyzer. You will get a series of messages indicating that the analyzer is installing required device software.

When the installation is complete, you will get a message to that effect. You can then use the “Add Installed USB Sources” function (above) to add the source to the list of sources in the Available Source List.

GPIB

Lets you add GPIB sources to the Available Source List.

For the GPIB interface to work properly, it must be configured as a Controller. You can find this setting in the System menu under System, I/O Config, GPIB. Set the GPIB Controller function to Enabled.

Note that you must also make sure that the GPIB interface is not set to “Ignore” in the Agilent Connection Expert. If it is set to **Ignore**, then even if the GPIB Controller is set to **Enabled**, it is not possible for the analyzer to find a GPIB connected source. See ["More Information" on page 2790](#).

Key Path	Source, Select Source, Add Source to List
Initial S/W Revision	A.06.01

More Information

If you suspect that the GPIB interface is not set to Ignore, run the Agilent Connection Expert (ACE). To run ACE, press Source, Select Source, Add Source to List, LAN, Run Connection Expert. Look for the GPIB branch on the interface tree:

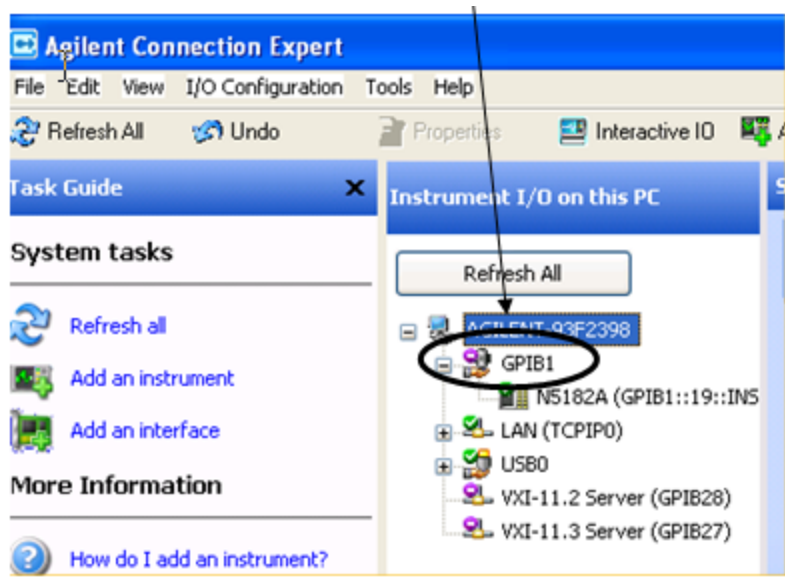

Right click on the GPIB branch (you will have to plug in a mouse to do this). You should see a dialog like the one below. If this dialog says **Stop Ignoring**, select **Stop Ignoring** and close ACE.

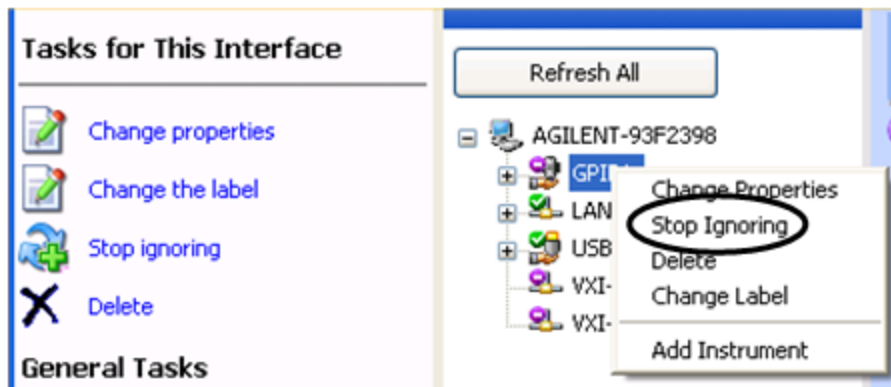

Scan & Add GPIB Sources

Sources on GPIB can be added by pressing **Scan & Add GPIB Sources**. Any supported source found will be added to the Available Source List.

NOTE

This will cause any older, non-SCPI compatible devices on your GPIB to generate error messages.

Key Path	Source, Select Source, Add Source to List, GPIB
Notes	If the GPIB controller mode is not enabled, an error message is generated If no GPIB device is found which is a supported source, an error message is generated
Initial S/W Revision	A.06.01

Enter GPIB Address

Opens a menu that lets you enter the GPIB address of the desired source directly.

NOTE

For this to work properly, the GPIB interface must be configured as GPIB1. This is the default state and should normally be the case. To see how to verify this, see **"More Information"** on page 2792.

Key Path	Source, Select Source, Add Source to List, GPIB
Initial S/W Revision	A.06.01

More Information

If you suspect that the GPIB interface is not set to GPIB1, run the Agilent Connection Expert (ACE). To run ACE, press Source, Select Source, Add Source to List, LAN, Run Connection Expert. Look for the GPIB branch on the interface tree:

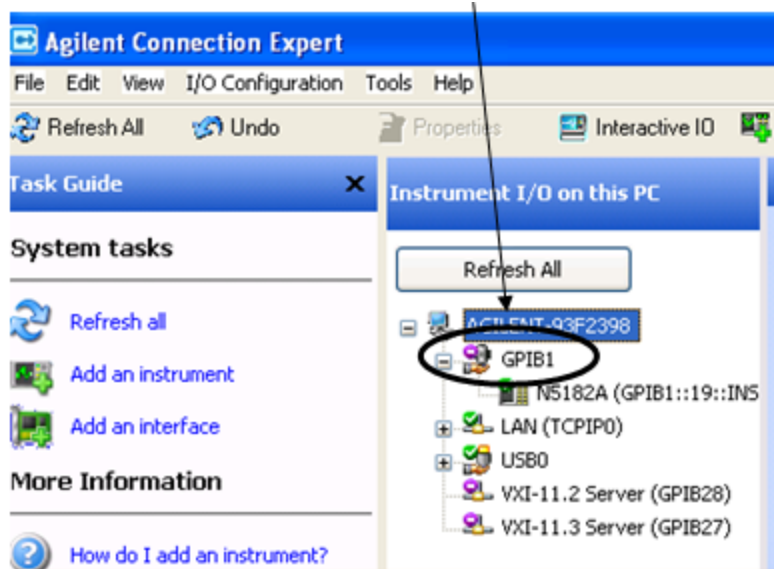

If this branch is not labeled **GPIB1**, right click on the GPIB branch (you will have to plug in a mouse to do this) and select **Change Properties**.

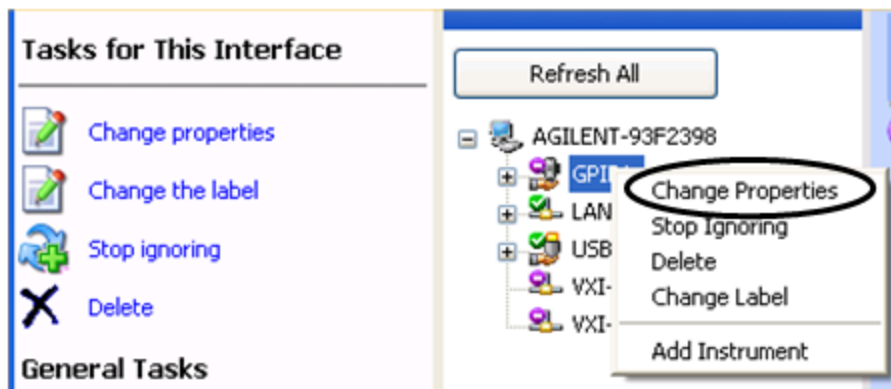

You should see a dialog like the one below. Click on the drop-down arrow under **VISA Interface ID**, select **GPIB1** and click **OK**

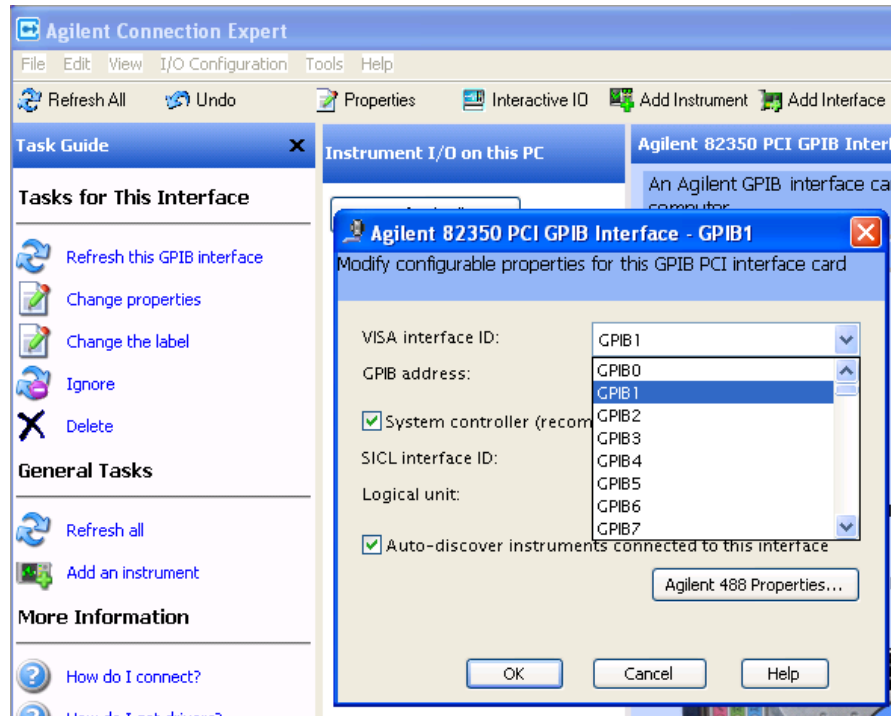

GPIB Address

Lets you enter the GPIB address. After you enter the address press **Add** to add the source at that address to the Available Source List.

Key Path	Source, Select Source, Add Source to List, GPIB, Enter GPIB Address
Preset	Unaffected by Mode Preset but set to 19 by "Restore Input/Output defaults"
State Saved	No
Min	0
Max	30
Initial S/W Revision	A.06.01

Add

Add the source at the entered GPIB address to the Available Source List. If a supported source is found at that address it will be added to the list.

Key Path	Source, Select Source, Add Source to List, GPIB, Enter GPIB Address
Notes	If GPIB controller mode is not enabled, an error message is generated If no supported source is found at the specified address, an error message is generated
Initial S/W Revision	A.06.01

LAN

The LAN cannot be scanned directly from the analyzer software, but you can import the list of currently configured devices from Agilent Connection Expert by pressing

“Add From Connection Expert List.” The Connection Expert list depends on which instruments have already been discovered by the Agilent Connection Expert application. Any connected, supported sources in that list will be added.

You can also enter the IP address and press “Add”. If a supported source is found at that address it will be added.

If you want to discover sources on the LAN, you can open Connection Expert by pressing the “Run Connection Expert...” softkey.

Key Path	Source, Select Source, Add Source to List
Initial S/W Revision	A.06.01

Enter LAN Address

Opens up a menu which lets you enter the IP address of the desired source directly.

Key Path	Source, Select Source, Add Source to List, LAN
Initial S/W Revision	A.06.01

IP Address

Lets you enter the IP address of the desired source. After you enter the address you should press “Add” to add the source at that address to the Available Source List.

Key Path	Source
Preset	Unaffected by Mode Preset but set to 0.0.0.0 by Restore Input/Output defaults
State Saved	No
Initial S/W Revision	A.06.01

Add

Adds the source at the entered IP address to the Available Source List. If a supported source is found at that address it will be added to the list.

Key Path	Source
Notes	If no supported source is found at the specified address, an error message is generated
Initial S/W Revision	A.06.01

Run Connection Expert...

Runs the Agilent Connection Expert so that you can scan the LAN for sources.

Key Path	Source, Select Source, Add Source to List, LAN
Initial S/W Revision	A.06.01

Add From Connection Expert List

You can import the list of currently configured devices from Agilent Connection Expert by pressing **Add From Connection Expert List**. The Connection Expert list depends on which instruments have already been discovered by the Agilent Connection Expert application. Any connected, supported sources in that list will be added.

Key Path	Source, Select Source, Add Source to List, LAN
Notes	If no supported source is found in the Connection Expert list, an error message is generated
Initial S/W Revision	A.06.01

Verify Current Source Connection

This key verifies the interface connection to the Current Source (it does NOT verify any signal connections!)

Until the selected source is verified, a statement appears at the bottom of the screen which says (in red):

This Source has not been verified. Press "Verify Source" to check the interface connection.

When you press this key, the connection is checked to the selected source. If all is well, the statement is changed to (in green):

This connection to this source has been verified.

If the verification fails, the statement at the bottom will change to (in red):

Verification of this source failed. Check the interface connection

The selected source is also verified whenever it is acquired. If a Source's connection has been verified by any means, then that Source is considered to have been verified until either the analyzer software is shut down or if, in attempting to use the Source, communication with it fails.

Key Path	Source, Select Source
Initial S/W Revision	A.06.01

Source Setup

This menu is used to set up miscellaneous source functions, including trigger settings. For more on triggering in Tracking Mode, see ["Tracking Setup Details" on page 2796](#). For information on bypassing the Microwave Preselector, see ["Use of the YTF \(Microwave or mm Preselector\) with External Source Control" on page 2797](#)

Key Path	Source
Mode	SA
Initial S/W Revision	A.06.01

Tracking Setup Details

When an external source is operating in Tracking Mode, operation can be greatly enhanced by using hardware triggers. Below is a typical connection diagram showing a hardware handshake using Trigger 1 inputs and outputs on the analyzer (trigger 2 in and out is also a valid connection).

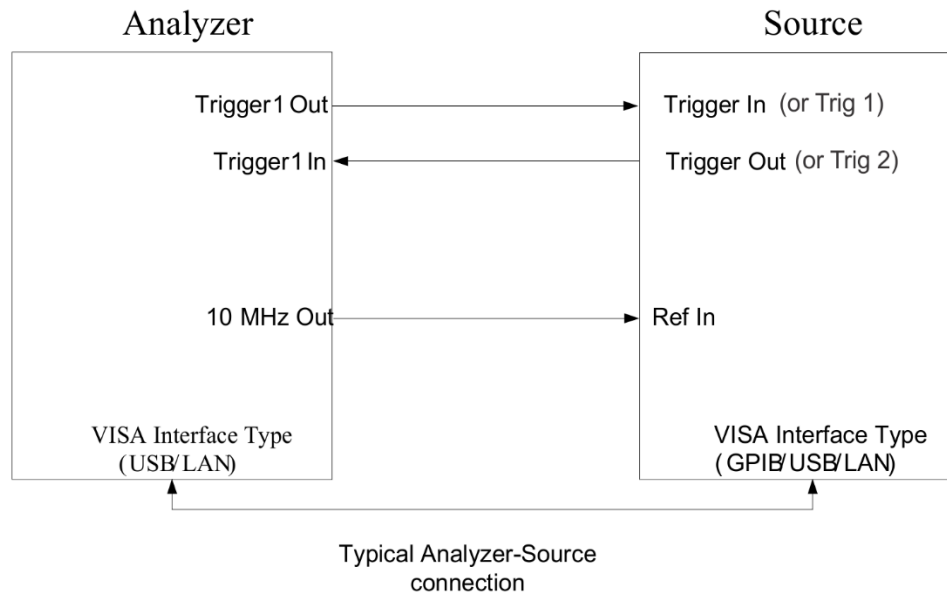

Analyzer Trigger 1 Out: Triggers the external source to step to next point in the frequency step/list.

Analyzer Trigger 1 In: Triggers the analyzer to make a measurement on this point

Source Trigger In (or “Trig 1” at default setting for N5181B/82B, N5183B MXG or N5171B/72B, N5173B EXG):

Triggers the source to step to the next point.

Source Trigger Out (or “Trig 2” at default setting for N5181B/82B, N5183B MXG or N5171B/72B, N5173B EXG): Indicates that the source has settled.

IO interface Connection: analyzer can connect to sources with its GPIB, USB or LAN interface.

Notes:

- Trigger sync connections are optional – synchronization can be done via remote commands if Bus Trigger is enabled in the Source Setup menu.
- Connection from the SA external frequency reference output to the source frequency reference input (10 MHz Out to Ref In) is not required, but may improve the measurement accuracy.

Use of the YTF (Microwave or mm Preselector) with External Source Control

In most stimulus/response measurements that utilize External Source Control, the source exactly tracks the tuned analyzer frequency. Consequently, preselection is not needed, and you can achieve greatly superior amplitude accuracy and repeatability by bypassing the YTF (Preselector) using the Microwave Preselector Bypass control in the Amplitude, μ W Path Control menu.

NOTE

This control is only available if option MPB is installed.

There are rare but important cases, however, where the source is tuned to a different frequency than the analyzer, using the Multiplier and Reverse controls in the Source, Frequency menu. For example, you might be tuning the source to $\frac{1}{2}$ of the analyzer frequency when looking at second harmonic distortion in a DUT. In these cases, it would be commonplace for there to be an undesired signal at the analyzer input that is at an image frequency that you will want to reject with the YTF.

Understanding these cases is important for proper operation of the Microwave Preselector with External Source Control, so that you only bypass it when it will improve accuracy but not hinder the measurement.

Point Trigger

Shows point trigger type selected and navigates to the Point Trigger menu.

The Point Trigger menu lists all analyzer point trigger types. The analyzer and source point trigger synchronization can be done using SCPI bus commands or by using external trigger output and input lines.

NOTE

For X-Series software versions earlier than A.10.01, hardware triggering was unavailable in stepped tracking at frequencies above 3.6 GHz, so above 3.6 GHz, software triggering was always used. This is no longer the case.

Key Path	Source, Source Setup
Mode	SA
Scope	Mode Global
Remote Command	:SOURce:TRIGger:TYPE BUS EXTernal[1] EXTernal2 :SOURce:TRIGger:TYPE?
Example	:SOUR:TRIG:TYPE EXT1 Selects analyzer external trigger 1 in and out for point trigger synchronization with selected source
Dependencies	If an internal Tracking Generator is selected, then this menu is unavailable, Additionally, the External 1 and External 2 Trigger keys on the Spectrum Analyzer are released from any grayout that may have been forced on them by the external source Point Trigger selection. In some models, there is no second External input. In these models, the External 2 key is blanked and the EXTernal2 parameter will generate a "Hardware missing; Not available for this model number" message.
Couplings	The source control point trigger selection can select external trigger 1 or 2 in for synchronized point triggering. This can conflict with the selection under the Trigger hardkey, if it has External 1 or 2 selected. If there is a conflict when the selection is made under the Point Trigger menu, the

	Trigger selection under the Trigger hardkey will be changed to Free Run.
Preset	This is unaffected by "Mode Preset" but is set to EXTERNAL1 on a "Source Preset" or "Restore Input/Output Defaults".
State Saved	Part of the Input/Output system, which means it is Loaded and Saved with state
Readback	1-of-N selection
Initial S/W Revision	A.06.01

SW Trigger

Analyzer and source point trigger synchronization is setup using the SCPI commands. Source is stepped via SCPI commands. Analyzer waits for source to settle by polling source.

Key Path	Source, Source Setup, Point Trigger
Mode	SA
Example	:SOUR:TRIG:TYPE BUS
Readback	SW Trigger
Initial S/W Revision	A.06.01

Ext Trigger 1

Analyzer and source point trigger synchronization is setup using the analyzer Trigger 1 Output and Trigger 1 Input. The Source is stepped via Trigger 1 Output. The Analyzer waits for source to settle via Trigger 1 Input.

Key Path	Source, Source Setup, Point Trigger
Mode	SA
Example	:SOUR:TRIG:TYP EXT1
Couplings	<p>With an acquired source, selecting this point trigger mode overrides existing external trigger 1 output level, slope, and delay, and external trigger 1 type and polarity.</p> <p>External trigger 1 input level = 1.20 V</p> <p>External trigger 1 input slope = Positive</p> <p>External trigger 1 input delay = Off</p> <p>External trigger 1 output type = Source Point Trigger</p> <p>External trigger 1 output polarity = Positive</p> <p>When this selection is made:</p> <ul style="list-style-type: none"> - The External 1 key in the Trigger menu (under the Trigger hardkey) is grayed out and, if External 1 was previously selected, it will be changed to Free Run. - Trig 1 Out selected under Output Config in the Input/Output menu will be changed to Source Point Trigger <p>If the user subsequently goes into the Trig 1 Out menu and selects a different Trigger Output, the Point Trigger will revert to SW Trigger.</p>

Readback	Ext Trigger 1
Initial S/W Revision	A.06.01

Ext Trigger 2

Analyzer and source point trigger synchronization is setup using the analyzer Trigger 2 Output and Trigger 2 Input. The Source is stepped via Trigger 2 Output. The Analyzer waits for source to settle via Trigger 2 Input.

Key Path	Source, Source Setup, Point Trigger
Mode	SA
Example	:SOUR:TRIG:TYP EXT2
Dependencies	This key is blanked out on CXA as there is only one trigger input
Couplings	<p>With an acquired source, selecting this point trigger mode overrides existing external trigger 2 output level, slope, and delay, and external trigger 2 type and polarity.</p> <p>External trigger 2 input level = 1.20 V</p> <p>External trigger 2 input slope = Positive</p> <p>External trigger 2 input delay = Off</p> <p>External trigger 2 output type = Source Point Trigger</p> <p>External trigger 2 output polarity = Positive</p> <p>When this selection is made:</p> <ul style="list-style-type: none"> - The External 2 key in the Trigger menu (under the Trigger hardkey) is grayed out and, if External 2 was previously selected, it will be changed to Free Run. - Trig 2 Out selected under Output Config in the Input/Output menu will be changed to Source Point Trigger - If the user subsequently goes into the Trig 2 Out menu and selects a different Trigger Output, the Point Trigger will revert to SW Trigger.

Readback	Ext Trigger 2
Initial S/W Revision	A.06.01

Show Source Capabilities & Settings

Shows the capabilities of the currently selected Source. The menu is useful for displaying source capabilities such as frequency and amplitude ranges. In addition, the results of the source control sweep algorithms can be viewed. This gives information of the source range required for a given analyzer sweep range. This can be used dynamically as a way of configuring the sweep settings.

Key Path	Source, Source Setup
Mode	SA
Dependencies	If no source is selected this key is grayed out.
Initial S/W Revision	A.06.01

Source Preset

The Source Preset key forces all the settings in the analyzer's Source State to their preset condition.

The Source State is the set of Source settings that is maintained and remembered by the analyzer for use in the Tracking Source Mode. The Source State variables are controlled and set in the menus under the Source front panel key. These settings include:

- RF Output Off
- Amplitude = - 10 dBm
- Amplitude Step = Auto
- Power Sweep = 0 dB
- Amplitude Offset = 0 dB
- Source Sweep Reverse = Off
- Multiplier Numerator = 1
- Multiplier Denominator = 1
- Freq Offset = 0 Hz
- Point trigger is set to "Ext1"

The Source State is saved along with the state of the current Mode when you save a State, and is recalled when that Mode State is recalled.

When the analyzer first starts up, a Source Preset is performed. In the Input/Output menu, Restore Input/Output Defaults will also perform a Source Preset.

A Mode Preset, from modes that support the External Source, will turn the RF Off but will **not** perform a Source Preset. By the same token, Source Preset does **not** perform a Mode Preset.

Source Preset does **not** change the Source Mode nor the selection of which physical source is being used, nor does it release the current source (the source remains under the control of the analyzer) nor exit the Source menu.

Key Path	Source
Mode	SA
Remote Command	:SOURce:PRESet
Example	:SOUR:PRES
Preset	Initiates a Source Preset
State Saved	No
Initial S/W Revision	A.06.01

Span X Scale

Accesses a menu of functions that enable you to set the horizontal scale parameters.

Key Path	Front-panel key
Initial S/W Revision	A.11.00

Ref Value

Sets the X reference value.

Key Path	SPAN X Scale
Mode	BASIC, PNOISE, WCDMA, C2K, GSM, WIMAXOFDMA, TDSCDMA, 1XEVD0, DVB, DTMB, ISDBT, CMMB, LTE, LTETDD, DCTV, WLAN, MSR, LTEAFDD, LTEATDD
Remote Command	:DISP:SEMask:VIEW[1]:WINDow[1]:TRACe:X[:SCALE]:RLEVe1 <freq> :DISP:SEMask:VIEW[1]:WINDow[1]:TRACe:X[:SCALE]:RLEVe1?
Example	DISP:SEM:VIEW:WIND:TRAC:X:RLEV 10 DISP:SEM:VIEW:WIND:TRAC:X:RLEV?
Notes	You must be in the mode that includes SEM measurement to use this command. Use :INSTrument:SElect to set the mode.
Couplings	If Auto Scaling is set to On, this value is automatically determined by the measurement result. When you set this value manually, Auto Scaling automatically changes to Off.
Preset	1.0 GHz
State Saved	Saved in instrument state.
Min	-1000 GHz
Max	1000 GHz
Default Unit	Hz
Initial S/W Revision	A.11.00

Scale/Div

Sets the horizontal scale.

Key Path	SPAN X Scale
Mode	BASIC, PNOISE, WCDMA, C2K, GSM, WIMAXOFDMA, TDSCDMA, 1XEVD0, DVB, DTMB, ISDBT, CMMB, LTE, LTETDD, DCTV, WLAN, MSR, LTEAFDD, LTEATDD
Remote Command	:DISP:SEMask:VIEW[1]:WINDow[1]:TRACe:X[:SCALE]:PDIVision <freq> :DISP:SEMask:VIEW[1]:WINDow[1]:TRACe:X[:SCALE]:PDIVision ?
Example	DISP:SEM:VIEW:WIND:TRAC:X:PDIV 500 DISP:SEM:VIEW:WIND:TRAC:X:PDIV?
Notes	You must be in a mode that includes the SEM measurement to use this command. Use INSTrument:SElect to set the mode.
Couplings	If Auto Scaling is set to On, this value is automatically determined by the measurement result.

	When you set this value manually, Auto Scaling automatically changes to Off.
Preset	Automatically Calculated
State Saved	Yes Saved in instrument state.
Min	1 Hz
Max	10.0 GHz
Initial S/W Revision	A.11.00

Ref Position

Sets the reference position for the X axis to Left, Center or Right.

Key Path	SPAN X Scale
Mode	BASIC, PNOISE, WCDMA, C2K, GSM, WIMAXOFDMA, TDSCDMA, 1XEVDO, DVB, DTMB, ISDBT, CMMB, LTE, LTETDD, DCTV, WLAN, MSR, LTEAFDD, LTEATDD
Remote Command	:DISP:SEMask:VIEW[1]:WINDow[1]:TRACe:X[:SCALE]:RPOsition LEFT CENTER RIGHT :DISP:SEMask:VIEW[1]:WINDow[1]:TRACe:X[:SCALE]:RPOsition?
Example	DISP:SEM:VIEW:WIND:TRAC:X:RPOS LEFT DISP:SEM:VIEW:WIND:TRAC:X:RPOS?
Notes	You must be in a mode that includes the SEM measurement to use this command. Use INSTRument:SElect to set the mode.
Preset	CENTER
State Saved	Yes Saved in instrument state.
Range	Left Ctr Right
Initial S/W Revision	A.11.00

Auto Scaling

Toggles the scale coupling function between On and Off.

Key Path	SPAN X Scale
Mode	BASIC, PNOISE, WCDMA, C2K, GSM, WIMAXOFDMA, TDSCDMA, 1XEVDO, DVB, DTMB, ISDBT, CMMB, LTE, LTETDD, DCTV, WLAN, MSR, LTEAFDD, LTEATDD
Remote Command	:DISP:SEMask:VIEW[1]:WINDow[1]:TRACe:X[:SCALE]:COUPle 0 1 OFF ON :DISP:SEMask:VIEW[1]:WINDow[1]:TRACe:X[:SCALE]:COUPle?
Example	DISP:SEM:VIEW:WIND:TRAC:X:COUP ON DISP:SEM:VIEW:WIND:TRAC:X:COUP?
Notes	You must be in a mode that includes the SEM measurement to use this command. Use INSTRument:SElect to set the mode.
Couplings	When Auto Scaling is On and the Restart front-panel key is pressed, this function automatically determines the scale per division and reference values based on the measurement results.

15 Spectrum Emission Mask Measurement
Span X Scale

	When you set a value to either Scale/Div or Ref Value manually, Auto Scaling automatically changes to Off.
Preset	1
State Saved	Yes Saved in instrument state.
Range	On Off
Initial S/W Revision	A.11.00

Sweep/Control

Displays a menu that enables you to set up and control the sweep time, gate method, and source of the current measurement. See ["Sweep/Control" on page 927](#) for more information.

Key Path	Front-panel key
Initial S/W Revision	Prior to A.02.00

Pause

Pauses a measurement after the current data acquisition is complete. When Paused, the label on the key changes to Resume. Pressing the Resume key resumes the measurement at the point it was at when paused. See ["Pause/Resume" on page 2263](#) for more details.

Key Path	Sweep/Control
Initial S/W Revision	Prior to A.02.00

Gate

Accesses a menu that enables you to control the gating function. The Gate functionality is used to view signals best viewed by qualifying them with other events.

Gate setup parameters are the same for all measurements – they do not change as you change measurements. Settings like these are called “Meas Global” and are unaffected by Meas Preset.

Note that Sweep Time autocoupling rules and annotation are changed by Gate being on.

Key Path	Sweep/Control
Scope	Meas Global
Readback	The state and method of Gate, as [Off, LO] or [On, Video]. Note that for measurements that only support gated LO, the method is nonetheless read back, but always as LO.
Initial S/W Revision	Prior to A.02.00

Gate On/Off

Turns the gate function on and off.

When the Gate Function is on, the selected Gate Method is used along with the gate settings and the signal at the gate source to control the sweep and video system with the gate signal. Not all measurements allow every type of Gate Methods.

When Gate is on, the annunciation in the measurement bar reflects that it is on and what method is used, as seen in the following "Gate: LO" annunciator graphic.

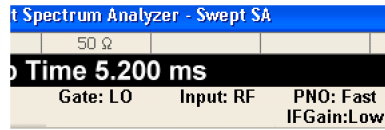

Key Path	Sweep/Control, Gate
Remote Command	[:SENSe] :SWEep:EGATe [:STATe] OFF ON 0 1 [:SENSe] :SWEep:EGATe [:STATe] ?
Example	SWE:EGAT ON SWE:EGAT?
Dependencies	<p>The function is unavailable (grayed out) and Off when:</p> <ul style="list-style-type: none"> – Gate Method is LO or Video and FFT Sweep Type is manually selected. – Gate Method is FFT and Swept Sweep Type is manually selected. – Marker Count is ON. <p>The following are unavailable whenever Gate is on:</p> <ul style="list-style-type: none"> – FFT under Sweep Type when Method=LO or Video or Swept under Sweep Type when Method=FFT <p>Marker Count</p> <p>While Gate is on, the Auto Rules for Sweep Type are modified so that the choice agrees with the Gate Method: i.e., FFT for Method = FFT and Swept for Method = LO or Video.</p> <p>The Gate softkey and all SCPI under the [:SENSe]:SWEep:EGATe SCPI node are grayed out when Source Mode is Tracking with an external source. This is because the Gate circuitry is used to sync the external source. If the Tracking Source is turned on, the Gate is turned off.</p> <p>When in the ACP measurement:</p> <ul style="list-style-type: none"> – When Meas Method is RBW or FAST, this function is unavailable and the key is grayed out. – Whenever Gate is on, Meas Method, RBW or FAST is unavailable and keys for those are grayed out. – When Gate is on, Offset Res BW and Offset Video BW are ignored (if you set these values) and the measurement works as if all Offset Res BW and all Offset Video BW are coupled with the Res BW and the Video BW under the BW menu. When Gate is on, the Offset BW key in the Offset/Limit menu is grayed out.
Preset	Off LTETDD: On
State Saved	Saved in instrument state
Range	On Off
Backwards Compatibility SCPI	[:SENSe]:SWEep:TIME:GATE[:STATe] ESA compatibility
Backwards Compatibility Notes	In ESA, Trig Delay (On) and Gate (On) could not be active at the same time.. This dependency does not exist in PSA or in the X-Series.

Initial S/W Revision Prior to A.02.00

Gate View On/Off

Turning on Gate View in the Swept SA measurement provides a single-window gate view display..

Turning on Gate View in other measurements shows the split-screen Gate View. In these measurements, when the Gate View is on, the regular view of the current measurement traces and results are reduced vertically to about 70% of the regular height. The Zero Span window, showing the positions of the Gate, is shown between the Measurement Bar and the reduced measurement window. By reducing the height of the measurement window, some of the annotation on the Data Display may not fit and is not shown.

Key Path	Sweep/Control, Gate
Remote Command	[:SENSe] :SWEep :EGATe :VIEW ON OFF 1 0 [:SENSe] :SWEep :EGATe :VIEW?
Example	SWE:EGAT:VIEW ON turns on the gate view.
Dependencies	In the Swept SA measurement: In Gate View, the regular Sweep Time key is grayed out . When pressed, the grayed out key puts up the informational message "Use Gate View Sweep Time in the Gate menu." In the other measurements: When you turn Gate View on, the lower window takes on the current state of the instrument. Upon leaving Gate View, the instrument takes on the state of the lower window. When you turn Gate View on, the upper window Sweep Time is set to the gate view sweep time.
Couplings	These couplings apply to the Swept SA measurement: <ul style="list-style-type: none"> - When Gate View is turned on, the instrument is set to Zero Span. - Gate View automatically turns off whenever a Span other than Zero is selected. - Gate View automatically turns off if you press the Last Span key while in Gate View, and the instrument returns to the Span it was in before entering Gate View (even if that is Zero Span). - When Gate View is turned on, the sweep time used is the gate view sweep time. This is set according to the rules in section "Gate View Setup " on page 2809 - When Gate View is turned off, Sweep Time is set to the normal Swept SA measurement sweep time. - If Gate View is on and Gate is off, then turning on Gate turns off Gate View.
Preset	OFF
State Saved	Saved in instrument state
Range	On Off
Initial S/W Revision	Prior to A.02.00

15 Spectrum Emission Mask Measurement Sweep/Control

A sample of the Gate View screen in the Swept SA measurement is shown in the following graphic :

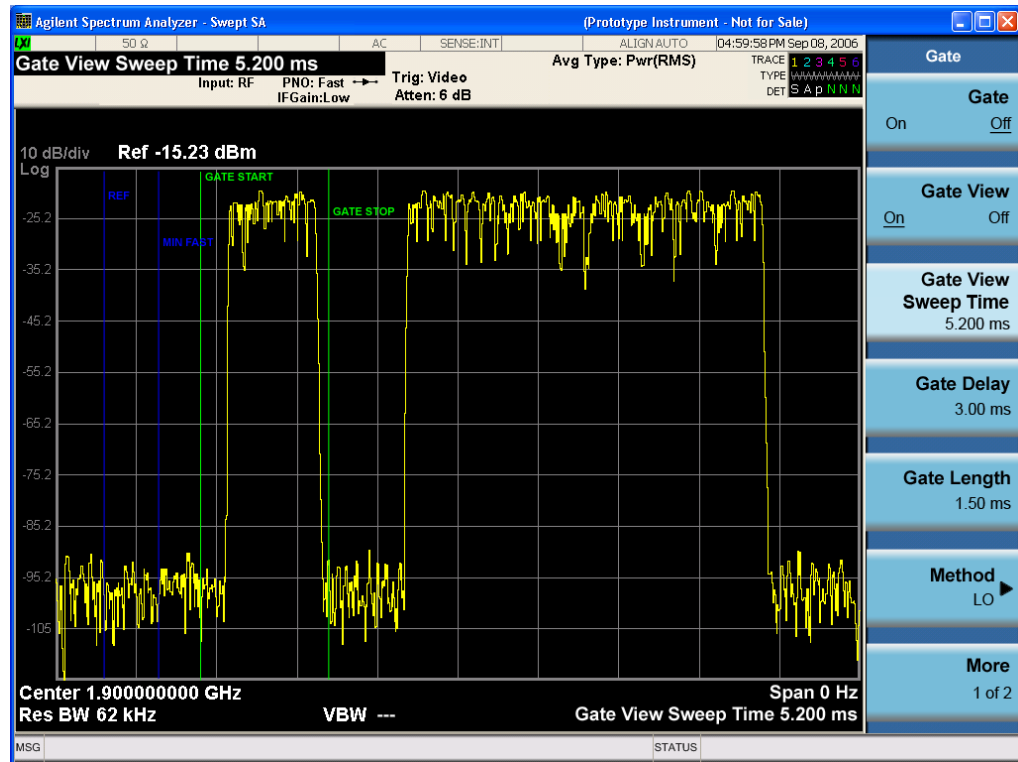

A sample of the Gate View screen in other measurements is shown in the following graphic . This example is for the ACP measurement:

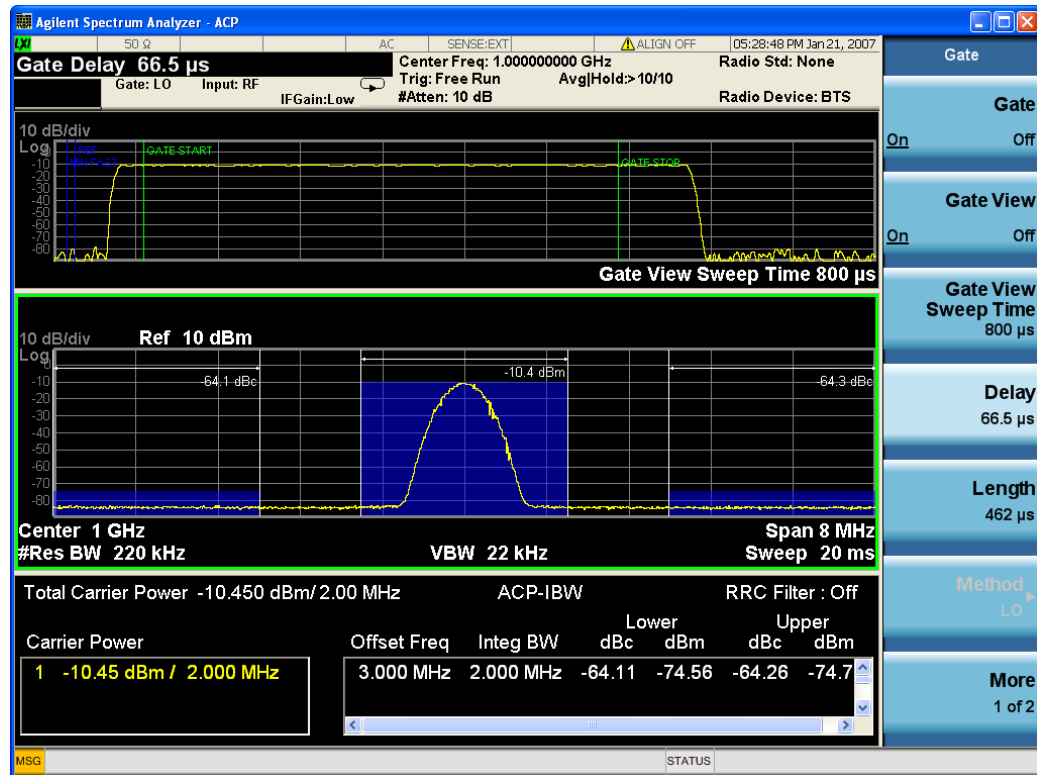

Turning Gate View off returns the analyzer to the Normal measurement view.

In the Swept SA, the normal measurement view is the single-window Swept SA view. When returning to this view, the Swept SA measurement returns to the Span it was in before entering **Gate View** (even if that is Zero Span).

The **Gate View** window is triggered from the Gate Source, with zero trigger delay. Also, when updating the **Gate View** window, the Gate itself must not operate. So it is internally shut off while the gate view window is being updated. For the Swept SA measurement, this means that the Gate is internally shut off whenever the gate view window is displayed. The measurement bar and softkeys continue to show the Trigger source for the main sweep window and give no indication that the Gate is shut off or that the Gate View window is triggered from the Gate Source.

When in **Gate View**, vertical lines are displayed in the Gate View window as follows:

- Green lines are displayed at the gate edges as follows: in Edge Gate, a line is shown for Delay and one for the end of the Gate period, defined by Length. In Level Gate a line is shown only for Delay. You can adjust the position of the green lines by adjusting the gate length and the gate delay. These lines update in the Gate View window as the active function changes, even if the window is not being updated. In Gated LO and Gated Video, these lines are positioned relative to the delay reference line (not relative to 0 time). In Gated FFT, their location is relative to the left edge of the screen.

- A blue line is displayed showing the delay reference, that is, the reference point for the Gate Delay within the Zero Span window. The blue line represents where (in time) the effective location of the gate start would be if the gate were programmed to zero delay.
-
- The second blue line is labeled "MIN FAST" as shown in the figure above because it represents the minimum Gate Delay for fast Gated LO operation. This line is only displayed in Gated LO. You cannot scroll (knob) or decrement (down key) the Gate Delay to less than that represented by the position of this line, it can only be set below this position manually, although once there it can be moved freely with the knob while below the line.
- A yellow line in the Gated Video case only, is displayed at Blength, where Blength is the display point (bucket) length for the swept trace, which is given by the sweep time for that trace divided by number of Points - 1. So it is referenced to 0 time, not to the delay reference. This line is labeled NEXT PT (it is not shown in the figure above because the figure above is for Gated LO).
- The yellow line represents the edge of a display point (bucket). Normally in Gated Video, the bucket length must be selected so that it exceeds the off time of the burst. There is another way to use the analyzer in Gated Video measurements, and that is to set the bucket width much shorter than the off time of the burst. Then use the Max Hold trace function to fill in "missing" buckets more slowly. This allows you to see some of the patterns of the Gated Video results earlier, though seeing a completely filled-in spectrum later.

Gate View Setup

Accesses a menu that enables you to setup parameters relevant to the Gate View

Key Path	Sweep/Control, Gate
Scope	Meas Global
Initial S/W Revision	A.10.00

Gate View Sweep Time

Controls the sweep time in the Gate View window. To provide an optimal view of the gate signal, the analyzer initializes Gate View Sweep Time based on the current settings of Gate Delay and Gate Length.

Key Path	Sweep/Control, Gate, Gate View Setup
Remote Command	[:SENSe] :SWEep:EGATe:TIME <time>

	[:SENSe] :SWEep:EGATe:TIME?
Example	SWE:EGAT:TIME 500 ms
Dependencies	Gate View Sweep Time is initialized: <ul style="list-style-type: none"> - On Preset (after initializing delay and length). - Every time the Gate Method is set/changed. <p>Additionally, in the Swept SA measurement, whenever you do a Preset, or leave Gate View, the analyzer remembers the Gate Delay and Gate Length settings. Then, when returning to Gate View, if the current Gate Delay and/or Gate Length do not match the remembered values Gate View Sweep Time is re-initialized.</p>
Preset	519.3 μ s WiMAX OFDMA: 5 ms GSM/EDGE: 1 ms
State Saved	Saved in instrument state
Max	6000 s
Initial S/W Revision	Prior to A.02.00

Gate View Start Time

Controls the time at the left edge of the Gate View.

Key Path	Sweep/Control, Gate, Gate View Setup
Remote Command	[:SENSe] :SWEep:EGATe:VIEW:STARt <time> [:SENSe] :SWEep:EGATe:VIEW:STARt?
Example	SWE:EGAT:VIEW:STAR 10ms
Notes	Units of time are required or no units; otherwise an invalid suffix error message will be generated. See error -131.
Preset	0 ms
State Saved	Saved in instrument state
Min	0
Max	500 ms
Initial S/W Revision	A.10.00

Gate Delay

Controls the length of time from the time the gate condition goes True until the gate is turned on.

Key Path	Sweep/Control, Gate
Remote Command	[:SENSe] :SWEep:EGATe:DELay <time> [:SENSe] :SWEep:EGATe:DELay?
Example	SWE:EGAT:DELay 500ms

	SWE:EGAT:DElAY?
Notes	Units of time are required or no units; otherwise an invalid suffix error message will be generated.
Preset	57.7 us WiMAX OFDMA: 71 us GSM/EDGE: 600 us WLAN: 500 us
State Saved	Saved in instrument state
Min	0.0 us
Max	100 s
Backwards Compatibility SCPI	[:SENSE] :SWEep:TIME:GATE:DElAY ESA compatibility
Initial S/W Revision	Prior to A.02.00

Gate Length

Controls the length of time that the gate is on after it opens.

Key Path	Sweep/Control, Gate
Remote Command	[:SENSE] :SWEep:EGATE:LENGth <time> [:SENSE] :SWEep:EGATE:LENGth?
Example	SWE:EGAT:LENG 1 SWE:EGAT:LENG?
Notes	Units of time are required or no units; otherwise an invalid suffix error message will be generated.
Dependencies	Grayed out when Gate Method is set to FFT in which case the label changes to that shown below. <div style="border: 1px solid gray; padding: 5px; display: inline-block; margin-bottom: 10px;"> Gate Length (=1.83/RBW) 2.8 ms </div> <small>vsd 39-1</small> The key is also grayed out if Gate Control = Level.
Preset	461.6 us WiMAX OFDMA: 50 us GSM/EDGE: 200 us WLAN: 1.54 ms
State Saved	Saved in instrument state
Min	100 ns
Max	5 s
Backwards Compatibility SCPI	[:SENSE] :SWEep:TIME:GATE:LENGth ESA compatibility
Initial S/W Revision	Prior to A.02.00

Method

This lets you choose one of the three different types of gating.

Not all types of gating are available for all measurements.

Key Path	Sweep/Control, Gate
Remote Command	[:SENSe] :SWEep:EGATe:METhod LO VIDeo FFT [:SENSe] :SWEep:EGATe:METhod?
Example	SWE:EGAT: METH FFT
Preset	LO
State Saved	Saved in instrument state
Initial S/W Revision	Prior to A.02.00

LO

When Gate is set to On, the LO sweeps whenever the gate conditions as specified in the Gate menu are satisfied by the signal at the Gate Source.

This form of gating is more sophisticated, and results in faster measurements. With Gated LO, the analyzer only sweeps while the gate conditions are satisfied. This means that a sweep could take place over several gate events. It would start when the gate signal goes true and stop when it goes false, and then continue when it goes true again. But since the LO is sweeping as long as the gate conditions are satisfied, the sweep typically finishes much more quickly than with Gated Video.

When in zero span, there is no actual sweep performed. But data is only taken while the gate conditions are satisfied. So even though there is no sweep, the gate settings will impact when data is acquired.

Key Path	Sweep/Control, Gate, Method
Dependencies	Key is unavailable when Gate is On and FFT Sweep Type manually selected. When selected, Sweep Type is forced to Swept and the FFT key in Sweep Type is grayed out.
Readback	LO
Initial S/W Revision	Prior to A.02.00

Video

When Gate is set to On, the video signal is allowed to pass through whenever the gate conditions as specified in the Gate menu are satisfied by the signal at the Gate Source.

This form of gating may be thought of as a simple switch, which connects the signal to the input of the spectrum analyzer. When the gate conditions are satisfied, the switch is closed, and when the gate conditions are not satisfied, the switch is open. So we only look at the signal while the gate conditions are satisfied.

With this type of gating, you usually set the analyzer to sweep very slowly. In fact, a general rule is to sweep slowly enough that the gate is guaranteed to be closed at

least once per data measurement interval (bucket). Then if the peak detector is used, each bucket will represent the peak signal as it looks with the gate closed.

Key Path	Sweep/Control, Gate, Method
Dependencies	Key is unavailable when Gate is On and FFT Sweep Type manually selected. When selected, Sweep Type is forced to Swept and the FFT key in Sweep Type is grayed out
Readback	Video
Initial S/W Revision	Prior to A.02.00

FFT

When Gate is set to On, an FFT is performed whenever the gate conditions as specified in the Gate menu are satisfied by the signal at the Gate Source. This is an FFT measurement which begins when the gate conditions are satisfied. Since the time period of an FFT is approximately $1.83/\text{RBW}$, you get a measurement that starts under predefined conditions and takes place over a predefined period. So, in essence, this is a gated measurement. You have limited control over the gate length but it works in FFT sweeps, which the other two methods do not.

Gated FFT cannot be done in zero span since the instrument is not sweeping. So in zero span the Gated LO method is used. Data is still only taken while the gate conditions are satisfied, so the gate settings do impact when data is acquired.

The Gate Length will be $1.83/\text{RBW}$.

This is a convenient way to make a triggered FFT measurement under control of an external gating signal.

Key Path	Sweep/Control, Gate
Dependencies	Key is unavailable when Gate is On and Swept Sweep Type is manually selected. When selected, Sweep Type is forced to FFT and the Swept key in Sweep Type is grayed out Key is unavailable when gate Control is set to Level. Forces Gate Length to $1.83/\text{RBW}$
Readback	FFT
Initial S/W Revision	Prior to A.02.00

Gate Source

The menus under the **Gate Source** key are the same as those under the **Trigger key**, with the exception that neither **Free Run** nor **Video** are available as Gate Source selections. However, a different SCPI command is used to select the Gate Source (see table below) because you may independently set the Gate Source and the Trigger Source.

Any changes to the settings in the setup menus under each Gate Source selection key (for example: Trigger Level, Trigger Delay, etc.) also affect the corresponding settings under the Trigger menu keys. The SCPI commands used for these are the same for Trigger and Gate, since there is only one setting which affects both Gate and Trigger. Example: to set the Trigger Level for External 1 you use the command

:TRIG:EXT1:LEV regardless of whether you are using External 1 as a Trigger Source or a Gate Source.

Key Path	Sweep/Control, Gate
Remote Command	[:SENSe] :SWEep :EGATe :SOURce EXTerna11 EXTerna12 LINE FRAMe RFBurst TV PXI [:SENSe] :SWEep :EGATe :SOURce ?
Dependencies	In some models, there is no second External input. In these models, the External 2 key is blanked and the EXTerna12 parameter will generate a "Hardware missing; Not available for this model number" error. PXI trigger is only supported in PXI (modular) instruments.
Preset	EXTerna1 GSM/EDGE, MSR: FRAMe LTETDD: EXTerna1When Direction is Downlink, FRAMe when Direction is Uplink.
Backwards Compatibility Notes	In ESA, there is a single Gate input port. In PSA, the Gate Source may be taken from one of two specified input ports. In the X-Series, any Trigger Source can be a Gate Source.
Initial S/W Revision	Prior to A.02.00
Modified at S/W Revision	A.03.00, A.14.00

Line

Pressing this key, when it is not selected, selects the line signal as the trigger. A new sweep/measurement will start synchronized with the next cycle of the line voltage. Pressing this key, when it is already selected, access the line trigger setup menu.

Key Path	Trigger
Example	TRIG:SOUR LINE Swept SA measurement TRIG:<meas>:SOUR LINE Measurements other than Swept SA
Dependencies	Line trigger is not available when operating from a "dc power source", for example, when the instrument is powered from batteries.
State Saved	Saved in instrument state
Status Bits/OPC dependencies	The Status Operation Register bit 5 "Waiting for Trigger" is set at the same time as the Sweeping or Measuring bit is set. It is cleared when the trigger actually occurs (that is, after the trigger event occurs and all the applicable trigger criteria have been met). A corresponding pop-up message ("Waiting for trigger") is generated if no trigger signal appears after approximately 2 sec. This message goes away when a trigger signal appears.
Initial S/W Revision	Prior to A.02.00

Trig Slope

Controls the trigger polarity. It is set positive to trigger on a rising edge and negative to trigger on a falling edge.

Key Path	Trigger, Line
Remote Command	:TRIGger [:SEQuence] :LINE :SLOPe POSitive NEGative

	:TRIGger[:SEQuence]:LINE:SLOPe?
Example	TRIG:LINE:SLOP NEG
Preset	POSitive
State Saved	Saved in instrument state
Backwards Compatibility Notes	The legacy :TRIGger[:SEQuence]:SLOPe command affects the slopes for the VID, LINE, EXT1, EXT2, and RFB triggers.
Initial S/W Revision	Prior to A.02.00

External 1

Pressing this key, when it is not selected, selects an external input signal as the trigger. A new sweep/measurement will start when the external trigger condition is met using the external 1 input connector on the rear panel.

Pressing this key, when it is already selected, accesses the external 1 trigger setup menu.

Key Path	Trigger
Example	TRIG:SOUR EXT1 Swept SA measurement TRIG:<meas>:SOUR EXT1 Measurements other than Swept SA
Dependencies	Grayed out if in use by Point Trigger in the Source Setup menu. Forced to Free Run if already selected and Point Trigger is set to External 1.
State Saved	Saved in instrument state
Status Bits/OPC dependencies	The Status Operation Register bit 5 "Waiting for Trigger" is set at the same time as the Sweeping or Measuring bit is set. It is cleared when the trigger actually occurs (that is, after the trigger event occurs and all the applicable trigger criteria have been met). A corresponding pop-up message ("Waiting for trigger") is generated if no trigger signal appears after approximately 2 sec. This message goes away when a trigger signal appears.
Initial S/W Revision	Prior to A.02.00

Trigger Level

Sets the value where the external 1 trigger input will trigger a new sweep/measurement.

Key Path	Trigger, External 1
Remote Command	:TRIGger[:SEQuence]:EXTernal1:LEVel <level> :TRIGger[:SEQuence]:EXTernal1:LEVel?
Example	TRIG:EXT1:LEV 0.4 V
Couplings	This same level is used for the Ext1 trigger source in the Trigger menu, for the Ext1 selection in the Periodic Timer sync source (in the Trigger menu and in the Gate Source menu), and also for the Ext1 selection in the Gate Source menu.
Preset	1.2 V
State Saved	Saved in instrument state

Min	-5 V
Max	5 V
Default Unit	V
Backwards Compatibility SCPI	:TRIGger[:SEquence]:EXTernal:LEVel
	For backward compatibility, the parameter EXTernal is mapped to EXTernal1
Backwards Compatibility SCPI	:TRIGger[:SEquence]:FRAME:EXTernal1:LEVel
Initial S/W Revision	Prior to A.02.00

Trig Slope

Controls the trigger polarity. It is set positive to trigger on a rising edge and negative to trigger on a falling edge.

Key Path	Trigger, External 1
Remote Command	:TRIGger[:SEquence]:EXTernal1:SLOPe POSitive NEGative :TRIGger[:SEquence]:EXTernal1:SLOPe?
Example	TRIG:EXT1:SLOP NEG
Couplings	This same slope is used in the Ext1 selection for the trigger source in the Trigger menu and for the period timer sync source (in the Trigger menu and in the Gate Source menu).
Preset	POSitive
State Saved	Saved in instrument state
Backwards Compatibility SCPI	:TRIGger[:SEquence]:EXTernal:SLOPe
	For backward compatibility, the parameter EXTernal is mapped to EXTernal1
Backwards Compatibility SCPI	:TRIGger[:SEquence]:FRAME:EXTernal1:SLOPe
Backwards Compatibility Notes	The legacy :TRIGger[:SEquence]:SLOPe command affects the slopes for the VID, LINE, EXT1, EXT2, and RFB triggers.
Initial S/W Revision	Prior to A.02.00

Zero Span Delay Comp On/Off

In zero span, there is a natural delay in the signal path, which comes from the RBW filter. This is usually desirable, as it allows you to trigger on events and also see those events, because the signal is delayed from the trigger event. However, in some cases it is desirable to eliminate this delay, so that trigger events line up exactly with the zero time point in zero span. You can use the **Zero Span Delay Comp On/Off** feature to enable or disable zero span delay compensation.

Key Path	Trigger, External 1
Remote Command	:TRIGger[:SEquence]:EXTernal1:DElay:COMPensation OFF ON 0 1 :TRIGger[:SEquence]:EXTernal1:DElay:COMPensation?

Example	TRIG:EXT1:DEL:COMP ON
Dependencies	No effect except in zero-span, but not locked out in nonzero spans. Blanked in modes that do not support zero-span measurements. If the SCPI command is sent when the key is blanked, an error is returned: -221, "Settings conflict; Feature not supported for this measurement" In analyzers shipping N9060A, this feature requires N9060A-7FP.
Preset	OFF
State Saved	Saved in instrument state
Initial S/W Revision	A.11.00

External 2

Pressing this key, when it is not selected, selects an external input signal as the trigger. A new sweep/measurement will start when the external trigger condition is met using the external 2 input connector. The external trigger 2 input connector is on the rear panel.

Pressing this key, when it is already selected, accesses the external 2 trigger setup menu.

Key Path	Trigger
Example	TRIG:SOUR EXT2 Swept SA measurement TRIG:<meas>:SOUR EXT2 Measurements other than Swept SA
Dependencies	In some models, there is no second External input. In these models, the External 2 key is blanked and the EXTERNAL2 parameter will generate a "Hardware missing; Not available for this model number" message. Grayed out if in use by Point Trigger in the Source Setup menu. Forced to Free Run if already selected and Point Trigger is set to External 2.
State Saved	Saved in instrument state
Status Bits/OPC dependencies	The Status Operation Register bit 5 "Waiting for Trigger" is set at the same time as the Sweeping or Measuring bit is set. It is cleared when the trigger actually occurs (that is, after the trigger event occurs and all the applicable trigger criteria have been met). A corresponding pop-up message ("Waiting for trigger") is generated if no trigger signal appears after approximately 2 sec. This message goes away when a trigger signal appears.
Initial S/W Revision	Prior to A.02.00
Modified at S/W Revision	A.03.00

Trigger Level

Sets the value where the external 2 trigger input will trigger a new sweep/measurement.

Key Path	Trigger, External 2
Remote Command	:TRIGger[:SEquence]:EXTerna12:LEVe1 :TRIGger[:SEquence]:EXTerna12:LEVe1?

Example	TRIG:EXT2:LEV 1.1 V
Couplings	This same level is used for the Ext2 trigger source in the Trigger menu, for the Ext2 selection in the Periodic Timer sync source (in the Trigger menu and in the Gate Source menu), and also for the Ext2 selection in the Gate Source menu.
Preset	1.2 V
State Saved	Saved in instrument state
Min	-5 V
Max	5 V
Default Unit	V
Backwards Compatibility SCPI	:TRIGger[:SEQuence]:FRAME:EXTerna12:LEVel
Initial S/W Revision	Prior to A.02.00

Trig Slope

Controls the trigger polarity. It is set positive to trigger on a rising edge and negative to trigger on a falling edge.

Key Path	Trigger, External 2
Remote Command	:TRIGger[:SEQuence]:EXTerna12:SLOPe POSitive NEGative :TRIGger[:SEQuence]:EXTerna12:SLOPe?
Example	TRIG:EXT2:SLOP NEG
Couplings	This same slope is used in the Ext2 selection for the trigger source in the Trigger menu and for the period timer sync source (in the Trigger menu and in the Gate Source menu).
Preset	POSitive
State Saved	Saved in instrument state
Backwards Compatibility SCPI	:TRIGger[:SEQuence]:FRAME:EXTerna12:SLOPe
Backwards Compatibility Notes	The legacy :TRIGger[:SEQuence]:SLOPe command affects the slopes for the VID, LINE, EXT1, EXT2, and RFB triggers.
Initial S/W Revision	Prior to A.02.00

Zero Span Delay Comp On/Off

In zero span, there is a natural delay in the signal path, which comes from the RBW filter. This is usually desirable, as it allows you to trigger on events and also see those events, because the signal is delayed from the trigger event. However, in some cases it is desirable to eliminate this delay, so that trigger events line up exactly with the zero time point in zero span. You can use the **Zero Span Delay Comp On/Off** feature to enable or disable zero span delay compensation.

Key Path	Trigger, External 2
Remote Command	:TRIGger[:SEQuence]:EXTerna12:DElAY:COMPensation OFF ON 0 1

:TRIGger[:SEquence]:EXternal2:DElay:COMPensation?	
Example	TRIG:EXT2:DEL:COMP ON
Dependencies	No effect except in zero-span, but not locked out in nonzero spans. Blanked in modes that do not support zero-span measurements. If the SCPI command is sent when the key is blanked, an error is returned: -221, "Settings conflict; Feature not supported for this measurement" In analyzers shipping N9060A, this feature requires N9060A-7FP.
Preset	OFF
State Saved	Saved in instrument state
Initial S/W Revision	A.11.00

RF Burst

Pressing this key, when it is not selected, selects the RF Burst as the trigger. A new sweep/measurement will start when an RF burst envelope signal is identified from the signal at the RF Input connector. Pressing this key, when it is already selected, accesses the RF Burst trigger setup menu.

In some models, a variety of burst trigger circuitry is available, resulting in various available burst trigger bandwidths. The analyzer automatically chooses the appropriate trigger path based on the hardware configuration and other settings of the analyzer.

Key Path	Trigger
Example	TRIG:SOUR RFB Swept SA measurement TRIG:<meas>:SOUR RFB Measurements other than Swept SA
State Saved	Saved in instrument state
Status Bits/OPC dependencies	The Status Operation Register bit 5 "Waiting for Trigger" is set at the same time as the Sweeping or Measuring bit is set. It is cleared when the trigger actually occurs (that is, after the trigger event occurs and all the applicable trigger criteria have been met). A corresponding pop-up message ("Waiting for trigger") is generated if no trigger signal appears after approximately 2 sec. This message goes away when a trigger signal appears.
Backwards Compatibility Notes	The legacy command: :TRIGger[:SEquence]:RFBurst:FSElectivity[:STATe] OFF ON 0 1 is not supported in the X-Series, as the hardware to do Frequency Selective burst triggers does not exist in X-Series.
Initial S/W Revision	Prior to A.02.00
Modified at S/W Revision	A.04.00

Absolute Trigger Level

Sets the absolute trigger level for the RF burst envelope.

When using the External Mixing path, the Absolute Trigger Level is uncalibrated because the factory default was set to accommodate the expected IF levels for the RF path.

Key Path	Trigger, RF Burst
Scope	Meas Global
Remote Command	:TRIGger[:SEquence]:RFBurst:LEVel:ABSolute <aml> :TRIGger[:SEquence]:RFBurst:LEVel:ABSolute?
Example	TRIG:RFB:LEV:ABS 10 dBm sets the trigger level of the RF burst envelope signal to the absolute level of 10 dBm
Notes	Sending this command does not switch the setting from relative to absolute; to switch it you need to send the :TRIGger[:SEquence]:RFBurst:LEVel:TYPE command, below. Amplitude Corrections are not taken into account by the Absolute Trigger Level. For example, if you have given yourself effective gain with an amplitude correction factor, the Absolute Trigger will not fire until you have set the trigger level that far below the displayed signal level, rather than simply to the displayed signal level. This is only true for Amplitude Corrections, not External Gain or Ref Level Offset functions. If mode is Bluetooth, the default value is -50 dBm.
Couplings	This same level is used for the RF Burst trigger source in the Trigger menu, for the RF Burst selection in the Periodic Timer sync source (in the Trigger menu and in the Gate Source menu), and also for the RF Burst selection in the Gate Source menu
Preset	-20 dBm
State Saved	Saved in instrument state
Min	-200 dBm
Max	100 dBm
Default Unit	depends on the current selected Y-Axis unit
Backwards Compatibility SCPI	:TRIGger[:SEquence]:FRAME:RFBurst:LEVel:ABSolute
Initial S/W Revision	Prior to A.02.00
Modified at S/W Revision	A.04.00

Key Path	Trigger, RF Burst
Remote Command	:TRIGger[:SEquence]:RFBurst:LEVel:TYPE ABSolute RELative :TRIGger[:SEquence]:RFBurst:LEVel:TYPE?
Example	TRIG:RFB:LEV:TYPE REL sets the trigger level type of the RF burst trigger to Relative.
Preset	ABSolute
State Saved	Saved in instrument state
Initial S/W Revision	Prior to A.02.00
Modified at S/W Revision	A.04.00

Relative Trigger Level

Sets the relative trigger level for the RF burst envelope.

In some models, the relative burst trigger function is implemented in hardware. In other models, without the advanced triggering hardware required, the relative burst trigger function is implemented in software in some measurements, and is unavailable in other measurements.

When implemented in software, the relative RF Burst trigger function is implemented as follows:

5. The measurement starts with the absolute RF Burst trigger setting. If it cannot get a trigger with that level, auto trigger fires and the acquisition starts anyway. After the acquisition, the measurement searches for the peak in the acquired waveform and saves it.
6. Now, in the next cycle of the measurement, the measurement determines a new absolute RF Burst level based on the peak value from the first measurement and the Relative RF Burst Trigger Level (always 0 or negative dB) set by the user. The following formula is used:
7. absolute RF Burst level = peak level of the previous acquisition + relative RF Burst level
8. If the new absolute RF Burst level differs from the previous by more than 0.5 dB, the new level is sent to the hardware; otherwise it is not updated (to avoid slowing down the acquisition)

Steps 2 and 3 repeat for subsequent measurements.

Key Path	Trigger, RF Burst
Scope	Meas Global
Remote Command	:TRIGger[:SEquence]:RFBurst:LEVel:RELative <rel_amp1> :TRIGger[:SEquence]:RFBurst:LEVel:RELative?
Example	TRIG:RFB:LEV:REL -10 dB sets the trigger level of the RF burst envelope signal to the relative level of -10 dB
Notes	Sending this command does not switch the setting from absolute to relative; to switch it you need to send the :TRIGger[:SEquence]:RFBurst:LEVel:TYPE command, above. The relative trigger level is not available in some measurements. In those measurements the RELative parameter, and the :TRIGger[:SEquence]:RFBurst:LEVel:TYPE command (above), will generate an error if sent.
Dependencies	This key is grayed out and Absolute Trigger Level selected if the required hardware is not present in your analyzer and the current measurement does not support Relative triggering.
Preset	-6 dB GSM: -25 dB

State Saved	Saved in instrument state
Min	-45 dB
Max	0 dB
Default Unit	dB or dBc
Backwards Compatibility SCPI	:TRIGger[:SEquence]:RFBurst:LEVel This legacy command is aliased to :TRIGger[:SEquence]:RFBurst:LEVel:RELative because the PSA had ONLY relative burst triggering
Initial S/W Revision	Prior to A.02.00
Modified at S/W Revision	A.04.00

Trigger Slope

It is set positive to trigger on a rising edge and negative to trigger on a falling edge.

Key Path	Trigger, RF Burst
Remote Command	:TRIGger[:SEquence]:RFBurst:SLOPe POSitive NEGative :TRIGger[:SEquence]:RFBurst:SLOPe?
Example	TRIG:RFB:SLOP NEG
Couplings	This same slope is used in the RF Burst selection for the trigger source in the Trigger menu and for the period timer sync source (in the Trigger menu and in the Gate Source menu).
Preset	POSitive
State Saved	Saved in instrument state
Backwards Compatibility SCPI	:TRIGger[:SEquence]:FRAME:RFBurst:SLOPe
Backwards Compatibility Notes	The legacy :TRIGger[:SEquence]:SLOPe command affects the slopes for the VID, LINE, EXT1, EXT2, and RFB triggers.
Initial S/W Revision	Prior to A.02.00

Zero Span Delay Comp On/Off

In zero span, there is a natural delay in the signal path, which comes from the RBW filter. This is usually desirable, as it allows you to trigger on events and also see those events, because the signal is delayed from the trigger event. However, in some cases it is desirable to eliminate this delay, so that trigger events line up exactly with the zero time point in zero span. You can use the **Zero Span Delay Comp On/Off** feature to enable or disable zero span delay compensation.

Key Path	Trigger, RF Burst
Remote Command	:TRIGger[:SEquence]:RFBurst:DELAy:COMPensation OFF ON 0 1 :TRIGger[:SEquence]:RFBurst:DELAy:COMPensation?
Example	TRIG:RFB:DEL:COMP ON
Dependencies	No effect except in zero-span, but not locked out in nonzero spans.

	Blanked in modes that do not support zero-span measurements. If the SCPI command is sent when the key is blanked, an error is returned: -221, "Settings conflict; Feature not supported for this measurement" In analyzers shipping N9060A, this feature requires N9060A-7FP.
Preset	OFF
State Saved	Saved in instrument state
Initial S/W Revision	A.11.00

Periodic Timer (Frame Trigger)

Pressing this key, when it is not selected, selects the internal periodic timer signal as the trigger. Triggering occurrences are set by the **Period** parameter, which is modified by the **Sync Source** and **Offset**. Pressing this key, when it is already selected, accesses the periodic timer trigger setup functions.

If you do not have a sync source selected (it is Off), then the internal timer will not be synchronized with any external timing events.

Key Path	Trigger
Example	TRIG:SOUR FRAM Swept SA measurement TRIG:<meas>:SOUR FRAM Measurements other than Swept SA
State Saved	Saved in instrument state
Readback	[Sync: <value of Sync Source>], for example, [Sync: External 1]
Status Bits/OPC dependencies	The Status Operation Register bit 5 "Waiting for Trigger" is set at the same time as the Sweeping or Measuring bit is set. It is cleared when the trigger actually occurs (that is, after the trigger event occurs and all the applicable trigger criteria have been met). A corresponding pop-up message ("Waiting for trigger") is generated if no trigger signal appears after approximately 2 sec. This message goes away when a trigger signal appears.
Initial S/W Revision	Prior to A.02.00

Periodic Timer Triggering:

This feature selects the internal periodic timer signal as the trigger. Trigger occurrences are set by the **Periodic Timer** parameter, which is modified by the **Sync Source** and **Offset**.

The figure below shows the action of the periodic timer trigger. Before reviewing the figure, we'll explain some uses for the periodic trigger.

A common application is measuring periodic burst RF signals for which a trigger signal is not easily available. For example, we might be measuring a TDMA radio which bursts every 20 ms. Let's assume that the 20 ms period is very consistent. Let's also assume that we do not have an external trigger source available that is synchronized with the period, and that the signal-to-noise ratio of the signal is not high enough to provide a clean RF burst trigger at all of the analysis frequencies. For example, we might want to measure spurious transmissions at an offset from the carrier that is larger than the bandwidth of the RF burst trigger. In this application, we can set the Periodic Timer to a 20.00 ms period and adjust the offset from that timer to position our trigger just where we want it. If we find that the 20.00 ms is not

exactly right, we can adjust the period slightly to minimize the drift between the period timer and the signal to be measured.

A second way to use this feature would be to use **Sync Source** temporarily, instead of **Offset**. In this case, we might tune to the signal in a narrow span and use the RF Burst trigger to synchronize the periodic timer. Then we would turn the sync source off so that it would not miss-trigger. Miss-triggering can occur when we are tuned so far away from the RF burst trigger that it is no longer reliable.

A third example would be to synchronize to a signal that has a reference time element of much longer period than the period of interest. In some CDMA applications, it is useful to look at signals with a short periodicity, by synchronizing that periodicity to the "even-second clock" edge that happens every two seconds. Thus, we could connect the even-second clock trigger to Ext1 and use then Ext1 as the sync source for the periodic timer.

The figure below illustrates this third example. The top trace represents the even-second clock. It causes the periodic timer to synchronize with the leading edge shown. The analyzer trigger occurs at a time delayed by the accumulated offset from the period trigger event. The periodic timer continues to run, and triggers continue to occur, with a periodicity determined by the analyzer time base. The timer output (labeled "late event") will drift away from its ideal time due to imperfect matching between the time base of the signal being measured and the time base of the analyzer, and also because of imperfect setting of the period parameter. But the synchronization is restored on the next even-second clock event. ("Accumulated offset" is described in the in the **Offset** function section.)

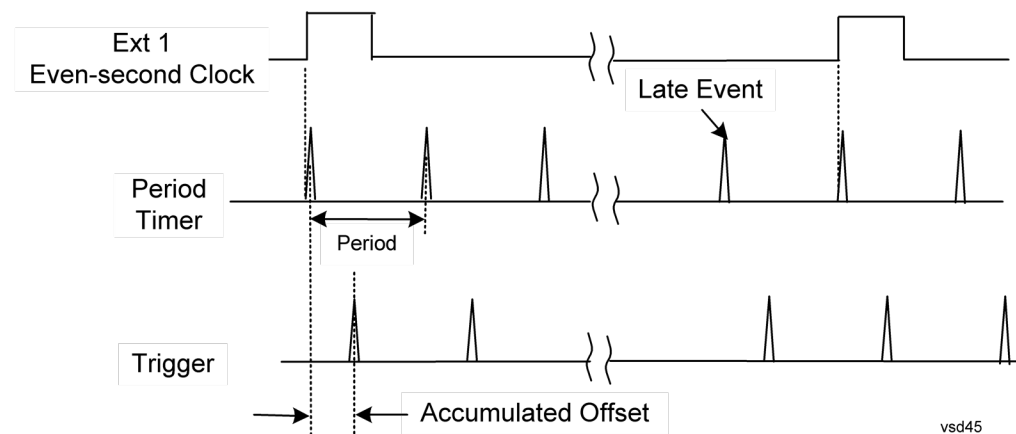

Period

Sets the period of the internal periodic timer clock. For digital communications signals, this is usually set to the frame period of your current input signal. In the case that sync source is not set to OFF, and the external sync source rate is changed for some reason, the periodic timer is synchronized at the every external synchronization pulse by resetting the internal state of the timer circuit.

Key Path	Trigger, Periodic Timer
Remote Command	:TRIGGER[:SEQUENCE]:FRAME:PERIOD <time>

	:TRIGger[:SEQuence]:FRAMe:PERiod?
Example	TRIG:FRAM:PER 100 ms
Dependencies	The invalid data indicator turns on when the period is changed, until the next sweep/measurement completes.
Couplings	The same period is used in the Gate Source selection of the period timer.
Preset	20 ms GSM: 4.615383
State Saved	Saved in instrument state
Min	100.000 ns
Max	559.0000 ms
Default Unit	S
Initial S/W Revision	Prior to A.02.00

Offset

Adjusts the accumulated offset between the periodic timer events and the trigger event. Adjusting the accumulated offset is different than setting an offset, and requires explanation.

The periodic timer is usually not synchronized with any external events, so the timing of its output events has no absolute meaning. Since the timing relative to external events (RF signals) is important, you need to be able to adjust (offset) it. However, you have no direct way to see when the periodic timer events occur. All that you can see is the trigger timing. When you want to adjust the trigger timing, you will be changing the internal offset between the periodic timer events and the trigger event. Because the absolute value of that internal offset is unknown, we will just call that the accumulated offset. Whenever the Offset parameter is changed, you are changing that accumulated offset. You can reset the displayed offset using Reset Offset Display. Changing the display does not change the value of the accumulated offset, and you can still make additional changes to accumulated offset.

To avoid ambiguity, we define that an increase in the "offset" parameter, either from the knob or the SCPI adjust command, serves to delay the timing of the trigger event.

Key Path	Trigger, Periodic Timer
Remote Command	:TRIGger[:SEQuence]:FRAMe:OFFSet <time> :TRIGger[:SEQuence]:FRAMe:OFFSet?
Example	TRIG:FRAM:OFFS 1.2 ms
Notes	The front panel interface (for example, the knob), and this command, adjust the accumulated offset, which is shown on the active function display. However, the actual amount sent to the hardware each time the offset is updated is the delta value, that is, the current accumulated offset value minus the previous accumulated offset value. Note that the accumulated offset value is essentially arbitrary; it represents the accumulated offset from the last time the offset was zeroed (with the Reset Offset Display key). Note that this command does not change the period of the trigger waveform. Note also that Offset

	is used only when the sync source is set to OFF, otherwise delay is used, see section "Trig Delay" on page 568 . An increase in the "offset" parameter, either from the knob or the SCPI adjust command, serves to delay the timing of the trigger event.
Notes	When the SCPI command is sent the value shown on the key (and the Active Function, if this happens to be the active function) is updated with the new value. However, the actual amount sent to the hardware is the delta value, that is, the current accumulated offset value minus the previous accumulated offset value. The SCPI query simply returns the value currently showing on the key.
Dependencies	The invalid data indicator turns on when the offset is changed, until the next sweep/measurement completes.
Couplings	The same offset is used in the Gate Source selection of the period timer.
Preset	0 s
State Saved	Saved in instrument state
Min	-10.000 s
Max	10.000 s
Default Unit	S
Initial S/W Revision	Prior to A.02.00

Offset Adjust (Remote Command Only)

This remote command does not work at all like the related front panel keys. This command lets you advance the phase of the frame trigger by the amount you specify.

It does not change the period of the trigger waveform. If the command is sent multiple times, it advances the phase of the frame trigger an additional amount each time it is sent. Negative numbers are permitted.

Remote Command	:TRIGger[:SEquence]:FRAMe:ADJust <time>
Example	TRIG:FRAM:ADJ 1.2 ms
Notes	Note also that Offset is used only when the sync source is set to OFF, otherwise delay is used, see section "Trig Delay" on page 568 . An increase in the "offset" parameter, either from the knob or the SCPI adjust command, serves to delay the timing of the trigger event.
Notes	The front panel interface (for example, the knob) and the :TRIG:FRAM:OFFS command adjust the accumulated offset, which is shown on the active function display. However, the actual amount sent to the hardware is the delta value, that is, the current offset value minus the previous offset value. When the SCPI command is sent the value shown on the key (and the Active Function, if this happens to be the active function) is updated by increasing it (or decreasing it if the value sent is negative) by the amount specified in the SCPI command. This is a "command only" SCPI command, with no query.
Dependencies	The invalid data indicator turns on when the offset is changed, until the next sweep/measurement completes.

Couplings	The same offset is used in the Gate Source selection of the period timer.
Preset	0 s
State Saved	Saved in instrument state
Min	-10.000 s
Max	10.000 s
Default Unit	S
Initial S/W Revision	Prior to A.02.00

Reset Offset Display

Resets the value of the periodic trigger offset display setting to 0.0 seconds. The current displayed trigger location may include an offset value defined with the **Offset** key. Pressing this key redefines the currently displayed trigger location as the new trigger point that is 0.0 s offset. The **Offset** key can then be used to add offset relative to this new timing.

Key Path	Trigger, Periodic Timer
Remote Command	:TRIGger[:SEquence]:FRAMe:OFFSet:DISPlay:RESet
Example	TRIG:FRAM:OFFS:DISP:RES
Initial S/W Revision	Prior to A.02.00

Sync Source

Selects a signal source for you to synchronize your periodic timer trigger to, otherwise you are triggering at some arbitrary location in the frame. Synchronization reduces the precision requirements on the setting of the period.

For convenience you may adjust the level and slope of the selected sync source in a conditional branch setup menu accessed from the Sync Source menu. Note that these settings match those in the **Trigger** and **Gate Source** menus; that is, each trigger source has only one value of level and slope, regardless of which menu it is accessed from.

Key Path	Trigger, Periodic Timer
Remote Command	:TRIGger[:SEquence]:FRAMe:SYNC EXTerna11 EXTerna12 RFBurst PXI OFF :TRIGger[:SEquence]:FRAMe:SYNC?
Example	TRIG:FRAM:SYNC EXT2
Dependencies	In some models, there is no second External input. In these models, the External 2 key is blanked and the EXTerna12 parameter will generate a "Hardware missing; Not available for this model number" message. PXI trigger is only supported in PXI (modular) instruments.
Preset	Off GSM/EDGE, MSR,LTE,LTETDD: RFBurst
State Saved	Saved in instrument state

Readback	The current setting is read back to this key and it is also Readback to the previous Periodic Timer trigger key.
Backwards Compatibility SCPI	:TRIGger[:SEquence]:FRAMe:SYNC EXTernal For backward compatibility, the parameter EXTernal is mapped to EXTernal1
Initial S/W Revision	Prior to A.02.00
Modified at S/W Revision	A.03.00, A.14.00

Off

Turns off the sync source for your periodic trigger. With the sync source off, the timing will drift unless the signal source frequency is locked to the analyzer frequency reference.

Key Path	Trigger, Periodic Timer, Sync Source
Example	TRIG:FRAM:SYNC OFF
Readback	Off
Initial S/W Revision	Prior to A.02.00

External 1

Pressing this key, when it is not selected, selects an external input signal as the trigger. A new sweep/measurement will start when the external trigger condition is met using the external 1 input connector on the rear panel.

Pressing this key, when it is already selected, accesses the external 1 trigger setup menu.

Key Path	Trigger
Example	TRIG:SOUR EXT1 Swept SA measurement TRIG:<meas>:SOUR EXT1 Measurements other than Swept SA
Dependencies	Grayed out if in use by Point Trigger in the Source Setup menu. Forced to Free Run if already selected and Point Trigger is set to External 1.
State Saved	Saved in instrument state
Status Bits/OPC dependencies	The Status Operation Register bit 5 "Waiting for Trigger" is set at the same time as the Sweeping or Measuring bit is set. It is cleared when the trigger actually occurs (that is, after the trigger event occurs and all the applicable trigger criteria have been met). A corresponding pop-up message ("Waiting for trigger") is generated if no trigger signal appears after approximately 2 sec. This message goes away when a trigger signal appears.
Initial S/W Revision	Prior to A.02.00

Trigger Level

Sets the value where the external 1 trigger input will trigger a new sweep/measurement.

Key Path	Trigger, External 1
Remote Command	:TRIGger[:SEquence]:EXTernal1:LEVel <level> :TRIGger[:SEquence]:EXTernal1:LEVel?
Example	TRIG:EXT1:LEV 0.4 V
Couplings	This same level is used for the Ext1 trigger source in the Trigger menu, for the Ext1 selection in the Periodic Timer sync source (in the Trigger menu and in the Gate Source menu), and also for the Ext1 selection in the Gate Source menu.
Preset	1.2 V
State Saved	Saved in instrument state
Min	-5 V
Max	5 V
Default Unit	V
Backwards Compatibility SCPI	:TRIGger[:SEquence]:EXTernal:LEVel For backward compatibility, the parameter EXTernal is mapped to EXTernal1
Backwards Compatibility SCPI	:TRIGger[:SEquence]:FRAME:EXTernal1:LEVel
Initial S/W Revision	Prior to A.02.00

Trig Slope

Controls the trigger polarity. It is set positive to trigger on a rising edge and negative to trigger on a falling edge.

Key Path	Trigger, External 1
Remote Command	:TRIGger[:SEquence]:EXTernal1:SLOPe POSitive NEGative :TRIGger[:SEquence]:EXTernal1:SLOPe?
Example	TRIG:EXT1:SLOP NEG
Couplings	This same slope is used in the Ext1 selection for the trigger source in the Trigger menu and for the period timer sync source (in the Trigger menu and in the Gate Source menu).
Preset	POSitive
State Saved	Saved in instrument state
Backwards Compatibility SCPI	:TRIGger[:SEquence]:EXTernal:SLOPe For backward compatibility, the parameter EXTernal is mapped to EXTernal1
Backwards Compatibility SCPI	:TRIGger[:SEquence]:FRAME:EXTernal1:SLOPe
Backwards Compatibility Notes	The legacy :TRIGger[:SEquence]:SLOPe command affects the slopes for the VID, LINE, EXT1, EXT2, and RFB triggers.
Initial S/W Revision	Prior to A.02.00

External 2

Pressing this key, when it is not selected, selects an external input signal as the trigger. A new sweep/measurement will start when the external trigger condition is

met using the external 2 input connector. The external trigger 2 input connector is on the rear panel.

Pressing this key, when it is already selected, accesses the external 2 trigger setup menu.

Key Path	Trigger
Example	TRIG:SOUR EXT2 Swept SA measurement TRIG:<meas>:SOUR EXT2 Measurements other than Swept SA
Dependencies	In some models, there is no second External input. In these models, the External 2 key is blanked and the EXTERNAL2 parameter will generate a "Hardware missing; Not available for this model number" message. Grayed out if in use by Point Trigger in the Source Setup menu. Forced to Free Run if already selected and Point Trigger is set to External 2.
State Saved	Saved in instrument state
Status Bits/OPC dependencies	The Status Operation Register bit 5 "Waiting for Trigger" is set at the same time as the Sweeping or Measuring bit is set. It is cleared when the trigger actually occurs (that is, after the trigger event occurs and all the applicable trigger criteria have been met). A corresponding pop-up message ("Waiting for trigger") is generated if no trigger signal appears after approximately 2 sec. This message goes away when a trigger signal appears.
Initial S/W Revision	Prior to A.02.00
Modified at S/W Revision	A.03.00

Trigger Level

Sets the value where the external 2 trigger input will trigger a new sweep/measurement.

Key Path	Trigger, External 2
Remote Command	:TRIGger[:SEquence]:EXTerna12:LEVe1 :TRIGger[:SEquence]:EXTerna12:LEVe1?
Example	TRIG:EXT2:LEV 1.1 V
Couplings	This same level is used for the Ext2 trigger source in the Trigger menu, for the Ext2 selection in the Periodic Timer sync source (in the Trigger menu and in the Gate Source menu), and also for the Ext2 selection in the Gate Source menu.
Preset	1.2 V
State Saved	Saved in instrument state
Min	-5 V
Max	5 V
Default Unit	V
Backwards Compatibility SCPI	:TRIGger[:SEquence]:FRAME:EXTerna12:LEVe1
Initial S/W Revision	Prior to A.02.00

Trig Slope

Controls the trigger polarity. It is set positive to trigger on a rising edge and negative to trigger on a falling edge.

Key Path	Trigger, External 2
Remote Command	:TRIGger[:SEquence]:EXTerna12:SLOPe POSitive NEGative :TRIGger[:SEquence]:EXTerna12:SLOPe?
Example	TRIG:EXT2:SLOP NEG
Couplings	This same slope is used in the Ext2 selection for the trigger source in the Trigger menu and for the period timer sync source (in the Trigger menu and in the Gate Source menu).
Preset	POSitive
State Saved	Saved in instrument state
Backwards Compatibility SCPI	:TRIGger[:SEquence]:FRAMe:EXTerna12:SLOPe
Backwards Compatibility Notes	The legacy :TRIGger[:SEquence]:SLOPe command affects the slopes for the VID, LINE, EXT1, EXT2, and RFB triggers.
Initial S/W Revision	Prior to A.02.00

RF Burst

Pressing this key, when it is not selected, selects the RF Burst as the trigger. A new sweep/measurement will start when an RF burst envelope signal is identified from the signal at the RF Input connector. Pressing this key, when it is already selected, accesses the RF Burst trigger setup menu.

In some models, a variety of burst trigger circuitry is available, resulting in various available burst trigger bandwidths. The analyzer automatically chooses the appropriate trigger path based on the hardware configuration and other settings of the analyzer.

Key Path	Trigger
Example	TRIG:SOUR RFB Swept SA measurement TRIG:<meas>:SOUR RFB Measurements other than Swept SA
State Saved	Saved in instrument state
Status Bits/OPC dependencies	The Status Operation Register bit 5 "Waiting for Trigger" is set at the same time as the Sweeping or Measuring bit is set. It is cleared when the trigger actually occurs (that is, after the trigger event occurs and all the applicable trigger criteria have been met). A corresponding pop-up message ("Waiting for trigger") is generated if no trigger signal appears after approximately 2 sec. This message goes away when a trigger signal appears.
Backwards Compatibility Notes	The legacy command: :TRIGger[:SEquence]:RFBurst:FSElectivity[:STATE] OFF ON 0 1 is not supported in the X-Series, as the hardware to do Frequency Selective burst triggers does not exist in X-Series.
Initial S/W Revision	Prior to A.02.00
Modified at S/W Revision	A.04.00

Absolute Trigger Level

Sets the absolute trigger level for the RF burst envelope.

When using the External Mixing path, the Absolute Trigger Level is uncalibrated because the factory default was set to accommodate the expected IF levels for the RF path.

Key Path	Trigger, RF Burst
Scope	Meas Global
Remote Command	:TRIGger[:SEquence]:RFBurst:LEVel:ABSolute <ampl> :TRIGger[:SEquence]:RFBurst:LEVel:ABSolute?
Example	TRIG:RFB:LEV:ABS 10 dBm sets the trigger level of the RF burst envelope signal to the absolute level of 10 dBm
Notes	Sending this command does not switch the setting from relative to absolute; to switch it you need to send the :TRIGger[:SEquence]:RFBurst:LEVel:TYPE command, below. Amplitude Corrections are not taken into account by the Absolute Trigger Level. For example, if you have given yourself effective gain with an amplitude correction factor, the Absolute Trigger will not fire until you have set the trigger level that far below the displayed signal level, rather than simply to the displayed signal level. This is only true for Amplitude Corrections, not External Gain or Ref Level Offset functions. If mode is Bluetooth, the default value is -50 dBm.
Couplings	This same level is used for the RF Burst trigger source in the Trigger menu, for the RF Burst selection in the Periodic Timer sync source (in the Trigger menu and in the Gate Source menu), and also for the RF Burst selection in the Gate Source menu
Preset	-20 dBm
State Saved	Saved in instrument state
Min	-200 dBm
Max	100 dBm
Default Unit	depends on the current selected Y-Axis unit
Backwards Compatibility SCPI	:TRIGger[:SEquence]:FRAMe:RFBurst:LEVel:ABSolute
Initial S/W Revision	Prior to A.02.00
Modified at S/W Revision	A.04.00

Key Path	Trigger, RF Burst
Remote Command	:TRIGger[:SEquence]:RFBurst:LEVel:TYPE ABSolute RELative :TRIGger[:SEquence]:RFBurst:LEVel:TYPE?
Example	TRIG:RFB:LEV:TYPE REL sets the trigger level type of the RF burst trigger to Relative.
Preset	ABSolute

State Saved	Saved in instrument state
Initial S/W Revision	Prior to A.02.00
Modified at S/W Revision	A.04.00

Relative Trigger Level

Sets the relative trigger level for the RF burst envelope.

In some models, the relative burst trigger function is implemented in hardware. In other models, without the advanced triggering hardware required, the relative burst trigger function is implemented in software in some measurements, and is unavailable in other measurements.

When implemented in software, the relative RF Burst trigger function is implemented as follows:

5. The measurement starts with the absolute RF Burst trigger setting. If it cannot get a trigger with that level, auto trigger fires and the acquisition starts anyway. After the acquisition, the measurement searches for the peak in the acquired waveform and saves it.
6. Now, in the next cycle of the measurement, the measurement determines a new absolute RF Burst level based on the peak value from the first measurement and the Relative RF Burst Trigger Level (always 0 or negative dB) set by the user. The following formula is used:
7. absolute RF Burst level = peak level of the previous acquisition + relative RF Burst level
8. If the new absolute RF Burst level differs from the previous by more than 0.5 dB, the new level is sent to the hardware; otherwise it is not updated (to avoid slowing down the acquisition)

Steps 2 and 3 repeat for subsequent measurements.

Key Path	Trigger, RF Burst
Scope	Meas Global
Remote Command	<code>:TRIGger[:SEquence]:RFBurst:LEVel:RELative <rel_amp1></code> <code>:TRIGger[:SEquence]:RFBurst:LEVel:RELative?</code>
Example	TRIG:RFB:LEV:REL -10 dB sets the trigger level of the RF burst envelope signal to the relative level of -10 dB
Notes	Sending this command does not switch the setting from absolute to relative; to switch it you need to send the <code>:TRIGger[:SEquence]:RFBurst:LEVel:TYPE</code> command, above. The relative trigger level is not available in some measurements. In those measurements the RELative parameter, and the <code>:TRIGger[:SEquence]:RFBurst:LEVel:TYPE</code> command (above), will generate an error if sent.

Dependencies	This key is grayed out and Absolute Trigger Level selected if the required hardware is not present in your analyzer and the current measurement does not support Relative triggering.
Preset	-6 dB GSM: -25 dB
State Saved	Saved in instrument state
Min	-45 dB
Max	0 dB
Default Unit	dB or dBc
Backwards Compatibility SCPI	:TRIGger[:SEquence]:RFBurst:LEVel This legacy command is aliased to :TRIGger[:SEquence]:RFBurst:LEVel:RELative because the PSA had ONLY relative burst triggering
Initial S/W Revision	Prior to A.02.00
Modified at S/W Revision	A.04.00

Trigger Slope

It is set positive to trigger on a rising edge and negative to trigger on a falling edge.

Key Path	Trigger, RF Burst
Remote Command	:TRIGger[:SEquence]:RFBurst:SLOPe POSitive NEGative :TRIGger[:SEquence]:RFBurst:SLOPe?
Example	TRIG:RFB:SLOP NEG
Couplings	This same slope is used in the RF Burst selection for the trigger source in the Trigger menu and for the period timer sync source (in the Trigger menu and in the Gate Source menu).
Preset	POSitive
State Saved	Saved in instrument state
Backwards Compatibility SCPI	:TRIGger[:SEquence]:FRAME:RFBurst:SLOPe
Backwards Compatibility Notes	The legacy :TRIGger[:SEquence]:SLOPe command affects the slopes for the VID, LINE, EXT1, EXT2, and RFB triggers.
Initial S/W Revision	Prior to A.02.00

Zero Span Delay Comp On/Off

In zero span, there is a natural delay in the signal path, which comes from the RBW filter. This is usually desirable, as it allows you to trigger on events and also see those events, because the signal is delayed from the trigger event. However, in some cases it is desirable to eliminate this delay, so that trigger events line up exactly with the zero time point in zero span. You can use the **Zero Span Delay Comp On/Off** feature to enable or disable zero span delay compensation.

Key Path	Trigger, RF Burst
----------	-------------------

Remote Command	:TRIGger[:SEquence]:RFBurst:DElay:COMPensation OFF ON 0 1 :TRIGger[:SEquence]:RFBurst:DElay:COMPensation?
Example	TRIG:RFB:DEL:COMP ON
Dependencies	No effect except in zero-span, but not locked out in nonzero spans. Blanked in modes that do not support zero-span measurements. If the SCPI command is sent when the key is blanked, an error is returned: -221, "Settings conflict; Feature not supported for this measurement" In analyzers shipping N9060A, this feature requires N9060A-7FP.
Preset	OFF
State Saved	Saved in instrument state
Initial S/W Revision	A.11.00

TV

Pressing this key, when it is not selected, selects the TV input signal as the trigger. A new sweep/measurement will start synchronized with the next occurrence of the synchronizing pulse of the selected TV line number.

Pressing this key, when it is already selected, opens a menu of TV Trigger setup functions. The default active function in this menu is the TV line number on which you want to trigger.

The Frame and Field options enable you to determine how the fields of the TV picture signal will be affected by the trigger system. One complete TV image consists of one frame of 525 or 625 horizontal lines depending on the TV standard being used. Each frame is composed of two fields of interlacing lines, each consisting of 262 1/2 lines (or 312 1/2 lines). The fields are called Field One and Field Two. Field One is viewed as having 263 lines (or 313 lines) and Field Two is viewed as having 262 lines (or 312 lines).

For the 525 line NTSC video standard, we refer to TV lines as follows (these are the Field Modes):

Entire Frame, lines 1 to 525

Field One, lines 1 to 263

Field Two, lines 1 to 262 (note that this really refers to "actual" lines 264 to 525)

For the 625 line PAL and SECAM video standards, we refer to TV lines as follows:

Entire Frame, lines 1 to 625

Field One, lines 1 to 313

Field Two, lines 314 to 625

As the Field is changed, the appropriate value for Line is chosen to keep triggering on the same line as before, or if this is not possible, the corresponding line in the new Field. For example, suppose line 264 is selected while in the NTSC-M standard and the Entire Frame mode. This is the first line in Field Two. If Field Two is then selected, the Line number changes to Line 1, the same actual line in the TV signal. If Field One

is then selected, the line number stays at 1, but now we are triggering in the first line in Field One. The only exception to this is if we are on the last line of Field One and change to Field Two. In this case, we go to the last line in Field Two.

Key Path	Trigger
Example	TRIG:SOUR TV Swept SA measurement TRIG:<meas>:SOUR TV Measurements other than Swept SA
Dependencies	This key only appears in Modes which support TV Trigger, otherwise the key is blanked. If the SCPI command is sent while the key is blanked, an error is returned.
Readback	This key displays the value read back from TV Line
Status Bits/OPC dependencies	The Status Operation Register bit 5 "Waiting for Trigger" is set at the same time as the Sweeping or Measuring bit is set. It is cleared when the trigger actually occurs (that is, after the trigger event occurs and all the applicable trigger criteria have been met). A corresponding pop-up message ("Waiting for trigger") is generated if no trigger signal appears after approximately 2 sec. This message goes away when a trigger signal appears.
Initial S/W Revision	Prior to A.02.00

TV Line

Selects the TV line number to trigger on. Line number range is dependent on the settings of the **Standard** and **Field** menus within the TV trigger setup functions. When the line number is incremented beyond the upper limit, the value will change to the lower limit and continue incrementing from there. When the line number is decremented below the lower limit, the value will change to the upper limit and continue decrementing from there.

Key Path	Trigger, TV
Remote Command	:TRIGger[:SEquence]:TV:LINE <integer> :TRIGger[:SEquence]:TV:LINE?
Example	TRIG:TV:LINE 20 TRIG:TV:LINE?
Notes	The range of the TV line number is dependent on the settings of the Standard and Field menus within the TV trigger setup functions.
Preset	17
State Saved	Saved in instrument state
Min	The minimum value is the minimum line, and rolls over to the maximum value. The minimum line number depends on which Field and standard are selected.
Max	The maximum value is the maximum line, and rolls over to the minimum value. The maximum line number depends on which Field and standard are selected.
Initial S/W Revision	Prior to A.02.00

Field

Accesses the menu to select the field.

Key Path	Trigger, TV
----------	--------------------

Remote Command	:TRIGger[:SEquence]:TV:FMODe ENTire ODD EVEN :TRIGger[:SEquence]:TV:FMODe?
Example	TRIG:TV:FMOD EVEN
Notes	ODD is Field 1 EVEN is Field 2
Dependencies	This command is available only when Option B7B (TV trigger) is installed.
Preset	ENTire
Readback	Displays the Readback value
Initial S/W Revision	Prior to A.02.00

Entire Frame

When you select Entire Frame it causes the selected line number to be viewed as an offset into the entire frame starting with line 1, the first line in Field One.

Key Path	Trigger, TV, Field
Example	TRIG:TV:FMOD ENT
Min	1, for all formats.
Max	525, for formats NTSC-M, NTSC-Japan, NTSC-4.43, PAL-M and PAL-60 625, for formats PAL-B, D, G, H, I, PAL-N, PAL-N Combin, and SECAM-L.
Readback	Entire Frame
Initial S/W Revision	Prior to A.02.00

Field One

When you select Field One it causes the selected line number to be viewed as an offset into the first field starting with Line 1, the first line in Field One.

Key Path	Trigger, TV, Field
Example	TRIG:TV:FMOD ODD
Min	Field 1 (ODD) The minimum line is 1
Max	Field 1 (ODD) Maximum line is 263 for formats NTSC-M, NTSC-Japan, NTSC-4.43, PAL-M and PAL-60 Maximum line is 313 for formats PAL-B, D, G, H, I, PAL-N, PAL-N Combin, and SECAM-L.
Readback	Field 1
Initial S/W Revision	Prior to A.02.00

Field Two

When you select Field Two it causes the selected line number to be viewed as an offset into the second field. If Line 1 is selected, it is the 264th line of the frame (NTSC-M, NTSC-Japan, NTSC-4.43, PAL-M, PAL-60) or the 314th line of the frame (PAL-B,D,G,H,I, PAL-N, PAL-N-Combin, SECAM-L).

Key Path	Trigger, TV, Field
Example	TRIG:TV:FMODEVEN
Min	Field 2 (EVEN) The minimum line is 1
Max	Field 2 (EVEN) The maximum line 262 for formats NTSC-M, NTSC-Japan, NTSC-4.43, PAL-M and PAL-60 The maximum line is 312 for formats PAL-B, D, G, H, I, PAL-N, PAL-N Combin, and SECAM-L
Readback	Field 2
Initial S/W Revision	Prior to A.02.00

Standard

Accesses the Standard menu keys which select from the following TV standards: **NTSC-M, NTSC-Japan, NTSC-4.43, PAL-M, PAL-B,D,G,H,I, PAL-N, PAL-N-Combin, PAL-60, SECAM-L.**

As the TV standard is changed, the current line value is clipped as necessary to keep it valid for the chosen standard and field mode. For example, line 600 is selected in Entire Frame mode in PAL-N; if NTSC-M is selected, the line number is clipped to 525. Or, if line 313 is selected in Field 1 mode in PAL-N and NTSC-M is selected, the line number is clipped to 263. Changing back to the PAL-N standard will leave the line number at 263.

Key Path	Trigger, TV
Remote Command	:TRIGger[:SEquence]:TV:STANdard MNTSc JNTSc NTSC443 MPAL BPAL NPAL CPAL PAL60 LSEC :TRIGger[:SEquence]:TV:STANdard?
Example	TRIG:TV:STAN MPAL TRIG:TV:STAN?
Preset	MNTS
State Saved	Saved in instrument state
Readback	Displays Readback value
Initial S/W Revision	Prior to A.02.00

NTSC-M

Sets the TV standard to NTSC-M.

Key Path	Trigger, TV, Standard
Example	TRIG:TV:STAN MNTS
Readback	NTSC-M
Initial S/W Revision	Prior to A.02.00

NTSC-Japan

Sets the TV standard to **NTSC-Japan**.

Key Path	Trigger, TV, Standard
Example	TRIG:TV:STAN JNTS
Readback	NTSC-Japan
Initial S/W Revision	Prior to A.02.00

NTSC-4.43

Sets the TV standard to **NTSC-4.43**.

Key Path	Trigger, TV, Standard
Example	TRIG:TV:STAN NTSC443
Readback	NTSC-Japan
Initial S/W Revision	Prior to A.02.00

PAL-M

Sets the TV standard to **PAL-M**.

Key Path	Trigger, TV, Standard
Example	TRIG:TV:STAN MPAL
Readback	PAL-M
Initial S/W Revision	Prior to A.02.00

PAL-N

Sets the TV standard to **PAL-N**.

Key Path	Trigger, TV, Standard
Example	TRIG:TV:STAN NPAL
Readback	PAL-N
Initial S/W Revision	Prior to A.02.00

PAL-N-Combin

Sets the TV standard to **PAL-N-Combin**.

Key Path	Trigger, TV, Standard
Example	TRIG:TV:STAN CPAL
Readback	PAL-N-C
Initial S/W Revision	Prior to A.02.00

PAL-B,D,G,H,I

Sets the TV standard to **PAL-B,D,G,H,I**

Key Path	Trigger, TV, Standard
Example	TRIG:TV:STAN BPAL
Readback	PAL-B
Initial S/W Revision	Prior to A.02.00

PAL-60

Sets the TV standard to **PAL-60**.

Key Path	Trigger, TV, Standard
Example	TRIG:TV:STAN PAL60
Readback	PAL-N
Initial S/W Revision	Prior to A.02.00

SECAM-L

Sets the TV standard to **SECAM-L**.

Key Path	Trigger, TV, Standard
Example	TRIG:TV:STAN LSEC
Readback	SECAM-L
Initial S/W Revision	Prior to A.02.00

Control Edge/Level

Sets the method of controlling the gating function from the gating signal.

Edge

In Edge triggering, the gate opens (after the Delay) on the selected edge (for example, positive) of the gate signal and closes on the alternate edge (for example, negative).

Level

In Level triggering, the gate opens (after the Delay) when the gate signal has achieved a certain level and stays open as long as that level is maintained.

Key Path	Sweep/Control, Gate
Remote Command	[:SENSe] :SWEep:EGATe:CONTRo1 EDGE LEVe1 [:SENSe] :SWEep:EGATe:CONTRo1?
Example	SWE:EGAT:CONT EDGE
Dependencies	If the Gate Method is FFT the Control key is grayed out and Edge is selected. If the Gate Source is TV, Frame or Line, the Control key is grayed out and Edge is selected.
Preset	EDGE
State Saved	Saved in instrument state
Backwards Compatibility SCPI	[:SENSe] :SWEep:TIME:GATE:TYPE ESA Compatibility

Initial S/W Revision Prior to A.02.00

Gate Holdoff

Lets you increase or decrease the wait time after a gate event ends before the analyzer will respond to the next gate signal.

After any Gate event finishes, the analyzer must wait for the sweep system to settle before it can respond to another Gate signal. The analyzer calculates a "wait time," taking into account a number of factors, including RBW and Phase Noise Optimization settings. The goal is to achieve the same accuracy when gated as in ungated operation. The figure below illustrates this concept:

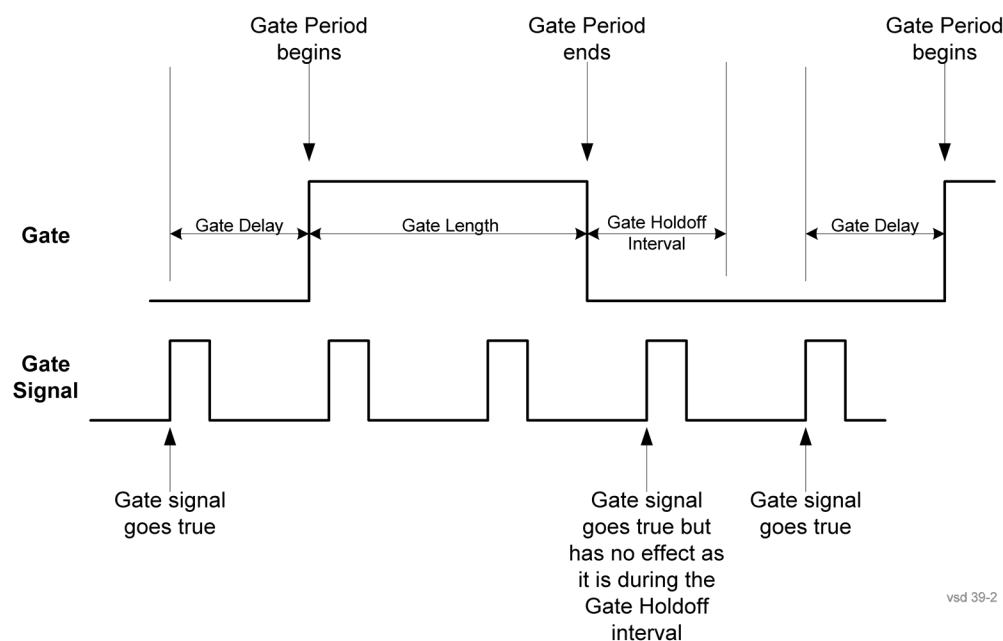

When Gate Holdoff is in Auto, the wait time calculated by the analyzer is used. When Gate Time is in Manual, the user may adjust the wait time, usually decreasing it in order to achieve greater speed, but at the risk of decreasing accuracy.

When the **Method** key is set to **Video** or **FFT**, the **Gate Holdoff** function has no effect.

In measurements that do not support Auto, the value shown when Auto is selected is "---" and the manually set holdoff is returned to a query.

Key Path	Sweep/Control, Gate
Remote Command	[:SENSe]:SWEep:EGATe:HOLDoff <time> [:SENSe]:SWEep:EGATe:HOLDoff? [:SENSe]:SWEep:EGATe:HOLDoff:AUTO OFF ON 0 1 [:SENSe]:SWEep:EGATe:HOLDoff:AUTO?
Example	SWE:EGAT:HOLD 0.0002 SWE:EGAT:HOLD?

	SWE:EGAT:HOLD:AUTO ON SWE:EGAT:HOLD:AUTO?
Couplings	<p>When Gate Holdoff is Auto, the Gate Holdoff key shows the value calculated by the analyzer for the wait time.</p> <p>Pressing the Gate Holdoff key while it is in Auto and not selected, causes the key to become selected and allows the user to adjust the value. If the value is adjusted, the setting changes to Man.</p> <p>Pressing the Gate Holdoff key, while it is in Auto and selected, does not change the value of Gate Holdoff, but causes the setting to change to Man. Now the user can adjust the value.</p> <p>Pressing the key while it is in Man and selected, cause the value to change back to Auto.</p> <p>Pressing the key while it is in Man and not selected, causes the key to become selected and allows the user to adjust the value.</p> <p>When Method is set to Video or FFT, the Gate Holdoff function has no effect.</p>
Preset	Auto Auto/On
State Saved	Saved in instrument state
Min	1 µsec
Max	1 sec
Initial S/W Revision	Prior to A.02.00

Gate Delay Compensation

This function allows you to select an RBW-dependent value by which to adjust the gate delay, to compensate for changes in the delay caused by RBW effects.

You can select between uncompensated operation and two types of compensation, **Delay Until RBW Settled** and **Compensate for RBW Group Delay**.

See "[More Information](#)" on page 2843

Key Path	Sweep/Control, Gate
Scope	Meas Global
Remote Command	[:SENSe] :SWEep:EGATe:DELay:COMPensation:TYPE OFF SETTled GDELay [:SENSe] :SWEep:EGATe:DELay:COMPensation:TYPE?
Example	SWE:EGAT:DEL:COMP:TYPE SETT SWE:EGAT:DEL:COMP:TYPE?
Notes	<p>Although this function is Meas Global, there are some measurements that do not support this function. In those measurements the operation will be Uncompensated. Going into one of those measurements will not change the Meas Global selection; it will simply display the grayed-out menu key with "Uncompensated" showing as the selection. This is a non-forceful grayout, so the SCPI command is still accepted.</p> <p>If Gate Delay Compensation is not supported at all within a particular mode, the key is not displayed, and if the SCPI command is sent while in a measurement within that mode, an "Undefined Header" message is generated.</p> <p>Measurements that do not support this function include:</p>

	Swept SA
Preset	TD-SCDMA mode: Compensate for RBW Group Delay All other modes: Delay Until RBW Settled
State Saved	Saved in instrument state
Range	Uncompensated Delay Until RBW Settled Compensate for RBW Group Delay
Readback text	Uncompensated Settled Group Delay
Initial S/W Revision	Prior to A.02.00
Modified at S/W Revision	A.11.0

More Information

Selecting **Uncompensated** means that the actual gate delay is as you sets it.

Selecting **Delay Until RBW Settled** causes the gate delay to be increased above the user setting by an amount equal to $3.06/\text{RBW}$. This compensated delay causes the GATE START and GATE STOP lines on the display to move by the compensation amount, and the actual hardware gate delay to be increased by the same amount. All the other gate lines (for example, MIN FAST) are unaffected. If the RBW subsequently changes, the compensation is readjusted for the new RBW. The value shown on the **Gate Delay** key does NOT change.

Delay Until RBW Settled allows excellent measurements of gated signals, by allowing the IF to settle following any transient that affects the burst. Excellent measurements also require that the analysis region not extend into the region affected by the falling edge of the burst. Thus, excellent measurements can only be made over a width that declines with narrowing RBWs, which is achieved by decreasing the gate length below the user setting by an amount equal to $2.53/\text{RBW}$. Therefore, for general purpose compensation, you will still want to change the gate length with changes in RBW even if the gate delay is compensated. The compensated Gate Length is limited by the analyzer so that it will never go below 10% of the value shown on the Gate Length key, as otherwise the sweep times could get very long. Anytime the **Gate Length and RBW** values combine in such a way that this limiting takes place, a warning is displayed . For measurements which contain multiple sweeps with different RBW like SEM and SPUR, the smallest RBW is used for this limiting.

Selecting **Compensate for RBW Group Delay** causes the gate delay to be increased above the user setting by an amount equal to $1.81/\text{RBW}$. This compensated delay causes the GATE START, GATE STOP lines on the display to move by the compensation amount, and the actual hardware gate delay to be increased by the same amount. All the other gate lines (for example, MIN FAST) are unaffected. If the RBW subsequently changes, the compensation is readjusted for the new RBW. The value shown on the **Gate Delay** key does NOT change. **Compensate for RBW Group Delay** also includes gate length compensation; the gate length itself is adjusted as necessary to attempt to compensate for delay effects imposed by the RBW.

Compensate for RBW Group Delay is similar to **Delay Until RBW Settled** , but compensates for the group delay of the RBW filter, rather than the filter settling

time. As the RBW gets narrow, this can allow the settling tail of the RBW to affect the beginning part of the gated measurement, and allow the beginning of the RBW settling transient to affect the end of the gated measurement. These two effects are symmetric because the RBW response is symmetric. Because the gate length is not automatically compensated, some users might find this compensation to be more intuitive than compensation for RBW settling.

Min Fast Position Query (Remote Command Only)

This command queries the position of the MIN FAST line, relative to the delay reference (REF) line. See section "Gate View On/Off" on page 2806. If this query is sent while not in gate view, the MinFast calculation is performed based on the current values of the appropriate parameters and the result is returned. Knowing this value lets you set an optimal gate delay value for the current measurement setup.

Remote Command	<code>[:SENSe] :SWEep:EGATe:MINFast?</code>
Example	<code>SWE:EGAT:MIN?</code>
Initial S/W Revision	Prior to A.02.00

Gate Preset (Remote Command Only)

Presets the time-gated spectrum analysis capability.

This command sets gate parameter values to the ESA preset values, as follows:

Gate trigger type = edge

Gate polarity = positive

Gate delay = 1 us

Gate length = 1 us

Remote Command	<code>[:SENSe] :SWEep:TIME:GATE:PRESet ESA Compatibility</code>
Initial S/W Revision	Prior to A.02.00

Gate Level (Remote Command Only)

Sets the gate input transition point level for the external TRIGGER inputs on the front and rear panel. This is a legacy command for PSA compatibility. It is simply an alias to the equivalent trigger level command.

Remote Command	<code>[:SENSe] :SWEep:EGATe:EXTernal[1] 2:LEVel <voltage></code> <code>[:SENSe] :SWEep:EGATe:EXTernal[1] 2:LEVel?</code>
Notes	This command is simply an alias to <code>:TRIGger[:SEQUence]:EXTernal[1]2:LEVel</code>
Initial S/W Revision	Prior to A.02.00

Gate Polarity (Remote Command Only)

Sets the polarity for the gate signal. This setup is now done using the gate trigger's slope setting.

When Positive (Pos) is selected, a positive-going edge (Edge) or a high voltage (Level) will satisfy the gate condition, after the delay set with the Gate Delay key. When Negative (Neg) is selected, a negative-going edge (Edge) or a low voltage (Level) will satisfy the gate condition after the delay.

Remote Command	<code>[:SENSe] :SWEep:EGATe:POLarity NEGative POSitive</code> <code>[:SENSe] :SWEep:EGATe:POLarity?</code>
Example	SWE:EGAT:POL NEG SWE:EGAT:POL?
Preset	POSitive
State Saved	Saved in instrument state
Backwards Compatibility SCPI	[:SENSe] :SWEep:TIME:GATE:POLarity ESA compatibility
Initial S/W Revision	Prior to A.02.00

Remote Command	<code>[:SENSe] :SWEep:TIME:GATE:LEVe1 HIGH LOW</code> <code>[:SENSe] :SWEep:TIME:GATE:LEVe1?</code> ESA compatibility
Preset	HIGH
Initial S/W Revision	Prior to A.02.00

System

See "System" on page 431

Trace/Detector

Accesses a menu of functions that enable you to control trace and detector for the current measurement.

Key Path	Front-panel key
Initial S/W Revision	Prior to A.02.00

Trace Type

Allows you to select the type of trace for the current measurement. The menu contains a 1-of-N selection of the trace type (Clear Write, Average, Max Hold, Min Hold).

Key Path	Trace/Detector
Mode	SA, WCDMA, C2K, WIMAX OFDMA, TD-SCDMA, 1xEVDO, DTMB (CTTB), DVB-T/H, ISDB-T, CMMB, LTE, LTETDD, Digital Cable TV, WLAN, MSR, LTEAFDD, LTEATDD
Remote Command	:TRACe:SEMask:TYPE WRITe AVERAge MAXHold MINHold :TRACe:SEMask:TYPE?
Example	TRAC:SEM:TYPE MINH TRAC:SEM:TYPE?
Notes	WRITe = Clear Write AVERAge = Average MAXHold = Maximum Hold MINHold = Minimum Hold
Couplings	When Detector setting is "Auto" ([:SENSe]:SEMask:DETECTOR:AUTO?), Detector ([:SENSe]:SEMask:DETECTOR[:FUNCTION]?) switches aligning with the switch of this parameter: "NORMal" with WRITe (Clear Write), "AVERAge" with AVERAge, "POSitive (peak)" with MAXHold, and "NEGative (peak)" with MINHold.
Preset	AVERAge
State Saved	Saved in instrument state.
Range	WRITe AVERAge MAXHold MINHold
Initial S/W Revision	Prior to A.02.00
Modified at S/W Revision	A.02.00, A.03.00

Chan Detector

Accesses a menu of functions that enable you to control the detectors for reference channel. The following choices are available:

- Auto– the detector selected depends on marker functions, trace functions, average type, and the trace averaging function.

- Normal—the detector determines the peak of the CW-like signals, and it yields alternating maximums and minimums of noise-like signals. This is also referred to as Rosenfell detection.
- Average—the detector determines the average of the signal within the sweep points. The averaging method depends upon the Average Type selection (voltage, power or log scales).
- Peak—the detector determines the maximum of the signal within the sweep points.
- Sample—the detector indicates the instantaneous level of the signal at the center of the sweep points represented by each display point.
- Negative Peak—the detector determines the minimum of the signal within the sweep points.

Key Path	Trace/Detector
Initial S/W Revision	Prior to A.02.00

Chan Detector Auto

Sets the detector to the default detection mode for the reference channel. This mode is dependent upon the current reference channel conditions.

Key Path	Trace/Detector
Mode	SA, WCDMA, C2K, WIMAX OFDMA, TD-SCDMA, 1xEVDO, DTMB (CTTB), DVB-T/H, ISDB-T, CMMB, LTE, LTETDD, Digital Cable TV, WLAN, MSR, LTEAFDD, LTEATDD
Remote Command	<code>[:SENSe] :SEMAsk:DETEctor:CARRier:AUTO ON OFF 1 0</code> <code>[:SENSe] :SEMAsk:DETEctor:CARRier:AUTO?</code>
Example	SEM:DET:CARR:AUTO OFF SEM:DET:CARR:AUTO?
Notes	See Couplings in the Trace Type section. You must be in the mode that includes SEM measurement to use this command. Use :INSTrument:SElect to set the mode.
Preset	ON
State Saved	Saved in instrument state
Range	On Off
Initial S/W Revision	Prior to A.02.00
Modified at S/W Revision	A.02.00, A.03.00

Chan Detector Selection

Selects the detector mode for the reference channel.

Key Path	Trace/Detector
Mode	SA, WCDMA, C2K, WIMAX OFDMA, TD-SCDMA, 1xEVDO, DTMB (CTTB), DVB-T/H, ISDB-T, CMMB, LTE, LTETDD, Digital Cable TV, WLAN, MSR, LTEAFDD, LTEATDD
Remote Command	[:SENSe]:SEMAsk:DETEctor:CARRier[:FUNction] AVERAge NEGAtive NORMAl POSitive SAMPlE [:SENSe]:SEMAsk:DETEctor:CARRier[:FUNction]?
Example	SEM:DET:CARR NEG SEM:DET:CARR?
Notes	When you manually select a detector (instead of selecting Auto), that detector is used regardless of other analyzer settings. <div style="background-color: #cccccc; padding: 2px; display: inline-block; margin-right: 10px;">NOTE</div> This detector setting affects the reference channel. There is not a per trace detector. You must be in the mode that includes SEM measurement to use this command. Use :INSTrument:SElect to set the mode.
Couplings	See Couplings in the Trace Type section.
Preset	AVERAge
State Saved	Saved in instrument state.
Range	Normal Average Peak Sample Negative Peak
Initial S/W Revision	Prior to A.02.00
Modified at S/W Revision	A.02.00, A.03.00

Offset Detector

Accesses a menu of functions that enable you to control the detector for offsets. The following choices are available.

- Auto– the detector selected depends on marker functions, trace functions, average type, and the trace averaging function.
- Normal–the detector determines the peak of the CW-like signals, and it yields alternating maximums and minimums of noise-like signals. This is also referred to as Rosenfell detection.
- Average–the detector determines the average of the signal within the sweep points. The averaging method depends upon the Average Type selection (voltage, power or log scales).
- Peak–the detector determines the maximum of the signal within the sweep points.
- Sample–the detector indicates the instantaneous level of the signal at the center of the sweep points represented by each display point.

- Negative Peak—the detector determines the minimum of the signal within the sweep points.

Key Path	Trace/Detector
Initial S/W Revision	Prior to A.02.00

Offset Detector Auto

Sets the detector to the default detection mode for the offsets. This mode is dependent upon the current signal conditions of the offsets.

Key Path	Trace/Detector
Mode	SA, WCDMA, C2K, WIMAX OFDMA, TD-SCDMA, 1xEVDO, DTMB (CTTB), DVB-T/H, ISDB-T, CMMB, LTE, LTETDD, Digital Cable TV, WLAN, MSR, LTEAFDD, LTEATDD
Remote Command	[:SENSe] :SEMAsk:DETEctor:OFFSet:AUTO ON OFF 1 0 [:SENSe] :SEMAsk:DETEctor:OFFSet:AUTO?
Example	SEM:DET:OFFS:AUTO OFF SEM:DET:OFFS:AUTO?
Notes	See Couplings in the Trace Type section. You must be in the mode that includes SEM measurement to use this command. Use :INSTrument:SElect to set the mode.
Preset	ON
State Saved	Saved in instrument state.
Range	On Off
Initial S/W Revision	Prior to A.02.00
Modified at S/W Revision	A.02.00, A.03.00

Offset Detector Selection

Selects the detector mode for the offsets.

Key Path	Trace/Detector
Mode	SA, WCDMA, C2K, WIMAX OFDMA, TD-SCDMA, 1xEVDO, DTMB (CTTB), DVB-T/H, ISDB-T, CMMB, LTE, LTETDD, Digital Cable TV, WLAN, MSR, LTEAFDD, LTEATDD
Remote Command	[:SENSe] :SEMAsk:DETEctor:OFFSet[:FUNction] AVERAge NEGAtive NORMAl POSitive SAMPlE [:SENSe] :SEMAsk:DETEctor:OFFSet[:FUNction]?
Example	SEM:DET:OFFS AVER SEM:DET:OFFS?
Notes	When you manually select a detector (instead of selecting Auto), that detector is used regardless of other analyzer settings.

NOTE

This detector setting has effects all offsets. There is not a per trace detector.

You must be in the mode that includes SEM measurement to use this command. Use :INSTrument:SElect to set the mode.

Couplings	See Couplings in the Trace Type section.
Preset	POSitive
State Saved	Saved in instrument state.
Range	Normal Average Peak Sample Negative Peak
Initial S/W Revision	Prior to A.02.00
Modified at S/W Revision	A.02.00, A.03.00

Trigger

See ["Trigger" on page 529](#)

Free Run

See ["Free Run " on page 537](#)

Video

See ["Video \(IF Envelope\) " on page 538](#)

Trigger Level

See ["Trigger Level" on page 538](#)

Trig Slope

See ["Trig Slope" on page 539](#)

Trig Delay

See ["Trig Delay" on page 540](#)

X Axis Relative to Trigger

See ["X Axis Relative to Trigger" on page 583](#)

Line

See ["Line" on page 2814](#)

Trig Slope

See ["Trig Slope" on page 2814](#)

Trig Delay

See ["Trig Delay" on page 543](#)

X Axis Relative to Trigger

See ["X Axis Relative to Trigger" on page 583](#)

External 1

See ["External 1" on page 2828](#)

Trigger Level

See ["Trigger Level" on page 2828](#)

Trig Slope

See ["Trig Slope" on page 2829](#)

Trig Delay

See ["Trig Delay" on page 546](#)

X Axis Relative to Trigger

See ["X Axis Relative to Trigger" on page 583](#)

Zero Span Delay Comp

See ["Zero Span Delay Comp On/Off " on page 2816](#)

External 2

See ["External 2 " on page 2829](#)

Trigger Level

See ["Trigger Level" on page 2830](#)

Trig Slope

See ["Trig Slope" on page 2831](#)

Trig Delay

See ["Trig Delay " on page 549](#)

X Axis Relative to Trigger

See ["X Axis Relative to Trigger" on page 583](#)

Zero Span Delay Comp

See ["Zero Span Delay Comp On/Off" on page 2818](#)

RF Burst

See ["RF Burst" on page 2831](#)

Absolute Trigger

See ["Absolute Trigger Level" on page 2832](#)

Relative Trigger

See ["Relative Trigger Level" on page 2833](#)

Trig Slope

See ["Trigger Slope" on page 2834](#)

Trig Delay

See ["Trig Delay" on page 554](#)

X Axis Relative to Trigger

See ["X Axis Relative to Trigger" on page 583](#)

Zero Span Delay Comp

See ["Zero Span Delay Comp On/Off" on page 2834](#)

Periodic Timer

See ["Periodic Timer \(Frame Trigger\)" on page 2823](#)

Period

See ["Period" on page 2824](#)

Offset

See ["Offset" on page 2825](#)

Offset Adjust (Remote Command Only)

See ["Offset Adjust \(Remote Command Only\)" on page 2826](#)

Reset Offset Display

See ["Reset Offset Display" on page 2827](#)

Sync Source

See ["Sync Source" on page 2827](#)

Off

See ["Off" on page 2828](#)

External 1

See ["External 1" on page 2828](#)

Trigger Level

See ["Trigger Level" on page 2828](#)

Trig Slope

See ["Trig Slope" on page 2829](#)

External 2

See ["External 2 " on page 2829](#)

Trigger Level

See ["Trigger Level" on page 2830](#)

Trig Slope

See ["Trig Slope" on page 2831](#)

RF Burst

See ["RF Burst" on page 2831](#)

Absolute Trigger

See ["Absolute Trigger Level" on page 2832](#)

Relative Trigger

See ["Relative Trigger Level" on page 2833](#)

Trig Slope

See ["Trigger Slope" on page 2834](#)

Zero Span Delay Comp

See ["Zero Span Delay Comp On/Off" on page 2834](#)

Trig Delay

See ["Trig Delay" on page 568](#)

X Axis Relative to Trigger

See ["X Axis Relative to Trigger" on page 583](#)

Sync Holdoff

See ["Sync Holdoff" on page 1289](#)

Baseband I/Q

See ["Baseband I/Q " on page 570](#)

I/Q Mag

See ["I/Q Mag" on page 570](#)

Trigger Level

See ["Trigger Level" on page 570](#)

Trig Slope

See ["Trig Slope" on page 571](#)

Trig Delay

See ["Trig Delay" on page 571](#)

X Axis Relative to Trigger

See ["X Axis Relative to Trigger" on page 583](#)

I (Demodulated)

See ["I \(Demodulated\)" on page 572](#)

Trigger Level

See ["Trigger Level" on page 573](#)

Trig Slope

See ["Trig Slope" on page 573](#)

Trig Delay

See ["Trig Delay" on page 573](#)

X Axis Relative to Trigger

See ["X Axis Relative to Trigger" on page 583](#)

Q (Demodulated)

See ["Q \(Demodulated\)" on page 575](#)

Trigger Level

See ["Trigger Level" on page 575](#)

Trig Slope

See ["Trig Slope" on page 575](#)

Trig Delay

See ["Trig Delay" on page 576](#)

X Axis Relative to Trigger

See ["X Axis Relative to Trigger" on page 583](#)

Input I

See ["Input I" on page 577](#)

Trigger Level

See ["Trigger Level" on page 577](#)

Trig Slope

See ["Trig Slope" on page 578](#)

Trig Delay

See ["Trig Delay" on page 578](#)

X Axis Relative to Trigger

See ["X Axis Relative to Trigger" on page 583](#)

Input Q

See ["Input Q" on page 579](#)

Trigger Level

See ["Trigger Level" on page 579](#)

Trig Slope

See ["Trig Slope" on page 580](#)

Trig Delay

See ["Trig Delay" on page 580](#)

X Axis Relative to Trigger

See ["X Axis Relative to Trigger" on page 583](#)

Auxiliary Channel I/Q Mag

See ["Auxiliary Channel I/Q Mag" on page 581](#)

Trigger Level

See ["Trigger Level" on page 582](#)

Trig Slope

See ["Trig Slope" on page 582](#)

Trig Delay

See ["Trig Delay" on page 582](#)

X Axis Relative to Trigger

See ["X Axis Relative to Trigger" on page 583](#)

Trigger Center Frequency

See ["Trigger Center Frequency" on page 583](#)

Trigger Bandwidth

See ["Trigger Bandwidth" on page 584](#)

TV

See ["TV" on page 2835](#)

TV Line

See ["TV Line" on page 2836](#)

Field

See ["Field" on page 2836](#)

Entire Frame

See ["Entire Frame" on page 2837](#)

Field One

See ["Field One" on page 2837](#)

Field Two

See ["Field Two" on page 2837](#)

Standard

See ["Standard" on page 2838](#)

NTSC-M

See ["NTSC-M" on page 2838](#)

NTSC-Japan

See ["NTSC-Japan" on page 2839](#)

NTSC-4.43

See ["NTSC-4.43" on page 2839](#)

PAL-M

See ["PAL-M" on page 2839](#)

PAL-N

See ["PAL-N" on page 2839](#)

PAL-N Combin

See ["PAL-N-Combin" on page 2839](#)

PAL-B,D,G,H,I

See ["PAL-B,D,G,H,I" on page 2839](#)

PAL-60

See ["PAL-60" on page 2840](#)

SECAM-L

See ["SECAM-L" on page 2840](#)

Auto/Holdoff

See ["Auto/Holdoff" on page 590](#)

Auto Trig

See ["Auto Trig" on page 590](#)

Trig Holdoff

See ["Trig Holdoff" on page 591](#)

Holdoff Type

See ["Holdoff Type" on page 591](#)

User Preset

Accesses a menu that gives you the following three choices:

- **User Preset** – recalls a state previously saved using the Save User Preset function.
- **User Preset All Modes** – presets all of the modes in the analyzer
- **Save User Preset**– saves the current state for the current mode

Key Path	Front-panel key
Backwards Compatibility Notes	<p>User Preset is actually loading a state, and in legacy analyzers, it was possible to load a state without affecting the trace data, limit lines or correction data. Similarly it was possible to do a User Preset without affecting the trace data, limit lines or correction data.</p> <p>In the X-Series, “state” always includes all of this data; so whenever state is loaded, or User Preset is executed, all of the traces, limit lines and corrections are affected. Although this differs from previous behavior, it is desirable behavior, and should not cause adverse issues for users.</p> <p>On ESA and PSA, User Preset affected the entire instrument’s state. In the X-Series, User Preset only recalls the state for the active mode. There is a User Preset file for each mode. User Preset can never cause a mode switch as it can in legacy analyzers. If you want to recall all modes to their user preset file state, you will need to do a User Preset after mode switching into each mode.</p> <p>User Preset recalls mode state which can now include data like traces; whereas on ESA and PSA, User Preset did not affect data.</p>
Initial S/W Revision	Prior to A.02.00

User Preset

User Preset sets the state of the currently active mode back to the state that was previously saved for this mode using the Save User Preset menu key or the SCPI command, **SYST:PRES:USER:SAV**. **It not only recalls the** Mode Preset settings, but it also recalls all of the mode persistent settings, and the Input/Output system setting that existed at the time Save User Preset was executed.

If a Save User Preset has not been done at any time, User Preset recalls the default user preset file for the currently active mode. The default user preset files are created if, at power-on, a mode detects there is no user preset file. There will never be a scenario when there is no user preset file to restore. For each mode, the default user preset state is the same state that would be saved if a Save User Preset is performed in each mode right after doing a Restore Mode Default and after a Restore Input/Output Defaults.

The User Preset function does the following:

- Aborts the currently running measurement.
- Sets the mode State to the values defined by Save User Preset.

- Makes the saved measurement for the currently running mode the active measurement.
- Brings up the saved menu for the power-on mode.
- Clears the input and output buffers.
- Sets the Status Byte to 0.

Key Path	User Preset
Remote Command	:SYSTem:PRESet:USER
Example	:SYST:PRES:USER
Notes	:SYST:PRES:USER:SAVE is used to save the current state as the user preset state. Clears all pending OPC bits. The Status Byte is set to 0. Pressing the User Preset front-panel key while already in the User Preset menu will cause the User Preset to get executed
Couplings	A user preset will cause the currently running measurement to be aborted and cause the saved measurement to be active. Recalling a User Preset file has the same issues that recalling a Save State file has. Some settings may need to be limited and therefore re-coupled, since the capabilities of the mode may have changes when the User Preset file was last saved.
Initial S/W Revision	Prior to A.02.00

User Preset All Modes

Recalls all of the User Preset files for each mode, switches to the power-on mode, and activates the saved measurement from the power-on mode User Preset file.

NOTE

When the instrument is secured, all of the user preset files are converted back to their default user preset files.

The User Preset function does the following:

- Aborts the currently running measurement.
- Switches the Mode to the power-on mode.
- Restores the User Preset files for each mode.
- Makes the saved measurement for the power-on mode the active measurement.
- Brings up the saved menu for the power-on mode.
- Clears the input and output buffers.
- Sets the Status Byte to 0.

Key Path	User Preset
----------	-------------

Remote Command	:SYSTem:PRESet:USER:ALL
Example	:SYST:PRES:USER:SAVE :SYST:PRES:USER:ALL
Notes	Clears all pending OPC bits. The Status Byte is set to 0. :SYST:PRES:USER:SAVE is used to save the current state as the user preset state.
Couplings	A user preset will cause the currently running measurement to be aborted, cause a mode switch to the power-on mode, and cause the saved measurement to be active in the power-on mode. Recalling a User Preset file has the same issues that recalling a Save State file has. Some settings may need to be limited and therefore re-coupled, since the capabilities of the mode may have changes when the User Preset file was last saved.
Initial S/W Revision	Prior to A.02.00

Save User Preset

Saves the currently active mode and its State. You can recall this User Preset file by pressing the User Preset menu key or sending the SYST:PRES:USER remote command. This same state is also saved by the Save State function.

Key Path	User Preset
Remote Command	:SYSTem:PRESet:USER:SAVE
Example	:SYST:PRES:USER:SAVE
Notes	:SYST:PRES:SAVE creates the same file as if the user requested a *SAV or a MMEM: STOR:STAT, except User Preset Save does not allow the user to specify the filename or the location of the file.
Initial S/W Revision	Prior to A.02.00

View/Display

Accesses a menu of functions that enable you to control the instrument display.

The following keys select how the results are displayed:

- **Abs Pwr Freq**—displays the absolute power levels in dBm and the corresponding frequencies in the text window.
- **Rel Pwr Freq**—displays the relative power levels in dBc and the corresponding frequencies in the text window.
- **Integrated Power**—displays the absolute and relative power levels integrated throughout the bandwidths between the start and stop frequencies in the text window.
- **Carrier Info**—displays the carrier configuration information with measure powers. (Only available in MSR and LTE-Advanced FDD/TDD)

["View Selection by Name \(Remote Command Only\)" on page 2863](#)

["Views Selection by Number \(Remote Command only\)" on page 2864](#)

View Selection by Name (Remote Command Only)

Key Path	View/Display
Mode	SA, WCDMA, C2K, WIMAX OFDMA, TD-SCDMA, 1xEVDO, DTMB (CTTB), DVB-T/H, ISDB-T, CMMB, LTE, LTETDD, Digital Cable TV, WLAN, MSR, LTEAFDD, LTEATDD
Remote Command	:DISPlay:SEMask:VIEW[:SElect] APFReq RPFReq IPOwer CInFormation :DISPlay:SEMask:VIEW[:SElect]?
Example	DISP:SEM:VIEW IPOW DISP:SEM:VIEW?
Notes	You must be in the mode that includes SEM measurement to use this command. Use :INSTrument:SElect to set the mode.
Dependencies	In the SA mode, when "Radio Standard" is set to WLAN, IPOwer is not available and the key is grayed out. CInFormation is available only in MSR and LTE-Advanced FDD/TDD mode, otherwise the key is blank.
Preset	SA, WCDMA, C2K, TD-SCDMA, 1xEVDO, DTMB (CTTB), DVB-T/H, ISDB-T, CMMB, LTE, LTETDD, Digital Cable TV, MSR, LTEAFDD, LTEATDD: APFReq WIMAX OFDMA, WLAN: RPFReq
State Saved	Saved in instrument state.
Range	Abs Pwr & Freq Rel Pwr & Freq Integrated Power Carrier Info
Initial S/W Revision	Prior to A.02.00
Modified at S/W Revision	A.02.00, A.03.00, A.10.00

Views Selection by Number (Remote Command only)

The following numerical selections determine how the results are displayed:

1. displays the absolute power levels in dBm and the corresponding frequencies in the text window.
2. displays the relative power levels in dBc and the corresponding frequencies in the text window.
3. displays the absolute and relative power levels integrated throughout the bandwidths between the start and stop frequencies in the text window.
4. displays the carrier info table. (Only available in MSR and LTE-Advanced FDD/TDD)

Mode	SA, WCDMA, C2K, WIMAX OFDMA, TD-SCDMA, 1xEVDO, DTMB (CTTB), DVB-T/H, ISDB-T, CMMB, LTE, LTETDD, Digital Cable TV, WLAN, MSR, LTEAFDD, LTEATDD
Remote Command	:DISPlay:SEMask:VIEW:NSElect <integer> :DISPlay:SEMask:VIEW:NSElect?
Example	DISP:SEM:VIEW:NSEL 2 DISP:SEM:VIEW:NSEL?
Notes	In the SA mode, when "Radio Standard" is set to WLAN, Option 3 is not available. Option 4 is available only in MSR and LTE-Advanced FDD/TDD mode. You must be in the mode that includes SEM measurement to use this command. Use :INSTrument:SElect to set the mode.
Preset	SA, WCDMA, C2K, TD-SCDMA, 1xEVDO, DTMB (CTTB), DVB-T/H, ISDB-T, CMMB, LTE, LTETDD, Digital Cable TV, MSR, LTEAFDD, LTEATDD: 1 WIMAX OFDMA, WLAN: 2
State Saved	Saved in instrument state.
Min	1
Max	MSR, LTEAFDD, LTEATDD: 4 Other modes: 3
Initial S/W Revision	Prior to A.02.00
Modified at S/W Revision	A.02.00, A.03.00, A.10.00
Key Path	Front-panel key
Initial S/W Revision	Prior to A.02.00

Display

The Display menu is common to most measurements, and is used for configuring items on the display. Some Display menu settings apply to all the measurements in

a mode, and some only to the current measurement. Those under the **System Display Settings** key apply to all measurements in all modes.

Key Path	Display
Key Path	View/Display
Initial S/W Revision	Prior to A.02.00

Annotation

Turns on and off various parts of the display annotation. The annotation is divided up into four categories:

13. Meas Bar: This is the measurement bar at the top of the screen. It does not include the settings panel or the Active Function. Turning off the Meas Bar turns off the settings panel and the Active Function. When the Meas Bar is off, the graticule area expands to fill the area formerly occupied by the Meas Bar.
14. Screen Annotation: this is the annotation and annunciation around the graticule, including any annotation on lines (such as the display line, the threshold line, etc.) This does NOT include the marker number or the N dB result. When off, the graticule expands to fill the entire graticule area.
15. Trace annotation: these are the labels on the traces, showing their detector (or their math mode).
16. Active Function annotation: this is the active function display in the meas bar, and all of the active function values displayed on softkeys.

See the figure below. Each type of annotation can be turned on and off individually.

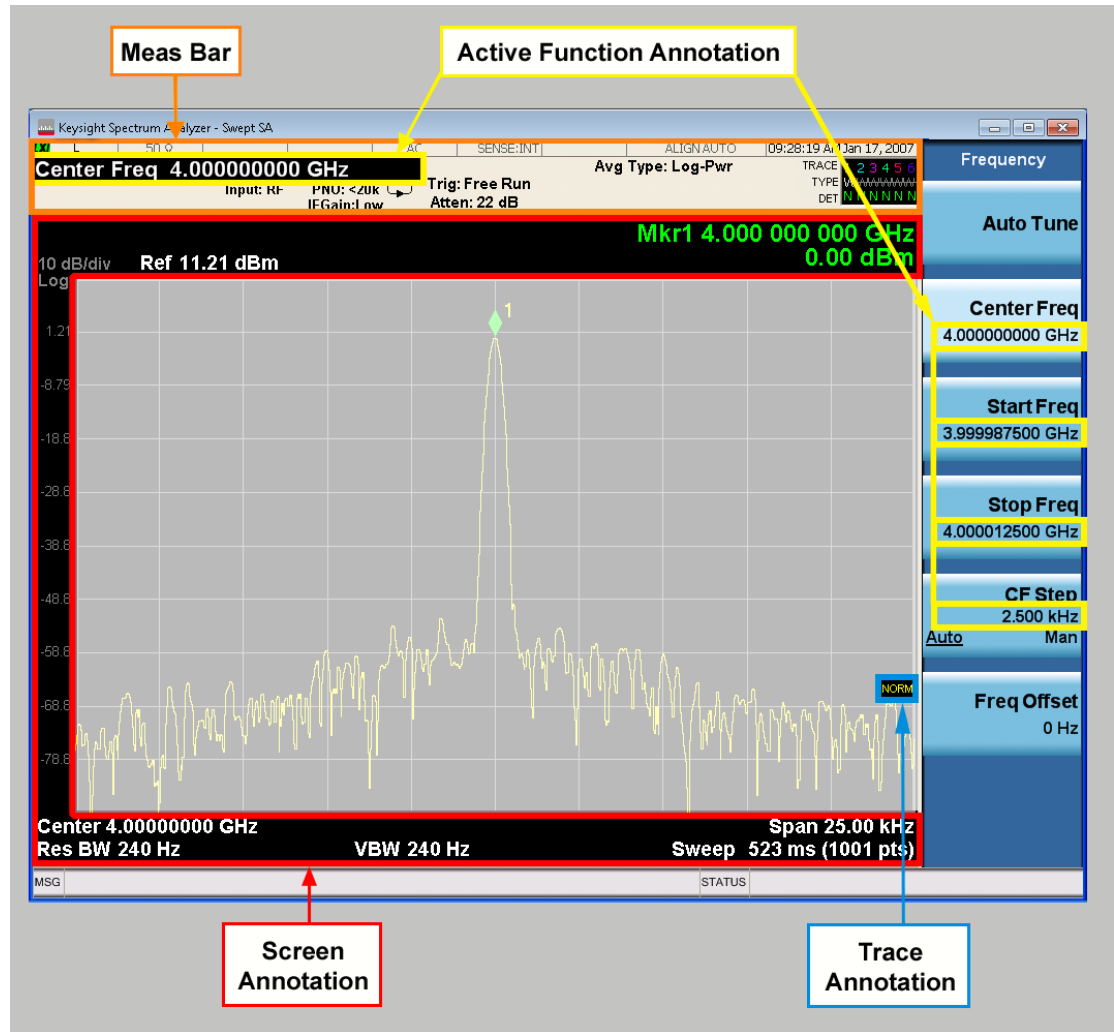

Key Path	View/Display, Display
Initial S/W Revision	Prior to A.02.00

Meas Bar On/Off

This function turns the Measurement Bar on and off, including the settings panel. When off, the graticule area expands to fill the area formerly occupied by the Measurement Bar.

Key Path	View/Display, Display, Annotation
Remote Command	:DISPlay:ANNotation:MBAR[:STATe] OFF ON 0 1 :DISPlay:ANNotation:MBAR[:STATe]?
Example	DISP:ANN:MBAR OFF
Dependencies	Grayed out and forced to OFF when System Display Settings, Annotation is set to Off.

Preset	On This should remain Off through a Preset when System DisplaySettings, Annotation is set to Off.
State Saved	Saved in instrument state.
Initial S/W Revision	Prior to A.02.00

Screen

This controls the display of the annunciation and annotation around the graticule, including any annotation on lines (such as the display line, the threshold line, etc.) and the y-axis annotation. This does NOT include marker annotation (or the N dB result). When off, the graticule expands to fill the entire graticule area, leaving only the 1.5% gap above the graticule as described in the Trace/Detector chapter.

Key Path	View/Display, Display, Annotation
Remote Command	:DISP:ANN:SCR:STATe OFF ON 0 1 :DISP:ANN:SCR:STATe?
Example	DISP:ANN:SCR OFF
Dependencies	Grayed-out and forced to OFF when System Display Settings, Annotation is set to Off.
Preset	On This should remain Off through a Preset when System DisplaySettings, Annotation is set to Off
State Saved	Saved in instrument state.
Initial S/W Revision	Prior to A.02.00

Trace

Turns on and off the labels on the traces, showing their detector (or their math mode) as described in the Trace/Detector section.

If trace math is being performed with a trace, then the trace math annotation will replace the detector annotation.

Key Path	View/Display, Display, Annotation
Remote Command	:DISP:ANN:TRACe[:STATe] ON OFF 1 0 :DISP:ANN:TRACe[:STATe]?
Example	DISP:ANN:TRAC OFF
Preset	Off
State Saved	Saved in instrument state.
Initial S/W Revision	Prior to A.02.00

Active Function Values On/Off

Turns on and off the active function display in the Meas Bar, and all of the active function values displayed on the softkeys.

Note that all of the softkeys that have active functions have these numeric values blanked when this function is on. This is a security feature..

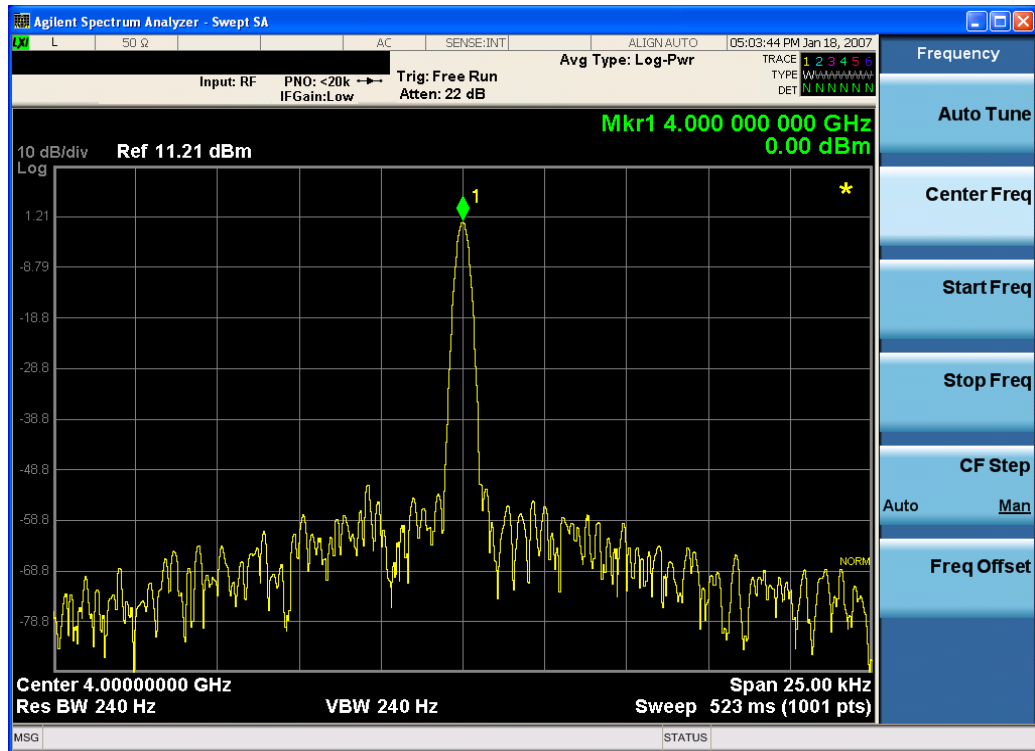

Key Path	View/Display, Display, Annotation
Remote Command	:DISPlay:ACTivefunc[:STATe] ON OFF 1 0 :DISPlay:ACTivefunc[:STATe]?
Example	DISP:ACT OFF
Dependencies	Grayed out and forced to OFF when System Display Settings, Annotation is set to Off.
Preset	On This should remain Off through a Preset when System DisplaySettings, Annotation is set to Off
State Saved	Saved in instrument state.
Initial S/W Revision	Prior to A.02.00

Title

Displays menu keys that enable you to change or clear a title on your display.

Key Path	View/Display, Display
Initial S/W Revision	Prior to A.02.00

Change Title

Writes a title into the "measurement name" field in the banner, for example, "Swept SA".

Press Change Title to enter a new title through the alpha editor. Press Enter or Return to complete the entry. Press ESC to cancel the entry and preserve your existing title.

The display title will replace the measurement name. It remains for this measurement until you press **Change Title** again, or you recall a state, or a Preset is performed. A title can also be cleared by pressing **Title, Clear Title**.

NOTE

Notice the inclusion of the <measurement> parameter in the command below. Because each measurement remembers the Display Title, the command must be qualified with the measurement name. For the Swept SA measurement this is not the case; no <measurement> parameter is used when changing the Display Title for the Swept SA measurement.

Key Path	View/Display, Display, Title
Mode	All
Remote Command	:DISPlay:<measurement>:ANNotation:TITLe:DATA <string> :DISPlay:<measurement>:ANNotation:TITLe:DATA?
Example	DISP:ANN:TITL:DATA "This Is My Title" This example is for the Swept SA measurement in the Spectrum Analyzer mode. The SANalyzer <measurement> name is not used. DISP:ACP:ANN:TITL:DATA "This Is My Title" This example is for Measurements other than Swept SA. Both set the title to: This Is My Title
Notes	Pressing this key cancels any active function. When a title is edited the previous title remains intact (it is not cleared) and the cursor goes at the end so that characters can be added or BKSP can be used to go back over previous characters.
Preset	No title (measurement name instead)
State Saved	Saved in instrument state.
Initial S/W Revision	Prior to A.02.00

Clear Title

Clears a title from the front-panel display. Once cleared, the title cannot be retrieved. After the title is cleared, the current Measurement Name replaces it in the

title bar.

Key Path	View/Display, Display, Title
Example	The following commands clear the title and restore the measurement's original title: DISP:ANN:TITL:DATA "" This example is for the Swept SA measurement in the Spectrum Analyzer mode. The SANalyzer <measurement> name is not used. DISP:ACP:ANN:TITL:DATA "" This example is for ACP; in measurements other than Swept SA the measurement name is required.
Notes	Uses the :DISPlay:<measurement>:ANNotation:TITLe:DATA <string> command with an empty string (in the Swept SA, the <measurement> is omitted).
Preset	Performed on Preset.
Initial S/W Revision	Prior to A.02.00

Graticule

Pressing Graticule turns the display graticule On or Off. It also turns the graticule y-axis annotation on and off.

Key Path	View/Display, Display
Remote Command	:DISPlay:WINDow[1]:TRACe:GRATicule:GRID[:STATe] OFF ON 0 1 :DISPlay:WINDow[1]:TRACe:GRATicule:GRID[:STATe]?
Example	DISP:WIND:TRAC:GRAT:GRID OFF
Notes	The graticule is the set of horizontal and vertical lines that make up the grid/divisions for the x-axis and y-axis.
Preset	On
State Saved	Saved in instrument state
Initial S/W Revision	Prior to A.02.00

System Display Settings

These settings are "Mode Global" – they affect all modes and measurements and are reset only by **Restore Misc Defaults** or **Restore System Defaults** under System.

Key Path	View/Display, Display
Initial S/W Revision	Prior to A.02.00

Annotation Local Settings

This is a Mode Global override of the meas local annotation settings. When it is **All Off**, it forces **ScreenAnnotation, Meas Bar, Trace, and Active Function Values** settings to be **OFF** for all measurements in all modes. This provides the security based "annotation off" function of previous analyzers; hence it uses the legacy SCPI command.

When it is **All Off**, the **Screen, Meas Bar, Trace, and Active Function Values** keys under the **Display, Annotation** menu are grayed out and forced to **Off**. When **Local Settings** is selected, you are able to set the local annotation settings on a measurement by measurement basis.

Key Path	View/Display, Display, System Display Settings
Remote Command	:DISPlay:WINDow[1]:ANNotation[:ALL] OFF ON 0 1 :DISPlay:WINDow[1]:ANNotation[:ALL]?
Example	:DISP:WIND:ANN OFF
Preset	On (Set by Restore Misc Defaults)
State Saved	Not saved in instrument state.
Backwards Compatibility Notes	The WINDow parameter and optional subopcode is included for backwards compatibility but ignored – all windows are equally affected.
Initial S/W Revision	Prior to A.02.00

Themes

Accesses a menu of functions that enable you to choose the theme to be used when saving the screen image.

The **Themes** option is the same as the **Themes** option under the **Display** and **Page Setup** dialogs. It allows you to choose between themes to be used when saving the screen image.

Key Path	Save, Screen Image
Remote Command	:MMEMory:STORe:SCReem:THEMe TDColor TDMonochrome FCOLor FMONochrome :MMEMory:STORe:SCReem:THEMe?
Example	:MMEM:STOR:SCR:THEM TDM
Preset	3D Color; Is not part of Preset, but is reset by Restore Misc Defaults or Restore System Defaults All and survives subsequent running of the modes.
Readback	3D Color 3D Mono Flat Color Flat Mono
Backwards Compatibility Notes	In ESA and PSA we offer the choice of "Reverse Bitmap" or "Reverse Metafile" when saving screen images. This is much like the "Flat Color" theme available in X-Series. Also, if you selected Reverse Bitmap AND a black & white screen image, that would be much like "Flat Monochrome". In other words, each of the X-Series themes has a similar screen image type in ESA/PSA. But they are not identical.
Initial S/W Revision	Prior to A.02.00

3D Color

Selects a standard color theme with each object filled, shaded and colored as designed.

Key Path	Save, Screen Image, Themes
Example	MMEM:STOR:SCR:THEM TDC
Readback	3D Color
Initial S/W Revision	Prior to A.02.00

3D Monochrome

Selects a format that is like 3D color but shades of gray are used instead of colors.

Key Path	Save, Screen Image, Themes
Example	MMEM:STOR:SCR:THEM TDM
Readback	3D Mono
Initial S/W Revision	Prior to A.02.00

Flat Color

Selects a format that is best when the screen is to be printed on an ink printer.

Key Path	Save, Screen Image, Themes
Example	MMEM:STOR:SCR:THEM FCOL
Readback	Flat Color
Initial S/W Revision	Prior to A.02.00

Flat Monochrome

Selects a format that is like Flat Color. But only black is used (no colors, not even gray), and no fill.

Key Path	Save, Screen Image, Themes
Example	MMEM:STOR:SCR:THEM FMON
Readback	Flat Mono
Initial S/W Revision	Prior to A.02.00

Backlight

Accesses the display backlight on/off keys. This setting may interact with settings under the Windows "Power" menu.

When the backlight is off, pressing ESC, TAB, SPACE, ENTER, UP, DOWN, LEFT, RIGHT, DEL, BKSP, CTRL, or ALT turns the backlight on without affecting the application. Pressing any other key will turn backlight on and could potentially perform the action as well.

Key Path	View/Display, Display, System Display Settings
Remote Command	:DISPlay:BACKlight ON OFF :DISPlay:BACKlight?
Preset	ON (Set by Restore Misc Defaults)
Initial S/W Revision	Prior to A.02.00

Backlight Intensity

An active function used to set the backlight intensity. It goes from 0 to 100 where 100 is full on and 0 is off. This value is independent of the values set under the Backlight on/off key.

Key Path	View/Display, Display, System Display Settings
Remote Command	:DISPlay:BACKlight:INTensity <integer> :DISPlay:BACKlight:INTensity?
Example	DISP:BACK:INT 50
Preset	100 (Set by Restore Misc Defaults)
Min	0
Max	100
Initial S/W Revision	Prior to A.02.00

Abs Pwr Freq

Sets the display to the Absolute Peak Power and Frequency view. The views differ depending on the setting of the measurement type (Meas Type) under the Measurement Setup menu.

"Abs Peak Pwr & Freq (Total Pwr Ref)" on page 2873

"Abs Peak Pwr & Freq (PSD Ref)" on page 2875

"Abs Peak Pwr & Freq (Spectrum Pk Ref)" on page 2877

Abs Peak Pwr & Freq (Total Pwr Ref)

This view consists of the following two windows:

"Trace Window" on page 2875

"Results Window " on page 2875

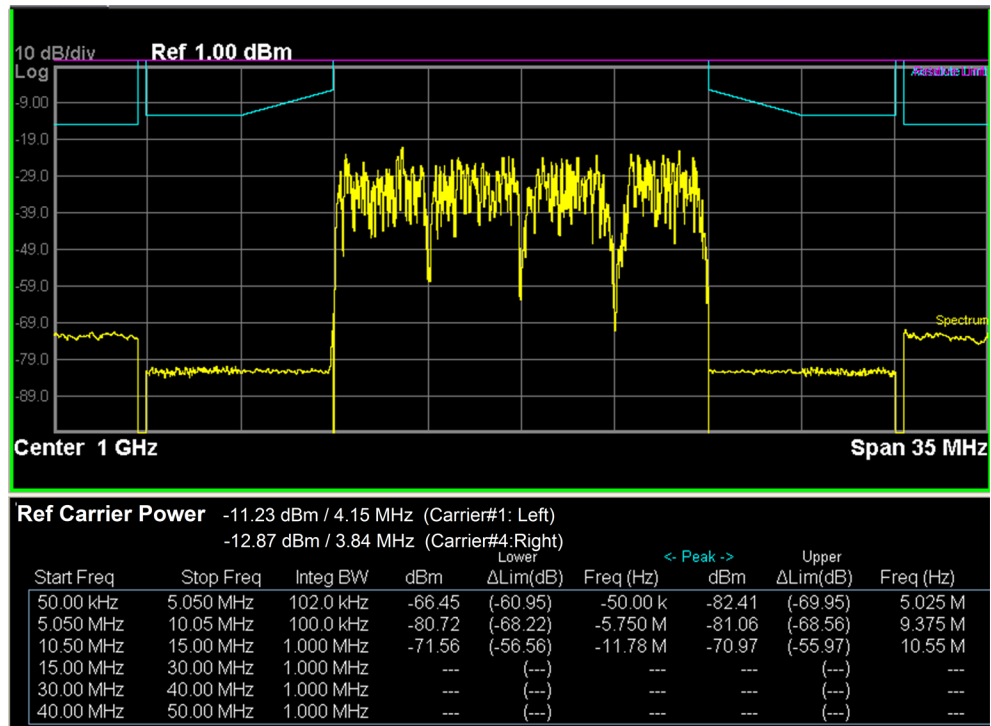
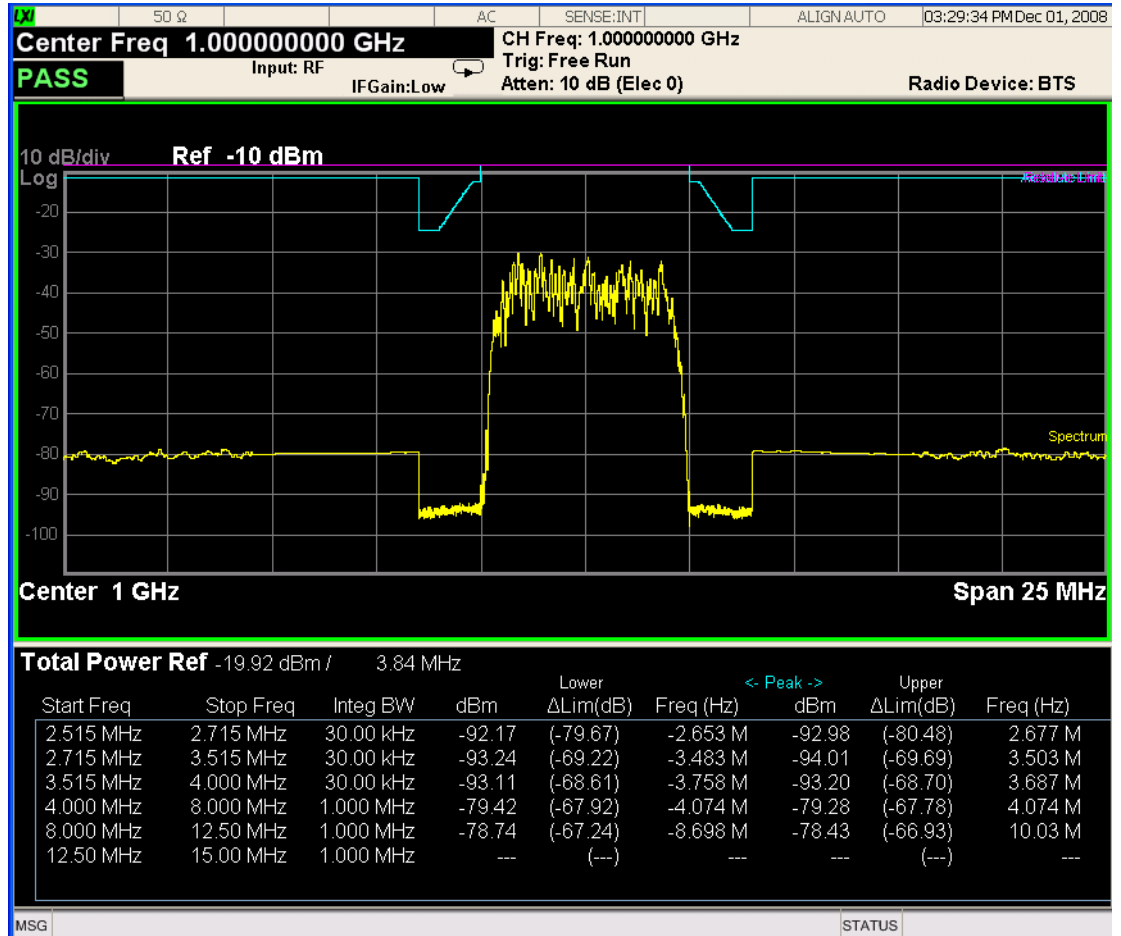

Trace Window

Corresponding Trace	yellow - Combined trace from carrier and each offset
---------------------	--

Results Window

Name	Corresponding Results
Total Pwr Ref	n=1 2nd element Absolute power at the reference area.
	Channel Integration Bandwidth
Start (Hz)	Start frequency for offset
Stop (Hz)	Stop frequency for offset
Meas BW (Hz)	Measurement bandwidth for offset
Lower Peak (dBm)	Absolute peak power on minimum margin point of the negative offset
Lower Δ lim (dB)	Minimum margin from limit line which is decided by Fail Mask setting on the negative offset
Lower Freq (Hz)	Frequency on minimum margin point of the negative offset
Upper Peak (dBm)	Absolute peak power on minimum margin point of the positive offset
Upper Δ lim (dB)	Minimum margin from limit line which is decided by Fail Mask setting on the positive offset
Upper Freq (Hz)	Frequency on minimum margin point of the positive offset

Abs Peak Pwr & Freq (PSD Ref)

This view consists of the following two windows:

"Trace Window" on page 2877

"Results Window " on page 2877

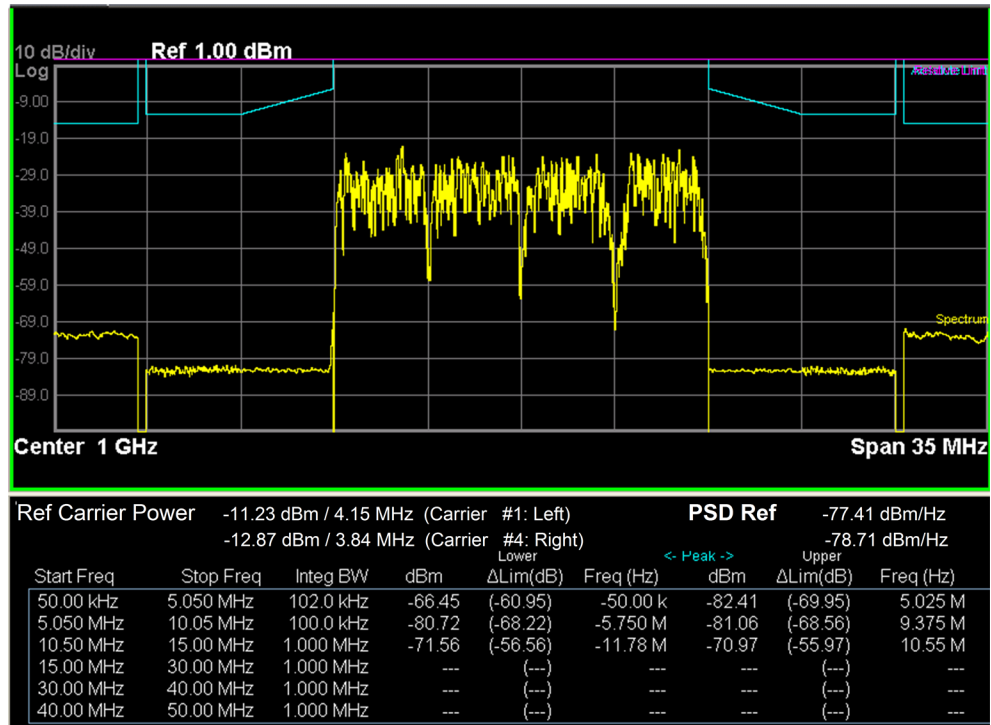
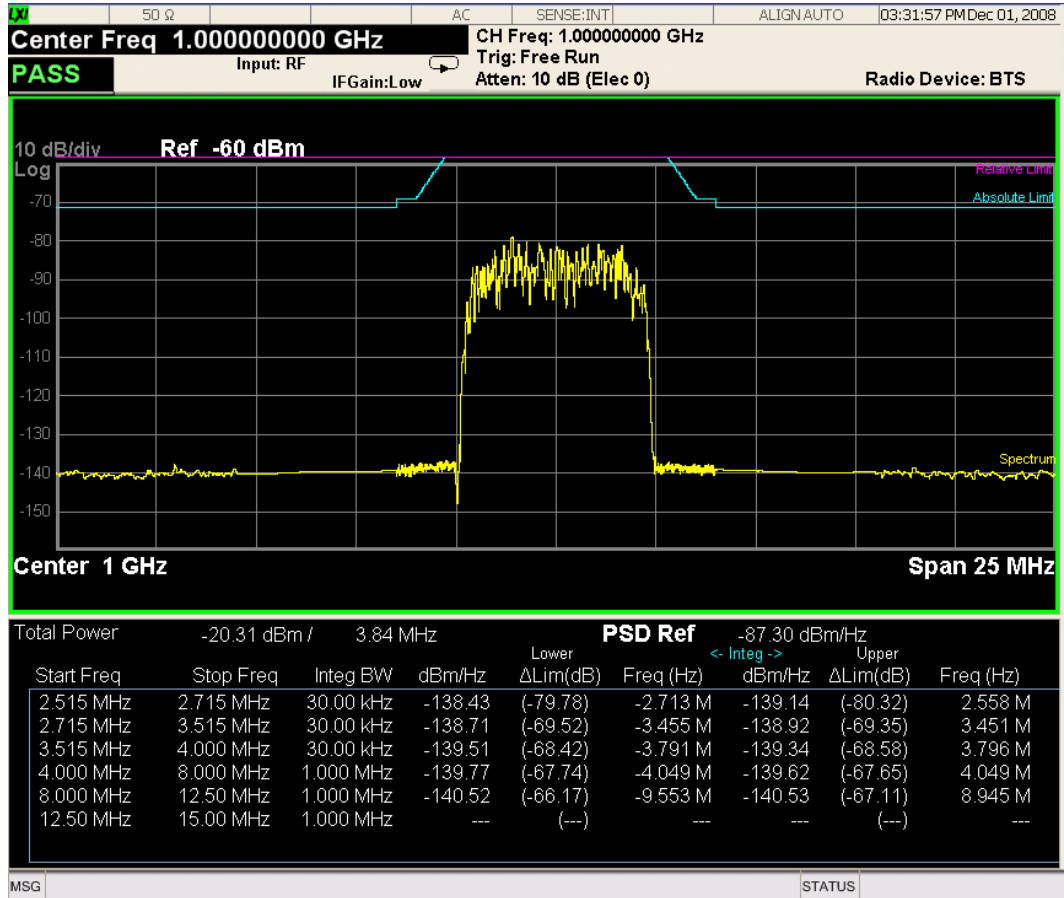

Trace Window

Corresponding Trace	yellow - Combined trace from carrier and each offset
---------------------	--

Results Window

Name	Corresponding Results
Total Pwr	n=1 2nd element Absolute power at the reference area.
	Channel Integration Bandwidth
PSD Ref	n=5 1st element Power spectral density reference at the reference area
Start (Hz)	Start frequency for offset
Stop (Hz)	Stop frequency for offset
Meas BW (Hz)	Measurement bandwidth for offset
Lower (dBm/Hz)	Absolute power spectrum density of the negative offset
Lower Δ lim (dB)	Minimum margin from limit line which is decided by Fail Mask setting on the negative offset
Lower Freq (Hz)	Frequency on minimum margin point of the negative offset
Upper (dBm/Hz)	Absolute power spectrum density of the positive offset
Upper Δ lim (dB)	Minimum margin from limit line which is decided by Fail Mask setting on the positive offset
Upper Freq (Hz)	Frequency on minimum margin point of the positive offset

Abs Peak Pwr & Freq (Spectrum Pk Ref)

This view consists of the following two windows:

"Trace Window" on page 2877

"Results Window " on page 2877

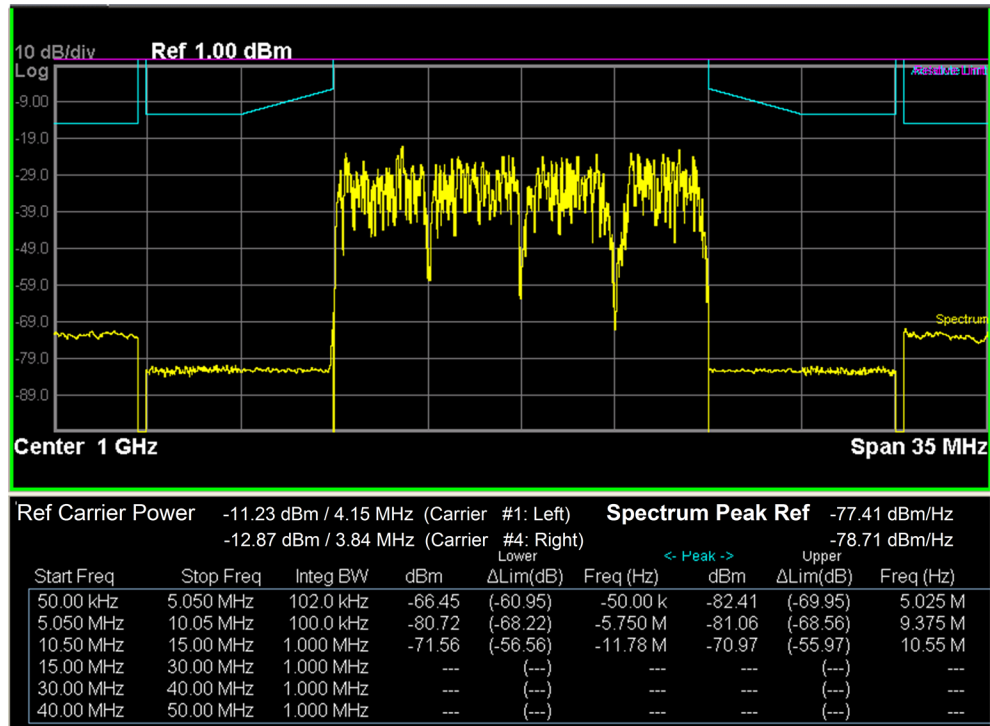
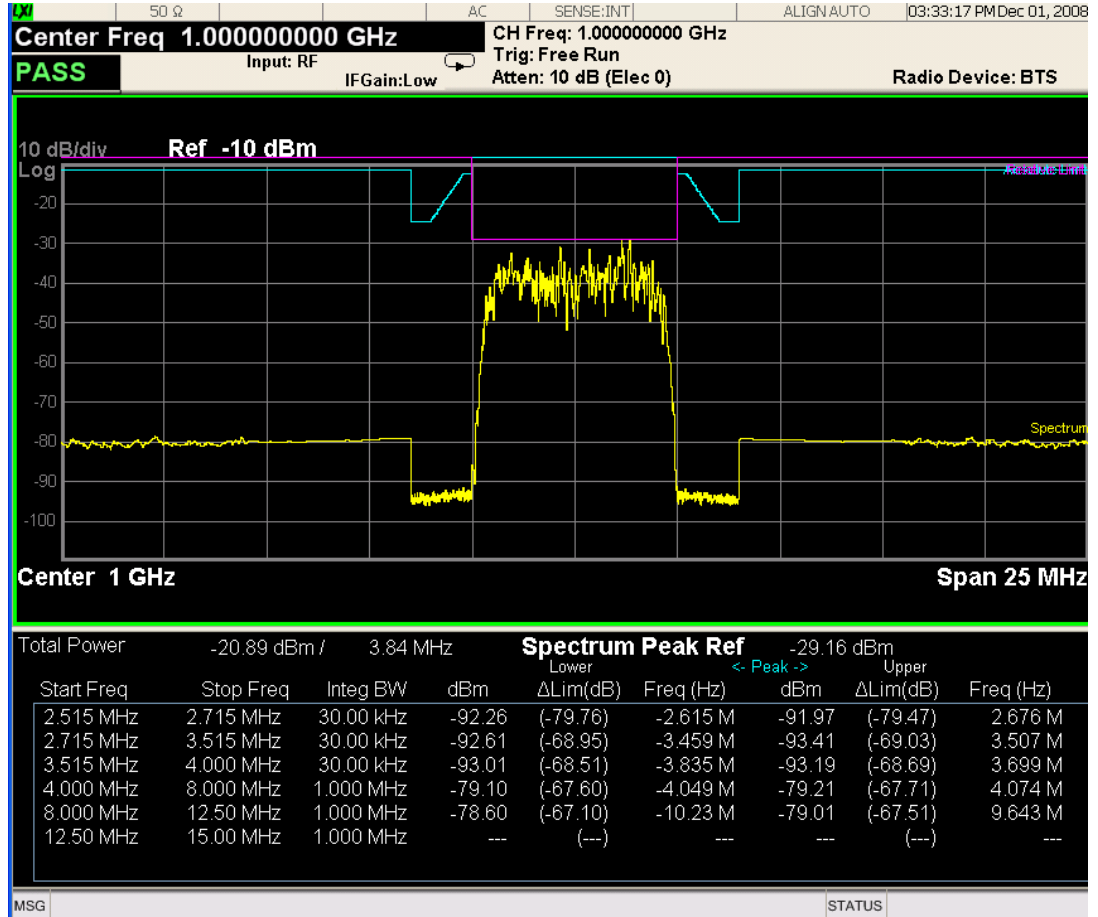

Trace Window

Corresponding Trace	yellow - Combined trace from carrier and each offset
---------------------	--

Results Window

Name	Corresponding Results
Total Pwr	Absolute power at the reference area. Channel Integration Bandwidth
Spectrum Peak Ref	n=5 1st element Spectrum peak power reference at the reference area
Start (Hz)	Start frequency for offset
Stop (Hz)	Stop frequency for offset
Meas BW (Hz)	Measurement bandwidth for offset
Lower(dBm)	Absolute peak power on minimum margin point of the negative offset
Lower Δ lim (dB)	Minimum margin from limit line which is decided by Fail Mask setting on the negative offset
Lower Freq (Hz)	Frequency on minimum margin point of the negative offset
Upper (dBm)	Absolute peak power on minimum margin point of the positive offset
Upper Δ lim (dB)	Minimum margin from limit line which is decided by Fail Mask setting on the positive offset
Upper Freq (Hz)	Frequency on minimum margin point of the positive offset

Key Path	View/Display
Initial S/W Revision	Prior to A.02.00

Rel Pwr Freq

Sets the display to the Relative Peak Power and Frequency view. The views differ depending on the setting of the measurement type (Meas Type) under the Measurement Setup menu.

"Rel Peak Pwr & Freq (Total Pwr Ref)" on page 2879

"Rel Peak Pwr & Freq (PSD Ref)" on page 2881

"Rel Peak Pwr & Freq (Spectrum Pk Ref)" on page 2882

Rel Peak Pwr & Freq (Total Pwr Ref)

This view consists of the following two windows:

"Trace Window" on page 2880

"Results Window" on page 2880

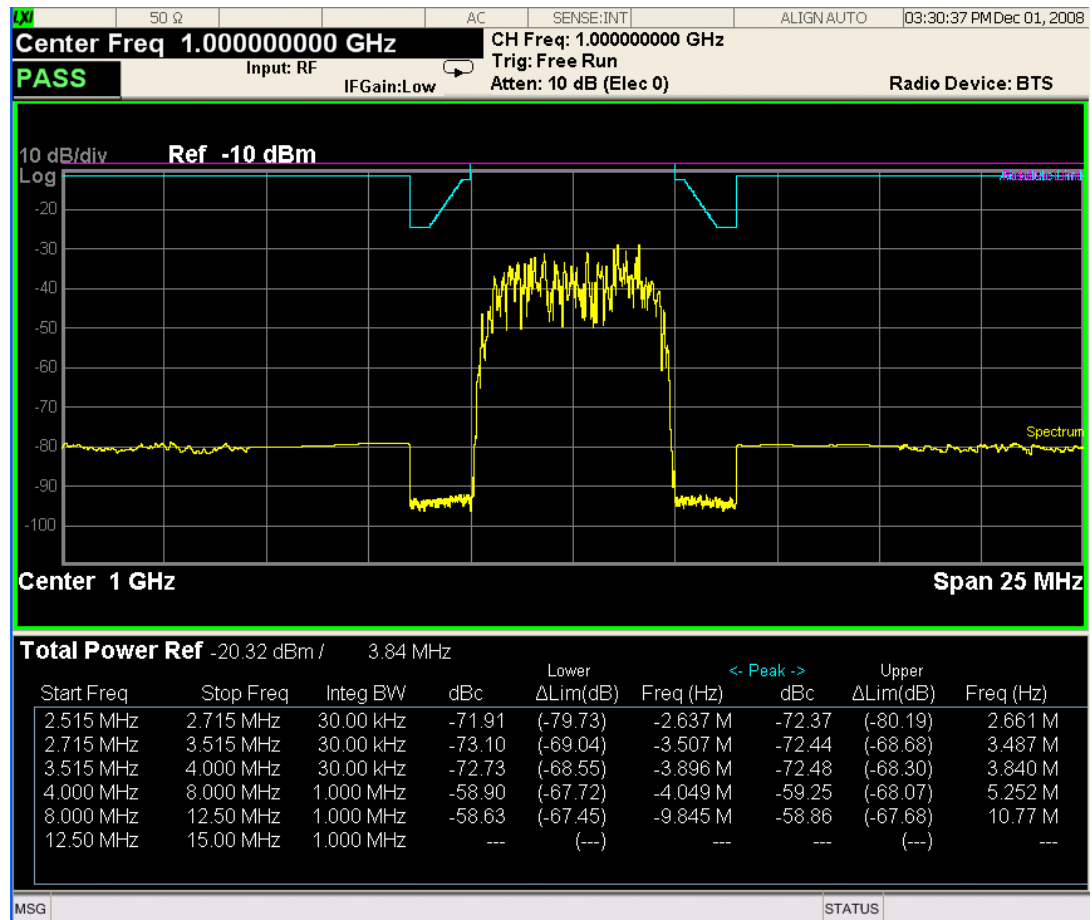

Trace Window

Corresponding Trace yellow - Combined trace from carrier and each offset

Results Window

Name	Corresponding Results
Total Pwr Ref	n=1 2nd element Absolute power at the reference area.
	Channel Integration Bandwidth
Start (Hz)	Start frequency for offset
Stop (Hz)	Stop frequency for offset
Meas BW (Hz)	Measurement bandwidth for offset
Lower Peak (dBc)	Relative peak power on minimum margin point of the negative offset
Lower ΔLim (dB)	Minimum margin from limit line which is decided by Fail Mask setting on the negative offset

Name	Corresponding Results
Lower Freq (Hz)	Frequency on minimum margin point of the negative offset
Upper Peak (dBc)	Relative peak power on minimum margin point of the positive offset
Upper ΔLim (dB)	Minimum margin from limit line which is decided by Fail Mask setting on the positive offset
Upper Freq (Hz)	Frequency on minimum margin point of the positive offset

Rel Peak Pwr & Freq (PSD Ref)

This view consists of the following two windows:

"Trace Window" on page 2881

"Results Window" on page 2882

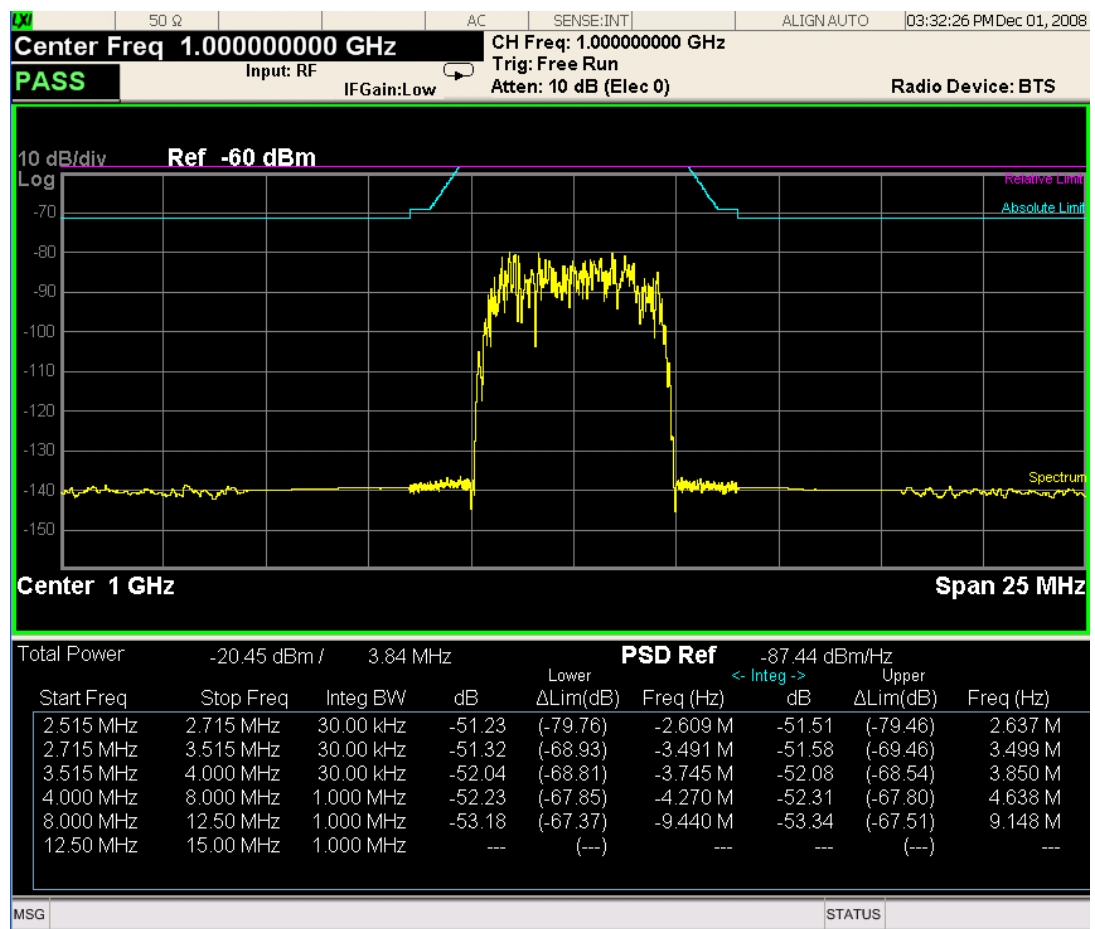

Trace Window

Corresponding Trace yellow - Combined trace from carrier and each offset

Results Window

Name	Corresponding Results
Total Pwr	n=1 2nd element Absolute power at the reference area.
	Channel Integration Bandwidth
PSD Ref	n=5 1st element Power spectral density reference at the reference area
Start (Hz)	Start frequency for offset
Stop (Hz)	Stop frequency for offset
Meas BW (Hz)	Measurement bandwidth for offset
Lower (dB)	Relative power spectrum density of the negative offset
Lower Δ Lim (dB)	Minimum margin from limit line which is decided by Fail Mask setting on the negative offset
Lower Freq (Hz)	Frequency on minimum margin point of the negative offset
Upper (dB)	Relative power spectrum density of the positive offset
Upper Δ Lim (dB)	Minimum margin from limit line which is decided by Fail Mask setting on the positive offset
Upper Freq (Hz)	Frequency on minimum margin point of the positive offset

Rel Peak Pwr & Freq (Spectrum Pk Ref)

This view consists of the following two windows:

"Trace Window" on page 2880

"Results Window" on page 2880

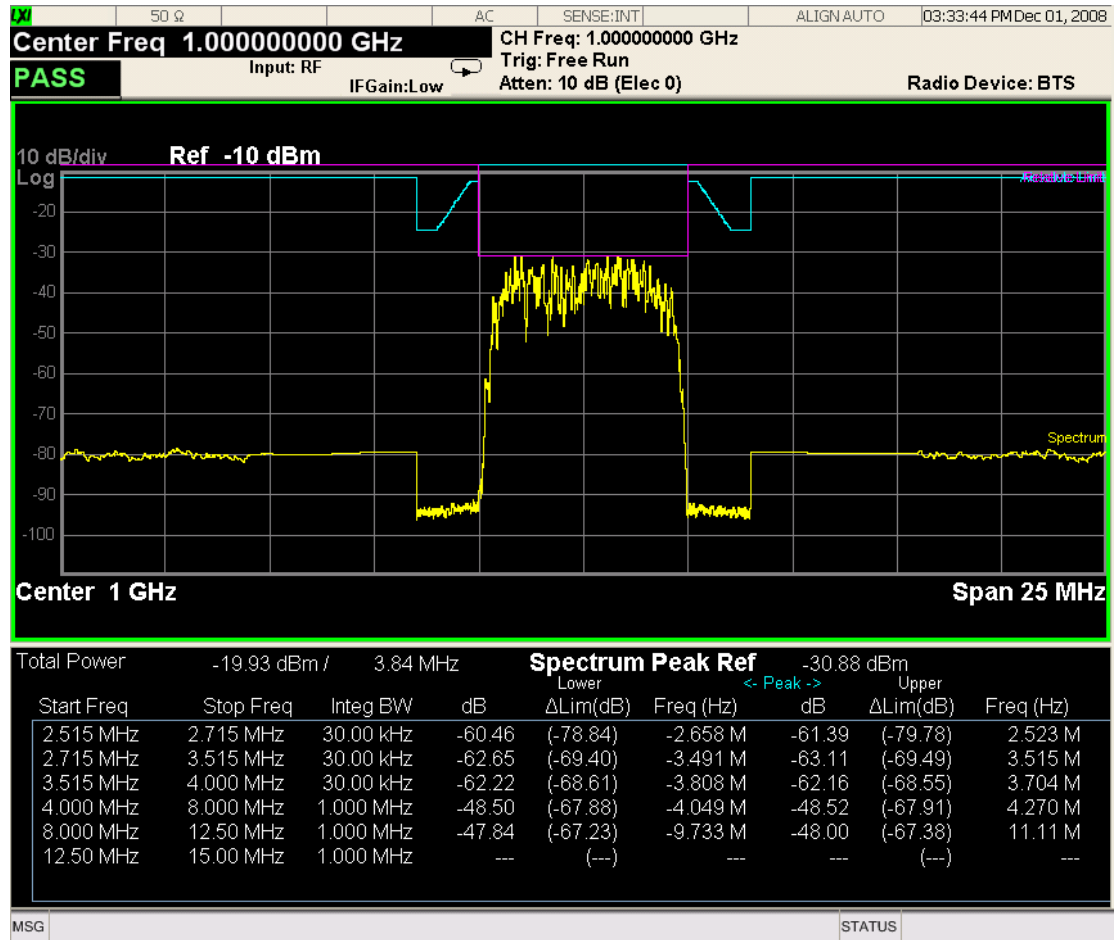

Trace Window

Corresponding Trace yellow - Combined trace from carrier and each offset

Results Window

Name	Corresponding Results
Total Pwr	Absolute power at the reference area.
	Channel Integration Bandwidth
Spectrum Peak Ref	n=5 1st element Spectrum peak power reference at the reference area
Start (Hz)	Start frequency for offset
Stop (Hz)	Stop frequency for offset
Meas BW (Hz)	Measurement bandwidth for offset
Lower Peak (dB)	Relative peak power on minimum margin point of the negative offset
Lower ΔLim (dB)	Minimum margin from limit line which is decided by Fail Mask setting on the negative offset

Name	Corresponding Results
Lower Freq (Hz)	Frequency on minimum margin point of the negative offset
Upper Peak (dB)	Relative peak power on minimum margin point of the positive offset
Upper Δ Lim (dB)	Minimum margin from limit line which is decided by Fail Mask setting on the positive offset
Upper Freq (Hz)	Frequency on minimum margin point of the positive offset

Key Path	View/Display
Initial S/W Revision	Prior to A.02.00

Integrated Power

Sets the display to the Integrated Power view. The views differ depending on the setting of the measurement type (Meas Type) under the Measurement Setup menu.

"Integrated Power (Total Pwr Ref)" on page 2884

"Integrated Power (PSD Ref)" on page 2887

"Integrated Power (Spectrum Pk Ref)" on page 2889

Integrated Power (Total Pwr Ref)

"Trace Window" on page 2886

"Results Window" on page 2886

15 Spectrum Emission Mask Measurement
View/Display

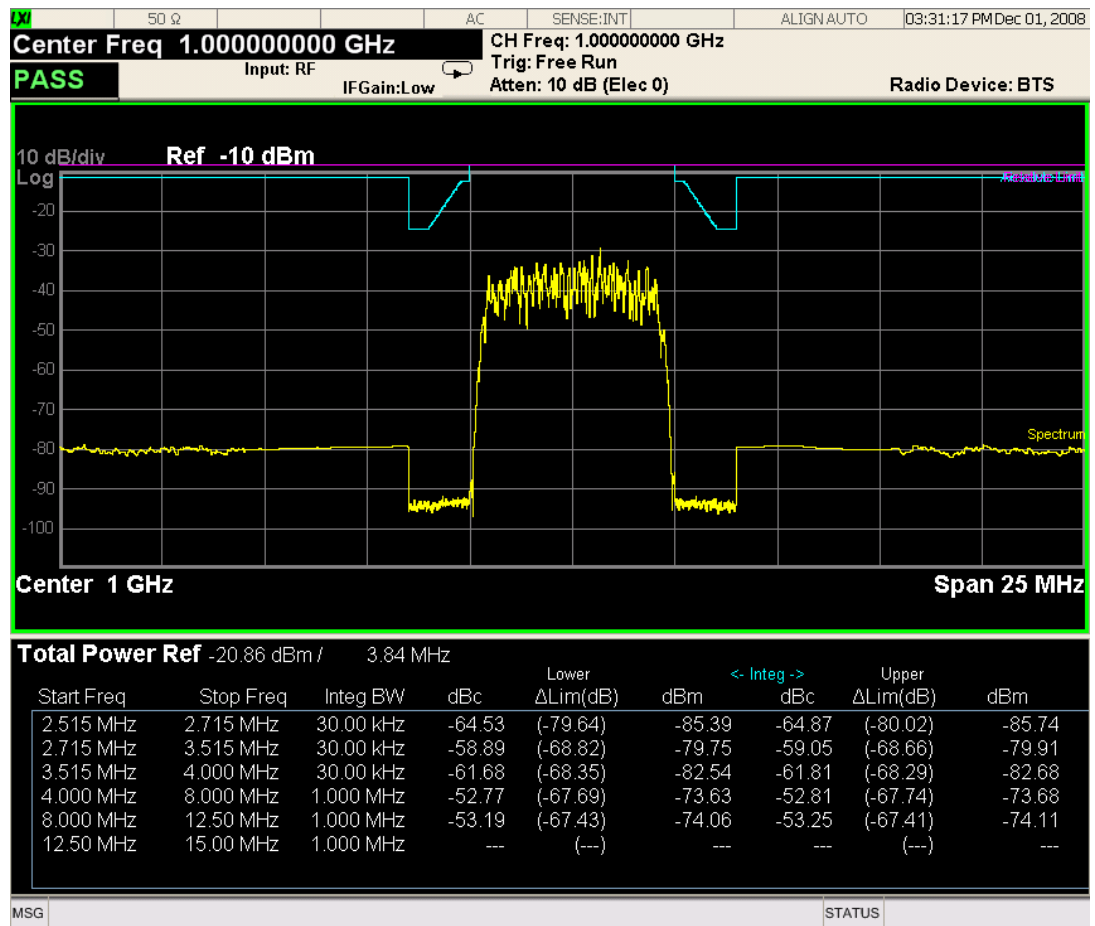

For WLAN 802.11ac (80 + 80 MHz), power readouts of both of the carriers are displayed in the lower result window.

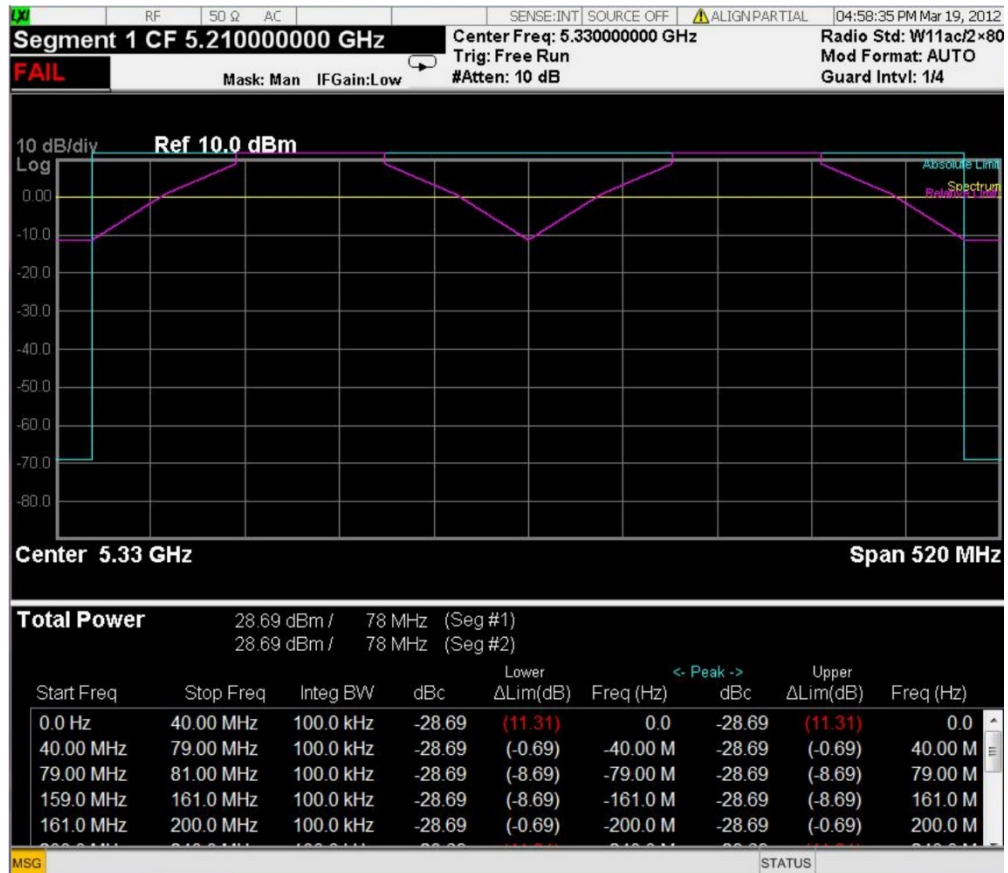

Trace Window

Corresponding Trace yellow - Combined trace from carrier and each offset

Results Window

Name	Corresponding Results
Total Pwr Ref	n=1 2nd element Absolute power at the reference area.
	Channel Integration Bandwidth
Start (Hz)	Start frequency for offset
Stop (Hz)	Stop frequency for offset
Meas BW (Hz)	Measurement bandwidth for offset
Lower Integ (dBc)	Relative integrated power on the negative offset
Lower ΔLim (dB)	Minimum margin from limit line which is decided by Fail Mask setting on the negative offset
Lower Integ (dBm)	Absolute integrated power on the negative offset
Upper Integ (dBc)	Relative integrated power on the positive offset
Upper ΔLim (dB)	Minimum margin from limit line which is decided by Fail

Name	Corresponding Results
	Mask setting on the positive offset
Upper Integ (dBm)	Absolute integrated power on the positive offset

Integrated Power (PSD Ref)

"Trace Window" on page 2888

"Results Window" on page 2888

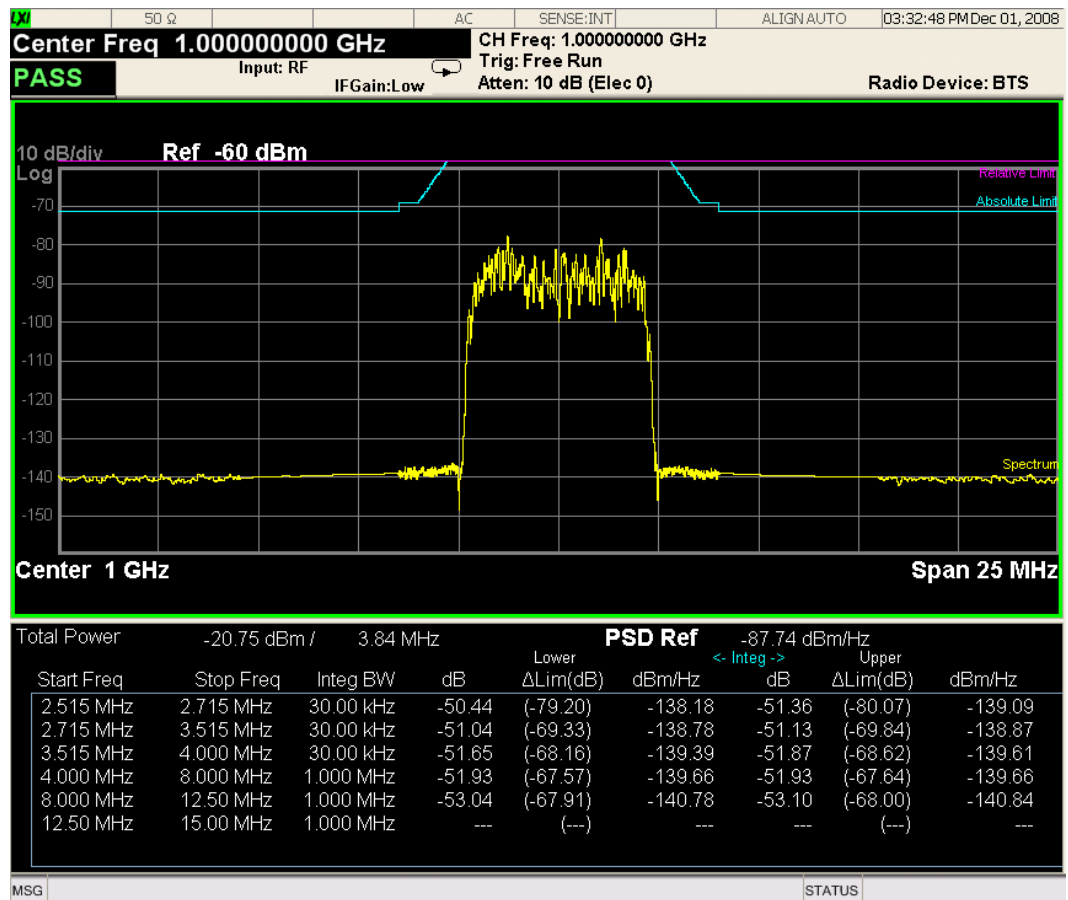

For WLAN 802.11ac (80 + 80 MHz), power readouts of both of the carriers are displayed in the lower result window.

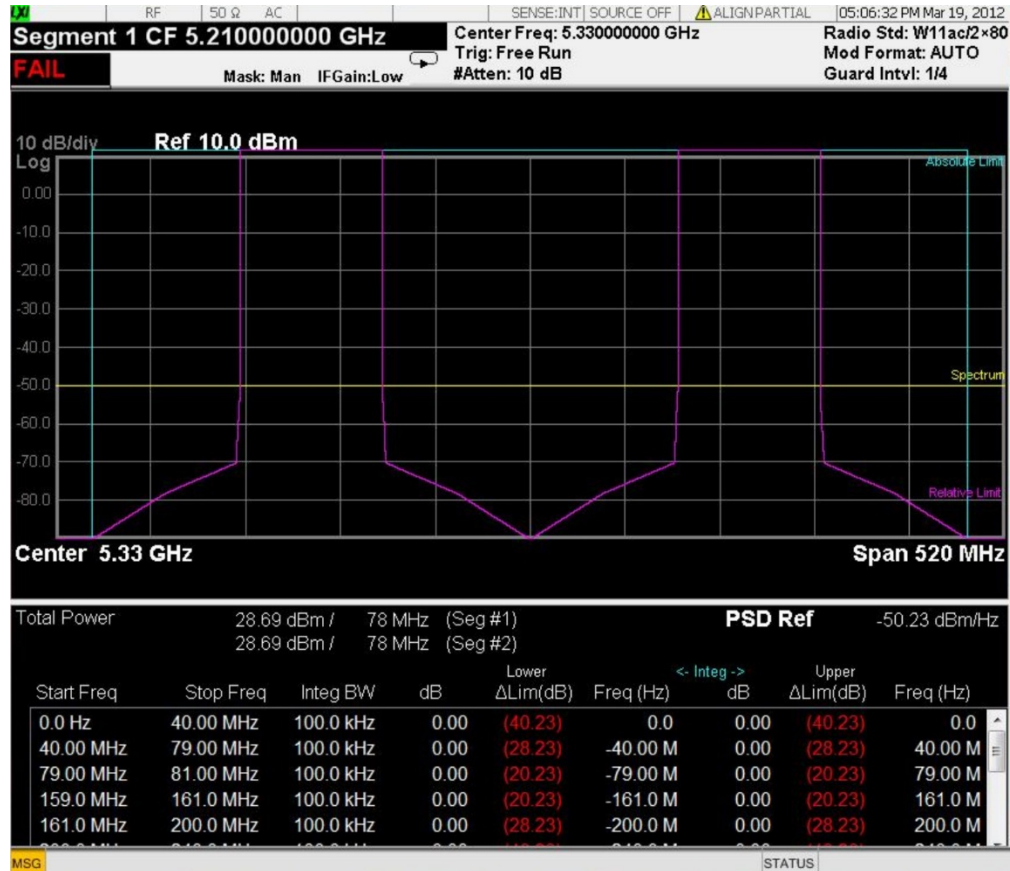

Trace Window

Corresponding Trace yellow - Combined trace from carrier and each offset

Results Window

Name	Corresponding Results
Total Pwr	n=1 2nd element Absolute power at the reference area. Channel Integration Bandwidth
PSD Ref	n=5 1st element Power spectral density reference at the reference area
Start (Hz)	Start frequency for offset
Stop (Hz)	Stop frequency for offset
Meas BW (Hz)	Measurement bandwidth for offset
Lower (dB)	Relative power spectrum density of the negative offset
Lower Δ Lim (dB)	Minimum margin from limit line which is decided by Fail Mask setting on the negative offset
Lower (dBm/Hz)	Absolute power spectrum density of the negative offset

Name	Corresponding Results
Upper (dB)	Relative power spectrum density of the positive offset
Upper Δ Lim (dB)	Minimum margin from limit line which is decided by Fail Mask setting on the positive offset
Upper (dBm/Hz)	Absolute power spectrum density of the negative offset

Integrated Power (Spectrum Pk Ref)

"Trace Window" on page 2886

"Results Window" on page 2886

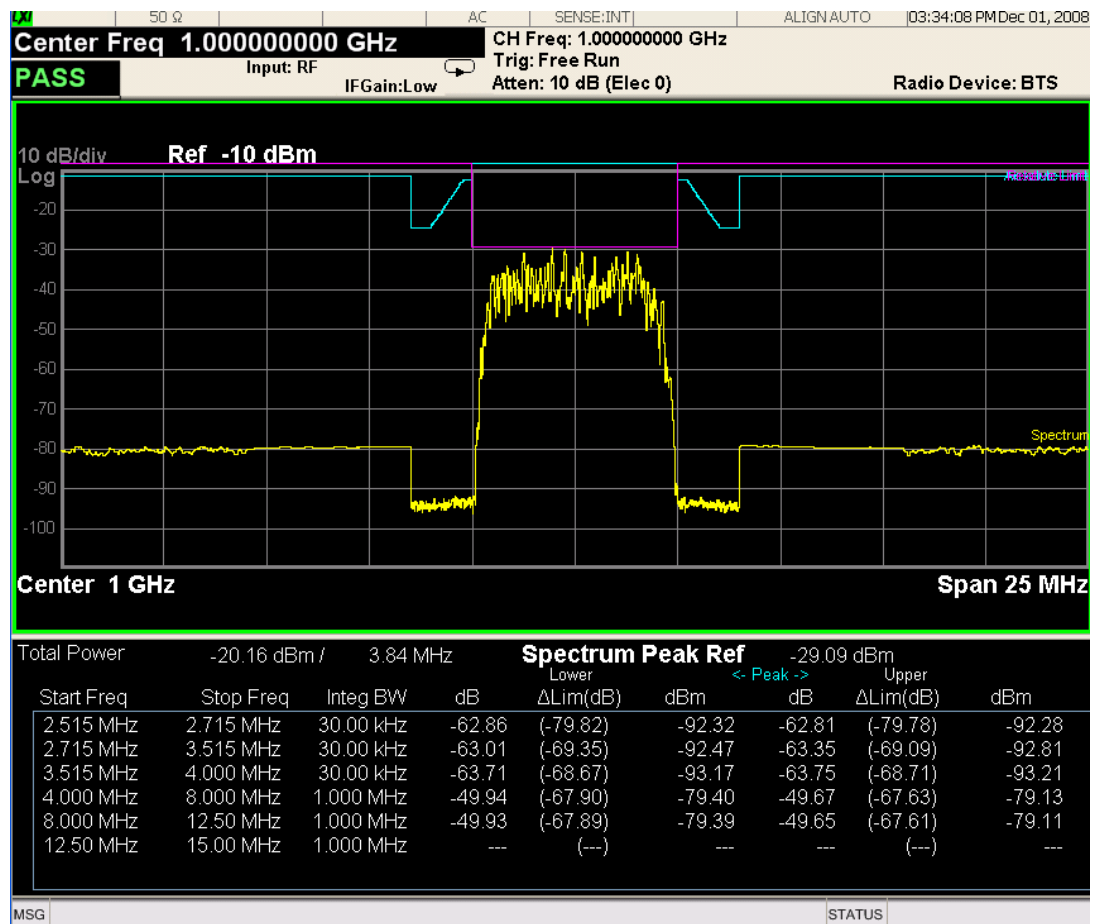

For WLAN 802.11ac (80 + 80 MHz), power readouts of both of the carriers are displayed in the lower result window.



Trace Window

Corresponding Trace yellow - Combined trace from carrier and each offset

Results Window

Name	Corresponding Results
Total Pwr	Absolute power at the reference area.
	Channel Integration Bandwidth
Spectrum Peak Ref	n=5 1st element Peak power at the reference area
Start (Hz)	Start frequency for offset
Stop (Hz)	Stop frequency for offset
Meas BW (Hz)	Measurement bandwidth for offset
Lower Peak (dB)	Relative peak power on minimum margin point of the negative offset
Lower Δlim (dB)	Minimum margin from limit line which is decided by Fail Mask setting on the negative offset
Lower Peak (dBm)	Absolute peak power on minimum margin point of the negative offset

Name	Corresponding Results
Upper Peak (dB)	Relative peak power on minimum margin point of the positive offset
Upper Δ lim (dB)	Minimum margin from limit line which is decided by Fail Mask setting on the positive offset
Upper Peak (dBm)	Absolute peak power on minimum margin point of the positive offset

Key Path	View/Display
Initial S/W Revision	Prior to A.02.00

Limit Lines

Toggles the limit lines display function for the spectrum emission mask measurements On and Off.

Key Path	View/Display
Mode	SA, WCDMA, C2K, WIMAX OFDMA, TD-SCDMA, 1xEVDO, DTMB (CTTB), DVB-T/H, ISDB-T, CMMB, LTE, LTETDD, Digital Cable TV, WLAN, MSR, LTEAFDD, LTEATDD
Remote Command	:CALCulate:SEMask:LLINe:STATe ON OFF 1 0 :CALCulate:SEMask:LLINe:STATe?
Example	CALC:SEM:LLIN:STAT OFF CALC:SEM:LLIN:STAT?
Notes	You must be in the mode that includes SEM measurement to use this command. Use :INSTrument:SElect to set the mode.
Preset	ON
State Saved	Saved in instrument state.
Range	On Off
Initial S/W Revision	Prior to A.02.00
Modified at S/W Revision	A.02.00, A.03.00

16 TOI Measurement

The TOI measurement allows a simple (one-button) measurement of the third-order intercept of a two-tone signal. It also allows a more accurate (zero-span) measurement of that signal.

For more information see ["TOI Measurement Details" on page 2895](#).

For measurement results and views, see ["TOI View" on page 3094](#).

TOI Measurement Fetch/Read Results

For more measurement related commands, see the SENSE subsystem, and the ["Remote Measurement Functions" on page 3140](#).

All returned frequencies are affected by Frequency Offset, and all absolute amplitudes are affected by Ref Level Offset. Amplitudes are returned in dBm regardless of the Y Axis Unit.

Command	n	Return Value
CONFigure?	n/a	Name of current measurement: "TOI"
CONFigure:TOI	n/a	N/A
CONFigure:TOI:NDEFault		
INITiate:TOI		
FETCh:TOI[n]? MEASure:TOI[n]? READ:TOI[n]?	0	Returns the trace data, in interleaved X/Y pairs.
FETCh:TOI[n]? MEASure:TOI[n]? READ:TOI[n]?	1	Returns 6 scalar results, in the following order. 1. The worst case Output Intercept Power value in dBm 2. The worst case Output Intermod Point in Hz 3. The lower Output Intercept Power value in dBm 4. The lower Output Intermod Point in Hz 5. The upper Output Intercept Power value in dBm 6. The upper Output Intermod Point in Hz
	2	Returns 12 scalar results, in the following order. 1. The worst case Output Intermod Point value in Hz. 2. The worst case Output Intermod Power value in dBm 3. The worst case Output Intercept Power value in dBm 4. The lower base frequency value in Hz 5. The lower base power value in dBm 6. The upper base frequency value in Hz 7. The upper base power value in dBm 8. The lower Output Intermod Point in Hz 9. The lower Output Intermod Power value in dBm 10. The lower Output Intercept Power value in dBm 11. The upper Output Intermod Point in Hz 12. The upper Output Intermod Power value in dBm 13. The upper Output Intercept Power value in

		dBm
<code>FETCh:TOI:IP3?</code>	1	Returns the worst-case Output Intercept Power value in dBm
<code>MEASure:TOI:IP3?</code>		
<code>READ:TOI:IP3?</code>		

Backwards Compatibility SCPI. Each of these commands translates to the equivalent `:TOI` command.

Command
<code>CONFigure:TOINtercept</code>
<code>CONFigure:TOINtercept:NDEFault</code>
<code>INITiate:TOINtercept</code>
<code>FETCh:TOINtercept[n]?</code>
<code>MEASure:TOINtercept[n]?</code>
<code>READ:TOINtercept[n]?</code>
<code>FETCh:TOINtercept[n]:IP3?</code>
<code>MEASure:TOINtercept[n]:IP3?</code>
<code>READ:TOINtercept[n]:IP3?</code>

TOI Measurement Details

The TOI measurement begins by taking a sweep using the current center frequency and span. It chooses the two highest peaks as the lower and upper tone frequencies, F_{Lower} and F_{Upper} . Then the third-order intermod frequencies are computed as:

$$f_{Lower} = 2F_{Lower} - F_{Upper}$$

$$f_{Upper} = 2F_{Upper} - F_{Lower}$$

The power is then measured at the four frequencies (unless either intermod frequency falls outside the span).

The third order intercept level is defined (all values expressed in dBm) as:

$$TOI_{Lower} = \frac{P_{Upper}}{2} + P_{Lower} - \frac{P_{LowerIntermod}}{2}$$

$$TOI_{Upper} = \frac{P_{Lower}}{2} + P_{Upper} - \frac{P_{UpperIntermod}}{2}$$

The third order delta level is defined (all values expressed in dBm) as:

$$\Delta_{Lower} = P_{LowerIntermod} - \frac{2 \times P_{Lower} + P_{Upper}}{3}$$

$$\Delta_{Upper} = P_{UpperIntermod} - \frac{2 \times P_{Upper} + P_{Lower}}{3}$$

Both values are computed and the TOI is reported as the worst of the two measurements.

There are two approaches to TOI measurement acquisition. The first approach is a simple method to use a single sweep. This method gives the quickest approximate measurement and highest usability. (The span must be sufficient to encompass both the lower and upper intermod frequencies.)

The second approach is to supplement the above with zero-span acquisitions at the intermod frequencies. Because we spend the majority of our acquisition time at key frequencies, this technique gives more accurate measurement of low-power intermodulation distortion signals.

Key Path	Meas
Initial S/W Revision	A.04.00

AMPTD Y Scale

Activates the Reference Value function and displays the Amplitude menu keys. These functions control how data on the vertical (Y) axis is displayed and control instrument settings that affect the vertical axis.

Key Path	Front-panel key
----------	-----------------

Ref Value

The reference value specifies the amplitude of a signal displayed on the reference graticule line. The reference line is either at the top, center, or bottom of the graticule, depending on the value of the Ref Position function .

Key Path	AMPTD Y Scale
Remote Command	DISP:TOI:VIEW:WINDow:TRACe:Y[:SCALE]:RLEVel <amplitude> DISP:TOI:VIEW:WINDow:TRACe:Y[:SCALE]:RLEVel?
Example	DISP:TOI:VIEW:WIND:TRAC:Y:RLEV -10 dBm Sets the reference value to -10 dBm
Couplings	This value is affected by Ref Level Offset, as are the max and min values.
Preset	0.0 dBm
Min	-250 + Ref Level Offset
Max	250 dBm + Ref Level Offset
Initial S/W Revision	Prior to A.02.00

Attenuation

This menu controls the attenuator functions and interactions between the attenuation system components.

There are two attenuator configurations in the X-Series. One is a dual attenuator configuration consisting of a mechanical attenuator and an optional electronic attenuator. The other configuration uses a single attenuator with combined mechanical and electronic sections that controls all the attenuation functions. Different models in the X-Series come with different configurations.

See ["Dual Attenuator Configurations:" on page 2897](#)

See ["Single Attenuator Configuration:" on page 2897](#)

Most Attenuation settings are the same for all measurements – they do not change as you change measurements. Settings like these are called “Meas Global” and are unaffected by Meas Preset.

Key Path	AMPTD Y Scale
Scope	Meas Global
Dependencies	In measurements that support the I/Q inputs, this key is unavailable when I/Q is the selected input, and is replaced by the Range key in that case.
Readback Line	Contains a summary in [] brackets of the current total attenuation. See the descriptions of the , " (Mech) Atten " on page 3103, and "Enable Elec Atten" on page 3105 keys for more detail on the contributors to the total attenuation. Note that when "Pre-Adjust for Min Clip" is on, this value can change at the start of every measurement.
Initial S/W Revision	Prior to A.02.00
Modified at S/W Revision	A.03.00

Dual Attenuator Configurations:

Configuration 1: Mechanical attenuator + optional electronic attenuator

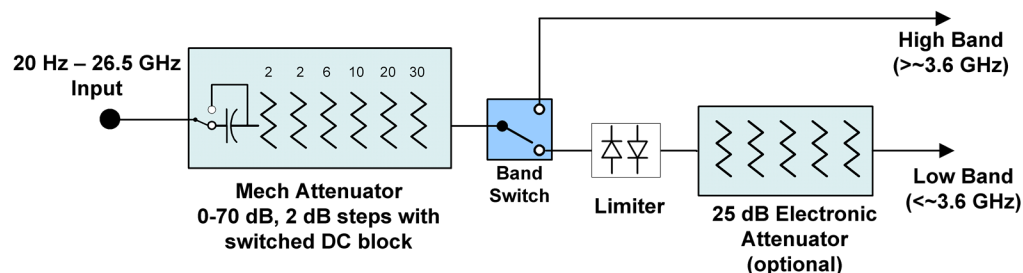

Configuration 2: Mechanical attenuator, no optional electronic attenuator

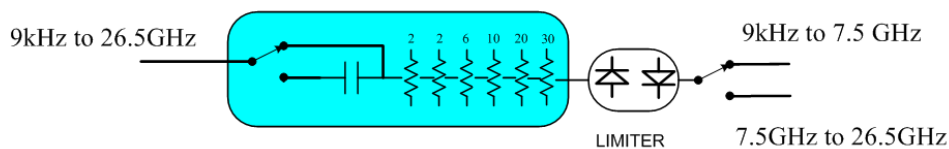

(note that Configuration 2 is not strictly speaking a dual-section attenuator, since there is no electronic section available. However, it behaves exactly like Configuration 1 without the Electronic Attenuator option EA3, therefore for the sake of this document it is grouped into the "Dual Attenuator" configuration)

Single Attenuator Configuration:

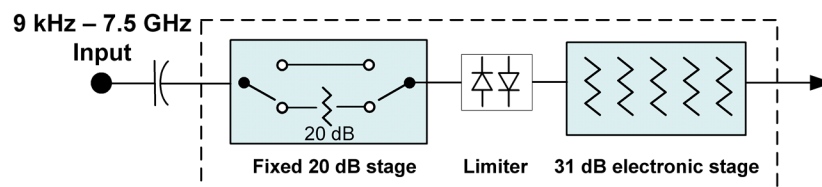

You can tell which attenuator configuration you have by pressing the Attenuation key, which (in most Modes) opens the Attenuation menu. If the first key in the Attenuation menu says **Mech Atten** you have the dual attenuator configuration. If the first key says **Atten** you have the single attenuator configuration.



Dual Attenuator

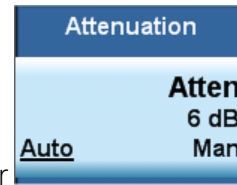

In the single attenuator configuration, you control the attenuation with a single control, as the fixed stage has only two states. In the dual attenuator configuration, both stages have significant range so you are given separate control of the mechanical and electronic attenuator stages.

When you have the dual attenuator configuration, you may still have only a single attenuator, because unless option EA3 (the Electronic Attenuator option) is available, and you purchase it, you will have only the mechanical attenuator.

(Mech) Atten

This key is labeled **Mech Atten** in dual attenuator models and **Atten** in single attenuator models. In the dual attenuator configuration, this key only affects the mechanical attenuator.

This key lets you modify the attenuation applied to the RF input signal path. This value is normally auto coupled to the Ref Level, the Internal Preamp Gain, any External Gain that is entered, and the Max Mixer Level, as described in the table below.

See ["Attenuator Configurations and Auto/Man" on page 2899](#)

Key Path	AMPTD Y Scale, Attenuation
Remote Command	<pre>[:SENSe]:POWer[:RF]:ATTenuation <rel_amp1> [:SENSe]:POWer[:RF]:ATTenuation? [:SENSe]:POWer[:RF]:ATTenuation:AUTO OFF ON 0 1 [:SENSe]:POWer[:RF]:ATTenuation:AUTO?</pre>
Example	<p>POW:ATT 20</p> <p>Dual attenuator configuration: sets the mechanical attenuator to 20 dB</p> <p>Single attenuator mode: sets the main attenuation to 20 dB (see below for definition of "main" attenuation).</p> <p>If the attenuator was in Auto, it sets it to Manual.</p>
Dependencies	<p>Some measurements do not support the Auto setting of (Mech) Atten. In these measurements, the Auto/Man selection is not available, and the Auto/Man line on the key disappears.</p> <p>In dual attenuator configurations, when the electronic attenuator is enabled, the mechanical attenuator has no auto setting and the Auto/Man line on the key disappears. The state of Auto/Man is remembered and restored when the electronic attenuator is once again disabled. This is described in more detail in the "Enable Elec Atten" on page 3105 key description.</p>

	See "Attenuator Configurations and Auto/Man" on page 2899 for more information on the Auto/Man functionality of Attenuation.
Couplings	<p>When (Mech) Atten is in Auto, it uses the following algorithm to determine a value: If the USB Preamp is connected to USB, use 0 dB. Otherwise, $Atten = ReferenceLevel + PreAmpGain + ExternalGain - RefLevelOffset - MaxMixerLevel + IF\ Gain$. Limit this value to be between 6 dB and the Max value. No value below 6 dB can ever be chosen by Auto. The resulting value is rounded up to the largest value possible given the attenuation step setting. That is, 50.01 dB would change to 60 dB (for a 10 dB attenuation step). The "IF Gain" term in the equation above is either 0 dB or +10 dB, depending on the settings of FFT IF Gain, Swept IF Gain, max Ref Level and the Auto/Man setting of Mech Atten. In External Mixing and BBIQ, where the Attenuator is not in the signal path, the Attenuator setting changes as described above when (Mech) Atten is in Auto, but no changes are made to the actual attenuator hardware setting until the input is changed back to the RF Input.</p>
Preset	<p>The preset for Mech Attenuation is "Auto." The Auto value of attenuation is: CXA, EXA, MXA and PXA: 10 dB</p>
State Saved	Saved in instrument state
Min	<p>0 dB The attenuation set by this key cannot be decreased below 6 dB with the knob or step keys. To get to a value below 6 dB it has to be directly entered from the keypad or via SCPI. This protects from adjusting the attenuation to a dangerously small value which can put the instrument at risk of damage to input circuitry. However, if the current mechanical attenuation is below 6 dB it can be increased with the knob and step keys, but not decreased.</p>
Max	<p>CXA N9000A-503/507: 50 dB CXA N9000A-513/526: 70dB EXA: 60 dB MXA and PXA: 70 dB In the single attenuator configuration, the total of ATT and EATT cannot exceed 50 dB, so if the EATT is set to 24 dB first, the main attenuation cannot be greater than 26 dB and will be reduced accordingly; if the main attenuator is set to 40 dB first, EATT cannot be greater than 10 dB.</p>
Initial S/W Revision	Prior to A.02.00
Modified at S/W Revision	A.03.00

Attenuator Configurations and Auto/Man

As described in the Attenuation key description, there are two distinct attenuator configurations available in the X-Series, the single attenuator and dual attenuator configurations. In dual attenuator configurations, we have the mechanical attenuation and the electronic attenuation, and the current total attenuation is the sum of the electronic + mechanical attenuation. In single attenuator configurations, we refer to the attenuation set using the **(Mech) Atten** key (or POW:ATT SCPI) as the "main" attenuation; and the attenuation that is set by the SCPI command POW:EATT as the "soft" attenuation (the POW:EATT command is honored even in the single

attenuator configuration, for compatibility purposes). Then the current total attenuation is the sum of the main + soft attenuation. See the **Elec Atten** key description for more on “soft” attenuation.

In the dual attenuator configuration, when the electronic attenuator is enabled, there is no Auto/Man functionality for the mechanical attenuator, and the third line of the key label (the Auto/Man line) disappears:



Enable Elec Atten

Enables the Electronic Attenuator.

The electronic attenuator offers finer steps than the mechanical attenuator, has no acoustical noise, is faster, and is less subject to wear. These advantages primarily aid in remote operation and are negligible for front panel use. See ["Using the Electronic Attenuator: Pros and Cons" on page 2902](#) for a detailed discussion of the pros and cons of using the electronic attenuator.

For the single attenuator configuration, for SCPI backwards compatibility, the “soft” attenuation feature replaces the dual attenuator configuration’s electronic attenuator. All the same couplings and limitations apply. See ["Attenuator Configurations and Auto/Man" on page 3105](#)

See [Error! Reference source not found.](#)

Key Path	AMPTD Y Scale, Attenuation
Remote Command	[:SENSE] :POWer [:RF] :EATTenuation :STATe OFF ON 0 1 [:SENSE] :POWer [:RF] :EATTenuation :STATe ?
Example	POW:EATT:STAT ON
Dependencies	<p>This key only appears in Dual Attenuator models with an Electronic Attenuator installed. It does not appear in models with the Single Attenuator configuration, as in the single attenuator configuration there is no “electronic attenuator” there is only a single integrated attenuator (which has both a mechanical and electronic stage). However, in the single attenuator configuration, EATT SCPI commands are accepted for compatibility with other X-series instruments and set a “soft” attenuation as described in "Attenuator Configurations and Auto/Man" on page 3105.</p> <p>The electronic attenuator (and the “soft” attenuation function provided in single attenuator configurations) is unavailable above 3.6 GHz. Therefore, if the Stop Frequency of the analyzer is > 3.6 GHz then the Enable Elec Atten key will be OFF and grayed out.</p> <p>If the Internal Preamp is on, meaning it is set to Low Band or Full, the electronic attenuator (and the “soft” attenuation function provided in single attenuator configurations) is unavailable. In this case the Enable Elec Atten key will be OFF and grayed out.</p> <p>If either of the above is true, if the SCPI command is sent, an error indicating that the electronic</p>

	attenuator is unavailable will be sent. If the electronic/soft Attenuator is enabled, then the Stop Freq of the analyzer is limited to 3.6 GHz and the Internal Preamp is unavailable. The SCPI-only “soft” electronic attenuation for the single-attenuator configuration is not available in all measurements; in particular, it is not available in the Swept SA measurement.
Couplings	Enabling and disabling the Electronic Attenuator affects the setting of the Mechanical Attenuator (in dual attenuator configurations). This is described in more detail below this table.
Preset	OFF for Swept SA measurement; ON for all other measurements that support the electronic attenuator
State Saved	Saved in instrument state
Initial S/W Revision	Prior to A.02.00
Modified at S/W Revision	A.03.00

Mechanical Attenuator Transition Rules

When the Electronic Attenuator is enabled, the Mechanical Attenuator transitions to a state that has no Auto function. Below are the rules for transitioning the Mechanical Attenuator. NOTE that the information below ONLY applies to the dual attenuator configurations, and ONLY when the Electronic Attenuator is installed:

When the Electronic Attenuation is enabled from a disabled state:

- The Mechanical Attenuator is initialized to 10 dB (this is its optimal performance setting). You can then set it as desired with SCPI, numeric keypad, step keys, or knob, and it behaves as it normally would in manual mode
- The Auto/Man state of (Mech) Atten is saved
- The Auto/Man line on the (Mech) Atten key disappears and the auto rules are disabled
- The Electronic Attenuator is set to 10 dB less than the previous value of the Mechanical Attenuator, within the limitation that it must stay within the range of 0 to 24 dB of attenuation.

Examples in the dual attenuator configuration:

- Mech Atten at 20 dB. Elec Atten enabled, Mech Atten set to 10 dB, and Elec Atten set to 10 dB. New total attenuation equals the value before Elec Atten enabled.
- Mech Atten at 0 dB. Elec Atten enabled, Mech Atten set to 10 dB, and Elec Atten set to 0 dB. New total attenuation does not equal the value before Elec Atten enabled.

- Mech Atten at 40 dB. Elec Atten enabled, Mech Atten set to 10 dB, and Elec Atten set to 24 dB. New total attenuation does not equal the value before Elec Atten enabled.

When the Electronic Attenuation is disabled from an enabled state:

- The Elec Atten key is grayed out
- The Auto/Man state of (Mech) Atten is restored
- If now in Auto, (Mech) Atten recouples
- If now in Man, (Mech) Atten is set to the value of total attenuation that existed before the Elec Atten was disabled. The resulting value is rounded up to the smallest value possible given the (Mech) Atten Step setting - (That is, 57 dB changes to 58 dB when (Mech) Atten Step is 2 dB.)

Using the Electronic Attenuator: Pros and Cons

The electronic attenuator offers finer steps than the mechanical attenuator, has no acoustical noise, is faster, and is less subject to wear.

The “finer steps” advantage of the electronic attenuator is beneficial in optimizing the alignment of the analyzer dynamic range to the signal power in the front panel as well as remote use. Thus, you can achieve improved relative signal measurement accuracy. Compared to a mechanical attenuator with 2 dB steps, the 1 dB resolution of the electronic attenuator only gives better resolution when the odd-decibel steps are used. Those odd-decibel steps are less accurately calibrated than the even-decibel steps, so one tradeoff for this superior relative accuracy is reduced absolute amplitude accuracy.

Another disadvantage of the electronic attenuator is that the spectrum analyzer loses its “Auto” setting, making operation less convenient.

Also, the relationship between the dynamic range specifications (TOI, SHI, compression and noise) and instrument performance are less well-known with the electrical attenuator. With the mechanical attenuator, TOI, SHI and compression threshold levels increase dB-for-dB with increasing attenuation, and the noise floor does as well. With the electronic attenuator, there is an excess attenuation of about 1 to 3 dB between 0 and 3.6 GHz, making the effective TOI, SHI, and so forth, less well known. Excess attenuation is the actual attenuation relative to stated attenuation. Excess attenuation is accounted for in the analyzer calibration

Elec Atten

Controls the Electronic Attenuator in dual attenuator configurations. This key does not appear in single attenuator configurations, as the control of both the mechanical and electronic stages of the single attenuator is integrated into the single **Atten** key.

Key Path	AMPTD Y Scale, Attenuation
Remote Command	[:SENSe]:POWer[:RF]:EATTenuation <rel_amp1> [:SENSe]:POWer[:RF]:EATTenuation?
Notes	Electronic Attenuation's specification is defined only when Mechanical Attenuation is 6 dB.
Dependencies	This key only appears in Dual Attenuator models with an Electronic Attenuator installed. It does not appear in models with the Single Attenuator configuration, as in the single attenuator configuration there is no "electronic attenuator" there is only a single integrated attenuator (which has both a mechanical and electronic stage). However, in the single attenuator configuration, EATT SCPI commands are accepted for compatibility with other X-series instruments and set a "soft" attenuation as described in "Attenuator Configurations and Auto/Man" on page 3105 . The "soft" attenuation is treated as an addition to the "main" attenuation value set by the Atten softkey or the POW:ATT SCPI command and affects the total attenuation displayed on the Attenuation key and the Meas Bar. When Enable Elec Atten is off or grayed out, the Elec Atten key is grayed out.
Preset	0 dB
State Saved	Saved in instrument state
Min	0 dB
Max	Dual attenuator configuration: 24 dB Single attenuator configuration: the total of ATT and EATT cannot exceed 50 dB, so if the EATT is set to 24 dB first, the main attenuation cannot be greater than 26 dB and will be reduced accordingly; if the main attenuator is set to 40 dB first, EATT cannot be greater than 10 dB
Initial S/W Revision	Prior to A.02.00
Modified at S/W Revision	A.03.00

Adjust Atten for Min Clip

Sets the combination of mechanical and electronic attenuation and gain based on the current measured signal level so that clipping will be at a minimum.

This is an "immediate action" function, that is, it executes once, when the key is pressed.

This key does not appear in measurements that do not support this functionality. The spectrum analyzer measurement, Swept SA, does not support this functionality.

Key Path	AMPTD Y Scale, Attenuation
Remote Command	[:SENSe]:POWer[:RF]:RANGe:OPTimize IMMEDIATE
Initial S/W Revision	Prior to A.02.00
Modified at S/W Revision	A.03.00

Pre-Adjust for Min Clip

If this function is on, it does the adjustment described under ["Adjust Atten for Min Clip" on page 3108](#) each time a measurement restarts. Therefore, in Continuous measurement mode, it only executes before the first measurement.

In dual attenuator models, you can set **Elec+Mech Atten**, in which case both attenuators participate in the autoranging, or **Elec Atten Only**, in which case the mechanical attenuator does not participate in the autoranging. This latter case results in less wear on the mechanical attenuator and is usually faster.

This key is grayed out in measurements that do not support this functionality. The spectrum analyzer measurement, Swept SA, does not support this functionality.

Key Path	AMPTD Y Scale, Attenuation
Remote Command	[:SENSe] :POWer [:RF] :RANGe :OPTimize :ATTenuation OFF ELECtrical COMBined [:SENSe] :POWer [:RF] :RANGe :OPTimize :ATTenuation ?
Notes	The SCPI parameter ELECtrical sets this function to On in single attenuator models. The SCPI parameter COMBined is mapped to ELECtrical in single attenuator models; if you send COMBined, it sets the function to On and returns ELEC to a query.
Dependencies	This key only appears in Dual Attenuator models with an Electronic Attenuator installed. In instruments with Dual Attenuator model, when Enable Elec Atten is off or grayed out, the Pre-Adjust for Min Clip key is grayed out.
Preset	OFF for Swept SA measurement; ON for all other measurements that support Pre-Adjust for Min Clip
State Saved	Saved in instrument state
Range	Dual attenuator models: Off Elec Atten Only Mech + Elec Atten Single attenuator models: Off On
Initial S/W Revision	Prior to A.02.00
Modified at S/W Revision	A.03.00

Remote Command	[:SENSe] :POWer [:RF] :RANGe :AUTO ON OFF 1 0 [:SENSe] :POWer [:RF] :RANGe :AUTO ?
Notes	ON aliases to "Elec Atten Only" (:POW:RANG:OPT:ATT ELEC) OFF aliases to "Off" (:POW:RANG:OPT:ATT OFF) The query :POW:RANG:AUTO? returns true if :POW:RANG:OPT:ATT is not "Off"
Initial S/W Revision	Prior to A.02.00

Off

Turns **Pre-Adjust for Min Clip** off. This is the default setting.

This key is grayed out in measurements that do not support this functionality. The spectrum analyzer measurement, Swept SA, does not support this functionality.

Key Path	AMPTD Y Scale, Attenuation, Pre-Adjust for Min Clip
----------	---

Example	:POW:RANGe:OPT:ATT OFF
Initial S/W Revision	Prior to A.02.00

Elec Atten Only

Selects only the electric attenuator to participate in auto ranging. This offers less wear on the mechanical attenuator and is usually faster.

This key is grayed out in measurements that do not support this functionality. The spectrum analyzer measurement, Swept SA, does not support this functionality.

Key Path	AMPTD Y Scale, Attenuation, Pre-Adjust for Min Clip
Example	:POW:RANGe:OPT:ATT ELEC
Initial S/W Revision	Prior to A.02.00

Mech + Elec Atten

In dual attenuator models, this selects both attenuators participate in the autoranging.

This key is grayed out in measurements that do not support this functionality. The spectrum analyzer measurement, Swept SA, does not support this functionality.

Key Path	AMPTD Y Scale, Attenuation, Pre-Adjust for Min Clip
Example	:POW:RANGe:OPT:ATT COMB
Initial S/W Revision	Prior to A.02.00

(Mech) Atten Step

This controls the step size used when making adjustments to the input attenuation.

This key is labeled **Mech Atten Step** in dual attenuator models and **Atten Step** in single attenuator models. In the dual attenuator configuration, this key only affects the step size of the mechanical attenuator.

Key Path	AMPTD Y Scale, Attenuation
Remote Command	[:SENSe] :POWer [:RF] :ATTenuation :STEP [:INCRement] 10 dB 2 dB [:SENSe] :POWer [:RF] :ATTenuation :STEP [:INCRement] ?
Example	POW:ATT:STEP 2
Notes	Note this feature works like a 1-N choice from the front panel, but it takes a specific value (in dB) when used remotely. The only valid values are 2 and 10.
Dependencies	Blanked in CXA and EXA if option FSA (2 dB steps) is not present. If blanked, attempts to set it via SCPI will yield an error.
Couplings	When the attenuation step size changes, the current mechanical attenuation value is adjusted (if necessary) to be quantized to the new step size. That is, if step is set to 10 dB, mech atten is increased if necessary so it is a multiple of 10 dB
Preset	PXA and MXA: 2 dB

	EXA and CXA: 10 dB (2 dB with option FSA)
State Saved	Saved in instrument state
Initial S/W Revision	Prior to A.02.00
Modified at S/W Revision	A.03.00

Scale/Div

Sets the units per vertical graticule division on the display.

Key Path	AMPTD Y Scale
Remote Command	<code>DISPlay:TOI:VIEW:WINDow:TRACe:Y[:SCALe]:PDIVision <relative amplitude></code> <code>DISPlay:TOI:VIEW:WINDow:TRACe:Y[:SCALe]:PDIVision?</code>
Example	DISP:TOI:VIEW:WIND:TRAC:Y:PDIV 5
Preset	10.00 dB
Min	0.1 dB
Max	20 dB
Initial S/W Revision	Prior to A.02.00

Presel Center

When this key is pressed, the centering of the preselector filter is adjusted to optimize the amplitude accuracy at the frequency of the selected marker. If the selected marker is not on when Presel Center is pressed, the analyzer will turn on the selected marker, perform a peak search, and then perform centering on the marker's center frequency. If the selected marker is already on and between the start and stop frequencies of the analyzer, the analyzer performs the preselector calibration on that marker's frequency. If the selected marker is already on, but outside the frequency range between Start Freq and Stop Freq, the analyzer will first perform a peak search, and then perform centering on the marker's center frequency.

The value displayed on the **Presel Adjust** key will change to reflect the new preselector tuning (see **Presel Adjust**).

A number of considerations should be observed to ensure proper operation. See ["Proper Preselector Operation" on page 2907](#).

Key Path	AMPTD Y Scale
Remote Command	<code>[:SENSe]:POWer[:RF]:PCENter</code>
Example	POW:PCEN
Notes	Note that the rules outlined above under the key description apply for the remote command as well as the key. The result of the command is dependent on marker position, and so forth. Any

	message shown by the key press is also shown in response to the remote command.
Dependencies	<ul style="list-style-type: none"> - Grayed out if the microwave preselector is off.) - If the selected marker's frequency is below Band 1, advisory message 0.5001 is generated and no action is taken. - Grayed out if entirely in Band 0. - Blank in models that do not include a preselector, such as option 503. If the SCPI is sent in these instruments, it is accepted without error, and the query always returns 0. - Grayed out in the Spectrogram View.
Couplings	<p>The active marker position determines where the centering will be attempted.</p> <p>If the analyzer is in a measurement such as averaging when centering is initiated, the act of centering the preselector will restart averaging but the first average trace will not be taken until the centering is completed.</p>
Status Bits/OPC dependencies	<p>When centering the preselector, *OPC will not return true until the process is complete and a subsequent measurement has completed, nor will results be returned to a READ or MEASure command.</p> <p>The Measuring bit should remain set while this command is operating and should not go false until the subsequent sweep/measurement has completed.</p>
Initial S/W Revision	Prior to A.02.00
Modified at S/W Revision	A.03.00

Proper Preselector Operation

A number of considerations should be observed to ensure proper operation:

3. If the selected marker is off, the analyzer will turn on a marker, perform a peak search, and adjust the preselector using the selected marker's frequency. It uses the "highest peak" peak search method unqualified by threshold or excursion, so that there is no chance of a 'no peak found' error. It continues with that peak, even if it is the peak of just noise. Therefore, for this operation to work properly, there should be a signal on screen in a preselected range for the peak search to find.
4. If the selected marker is already on, the analyzer will attempt the centering at that marker's frequency. There is no preselector for signals below about 3.6 GHz, therefore if the marker is on a signal below 3.6 GHz, no centering will be attempted and an advisory message generated
5. In some models, the preselector can be bypassed. If it is bypassed, no centering will be attempted in that range and a message will be generated.

Preselector Adjust

Allows you to manually adjust the preselector filter frequency to optimize its response to the signal of interest. This function is only available when "[Presel Center](#)" on page 3111 is available.

For general purpose signal analysis, using Presel Center is recommended. Centering the filter minimizes the impact of long-term preselector drift. Presel Adjust can be used instead to manually optimize the preselector. One application of manual optimization would be to peak the preselector response, which both optimizes the signal-to-noise ratio and minimizes amplitude variations due to small (short-term) preselector drifting.

Key Path	AMPTD Y Scale
Scope	Meas Global
Remote Command	<code>[:SENSe] :POWer [:RF] :PADJust <freq></code> <code>[:SENSe] :POWer [:RF] :PADJust?</code>
Example	POW:PADJ 100KHz POW:PADJ?
Notes	The value on the key reads out to 0.1 MHz resolution.
Dependencies	<ul style="list-style-type: none"> - Grayed out if microwave preselector is off.) - Grayed out if entirely in Band 0. - Blank in models that do not include a preselector, such as option 503. If the SCPI is sent in these instruments, it is accepted without error, and the query always returns 0. - Grayed out in the Spectrogram View.
Preset	0 MHz
State Saved	The Presel Adjust value set by Presel Center , or by manually adjusting Presel Adjust , is not saved in instrument state, and does not survive a Preset or power cycle.
Min	-500 MHz
Max	500 MHz
Default Unit	Hz
Backwards Compatibility SCPI	<code>[:SENSe] :POWer [:RF] :MW :PADJust</code> <code>[:SENSe] :POWer [:RF] :MMW :PADJust</code> PSA had multiple preselectors, but the X-Series has only one. These commands simply alias to <code>[:SENSe] :POWer [:RF] :PADJust</code>
Initial S/W Revision	Prior to A.02.00
Modified at S/W Revision	A.03.00

Remote Command	<code>[:SENSe]:POWer[:RF]:PADJust:PRESelector MWAVE MMWave EXTernal</code> <code>[:SENSe]:POWer[:RF]:PADJust:PRESelector?</code>
Notes	PSA had multiple preselectors, and you could select which preselector to adjust. Since the X-Series has only one mm/uW preselector, the preselector selection softkey is no longer available. However, to provide backward compatibility, we accept the legacy remote commands. The command form has no effect, the query always returns MWAVE
Initial S/W Revision	Prior to A.02.00

Y Axis Unit

Displays the menu keys that enable you to change the vertical (Y) axis amplitude unit. The analyzer retains the entered Y Axis Unit separately for both Log and Lin amplitude scale types. For example, if Scale Type has been set to Log, and you set Y Axis Unit to dBm, pressing Scale Type (Log) sets the Y Axis Unit to dBm. If Scale Type has been set to Lin and you set Y Axis Unit to V, pressing Scale Type (Lin) sets the Y Axis Unit to V. Pressing Scale Type (Log) again sets the Y axis unit back to dBm.

NOTE

The units of current (A, dBmA, dBuA) are calculated based on 50 ohms input impedance.

All four of the EMI units (dB μ A/m, dB μ V/m, dBG, dBpT) are treated by the instrument exactly as though they were dBuV. The user must load an appropriate correction factor using Amplitude Corrections for accurate and meaningful results. If a SCPI command is sent to the analyzer that uses one of the EMI units as a terminator, the analyzer treats it as though DBUV had been sent as the terminator.

Key Path	AMPTD Y Scale
Mode	SA
Scope	Meas Global
Remote Command	<code>:UNIT:POWer DBM DBMV DBMA V W A DBUV DBUA DBPW DBUVM DBUAM DBPT DBG</code> <code>:UNIT:POWer?</code>
Example	UNIT:POW dBmV UNIT:POW?
Notes	The Y axis unit has either logarithmic or linear characteristics. The set of units that is logarithmic consists of dBm, dBmV, dBmA, dB μ V, dB μ A, dB μ V/m, dB μ A/m, dBpT, and dBG. The set of units that are linear consists of V, W, and A. The chosen unit will determine how the reference level and all the amplitude-related outputs like trace data, marker data, etc. read out.
Notes	The settings of Y Axis Unit and Scale Type, affect how the data is read over the remote interface. When using the remote interface no unit is returned, so you must know what the Y axis unit is to interpret the results: Example 1, set the following: Scale Type (Log) Y Axis Unit, dBm Scale/Div, 1 dB Ref Level, 10 dBm

	<p>This sets the top line to 10 dBm with each vertical division representing 1 dB. Thus, if a point on trace 1 is on the fifth graticule line from the top, it represents 5 dBm and will read out remotely as 5.</p> <p>Example 2, set the following: Scale Type (Lin) Y Axis Unit, Volts Ref Level, 100 mV (10 mV/div)</p> <p>This sets the top line to 100 mV and the bottom line to 0 V, so each vertical division represents 10 mV. Thus, if a point on trace 1 is on the fifth graticule line from the top, it represents 50 mV and will read out remotely as 50.</p>
Dependencies	<p>If an amplitude correction with an Antenna Unit other than None is applied and enabled, then that antenna unit is forced and the key with that unit is the only Y Axis Unit available. All other Y Axis Unit keys are grayed out.</p> <p>If an amplitude correction with an Antenna Unit other than None is applied and enabled, and you then turn off that correction or set Apply Corrections to No, the Y Axis Unit that existed before the Antenna Unit was applied is restored.</p>
Couplings	The analyzer retains the entered Y Axis Unit separately for both Log and Lin amplitude scale types
Preset	dBm for log scale, V for linear. The true 'preset' value is dBm, since at preset the Y Scale type is set to logarithmic.
State Saved	Saved in instrument state
Readback line	1-of-N selection
Initial S/W Revision	Prior to A.02.00
Modified at S/W Revision	A.02.00, A.04.00, A.11.00

dBm

Sets the amplitude unit for the selected amplitude scale (log/lin) to dBm.

Key Path	AMPTD Y Scale, Y Axis Unit
Example	UNIT:POW DBM
Dependencies	Grayed out if an Amplitude Correction with an Antenna Unit is ON.
Readback	dBm
Initial S/W Revision	Prior to A.02.00
Modified at S/W Revision	A.02.00

dBmV

Sets the amplitude unit for the selected amplitude scale (log/lin) to dBmV.

Key Path	AMPTD Y Scale, Y Axis Unit
Example	UNIT:POW DBMV

Dependencies	Grayed out if an Amplitude Correction with an Antenna Unit is ON.
Readback	dBmV
Initial S/W Revision	Prior to A.02.00
Modified at S/W Revision	A.02.00

dBmA

Sets the amplitude unit for the selected amplitude scale (log/lin) to dBmA.

Key Path	AMPTD Y Scale, Y Axis Unit
Example	UNIT:POW DBMA
Dependencies	Grayed out if an Amplitude Correction with an Antenna Unit is ON.
Readback	dBmA
Initial S/W Revision	Prior to A.02.00
Modified at S/W Revision	A.02.00

W

Sets the amplitude unit for the selected amplitude scale (log/lin) to watt.

Key Path	AMPTD Y Scale, Y Axis Unit
Example	UNIT:POW W
Dependencies	Grayed out if an Amplitude Correction with an Antenna Unit is ON.
Readback	W
Initial S/W Revision	Prior to A.02.00
Modified at S/W Revision	A.02.00

V

Sets the amplitude unit for the selected amplitude scale (log/lin) to volt.

Key Path	AMPTD Y Scale, Y Axis Unit
Example	UNIT:POW V
Dependencies	Grayed out if an Amplitude Correction with an Antenna Unit is ON.
Readback	V
Initial S/W Revision	Prior to A.02.00
Modified at S/W Revision	A.02.00

A

Sets the amplitude unit for the selected amplitude scale (log/lin) to Ampere.

Key Path	AMPTD Y Scale, Y Axis Unit
Example	UNIT:POW A
Dependencies	Grayed out if an Amplitude Correction with an Antenna Unit is ON.
Readback	A
Initial S/W Revision	Prior to A.02.00
Modified at S/W Revision	A.02.00

dB μ V

Sets the amplitude unit for the selected amplitude scale (log/lin) to dB μ V.

Key Path	AMPTD Y Scale, Y Axis Unit
Example	UNIT:POW DBUV
Dependencies	Grayed out if an Amplitude Correction with an Antenna Unit is ON.
Readback	dB μ V
Initial S/W Revision	Prior to A.02.00
Modified at S/W Revision	A.02.00

dB μ A

Sets the amplitude unit for the selected amplitude scale (log/lin) to dB μ A.

NOTE

The unit dBuA can also appear as an Antenna Unit. This will be used by customers using current probes, because current probes are often supplied with conversion tables that provide the transducer factors. When dBuA is used as an Antenna Unit the normal conversion from power to amps for dBuA (based on the analyzer input impedance) is not done, but instead the conversion is based solely on the Correction that contains the transducer factors. This is what distinguishes dBuA as a normal unit from dBuA as an antenna unit. When querying the Y-Axis unit, you can query the Antenna Unit to distinguish between regular dBuA and the dBuA antenna unit. If :CORR:CSET:ANT? returns NOC (for No Conversion), you are using a normal Y Axis dBuA. If it returns UA you are using an Antenna Unit dBuA.

Key Path	AMPTD Y Scale, Y Axis Unit
Example	UNIT:POW DBUA
Dependencies	Grayed out if an Amplitude Correction with an Antenna Unit is ON.
Readback	dB μ A
Initial S/W Revision	Prior to A.02.00
Modified at S/W Revision	A.02.00

Antenna Unit

When a Correction is turned on that uses an Antenna Unit, the Y Axis Unit changes to that Antenna Unit. All of the keys in the Y-Axis Unit menu are then greyed out, except the Antenna Unit key. The unit being used is shown on this key and is shown as selected in the submenu.

Key Path	AMPTD Y Scale, Y Axis Unit
Dependencies	Grayed out if no Amplitude Correction with an Antenna Unit is on.
Readback line	Currently selected unit
Initial S/W Revision	A.11.00

dB μ V/m

Sets the amplitude unit for the selected amplitude scale (log/lin) to dB μ V/m. This is an antenna unit, and this key is grayed out unless a Correction with this Antenna Unit selected is ON. If this is the case, all of the other Antenna Units are grayed out.

Key Path	AMPTD Y Scale, Y Axis Unit, Antenna Unit
Example	UNIT:POW DBUVM
Dependencies	Grayed out if no Amplitude Correction with an Antenna Unit is on.
Readback	dB μ V/m
Initial S/W Revision	A.02.00

dB μ A/m

Sets the amplitude unit for the selected amplitude scale (log/lin) to dB μ A/m. This is an antenna unit, and this key is grayed out unless a Correction with this Antenna Unit selected is ON. If this is the case, all of the other Antenna Units are grayed out.

Key Path	AMPTD Y Scale, Y Axis Unit, Antenna Unit
Example	UNIT:POW DBUAM
Dependencies	Grayed out if no Amplitude Correction with an Antenna Unit is on.
Readback	dB μ A/m
Initial S/W Revision	A.02.00

dB μ A

Sets the amplitude unit for the selected amplitude scale (log/lin) to dB μ A. This is an antenna unit, and this key is grayed out unless a Correction with this Antenna Unit selected is ON. If this is the case, all of the other Antenna Units are grayed out.

Key Path	AMPTD Y Scale, Y Axis Unit, Antenna Unit
Example	UNIT:POW DBUAM
Dependencies	Grayed out if no Amplitude Correction with an Antenna Unit is on.
Readback	dB μ A
Initial S/W Revision	A.11.00

dBpT

Sets the amplitude unit for the selected amplitude scale (log/lin) to dBpT. This is an antenna unit, and this key is grayed out unless a Correction with this Antenna Unit selected is ON. If this is the case, all of the other Antenna Units are grayed out.

Key Path	AMPTD Y Scale, Y Axis Unit, Antenna Unit
Example	UNIT:POW DBPT
Dependencies	Grayed out if no Amplitude Correction with an Antenna Unit is on.
Readback	dBpT
Initial S/W Revision	A.02.00

dBG

Sets the amplitude unit for the selected amplitude scale (log/lin) to dBG. This is an antenna unit, and this key is grayed out unless a Correction with this Antenna Unit selected is ON. If this is the case, all of the other Antenna Units are grayed out.

Key Path	AMPTD Y Scale, Y Axis Unit, Antenna Unit
Example	UNIT:POW DBG
Dependencies	Grayed out if no Amplitude Correction with an Antenna Unit is on.
Readback	dBG
Initial S/W Revision	A.02.00

None

This is selected if no Antenna Unit is currently on, however you cannot actually set this value, since it is always grayed out. The key is included simply to provide an indication on the Readback line of the Antenna Unit key when there is no Antenna Unit selected.

Key Path	AMPTD Y Scale, Y Axis Unit, Antenna Unit
Readback	"None"
Initial S/W Revision	A.11.00

Measurement Results

Pressing this key selects Meas Results as the data type to be exported.

See ["Measurement results contents" on page 2915](#)

Key Path	Save, Data
Remote Command	:MMEMory:STORe:RESults <filename>
Example	:MMEM:STOR:RES "myResults.csv" saves the measurement results to the file myResults.csv in the current path. The default path is My Documents\SA\data\TOI\results

Notes	If the save is initiated via SCPI, and the file already exists, the file will be overwritten. Using the C: drive is strongly discouraged, since it runs the risk of being overwritten during an instrument software upgrade. Both single and double quotes are supported for any filename parameter over SCPI.
Initial S/W Revision	Prior to A.02.00

Measurement results contents

The saved measurement results file contains a header with relevant measurement state followed by the measurement results.

This file in csv form would look like this:

MeasResult

SA:TOI

A.01.30,N9020A

EA3 B25 526 P26 PFR ,01

Average Number,10

Average State,False

Center Frequency,13255000000

DwellTime,0.066266666667

ReferenceLevelOffset,0

Resolution Band Width,3000000

Span,26490000000

Sweep Time,0.066266666667

Video Bandwidth,3000000

ZeroSpanMeasurement,False

ZeroSpanRBW,300000

MeasResult1

(TOI)

(Delta)

(Lower 3rd Freq)

(Lower 3rd Ampl)

(Lower 3rd TOI)

(Lower 3rd Delta)

- (Lower Tone Freq)
- (Lower Tone Ampl)
- (Upper Tone Freq)
- (Upper Tone Ampl)
- (Upper 3rd Freq)
- (Upper 3rd Ampl)
- (Upper 3rd TOI)
- (Upper 3rd Delta)

Items in parentheses denote what the values actually saved represent. In the exported file, there is no header information for these results.

μW Path Control

The **μW Path Control** functions include the **μW Preselector Bypass** (Option MPB) and **Low Noise Path** (Option LNP) controls in the High Band path circuits.

When the μW Preselector is bypassed, the user has better flatness, but will be subject to spurs from out of band interfering signals. When the Low Noise Path is enabled, the analyzer automatically switches around certain circuitry in the high frequency bands which can contribute to noise, when it is appropriate based on other analyzer settings.

For most applications, the preset state is Standard Path, which gives the best remote-control throughput, minimizes acoustic noise from switching and minimizes the risk of wear out in the hardware switches. For applications that utilize the wideband IF paths, the preset state is the μW Preselector Bypass path, if option MPB is present. This is because, when using a wideband IF such as the 140 MHz IF, the μW Preselector's bandwidth can be narrower than the available IF bandwidth, causing degraded amplitude flatness and phase linearity, so it is desirable to bypass the preselector in the default case.

Users may choose Low Noise Path Enable. It gives a lower noise floor, especially in the 21-26.5 GHz region, though without improving many measures of dynamic range, and without giving the best possible noise floor. The preamp, if purchased and used, gives better noise floor than does the Low Noise Path, however its compression threshold and third-order intercept are much poorer than that of the non-preamp Low Noise Path. There are some applications, typically for signals around -30 dBm, for which the third-order dynamic range of the standard path is good enough, but the noise floor is not low enough even with 0 dB input attenuation. When the third-order dynamic range of the preamp path is too little and the noise floor of the standard path is too high, the Low Noise Path can provide the best dynamic range.

Key Path	AMPTD Y Scale
Mode	SA, BASIC, PNOISE, VSA , LTE, LTETDD

Scope	Meas Global
Remote Command	[:SENSe] :POWer [:RF] :MW :PATH STD LNPath MPBypass FULL [:SENSe] :POWer [:RF] :MW :PATH?
Example	:POW:MW:PATH LNP Enables the Low Noise path
Notes	If a Presel Center is performed, the analyzer will momentarily switch to the Standard Path, regardless of the setting of μW Path Control The DC Block will always be switched in when the low noise path is switched in, to protect succeeding circuitry from DC. Note that this does not mean “when the low noise path is enabled” but when, based on the Low Noise Path rules, the path is actually switched in. This can happen when the selection is Low Noise Path Enable . In the case where the DC Block is switched in the analyzer is now AC coupled. However, if the user has selected DC coupling, the UI will still behave as though it were DC coupled, including all annunciation, warnings, status bits, and responses to SCPI queries. This is because, based on other settings, the analyzer could switch out the low noise path at any time and hence go back to being DC coupled. Alignment switching ignores the settings in this menu, and restores them when finished.
Dependencies	Unavailable in BBIQ and External Mixing
Preset	All modes other than IQ Analyzer mode and VXA: STD IQ Analyzer, VXA and WLAN mode: MPB option present and licensed: MPB MPB option not present and licensed: STD
State Saved	Save in instrument state
Readback	Value selected in the submenu
Initial S/W Revision	A.04.00
Modified at S/W Revision	A.10.00

Standard Path

This path gives the best remote-control throughput, minimizes acoustic noise from switching and minimizes the risk of wear in the hardware switches, particularly in remote test scenarios where both low band and high band setups will follow in rapid succession.

In this path, the bypass of the low band/high band switch and microwave preamp is never activated, which can cause some noise degradation but preserves the life of the bypass switch.

Key Path	AMPTD Y Scale, μW Path Control
Example	:POW:MW:PATH STD
Readback Text	Standard Path
Initial S/W Revision	A.04.00

μW Preselector Bypass

This key toggles the preselector bypass switch for band 1 and higher. When the microwave presel is on, the signal path is preselected. When the microwave

preselector is off, the signal path is not preselected. The preselected path is the normal path for the analyzer.

The preselector is a tunable bandpass filter which prevents signals away from the frequency of interest from combining in the mixer to generate in-band spurious signals (images). The consequences of using a preselector filter are its limited bandwidth, the amplitude and phase ripple in its passband, and any amplitude and phase instability due to center frequency drift.

Option MPB or pre-selector bypass provides an unpreselected input mixer path for certain X-Series signal analyzers with frequency ranges above 3.6 GHz. This signal path allows a wider bandwidth and less amplitude variability, which is an advantage when doing modulation analysis and broadband signal analysis. The disadvantage is that, without the preselector, image signals will be displayed. Another disadvantage of bypassing the preselector is increased LO emission levels at the front panel input port.

Image responses are separated from the real signal by twice the 1st IF. For IF Paths of 10 MHz and 25 MHz, the 1st IF is 322.5 MHz, so the image response and the real signal will be separated by 645 MHz. The 1st IF will be different for other IF Path settings. When viewing a real signal and its corresponding image response in internal mixing, the image response will be to the left of the real signal.

Also, the image response and the real signal typically have the same amplitude and exhibit the same shape factor.

However, if Option FS1, Fast Sweep Capability, is enabled, the image response in the Swept SA measurement will appear lower in amplitude and have a much wider shape factor compared to the real signal.

Key Path	AMPTD Y Scale, μW Path Control
Example	:POW:MW:PATH MPB
Dependencies	Key is blanked if current mode does not support it. Key is grayed out if mode supports it but current measurement does not support it. Key is blank unless Option MPB is present and licensed. If SCPI command sent when MPB not present, error -241, "Hardware missing; Option not installed" is generated.
Readback Text	μ W Preselector Bypass
Initial S/W Revision	A.04.00

Remote Command	[:SENSe]:POWer[:RF]:MW:PRESelector[:STATe] ON OFF 0 1 [:SENSe]:POWer[:RF]:MW:PRESelector[:STATe]?
Example	:POW:MW:PRES OFF Bypasses the microwave preselector
Notes	The ON parameter sets the STD path (:POW:MW:PATH STD) The OFF parameter sets path MPB (:POW:MW:PATH MPB)
Preset	ON

Internal Preamp

Accesses a menu of keys that control the internal preamps. Turning on the preamp gives a better noise figure, but a poorer TOI to noise floor dynamic range. You can optimize this setting for your particular measurement.

The instrument takes the preamp gain into account as it sweeps. If you sweep outside of the range of the preamp the instrument will also account for that. The displayed result will always reflect the correct gain.

For some measurements, when the preamp is on and any part of the displayed frequency range is below the lowest frequency for which the preamp has specifications, a warning condition message appears in the status line. For example ,for a preamp with a 9 kHz lowest specified frequency: "Preamp: Accy unspec'd below 9 kHz".

Key Path	AMPTD Y Scale
Scope	Meas Global
Remote Command	[:SENSe] :POWer [:RF] :GAIN [:STATe] OFF ON 0 1 [:SENSe] :POWer [:RF] :GAIN [:STATe] ?
Dependencies	Preamp is not available on all hardware platforms. If the preamp is not present or is unlicensed, the key is not shown. The preamp is not available when the electronic/soft attenuator is enabled.
Couplings	The act of connecting the U7227A USB Preamplifier to one of the analyzer's USB ports will cause the Internal Preamp to be switched on. When this happens an informational message will be generated: "Internal Preamp turned on for optimal operation with USB Preamp." Note that if the Internal Preamp was already on, there will be no change to the setting, but if it was Off it will be switched On, to Full Range. Note that this same action occurs when the SA mode is selected while the USB Preamp is connected to one of the analyzer's USB ports, if it is the first time that the SA mode has run since powerup, or if the last time the SA mode was running the USB Preamp was NOT connected. Subsequently disconnecting the USB Preamp from USB does not change the Internal Preamp setting nor restore the previous setting.
Preset	OFF
State Saved	Saved in instrument state
Initial S/W Revision	Prior to A.02.00
Modified at S/W Revision	A.14.00

Key Path	AMPTD Y Scale, Internal Preamp
Scope	Meas Global
Remote Command	[:SENSe] :POWer [:RF] :GAIN :BAND LOW FULL [:SENSe] :POWer [:RF] :GAIN :BAND ?
Dependencies	Preamp is not available on all hardware platforms. If the preamp is not present or is unlicensed, the key is not shown.

	If a POW:GAIN:BAND FULL command is sent when a low band preamp is available, the preamp band parameter is to LOW instead of FULL, and an "Option not installed" message is generated.
Preset	LOW
State Saved	Saved in instrument state
Initial S/W Revision	Prior to A.02.00

Off

Turns the internal preamp off

Key Path	AMPTD Y Scale, Internal Preamp
Example	:POW:GAIN OFF
Readback	Off
Initial S/W Revision	Prior to A.02.00

Low Band

Sets the internal preamp to use only the low band.

The frequency range of the installed (optional) low-band preamp is displayed in square brackets on the **Low Band** key label.

Key Path	AMPTD Y Scale, Internal Preamp
Example	:POW:GAIN ON :POW:GAIN:BAND LOW
Readback	Low Band
Initial S/W Revision	Prior to A.02.00

Full Range

Sets the internal preamp to use its full range. The low band (0-3.6 GHz or 0-3GHz, depending on the model) is supplied by the low band preamp and the frequencies above low band are supplied by the high band preamp.

The frequency range of the installed (optional) preamp is displayed in square brackets on the **Full Range** key label. If the high band option is not installed the Full Range key does not appear.

Key Path	AMPTD Y Scale, Internal Preamp
Example	:POW:GAIN ON :POW:GAIN:BAND FULL
Readback	Full Range
Initial S/W Revision	Prior to A.02.00

Ref Position

Positions the reference value at the top, center or bottom of the Y Scale display.
 Changing the reference position does not change the reference value.

Key Path	Amplitude
Scope	Meas Local
Remote Command	:DISPlay:TOI:VIEW:WINDow:TRACe:Y[:SCALE]:RPOStion TOP CENTer BOTTOm :DISPlay:TOI:VIEW:WINDow:TRACe:Y[:SCALE]:RPOStion?
Example	DISP:TOI:VIEW:WIND:TRAC:Y:RPOS BOTT
Preset	Top
Range	Top Ctr Bot
Initial S/W Revision	Prior to A.02.00

Auto Couple

The Auto Couple feature provides a quick and convenient way to automatically couple multiple instrument settings. This helps ensure accurate measurements and optimum dynamic range. When the Auto Couple feature is activated, either from the front panel or remotely, all parameters of the current measurement that have an Auto/Manual mode are set to Auto mode and all measurement settings dependent on (or coupled to) the Auto/Man parameters are automatically adjusted for optimal performance.

However, the Auto Couple key actions are confined to the current measurement only. It does not affect other measurements in the mode, and it does not affect markers, marker functions, or trace or display attributes.

See "[More Information](#)" on page 2922

Key Path	Front-panel key
Remote Command	:COUPlE ALL NONE
Example	:COUP ALL
Notes	:COUPlE ALL puts all Auto/Man parameters in Auto mode (equivalent to pressing the Auto Couple key). :COUPLE NONE puts all Auto/Man parameters in manual mode. It decouples all the coupled instrument parameters and is not recommended for making measurements.
Initial S/W Revision	Prior to A.02.00

More Information

There are two types of functions that have Auto/Manual modes.

Auto/Man Active Function keys

An Auto/Man toggle key controls the binary state associated with an instrument parameter by toggling between **Auto** (where the parameter is automatically coupled to the other parameters it is dependent upon) and **Man** (where the parameter is controlled independent of the other parameters), as well as making the parameter the active function. The current mode is indicated on the softkey with either **Auto** or **Man** underlined as illustrated below.

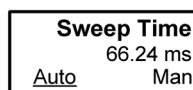

vsd07

Auto/Man 1-of-N keys

An Auto/Man 1-of-N key allows you to manually pick from a list of parameter values, or place the function in Auto, in which case the value is automatically selected (and indicated).

- If in Auto, Auto is underlined on the calling key.

- If in manual operation, manual is indicated on the calling key, but note that the calling key simply opens the menu and does **not** actually toggle the function.

BW

Accesses a menu that enables you to control the bandwidth functions of the instrument.

Key Path	Front-panel key
Initial S/W Revision	Prior to A.02.00

Res BW

Allows setting the Resolution Bandwidth (RBW) used when measuring the trace. Only Gaussian RBW filters are enabled and the list of allowable RBW values matches those of the Spectrum Analyzer measurement.

Normally, Res BW (Auto) selects automatic coupling of the Res BW to Span using the ratio set by the Span:3dB RBW key. To decouple the resolution bandwidth, press Res BW until Man is underlined or simply enter a different value for Res BW.

The resolution bandwidth used for the zero-span measurement is separately set under the Meas Setup menu.

Key Path	BW
Remote Command	<pre>[:SENSe]:TOI:BANDwidth BWIDth[:RESolution] <freq> [:SENSe]:TOI:BANDwidth BWIDth[:RESolution]? [:SENSe]:TOI:BANDwidth BWIDth[:RESolution]:AUTO OFF ON 0 1 [:SENSe]:TOI:BANDwidth BWIDth[:RESolution]:AUTO?</pre>
Example	<pre>TOI:BWID 10 kHz TOI:BWID?</pre>
Couplings	Res BW can be auto-coupled to Span via the Span:3dB RBW ratio parameter. This auto-coupled RBW will not exceed 3 MHz.
Preset	3 MHz ON
Min	1 Hz
Max	8 MHz
Initial S/W Revision	Prior to A.02.00

Video BW

Lets you change the analyzer post-detection filter (VBW) used in measuring the trace. The list of allowable VBW values matches those of the Spectrum Analyzer measurement.

Note that, if Zero-Span measurement is turned on, the measurements at zero-span do not use a video bandwidth filter, and hence ignore the Video BW setting. The Video BW setting is used when measuring the non-zero span trace.

Key Path	BW
Remote Command	<pre>[:SENSe]:TOI:BANDwidth BWIDth:VIDeo <freq> [:SENSe]:TOI:BANDwidth BWIDth:VIDeo? [:SENSe]:TOI:BANDwidth BWIDth:VIDeo:AUTO OFF ON 0 1 [:SENSe]:TOI:BANDwidth BWIDth:VIDeo:AUTO?</pre>
Example	<pre>TOI:BAND:VID 1 KHZ TOI:BAND:VID?</pre>
Couplings	Couples to the resolution bandwidth according to the VBW:3 dB RBW ratio.
Preset	Determined by RBW.
Min	1 Hz
Max	50 MHz
Initial S/W Revision	Prior to A.02.00

VBW:3dB RBW

Selects the ratio between the video bandwidth and the equivalent 3 dB resolution bandwidth to be used for setting VBW when VBW is in Auto.

Key Path	BW
Remote Command	<pre>[:SENSe]:TOI:BANDwidth BWIDth:VIDeo:RATio <real> [:SENSe]:TOI:BANDwidth BWIDth:VIDeo:RATio? [:SENSe]:TOI:BANDwidth BWIDth:VIDeo:RATio:AUTO OFF ON 0 1 [:SENSe]:TOI:BANDwidth BWIDth:VIDeo:RATio:AUTO?</pre>
Example	<pre>TOI:BAND:VID:RAT 2 TOI:BAND:VID:RAT?</pre>
Couplings	The auto rule always sets VBW:3dB RBW to 1.
Preset	1 ON
Min	0.00001
Max	3000000
Initial S/W Revision	Prior to A.02.00

Span:3dB RBW

Selects the ratio between the span and the resolution bandwidth.

Key Path	BW
Remote Command	<code>[:SENSe]:TOI:FREQuency:SPAN:BANDwidth[:RESolution]:RATio <integer></code> <code>[:SENSe]:TOI:FREQuency:SPAN:BANDwidth[:RESolution]:RATio?</code> <code>[:SENSe]:TOI:FREQuency:SPAN:BANDwidth[:RESolution]:RATio:AUTO OFF ON 0 1</code> <code>[:SENSe]:TOI:FREQuency:SPAN:BANDwidth[:RESolution]:RATio:AUTO?</code>
Example	<code>TOI:FREQ:SPAN:BAND:RAT 106</code> <code>TOI:FREQ:SPAN:BAND:RAT:AUTO 0</code>
Preset	106 ON
Min	2
Max	10000
Initial S/W Revision	Prior to A.02.00

Cont (Continuous Measurement/Sweep)

Sets the analyzer for Continuous measurement operation. The single/continuous state is Meas Global so the setting will affect all measurements. If you are Paused, pressing **Cont** does a Resume.

Key Path	Front-panel key
Remote Command	:INITiate:CONTinuous OFF ON 0 1 :INITiate:CONTinuous?
Example	:INIT:CONT 0 puts analyzer in Single measurement operation. :INIT:CONT 1 puts analyzer in Continuous measurement operation
Preset	ON (Note that SYST:PRESet sets INIT:CONT to ON but *RST sets INIT:CONT to OFF)
State Saved	Saved in instrument state
Backwards Compatibility Notes	For Spectrum Analysis mode in ESA and PSA, there is no Cont hardkey, instead there is a Sweep Single/Cont key. In these analyzers, switching the Sweep Single/Cont key from Single to Cont restarts averages (displayed average count reset to 1), but does not restart Max Hold and Min Hold . The X-Series has Single and Cont keys in place of the SweepSingleCont key. In the X-Series, if in single measurement, the Cont key (and INIT:CONT ON) switches to continuous measurement, but never restarts a measurement and never resets a sweep.
Initial S/W Revision	Prior to A.02.00

In Swept SA Measurement (Spectrum Analysis Mode):

The analyzer takes repetitive sweeps, averages, measurements, etc., when in Continuous mode. When the average count reaches the Average/Hold Number the count stops incrementing, but the analyzer keeps sweeping. See the Trace/Detector section for the averaging formula used both before and after the Average/Hold Number is reached. The trigger condition must be met prior to each sweep. The type of trace processing for multiple sweeps, is set under the Trace/Detector key, with choices of **Trace Average**, **Max Hold**, or **Min Hold**.

In Other Measurements/Modes:

With **Avg/Hold Num** (in the **Meas Setup** menu) set to **Off** or set to **On** with a value of 1, a sweep is taken after the trigger condition is met; and the analyzer continues to take new sweeps after the current sweep has completed and the trigger condition is again met. However, with **Avg/Hold Num** set to On with a value >1, multiple sweeps (data acquisitions) are taken for the measurement. The trigger condition must be met prior to each sweep. The sweep is not stopped when the average count k equals the number N set for Avg/Hold Num is reached, but the number k stops incrementing. A measurement average usually applies to all traces, marker results, and numeric results. But sometimes it only applies to the numeric results.

If the analyzer is in Single measurement, pressing the **Cont** key does not change k and does not cause the sweep to be reset; the only action is to put the analyzer into Continuous measurement operation.

If it is already in continuous sweep:

the INIT:CONT 1 command has no effect

the INIT:CONT 0 command will place the analyzer in Single Sweep but will have no effect on the current sequence until $k = N$, at which point the current sequence will stop and the instrument will go to the idle state.

File

See "File" on page 426

FREQ Channel

Accesses a menu of keys that allow you to control the Frequency and Channel parameters of the instrument.

See "[FREQ Channel](#)" on page 2613 for more information.

Key Path	Front-panel key
Initial S/W Revision	Prior to A.02.00

Auto Tune

Auto Tune is an immediate action key. When it is pressed, it causes the analyzer to change Center Frequency to the strongest signal pair in the tunable span of the analyzer, excluding the LO. It is designed to quickly get you to the most likely signal (s) of interest, with no signal analysis knowledge required. As such, there are no configurable parameters for this feature. There are only pre-selected values that work in most real world situations.

NOTE

You may see a slight pause before the signal of interest is presented onscreen.

Key Path	FREQ Channel
Remote Command	[:SENSe] :TOI :FREQuency :TUNE :IMMediate
Initial S/W Revision	Prior to A.02.00

Center Freq

Sets the frequency that corresponds to the horizontal center of the graticule (when frequency Scale Type is set to linear). While adjusting the Center Frequency the Span is held constant, which means that both Start Frequency and Stop Frequency will change.

Pressing Center Freq also sets the frequency entry mode to Center/Span. In Center/Span mode, the center frequency and span values are displayed below the graticule, and the default active function in the Frequency menu is **Center Freq**.

The center frequency setting is the same for all measurements within a mode, that is, it is Meas Global. Some modes are also able to share a Mode Global center frequency value. If this is the case, the Mode will have a **Global Settings** key in its **Mode Setup** menu.

The **Center Freq** function sets (and queries) the Center Frequency for the currently selected input. If your analyzer has multiple inputs, and you select another input, the Center Freq changes to the value for that input. SCPI commands are available to directly set the Center Freq for a specific input.

Center Freq is remembered as you go from input to input. Thus you can set a Center Freq of 10 GHz with the RF Input selected, change to BBIQ and set a Center Freq of 20 MHz, then switch to External Mixing and set a Center Freq of 60 GHz, and when you go back to the RF Input the Center Freq will go back to 10 GHz; back to BBIQ and it is 20 MHz; back to External Mixing and it is 60 GHz.

See ["RF Center Freq" on page 2934](#)

See [Ext Mix Center Freq](#)

See ["I/Q Center Freq" on page 2936](#)

See ["Center Frequency Presets" on page 2932](#)

Key Path	FREQ Channel
Scope	Meas Global
Remote Command	[:SENSe] :FREQuency:CENTer <freq> [:SENSe] :FREQuency:CENTer?
Example	FREQ:CENT 50 MHz FREQ:CENT UP changes the center frequency to 150 MHz if you use FREQ:CENT:STEP 100 MHz to set the center frequency step size to 100 MHz FREQ:CENT?
Notes	This command sets either the RF or I/Q Center Frequency depending on the selected input. For RF input it is equivalent to FREQ:RF:CENT For I/Q input it is equivalent to FREQ:IQ:CENT Preset and Max values are dependent on Hardware Options (5xx) If no terminator (e.g. MHz) is sent the terminator Hz is used. If a terminator with unit other than Frequency is used, an invalid suffix error message is generated.
Dependencies	The Center Frequency can be limited by Start or Stop Freq limits, if the Span is so large that Start or Stop reach their limit.
Couplings	When operating in "swept span", any value of the Center Frequency or Span that is within the frequency range of the analyzer is allowed when the value is being set through the front panel numeric key pad or the SCPI command. The other parameter is forced to a different value if needed, to keep the Start and the Stop Frequencies within the analyzer's frequency range
Preset	Depends on instrument maximum frequency, mode, measurement, and selected input. See "Center Frequency Presets" on page 2932 and "RF Center Freq" on page 2934 and Ext Mix Center Freq and "I/Q Center Freq" on page 2936 .
State Saved	Saved in instrument state
Min	Depends on instrument maximum frequency, mode, measurement, and selected input.. See "Center Frequency Presets" on page 2932 and "RF Center Freq" on page 2934 and "I/Q Center Freq" on page 2936 .
Max	Depends on instrument maximum frequency, mode, measurement, and selected input.. See "Center Frequency Presets" on page 2932 and "RF Center Freq" on page 2934 and "I/Q Center Freq" on page 2936 .
Default Unit	Hz
Status Bits/OPC	Non-overlapped

Dependencies

Initial S/W Revision Prior to A.02.00

Center Frequency Presets

The following table provides the Center Frequency Presets for the Spectrum Analyzer mode, and the Max Freq, for the various frequency options:

Freq Option	CF after Mode Preset	Stop Freq after Mode Preset	Max Freq (can't tune above)
503 (all but N9000A)		1.805 GHz	3.6 GHz 3.7 GHz
503 (N9000A)		1.505 GHz	3.0 GHz 3.08 GHz
504 (M9420A)		1 GHz	3.8GHz 3.88 GHz
506 (M9420A)		1 GHz	6.0GHz 6.08 GHz
507 (all but N9000A)		3.505 GHz	7.0 GHz 7.1 GHz
507 (N9000A)		3.755 GHz	7.5 GHz 7.58 GHz
508 (all but N9038A)		1.805 GHz	3.6 GHz 8.5 GHz
508 (N9038A)		4.205 GHz	8.4 GHz 8.5 GHz
513		6.805 GHz	13.6 GHz 13.8 GHz
526 (all but N9000A and N9038A)		13.255 GHz	26.5 GHz 27.0 GHz
526 (N9000A)		13.255 GHz	26.5 GHz 26.55 GHz
526 (N9038A)		1.805 GHz	3.6 GHz 27.0 GHz
532	16.005 GHz		32.0 GHz 32.5 GHz

Freq Option	CF after Mode Preset	Stop Freq after Mode Preset	Max Freq (can't tune above)
543	21.505 GHz	43.0 GHz	TBD
544	22.005 GHz	44.0 GHz	44.5 GHz
550	25.005 GHz	50.0 GHz	51 GHz

Input 2:

Model	CF after Mode Preset	Stop Freq after Mode Preset	Max Freq (can't tune above)
N9000A opt C75	0.7505GHz	1.5 GHz	1.58 GHz
N9038A	505 MHz	1 GHz	1.000025 GHz

Tracking Generator Frequency Limits (N9000A only):

Tracking Generator Option	Min Freq (clips to this freq when turn TG on and can't tune below while TG on)	If above this Freq, Stop Freq clipped to this Freq when TG turned on	Max Freq (can't tune above) while TG on
T03	9 kHz	3.0 GHz	3.08 GHz
T06	9 kHz	6.0 GHz	6.05 GHz

Tracking Generator Frequency Limits(M9290A only):

Tracking Generator Option	Min Freq (clips to this freq when turn TG on and can't tune below while TG on)	If above this Freq, Stop Freq clipped to this Freq when TG turned on	Max Freq (can't tune above) while TG on
T03	2 MHz	3.08 GHz	3.08 GHz
T07	2 MHz	7.575 GHz	7.575 GHz
T13	2 MHz	13.8 GHz	13.8 GHz
T26	2 MHz	26.55 GHz	26.55 GHz

The following table shows the Center Frequency Presets for modes other than Spectrum Analyzer:

Mode	CF Preset for RF
WCDMA	1 GHz
WIMAXOFDMA,	1 GHz
BASIC	1 GHz
ADEMOD	1 GHz
VSA	1 GHz
TDSCDMA	1 GHz
PNOISE	1 GHz
LTE	1 GHz
LTETDD	1 GHz
MSR	1 GHz
GSM	935.2 MHz
NFIGURE	1.505 GHz

RF Center Freq

SCPI command for specifying the RF Center Frequency. This command will set the Center Frequency to be used when the RF input is selected, even if the RF input is not the input that is selected at the time the command is sent. Note that the **Center Freq** function in the **Frequency** menu on the front panel always applies to the currently selected input.

Scope	Meas Global
Remote Command	<code>[:SENSe] :FREQuency :RF :CENTer <freq></code> <code>[:SENSe] :FREQuency :RF :CENTer ?</code>
Example	FREQ:RF:CENT 30 MHz
Notes	This command is the same in all modes, but the parameter is Measurement Global. So the value is independent in each mode and common across all the measurements in the mode.
Dependencies	If the electronic/soft attenuator is enabled, any attempt to set Center Frequency such that the Stop Frequency would be >3.6 GHz fails and results in an advisory message. If the equivalent SCPI command is sent, this same message is generated as part of a "-221, Settings conflict" warning. If Source Mode is set to Tracking, and the Max or Min Center Freq is therefore limited by the limits of the source, a warning message is generated, "Data out of range;clipped to source max/min" if these limits are exceeded. Note that for an external source, these limits can be affected by the settings of Source Numerator, Source Denominator and Power Sweep.
Preset	See table above
State Saved	Saved in instrument state.
Min	-79.999995 MHz, unless Source Mode is set to Tracking, in which case it is limited by the minimum frequency of the Source

Max	See table above. Basically instrument maximum frequency - 5 Hz. Note that, if the Source Mode is set to Tracking, the effective instrument maximum frequency may be limited by the source maximum frequency. If the knob or step keys are being used, also depends on the value of the other three interdependent parameters Span, Start Frequency and Stop Frequency
Initial S/W Revision	Prior to A.02.00
Modified at S/W Revision	A.03.00

Ext Mix Center Freq

SCPI command for specifying the External Mixer Center Frequency. This command will set the Center Frequency to be used when the External Mixer is selected, even if the External Mixer input is not the input which is selected at the time the command is sent. Note that the **Center Freq** function in the **Frequency** menu on the front panel always applies to the currently selected input.

Scope	Meas Global
Remote Command	[:SENSe] :FREQuency:EMIXer:CENTer <freq> [:SENSe] :FREQuency:EMIXer:CENTer?
Example	:FREQ:EMIX:CENT 60 GHz :FREQ:EMIX:CENT?
Notes	This command is the same in all modes, but the parameter is Measurement Global. So the value is independent in each mode and common across all the measurements in the mode.
Couplings	When returning to External Mixing after having been switched to one of the other inputs (e.g., RF), you will come back into the settings that you had when you left External Mixing. So you will come back to the band you were in with the Center Frequency that you had. However, Span is not an input-dependent parameter, therefore you will bring the span over from the other input. Therefore, the analyzer comes back with the span from the previous input, limited as necessary by the current mixer setup.
Preset	When a Mode Preset is performed while in External Mixing, the Start frequency of the current Mode is set to the nominal Min Freq of the lowest harmonic range in the Harmonic Table for the current mixer setup. Similarly, the Stop frequency of the current Mode is set to the nominal Max Freq of the highest harmonic range in the Harmonic Table. The Center Freq thus presets to the point arithmetically equidistant from these two frequencies. If the current measurement has a limited Span available to it, and cannot achieve the Span shown in the table (Span=Stop Freq – Start Freq), the analyzer uses the maximum Span the measurement allows, and still sets the Center Freq to the midpoint of the Start and Stop Freq values in the Harmonic Table. When Restore Input/Output Defaults is performed, the mixer presets to the 11970A, whose Start and Stop frequencies are 26.5 and 40 GHz respectively. The center of these two frequencies is 33.25 GHz. Therefore, after a Restore Input/Output Defaults, if you go into External Mixing and do a Mode Preset while in the Spectrum Analyzer Mode, the resulting Center Freq is 33.25 GHz.
State Saved	Saved in instrument state.
Min	The minimum frequency in the currently selected mixer band + 5 Hz

Max	The maximum frequency in the currently selected mixer band - 5 Hz If the knob or step keys are being used, also depends on the value of the other three interdependent parameters Span, Start Frequency and Stop Frequency
Initial S/W Revision	A.08.01

I/Q Center Freq

SCPI command for specifying the I/Q Center Frequency. This command will set the Center Frequency to be used when the I/Q input is selected, even if the I/Q input is not the input which is selected at the time the command is sent. Note that the **Center Freq** function in the **Frequency** menu on the front panel always applies to the currently selected input.

Scope	Meas Global
Remote Command	[:SENSe] :FREQuency:IQ:CENTer <freq> [:SENSe] :FREQuency:IQ:CENTer?
Example	FREQ:IQ:CENT: 30 MHz
Notes	This command is the same in all modes, but the parameter is Measurement Global. So the value is independent in each mode and common across all the measurements in the mode.
Preset	0 Hz
State Saved	Saved in instrument state.
Min	-40.049995 MHz
Max	40.049995 MHz
Initial S/W Revision	Prior to A.02.00

Lower Tone Frequency

The lower base sets the lower of the two base frequencies for TOI measurement.

Normally, the lower base frequency is set by choosing the lower in frequency of the two highest peaks on the trace. When in manual mode, the measurement frequency is fixed.

When zero-span measurement is turned on, a frequency count is required to accurately calculate the needed intermodulation frequencies. Thus, the measurement will be slightly faster if you switch the lower base frequency to manual.

Key Path	FREQ Channel
Remote Command	[:SENSe] :TOI:FREQuency:BASE:LOWer <freq> [:SENSe] :TOI:FREQuency:BASE:LOWer? [:SENSe] :TOI:FREQuency:BASE:LOWer:AUTO OFF ON 0 1 [:SENSe] :TOI:FREQuency:BASE:LOWer:AUTO?
Example	TOI:FREQ:BASE:LOW 13.2500000 GHz TOI:FREQ:BASE:LOW:AUTO ON

Notes	Forces measurement restart.
Couplings	<p>In auto mode, after each sweep the lower frequency base is set to the lower in frequency of the two highest peaks within the span. If there is no or one peak within the span, the lower frequency base is set to NaN.</p> <p>If you set Lower Frequency Tone \geq Upper Frequency Tone, the Upper Frequency Tone will change to 1 Hz greater than Lower Frequency Tone.</p> <p>If in auto when Zero-Span measurement is on, a frequency count is run at the lower frequency base so that we can more accurately calculate the intermod frequency. This is needed since the Resolution Bandwidth of the intermod measurement will likely be significantly lower than the main sweep RBW.</p> <p>This value is affected by Frequency Offset</p>
Couplings	When the lower frequency tone auto is changed, the upper frequency tone auto is set to the same value.
Preset	Determined by trace data
Min	10 Hz
Max	The maximum value for this parameter is the maximum frequency of the analyzer minus 1 kHz.
Initial S/W Revision	Prior to A.02.00

Upper Tone Frequency

The upper base frequency sets the upper of the two base frequencies for TOI measurement.

Normally, the upper base frequency is set by choosing the higher in frequency of the two highest peaks on the trace. When in manual mode, the measurement frequency is fixed.

When zero-span measurement is turned on, a frequency count is required to accurately calculate the needed intermodulation frequencies. Thus, the measurement will be slightly faster if you switch the lower base frequency to manual.

Key Path	FREQ Channel
Remote Command	<pre>[:SENSe] :TOI :FREQuency :BASE :UPPer <frequency> [:SENSe] :TOI :FREQuency :BASE :UPPer? [:SENSe] :TOI :FREQuency :BASE :UPPer :AUTO OFF ON 0 1 [:SENSe] :TOI :FREQuency :BASE :UPPer :AUTO?</pre>
Example	<pre>TOI:FREQ:BASE:UPP 13.2600000 GHz TOI:FREQ:BASE:UPP:AUTO ON</pre>
Notes	Forces measurement restart.
Couplings	<p>If you set Upper Frequency Tone \leq Lower Frequency Tone, the Lower Frequency Tone will change to 1 Hz less than Upper Frequency Tone.</p> <p>In Auto, after each sweep the upper frequency base is set to the upper in frequency of the two highest peaks within the span. If there is no or one peak within the span, the lower frequency</p>

	base is set to NaN. If in auto when Zero-Span measurement is on, a frequency count is run at the upper frequency base so that we can more accurately calculate the intermod frequency. This is needed since the Resolution Bandwidth of the intermod measurement will likely be significantly lower than the main sweep RBW. This value is affected by Frequency Offset
Couplings	When the upper frequency tone auto is changed, the lower frequency tone auto is set to the same value.
Preset	13.2600000 GHz ON
Min	11 Hz
Max	The maximum value is the maximum frequency of the analyzer.
Initial S/W Revision	Prior to A.02.00

CF Step

Changes the step size for the center frequency and start and stop frequency functions. Once a step size has been selected and the center frequency function is active, the step keys (and the UP|DOWN parameters for Center Frequency from remote commands) change the center frequency by the step-size value. The step size function is useful for finding harmonics and sidebands beyond the current frequency span of the analyzer.

Note that the start and stop frequencies also step by the CF Step value.

Key Path	FREQ Channel
Remote Command	[:SENSe] :FREQuency:CENTer:STEP [:INCRement] <freq> [:SENSe] :FREQuency:CENTer:STEP [:INCRement] ? [:SENSe] :FREQuency:CENTer:STEP:AUTO OFF ON 0 1 [:SENSe] :FREQuency:CENTer:STEP:AUTO?
Example	FREQ:CENT:STEP:AUTO ON FREQ:CENT:STEP 500 MHz FREQ:CENT UP increases the current center frequency value by 500 MHz FREQ:CENT:STEP? FREQ:CENT:STEP:AUTO?
Notes	Preset and Max values are depending on Hardware Options (503, 507, 508, 513, 526)
Notes	Preset and Max values are dependent on Hardware Options (5xx)
Dependencies	Freq Offset is not available in External Mixing. In this case the Freq Offset key is grayed out and shows a value of zero. It will once again be available, and show the previously set value, when you return to the RF Input.
Dependencies	Span, RBW, Center frequency

	If the electronic/soft attenuator is enabled, any attempt to change the value of the center frequency >3.6 GHz by pressing the Up-arrow key, fails and results in an advisory message. If the equivalent SCPI command is sent, this same message is generated as part of a “-221, Settings conflict” warning.
Couplings	When auto-coupled in a non-zero span, the center frequency step size is set to 10% of the span. When auto-coupled in zero span, the center frequency step size is set to the equivalent -3 dB RBW value.
Preset	Auto ADEM0D: 1 MHz ON
State Saved	Saved in instrument state
Min	– (the maximum frequency of the instrument). That is, 27 GHz max freq instrument has a CF step range of +/- 27 GHz. Note that this is the maximum frequency given the current settings of the instrument, so in External Mixing, for example, it is the maximum frequency of the current mixer band.
Max	The maximum frequency of the instrument. That is, 27 GHz max freq instrument has a CF step range of +/- 27 GHz. Note that this is the maximum frequency given the current settings of the instrument, so in External Mixing, for example, it is the maximum frequency of the current mixer band.
Default Unit	Hz
Status Bits/OPC dependencies	non-overlapped
Initial S/W Revision	Prior to A.02.00
Modified at S/W Revision	A.03.00

Freq Offset

Enables you to set a frequency offset value to account for frequency conversions outside of the analyzer. This value is added to the display readout of the marker frequency, center frequency, start frequency, stop frequency, and all other absolute frequency settings in the analyzer including frequency count. When a frequency offset is entered, the value appears below the center of the graticule. To eliminate an offset, perform a Mode Preset or set the frequency offset to 0 Hz.

See ["More Information" on page 2940](#).

Key Path	FREQ Channel
Scope	Meas Global
Remote Command	[:SENSe] :FREQuency:OFFSet <freq> [:SENSe] :FREQuency:OFFSet?
Example	FREQ:OFFS 10 MHz
Notes	Preset and Max values are dependent on Hardware Options (503, 507, 508, 513, 526)
Dependencies	Freq Offset is not available in External Mixing. In this case the Freq Offset key is grayed out and shows a value of zero. However, the value of CF Offset that was set for the RF Input is retained

	and restored when the user switches back to the RF Input.
Preset	See "Center Frequency Presets" on page 2932
State Saved	Saved in instrument state
Min	-500 GHz
Max	500 GHz
Default Unit	Hz
Status Bits/OPC dependencies	Non-overlapped
Backwards Compatibility SCPI	DISPlay:WINDow[1]:TRACe:X[:SCALE]:OFFSet The DISPlay version of the command is in the instrument for compatibility across platforms and is not recommended for new development.
Backwards Compatibility Notes	<ol style="list-style-type: none"> 1. In pre-X-Series instruments, Frequency Offset could not be adjusted by the knob or step keys. That is no longer the case. 2. Some previous spectrum analyzers did not adjust frequency counter results for the Frequency Offset. The X-Series does adjust the frequency counter for the offset.
Initial S/W Revision	Prior to A.02.00
Modified at S/W Revision	A.04.00, A.08.50

More Information

This command does not affect any bandwidths or the settings of relative frequency parameters such as delta markers or span. It does not affect the current hardware settings of the analyzer, but only the displayed frequency values. Entering an offset does not affect the trace position or display, just the value of the start and stop frequency and the values represented by the trace data. The frequency values of exported trace data, queried trace data, markers, trace data used in calculations such as N dB points, trace math, etc., are all affected by Freq Offset. Changing the offset, even on a trace that is not updating will immediately change all of the above, without taking new data.

NOTE

If a trace is exported with a nonzero Freq Offset, the exported data will contain the trace data with the offset applied. Therefore, if that trace were to be imported back into the analyzer, you would want Freq Offset to be 0, or the offset would be applied again to data which is already offset. No such care need be taken when saving a State+Trace file because the data and state are saved together.

Input/Output

See ["Input/Output" on page 241](#)

Marker

There is no marker functionality in the TOI measurement.

Key Path	Front-panel key
Initial S/W Revision	Prior to A.02.00

Marker Function

There is no marker functionality in the TOI measurement.

Key Path	Front-panel key
Initial S/W Revision	Prior to A.02.00

Marker To

There is no marker functionality in the TOI measurement.

Key Path	Front-panel key
Initial S/W Revision	Prior to A.02.00

Meas

The information in this section is common to all measurements. For key and remote command information for a specific measurement, refer to the section that describes the measurement of interest.

Measurements available under the Meas key are specific to the current Mode.

When viewing Help for measurements, note the following:

NOTE

Operation for some keys differs between measurements. The information displayed in Help pertains to the current measurement. To see how a key operates in a different measurement, exit Help (press the Cancel Esc key), select the measurement, then reenter Help (press the Help key) and press that key.

Key Path	Front-panel key
Initial S/W Revision	Prior to A.02.00

Remote Measurement Functions

This section contains the following topics:

["Measurement Group of Commands" on page 3141](#)

["Current Measurement Query \(Remote Command Only\)" on page 3144](#)

["Limit Test Current Results \(Remote Command Only\)" on page 3144](#)

["Data Query \(Remote Command Only\)" on page 3144](#)

["Calculate/Compress Trace Data Query \(Remote Command Only\)" on page 3144](#)

["Calculate Peaks of Trace Data \(Remote Command Only\)" on page 3150](#)

["Hardware-Accelerated Fast Power Measurement \(Remote Command Only\)" on page 3151](#)

["Format Data: Numeric Data \(Remote Command Only\)" on page 3165](#)

["Format Data: Byte Order \(Remote Command Only\)" on page 3166](#)

Initial S/W Revision	Prior to A.02.00
----------------------	------------------

Measurement Group of Commands

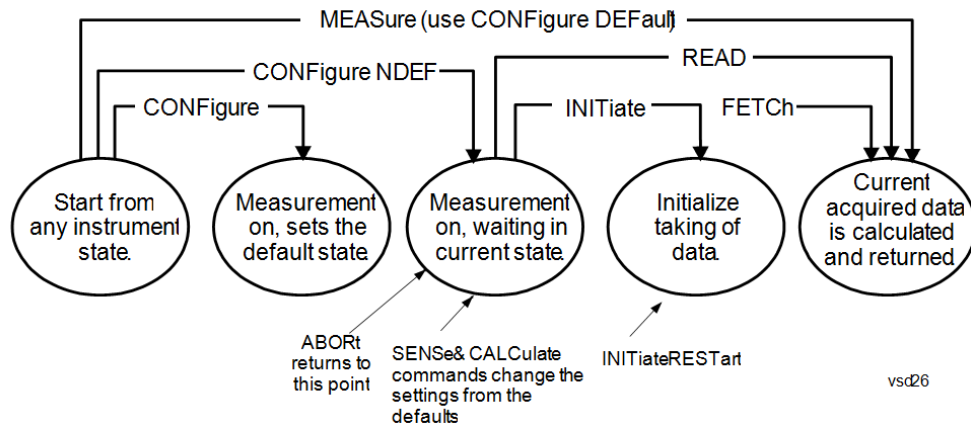

Measure Commands:

:MEASure:<measurement>[n]?

This is a fast single-command way to make a measurement using the factory default instrument settings. These are the settings and units that conform to the Mode Setup settings (e.g. radio standard) that you have currently selected.

- Stops the current measurement (if any) and sets up the instrument for the specified measurement using the factory defaults
- Initiates the data acquisition for the measurement
- Blocks other SCPI communication, waiting until the measurement is complete before returning results.
- If the function does averaging, it is turned on and the number of averages is set to 10.
- After the data is valid it returns the scalar results, or the trace data, for the specified measurement. The type of data returned may be defined by an [n] value that is sent with the command.
- The scalar measurement results will be returned if the optional [n] value is not included, or is set to 1. If the [n] value is set to a value other than 1, the selected trace data results will be returned. See each command for details of what types of scalar results or trace data results are available.
- ASCII is the default format for the data output. (Older versions of Spectrum Analysis and Phase Noise mode measurements only use ASCII.) The binary data formats should be used for handling large blocks of data since they are smaller and faster than the ASCII format. Refer to the FORMat:DATA command for more information.

If you need to change some of the measurement parameters from the factory default settings you can set up the measurement with the CONFIGure command. Use the commands in the SENSE:<measurement> and CALCulate:<measurement> subsystems to change the settings. Then you can use the READ? command to initiate the measurement and query the results.

If you need to repeatedly make a given measurement with settings other than the factory defaults, you can use the commands in the SENSE:<measurement> and CALCulate:<measurement> subsystems to set up the measurement. Then use the READ? command to initiate the measurement and query results.

Measurement settings persist if you initiate a different measurement and then return to a previous one. Use READ:<measurement>? if you want to use those persistent settings. If you want to go back to the default settings, use MEASure:<measurement>?.

Configure Commands:

:CONFigure:<measurement>

This command stops the current measurement (if any) and sets up the instrument for the specified measurement using the factory default instrument settings. It does not initiate the taking of measurement data unless INIT:CONTinuous is ON. If you change any measurement settings after using the CONFigure command, the READ command can be used to initiate a measurement without changing the settings back to their defaults.

In the Swept SA measurement in Spectrum Analyzer mode the CONFigure command also turns the averaging function on and sets the number of averages to 10 for all measurements.

:CONFigure: <measurement>: NDEFault stops the current measurement and changes to the specified measurement. It does not change the settings to the defaults. It does not initiate the taking of measurement data unless INIT:CONTinuous is ON.

The CONFigure? query returns the current measurement name.

The CONFigure:CATalog? query returns a quoted string of all licensed measurement names in the current mode. For example, "SAN, CHP, OBW, ACP, PST, TXP, SPUR, SEM, LIST".

Fetch Commands:

:FETCh:<measurement>[n]?

This command puts selected data from the most recent measurement into the output buffer. Use FETCh if you have already made a good measurement and you want to return several types of data (different [n] values, for example, both scalars and trace data) from a single measurement. FETCh saves you the time of re-making the measurement. You can only FETCh results from the measurement that is currently active, it will not change to a different measurement. An error message is reported if a measurement other than the current one is specified.

If you need to get new measurement data, use the READ command, which is equivalent to an INITiate followed by a FETCh.

The scalar measurement results will be returned if the optional [n] value is not included, or is set to 1. If the [n] value is set to a value other than 1, the selected trace data results will be returned. See each command for details of what types of scalar results or trace data results are available. The binary data formats should be used for handling large blocks of data since they are smaller and transfer faster than the ASCII format. (FORMat:DATA)

FETCh may be used to return results other than those specified with the original READ or MEASure command that you sent.

INITiate Commands:

:INITiate:<measurement>

This command is not available for measurements in all the instrument modes:

- Initiates a trigger cycle for the specified measurement, but does not output any data. You must then use the FETCh<meas> command to return data. If a

measurement other than the current one is specified, the instrument will switch to that measurement and then initiate it.

- For example, suppose you have previously initiated the ACP measurement, but now you are running the channel power measurement. If you send INIT:ACP? it will change from channel power to ACP and will initiate an ACP measurement.
- Does not change any of the measurement settings. For example, if you have previously started the ACP measurement and you send INIT:ACP? it will initiate a new ACP measurement using the same instrument settings as the last time ACP was run.
- If your selected measurement is currently active (in the idle state) it triggers the measurement, assuming the trigger conditions are met. Then it completes one trigger cycle. Depending upon the measurement and the number of averages, there may be multiple data acquisitions, with multiple trigger events, for one full trigger cycle. It also holds off additional commands on GPIB until the acquisition is complete.

READ Commands:

:READ:<measurement>[n]?

- Does not preset the measurement to the factory default settings. For example, if you have previously initiated the ACP measurement and you send READ:ACP? it will initiate a new measurement using the same instrument settings.
 - Initiates the measurement and puts valid data into the output buffer. If a measurement other than the current one is specified, the instrument will switch to that measurement before it initiates the measurement and returns results.
 - For example, suppose you have previously initiated the ACP measurement, but now you are running the channel power measurement. Then you send READ:ACP? It will change from channel power back to ACP and, using the previous ACP settings, will initiate the measurement and return results.
 - Blocks other SCPI communication, waiting until the measurement is complete before returning the results
 - If the optional [n] value is not included, or is set to 1, the scalar measurement results will be returned. If the [n] value is set to a value other than 1, the selected trace data results will be returned. See each command for details of what types of scalar results or trace data results are available. The binary data formats should be used when handling large blocks of data since they are smaller and faster than the ASCII format. (FORMat:DATA)
-

Current Measurement Query (Remote Command Only)

This command returns the name of the measurement that is currently running.

Remote Command	:CONFiGure?
Example	CONF?
Initial S/W Revision	Prior to A.02.00

Limit Test Current Results (Remote Command Only)

Queries the status of the current measurement limit testing. It returns a 0 if the measured results pass when compared with the current limits. It returns a 1 if the measured results fail any limit tests.

Remote Command	:CALCuLate:CLIMits:FAIL?
Example	CALC:CLIM:FAIL? queries the current measurement to see if it fails the defined limits. Returns a 0 or 1: 0 it passes, 1 it fails.
Initial S/W Revision	Prior to A.02.00

Data Query (Remote Command Only)

Returns the designated measurement data for the currently selected measurement and subopcode.

n = any valid subopcode for the current measurement. See the measurement command results table for your current measurement, for information about what data is returned for the subopcodes.

This command uses the data setting specified by the FORMat:BORDER and FORMat:DATA commands and can return real or ASCII data. (See the format command descriptions under Input/Output in the Analyzer Setup section.)

Remote Command	:CALCuLate:DATA[n]?
Notes	The return trace depends on the measurement. In CALCulate:<meas>:DATA[n], n is any valid subopcode for the current measurement. It returns the same data as the FETCh:<measurement>? query where <measurement> is the current measurement.
Initial S/W Revision	Prior to A.02.00

Calculate/Compress Trace Data Query (Remote Command Only)

Returns compressed data for the currently selected measurement and sub-opcode [n].

n = any valid sub-opcode for that measurement. See the MEASure:<measurement>? command description of your specific measurement for information on the data that can be returned.

The data is returned in the current Y Axis Unit of the analyzer. The command is used with a sub-opcode <n> (default=1) to specify the trace. With trace queries, it is best if the analyzer is not sweeping during the query. Therefore, it is generally advisable to be in Single Sweep, or Update=Off.

This command is used to compress or decimate a long trace to extract and return only the desired data. A typical example would be to acquire N frames of GSM data and return the mean power of the first burst in each frame. The command can also be used to identify the best curve fit for the data.

Remote Command	:CALCulate:DATA<n>:COMPRESS? BLOCK CFIT MAXimum MINimum MEAN DMEan RMS RMSCubed SAMPLE SDEVIation PPHase [,<soffset> [,<length>[,<roffset>[,<rlimit>]]]]
Example	To query the mean power of a set of GSM bursts: Supply a signal that is a set of GSM bursts. Select the IQ Waveform measurement (in IQ Analyzer Mode). Set the sweep time to acquire at least one burst. Set the triggers such that acquisition happens at a known position relative to a burst. Then query the mean burst levels using, CALC:DATA2:COMP? MEAN, 24e-6, 526e-6 (These parameter values correspond to GSM signals, where 526e-6 is the length of the burst in the slot and you just want 1 burst.)
Notes	The command supports 5 parameters. Note that the last 4 (<soffset>, <length>, <roffset>, <rlimit>) are optional. But these optional parameters must be entered in the specified order. For example, if you want to specify <length>, then you must also specify <soffset>. See details below for a definition of each of these parameters. This command uses the data in the format specified by FORMat:DATA, returning either binary or ASCII data.
Initial S/W Revision	Prior to A.02.00

- BLOCK or block data - returns all the data points from the region of the trace data that you specify. For example, it could be used to return the data points of an input signal over several timeslots, excluding the portions of the trace data that you do not want. (This is x,y pairs for trace data and I,Q pairs for complex data.)
- CFIT or curve fit - applies curve fitting routines to the data. <soffset> and <length> are required to define the data that you want. <roffset> is an optional parameter for the desired order of the curve equation. The query will return the following values: the x-offset (in seconds) and the curve coefficients ((order + 1) values).

MIN, MAX, MEAN, DME, RMS, RMSC, SAMP, SDEV and PPH return one data value for each specified region (or <length>) of trace data, for as many regions as possible until you run out of trace data (using <roffset> to specify regions). Or they return the number of regions you specify (using <rlimit>) ignoring any data beyond that.

- MINimum - returns the minimum data point (y value) for the specified region (s) of trace data. For I/Q trace data, the minimum magnitude of the I/Q pairs is returned.
- MAXimum - returns the maximum data point (y value) for the specified region(s) of trace data. For I/Q trace data, the maximum magnitude of the I/Q pairs is returned.
- MEAN - returns a single value that is the arithmetic mean of the data point values (in dB/ dBm) for the specified region(s) of trace data. For I/Q trace data, the mean of the magnitudes of the I/Q pairs is returned. See the following equations.

NOTE

If the original trace data is in dB, this function returns the arithmetic mean of those log values, not log of the mean power which is a more useful value. The mean of the log is the better measurement technique when measuring CW signals in the presence of noise. The mean of the power, expressed in dB, is useful in power measurements such as Channel Power. To achieve the mean of the power, use the RMS option.

Equation 1

Mean Value of Data Points for Specified Region(s)

$$MEAN = \frac{1}{n} \sum_{X_i \in \text{region}(s)} X_i$$

where X_i is a data point value, and n is the number of data points in the specified region(s).

Equation 2

Mean Value of I/Q Data Pairs for Specified Region(s)

$$MEAN = \frac{1}{n} \sum_{X_i \in \text{region}(s)} |X_i|$$

where $|X_i|$ is the magnitude of an I/Q pair, and n is the number of I/Q pairs in the specified region(s).

- DMEan - returns a single value that is the mean power (in dB/ dBm) of the data point values for the specified region(s) of trace data. See the following

equation:

Equation 3

DMEan Value of Data Points for Specified Region(s)

$$\text{DME} = 10 \times \log_{10} \left(\frac{1}{n} \sum_{X_i \in \text{region}(s)} 10^{\frac{X_i}{10}} \right)$$

- RMS - returns a single value that is the average power on a root-mean-squared voltage scale (arithmetic rms) of the data point values for the specified region(s) of trace data. See the following equation.

NOTE

For I/Q trace data, the rms of the magnitudes of the I/Q pairs is returned. See the following equation.

This function is very useful for I/Q trace data. However, if the original trace data is in dB, this function returns the rms of the log values which is not usually needed.

Equation 4

RMS Value of Data Points for Specified Region(s)

$$\text{RMS} = \sqrt{\frac{1}{n} \sum_{X_i \in \text{region}(s)} X_i^2}$$

where X_i is a data point value, and n is the number of data points in the specified region(s).

Equation 5

RMS Value of I/Q Data Pairs for Specified Region(s)

$$\text{RMS} = \sqrt{\frac{1}{n} \sum_{X_i \in \text{region}(s)} X_i X_i^*}$$

where X_i is the complex value representation of an I/Q pair, X_i^* its conjugate complex number, and n is the number of I/Q pairs in the specified region(s).

Once you have the rms value for a region of trace data (linear or I/Q), you may want to calculate the mean power. You must convert this rms value (peak volts) to power in dBm:

$$10 \times \log[10 \times (\text{rms value})^2]$$

- SAMPlE - returns the first data value (x,y pair) for the specified region(s) of trace data. For I/Q trace data, the first I/Q pair is returned.
- SDEViation - returns a single value that is the arithmetic standard deviation for the data point values for the specified region(s) of trace data. See the following equation.
- For I/Q trace data, the standard deviation of the magnitudes of the I/Q pairs is returned. See the following equation.

Equation 6

Standard Deviation of Data Point Values for Specified Region(s)

$$SDEV = \sqrt{\frac{1}{n} \sum_{X_i \in \text{region}(s)} (X_i - \bar{X})^2}$$

where X_i is a data point value, \bar{X} is the arithmetic mean of the data point values for the specified region(s), and n is the number of data points in the specified region(s).

$$SDEV = \sqrt{\frac{1}{n} \sum_{X_i \in \text{region}(s)} (|X_i| - \bar{X})^2}$$

where $|X_i|$ is the magnitude of an I/Q pair, \bar{X} is the mean of the magnitudes for the specified region(s), and n is the number of data points in the specified region(s).

- PPHase - returns the x,y pairs of both rms power (dBm) and arithmetic mean phase (radian) for every specified region and frequency offset (Hz). The number of pairs is defined by the specified number of regions. This parameter can be used for I/Q vector ($n=0$) in Waveform (time domain) measurement and all parameters are specified by data point in PPHase.

The rms power of the specified region may be expressed as:

$$\text{Power} = 10 \times \log [10 \times (\text{RMS I/Q value})] + 10.$$

The RMS I/Q value (peak volts) is:

$$\sqrt{\frac{1}{n} \sum_{X_i \in \text{region}} X_i X_i^*}$$

where X_i is the complex value representation of an I/Q pair, X_i^* its conjugate complex number, and n is the number of I/Q pairs in the specified region.

The arithmetic mean phase of the specified region may be expressed as:

$$\frac{1}{n} \sum_{Y_i \in \text{region}} Y_i$$

where Y_i is the unwrapped phase of I/Q pair with applying frequency correction and n is the number of I/Q pairs in the specified region.

The frequency correction is made by the frequency offset calculated by the arithmetic mean of every specified region's frequency offset. Each frequency offset is calculated by the least square method against the unwrapped phase of I/Q pair.

Sample Trace Data - Constant Envelope

(See below for explanation of variables.)

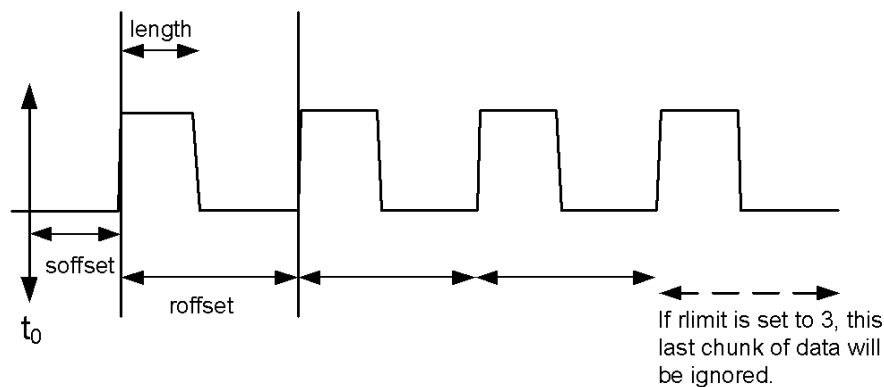

Sample Trace Data - Not Constant Envelope

(See below for explanation of variables.)

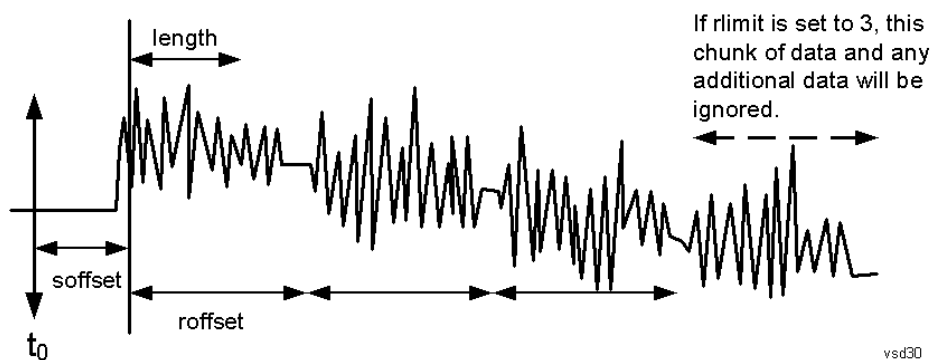

<soffset> - start offset is an optional real number. (It is in seconds for time-domain traces, and is a dimensionless index 0 to Npoints - 1, for frequency-domain traces). It specifies the amount of data at the beginning of the trace that will be ignored before the decimation process starts. It is the time or frequency change from the start of the trace to the point where you want to start using the data. The default value is zero.

<length> - is an optional real number. (It is in seconds for time-domain traces, and is a dimensionless index 0 to Npoints - 1, for frequency-domain traces). It defines how much data will be compressed into one value. This parameter has a default value equal to the current trace length.

<roffset> - repeat offset is an optional real number. (It is in seconds for time-domain traces, and is a dimensionless index 0 to Npoints - 1, for frequency-domain traces). It defines the beginning of the next field of trace elements to be compressed. This is relative to the beginning of the previous field. This parameter has a default value equal to the <length> variable. Note that this parameter is used for a completely different purpose when curve fitting (see CFIT above).

<rlimit> - repeat limit is an optional integer. It specifies the number of data items that you want returned. It will ignore any additional items beyond that number. You can use the Start offset and the Repeat limit to pick out exactly what part of the data you want to use. The default value is all the data.

Calculate Peaks of Trace Data (Remote Command Only)

Returns a list of all the peaks for the currently selected measurement and sub-opcode [n]. The peaks must meet the requirements of the peak threshold and excursion values.

n = any valid sub-opcode for the current measurement. See the MEASure:<measurement> command description of your specific measurement for information on the data that can be returned.

The command can only be used with specific sub-opcodes with measurement results that are trace data. Both real and complex traces can be searched, but complex traces are converted to magnitude in dBm. In many measurements the sub-opcode n=0, is the raw trace data which cannot be searched for peaks. And Sub-opcode n=1, is often calculated results values which also cannot be searched for peaks.

This command uses the data setting specified by the FORMat:BORDER and FORMat:DATA commands and can return real or ASCII data. If the format is set to INT,32, it returns REAL,32 data.

The command has four types of parameters:

- Threshold (in dBm)
- Excursion (in dB)
- Sorting order (amplitude, frequency, time)
- Optional in some measurements: Display line use (all, > display line, < display line)

Remote Command

For Swept SA measurement:

```
:CALCulate:DATA[1]|2|...|6:PEAKS? <threshold>,<excursion>[,AMPLitude  
| FREQuency | TIME[,ALL | GTDLine | LTDLine]]
```

For most other measurements:

	<pre>:CALCulate:DATA[1] 2 ... 6:PEAKs? <threshold>,<excursion>[,AMPLitude FREQUENCY TIME]</pre>
Example	<p>Example for Swept SA measurement in Spectrum Analyzer Mode:</p> <p>CALC:DATA4:PEAK? -40, 10, FREQ, GTDL This will identify the peaks of trace 4 that are above -40 dBm, with excursions of at least 10 dB. The peaks are returned in order of increasing frequency, starting with the lowest frequency. Only the peaks that are above the display line are returned.</p> <p>Query Results 1:</p> <p>With FORMat:DATA REAL, 32 selected, it returns a list of floating-point numbers. The first value in the list is the number of peak points that are in the following list. A peak point consists of two values: a peak amplitude followed by its corresponding frequency (or time).</p> <p>If no peaks are found the peak list will consist of only the number of peaks, (0).</p>
Notes	<p><n> - is the trace that will be used</p> <p><threshold> - is the level below which trace data peaks are ignored. Note that the threshold value is required and is always used as a peak criterion. To effectively disable the threshold criterion for this command, provide a substantially low threshold value such as -200 dBm. Also note that the threshold value used in this command is independent of and has no effect on the threshold value stored under the Peak Criteria menu.</p> <p><excursion> - is the minimum amplitude variation (rise and fall) required for a signal to be identified as peak. Note that the excursion value is required and is always used as a peak criterion. To effectively disable the excursion criterion for this command, provide the minimum value of 0.0 dB. Also note that the excursion value used in this command is independent of and has no effect on the excursion value stored under the Peak Criteria menu.</p> <p>Values must be provided for threshold and excursion. The sorting and display line parameters are optional (defaults are AMPLitude and ALL).</p> <p>Note that there is always a Y-axis value for the display line, regardless of whether the display line state is on or off. It is the current Y-axis value of the display line which is used by this command to determine whether a peak should be reported</p> <p>Sorting order:</p> <p>AMPLitude - lists the peaks in order of descending amplitude, with the highest peak first (default if optional parameter not sent)</p> <p>FREQUENCY - lists the peaks in order of occurrence, left to right across the x-axis.</p> <p>TIME - lists the peaks in order of occurrence, left to right across the x-axis.</p> <p>Peaks vs. Display Line:</p> <p>ALL - lists all of the peaks found (default if optional parameter not sent).</p> <p>GTDLLine (greater than display line) - lists all of the peaks found above the display line.</p> <p>LTDLine (less than display line) - lists all of the peaks found below the display line.</p>
Initial S/W Revision	Prior to A.02.00

Hardware-Accelerated Fast Power Measurement (Remote Command Only)

The Fast Power option (FP2) enables very fast channel power measurements for instruments with the prerequisite hardware (DP2 and/or B40). It accomplishes this by performing real-time overlapped FFTs at the hardware layer, using software for basic post-processing before returning the result to the user. The upshot of this

approach is improved throughput for user applications that require many sequential power measurements.

The analysis bandwidth of FP2 is limited by the licenses in the instrument, but its maximum overall analysis bandwidth per acquisition is 40 MHz.

FP2 is remote-only, which means the instrument does not switch to any particular mode or measurement. FP2 commands can be sent while another application is in use on the front panel.

Each Fast Power measurement can be predefined using an array index, and up to 1,000 measurements can be stored. In the following documentation, instances of [1,2,...,999] can be substituted with a particular measurement index, e.g. CALC:FPOW:POW1?, CALC:FPOW:POW2?, CALC:FPOW:POW134?. In this way, power measurements can be defined one time in a batch, and then executed multiple times without having to redefine them, similar to “list mode” on other measurements.

In addition to basic channel power measurements, there are a number of other measurement “functions” for each channel, including peak power, peak frequency, and power spectral density. See the Function parameter for more information.

Reset Fast Power Measurement (Remote Command Only)

Resets the measurement configuration to the defaults.

Mode	All
Remote Command	:CALCulate:FPOWer:POWer[1,2,...,999]:RESet
Example	:CALC:FPOW:POW1:RES
Notes	Option FP2 is required.
Initial S/W Revision	A.14.00

Define Fast Power Measurement (Remote Command Only)

Fast Power acquisitions are configured using the DEFine command. This command accepts a comma-delimited string of configuration parameters and their appropriate values, which are all specified in the subsection below.

Mode	All
Remote Command	:CALCulate:FPOWer:POWer[1,2,...,999]:DEFine "configuration string"
Example	:CALC:FPOW:POW1:DEF "CenterFrequency=2e9, AcquisitionTime=0.005"
Notes	See below for a list of measurement variables that can be defined in the configuration string.
Initial S/W Revision	A.14.00

Acquisition Time

Example	CALC:FPOW:POW1:DEF "AcquisitionTime=0.002"
Notes	The acquisition time parameter sets the time in which the entire spectrum is measured. An increase in the acquisition time yields an improvement in measurement repeatability.
Preset	0.001 s
Range	0 s to 1 s
Default Unit	Time (s)
Initial S/W Revision	A.14.00

Center Frequency

Example	CALC:FPOW:POW1:DEF "CenterFrequency=2e9"
Notes	The center frequency parameter sets the frequency in which the measurement is centered around. The OffsetFrequency parameter is calculated relative to the center frequency.
Preset	1 GHz
Range	0 Hz to maximum instrument frequency
Default Unit	Frequency (Hz)
Initial S/W Revision	A.14.00

DC Coupled

Example	CALC:FPOW:POW1:DEF "DCCoupled=True"
Notes	The DC coupled parameter allows the user to specify whether the DC blocking capacitor is utilized. Set parameter to true when measuring frequencies below 10 MHz.
Preset	False
Range	True (DC Coupled) or False (AC Coupled)
Default Unit	Boolean
Initial S/W Revision	A.14.00

DetectorType

Example	CALC:FPOW:POW1:DEF "DetectorType=Peak"
Notes	Option FP2 is required. The detector type parameter allows the user to choose whether a RMS average or peak value is used during the measurement.
Preset	RmsAverage
Range	RmsAverage, Peak
Initial S/W Revision	A.14.00

Do Noise Correction

Example	CALC:FPOW:POW1:DEF "DoNoiseCorrection=True"
Notes	<p>When noise correction is enabled, the linear noise power contributed by the analyzer is subtracted from all measurements. This effectively lowers the noise floor of the analyzer.</p> <p>When noise correction is enabled, the first measurement for a given set of input parameters will take extra time. This is because the analyzer takes an extra acquisition with the RF input disconnected from the analyzer's front end to measure the noise of just the analyzer. The measured noise floor is stored in a cache so the noise acquisition will occur only once for the same state settings. In other words, if noise correction was turned on and the analyzer made an acquisition at frequency A, then frequency B, and back again to frequency A, the hidden initial noise floor acquisition would only occur for the first acquisition at frequency A and the cached noise floor would be used the second time frequency A was measured.</p>
Preset	False
Range	True (enable noise correction) or False (disable noise correction)
Default Unit	Boolean
Initial S/W Revision	A.14.00

Do Spur Suppression

Example	CALC:FPOW:POW1:DEF "DoSpurSuppression=True"
Notes	<p>When measuring very low level signals, or when large out-of-band inputs are input into the analyzer, sometimes unwanted spurs and residuals can appear in the measured spectrum. Spur suppression is a method to help minimize the levels of these internally generated spurs and residuals.</p> <p>When spur suppression is enabled, the analyzer will automatically take two acquisitions using two different internal analog LO frequencies. The FFT spectrums from both acquisitions are combined by taking the minimum power between both traces on a per FFT bin basis. External signals will have the same amplitude for both traces and therefore will return the expected amplitudes. However, low level spurs and residuals generated internally to the analyzer tend to move to different FFT bins depending on the internal analog LO frequency used, and therefore tend to be suppressed using this spur suppression method.</p> <p>Because two acquisitions, rather than a single acquisition, are made when spur suppression is enabled, the measurement time will always be slower when spur suppression is enabled.</p>
Preset	False
Range	True (enable spur suppression) or False (disable spur suppression)
Default Unit	Boolean
Initial S/W Revision	A.14.00

Electronic Attenuator Bypass

Example	CALC:FPOW:POW1:DEF "ElecAttBypass =False"
---------	---

Notes	The electronic attenuation bypass parameter allows the user to either utilize or bypass the electronic attenuator. The electronic attenuator is only available for frequencies up to 3.6 GHz. Set parameter to true when using frequencies above 3.6 GHz and set the parameter to false when using the preamp.
Preset	True
Range	True (bypass electronic attenuator) or False (use electronic attenuator)
Default Unit	Boolean
Initial S/W Revision	A.14.00

Electronic Attenuation

Example	CALC:FPOW:POW1:DEF "ElecAttenuation=10"
Notes	Option EA3 is required. The electronic attenuation value parameter sets the amount of electrical attenuation from 0 to 24 dB (1 dB steps). Set "ElecAttBypass=False" to make sure the electronic attenuator path is enabled.
Preset	0 dB
Range	0 – 24 dB (1 dB steps)
Default Unit	dB
Initial S/W Revision	A.14.00

IF Gain

Example	CALC:FPOW:POW1:DEF "IFGain=10"
Notes	The IF gain parameter allows the user to specify the gain at the IF stage anywhere from -6 to 16 dB (1 dB steps). This is an advanced feature, and for most cases this should remain at its default value of 0 dB.
Preset	0 dB
Range	-6 – 16 dB (1 dB steps)
Default Unit	dB
Initial S/W Revision	A.14.00

IF Type

Example	CALC:FPOW:POW1:DEF "IFType=B25M"
Notes	The IF type parameter allows the user to select between different IF paths. For example, if the signal is less than 25 MHz wide, then the user can select the B25M path to take advantage of additional filtering on this analog IF path.

Preset	B40M
Range	B10M, B25M, B40M
Initial S/W Revision	A.14.00

Include Power Spectrum

Example	CALC:FPOW:POW1:DEF "IncludePowerSpectrum=True"
Notes	The power spectrum parameter allows the user to read data on the entire spectrum for diagnostic purposes. It is not recommended for production use. See CALC:FPOW:POW[n]:READ2? for details on the binary format of the response.
Preset	False
Range	True (return both channel power and full power spectrum) or False (returns only channel power)
Default Unit	Boolean
Initial S/W Revision	A.14.00

Mechanical Attenuation

Example	CALC:FPOW:POW1:DEF "MechAttenuation=10"
Notes	The mechanical attenuation value parameter sets the amount of mechanical attenuation anywhere from 0 to 70 dB (2 dB steps).
Preset	0 dB
Range	0 – 70 dB (2 dB steps)
Default Unit	dB
Initial S/W Revision	A.14.00

Preamp Mode

Example	CALC:FPOW:POW1:DEF "PreAmpMode=Low"
Notes	The license for the appropriate preamp is required. The preamp mode parameter specifies whether the preamps are being utilized. Low allows any preamps up to 3.6 GHz, and Full allows all licensed preamps. Set "ElecAttBypass=True" in order to utilize any preamps.
Preset	Off
Range	Off, Low, Full
Initial S/W Revision	A.14.00

Resolution Bandwidth Mode

Example	CALC:FPOW:POW1:DEF "PreAmpMode=Low"
Notes	The resolution bandwidth mode parameter allows the user to choose whether the RBW filter is automatically or manually set. The BestSpeed value minimizes measurement time, while the Narrowest value minimizes RBW size (minimum of two FFT bins per RBW). To manually specify an RBW, set this parameter to Explicit, and set the ResolutionBW parameter to the desired value.
Preset	BestSpeed
Range	BestSpeed, Narrowest, Explicit
Initial S/W Revision	A.14.00

Resolution Bandwidth

Example	CALC:FPOW:POW1:DEF "ResolutionBW=25e3"
Notes	The resolution bandwidth parameter sets the 3-dB bandwidth of the RBW filter. The ResolutionBWMode parameter must be set to Explicit in order to manually set the RBW.
Preset	0 Hz
Default Unit	Hz
Initial S/W Revision	A.14.00

Trigger Delay

Example	CALC:FPOW:POW1:DEF "TriggerDelay=0.025"
Notes	The trigger delay parameter sets the time after an external trigger is detected until the measurement is performed.
Preset	0 s
Range	0 – 1 s
Default Unit	Seconds
Initial S/W Revision	A.14.00

Trigger Level

Example	CALC:FPOW:POW1:DEF "TriggerLevel=2"
Notes	The trigger level parameter sets the voltage value at which an external trigger is detected.
Preset	1.2 V
Range	-5 to 5 V
Default Unit	Volts
Initial S/W Revision	A.14.00

Trigger Slope

Example	CALC:FPOW:POW1:DEF "TriggerSlope=Negative"
Notes	The trigger slope parameter indicates the direction of the edge trigger voltage for detection.
Preset	Positive
Range	Positive, Negative
Initial S/W Revision	A.14.00

Trigger Source

Example	CALC:FPOW:POW1:DEF "TriggerSource=Ext1"
Notes	The trigger source parameter allows the user to choose between measurement's triggering freely or controlled by an external input. Ext1 and Ext2 correspond to Trigger 1 In and Trigger 2 In, respectively.
Preset	Free
Range	Free, Ext1, Ext2
Initial S/W Revision	A.14.00

Trigger Timeout

Example	CALC:FPOW:POW1:DEF "TriggerTimeout=0.1"
Notes	The trigger timeout parameter sets the time in which the analyzer will wait for a trigger before automatically performing the measurement.
Preset	1 s
Range	0 – 1 s
Default Unit	Seconds
Initial S/W Revision	A.14.00

Signal Input

Example	CALC:FPOW:POW1:DEF "SignalInput=Fp50MHzCW"
Notes	The signal input parameter allows the user to select between using the main RF input or the internal analyzer reference CW signal of 50 MHz.
Preset	FpMainRf
Range	FpMainRf, Fp50MHzCW
Initial S/W Revision	A.14.00

Use Preselector

Example	CALC:FPOW:POW1:DEF "UsePreSelector=True"
Notes	The preselector parameter allows the user to either utilize or bypass the front end tunable filter at frequencies above 3.6 GHz. For frequencies below 3.6 GHz, the preselector is automatically bypassed, so you do not need to set this parameter to False in those cases.
Preset	False
Range	True (use preselector above 3.6 GHz), or False (preselector bypassed)
Default Unit	Boolean
Initial S/W Revision	A.14.00

Channel Bandwidth Array

Example	CALC:FPOW:POW1:DEF "Bandwidth=[3.84e6, 5e6, 3.84e6]"
Notes	The bandwidth parameter array defines the bandwidth of each channel that will be measured. All array parameters should have the same number of elements. Alternatively, if all the elements are the same value, a single number with no square brackets can be used to define the parameter.
Preset	[1e6]
Range	0 to 40 MHz
Default Unit	Hz
Initial S/W Revision	A.14.00

Channel Filter Type Array

Example	CALC:FPOW:POW1:DEF "FilterType=[RRC, IBW, RRC]"
Notes	The filter type parameter allows the user to choose between an integration bandwidth (IBW) filter or a root-raised-cosine (RRC) filter. The integration bandwidth filter weighs all frequencies within the bandwidth equally. The root-raised-cosine filter has an associated shape parameter, defined by the FilterAlpha parameter. All array parameters should have the same number of elements. Alternatively, if all the elements are the same value, a single value with no square brackets can be used to define the parameter.
Preset	[IBW]
Range	IBW, RRC
Initial S/W Revision	A.14.00

Channel Filter Alpha Array

Example	CALC:FPOW:POW1:DEF "FilterAlpha=[0.5, 0.0, 0.5]"
Notes	The filter alpha parameter allows the user to adjust the alpha value associated with the root-

	raised-cosine (RRC) filter type. Set FilterType to RRC in order to utilize this parameter. All array parameters should have the same number of elements. Alternatively, if all the elements are the same value, a single number with no square brackets can be used to define the parameter.
Preset	[0.22]
Range	0.0 – 1.0
Initial S/W Revision	A.14.00

Channel Measurement Function Array

Example	CALC:FPOW:POW1:DEF "Function=[BandPower, PeakPower, BandPower]"
Notes	This parameter array defines what measurement is being made for each individually-specified channel: BandPower: Total power within the specified bandwidth of the channel (dBm) BandDensity: Total power density within the specified bandwidth of the channel (dBm/Hz) PeakPower: The peak power value within the specified bandwidth of the channel (dBm) PeakFrequency: The frequency which corresponds to the peak power value within the specified bandwidth of the channel. This frequency is relative to the center frequency (Hz) XdBBandwidth: The half power (-3.01 dB) bandwidth of the highest amplitude signal that resides within the channel (Hz), dB is configurable using XdBBandwidth parameter OccupiedBandwidth: The bandwidth at which 99% of the total power resides within the channel (Hz), percentage configurable using OccupiedBandwidthPercent parameter All array parameters should have the same number of elements. Alternatively, if all the elements are the same value, a single value with no square brackets can be used to define the parameter.
Preset	[BandPower]
Range	BandPower, BandDensity, PeakPower, PeakFrequency, XdBBandwidth, OccupiedBandwidth
Initial S/W Revision	A.14.00

Channel Offset Frequency Array

Example	CALC:FPOW:POW1:DEF "OffsetFrequency=[-5e6, 0, 5e6]"
Notes	The offset frequency parameter array defines the difference between the center frequency to the center frequency of each channel. All array parameters should have the same number of elements.
Preset	[0]
Range	0 to 20 MHz
Default Unit	Hz
Initial S/W Revision	A.14.00

Channel Occupied Bandwidth Percent Array

Example	CALC:FPOW:POW1:DEF "OccupiedBandwidthPercent =[0.95, 0.95, 0.95]"
Notes	This parameter only applies for channels whose Function is set to OccupiedBandwidth. The occupied bandwidth percent parameter specifies the percent of total power in these channels. The valid range for this parameter is 0.0 to 1.0, where 1.0 represents 100%. The default for this parameter is 0.99, which will return the bandwidth that contains 99% of the total channel power.
Preset	[0.99]
Range	0 – 1.0
Initial S/W Revision	A.14.00

Channel x-dB Bandwidth Array

Example	CALC:FPOW:POW1:DEF "XdBBandwidth =[-6.02, -3.01, -1.0]"
Notes	This parameter only applies for channels whose Function is set to XdBBandwidth. The X dB bandwidth parameter is used to specify the power relative to the peak channel power over which the bandwidth is calculated. The parameter value must be a negative number.
Preset	[-3.01]
Range	-200 to 0 dB
Default Unit	dB
Initial S/W Revision	A.14.00

Define Fast Power Measurement Query (Remote Command Only)

The DEFine? command is used to retrieve a list of all defined parameters in an ASCII string format

M All
o
d
e

R :CALCulate:FPOWer:POWer[1,2,...,999]:DEFine?

e
m
o
t
e

C
o
m
m
a
n

d

E :CALC:FPOW:POW1:DEF?

x
a
m
p
l
e

N This command query is used to retrieve a list of all defined parameters in an ASCII format.

O The following is an example of the returned results:

t "DCCoupled=False,ElecAttBypass=True,ElecAttenuation=0,IFGain=0,MechAttenuation=0,PreAmpMode=Off,PreSelectorOf
e fset=0,UsePreSelector=False,ExternalReferenceFrequency=10000000,FrequencyReferenceSource=AutoExternalFrequenc
s yReference,IFType=B40M,LOMode=SLW,SignalInput=FpMainRf,AcquisitionTime=0.001,CenterFrequency=1000000000,Re
solutionBW=0,ResolutionBWMode=BestSpeed,DetectorType=RmsAverage,Bandwidth=[1000000],OffsetFrequency=
[0],Function=[BandPower],FilterType=[BW],FilterAlpha=[0.22],OccupiedBandwidthPercent=[0.99],XdBBandwidth=[-
3.01],DoNoiseCorrection=False,DoSpurSuppression=False,MeasurementMethod=HardwareFFT,IncludePowerSpectrum=F
alse,TriggerDelay=0,TriggerLevel=1.2,TriggerSlope=Positive,TriggerSource=Free,TriggerTimeout=1"

I A.14.00

n
i
t
i
a
l

S
/
W

R
e
v
i
s
i
o
n

Configure Fast Power Measurement (Remote Command Only)

The configure command begins hardware setup and returns immediately, with no acquisition made. This can be used in parallel with other hardware operations to effectively hide the hardware setup time.

Mode	All
Remote Command	:CALCulate:FPOWer:POWer[1,2,...,999]:CONFigure
Example	:CALC:FPOW:POW1:CONF

Notes	Option FP2 is required.
Initial S/W Revision	A.14.00

Initiate Fast Power Measurement (Remote Command Only)

The INITiate command begins an acquisition and returns immediately. The results of the measurement can be retrieved using FETCh.

Mode	All
Remote Command	:CALCulate:FPOWer:POWer[1,2,...,999]:INITiate
Example	:CALC:FPOW:POW1:INIT
Notes	Option FP2 is required.
Initial S/W Revision	A.14.00

Fetch Fast Power Measurement (Remote Command Only)

The FETCh command query is used to retrieve the results of an acquisition initiated by the INIT command. The returned results are in ASCII string format. The string begins and ends with quotation marks.

Mode	All
Remote Command	:CALCuLate:FPOWer:POWer[1,2,...,999]:FETCh?
Example	:CALC:FPOW:POW1:FETC?
Notes	Option FP2 is required. Returns m comma-separated ASCII values, where m corresponds to the number of bandwidths defined. 1. Declared function return in the 1st specified channel 2. Declared function return in the 2nd specified channel ... m. Declared function return in the last specified channel The INIT and FETC? command sequence performs the same functionality of a single CALC:FPOW:POW[n]? query. Units of the returned values are dependent on the Function parameter for each channel.
Initial S/W Revision	A.14.00

Execute Fast Power Measurement (Remote Command Only)

This command query is used as shorthand for an INIT command immediately followed by a FETC? command. The returned results are in ASCII string format. The string begins and ends with quotation marks.

Mode	All
Remote Command	:CALCulate:FPOWer:POWer[1,2,...,999]?
Example	:CALC:FPOW:POW1?
Notes	Option FP2 is required. See notes for Fast Power Fetch for return format.
Initial S/W Revision	A.14.00

Binary Read Fast Power Measurement (Remote Command Only)

This command query is used as shorthand for an INIT command immediately followed by a FETC? command. The returned results are in a binary format.

Mode	All
Remote Command	:CALCulate:FPOWer:POWer[1,2,...,999]:READ? :CALCulate:FPOWer:POWer[1,2,...,999]:READ1?
Example	:CALC:FPOW:POW1:READ? :CALC:FPOW:POW1:READ1?
Notes	Option FP2 is required. Returns m 4 byte floating point binary values (Little-Endian), where m corresponds to the number of bandwidths defined.
Initial S/W Revision	A.14.00

Diagnostic Binary Read Fast Power Measurement (Remote Command Only)

This command query is used as shorthand for an INIT command immediately followed by a FETC? command. The returned results are in a binary format. This command is used primarily for diagnostic purposes to test for ADC overloads and to visibly inspect the spectrum.

Mode	All
Remote Command	:CALCulate:FPOWer:POWer[1,2,...,999]:READ2?
Example	:CALC:FPOW:POW1:READ2?
Notes	Option FP2 is required. <div style="display: flex; align-items: flex-start;"> <div style="background-color: #cccccc; padding: 2px 5px; margin-right: 10px;">NOTE</div> <div> <p>Spectrum data is only returned if the IncludePowerSpectrum parameter is set to True. If IncludePowerSpectrum is False, the number of spectrum points will be zero (0).</p> </div> </div> <p>Units of the returned values are dependent on the Function parameter per channel (e.g. dBm for BandPower, Hz for PeakFrequency). Returns binary data (Little-Endian) that contains information on m amount of channels, along with ADC over range and full spectrum data.</p>

The following is the binary format of the response.

Bandwidth Return Value

1. Number of channels specified, m [4 byte int]
2. Declared function result for the 1st specified channel [4 byte float]
3. Declared function result for the 2nd specified channel [4 byte float]
- ...
- (m + 1). Declared function result for the last (mth) specified channel [4 byte float]

ADC Over Range

1. ADC over-range occurred (1: true, 0: false) [2 byte short]

Spectrum Data

1. Number of points in the spectrum data, k [4 byte int]
 2. Start frequency of spectrum data (Hz) [8 byte double]
 3. Step frequency of spectrum data (Hz) [8 byte double]
 4. FFT bin at 1st point (dBm) [4 byte float]
 5. FFT bin at 2nd point (dBm) [4 byte float]
 - ...
 - (k + 3). FFT bin at last (kth) point (dBm) [4 byte float]
-

Initial S/W Revision A.14.00

Format Data: Numeric Data (Remote Command Only)

This command specifies the format of the trace data input and output. It specifies the formats used for trace data during data transfer across any remote port. It affects only the data format for setting and querying trace data for the :TRACe[:DATA], TRACe[:DATA]?, :CALCulate:DATA[n]? and FETCh:SANalyzer[n]? commands and queries.

Remote Command	:FORMat[:TRACe][:DATA] ASCii INTeger,32 REAL,32 REAL,64 :FORMat[:TRACe][:DATA]?
-----------------------	---

Notes The query response is:

ASCii: ASC,8

REAL,32: REAL,32

REAL,64: REAL,64

INTeger,32: INT,32

When the numeric data format is REAL or ASCii, data is output in the current Y Axis unit. When the data format is INTeger, data is output in units of m dBm (.001 dBm).

The INT,32 format returns binary 32-bit integer values in internal units (m dBm), in a definite length block.

Dependencies	Sending a data format spec with an invalid number (for example, INT,48) generates no error. The analyzer simply uses the default (8 for ASCii, 32 for INTeger, 32 for REAL).
--------------	--

Sending data to the analyzer which does not conform to the current FORMat specified, results in an error. Sending ASCII data when a definite block is expected generates message -161 "Invalid"

	Block Data" and sending a definite block when ASCII data is expected generates message -121 "Invalid Character in Number".
Preset	AScii
Backwards Compatibility Notes	Note that the INT,32 format is only applicable to the command, TRACe:DATA. This preserves backwards compatibility for the Swept SA measurement. For all other commands/queries which honor FORMat:DATA, if INT,32 is sent the analyzer will behave as though it were set to REAL,32.
Initial S/W Revision	Prior to A.02.00

The specs for each output type follow:

AScii - Amplitude values are in ASCII, in the current Y Axis Unit, one ASCII character per digit, values separated by commas, each value in the form:

SX.YYYYEsZZ

Where:

S = sign (+ or -)

X = one digit to left of decimal point

Y = 5 digits to right of decimal point

E = E, exponent header

s = sign of exponent (+ or -)

ZZ = two digit exponent

REAL,32 - Binary 32-bit real values in the current Y Axis Unit, in a definite length block.

REAL,64 - Binary 64-bit real values in the current Y Axis Unit, in a definite length block.

Format Data: Byte Order (Remote Command Only)

This command selects the binary data byte order for data transfer and other queries. It controls whether binary data is transferred in normal or swapped mode. This command affects only the byte order for setting and querying trace data for the :TRACe[:DATA], TRACe[:DATA]? , :CALCulate:DATA[n]? and FETCh:SANalyzer[n]? commands and queries.

By definition any command that says it uses FORMat:DATA uses any format supported by FORMat:DATA.

The NORMal order is a byte sequence that begins with the most significant byte (MSB) first, and ends with the least significant byte (LSB) last in the sequence: 1|2|3|4. SWAPped order is when the byte sequence begins with the LSB first, and ends with the MSB last in the sequence: 4|3|2|1.

Remote Command	:FORMat:BORDER NORMa1 SWAPped
-----------------------	--

	:FORMat:BORDER?
Preset	NORMal
Initial S/W Revision	Prior to A.02.00

Meas Setup

Accesses a menu of keys that allows averaging control, and enables zero-span measurements for increased accuracy.

Key Path	Front-panel key
Initial S/W Revision	Prior to A.02.00

Avg/Hold Num

When Average/Hold is turned on, at each frequency a specified number of sweeps is taken, and the data in those sweeps averaged for the purposes of establishing the measurement.

The average Type is always Power Average.

Key Path	Meas Setup
Remote Command	[:SENSe]:TOI:AVERAge:COUNT <integer> [:SENSe]:TOI:AVERAge:COUNT? [:SENSe]:TOI:AVERAge[:STATe] ON OFF 1 0 [:SENSe]:TOI:AVERAge[:STATe]?
Example	TOI:AVER:COUN 20
Preset	10 OFF
Min	1
Max	10000
Backwards Compatibility SCPI	[:SENSe]:TOINtercept:AVERAge:COUNT
Initial S/W Revision	Prior to A.02.00

Avg Mode

Avg Mode key selects the termination control used for the averaging function when averaging the trace. This determines the action after the specified number of measurements (Avg/Hold Num) is reached.

- Exp (Exponential Averaging Mode) – When you set Avg Mode to Exp, each successive data acquisition after the average count is reached is exponentially weighted and combined with the existing average. Exponential averaging weights new data more than old data, which facilitates tracking of slow-changing signals. The average will be displayed at the end of each sweep.
- Repeat – After reaching the Avg/Hold Num, all previous result data is cleared and the average count set back to 1.

Key Path	Meas Setup
Remote Command	[:SENSe] : TOI : AVERage : TCONtrol EXPonential REPeat [:SENSe] : TOI : AVERage : TCONtrol ?
Example	TOI: AVER: TCON EXP
Preset	EXP
Range	Exp Repeat
Backwards Compatibility SCPI	[:SENSe] : TOINtercept : AVERage : TCONtrol
Initial S/W Revision	Prior to A.02.00

Zero-Span Measurement

Zero-span measurement uses two additional zero-span sweeps – one at each intermodulation product – to significantly increase the accuracy and the dynamic range of the TOI measurement. Zero-span measurement cannot be used on signals that vary rapidly in frequency.

This branch key summons a menu that controls this measurement approach.

Key Path	Meas Setup
Initial S/W Revision	Prior to A.02.00

Zero-Span Measurement

Zero-span measurement uses two additional zero-span sweeps – one at each intermodulation product – to significantly increase the accuracy and the dynamic range of the TOI measurement. Zero-span measurement cannot be used on signals that vary rapidly in frequency.

Key Path	Meas Setup
Remote Command	[:SENSe] : TOI : ZSPan : STATe ON OFF 1 0 [:SENSe] : TOI : ZSPan : STATe ?
Example	TOI: ZSP: STAT OFF
Notes	Forces a measurement restart.
Preset	Off
Range	On Off
Initial S/W Revision	Prior to A.02.00

Zero-Span RBW

Zero-Span RBW is the resolution bandwidth used when making the zero-span intermod measurements when Zero-Span measurement is active. The Zero-Span RBW is typically smaller than the main resolution bandwidth, although it must still be large enough to accommodate three times the width of the intermodulation products.

The required frequency accuracy of the lower and upper base frequencies increases when the Zero-Span RBW decreases. For this reason, frequency counting is used when the lower and upper base frequencies are in auto mode. For optimum measurement speed, set the lower and upper base frequencies explicitly.

Key Path	Meas Setup
Remote Command	[:SENSe]:TOI:ZSPan:BANDwidth BWIDth <frequency> [:SENSe]:TOI:ZSPan:BANDwidth BWIDth? [:SENSe]:TOI:ZSPan:BANDwidth BWIDth:AUTO OFF ON 0 1 [:SENSe]:TOI:ZSPan:BANDwidth BWIDth:AUTO?
Example	TOI:ZSP:BAND 300 kHz TOI:ZSP:BAND:AUTO ON
Notes	Forces a measurement restart.
Couplings	When Auto is on, The Zero-Span RBW is one step down from the measurement RBW.
Preset	3 MHz ON
Min	1 Hz
Max	8 MHz
Initial S/W Revision	Prior to A.02.00

Dwell Time

The Dwell Time is the sweep time used when making the zero-span intermod measurements when Zero-Span measurement is turned on. Additional sweep time gives better noise performance.

Key Path	Meas Setup
Remote Command	[:SENSe]:TOI:ZSPan:SWEEp:TIME <time> [:SENSe]:TOI:ZSPan:SWEEp:TIME? [:SENSe]:TOI:ZSPan:SWEEp:TIME:AUTO OFF ON 0 1 [:SENSe]:TOI:ZSPan:SWEEp:TIME:AUTO?
Example	TOI:ZSP:SWE:TIME 66.24 ms TOI:ZSP:SWE:TIME:AUTO ON
Couplings	If ZS Sweep Time Auto is on, the Dwell Time will be the same as the measurement sweep time.
Preset	Depends upon the maximum span of the analyzer, see Sweep Time for more information.

Min	100 us
Max	4000 s
Initial S/W Revision	Prior to A.02.00

Meas Preset

This key initiates the first sweep. It will return the Meas Local variables in the current measurement to their preset values (many of which are determined from the results of the first sweep).

Key Path	Meas Setup
Remote Command	:CONFigure:TOI
Initial S/W Revision	Prior to A.02.00

Mode

See "[Mode](#)" on page 353

Mode Preset

Returns the active mode to a known state.

Mode Preset does the following for the currently active mode:

- Aborts the currently running measurement.
- Brings up the default menu for the mode, with no active function.
- Sets measurement Global settings to their preset values for the active mode only.
- Activates the default measurement.
- Brings up the default menu for the mode.
- Clears the input and output buffers.
- Sets Status Byte to 0.

Mode Preset does not:

- Cause a mode switch
- Affect mode persistent settings
- Affect system settings
- See "[How-To Preset](#)" on page 2979 for more information.

Key Path	Front-panel key
Remote Command	:SYSTem:PRESet
Example	:SYST:PRES
Notes	<p>*RST is preferred over :SYST:PRES for remote operation. *RST does a Mode Preset, as done by the :SYST:PRES command, and it sets the measurement mode to Single measurement rather than Continuous for optimal remote control throughput.</p> <p>Clears all pending OPC bits. The Status Byte is set to 0.</p>
Couplings	A Mode Preset aborts the currently running measurement, activates the default measurement, and gets the mode to a consistent state with all of the default couplings set.
Backwards Compatibility Notes	<p>In the X-Series, the legacy "Factory Preset" has been replaced with Mode Preset, which only presets the currently active mode, not the entire instrument. In the X-Series, the way to preset the entire instrument is by using System, Restore System Defaults All, which behaves essentially the same way as restore System Defaults does on ESA and PSA.</p> <p>There is also no "Preset Type" as there is on the PSA. There is a green Mode Preset front-panel key that does a Mode Preset and a white-with-green-letters User Preset front-panel key that does a User Preset. The old PRESet:TYPE command is ignored (without generating an error), and SYST:PRES without a parameter does a Mode Preset, which should cover most backward code compatibility issues.</p>

The settings and correction data under the Input/Output front-panel key (examples: Input Z Corr, Ext Amp Gain, etc.) are no longer part of any Mode, so they will not be preset by a Mode Preset. They are preset using Restore Input/Output Defaults, Restore System Defaults All. Note that because User Preset does a Recall State, and all of these settings are saved in State, they ARE recalled when using User Preset.

Initial S/W Revision Prior to A.02.00

How-To Preset

The table below shows all possible presets, their corresponding SCPI commands and front-panel access (key paths). Instrument settings depend on the current measurement context. Some settings are local to the current measurement, some are global (common) across all the measurements in the current mode, and some are global to all the available modes. In a similar way, restoring the settings to their preset state can be done within the different contexts.

Auto Couple - is a measurement local key. It sets all Auto/Man parameter couplings in the measurement to Auto. Any Auto/Man selection that is local to other measurements in the mode will not be affected.

Meas Preset - is a measurement local key. Meas Preset resets all the variables local to the current measurement except the persistent ones.

Mode Preset - resets all the current mode's measurement local and measurement global variables except the persistent ones.

Restore Mode Defaults - resets ALL the Mode variables (and all the Meas global and Meas local variables), including the persistent ones.

Type Of Preset	SCPI Command	Front Panel Access
Auto Couple	:COUPle ALL	Auto Couple front-panel key
Meas Preset	:CONFigure:<Measurement>	Meas Setup Menu
Mode Preset	:SYSTem:PRESet	Mode Preset (green key)
Restore Mode Defaults	:INSTrument:DEFault	Mode Setup Menu
Restore All Mode Defaults	:SYSTem:DEFault MODes	System Menu; Restore System Default Menu
*RST	*RST	not possible (Mode Preset with Single)
Restore Input/Output Defaults	:SYSTem:DEFault INPut	System Menu; Restore System Default Menu
Restore Power On Defaults	:SYSTem:DEFault PON	System Menu; Restore System Default Menu
Restore Alignment Defaults	:SYSTem:DEFault ALIGN	System Menu; Restore System Default Menu
Restore Miscellaneous Defaults	:SYSTem:DEFault MISC	System Menu; Restore System Default Menu

Restore All System Defaults	:SYSTem:DEFault [ALL] :SYSTem:PRESet:PERSistent	System Menu; Restore System Default Menu
User Preset	:SYSTem:PRESet:USER	User Preset Menu
User Preset All Modes	:SYSTem:PRESet:USER:ALL	User Preset Menu
Power On Mode Preset	:SYSTem:PON:TYPE MODE	System Menu
Power On User Preset	:SYSTem:PON:TYPE USER	System Menu
Power On Last State	:SYSTem:PON:TYPE LAST	System Menu

Mode Setup

See "[Mode Setup](#)" on page 388

Peak Search

There is no peak search functionality in the TOI measurement. .

Key Path	Front-panel key
Initial S/W Revision	Prior to A.02.00

Print

See "Print " on page 430

Quick Save

The Quick Save front-panel key repeats the most recent save that was performed from the Save menu, with the following exceptions:

- Register saves are not remembered as Saves for the purpose of the Quick Save function
- If the current measurement does not support the last non-register save that was performed, an informational message is generated, “File type not supported for this measurement”

Quick Save repeats the last type of qualified save (that is, a save qualified by the above criteria) in the last save directory by creating a unique filename using the Auto File Naming algorithm described below.

If Quick Save is pressed after startup and before any qualified Save has been performed, the Quick Save function performs a Screen Image save using the current settings for Screen Image saves (current theme, current directory), which then becomes the “last save” for the purpose of subsequent Quick Saves.

The Auto File Naming feature automatically generates a file name for use when saving a file. The filename consists of a prefix and suffix separated by a dot, as is standard for the Windows® file system. A default prefix exists for each of the available file types:

Type	Default Prefix	Menu
State	State_	(Save/Recall)
Trace + State	State_	(Save/Recall)
Screen	Screen_	(Save/Recall)
Amplitude Corrections	Ampcor_	(Import/Export)
Traces	Trace_	(Import/Export)
Limit Lines	LLine_	(Import/Export)
Measurement Result	MeasR_	(Import/Export)
Capture Buffer	CapBuf_	(Import/Export)

A four digit number is appended to the prefix to create a unique file name. The numbering sequence starts at 0000 within each Mode for each file type and updates incrementally to 9999, then wraps to 0000 again. It remembers where it was through a Mode Preset and when leaving and returning to the Mode. It is reset by Restore Misc Defaults and Restore System Defaults and subsequent running of the instrument application. So, for example, the first auto file name generated for State files is State_0000.state. The next is State_0001, and so forth.

One of the key features of Auto File Name is that we guarantee that the Auto File Name will never conflict with an existing file. The algorithm looks for the next available number. If it gets to 9999, then it looks for holes. If it find no holes, that is no more numbers are available, it gives an error.

For example, if when we get to State_0010.state there is already a State_0010.state file in the current directory, it advances the counter to State_0011.state to ensure that no conflict will exist (and then it verifies that State_0011.state also does not exist in the current directory and advances again if it does, and so forth).

If you enter a file name for a given file type, then the prefix becomes the filename you entered instead of the default prefix, followed by an underscore. The last four letters (the suffix) are the 4-digit number.

For example, if you save a measurement results file as "fred.csv", then the next auto file name chosen for a measurement results save will be fred_0000.csv.

NOTE

Although 0000 is used in the example above, the number that is used is actually the current number in the Meas Results sequence, that is, the number that would have been used if you had not entered your own file name.

If the filename you entered ends with _dddd, where d=any number, making it look just like an auto file name, then the next auto file name picks up where you left off with the suffix being dddd + 1.

Key Path	Front-panel key
Notes	No remote command for this key specifically.
Initial S/W Revision	Prior to A.02.00

Recall

The **Recall** menu lets you choose what you want to recall, and where you want to recall it from. Among the types of files you can recall are **States and Traces**. In addition, an **Import (Data)** option lets you recall a number of data types stored in CSV files (as used by Excel and other spreadsheet programs).

The default paths for Recall are data type dependent and are the same as for the Save key.

Key Path	Front-panel key
Notes	<p>No remote command for this key specifically, but the :MMEM:LOAD command is available for specific file types. An example is :MMEM:LOAD:STATe <filename>.</p> <p>If you try to recall a State file for a mode that is not licensed or not available in the instrument, an error message will occur and the state will not change.</p>
Backwards Compatibility Notes	<p>In legacy analyzers, it was possible to load a state without affecting the trace data, limit lines or correction data. Similarly (since User Preset is actually loading a state), it was possible to do a User Preset without affecting the trace data, limit lines or correction data.</p> <p>In the X-Series, "state" always includes all of this data; so whenever state is loaded, all of the traces, limit lines and corrections are affected. Although this differs from previous behavior, it is desirable behavior, and should not cause adverse issues for users.</p>
Backwards Compatibility Notes	<p>Recall for the X-Series supports backward compatibility in the sense that you can recall a state file from any X-Series model number and any version of X-Series software. This is only possible if part of the recalling process goes through a limiting step after recalling the mode settings, at least for settings that may vary with version number, model number, option and license differences. If you try to recall a state file onto an instrument with less capability than what was available on the instrument during the save, the recall will ignore the state it doesn't support and it will limit the recalled setting to what it allows.</p> <p>Example: if the saved state includes preamp ON, but the recalling instrument does not have a preamp; the preamp is limited to OFF. Conversely, if you save a state without a preamp, the preamp is OFF in the state file. When this saved file is recalled on an instrument with a licensed preamp, the preamp is changed to OFF. Another example is if the saved state has center frequency set to 20 GHz, but the instrument recalling the saved state is a different model and only supports 13.5 GHz. In this case, the center frequency is limited along with any other frequency based settings. Since the center frequency can't be preserved in this case, the recall limiting tries to at least preserve span to keep the measurement setup as intact as possible.</p> <p>It may be appropriate to issue a warning if the state is limited on the recall; warnings do not go out to SCPI so this would only affect the manual user.</p> <p>Note that there is no state file compatibility outside of the X-Series. For example, you cannot recall a state file from ESA or PSA.</p>
Initial S/W Revision	Prior to A.02.00

State

The **Recall State** menu lets you choose a register or file from which to recall the state.

The content of a state file includes all of the settings and data required to return the analyzer as closely as possible to the Mode it was in, with the exact settings that were in place, when the save occurred. The Mode settings in each state file include the settings that are affected by Mode Preset, as well as the additional settings affected by Restore Mode Defaults; all of the Mode's settings. In addition, all of the settings of the **Input/Output** system are included, even though they are outside of the Mode's state, because they are needed to restore the complete setup. Persistent System settings (for example, GPIB address) are not affected by either a Mode Preset or Restore Mode Defaults, nor are they included in a saved State file.

Since each state file is only for one Mode, the settings for other Modes are unaffected when it is loaded. **Recall State** will cause a mode switch if the state being recalled is not from the current active mode.

After the recall completes, the message "File <filename> recalled" or "Recalled State Register <register number>" is displayed.

For rapid recalls, the State menu lists 16 registers that you can choose from to recall. Pressing a Register key initiates the recall. You can also select a file from which to recall.

The default path for all State Files is:

My Documents\<<mode name>\state

where <mode name> is the parameter used to select the mode with the INST:SEL command (for example, SA for the Spectrum Analyzer).

See ["More Information" on page 2988](#).

Key Path	Recall
Mode	All
Remote Command	:MMEMory:LOAD:STATe <filename>
Example	:MMEM:LOAD:STAT "myState.state" This recalls the file myState.state on the default path
Example	MMEM:LOAD:STAT "MyStateFile.state" This loads the state file data (on the default file directory path) into the instrument state.
Notes	When you pick a file to recall, the analyzer first verifies that the file is recallable in the current instrument by checking the software version and model number of the instrument. If everything matches, a full recall proceeds by aborting the currently running measurement, clearing any pending operations, and then loading the State from the saved state file. You can open state files from any mode, so recalling a State file switches to the mode that was active when the save occurred. After switching to the mode of the saved state file, mode settings and data (if any for the mode) are loaded with values from the saved file. The saved measurement of the mode becomes the newly active measurement and the data relevant to the measurement (if there is any) is recalled. <ul style="list-style-type: none"> - If there is a mismatch between file version or model number or instrument version or model number, the recall function tries to recall as much as possible and returns a warning message. It may limit settings that differ based on model number, licensing or version number.

After recalling the state, the Recall State function does the following:

- Makes the saved measurement for the mode the active measurement.
- Clears the input and output buffers.
- Status Byte is set to 0.
- Executes a *CLS

If the file specified is empty an error is generated. If the specified file does not exist, another error is generated. If there is a mismatch between the file and the proper file type, an error is generated. If there is a mismatch between file version or model number or instrument version or model number, a warning is displayed. Then it returns to the State menu and File Open dialog goes away.

After the Recall, the analyzer exits the Recall menu and returns to the previous menu.

**Backwards
Compatibility SCPI**

:MMEMory:LOAD:STATE 1,<filename>

For backwards compatibility, the above syntax is supported. The "1" is simply ignored.

Initial S/W Revision

Prior to A.02.00

More Information

In measurements that support saving Traces, for example, Swept SA, the Trace data is saved along with the State in the State file. When recalling the State, the Trace data is recalled as well. Traces are recalled exactly as they were stored, including the writing mode and update and display modes. If a Trace was updating and visible when the State was saved, it will come back updating and visible, and its data will be rewritten right away. When you use State to save and recall traces, any trace whose data must be preserved should be placed in View or Blank mode before saving.

The following table describes the Trace Save and Recall possibilities:

You want to recall state and one trace's data, leaving other traces unaffected.	Save Trace+State from 1 trace. Make sure that no other traces are updating (they should all be in View or Blank mode) when the save is performed.	On Recall, specify the trace you want to load the one trace's data into. This trace will load in View. All other traces' data will be unaffected, although their trace mode will be as it was when the state save was performed.
You want to recall all traces	Save Trace+State from ALL traces.	On Recall, all traces will come back in View (or Blank if they were in Blank or Background when saved)
You want all traces to load exactly as they were when saved.	Save State	On recall, all traces' mode and data will be exactly as they were when saved. Any traces that were updating will have their data immediately overwritten.

From File...

When you press “From File”, the analyzer brings up a Windows dialog and a menu entitled “File Open.” This menu allows you to navigate to the various fields in the Windows dialog without using a keyboard or mouse. The **Tab** and **Arrow** keys can also be used for dialog navigation.

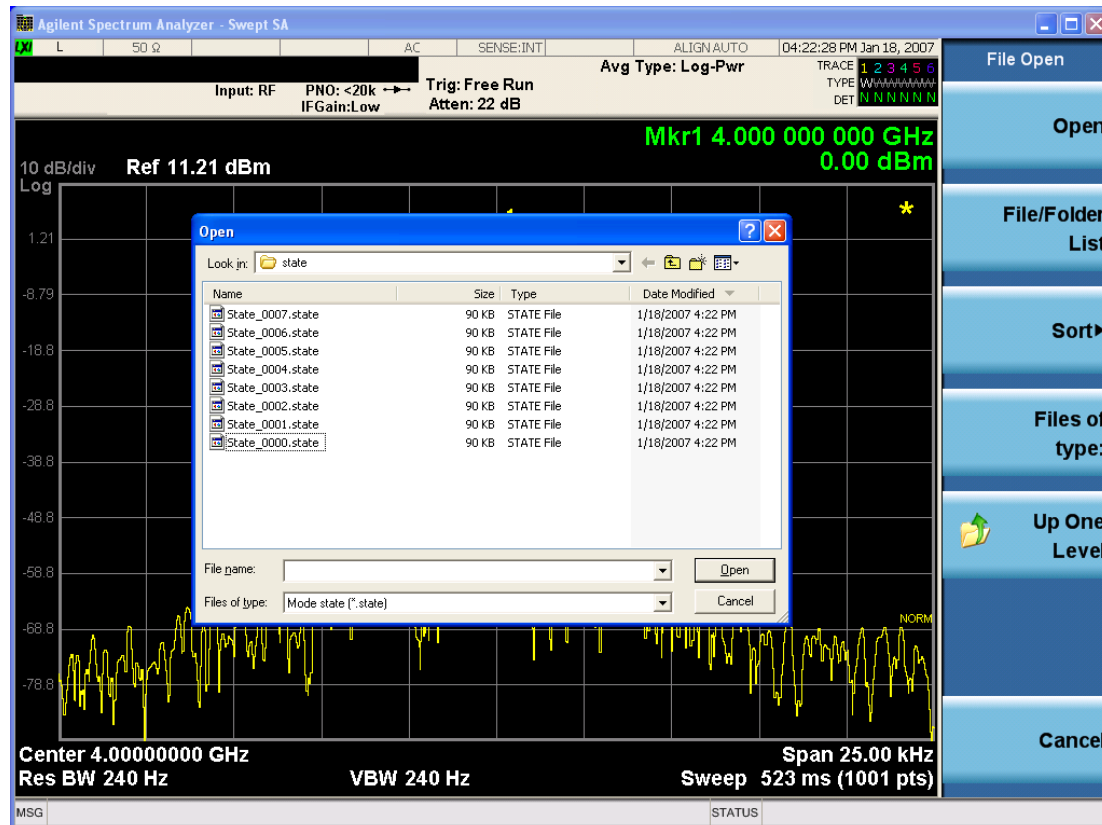

Listed below are the functions of the various fields in the dialog, and the corresponding softkeys:

Open

Performs the recall of the specified file. While the recall is being performed, the floppy icon appears briefly in the Meas bar.

File/Folder List

Enables you to navigate to the center of the dialog that contains the list of files and folders. Once here you can get information about the file and use the tab keys to navigate to the other fields in the dialog, such as Look In.

Look In

The **Look In** field shows the path from which the file will be recalled and allows you to change the path using the up and down arrow keys to navigate to other paths; the Enter key to open a directory; and the Backspace key to go back one directory. The **Look In** field first uses the last path from the Save As dialog **Save In:** path for that

same file type. There is no softkey for directly navigating to the Look In field, but you can use the left tab to get here from the File/Folder List.

User specified paths are remembered when you leave and return to a Mode and are reset back to the default using **Restore Mode Defaults**.

Sort

Accesses a menu that enables you to sort the files within the File Open dialog. Only one sorting type can be selected at a time and the sorting happens immediately. The sorting types are **By Date**, **By Name**, **By extension**, and **By Size**.

Files of Type

This field shows the file suffix for the type of file you have selected to recall. For example, if you navigated here while recalling State, "Mode state (*.state)" is in the field. If you navigated here while recalling Trace, "Mode state (*.trace)" is in the field. If you navigated here while importing a trace data file, "Trace Data (*.csv)" is in the field. For some file types, there is more than one choice in the dropdown menu, which you can select by using the up and down arrow keys and Enter.

Up One Level

This key corresponds to the icon of a folder with the up arrow that is in the tool bar of the dialog. When pressed, it causes the file and folder list to navigate up one level in the directory structure. The Backspace key does the same thing.

Cancel

This key corresponds to the **Cancel** selection in the dialog. It causes the current **Open** request to be cancelled. The ESC key does the same thing.

Key Path	Recall, State
Notes	Brings up the Open dialog for recalling a State Save Type
Initial S/W Revision	Prior to A.02.00

Edit Register Names

You may enter a custom name on any of the Register keys, to help you remember what you are using that state to save. To do this, press the **Edit Register Names** key, choose the register whose name you wish to edit, and then enter the desired label using the Alpha Editor or an external PC keyboard.

The maximum number of characters that can be added is 30. In most cases, 30 characters will fit on two lines of the key.

For more information and the SCPI command, see Edit Register Names under the **Save, State** function.

Key Path	Recall, State
Mode	All
Dependencies	N9060A-7FP or N9060B-2FP license required to edit the register names. When the feature is not

	licensed, sending the SCPI command generates an error, -221, "Settings conflict;Option not available"
Initial S/W Revision	A.11.00

Register 1 thru Register 16

Selecting any one of these register keys causes the State of the mode from the specified Register to be recalled. Each of the register keys annotates whether it is empty or at what date and time it was last modified. In addition, you can use the **Edit Register Names** key under **Save, State** to enter custom names for each register.

Registers are shared by all modes, so recalling from any one of the registers will cause a mode switch to the mode that was active when the save to the Register occurred.

Although these 16 registers are the only registers available from the front panel, there are 128 state registers available in the instrument. Registers 17-128 are only available from the SCPI interface, using the *RCL command.

After the recall completes, the message "Register <register number> recalled" appears in the message bar. If you are in the Spectrum Analyzer Mode, and you are recalling a register that was saved in the Spectrum Analyzer Mode, then after the recall, you will still be in the Recall Register menu. If the Recall causes you to switch modes, then after the Recall, you will be in the Frequency menu.

If a requested register is empty an error is generated.

Key Path	Recall, State
Example	*RCL 1
Range	1-16 from front panel, 1-128 from SCPI
Readback	Date and time with seconds resolution are displayed on the key OR A custom name of up to 30 characters entered using the Save, State,Edit Register Names key OR “(empty)” if no prior save operation has been performed to this register.
Initial S/W Revision	Prior to A.02.00
Modified at S/W Revision	Prior to A.11.00

Register 1 thru Register 16

Selecting any one of these register keys causes the State of the mode from the specified Register to be recalled. Each of the register keys annotates whether it is empty or at what date and time it was last modified. In addition, you can use the **Edit Register Names** key under **Save, State** to enter custom names for each register.

Registers are shared by all modes, so recalling from any one of the registers will cause a mode switch to the mode that was active when the save to the Register occurred.

Although these 16 registers are the only registers available from the front panel, there are 128 state registers available in the instrument. Registers 17-128 are only available from the SCPI interface, using the *RCL command.

After the recall completes, the message "Register <register number> recalled" appears in the message bar. If you are in the Spectrum Analyzer Mode, and you are recalling a register that was saved in the Spectrum Analyzer Mode, then after the recall, you will still be in the Recall Register menu. If the Recall causes you to switch modes, then after the Recall, you will be in the Frequency menu.

If a requested register is empty an error is generated.

Key Path	Recall, State
Example	*RCL 1
Range	1-16 from front panel, 1-128 from SCPI
Readback	Date and time with seconds resolution are displayed on the key OR A custom name of up to 30 characters entered using the Save, State,Edit Register Names key OR “(empty)” if no prior save operation has been performed to this register.
Initial S/W Revision	Prior to A.02.00
Modified at S/W Revision	Prior to A.11.00

Trace (+State)

The Recall Trace (+State) menu lets you choose a register or file from which to recall the Trace+State state file.

A saved state contains all of the settings and data required to return the analyzer as closely as possible to the exact setup it had when the save occurred. This includes the Input/Output settings, even though they are outside of the Mode's state, because they are needed to restore the complete setup. A Trace+State file also includes trace data from one trace or all traces, which will load in View mode when the Trace+State file is recalled. Recall Trace (+State) will also cause a mode switch if the state being recalled is not for the current active mode.

After the recall completes, the message "File <filename> recalled" or "Recalled Trace Register <register number>" is displayed.

For rapid recalls, the Trace (+State) menu lists 5 registers to choose from to recall. Pressing a Register key initiates the recall. You can also select a file from which to recall.

The default path for all State Files including .trace files is:

My Documents\<<mode name>\state

where <mode name> is the parameter used to select the mode with the INST:SEL command (for example, SA for the Spectrum Analyzer).

Key Path	Recall
Mode	SA
Remote Command	:MMEMory:LOAD:TRACe TRACE1 TRACE2 TRACE3 TRACE4 TRACE5 TRACE6,<filename> :MMEMory:LOAD:TRACe:REGister TRACE1 TRACE2 TRACE3 TRACE4 TRACE5 TRACE6,<integer>
Example	MMEM:LOAD:TRAC TRACE2, "MyTraceFile.trace" This loads the trace file data (on the default file directory path) into the specified trace; if it is a "single trace" save file, that trace is loaded to trace 2, and is set to be not updating. :MMEM:LOAD:TRAC:REG TRACE1,2 restores the trace data in register 2 to Trace 1
Notes	When you perform the recall, the recalling Trace function must first verify the file is recallable in this instrument by checking instrument software version and model number, since it includes State. If everything matches, a full recall proceeds by aborting the currently running measurement, and loading the state from the saved state file to as close as possible to the context in which the save occurred. You can open .trace files from any mode that supports them, so recalling a Trace file switches to the mode that was active when the save occurred. After switching to the mode of the saved state file, mode settings and data (if any for the mode) are loaded with values from the saved file and the saved measurement of the mode becomes the newly active measurement, and the data relevant to the measurement (if there is any) is recalled. Once the state is loaded, the trace data must be loaded. The internal flags are consulted to see which trace to load and the "To Trace" setting to see where to load it. Trace data is always loaded with the specified trace set to View, so that the data is visible and not updating (so as not to erase the recalled data). If the file is an "all trace" file, all traces are loaded with the saved data (to the original trace the data was saved from) and set to View. Traces whose data is not loaded are restored to the update state that existed when they were saved. After the Recall the analyzer exits the Recall menu and returns to the previous menu. Some modes and measurements do not have available all 6 traces. Phase Noise mode command, for example, is: MMEMory:LOAD:TRACe TRACE1 TRACE2 TRACE3,<filename> Some modes and measurements have more than 6 traces available. The Realtime SA mode command, for example, is: MMEMory:STORe:TRACe TRACE1 TRACE2 TRACE3 TRACE4 TRACE5 TRACE6 TRACE7 TRACE8 TRACE9 TRACE10 TRACE11 TRACE12 ALL,<filename>
Initial S/W Revision	Prior to A.02.00

To Trace

These menu selections let you choose the Trace where the recalled saved trace will go. Not all modes have the full 6 traces available. The default is the currently selected trace, selected in this menu or in the Trace/Detector, Export Data, Import Data, or Save Trace menus, except if you have chosen All, then it remains chosen until you specifically change it to a single trace.

If the .trace file is an "all trace" file, "To Trace" is ignored and the traces each go back to the trace from which they were saved.

Once selected, the key returns back to the Recall Trace menu and the selected Trace number is annotated on the key. Now you have selected exactly where the

trace needs to be recalled. To trigger a recall of the selected Trace, you must select the **Open** key in the Recall Trace menu.

When you select a trace, it makes that trace the current trace, so it displays on top of all of the other traces.

Key Path	Save, Data, Trace
Mode	SA
Initial S/W Revision	Prior to A.02.00

Register 1 thru Register 16

Selecting any one of these register keys causes the State of the mode from the specified Register to be recalled. Each of the register keys annotates whether it is empty or at what date and time it was last modified. In addition, you can use the **Edit Register Names** key under **Save, State** to enter custom names for each register.

Registers are shared by all modes, so recalling from any one of the registers will cause a mode switch to the mode that was active when the save to the Register occurred.

Although these 16 registers are the only registers available from the front panel, there are 128 state registers available in the instrument. Registers 17-128 are only available from the SCPI interface, using the *RCL command.

After the recall completes, the message "Register <register number> recalled" appears in the message bar. If you are in the Spectrum Analyzer Mode, and you are recalling a register that was saved in the Spectrum Analyzer Mode, then after the recall, you will still be in the Recall Register menu. If the Recall causes you to switch modes, then after the Recall, you will be in the Frequency menu.

If a requested register is empty an error is generated.

Key Path	Recall, State
Example	*RCL 1
Range	1-16 from front panel, 1-128 from SCPI
Readback	Date and time with seconds resolution are displayed on the key OR A custom name of up to 30 characters entered using the Save, State, Edit Register Names key OR “(empty)” if no prior save operation has been performed to this register.
Initial S/W Revision	Prior to A.02.00
Modified at S/W Revision	Prior to A.11.00

From File...

When you press “From File”, the analyzer brings up a Windows dialog and a menu entitled “**File Open.**” This menu allows you to navigate to the various fields in the

Windows dialog without using a keyboard or mouse. The **Tab** and **Arrow** keys can also be used for dialog navigation.

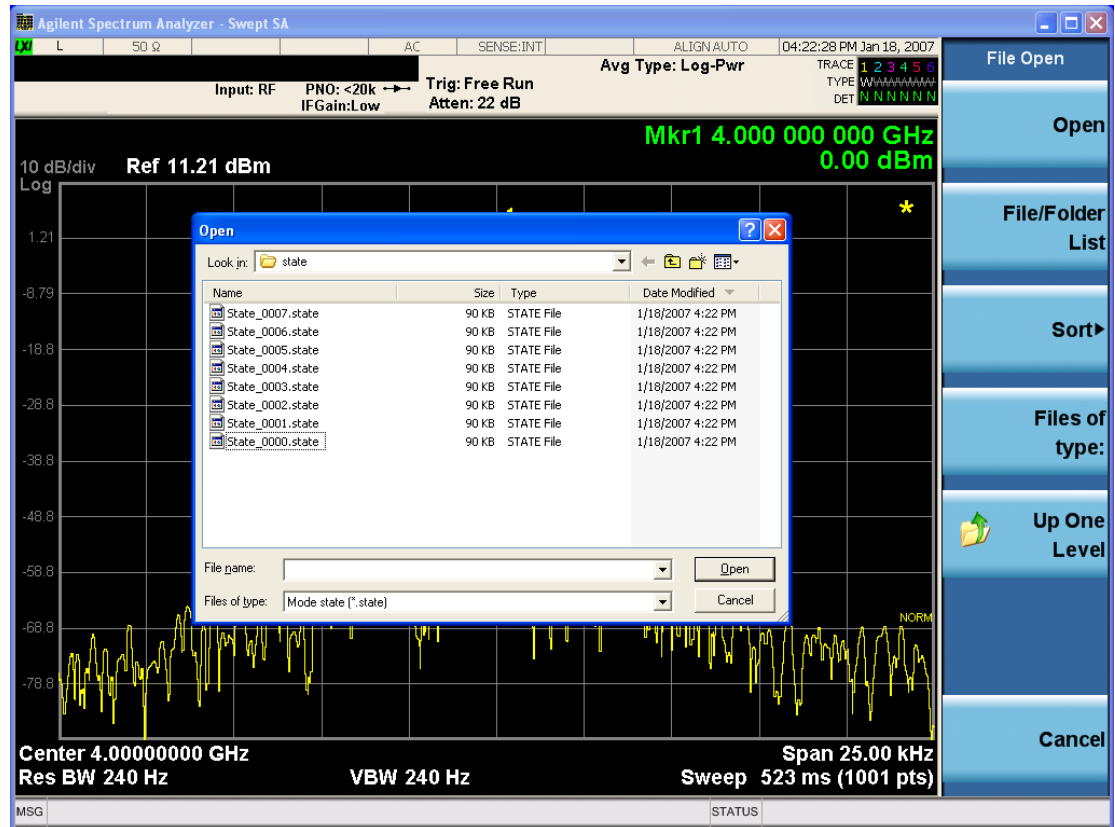

Listed below are the functions of the various fields in the dialog, and the corresponding softkeys:

Open

Performs the recall of the specified file. While the recall is being performed, the floppy icon appears briefly in the Meas bar.

File/Folder List

Enables you to navigate to the center of the dialog that contains the list of files and folders. Once here you can get information about the file and use the tab keys to navigate to the other fields in the dialog, such as Look In.

Look In

The **Look In** field shows the path from which the file will be recalled and allows you to change the path using the up and down arrow keys to navigate to other paths; the Enter key to open a directory; and the Backspace key to go back one directory. The **Look In** field first uses the last path from the Save As dialog **Save In**: path for that same file type. There is no softkey for directly navigating to the Look In field, but you can use the left tab to get here from the File/Folder List.

User specified paths are remembered when you leave and return to a Mode and are reset back to the default using **Restore Mode Defaults**.

Sort

Accesses a menu that enables you to sort the files within the File Open dialog. Only one sorting type can be selected at a time and the sorting happens immediately. The sorting types are **By Date**, **By Name**, **By extension**, and **By Size**.

Files of Type

This field shows the file suffix for the type of file you have selected to recall. For example, if you navigated here while recalling State, "Mode state (*.state)" is in the field. If you navigated here while recalling Trace, "Mode state (*.trace)" is in the field. If you navigated here while importing a trace data file, "Trace Data (*.csv)" is in the field. For some file types, there is more than one choice in the dropdown menu, which you can select by using the up and down arrow keys and Enter.

Up One Level

This key corresponds to the icon of a folder with the up arrow that is in the tool bar of the dialog. When pressed, it causes the file and folder list to navigate up one level in the directory structure. The Backspace key does the same thing.

Cancel

This key corresponds to the **Cancel** selection in the dialog. It causes the current **Open** request to be cancelled. The ESC key does the same thing.

Key Path	Recall, State
Notes	Brings up the Open dialog for recalling a State Save Type
Initial S/W Revision	Prior to A.02.00

Data (Import)

Importing a data file loads data that was previously saved from the current measurement or from other measurements and/or modes that produce compatible data files. The Import Menu only contains Data Types that are supported by the current measurement.

Since the commonly exported data files are in .csv format, the data can be edited by the user prior to importing. This allows you to export a data file, manipulate the data in Excel (the most common PC Application for manipulating .csv files) and then import it.

Importing Data loads measurement data from the specified file into the specified or default destination, depending on the data type selected. Selecting an Import Data menu key will not actually cause the importing to occur, since the analyzer still needs to know from where to get the data. Pressing the Open key in this menu brings up the Open dialog and Open menu that provides you with the options from where to recall the data. Once a filename has been selected or entered in the Open menu, the recall occurs as soon as the Open button is pressed.

Key Path	Recall
----------	---------------

Mode	All
Notes	The menu is built from whatever data types are available for the mode. Some keys will be missing completely, so the key locations in the sub-menu will vary. No SCPI command directly controls the Data Type that this key controls. The Data Type is included in the MMEM:LOAD commands.
Dependencies	If a file type is not used by a certain measurement, it is grayed out for that measurement. The key for a file type will not show at all if there are no measurements in the Mode that support it.
Preset	Is not affected by Preset or shutdown, but is reset during Restore Mode Defaults
Readback	The data type that is currently selected
Initial S/W Revision	Prior to A.02.00

Amplitude Correction

This key selects the Amplitude Corrections as the data type to be imported. When pressed a second time, it brings up the Select Menu, which lets you select the Correction into which the data will be imported.

Amplitude Corrections are fully discussed in the documentation of the Input/Output key, under the Corrections key.

A set of preloaded Corrections files can be found in the directory

/My Documents/ EMC Limits and Ampcor.

When the Amplitude Correction is an Antenna correction and the Antenna Unit in the file is not **None**, the Y Axis Unit setting will change to match the Antenna Unit in the file.

Key Path	Recall
Mode	SA EDGE GSM PN
Remote Command	:MMEMory:LOAD:CORRection 1 2 3 4 5 6 7 8, <filename>
Example	:MMEM:LOAD:CORR 2, "myAmpcor.csv" recalls the Amplitude Correction data from the file myAmpcor.csv in the current directory to the 2nd Amplitude Correction table, and turns on Correction 2. The default path is D:\Users\Instrument\My Documents\amplitudeCorrections\
Dependencies	Only the first correction array (Correction 1) supports antenna units. This means that a correction file with an Antenna Unit can only be loaded into the Corrections 1 register. Consequently only for Correction 1 does the dropdown in the Recall dialog include.ant, and if an attempt is made to load a correction file into any other Correction register which DOES contain an antenna unit, a Mass Storage error is generated. Corrections are not supported by all Measurements. If in a Mode in which some Measurements support it, this key will be grayed out in measurements that do not. The key will not show at all if no measurements in the Mode support it. Errors are reported if the file is empty or missing, or if the file type does not match, or if there is a mismatch between the file type and the destination data type. If any of these occur during manual operation, the analyzer returns to the Import Data menu and the File Open dialog goes away. This key does not appear unless you have the proper option installed in your instrument.

	This command will generate an “Option not available” error unless you have the proper option installed in your instrument.
Couplings	When a correction file is loaded from mass storage, it is automatically turned on (Correction ON) and ApplyCorrections is set to On. This allows you to see its effect, thus confirming the load.
Readback	selected Correction
Backwards Compatibility SCPI	:MMEMory:LOAD:CORRection ANTenna CABLe OTHer USER, <filename> For backwards compatibility, ANTenna maps to 1, CABLe maps to 2, OTHer maps to 3 and USER maps to 4
Initial S/W Revision	A.02.00

Amplitude Correction

These keys let you select which Correction to import the data into. Once selected, the key returns back to the Import Data menu and the selected Correction number is annotated on the key. The next step is to select the Open key in the Import Data menu.

Antenna corrections are a particular kind of Amplitude Corrections – they are distinguished in the corrections file by having the Antenna Unit set to a value other than None. Only Correction 1 supports Antenna Units.

Key Path	Recall, Data, Amplitude Correction
Notes	auto return
Dependencies	Only Correction 1 may be used to load a Correction that contains an Antenna Unit other than None
Preset	Not part of Preset, but is reset to Correction 1 by Restore Input/Output Defaults; survives shutdown.
State Saved	The current Correction number is saved in instrument state
Initial S/W Revision	A.02.00

Trace

This key selects Trace as the data type to be imported. When pressed a second time, it brings up the Trace Menu, which lets you select the Trace into which the data will be imported.

The trace file contains “meta” data which describes the state of the analyzer when the trace was exported (see ["Trace File Contents" on page 3216](#)). If the meta data in the file does not match the current SA state, the “invalid data indicator” (*) is displayed.

Key Path	Recall, Data
----------	---------------------

Remote Command	:MMEMory:LOAD:TRACe:DATA TRACE1 TRACE2 TRACE3 TRACE4 TRACE5 TRACE6,<filename>
Example	:MMEM:LOAD:TRAC DATA TRACE2, "myTrace2.csv" Imports the 2nd trace from the file myTrace2.csv in the current path. The default path is My Documents\SA\data\traces
Dependencies	For SA measurements, a trace cannot be recalled from a trace file that was exported with ALL traces selected. A trace cannot be imported if the number of trace points in the file do not match the number of sweep points currently set for the measurement. If this happens, an error message is generated. Errors are reported if the file is empty or missing, or if the file type does not match, or if there is a mismatch between the file type and the destination data type. If any error occurs while trying to load a file manually (as opposed to during remote operation), the analyzer returns to the Import Data menu and the File Open dialog goes away.
Couplings	When a trace is imported, Trace Update is always turned OFF for that trace and Trace Display is always turned ON.
Readback	Selected Trace
Status Bits/OPC dependencies	Sequential - aborts the current measurement.
Initial S/W Revision	Prior to A.02.00

Select Trace

These keys let you pick the Trace into which to import the data; either 1, 2, 3, 4, 5 or 6. The default is the currently selected trace, selected in this menu or in the Trace/Det, Export Data, Recall Trace, or Save Trace menus; except if you have chosen **All** then **All** remains chosen until you specifically change it to a single trace.

Once selected, the key returns back to the Import Data menu and the selected Trace number is annotated on the key. The next step is to select the Open key in the Import Data menu.

Key Path	Recall, Data, Trace
Notes	Auto return
Couplings	When you select the trace into which to import the data, it makes that trace the current trace, so it displays on top of all of the other traces.
Preset	Not part of Preset, but is reset to TRACE1 by Restore Mode Defaults; survives shutdown
State Saved	The current trace number is saved in State
Initial S/W Revision	Prior to A.02.00

Limit

This key selects Limit Lines as the data type to be imported. When pressed a second time, it brings up the Limits Menu, which lets you select into which Limit the data will be imported.

A set of preloaded Limits files can be found in the directory
/My Documents/ EMC Limits and Ampcor.

Under this directory, the directory called Limits (Legacy Naming) contains a set of legacy limits, generally the same files that were supplied with older Agilent EMC analyzers, that use the legacy suffix .lim, and the old 8-character file names. In the directory called Limits, the same files can be found, with the same suffix, but with longer, more descriptive filenames.

Key Path	Recall, Data
Remote Command	:MMEMory:LOAD:LIMit LLINE1 LLINE2,<filename>
Example	:MMEM:LOAD:LIM LLINE2, "myLimitLine2.csv" Imports the 2nd Limit Line from the file myLimitLine2.csv in the current path. The default path is My Documents\SA\data\limits
Dependencies	Errors are reported if the file is empty or missing, or if the file type does not match, or if there is a mismatch between the file type and the destination data type. If any of these occur during manual operation, the analyzer returns to the Import Data menu and the File Open dialog goes away. This key will only appear if you have the proper option installed in your instrument.
Couplings	When a limit line is loaded from mass storage, it is automatically turned on. This allows the user to see it, thus confirming the load. The Margin settings will match those when the limit was saved The instrument cannot mix Limits domains (X Axis Unit must be Frequency or Time for both Limits). So when a Limits file is loaded, the analyzer will set the Limits domain (X Axis Unit) to match that of the file. If this changes the Limits domain from what it was before the file was loaded, all Limits data in all Limits sets will be erased before the data loads. If this operation is over the remote interface there will be no warning if this occurs, so care should be taken to know the domain of the file you are loading.
Readback	Selected Limit Line
Status Bits/OPC dependencies	Sequential - aborts the current measurement
Initial S/W Revision	A.02.00

Limit Selection

These keys let you pick which Limit Line to import the data into; either 1, 2, 3, 4, 5 or 6. The default is the currently selected limit. Once selected, the key returns back to the Import Data menu and the selected Limit Line number is annotated on the key. Now you have selected exactly what needs to be imported. In order to trigger an import of the selected Limit Line, you must select the Open key in the Import Data menu.

An example of using this menu is: If you select 2 and continue to the File Open menu, Limit Line 2 will be imported from the file selected or entered in File Name option in the File Open dialog.

Key Path	Recall, Data, Limit Line
Notes	Auto return
Preset	Not part of Preset, but is reset to LLINE1 by Restore Mode Defaults; survives a shutdown.
State Saved	The selected limit number is saved in instrument state
Initial S/W Revision	A.02.00

Open...

When you press “Open”, the analyzer brings up a Windows dialog and a menu entitled “**File Open.**” This menu allows you to navigate to the various fields in the Windows dialog without using a keyboard or mouse. The **Tab** and **Arrow** keys can also be used for dialog navigation.

See "[From File...](#)" on page 3210 in **Recall, State**, for a full description of this dialog and menu.

Key Path	Recall, Data
Notes	The key location is mode-dependent and will vary. Brings up Open dialog for recalling a <mode specific> Save Type
Initial S/W Revision	Prior to A.02.00

Restart

The Restart function restarts the current sweep, or measurement, or set of averaged/hold sweeps or measurements. If you are Paused, pressing Restart does a Resume.

The Restart function is accessed in several ways:

- Pressing the Restart key
- Sending the remote command INIT:IMMEDIATE
- Sending the remote command INIT:RESTART

See ["More Information" on page 3002](#)

Key Path	Front-panel key
Remote Command	:INITiate[:IMMEDIATE] :INITiate:RESTART
Example	:INIT:IMM :INIT:REST
Notes	:INITiate:RESTART and :INITiate:IMMEDIATE perform exactly the same function.
Couplings	Resets average/hold count k. For the first sweep overwrites all active (update=on) traces with new current data. For application modes, it resets other parameters as required by the measurement.
Status Bits/OPC dependencies	This is an Overlapped command. The STATus:OPERation register bits 0 through 8 are cleared. The STATus:QUESTionable register bit 9 (INTegrity sum) is cleared. The SWEEPING bit is set. The MEASURING bit is set.
Backwards Compatibility Notes	For Spectrum Analysis mode in ESA and PSA, the Restart hardkey and the INITiate:RESTART command restart trace averages (displayed average count reset to 1) for a trace in Clear Write , but did not restart Max Hold and Min Hold . In the X-Series, the Restart hardkey and the INITiate:RESTART command restart not only Trace Average , but MaxHold and MinHold traces as well. For wireless comms modes in ESA and PSA, the Restart hardkey and the INITiate:RESTART command restart every measurement, which includes all traces and numeric results. There is no change to this operation.
Initial S/W Revision	Prior to A.02.00

More Information

The **Restart** function first aborts the current sweep/measurement as quickly as possible. It then resets the sweep and trigger systems, sets up the measurement

and initiates a new data measurement sequence with a new data acquisition (sweep) taken once the trigger condition is met.

If the analyzer is in the process of aligning when **Restart** is executed, the alignment finishes before the restart function is performed.

Even when set for Single operation, multiple sweeps may be taken when Restart is pressed (for example, when averaging/holding is on). Thus when we say that **Restart** "restarts a measurement," we may mean:

- It restarts the current sweep
- It restarts the current measurement
- It restarts the current set of sweeps if any trace is in Trace Average, Max Hold or Min Hold
- It restarts the current set of measurements if Averaging, or Max Hold, or Min Hold is on for the measurement
- depending on the current settings.

With **Average/Hold Number** (in **Meas Setup** menu) set to 1, or Averaging off, or no trace in Trace Average or Hold, a single sweep is equivalent to a single measurement. A single sweep is taken after the trigger condition is met; and the analyzer stops sweeping once that sweep has completed. However, with **Average/Hold Number** > 1 and at least one trace set to **Trace Average**, **Max Hold**, or **Min Hold (SA Measurement)** or **Averaging on (most other measurements)**, multiple sweeps/data acquisitions are taken for a single measurement. The trigger condition must be met prior to each sweep. The sweep is stopped when the average count k equals the number N set for **Average/Hold Number**. A measurement average usually applies to all traces, marker results, and numeric results; but sometimes it only applies to the numeric results.

Once the full set of sweeps has been taken, the analyzer will go to idle state. To take one more sweep without resetting the average count, increment the average count by 1, by pressing the step up key while **Average/Hold Number** is the active function, or sending the remote command `CALC:AVER:TCON UP`.

Save

The **Save** menu lets you choose what you want to save and where you want to save it. Among the types of files you can save are **States**, **Traces**, and **Screen Images**. In addition, an **Export (Data)** option lets you save a number of data types as CSV files for easy import into Excel and other spreadsheet programs.

Key Path	Front-panel key
Mode	All
Notes	No remote command for this key specifically, but the :MMEM:STORe command is available for specific file types. An example is :MMEM:STOR:STATe <filename>.
Initial S/W Revision	Prior to A.02.00

State

The Save State menu lets you choose a register or file for saving the state.

The content of a state file includes all of the settings and data required to return the analyzer as closely as possible to the Mode it was in, with the exact settings which were in place, when the save occurred. The Mode settings in each state file include the settings that are affected by Mode Preset, as well as the additional settings affected by Restore Mode Defaults; all of the Mode's settings. In addition, all of the settings of the **Input/Output** system are included, even though they are outside of the Mode's state, because they are needed to restore the complete setup. Persistent **System** settings (for example, Verbose SCPI) are not affected by either Mode Preset or Restore Mode Defaults, nor are they included in a saved State file.

After the save completes, the message "File <filename> saved" or "State Register <register number> saved" is displayed.

For rapid saving, the State menu lists 16 registers to save to. Pressing a Register key initiates the save. You can also select a file to save to.

The default path for all State Files is:

My Documents\<<mode name>\state

where <mode name> is the parameter used to select the mode with the INST:SEL command (for example, SA for the Spectrum Analyzer).

Key Path	Save
Mode	All
Remote Command	:MMEMory:STORe:STATe <filename>
Example	MMEM:STOR:STATe "MyStateFile.state" This stores the current instrument state data in the file MyStateFile.state in the default directory.
Notes	Both single and double quotes are supported for any filename parameter over remote. After saving to a register, that register's menu key is updated with the date the time, unless a

	custom label has been entered for that key. After saving to a register, you remain in the Save State menu, so that you can see the Register key update. After saving to a file, the analyzer automatically returns to the previous menu and any Save As dialog goes away.
Backwards Compatibility SCPI	:MMEMory:STORe:STATe 1,<filename> For backwards compatibility, the above syntax is supported. The "1" is simply ignored. The command is sequential.
Initial S/W Revision	Prior to A.02.00

To File . . .

When you press "To File", the analyzer brings up a Windows dialog and a menu entitled "**Save As.**" This menu allows you to navigate to the various fields in the Windows dialog without using a keyboard or mouse. The **Tab** and **Arrow** keys can also be used for dialog navigation.

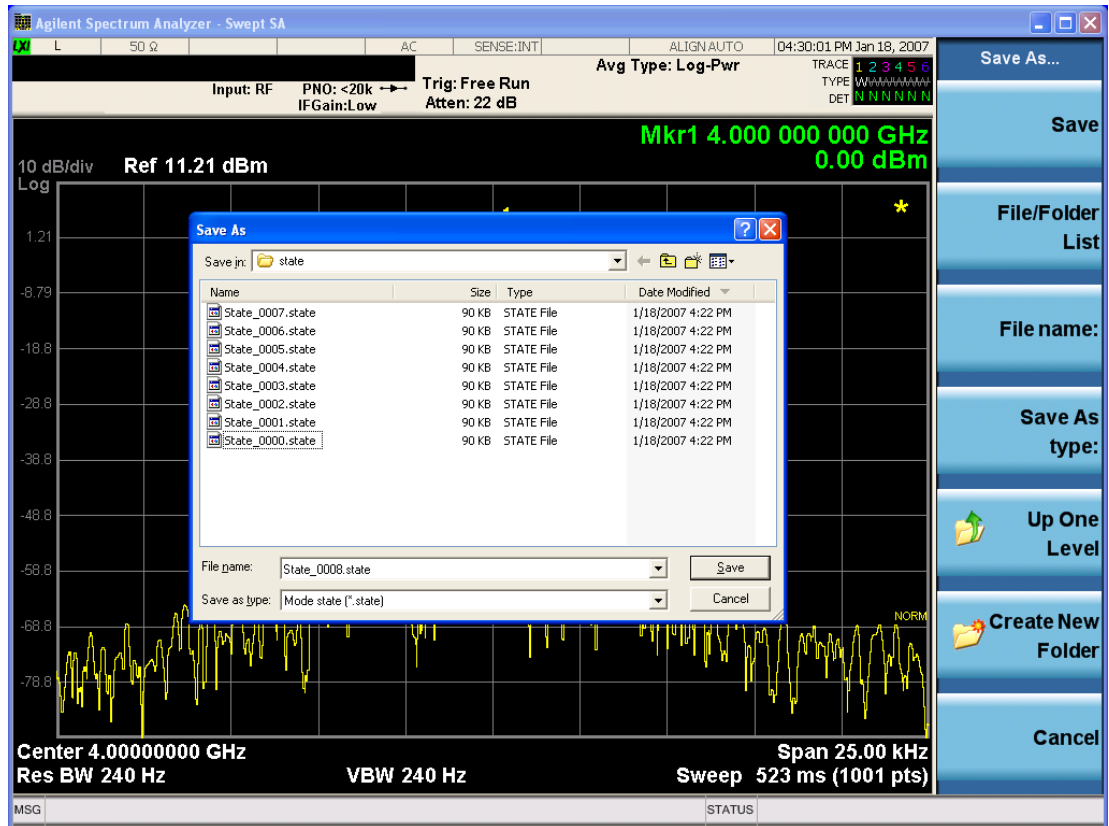

The Listed below are the functions of the various fields in the dialog, and the

corresponding softkeys:

Save

Performs the save to the specified file of the selected type. If the file already exists, a dialog will appear that allows you to replace the existing file by selecting **OK**, or you can Cancel the request. If you select OK, the file will be overwritten. Using the C: drive is strongly discouraged, since it runs the risk of being overwritten during an instrument software upgrade.

While the save is being performed, the floppy icon appears briefly in the Meas bar.

File/Folder List

Enables you to navigate to the center of the dialog that contains the list of files and folders. Once here you can get information about the file and use the tab keys to navigate to the other fields in the dialog, such as Save In.

Save In

The Save In field shows the path to which the file will be saved and allows you to change the path using the up and down arrow keys to navigate to other paths; the Enter key to open a directory; and the Backspace key to go back one directory. The **Save In field** defaults to the default path for this type of file and remembers the last path you used to save this type of file. There is no softkey for directly navigating to the Save In field but you can use left tab to get here from the File/Folder List.

User specified paths are remembered when you leave and return to a Mode and are reset back to the default using **Restore Mode Defaults**.

File Name

The **File Name** field is initially loaded with an automatically generated filename specific to the appropriate Save Type. The automatically generated filename is guaranteed not to conflict with any filename currently in the directory. You may replace or modify this filename using the File Name key. See the ["Quick Save " on page 3181](#) documentation for more on the automatic file naming algorithm.

When you press the **File Name** key the analyzer displays the Alpha Editor. Use the knob to choose the letter to add and the front-panel Enter key to add the letter to the file name. The BK character moves you back and the FW character moves you forward in the filename. The Select key on the front panel generates a space character. When you are done entering the filename press the **Done** softkey. This returns back to the **File Open** dialog and menu, but does not cause the save to occur.

Save As Type

This field shows the file suffix for the type of file you have selected to save. For example, if you navigated here while saving State, "Mode state (*.state)" is in the field. If you navigated here from saving Trace, ""Mode state (*.trace)" is in the field. If you navigated here while exporting a trace data file, "Trace Data (*.csv)" is in the field. For some file types, there is more than one choice in the dropdown, which you can select by using the up and down arrow keys and Enter.

Up One Level

This key corresponds to the icon of a folder with the up arrow that is in the tool bar of the dialog. When pressed, it causes the file and folder list to navigate up one level in the directory structure. The Backspace key does the same thing.

Create New Folder

This key corresponds to the icon of a folder with the "*" that is in the tool bar of the dialog. When pressed, a new folder is created in the current directory with the name **New Folder** and you can enter a new folder name using the Alpha Editor.

Cancel

This key corresponds to the **Cancel** selection in the dialog. It causes the current **Save As** request to be cancelled. The ESC key does the same thing.

Key Path	Save, State
Mode	All
Notes	Brings up Save As dialog for saving a State Save Type
Initial S/W Revision	Prior to A.02.00

Edit Register Names

You may enter a custom name on any of the Register keys, to help you remember what you are using that state to save. To do this, press the **Edit Register Names** key, choose the register whose name you wish to edit, and then enter the desired label using the Alpha Editor or an external PC keyboard.

The maximum number of characters that can be added is 30. In most cases, 30 characters will fit on two lines of the key.

See ["More Information" on page 3009](#)

Key Path	Save, State
Mode	All
Remote Command	:MMEMory:REGiSTER:STATe:LABeL <reg number>,"label" :MMEMory:REGiSTER:STATe:LABeL? <reg number>
Example	:MMEM:REG:STAT:LAB 1,"my label"
Notes	<reg number> is an integer from 1 to 16. If the SCPI specifies an invalid register number an error message is generated, -222,"Data out of range;Invalid register label number" "label" is a string from 0 to 30 characters in length. If a label exceeds 30 characters, an error message is generated, -150,"String data error;Label clipped to 30 characters" "label" of length 0 erases the custom label and restores the default (time and date) label. E.g.: :MMEM:REG:STAT:LAB 1,""
Dependencies	N9060A-7FP or N9060B-2FP license required to edit the register names. When the feature is not licensed, sending this command generates an error, -221,"Settings conflict;Option not available"
Preset	The names are unaffected by Preset or power cycle but are set to the default label (time and date) on a "Restore System Defaults->Misc"
Initial S/W Revision	A.11.00

More Information

When you edit one of the register names, the time and date field will be replaced by the custom name.

If you delete all the characters in the custom name, it restores the default (time and date).

The register names are stored within the state files, but they are not part of the instrument state; that is, once you have edited a register name, loading a new state will not change that register name. Another consequence of this is that the names will be persistent through a power cycle. Also, if a named state file is transferred to another analyzer, it will bring its custom name along with it.

If you try to edit the name of an empty register, the analyzer will first save the state to have a file to put the name in. If you load a named state file into an analyzer with older firmware it will ignore the metadata.

The *SAV and *RCL commands will not be affected by the custom register names, nor will the MMEM commands.

Register 1 thru Register 16

Selecting any one of these register menu keys causes the State of the currently active mode to be saved to the specified Register. The registers are provided for rapid saving and recalling, since you do not need to specify a filename or navigate to a file. Each of the register menu keys annotates whether it is empty or at what date and time it was last modified. In addition, you can use the **Edit Register Names** key to enter custom names for each register.

Although these 16 registers are the only registers available from the front panel, there are 128 state registers available in the instrument. Registers 17-128 are only available from the SCPI interface, using the *SAV command.

There is one set of 128 state registers in the instrument, not one set for each Mode. When a state is saved, the Mode it was saved from is saved with it; then when it is recalled, the instrument switches to that Mode.

After the save completes, the corresponding register menu key annotation is updated with the date and time and the message "Register <register number> saved" is displayed.

Key Path	Save, State
Mode	All
Example	*SAV 1
Range	1-16 from front panel, 1-128 from SCPI
Readback	Date and time with seconds resolution are displayed on the key OR A custom name of up to 30 characters entered using the Edit Register Names key OR “(empty)” if no prior save operation has been performed to this register.

Initial S/W Revision	Prior to A.02.00
Modified at S/W Revision	A.11.00

Register 1 thru Register 16

Selecting any one of these register menu keys causes the State of the currently active mode to be saved to the specified Register. The registers are provided for rapid saving and recalling, since you do not need to specify a filename or navigate to a file. Each of the register menu keys annotates whether it is empty or at what date and time it was last modified. In addition, you can use the **Edit Register Names** key to enter custom names for each register.

Although these 16 registers are the only registers available from the front panel, there are 128 state registers available in the instrument. Registers 17-128 are only available from the SCPI interface, using the *SAV command.

There is one set of 128 state registers in the instrument, not one set for each Mode. When a state is saved, the Mode it was saved from is saved with it; then when it is recalled, the instrument switches to that Mode.

After the save completes, the corresponding register menu key annotation is updated with the date and time and the message "Register <register number> saved" is displayed.

Key Path	Save, State
Mode	All
Example	*SAV 1
Range	1-16 from front panel, 1-128 from SCPI
Readback	Date and time with seconds resolution are displayed on the key OR A custom name of up to 30 characters entered using the Edit Register Names key OR “(empty)” if no prior save operation has been performed to this register.
Initial S/W Revision	Prior to A.02.00
Modified at S/W Revision	A.11.00

Trace (+State)

The **Save Trace (+State)** menu lets you choose a register or file specifying where to save the Trace+State state file.

A saved state contains all of the settings and data required to return the analyzer as closely as possible to the exact setup it had when the save occurred. This includes the Input/Output settings, even though they are outside of the Mode's state, because they are needed to restore the complete setup. A Trace+State file also

includes trace data from one trace or all traces, which will load in View mode when the Trace+State file is recalled.

After the save completes, the message "File <filename> saved" or "Trace Register <register number> saved" is displayed.

For rapid saves, the Trace (+State) menu lists 5 registers to save to. Pressing a Register key initiates the save. You can also select a file to save to.

The default path for all State Files including .trace files is:

My Documents\<mode name>\state

where <mode name> is the parameter used to select the mode with the INST:SEL command (for example, Basic for the IQAnalyzer).

This key is grayed out for measurements that do not support trace saves. It is blanked for modes that do not support trace saves. Saving **Trace** is identical to saving State except a .trace extension is used on the file instead of .state, and internal flags are set in the file indicating which trace was saved. You may select to save one trace or ALL traces.

Key Path	Save
Mode	SA
Remote Command	:MMEMory:STORe:TRACe TRACE1 TRACE2 TRACE3 TRACE4 TRACE5 TRACE6 ALL,<filename> :MMEMory:STORe:TRACe:REGister TRACE1 TRACE2 TRACE3 TRACE4 TRACE5 TRACE6 ALL,<integer>
Example	:MMEM:STOR:TRAC TRACE1, "myState.trace" saves the file myState.trace on the default path and flags it as a "single trace" file with Trace 1 as the single trace (even though all of the traces are in fact stored). :MMEM:STOR:TRAC ALL, "myState.trace" saves the file myState.trace on the default path and flags it as an "all traces" file :MMEM:STOR:TRAC:REG TRACE1, 2 stores trace 1 data in trace register 2
Notes	This command actually performs a save state, which in the Swept SA measurement includes the trace data. However it flags it (in the file) as a "save trace" file of the specified trace (or all traces). Some modes and measurements do not have available all 6 traces. The Phase Noise mode command, for example, is: MMEMory:STORe:TRACe TRACE1 TRACE2 TRACE3 ALL,<filename> Some modes and measurements have more than 6 traces available. The Realtime SA mode command, for example, is: MMEMory:STORe:TRACe TRACE1 TRACE2 TRACE3 TRACE4 TRACE5 TRACE6 TRACE7 TRACE8 TRACE9 TRACE10 TRACE11 TRACE12 ALL,<filename> The range for the register parameter is 1-5 When you initiate a save, if the file already exists, a dialog will appear that allows you to replace the existing file by selecting OK or you can Cancel the request. If you select OK, the file will be overwritten. Using the C: drive is strongly discouraged, since it runs the risk of being overwritten during an instrument software upgrade. Both single and double quotes are supported for any filename parameter over remote. After saving to a register, that register's menu key is updated with the date and time of the save. After saving to a register, you remain in the Save Trace menu, so that you can see the Register

key update. After saving to a file, the analyzer automatically returns to the previous menu and any Save As dialog goes away.

Initial S/W Revision Prior to A.02.00

Register 1 thru Register 16

Selecting any one of these register menu keys causes the State of the currently active mode to be saved to the specified Register. The registers are provided for rapid saving and recalling, since you do not need to specify a filename or navigate to a file. Each of the register menu keys annotates whether it is empty or at what date and time it was last modified. In addition, you can use the **Edit Register Names** key to enter custom names for each register.

Although these 16 registers are the only registers available from the front panel, there are 128 state registers available in the instrument. Registers 17-128 are only available from the SCPI interface, using the *SAV command.

There is one set of 128 state registers in the instrument, not one set for each Mode. When a state is saved, the Mode it was saved from is saved with it; then when it is recalled, the instrument switches to that Mode.

After the save completes, the corresponding register menu key annotation is updated with the date and time and the message "Register <register number> saved" is displayed.

Key Path	Save, State
Mode	All
Example	*SAV 1
Range	1-16 from front panel, 1-128 from SCPI
Readback	Date and time with seconds resolution are displayed on the key OR A custom name of up to 30 characters entered using the Edit Register Names key OR “(empty)” if no prior save operation has been performed to this register.
Initial S/W Revision	Prior to A.02.00
Modified at S/W Revision	A.11.00

From Trace

Accesses a menu that enables you to select the trace to be saved. Once a trace is selected, the key returns to the Save Trace menu and the selected trace number is annotated on the key. The default is the currently selected trace, selected in this menu or in the Trace/Det, Export Data, Import Data or Recall Trace menus, except if you have chosen All then it remains chosen until you specifically change it to a single trace. To save the Trace you must select the **Save As** key in the Save Trace menu.

When you select a trace, it makes that trace the current trace, so it displays on top of all of the other traces.

Key Path	Save, Trace + State
Mode	SA
Initial S/W Revision	Prior to A.02.00

From File...

When you press “From File”, the analyzer brings up a Windows dialog and a menu entitled “File Open.” This menu allows you to navigate to the various fields in the Windows dialog without using a keyboard or mouse. The **Tab** and **Arrow** keys can also be used for dialog navigation.

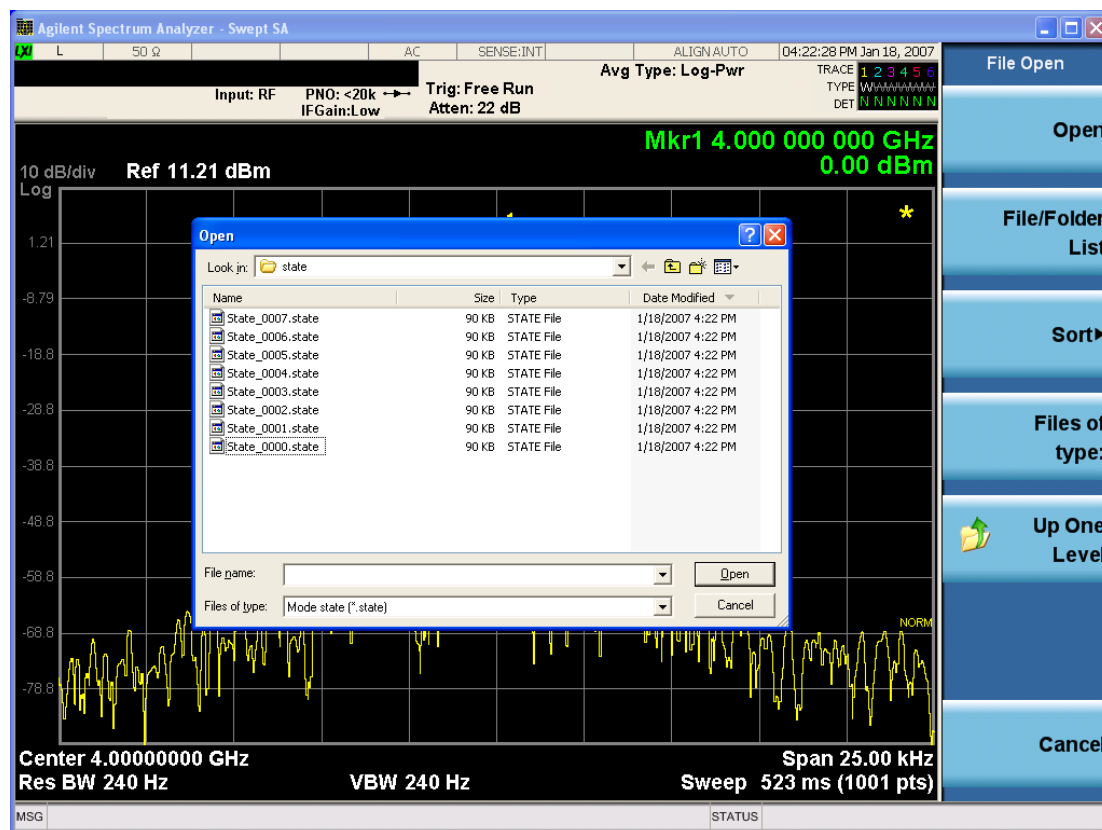

Listed below are the functions of the various fields in the dialog, and the corresponding softkeys:

Open

Performs the recall of the specified file. While the recall is being performed, the floppy icon appears briefly in the Meas bar.

File/Folder List

Enables you to navigate to the center of the dialog that contains the list of files and folders. Once here you can get information about the file and use the tab keys to navigate to the other fields in the dialog, such as Look In.

Look In

The **Look In** field shows the path from which the file will be recalled and allows you to change the path using the up and down arrow keys to navigate to other paths; the Enter key to open a directory; and the Backspace key to go back one directory. The **Look In field** first uses the last path from the Save As dialog **Save In:** path for that same file type. There is no softkey for directly navigating to the Look In field, but you can use the left tab to get here from the File/Folder List.

User specified paths are remembered when you leave and return to a Mode and are reset back to the default using **Restore Mode Defaults**.

Sort

Accesses a menu that enables you to sort the files within the File Open dialog. Only one sorting type can be selected at a time and the sorting happens immediately. The sorting types are **By Date, By Name, By extension, and By Size**.

Files of Type

This field shows the file suffix for the type of file you have selected to recall. For example, if you navigated here while recalling State, "Mode state (*.state)" is in the field. If you navigated here while recalling Trace, "Mode state (*.trace)" is in the field. If you navigated here while importing a trace data file, "Trace Data (*.csv)" is in the field. For some file types, there is more than one choice in the dropdown menu, which you can select by using the up and down arrow keys and Enter.

Up One Level

This key corresponds to the icon of a folder with the up arrow that is in the tool bar of the dialog. When pressed, it causes the file and folder list to navigate up one level in the directory structure. The Backspace key does the same thing.

Cancel

This key corresponds to the **Cancel** selection in the dialog. It causes the current **Open** request to be cancelled. The ESC key does the same thing.

Key Path	Recall, State
Notes	Brings up the Open dialog for recalling a State Save Type
Initial S/W Revision	Prior to A.02.00

Data (Export)

Exporting a data file stores data from the current measurement to mass storage files. The Export Menu only contains data types that are supported by the current measurement.

Since the commonly exported data files are in .csv format, the data can be edited by you prior to importing. This allows you to export a data file, manipulate the data in Excel (the most common PC Application for manipulating .csv files) and then import it.

Selecting an Export Data menu key will not actually cause the exporting to occur, since the analyzer still needs to know where you wish to save the data. Pressing the Save As key in this menu brings up the Save As dialog and Save As menu that allows you to specify the destination file and directory. Once a filename has been selected or entered in the Open menu, the export will occur as soon as the Save key is pressed.

Key Path	Save
Mode	All
Notes	The menu is built from whatever data types are available for the mode. So the key locations in the sub menu will vary. No SCPI command directly controls the Data Type that this key controls. The Data Type is included in the MMEM:STORe commands.
Dependencies	If a file type is not used by a certain measurement, that type is grayed out for that measurement. The key for a file type will not show at all if there are no measurements in the Mode that support it.
Preset	Is not affected by a Preset or shutdown, but is reset during Restore Mode Defaults
Readback	The data type that is currently selected
Initial S/W Revision	Prior to A.02.00

Amplitude Correction

Pressing this key selects **Amplitude Corrections** as the data type to be exported. Pressing this key again brings up the Select Menu, which allows the user to select which **Amplitude Correction** to save.

Amplitude Corrections are fully discussed in the documentation of the Input/Output key, under the Corrections softkey.

See "[Correction Data File](#)" on page 3016

Key Path	Save
Remote Command	:MMEMory:STORe:CORRection 1 2 3 4 5 6, <filename>
Example	:MMEM:STOR:CORR 2 "myAmpcor.csv" saves Correction 2 to the file myAmpcor.csv on the current path. The default path is My Documents\amplitudeCorrections.
Notes	If the save is initiated via SCPI, and the file already exists, the file will be overwritten. Using the C: drive is strongly discouraged, since it runs the risk of being overwritten during an instrument software upgrade. Both single and double quotes are supported for any filename parameter over SCPI.
Dependencies	Corrections are not supported by all Measurements. If in a Mode in which some Measurements support it, this key will be grayed out in measurements that do not. The key will not show at all if no measurements in the Mode support it.

	This key will not appear unless you have the proper option installed in your instrument.
Readback	Selected Correction
Backwards Compatibility SCPI	:MMEMory:STORE:CORRection ANTenna CABLe OTHer USER, <filename> For backwards compatibility, ANTenna maps to 1, CABLe maps to 2, OTHer maps to 3 and USER maps to 4
Initial S/W Revision	A.02.00

Correction Data File

A Corrections Data File contains a copy of one of the analyzer correction tables. Corrections provide a way to adjust the trace display for predetermined gain curves (such as for cable loss).

Corrections files are text files in .csv (comma separated values) form, to make them importable into Excel or other spreadsheet programs. The format for Corrections files is as follows.

Line #	Type of field	Example	Notes
1	File type, must be "Amplitude Correction"	Amplitude Correction	May not be omitted
2	File Description (in quotes)	"Correction Factors for 11966E"	60 characters max; may be empty but may not be omitted. If exceeds 60 characters, error -233 Too much data reported
3	Comment (in quotes)	"Class B Radiated"	60 characters max; may be empty but may not be omitted. . If exceeds 60 characters, error -233 Too much data reported
4	Instrument Version, Model #	A.02.06,N9020A	May be empty but may not be omitted
5	Option List, File Format Version	K03 LFE EXM ,01	May be empty but may not be omitted
6	Freq Unit to be used for all frequency values in the file	Frequency Unit,MHz	assumed to be Hz if omitted
7	Antenna Unit	Antenna Unit,None	If omitted leaves the Antenna unit unchanged. The amplitude unit in the Antenna Unit field is a conversion factor that is used to adjust the Y Axis Units of the current mode, if the mode supports Antenna Units.

Line #	Type of field	Example	Notes
			For more details on antenna correction data, refer to the Input/Output, Corrections key description. Allowable values: dBuv/m, dBuA/m, dBG, dBpT, None
8	Freq Interpolation	Frequency Interpolation, Linear	if omitted leaves the Freq Interpolation unchanged. Allowable values: Linear, Logarithmic
9	Bias value in mA	Bias, 0.00	If omitted leaves the Bias value unchanged (added as of A.08.50)
10	Bias State	Bias State, On	If omitted leaves the Bias State unchanged. Allowable values: On, Off (added as of A.08.50)
11	Overlap, two values, Freq1 and Freq2, separated by commas.	Overlap, 33500, 40000	Uses Freq Unit from line 6. Thus, in this example Freq1=33.5 GHz, Freq2= 40.0 GHz (see note below). If omitted leaves the overlap unchanged (added as of A.08.50)
12	DATA marker	DATA	Corrections data begins in the next line

Lines 2 through 5 can be empty but must appear in the file. Lines 6 through 11 are optional, the lines can be left out of the file altogether.

The Overlap row and the two Bias rows apply only to external mixing. Both are read-only, they are never written by the analyzer. The only way to insert or modify these rows is to edit the file with a text editor or a spreadsheet editor. These rows are intended for use by mixer manufacturers, as they allow the manufacturer to insert data about how the mixer corrections were generated and how they should be applied. The Bias rows allow you to specify whether to turn Bias on or off when the Correction is turned on and to specify a Bias value (turning off the Correction does not change the Bias, but turning it back on again sets it to the value specified in the file). The Overlap row allows you to specify an overlap region in which two different corrections may be applied. It is expected that in the corrections data itself, there will be TWO corrections values exactly at Max Freq, otherwise Overlap is ignored. The way the overlap is processed is as follows: if at any given time the current analyzer Start Freq is greater than Freq 1 and lower than Freq 2, and the current Stop Freq is greater than Freq 2, extend the first correction point at or above Freq 2 down to Freq 1, rather than using the correction data between Freq1 and Freq2.

The Antenna Unit row can only be used in Correction register 1, because there can only be one setting for Antenna Unit at any given time. If a Correction whose Antenna Unit is set to anything but None is loaded into any Correction register but 1, an error is generated (Mass storage error; Can only load an Antenna Unit into Correction 1). When a correction file is saved from any Correction register but 1, Antenna Unit is always written as None.

Similarly, the Bias rows can only be used in Correction register 1, because there can only be one setting for Bias at any given time. If a Correction file with a Bias or Bias State row is loaded into any Correction register but 1, an error is generated: Mass storage error; Can only load Bias Settings into Correction 1

The data follows the DATA row, as comma separated X, Y pairs; one pair per line.

For example, suppose you have an Antenna to correct for on an N9020A version A.02.06 and the correction data is:

- 0 dB at 200 MHz
- 17 dB at 210 MHz
- 14.8 dB at 225 MHz

Then the file will look like:

- Amplitude Correction
- "Correction Factors for 11966E"
- "Class B Radiated"
- A.02.06,N9020A
- P13 EA3 UK6,01
- Frequency Unit,MHz
- Antenna Unit,dBuV/m
- Frequency Interpolation,Linear
- DATA
- 200.000000,0.00
- 210.000000,17.00
- 225.000000,14.80

The choices for the 1 of N fields in the metadata are as follows:

- Frequency Unit: Hz, kHz, MHz, GHz
- Antenna Unit: dBuV/m, dBuA/m, dBG, dBpT, None

- Frequency Interpolation: Logarithmic, Linear

Amplitude Correction

These keys let you choose which Correction to save. Once selected, the key returns back to the Export Data menu and the selected Correction number is annotated on the key.

The next step in the Save process is to select the Save As key in the Export Data menu.

Key Path	Save, Data, Amplitude Correction
Preset	Not part of a Preset, but is reset to Correction 1 by Restore Input/Output Defaults. Survives a shutdown.
Readback	1
Initial S/W Revision	A.02.00

Limit

Pressing this key selects Limit Lines as the data type to be exported. Pressing the key a second time brings up the Limit Menu that allows you to select which **Limit Line** to save.

- See "[Limits File Contents](#)" on page 3020.
- See "[.csv file format](#)" on page 3020
- See "[.lim file format](#)" on page 3021

Key Path	Save, Data
Remote Command	:MMEMory:STORe:LIMit LLINE1 LLINE2,<filename>
Example	:MMEM:STOR:LIM LLINE2, "myLimitLine2.csv" Saves the 2nd Limit Line to the file myLimitLine2.csv in the current path. The default path is My Documents\SA\data\limits
Notes	If the save is initiated via SCPI, and the file already exists, the file will be overwritten. Using the C: drive is strongly discouraged, since it runs the risk of being overwritten during an instrument software upgrade. Both single and double quotes are supported for any filename parameter over SCPI.
Dependencies	This key will only appear if you have the proper option installed in your instrument.
Preset	1; not part of Preset, but is reset by Restore Mode Defaults and survives power cycles
State Saved	The selected Limit number is saved in instrument state.
Readback	selected Limit Line
Status Bits/OPC dependencies	Sequential - waits for previous measurement to complete
Initial S/W Revision	A.02.00

Limits File Contents

Limits may be exported into a data file with a .csv extension. They may be imported from that data file; they may also be imported from a legacy limit file with a .lim extension. The .lim files meet the specification for limit files contained in the EMI measurement guide, HP E7415A.

.csv file format

Except for information in quotes, limit line files are not case sensitive. Information in bold is required verbatim; other text is example text, and italic text is commentary which should not be present in the file.

The first five lines are system-required header lines, and must be in the correct order.

Limit	<i>Data file type name</i>
"FCC Part 15"	<i>File Description</i>
"Class B Radiated"	<i>Comment</i>
A.01.00.R0001.N9020A	<i>Instrument Version, Model Number</i>
P13 EA3 UK6 ,01	<i>Option List, File Format Version</i>

The next few lines describe the parameters; on export they will be in the order shown, on import they can be in any order. If some parameters are missing, they will revert to the default.

Type , Upper	<i>Upper Lower</i>
X Axis Unit , MHz	<i>MHz S; other units should be converted; this also specifies the domain</i>
Amplitude Unit , dBm	<i>dBm V; all other units should be converted appropriately</i>
Frequency Interpolation , Linear	<i>Logarithmic Linear</i>
Amplitude Interpolation , Logarithmic	<i>Logarithmic Linear</i>
X Control , Fixed	<i>Fixed Relative; on input we consider only the first three characters</i>
Y Control , Fixed	<i>Fixed Relative; on input we consider only the first three characters</i>
Margin , 0	<i>Always in dB. A 0 margin is equivalent to margin off</i>
X Offset , 10	<i>Expressed in the X axis units</i>
Y Offset , 5	<i>Expressed in the Amplitude units</i>

The Amplitude Unit line in the limits file may contain an antenna factor unit, for example:

Amplitude Unit=dBuV/m

Antenna factor units are dBuV/m, dBuA/m, dBpT, and dBG. In this case, the unit is treated exactly as though it were dBuV, meaning that all of the limits are interpreted to have units of dBuV. The box does NOT change Y Axis Units when such a limit is loaded in.

The X axis unit also specifies the domain (time or frequency). It is not possible to have both time-domain lines and frequency-domain lines at the same time; if a time-domain line is imported while the other lines are in the frequency domain (or vice-versa), all limit lines will be deleted prior to import.

If the sign of the margin is inappropriate for the limit type (for example a positive margin for an upper limit), the sign of the margin will be changed internally so that it is appropriate.

The remaining lines describe the data. Each line in the file represents an X-Y pair. The X values should be monotonically non-decreasing, although adjacent lines in the file can have the same X value as an aid to building a stair-stepped limit line. To specify a region over which there is no limit, use +1000 dBm for upper limits or -1000 dBm for lower limits.

The data region begins with the keyword DATA:

```
DATA
200.000000,-10.00
300.000000,-10.00
300.000000,-20.00
500.000000,-20.00
```

.lim file format

This is a legacy format which allows files saved from older analyzers to be loaded into the X-Series. Design of files in this format is not recommended.

Limit Selection

These keys let you pick which Limit Line to save. Once selected, the key returns back to the **Export Data** menu and the selected Limit Line number is annotated on the key.

The next step in the Save process is to select the Save As key in the Export Data menu.

Key Path	Save, Data, Limit Line
Notes	auto return
Preset	Not part of Preset, but is reset to LLINE1 by Restore Mode Defaults; survives shutdown
Initial S/W Revision	A.02.00

Measurement Results

Pressing this key selects Meas Results as the data type to be exported. Pressing the key a second time brings up the Meas Results menu, which allows you to select which **Meas Result** to save. In the Swept SA measurement, there are three types of Measurement Results files: Peak Table, Marker Table and Spectrogram.

- See ["Meas Results File Contents" on page 3022.](#)
- See ["Marker Table" on page 3022.](#)
- See ["Peak Table" on page 3026.](#)
- See ["Spectrogram" on page 3029](#)

Remote Command	:MMEMory:STORe:RESuLts:MTABle PTABle SPECTrogram <filename>
Example	:MMEM:STOR:RES:MTAB "myResults.csv" Saves the results from the current marker table to the file myResults.csv in the current path. :MMEM:STOR:RES:PTAB "myResults.csv" Saves the results from the current peak table to the file myResults.csv in the current path.

	:MMEM:STOR:RES:SPEC "myResults.csv" Saves the results from the current Spectrogram display to the file myResults.csv in the current path. The default path is My Documents\SA\data\SAN\results
Notes	If the save is initiated via SCPI, and the file already exists, the file will be overwritten. Using the C: drive is strongly discouraged, since it runs the risk of being overwritten during an instrument software upgrade. Both single and double quotes are supported for any filename parameter over SCPI.
Dependencies	If a save of Marker Table results is requested and the Marker Table is not on, no file is saved and a message is generated If a save of Peak Table results is requested and the Peak Table is not on, no file is saved and a message is generated If a save of Spectrogram results is requested and the Spectrogram is not on, no file is saved and a message is generated. The Spectrogram choice only appears if option EDP is licensed.
Preset	Not part of Preset, but is reset to Peak Table by Restore Mode Defaults. Survives a shutdown.
Initial S/W Revision	Prior to A.02.00

Meas Results File Contents

All files are .csv files. The following section details the data in each file type.

Marker Table

This section discusses the Marker Table Meas Results file format.

Imagine that, at the point where a Marker Table Meas Result is requested, the following screen is showing:

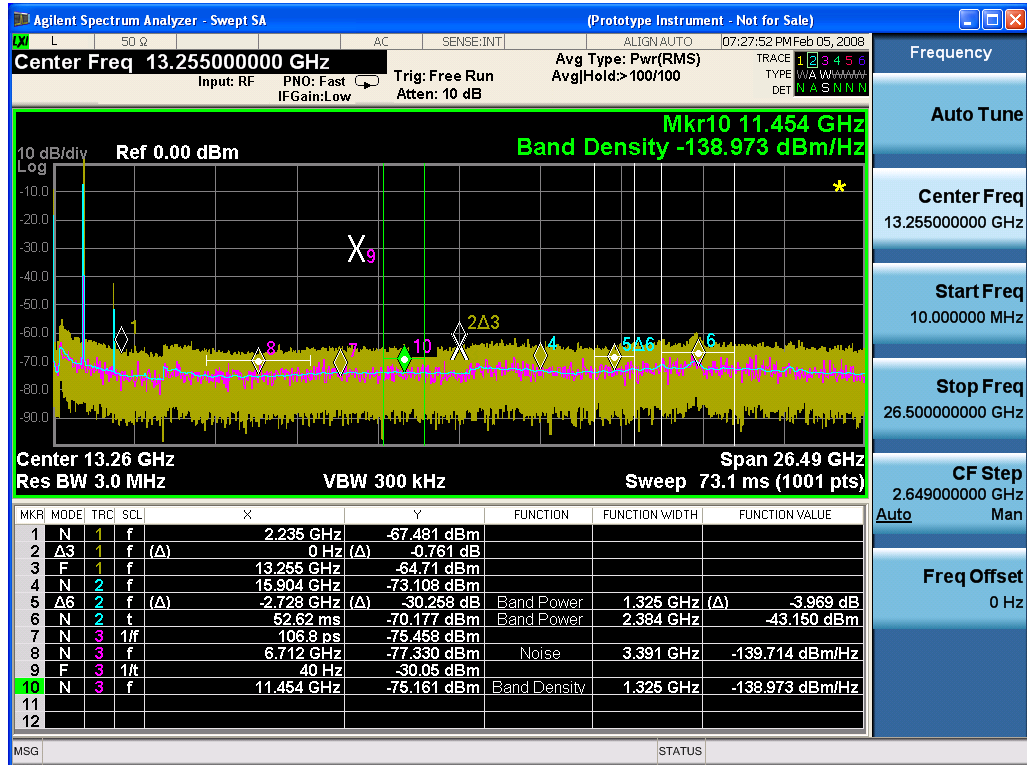

Then the Meas Results file, when opened, would show the following data:

Measurement	Result
Swept SA	
A.01.40_	N9020A
R0017	
526 B25	1
PFR P26	
EA3	
Result Type	Marker Table
Ref Level	0
Number of Points	1001
Sweep Time	0.066266667
Start Frequency	10000000
Stop Frequency	265000000
Average Count	0

Average Type	LogPower (Video)
RBW	300000
RBW Filter	Gaussian
RBW Filter BW	3dB
VBW	300000
Sweep Type	Swept
X Axis Scale	Lin
PreAmp State	Off
PreAmp Band	Low
Trigger Source	Free
Trigger Level	1.2
Trigger Slope	Positive
Trigger Delay	1.00E-06
Phase Noise Optimization	Fast
Swept If Gain	Low
FFT If Gain	Autorange
RF Coupling	AC
FFT Width	411900
Ext Ref	100000
Input	RF
RF Calibrator	Off
Attenuation	10
Ref Level Offset	0

External Gain	0								
X Axis Units	Hz								
Y Axis Units	dBm								
DATA									
MKR	MODE	T R C	SCL	X	Y	FUNC TION	FUNC TION WIDT H	FUNC TION VALU E	FUNC TION UNIT
1	Normal	1	Frequ ency	2.2350 E+09	- 67. 48 1	Off	0.0000 E+00	0	None
2	Delta3	1	Frequ ency	0.0000 E+00	- 0.7 61	Off	0.0000 E+00	0	None
3	Fixed	1	Frequ ency	1.3255 E+10	- 64. 71	Off	0.0000 E+00	0	None
4	Normal	2	Frequ ency	1.5904 E+10	- 73. 10 8	Off	0.0000 E+00	0	None
5	Delta7	2	Frequ ency	- 2.7280 E+09	- 30. 25 8	Band Power	1.3250 E+06	- 3.969	dB
6	Normal	2	Time	5.2620 E-02	- 70. 17 7	Band Power	2.3840 E+06	- 43.15	dBm
7	Normal	3	Perio d	1.0680 E-10	- 75. 45 8	Off	0.0000 E+00	0	None
8	Normal	3	Frequ ency	6.7120 E+09	- 77. 33	Noise	3.3910 E+06	- 139.7 14	dBm/ Hz
9	Fixed	3	Inver se Time	4.0000 E+01	- 30. 05	Off	0.0000 E+00	0	None
10	Normal	3	Frequ ency	1.1454 E+10	- 75. 16 1	Band Densi ty	1.3250 E+06	- 138.9 73	dBm/ Hz
11	Off	1	Frequ	0.0000	0	Off	0.0000	0	None

			ency	E+00			E+00		
12	Off	1	Frequ	0.0000	0	Off	0.0000	0	None
			ency	E+00			E+00		

The numbers appear in the file exactly as they appear onscreen. If it says 11.454 GHz onscreen, then in the file it is 11.454E+09.

The metadata header is very similar to the metadata used in the trace data .csv files. See ["Trace File Contents" on page 3216](#). The only new information concerns the 1-of-N fields in the marker table itself.

Peak Table

This section discusses the Peak Table Meas Results file format.

Imagine that, at the point where a Marker Table Meas Result is requested, the following screen is showing:

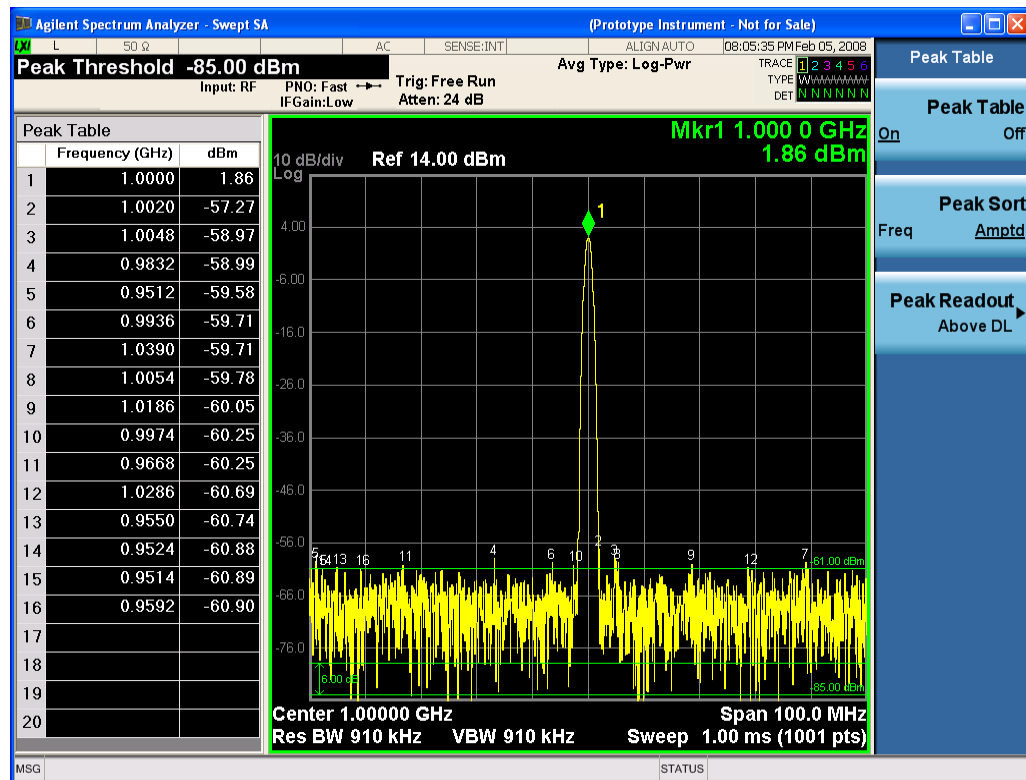

Then the Meas Results file, when opened, would show the header data (the same as for the Marker Table except that the Result Type is Peak Table) ending with a few fields of specific interest to Peak Table users:

- Peak Threshold
- Peak Threshold State (On|Off)

- Peak Excursion
- Peak Excursion State (On|Off)
- Display Line
- Peak Readout (All|AboveDL|BelowDL)
- Peak Sort (Freq|Amptd)

These fields are then followed by the data for the Peak Table itself.

Note that the label for the Frequency column changes to Time in 0 span.

Here is what the table for the above display looks like:

MeasurementResult	
Swept SA	
A.18.00	N9020A
526 B25 PFR P26 EA3	1
Result Type	Peak Table
Ref Level	0
Number of Points	1001
Sweep Time	0.066266667
Start Frequency	10000000
Stop Frequency	26500000000
Average Count	0
Average Type	LogPower (Video)
RBW	3000000
RBW Filter	Gaussian
RBW Filter BW	3dB
VBW	3000000
Sweep Type	Swept
X Axis Scale	Lin
PreAmp State	Off
PreAmp Band	Low
Trigger Source	Free
Trigger Level	1.2
Trigger Slope	Positive
Trigger Delay	1.00E-06
Phase Noise Optimization	Fast

Swept If Gain	Low		
FFT If Gain	Autorange		
RF Coupling	AC		
FFT Width	411900		
Ext Ref	10000000		
Input	RF		
RF Calibrator	Off		
Attenuation	10		
Ref Level Offset	0		
External Gain	0		
X Axis Units	Hz		
Y Axis Units	dBm		
Peak Threshold	-85		
Peak Threshold State	On		
Peak Excursion	6		
Peak Excursion State	On		
Display Line	-61		
Peak Readout	AboveDL		
Peak Sort	Amptd		
DATA			
Peak	Frequency	Amplitude	Delta to Limit
1	1.000009988E+09	-26.08	41.1
2	9.99989974E+08	-26.11	43.9
3	1.000019929E+09	-29.47	35.2
4	9.999799016E+08	-29.54	40.4
5	1.000030002E+09	-37.51	23.1
6	9.999699601E+08	-37.62	32.4
7	9.999999155E+08	-37.71	32.3
8	1.000039943E+09	-48.38	9.1

9	9.999598877E+08	-48.55	21.4
10	1.000049885E+09	-61.43	-8.1
11	9.999499461E+08	-61.66	8.3
12	1.000059957E+09	-76.53	- 26.1
13	9.999398738E+08	-77.01	-7.6
14			
15			
16			
17			
18			
19			
20			

Spectrogram

This section discusses the Spectrogram Results file format. The Spectrogram choice only appears if option EDP is licensed.

The Spectrogram results are the same as a Trace data export, except that instead of having just one trace's data, all 300 traces appear one after the other.

Each trace has its own data mark; the data for Spectrogram Trace 0 follows the row marked DATA, the data for Spectrogram Trace 1 follows the row marked DATA1, for Spectrogram Trace 2 follows the row marked DATA2, and so on.

Each DATA row has a timestamp in the second column (as of firmware revision A.11.01). So, for example, if Trace 0 had a relative start time of 1729.523 sec, then the first DATA row would look like this:

DATA,1729.523

And if Trace 13 had a relative start time of 100.45 sec, then the fourteenth data row would look like:

DATA13,100.453

To find the absolute time for the relative timestamps of each trace, the last row before the first DATA row gives the absolute start time of the Spectrogram, in the form YYYYMMDDHHMMSS

So, for example, if the absolute start time is 13:23:45:678 on January 30, 2012, this row would look like:

Start Time,20120130132345678

NOTE:

NOTE

The resolution of the absolute time stored is 1 ms, which matches up with the fact that the fastest sweep time is also 1 ms. However, there is no specification for the absolute accuracy of the clock in the analyzer, nor is there any facility provided to allow the user to set this time to any particular degree of accuracy.

Traces that have not yet been filled in the Spectrogram display are empty; there is no DATA header for them. The file ends after the last non-empty trace.

Imagine that, at the point where a Spectrogram Meas Result is requested, the following screen is showing:



For the purpose of this example, we have set the Average/Hold Number to 10, thus we have only traces 0 thru 10. The Spectrogram was started at 02:28:08:700 pm on April 25, 2012 (that is, 700 ms after 2:28:08 pm), although the screen dump itself shows a different time, as it was taken ten minutes after the Spectrogram data. Trace 0 is showing a start time of 5.30 seconds, meaning 5.3 seconds after the Spectrogram started (trace 10 has a start time of 0, as it was the first trace taken but has now rolled up into the tenth trace slot).

The Meas Results file, when opened, shows the header data and ten traces of trace data. Below is an extract from the result file for the above display. Note the start time of 20120425142808700 showing in the last row before the first DATA row, and the relative time of 5.299231048 showing in the first DATA row:

Result Type	Spectrogram
MeasResult	
Swept SA	
A.11.00.01	N9020A
503 508 513 526 ALL ALV B1C B1X B25 B2X B40 BAB BBA CR3 CRP DP2 DRD EA3 EDP EMC EP1 ERC ESC ESP EXM FSA HBA K03 LFE MPB P03 P08 P13 P26 PFR RTL RTS S40 SB1 SEC SM1 UK6 YAS YAV	1
Segment	0
Number of Points	1001
Sweep Time	0.523333333
Start Frequency	5999984415
Stop Frequency	6000009415
Average Count	0
Average Type	LogPower(Video)
RBW	240
RBW Filter	Gaussian
RBW Filter BW	3dB
VBW	240
Sweep Type	Swept
X Axis Scale	Lin
PreAmp State	Off
PreAmp Band	Low
Trigger Source	Free
Trigger Level	1.2
Trigger Slope	Positive
Trigger Delay	0
Phase Noise Optimization	Wide
Swept If Gain	Low
FFT If Gain	Autorange
RF Coupling	AC
FFT Width	411900
Ext Ref	10000000
Input	RF
RF Calibrator	Off

Result Type	Spectrogram
Attenuation	14
Ref Level Offset	0
External Gain	0
Trace Type	Clearwrite
Detector	Normal
Trace Math	Off
Trace Math Oper1	Trace5
Trace Math Oper2	Trace6
Trace Math Offset	0
Trace Name	Trace1
X Axis Units	Hz
Y Axis Units	dBm
Start Time	20120425142808700
DATA	5.299231048
5999984415	-76.34749519
5999984440	-77.28097006
5999984465	-75.32317869
5999984490	-73.64417681
5999984515	-72.67154604

o
o
o

6000009315	-77.94423277
6000009340	-79.51829697
6000009365	-78.46108961
6000009390	-78.46108957
6000009415	-76.59570596
DATA2	4.708697055
5999984415	-80.98197882
5999984440	-80.98197879
5999984465	-75.83142132
5999984490	-74.02712079
5999984515	-73.57213005

o
o

o

6000009315	-75.9183103
6000009340	-79.53787488
6000009365	-78.82602191
6000009390	-78.82602188
6000009415	-76.37486709
DATA10	0
5999984415	-75.56751112
5999984440	-75.76485645
5999984465	-76.67718717
5999984490	-78.79238489
5999984515	-83.72680212

o
o
o

6000009315	-71.3942461
6000009340	-72.28308332
6000009365	-73.92684489
6000009390	-75.45548832
6000009415	-75.17904815

Save As . . .

When you press “Save As”, the analyzer brings up a Windows dialog and a menu entitled “**Save As.**” This menu allows you to navigate to the various fields in the Windows dialog without using a keyboard or mouse. The **Tab** and **Arrow** keys can also be used for dialog navigation.

See "[To File . . .](#)" on page 3202 in **Save, State** for a full description of this dialog and menu.

The default path for saving files is:

For all of the Trace Data Files:

- My Documents\<<mode name>\data\traces

For all of the Limit Data Files:

- My Documents\<<mode name>\data\limits

For all of the Measurement Results Data Files:

- My Documents\<<mode name>\data\<<measurement name>\results

For all of the Capture Buffer Data Files:

- My Documents\<<mode name>\data\captureBuffer

Key Path	Save, Data
Mode	All
Notes	The key location is mode-dependent and will vary. Brings up the Save As dialog for saving a <mode specific> Save Type. The save is performed immediately and does not wait until the measurement is complete.
Initial S/W Revision	Prior to A.02.00

Screen Image

Pressing Screen Image accesses a menu of functions that enable you to specify a format and location for the saved screen image. It brings up a menu that allows you to specify the color scheme of the Screen Image (Themes) or navigate to the Save As dialog to perform the actual save.

Screen Image files contain an exact representation of the analyzer display. They cannot be loaded back onto the analyzer, but they can be loaded into your PC for use in many popular applications.

The image to be saved is actually captured when the **Save** front panel key is pressed, and kept in temporary storage to be used if you ask for a Screen Image save. When the Screen Image key is pressed, a "thumbnail" of the captured image is displayed, as shown below:

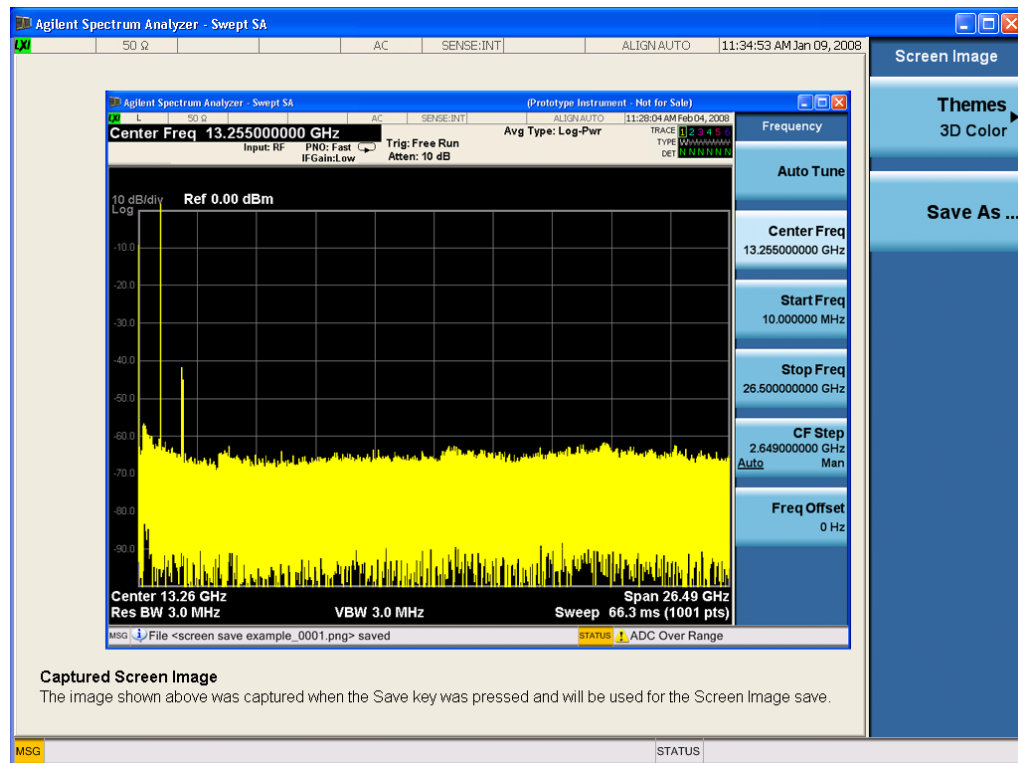

When you continue on into the **Save As** menu and complete the Screen Image save, the image depicted in the thumbnail is the one that gets saved, showing the menus that were on the screen before going into the **Save** menus. The save is performed immediately and does not wait until the measurement is complete.

After you have completed the save, the **Quick Save** front-panel key lets you quickly repeat the last save performed, using an auto-named file, with the current screen data.

NOTE

For versions previous to A.01.55, if you initiate a screen image save by navigating through the Save menus, the image that is saved will contain the Save menu softkeys, not the menus and the active function that were on the screen when you first pressed the Save front panel key.

Key Path	Save
Mode	All
Remote Command	:MMEMory:STORe:SCReen <filename>
Example	:MMEM:STOR:SCR "myScreen.png" This stores the current screen image in the file MyScreenFile.png in the default directory.
Backwards Compatibility SCPI	HCOPy:SDUMp:DATA? returns the screen image in a <DEFINITE LENGTH ARBITRARY RESPONSE DATA> element. The response data is IEEE Block format; the controlling computer can strip the header and store the result as a .png file.
Initial S/W Revision	Prior to A.02.00

Themes

Accesses a menu of functions that enable you to choose the theme to be used when saving the screen image.

The **Themes** option is the same as the **Themes** option under the **Display** and **Page Setup** dialogs. It allows you to choose between themes to be used when saving the screen image.

Key Path	Save, Screen Image
Remote Command	:MMEMory:STORe:SCReen:THEMe TDCoLor TDMonochrome FCOLor FMONochrome :MMEMory:STORe:SCReen:THEMe?
Example	:MMEM:STOR:SCR:THEM TDM
Preset	3D Color; Is not part of Preset, but is reset by Restore Misc Defaults or Restore System Defaults All and survives subsequent running of the modes.
Readback	3D Color 3D Mono Flat Color Flat Mono
Backwards Compatibility Notes	In ESA and PSA we offer the choice of "Reverse Bitmap" or "Reverse Metafile" when saving screen images. This is much like the "Flat Color" theme available in X-Series. Also, if you selected Reverse Bitmap AND a black & white screen image, that would be much like "Flat Monochrome". In other words, each of the X-Series themes has a similar screen image type in ESA/PSA. But they are not identical.
Initial S/W Revision	Prior to A.02.00

3D Color

Selects a standard color theme with each object filled, shaded and colored as designed.

Key Path	Save, Screen Image, Themes
Example	MMEM:STOR:SCR:THEM TDC
Readback	3D Color
Initial S/W Revision	Prior to A.02.00

3D Monochrome

Selects a format that is like 3D color but shades of gray are used instead of colors.

Key Path	Save, Screen Image, Themes
Example	MMEM:STOR:SCR:THEM TDM
Readback	3D Mono
Initial S/W Revision	Prior to A.02.00

Flat Color

Selects a format that is best when the screen is to be printed on an ink printer.

Key Path	Save, Screen Image, Themes
Example	MMEM:STOR:SCR:THEM FCOL
Readback	Flat Color
Initial S/W Revision	Prior to A.02.00

Flat Monochrome

Selects a format that is like Flat Color. But only black is used (no colors, not even gray), and no fill.

Key Path	Save, Screen Image, Themes
Example	MMEM:STOR:SCR:THEM FMON
Readback	Flat Mono
Initial S/W Revision	Prior to A.02.00

Save As...

When you press "Save As", the analyzer brings up a Windows dialog and a menu entitled "**Save As.**" This menu allows you to navigate to the various fields in the Windows dialog without using a keyboard or mouse. The **Tab** and **Arrow** keys can also be used for dialog navigation.

See "[To File . . .](#)" on page 3202 in **Save, State** for a full description of this dialog and menu.

The default path for Screen Images is

- My Documents\<<mode name>\screen.

where <mode name> is the parameter used to select the mode with the INST:SEL command (for example, SA for the Spectrum Analyzer).

Key Path	Save, Screen Image
Notes	Brings up Save As dialog for saving a Screen Image Save Type
Initial S/W Revision	Prior to A.02.00

Mass Storage Catalog (Remote Command Only)

Key path	SCPI Only
Remote Command	:MMEMory:CATalog? [<directory_name>]
Notes	<p>The string must be a valid logical path.</p> <p>Queries disk usage information (drive capacity, free space available) and obtains a list of files and directories in a specified directory in the following format:</p> <p><numeric_value>,<numeric_value>,{<file_entry>}</p> <p>It returns two numeric parameters and as many strings as there are files and directories. The first parameter indicates the total amount of storage currently used in bytes. The second parameter indicates the total amount of storage available, also in bytes. The <file_entry> is a string. Each <file_entry> indicates the name, type, and size of one file in the directory list:</p> <p><file_name>,<file_type>,<file_size></p> <p>As the windows file system has an extension that indicates file type, <file_type> is always empty. <file_size> provides the size of the file in bytes. For directories, <file_entry> is surrounded by square brackets and both <file_type> and <file_size> are empty</p>
Initial S/W Revision	Prior to A.02.00

Mass Storage Change Directory (Remote Command Only)

Key path	SCPI Only
Remote Command	:MMEMory:CDIRectory [<directory_name>] :MMEMory:CDIRectory?
Notes	<p>The string must be a valid logical path.</p> <p>Changes the default directory for a mass memory file system. The <directory_name> parameter is a string. If no parameter is specified, the directory is set to the *RST value.</p> <p>At *RST, this value is set to the default user data storage area, that is defined as System.Environment.SpecialFolder.Personal.</p> <p>Query returns full path of the default directory.</p>
Initial S/W Revision	Prior to A.02.00

Mass Storage Copy (Remote Command Only)

Key path	SCPI Only
----------	------------------

Remote Command	:MMEMory:COpy <string>,<string>[,<string>,<string>]
Notes	<p>The string must be a valid logical path.</p> <p>Copies an existing file to a new file or an existing directory to a new directory.</p> <p>Two forms of parameters are allowed. The first form has two parameters. In this form, the first parameter specifies the source, and the second parameter specifies the destination.</p> <p>The second form has four parameters. In this form, the first and third parameters specify the source. The second and fourth parameters specify the directories. The first pair of parameters specifies the source. The second pair specifies the destination. An error is generated if the source doesn't exist or the destination file already exists.</p> <p>This command will generate an "access denied" error if the destination is a restricted folder (e.g., C:\Windows) and the current user does not have Power User or Administrator privileges.</p>

Mass Storage Device Copy (Remote Command Only)

This command transfers data to/from a file and a peripheral device.

Key path	SCPI Only
Remote Command	:MMEMory:COpy:DEvice <source_string>,<dest_string>
Notes	<p>The strings must be a valid logical path or a valid device keyword. If the dest_string is a device keyword, the data is copied from the source file to the device. If the source_string is a device keyword, the data is copied to the source file from the device.</p> <p>Valid device keywords are:</p> <p>SNS (smart noise source)</p> <p>An error is generated if the file or device is not found.</p>

Mass Storage Delete (Remote Command Only)

Key path	SCPI Only
Remote Command	:MMEMory:DELeTe <file_name>[,<directory_name>]
Notes	<p>The string must be a valid logical path.</p> <p>Removes a file from the specified directory. The <file_name> parameter specifies the file name to be removed. This command will generate an "access denied" error if the file is in a restricted folder (e.g., C:\Windows) and the current user does not have Power User or Administrator privileges.</p>
Initial S/W Revision	Prior to A.02.00

Mass Storage Data (Remote Command Only)

Creates a file containing the specified data OR queries the data from an existing file.

Key path	SCPI Only
Remote Command	:MMEMory:DATA <file_name>, <data> :MMEMory:DATA? <file_name>
Notes	The string must be a valid logical path.

	<p>The command form is MMEemory:DATA <file_name>,<data>. It loads <data> into the file <file_name>. <data> is in 488.2 block format. <file_name> is string data.</p> <p>The query form is MMEemory:DATA? <file_name> with the response being the associated <data> in block format.</p>
Initial S/W Revision	Prior to A.02.00

Mass Storage Make Directory (Remote Command Only)

Key path	SCPI Only
Remote Command	:MMEemory:MDIRectory <directory_name>
Notes	<p>The string must be a valid logical path.</p> <p>Creates a new directory. The <directory_name> parameter specifies the name to be created.</p> <p>This command will generate an “access denied” error if the new directory would be in a restricted folder (e.g., C:\Windows) and the current user does not have Power User or Administrator privileges.</p>
Initial S/W Revision	Prior to A.02.00

Mass Storage Move (Remote Command Only)

Key path	SCPI Only
Remote Command	:MMEemory:MOVE <string>,<string>[,<string>,<string>]
Notes	<p>The string must be a valid logical path.</p> <p>Moves an existing file to a new file or an existing directory to a new directory.</p> <p>Two forms of parameters are allowed. The first form has two parameters. In this form, the first parameter specifies the source, and the second parameter specifies the destination.</p> <p>The second form has four parameters. In this form, the first and third parameters specify the source. The second and fourth parameters specify the directories. The first pair of parameters specifies the source. The second pair specifies the destination. An error is generated if the source doesn't exist or the destination file already exists.</p> <p>This command will generate an “access denied” error if the destination is a restricted folder (e.g., C:\Windows) and the current user does not have Power User or Administrator privileges.</p>
Initial S/W Revision	Prior to A.02.00

Mass Storage Remove Directory (Remote Command Only)

Key path	SCPI Only
Remote Command	:MMEemory:RDIRectory <directory_name>
Notes	<p>The string must be a valid logical path.</p> <p>Removes a directory. The <directory_name> parameter specifies the directory name to be removed. All files and directories under the specified directory shall also be removed.</p> <p>This command will generate an “access denied” error if the folder is a restricted folder (e.g., C:\Windows) or is in a restricted folder and the current user does not have Power User or Administrator privileges.</p>
Initial S/W Revision	Prior to A.02.00

Mass Storage Determine Removable Media (Remote Command Only)

This command is used to determine if any removable media devices are connected to the instrument. Primarily, these are USB memory devices plugged-in to the front panel or rear panel USB ports. On instruments with PC6 or PC7 CPU's, one SD card slot is available for removable media. The instrument's primary disk drive is not a removable media device.

Key Path	SCPI Only
Remote Command	:MMEMory:RMEDia:LIST?
Notes	<p>The return value is a string containing a list of partition identifiers that are removable media devices. Each identifier is separated by a comma. If no removable media is present, an empty string is returned.</p> <p>Examples:</p> <ul style="list-style-type: none"> - One removable device present results in a return string of "F:". - Two removable devices present results in a return string of "F:,G:". - No removable devices present results in a return string of "".
Initial S/W Revision	x.15.00

Mass Storage Determine Removable Media Label (Remote Command Only)

This command is used to set or query a removable media device's label.

Key Path	SCPI Only
Remote Command	:MMEMory:RMEDia:LABel <partition>,<string> :MMEMory:RMEDia:LABel? <partition>
Example	MMEM:RMED:LAB "F:","My Device"
Notes	<p>If the <partition> specified does not exist or is not a removable media device, the error -252,"Missing Media" is generated.</p> <p>Setting the removable media label requires Administrative privileges. If the currently logged in user does not have appropriate privileges the error "-221.9900,Settings conflict;Administrator privileges required" is generated.</p>
Initial S/W Revision	x.15.00

Mass Storage Determine Removable Media Write-protect status (Remote Command Only)

This command is used to query a removable media device's write-protect status.

Key Path	SCPI Only
----------	-----------

Remote Command	:MMEMory:RMEDia:WPRotect? <partition>
Example	MMEM:RMED:WPR? "F:"
Notes	The return value is 1 if the device is write-protected, or 0 if the device is write-enabled. If the <partition> specified does not exist or is not a removable media device the error - 252,"Missing Media" is generated.
Preset	The return value will be depending on SD card installed.
Initial S/W Revision	x.15.00

Mass Storage Determine Removable Media size (Remote Command Only)

This command is used to query a removable media device's total memory size (not available memory size).

Key Path	SCPI Only
Remote Command	:MMEMory:RMEDia:SIZE? <partition>
Example	MMEM:RMED:SIZE? "F:"
Notes	The return value is integer value in GBytes. Any device that is less than 1 GB returns 0 GB. If the <partition> specified does not exist or is not a removable media device, the error - 252,"Missing Media" is generated.
Initial S/W Revision	x.15.00

:SYSTem:SET (Remote Command Only)

Remote command that allows the user to obtain the state of the currently active mode in a form that can then be loaded back into the instrument quickly.

Remote Command	SYSTem:SET <instrument state in IEEE Block> SYSTem:SET?
Notes	SYST:SET? returns current instrument state of the active mode in IEEE Block data format. The state is in a machine readable format only. Sending the query returns the following format: <syst set preamble><state block data> Where: <syst set preamble> is the format: #NMMM N=number of digits that comprise MMM MMM=length in bytes of following data <state block data> is machine readable state data Example response: #42016<state data> The state is recalled by sending the SYST:SET? Response data to the instrument. From example above: SYST:SET #42016<state data>
Initial S/W Revision	x.17.00

Single (Single Measurement/Sweep)

Sets the analyzer for Single measurement operation. The single/continuous state is Meas Global, so the setting will affect all the measurements. If you are Paused, pressing **Single** does a Resume.

See "[More Information](#)" on page 3042

Key Path	Front-panel key
Example	:INIT:CONT OFF
Notes	See Cont key description.
Backwards Compatibility Notes	<p>For Spectrum Analysis mode in ESA and PSA, the Single hardkey and the INITiate:IMM switched from continuous measurement to single measurement and restarted sweeps and averages (displayed average count reset to 1), but did not restart Max Hold and Min Hold. In the X-Series, the Single hardkey and the INITiate:IMM command initiate a sweep/ measurement/ average sequence/hold sequence including MaxHold and MinHold.</p> <p>For Spectrum Analysis mode in ESA and PSA, the Single hardkey restarted the sweep regardless of whether or not you were in an active sweep or sweep sequence. In the X-Series, Restart does this but Single only restarts the sweep or sweep sequence if you are in the idle state.</p> <p>INIT[:IMM] in ESA & PSA Spectrum Analysis Mode does an implied ABORT. In some other PSA Modes, INIT[:IMM] is ignored if not in the idle state. . The X-Series follows the ESA/PSA SA Mode model, which may cause some Modes to have compatibility problems.</p>
Initial S/W Revision	Prior to A.02.00

More Information

See "[Restart](#)" on page 3199 for details on the INIT:IMMEDIATE (Restart) function.

If you are already in single sweep, the INIT:CONT OFF command has no effect.

If you are already in Single Sweep, then pressing the **Single** key in the middle of a sweep does not restart the sweep or sequence. Similarly, pressing the **Single** key does not restart the sweep or sequence if the sweep is not in the idle state (for example, if you are taking a very slow sweep, or the analyzer is waiting for a trigger). Instead, it results in a message. "Already in Single, press Restart to initiate a new sweep or sequence". Even though pressing the **Single** key in the middle of a sweep does not restart the sweep, sending INIT:IMMEDIATE does reset it.

To take one more sweep without resetting the average count, increment the average count by 1, by pressing the step up key while **Average/Hold Number** is the active function, or sending the remote command CALC:AVER:TCON UP.

Source

The Source key accesses menus for controlling a Source in Tracking Source mode

Key Path	Front-panel key
Dependencies	<p>Operation with a source requires a license. If the proper license is not installed, the following occurs:</p> <ul style="list-style-type: none"> - When the Source key is pressed the user sees an informational message, "Option not installed" - If any SCPI command in the :SOURce subsystem is sent it generates a message, "Settings conflict;option not installed"
Initial S/W Revision	A.06.01

NOTE

Option T03 or T06 is required for the Tracking Generator function in CXA. Option T03, T07, T13 or T26 is required for the Tracking Generator function in CXA-m.

When using the CXA-m Tracking Generator, if the Source Frequency is in the frequency range of the below table, and the Source Amplitude is in the corresponding amplitude range of the below table, a warning status message is generated, +313 "Source Uncal". This is also true if Power Sweep is on and any amplitude in the Power Sweep (as calculated by Amplitude, Power Sweep, and Amptd Offset) is in that range.

CXA-m TG Un-calibrated Amplitude Range

Frequency Range	Amplitude Range
$2 \text{ MHz} \leq \text{frequency} < 10 \text{ GHz}$	$-40 \text{ dBm} \leq \text{amplitude} < -35 \text{ dBm}$
$10 \text{ GHz} \leq \text{frequency} < 20 \text{ GHz}$	$-40 \text{ dBm} \leq \text{amplitude} < -35 \text{ dBm}$ or $-5 \text{ dBm} < \text{amplitude} \leq 0 \text{ dBm}$
$20 \text{ GHz} \leq \text{frequency} \leq 26.55 \text{ GHz}$	$-12 \text{ dBm} < \text{amplitude} \leq 0 \text{ dBm}$

RF Output

Allows you to turn the source RF Power on or off.

NOTE

When the RF Output is turned on, the Source Mode is set to Tracking. See the Source Mode key description for special considerations concerning how to configure your N5172B or N5182B source for use with External Source Control.

Key Path	Source
Scope	Meas Global
Remote Command	:OUTPut[:EXTErnal] [:STATe] ON OFF 1 0 :OUTPut[:EXTErnal] [:STATe]?

Example	:OUTP ON :OUTP?
Dependencies	Grayed out in measurements that do not support a source. If you go to such a measurement the output will be forced to Off. Grayed out if there is no valid source selection, in this case go to the Select Source menu to choose, configure and/or verify your source When there is no available Source Mode (other than Off), due to other couplings, then the RF Output key is grayed out.
Couplings	When RF Output is turned On, Source Mode is set to Tracking When Source Mode is turned Off, RF Output is turned Off. When Source Mode is turned Off (or forced to Off by another coupling), RF Output is turned Off. Turning RF Output Off does not affect Source Mode or other settings.
Preset	OFF (on either a Mode Preset, a Source Preset, or Restore Input/Output Defaults)
State Saved	Part of the Input/Output system, which means it is Loaded and Saved with state.
Range	On Off
Initial S/W Revision	A.06.01
Modified at S/W Revision	A.10.01

Amplitude

Allows you to access the Amplitude sub-menu to control various amplitude parameters of the Source. The resolution of the Source amplitude parameters is coupled to match the minimum resolution of the source when the source is acquired. When the source is released, the amplitude parameter resolution reverts to default values.

Key Path	Source
Readback	In square brackets, the amplitude value from Amplitude key in the next menu level down
Initial S/W Revision	A.06.01

Amplitude

Allows you to adjust the power level of the selected source. Note that the actual amplitude is also affected by the Amplitude Offset and Power Sweep parameters.

Key Path	Source, Amplitude
Scope	Mode Global
Remote Command	:SOURce[:EXTernal]:POWer[:LEVel][:IMMediate][:AMPLitude] <amp1> :SOURce[:EXTernal]:POWer[:LEVel][:IMMediate][:AMPLitude]?
Example	:OUTP ON :SOUR:POW -10dBm
Dependencies	If the requested setting of Source Amplitude causes the calculated external source start or stop

	Amplitude to exceed the external source capability, a warning status message is generated, "Data out of Range; clipped to source max/min" The "Show Source Capabilities and Settings" menu can then be examined to check the source capabilities. This parameter test and clip is also performed at source acquisition.
Preset	-10.00 dBm (On Source Preset and Restore Input/Output Defaults) Not affected by Mode Preset
State Saved	Part of the Input/Output system, which means it is Loaded and Saved with state.
Min	The range of the amplitude parameter is dependent on the amplitude range of the source that is selected, and the settings of Amplitude Offset and Power Sweep.
Max	The range of the amplitude parameter is dependent on the amplitude range of the source that is selected, and the settings of Amplitude Offset and Power Sweep.
Backwards Compatibility SCPI	:SOURce:POWer:STARTt <amp1> :SOURce:POWer:START? This alias is for the ESA tracking generator. It specifies the source output power level at the start of the power sweep, just as does :SOURce:POWer.
Initial S/W Revision	A.06.01
Modified at S/W Revision	A.10.01

Power Sweep

Allows you to set up a Power Sweep. Power Sweep is useful for measuring saturation behavior in a test device, such as a power amplifier.

Pressing the key sets the power-sweep function to On or Off. The value of the power-sweep range is displayed in the active function block, and can be adjusted, when set to On.

The source will sweep the power between the start power defined by the Amplitude function and the stop power = start power + power sweep value:

Source (start) amplitude = Amplitude – Amplitude Offset

Source (stop) amplitude = Amplitude – Amplitude Offset + Power Sweep

In Stepped Tracking, such as is used with an external source or the CXA-m TG, the analyzer controls the source with step sweep mode, which provides a linear progression from one selected frequency, amplitude, or both, to another, pausing at linearly spaced points (steps) along the sweep. The analyzer continues to sweep the specified frequency range when power sweep is on, although generally Power Sweep is performed in Zero Span.

With CXA options T03, T06, the hardware is capable of continuous power sweeps. This makes it possible to use the swept sweep time rules and should be employed for faster sweeps. Care should be taken to limit the sweep time you use as there are no sweep time couplings to Power Sweep settings. The recommended minimum sweep time depends on the RBW and power-sweep range. Start by computing $(1.28/RBW) * (abs(startPower - stopPower)/(5 \text{ dB}))$. The recommended minimum sweep time is the larger of this value and 50 ms.

Some external Sources have mechanical attenuators, which are not used in Power Sweep in order to save wear on the attenuators. To allow an acceptable range of Power Sweep without changing the mechanical attenuation, the Sources are put in a mode that allows the Source to handle a wide amplitude range without switching the attenuators. When the Power Sweep settings put the Source in an amplitude range that requires the mechanical attenuators, the analyzer displays a condition warning message:

Settings Alert;Src pwr ramp>ALC range

Key Path	Source, Amplitude
Mode	SA
Scope	Mode Global
Remote Command	:SOURce:POWer:SWEEp <rel_amp1> :SOURce:POWer:SWEEp? :SOURce:POWer:SWEEp:STATe ON OFF 1 0 :SOURce:POWer:SWEEp:STATe?
Example	:SOUR:POW -5 :SOUR:POW:SWE:STAT ON :SOUR:POW:SWE 10 Set source start power to - 5 dBm and stop power + 5dBm (-5 + 10).
Example	:SOUR:POW:SWE:STAT ON
Dependencies	If the requested setting of Power Sweep causes the calculated external source start or stop Amplitude to exceed the external source capability, a warning status message is generated, "Data out of Range; clipped to source max/min". The Show Source Capabilities and Settings menu can then be examined to check the source capabilities. This parameter test and clip is also performed at source acquisition.
Preset	This is unaffected by "Mode Preset" but is set to 0dB on a "Source Preset" or "Restore Input/Output Defaults".
State Saved	Part of the Input/Output system, which means it is Loaded and Saved with state.
Min	-500 dB
Max	+500 dB
Backwards Compatibility SCPI	:SOURce[:EXTErnal][:SWEEp]:POWer:SPAN <rel_amp1> :SOURce[:EXTErnal][:SWEEp]:POWer:SPAN? This alias is for the ESA tracking generator and PSA option 215. It specifies the range of power levels through which the source output will sweep just as does :SOURce:POWer:SWEEp.
Initial S/W Revision	A.06.01
Remote Command	:SOURce[:EXTErnal]:POWer:MODE FIXEd SWEEp :SOURce[:EXTErnal]:POWer:MODE?
Notes	The ESA tracking generator and the PSA option 215 support this SCPI command. It sets the source output to be at a single amplitude (fixed) or to sweep through a range of power levels

	SOURce:POWer:MODE FIXed is equivalent to :SOURce:POWer:SWEEp:STATe OFF SOURce:POWer:MODE SWEEp is equivalent to :SOURce:POWer:SWEEp:STATe ON
Preset	This is unaffected by "Mode Preset" but is set to FIXed on a "Source Preset" or "Restore Input/Output Defaults".
Initial S/W Revision	A.06.01
Modified at S/W Revision	A.10.01

Amptd Offset

Offsets the displayed power of the source in the Amplitude parameter. Using the amplitude offset allows you to take into account any system losses or gains (for example, due to cable loss), thereby displaying the actual power delivered to the device under test. See the equations under the Source, Amplitude, Power Sweep key.

Key Path	Source, Amplitude
Mode	SA
Scope	Mode Global
Remote Command	:SOURce:CORRection:OFFSet <rel_ampl> :SOURce:CORRection:OFFSet?
Example	:SOUR:CORR:OFFS 5 Sets the displayed source offset power to 5 dB.
Dependencies	If the requested setting of Amptd Offset causes the calculated external source start or stop Amplitude to exceed the external source capability, a warning status message is generated, "Data out of Range; clipped to source max/min". The Show Source Capabilities and Settings menu can then be examined to check the source capabilities. This parameter test and clip is also performed at source acquisition.
Preset	This is unaffected by Mode Preset but is set to 0.00dBm on a Source Preset or Restore Input/Output Defaults.
State Saved	Part of the Input/Output system, which means it is Loaded and Saved with state.
Min	-1000 dB
Max	+1000 dB
Initial S/W Revision	A.06.01

Amptd Step Auto/Man

Allows you to set the step size associated with the Source Amplitude key. When auto-coupled, the step size is the current Scale/Div setting under the Amplitude hardkey (note that this is true even if the analyzer is currently in Linear amplitude scale).

Once a step size has been selected and the Source Amplitude function is active, the step keys (and the UP|DOWN parameters for Source Amplitude from remote commands) change the Source Amplitude by the step-size value.

You may change the step size manually by pressing Amptd Step and entering a value. The function (and the step size) will return to Auto when a Mode Preset or Auto Couple is performed.

Key Path	Source, Amplitude
Scope	Mode Global
Remote Command	<pre>:SOURce:POWer:STEP[:INCRement] <amp1> :SOURce:POWer:STEP[:INCRement]? :SOURce:POWer:STEP:AUTO OFF ON 0 1 :SOURce:POWer:STEP:AUTO?</pre>
Example	<pre>:SOUR:POW:STEP 0.1 Set amplitude step to 0.1 dB :SOUR:POW:STEP:AUTO ON</pre>
Couplings	In Auto, coupled to the size of one logarithmic vertical graticule division
Preset	Auto
State Saved	Part of the Input/Output system, which means it is Loaded and Saved with state.
Min	0.1 dB
Max	20 dB
Initial S/W Revision	A.06.01

Frequency

Allows a you to access the Frequency sub-menu. This menu lets you use a stepped tracking source for stimulus/response measurements for some added flexibility. Because with such a source, the source frequency does not need to track 1:1 with the analyzer LO frequency, it is possible to measure scalar harmonic and subharmonic responses of devices. For example, the second harmonic response is measured by stepping the analyzer and source so that the analyzer is always at twice the source frequency. In addition, the frequency offset capability allows the measurement of frequency conversion devices (like mixers).

In tracking mode, the source frequency tracks the analyzer frequency according to the source frequency equation:

$$\text{Source Frequency} = (\text{Analyzer Frequency} * \text{Multiplier Numerator} / \text{Multiplier Denominator}) + \text{Source Frequency Offset}$$

NOTE

Analyzer Frequency is the frequency to which the analyzer is set, which is the analyzer's displayed frequency, offset by any Freq Offset set under the Frequency hardkey. **Source Frequency Offset** is the value set under **Source, Frequency, Freq Offset**.

Key Path	Source
----------	---------------

Readback	none in Tracking Source mode
Initial S/W Revision	A.06.01

Multiplier Numerator

The multiplier numerator parameter offsets the source frequency from the analyzer frequency. The source frequency tracks the SA frequency according to the source frequency equation shown under the **Source, Frequency** key description.

The multiplier numerator must be restricted to operate within the range of the source minimum and maximum frequencies.

Key Path	Source, Frequency
Mode	SA
Scope	Mode Global
Remote Command	:SOURCE:FREQUENCY[:MULTIPLIER]:NUMERATOR <integer> :SOURCE:FREQUENCY[:MULTIPLIER]:NUMERATOR?
Example	:SOUR:FREQ:NUM 3 Sets the source frequency multiplier numerator to 3.
Dependencies	If the currently selected source does not support this capability (for example, an internal Tracking Generator which must track the LO), this key is forced to its Preset value and grayed out
Preset	This is unaffected by Mode Preset but is set to 1 on a Source Preset or Restore Input/Output Defaults.
State Saved	Part of the Input/Output system, which means it is Loaded and Saved with state.
Min	1
Max	1000
Initial S/W Revision	A.06.01

Multiplier Denominator

The multiplier denominator parameter offsets the source frequency from the analyzer frequency. The source frequency tracks the SA frequency according to the source frequency equation shown under the **Source, Frequency** key description.

The multiplier denominator must be restricted to operate within the range of the source minimum and maximum frequencies.

Key Path	Source, Frequency
Mode	SA
Scope	Mode Global
Remote Command	:SOURCE:FREQUENCY[:MULTIPLIER]:DENOMINATOR <integer> :SOURCE:FREQUENCY[:MULTIPLIER]:DENOMINATOR?
Example	:SOUR:FREQ:DEN 3 Sets the source frequency multiplier denominator to 3
Dependencies	If the currently selected source does not support this capability (for example, an internal Tracking

	Generator which must track the LO), this key is forced to its Preset value and grayed out
Preset	This is unaffected by Mode Preset but is set to 1 on a Source Preset or Restore Input/Output Defaults.
State Saved	Part of the Input/Output system, which means it is Loaded and Saved with state
Min	1
Max	1000
Initial S/W Revision	A.06.01

Source Sweep Reverse

Allows you to reverse the source sweep direction

Normally, the source will sweep from a lower frequency to a higher frequency. However, there are test scenarios in which the source sweep needs to be “reversed”. In this case, it sweeps from a higher frequency to a lower frequency. For example, when the DUT is a frequency converter and a measurement of the Lower Side Band characteristics is desired, a reverse sweep is employed. Reverse sweeps are supported for such scenarios, but two cautions are in order:

4. Reverse Sweep only reverses the direction of the source’s sweep, not the analyzer’s sweep. Unless you are actually using a device like a frequency converter and looking at the lower sideband, thus effectively reversing the direction of the source’s sweep, the source will be sweeping in the opposite direction from the analyzer, and it will not be possible track the desired device output frequency.
5. Any time you are using a frequency converter, care must be taken in setting up all of the sweep parameters, including analyzer start/stop frequency and source multiplier, to make sure that the analyzer’s sweep tracks the output of the converter device.

Key Path	Source, Frequency
Mode	SA
Scope	Mode Global
Remote Command	:SOURce:FREQuency:SSReverse:ON OFF 0 1 :SOURce:FREQuency:SSReverse?
Example	SOUR:FREQ:SSR:OFF SOUR:FREQ:SSR?
Notes	You must be in Spectrum Analyzer mode to use this command. Use INSTRument:SElect to set the mode.
Dependencies	If the currently selected source does not support this capability (for example, an internal Tracking Generator which must track the LO), this key is forced to its Preset value and grayed out
Preset	This is unaffected by Mode Preset but is set to OFF on a Source Preset or Restore Input/Output Defaults.

State Saved	Part of the Input/Output system, which means it is Loaded and Saved with state
Range	On Off
Initial S/W Revision	A.06.01

Freq Offset

The frequency offset parameter offsets the source frequency from the analyzer frequency. The source frequency tracks the SA frequency according to the equations under the **Source, Frequency** key.

Pressing the key sets the Freq Offset function to On or Off. The value of Freq Offset is displayed in the active function block, and can be adjusted, when set to On.

The frequency offset must be restricted to operate within the range of the source minimum and maximum frequencies.

Key Path	Source, Frequency
Mode	SA
Scope	Mode Global
Remote Command	:SOURce:FREQuency:OFFSet <freq> :SOURce:FREQuency:OFFSet? :SOURce:FREQuency:OFFSet:STATe ON OFF 1 0 :SOURce:FREQuency:OFFSet:STATe?
Example	:SOUR:FREQ:OFFS 10MHz Sets the source frequency offset to 10MHz.
Dependencies	If the currently selected source does not support this capability (for example, an internal Tracking Generator which must track the LO), this key is forced to its Preset value and grayed out
Preset	This is unaffected by Mode Preset but is set to 0.00Hz on a Source Preset or Restore Input/Output Defaults.
State Saved	Part of the Input/Output system, which means it is loaded and saved with state
Min	-500 GHz
Max	500 GHz
Backwards Compatibility SCPI	:SOURce:EXTernal:SWEEp:OFFSet:FREQuency <freq> :SOURce:EXTernal:SWEEp:OFFSet:FREQuency? The PSA option 215 supports this SCPI command. This command is equivalent to :SOURce:FREQuency:OFFSet
Initial S/W Revision	A.06.01
Modified at S/W Revision	A.10.01

Source Mode

Accesses the Source Mode softkey menu. This menu lets you select Tracking mode for the Source, and also allows you to set the Source Mode to OFF.

The Source Mode can be set to Tracking without the user setting it directly. There are several couplings that cause Source Mode to be automatically set to Tracking (detailed in the table below). One important coupling is that Source Mode is forced to Tracking when the RF Output is turned on if the measurement supports Tracking. Since Source Mode is set to Off on a Mode Preset, this means that you will rarely need to change the Source Mode setting directly.

NOTE

When the Source Mode is set to Tracking, the analyzer acquires control of the source. When this happens the source is told to save its state and then perform a preset. Usually both of these operations take very little time; however, on an N5172B or an N5182B, if many Source real-time apps are in use, both save and preset can take many seconds. If it takes longer than the analyzer expects to acquire control, you will see an error: “Source connection lost, check interface connection”. If you see this error, and you are using an N5172B or an N5182B, you can shorten the acquire time by presetting your MXG before attempting to use External Source Control.

Key Path	Source
Scope	Meas Global
Remote Command	:INSTrument:SOURce[:SElect] TRACKing OFF :INSTrument:SOURce[:SElect]?
Example	:INST:SOUR TRAC
Dependencies	<p>Grayed out if no Source is selected, in this case go to the Select Source menu to choose, configure and/or verify your source</p> <p>Grayed out and forced to Off if either BBIQ or External Mixing are selected</p> <p>Blanked in Modes that do not support a source</p> <p>Grayed out in Measurements that do not support a source</p> <p>Tracking is grayed out when Manual FFT is selected</p> <p>Tracking is grayed out when the RF Preselector is on (in models which support the RF Preselector).</p>
Couplings	<p>When RF Output is turned On, Source Mode is set to Tracking. When Source Mode is turned Off, RF Output is turned Off.</p> <p>Whenever you switch to an application (Mode) in which the Source Mode was previously set to Tracking, it is again set to Tracking. That is, the last setting of the Source Mode is remembered when you leave an application (Mode) and restored when you return</p> <p>Source Mode is forced to Tracking when the RF Output is turned on if the measurement supports Tracking</p> <p>If Source Mode is set to Tracking, then it is forced to Off when you select a measurement that does not support Tracking.</p> <p>If Source Mode is set to Tracking, then it is forced to Off when you turn on the RF Preselector (in models which support the RF Preselector).</p> <p>Whenever the Source Mode is set to Tracking, the analyzer acquires the Source. Similarly, the Source is released whenever the Source Mode is set to Off. This is true whether the Source Mode was set directly by you, was set indirectly through a coupling, if you switched to an application (Mode) that had previously been set to Tracking, or if you switched to an application (Mode) in which the Source Mode is not set to Tracking.</p>

For an external source, “acquiring the source” involves contacting the external instrument over the remote interface (which puts it into Remote) and taking control of it.

When you set the Source Mode to OFF, it releases the Source (and puts it into Local). For an external source, this means you are now free to operate the source for other purposes.

When the Source is acquired, its previous state is saved, and when it is released, that state is restored, so that you can acquire and then release the source and it will return to the state it was in before you acquired it.

Preset	OFF
State Saved	Saved in instrument state
Initial S/W Revision	A.06.01
Modified at S/W Revision	A.10.01

Select Source

The Select Source menu allows you to maintain a list of available external Sources, and choose the Source that you want to use from the list. It shows the currently selected source at the bottom of the screen.

While in the Select Source menu, you can see, and select from, a list of the currently available sources. The sources listed in this table are as follows:

- Any internal sources which are installed and licensed

NOTE

Only one internal source can be installed, displayed at address “INTERNAL”

- Any external sources which you have previously configured, whether or not they are currently connected, displayed with their VISA address

Note that only external sources that are supported by the Tracking Source Mode are displayed in the Available Source List. Here are the Keysight/Agilent sources currently supported:

Source	PXA	MXA	EXA	CXA	MXE (Presel off)
MXG N5181A	X	X	X	X	X
MXG N5182A	X	X	X	X	X
MXG N5183A	X	X	X		X
EXG N5171B	X	X	X	X	X
MXG N5181B	X	X	X	X	X
EXG	X	X	X	X	X

N5172B					
EXG	X	X	X	X	X
N5173B					
MXG	X	X	X	X	X
N5182B					
MXG	X	X	X	X	X
N5183B					
PSG	X	X	X		
E8257D					
PSG	X	X	X		
E8267D					

NOTE

For X-Series software versions earlier than A.10.01, option UNZ (Fast switching) was required on the MXG for some use cases. This is no longer the case, option ESC now works without MXG option UNZ for all use cases. (Note that you will get better performance if your MXG has option UNZ, because without option UNZ your sweep speeds will be noticeably slower.)

While in the Select Source menu and its submenus, detailed instructions are presented that tell you how to operate the Select Source functions. Basically they tell you to first use the up and down arrow keys to move the selection highlighted in the “Available Source List” to the source that you want to use. The list of available sources includes any sources that you have previously used (unless you have deleted them) and any found while in the “Add Source to List” menu.

When the source you want to use is highlighted, press “Select Highlighted Source” or “Enter”. The source you have selected shows up at the bottom of the screen as the “Current Source”. Press “Verify Current Source Connection” to make sure that the interface connection to the Source is still functional.

At any time you may use the “Add Source to List” or “Delete Highlighted Source” keys to find new sources or remove a source from the list of available sources.

Key Path	Source
Readback Text	Two lines of readback give the type information and serial number of the current source, in square brackets
Initial S/W Revision	A.06.01

Select Highlighted Source

You can navigate up and down in the list with the up and down arrow keys, and can select any entry by pressing the Select Highlighted Source key (or by double-clicking on the entry in the table with a mouse). The highlighted source becomes the Current Source and is prominently displayed at the bottom of the screen.

At any given time there is only one selected Source for the entire system; once a Source is selected, it becomes the Current Source and will be used by all applications that support Source Control.

For example, if no Source has yet been selected, the statement at the bottom of the screen would say

Current Source

None

If an N5182A connected via USB were the Current Source, the statement at the bottom of the screen might say:

Current Source

Agilent N5182A US00000258 at USB0::2931::7937::US00000258::0::INSTR

The SCPI command defined below allows the programmatic user to directly define the VISA address via a string parameter. The parameter is checked for proper syntax, the connection to the instrument is verified, and the source is added to the Available Source List if it verifies. If it does not verify or no source is found at that address, an error message is generated.

Normally the source selection activities should be performed only when the user changes the hardware connection configuration or activates/deactivates a source option license; shutdown and startup of the application will not cause source re-selection.

The Agilent IO Libraries Suite provides an “Agilent VISA Help” document that has a section that shows the proper syntax for valid VISA address strings, in the ViOpen function definition.

Key Path	Source, Select Source
Mode	SA
Remote Command	:SYSTem:COMMunicate:SOURce[1]:ADDRess <address string> :SYSTem:COMMunicate:SOURce[1]:ADDRess?
Example	Different examples for setting external source address :SYST:COMM:SOUR:ADDR "TCPIP0::MyHostName::INSTR" :SYST:COMM:SOUR:ADDR "TCPIP0::123.121.100.210::INSTR" :SYST:COMM:SOUR:ADDR "USB0::12212::32145::US1234567A::INSTR" :SYST:COMM:SOUR:ADDR "GPIB1::19::INSTR"
Notes	Empty string is allowed and means no source is defined or selected.
Remote Command Notes	The address string is the VISA address for external sources and "INTERNAL" for an internal source
Dependencies	Operation with a source requires a license. If the proper license is not installed, the SCPI command generates an error message, "Settings conflict;option not installed" If no supported source, or no source at all, is found at the specified address, the SCPI command generates an error message
Preset	The current source selection is unaffected by a Mode Preset and Source Preset but reverts to

	[None] on a Restore Input/Output Defaults. If an internal Tracking Generator is installed, then instead of None, the default selection will be INTERNAL.
State Saved	Selected Source is <ul style="list-style-type: none"> - Power On Persistent (survives power cycle) - Part of the Input/Output system, which means it is Loaded and Saved with state.
Readback	Two lines of readback give the type information and serial number of the current source on the Select Source key in the form [<source type>] [<serial number>] [None] shows in the type area and blank in the serial number area if a source has not been configured. [Internal TG] shows in type area and serial number in the serial number area if an internal Tracking Generator has been selected. For example: [MXG]/n, [US01020022]. This indicates an MXG of serial number US01020022.
Backwards Compatibility SCPI	:SYSTem:COMMunicate:LAN:SOURce[:EXTernal]:IP <address string> :SYSTem:COMMunicate:LAN:SOURce[:EXTernal]:IP? This command is provided for compatibility with PSA Option 215. The address string is reformatted for the X-Series. For example, if the customer sends :SYSTem:COMMunicate:LAN:SOURce:EXTernal:IP 146.208.172.111 The analyzer turns this into :SYSTem:COMMunicate:SOURce:ADDRess "TCPIP0::146.208.172.111::INSTR"
Initial S/W Revision	A.06.01
Modified at S/W Revision	A.10.01

Delete Highlighted Source

Deletes the highlighted source from the list of available sources. You will be prompted with a dialog box to make sure you REALLY want to do this. The prompt says "The highlighted source will be permanently deleted from the list. Are you sure you want to do this? Press Enter to proceed, or Cancel (ESC) to cancel."

Key Path	Source, Select Source
Initial S/W Revision	A.06.01

Add Source To List

This menu allows you to add to the list of available sources from various interfaces.

Key Path	Source, Select Source
Initial S/W Revision	A.06.01

USB

Sources on USB (once installed) can be added to the list by pressing “Add Installed USB Sources.” Any supported source found will be added to the list.

See ["Add Installed USB Sources" on page 3259](#) for information on connecting and installing USB devices.

Key Path	Source, Select Source, Add Source to List
Initial S/W Revision	A.06.01

Add Installed USB Sources

Press this key to add USB sources to the Available Source List. Note that this function will ONLY find sources that have previously been installed onto the USB. For information on how to install a USB source, see ["Installing a USB source" on page 3058](#)

Key Path	Source, Select Source, Add Source to List, USB
Notes	If no installed USB device is found which is a supported source, an error message is generated
Initial S/W Revision	A.06.01

Installing a USB source

USB is the only interface which requires no runtime action by the user in the Select Source menu, but does require “installation” when a source is plugged in.

You start by connecting the USB source to the analyzer. You will get a series of messages indicating that the analyzer is installing required device software.

When the installation is complete, you will get a message to that effect. You can then use the “Add Installed USB Sources” function (above) to add the source to the list of sources in the Available Source List.

GPIB

Lets you add GPIB sources to the Available Source List.

For the GPIB interface to work properly, it must be configured as a Controller. You can find this setting in the System menu under System, I/O Config, GPIB. Set the GPIB Controller function to Enabled.

Note that you must also make sure that the GPIB interface is not set to “Ignore” in the Agilent Connection Expert. If it is set to **Ignore**, then even if the GPIB Controller is set to **Enabled**, it is not possible for the analyzer to find a GPIB connected source. See ["More Information" on page 3058](#).

Key Path	Source, Select Source, Add Source to List
Initial S/W Revision	A.06.01

More Information

If you suspect that the GPIB interface is not set to Ignore, run the Agilent Connection Expert (ACE). To run ACE, press Source, Select Source, Add Source to List, LAN, Run Connection Expert. Look for the GPIB branch on the interface tree:

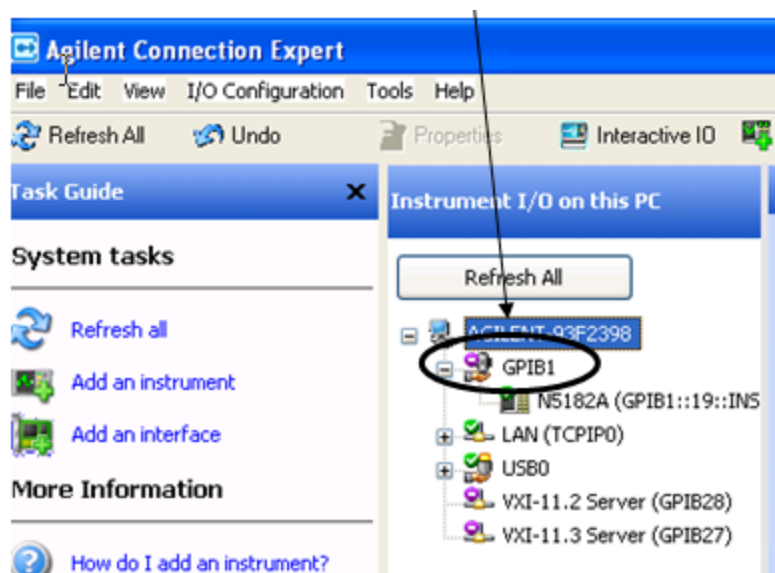

Right click on the GPIB branch (you will have to plug in a mouse to do this). You should see a dialog like the one below. If this dialog says **Stop Ignoring**, select **Stop Ignoring** and close ACE.

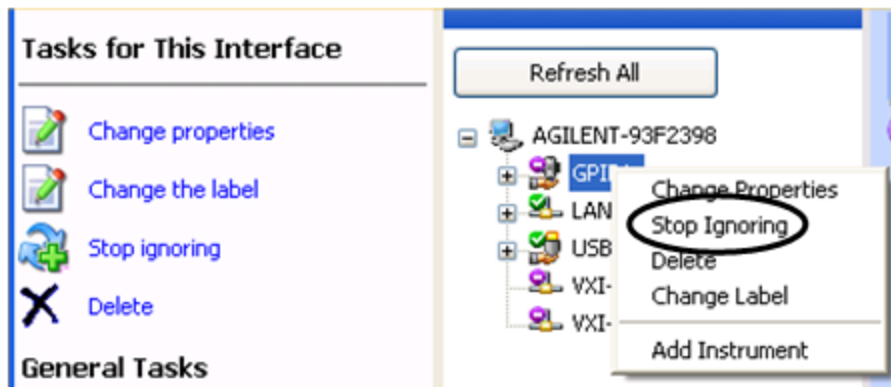

Scan & Add GPIB Sources

Sources on GPIB can be added by pressing **Scan & Add GPIB Sources**. Any supported source found will be added to the Available Source List.

NOTE

This will cause any older, non-SCPI compatible devices on your GPIB to generate error messages.

Key Path	Source, Select Source, Add Source to List, GPIB
Notes	If the GPIB controller mode is not enabled, an error message is generated If no GPIB device is found which is a supported source, an error message is generated
Initial S/W Revision	A.06.01

Enter GPIB Address

Opens a menu that lets you enter the GPIB address of the desired source directly.

NOTE

For this to work properly, the GPIB interface must be configured as GPIB1. This is the default state and should normally be the case. To see how to verify this, see **"More Information"** on page 3060.

Key Path	Source, Select Source, Add Source to List, GPIB
Initial S/W Revision	A.06.01

More Information

If you suspect that the GPIB interface is not set to GPIB1, run the Agilent Connection Expert (ACE). To run ACE, press Source, Select Source, Add Source to List, LAN, Run Connection Expert. Look for the GPIB branch on the interface tree:

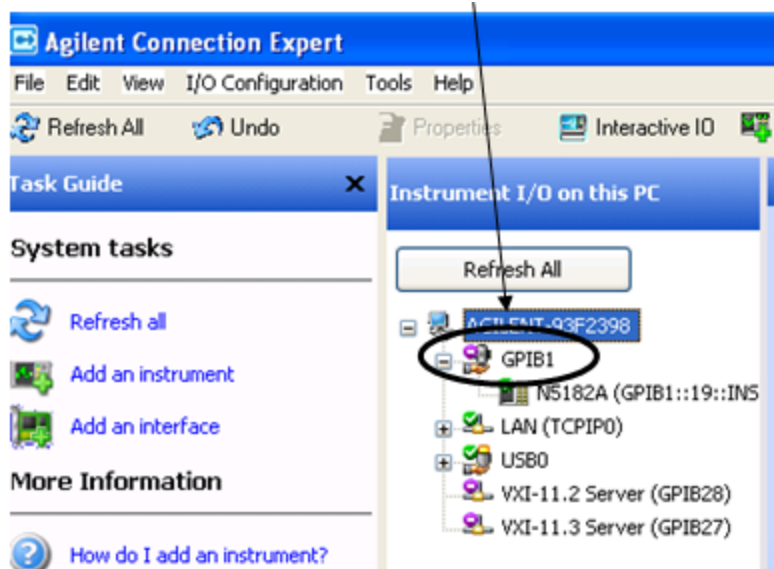

If this branch is not labeled **GPIB1**, right click on the GPIB branch (you will have to plug in a mouse to do this) and select **Change Properties**.

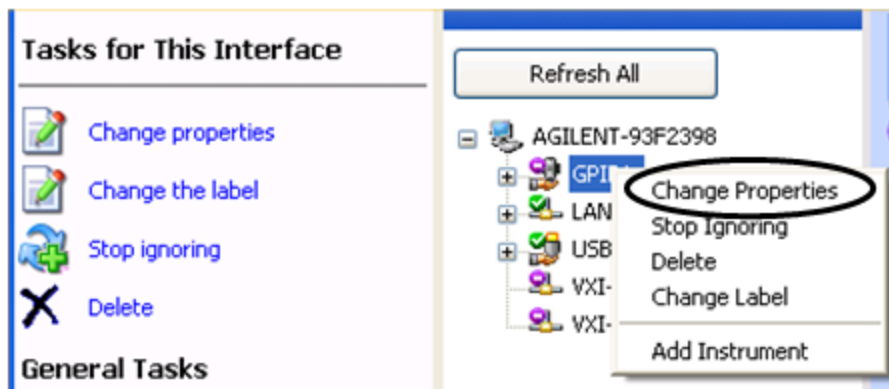

You should see a dialog like the one below. Click on the drop-down arrow under **VISA Interface ID**, select **GPIB1** and click **OK**

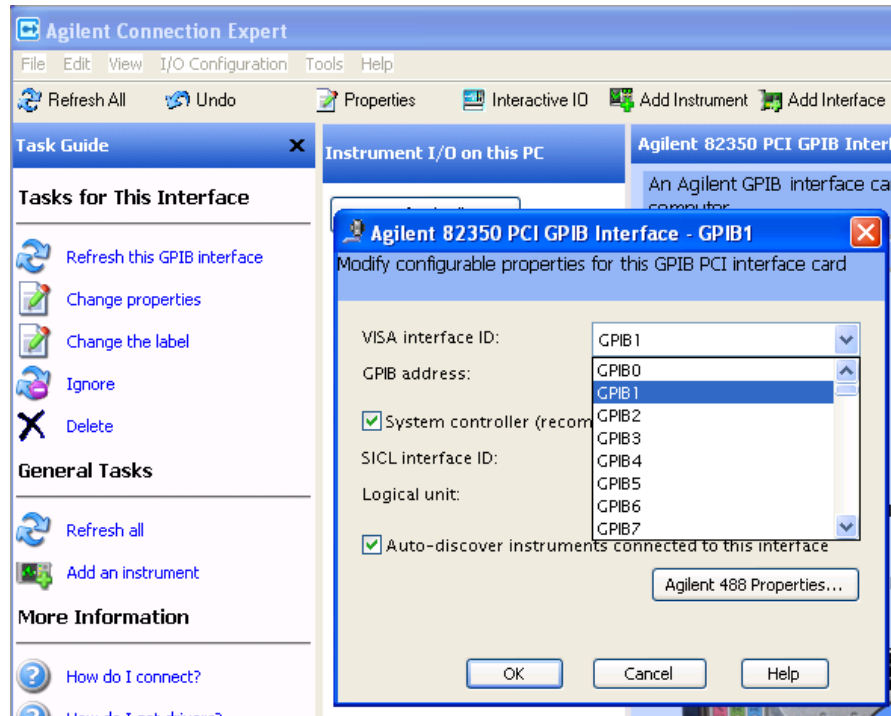

GPIB Address

Lets you enter the GPIB address. After you enter the address press **Add** to add the source at that address to the Available Source List.

Key Path	Source, Select Source, Add Source to List, GPIB, Enter GPIB Address
Preset	Unaffected by Mode Preset but set to 19 by "Restore Input/Output defaults"
State Saved	No
Min	0
Max	30
Initial S/W Revision	A.06.01

Add

Add the source at the entered GPIB address to the Available Source List. If a supported source is found at that address it will be added to the list.

Key Path	Source, Select Source, Add Source to List, GPIB, Enter GPIB Address
Notes	If GPIB controller mode is not enabled, an error message is generated If no supported source is found at the specified address, an error message is generated
Initial S/W Revision	A.06.01

LAN

The LAN cannot be scanned directly from the analyzer software, but you can import the list of currently configured devices from Agilent Connection Expert by pressing

“Add From Connection Expert List.” The Connection Expert list depends on which instruments have already been discovered by the Agilent Connection Expert application. Any connected, supported sources in that list will be added.

You can also enter the IP address and press “Add”. If a supported source is found at that address it will be added.

If you want to discover sources on the LAN, you can open Connection Expert by pressing the “Run Connection Expert...” softkey.

Key Path	Source, Select Source, Add Source to List
Initial S/W Revision	A.06.01

Enter LAN Address

Opens up a menu which lets you enter the IP address of the desired source directly.

Key Path	Source, Select Source, Add Source to List, LAN
Initial S/W Revision	A.06.01

IP Address

Lets you enter the IP address of the desired source. After you enter the address you should press “Add” to add the source at that address to the Available Source List.

Key Path	Source
Preset	Unaffected by Mode Preset but set to 0.0.0.0 by Restore Input/Output defaults
State Saved	No
Initial S/W Revision	A.06.01

Add

Adds the source at the entered IP address to the Available Source List. If a supported source is found at that address it will be added to the list.

Key Path	Source
Notes	If no supported source is found at the specified address, an error message is generated
Initial S/W Revision	A.06.01

Run Connection Expert...

Runs the Agilent Connection Expert so that you can scan the LAN for sources.

Key Path	Source, Select Source, Add Source to List, LAN
Initial S/W Revision	A.06.01

Add From Connection Expert List

You can import the list of currently configured devices from Agilent Connection Expert by pressing **Add From Connection Expert List**. The Connection Expert list depends on which instruments have already been discovered by the Agilent Connection Expert application. Any connected, supported sources in that list will be added.

Key Path	Source, Select Source, Add Source to List, LAN
Notes	If no supported source is found in the Connection Expert list, an error message is generated
Initial S/W Revision	A.06.01

Verify Current Source Connection

This key verifies the interface connection to the Current Source (it does NOT verify any signal connections!)

Until the selected source is verified, a statement appears at the bottom of the screen which says (in red):

This Source has not been verified. Press "Verify Source" to check the interface connection.

When you press this key, the connection is checked to the selected source. If all is well, the statement is changed to (in green):

This connection to this source has been verified.

If the verification fails, the statement at the bottom will change to (in red):

Verification of this source failed. Check the interface connection

The selected source is also verified whenever it is acquired. If a Source's connection has been verified by any means, then that Source is considered to have been verified until either the analyzer software is shut down or if, in attempting to use the Source, communication with it fails.

Key Path	Source, Select Source
Initial S/W Revision	A.06.01

Source Setup

This menu is used to set up miscellaneous source functions, including trigger settings. For more on triggering in Tracking Mode, see ["Tracking Setup Details" on page 3064](#). For information on bypassing the Microwave Preselector, see ["Use of the YTF \(Microwave or mm Preselector\) with External Source Control" on page 3065](#)

Key Path	Source
Mode	SA
Initial S/W Revision	A.06.01

Tracking Setup Details

When an external source is operating in Tracking Mode, operation can be greatly enhanced by using hardware triggers. Below is a typical connection diagram showing a hardware handshake using Trigger 1 inputs and outputs on the analyzer (trigger 2 in and out is also a valid connection).

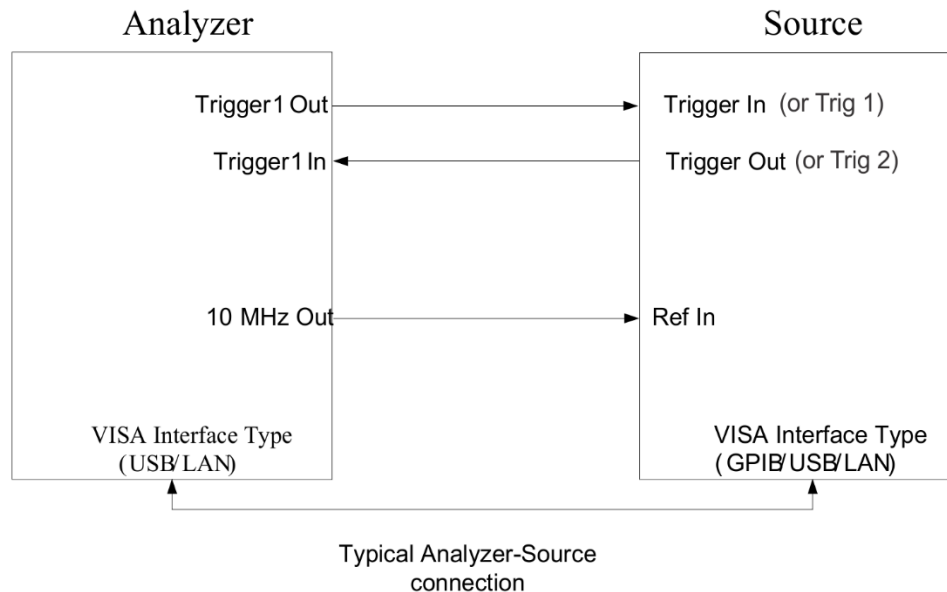

Analyzer Trigger 1 Out: Triggers the external source to step to next point in the frequency step/list.

Analyzer Trigger 1 In: Triggers the analyzer to make a measurement on this point

Source Trigger In (or “Trig 1” at default setting for N5181B/82B, N5183B MXG or N5171B/72B, N5173B EXG):

Triggers the source to step to the next point.

Source Trigger Out (or “Trig 2” at default setting for N5181B/82B, N5183B MXG or N5171B/72B, N5173B EXG): Indicates that the source has settled.

IO interface Connection: analyzer can connect to sources with its GPIB, USB or LAN interface.

Notes:

- Trigger sync connections are optional – synchronization can be done via remote commands if Bus Trigger is enabled in the Source Setup menu.
- Connection from the SA external frequency reference output to the source frequency reference input (10 MHz Out to Ref In) is not required, but may improve the measurement accuracy.

Use of the YTF (Microwave or mm Preselector) with External Source Control

In most stimulus/response measurements that utilize External Source Control, the source exactly tracks the tuned analyzer frequency. Consequently, preselection is not needed, and you can achieve greatly superior amplitude accuracy and repeatability by bypassing the YTF (Preselector) using the Microwave Preselector Bypass control in the Amplitude, μ W Path Control menu.

NOTE

This control is only available if option MPB is installed.

There are rare but important cases, however, where the source is tuned to a different frequency than the analyzer, using the Multiplier and Reverse controls in the Source, Frequency menu. For example, you might be tuning the source to $\frac{1}{2}$ of the analyzer frequency when looking at second harmonic distortion in a DUT. In these cases, it would be commonplace for there to be an undesired signal at the analyzer input that is at an image frequency that you will want to reject with the YTF.

Understanding these cases is important for proper operation of the Microwave Preselector with External Source Control, so that you only bypass it when it will improve accuracy but not hinder the measurement.

Point Trigger

Shows point trigger type selected and navigates to the Point Trigger menu.

The Point Trigger menu lists all analyzer point trigger types. The analyzer and source point trigger synchronization can be done using SCPI bus commands or by using external trigger output and input lines.

NOTE

For X-Series software versions earlier than A.10.01, hardware triggering was unavailable in stepped tracking at frequencies above 3.6 GHz, so above 3.6 GHz, software triggering was always used. This is no longer the case.

Key Path	Source, Source Setup
Mode	SA
Scope	Mode Global
Remote Command	:SOURce:TRIGger:TYPE BUS EXTernal[1] EXTernal2 :SOURce:TRIGger:TYPE?
Example	:SOUR:TRIG:TYPE EXT1 Selects analyzer external trigger 1 in and out for point trigger synchronization with selected source
Dependencies	If an internal Tracking Generator is selected, then this menu is unavailable, Additionally, the External 1 and External 2 Trigger keys on the Spectrum Analyzer are released from any grayout that may have been forced on them by the external source Point Trigger selection. In some models, there is no second External input. In these models, the External 2 key is blanked and the EXTernal2 parameter will generate a "Hardware missing; Not available for this model number" message.
Couplings	The source control point trigger selection can select external trigger 1 or 2 in for synchronized point triggering. This can conflict with the selection under the Trigger hardkey, if it has External 1 or 2 selected. If there is a conflict when the selection is made under the Point Trigger menu, the

	Trigger selection under the Trigger hardkey will be changed to Free Run.
Preset	This is unaffected by "Mode Preset" but is set to EXTERNAL1 on a "Source Preset" or "Restore Input/Output Defaults".
State Saved	Part of the Input/Output system, which means it is Loaded and Saved with state
Readback	1-of-N selection
Initial S/W Revision	A.06.01

SW Trigger

Analyzer and source point trigger synchronization is setup using the SCPI commands. Source is stepped via SCPI commands. Analyzer waits for source to settle by polling source.

Key Path	Source, Source Setup, Point Trigger
Mode	SA
Example	:SOUR:TRIG:TYPE BUS
Readback	SW Trigger
Initial S/W Revision	A.06.01

Ext Trigger 1

Analyzer and source point trigger synchronization is setup using the analyzer Trigger 1 Output and Trigger 1 Input. The Source is stepped via Trigger 1 Output. The Analyzer waits for source to settle via Trigger 1 Input.

Key Path	Source, Source Setup, Point Trigger
Mode	SA
Example	:SOUR:TRIG:TYP EXT1
Couplings	<p>With an acquired source, selecting this point trigger mode overrides existing external trigger 1 output level, slope, and delay, and external trigger 1 type and polarity.</p> <p>External trigger 1 input level = 1.20 V</p> <p>External trigger 1 input slope = Positive</p> <p>External trigger 1 input delay = Off</p> <p>External trigger 1 output type = Source Point Trigger</p> <p>External trigger 1 output polarity = Positive</p> <p>When this selection is made:</p> <ul style="list-style-type: none"> - The External 1 key in the Trigger menu (under the Trigger hardkey) is grayed out and, if External 1 was previously selected, it will be changed to Free Run. - Trig 1 Out selected under Output Config in the Input/Output menu will be changed to Source Point Trigger <p>If the user subsequently goes into the Trig 1 Out menu and selects a different Trigger Output, the Point Trigger will revert to SW Trigger.</p>

Readback	Ext Trigger 1
Initial S/W Revision	A.06.01

Ext Trigger 2

Analyzer and source point trigger synchronization is setup using the analyzer Trigger 2 Output and Trigger 2 Input. The Source is stepped via Trigger 2 Output. The Analyzer waits for source to settle via Trigger 2 Input.

Key Path	Source, Source Setup, Point Trigger
Mode	SA
Example	:SOUR:TRIG:TYP EXT2
Dependencies	This key is blanked out on CXA as there is only one trigger input
Couplings	<p>With an acquired source, selecting this point trigger mode overrides existing external trigger 2 output level, slope, and delay, and external trigger 2 type and polarity.</p> <p>External trigger 2 input level = 1.20 V External trigger 2 input slope = Positive External trigger 2 input delay = Off External trigger 2 output type = Source Point Trigger External trigger 2 output polarity = Positive</p> <p>When this selection is made:</p> <ul style="list-style-type: none"> - The External 2 key in the Trigger menu (under the Trigger hardkey) is grayed out and, if External 2 was previously selected, it will be changed to Free Run. - Trig 2 Out selected under Output Config in the Input/Output menu will be changed to Source Point Trigger - If the user subsequently goes into the Trig 2 Out menu and selects a different Trigger Output, the Point Trigger will revert to SW Trigger.
Readback	Ext Trigger 2
Initial S/W Revision	A.06.01

Show Source Capabilities & Settings

Shows the capabilities of the currently selected Source. The menu is useful for displaying source capabilities such as frequency and amplitude ranges. In addition, the results of the source control sweep algorithms can be viewed. This gives information of the source range required for a given analyzer sweep range. This can be used dynamically as a way of configuring the sweep settings.

Key Path	Source, Source Setup
Mode	SA
Dependencies	If no source is selected this key is grayed out.
Initial S/W Revision	A.06.01

Source Preset

The Source Preset key forces all the settings in the analyzer's Source State to their preset condition.

The Source State is the set of Source settings that is maintained and remembered by the analyzer for use in the Tracking Source Mode. The Source State variables are controlled and set in the menus under the Source front panel key. These settings include:

- RF Output Off
- Amplitude = - 10 dBm
- Amplitude Step = Auto
- Power Sweep = 0 dB
- Amplitude Offset = 0 dB
- Source Sweep Reverse = Off
- Multiplier Numerator = 1
- Multiplier Denominator = 1
- Freq Offset = 0 Hz
- Point trigger is set to "Ext1"

The Source State is saved along with the state of the current Mode when you save a State, and is recalled when that Mode State is recalled.

When the analyzer first starts up, a Source Preset is performed. In the Input/Output menu, Restore Input/Output Defaults will also perform a Source Preset.

A Mode Preset, from modes that support the External Source, will turn the RF Off but will **not** perform a Source Preset. By the same token, Source Preset does **not** perform a Mode Preset.

Source Preset does **not** change the Source Mode nor the selection of which physical source is being used, nor does it release the current source (the source remains under the control of the analyzer) nor exit the Source menu.

Key Path	Source
Mode	SA
Remote Command	:SOURce:PRESet
Example	:SOUR:PRES
Preset	Initiates a Source Preset
State Saved	No
Initial S/W Revision	A.06.01

SPAN X Scale

The Span key activates the Span function and displays the menu of span functions.

Key Path	Front-panel key
Initial S/W Revision	Prior to A.02.00

Span

Changes the displayed frequency range symmetrically about the center frequency. While adjusting the Span the Center Frequency is held constant.

Span also sets the frequency entry mode to Center/Span. In Center/Span mode, the center frequency and span values are displayed below the graticule, and the default active function in the Frequency menu is Center Freq.

Key Path	SPAN X Scale
Remote Command	[:SENSe] : TOI : FREQuency : SPAN <freq> [:SENSe] : TOI : FREQuency : SPAN?
Example	TOI:FREQ:SPAN 26.490000 GHz
Notes	Forces measurement restart.
Couplings	<p>If the electrical attenuator is enabled, any attempt to set Span such that the Stop Frequency would be >3.6 GHz results in an error. If the key is pressed, an advisory message is generated. If the equivalent SCPI command is sent, this same message is generated as part of a “-221, Settings conflict” warning.</p> <p>Any value of the Center Frequency or Span that is within the frequency range of the analyzer is allowed when the value is being set through the front panel numeric key pad or the SCPI command. The other parameter is forced to a different value if needed, to keep the Start and the Stop Frequencies within the analyzer’s frequency range</p> <p>When using the knob or the step up/down keys or the UP DOWN keywords in SCPI, the value that is being changed i.e. the Center Frequency or Span, is limited so that the other parameter is not forced to a new value.</p>
Preset	The instrument maximum frequency minus 10 MHz.
Min	10 Hz
Max	Maximum span depends upon the instrument frequency range.
Backwards Compatibility SCPI	[:SENSe] : TOI ntercept : FREQuency : SPAN
Initial S/W Revision	Prior to A.02.00

Sweep/Control

Accesses a menu that allows you to set the measurement Sweep parameters.

Key Path	Front-panel key
Initial S/W Revision	Prior to A.02.00

Sweep Time

Selects the length of time in which the spectrum analyzer sweeps when measuring the span. Additional overhead time is required by the analyzer that impacts the sweep rate, but is not calculated as part of the sweep time.

Reducing the sweep time increases the rate of sweeps.

Key Path	Sweep/ Control
Remote Command	<code>[:SENSe] : TOI : SWEEp : TIME <time></code> <code>[:SENSe] : TOI : SWEEp : TIME ?</code> <code>[:SENSe] : TOI : SWEEp : TIME : AUTO OFF ON 0 1</code> <code>[:SENSe] : TOI : SWEEp : TIME : AUTO ?</code>
Example	TOI:SWE:TIME 1ms sets the sweep time to 1ms
Couplings	Sweep time is coupled to RBW and VBW, and impacted by the number of sweep points.
Preset	Depends upon the maximum span of the analyzer, 66.27 is the preset in a 26.5 GHz MXA
Min	1 ms
Max	4000 s
Initial S/W Revision	Prior to A.02.00

Sweep Points

Sets the number of measured points in each sweep.

Key Path	Sweep/ Control
Remote Command	<code>[:SENSe] : TOI : SWEEp : POINts <integer></code> <code>[:SENSe] : TOI : SWEEp : POINts ?</code>
Example	TOI:SWE:POIN 1001
Notes	Forces measurement restart.
Couplings	The resolution of setting the sweep time depends on the number of points selected. When the sweep points change, erase the trace data.
Preset	1001

16 TOI Measurement
Sweep/Control

Min	1
Max	40001
Initial S/W Revision	Prior to A.02.00

System

See "System" on page 431

Trace/Detector

This key enables selection of trace max hold characteristics.

Key Path	Front-panel key
Remote Command	TRACe:TOI:TYPE WRITe MAXHoId
Preset	The trace is set to Clear Write
Initial S/W Revision	Prior to A.02.00

Clear Write

In Clear Write type each trace update replaces the old data in the trace with new data. Pressing the Clear

Write key, or sending the TRAC:TOI:TYPE WRIT command, sets the trace type to Clear Write.

When in Clear Write, if a measurement-related instrument setting is changed when the instrument is sweeping, a new sweep is initiated but the trace is not cleared. While the sweep always uses the peak detector, in zero-span measurement the average detector is used and the metrics are calculated using the average of the zero-span data.

Key Path	Trace/Detector
Example	TRAC:TOI:TYPE WRIT sets the trace to clear write
Couplings	Selects the average detector, and uses the average value for zero-span measurements.
Initial S/W Revision	Prior to A.02.00

Max Hold

Max Hold makes the trace represent the maximum data value on a point-by-point basis of the new trace data and the previous trace data. Max hold enables a simplified (albeit lower-speed) measurement of the TOI of a pulsed signal.

Pressing the Max Hold key, or sending the :TRAC:TOI:TYPE MAXH command, sets the trace type to Max Hold. The max hold trace uses peak detection; in zero-span measurement the metrics are calculated using the peak value of the zero-span data.

When in Max Hold, if a measurement-related instrument setting is changed, the Max Hold sequence restarts and a new sweep is initiated but the trace is not cleared.

Key Path	Trace/Detector
Example	TRAC:TOI:TYPE MAXHold sets the trace to max hold

Couplings	Selects the peak detector, and uses the peak value for zero-span measurements.
Initial S/W Revision	Prior to A.02.00

Trigger

See ["Trigger" on page 529](#)

Free Run

See ["Free Run " on page 537](#)

Video

See ["Video \(IF Envelope\) " on page 538](#)

Trigger Level

See ["Trigger Level" on page 538](#)

Trig Slope

See ["Trig Slope" on page 539](#)

Trig Delay

See ["Trig Delay" on page 540](#)

X Axis Relative to Trigger

See ["X Axis Relative to Trigger" on page 583](#)

Line

See ["Line" on page 2814](#)

Trig Slope

See ["Trig Slope" on page 2814](#)

Trig Delay

See ["Trig Delay" on page 543](#)

X Axis Relative to Trigger

See ["X Axis Relative to Trigger" on page 583](#)

External 1

See ["External 1" on page 2828](#)

Trigger Level

See ["Trigger Level" on page 2828](#)

Trig Slope

See ["Trig Slope" on page 2829](#)

Trig Delay

See ["Trig Delay" on page 546](#)

X Axis Relative to Trigger

See ["X Axis Relative to Trigger" on page 583](#)

Zero Span Delay Comp

See ["Zero Span Delay Comp On/Off " on page 2816](#)

External 2

See ["External 2 " on page 2829](#)

Trigger Level

See ["Trigger Level" on page 2830](#)

Trig Slope

See ["Trig Slope" on page 2831](#)

Trig Delay

See ["Trig Delay " on page 549](#)

X Axis Relative to Trigger

See ["X Axis Relative to Trigger" on page 583](#)

Zero Span Delay Comp

See ["Zero Span Delay Comp On/Off" on page 2818](#)

RF Burst

See ["RF Burst" on page 2831](#)

Absolute Trigger

See ["Absolute Trigger Level" on page 2832](#)

Relative Trigger

See ["Relative Trigger Level" on page 2833](#)

Trig Slope

See ["Trigger Slope" on page 2834](#)

Trig Delay

See ["Trig Delay" on page 554](#)

X Axis Relative to Trigger

See ["X Axis Relative to Trigger" on page 583](#)

Zero Span Delay Comp

See ["Zero Span Delay Comp On/Off" on page 2834](#)

Periodic Timer

See ["Periodic Timer \(Frame Trigger\)" on page 2823](#)

Period

See ["Period" on page 2824](#)

Offset

See ["Offset" on page 2825](#)

Offset Adjust (Remote Command Only)

See ["Offset Adjust \(Remote Command Only\)" on page 2826](#)

Reset Offset Display

See ["Reset Offset Display" on page 2827](#)

Sync Source

See ["Sync Source" on page 2827](#)

Off

See ["Off" on page 2828](#)

External 1

See ["External 1" on page 2828](#)

Trigger Level

See ["Trigger Level" on page 2828](#)

Trig Slope

See ["Trig Slope" on page 2829](#)

External 2

See ["External 2 " on page 2829](#)

Trigger Level

See ["Trigger Level" on page 2830](#)

Trig Slope

See ["Trig Slope" on page 2831](#)

RF Burst

See ["RF Burst" on page 2831](#)

Absolute Trigger

See ["Absolute Trigger Level" on page 2832](#)

Relative Trigger

See ["Relative Trigger Level" on page 2833](#)

Trig Slope

See ["Trigger Slope" on page 2834](#)

Zero Span Delay Comp

See ["Zero Span Delay Comp On/Off" on page 2834](#)

Trig Delay

See ["Trig Delay" on page 568](#)

X Axis Relative to Trigger

See ["X Axis Relative to Trigger" on page 583](#)

Sync Holdoff

See ["Sync Holdoff" on page 1289](#)

Baseband I/Q

See ["Baseband I/Q " on page 570](#)

I/Q Mag

See ["I/Q Mag" on page 570](#)

Trigger Level

See ["Trigger Level" on page 570](#)

Trig Slope

See ["Trig Slope" on page 571](#)

Trig Delay

See ["Trig Delay" on page 571](#)

X Axis Relative to Trigger

See ["X Axis Relative to Trigger" on page 583](#)

I (Demodulated)

See ["I \(Demodulated\)" on page 572](#)

Trigger Level

See ["Trigger Level" on page 573](#)

Trig Slope

See ["Trig Slope" on page 573](#)

Trig Delay

See ["Trig Delay" on page 573](#)

X Axis Relative to Trigger

See ["X Axis Relative to Trigger" on page 583](#)

Q (Demodulated)

See ["Q \(Demodulated\)" on page 575](#)

Trigger Level

See ["Trigger Level" on page 575](#)

Trig Slope

See ["Trig Slope" on page 575](#)

Trig Delay

See ["Trig Delay" on page 576](#)

X Axis Relative to Trigger

See ["X Axis Relative to Trigger" on page 583](#)

Input I

See ["Input I" on page 577](#)

Trigger Level

See ["Trigger Level" on page 577](#)

Trig Slope

See ["Trig Slope" on page 578](#)

Trig Delay

See ["Trig Delay" on page 578](#)

X Axis Relative to Trigger

See ["X Axis Relative to Trigger" on page 583](#)

Input Q

See ["Input Q" on page 579](#)

Trigger Level

See ["Trigger Level" on page 579](#)

Trig Slope

See ["Trig Slope" on page 580](#)

Trig Delay

See ["Trig Delay" on page 580](#)

X Axis Relative to Trigger

See ["X Axis Relative to Trigger" on page 583](#)

Auxiliary Channel I/Q Mag

See ["Auxiliary Channel I/Q Mag" on page 581](#)

Trigger Level

See ["Trigger Level" on page 582](#)

Trig Slope

See ["Trig Slope" on page 582](#)

Trig Delay

See ["Trig Delay" on page 582](#)

X Axis Relative to Trigger

See ["X Axis Relative to Trigger" on page 583](#)

Trigger Center Frequency

See ["Trigger Center Frequency" on page 583](#)

Trigger Bandwidth

See ["Trigger Bandwidth" on page 584](#)

TV

See ["TV" on page 2835](#)

TV Line

See ["TV Line" on page 2836](#)

Field

See ["Field" on page 2836](#)

Entire Frame

See ["Entire Frame" on page 2837](#)

Field One

See ["Field One" on page 2837](#)

Field Two

See ["Field Two" on page 2837](#)

Standard

See ["Standard" on page 2838](#)

NTSC-M

See ["NTSC-M" on page 2838](#)

NTSC-Japan

See ["NTSC-Japan" on page 2839](#)

NTSC-4.43

See ["NTSC-4.43" on page 2839](#)

PAL-M

See ["PAL-M" on page 2839](#)

PAL-N

See ["PAL-N" on page 2839](#)

PAL-N Combin

See ["PAL-N-Combin" on page 2839](#)

PAL-B,D,G,H,I

See ["PAL-B,D,G,H,I" on page 2839](#)

PAL-60

See "PAL-60" on page 2840

SECAM-L

See "SECAM-L" on page 2840

Auto/Holdoff

See "Auto/Holdoff" on page 590

Auto Trig

See "Auto Trig" on page 590

Trig Holdoff

See "Trig Holdoff" on page 591

Holdoff Type

See "Holdoff Type" on page 591

User Preset

Accesses a menu that gives you the following three choices:

- **User Preset** – recalls a state previously saved using the Save User Preset function.
- **User Preset All Modes** – presets all of the modes in the analyzer
- **Save User Preset**– saves the current state for the current mode

Key Path	Front-panel key
Backwards Compatibility Notes	<p>User Preset is actually loading a state, and in legacy analyzers, it was possible to load a state without affecting the trace data, limit lines or correction data. Similarly it was possible to do a User Preset without affecting the trace data, limit lines or correction data.</p> <p>In the X-Series, “state” always includes all of this data; so whenever state is loaded, or User Preset is executed, all of the traces, limit lines and corrections are affected. Although this differs from previous behavior, it is desirable behavior, and should not cause adverse issues for users.</p> <p>On ESA and PSA, User Preset affected the entire instrument’s state. In the X-Series, User Preset only recalls the state for the active mode. There is a User Preset file for each mode. User Preset can never cause a mode switch as it can in legacy analyzers. If you want to recall all modes to their user preset file state, you will need to do a User Preset after mode switching into each mode.</p> <p>User Preset recalls mode state which can now include data like traces; whereas on ESA and PSA, User Preset did not affect data.</p>
Initial S/W Revision	Prior to A.02.00

User Preset

User Preset sets the state of the currently active mode back to the state that was previously saved for this mode using the Save User Preset menu key or the SCPI command, **SYST:PRES:USER:SAV**. **It not only recalls the** Mode Preset settings, but it also recalls all of the mode persistent settings, and the Input/Output system setting that existed at the time Save User Preset was executed.

If a Save User Preset has not been done at any time, User Preset recalls the default user preset file for the currently active mode. The default user preset files are created if, at power-on, a mode detects there is no user preset file. There will never be a scenario when there is no user preset file to restore. For each mode, the default user preset state is the same state that would be saved if a Save User Preset is performed in each mode right after doing a Restore Mode Default and after a Restore Input/Output Defaults.

The User Preset function does the following:

- Aborts the currently running measurement.
- Sets the mode State to the values defined by Save User Preset.

- Makes the saved measurement for the currently running mode the active measurement.
- Brings up the saved menu for the power-on mode.
- Clears the input and output buffers.
- Sets the Status Byte to 0.

Key Path	User Preset
Remote Command	:SYSTem:PRESet:USER
Example	:SYST:PRES:USER
Notes	:SYST:PRES:USER:SAVE is used to save the current state as the user preset state. Clears all pending OPC bits. The Status Byte is set to 0. Pressing the User Preset front-panel key while already in the User Preset menu will cause the User Preset to get executed
Couplings	A user preset will cause the currently running measurement to be aborted and cause the saved measurement to be active. Recalling a User Preset file has the same issues that recalling a Save State file has. Some settings may need to be limited and therefore re-coupled, since the capabilities of the mode may have changes when the User Preset file was last saved.
Initial S/W Revision	Prior to A.02.00

User Preset All Modes

Recalls all of the User Preset files for each mode, switches to the power-on mode, and activates the saved measurement from the power-on mode User Preset file.

NOTE

When the instrument is secured, all of the user preset files are converted back to their default user preset files.

The User Preset function does the following:

- Aborts the currently running measurement.
- Switches the Mode to the power-on mode.
- Restores the User Preset files for each mode.
- Makes the saved measurement for the power-on mode the active measurement.
- Brings up the saved menu for the power-on mode.
- Clears the input and output buffers.
- Sets the Status Byte to 0.

Key Path	User Preset
----------	--------------------

Remote Command	:SYSTem:PRESet:USER:ALL
Example	:SYST:PRES:USER:SAVE :SYST:PRES:USER:ALL
Notes	Clears all pending OPC bits. The Status Byte is set to 0. :SYST:PRES:USER:SAVE is used to save the current state as the user preset state.
Couplings	A user preset will cause the currently running measurement to be aborted, cause a mode switch to the power-on mode, and cause the saved measurement to be active in the power-on mode. Recalling a User Preset file has the same issues that recalling a Save State file has. Some settings may need to be limited and therefore re-coupled, since the capabilities of the mode may have changes when the User Preset file was last saved.
Initial S/W Revision	Prior to A.02.00

Save User Preset

Saves the currently active mode and its State. You can recall this User Preset file by pressing the User Preset menu key or sending the SYST:PRES:USER remote command. This same state is also saved by the Save State function.

Key Path	User Preset
Remote Command	:SYSTem:PRESet:USER:SAVE
Example	:SYST:PRES:USER:SAVE
Notes	:SYST:PRES:SAVE creates the same file as if the user requested a *SAV or a MMEM:STOR:STAT, except User Preset Save does not allow the user to specify the filename or the location of the file.
Initial S/W Revision	Prior to A.02.00

View/Display

Accesses a menu of functions that enable you to set the display parameters

Key Path	Front-panel key
Initial S/W Revision	Prior to A.02.00

Display

The Display menu is common to most measurements, and is used for configuring items on the display. Some Display menu settings apply to all the measurements in a mode, and some only to the current measurement. Those under the **System Display Settings** key apply to all measurements in all modes.

Key Path	Display
Key Path	View/Display
Initial S/W Revision	Prior to A.02.00

Annotation

Turns on and off various parts of the display annotation. The annotation is divided up into four categories:

13. Meas Bar: This is the measurement bar at the top of the screen. It does not include the settings panel or the Active Function. Turning off the Meas Bar turns off the settings panel and the Active Function. When the Meas Bar is off, the graticule area expands to fill the area formerly occupied by the Meas Bar.
14. Screen Annotation: this is the annotation and annunciation around the graticule, including any annotation on lines (such as the display line, the threshold line, etc.) This does NOT include the marker number or the N dB result. When off, the graticule expands to fill the entire graticule area.
15. Trace annotation: these are the labels on the traces, showing their detector (or their math mode).
16. Active Function annotation: this is the active function display in the meas bar, and all of the active function values displayed on softkeys.

See the figure below. Each type of annotation can be turned on and off individually.

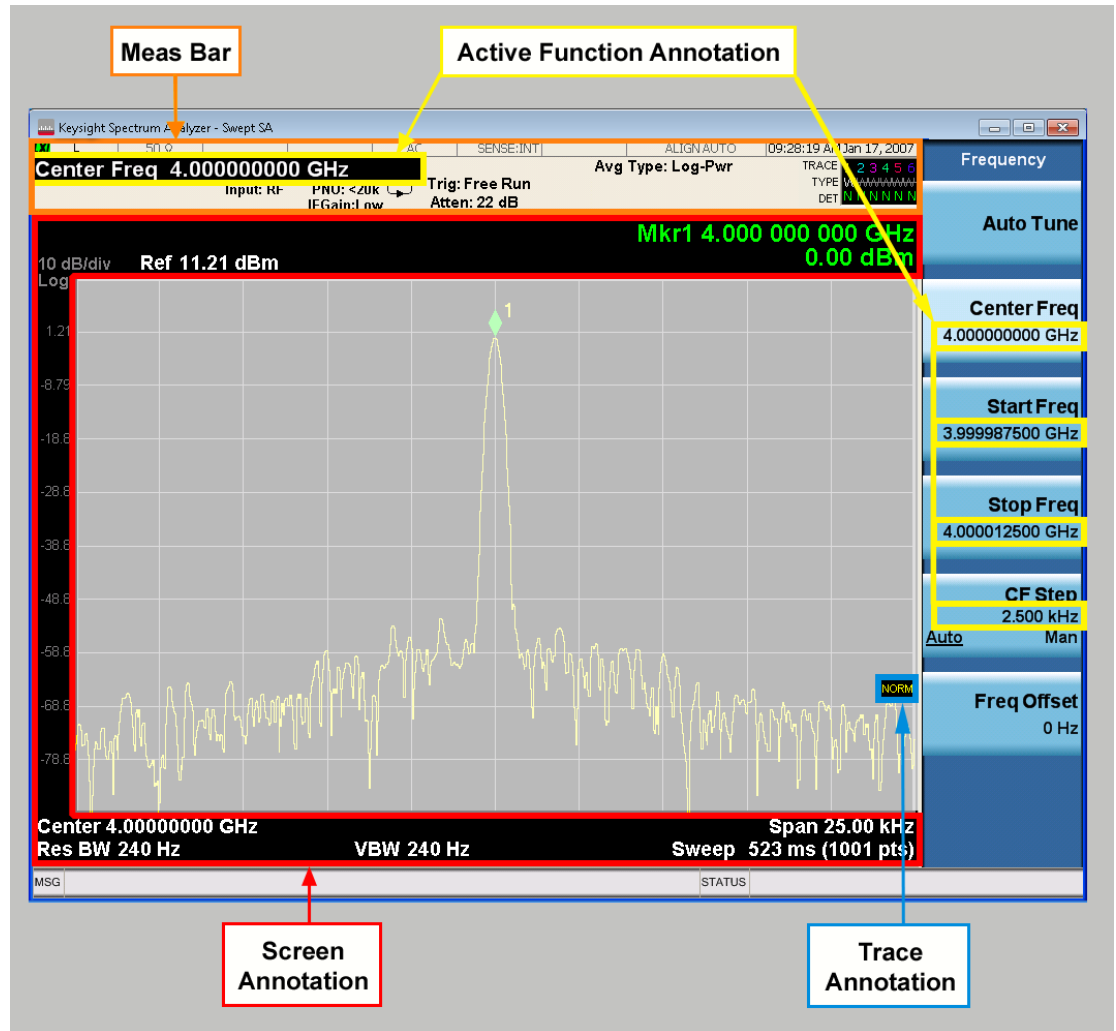

Key Path	View/Display, Display
Initial S/W Revision	Prior to A.02.00

Meas Bar On/Off

This function turns the Measurement Bar on and off, including the settings panel. When off, the graticule area expands to fill the area formerly occupied by the Measurement Bar.

Key Path	View/Display, Display, Annotation
Remote Command	:DISPlay:ANNotation:MBAR[:STATE] OFF ON 0 1 :DISPlay:ANNotation:MBAR[:STATE]?
Example	DISP:ANN:MBAR OFF
Dependencies	Grayed out and forced to OFF when System Display Settings, Annotation is set to Off.
Preset	On

	This should remain Off through a Preset when System DisplaySettings, Annotation is set to Off.
State Saved	Saved in instrument state.
Initial S/W Revision	Prior to A.02.00

Screen

This controls the display of the annunciation and annotation around the graticule, including any annotation on lines (such as the display line, the threshold line, etc.) and the y-axis annotation. This does NOT include marker annotation (or the N dB result). When off, the graticule expands to fill the entire graticule area, leaving only the 1.5% gap above the graticule as described in the Trace/Detector chapter.

Key Path	View/Display, Display, Annotation
Remote Command	:DISPlay:ANNotation:SCReen[:STATe] OFF ON 0 1 :DISPlay:ANNotation:SCReen[:STATe]?
Example	DISP:ANN:SCR OFF
Dependencies	Grayed-out and forced to OFF when System Display Settings, Annotation is set to Off.
Preset	On This should remain Off through a Preset when System DisplaySettings, Annotation is set to Off
State Saved	Saved in instrument state.
Initial S/W Revision	Prior to A.02.00

Trace

Turns on and off the labels on the traces, showing their detector (or their math mode) as described in the Trace/Detector section.

If trace math is being performed with a trace, then the trace math annotation will replace the detector annotation.

Key Path	View/Display, Display, Annotation
Remote Command	:DISPlay:ANNotation:TRACe[:STATe] ON OFF 1 0 :DISPlay:ANNotation:TRACe[:STATe]?
Example	DISP:ANN:TRAC OFF
Preset	Off
State Saved	Saved in instrument state.
Initial S/W Revision	Prior to A.02.00

Active Function Values On/Off

Turns on and off the active function display in the Meas Bar, and all of the active function values displayed on the softkeys.

Note that all of the softkeys that have active functions have these numeric values blanked when this function is on. This is a security feature..

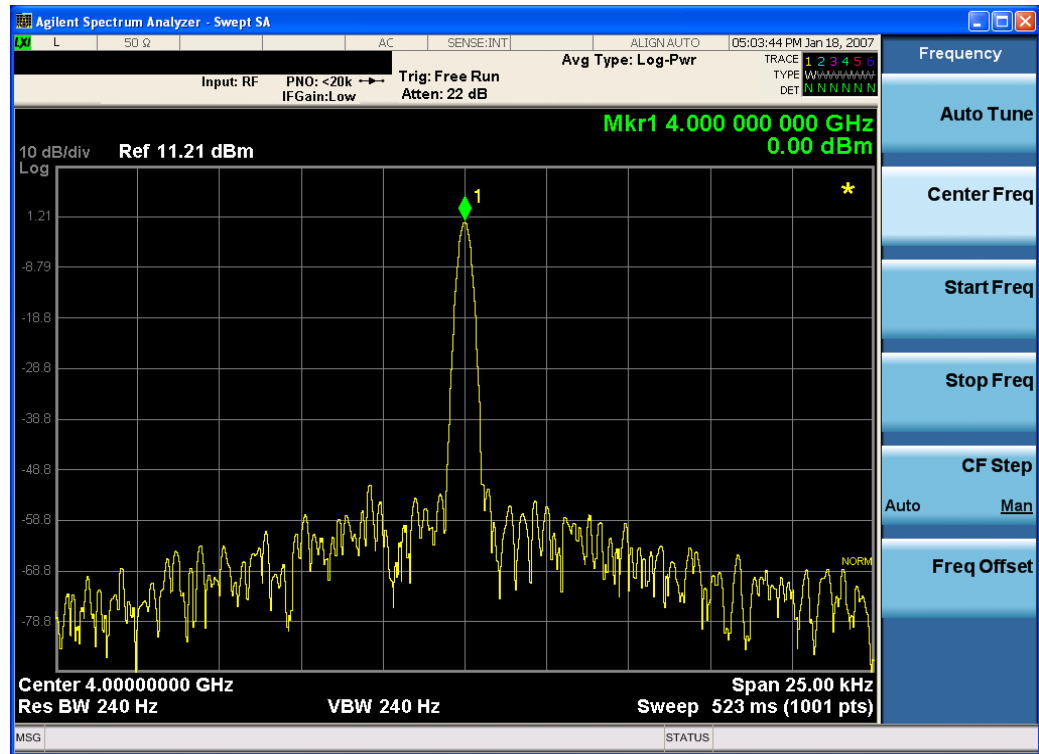

Key Path	View/Display, Display, Annotation
Remote Command	:DISPlay:ACTivefunc[:STATe] ON OFF 1 0 :DISPlay:ACTivefunc[:STATe]?
Example	DISP:ACT OFF
Dependencies	Grayed out and forced to OFF when System Display Settings, Annotation is set to Off.
Preset	On This should remain Off through a Preset when System DisplaySettings, Annotation is set to Off
State Saved	Saved in instrument state.
Initial S/W Revision	Prior to A.02.00

Title

Displays menu keys that enable you to change or clear a title on your display.

Key Path	View/Display, Display
Initial S/W Revision	Prior to A.02.00

Change Title

Writes a title into the "measurement name" field in the banner, for example, "Swept SA".

Press Change Title to enter a new title through the alpha editor. Press Enter or Return to complete the entry. Press ESC to cancel the entry and preserve your existing title.

The display title will replace the measurement name. It remains for this measurement until you press **Change Title** again, or you recall a state, or a Preset is performed. A title can also be cleared by pressing **Title**, **Clear Title**.

NOTE

Notice the inclusion of the <measurement> parameter in the command below. Because each measurement remembers the Display Title, the command must be qualified with the measurement name. For the Swept SA measurement this is not the case; no <measurement> parameter is used when changing the Display Title for the Swept SA measurement.

Key Path	View/Display, Display, Title
Mode	All
Remote Command	:DISPlay:<measurement>:ANNotation:TITLe:DATA <string> :DISPlay:<measurement>:ANNotation:TITLe:DATA?
Example	DISP:ANN:TITL:DATA "This Is My Title" This example is for the Swept SA measurement in the Spectrum Analyzer mode. The SANalyzer <measurement> name is not used. DISP:ACP:ANN:TITL:DATA "This Is My Title" This example is for Measurements other than Swept SA. Both set the title to: This Is My Title
Notes	Pressing this key cancels any active function. When a title is edited the previous title remains intact (it is not cleared) and the cursor goes at the end so that characters can be added or BKSP can be used to go back over previous characters.
Preset	No title (measurement name instead)
State Saved	Saved in instrument state.
Initial S/W Revision	Prior to A.02.00

Clear Title

Clears a title from the front-panel display. Once cleared, the title cannot be retrieved. After the title is cleared, the current Measurement Name replaces it in the title bar.

Key Path	View/Display, Display, Title
Example	<p>The following commands clear the title and restore the measurement's original title: DISP:ANN:TITL:DATA ""</p> <p>This example is for the Swept SA measurement in the Spectrum Analyzer mode. The SANalyzer <measurement> name is not used. DISP:ACP:ANN:TITL:DATA ""</p> <p>This example is for ACP; in measurements other than Swept SA the measurement name is required.</p>
Notes	Uses the :DISPlay:<measurement>:ANNotation:TITLe:DATA <string> command with an empty string (in the Swept SA, the <measurement> is omitted).
Preset	Performed on Preset.
Initial S/W Revision	Prior to A.02.00

Graticule

Pressing Graticule turns the display graticule On or Off. It also turns the graticule y-axis annotation on and off.

Key Path	View/Display, Display
Remote Command	:DISPlay:WINDow[1]:TRACe:GRATicule:GRID[:STATe] OFF ON 0 1 :DISPlay:WINDow[1]:TRACe:GRATicule:GRID[:STATe]?
Example	DISP:WIND:TRAC:GRAT:GRID OFF
Notes	The graticule is the set of horizontal and vertical lines that make up the grid/divisions for the x-axis and y-axis.
Preset	On
State Saved	Saved in instrument state
Initial S/W Revision	Prior to A.02.00

System Display Settings

These settings are "Mode Global" – they affect all modes and measurements and are reset only by **Restore Misc Defaults** or **Restore System Defaults** under System.

Key Path	View/Display, Display
Initial S/W Revision	Prior to A.02.00

Annotation Local Settings

This is a Mode Global override of the meas local annotation settings. When it is **All Off**, it forces **ScreenAnnotation, Meas Bar, Trace, and Active Function Values** settings to be **OFF** for all measurements in all modes. This provides the security

based "annotation off" function of previous analyzers; hence it uses the legacy SCPI command.

When it is **All Off**, the **Screen, Meas Bar, Trace, and Active Function Values** keys under the **Display, Annotation** menu are grayed out and forced to **Off**. When **Local Settings** is selected, you are able to set the local annotation settings on a measurement by measurement basis.

Key Path	View/Display, Display, System Display Settings
Remote Command	:DISPlay:WINDow[1]:ANNotation[:ALL] OFF ON 0 1 :DISPlay:WINDow[1]:ANNotation[:ALL]?
Example	:DISP:WIND:ANN OFF
Preset	On (Set by Restore Misc Defaults)
State Saved	Not saved in instrument state.
Backwards Compatibility Notes	The WINDow parameter and optional subopcode is included for backwards compatibility but ignored – all windows are equally affected.
Initial S/W Revision	Prior to A.02.00

Themes

Accesses a menu of functions that enable you to choose the theme to be used when saving the screen image.

The **Themes** option is the same as the **Themes** option under the **Display and Page Setup** dialogs. It allows you to choose between themes to be used when saving the screen image.

Key Path	Save, Screen Image
Remote Command	:MMEMory:STORe:SCReEn:THEMe TDCoLor TDMonochrome FCOLor FMONochrome :MMEMory:STORe:SCReEn:THEMe?
Example	:MMEM:STOR:SCR:THEM TDM
Preset	3D Color; Is not part of Preset, but is reset by Restore Misc Defaults or Restore System Defaults All and survives subsequent running of the modes.
Readback	3D Color 3D Mono Flat Color Flat Mono
Backwards Compatibility Notes	In ESA and PSA we offer the choice of "Reverse Bitmap" or "Reverse Metafile" when saving screen images. This is much like the "Flat Color" theme available in X-Series. Also, if you selected Reverse Bitmap AND a black & white screen image, that would be much like "Flat Monochrome". In other words, each of the X-Series themes has a similar screen image type in ESA/PSA. But they are not identical.
Initial S/W Revision	Prior to A.02.00

3D Color

Selects a standard color theme with each object filled, shaded and colored as designed.

Key Path	Save, Screen Image, Themes
Example	MMEM:STOR:SCR:THEM TDC
Readback	3D Color
Initial S/W Revision	Prior to A.02.00

3D Monochrome

Selects a format that is like 3D color but shades of gray are used instead of colors.

Key Path	Save, Screen Image, Themes
Example	MMEM:STOR:SCR:THEM TDM
Readback	3D Mono
Initial S/W Revision	Prior to A.02.00

Flat Color

Selects a format that is best when the screen is to be printed on an ink printer.

Key Path	Save, Screen Image, Themes
Example	MMEM:STOR:SCR:THEM FCOL
Readback	Flat Color
Initial S/W Revision	Prior to A.02.00

Flat Monochrome

Selects a format that is like Flat Color. But only black is used (no colors, not even gray), and no fill.

Key Path	Save, Screen Image, Themes
Example	MMEM:STOR:SCR:THEM FMON
Readback	Flat Mono
Initial S/W Revision	Prior to A.02.00

Backlight

Accesses the display backlight on/off keys. This setting may interact with settings under the Windows "Power" menu.

When the backlight is off, pressing ESC, TAB, SPACE, ENTER, UP, DOWN, LEFT, RIGHT, DEL, BKSP, CTRL, or ALT turns the backlight on without affecting the application. Pressing any other key will turn backlight on and could potentially perform the action as well.

Key Path	View/Display, Display, System Display Settings
Remote Command	:DISPlay:BACKlight ON OFF :DISPlay:BACKlight?

Preset	ON (Set by Restore Misc Defaults)
Initial S/W Revision	Prior to A.02.00

Backlight Intensity

An active function used to set the backlight intensity. It goes from 0 to 100 where 100 is full on and 0 is off. This value is independent of the values set under the Backlight on/off key.

Key Path	View/Display, Display, System Display Settings
Remote Command	:DISPlay:BACKlight:INTensity <integer> :DISPlay:BACKlight:INTensity?
Example	DISP:BACK:INT 50
Preset	100 (Set by Restore Misc Defaults)
Min	0
Max	100
Initial S/W Revision	Prior to A.02.00

TOI View

In the TOI measurement view, the data and graticule are identical to GPSA, except that the base and intermod peaks are annotated with a number in white:

- 1 – lower intermod
- 2 – lower base
- 3 – upper base
- 4 – upper intermod

The TOI result is displayed in a table below the graticule. The TOI number is the worse (lower) of the two calculated intercept points, while the Δ is the worse (higher) of the measured dBc values.

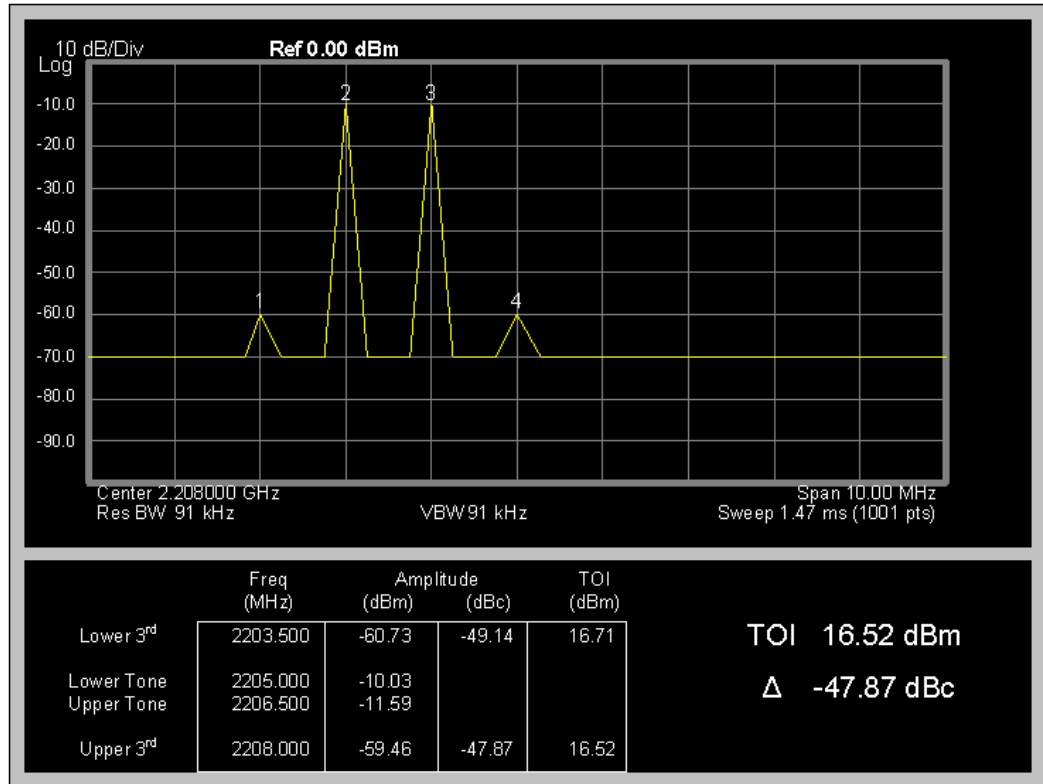

The frequency uses 6 significant digits throughout. The amplitude should be 0.01 dB, with a single leading zero blanked if necessary.

Absolute amplitude results are presented in the current Y Axis Unit.

When zero-span measurement is turned on, the intercept frequencies are measured in zero span (typically with a lower resolution bandwidth), and the results of that measurement are superimposed on the graticule in the form of a blue box displayed behind the trace data. The box has 50% transparency, height equal to the power measured by the zero-span measurement, and width equal to twice the resolution bandwidth.

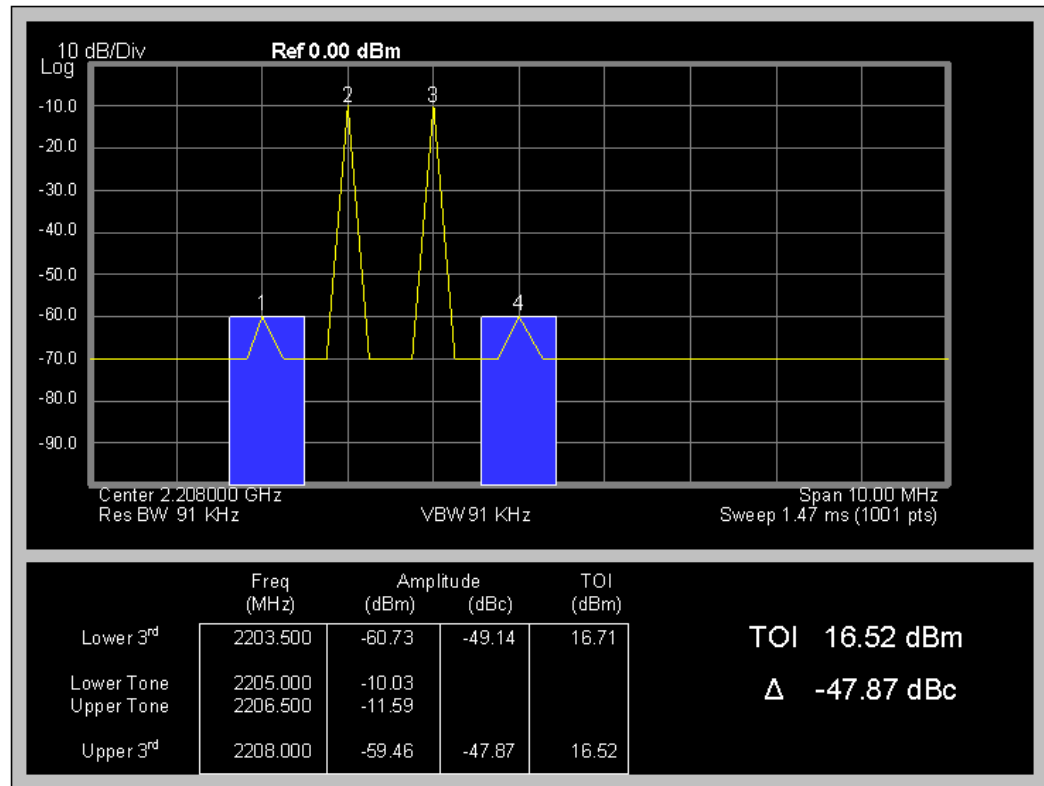

The graticule shows the most recent measurement of each frequency. The result table updates after all three sweeps have been made, and uses a single-point result from the zero-span sweep to calculate the intercept amplitude.

Only a single trace is supported.

17 Harmonic Measurement

The Harmonics measurement allows a simple (one-button) measurement of the harmonics of a specified carrier frequency.

At each cycle, the instrument will do a zero-span measurement at the fundamental and at each harmonic frequency. With that information, it will calculate and report each harmonic in dBc, and will also calculate and report the total harmonic distortion.

In most use cases, this approach is sufficient. In cases where a specialized harmonic measurement is required, such as measuring the harmonics of a baseband amplifier when looking at the carrier signal, the user may separately specify the parameters of each harmonic measurement. For measurement results and views, see ["View/Display" on page 3286](#).

This topic contains the following sections.

["Harmonic Measurement Details" on page 3100](#)

["Harmonic Measurement Fetch/Read Results" on page 3098](#)

For more measurement related commands, see the SENSE subsystem, and the ["Remote Measurement Functions" on page 3140](#).

Harmonic Measurement Fetch/Read Results

These commands retrieve each harmonic measurement, and the Total Harmonic Distortion calculated from the measurement. Returned amplitudes are in fixed units and do not honor the Y Axis Unit setting. Returned absolute amplitudes are affected by Ref Level Offset, and returned absolute frequencies are affected by Freq Offset.

Command	n	Return Value
INITiate:HARM	n/a	n/a
CONFigure?	n/a	Name of current measurement: "HARM"
CONFigure:HARMonics	n/a	N/A
CONFigure:HARMonics:NDEFault		
INITiate:HARMonics		
FETCh:HARMonics:AMPLitude:ALL? MEASure:HARMonics:AMPLitude:ALL? READ:HARMonics:AMPLitude:ALL?	n/a	Returns the amplitude values of the first 10 harmonics. The first value (for the fundamental) is measured in dBm. The remaining harmonics are measured in dBc (relative to the fundamental). If fewer than 10 harmonics are measured, zero is returned for any harmonic not measured.
FETCh:HARMonics:AMPLitude[n]? MEASure:HARMonics:AMPLitude[n]? READ:HARMonics:AMPLitude[n]?	1– 10	Returns the amplitude values of the specified harmonic. If N=1 is specified, the return value is in dBm. Otherwise, the returned value is in dBc (relative to the fundamental).
FETCh:HARMonics:DISToRTion? MEASure:HARMonics:DISToRTion? READ:HARMonics:DISToRTion?	n/a	Returns the computed total harmonic distortion as a percentage.
FETCh:HARMonics:FREQuency:ALL? MEASure:HARMonics:FREQuency:ALL? READ:HARMonics:FREQuency:ALL?	n/a	Returns the frequency values of the first 10 harmonics in Hz. The first value returned is the fundamental. If fewer than 10 harmonics are measured, zero is returned for any harmonic not measured.
FETCh:HARMonics:FREQuency[n]? MEASure:HARMonics:FREQuency[n]? READ:HARMonics:FREQuency[n]?	1– 10	Returns the frequency of the specified harmonic in Hz. If N=1 is specified, the fundamental frequency is returned.
FETCh:HARMonics:FUNDamental? MEASure:HARMonics:FUNDamental? READ:HARMonics:FUNDamental?	n/a	Returns the frequency of the fundamental in Hz.
FETCh:HARMonics[n]? MEASure:HARMonics[n]? READ:HARMonics[n]?	1– 2	For n=1, or n not specified, returns the computed total harmonic distortion as a percentage.

For $n=2$, returns the computed total harmonic distortion in dBc.

Key Path	Meas
Initial S/W Revision	A.04.00

Harmonic Measurement Details

First Sweep

The first sweep of the harmonics measurement is used to find the fundamental frequency and bandwidth.

First Sweep Initiation

The first sweep is not used when the range table is turned on, or when all parameters are in “Manual” mode. It is only used when at least one of the following parameters is in “Sense” mode:

1. Fundamental frequency
2. Resolution Bandwidth

If one of the above parameters is in “Sense”, the first sweep occurs when any of the following happen:

1. We first enter the measurement
2. After a preset
3. When a parameter change causes a measurement restart in continuous sweep mode
4. When the user initiates a sweep.

First Sweep Action

If Fundamental Frequency is set to “Sense”, the first sweep sets the fundamental frequency to the largest amplitude signal between 10 MHz and half the bandwidth of the spectrum analyzer. We should span zoom (or frequency count) to give us a good measurement of the fundamental frequency.

If Resolution Bandwidth is set to “Sense”, the first sweep sets the resolution bandwidth to the lowest available Resolution Bandwidth greater than the 3.5 times the 99% occupied bandwidth of the signal, to a minimum of 30 Hz. By default, the video bandwidth and sweep time are coupled to those parameters. Also by default, all harmonic parameters are coupled to the fundamental parameters.

Note that, even though the automatic RBW is limited to a minimum of 30 Hz, the actual value measured should be retained. When multiplying the RBW for the 2nd and subsequent harmonics, use the maximum of the calculated value and 30 Hz.

For example, assume that the occupied bandwidth calculation results in desired RBW of 12 Hz. The fundamental RBW will use 30 Hz, the second harmonic RBW will use 30 Hz. The calculated RBW for the third and subsequent harmonics exceeds 30 Hz, so we should use the calculated value when measuring those harmonics.

AMPTD Y Scale

Activates the Reference Value function and displays the Amplitude menu keys. These functions control how data on the vertical (Y) axis is displayed and control instrument settings that affect the vertical axis.

Key Path	Front-panel key
Initial S/W Revision	Prior to A.02.00

Ref Value

The reference value specifies the amplitude of a signal displayed on the reference graticule line. The reference line is either at the top, center, or bottom of the graticule, depending on the value of the Ref Position function (below).

Changing the reference value does not restart a measurement, and instead changes all displayed traces and markers to the new value. Note that the displayed ref level is identical across all harmonic measurements.

Key Path	AMPTD Y Scale
Remote Command	DISPlay:HARMonics:VIEW:WINDow:TRACe:Y[:SCALE]:RLEVel <amplitude> DISPlay:HARMonics:VIEW:WINDow:TRACe:Y[:SCALE]:RLEVel?
Example	DISP:HARM:VIEW:WIND:TRAC:Y:RLEV -10 dBm Sets the reference value to -10 dBm
Couplings	Max reference level is adjusted by the Ref Level Offset This value is affected by Ref Level Offset
Preset	0.0 dBm
Min	-250 dBm + Ref Level Offset
Max	250 dBm + Ref Level Offset
Initial S/W Revision	Prior to A.02.00

Attenuation

This menu controls the attenuator functions and interactions between the attenuation system components.

There are two attenuator configurations in the X-Series. One is a dual attenuator configuration consisting of a mechanical attenuator and an optional electronic attenuator. The other configuration uses a single attenuator with combined mechanical and electronic sections that controls all the attenuation functions. Different models in the X-Series come with different configurations.

See ["Dual Attenuator Configurations:" on page 3102](#)

See ["Single Attenuator Configuration:" on page 3103](#)

Most Attenuation settings are the same for all measurements – they do not change as you change measurements. Settings like these are called “Meas Global” and are unaffected by Meas Preset.

Key Path	AMPTD Y Scale
Scope	Meas Global
Dependencies	In measurements that support the I/Q inputs, this key is unavailable when I/Q is the selected input, and is replaced by the Range key in that case.
Readback Line	Contains a summary in [] brackets of the current total attenuation. See the descriptions of the , " (Mech) Atten " on page 3103, and "Enable Elec Atten" on page 3105 keys for more detail on the contributors to the total attenuation. Note that when "Pre-Adjust for Min Clip" is on, this value can change at the start of every measurement.
Initial S/W Revision	Prior to A.02.00
Modified at S/W Revision	A.03.00

Dual Attenuator Configurations:

Configuration 1: Mechanical attenuator + optional electronic attenuator

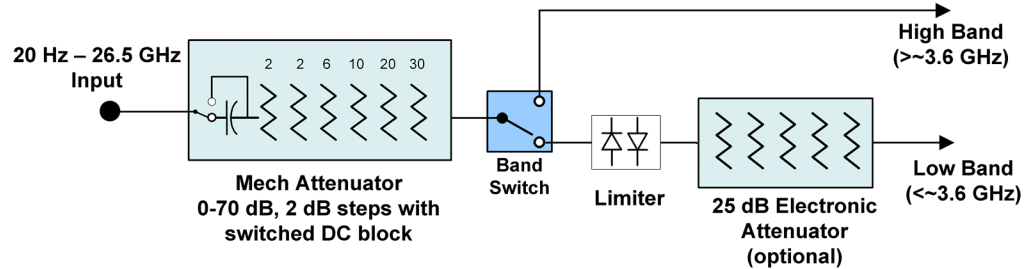

Configuration 2: Mechanical attenuator, no optional electronic attenuator

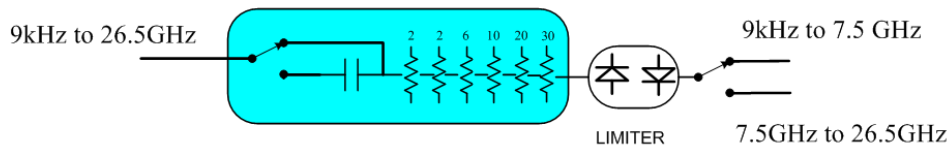

(note that Configuration 2 is not strictly speaking a dual-section attenuator, since there is no electronic section available. However, it behaves exactly like Configuration 1 without the Electronic Attenuator option EA3, therefore for the sake of this document it is grouped into the “Dual Attenuator” configuration)

Single Attenuator Configuration:

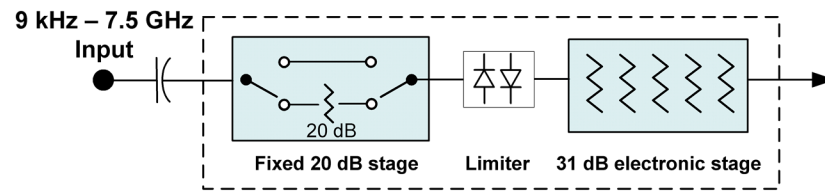

You can tell which attenuator configuration you have by pressing the Attenuation key, which (in most Modes) opens the Attenuation menu. If the first key in the Attenuation menu says **Mech Atten** you have the dual attenuator configuration. If the first key says **Atten** you have the single attenuator configuration.



In the single attenuator configuration, you control the attenuation with a single control, as the fixed stage has only two states. In the dual attenuator configuration, both stages have significant range so you are given separate control of the mechanical and electronic attenuator stages.

When you have the dual attenuator configuration, you may still have only a single attenuator, because unless option EA3 (the Electronic Attenuator option) is available, and you purchase it, you will have only the mechanical attenuator.

(Mech) Atten

This key is labeled **Mech Atten** in dual attenuator models and **Atten** in single attenuator models. In the dual attenuator configuration, this key only affects the mechanical attenuator.

This key lets you modify the attenuation applied to the RF input signal path. This value is normally auto coupled to the Ref Level, the Internal Preamp Gain, any External Gain that is entered, and the Max Mixer Level, as described in the table below.

See "[Attenuator Configurations and Auto/Man](#)" on page 3105

Key Path	AMPTD Y Scale, Attenuation
Remote Command	[:SENSe]:POWer[:RF]:ATTenuation <rel_amp1> [:SENSe]:POWer[:RF]:ATTenuation? [:SENSe]:POWer[:RF]:ATTenuation:AUTO OFF ON 0 1 [:SENSe]:POWer[:RF]:ATTenuation:AUTO?
Example	POW:ATT 20 Dual attenuator configuration: sets the mechanical attenuator to 20 dB Single attenuator mode: sets the main attenuation to 20 dB (see below for definition of "main")

	<p>attenuation).</p> <p>If the attenuator was in Auto, it sets it to Manual.</p>
Dependencies	<p>Some measurements do not support the Auto setting of (Mech) Atten. In these measurements, the Auto/Man selection is not available, and the Auto/Man line on the key disappears.</p> <p>In dual attenuator configurations, when the electronic attenuator is enabled, the mechanical attenuator has no auto setting and the Auto/Man line on the key disappears. The state of Auto/Man is remembered and restored when the electronic attenuator is once again disabled. This is described in more detail in the "Enable Elec Atten" on page 3105 key description.</p> <p>See "Attenuator Configurations and Auto/Man" on page 3105 for more information on the Auto/Man functionality of Attenuation.</p>
Couplings	<p>When (Mech) Atten is in Auto, it uses the following algorithm to determine a value:</p> <p>If the USB Preamp is connected to USB, use 0 dB.</p> <p>Otherwise, $Atten = ReferenceLevel + PreAmpGain + ExternalGain - RefLevelOffset - MaxMixerLevel + IF\ Gain$.</p> <p>Limit this value to be between 6 dB and the Max value. No value below 6 dB can ever be chosen by Auto.</p> <p>The resulting value is rounded up to the largest value possible given the attenuation step setting. That is, 50.01 dB would change to 60 dB (for a 10 dB attenuation step).</p> <p>The "IF Gain" term in the equation above is either 0 dB or +10 dB, depending on the settings of FFT IF Gain, Swept IF Gain, max Ref Level and the Auto/Man setting of Mech Atten.</p> <p>In External Mixing and BBIQ, where the Attenuator is not in the signal path, the Attenuator setting changes as described above when (Mech) Atten is in Auto, but no changes are made to the actual attenuator hardware setting until the input is changed back to the RF Input.</p>
Preset	<p>The preset for Mech Attenuation is "Auto."</p> <p>The Auto value of attenuation is:</p> <p>CXA, EXA, MXA and PXA: 10 dB</p>
State Saved	<p>Saved in instrument state</p>
Min	<p>0 dB</p> <p>The attenuation set by this key cannot be decreased below 6 dB with the knob or step keys. To get to a value below 6 dB it has to be directly entered from the keypad or via SCPI. This protects from adjusting the attenuation to a dangerously small value which can put the instrument at risk of damage to input circuitry. However, if the current mechanical attenuation is below 6 dB it can be increased with the knob and step keys, but not decreased.</p>
Max	<p>CXA N9000A-503/507: 50 dB</p> <p>CXA N9000A-513/526: 70dB</p> <p>EXA: 60 dB</p> <p>MXA and PXA: 70 dB</p> <p>In the single attenuator configuration, the total of ATT and EATT cannot exceed 50 dB, so if the EATT is set to 24 dB first, the main attenuation cannot be greater than 26 dB and will be reduced accordingly; if the main attenuator is set to 40 dB first, EATT cannot be greater than 10 dB.</p>
Initial S/W Revision	<p>Prior to A.02.00</p>
Modified at S/W Revision	<p>A.03.00</p>

Attenuator Configurations and Auto/Man

As described in the Attenuation key description, there are two distinct attenuator configurations available in the X-Series, the single attenuator and dual attenuator configurations. In dual attenuator configurations, we have the mechanical attenuation and the electronic attenuation, and the current total attenuation is the sum of the electronic + mechanical attenuation. In single attenuator configurations, we refer to the attenuation set using the **(Mech) Atten** key (or POW:ATT SCPI) as the “main” attenuation; and the attenuation that is set by the SCPI command POW:EATT as the “soft” attenuation (the POW:EATT command is honored even in the single attenuator configuration, for compatibility purposes). Then the current total attenuation is the sum of the main + soft attenuation. See the **Elec Atten** key description for more on “soft” attenuation.

In the dual attenuator configuration, when the electronic attenuator is enabled, there is no Auto/Man functionality for the mechanical attenuator, and the third line of the key label (the Auto/Man line) disappears:

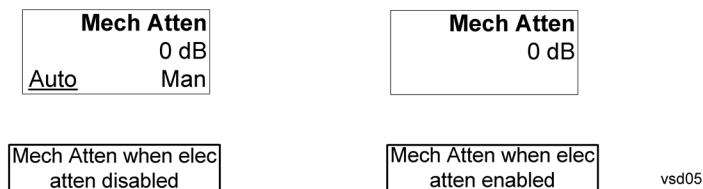

Enable Elec Atten

Enables the Electronic Attenuator.

The electronic attenuator offers finer steps than the mechanical attenuator, has no acoustical noise, is faster, and is less subject to wear. These advantages primarily aid in remote operation and are negligible for front panel use. See ["Using the Electronic Attenuator: Pros and Cons" on page 3107](#) for a detailed discussion of the pros and cons of using the electronic attenuator.

For the single attenuator configuration, for SCPI backwards compatibility, the “soft” attenuation feature replaces the dual attenuator configuration’s electronic attenuator. All the same couplings and limitations apply. See ["Attenuator Configurations and Auto/Man" on page 3105](#)

See [Error! Reference source not found.](#)

Key Path	AMPTD Y Scale, Attenuation
Remote Command	[:SENSe] :POWer [:RF] :EATTenuation :STATe OFF ON 0 1 [:SENSe] :POWer [:RF] :EATTenuation :STATe ?
Example	POW:EATT:STAT ON
Dependencies	This key only appears in Dual Attenuator models with an Electronic Attenuator installed. It does not appear in models with the Single Attenuator configuration, as in the single attenuator configuration there is no “electronic attenuator” there is only a single integrated attenuator (which has both a mechanical and electronic stage). However, in the single attenuator configuration, EATT SCPI commands are accepted for compatibility with other X-series

instruments and set a “soft” attenuation as described in "[Attenuator Configurations and Auto/Man](#)" on page 3105.

The electronic attenuator (and the “soft” attenuation function provided in single attenuator configurations) is unavailable above 3.6 GHz. Therefore, if the Stop Frequency of the analyzer is > 3.6 GHz then the **Enable Elec Atten** key will be OFF and grayed out.

If the Internal Preamp is on, meaning it is set to Low Band or Full, the electronic attenuator (and the “soft” attenuation function provided in single attenuator configurations) is unavailable. In this case the **Enable Elec Atten** key will be OFF and grayed out.

If either of the above is true, if the SCPI command is sent, an error indicating that the electronic attenuator is unavailable will be sent.

If the electronic/soft Attenuator is enabled, then the Stop Freq of the analyzer is limited to 3.6 GHz and the Internal Preamp is unavailable.

The SCPI-only “soft” electronic attenuation for the single-attenuator configuration is not available in all measurements; in particular, it is not available in the Swept SA measurement.

Couplings	Enabling and disabling the Electronic Attenuator affects the setting of the Mechanical Attenuator (in dual attenuator configurations). This is described in more detail below this table.
Preset	OFF for Swept SA measurement; ON for all other measurements that support the electronic attenuator
State Saved	Saved in instrument state
Initial S/W Revision	Prior to A.02.00
Modified at S/W Revision	A.03.00

Mechanical Attenuator Transition Rules

When the Electronic Attenuator is enabled, the Mechanical Attenuator transitions to a state that has no Auto function. Below are the rules for transitioning the Mechanical Attenuator. NOTE that the information below ONLY applies to the dual attenuator configurations, and ONLY when the Electronic Attenuator is installed:

When the Electronic Attenuation is enabled from a disabled state:

- The Mechanical Attenuator is initialized to 10 dB (this is its optimal performance setting). You can then set it as desired with SCPI, numeric keypad, step keys, or knob, and it behaves as it normally would in manual mode
- The Auto/Man state of (Mech) Atten is saved
- The Auto/Man line on the (Mech) Atten key disappears and the auto rules are disabled
- The Electronic Attenuator is set to 10 dB less than the previous value of the Mechanical Attenuator, within the limitation that it must stay within the range of 0 to 24 dB of attenuation.

Examples in the dual attenuator configuration:

- Mech Atten at 20 dB. Elec Atten enabled, Mech Atten set to 10 dB, and Elec Atten set to 10 dB. New total attenuation equals the value before Elec Atten enabled.
- Mech Atten at 0 dB. Elec Atten enabled, Mech Atten set to 10 dB, and Elec Atten set to 0 dB. New total attenuation does not equal the value before Elec Atten enabled.
- Mech Atten at 40 dB. Elec Atten enabled, Mech Atten set to 10 dB, and Elec Atten set to 24 dB. New total attenuation does not equal the value before Elec Atten enabled.

When the Electronic Attenuation is disabled from an enabled state:

- The Elec Atten key is grayed out
- The Auto/Man state of (Mech) Atten is restored
- If now in Auto, (Mech) Atten recouples
- If now in Man, (Mech) Atten is set to the value of total attenuation that existed before the Elec Atten was disabled. The resulting value is rounded up to the smallest value possible given the (Mech) Atten Step setting - (That is, 57 dB changes to 58 dB when (Mech) Atten Step is 2 dB.)

Using the Electronic Attenuator: Pros and Cons

The electronic attenuator offers finer steps than the mechanical attenuator, has no acoustical noise, is faster, and is less subject to wear.

The “finer steps” advantage of the electronic attenuator is beneficial in optimizing the alignment of the analyzer dynamic range to the signal power in the front panel as well as remote use. Thus, you can achieve improved relative signal measurement accuracy. Compared to a mechanical attenuator with 2 dB steps, the 1 dB resolution of the electronic attenuator only gives better resolution when the odd-decibel steps are used. Those odd-decibel steps are less accurately calibrated than the even-decibel steps, so one tradeoff for this superior relative accuracy is reduced absolute amplitude accuracy.

Another disadvantage of the electronic attenuator is that the spectrum analyzer loses its “Auto” setting, making operation less convenient.

Also, the relationship between the dynamic range specifications (TOI, SHI, compression and noise) and instrument performance are less well-known with the electrical attenuator. With the mechanical attenuator, TOI, SHI and compression threshold levels increase dB-for-dB with increasing attenuation, and the noise floor does as well. With the electronic attenuator, there is an excess attenuation of about 1 to 3 dB between 0 and 3.6 GHz, making the effective TOI, SHI, and so forth, less

well known. Excess attenuation is the actual attenuation relative to stated attenuation. Excess attenuation is accounted for in the analyzer calibration

Elec Atten

Controls the Electronic Attenuator in dual attenuator configurations. This key does not appear in single attenuator configurations, as the control of both the mechanical and electronic stages of the single attenuator is integrated into the single **Atten** key.

Key Path	AMPTD Y Scale, Attenuation
Remote Command	[:SENSe]:POWer[:RF]:EATTenuation <rel_amp1> [:SENSe]:POWer[:RF]:EATTenuation?
Notes	Electronic Attenuation's specification is defined only when Mechanical Attenuation is 6 dB.
Dependencies	This key only appears in Dual Attenuator models with an Electronic Attenuator installed. It does not appear in models with the Single Attenuator configuration, as in the single attenuator configuration there is no "electronic attenuator" there is only a single integrated attenuator (which has both a mechanical and electronic stage). However, in the single attenuator configuration, EATT SCPI commands are accepted for compatibility with other X-series instruments and set a "soft" attenuation as described in "Attenuator Configurations and Auto/Man" on page 3105 . The "soft" attenuation is treated as an addition to the "main" attenuation value set by the Atten softkey or the POW:ATT SCPI command and affects the total attenuation displayed on the Attenuation key and the Meas Bar. When Enable Elec Atten is off or grayed out, the Elec Atten key is grayed out.
Preset	0 dB
State Saved	Saved in instrument state
Min	0 dB
Max	Dual attenuator configuration: 24 dB Single attenuator configuration: the total of ATT and EATT cannot exceed 50 dB, so if the EATT is set to 24 dB first, the main attenuation cannot be greater than 26 dB and will be reduced accordingly; if the main attenuator is set to 40 dB first, EATT cannot be greater than 10 dB
Initial S/W Revision	Prior to A.02.00
Modified at S/W Revision	A.03.00

Adjust Atten for Min Clip

Sets the combination of mechanical and electronic attenuation and gain based on the current measured signal level so that clipping will be at a minimum.

This is an "immediate action" function, that is, it executes once, when the key is pressed.

This key does not appear in measurements that do not support this functionality. The spectrum analyzer measurement, Swept SA, does not support this functionality.

Key Path	AMPTD Y Scale, Attenuation
Remote Command	[:SENSe]:POWer[:RF]:RANGe:OPTimize IMMEDIATE

Initial S/W Revision	Prior to A.02.00
Modified at S/W Revision	A.03.00

Pre-Adjust for Min Clip

If this function is on, it does the adjustment described under "[Adjust Atten for Min Clip](#)" on page 3108 each time a measurement restarts. Therefore, in Continuous measurement mode, it only executes before the first measurement.

In dual attenuator models, you can set **Elec+Mech Atten**, in which case both attenuators participate in the autoranging, or **Elec Atten Only**, in which case the mechanical attenuator does not participate in the autoranging. This latter case results in less wear on the mechanical attenuator and is usually faster.

This key is grayed out in measurements that do not support this functionality. The spectrum analyzer measurement, Swept SA, does not support this functionality.

Key Path	AMPTD Y Scale, Attenuation
Remote Command	<code>[:SENSe] :POWer [:RF] :RANGe :OPTimize :ATTenuation OFF ELECtrical COMBined</code> <code>[:SENSe] :POWer [:RF] :RANGe :OPTimize :ATTenuation?</code>
Notes	The SCPI parameter ELECtrical sets this function to On in single attenuator models. The SCPI parameter COMBined is mapped to ELECtrical in single attenuator models; if you send COMBined, it sets the function to On and returns ELEC to a query.
Dependencies	This key only appears in Dual Attenuator models with an Electronic Attenuator installed. In instruments with Dual Attenuator model, when Enable Elec Atten is off or grayed out, the Pre-Adjust for Min Clip key is grayed out.
Preset	OFF for Swept SA measurement; ON for all other measurements that support Pre-Adjust for Min Clip
State Saved	Saved in instrument state
Range	Dual attenuator models: Off Elec Atten Only Mech + Elec Atten Single attenuator models: Off On
Initial S/W Revision	Prior to A.02.00
Modified at S/W Revision	A.03.00

Remote Command	<code>[:SENSe] :POWer [:RF] :RANGe :AUTO ON OFF 1 0</code> <code>[:SENSe] :POWer [:RF] :RANGe :AUTO?</code>
Notes	ON aliases to "Elec Atten Only" (:POW:RANG:OPT:ATT ELEC) OFF aliases to "Off" (:POW:RANG:OPT:ATT OFF)

	The query :POW:RANG:AUTO? returns true if :POW:RANG:OPT:ATT is not "Off"
Initial S/W Revision	Prior to A.02.00

Off

Turns **Pre-Adjust for Min Clip** off. This is the default setting.

This key is grayed out in measurements that do not support this functionality. The spectrum analyzer measurement, Swept SA, does not support this functionality.

Key Path	AMPTD Y Scale, Attenuation, Pre-Adjust for Min Clip
Example	:POW:RANGe:OPT:ATT OFF
Initial S/W Revision	Prior to A.02.00

Elec Atten Only

Selects only the electric attenuator to participate in auto ranging. This offers less wear on the mechanical attenuator and is usually faster.

This key is grayed out in measurements that do not support this functionality. The spectrum analyzer measurement, Swept SA, does not support this functionality.

Key Path	AMPTD Y Scale, Attenuation, Pre-Adjust for Min Clip
Example	:POW:RANGe:OPT:ATT ELEC
Initial S/W Revision	Prior to A.02.00

Mech + Elec Atten

In dual attenuator models, this selects both attenuators participate in the autoranging.

This key is grayed out in measurements that do not support this functionality. The spectrum analyzer measurement, Swept SA, does not support this functionality.

Key Path	AMPTD Y Scale, Attenuation, Pre-Adjust for Min Clip
Example	:POW:RANGe:OPT:ATT COMB
Initial S/W Revision	Prior to A.02.00

(Mech) Atten Step

This controls the step size used when making adjustments to the input attenuation.

This key is labeled **Mech Atten Step** in dual attenuator models and **Atten Step** in single attenuator models. In the dual attenuator configuration, this key only affects the step size of the mechanical attenuator.

Key Path	AMPTD Y Scale, Attenuation
Remote Command	[:SENSe] :POWer [:RF] :ATTenuation :STEP [:INCRement] 10 dB 2 dB [:SENSe] :POWer [:RF] :ATTenuation :STEP [:INCRement] ?

Example	POW:ATT:STEP 2
Notes	Note this feature works like a 1-N choice from the front panel, but it takes a specific value (in dB) when used remotely. The only valid values are 2 and 10.
Dependencies	Blanked in CXA and EXA if option FSA (2 dB steps) is not present. If blanked, attempts to set it via SCPI will yield an error.
Couplings	When the attenuation step size changes, the current mechanical attenuation value is adjusted (if necessary) to be quantized to the new step size. That is, if step is set to 10 dB, mech atten is increased if necessary so it is a multiple of 10 dB
Preset	PXA and MXA: 2 dB EXA and CXA: 10 dB (2 dB with option FSA)
State Saved	Saved in instrument state
Initial S/W Revision	Prior to A.02.00
Modified at S/W Revision	A.03.00

Scale/Div

Sets the units per vertical graticule division on the display. The displayed Scale/Div is identical for all harmonics displayed.

Key Path	AMPTD Y Scale
Remote Command	<code>DISPlay:HARMonics:VIEW:WINDow:TRACe:Y[:SCALe]:PDIVision <relative amplitude></code> <code>DISPlay:HARMonics:VIEW:WINDow:TRACe:Y[:SCALe]:PDIVision?</code>
Example	DISP:HARM:VIEW:WIND:TRAC:Y:PDIV 5
Preset	10.00 dB
Min	0.1 dB
Max	20 dB
Initial S/W Revision	Prior to A.02.00

Presel Center

When this key is pressed, the centering of the preselector filter is adjusted to optimize the amplitude accuracy at the frequency of the selected marker. If the selected marker is not on when Presel Center is pressed, the analyzer will turn on the selected marker, perform a peak search, and then perform centering on the marker's center frequency. If the selected marker is already on and between the start and stop frequencies of the analyzer, the analyzer performs the preselector calibration on that marker's frequency. If the selected marker is already on, but outside the frequency range between Start Freq and Stop Freq, the analyzer will first perform a peak search, and then perform centering on the marker's center frequency.

The value displayed on the **Presel Adjust** key will change to reflect the new preselector tuning (see **Presel Adjust**).

A number of considerations should be observed to ensure proper operation. See ["Proper Preselector Operation" on page 3112](#).

Key Path	AMPTD Y Scale
Remote Command	[:SENSe] :POWer [:RF] :PCENter
Example	POW:PCEN
Notes	Note that the rules outlined above under the key description apply for the remote command as well as the key. The result of the command is dependent on marker position, and so forth. Any message shown by the key press is also shown in response to the remote command.
Dependencies	<ul style="list-style-type: none"> - Grayed out if the microwave preselector is off.) - If the selected marker's frequency is below Band 1, advisory message 0.5001 is generated and no action is taken. - Grayed out if entirely in Band 0. - Blank in models that do not include a preselector, such as option 503. If the SCPI is sent in these instruments, it is accepted without error, and the query always returns 0. - Grayed out in the Spectrogram View.
Couplings	<p>The active marker position determines where the centering will be attempted.</p> <p>If the analyzer is in a measurement such as averaging when centering is initiated, the act of centering the preselector will restart averaging but the first average trace will not be taken until the centering is completed.</p>
Status Bits/OPC dependencies	<p>When centering the preselector, *OPC will not return true until the process is complete and a subsequent measurement has completed, nor will results be returned to a READ or MEASure command.</p> <p>The Measuring bit should remain set while this command is operating and should not go false until the subsequent sweep/measurement has completed.</p>
Initial S/W Revision	Prior to A.02.00
Modified at S/W Revision	A.03.00

Proper Preselector Operation

A number of considerations should be observed to ensure proper operation:

3. If the selected marker is off, the analyzer will turn on a marker, perform a peak search, and adjust the preselector using the selected marker's frequency. It uses the "highest peak" peak search method unqualified by threshold or excursion, so that there is no chance of a 'no peak found' error. It continues with that peak, even if it is the peak of just noise. Therefore, for this operation to work properly, there should be a signal on screen in a preselected range for the peak search to find.

4. If the selected marker is already on, the analyzer will attempt the centering at that marker's frequency. There is no preselector for signals below about 3.6 GHz, therefore if the marker is on a signal below 3.6 GHz, no centering will be attempted and an advisory message generated
5. In some models, the preselector can be bypassed. If it is bypassed, no centering will be attempted in that range and a message will be generated.

Preselector Adjust

Allows you to manually adjust the preselector filter frequency to optimize its response to the signal of interest. This function is only available when "[Presel Center](#)" on page 3111 is available.

For general purpose signal analysis, using Presel Center is recommended. Centering the filter minimizes the impact of long-term preselector drift. Presel Adjust can be used instead to manually optimize the preselector. One application of manual optimization would be to peak the preselector response, which both optimizes the signal-to-noise ratio and minimizes amplitude variations due to small (short-term) preselector drifting.

Key Path	AMPTD Y Scale
Scope	Meas Global
Remote Command	<code>[:SENSe] :POWer [:RF] :PADJust <freq></code> <code>[:SENSe] :POWer [:RF] :PADJust?</code>
Example	POW:PADJ 100KHz POW:PADJ?
Notes	The value on the key reads out to 0.1 MHz resolution.
Dependencies	<ul style="list-style-type: none"> - Grayed out if microwave preselector is off.) - Grayed out if entirely in Band 0. - Blank in models that do not include a preselector, such as option 503. If the SCPI is sent in these instruments, it is accepted without error, and the query always returns 0. - Grayed out in the Spectrogram View.
Preset	0 MHz
State Saved	The Presel Adjust value set by Presel Center , or by manually adjusting Presel Adjust , is not saved in instrument state, and does not survive a Preset or power cycle.
Min	-500 MHz
Max	500 MHz
Default Unit	Hz
Backwards Compatibility SCPI	<code>[:SENSe] :POWer [:RF] :MW:PADJust</code> <code>[:SENSe] :POWer [:RF] :MMW:PADJust</code>

	PSA had multiple preselectors, but the X-Series has only one. These commands simply alias to [:SENSe]:POWer[:RF]:PADJust
Initial S/W Revision	Prior to A.02.00
Modified at S/W Revision	A.03.00

Remote Command	[:SENSe]:POWer[:RF]:PADJust:PRESelector MWAVE MMWave EXTERNAL [:SENSe]:POWer[:RF]:PADJust:PRESelector?
Notes	PSA had multiple preselectors, and you could select which preselector to adjust. Since the X-Series has only one mm/uW preselector, the preselector selection softkey is no longer available. However, to provide backward compatibility, we accept the legacy remote commands. The command form has no effect, the query always returns MWAVE
Initial S/W Revision	Prior to A.02.00

Y Axis Unit

Displays the menu keys that enable you to change the vertical (Y) axis amplitude unit. The analyzer retains the entered Y Axis Unit separately for both Log and Lin amplitude scale types. For example, if Scale Type has been set to Log, and you set Y Axis Unit to dBm, pressing Scale Type (Log) sets the Y Axis Unit to dBm. If Scale Type has been set to Lin and you set Y Axis Unit to V, pressing Scale Type (Lin) sets the Y Axis Unit to V. Pressing Scale Type (Log) again sets the Y axis unit back to dBm.

NOTE

The units of current (A, dBmA, dBuA) are calculated based on 50 ohms input impedance.

All four of the EMI units (dBμA/m, dBμV/m, DBG, dBpT) are treated by the instrument exactly as though they were dBuV. The user must load an appropriate correction factor using Amplitude Corrections for accurate and meaningful results.

If a SCPI command is sent to the analyzer that uses one of the EMI units as a terminator, the analyzer treats it as though DBUV had been sent as the terminator.

Key Path	AMPTD Y Scale
Mode	SA
Scope	Meas Global
Remote Command	:UNIT:POWer DBM DBMV DBMA V W A DBUV DBUA DBPW DBUVM DBUAM DBPT DBG :UNIT:POWer?
Example	UNIT:POW dBmV UNIT:POW?
Notes	The Y axis unit has either logarithmic or linear characteristics. The set of units that is logarithmic consists of dBm, dBmV, dBmA, dBμV, dBμA, dBμV/m, dBμA/m, dBpT, and DBG. The set of units that are linear consists of V, W, and A. The chosen unit will determine how the reference level and all the amplitude-related outputs like trace data, marker data, etc. read out.

Notes	<p>The settings of Y Axis Unit and Scale Type, affect how the data is read over the remote interface. When using the remote interface no unit is returned, so you must know what the Y axis unit is to interpret the results:</p> <p>Example 1, set the following:</p> <p>Scale Type (Log) Y Axis Unit, dBm Scale/Div, 1 dB Ref Level, 10 dBm</p> <p>This sets the top line to 10 dBm with each vertical division representing 1 dB. Thus, if a point on trace 1 is on the fifth graticule line from the top, it represents 5 dBm and will read out remotely as 5.</p> <p>Example 2, set the following:</p> <p>Scale Type (Lin) Y Axis Unit, Volts Ref Level, 100 mV (10 mV/div)</p> <p>This sets the top line to 100 mV and the bottom line to 0 V, so each vertical division represents 10 mV. Thus, if a point on trace 1 is on the fifth graticule line from the top, it represents 50 mV and will read out remotely as 50.</p>
Dependencies	<p>If an amplitude correction with an Antenna Unit other than None is applied and enabled, then that antenna unit is forced and the key with that unit is the only Y Axis Unit available. All other Y Axis Unit keys are grayed out.</p> <p>If an amplitude correction with an Antenna Unit other than None is applied and enabled, and you then turn off that correction or set Apply Corrections to No, the Y Axis Unit that existed before the Antenna Unit was applied is restored.</p>
Couplings	The analyzer retains the entered Y Axis Unit separately for both Log and Lin amplitude scale types
Preset	dBm for log scale, V for linear. The true 'preset' value is dBm, since at preset the Y Scale type is set to logarithmic.
State Saved	Saved in instrument state
Readback line	1-of-N selection
Initial S/W Revision	Prior to A.02.00
Modified at S/W Revision	A.02.00, A.04.00, A.11.00

dBm

Sets the amplitude unit for the selected amplitude scale (log/lin) to dBm.

Key Path	AMPTD Y Scale, Y Axis Unit
Example	UNIT:POW DBM
Dependencies	Grayed out if an Amplitude Correction with an Antenna Unit is ON.
Readback	dBm
Initial S/W Revision	Prior to A.02.00
Modified at S/W Revision	A.02.00

dBmV

Sets the amplitude unit for the selected amplitude scale (log/lin) to dBmV.

Key Path	AMPTD Y Scale, Y Axis Unit
Example	UNIT:POW DBMV
Dependencies	Grayed out if an Amplitude Correction with an Antenna Unit is ON.
Readback	dBmV
Initial S/W Revision	Prior to A.02.00
Modified at S/W Revision	A.02.00

dBmA

Sets the amplitude unit for the selected amplitude scale (log/lin) to dBmA.

Key Path	AMPTD Y Scale, Y Axis Unit
Example	UNIT:POW DBMA
Dependencies	Grayed out if an Amplitude Correction with an Antenna Unit is ON.
Readback	dBmA
Initial S/W Revision	Prior to A.02.00
Modified at S/W Revision	A.02.00

W

Sets the amplitude unit for the selected amplitude scale (log/lin) to watt.

Key Path	AMPTD Y Scale, Y Axis Unit
Example	UNIT:POW W
Dependencies	Grayed out if an Amplitude Correction with an Antenna Unit is ON.
Readback	W
Initial S/W Revision	Prior to A.02.00
Modified at S/W Revision	A.02.00

V

Sets the amplitude unit for the selected amplitude scale (log/lin) to volt.

Key Path	AMPTD Y Scale, Y Axis Unit
Example	UNIT:POW V
Dependencies	Grayed out if an Amplitude Correction with an Antenna Unit is ON.
Readback	V
Initial S/W Revision	Prior to A.02.00

Modified at S/W Revision	A.02.00
--------------------------	---------

A

Sets the amplitude unit for the selected amplitude scale (log/lin) to Ampere.

Key Path	AMPTD Y Scale, Y Axis Unit
----------	----------------------------

Example	UNIT:POW A
----------------	------------

Dependencies	Grayed out if an Amplitude Correction with an Antenna Unit is ON.
--------------	---

Readback	A
----------	---

Initial S/W Revision	Prior to A.02.00
----------------------	------------------

Modified at S/W Revision	A.02.00
--------------------------	---------

dB μ V

Sets the amplitude unit for the selected amplitude scale (log/lin) to dB μ V.

Key Path	AMPTD Y Scale, Y Axis Unit
----------	----------------------------

Example	UNIT:POW DBUV
----------------	---------------

Dependencies	Grayed out if an Amplitude Correction with an Antenna Unit is ON.
--------------	---

Readback	dB μ V
----------	------------

Initial S/W Revision	Prior to A.02.00
----------------------	------------------

Modified at S/W Revision	A.02.00
--------------------------	---------

dB μ A

Sets the amplitude unit for the selected amplitude scale (log/lin) to dB μ A.

NOTE

The unit dBuA can also appear as an Antenna Unit. This will be used by customers using current probes, because current probes are often supplied with conversion tables that provide the transducer factors. When dBuA is used as an Antenna Unit the normal conversion from power to amps for dBuA (based on the analyzer input impedance) is not done, but instead the conversion is based solely on the Correction that contains the transducer factors. This is what distinguishes dBuA as a normal unit from dBuA as an antenna unit. When querying the Y-Axis unit, you can query the Antenna Unit to distinguish between regular dBuA and the dBuA antenna unit. If :CORR:CSET:ANT? returns NOC (for No Conversion), you are using a normal Y Axis dBuA. If it returns UA you are using an Antenna Unit dBuA.

Key Path	AMPTD Y Scale, Y Axis Unit
----------	----------------------------

Example	UNIT:POW DBUA
----------------	---------------

Dependencies	Grayed out if an Amplitude Correction with an Antenna Unit is ON.
--------------	---

Readback	dB μ A
Initial S/W Revision	Prior to A.02.00
Modified at S/W Revision	A.02.00

Antenna Unit

When a Correction is turned on that uses an Antenna Unit, the Y Axis Unit changes to that Antenna Unit. All of the keys in the Y-Axis Unit menu are then greyed out, except the Antenna Unit key. The unit being used is shown on this key and is shown as selected in the submenu.

Key Path	AMPTD Y Scale, Y Axis Unit
Dependencies	Grayed out if no Amplitude Correction with an Antenna Unit is on.
Readback line	Currently selected unit
Initial S/W Revision	A.11.00

dB μ V/m

Sets the amplitude unit for the selected amplitude scale (log/lin) to dB μ V/m. This is an antenna unit, and this key is grayed out unless a Correction with this Antenna Unit selected is ON. If this is the case, all of the other Antenna Units are grayed out.

Key Path	AMPTD Y Scale, Y Axis Unit, Antenna Unit
Example	UNIT:POW DBUVM
Dependencies	Grayed out if no Amplitude Correction with an Antenna Unit is on.
Readback	dB μ V/m
Initial S/W Revision	A.02.00

dB μ A/m

Sets the amplitude unit for the selected amplitude scale (log/lin) to dB μ A/m. This is an antenna unit, and this key is grayed out unless a Correction with this Antenna Unit selected is ON. If this is the case, all of the other Antenna Units are grayed out.

Key Path	AMPTD Y Scale, Y Axis Unit, Antenna Unit
Example	UNIT:POW DBUAM
Dependencies	Grayed out if no Amplitude Correction with an Antenna Unit is on.
Readback	dB μ A/m
Initial S/W Revision	A.02.00

dB μ A

Sets the amplitude unit for the selected amplitude scale (log/lin) to dB μ A. This is an antenna unit, and this key is grayed out unless a Correction with this Antenna Unit selected is ON. If this is the case, all of the other Antenna Units are grayed out.

Key Path	AMPTD Y Scale, Y Axis Unit, Antenna Unit
Example	UNIT:POW DBUAM
Dependencies	Grayed out if no Amplitude Correction with an Antenna Unit is on.
Readback	dB μ A
Initial S/W Revision	A.11.00

dBpT

Sets the amplitude unit for the selected amplitude scale (log/lin) to dBpT. This is an antenna unit, and this key is grayed out unless a Correction with this Antenna Unit selected is ON. If this is the case, all of the other Antenna Units are grayed out.

Key Path	AMPTD Y Scale, Y Axis Unit, Antenna Unit
Example	UNIT:POW DBPT
Dependencies	Grayed out if no Amplitude Correction with an Antenna Unit is on.
Readback	dBpT
Initial S/W Revision	A.02.00

dBG

Sets the amplitude unit for the selected amplitude scale (log/lin) to dBG. This is an antenna unit, and this key is grayed out unless a Correction with this Antenna Unit selected is ON. If this is the case, all of the other Antenna Units are grayed out.

Key Path	AMPTD Y Scale, Y Axis Unit, Antenna Unit
Example	UNIT:POW DBG
Dependencies	Grayed out if no Amplitude Correction with an Antenna Unit is on.
Readback	dBG
Initial S/W Revision	A.02.00

None

This is selected if no Antenna Unit is currently on, however you cannot actually set this value, since it is always grayed out. The key is included simply to provide an indication on the Readback line of the Antenna Unit key when there is no Antenna Unit selected.

Key Path	AMPTD Y Scale, Y Axis Unit, Antenna Unit
Readback	"None"
Initial S/W Revision	A.11.00

Reference Level Offset

Adds an offset value to the displayed reference level. The reference level is the absolute amplitude represented by the top graticule line on the display.

See ["More Information" on page 3120](#)

Key Path	AMPTD Y Scale
Mode	SA
Scope	Meas Global
Remote Command	:DISP:WINDow[1]:TRACe:Y[:SCALe]:RLEVel:OFFSet <rel_amp1> :DISP:WINDow[1]:TRACe:Y[:SCALe]:RLEVel:OFFSet?
Example	DISP:WIND:TRAC:Y:RLEV:OFFS 12.7 Sets the Ref Level Offset to 12.7 dB. The only valid suffix is dB. If no suffix is sent, dB will be assumed.
Preset	0 dBm
State Saved	Saved in instrument state
Min	The range for Ref Lvl Offset is variable. It is limited to values that keep the reference level within the range of -327.6 dB to 327.6 dB.
Max	327.6 dB
Backwards Compatibility Notes	<ol style="list-style-type: none"> 6. In pre-X-Series instruments, Ref Level Offset could not be adjusted by the knob or step keys. That is no longer the case. 7. In ESA and PSA, Ref Level Offset was applied to the data as it was acquired; thus if the Offset changed the new offset was not applied until new trace data was taken. In X-Series, the offset is applied as the data is displayed/queried, so if you change the offset, it will change the data immediately.
Initial S/W Revision	Prior to A.02.00
Modified at S/W Revision	A.04.00

More Information

Offsets are used when gain or loss occurs between a device under test and the analyzer input. Thus, the signal level measured by the analyzer may be thought of as the level at the input of an external amplitude conversion device. Entering an offset does not affect the trace position or attenuation value, just the value of the top line of the display and the values represented by the trace data. Thus, the values of exported trace data, queried trace data, marker amplitudes, trace data used in calculations such as N dB points, trace math, peak threshold, and so forth, are all affected by Ref Level Offset.

NOTE

Changing the offset causes the analyzer to immediately stop the current sweep and prepare to begin a new sweep, but the data will not change until the trace data updates, because the offset is applied to the data as it is taken. If a trace is exported with a nonzero Ref Level Offset, the exported data will contain the trace data with the offset applied.

The maximum reference level available is dependent on the reference level offset. That is, Ref Level - Ref Level Offset must be in the range -170 to +30 dBm. For example, the reference level value range can be initially set to values from -170 dBm

to 30 dBm with no reference level offset. If the reference level is first set to -20 dBm, then the reference level offset can be set to values of -150 to +50 dB.

If the reference level offset is first set to -30 dB, then the reference level can be set to values of -200 dBm to 0 dBm. In this case, the reference level is “clamped” at 0 dBm because the maximum limit of +30 dBm is reached with a reference level setting of 0 dBm with an offset of -30 dB. If instead, the reference level offset is first set to 30 dB, then the reference level can be set to values of -140 to +60 dBm.

μW Path Control

The **μW Path Control** functions include the **μW Preselector Bypass** (Option MPB) and **Low Noise Path** (Option LNP) controls in the High Band path circuits.

When the μW Preselector is bypassed, the user has better flatness, but will be subject to spurs from out of band interfering signals. When the Low Noise Path is enabled, the analyzer automatically switches around certain circuitry in the high frequency bands which can contribute to noise, when it is appropriate based on other analyzer settings.

For most applications, the preset state is Standard Path, which gives the best remote-control throughput, minimizes acoustic noise from switching and minimizes the risk of wear out in the hardware switches. For applications that utilize the wideband IF paths, the preset state is the μW Preselector Bypass path, if option MPB is present. This is because, when using a wideband IF such as the 140 MHz IF, the μW Preselector’s bandwidth can be narrower than the available IF bandwidth, causing degraded amplitude flatness and phase linearity, so it is desirable to bypass the preselector in the default case.

Users may choose Low Noise Path Enable. It gives a lower noise floor, especially in the 21-26.5 GHz region, though without improving many measures of dynamic range, and without giving the best possible noise floor. The preamp, if purchased and used, gives better noise floor than does the Low Noise Path, however its compression threshold and third-order intercept are much poorer than that of the non-preamp Low Noise Path. There are some applications, typically for signals around -30 dBm, for which the third-order dynamic range of the standard path is good enough, but the noise floor is not low enough even with 0 dB input attenuation. When the third-order dynamic range of the preamp path is too little and the noise floor of the standard path is too high, the Low Noise Path can provide the best dynamic range.

Key Path	AMPTD Y Scale
Mode	SA, BASIC, PNOISE, VSA , LTE, LTETDD
Scope	Meas Global
Remote Command	[:SENSe] :POWer [:RF] :MW:PATH STD LNPath MPBypass FULL [:SENSe] :POWer [:RF] :MW:PATH?
Example	:POW:MW:PATH LNP Enables the Low Noise path
Notes	If a Presel Center is performed, the analyzer will momentarily switch to the Standard Path, regardless of the setting of μW Path Control

The DC Block will always be switched in when the low noise path is switched in, to protect succeeding circuitry from DC. Note that this does not mean “when the low noise path is enabled” but when, based on the Low Noise Path rules, the path is actually switched in. This can happen when the selection is **Low Noise Path Enable** . In the case where the DC Block is switched in the analyzer is now AC coupled. However, if the user has selected DC coupling, the UI will still behave as though it were DC coupled, including all annunciation, warnings, status bits, and responses to SCPI queries. This is because, based on other settings, the analyzer could switch out the low noise path at any time and hence go back to being DC coupled.

Alignment switching ignores the settings in this menu, and restores them when finished.

Dependencies	Unavailable in BBIQ and External Mixing
Preset	All modes other than IQ Analyzer mode and VXA: STD IQ Analyzer, VXA and WLAN mode: MPB option present and licensed: MPB MPB option not present and licensed: STD
State Saved	Save in instrument state
Readback	Value selected in the submenu
Initial S/W Revision	A.04.00
Modified at S/W Revision	A.10.00

Standard Path

This path gives the best remote-control throughput, minimizes acoustic noise from switching and minimizes the risk of wear in the hardware switches, particularly in remote test scenarios where both low band and high band setups will follow in rapid succession.

In this path, the bypass of the low band/high band switch and microwave preamp is never activated, which can cause some noise degradation but preserves the life of the bypass switch.

Key Path	AMPTD Y Scale, μW Path Control
Example	:POW:MW:PATH STD
Readback Text	Standard Path
Initial S/W Revision	A.04.00

μ W Preselector Bypass

This key toggles the preselector bypass switch for band 1 and higher. When the microwave preselector is on, the signal path is preselected. When the microwave preselector is off, the signal path is not preselected. The preselected path is the normal path for the analyzer.

The preselector is a tunable bandpass filter which prevents signals away from the frequency of interest from combining in the mixer to generate in-band spurious signals (images). The consequences of using a preselector filter are its limited

bandwidth, the amplitude and phase ripple in its passband, and any amplitude and phase instability due to center frequency drift.

Option MPB or pre-selector bypass provides an unpreselected input mixer path for certain X-Series signal analyzers with frequency ranges above 3.6 GHz. This signal path allows a wider bandwidth and less amplitude variability, which is an advantage when doing modulation analysis and broadband signal analysis. The disadvantage is that, without the preselector, image signals will be displayed. Another disadvantage of bypassing the preselector is increased LO emission levels at the front panel input port.

Image responses are separated from the real signal by twice the 1st IF. For IF Paths of 10 MHz and 25 MHz, the 1st IF is 322.5 MHz, so the image response and the real signal will be separated by 645 MHz. The 1st IF will be different for other IF Path settings. When viewing a real signal and its corresponding image response in internal mixing, the image response will be to the left of the real signal.

Also, the image response and the real signal typically have the same amplitude and exhibit the same shape factor.

However, if Option FS1, Fast Sweep Capability, is enabled, the image response in the Swept SA measurement will appear lower in amplitude and have a much wider shape factor compared to the real signal.

Key Path	AMPTD Y Scale, μ W Path Control
Example	:POW:MW:PATH MPB
Dependencies	Key is blanked if current mode does not support it. Key is grayed out if mode supports it but current measurement does not support it. Key is blank unless Option MPB is present and licensed. If SCPI command sent when MPB not present, error -241, "Hardware missing; Option not installed" is generated.
Readback Text	μ W Preselector Bypass
Initial S/W Revision	A.04.00

Remote Command	[:SENSe] :POWer [:RF] :MW:PRESelector [:STATe] ON OFF 0 1 [:SENSe] :POWer [:RF] :MW:PRESelector [:STATe] ?
Example	:POW:MW:PRES OFF Bypasses the microwave preselector
Notes	The ON parameter sets the STD path (:POW:MW:PATH STD) The OFF parameter sets path MPB (:POW:MW:PATH MPB)
Preset	ON

Internal Preamp

Accesses a menu of keys that control the internal preamps. Turning on the preamp gives a better noise figure, but a poorer TOI to noise floor dynamic range. You can optimize this setting for your particular measurement.

The instrument takes the preamp gain into account as it sweeps. If you sweep outside of the range of the preamp the instrument will also account for that. The displayed result will always reflect the correct gain.

For some measurements, when the preamp is on and any part of the displayed frequency range is below the lowest frequency for which the preamp has specifications, a warning condition message appears in the status line. For example ,for a preamp with a 9 kHz lowest specified frequency: "Preamp: Accy unspec'd below 9 kHz".

Key Path	AMPTD Y Scale
Scope	Meas Global
Remote Command	[:SENSe] :POWer [:RF] :GAIN [:STATe] OFF ON 0 1 [:SENSe] :POWer [:RF] :GAIN [:STATe] ?
Dependencies	Preamp is not available on all hardware platforms. If the preamp is not present or is unlicensed, the key is not shown. The preamp is not available when the electronic/soft attenuator is enabled.
Couplings	The act of connecting the U7227A USB Preamplifier to one of the analyzer's USB ports will cause the Internal Preamp to be switched on. When this happens an informational message will be generated: "Internal Preamp turned on for optimal operation with USB Preamp." Note that if the Internal Preamp was already on, there will be no change to the setting, but if it was Off it will be switched On, to Full Range. Note that this same action occurs when the SA mode is selected while the USB Preamp is connected to one of the analyzer's USB ports, if it is the first time that the SA mode has run since powerup, or if the last time the SA mode was running the USB Preamp was NOT connected. Subsequently disconnecting the USB Preamp from USB does not change the Internal Preamp setting nor restore the previous setting.
Preset	OFF
State Saved	Saved in instrument state
Initial S/W Revision	Prior to A.02.00
Modified at S/W Revision	A.14.00

Key Path	AMPTD Y Scale, Internal Preamp
Scope	Meas Global
Remote Command	[:SENSe] :POWer [:RF] :GAIN :BAND LOW FULL [:SENSe] :POWer [:RF] :GAIN :BAND ?
Dependencies	Preamp is not available on all hardware platforms. If the preamp is not present or is unlicensed, the key is not shown. If a POW:GAIN:BAND FULL command is sent when a low band preamp is available, the preamp band parameter is to LOW instead of FULL, and an "Option not installed" message is generated.
Preset	LOW
State Saved	Saved in instrument state
Initial S/W Revision	Prior to A.02.00

Off

Turns the internal preamp off

Key Path	AMPTD Y Scale, Internal Preamp
Example	:POW:GAIN OFF
Readback	Off
Initial S/W Revision	Prior to A.02.00

Low Band

Sets the internal preamp to use only the low band.

The frequency range of the installed (optional) low-band preamp is displayed in square brackets on the **Low Band** key label.

Key Path	AMPTD Y Scale, Internal Preamp
Example	:POW:GAIN ON :POW:GAIN:BAND LOW
Readback	Low Band
Initial S/W Revision	Prior to A.02.00

Full Range

Sets the internal preamp to use its full range. The low band (0-3.6 GHz or 0-3GHz, depending on the model) is supplied by the low band preamp and the frequencies above low band are supplied by the high band preamp.

The frequency range of the installed (optional) preamp is displayed in square brackets on the **Full Range** key label. If the high band option is not installed the Full Range key does not appear.

Key Path	AMPTD Y Scale, Internal Preamp
Example	:POW:GAIN ON :POW:GAIN:BAND FULL
Readback	Full Range
Initial S/W Revision	Prior to A.02.00

Ref Position

Positions the reference value at the top, center or bottom of the Y Scale display. Changing the reference position does not change the reference value.

Key Path	AMPTD Y Scale
Remote Command	:DISPlay:HARMonics:VIEW:WINDow:TRACe:Y[:SCALE]:RPOSition TOP CENTer BOTTom :DISPlay:HARMonics:VIEW:WINDow:TRACe:Y[:SCALE]:RPOSition?

Example	DISP:HARM:VIEW:WIND:TRAC:Y:RPOS BOTT
Preset	Top
Range	Top Ctr Bot
Initial S/W Revision	Prior to A.02.00

Auto Couple

The Auto Couple feature provides a quick and convenient way to automatically couple multiple instrument settings. This helps ensure accurate measurements and optimum dynamic range. When the Auto Couple feature is activated, either from the front panel or remotely, all parameters of the current measurement that have an Auto/Manual mode are set to Auto mode and all measurement settings dependent on (or coupled to) the Auto/Man parameters are automatically adjusted for optimal performance.

However, the Auto Couple key actions are confined to the current measurement only. It does not affect other measurements in the mode, and it does not affect markers, marker functions, or trace or display attributes.

See ["More Information" on page 3127](#)

Key Path	Front-panel key
Remote Command	:COUPlE ALL NONE
Example	:COUP ALL
Notes	:COUPlE ALL puts all Auto/Man parameters in Auto mode (equivalent to pressing the Auto Couple key). :COUPLE NONE puts all Auto/Man parameters in manual mode. It decouples all the coupled instrument parameters and is not recommended for making measurements.
Initial S/W Revision	Prior to A.02.00

More Information

There are two types of functions that have Auto/Manual modes.

Auto/Man Active Function keys

An Auto/Man toggle key controls the binary state associated with an instrument parameter by toggling between **Auto** (where the parameter is automatically coupled to the other parameters it is dependent upon) and **Man** (where the parameter is controlled independent of the other parameters), as well as making the parameter the active function. The current mode is indicated on the softkey with either **Auto** or **Man** underlined as illustrated below.

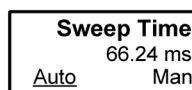

vsd07

Auto/Man 1-of-N keys

An Auto/Man 1-of-N key allows you to manually pick from a list of parameter values, or place the function in Auto, in which case the value is automatically selected (and indicated).

- If in Auto, Auto is underlined on the calling key.

- If in manual operation, manual is indicated on the calling key, but note that the calling key simply opens the menu and does **not** actually toggle the function.

BW

Accesses a menu that enables you to control the bandwidth functions of the instrument.

Key Path	Front-panel key
Initial S/W Revision	Prior to A.02.00

Res BW

Allows setting the Resolution Bandwidth (RBW) used in measuring the fundamental signal. Second and subsequent harmonics by default use a multiple of the resolution bandwidth proportional to their frequency multiplier. Only Gaussian RBW filters are enabled and the list of allowable RBW values matches those of the Spectrum Analyzer measurement.

In the harmonics measurement, the resolution bandwidth is not auto-coupled to span. If Auto is on, the resolution bandwidth is determined from the first sweep ("[Harmonic Measurement Details](#)" on page 3100) when the measurement is restarted.

Only Gaussian RBW filters are enabled.

Key Path	BW
Remote Command	<pre>[:SENSe]:HARMonics:BAWdwidth BWIDth[:RESolution] <freq> [:SENSe]:HARMonics:BAWdwidth BWIDth[:RESolution]? [:SENSe]:HARMonics:BAWdwidth BWIDth[:RESolution]:AUTO OFF ON 0 1 [:SENSe]:HARMonics:BAWdwidth BWIDth[:RESolution]:AUTO?</pre>
Example	<pre>HARM:BWID 10 kHz HARM:BWID?</pre>
Notes	Forces measurement restart.
Preset	The bandwidth found by the first sweep (" Harmonic Measurement Details " on page 3100). The resulting value will vary, depending upon the input signal.
Min	1 Hz
Max	8 MHz
Initial S/W Revision	Prior to A.02.00

Cont (Continuous Measurement/Sweep)

Sets the analyzer for Continuous measurement operation. The single/continuous state is Meas Global so the setting will affect all measurements. If you are Paused, pressing **Cont** does a Resume.

Key Path	Front-panel key
Remote Command	:INITiate:CONTinuous OFF ON 0 1 :INITiate:CONTinuous?
Example	:INIT:CONT 0 puts analyzer in Single measurement operation. :INIT:CONT 1 puts analyzer in Continuous measurement operation
Preset	ON (Note that SYST:PRESet sets INIT:CONT to ON but *RST sets INIT:CONT to OFF)
State Saved	Saved in instrument state
Backwards Compatibility Notes	For Spectrum Analysis mode in ESA and PSA, there is no Cont hardkey, instead there is a Sweep Single/Cont key. In these analyzers, switching the Sweep Single/Cont key from Single to Cont restarts averages (displayed average count reset to 1), but does not restart Max Hold and Min Hold . The X-Series has Single and Cont keys in place of the SweepSingleCont key. In the X-Series, if in single measurement, the Cont key (and INIT:CONT ON) switches to continuous measurement, but never restarts a measurement and never resets a sweep.
Initial S/W Revision	Prior to A.02.00

In Swept SA Measurement (Spectrum Analysis Mode):

The analyzer takes repetitive sweeps, averages, measurements, etc., when in Continuous mode. When the average count reaches the Average/Hold Number the count stops incrementing, but the analyzer keeps sweeping. See the Trace/Detector section for the averaging formula used both before and after the Average/Hold Number is reached. The trigger condition must be met prior to each sweep. The type of trace processing for multiple sweeps, is set under the Trace/Detector key, with choices of **Trace Average**, **Max Hold**, or **Min Hold**.

In Other Measurements/Modes:

With **Avg/Hold Num** (in the **Meas Setup** menu) set to **Off** or set to **On** with a value of 1, a sweep is taken after the trigger condition is met; and the analyzer continues to take new sweeps after the current sweep has completed and the trigger condition is again met. However, with **Avg/Hold Num** set to On with a value >1, multiple sweeps (data acquisitions) are taken for the measurement. The trigger condition must be met prior to each sweep. The sweep is not stopped when the average count k equals the number N set for Avg/Hold Num is reached, but the number k stops incrementing. A measurement average usually applies to all traces, marker results, and numeric results. But sometimes it only applies to the numeric results.

If the analyzer is in Single measurement, pressing the **Cont** key does not change k and does not cause the sweep to be reset; the only action is to put the analyzer into Continuous measurement operation.

If it is already in continuous sweep:

the INIT:CONT 1 command has no effect

the INIT:CONT 0 command will place the analyzer in Single Sweep but will have no effect on the current sequence until $k = N$, at which point the current sequence will stop and the instrument will go to the idle state.

File

See "File" on page 426

FREQ Channel

Accesses a menu of keys that allow you to control the Frequency and Channel parameters of the instrument.

Key Path	Front-panel key
Initial S/W Revision	Prior to A.02.00

Fundamental

Sets the frequency of the fundamental measured signal. By default, other harmonic measurements will be measured at multiples of the specified fundamental frequency.

If Auto is on, the fundamental is determined from the first sweep ("[Harmonic Measurement Details](#)" on page 3100) whenever the measurement is restarted. .

Key Path	FREQ Channel
Remote Command	[:SENSe]:HARMonics:FREQuency:FUNDamental <freq> [:SENSe]:HARMonics:FREQuency:FUNDamental? [:SENSe]:HARMonics:FREQuency:FUNDamental:AUTO OFF ON 0 1 [:SENSe]:HARMonics:FREQuency:FUNDamental:AUTO?
Example	HARM:FREQ:FUND 1 GHZ HARM:FREQ:FUND?
Notes	Forces measurement restart.
Couplings	This value is affected by Freq Offset.
Preset	The frequency found when initiating an Auto Tune from the current SA measurement condition.
Min	1 Hz
Max	Half the maximum available instrument frequency.
Initial S/W Revision	Prior to A.02.00

Freq Step

Enables you to change the step size for the fundamental frequency. Once a step size has been selected and the fundamental frequency function is active, the step keys (and the UP|DOWN parameters for Fundamental Frequency from remote commands) change frequency by the step-size value.

Key Path	FREQ Channel
Remote Command	[:SENSe]:HARMonics:FREQuency:STEP[:INCRement] <freq> [:SENSe]:HARMonics:FREQuency:STEP[:INCRement]?

Example	HARM:FREQ:STEP 1 MHZ HARM:FREQ:STEP?
Preset	1 GHz
Min	1 Hz
Max	Set by the instrument maximum frequency.
Initial S/W Revision	Prior to A.02.00

Freq Offset

Enables you to set a frequency offset value to account for frequency conversions outside of the analyzer. This value is added to the display readout of the marker frequency, center frequency, start frequency, stop frequency, and all other absolute frequency settings in the analyzer including frequency count. When a frequency offset is entered, the value appears below the center of the graticule. To eliminate an offset, perform a Mode Preset or set the frequency offset to 0 Hz.

See ["More Information" on page 3135](#).

Key Path	FREQ Channel
Scope	Meas Global
Remote Command	[:SENSe] :FREQuency:OFFSet <freq> [:SENSe] :FREQuency:OFFSet?
Example	FREQ:OFFS 10 MHz
Notes	Preset and Max values are dependent on Hardware Options (503, 507, 508, 513, 526)
Dependencies	Freq Offset is not available in External Mixing. In this case the Freq Offset key is grayed out and shows a value of zero. However, the value of CF Offset that was set for the RF Input is retained and restored when the user switches back to the RF Input.
Preset	See "Center Frequency Presets" on page 2932
State Saved	Saved in instrument state
Min	-500 GHz
Max	500 GHz
Default Unit	Hz
Status Bits/OPC dependencies	Non-overlapped
Backwards Compatibility SCPI	DISPlay:WINDow[1]:TRACe:X[:SCALE]:OFFSet The DISPlay version of the command is in the instrument for compatibility across platforms and is not recommended for new development.
Backwards Compatibility Notes	<ol style="list-style-type: none"> 1. In pre-X-Series instruments, Frequency Offset could not be adjusted by the knob or step keys. That is no longer the case. 2. Some previous spectrum analyzers did not adjust frequency counter results for the Frequency Offset. The X-Series does adjust the frequency counter for the offset.

Initial S/W Revision	Prior to A.02.00
Modified at S/W Revision	A.04.00, A.08.50

More Information

This command does not affect any bandwidths or the settings of relative frequency parameters such as delta markers or span. It does not affect the current hardware settings of the analyzer, but only the displayed frequency values. Entering an offset does not affect the trace position or display, just the value of the start and stop frequency and the values represented by the trace data. The frequency values of exported trace data, queried trace data, markers, trace data used in calculations such as N dB points, trace math, etc., are all affected by Freq Offset. Changing the offset, even on a trace that is not updating will immediately change all of the above, without taking new data.

NOTE

If a trace is exported with a nonzero Freq Offset, the exported data will contain the trace data with the offset applied. Therefore, if that trace were to be imported back into the analyzer, you would want Freq Offset to be 0, or the offset would be applied again to data which is already offset. No such care need be taken when saving a State+Trace file because the data and state are saved together.

Input/Output

See ["Input/Output" on page 241](#)

Marker

There is no marker functionality in the Harmonics measurement.

Key Path	Front-panel key
Initial S/W Revision	Prior to A.02.00

Marker Function

There is no marker functionality in the Harmonics measurement.

Key Path	Front-panel key
Initial S/W Revision	Prior to A.02.00

Marker To

There is no marker functionality in the Harmonics measurement.

Key Path	Front-panel key
Initial S/W Revision	Prior to A.02.00

Meas

The information in this section is common to all measurements. For key and remote command information for a specific measurement, refer to the section that describes the measurement of interest.

Measurements available under the Meas key are specific to the current Mode.

When viewing Help for measurements, note the following:

NOTE

Operation for some keys differs between measurements. The information displayed in Help pertains to the current measurement. To see how a key operates in a different measurement, exit Help (press the Cancel Esc key), select the measurement, then reenter Help (press the Help key) and press that key.

Key Path	Front-panel key
Initial S/W Revision	Prior to A.02.00

Remote Measurement Functions

This section contains the following topics:

["Measurement Group of Commands" on page 3141](#)

["Current Measurement Query \(Remote Command Only\)" on page 3144](#)

["Limit Test Current Results \(Remote Command Only\)" on page 3144](#)

["Data Query \(Remote Command Only\)" on page 3144](#)

["Calculate/Compress Trace Data Query \(Remote Command Only\)" on page 3144](#)

["Calculate Peaks of Trace Data \(Remote Command Only\)" on page 3150](#)

["Hardware-Accelerated Fast Power Measurement \(Remote Command Only\)" on page 3151](#)

["Format Data: Numeric Data \(Remote Command Only\)" on page 3165](#)

["Format Data: Byte Order \(Remote Command Only\)" on page 3166](#)

Initial S/W Revision	Prior to A.02.00
----------------------	------------------

Measurement Group of Commands

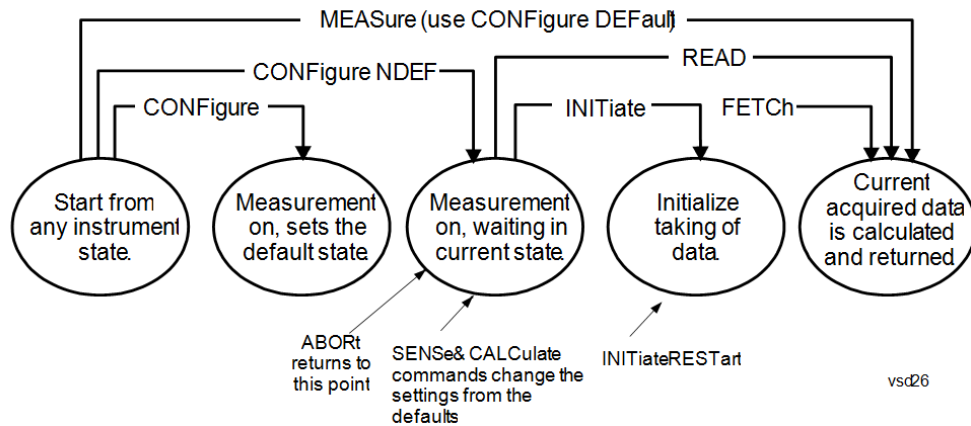

Measure Commands:

:MEASure:<measurement>[n]?

This is a fast single-command way to make a measurement using the factory default instrument settings. These are the settings and units that conform to the Mode Setup settings (e.g. radio standard) that you have currently selected.

- Stops the current measurement (if any) and sets up the instrument for the specified measurement using the factory defaults
- Initiates the data acquisition for the measurement
- Blocks other SCPI communication, waiting until the measurement is complete before returning results.
- If the function does averaging, it is turned on and the number of averages is set to 10.
- After the data is valid it returns the scalar results, or the trace data, for the specified measurement. The type of data returned may be defined by an [n] value that is sent with the command.
- The scalar measurement results will be returned if the optional [n] value is not included, or is set to 1. If the [n] value is set to a value other than 1, the selected trace data results will be returned. See each command for details of what types of scalar results or trace data results are available.
- ASCII is the default format for the data output. (Older versions of Spectrum Analysis and Phase Noise mode measurements only use ASCII.) The binary data formats should be used for handling large blocks of data since they are smaller and faster than the ASCII format. Refer to the FORMat:DATA command for more information.

If you need to change some of the measurement parameters from the factory default settings you can set up the measurement with the CONFIGure command. Use the commands in the SENSE:<measurement> and CALCulate:<measurement> subsystems to change the settings. Then you can use the READ? command to initiate the measurement and query the results.

If you need to repeatedly make a given measurement with settings other than the factory defaults, you can use the commands in the SENSE:<measurement> and CALCulate:<measurement> subsystems to set up the measurement. Then use the READ? command to initiate the measurement and query results.

Measurement settings persist if you initiate a different measurement and then return to a previous one. Use READ:<measurement>? if you want to use those persistent settings. If you want to go back to the default settings, use MEASure:<measurement>?.

Configure Commands:

:CONFigure:<measurement>

This command stops the current measurement (if any) and sets up the instrument for the specified measurement using the factory default instrument settings. It does not initiate the taking of measurement data unless INIT:CONTinuous is ON. If you change any measurement settings after using the CONFigure command, the READ command can be used to initiate a measurement without changing the settings back to their defaults.

In the Swept SA measurement in Spectrum Analyzer mode the CONFigure command also turns the averaging function on and sets the number of averages to 10 for all measurements.

:CONFigure: <measurement>: NDEFault stops the current measurement and changes to the specified measurement. It does not change the settings to the defaults. It does not initiate the taking of measurement data unless INIT:CONTinuous is ON.

The CONFigure? query returns the current measurement name.

The CONFigure:CATalog? query returns a quoted string of all licensed measurement names in the current mode. For example, "SAN, CHP, OBW, ACP, PST, TXP, SPUR, SEM, LIST".

Fetch Commands:

:FETCh:<measurement>[n]?

This command puts selected data from the most recent measurement into the output buffer. Use FETCh if you have already made a good measurement and you want to return several types of data (different [n] values, for example, both scalars and trace data) from a single measurement. FETCh saves you the time of re-making the measurement. You can only FETCh results from the measurement that is currently active, it will not change to a different measurement. An error message is reported if a measurement other than the current one is specified.

If you need to get new measurement data, use the READ command, which is equivalent to an INITiate followed by a FETCh.

The scalar measurement results will be returned if the optional [n] value is not included, or is set to 1. If the [n] value is set to a value other than 1, the selected trace data results will be returned. See each command for details of what types of scalar results or trace data results are available. The binary data formats should be used for handling large blocks of data since they are smaller and transfer faster than the ASCII format. (FORMat:DATA)

FETCh may be used to return results other than those specified with the original READ or MEASure command that you sent.

INITiate Commands:

:INITiate:<measurement>

This command is not available for measurements in all the instrument modes:

- Initiates a trigger cycle for the specified measurement, but does not output any data. You must then use the FETCh<meas> command to return data. If a

measurement other than the current one is specified, the instrument will switch to that measurement and then initiate it.

- For example, suppose you have previously initiated the ACP measurement, but now you are running the channel power measurement. If you send INIT:ACP? it will change from channel power to ACP and will initiate an ACP measurement.
- Does not change any of the measurement settings. For example, if you have previously started the ACP measurement and you send INIT:ACP? it will initiate a new ACP measurement using the same instrument settings as the last time ACP was run.
- If your selected measurement is currently active (in the idle state) it triggers the measurement, assuming the trigger conditions are met. Then it completes one trigger cycle. Depending upon the measurement and the number of averages, there may be multiple data acquisitions, with multiple trigger events, for one full trigger cycle. It also holds off additional commands on GPIB until the acquisition is complete.

READ Commands:

:READ:<measurement>[n]?

- Does not preset the measurement to the factory default settings. For example, if you have previously initiated the ACP measurement and you send READ:ACP? it will initiate a new measurement using the same instrument settings.
 - Initiates the measurement and puts valid data into the output buffer. If a measurement other than the current one is specified, the instrument will switch to that measurement before it initiates the measurement and returns results.
 - For example, suppose you have previously initiated the ACP measurement, but now you are running the channel power measurement. Then you send READ:ACP? It will change from channel power back to ACP and, using the previous ACP settings, will initiate the measurement and return results.
 - Blocks other SCPI communication, waiting until the measurement is complete before returning the results
 - If the optional [n] value is not included, or is set to 1, the scalar measurement results will be returned. If the [n] value is set to a value other than 1, the selected trace data results will be returned. See each command for details of what types of scalar results or trace data results are available. The binary data formats should be used when handling large blocks of data since they are smaller and faster than the ASCII format. (FORMat:DATA)
-

Current Measurement Query (Remote Command Only)

This command returns the name of the measurement that is currently running.

Remote Command	:CONFiGure?
Example	CONF?
Initial S/W Revision	Prior to A.02.00

Limit Test Current Results (Remote Command Only)

Queries the status of the current measurement limit testing. It returns a 0 if the measured results pass when compared with the current limits. It returns a 1 if the measured results fail any limit tests.

Remote Command	:CALCuLate:CLIMits:FAIL?
Example	CALC:CLIM:FAIL? queries the current measurement to see if it fails the defined limits. Returns a 0 or 1: 0 it passes, 1 it fails.
Initial S/W Revision	Prior to A.02.00

Data Query (Remote Command Only)

Returns the designated measurement data for the currently selected measurement and subopcode.

n = any valid subopcode for the current measurement. See the measurement command results table for your current measurement, for information about what data is returned for the subopcodes.

This command uses the data setting specified by the FORMat:BORDER and FORMat:DATA commands and can return real or ASCII data. (See the format command descriptions under Input/Output in the Analyzer Setup section.)

Remote Command	:CALCuLate:DATA[n]?
Notes	The return trace depends on the measurement. In CALCulate:<meas>:DATA[n], n is any valid subopcode for the current measurement. It returns the same data as the FETCh:<measurement>? query where <measurement> is the current measurement.
Initial S/W Revision	Prior to A.02.00

Calculate/Compress Trace Data Query (Remote Command Only)

Returns compressed data for the currently selected measurement and sub-opcode [n].

n = any valid sub-opcode for that measurement. See the MEASure:<measurement>? command description of your specific measurement for information on the data that can be returned.

The data is returned in the current Y Axis Unit of the analyzer. The command is used with a sub-opcode <n> (default=1) to specify the trace. With trace queries, it is best if the analyzer is not sweeping during the query. Therefore, it is generally advisable to be in Single Sweep, or Update=Off.

This command is used to compress or decimate a long trace to extract and return only the desired data. A typical example would be to acquire N frames of GSM data and return the mean power of the first burst in each frame. The command can also be used to identify the best curve fit for the data.

Remote Command	:CALCulate:DATA<n>:COMPRESS? BLOCK CFIT MAXimum MINimum MEAN DMEan RMS RMSCubed SAMPLE SDEVIation PPHase [,<soffset> [,<length>[,<roffset>[,<rlimit>]]]]
Example	To query the mean power of a set of GSM bursts: Supply a signal that is a set of GSM bursts. Select the IQ Waveform measurement (in IQ Analyzer Mode). Set the sweep time to acquire at least one burst. Set the triggers such that acquisition happens at a known position relative to a burst. Then query the mean burst levels using, CALC:DATA2:COMP? MEAN, 24e-6, 526e-6 (These parameter values correspond to GSM signals, where 526e-6 is the length of the burst in the slot and you just want 1 burst.)
Notes	The command supports 5 parameters. Note that the last 4 (<soffset>, <length>, <roffset>, <rlimit>) are optional. But these optional parameters must be entered in the specified order. For example, if you want to specify <length>, then you must also specify <soffset>. See details below for a definition of each of these parameters. This command uses the data in the format specified by FORMat:DATA, returning either binary or ASCII data.
Initial S/W Revision	Prior to A.02.00

- BLOCK or block data - returns all the data points from the region of the trace data that you specify. For example, it could be used to return the data points of an input signal over several timeslots, excluding the portions of the trace data that you do not want. (This is x,y pairs for trace data and I,Q pairs for complex data.)
- CFIT or curve fit - applies curve fitting routines to the data. <soffset> and <length> are required to define the data that you want. <roffset> is an optional parameter for the desired order of the curve equation. The query will return the following values: the x-offset (in seconds) and the curve coefficients ((order + 1) values).

MIN, MAX, MEAN, DME, RMS, RMSC, SAMP, SDEV and PPH return one data value for each specified region (or <length>) of trace data, for as many regions as possible until you run out of trace data (using <roffset> to specify regions). Or they return the number of regions you specify (using <rlimit>) ignoring any data beyond that.

- MINimum - returns the minimum data point (y value) for the specified region (s) of trace data. For I/Q trace data, the minimum magnitude of the I/Q pairs is returned.
- MAXimum - returns the maximum data point (y value) for the specified region(s) of trace data. For I/Q trace data, the maximum magnitude of the I/Q pairs is returned.
- MEAN - returns a single value that is the arithmetic mean of the data point values (in dB/ dBm) for the specified region(s) of trace data. For I/Q trace data, the mean of the magnitudes of the I/Q pairs is returned. See the following equations.

NOTE

If the original trace data is in dB, this function returns the arithmetic mean of those log values, not log of the mean power which is a more useful value. The mean of the log is the better measurement technique when measuring CW signals in the presence of noise. The mean of the power, expressed in dB, is useful in power measurements such as Channel Power. To achieve the mean of the power, use the RMS option.

Equation 1

Mean Value of Data Points for Specified Region(s)

$$MEAN = \frac{1}{n} \sum_{X_i \in \text{region}(s)} X_i$$

where X_i is a data point value, and n is the number of data points in the specified region(s).

Equation 2

Mean Value of I/Q Data Pairs for Specified Region(s)

$$MEAN = \frac{1}{n} \sum_{X_i \in \text{region}(s)} |X_i|$$

where $|X_i|$ is the magnitude of an I/Q pair, and n is the number of I/Q pairs in the specified region(s).

- DMEan - returns a single value that is the mean power (in dB/ dBm) of the data point values for the specified region(s) of trace data. See the following

equation:

Equation 3

DMEan Value of Data Points for Specified Region(s)

$$\text{DME} = 10 \times \log_{10} \left(\frac{1}{n} \sum_{X_i \in \text{region}(s)} 10^{\frac{X_i}{10}} \right)$$

- RMS - returns a single value that is the average power on a root-mean-squared voltage scale (arithmetic rms) of the data point values for the specified region(s) of trace data. See the following equation.

NOTE

For I/Q trace data, the rms of the magnitudes of the I/Q pairs is returned. See the following equation.

This function is very useful for I/Q trace data. However, if the original trace data is in dB, this function returns the rms of the log values which is not usually needed.

Equation 4

RMS Value of Data Points for Specified Region(s)

$$\text{RMS} = \sqrt{\frac{1}{n} \sum_{X_i \in \text{region}(s)} X_i^2}$$

where X_i is a data point value, and n is the number of data points in the specified region(s).

Equation 5

RMS Value of I/Q Data Pairs for Specified Region(s)

$$\text{RMS} = \sqrt{\frac{1}{n} \sum_{X_i \in \text{region}(s)} X_i X_i^*}$$

where X_i is the complex value representation of an I/Q pair, X_i^* its conjugate complex number, and n is the number of I/Q pairs in the specified region(s).

Once you have the rms value for a region of trace data (linear or I/Q), you may want to calculate the mean power. You must convert this rms value (peak volts) to power in dBm:

$$10 \times \log[10 \times (\text{rms value})^2]$$

- SAMPlE - returns the first data value (x,y pair) for the specified region(s) of trace data. For I/Q trace data, the first I/Q pair is returned.
- SDEViation - returns a single value that is the arithmetic standard deviation for the data point values for the specified region(s) of trace data. See the following equation.
- For I/Q trace data, the standard deviation of the magnitudes of the I/Q pairs is returned. See the following equation.

Equation 6

Standard Deviation of Data Point Values for Specified Region(s)

$$SDEV = \sqrt{\frac{1}{n} \sum_{X_i \in \text{region}(s)} (X_i - \bar{X})^2}$$

where X_i is a data point value, \bar{X} is the arithmetic mean of the data point values for the specified region(s), and n is the number of data points in the specified region(s).

$$SDEV = \sqrt{\frac{1}{n} \sum_{X_i \in \text{region}(s)} (|X_i| - \bar{X})^2}$$

where $|X_i|$ is the magnitude of an I/Q pair, \bar{X} is the mean of the magnitudes for the specified region(s), and n is the number of data points in the specified region(s).

- PPHase - returns the x,y pairs of both rms power (dBm) and arithmetic mean phase (radian) for every specified region and frequency offset (Hz). The number of pairs is defined by the specified number of regions. This parameter can be used for I/Q vector (n=0) in Waveform (time domain) measurement and all parameters are specified by data point in PPHase.

The rms power of the specified region may be expressed as:

$$\text{Power} = 10 \times \log [10 \times (\text{RMS I/Q value})] + 10.$$

The RMS I/Q value (peak volts) is:

$$\sqrt{\frac{1}{n} \sum_{X_i \in \text{region}} X_i X_i^*}$$

where X_i is the complex value representation of an I/Q pair, X_i^* its conjugate complex number, and n is the number of I/Q pairs in the specified region.

The arithmetic mean phase of the specified region may be expressed as:

$$\frac{1}{n} \sum_{Y_i \in \text{region}} Y_i$$

where Y_i is the unwrapped phase of I/Q pair with applying frequency correction and n is the number of I/Q pairs in the specified region.

The frequency correction is made by the frequency offset calculated by the arithmetic mean of every specified region's frequency offset. Each frequency offset is calculated by the least square method against the unwrapped phase of I/Q pair.

Sample Trace Data - Constant Envelope

(See below for explanation of variables.)

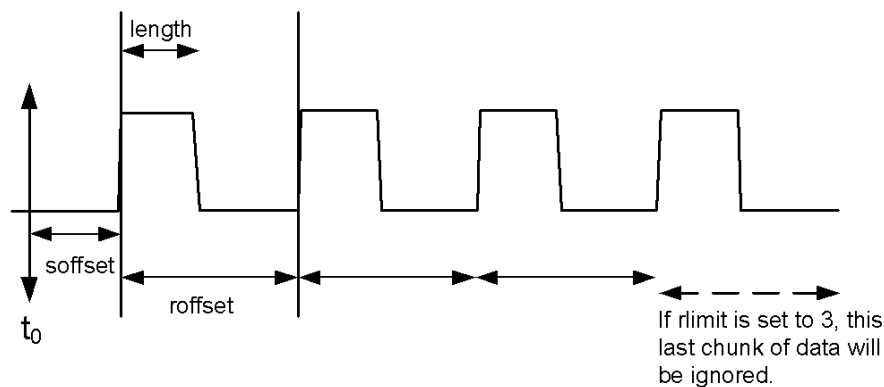

Sample Trace Data - Not Constant Envelope

(See below for explanation of variables.)

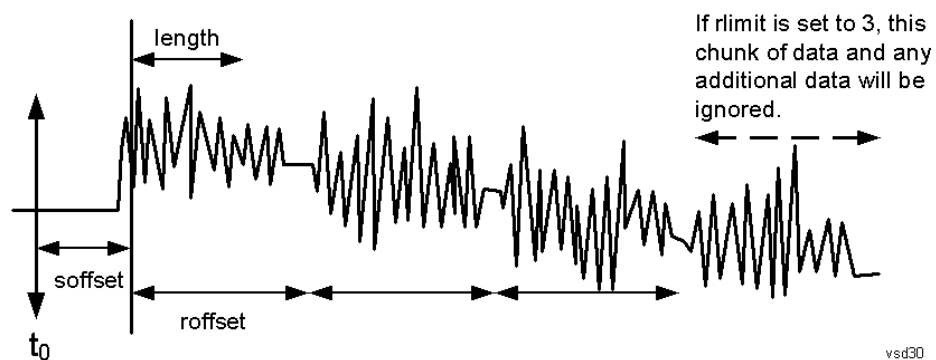

<soffset> - start offset is an optional real number. (It is in seconds for time-domain traces, and is a dimensionless index 0 to $N_{\text{points}} - 1$, for frequency-domain traces). It specifies the amount of data at the beginning of the trace that will be ignored before the decimation process starts. It is the time or frequency change from the start of the trace to the point where you want to start using the data. The default value is zero.

<length> - is an optional real number. (It is in seconds for time-domain traces, and is a dimensionless index 0 to Npoints - 1, for frequency-domain traces). It defines how much data will be compressed into one value. This parameter has a default value equal to the current trace length.

<roffset> - repeat offset is an optional real number. (It is in seconds for time-domain traces, and is a dimensionless index 0 to Npoints - 1, for frequency-domain traces). It defines the beginning of the next field of trace elements to be compressed. This is relative to the beginning of the previous field. This parameter has a default value equal to the <length> variable. Note that this parameter is used for a completely different purpose when curve fitting (see CFIT above).

<rlimit> - repeat limit is an optional integer. It specifies the number of data items that you want returned. It will ignore any additional items beyond that number. You can use the Start offset and the Repeat limit to pick out exactly what part of the data you want to use. The default value is all the data.

Calculate Peaks of Trace Data (Remote Command Only)

Returns a list of all the peaks for the currently selected measurement and sub-opcode [n]. The peaks must meet the requirements of the peak threshold and excursion values.

n = any valid sub-opcode for the current measurement. See the MEASure:<measurement> command description of your specific measurement for information on the data that can be returned.

The command can only be used with specific sub-opcodes with measurement results that are trace data. Both real and complex traces can be searched, but complex traces are converted to magnitude in dBm. In many measurements the sub-opcode n=0, is the raw trace data which cannot be searched for peaks. And Sub-opcode n=1, is often calculated results values which also cannot be searched for peaks.

This command uses the data setting specified by the FORMat:BORDER and FORMat:DATA commands and can return real or ASCII data. If the format is set to INT,32, it returns REAL,32 data.

The command has four types of parameters:

- Threshold (in dBm)
- Excursion (in dB)
- Sorting order (amplitude, frequency, time)
- Optional in some measurements: Display line use (all, > display line, < display line)

Remote Command	For Swept SA measurement: :CALCulate:DATA[1] 2 ... 6:PEAKS? <threshold>,<excursion>[,AMPLitude FREQuency TIME[,ALL GTDLine LTDLine]] For most other measurements:
-----------------------	--

	<pre>:CALCulate:DATA[1] 2 ... 6:PEAKs? <threshold>,<excursion>[,AMPLitude FREQUENCY TIME]</pre>
Example	<p>Example for Swept SA measurement in Spectrum Analyzer Mode:</p> <p>CALC:DATA4:PEAK? -40, 10, FREQ, GTDL This will identify the peaks of trace 4 that are above -40 dBm, with excursions of at least 10 dB. The peaks are returned in order of increasing frequency, starting with the lowest frequency. Only the peaks that are above the display line are returned.</p> <p>Query Results 1:</p> <p>With FORMat:DATA REAL, 32 selected, it returns a list of floating-point numbers. The first value in the list is the number of peak points that are in the following list. A peak point consists of two values: a peak amplitude followed by its corresponding frequency (or time).</p> <p>If no peaks are found the peak list will consist of only the number of peaks, (0).</p>
Notes	<p><n> - is the trace that will be used</p> <p><threshold> - is the level below which trace data peaks are ignored. Note that the threshold value is required and is always used as a peak criterion. To effectively disable the threshold criterion for this command, provide a substantially low threshold value such as -200 dBm. Also note that the threshold value used in this command is independent of and has no effect on the threshold value stored under the Peak Criteria menu.</p> <p><excursion> - is the minimum amplitude variation (rise and fall) required for a signal to be identified as peak. Note that the excursion value is required and is always used as a peak criterion. To effectively disable the excursion criterion for this command, provide the minimum value of 0.0 dB. Also note that the excursion value used in this command is independent of and has no effect on the excursion value stored under the Peak Criteria menu.</p> <p>Values must be provided for threshold and excursion. The sorting and display line parameters are optional (defaults are AMPLitude and ALL).</p> <p>Note that there is always a Y-axis value for the display line, regardless of whether the display line state is on or off. It is the current Y-axis value of the display line which is used by this command to determine whether a peak should be reported</p> <p>Sorting order:</p> <p>AMPLitude - lists the peaks in order of descending amplitude, with the highest peak first (default if optional parameter not sent)</p> <p>FREQUENCY - lists the peaks in order of occurrence, left to right across the x-axis.</p> <p>TIME - lists the peaks in order of occurrence, left to right across the x-axis.</p> <p>Peaks vs. Display Line:</p> <p>ALL - lists all of the peaks found (default if optional parameter not sent).</p> <p>GTDLLine (greater than display line) - lists all of the peaks found above the display line.</p> <p>LTDLine (less than display line) - lists all of the peaks found below the display line.</p>
Initial S/W Revision	Prior to A.02.00

Hardware-Accelerated Fast Power Measurement (Remote Command Only)

The Fast Power option (FP2) enables very fast channel power measurements for instruments with the prerequisite hardware (DP2 and/or B40). It accomplishes this by performing real-time overlapped FFTs at the hardware layer, using software for basic post-processing before returning the result to the user. The upshot of this

approach is improved throughput for user applications that require many sequential power measurements.

The analysis bandwidth of FP2 is limited by the licenses in the instrument, but its maximum overall analysis bandwidth per acquisition is 40 MHz.

FP2 is remote-only, which means the instrument does not switch to any particular mode or measurement. FP2 commands can be sent while another application is in use on the front panel.

Each Fast Power measurement can be predefined using an array index, and up to 1,000 measurements can be stored. In the following documentation, instances of [1,2,...,999] can be substituted with a particular measurement index, e.g. CALC:FPOW:POW1?, CALC:FPOW:POW2?, CALC:FPOW:POW134?. In this way, power measurements can be defined one time in a batch, and then executed multiple times without having to redefine them, similar to “list mode” on other measurements.

In addition to basic channel power measurements, there are a number of other measurement “functions” for each channel, including peak power, peak frequency, and power spectral density. See the Function parameter for more information.

Reset Fast Power Measurement (Remote Command Only)

Resets the measurement configuration to the defaults.

Mode	All
Remote Command	:CALCulate:FPOWer:POWer[1,2,...,999]:RESet
Example	:CALC:FPOW:POW1:RES
Notes	Option FP2 is required.
Initial S/W Revision	A.14.00

Define Fast Power Measurement (Remote Command Only)

Fast Power acquisitions are configured using the DEFine command. This command accepts a comma-delimited string of configuration parameters and their appropriate values, which are all specified in the subsection below.

Mode	All
Remote Command	:CALCulate:FPOWer:POWer[1,2,...,999]:DEFine "configuration string"
Example	:CALC:FPOW:POW1:DEF "CenterFrequency=2e9, AcquisitionTime=0.005"
Notes	See below for a list of measurement variables that can be defined in the configuration string.
Initial S/W Revision	A.14.00

Acquisition Time

Example	CALC:FPOW:POW1:DEF "AcquisitionTime=0.002"
Notes	The acquisition time parameter sets the time in which the entire spectrum is measured. An increase in the acquisition time yields an improvement in measurement repeatability.
Preset	0.001 s
Range	0 s to 1 s
Default Unit	Time (s)
Initial S/W Revision	A.14.00

Center Frequency

Example	CALC:FPOW:POW1:DEF "CenterFrequency=2e9"
Notes	The center frequency parameter sets the frequency in which the measurement is centered around. The OffsetFrequency parameter is calculated relative to the center frequency.
Preset	1 GHz
Range	0 Hz to maximum instrument frequency
Default Unit	Frequency (Hz)
Initial S/W Revision	A.14.00

DC Coupled

Example	CALC:FPOW:POW1:DEF "DCCoupled=True"
Notes	The DC coupled parameter allows the user to specify whether the DC blocking capacitor is utilized. Set parameter to true when measuring frequencies below 10 MHz.
Preset	False
Range	True (DC Coupled) or False (AC Coupled)
Default Unit	Boolean
Initial S/W Revision	A.14.00

DetectorType

Example	CALC:FPOW:POW1:DEF "DetectorType=Peak"
Notes	Option FP2 is required. The detector type parameter allows the user to choose whether a RMS average or peak value is used during the measurement.
Preset	RmsAverage
Range	RmsAverage, Peak
Initial S/W Revision	A.14.00

Do Noise Correction

Example	CALC:FPOW:POW1:DEF "DoNoiseCorrection=True"
Notes	<p>When noise correction is enabled, the linear noise power contributed by the analyzer is subtracted from all measurements. This effectively lowers the noise floor of the analyzer.</p> <p>When noise correction is enabled, the first measurement for a given set of input parameters will take extra time. This is because the analyzer takes an extra acquisition with the RF input disconnected from the analyzer's front end to measure the noise of just the analyzer. The measured noise floor is stored in a cache so the noise acquisition will occur only once for the same state settings. In other words, if noise correction was turned on and the analyzer made an acquisition at frequency A, then frequency B, and back again to frequency A, the hidden initial noise floor acquisition would only occur for the first acquisition at frequency A and the cached noise floor would be used the second time frequency A was measured.</p>
Preset	False
Range	True (enable noise correction) or False (disable noise correction)
Default Unit	Boolean
Initial S/W Revision	A.14.00

Do Spur Suppression

Example	CALC:FPOW:POW1:DEF "DoSpurSuppression=True"
Notes	<p>When measuring very low level signals, or when large out-of-band inputs are input into the analyzer, sometimes unwanted spurs and residuals can appear in the measured spectrum. Spur suppression is a method to help minimize the levels of these internally generated spurs and residuals.</p> <p>When spur suppression is enabled, the analyzer will automatically take two acquisitions using two different internal analog LO frequencies. The FFT spectrums from both acquisitions are combined by taking the minimum power between both traces on a per FFT bin basis. External signals will have the same amplitude for both traces and therefore will return the expected amplitudes. However, low level spurs and residuals generated internally to the analyzer tend to move to different FFT bins depending on the internal analog LO frequency used, and therefore tend to be suppressed using this spur suppression method.</p> <p>Because two acquisitions, rather than a single acquisition, are made when spur suppression is enabled, the measurement time will always be slower when spur suppression is enabled.</p>
Preset	False
Range	True (enable spur suppression) or False (disable spur suppression)
Default Unit	Boolean
Initial S/W Revision	A.14.00

Electronic Attenuator Bypass

Example	CALC:FPOW:POW1:DEF "ElecAttBypass =False"
---------	---

Notes	The electronic attenuation bypass parameter allows the user to either utilize or bypass the electronic attenuator. The electronic attenuator is only available for frequencies up to 3.6 GHz. Set parameter to true when using frequencies above 3.6 GHz and set the parameter to false when using the preamp.
Preset	True
Range	True (bypass electronic attenuator) or False (use electronic attenuator)
Default Unit	Boolean
Initial S/W Revision	A.14.00

Electronic Attenuation

Example	CALC:FPOW:POW1:DEF "ElecAttenuation=10"
Notes	Option EA3 is required. The electronic attenuation value parameter sets the amount of electrical attenuation from 0 to 24 dB (1 dB steps). Set "ElecAttBypass=False" to make sure the electronic attenuator path is enabled.
Preset	0 dB
Range	0 – 24 dB (1 dB steps)
Default Unit	dB
Initial S/W Revision	A.14.00

IF Gain

Example	CALC:FPOW:POW1:DEF "IFGain=10"
Notes	The IF gain parameter allows the user to specify the gain at the IF stage anywhere from -6 to 16 dB (1 dB steps). This is an advanced feature, and for most cases this should remain at its default value of 0 dB.
Preset	0 dB
Range	-6 – 16 dB (1 dB steps)
Default Unit	dB
Initial S/W Revision	A.14.00

IF Type

Example	CALC:FPOW:POW1:DEF "IFType=B25M"
Notes	The IF type parameter allows the user to select between different IF paths. For example, if the signal is less than 25 MHz wide, then the user can select the B25M path to take advantage of additional filtering on this analog IF path.

Preset	B40M
Range	B10M, B25M, B40M
Initial S/W Revision	A.14.00

Include Power Spectrum

Example	CALC:FPOW:POW1:DEF "IncludePowerSpectrum=True"
Notes	The power spectrum parameter allows the user to read data on the entire spectrum for diagnostic purposes. It is not recommended for production use. See CALC:FPOW:POW[n]:READ2? for details on the binary format of the response.
Preset	False
Range	True (return both channel power and full power spectrum) or False (returns only channel power)
Default Unit	Boolean
Initial S/W Revision	A.14.00

Mechanical Attenuation

Example	CALC:FPOW:POW1:DEF "MechAttenuation=10"
Notes	The mechanical attenuation value parameter sets the amount of mechanical attenuation anywhere from 0 to 70 dB (2 dB steps).
Preset	0 dB
Range	0 – 70 dB (2 dB steps)
Default Unit	dB
Initial S/W Revision	A.14.00

Preamp Mode

Example	CALC:FPOW:POW1:DEF "PreAmpMode=Low"
Notes	The license for the appropriate preamp is required. The preamp mode parameter specifies whether the preamps are being utilized. Low allows any preamps up to 3.6 GHz, and Full allows all licensed preamps. Set "ElecAttBypass=True" in order to utilize any preamps.
Preset	Off
Range	Off, Low, Full
Initial S/W Revision	A.14.00

Resolution Bandwidth Mode

Example	CALC:FPOW:POW1:DEF "PreAmpMode=Low"
Notes	The resolution bandwidth mode parameter allows the user to choose whether the RBW filter is automatically or manually set. The BestSpeed value minimizes measurement time, while the Narrowest value minimizes RBW size (minimum of two FFT bins per RBW). To manually specify an RBW, set this parameter to Explicit, and set the ResolutionBW parameter to the desired value.
Preset	BestSpeed
Range	BestSpeed, Narrowest, Explicit
Initial S/W Revision	A.14.00

Resolution Bandwidth

Example	CALC:FPOW:POW1:DEF "ResolutionBW=25e3"
Notes	The resolution bandwidth parameter sets the 3-dB bandwidth of the RBW filter. The ResolutionBWMode parameter must be set to Explicit in order to manually set the RBW.
Preset	0 Hz
Default Unit	Hz
Initial S/W Revision	A.14.00

Trigger Delay

Example	CALC:FPOW:POW1:DEF "TriggerDelay=0.025"
Notes	The trigger delay parameter sets the time after an external trigger is detected until the measurement is performed.
Preset	0 s
Range	0 – 1 s
Default Unit	Seconds
Initial S/W Revision	A.14.00

Trigger Level

Example	CALC:FPOW:POW1:DEF "TriggerLevel=2"
Notes	The trigger level parameter sets the voltage value at which an external trigger is detected.
Preset	1.2 V
Range	-5 to 5 V
Default Unit	Volts
Initial S/W Revision	A.14.00

Trigger Slope

Example	CALC:FPOW:POW1:DEF "TriggerSlope=Negative"
Notes	The trigger slope parameter indicates the direction of the edge trigger voltage for detection.
Preset	Positive
Range	Positive, Negative
Initial S/W Revision	A.14.00

Trigger Source

Example	CALC:FPOW:POW1:DEF "TriggerSource=Ext1"
Notes	The trigger source parameter allows the user to choose between measurement's triggering freely or controlled by an external input. Ext1 and Ext2 correspond to Trigger 1 In and Trigger 2 In, respectively.
Preset	Free
Range	Free, Ext1, Ext2
Initial S/W Revision	A.14.00

Trigger Timeout

Example	CALC:FPOW:POW1:DEF "TriggerTimeout=0.1"
Notes	The trigger timeout parameter sets the time in which the analyzer will wait for a trigger before automatically performing the measurement.
Preset	1 s
Range	0 – 1 s
Default Unit	Seconds
Initial S/W Revision	A.14.00

Signal Input

Example	CALC:FPOW:POW1:DEF "SignalInput=Fp50MHzCW"
Notes	The signal input parameter allows the user to select between using the main RF input or the internal analyzer reference CW signal of 50 MHz.
Preset	FpMainRf
Range	FpMainRf, Fp50MHzCW
Initial S/W Revision	A.14.00

Use Preselector

Example	CALC:FPOW:POW1:DEF "UsePreSelector=True"
Notes	The preselector parameter allows the user to either utilize or bypass the front end tunable filter at frequencies above 3.6 GHz. For frequencies below 3.6 GHz, the preselector is automatically bypassed, so you do not need to set this parameter to False in those cases.
Preset	False
Range	True (use preselector above 3.6 GHz), or False (preselector bypassed)
Default Unit	Boolean
Initial S/W Revision	A.14.00

Channel Bandwidth Array

Example	CALC:FPOW:POW1:DEF "Bandwidth=[3.84e6, 5e6, 3.84e6]"
Notes	The bandwidth parameter array defines the bandwidth of each channel that will be measured. All array parameters should have the same number of elements. Alternatively, if all the elements are the same value, a single number with no square brackets can be used to define the parameter.
Preset	[1e6]
Range	0 to 40 MHz
Default Unit	Hz
Initial S/W Revision	A.14.00

Channel Filter Type Array

Example	CALC:FPOW:POW1:DEF "FilterType=[RRC, IBW, RRC]"
Notes	The filter type parameter allows the user to choose between an integration bandwidth (IBW) filter or a root-raised-cosine (RRC) filter. The integration bandwidth filter weighs all frequencies within the bandwidth equally. The root-raised-cosine filter has an associated shape parameter, defined by the FilterAlpha parameter. All array parameters should have the same number of elements. Alternatively, if all the elements are the same value, a single value with no square brackets can be used to define the parameter.
Preset	[IBW]
Range	IBW, RRC
Initial S/W Revision	A.14.00

Channel Filter Alpha Array

Example	CALC:FPOW:POW1:DEF "FilterAlpha=[0.5, 0.0, 0.5]"
Notes	The filter alpha parameter allows the user to adjust the alpha value associated with the root-

	raised-cosine (RRC) filter type. Set FilterType to RRC in order to utilize this parameter. All array parameters should have the same number of elements. Alternatively, if all the elements are the same value, a single number with no square brackets can be used to define the parameter.
Preset	[0.22]
Range	0.0 – 1.0
Initial S/W Revision	A.14.00

Channel Measurement Function Array

Example	CALC:FPOW:POW1:DEF "Function=[BandPower, PeakPower, BandPower]"
Notes	This parameter array defines what measurement is being made for each individually-specified channel: BandPower: Total power within the specified bandwidth of the channel (dBm) BandDensity: Total power density within the specified bandwidth of the channel (dBm/Hz) PeakPower: The peak power value within the specified bandwidth of the channel (dBm) PeakFrequency: The frequency which corresponds to the peak power value within the specified bandwidth of the channel. This frequency is relative to the center frequency (Hz) XdBBandwidth: The half power (-3.01 dB) bandwidth of the highest amplitude signal that resides within the channel (Hz), dB is configurable using XdBBandwidth parameter OccupiedBandwidth: The bandwidth at which 99% of the total power resides within the channel (Hz), percentage configurable using OccupiedBandwidthPercent parameter All array parameters should have the same number of elements. Alternatively, if all the elements are the same value, a single value with no square brackets can be used to define the parameter.
Preset	[BandPower]
Range	BandPower, BandDensity, PeakPower, PeakFrequency, XdBBandwidth, OccupiedBandwidth
Initial S/W Revision	A.14.00

Channel Offset Frequency Array

Example	CALC:FPOW:POW1:DEF "OffsetFrequency=[-5e6, 0, 5e6]"
Notes	The offset frequency parameter array defines the difference between the center frequency to the center frequency of each channel. All array parameters should have the same number of elements.
Preset	[0]
Range	0 to 20 MHz
Default Unit	Hz
Initial S/W Revision	A.14.00

Channel Occupied Bandwidth Percent Array

Example	CALC:FPOW:POW1:DEF "OccupiedBandwidthPercent =[0.95, 0.95, 0.95]"
Notes	This parameter only applies for channels whose Function is set to OccupiedBandwidth. The occupied bandwidth percent parameter specifies the percent of total power in these channels. The valid range for this parameter is 0.0 to 1.0, where 1.0 represents 100%. The default for this parameter is 0.99, which will return the bandwidth that contains 99% of the total channel power.
Preset	[0.99]
Range	0 – 1.0
Initial S/W Revision	A.14.00

Channel x-dB Bandwidth Array

Example	CALC:FPOW:POW1:DEF "XdBBandwidth =[-6.02, -3.01, -1.0]"
Notes	This parameter only applies for channels whose Function is set to XdBBandwidth. The X dB bandwidth parameter is used to specify the power relative to the peak channel power over which the bandwidth is calculated. The parameter value must be a negative number.
Preset	[-3.01]
Range	-200 to 0 dB
Default Unit	dB
Initial S/W Revision	A.14.00

Define Fast Power Measurement Query (Remote Command Only)

The DEFine? command is used to retrieve a list of all defined parameters in an ASCII string format

M All
o
d
e

R :CALCulate:FPOWer:POWer[1,2,...,999]:DEFine?

e
m
o
t
e

C
o
m
m
a
n

d

E :CALC:FPOW:POW1:DEF?

x
a
m
p
l
e

N This command query is used to retrieve a list of all defined parameters in an ASCII format.

O The following is an example of the returned results:

t "DCCoupled=False,ElecAttBypass=True,ElecAttenuation=0,IFGain=0,MechAttenuation=0,PreAmpMode=Off,PreSelectorOf
e fset=0,UsePreSelector=False,ExternalReferenceFrequency=10000000,FrequencyReferenceSource=AutoExternalFrequenc
s yReference,IFType=B40M,LOMode=SLW,SignalInput=FpMainRf,AcquisitionTime=0.001,CenterFrequency=1000000000,Re
solutionBW=0,ResolutionBWMode=BestSpeed,DetectorType=RmsAverage,Bandwidth=[1000000],OffsetFrequency=
[0],Function=[BandPower],FilterType=[BW],FilterAlpha=[0.22],OccupiedBandwidthPercent=[0.99],XdBBandwidth=[-
3.01],DoNoiseCorrection=False,DoSpurSuppression=False,MeasurementMethod=HardwareFFT,IncludePowerSpectrum=F
alse,TriggerDelay=0,TriggerLevel=1.2,TriggerSlope=Positive,TriggerSource=Free,TriggerTimeout=1"

I A.14.00

n
i
t
i
a
l

S
/
W

R
e
v
i
s
i
o
n

Configure Fast Power Measurement (Remote Command Only)

The configure command begins hardware setup and returns immediately, with no acquisition made. This can be used in parallel with other hardware operations to effectively hide the hardware setup time.

Mode	All
Remote Command	:CALCulate:FPOWer:POWer[1,2,...,999]:CONFigure
Example	:CALC:FPOW:POW1:CONF

Notes	Option FP2 is required.
Initial S/W Revision	A.14.00

Initiate Fast Power Measurement (Remote Command Only)

The INITiate command begins an acquisition and returns immediately. The results of the measurement can be retrieved using FETCh.

Mode	All
Remote Command	:CALCulate:FPOWer:POWer[1,2,...,999]:INITiate
Example	:CALC:FPOW:POW1:INIT
Notes	Option FP2 is required.
Initial S/W Revision	A.14.00

Fetch Fast Power Measurement (Remote Command Only)

The FETCh command query is used to retrieve the results of an acquisition initiated by the INIT command. The returned results are in ASCII string format. The string begins and ends with quotation marks.

Mode	All
Remote Command	:CALCulate:FPOWer:POWer[1,2,...,999]:FETCh?
Example	:CALC:FPOW:POW1:FETC?
Notes	Option FP2 is required. Returns m comma-separated ASCII values, where m corresponds to the number of bandwidths defined. 1. Declared function return in the 1st specified channel 2. Declared function return in the 2nd specified channel ... m. Declared function return in the last specified channel The INIT and FETC? command sequence performs the same functionality of a single CALC:FPOW:POW[n]? query. Units of the returned values are dependent on the Function parameter for each channel.
Initial S/W Revision	A.14.00

Execute Fast Power Measurement (Remote Command Only)

This command query is used as shorthand for an INIT command immediately followed by a FETC? command. The returned results are in ASCII string format. The string begins and ends with quotation marks.

Mode	All
Remote Command	:CALCulate:FPOWer:POWer[1,2,...,999]?
Example	:CALC:FPOW:POW1?
Notes	Option FP2 is required. See notes for Fast Power Fetch for return format.
Initial S/W Revision	A.14.00

Binary Read Fast Power Measurement (Remote Command Only)

This command query is used as shorthand for an INIT command immediately followed by a FETC? command. The returned results are in a binary format.

Mode	All
Remote Command	:CALCulate:FPOWer:POWer[1,2,...,999]:READ? :CALCulate:FPOWer:POWer[1,2,...,999]:READ1?
Example	:CALC:FPOW:POW1:READ? :CALC:FPOW:POW1:READ1?
Notes	Option FP2 is required. Returns m 4 byte floating point binary values (Little-Endian), where m corresponds to the number of bandwidths defined.
Initial S/W Revision	A.14.00

Diagnostic Binary Read Fast Power Measurement (Remote Command Only)

This command query is used as shorthand for an INIT command immediately followed by a FETC? command. The returned results are in a binary format. This command is used primarily for diagnostic purposes to test for ADC overloads and to visibly inspect the spectrum.

Mode	All
Remote Command	:CALCulate:FPOWer:POWer[1,2,...,999]:READ2?
Example	:CALC:FPOW:POW1:READ2?
Notes	Option FP2 is required. <div style="display: flex; align-items: flex-start; margin-top: 10px;"> <div style="background-color: #cccccc; padding: 2px 5px; margin-right: 10px;">NOTE</div> <div> <p>Spectrum data is only returned if the IncludePowerSpectrum parameter is set to True. If IncludePowerSpectrum is False, the number of spectrum points will be zero (0).</p> <p>Units of the returned values are dependent on the Function parameter per channel (e.g. dBm for BandPower, Hz for PeakFrequency). Returns binary data (Little-Endian) that contains information on m amount of channels, along with ADC over range and full spectrum data.</p> </div> </div>

The following is the binary format of the response.

Bandwidth Return Value

1. Number of channels specified, m [4 byte int]
2. Declared function result for the 1st specified channel [4 byte float]
3. Declared function result for the 2nd specified channel [4 byte float]
- ...
- (m + 1). Declared function result for the last (mth) specified channel [4 byte float]

ADC Over Range

1. ADC over-range occurred (1: true, 0: false) [2 byte short]

Spectrum Data

1. Number of points in the spectrum data, k [4 byte int]
2. Start frequency of spectrum data (Hz) [8 byte double]
3. Step frequency of spectrum data (Hz) [8 byte double]
4. FFT bin at 1st point (dBm) [4 byte float]
5. FFT bin at 2nd point (dBm) [4 byte float]
- ...
- (k + 3). FFT bin at last (kth) point (dBm) [4 byte float]

Initial S/W Revision A.14.00

Format Data: Numeric Data (Remote Command Only)

This command specifies the format of the trace data input and output. It specifies the formats used for trace data during data transfer across any remote port. It affects only the data format for setting and querying trace data for the :TRACe[:DATA], TRACe[:DATA]?, :CALCulate:DATA[n]? and FETCh:SANalyzer[n]? commands and queries.

Remote Command	:FORMat[:TRACe][:DATA] ASCii INTEger,32 REAL,32 REAL,64 :FORMat[:TRACe][:DATA]?
-----------------------	---

Notes	<p>The query response is:</p> <p>ASCii: ASC,8</p> <p>REAL,32: REAL,32</p> <p>REAL,64: REAL,64</p> <p>INTEger,32: INT,32</p> <p>When the numeric data format is REAL or ASCii, data is output in the current Y Axis unit. When the data format is INTEger, data is output in units of m dBm (.001 dBm).</p> <p>The INT,32 format returns binary 32-bit integer values in internal units (m dBm), in a definite length block.</p>
-------	---

Dependencies	<p>Sending a data format spec with an invalid number (for example, INT,48) generates no error. The analyzer simply uses the default (8 for ASCii, 32 for INTEger, 32 for REAL).</p> <p>Sending data to the analyzer which does not conform to the current FORMat specified, results in an error. Sending ASCII data when a definite block is expected generates message -161 "Invalid</p>
--------------	---

	Block Data" and sending a definite block when ASCII data is expected generates message -121 "Invalid Character in Number".
Preset	AScii
Backwards Compatibility Notes	Note that the INT,32 format is only applicable to the command, TRACe:DATA. This preserves backwards compatibility for the Swept SA measurement. For all other commands/queries which honor FORMat:DATA, if INT,32 is sent the analyzer will behave as though it were set to REAL,32.
Initial S/W Revision	Prior to A.02.00

The specs for each output type follow:

AScii - Amplitude values are in ASCII, in the current Y Axis Unit, one ASCII character per digit, values separated by commas, each value in the form:

SX.YYYYEsZZ

Where:

S = sign (+ or -)

X = one digit to left of decimal point

Y = 5 digits to right of decimal point

E = E, exponent header

s = sign of exponent (+ or -)

ZZ = two digit exponent

REAL,32 - Binary 32-bit real values in the current Y Axis Unit, in a definite length block.

REAL,64 - Binary 64-bit real values in the current Y Axis Unit, in a definite length block.

Format Data: Byte Order (Remote Command Only)

This command selects the binary data byte order for data transfer and other queries. It controls whether binary data is transferred in normal or swapped mode. This command affects only the byte order for setting and querying trace data for the :TRACe[:DATA], TRACe[:DATA]? , :CALCulate:DATA[n]? and FETCh:SANalyzer[n]? commands and queries.

By definition any command that says it uses FORMat:DATA uses any format supported by FORMat:DATA.

The NORMal order is a byte sequence that begins with the most significant byte (MSB) first, and ends with the least significant byte (LSB) last in the sequence: 1|2|3|4. SWAPped order is when the byte sequence begins with the LSB first, and ends with the MSB last in the sequence: 4|3|2|1.

Remote Command	:FORMat:BORDER NORMa1 SWAPped
-----------------------	--

	:FORMat:BORDER?
Preset	NORMal
Initial S/W Revision	Prior to A.02.00

Meas Setup

Accesses a menu of keys that allows averaging control, and that also enables customization of the harmonic measurements.

Key Path	Front-panel key
Initial S/W Revision	Prior to A.02.00

Avg/Hold Num

When Average/Hold is turned on, the average/hold number of sweeps are taken at each frequency. The traces themselves are not averaged; the data resulting from each sweep is averaged when calculating the measurement result.

The average Type is RMS averaging.

Key Path	Meas Setup
Remote Command	[:SENSe]:HARMonics:AVERage:COUNT <integer> [:SENSe]:HARMonics:AVERage:COUNT? [:SENSe]:HARMonics:AVERage[:STATe] ON OFF 1 0 [:SENSe]:HARMonics:AVERage[:STATe]?
Example	HARM:AVER:COUN 20
Preset	10 OFF
Min	1
Max	9999
Initial S/W Revision	Prior to A.02.00

Avg Mode

Selects the termination control used for the averaging function. This determines the action after the specified number of measurements (Avg/Hold Num) is reached.

- Exp (Exponential Averaging Mode) – When you set Avg Mode to Exp, each successive data acquisition after the average count is reached is exponentially weighted and combined with the existing average. Exponential averaging weights new data more than old data, which facilitates tracking of slow-changing signals. The average will be displayed at the end of each sweep.
- Repeat – After reaching the Avg/Hold Num, all previous result data is cleared and the average count set back to 1.

Key Path	Meas Setup
Remote Command	[:SENSe]:HARMonics:AVERage:TCONTRol EXPonential REPeat

	<code>[:SENSe] :HARMonics :AVERAge :TCONtrol?</code>
Example	HARM:AVER:TCON EXP
Preset	REPeat
Range	Exp Repeat
Initial S/W Revision	Prior to A.02.00

Harmonics

Sets the number of harmonics that are measured, including the fundamental – thus, setting this to 3 measures up through the third harmonic. All measured harmonics enter into the calculation of Total Harmonic Distortion (THD).

Harmonics outside of the frequency range of the analyzer will not be measured. Harmonics which require a resolution bandwidth greater than the analyzer's range will be measured using the widest available resolution bandwidth.

Key Path	Meas Setup
Remote Command	<code>[:SENSe] :HARMonics :NUMBer <integer></code> <code>[:SENSe] :HARMonics :NUMBer?</code>
Example	HARM:NUMB 5
Preset	10
Min	2
Max	10
Initial S/W Revision	A.04.00

Meas Preset

Initiates the first sweep ("[Harmonic Measurement Details](#)" on page 3100). It will return the Meas Local variables in the current measurement to their preset values (many of which are determined from the results of the first sweep).

Key Path	Meas Setup
Remote Command	<code>:CONFIgure :HARMonics</code>
Initial S/W Revision	Prior to A.02.00

Selected Harmonic

Selects the harmonic to be edited. The remaining keys in the menu will be updated to reflect the parameters of the selected harmonic.

Harmonic 1 is the fundamental; all other measurements are made relative to that first harmonic.

Key Path	Meas Setup, Range Table
Couplings	The remaining keys in this menu show the values of the selected harmonic.
Preset	1
Min	1
Max	10
Initial S/W Revision	A.04.00

Measure Tone

Sets whether the selected harmonic is measured (on) or not measured (off). Harmonics that are not measured do not affect Total Harmonic Distortion (THD).

When sending the BWC SCPI command, send a complete list of 10 states. Each harmonic will be made active or inactive depending on the position. Thus, HARM:RANG:STAT 1,0,1,0,1,0,0,0,0,0 turns on the third and fifth harmonics. The BWC query form returns 10 states.

Key Path	Meas Setup, Range Table
Remote Command	[:SENSE]:HARMonics:TONE[1] 2 ... 10:STATE OFF ON 0 1 [:SENSE]:HARMonics:TONE[1] 2 ... 10:STATE OFF ON 0 1
Example	HARM:TONE2:STAT ON Turns on the second tone (by default the second harmonic)
Preset	On
Range	On Off
Initial S/W Revision	A.04.00

Remote Command	[:SENSE]:HARMonics:RANGe[:LIST]:STATE OFF ON 0 1, ... [:SENSE]:HARMonics:RANGe[:LIST]:STATE
Example	HARM:RANG:STAT 1,0,1,0,1,0,0,0,0,0

Frequency

Sets the frequency of the selected harmonic. This overrides the normal frequency calculation, and allows non-integral harmonics to be measured.

When sending the BWC SCPI command, send a complete list of 10 frequencies. Each harmonic will have its frequency set appropriately. The BWC query form returns 10 frequencies.

Key Path	Meas Setup, Range Table
Remote Command	[:SENSe]:HARMonics:TONE[1] 2 ... 10:FREQuency <frequency> [:SENSe]:HARMonics:TONE[1] 2 ... 10:FREQuency?
Example	HARM:TONE2:FREQ 2 GHz
Couplings	Tone frequencies are affected by Freq Offset
Preset	1 GHz
Min	Instrument minimum frequency
Max	Instrument maximum frequency
Initial S/W Revision	A.04.00

Remote Command	[:SENSe]:HARMonics:RANGe[:LIST]:FREQuency <frequency>,<frequency>,<frequency>,<frequency>,<frequency>,<frequency>,<frequency>,<frequency> [:SENSe]:HARMonics:RANGe[:LIST]:FREQuency?
Preset	1 GHz

Res BW

Sets the pre-detection filter (RBW) bandwidth of the selected harmonic measurement. The bandwidth of a harmonic signal is greater than the bandwidth of the fundamental; the auto rules multiply the fundamental bandwidth by the harmonic number. Thus, third harmonic measurement should typically use a resolution bandwidth 3 times as wide as the fundamental resolution bandwidth.

When using a measurement without a range table, or when auto is selected, this calculation is performed automatically. If the requested resolution bandwidth is higher than the maximum available resolution bandwidth, a "*" is shown next to the result in the measurement table.

Key Path	Meas Setup, Range Table
Remote Command	[:SENSe]:HARMonics:TONE[1] 2 ... 10:BANDwidth BWIDth[:RESolution] <frequency> [:SENSe]:HARMonics:TONE[1] 2 ... 10:BANDwidth BWIDth[:RESolution]? [:SENSe]:HARMonics:TONE[1] 2 ... 10:BANDwidth BWIDth [:RESolution]:AUTO ON OFF 1 0 [:SENSe]:HARMonics:TONE[1] 2 ... 10:BANDwidth BWIDth [:RESolution]:AUTO?
Example	HARM:TONE3:BAND 100 kHz sets the resolution bandwidth for the 3rd harmonic to 100 kHz.
Couplings	In auto mode, the tone RBW is set to the minimum available RBW which is at least as high as the fundamental RBW times the tone frequency divided by the fundamental frequency.

Preset	The value used after a preset is dependent upon the input signal, as the RBW defaults to Sense.
Min	1 Hz
Max	8 MHz
Initial S/W Revision	A.04.00

Dwell Time

Sets the dwell time for the specified harmonic. In zero-span, the auto mode strikes a balance between measurement speed and accuracy; increasing the dwell time will reduce measurement speed while increasing accuracy.

Key Path	Meas Setup, Range Table
Remote Command	<pre>[:SENSe]:HARMonics:TONE[1] 2 ... 10:SWEEp:TIME <time> [:SENSe]:HARMonics:TONE[1] 2 ... 10:SWEEp:TIME? [:SENSe]:HARMonics:TONE[1] 2 ... 10:SWEEp:TIME:AUTO OFF ON 0 1 [:SENSe]:HARMonics:TONE[1] 2 ... 10:SWEEp:TIME:AUTO?</pre>
Example	<pre>HARM:TONE:SWE:TIME 100 us</pre> <p>sets the sweep time for this harmonic to 100 us</p>
Couplings	If the sweep time is set to Auto, the sweep time will be 200 divided by the resolution bandwidth, to a minimum of 10 ms.
Preset	The actual preset value depends upon an input signal, since the Dwell Time defaults to Sense.
Min	100 us
Max	4000 s
Initial S/W Revision	A.04.00

Remote Command	<pre>[:SENSe]:HARMonics:RANGe[:LIST]:SWEEptime <time>, ... [:SENSe]:HARMonics:RANGe[:LIST]:SWEEptime? [:SENSe]:HARMonics:RANGe[:LIST]:SWEEptime:AUTO ON OFF 1 0, ... [:SENSe]:HARMonics:RANGe[:LIST]:SWEEptime:AUTO?</pre>
-----------------------	--

Auto-Fill Range Table

Auto Fill Range Table is used to automatically setup the range table based on the first entry in the range table. When selected, each of the entries after range 1 are set appropriately.

Key Path	Meas Setup, Range Table
Remote Command	<pre>[:SENSe]:HARMonics:RTABle:FILL</pre>
Example	<pre>HARM:RTAB:FILL</pre>

	fills the range table based on current fundamental measurement settings
Couplings	Changes all settings in the range table. The frequency for each range is set to the integer multiples of the first entry in the range table. The RBW for each range is set to integer multiples of the first RBW. The DwellTime for each range is set to integer divisors of the first dwell time.
Initial S/W Revision	A.04.00

Mode

See "[Mode](#)" on page 353

Mode Preset

Returns the active mode to a known state.

Mode Preset does the following for the currently active mode:

- Aborts the currently running measurement.
- Brings up the default menu for the mode, with no active function.
- Sets measurement Global settings to their preset values for the active mode only.
- Activates the default measurement.
- Brings up the default menu for the mode.
- Clears the input and output buffers.
- Sets Status Byte to 0.

Mode Preset does not:

- Cause a mode switch
- Affect mode persistent settings
- Affect system settings
- See "[How-To Preset](#)" on page 3176 for more information.

Key Path	Front-panel key
Remote Command	:SYSTem:PRESet
Example	:SYST:PRES
Notes	<p>*RST is preferred over :SYST:PRES for remote operation. *RST does a Mode Preset, as done by the :SYST:PRES command, and it sets the measurement mode to Single measurement rather than Continuous for optimal remote control throughput.</p> <p>Clears all pending OPC bits. The Status Byte is set to 0.</p>
Couplings	A Mode Preset aborts the currently running measurement, activates the default measurement, and gets the mode to a consistent state with all of the default couplings set.
Backwards Compatibility Notes	<p>In the X-Series, the legacy "Factory Preset" has been replaced with Mode Preset, which only presets the currently active mode, not the entire instrument. In the X-Series, the way to preset the entire instrument is by using System, Restore System Defaults All, which behaves essentially the same way as restore System Defaults does on ESA and PSA.</p> <p>There is also no "Preset Type" as there is on the PSA. There is a green Mode Preset front-panel key that does a Mode Preset and a white-with-green-letters User Preset front-panel key that does a User Preset. The old PRESet:TYPE command is ignored (without generating an error), and SYST:PRES without a parameter does a Mode Preset, which should cover most backward code compatibility issues.</p>

The settings and correction data under the Input/Output front-panel key (examples: Input Z Corr, Ext Amp Gain, etc.) are no longer part of any Mode, so they will not be preset by a Mode Preset. They are preset using Restore Input/Output Defaults, Restore System Defaults All. Note that because User Preset does a Recall State, and all of these settings are saved in State, they ARE recalled when using User Preset.

Initial S/W Revision Prior to A.02.00

How-To Preset

The table below shows all possible presets, their corresponding SCPI commands and front-panel access (key paths). Instrument settings depend on the current measurement context. Some settings are local to the current measurement, some are global (common) across all the measurements in the current mode, and some are global to all the available modes. In a similar way, restoring the settings to their preset state can be done within the different contexts.

Auto Couple - is a measurement local key. It sets all Auto/Man parameter couplings in the measurement to Auto. Any Auto/Man selection that is local to other measurements in the mode will not be affected.

Meas Preset - is a measurement local key. Meas Preset resets all the variables local to the current measurement except the persistent ones.

Mode Preset - resets all the current mode's measurement local and measurement global variables except the persistent ones.

Restore Mode Defaults - resets ALL the Mode variables (and all the Meas global and Meas local variables), including the persistent ones.

Type Of Preset	SCPI Command	Front Panel Access
Auto Couple	:COUPlE ALL	Auto Couple front-panel key
Meas Preset	:CONFIgure:<Measurement>	Meas Setup Menu
Mode Preset	:SYSTem:PRESet	Mode Preset (green key)
Restore Mode Defaults	:INSTrument:DEFault	Mode Setup Menu
Restore All Mode Defaults	:SYSTem:DEFault MODes	System Menu; Restore System Default Menu
*RST	*RST	not possible (Mode Preset with Single)
Restore Input/Output Defaults	:SYSTem:DEFault INPUt	System Menu; Restore System Default Menu
Restore Power On Defaults	:SYSTem:DEFault PON	System Menu; Restore System Default Menu
Restore Alignment Defaults	:SYSTem:DEFault ALIGN	System Menu; Restore System Default Menu
Restore Miscellaneous Defaults	:SYSTem:DEFault MISC	System Menu; Restore System Default Menu

Restore All System Defaults	:SYSTem:DEFault [ALL] :SYSTem:PRESet:PERSistent	System Menu; Restore System Default Menu
User Preset	:SYSTem:PRESet:USER	User Preset Menu
User Preset All Modes	:SYSTem:PRESet:USER:ALL	User Preset Menu
Power On Mode Preset	:SYSTem:PON:TYPE MODE	System Menu
Power On User Preset	:SYSTem:PON:TYPE USER	System Menu
Power On Last State	:SYSTem:PON:TYPE LAST	System Menu

Mode Setup

See "[Mode Setup](#)" on page 388

Peak Search

There is no peak search functionality in the Harmonics measurement .

Key Path	Front-panel key
Initial S/W Revision	Prior to A.02.00

Print

See "Print " on page 430

Quick Save

The Quick Save front-panel key repeats the most recent save that was performed from the Save menu, with the following exceptions:

- Register saves are not remembered as Saves for the purpose of the Quick Save function
- If the current measurement does not support the last non-register save that was performed, an informational message is generated, “File type not supported for this measurement”

Quick Save repeats the last type of qualified save (that is, a save qualified by the above criteria) in the last save directory by creating a unique filename using the Auto File Naming algorithm described below.

If Quick Save is pressed after startup and before any qualified Save has been performed, the Quick Save function performs a Screen Image save using the current settings for Screen Image saves (current theme, current directory), which then becomes the “last save” for the purpose of subsequent Quick Saves.

The Auto File Naming feature automatically generates a file name for use when saving a file. The filename consists of a prefix and suffix separated by a dot, as is standard for the Windows® file system. A default prefix exists for each of the available file types:

Type	Default Prefix	Menu
State	State_	(Save/Recall)
Trace + State	State_	(Save/Recall)
Screen	Screen_	(Save/Recall)
Amplitude Corrections	Ampcor_	(Import/Export)
Traces	Trace_	(Import/Export)
Limit Lines	LLine_	(Import/Export)
Measurement Result	MeasR_	(Import/Export)
Capture Buffer	CapBuf_	(Import/Export)

A four digit number is appended to the prefix to create a unique file name. The numbering sequence starts at 0000 within each Mode for each file type and updates incrementally to 9999, then wraps to 0000 again. It remembers where it was through a Mode Preset and when leaving and returning to the Mode. It is reset by Restore Misc Defaults and Restore System Defaults and subsequent running of the instrument application. So, for example, the first auto file name generated for State files is State_0000.state. The next is State_0001, and so forth.

One of the key features of Auto File Name is that we guarantee that the Auto File Name will never conflict with an existing file. The algorithm looks for the next available number. If it gets to 9999, then it looks for holes. If it find no holes, that is no more numbers are available, it gives an error.

For example, if when we get to State_0010.state there is already a State_0010.state file in the current directory, it advances the counter to State_0011.state to ensure that no conflict will exist (and then it verifies that State_0011.state also does not exist in the current directory and advances again if it does, and so forth).

If you enter a file name for a given file type, then the prefix becomes the filename you entered instead of the default prefix, followed by an underscore. The last four letters (the suffix) are the 4-digit number.

For example, if you save a measurement results file as "fred.csv", then the next auto file name chosen for a measurement results save will be fred_0000.csv.

NOTE

Although 0000 is used in the example above, the number that is used is actually the current number in the Meas Results sequence, that is, the number that would have been used if you had not entered your own file name.

If the filename you entered ends with _dddd, where d=any number, making it look just like an auto file name, then the next auto file name picks up where you left off with the suffix being dddd + 1.

Key Path	Front-panel key
Notes	No remote command for this key specifically.
Initial S/W Revision	Prior to A.02.00

Recall

The **Recall** menu lets you choose what you want to recall, and where you want to recall it from. Among the types of files you can recall are **States and Traces**. In addition, an **Import (Data)** option lets you recall a number of data types stored in CSV files (as used by Excel and other spreadsheet programs).

The default paths for Recall are data type dependent and are the same as for the Save key.

Key Path	Front-panel key
Notes	<p>No remote command for this key specifically, but the :MMEM:LOAD command is available for specific file types. An example is :MMEM:LOAD:STATe <filename>.</p> <p>If you try to recall a State file for a mode that is not licensed or not available in the instrument, an error message will occur and the state will not change.</p>
Backwards Compatibility Notes	<p>In legacy analyzers, it was possible to load a state without affecting the trace data, limit lines or correction data. Similarly (since User Preset is actually loading a state), it was possible to do a User Preset without affecting the trace data, limit lines or correction data.</p> <p>In the X-Series, "state" always includes all of this data; so whenever state is loaded, all of the traces, limit lines and corrections are affected. Although this differs from previous behavior, it is desirable behavior, and should not cause adverse issues for users.</p>
Backwards Compatibility Notes	<p>Recall for the X-Series supports backward compatibility in the sense that you can recall a state file from any X-Series model number and any version of X-Series software. This is only possible if part of the recalling process goes through a limiting step after recalling the mode settings, at least for settings that may vary with version number, model number, option and license differences. If you try to recall a state file onto an instrument with less capability than what was available on the instrument during the save, the recall will ignore the state it doesn't support and it will limit the recalled setting to what it allows.</p> <p>Example: if the saved state includes preamp ON, but the recalling instrument does not have a preamp; the preamp is limited to OFF. Conversely, if you save a state without a preamp, the preamp is OFF in the state file. When this saved file is recalled on an instrument with a licensed preamp, the preamp is changed to OFF. Another example is if the saved state has center frequency set to 20 GHz, but the instrument recalling the saved state is a different model and only supports 13.5 GHz. In this case, the center frequency is limited along with any other frequency based settings. Since the center frequency can't be preserved in this case, the recall limiting tries to at least preserve span to keep the measurement setup as intact as possible.</p> <p>It may be appropriate to issue a warning if the state is limited on the recall; warnings do not go out to SCPI so this would only affect the manual user.</p> <p>Note that there is no state file compatibility outside of the X-Series. For example, you cannot recall a state file from ESA or PSA.</p>
Initial S/W Revision	Prior to A.02.00

State

The **Recall State** menu lets you choose a register or file from which to recall the state.

The content of a state file includes all of the settings and data required to return the analyzer as closely as possible to the Mode it was in, with the exact settings that were in place, when the save occurred. The Mode settings in each state file include the settings that are affected by Mode Preset, as well as the additional settings affected by Restore Mode Defaults; all of the Mode's settings. In addition, all of the settings of the **Input/Output** system are included, even though they are outside of the Mode's state, because they are needed to restore the complete setup. Persistent System settings (for example, GPIB address) are not affected by either a Mode Preset or Restore Mode Defaults, nor are they included in a saved State file.

Since each state file is only for one Mode, the settings for other Modes are unaffected when it is loaded. **Recall State** will cause a mode switch if the state being recalled is not from the current active mode.

After the recall completes, the message "File <filename> recalled" or "Recalled State Register <register number>" is displayed.

For rapid recalls, the State menu lists 16 registers that you can choose from to recall. Pressing a Register key initiates the recall. You can also select a file from which to recall.

The default path for all State Files is:

My Documents\<<mode name>\state

where <mode name> is the parameter used to select the mode with the INST:SEL command (for example, SA for the Spectrum Analyzer).

See ["More Information" on page 3185](#).

Key Path	Recall
Mode	All
Remote Command	:MMEMory:LOAD:STATe <filename>
Example	:MMEM:LOAD:STAT "myState.state" This recalls the file myState.state on the default path
Example	MMEM:LOAD:STAT "MyStateFile.state" This loads the state file data (on the default file directory path) into the instrument state.
Notes	When you pick a file to recall, the analyzer first verifies that the file is recallable in the current instrument by checking the software version and model number of the instrument. If everything matches, a full recall proceeds by aborting the currently running measurement, clearing any pending operations, and then loading the State from the saved state file. You can open state files from any mode, so recalling a State file switches to the mode that was active when the save occurred. After switching to the mode of the saved state file, mode settings and data (if any for the mode) are loaded with values from the saved file. The saved measurement of the mode becomes the newly active measurement and the data relevant to the measurement (if there is any) is recalled. <ul style="list-style-type: none"> - If there is a mismatch between file version or model number or instrument version or model number, the recall function tries to recall as much as possible and returns a warning message. It may limit settings that differ based on model number, licensing or version number.

After recalling the state, the Recall State function does the following:

- Makes the saved measurement for the mode the active measurement.
- Clears the input and output buffers.
- Status Byte is set to 0.
- Executes a *CLS

If the file specified is empty an error is generated. If the specified file does not exist, another error is generated. If there is a mismatch between the file and the proper file type, an error is generated. If there is a mismatch between file version or model number or instrument version or model number, a warning is displayed. Then it returns to the State menu and File Open dialog goes away.

After the Recall, the analyzer exits the Recall menu and returns to the previous menu.

**Backwards
Compatibility SCPI**

:MMEMory:LOAD:STATE 1,<filename>

For backwards compatibility, the above syntax is supported. The "1" is simply ignored.

Initial S/W Revision

Prior to A.02.00

More Information

In measurements that support saving Traces, for example, Swept SA, the Trace data is saved along with the State in the State file. When recalling the State, the Trace data is recalled as well. Traces are recalled exactly as they were stored, including the writing mode and update and display modes. If a Trace was updating and visible when the State was saved, it will come back updating and visible, and its data will be rewritten right away. When you use State to save and recall traces, any trace whose data must be preserved should be placed in View or Blank mode before saving.

The following table describes the Trace Save and Recall possibilities:

You want to recall state and one trace's data, leaving other traces unaffected.	Save Trace+State from 1 trace. Make sure that no other traces are updating (they should all be in View or Blank mode) when the save is performed.	On Recall, specify the trace you want to load the one trace's data into. This trace will load in View. All other traces' data will be unaffected, although their trace mode will be as it was when the state save was performed.
You want to recall all traces	Save Trace+State from ALL traces.	On Recall, all traces will come back in View (or Blank if they were in Blank or Background when saved)
You want all traces to load exactly as they were when saved.	Save State	On recall, all traces' mode and data will be exactly as they were when saved. Any traces that were updating will have their data immediately overwritten.

From File...

When you press “From File”, the analyzer brings up a Windows dialog and a menu entitled “File Open.” This menu allows you to navigate to the various fields in the Windows dialog without using a keyboard or mouse. The **Tab** and **Arrow** keys can also be used for dialog navigation.

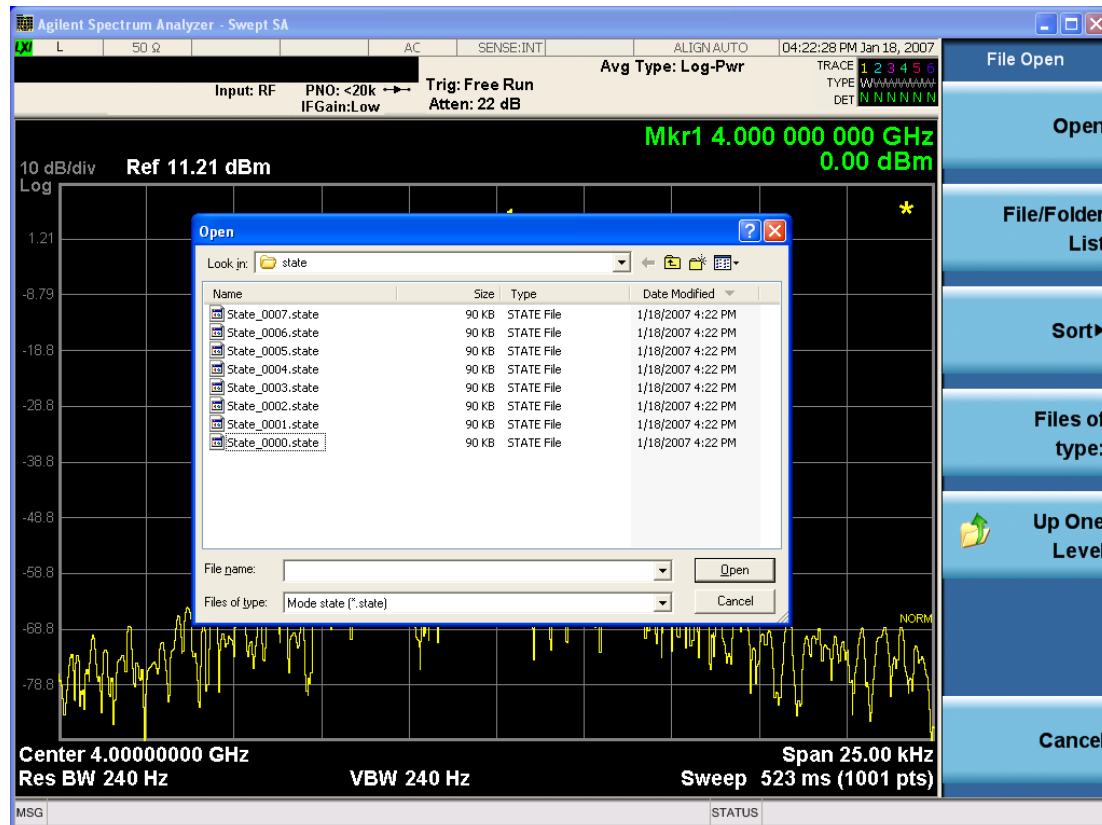

Listed below are the functions of the various fields in the dialog, and the corresponding softkeys:

Open

Performs the recall of the specified file. While the recall is being performed, the floppy icon appears briefly in the Meas bar.

File/Folder List

Enables you to navigate to the center of the dialog that contains the list of files and folders. Once here you can get information about the file and use the tab keys to navigate to the other fields in the dialog, such as Look In.

Look In

The **Look In** field shows the path from which the file will be recalled and allows you to change the path using the up and down arrow keys to navigate to other paths; the Enter key to open a directory; and the Backspace key to go back one directory. The **Look In** field first uses the last path from the Save As dialog **Save In:** path for that

same file type. There is no softkey for directly navigating to the Look In field, but you can use the left tab to get here from the File/Folder List.

User specified paths are remembered when you leave and return to a Mode and are reset back to the default using **Restore Mode Defaults**.

Sort

Accesses a menu that enables you to sort the files within the File Open dialog. Only one sorting type can be selected at a time and the sorting happens immediately. The sorting types are **By Date**, **By Name**, **By extension**, and **By Size**.

Files of Type

This field shows the file suffix for the type of file you have selected to recall. For example, if you navigated here while recalling State, "Mode state (*.state)" is in the field. If you navigated here while recalling Trace, "Mode state (*.trace)" is in the field. If you navigated here while importing a trace data file, "Trace Data (*.csv)" is in the field. For some file types, there is more than one choice in the dropdown menu, which you can select by using the up and down arrow keys and Enter.

Up One Level

This key corresponds to the icon of a folder with the up arrow that is in the tool bar of the dialog. When pressed, it causes the file and folder list to navigate up one level in the directory structure. The Backspace key does the same thing.

Cancel

This key corresponds to the **Cancel** selection in the dialog. It causes the current **Open** request to be cancelled. The ESC key does the same thing.

Key Path	Recall, State
Notes	Brings up the Open dialog for recalling a State Save Type
Initial S/W Revision	Prior to A.02.00

Edit Register Names

You may enter a custom name on any of the Register keys, to help you remember what you are using that state to save. To do this, press the **Edit Register Names** key, choose the register whose name you wish to edit, and then enter the desired label using the Alpha Editor or an external PC keyboard.

The maximum number of characters that can be added is 30. In most cases, 30 characters will fit on two lines of the key.

For more information and the SCPI command, see Edit Register Names under the **Save, State** function.

Key Path	Recall, State
Mode	All
Dependencies	N9060A-7FP or N9060B-2FP license required to edit the register names. When the feature is not

licensed, sending the SCPI command generates an error, -221, "Settings conflict;Option not available"

Initial S/W Revision A.11.00

Register 1 thru Register 16

Selecting any one of these register keys causes the State of the mode from the specified Register to be recalled. Each of the register keys annotates whether it is empty or at what date and time it was last modified. In addition, you can use the **Edit Register Names** key under **Save, State** to enter custom names for each register.

Registers are shared by all modes, so recalling from any one of the registers will cause a mode switch to the mode that was active when the save to the Register occurred.

Although these 16 registers are the only registers available from the front panel, there are 128 state registers available in the instrument. Registers 17-128 are only available from the SCPI interface, using the *RCL command.

After the recall completes, the message "Register <register number> recalled" appears in the message bar. If you are in the Spectrum Analyzer Mode, and you are recalling a register that was saved in the Spectrum Analyzer Mode, then after the recall, you will still be in the Recall Register menu. If the Recall causes you to switch modes, then after the Recall, you will be in the Frequency menu.

If a requested register is empty an error is generated.

Key Path	Recall, State
Example	*RCL 1
Range	1-16 from front panel, 1-128 from SCPI
Readback	Date and time with seconds resolution are displayed on the key OR A custom name of up to 30 characters entered using the Save, State,Edit Register Names key OR “(empty)” if no prior save operation has been performed to this register.
Initial S/W Revision	Prior to A.02.00
Modified at S/W Revision	Prior to A.11.00

Register 1 thru Register 16

Selecting any one of these register keys causes the State of the mode from the specified Register to be recalled. Each of the register keys annotates whether it is empty or at what date and time it was last modified. In addition, you can use the **Edit Register Names** key under **Save, State** to enter custom names for each register.

Registers are shared by all modes, so recalling from any one of the registers will cause a mode switch to the mode that was active when the save to the Register occurred.

Although these 16 registers are the only registers available from the front panel, there are 128 state registers available in the instrument. Registers 17-128 are only available from the SCPI interface, using the *RCL command.

After the recall completes, the message "Register <register number> recalled" appears in the message bar. If you are in the Spectrum Analyzer Mode, and you are recalling a register that was saved in the Spectrum Analyzer Mode, then after the recall, you will still be in the Recall Register menu. If the Recall causes you to switch modes, then after the Recall, you will be in the Frequency menu.

If a requested register is empty an error is generated.

Key Path	Recall, State
Example	*RCL 1
Range	1-16 from front panel, 1-128 from SCPI
Readback	Date and time with seconds resolution are displayed on the key OR A custom name of up to 30 characters entered using the Save, State, Edit Register Names key OR “(empty)” if no prior save operation has been performed to this register.
Initial S/W Revision	Prior to A.02.00
Modified at S/W Revision	Prior to A.11.00

Trace (+State)

The Recall Trace (+State) menu lets you choose a register or file from which to recall the Trace+State state file.

A saved state contains all of the settings and data required to return the analyzer as closely as possible to the exact setup it had when the save occurred. This includes the Input/Output settings, even though they are outside of the Mode's state, because they are needed to restore the complete setup. A Trace+State file also includes trace data from one trace or all traces, which will load in View mode when the Trace+State file is recalled. Recall Trace (+State) will also cause a mode switch if the state being recalled is not for the current active mode.

After the recall completes, the message "File <filename> recalled" or "Recalled Trace Register <register number>" is displayed.

For rapid recalls, the Trace (+State) menu lists 5 registers to choose from to recall. Pressing a Register key initiates the recall. You can also select a file from which to recall.

The default path for all State Files including .trace files is:

My Documents\<<mode name>\state

where <mode name> is the parameter used to select the mode with the INST:SEL command (for example, SA for the Spectrum Analyzer).

Key Path	Recall
Mode	SA
Remote Command	:MMEMory:LOAD:TRACe TRACE1 TRACE2 TRACE3 TRACE4 TRACE5 TRACE6,<filename> :MMEMory:LOAD:TRACe:REGister TRACE1 TRACE2 TRACE3 TRACE4 TRACE5 TRACE6,<integer>
Example	MMEM:LOAD:TRAC TRACE2, "MyTraceFile.trace" This loads the trace file data (on the default file directory path) into the specified trace; if it is a "single trace" save file, that trace is loaded to trace 2, and is set to be not updating. :MMEM:LOAD:TRAC:REG TRACE1,2 restores the trace data in register 2 to Trace 1
Notes	When you perform the recall, the recalling Trace function must first verify the file is recallable in this instrument by checking instrument software version and model number, since it includes State. If everything matches, a full recall proceeds by aborting the currently running measurement, and loading the state from the saved state file to as close as possible to the context in which the save occurred. You can open .trace files from any mode that supports them, so recalling a Trace file switches to the mode that was active when the save occurred. After switching to the mode of the saved state file, mode settings and data (if any for the mode) are loaded with values from the saved file and the saved measurement of the mode becomes the newly active measurement, and the data relevant to the measurement (if there is any) is recalled. Once the state is loaded, the trace data must be loaded. The internal flags are consulted to see which trace to load and the "To Trace" setting to see where to load it. Trace data is always loaded with the specified trace set to View, so that the data is visible and not updating (so as not to erase the recalled data). If the file is an "all trace" file, all traces are loaded with the saved data (to the original trace the data was saved from) and set to View. Traces whose data is not loaded are restored to the update state that existed when they were saved. After the Recall the analyzer exits the Recall menu and returns to the previous menu. Some modes and measurements do not have available all 6 traces. Phase Noise mode command, for example, is: MMEMory:LOAD:TRACe TRACE1 TRACE2 TRACE3,<filename> Some modes and measurements have more than 6 traces available. The Realtime SA mode command, for example, is: MMEMory:STORe:TRACe TRACE1 TRACE2 TRACE3 TRACE4 TRACE5 TRACE6 TRACE7 TRACE8 TRACE9 TRACE10 TRACE11 TRACE12 ALL,<filename>
Initial S/W Revision	Prior to A.02.00

To Trace

These menu selections let you choose the Trace where the recalled saved trace will go. Not all modes have the full 6 traces available. The default is the currently selected trace, selected in this menu or in the Trace/Detector, Export Data, Import Data, or Save Trace menus, except if you have chosen All, then it remains chosen until you specifically change it to a single trace.

If the .trace file is an "all trace" file, "To Trace" is ignored and the traces each go back to the trace from which they were saved.

Once selected, the key returns back to the Recall Trace menu and the selected Trace number is annotated on the key. Now you have selected exactly where the

trace needs to be recalled. To trigger a recall of the selected Trace, you must select the **Open** key in the Recall Trace menu.

When you select a trace, it makes that trace the current trace, so it displays on top of all of the other traces.

Key Path	Save, Data, Trace
Mode	SA
Initial S/W Revision	Prior to A.02.00

Register 1 thru Register 16

Selecting any one of these register keys causes the State of the mode from the specified Register to be recalled. Each of the register keys annotates whether it is empty or at what date and time it was last modified. In addition, you can use the **Edit Register Names** key under **Save, State** to enter custom names for each register.

Registers are shared by all modes, so recalling from any one of the registers will cause a mode switch to the mode that was active when the save to the Register occurred.

Although these 16 registers are the only registers available from the front panel, there are 128 state registers available in the instrument. Registers 17-128 are only available from the SCPI interface, using the *RCL command.

After the recall completes, the message "Register <register number> recalled" appears in the message bar. If you are in the Spectrum Analyzer Mode, and you are recalling a register that was saved in the Spectrum Analyzer Mode, then after the recall, you will still be in the Recall Register menu. If the Recall causes you to switch modes, then after the Recall, you will be in the Frequency menu.

If a requested register is empty an error is generated.

Key Path	Recall, State
Example	*RCL 1
Range	1-16 from front panel, 1-128 from SCPI
Readback	Date and time with seconds resolution are displayed on the key OR A custom name of up to 30 characters entered using the Save, State, Edit Register Names key OR “(empty)” if no prior save operation has been performed to this register.
Initial S/W Revision	Prior to A.02.00
Modified at S/W Revision	Prior to A.11.00

From File...

When you press “From File”, the analyzer brings up a Windows dialog and a menu entitled “**File Open.**” This menu allows you to navigate to the various fields in the

Windows dialog without using a keyboard or mouse. The **Tab** and **Arrow** keys can also be used for dialog navigation.

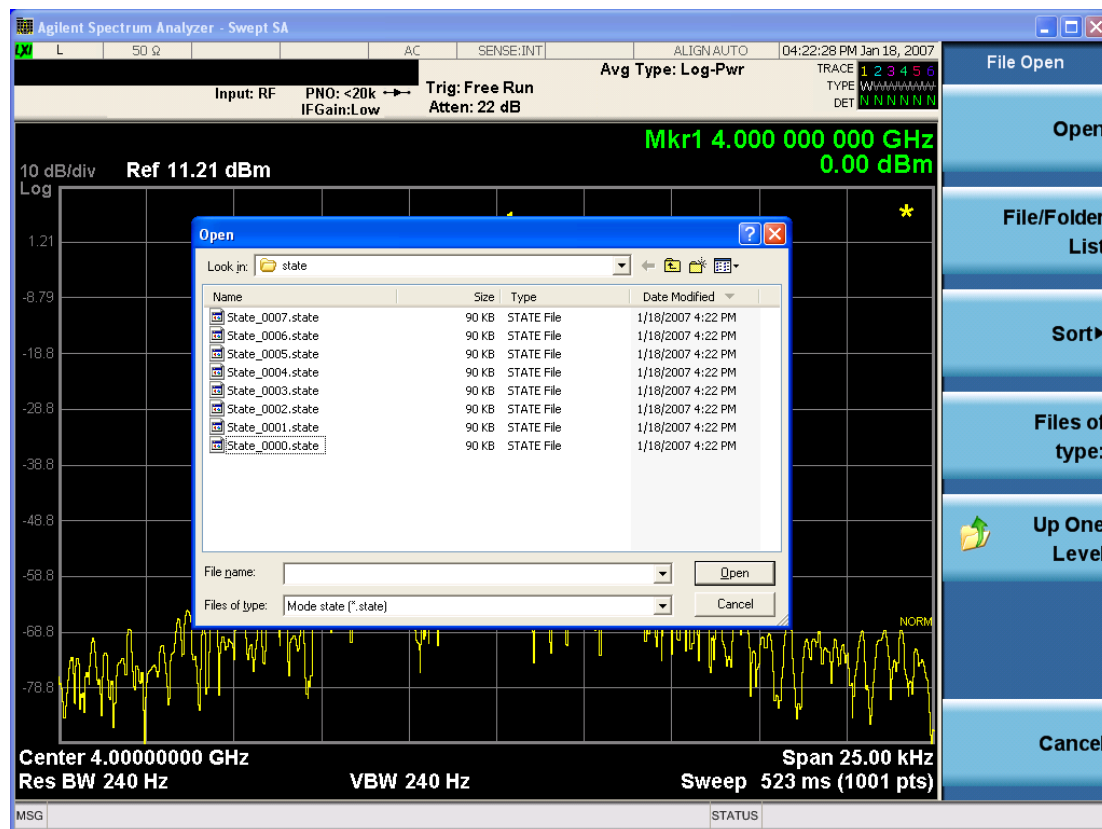

Listed below are the functions of the various fields in the dialog, and the corresponding softkeys:

Open

Performs the recall of the specified file. While the recall is being performed, the floppy icon appears briefly in the Meas bar.

File/Folder List

Enables you to navigate to the center of the dialog that contains the list of files and folders. Once here you can get information about the file and use the tab keys to navigate to the other fields in the dialog, such as Look In.

Look In

The **Look In** field shows the path from which the file will be recalled and allows you to change the path using the up and down arrow keys to navigate to other paths; the Enter key to open a directory; and the Backspace key to go back one directory. The **Look In** field first uses the last path from the Save As dialog **Save In**: path for that same file type. There is no softkey for directly navigating to the Look In field, but you can use the left tab to get here from the File/Folder List.

User specified paths are remembered when you leave and return to a Mode and are reset back to the default using **Restore Mode Defaults**.

Sort

Accesses a menu that enables you to sort the files within the File Open dialog. Only one sorting type can be selected at a time and the sorting happens immediately. The sorting types are **By Date, By Name, By extension, and By Size**.

Files of Type

This field shows the file suffix for the type of file you have selected to recall. For example, if you navigated here while recalling State, "Mode state (*.state)" is in the field. If you navigated here while recalling Trace, "Mode state (*.trace)" is in the field. If you navigated here while importing a trace data file, "Trace Data (*.csv)" is in the field. For some file types, there is more than one choice in the dropdown menu, which you can select by using the up and down arrow keys and Enter.

Up One Level

This key corresponds to the icon of a folder with the up arrow that is in the tool bar of the dialog. When pressed, it causes the file and folder list to navigate up one level in the directory structure. The Backspace key does the same thing.

Cancel

This key corresponds to the **Cancel** selection in the dialog. It causes the current **Open** request to be cancelled. The ESC key does the same thing.

Key Path	Recall, State
Notes	Brings up the Open dialog for recalling a State Save Type
Initial S/W Revision	Prior to A.02.00

Data (Import)

Importing a data file loads data that was previously saved from the current measurement or from other measurements and/or modes that produce compatible data files. The Import Menu only contains Data Types that are supported by the current measurement.

Since the commonly exported data files are in .csv format, the data can be edited by the user prior to importing. This allows you to export a data file, manipulate the data in Excel (the most common PC Application for manipulating .csv files) and then import it.

Importing Data loads measurement data from the specified file into the specified or default destination, depending on the data type selected. Selecting an Import Data menu key will not actually cause the importing to occur, since the analyzer still needs to know from where to get the data. Pressing the Open key in this menu brings up the Open dialog and Open menu that provides you with the options from where to recall the data. Once a filename has been selected or entered in the Open menu, the recall occurs as soon as the Open button is pressed.

Key Path	Recall
----------	---------------

Mode	All
Notes	The menu is built from whatever data types are available for the mode. Some keys will be missing completely, so the key locations in the sub-menu will vary. No SCPI command directly controls the Data Type that this key controls. The Data Type is included in the MMEM:LOAD commands.
Dependencies	If a file type is not used by a certain measurement, it is grayed out for that measurement. The key for a file type will not show at all if there are no measurements in the Mode that support it.
Preset	Is not affected by Preset or shutdown, but is reset during Restore Mode Defaults
Readback	The data type that is currently selected
Initial S/W Revision	Prior to A.02.00

Amplitude Correction

This key selects the Amplitude Corrections as the data type to be imported. When pressed a second time, it brings up the Select Menu, which lets you select the Correction into which the data will be imported.

Amplitude Corrections are fully discussed in the documentation of the Input/Output key, under the Corrections key.

A set of preloaded Corrections files can be found in the directory

/My Documents/ EMC Limits and Ampcor.

When the Amplitude Correction is an Antenna correction and the Antenna Unit in the file is not **None**, the Y Axis Unit setting will change to match the Antenna Unit in the file.

Key Path	Recall
Mode	SA EDGE GSM PN
Remote Command	:MMEMory:LOAD:CORRection 1 2 3 4 5 6 7 8, <filename>
Example	:MMEM:LOAD:CORR 2, "myAmpcor.csv" recalls the Amplitude Correction data from the file myAmpcor.csv in the current directory to the 2nd Amplitude Correction table, and turns on Correction 2. The default path is D:\Users\Instrument\My Documents\amplitudeCorrections\
Dependencies	Only the first correction array (Correction 1) supports antenna units. This means that a correction file with an Antenna Unit can only be loaded into the Corrections 1 register. Consequently only for Correction 1 does the dropdown in the Recall dialog include.ant, and if an attempt is made to load a correction file into any other Correction register which DOES contain an antenna unit, a Mass Storage error is generated. Corrections are not supported by all Measurements. If in a Mode in which some Measurements support it, this key will be grayed out in measurements that do not. The key will not show at all if no measurements in the Mode support it. Errors are reported if the file is empty or missing, or if the file type does not match, or if there is a mismatch between the file type and the destination data type. If any of these occur during manual operation, the analyzer returns to the Import Data menu and the File Open dialog goes away. This key does not appear unless you have the proper option installed in your instrument.

	This command will generate an “Option not available” error unless you have the proper option installed in your instrument.
Couplings	When a correction file is loaded from mass storage, it is automatically turned on (Correction ON) and ApplyCorrections is set to On. This allows you to see its effect, thus confirming the load.
Readback	selected Correction
Backwards Compatibility SCPI	:MMEMory:LOAD:CORRection ANTenna CABLe OTHer USER, <filename> For backwards compatibility, ANTenna maps to 1, CABLe maps to 2, OTHer maps to 3 and USER maps to 4
Initial S/W Revision	A.02.00

Amplitude Correction

These keys let you select which Correction to import the data into. Once selected, the key returns back to the Import Data menu and the selected Correction number is annotated on the key. The next step is to select the Open key in the Import Data menu.

Antenna corrections are a particular kind of Amplitude Corrections – they are distinguished in the corrections file by having the Antenna Unit set to a value other than None. Only Correction 1 supports Antenna Units.

Key Path	Recall, Data, Amplitude Correction
Notes	auto return
Dependencies	Only Correction 1 may be used to load a Correction that contains an Antenna Unit other than None
Preset	Not part of Preset, but is reset to Correction 1 by Restore Input/Output Defaults; survives shutdown.
State Saved	The current Correction number is saved in instrument state
Initial S/W Revision	A.02.00

Trace

This key selects Trace as the data type to be imported. When pressed a second time, it brings up the Trace Menu, which lets you select the Trace into which the data will be imported.

The trace file contains “meta” data which describes the state of the analyzer when the trace was exported (see ["Trace File Contents" on page 3216](#)). If the meta data in the file does not match the current SA state, the “invalid data indicator” (*) is displayed.

Key Path	Recall, Data
----------	---------------------

Remote Command	:MMEMory:LOAD:TRACe:DATA TRACE1 TRACE2 TRACE3 TRACE4 TRACE5 TRACE6,<filename>
Example	:MMEM:LOAD:TRAC DATA TRACE2, "myTrace2.csv" Imports the 2nd trace from the file myTrace2.csv in the current path. The default path is My Documents\SA\data\traces
Dependencies	For SA measurements, a trace cannot be recalled from a trace file that was exported with ALL traces selected. A trace cannot be imported if the number of trace points in the file do not match the number of sweep points currently set for the measurement. If this happens, an error message is generated. Errors are reported if the file is empty or missing, or if the file type does not match, or if there is a mismatch between the file type and the destination data type. If any error occurs while trying to load a file manually (as opposed to during remote operation), the analyzer returns to the Import Data menu and the File Open dialog goes away.
Couplings	When a trace is imported, Trace Update is always turned OFF for that trace and Trace Display is always turned ON.
Readback	Selected Trace
Status Bits/OPC dependencies	Sequential - aborts the current measurement.
Initial S/W Revision	Prior to A.02.00

Select Trace

These keys let you pick the Trace into which to import the data; either 1, 2, 3, 4, 5 or 6. The default is the currently selected trace, selected in this menu or in the Trace/Det, Export Data, Recall Trace, or Save Trace menus; except if you have chosen **All** then **All** remains chosen until you specifically change it to a single trace.

Once selected, the key returns back to the Import Data menu and the selected Trace number is annotated on the key. The next step is to select the Open key in the Import Data menu.

Key Path	Recall, Data, Trace
Notes	Auto return
Couplings	When you select the trace into which to import the data, it makes that trace the current trace, so it displays on top of all of the other traces.
Preset	Not part of Preset, but is reset to TRACE1 by Restore Mode Defaults; survives shutdown
State Saved	The current trace number is saved in State
Initial S/W Revision	Prior to A.02.00

Limit

This key selects Limit Lines as the data type to be imported. When pressed a second time, it brings up the Limits Menu, which lets you select into which Limit the data will be imported.

A set of preloaded Limits files can be found in the directory
/My Documents/ EMC Limits and Ampcor.

Under this directory, the directory called Limits (Legacy Naming) contains a set of legacy limits, generally the same files that were supplied with older Agilent EMC analyzers, that use the legacy suffix .lim, and the old 8-character file names. In the directory called Limits, the same files can be found, with the same suffix, but with longer, more descriptive filenames.

Key Path	Recall, Data
Remote Command	:MMEMory:LOAD:LIMit LLINE1 LLINE2,<filename>
Example	:MMEM:LOAD:LIM LLINE2, "myLimitLine2.csv" Imports the 2nd Limit Line from the file myLimitLine2.csv in the current path. The default path is My Documents\SA\data\limits
Dependencies	Errors are reported if the file is empty or missing, or if the file type does not match, or if there is a mismatch between the file type and the destination data type. If any of these occur during manual operation, the analyzer returns to the Import Data menu and the File Open dialog goes away. This key will only appear if you have the proper option installed in your instrument.
Couplings	When a limit line is loaded from mass storage, it is automatically turned on. This allows the user to see it, thus confirming the load. The Margin settings will match those when the limit was saved The instrument cannot mix Limits domains (X Axis Unit must be Frequency or Time for both Limits). So when a Limits file is loaded, the analyzer will set the Limits domain (X Axis Unit) to match that of the file. If this changes the Limits domain from what it was before the file was loaded, all Limits data in all Limits sets will be erased before the data loads. If this operation is over the remote interface there will be no warning if this occurs, so care should be taken to know the domain of the file you are loading.
Readback	Selected Limit Line
Status Bits/OPC dependencies	Sequential - aborts the current measurement
Initial S/W Revision	A.02.00

Limit Selection

These keys let you pick which Limit Line to import the data into; either 1, 2, 3, 4, 5 or 6. The default is the currently selected limit. Once selected, the key returns back to the Import Data menu and the selected Limit Line number is annotated on the key. Now you have selected exactly what needs to be imported. In order to trigger an import of the selected Limit Line, you must select the Open key in the Import Data menu.

An example of using this menu is: If you select 2 and continue to the File Open menu, Limit Line 2 will be imported from the file selected or entered in File Name option in the File Open dialog.

Key Path	Recall, Data, Limit Line
Notes	Auto return
Preset	Not part of Preset, but is reset to LLINE1 by Restore Mode Defaults; survives a shutdown.
State Saved	The selected limit number is saved in instrument state
Initial S/W Revision	A.02.00

Open...

When you press “Open”, the analyzer brings up a Windows dialog and a menu entitled “**File Open.**” This menu allows you to navigate to the various fields in the Windows dialog without using a keyboard or mouse. The **Tab** and **Arrow** keys can also be used for dialog navigation.

See "[From File...](#)" on page 3210 in **Recall, State**, for a full description of this dialog and menu.

Key Path	Recall, Data
Notes	The key location is mode-dependent and will vary. Brings up Open dialog for recalling a <mode specific> Save Type
Initial S/W Revision	Prior to A.02.00

Restart

The Restart function restarts the current sweep, or measurement, or set of averaged/held sweeps or measurements. If you are Paused, pressing Restart does a Resume.

The Restart function is accessed in several ways:

- Pressing the Restart key
- Sending the remote command INIT:IMMEDIATE
- Sending the remote command INIT:RESTART

See ["More Information" on page 3199](#)

Key Path	Front-panel key
Remote Command	:INITiate[:IMMEDIATE] :INITiate:RESTART
Example	:INIT:IMM :INIT:REST
Notes	:INITiate:RESTART and :INITiate:IMMEDIATE perform exactly the same function.
Couplings	Resets average/hold count k. For the first sweep overwrites all active (update=on) traces with new current data. For application modes, it resets other parameters as required by the measurement.
Status Bits/OPC dependencies	This is an Overlapped command. The STATus:OPERation register bits 0 through 8 are cleared. The STATus:QUESTionable register bit 9 (INTegrity sum) is cleared. The SWEEPING bit is set. The MEASURING bit is set.
Backwards Compatibility Notes	For Spectrum Analysis mode in ESA and PSA, the Restart hardkey and the INITiate:RESTART command restart trace averages (displayed average count reset to 1) for a trace in Clear Write , but did not restart Max Hold and Min Hold . In the X-Series, the Restart hardkey and the INITiate:RESTART command restart not only Trace Average , but MaxHold and MinHold traces as well. For wireless comms modes in ESA and PSA, the Restart hardkey and the INITiate:RESTART command restart every measurement, which includes all traces and numeric results. There is no change to this operation.
Initial S/W Revision	Prior to A.02.00

More Information

The **Restart** function first aborts the current sweep/measurement as quickly as possible. It then resets the sweep and trigger systems, sets up the measurement

and initiates a new data measurement sequence with a new data acquisition (sweep) taken once the trigger condition is met.

If the analyzer is in the process of aligning when **Restart** is executed, the alignment finishes before the restart function is performed.

Even when set for Single operation, multiple sweeps may be taken when Restart is pressed (for example, when averaging/holding is on). Thus when we say that **Restart** "restarts a measurement," we may mean:

- It restarts the current sweep
- It restarts the current measurement
- It restarts the current set of sweeps if any trace is in Trace Average, Max Hold or Min Hold
- It restarts the current set of measurements if Averaging, or Max Hold, or Min Hold is on for the measurement
- depending on the current settings.

With **Average/Hold Number** (in **Meas Setup** menu) set to 1, or Averaging off, or no trace in Trace Average or Hold, a single sweep is equivalent to a single measurement. A single sweep is taken after the trigger condition is met; and the analyzer stops sweeping once that sweep has completed. However, with **Average/Hold Number** > 1 and at least one trace set to **Trace Average**, **Max Hold**, or **Min Hold (SA Measurement)** or **Averaging on (most other measurements)**, multiple sweeps/data acquisitions are taken for a single measurement. The trigger condition must be met prior to each sweep. The sweep is stopped when the average count k equals the number N set for **Average/Hold Number**. A measurement average usually applies to all traces, marker results, and numeric results; but sometimes it only applies to the numeric results.

Once the full set of sweeps has been taken, the analyzer will go to idle state. To take one more sweep without resetting the average count, increment the average count by 1, by pressing the step up key while **Average/Hold Number** is the active function, or sending the remote command `CALC:AVER:TCON UP`.

Save

The **Save** menu lets you choose what you want to save and where you want to save it. Among the types of files you can save are **States**, **Traces**, and **Screen Images**. In addition, an **Export (Data)** option lets you save a number of data types as CSV files for easy import into Excel and other spreadsheet programs.

Key Path	Front-panel key
Mode	All
Notes	No remote command for this key specifically, but the :MMEM:STORe command is available for specific file types. An example is :MMEM:STOR:STATe <filename>.
Initial S/W Revision	Prior to A.02.00

State

The Save State menu lets you choose a register or file for saving the state.

The content of a state file includes all of the settings and data required to return the analyzer as closely as possible to the Mode it was in, with the exact settings which were in place, when the save occurred. The Mode settings in each state file include the settings that are affected by Mode Preset, as well as the additional settings affected by Restore Mode Defaults; all of the Mode's settings. In addition, all of the settings of the **Input/Output** system are included, even though they are outside of the Mode's state, because they are needed to restore the complete setup. Persistent **System** settings (for example, Verbose SCPI) are not affected by either Mode Preset or Restore Mode Defaults, nor are they included in a saved State file.

After the save completes, the message "File <filename> saved" or "State Register <register number> saved" is displayed.

For rapid saving, the State menu lists 16 registers to save to. Pressing a Register key initiates the save. You can also select a file to save to.

The default path for all State Files is:

My Documents\<<mode name>\state

where <mode name> is the parameter used to select the mode with the INST:SEL command (for example, SA for the Spectrum Analyzer).

Key Path	Save
Mode	All
Remote Command	:MMEMory:STORe:STATe <filename>
Example	MMEM:STOR:STATe "MyStateFile.state" This stores the current instrument state data in the file MyStateFile.state in the default directory.
Notes	Both single and double quotes are supported for any filename parameter over remote. After saving to a register, that register's menu key is updated with the date the time, unless a

custom label has been entered for that key.

After saving to a register, you remain in the **Save State** menu, so that you can see the Register key update. After saving to a file, the analyzer automatically returns to the previous menu and any Save As dialog goes away.

Backwards Compatibility SCPI :MMEMory:STORe:STATe 1,<filename>

For backwards compatibility, the above syntax is supported. The "1" is simply ignored. The command is sequential.

Initial S/W Revision Prior to A.02.00

To File . . .

When you press "To File", the analyzer brings up a Windows dialog and a menu entitled "**Save As.**" This menu allows you to navigate to the various fields in the Windows dialog without using a keyboard or mouse. The **Tab** and **Arrow** keys can also be used for dialog navigation.

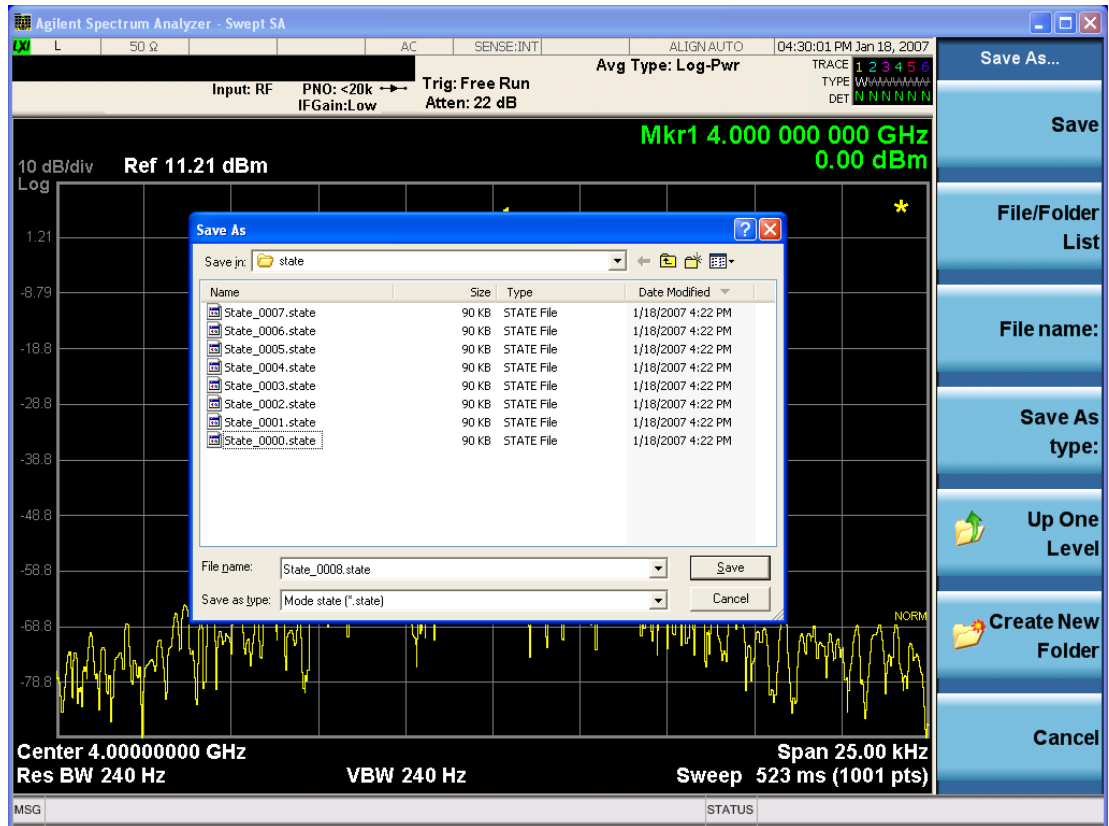

The Listed below are the functions of the various fields in the dialog, and the

corresponding softkeys:

Save

Performs the save to the specified file of the selected type. If the file already exists, a dialog will appear that allows you to replace the existing file by selecting **OK**, or you can Cancel the request. If you select OK, the file will be overwritten. Using the C: drive is strongly discouraged, since it runs the risk of being overwritten during an instrument software upgrade.

While the save is being performed, the floppy icon appears briefly in the Meas bar.

File/Folder List

Enables you to navigate to the center of the dialog that contains the list of files and folders. Once here you can get information about the file and use the tab keys to navigate to the other fields in the dialog, such as Save In.

Save In

The Save In field shows the path to which the file will be saved and allows you to change the path using the up and down arrow keys to navigate to other paths; the Enter key to open a directory; and the Backspace key to go back one directory. The **Save In field** defaults to the default path for this type of file and remembers the last path you used to save this type of file. There is no softkey for directly navigating to the Save In field but you can use left tab to get here from the File/Folder List.

User specified paths are remembered when you leave and return to a Mode and are reset back to the default using **Restore Mode Defaults**.

File Name

The **File Name** field is initially loaded with an automatically generated filename specific to the appropriate Save Type. The automatically generated filename is guaranteed not to conflict with any filename currently in the directory. You may replace or modify this filename using the File Name key. See the "[Quick Save](#)" on [page 3181](#) documentation for more on the automatic file naming algorithm.

When you press the **File Name** key the analyzer displays the Alpha Editor. Use the knob to choose the letter to add and the front-panel Enter key to add the letter to the file name. The BK character moves you back and the FW character moves you forward in the filename. The Select key on the front panel generates a space character. When you are done entering the filename press the **Done** softkey. This returns back to the **File Open** dialog and menu, but does not cause the save to occur.

Save As Type

This field shows the file suffix for the type of file you have selected to save. For example, if you navigated here while saving State, "Mode state (*.state)" is in the field. If you navigated here from saving Trace, "Mode state (*.trace)" is in the field. If you navigated here while exporting a trace data file, "Trace Data (*.csv)" is in the field. For some file types, there is more than one choice in the dropdown, which you can select by using the up and down arrow keys and Enter.

Up One Level

This key corresponds to the icon of a folder with the up arrow that is in the tool bar of the dialog. When pressed, it causes the file and folder list to navigate up one level in the directory structure. The Backspace key does the same thing.

Create New Folder

This key corresponds to the icon of a folder with the "*" that is in the tool bar of the dialog. When pressed, a new folder is created in the current directory with the name **New Folder** and you can enter a new folder name using the Alpha Editor.

Cancel

This key corresponds to the **Cancel** selection in the dialog. It causes the current **Save As** request to be cancelled. The ESC key does the same thing.

Key Path	Save, State
Mode	All
Notes	Brings up Save As dialog for saving a State Save Type
Initial S/W Revision	Prior to A.02.00

Edit Register Names

You may enter a custom name on any of the Register keys, to help you remember what you are using that state to save. To do this, press the **Edit Register Names** key, choose the register whose name you wish to edit, and then enter the desired label using the Alpha Editor or an external PC keyboard.

The maximum number of characters that can be added is 30. In most cases, 30 characters will fit on two lines of the key.

See ["More Information" on page 3206](#)

Key Path	Save, State
Mode	All
Remote Command	:MMEMory:REGister:STATe:LABel <reg number>,"label" :MMEMory:REGister:STATe:LABel? <reg number>
Example	:MMEM:REG:STAT:LAB 1,"my label"
Notes	<reg number> is an integer from 1 to 16. If the SCPI specifies an invalid register number an error message is generated, -222,"Data out of range;Invalid register label number" "label" is a string from 0 to 30 characters in length. If a label exceeds 30 characters, an error message is generated, -150,"String data error;Label clipped to 30 characters" "label" of length 0 erases the custom label and restores the default (time and date) label. E.g.: :MMEM:REG:STAT:LAB 1,""
Dependencies	N9060A-7FP or N9060B-2FP license required to edit the register names. When the feature is not licensed, sending this command generates an error, -221,"Settings conflict;Option not available"
Preset	The names are unaffected by Preset or power cycle but are set to the default label (time and date) on a "Restore System Defaults->Misc"
Initial S/W Revision	A.11.00

More Information

When you edit one of the register names, the time and date field will be replaced by the custom name.

If you delete all the characters in the custom name, it restores the default (time and date).

The register names are stored within the state files, but they are not part of the instrument state; that is, once you have edited a register name, loading a new state will not change that register name. Another consequence of this is that the names will be persistent through a power cycle. Also, if a named state file is transferred to another analyzer, it will bring its custom name along with it.

If you try to edit the name of an empty register, the analyzer will first save the state to have a file to put the name in. If you load a named state file into an analyzer with older firmware it will ignore the metadata.

The *SAV and *RCL commands will not be affected by the custom register names, nor will the MMEM commands.

Register 1 thru Register 16

Selecting any one of these register menu keys causes the State of the currently active mode to be saved to the specified Register. The registers are provided for rapid saving and recalling, since you do not need to specify a filename or navigate to a file. Each of the register menu keys annotates whether it is empty or at what date and time it was last modified. In addition, you can use the **Edit Register Names** key to enter custom names for each register.

Although these 16 registers are the only registers available from the front panel, there are 128 state registers available in the instrument. Registers 17-128 are only available from the SCPI interface, using the *SAV command.

There is one set of 128 state registers in the instrument, not one set for each Mode. When a state is saved, the Mode it was saved from is saved with it; then when it is recalled, the instrument switches to that Mode.

After the save completes, the corresponding register menu key annotation is updated with the date and time and the message "Register <register number> saved" is displayed.

Key Path	Save, State
Mode	All
Example	*SAV 1
Range	1-16 from front panel, 1-128 from SCPI
Readback	Date and time with seconds resolution are displayed on the key OR A custom name of up to 30 characters entered using the Edit Register Names key OR "(empty)" if no prior save operation has been performed to this register.

Initial S/W Revision	Prior to A.02.00
Modified at S/W Revision	A.11.00

Register 1 thru Register 16

Selecting any one of these register menu keys causes the State of the currently active mode to be saved to the specified Register. The registers are provided for rapid saving and recalling, since you do not need to specify a filename or navigate to a file. Each of the register menu keys annotates whether it is empty or at what date and time it was last modified. In addition, you can use the **Edit Register Names** key to enter custom names for each register.

Although these 16 registers are the only registers available from the front panel, there are 128 state registers available in the instrument. Registers 17-128 are only available from the SCPI interface, using the *SAV command.

There is one set of 128 state registers in the instrument, not one set for each Mode. When a state is saved, the Mode it was saved from is saved with it; then when it is recalled, the instrument switches to that Mode.

After the save completes, the corresponding register menu key annotation is updated with the date and time and the message "Register <register number> saved" is displayed.

Key Path	Save, State
Mode	All
Example	*SAV 1
Range	1-16 from front panel, 1-128 from SCPI
Readback	Date and time with seconds resolution are displayed on the key OR A custom name of up to 30 characters entered using the Edit Register Names key OR “(empty)” if no prior save operation has been performed to this register.
Initial S/W Revision	Prior to A.02.00
Modified at S/W Revision	A.11.00

Trace (+State)

The **Save Trace (+State)** menu lets you choose a register or file specifying where to save the Trace+State state file.

A saved state contains all of the settings and data required to return the analyzer as closely as possible to the exact setup it had when the save occurred. This includes the Input/Output settings, even though they are outside of the Mode's state, because they are needed to restore the complete setup. A Trace+State file also

includes trace data from one trace or all traces, which will load in View mode when the Trace+State file is recalled.

After the save completes, the message "File <filename> saved" or "Trace Register <register number> saved" is displayed.

For rapid saves, the Trace (+State) menu lists 5 registers to save to. Pressing a Register key initiates the save. You can also select a file to save to.

The default path for all State Files including .trace files is:

My Documents\<mode name>\state

where <mode name> is the parameter used to select the mode with the INST:SEL command (for example, Basic for the IQAnalyzer).

This key is grayed out for measurements that do not support trace saves. It is blanked for modes that do not support trace saves. Saving **Trace** is identical to saving State except a .trace extension is used on the file instead of .state, and internal flags are set in the file indicating which trace was saved. You may select to save one trace or ALL traces.

Key Path	Save
Mode	SA
Remote Command	:MMEMory:STORe:TRACe TRACE1 TRACE2 TRACE3 TRACE4 TRACE5 TRACE6 ALL,<filename> :MMEMory:STORe:TRACe:REGister TRACE1 TRACE2 TRACE3 TRACE4 TRACE5 TRACE6 ALL,<integer>
Example	:MMEM:STOR:TRAC TRACE1, "myState.trace" saves the file myState.trace on the default path and flags it as a "single trace" file with Trace 1 as the single trace (even though all of the traces are in fact stored). :MMEM:STOR:TRAC ALL, "myState.trace" saves the file myState.trace on the default path and flags it as an "all traces" file :MMEM:STOR:TRAC:REG TRACE1, 2 stores trace 1 data in trace register 2
Notes	This command actually performs a save state, which in the Swept SA measurement includes the trace data. However it flags it (in the file) as a "save trace" file of the specified trace (or all traces). Some modes and measurements do not have available all 6 traces. The Phase Noise mode command, for example, is: MMEMory:STORe:TRACe TRACE1 TRACE2 TRACE3 ALL,<filename> Some modes and measurements have more than 6 traces available. The Realtime SA mode command, for example, is: MMEMory:STORe:TRACe TRACE1 TRACE2 TRACE3 TRACE4 TRACE5 TRACE6 TRACE7 TRACE8 TRACE9 TRACE10 TRACE11 TRACE12 ALL,<filename> The range for the register parameter is 1-5 When you initiate a save, if the file already exists, a dialog will appear that allows you to replace the existing file by selecting OK or you can Cancel the request. If you select OK, the file will be overwritten. Using the C: drive is strongly discouraged, since it runs the risk of being overwritten during an instrument software upgrade. Both single and double quotes are supported for any filename parameter over remote. After saving to a register, that register's menu key is updated with the date and time of the save. After saving to a register, you remain in the Save Trace menu, so that you can see the Register

key update. After saving to a file, the analyzer automatically returns to the previous menu and any Save As dialog goes away.

Initial S/W Revision Prior to A.02.00

Register 1 thru Register 16

Selecting any one of these register menu keys causes the State of the currently active mode to be saved to the specified Register. The registers are provided for rapid saving and recalling, since you do not need to specify a filename or navigate to a file. Each of the register menu keys annotates whether it is empty or at what date and time it was last modified. In addition, you can use the **Edit Register Names** key to enter custom names for each register.

Although these 16 registers are the only registers available from the front panel, there are 128 state registers available in the instrument. Registers 17-128 are only available from the SCPI interface, using the *SAV command.

There is one set of 128 state registers in the instrument, not one set for each Mode. When a state is saved, the Mode it was saved from is saved with it; then when it is recalled, the instrument switches to that Mode.

After the save completes, the corresponding register menu key annotation is updated with the date and time and the message "Register <register number> saved" is displayed.

Key Path	Save, State
Mode	All
Example	*SAV 1
Range	1-16 from front panel, 1-128 from SCPI
Readback	Date and time with seconds resolution are displayed on the key OR A custom name of up to 30 characters entered using the Edit Register Names key OR “(empty)” if no prior save operation has been performed to this register.
Initial S/W Revision	Prior to A.02.00
Modified at S/W Revision	A.11.00

From Trace

Accesses a menu that enables you to select the trace to be saved. Once a trace is selected, the key returns to the Save Trace menu and the selected trace number is annotated on the key. The default is the currently selected trace, selected in this menu or in the Trace/Det, Export Data, Import Data or Recall Trace menus, except if you have chosen All then it remains chosen until you specifically change it to a single trace. To save the Trace you must select the **Save As** key in the Save Trace menu.

When you select a trace, it makes that trace the current trace, so it displays on top of all of the other traces.

Key Path	Save, Trace + State
Mode	SA
Initial S/W Revision	Prior to A.02.00

From File...

When you press “From File”, the analyzer brings up a Windows dialog and a menu entitled “File Open.” This menu allows you to navigate to the various fields in the Windows dialog without using a keyboard or mouse. The **Tab** and **Arrow** keys can also be used for dialog navigation.

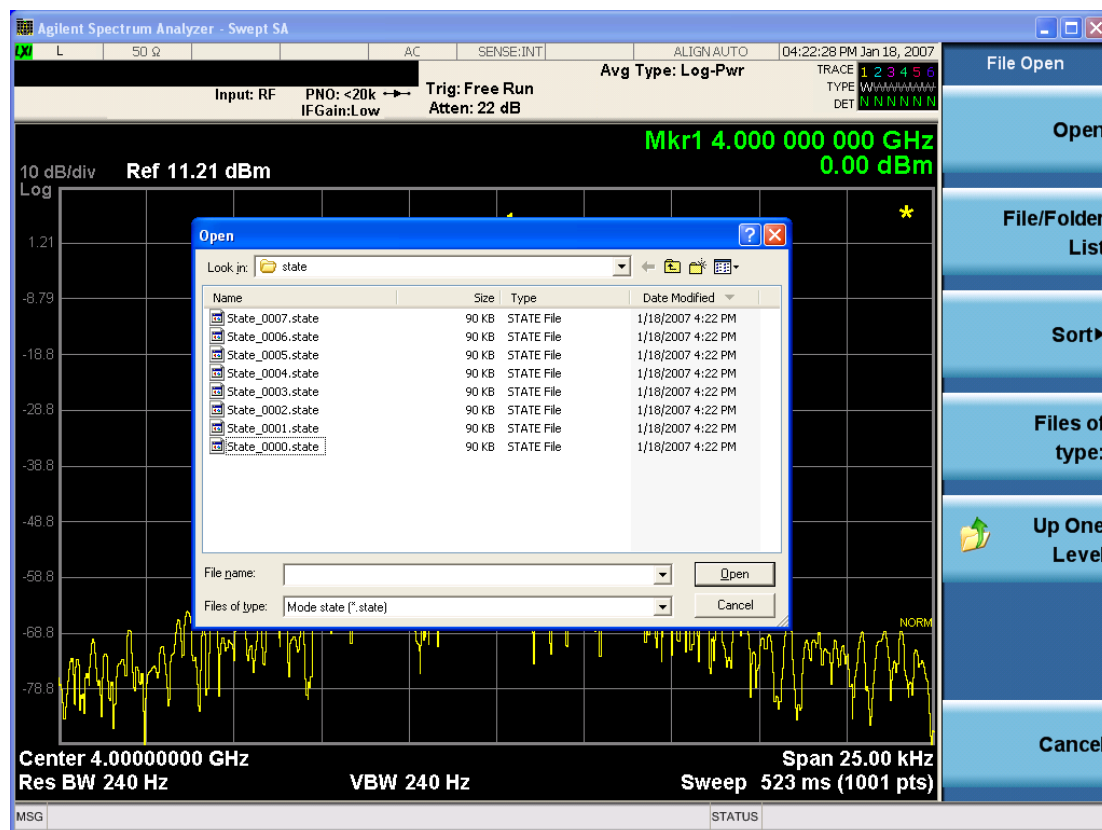

Listed below are the functions of the various fields in the dialog, and the corresponding softkeys:

Open

Performs the recall of the specified file. While the recall is being performed, the floppy icon appears briefly in the Meas bar.

File/Folder List

Enables you to navigate to the center of the dialog that contains the list of files and folders. Once here you can get information about the file and use the tab keys to navigate to the other fields in the dialog, such as Look In.

Look In

The **Look In** field shows the path from which the file will be recalled and allows you to change the path using the up and down arrow keys to navigate to other paths; the Enter key to open a directory; and the Backspace key to go back one directory. The **Look In field** first uses the last path from the Save As dialog **Save In:** path for that same file type. There is no softkey for directly navigating to the Look In field, but you can use the left tab to get here from the File/Folder List.

User specified paths are remembered when you leave and return to a Mode and are reset back to the default using **Restore Mode Defaults**.

Sort

Accesses a menu that enables you to sort the files within the File Open dialog. Only one sorting type can be selected at a time and the sorting happens immediately. The sorting types are **By Date, By Name, By extension, and By Size**.

Files of Type

This field shows the file suffix for the type of file you have selected to recall. For example, if you navigated here while recalling State, "Mode state (*.state)" is in the field. If you navigated here while recalling Trace, "Mode state (*.trace)" is in the field. If you navigated here while importing a trace data file, "Trace Data (*.csv)" is in the field. For some file types, there is more than one choice in the dropdown menu, which you can select by using the up and down arrow keys and Enter.

Up One Level

This key corresponds to the icon of a folder with the up arrow that is in the tool bar of the dialog. When pressed, it causes the file and folder list to navigate up one level in the directory structure. The Backspace key does the same thing.

Cancel

This key corresponds to the **Cancel** selection in the dialog. It causes the current **Open** request to be cancelled. The ESC key does the same thing.

Key Path	Recall, State
Notes	Brings up the Open dialog for recalling a State Save Type
Initial S/W Revision	Prior to A.02.00

Data (Export)

Exporting a data file stores data from the current measurement to mass storage files. The Export Menu only contains data types that are supported by the current measurement.

Since the commonly exported data files are in .csv format, the data can be edited by you prior to importing. This allows you to export a data file, manipulate the data in Excel (the most common PC Application for manipulating .csv files) and then import it.

Selecting an Export Data menu key will not actually cause the exporting to occur, since the analyzer still needs to know where you wish to save the data. Pressing the Save As key in this menu brings up the Save As dialog and Save As menu that allows you to specify the destination file and directory. Once a filename has been selected or entered in the Open menu, the export will occur as soon as the Save key is pressed.

Key Path	Save
Mode	All
Notes	The menu is built from whatever data types are available for the mode. So the key locations in the sub menu will vary. No SCPI command directly controls the Data Type that this key controls. The Data Type is included in the MMEM:STORe commands.
Dependencies	If a file type is not used by a certain measurement, that type is grayed out for that measurement. The key for a file type will not show at all if there are no measurements in the Mode that support it.
Preset	Is not affected by a Preset or shutdown, but is reset during Restore Mode Defaults
Readback	The data type that is currently selected
Initial S/W Revision	Prior to A.02.00

Amplitude Correction

Pressing this key selects **Amplitude Corrections** as the data type to be exported. Pressing this key again brings up the Select Menu, which allows the user to select which **Amplitude Correction** to save.

Amplitude Corrections are fully discussed in the documentation of the Input/Output key, under the Corrections softkey.

See ["Correction Data File " on page 3213](#)

Key Path	Save
Remote Command	:MMEMory:STORe:CORRection 1 2 3 4 5 6, <filename>
Example	:MMEM:STOR:CORR 2 "myAmpcor.csv" saves Correction 2 to the file myAmpcor.csv on the current path. The default path is My Documents\amplitudeCorrections.
Notes	If the save is initiated via SCPI, and the file already exists, the file will be overwritten. Using the C: drive is strongly discouraged, since it runs the risk of being overwritten during an instrument software upgrade. Both single and double quotes are supported for any filename parameter over SCPI.
Dependencies	Corrections are not supported by all Measurements. If in a Mode in which some Measurements support it, this key will be grayed out in measurements that do not. The key will not show at all if no measurements in the Mode support it.

	This key will not appear unless you have the proper option installed in your instrument.
Readback	Selected Correction
Backwards Compatibility SCPI	:MMEMory:STORe:CORRection ANTenna CABLe OTHer USER, <filename> For backwards compatibility, ANTenna maps to 1, CABLe maps to 2, OTHer maps to 3 and USER maps to 4
Initial S/W Revision	A.02.00

Correction Data File

A Corrections Data File contains a copy of one of the analyzer correction tables. Corrections provide a way to adjust the trace display for predetermined gain curves (such as for cable loss).

Corrections files are text files in .csv (comma separated values) form, to make them importable into Excel or other spreadsheet programs. The format for Corrections files is as follows.

Line #	Type of field	Example	Notes
1	File type, must be "Amplitude Correction"	Amplitude Correction	May not be omitted
2	File Description (in quotes)	"Correction Factors for 11966E"	60 characters max; may be empty but may not be omitted. If exceeds 60 characters, error -233 Too much data reported
3	Comment (in quotes)	"Class B Radiated"	60 characters max; may be empty but may not be omitted. . If exceeds 60 characters, error -233 Too much data reported
4	Instrument Version, Model #	A.02.06,N9020A	May be empty but may not be omitted
5	Option List, File Format Version	K03 LFE EXM ,01	May be empty but may not be omitted
6	Freq Unit to be used for all frequency values in the file	Frequency Unit,MHz	assumed to be Hz if omitted
7	Antenna Unit	Antenna Unit,None	If omitted leaves the Antenna unit unchanged. The amplitude unit in the Antenna Unit field is a conversion factor that is used to adjust the Y Axis Units of the current mode, if the mode supports Antenna Units.

Line #	Type of field	Example	Notes
			For more details on antenna correction data, refer to the Input/Output, Corrections key description. Allowable values: dBuv/m, dBuA/m, dBG, dBpT, None
8	Freq Interpolation	Frequency Interpolation, Linear	if omitted leaves the Freq Interpolation unchanged. Allowable values: Linear, Logarithmic
9	Bias value in mA	Bias, 0.00	If omitted leaves the Bias value unchanged (added as of A.08.50)
10	Bias State	Bias State, On	If omitted leaves the Bias State unchanged. Allowable values: On, Off (added as of A.08.50)
11	Overlap, two values, Freq1 and Freq2, separated by commas.	Overlap, 33500, 40000	Uses Freq Unit from line 6. Thus, in this example Freq1=33.5 GHz, Freq2= 40.0 GHz (see note below). If omitted leaves the overlap unchanged (added as of A.08.50)
12	DATA marker	DATA	Corrections data begins in the next line

Lines 2 through 5 can be empty but must appear in the file. Lines 6 through 11 are optional, the lines can be left out of the file altogether.

The Overlap row and the two Bias rows apply only to external mixing. Both are read-only, they are never written by the analyzer. The only way to insert or modify these rows is to edit the file with a text editor or a spreadsheet editor. These rows are intended for use by mixer manufacturers, as they allow the manufacturer to insert data about how the mixer corrections were generated and how they should be applied. The Bias rows allow you to specify whether to turn Bias on or off when the Correction is turned on and to specify a Bias value (turning off the Correction does not change the Bias, but turning it back on again sets it to the value specified in the file). The Overlap row allows you to specify an overlap region in which two different corrections may be applied. It is expected that in the corrections data itself, there will be TWO corrections values exactly at Max Freq, otherwise Overlap is ignored. The way the overlap is processed is as follows: if at any given time the current analyzer Start Freq is greater than Freq 1 and lower than Freq 2, and the current Stop Freq is greater than Freq 2, extend the first correction point at or above Freq 2 down to Freq 1, rather than using the correction data between Freq1 and Freq2.

The Antenna Unit row can only be used in Correction register 1, because there can only be one setting for Antenna Unit at any given time. If a Correction whose Antenna Unit is set to anything but None is loaded into any Correction register but 1, an error is generated (Mass storage error; Can only load an Antenna Unit into Correction 1). When a correction file is saved from any Correction register but 1, Antenna Unit is always written as None.

Similarly, the Bias rows can only be used in Correction register 1, because there can only be one setting for Bias at any given time. If a Correction file with a Bias or Bias State row is loaded into any Correction register but 1, an error is generated: Mass storage error; Can only load Bias Settings into Correction 1

The data follows the DATA row, as comma separated X, Y pairs; one pair per line.

For example, suppose you have an Antenna to correct for on an N9020A version A.02.06 and the correction data is:

- 0 dB at 200 MHz
- 17 dB at 210 MHz
- 14.8 dB at 225 MHz

Then the file will look like:

- Amplitude Correction
- "Correction Factors for 11966E"
- "Class B Radiated"
- A.02.06,N9020A
- P13 EA3 UK6,01
- Frequency Unit,MHz
- Antenna Unit,dBuV/m
- Frequency Interpolation,Linear
- DATA
- 200.000000,0.00
- 210.000000,17.00
- 225.000000,14.80

The choices for the 1 of N fields in the metadata are as follows:

- Frequency Unit: Hz, kHz, MHz, GHz
- Antenna Unit: dBuV/m, dBuA/m, dBG, dBpT, None

- Frequency Interpolation: Logarithmic, Linear

Amplitude Correction

These keys let you choose which Correction to save. Once selected, the key returns back to the Export Data menu and the selected Correction number is annotated on the key.

The next step in the Save process is to select the Save As key in the Export Data menu.

Key Path	Save, Data, Amplitude Correction
Preset	Not part of a Preset, but is reset to Correction 1 by Restore Input/Output Defaults. Survives a shutdown.
Readback	1
Initial S/W Revision	A.02.00

Trace

Pressing this key selects Traces as the data type to be exported. Pressing this key when it is already selected brings up the Trace Menu, which allows you to select which Trace to save.

The trace file contains “meta” data which describes the current state of the analyzer. The metadata is detailed in ["Trace File Contents" on page 3216](#) below.

Key Path	Save, Data
Remote Command	<code>:MMEMory:STORe:TRACe:DATA TRACE1 TRACE2 TRACE3 TRACE4 TRACE5 TRACE6 ALL,<filename></code>
Example	:MMEM:STOR:TRAC:DATA TRACE2, "myTrace2.csv" Exports the 2nd trace to the file myTrace2.csv in the current path. The default path is My Documents\SA\data\traces
Notes	If the save is initiated via SCPI, and the file already exists, the file will be overwritten. Using the C: drive is strongly discouraged, since it runs the risk of being overwritten during an instrument software upgrade. Both single and double quotes are supported for any filename parameter over SCPI.
Dependencies	For SA measurements, traces cannot be recalled from a trace file that was saved with ALL traces selected.
Couplings	When you select which trace to save, it makes that trace the current trace, so it displays on top of all of the other traces.
Readback	selected Trace
Status Bits/OPC dependencies	Sequential - waits for previous measurement to complete
Initial S/W Revision	Prior to A.02.00

Trace File Contents

A Trace Data File contains the data for one trace.

Metadata: Trace Specific

Besides the trace data, there is metadata describing the context by which the trace was produced. Some of the metadata is trace specific:

- Trace Type
- Detector
- Trace math (function, operand1, operand2, offset, reference)
- Trace name/number

When importing a trace, the detector and/or trace math function specified in the metadata is imported with the trace, so that the annotation correctly shows the detector and/or math type that was used to generate the data

Metadata: Display Specific

There is also some display-related metadata:

- Ref Level Offset
- External Gain
- X-Axis Unit
- Y-Axis Unit

Metadata: Measurement Related

The rest of the metadata is measurement specific and reflects the state of the measurement the last time the trace was updated. These are the “measurement-related instrument settings” which, if changed, cause a measurement restart.

- Number of Points
- Sweep Time
- Start Frequency
- Stop Frequency
- Average Count (actual; not the limit for the instrument)
- Average Type
- RBW
- RBW Filter Type
- RBW Filter BW Type
- VBW

- Sweep Type (FFT vs. Swept)
- Log/Lin X Scale (sometimes called Log Sweep)
- Preamp (on/off, band)
- Trigger (source, level, slope, delay)
- Phase Noise optimization setting
- Swept IF Gain
- FFT IF Gain
- AC/DC setting (RF Coupling)
- FFT Width
- External Reference setting
- Input (which input is in use)
- RF calibrator on/off
- Attenuation

Because any inactive trace can have a value that does not match the rest of the measurement, when performing a Save the metadata for each trace is pulled from the individual trace, not from the measurement.

A revision number is also included in the trace database, to allow for future changes.

The choices for the various 1 of N and binary fields are as follows:

- Average Type: Power(RMS), Voltage, LogPower(Video)
- RBW Filter Type: Flattop, EMI, Gaussian
- RBW Filter BW: 3dB, 6dB, Noise, Impulse
- Sweep Type: Swept, FFT
- PreAmp State: On, Off
- PreAmp Band: Low, Full
- Trigger Source: Free, RFBurst, Video, Line, Periodic, Ext1, Ext2, TV
- Trigger Slope: Positive, Negative
- Phase Noise Optimization: Fast, Narrow, Wide
- Swept IF Gain: Low, High

- FFT If Gain: Autorange, Low, High
- Input: RF, BBIQ
- RF Calibrator: 50M, 400G, Comb, Off
- Trace Type: ClearWrite, TraceAverage, MaxHold, MinHold
- Detector: Normal, Average, Peak, NegPeak, Sample
- Trace Math: Off, PowerDifference, PowerSum, LogOffset, LogDifference
- Y Axis Unit: dBm, dBmV, dBmA, W, V, A, dBuV, dBuA, dBuV/m, dBuA/m, dBuV, dBpT, dBG, dB

After the header, just before the trace data, a line with just the word DATA on it is inserted to flag the start of the trace data.

The following file example shows the first lines of a Trace 1 file with X Axis Unit = Hz and Y Axis Unit = dBuV, after importing into Excel (the second row contains the Title):

Trace	
"AS/NZS 1044; Conducted >1000 W, Motors, Average"	
A.01.00	E4410A
526 EA3 B25 P26 PFR	1
Segment	0
Number of Points	1001
Sweep Time	0.066266667
Start Frequency	18827440
Stop Frequency	24463718
Average Count	0
Average Type	Power(RMS)
RBW	51000
RBW Filter	Gaussian
RBW Filter BW	3dB
VBW	51000
Sweep Type	Swept
X Axis Scale	Lin
PreAmp State	Off
PreAmp Band	Low
Trigger Source	Video

Trigger Level	1.2
Trigger Slope	Positive
Trigger Delay	1.00E-06
Phase Noise Optimization	Fast
Swept IF Gain	Low
FFT IF Gain	Autorange
RF Coupling	AC
FFT Width	411900
Ext Ref	10000000
Input	RF
RF Calibrator	Off
Attenuation	10
Ref Level Offset	0
External Gain	0
Trace Type	ClearWrite
Detector	Normal
Trace Math	Off
Trace Math Oper1	Trace5
Trace Math Oper2	Trace6
Trace Math Offset	0
Trace Name	Trace1
X Axis Unit	Hz
Y Axis Unit	dBm
DATA	
1.6009301E+07	4.82047E+01
1.6018694E+07	4.69737E+01
1.6028087E+07	4.81207E+01
1.6037480E+07	4.72487E+01
1.6046873E+07	4.66437E+01
1.6056266E+07	4.66237E+01
1.6065659E+07	4.66967E+01
1.6075052E+07	4.77117E+01
1.6084445E+07	4.75787E+01
1.6093838E+07	4.83297E+01
1.6103231E+07	4.71327E+01
1.6112624E+07	4.78957E+01

1.6122017E+07	4.67507E+01
1.6131410E+07	4.81137E+01

Limit

Pressing this key selects Limit Lines as the data type to be exported. Pressing the key a second time brings up the Limit Menu that allows you to select which **Limit Line** to save.

- See "[Limits File Contents](#)" on page 3221.
- See "[.csv file format](#)" on page 3221
- See "[.lim file format](#)" on page 3223

Key Path	Save, Data
Remote Command	:MMEMory:STORe:LIMit LLINE1 LLINE2,<filename>
Example	:MMEM:STOR:LIM LLINE2, "myLimitLine2.csv" Saves the 2nd Limit Line to the file myLimitLine2.csv in the current path. The default path is My Documents\SA\data\limits
Notes	If the save is initiated via SCPI, and the file already exists, the file will be overwritten. Using the C: drive is strongly discouraged, since it runs the risk of being overwritten during an instrument software upgrade. Both single and double quotes are supported for any filename parameter over SCPI.
Dependencies	This key will only appear if you have the proper option installed in your instrument.
Preset	1; not part of Preset, but is reset by Restore Mode Defaults and survives power cycles
State Saved	The selected Limit number is saved in instrument state.
Readback	selected Limit Line
Status Bits/OPC dependencies	Sequential - waits for previous measurement to complete
Initial S/W Revision	A.02.00

Limits File Contents

Limits may be exported into a data file with a .csv extension. They may be imported from that data file; they may also be imported from a legacy limit file with a .lim extension. The .lim files meet the specification for limit files contained in the EMI measurement guide, HP E7415A.

.csv file format

Except for information in quotes, limit line files are not case sensitive. Information in bold is required verbatim; other text is example text, and italic text is commentary which should not be present in the file.

The first five lines are system-required header lines, and must be in the correct order.

Limit	<i>Data file type name</i>
"FCC Part 15"	<i>File Description</i>
"Class B Radiated"	<i>Comment</i>
A.01.00.R0001,N9020A	<i>Instrument Version, Model Number</i>
P13 EA3 UK6 ,01	<i>Option List, File Format Version</i>

The next few lines describe the parameters; on export they will be in the order shown, on import they can be in any order. If some parameters are missing, they will revert to the default.

Type, Upper	<i>Upper Lower</i>
X Axis Unit, MHz	<i>MHz S; other units should be converted; this also specifies the domain</i>
Amplitude Unit, dBm	<i>dBm V; all other units should be converted appropriately</i>
Frequency Interpolation, Linear	<i>Logarithmic Linear</i>
Amplitude Interpolation, Logarithmic	<i>Logarithmic Linear</i>
X Control, Fixed	<i>Fixed Relative; on input we consider only the first three characters</i>
Y Control, Fixed	<i>Fixed Relative; on input we consider only the first three characters</i>
Margin, 0	<i>Always in dB. A 0 margin is equivalent to margin off</i>
X Offset, 10	<i>Expressed in the X axis units</i>
Y Offset, 5	<i>Expressed in the Amplitude units</i>

The Amplitude Unit line in the limits file may contain an antenna factor unit, for example:

Amplitude Unit=dBuV/m

Antenna factor units are dBuV/m, dBuA/m, dBpT, and dBG. In this case, the unit is treated exactly as though it were dBuV, meaning that all of the limits are interpreted to have units of dBuV. The box does NOT change Y Axis Units when such a limit is loaded in.

The X axis unit also specifies the domain (time or frequency). It is not possible to have both time-domain lines and frequency-domain lines at the same time; if a time-domain line is imported while the other lines are in the frequency domain (or vice-versa), all limit lines will be deleted prior to import.

If the sign of the margin is inappropriate for the limit type (for example a positive margin for an upper limit), the sign of the margin will be changed internally so that it is appropriate.

The remaining lines describe the data. Each line in the file represents an X-Y pair. The X values should be monotonically non-decreasing, although adjacent lines in the file can have the same X value as an aid to building a stair-stepped limit line. To specify a region over which there is no limit, use +1000 dBm for upper limits or -1000 dBm for lower limits.

The data region begins with the keyword DATA:

DATA
200.000000,-10.00
300.000000,-10.00
300.000000,-20.00
500.000000,-20.00

.lim file format

This is a legacy format which allows files saved from older analyzers to be loaded into the X-Series. Design of files in this format is not recommended.

Limit Selection

These keys let you pick which Limit Line to save. Once selected, the key returns back to the **Export Data** menu and the selected Limit Line number is annotated on the key.

The next step in the Save process is to select the Save As key in the Export Data menu.

Key Path	Save, Data, Limit Line
Notes	auto return
Preset	Not part of Preset, but is reset to LLINE1 by Restore Mode Defaults; survives shutdown
Initial S/W Revision	A.02.00

Measurement Results

Pressing this key selects Meas Results as the data type to be exported. Pressing the key a second time brings up the Meas Results menu, which allows you to select which **Meas Result** to save. In the Swept SA measurement, there are three types of Measurement Results files: Peak Table, Marker Table and Spectrogram.

- See "[Meas Results File Contents](#)" on page 3224.
- See "[Marker Table](#)" on page 3224.
- See "[Peak Table](#)" on page 3227.
- See "[Spectrogram](#)" on page 3231

Remote Command	:MMEMory:STORe:RESuLts:MTABle PTABle SPECTrogram <filename>
Example	:MMEM:STOR:RES:MTAB "myResults.csv" Saves the results from the current marker table to the file myResults.csv in the current path. :MMEM:STOR:RES:PTAB "myResults.csv" Saves the results from the current peak table to the file myResults.csv in the current path. :MMEM:STOR:RES:SPEC "myResults.csv" Saves the results from the current Spectrogram display to the file myResults.csv in the current path. The default path is My Documents\SA\data\SAN\results
Notes	If the save is initiated via SCPI, and the file already exists, the file will be overwritten. Using the C: drive is strongly discouraged, since it runs the risk of being overwritten during an instrument software upgrade. Both single and double quotes are supported for any filename parameter over SCPI.
Dependencies	If a save of Marker Table results is requested and the Marker Table is not on, no file is saved and a message is generated If a save of Peak Table results is requested and the Peak Table is not on, no file is saved and a

	message is generated
	If a save of Spectrogram results is requested and the Spectrogram is not on, no file is saved and a message is generated.
	The Spectrogram choice only appears if option EDP is licensed.

Preset	Not part of Preset, but is reset to Peak Table by Restore Mode Defaults. Survives a shutdown.
--------	---

Initial S/W Revision	Prior to A.02.00
----------------------	------------------

Meas Results File Contents

All files are .csv files. The following section details the data in each file type.

Marker Table

This section discusses the Marker Table Meas Results file format.

Imagine that, at the point where a Marker Table Meas Result is requested, the following screen is showing:

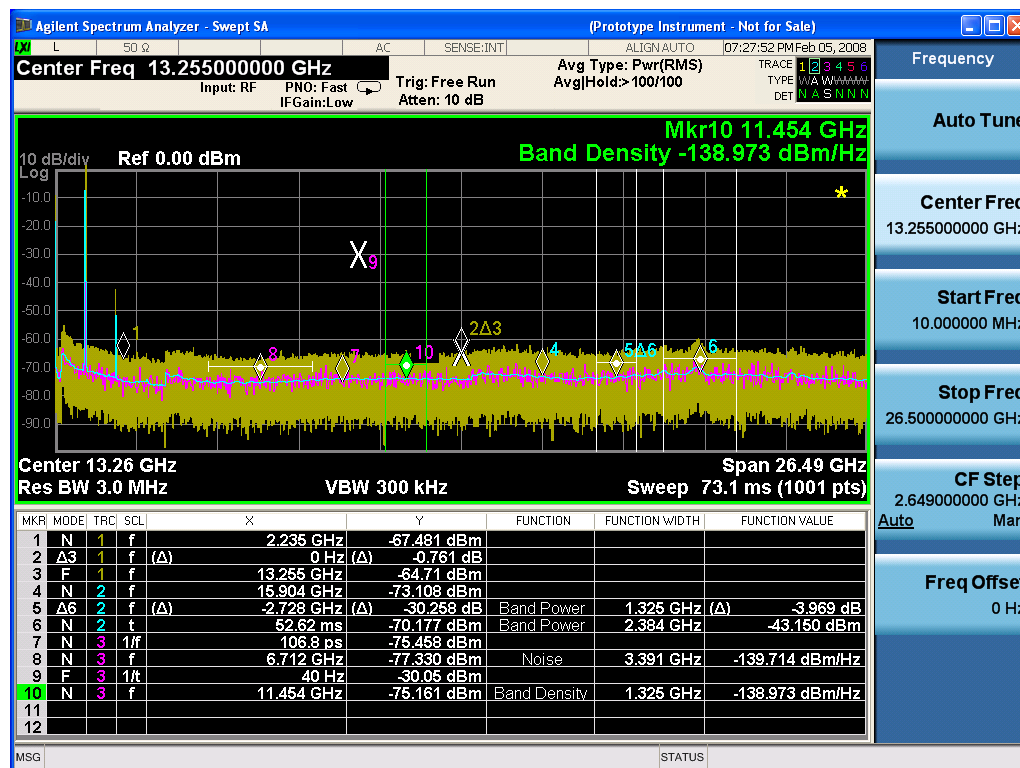

Then the Meas Results file, when opened, would show the following data:

Measureme	
ntResult	
Swept SA	
A.01.40_	N9020A
R0017	

526 B25 PFR P26 EA3	1
Result Type	Marker Table
Ref Level	0
Number of Points	1001
Sweep Time	0.06626 6667
Start Frequency	100000 00
Stop Frequency	265000 00000
Average Count	0
Average Type	LogPow er (Video)
RBW	300000 0
RBW Filter	Gaussia n
RBW Filter BW	3dB
VBW	300000 0
Sweep Type	Swept
X Axis Scale	Lin
PreAmp State	Off
PreAmp Band	Low
Trigger Source	Free
Trigger Level	1.2
Trigger Slope	Positive
Trigger Delay	1.00E- 06
Phase Noise Optimizatio	Fast

n									
Swept If Gain	Low								
FFT If Gain	Autorange								
RF Coupling	AC								
FFT Width	411900								
Ext Ref	10000000								
Input	RF								
RF Calibrator	Off								
Attenuation	10								
Ref Level Offset	0								
External Gain	0								
X Axis Units	Hz								
Y Axis Units	dBm								
DATA									
MKR	MODE	T R C	SCL	X	Y	FUNCTION	FUNCTION WIDTH	FUNCTION VALUE	FUNCTION UNIT
1	Normal	1	Frequency	2.2350 E+09	- 67.481	Off	0.0000 E+00	0	None
2	Delta3	1	Frequency	0.0000 E+00	- 0.761	Off	0.0000 E+00	0	None
3	Fixed	1	Frequency	1.3255 E+10	- 64.71	Off	0.0000 E+00	0	None
4	Normal	2	Frequency	1.5904 E+10	- 73.108	Off	0.0000 E+00	0	None
5	Delta7	2	Frequency	- 2.7280 E+09	- 30.258	Band Power	1.3250 E+06	- 3.969	dB
6	Normal	2	Time	5.2620 E-02	- 70.	Band Power	2.3840 E+06	- 43.15	dBm

17									
7									
7	Normal	3	Period	1.0680 E-10	- 75. 45 8	Off	0.0000 E+00	0	None
8	Normal	3	Frequency	6.7120 E+09	- 77. 33	Noise	3.3910 E+06	- 139.7 14	dBm/ Hz
9	Fixed	3	Inverse Time	4.0000 E+01	- 30. 05	Off	0.0000 E+00	0	None
10	Normal	3	Frequency	1.1454 E+10	- 75. 16 1	Band Density	1.3250 E+06	- 138.9 73	dBm/ Hz
11	Off	1	Frequency	0.0000 E+00	0	Off	0.0000 E+00	0	None
12	Off	1	Frequency	0.0000 E+00	0	Off	0.0000 E+00	0	None

The numbers appear in the file exactly as they appear onscreen. If it says 11.454 GHz onscreen, then in the file it is 11.454E+09.

The metadata header is very similar to the metadata used in the trace data .csv files. See ["Trace File Contents" on page 3216](#). The only new information concerns the 1-of-N fields in the marker table itself.

Peak Table

This section discusses the Peak Table Meas Results file format.

Imagine that, at the point where a Marker Table Meas Result is requested, the following screen is showing:

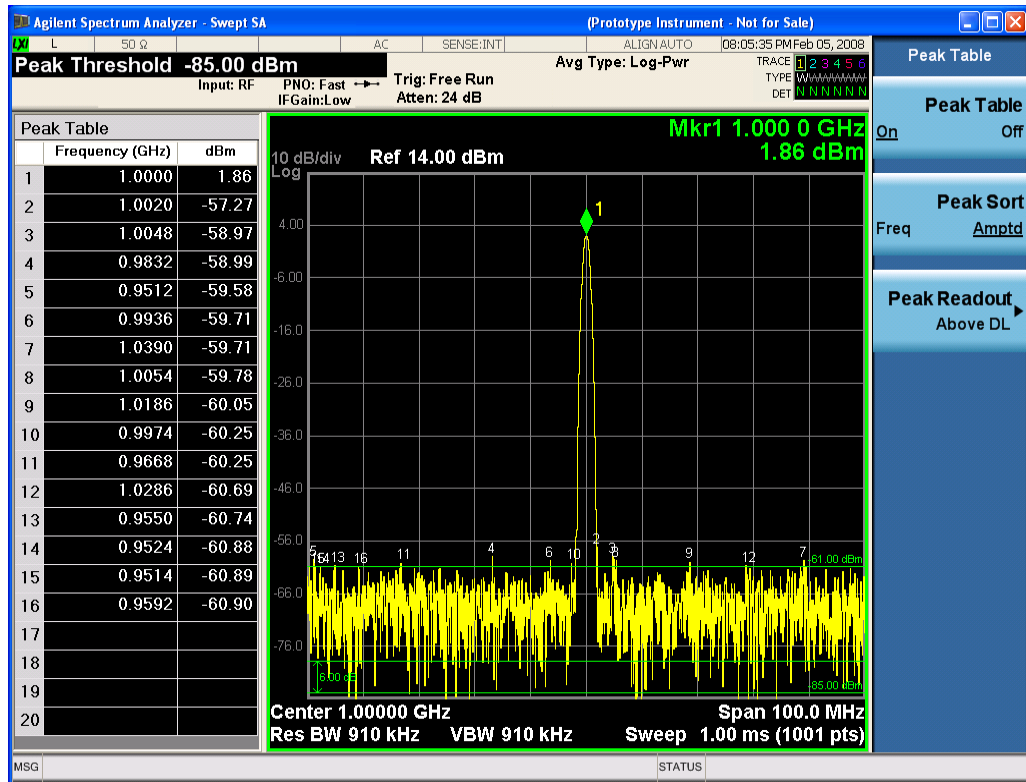

Then the Meas Results file, when opened, would show the header data (the same as for the Marker Table except that the Result Type is Peak Table) ending with a few fields of specific interest to Peak Table users:

- Peak Threshold
- Peak Threshold State (On|Off)
- Peak Excursion
- Peak Excursion State (On|Off)
- Display Line
- Peak Readout (All|AboveDL|BelowDL)
- Peak Sort (Freq|Amptd)

These fields are then followed by the data for the Peak Table itself.

Note that the label for the Frequency column changes to Time in 0 span.

Here is what the table for the above display looks like:

MeasurementResult
Swept SA

A.18.00	N9020A
526 B25 PFR P26 EA3	1
Result Type	Peak Table
Ref Level	0
Number of Points	1001
Sweep Time	0.066266667
Start Frequency	10000000
Stop Frequency	26500000000
Average Count	0
Average Type	LogPower (Video)
RBW	3000000
RBW Filter	Gaussian
RBW Filter BW	3dB
VBW	3000000
Sweep Type	Swept
X Axis Scale	Lin
PreAmp State	Off
PreAmp Band	Low
Trigger Source	Free
Trigger Level	1.2
Trigger Slope	Positive
Trigger Delay	1.00E-06
Phase Noise Optimization	Fast
Swept If Gain	Low
FFT If Gain	Autorange
RF Coupling	AC
FFT Width	411900
Ext Ref	10000000
Input	RF
RF Calibrator	Off
Attenuation	10
Ref Level Offset	0
External Gain	0
X Axis Units	Hz
Y Axis Units	dBm

Peak Threshold	-85		
Peak Threshold State	On		
Peak Excursion	6		
Peak Excursion State	On		
Display Line	-61		
Peak Readout	AboveDL		
Peak Sort	Amptd		
DATA			
Peak	Frequency	Amplitude	Delta to Limit
1	1.000009988E+09	-26.08	41.1
2	9.99989974E+08	-26.11	43.9
3	1.000019929E+09	-29.47	35.2
4	9.999799016E+08	-29.54	40.4
5	1.000030002E+09	-37.51	23.1
6	9.999699601E+08	-37.62	32.4
7	9.999999155E+08	-37.71	32.3
8	1.000039943E+09	-48.38	9.1
9	9.999598877E+08	-48.55	21.4
10	1.000049885E+09	-61.43	-8.1
11	9.999499461E+08	-61.66	8.3
12	1.000059957E+09	-76.53	-26.1
13	9.999398738E+08	-77.01	-7.6
14			
15			
16			

17
18
19
20

Spectrogram

This section discusses the Spectrogram Results file format. The Spectrogram choice only appears if option EDP is licensed.

The Spectrogram results are the same as a Trace data export, except that instead of having just one trace's data, all 300 traces appear one after the other.

Each trace has its own data mark; the data for Spectrogram Trace 0 follows the row marked DATA, the data for Spectrogram Trace 1 follows the row marked DATA1, for Spectrogram Trace 2 follows the row marked DATA2, and so on.

Each DATA row has a timestamp in the second column (as of firmware revision A.11.01). So, for example, if Trace 0 had a relative start time of 1729.523 sec, then the first DATA row would look like this:

```
DATA,1729.523
```

And if Trace 13 had a relative start time of 100.45 sec, then the fourteenth data row would look like:

```
DATA13,100.453
```

To find the absolute time for the relative timestamps of each trace, the last row before the first DATA row gives the absolute start time of the Spectrogram, in the form YYYYMMDDHHMMSS

So, for example, if the absolute start time is 13:23:45:678 on January 30, 2012, this row would look like:

```
Start Time,20120130132345678
```

NOTE:

NOTE

The resolution of the absolute time stored is 1 ms, which matches up with the fact that the fastest sweep time is also 1 ms. However, there is no specification for the absolute accuracy of the clock in the analyzer, nor is there any facility provided to allow the user to set this time to any particular degree of accuracy.

Traces that have not yet been filled in the Spectrogram display are empty; there is no DATA header for them. The file ends after the last non-empty trace.

Imagine that, at the point where a Spectrogram Meas Result is requested, the following screen is showing:

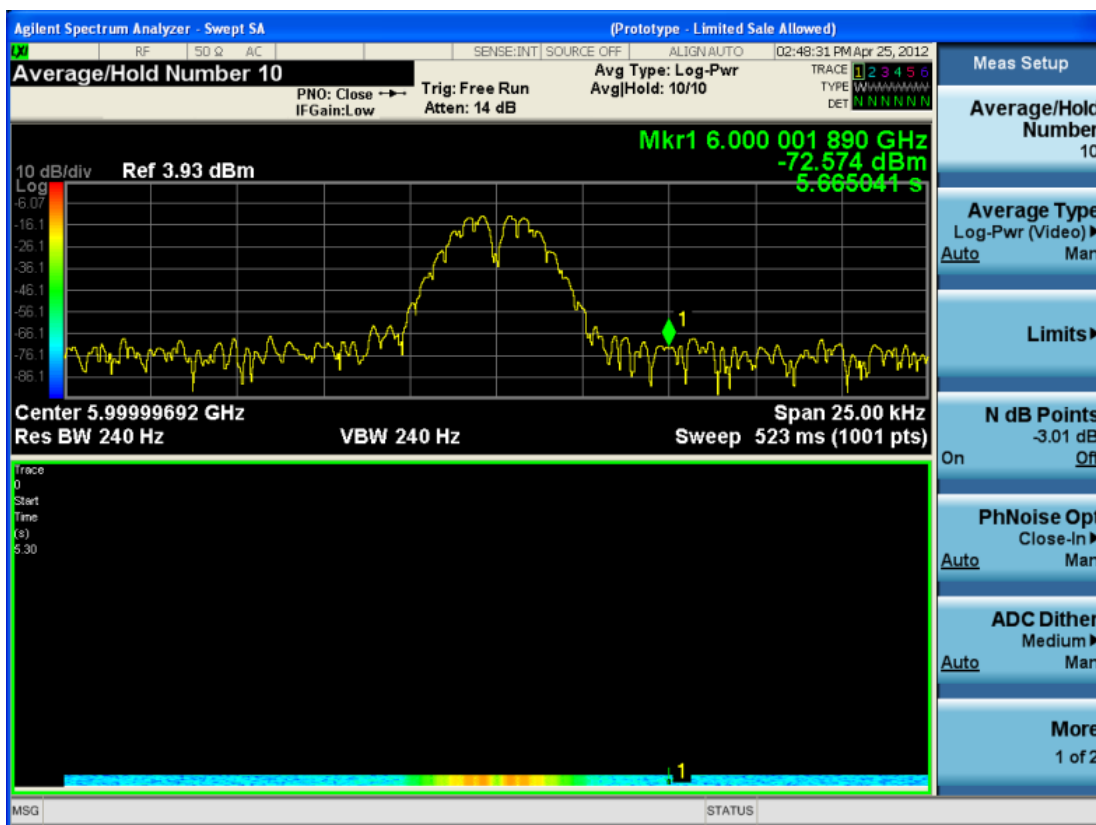

For the purpose of this example, we have set the Average/Hold Number to 10, thus we have only traces 0 thru 10. The Spectrogram was started at 02:28:08:700 pm on April 25, 2012 (that is, 700 ms after 2:28:08 pm), although the screen dump itself shows a different time, as it was taken ten minutes after the Spectrogram data. Trace 0 is showing a start time of 5.30 seconds, meaning 5.3 seconds after the Spectrogram started (trace 10 has a start time of 0, as it was the first trace taken but has now rolled up into the tenth trace slot).

The Meas Results file, when opened, shows the header data and ten traces of trace data. Below is an extract from the result file for the above display. Note the start time of 20120425142808700 showing in the last row before the first DATA row, and the relative time of 5.299231048 showing in the first DATA row:

Result Type	Spectrogram
MeasResult	
Swept SA	
A.11.00.01	N9020A
503 508 513 526 ALL ALV	1
B1C B1X B25 B2X B40 BAB	
BBA CR3 CRP DP2 DRD	
EA3 EDP EMC EP1 ERC	
ESC ESP EXM FSA HBA	
K03 LFE MPB P03 P08 P13	
P26 PFR RTL RTS S40 SB1	

Result Type	Spectrogram
SEC SM1 UK6 YAS YAV	
Segment	0
Number of Points	1001
Sweep Time	0.523333333
Start Frequency	5999984415
Stop Frequency	6000009415
Average Count	0
Average Type	LogPower(Video)
RBW	240
RBW Filter	Gaussian
RBW Filter BW	3dB
VBW	240
Sweep Type	Swept
X Axis Scale	Lin
PreAmp State	Off
PreAmp Band	Low
Trigger Source	Free
Trigger Level	1.2
Trigger Slope	Positive
Trigger Delay	0
Phase Noise Optimization	Wide
Swept If Gain	Low
FFT If Gain	Autorange
RF Coupling	AC
FFT Width	411900
Ext Ref	10000000
Input	RF
RF Calibrator	Off
Attenuation	14
Ref Level Offset	0
External Gain	0
Trace Type	Clearwrite
Detector	Normal
Trace Math	Off
Trace Math Oper1	Trace5
Trace Math Oper2	Trace6

Result Type	Spectrogram
Trace Math Offset	0
Trace Name	Trace1
X Axis Units	Hz
Y Axis Units	dBm
Start Time	20120425142808700
DATA	5.299231048
5999984415	-76.34749519
5999984440	-77.28097006
5999984465	-75.32317869
5999984490	-73.64417681
5999984515	-72.67154604

o

o

o

6000009315	-77.94423277
6000009340	-79.51829697
6000009365	-78.46108961
6000009390	-78.46108957
6000009415	-76.59570596
DATA2	4.708697055
5999984415	-80.98197882
5999984440	-80.98197879
5999984465	-75.83142132
5999984490	-74.02712079
5999984515	-73.57213005

o

o

o

6000009315	-75.9183103
6000009340	-79.53787488
6000009365	-78.82602191
6000009390	-78.82602188
6000009415	-76.37486709
DATA10	0

5999984415	-75.56751112
5999984440	-75.76485645
5999984465	-76.67718717
5999984490	-78.79238489
5999984515	-83.72680212
	o
	o
	o
6000009315	-71.3942461
6000009340	-72.28308332
6000009365	-73.92684489
6000009390	-75.45548832
6000009415	-75.17904815

Save As . . .

When you press “Save As”, the analyzer brings up a Windows dialog and a menu entitled “**Save As.**” This menu allows you to navigate to the various fields in the Windows dialog without using a keyboard or mouse. The **Tab** and **Arrow** keys can also be used for dialog navigation.

See "[To File . . .](#)" on page 3202 in **Save, State** for a full description of this dialog and menu.

The default path for saving files is:

For all of the Trace Data Files:

- My Documents\<<mode name>\data\traces

For all of the Limit Data Files:

- My Documents\<<mode name>\data\limits

For all of the Measurement Results Data Files:

- My Documents\<<mode name>\data\<<measurement name>\results

For all of the Capture Buffer Data Files:

- My Documents\<<mode name>\data\captureBuffer

Key Path	Save, Data
Mode	All
Notes	The key location is mode-dependent and will vary.

Brings up the Save As dialog for saving a <mode specific> Save Type. The save is performed immediately and does not wait until the measurement is complete.

Initial S/W Revision Prior to A.02.00

Screen Image

Pressing Screen Image accesses a menu of functions that enable you to specify a format and location for the saved screen image. It brings up a menu that allows you to specify the color scheme of the Screen Image (Themes) or navigate to the Save As dialog to perform the actual save.

Screen Image files contain an exact representation of the analyzer display. They cannot be loaded back onto the analyzer, but they can be loaded into your PC for use in many popular applications.

The image to be saved is actually captured when the **Save** front panel key is pressed, and kept in temporary storage to be used if you ask for a Screen Image save. When the Screen Image key is pressed, a "thumbnail" of the captured image is displayed, as shown below:

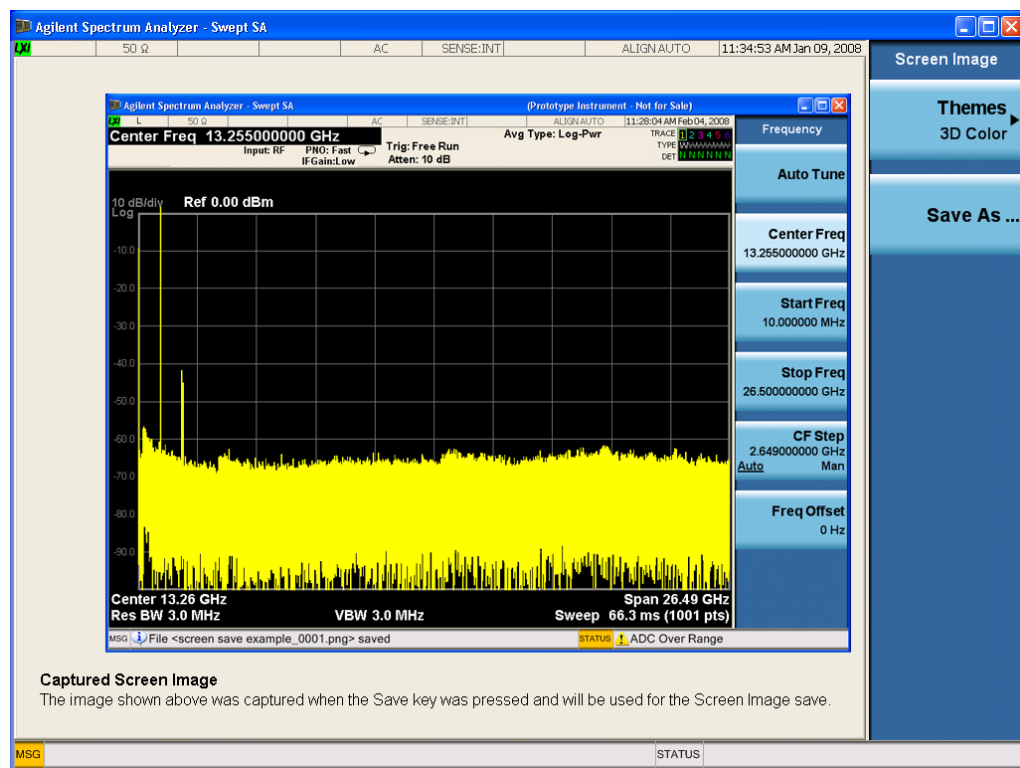

When you continue on into the **Save As** menu and complete the Screen Image save, the image depicted in the thumbnail is the one that gets saved, showing the menus that were on the screen before going into the **Save** menu. The save is performed immediately and does not wait until the measurement is complete.

After you have completed the save, the **Quick Save** front-panel key lets you quickly repeat the last save performed, using an auto-named file, with the current screen data.

NOTE

For versions previous to A.01.55, if you initiate a screen image save by navigating through the Save menus, the image that is saved will contain the Save menu softkeys, not the menus and the active function that were on the screen when you first pressed the Save front panel key.

Key Path	Save
Mode	All
Remote Command	:MMEMory:STORe:SCReen <filename>
Example	:MMEM:STOR:SCR "myScreen.png" This stores the current screen image in the file MyScreenFile.png in the default directory.
Backwards Compatibility SCPI	HCOPy:SDUMp:DATA? returns the screen image in a <DEFINITE LENGTH ARBITRARY RESPONSE DATA> element. The response data is IEEE Block format; the controlling computer can strip the header and store the result as a .png file.
Initial S/W Revision	Prior to A.02.00

Themes

Accesses a menu of functions that enable you to choose the theme to be used when saving the screen image.

The **Themes** option is the same as the **Themes** option under the **Display** and **Page Setup** dialogs. It allows you to choose between themes to be used when saving the screen image.

Key Path	Save, Screen Image
Remote Command	:MMEMory:STORe:SCReen:THEMe TDCoLor TDMonochrome FCOLor FMONochrome :MMEMory:STORe:SCReen:THEMe?
Example	:MMEM:STOR:SCR:THEM TDM
Preset	3D Color; Is not part of Preset, but is reset by Restore Misc Defaults or Restore System Defaults All and survives subsequent running of the modes.
Readback	3D Color 3D Mono Flat Color Flat Mono
Backwards Compatibility Notes	In ESA and PSA we offer the choice of "Reverse Bitmap" or "Reverse Metafile" when saving screen images. This is much like the "Flat Color" theme available in X-Series. Also, if you selected Reverse Bitmap AND a black & white screen image, that would be much like "Flat Monochrome". In other words, each of the X-Series themes has a similar screen image type in ESA/PSA. But they are not identical.
Initial S/W Revision	Prior to A.02.00

3D Color

Selects a standard color theme with each object filled, shaded and colored as designed.

Key Path	Save, Screen Image, Themes
Example	MMEM:STOR:SCR:THEM TDC
Readback	3D Color
Initial S/W Revision	Prior to A.02.00

3D Monochrome

Selects a format that is like 3D color but shades of gray are used instead of colors.

Key Path	Save, Screen Image, Themes
Example	MMEM:STOR:SCR:THEM TDM
Readback	3D Mono
Initial S/W Revision	Prior to A.02.00

Flat Color

Selects a format that is best when the screen is to be printed on an ink printer.

Key Path	Save, Screen Image, Themes
Example	MMEM:STOR:SCR:THEM FCOL
Readback	Flat Color
Initial S/W Revision	Prior to A.02.00

Flat Monochrome

Selects a format that is like Flat Color. But only black is used (no colors, not even gray), and no fill.

Key Path	Save, Screen Image, Themes
Example	MMEM:STOR:SCR:THEM FMON
Readback	Flat Mono
Initial S/W Revision	Prior to A.02.00

Save As...

When you press "Save As", the analyzer brings up a Windows dialog and a menu entitled "**Save As.**" This menu allows you to navigate to the various fields in the Windows dialog without using a keyboard or mouse. The **Tab** and **Arrow** keys can also be used for dialog navigation.

See "[To File . . .](#)" on page 3202 in **Save, State** for a full description of this dialog and menu.

The default path for Screen Images is

– My Documents\<<mode name>\screen.

where <mode name> is the parameter used to select the mode with the INST:SEL command (for example, SA for the Spectrum Analyzer).

Key Path	Save, Screen Image
Notes	Brings up Save As dialog for saving a Screen Image Save Type
Initial S/W Revision	Prior to A.02.00

Mass Storage Catalog (Remote Command Only)

Key path	SCPI Only
Remote Command	:MMEMory:CATalog? [<directory_name>]
Notes	<p>The string must be a valid logical path.</p> <p>Queries disk usage information (drive capacity, free space available) and obtains a list of files and directories in a specified directory in the following format:</p> <p><numeric_value>,<numeric_value>,{<file_entry>}</p> <p>It returns two numeric parameters and as many strings as there are files and directories. The first parameter indicates the total amount of storage currently used in bytes. The second parameter indicates the total amount of storage available, also in bytes. The <file_entry> is a string. Each <file_entry> indicates the name, type, and size of one file in the directory list:</p> <p><file_name>,<file_type>,<file_size></p> <p>As the windows file system has an extension that indicates file type, <file_type> is always empty. <file_size> provides the size of the file in bytes. For directories, <file_entry> is surrounded by square brackets and both <file_type> and <file_size> are empty</p>
Initial S/W Revision	Prior to A.02.00

Mass Storage Change Directory (Remote Command Only)

Key path	SCPI Only
Remote Command	:MMEMory:CDIRectory [<directory_name>] :MMEMory:CDIRectory?
Notes	<p>The string must be a valid logical path.</p> <p>Changes the default directory for a mass memory file system. The <directory_name> parameter is a string. If no parameter is specified, the directory is set to the *RST value.</p> <p>At *RST, this value is set to the default user data storage area, that is defined as System.Environment.SpecialFolder.Personal.</p> <p>Query returns full path of the default directory.</p>
Initial S/W Revision	Prior to A.02.00

Mass Storage Copy (Remote Command Only)

Key path	SCPI Only
----------	------------------

Remote Command	:MMEMory:COpy <string>,<string>[,<string>,<string>]
Notes	<p>The string must be a valid logical path.</p> <p>Copies an existing file to a new file or an existing directory to a new directory.</p> <p>Two forms of parameters are allowed. The first form has two parameters. In this form, the first parameter specifies the source, and the second parameter specifies the destination.</p> <p>The second form has four parameters. In this form, the first and third parameters specify the source. The second and fourth parameters specify the directories. The first pair of parameters specifies the source. The second pair specifies the destination. An error is generated if the source doesn't exist or the destination file already exists.</p> <p>This command will generate an "access denied" error if the destination is a restricted folder (e.g., C:\Windows) and the current user does not have Power User or Administrator privileges.</p>

Mass Storage Device Copy (Remote Command Only)

This command transfers data to/from a file and a peripheral device.

Key path	SCPI Only
Remote Command	:MMEMory:COpy:DEvice <source_string>,<dest_string>
Notes	<p>The strings must be a valid logical path or a valid device keyword. If the dest_string is a device keyword, the data is copied from the source file to the device. If the source_string is a device keyword, the data is copied to the source file from the device.</p> <p>Valid device keywords are:</p> <p>SNS (smart noise source)</p> <p>An error is generated if the file or device is not found.</p>

Mass Storage Delete (Remote Command Only)

Key path	SCPI Only
Remote Command	:MMEMory:DElete <file_name>[,<directory_name>]
Notes	<p>The string must be a valid logical path.</p> <p>Removes a file from the specified directory. The <file_name> parameter specifies the file name to be removed. This command will generate an "access denied" error if the file is in a restricted folder (e.g., C:\Windows) and the current user does not have Power User or Administrator privileges.</p>
Initial S/W Revision	Prior to A.02.00

Mass Storage Data (Remote Command Only)

Creates a file containing the specified data OR queries the data from an existing file.

Key path	SCPI Only
Remote Command	:MMEMory:DATA <file_name>, <data> :MMEMory:DATA? <file_name>
Notes	<p>The string must be a valid logical path.</p> <p>The command form is MMEMory:DATA <file_name>,<data>. It loads <data> into the file <file_</p>

	name>. <data> is in 488.2 block format. <file_name> is string data. The query form is MMEMory:DATA? <file_name> with the response being the associated <data> in block format.
Initial S/W Revision	Prior to A.02.00

Mass Storage Make Directory (Remote Command Only)

Key path	SCPI Only
Remote Command	:MMEMory:MDIRectory <directory_name>
Notes	The string must be a valid logical path. Creates a new directory. The <directory_name> parameter specifies the name to be created. This command will generate an “access denied” error if the new directory would be in a restricted folder (e.g., C:\Windows) and the current user does not have Power User or Administrator privileges.
Initial S/W Revision	Prior to A.02.00

Mass Storage Move (Remote Command Only)

Key path	SCPI Only
Remote Command	:MMEMory:MOVE <string>,<string>[,<string>,<string>]
Notes	The string must be a valid logical path. Moves an existing file to a new file or an existing directory to a new directory. Two forms of parameters are allowed. The first form has two parameters. In this form, the first parameter specifies the source, and the second parameter specifies the destination. The second form has four parameters. In this form, the first and third parameters specify the source. The second and fourth parameters specify the directories. The first pair of parameters specifies the source. The second pair specifies the destination. An error is generated if the source doesn't exist or the destination file already exists. This command will generate an “access denied” error if the destination is a restricted folder (e.g., C:\Windows) and the current user does not have Power User or Administrator privileges.
Initial S/W Revision	Prior to A.02.00

Mass Storage Remove Directory (Remote Command Only)

Key path	SCPI Only
Remote Command	:MMEMory:RDIRectory <directory_name>
Notes	The string must be a valid logical path. Removes a directory. The <directory_name> parameter specifies the directory name to be removed. All files and directories under the specified directory shall also be removed. This command will generate an “access denied” error if the folder is a restricted folder (e.g., C:\Windows) or is in a restricted folder and the current user does not have Power User or Administrator privileges.
Initial S/W Revision	Prior to A.02.00

Mass Storage Determine Removable Media (Remote Command Only)

This command is used to determine if any removable media devices are connected to the instrument. Primarily, these are USB memory devices plugged-in to the front panel or rear panel USB ports. On instruments with PC6 or PC7 CPU's, one SD card slot is available for removable media. The instrument's primary disk drive is not a removable media device.

Key Path	SCPI Only
Remote Command	:MMEMory:RMEDia:LIST?
Notes	<p>The return value is a string containing a list of partition identifiers that are removable media devices. Each identifier is separated by a comma. If no removable media is present, an empty string is returned.</p> <p>Examples:</p> <ul style="list-style-type: none"> - One removable device present results in a return string of "F:". - Two removable devices present results in a return string of "F:,G:". - No removable devices present results in a return string of "".
Initial S/W Revision	x.15.00

Mass Storage Determine Removable Media Label (Remote Command Only)

This command is used to set or query a removable media device's label.

Key Path	SCPI Only
Remote Command	:MMEMory:RMEDia:LABel <partition>,<string> :MMEMory:RMEDia:LABel? <partition>
Example	MMEM:RMED:LAB "F:","My Device"
Notes	<p>If the <partition> specified does not exist or is not a removable media device, the error - 252,"Missing Media" is generated.</p> <p>Setting the removable media label requires Administrative privileges. If the currently logged in user does not have appropriate privileges the error "-221.9900,Settings conflict;Administrator privileges required" is generated.</p>
Initial S/W Revision	x.15.00

Mass Storage Determine Removable Media Write-protect status (Remote Command Only)

This command is used to query a removable media device's write-protect status.

Key Path	SCPI Only
Remote Command	:MMEMory:RMEDia:WPRotect? <partition>

Example	MMEM:RMED:WPR? "F:"
Notes	The return value is 1 if the device is write-protected, or 0 if the device is write-enabled. If the <partition> specified does not exist or is not a removable media device the error - 252,"Missing Media" is generated.
Preset	The return value will be depending on SD card installed.
Initial S/W Revision	x.15.00

Mass Storage Determine Removable Media size (Remote Command Only)

This command is used to query a removable media device's total memory size (not available memory size).

Key Path	SCPI Only
Remote Command	:MMEMory:RMEDia:SIZE? <partition>
Example	MMEM:RMED:SIZE? "F:"
Notes	The return value is integer value in GBytes. Any device that is less than 1 GB returns 0 GB. If the <partition> specified does not exist or is not a removable media device, the error - 252,"Missing Media" is generated.
Initial S/W Revision	x.15.00

:SYSTem:SET (Remote Command Only)

Remote command that allows the user to obtain the state of the currently active mode in a form that can then be loaded back into the instrument quickly.

Remote Command	SYSTem:SET <instrument state in IEEE Block> SYSTem:SET?
Notes	SYST:SET? returns current instrument state of the active mode in IEEE Block data format. The state is in a machine readable format only. Sending the query returns the following format: <syst set preamble><state block data> Where: <syst set preamble> is the format: #NMMM N=number of digits that comprise MMM MMM=length in bytes of following data <state block data> is machine readable state data Example response: #42016<state data> The state is recalled by sending the SYST:SET? Response data to the instrument. From example above: SYST:SET #42016<state data>
Initial S/W Revision	x.17.00

Single (Single Measurement/Sweep)

Sets the analyzer for Single measurement operation. The single/continuous state is Meas Global, so the setting will affect all the measurements. If you are Paused, pressing **Single** does a Resume.

See "[More Information](#)" on page 3244

Key Path	Front-panel key
Example	:INIT:CONT OFF
Notes	See Cont key description.
Backwards Compatibility Notes	<p>For Spectrum Analysis mode in ESA and PSA, the Single hardkey and the INITiate:IMM switched from continuous measurement to single measurement and restarted sweeps and averages (displayed average count reset to 1), but did not restart Max Hold and Min Hold. In the X-Series, the Single hardkey and the INITiate:IMM command initiate a sweep/ measurement/ average sequence/hold sequence including MaxHold and MinHold.</p> <p>For Spectrum Analysis mode in ESA and PSA, the Single hardkey restarted the sweep regardless of whether or not you were in an active sweep or sweep sequence. In the X-Series, Restart does this but Single only restarts the sweep or sweep sequence if you are in the idle state.</p> <p>INIT[:IMM] in ESA & PSA Spectrum Analysis Mode does an implied ABORT. In some other PSA Modes, INIT[:IMM] is ignored if not in the idle state. . The X-Series follows the ESA/PSA SA Mode model, which may cause some Modes to have compatibility problems.</p>
Initial S/W Revision	Prior to A.02.00

More Information

See "[Restart](#)" on page 3199 for details on the INIT:IMMEDIATE (Restart) function.

If you are already in single sweep, the INIT:CONT OFF command has no effect.

If you are already in Single Sweep, then pressing the **Single** key in the middle of a sweep does not restart the sweep or sequence. Similarly, pressing the **Single** key does not restart the sweep or sequence if the sweep is not in the idle state (for example, if you are taking a very slow sweep, or the analyzer is waiting for a trigger). Instead, it results in a message. "Already in Single, press Restart to initiate a new sweep or sequence". Even though pressing the **Single** key in the middle of a sweep does not restart the sweep, sending INIT:IMMEDIATE does reset it.

To take one more sweep without resetting the average count, increment the average count by 1, by pressing the step up key while **Average/Hold Number** is the active function, or sending the remote command CALC:AVER:TCON UP.

Source

The Source key accesses menus for controlling a Source in Tracking Source mode

Key Path	Front-panel key
Dependencies	<p>Operation with a source requires a license. If the proper license is not installed, the following occurs:</p> <ul style="list-style-type: none"> - When the Source key is pressed the user sees an informational message, "Option not installed" - If any SCPI command in the :SOURce subsystem is sent it generates a message, "Settings conflict;option not installed"
Initial S/W Revision	A.06.01

NOTE

Option T03 or T06 is required for the Tracking Generator function in CXA. Option T03, T07, T13 or T26 is required for the Tracking Generator function in CXA-m.

When using the CXA-m Tracking Generator, if the Source Frequency is in the frequency range of the below table, and the Source Amplitude is in the corresponding amplitude range of the below table, a warning status message is generated, +313 "Source Uncal". This is also true if Power Sweep is on and any amplitude in the Power Sweep (as calculated by Amplitude, Power Sweep, and Amptd Offset) is in that range.

CXA-m TG Un-calibrated Amplitude Range

Frequency Range	Amplitude Range
$2 \text{ MHz} \leq \text{frequency} < 10 \text{ GHz}$	$-40 \text{ dBm} \leq \text{amplitude} < -35 \text{ dBm}$
$10 \text{ GHz} \leq \text{frequency} < 20 \text{ GHz}$	$-40 \text{ dBm} \leq \text{amplitude} < -35 \text{ dBm}$ or $-5 \text{ dBm} < \text{amplitude} \leq 0 \text{ dBm}$
$20 \text{ GHz} \leq \text{frequency} \leq 26.55 \text{ GHz}$	$-12 \text{ dBm} < \text{amplitude} \leq 0 \text{ dBm}$

RF Output

Allows you to turn the source RF Power on or off.

NOTE

When the RF Output is turned on, the Source Mode is set to Tracking. See the Source Mode key description for special considerations concerning how to configure your N5172B or N5182B source for use with External Source Control.

Key Path	Source
Scope	Meas Global
Remote Command	<code>:OUTPut[:EXTerna1] [:STATe] ON OFF 1 0</code> <code>:OUTPut[:EXTerna1] [:STATe]?</code>

Example	:OUTP ON :OUTP?
Dependencies	Grayed out in measurements that do not support a source. If you go to such a measurement the output will be forced to Off. Grayed out if there is no valid source selection, in this case go to the Select Source menu to choose, configure and/or verify your source When there is no available Source Mode (other than Off), due to other couplings, then the RF Output key is grayed out.
Couplings	When RF Output is turned On, Source Mode is set to Tracking When Source Mode is turned Off, RF Output is turned Off. When Source Mode is turned Off (or forced to Off by another coupling), RF Output is turned Off. Turning RF Output Off does not affect Source Mode or other settings.
Preset	OFF (on either a Mode Preset, a Source Preset, or Restore Input/Output Defaults)
State Saved	Part of the Input/Output system, which means it is Loaded and Saved with state.
Range	On Off
Initial S/W Revision	A.06.01
Modified at S/W Revision	A.10.01

Amplitude

Allows you to access the Amplitude sub-menu to control various amplitude parameters of the Source. The resolution of the Source amplitude parameters is coupled to match the minimum resolution of the source when the source is acquired. When the source is released, the amplitude parameter resolution reverts to default values.

Key Path	Source
Readback	In square brackets, the amplitude value from Amplitude key in the next menu level down
Initial S/W Revision	A.06.01

Amplitude

Allows you to adjust the power level of the selected source. Note that the actual amplitude is also affected by the Amplitude Offset and Power Sweep parameters.

Key Path	Source, Amplitude
Scope	Mode Global
Remote Command	:SOURce[:EXTeRna1]:POWer[:LEVe1][:IMMeDiate][:AMPLitude] <amp1> :SOURce[:EXTeRna1]:POWer[:LEVe1][:IMMeDiate][:AMPLitude]?
Example	:OUTP ON :SOUR:POW -10dBm
Dependencies	If the requested setting of Source Amplitude causes the calculated external source start or stop Amplitude to exceed the external source capability, a warning status message is generated,

	<p>“Data out of Range; clipped to source max/min” The “Show Source Capabilities and Settings” menu can then be examined to check the source capabilities.</p> <p>This parameter test and clip is also performed at source acquisition.</p>
Preset	<p>-10.00 dBm (On Source Preset and Restore Input/Output Defaults)</p> <p>Not affected by Mode Preset</p>
State Saved	Part of the Input/Output system, which means it is Loaded and Saved with state.
Min	The range of the amplitude parameter is dependent on the amplitude range of the source that is selected, and the settings of Amplitude Offset and Power Sweep.
Max	The range of the amplitude parameter is dependent on the amplitude range of the source that is selected, and the settings of Amplitude Offset and Power Sweep.
Backwards Compatibility SCPI	<p>:SOURce:POWer:STARt <amp1></p> <p>:SOURce:POWer:STARt?</p> <p>This alias is for the ESA tracking generator. It specifies the source output power level at the start of the power sweep, just as does :SOURce:POWer.</p>
Initial S/W Revision	A.06.01
Modified at S/W Revision	A.10.01

Power Sweep

Allows you to set up a Power Sweep. Power Sweep is useful for measuring saturation behavior in a test device, such as a power amplifier.

Pressing the key sets the power-sweep function to On or Off. The value of the power-sweep range is displayed in the active function block, and can be adjusted, when set to On.

The source will sweep the power between the start power defined by the Amplitude function and the stop power = start power + power sweep value:

Source (start) amplitude = Amplitude – Amplitude Offset

Source (stop) amplitude = Amplitude – Amplitude Offset + Power Sweep

In Stepped Tracking, such as is used with an external source or the CXA-m TG, the analyzer controls the source with step sweep mode, which provides a linear progression from one selected frequency, amplitude, or both, to another, pausing at linearly spaced points (steps) along the sweep. The analyzer continues to sweep the specified frequency range when power sweep is on, although generally Power Sweep is performed in Zero Span.

With CXA options T03, T06, the hardware is capable of continuous power sweeps. This makes it possible to use the swept sweep time rules and should be employed for faster sweeps. Care should be taken to limit the sweep time you use as there are no sweep time couplings to Power Sweep settings. The recommended minimum sweep time depends on the RBW and power-sweep range. Start by computing $(1.28/\text{RBW}) * (\text{abs}(\text{startPower} - \text{stopPower}) / (5 \text{ dB}))$. The recommended minimum sweep time is the larger of this value and 50 ms.

Some external Sources have mechanical attenuators, which are not used in Power Sweep in order to save wear on the attenuators. To allow an acceptable range of Power Sweep without changing the mechanical attenuation, the Sources are put in a mode that allows the Source to handle a wide amplitude range without switching the attenuators. When the Power Sweep settings put the Source in an amplitude range that requires the mechanical attenuators, the analyzer displays a condition warning message:

Settings Alert;Src pwr ramp>ALC range

Key Path	Source, Amplitude
Mode	SA
Scope	Mode Global
Remote Command	:SOURce:POWer:SWEep <rel_amp1> :SOURce:POWer:SWEep? :SOURce:POWer:SWEep:STATe ON OFF 1 0 :SOURce:POWer:SWEep:STATe?
Example	:SOUR:POW -5 :SOUR:POW:SWE:STAT ON :SOUR:POW:SWE 10 Set source start power to - 5 dBm and stop power + 5dBm (-5 + 10).
Example	:SOUR:POW:SWE:STAT ON
Dependencies	If the requested setting of Power Sweep causes the calculated external source start or stop Amplitude to exceed the external source capability, a warning status message is generated, "Data out of Range; clipped to source max/min". The Show Source Capabilities and Settings menu can then be examined to check the source capabilities. This parameter test and clip is also performed at source acquisition.
Preset	This is unaffected by "Mode Preset" but is set to 0dB on a "Source Preset" or "Restore Input/Output Defaults".
State Saved	Part of the Input/Output system, which means it is Loaded and Saved with state.
Min	-500 dB
Max	+500 dB
Backwards Compatibility SCPI	:SOURce[:EXTeRnAl][:SWEep]:POWer:SPAN <rel_amp1> :SOURce[:EXTeRnAl][:SWEep]:POWer:SPAN? This alias is for the ESA tracking generator and PSA option 215. It specifies the range of power levels through which the source output will sweep just as does :SOURce:POWer:SWEep.
Initial S/W Revision	A.06.01
Remote Command	:SOURce[:EXTeRnAl]:POWer:MODE FIXed SWEep :SOURce[:EXTeRnAl]:POWer:MODE?
Notes	The ESA tracking generator and the PSA option 215 support this SCPI command. It sets the source output to be at a single amplitude (fixed) or to sweep through a range of power levels

	SOURce:POWer:MODE FIXed is equivalent to :SOURce:POWer:SWEep:STATe OFF
	SOURce:POWer:MODE SWEep is equivalent to :SOURce:POWer:SWEep:STATe ON
Preset	This is unaffected by "Mode Preset" but is set to FIXed on a "Source Preset" or "Restore Input/Output Defaults".
Initial S/W Revision	A.06.01
Modified at S/W Revision	A.10.01

Amptd Offset

Offsets the displayed power of the source in the Amplitude parameter. Using the amplitude offset allows you to take into account any system losses or gains (for example, due to cable loss), thereby displaying the actual power delivered to the device under test. See the equations under the Source, Amplitude, Power Sweep key.

Key Path	Source, Amplitude
Mode	SA
Scope	Mode Global
Remote Command	:SOURce:CORRection:OFFSet <rel_amp1> :SOURce:CORRection:OFFSet?
Example	:SOUR:CORR:OFFS 5 Sets the displayed source offset power to 5 dB.
Dependencies	If the requested setting of Amptd Offset causes the calculated external source start or stop Amplitude to exceed the external source capability, a warning status message is generated, "Data out of Range; clipped to source max/min". The Show Source Capabilities and Settings menu can then be examined to check the source capabilities. This parameter test and clip is also performed at source acquisition.
Preset	This is unaffected by Mode Preset but is set to 0.00dBm on a Source Preset or Restore Input/Output Defaults.
State Saved	Part of the Input/Output system, which means it is Loaded and Saved with state.
Min	-1000 dB
Max	+1000 dB
Initial S/W Revision	A.06.01

Amptd Step Auto/Man

Allows you to set the step size associated with the Source Amplitude key. When auto-coupled, the step size is the current Scale/Div setting under the Amplitude hardkey (note that this is true even if the analyzer is currently in Linear amplitude scale).

Once a step size has been selected and the Source Amplitude function is active, the step keys (and the UP|DOWN parameters for Source Amplitude from remote commands) change the Source Amplitude by the step-size value.

You may change the step size manually by pressing Amptd Step and entering a value. The function (and the step size) will return to Auto when a Mode Preset or Auto Couple is performed.

Key Path	Source, Amplitude
Scope	Mode Global
Remote Command	<pre>:SOURce:POWer:STEP[:INCRement] <amp;lt;1> :SOURce:POWer:STEP[:INCRement]? :SOURce:POWer:STEP:AUTO OFF ON 0 1 :SOURce:POWer:STEP:AUTO?</pre>
Example	<pre>:SOUR:POW:STEP 0.1 Set amplitude step to 0.1 dB :SOUR:POW:STEP:AUTO ON</pre>
Couplings	In Auto, coupled to the size of one logarithmic vertical graticule division
Preset	Auto
State Saved	Part of the Input/Output system, which means it is Loaded and Saved with state.
Min	0.1 dB
Max	20 dB
Initial S/W Revision	A.06.01

Frequency

Allows a you to access the Frequency sub-menu. This menu lets you use a stepped tracking source for stimulus/response measurements for some added flexibility. Because with such a source, the source frequency does not need to track 1:1 with the analyzer LO frequency, it is possible to measure scalar harmonic and subharmonic responses of devices. For example, the second harmonic response is measured by stepping the analyzer and source so that the analyzer is always at twice the source frequency. In addition, the frequency offset capability allows the measurement of frequency conversion devices (like mixers).

In tracking mode, the source frequency tracks the analyzer frequency according to the source frequency equation:

$$\text{Source Frequency} = (\text{Analyzer Frequency} * \text{Multiplier Numerator} / \text{Multiplier Denominator}) + \text{Source Frequency Offset}$$

NOTE

Analyzer Frequency is the frequency to which the analyzer is set, which is the analyzer's displayed frequency, offset by any Freq Offset set under the Frequency hardkey. Source Frequency Offset is the value set under **Source, Frequency, Freq Offset.**

Key Path	Source
----------	---------------

Readback	none in Tracking Source mode
Initial S/W Revision	A.06.01

Multiplier Numerator

The multiplier numerator parameter offsets the source frequency from the analyzer frequency. The source frequency tracks the SA frequency according to the source frequency equation shown under the **Source, Frequency** key description.

The multiplier numerator must be restricted to operate within the range of the source minimum and maximum frequencies.

Key Path	Source, Frequency
Mode	SA
Scope	Mode Global
Remote Command	:SOURce:FREQuency[:MULTIplier]:NUMerator <integer> :SOURce:FREQuency[:MULTIplier]:NUMerator?
Example	:SOUR:FREQ:NUM 3 Sets the source frequency multiplier numerator to 3.
Dependencies	If the currently selected source does not support this capability (for example, an internal Tracking Generator which must track the LO), this key is forced to its Preset value and grayed out
Preset	This is unaffected by Mode Preset but is set to 1 on a Source Preset or Restore Input/Output Defaults.
State Saved	Part of the Input/Output system, which means it is Loaded and Saved with state.
Min	1
Max	1000
Initial S/W Revision	A.06.01

Multiplier Denominator

The multiplier denominator parameter offsets the source frequency from the analyzer frequency. The source frequency tracks the SA frequency according to the source frequency equation shown under the **Source, Frequency** key description.

The multiplier denominator must be restricted to operate within the range of the source minimum and maximum frequencies.

Key Path	Source, Frequency
Mode	SA
Scope	Mode Global
Remote Command	:SOURce:FREQuency[:MULTIplier]:DENominator <integer> :SOURce:FREQuency[:MULTIplier]:DENominator?
Example	:SOUR:FREQ:DEN 3 Sets the source frequency multiplier denominator to 3

Dependencies	If the currently selected source does not support this capability (for example, an internal Tracking Generator which must track the LO), this key is forced to its Preset value and grayed out
Preset	This is unaffected by Mode Preset but is set to 1 on a Source Preset or Restore Input/Output Defaults.
State Saved	Part of the Input/Output system, which means it is Loaded and Saved with state
Min	1
Max	1000
Initial S/W Revision	A.06.01

Source Sweep Reverse

Allows you to reverse the source sweep direction

Normally, the source will sweep from a lower frequency to a higher frequency. However, there are test scenarios in which the source sweep needs to be “reversed”. In this case, it sweeps from a higher frequency to a lower frequency. For example, when the DUT is a frequency converter and a measurement of the Lower Side Band characteristics is desired, a reverse sweep is employed. Reverse sweeps are supported for such scenarios, but two cautions are in order:

4. Reverse Sweep only reverses the direction of the source’s sweep, not the analyzer’s sweep. Unless you are actually using a device like a frequency converter and looking at the lower sideband, thus effectively reversing the direction of the source’s sweep, the source will be sweeping in the opposite direction from the analyzer, and it will not be possible track the desired device output frequency.
5. Any time you are using a frequency converter, care must be taken in setting up all of the sweep parameters, including analyzer start/stop frequency and source multiplier, to make sure that the analyzer’s sweep tracks the output of the converter device.

Key Path	Source, Frequency
Mode	SA
Scope	Mode Global
Remote Command	:SOURce:FREQuency:SSReverse:ON OFF 0 1 :SOURce:FREQuency:SSReverse?
Example	SOUR:FREQ:SSR:OFF SOUR:FREQ:SSR?
Notes	You must be in Spectrum Analyzer mode to use this command. Use INSTRument:SElect to set the mode.
Dependencies	If the currently selected source does not support this capability (for example, an internal Tracking Generator which must track the LO), this key is forced to its Preset value and grayed out
Preset	This is unaffected by Mode Preset but is set to OFF on a Source Preset or Restore Input/Output Defaults.

State Saved	Part of the Input/Output system, which means it is Loaded and Saved with state
Range	On Off
Initial S/W Revision	A.06.01

Freq Offset

The frequency offset parameter offsets the source frequency from the analyzer frequency. The source frequency tracks the SA frequency according to the equations under the **Source, Frequency** key.

Pressing the key sets the Freq Offset function to On or Off. The value of Freq Offset is displayed in the active function block, and can be adjusted, when set to On.

The frequency offset must be restricted to operate within the range of the source minimum and maximum frequencies.

Key Path	Source, Frequency
Mode	SA
Scope	Mode Global
Remote Command	:SOURce:FREQuency:OFFSet <freq> :SOURce:FREQuency:OFFSet? :SOURce:FREQuency:OFFSet:STATe ON OFF 1 0 :SOURce:FREQuency:OFFSet:STATe?
Example	:SOUR:FREQ:OFFS 10MHz Sets the source frequency offset to 10MHz.
Dependencies	If the currently selected source does not support this capability (for example, an internal Tracking Generator which must track the LO), this key is forced to its Preset value and grayed out
Preset	This is unaffected by Mode Preset but is set to 0.00Hz on a Source Preset or Restore Input/Output Defaults.
State Saved	Part of the Input/Output system, which means it is loaded and saved with state
Min	-500 GHz
Max	500 GHz
Backwards Compatibility SCPI	:SOURce:EXTernal:SWEep:OFFSet:FREQuency <freq> :SOURce:EXTernal:SWEep:OFFSet:FREQuency? The PSA option 215 supports this SCPI command. This command is equivalent to :SOURce:FREQuency:OFFSet
Initial S/W Revision	A.06.01
Modified at S/W Revision	A.10.01

Source Mode

Accesses the Source Mode softkey menu. This menu lets you select Tracking mode for the Source, and also allows you to set the Source Mode to OFF.

The Source Mode can be set to Tracking without the user setting it directly. There are several couplings that cause Source Mode to be automatically set to Tracking (detailed in the table below). One important coupling is that Source Mode is forced to Tracking when the RF Output is turned on if the measurement supports Tracking. Since Source Mode is set to Off on a Mode Preset, this means that you will rarely need to change the Source Mode setting directly.

NOTE

When the Source Mode is set to Tracking, the analyzer acquires control of the source. When this happens the source is told to save its state and then perform a preset. Usually both of these operations take very little time; however, on an N5172B or an N5182B, if many Source real-time apps are in use, both save and preset can take many seconds. If it takes longer than the analyzer expects to acquire control, you will see an error: “Source connection lost, check interface connection”. If you see this error, and you are using an N5172B or an N5182B, you can shorten the acquire time by presetting your MXG before attempting to use External Source Control.

Key Path	Source
Scope	Meas Global
Remote Command	:INSTrument:SOURce[:SElect] TRACKing OFF :INSTrument:SOURce[:SElect]?
Example	:INST:SOUR TRAC
Dependencies	<p>Grayed out if no Source is selected, in this case go to the Select Source menu to choose, configure and/or verify your source</p> <p>Grayed out and forced to Off if either BBIQ or External Mixing are selected</p> <p>Blanked in Modes that do not support a source</p> <p>Grayed out in Measurements that do not support a source</p> <p>Tracking is grayed out when Manual FFT is selected</p> <p>Tracking is grayed out when the RF Preselector is on (in models which support the RF Preselector).</p>
Couplings	<p>When RF Output is turned On, Source Mode is set to Tracking. When Source Mode is turned Off, RF Output is turned Off.</p> <p>Whenever you switch to an application (Mode) in which the Source Mode was previously set to Tracking, it is again set to Tracking. That is, the last setting of the Source Mode is remembered when you leave an application (Mode) and restored when you return</p> <p>Source Mode is forced to Tracking when the RF Output is turned on if the measurement supports Tracking</p> <p>If Source Mode is set to Tracking, then it is forced to Off when you select a measurement that does not support Tracking.</p> <p>If Source Mode is set to Tracking, then it is forced to Off when you turn on the RF Preselector (in models which support the RF Preselector).</p> <p>Whenever the Source Mode is set to Tracking, the analyzer acquires the Source. Similarly, the Source is released whenever the Source Mode is set to Off. This is true whether the Source Mode was set directly by you, was set indirectly through a coupling, if you switched to an application (Mode) that had previously been set to Tracking, or if you switched to an application (Mode) in which the Source Mode is not set to Tracking.</p> <p>For an external source, “acquiring the source” involves contacting the external instrument over</p>

the remote interface (which puts it into Remote) and taking control of it.
 When you set the Source Mode to OFF, it releases the Source (and puts it into Local). For an external source, this means you are now free to operate the source for other purposes.
 When the Source is acquired, its previous state is saved, and when it is released, that state is restored, so that you can acquire and then release the source and it will return to the state it was in before you acquired it.

Preset	OFF
State Saved	Saved in instrument state
Initial S/W Revision	A.06.01
Modified at S/W Revision	A.10.01

Select Source

The Select Source menu allows you to maintain a list of available external Sources, and choose the Source that you want to use from the list. It shows the currently selected source at the bottom of the screen.

While in the Select Source menu, you can see, and select from, a list of the currently available sources. The sources listed in this table are as follows:

- Any internal sources which are installed and licensed

NOTE

Only one internal source can be installed, displayed at address “INTERNAL”

- Any external sources which you have previously configured, whether or not they are currently connected, displayed with their VISA address

Note that only external sources that are supported by the Tracking Source Mode are displayed in the Available Source List. Here are the Keysight/Agilent sources currently supported:

Source	PXA	MXA	EXA	CXA	MXE (Presel off)
MXG N5181A	X	X	X	X	X
MXG N5182A	X	X	X	X	X
MXG N5183A	X	X	X		X
EXG N5171B	X	X	X	X	X
MXG N5181B	X	X	X	X	X
EXG	X	X	X	X	X

N5172B					
EXG	X	X	X	X	X
N5173B					
MXG	X	X	X	X	X
N5182B					
MXG	X	X	X	X	X
N5183B					
PSG	X	X	X		
E8257D					
PSG	X	X	X		
E8267D					

NOTE

For X-Series software versions earlier than A.10.01, option UNZ (Fast switching) was required on the MXG for some use cases. This is no longer the case, option ESC now works without MXG option UNZ for all use cases. (Note that you will get better performance if your MXG has option UNZ, because without option UNZ your sweep speeds will be noticeably slower.)

While in the Select Source menu and its submenus, detailed instructions are presented that tell you how to operate the Select Source functions. Basically they tell you to first use the up and down arrow keys to move the selection highlighted in the “Available Source List” to the source that you want to use. The list of available sources includes any sources that you have previously used (unless you have deleted them) and any found while in the “Add Source to List” menu.

When the source you want to use is highlighted, press “Select Highlighted Source” or “Enter”. The source you have selected shows up at the bottom of the screen as the “Current Source”. Press “Verify Current Source Connection” to make sure that the interface connection to the Source is still functional.

At any time you may use the “Add Source to List” or “Delete Highlighted Source” keys to find new sources or remove a source from the list of available sources.

Key Path	Source
Readback Text	Two lines of readback give the type information and serial number of the current source, in square brackets
Initial S/W Revision	A.06.01

Select Highlighted Source

You can navigate up and down in the list with the up and down arrow keys, and can select any entry by pressing the Select Highlighted Source key (or by double-clicking on the entry in the table with a mouse). The highlighted source becomes the Current Source and is prominently displayed at the bottom of the screen.

At any given time there is only one selected Source for the entire system; once a Source is selected, it becomes the Current Source and will be used by all applications that support Source Control.

For example, if no Source has yet been selected, the statement at the bottom of the screen would say

Current Source

None

If an N5182A connected via USB were the Current Source, the statement at the bottom of the screen might say:

Current Source

Agilent N5182A US00000258 at USB0::2931::7937::US00000258::0::INSTR

The SCPI command defined below allows the programmatic user to directly define the VISA address via a string parameter. The parameter is checked for proper syntax, the connection to the instrument is verified, and the source is added to the Available Source List if it verifies. If it does not verify or no source is found at that address, an error message is generated.

Normally the source selection activities should be performed only when the user changes the hardware connection configuration or activates/deactivates a source option license; shutdown and startup of the application will not cause source re-selection.

The Agilent IO Libraries Suite provides an “Agilent VISA Help” document that has a section that shows the proper syntax for valid VISA address strings, in the ViOpen function definition.

Key Path	Source, Select Source
Mode	SA
Remote Command	:SYSTem:COMMunicate:SOURce[1]:ADDRess <address string> :SYSTem:COMMunicate:SOURce[1]:ADDRess?
Example	Different examples for setting external source address :SYST:COMM:SOUR:ADDR "TCPIP0::MyHostName::INSTR" :SYST:COMM:SOUR:ADDR "TCPIP0::123.121.100.210::INSTR" :SYST:COMM:SOUR:ADDR "USB0::12212::32145::US1234567A::INSTR" :SYST:COMM:SOUR:ADDR "GPIB1::19::INSTR"
Notes	Empty string is allowed and means no source is defined or selected.
Remote Command Notes	The address string is the VISA address for external sources and "INTERNAL" for an internal source
Dependencies	Operation with a source requires a license. If the proper license is not installed, the SCPI command generates an error message, "Settings conflict;option not installed" If no supported source, or no source at all, is found at the specified address, the SCPI command generates an error message
Preset	The current source selection is unaffected by a Mode Preset and Source Preset but reverts to [None] on a Restore Input/Output Defaults. If an internal Tracking Generator is installed, then instead of None, the default selection will be INTERNAL.

State Saved	<p>Selected Source is</p> <ul style="list-style-type: none"> - Power On Persistent (survives power cycle) - Part of the Input/Output system, which means it is Loaded and Saved with state.
Readback	<p>Two lines of readback give the type information and serial number of the current source on the Select Source key in the form</p> <p>[<source type>] [<serial number>]</p> <p>[None] shows in the type area and blank in the serial number area if a source has not been configured.</p> <p>[Internal TG] shows in type area and serial number in the serial number area if an internal Tracking Generator has been selected.</p> <p>For example: [MXG]/n, [US01020022]. This indicates an MXG of serial number US01020022.</p>
Backwards Compatibility SCPI	<p>:SYSTem:COMMunicate:LAN:SOURce[:EXTernal]:IP <address string></p> <p>:SYSTem:COMMunicate:LAN:SOURce[:EXTernal]:IP?</p> <p>This command is provided for compatibility with PSA Option 215. The address string is reformatted for the X-Series. For example, if the customer sends</p> <p>:SYSTem:COMMunicate:LAN:SOURce:EXTernal:IP 146.208.172.111</p> <p>The analyzer turns this into</p> <p>:SYSTem:COMMunicate:SOURce:ADDRes "TCPIP0::146.208.172.111::INSTR"</p>
Initial S/W Revision	A.06.01
Modified at S/W Revision	A.10.01

Delete Highlighted Source

Deletes the highlighted source from the list of available sources. You will be prompted with a dialog box to make sure you REALLY want to do this. The prompt says "The highlighted source will be permanently deleted from the list. Are you sure you want to do this? Press Enter to proceed, or Cancel (ESC) to cancel."

Key Path	Source, Select Source
Initial S/W Revision	A.06.01

Add Source To List

This menu allows you to add to the list of available sources from various interfaces.

Key Path	Source, Select Source
Initial S/W Revision	A.06.01

USB

Sources on USB (once installed) can be added to the list by pressing "Add Installed USB Sources." Any supported source found will be added to the list.

See ["Add Installed USB Sources" on page 3259](#) for information on connecting and installing USB devices.

Key Path	Source, Select Source, Add Source to List
Initial S/W Revision	A.06.01

Add Installed USB Sources

Press this key to add USB sources to the Available Source List. Note that this function will ONLY find sources that have previously been installed onto the USB. For information on how to install a USB source, see ["Installing a USB source" on page 3260](#)

Key Path	Source, Select Source, Add Source to List, USB
Notes	If no installed USB device is found which is a supported source, an error message is generated
Initial S/W Revision	A.06.01

Installing a USB source

USB is the only interface which requires no runtime action by the user in the Select Source menu, but does require “installation” when a source is plugged in.

You start by connecting the USB source to the analyzer. You will get a series of messages indicating that the analyzer is installing required device software.

When the installation is complete, you will get a message to that effect. You can then use the “Add Installed USB Sources” function (above) to add the source to the list of sources in the Available Source List.

GPIB

Lets you add GPIB sources to the Available Source List.

For the GPIB interface to work properly, it must be configured as a Controller. You can find this setting in the System menu under System, I/O Config, GPIB. Set the GPIB Controller function to Enabled.

Note that you must also make sure that the GPIB interface is not set to “Ignore” in the Agilent Connection Expert. If it is set to **Ignore**, then even if the GPIB Controller is set to **Enabled**, it is not possible for the analyzer to find a GPIB connected source. See ["More Information" on page 3260](#).

Key Path	Source, Select Source, Add Source to List
Initial S/W Revision	A.06.01

More Information

If you suspect that the GPIB interface is not set to Ignore, run the Agilent Connection Expert (ACE). To run ACE, press Source, Select Source, Add Source to List, LAN, Run Connection Expert. Look for the GPIB branch on the interface tree:

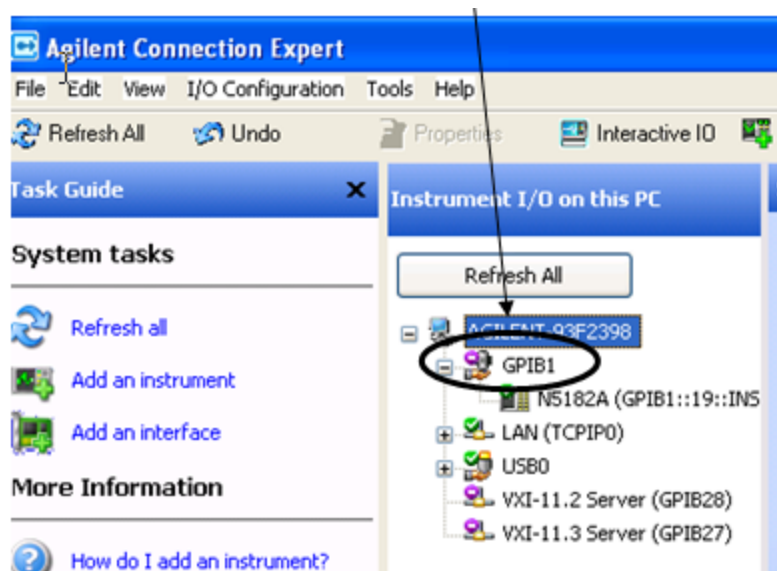

Right click on the GPIB branch (you will have to plug in a mouse to do this). You should see a dialog like the one below. If this dialog says **Stop Ignoring**, select **Stop Ignoring** and close ACE.

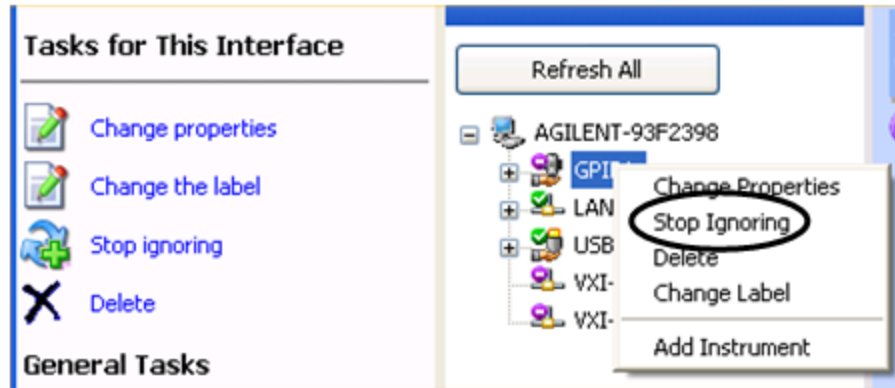

Scan & Add GPIB Sources

Sources on GPIB can be added by pressing **Scan & Add GPIB Sources**. Any supported source found will be added to the Available Source List.

NOTE

This will cause any older, non-SCPI compatible devices on your GPIB to generate error messages.

Key Path	Source, Select Source, Add Source to List, GPIB
Notes	If the GPIB controller mode is not enabled, an error message is generated If no GPIB device is found which is a supported source, an error message is generated
Initial S/W Revision	A.06.01

Enter GPIB Address

Opens a menu that lets you enter the GPIB address of the desired source directly.

NOTE

For this to work properly, the GPIB interface must be configured as GPIB1. This is the default state and should normally be the case. To see how to verify this, see **"More Information" on page 3262**.

Key Path	Source, Select Source, Add Source to List, GPIB
Initial S/W Revision	A.06.01

More Information

If you suspect that the GPIB interface is not set to GPIB1, run the Agilent Connection Expert (ACE). To run ACE, press Source, Select Source, Add Source to List, LAN, Run Connection Expert. Look for the GPIB branch on the interface tree:

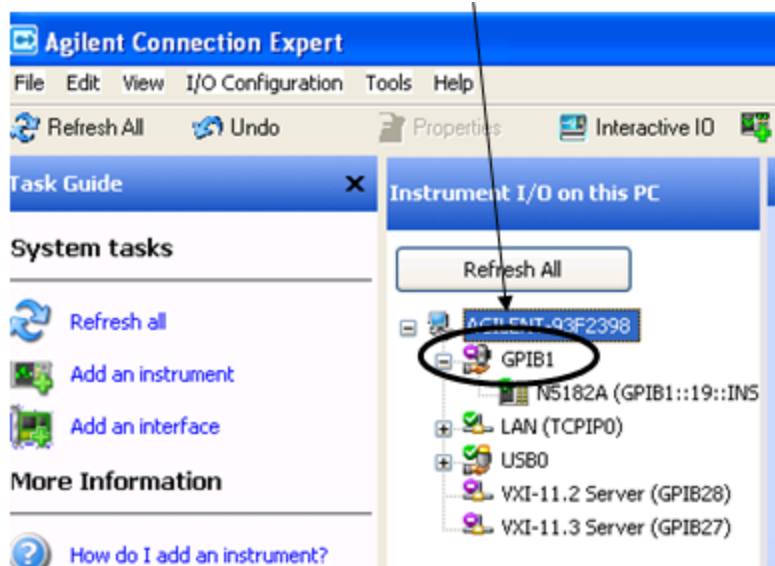

If this branch is not labeled **GPIB1**, right click on the GPIB branch (you will have to plug in a mouse to do this) and select **Change Properties**.

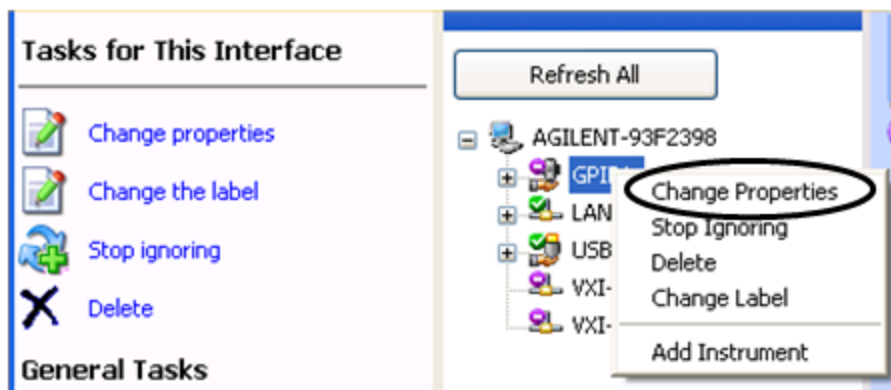

You should see a dialog like the one below. Click on the drop-down arrow under VISA Interface ID, select GPIB1 and click OK

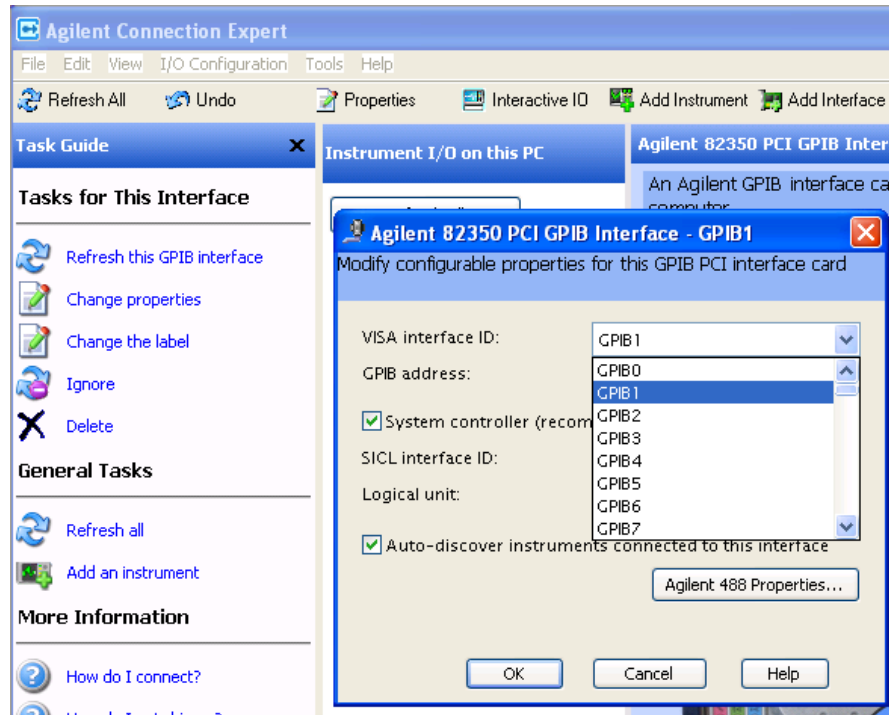

GPIB Address

Lets you enter the GPIB address. After you enter the address press **Add** to add the source at that address to the Available Source List.

Key Path	Source, Select Source, Add Source to List, GPIB, Enter GPIB Address
Preset	Unaffected by Mode Preset but set to 19 by "Restore Input/Output defaults"
State Saved	No
Min	0
Max	30
Initial S/W Revision	A.06.01

Add

Add the source at the entered GPIB address to the Available Source List. If a supported source is found at that address it will be added to the list.

Key Path	Source, Select Source, Add Source to List, GPIB, Enter GPIB Address
Notes	If GPIB controller mode is not enabled, an error message is generated If no supported source is found at the specified address, an error message is generated
Initial S/W Revision	A.06.01

LAN

The LAN cannot be scanned directly from the analyzer software, but you can import the list of currently configured devices from Agilent Connection Expert by pressing

“Add From Connection Expert List.” The Connection Expert list depends on which instruments have already been discovered by the Agilent Connection Expert application. Any connected, supported sources in that list will be added.

You can also enter the IP address and press “Add”. If a supported source is found at that address it will be added.

If you want to discover sources on the LAN, you can open Connection Expert by pressing the “Run Connection Expert...” softkey.

Key Path	Source, Select Source, Add Source to List
Initial S/W Revision	A.06.01

Enter LAN Address

Opens up a menu which lets you enter the IP address of the desired source directly.

Key Path	Source, Select Source, Add Source to List, LAN
Initial S/W Revision	A.06.01

IP Address

Lets you enter the IP address of the desired source. After you enter the address you should press “Add” to add the source at that address to the Available Source List.

Key Path	Source
Preset	Unaffected by Mode Preset but set to 0.0.0.0 by Restore Input/Output defaults
State Saved	No
Initial S/W Revision	A.06.01

Add

Adds the source at the entered IP address to the Available Source List. If a supported source is found at that address it will be added to the list.

Key Path	Source
Notes	If no supported source is found at the specified address, an error message is generated
Initial S/W Revision	A.06.01

Run Connection Expert...

Runs the Agilent Connection Expert so that you can scan the LAN for sources.

Key Path	Source, Select Source, Add Source to List, LAN
Initial S/W Revision	A.06.01

Add From Connection Expert List

You can import the list of currently configured devices from Agilent Connection Expert by pressing **Add From Connection Expert List**. The Connection Expert list

depends on which instruments have already been discovered by the Agilent Connection Expert application. Any connected, supported sources in that list will be added.

Key Path	Source, Select Source, Add Source to List, LAN
Notes	If no supported source is found in the Connection Expert list, an error message is generated
Initial S/W Revision	A.06.01

Verify Current Source Connection

This key verifies the interface connection to the Current Source (it does NOT verify any signal connections!)

Until the selected source is verified, a statement appears at the bottom of the screen which says (in red):

This Source has not been verified. Press "Verify Source" to check the interface connection.

When you press this key, the connection is checked to the selected source. If all is well, the statement is changed to (in green):

This connection to this source has been verified.

If the verification fails, the statement at the bottom will change to (in red):

Verification of this source failed. Check the interface connection

The selected source is also verified whenever it is acquired. If a Source's connection has been verified by any means, then that Source is considered to have been verified until either the analyzer software is shut down or if, in attempting to use the Source, communication with it fails.

Key Path	Source, Select Source
Initial S/W Revision	A.06.01

Source Setup

This menu is used to set up miscellaneous source functions, including trigger settings. For more on triggering in Tracking Mode, see ["Tracking Setup Details" on page 3265](#). For information on bypassing the Microwave Preselector, see ["Use of the YTF \(Microwave or mm Preselector\) with External Source Control" on page 3266](#)

Key Path	Source
Mode	SA
Initial S/W Revision	A.06.01

Tracking Setup Details

When an external source is operating in Tracking Mode, operation can be greatly enhanced by using hardware triggers. Below is a typical connection diagram showing

a hardware handshake using Trigger 1 inputs and outputs on the analyzer (trigger 2 in and out is also a valid connection).

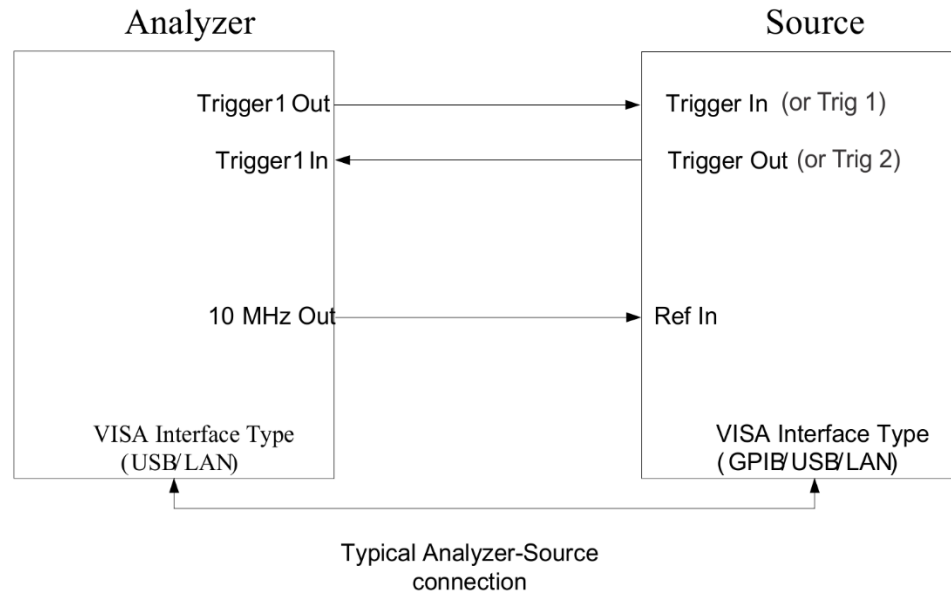

Analyzer Trigger 1 Out: Triggers the external source to step to next point in the frequency step/list.

Analyzer Trigger 1 In: Triggers the analyzer to make a measurement on this point

Source Trigger In (or “Trig 1” at default setting for N5181B/82B, N5183B MXG or N5171B/72B, N5173B EXG):

Triggers the source to step to the next point.

Source Trigger Out (or “Trig 2” at default setting for N5181B/82B, N5183B MXG or N5171B/72B, N5173B EXG): Indicates that the source has settled.

IO interface Connection: analyzer can connect to sources with its GPIB, USB or LAN interface.

Notes:

- Trigger sync connections are optional – synchronization can be done via remote commands if Bus Trigger is enabled in the Source Setup menu.
- Connection from the SA external frequency reference output to the source frequency reference input (10 MHz Out to Ref In) is not required, but may improve the measurement accuracy.

Use of the YTF (Microwave or mm Preselector) with External Source Control

In most stimulus/response measurements that utilize External Source Control, the source exactly tracks the tuned analyzer frequency. Consequently, preselection is not needed, and you can achieve greatly superior amplitude accuracy and

repeatability by bypassing the YTF (Preselector) using the Microwave Preselector Bypass control in the Amplitude, μ W Path Control menu.

NOTE

This control is only available if option MPB is installed.

There are rare but important cases, however, where the source is tuned to a different frequency than the analyzer, using the Multiplier and Reverse controls in the Source, Frequency menu. For example, you might be tuning the source to $\frac{1}{2}$ of the analyzer frequency when looking at second harmonic distortion in a DUT. In these cases, it would be commonplace for there to be an undesired signal at the analyzer input that is at an image frequency that you will want to reject with the YTF.

Understanding these cases is important for proper operation of the Microwave Preselector with External Source Control, so that you only bypass it when it will improve accuracy but not hinder the measurement.

Point Trigger

Shows point trigger type selected and navigates to the Point Trigger menu.

The Point Trigger menu lists all analyzer point trigger types. The analyzer and source point trigger synchronization can be done using SCPI bus commands or by using external trigger output and input lines.

NOTE

For X-Series software versions earlier than A.10.01, hardware triggering was unavailable in stepped tracking at frequencies above 3.6 GHz, so above 3.6 GHz, software triggering was always used. This is no longer the case.

Key Path	Source, Source Setup
Mode	SA
Scope	Mode Global
Remote Command	:SOURCE:TRIGGER:TYPE BUS EXTERNAL[1] EXTERNAL2 :SOURCE:TRIGGER:TYPE?
Example	:SOUR:TRIG:TYPE EXT1 Selects analyzer external trigger 1 in and out for point trigger synchronization with selected source
Dependencies	If an internal Tracking Generator is selected, then this menu is unavailable. Additionally, the External 1 and External 2 Trigger keys on the Spectrum Analyzer are released from any grayout that may have been forced on them by the external source Point Trigger selection. In some models, there is no second External input. In these models, the External 2 key is blanked and the EXTERNAL2 parameter will generate a "Hardware missing; Not available for this model number" message.
Couplings	The source control point trigger selection can select external trigger 1 or 2 in for synchronized point triggering. This can conflict with the selection under the Trigger hardkey, if it has External 1 or 2 selected. If there is a conflict when the selection is made under the Point Trigger menu, the Trigger selection under the Trigger hardkey will be changed to Free Run.
Preset	This is unaffected by "Mode Preset" but is set to EXTERNAL1 on a "Source Preset" or "Restore Input/Output Defaults".

State Saved	Part of the Input/Output system, which means it is Loaded and Saved with state
Readback	1-of-N selection
Initial S/W Revision	A.06.01

SW Trigger

Analyzer and source point trigger synchronization is setup using the SCPI commands. Source is stepped via SCPI commands. Analyzer waits for source to settle by polling source.

Key Path	Source, Source Setup, Point Trigger
Mode	SA
Example	:SOUR:TRIG:TYPE BUS
Readback	SW Trigger
Initial S/W Revision	A.06.01

Ext Trigger 1

Analyzer and source point trigger synchronization is setup using the analyzer Trigger 1 Output and Trigger 1 Input. The Source is stepped via Trigger 1 Output. The Analyzer waits for source to settle via Trigger 1 Input.

Key Path	Source, Source Setup, Point Trigger
Mode	SA
Example	:SOUR:TRIG:TYP EXT1
Couplings	<p>With an acquired source, selecting this point trigger mode overrides existing external trigger 1 output level, slope, and delay, and external trigger 1 type and polarity.</p> <p>External trigger 1 input level = 1.20 V</p> <p>External trigger 1 input slope = Positive</p> <p>External trigger 1 input delay = Off</p> <p>External trigger 1 output type = Source Point Trigger</p> <p>External trigger 1 output polarity = Positive</p> <p>When this selection is made:</p> <ul style="list-style-type: none"> - The External 1 key in the Trigger menu (under the Trigger hardkey) is grayed out and, if External 1 was previously selected, it will be changed to Free Run. - Trig 1 Out selected under Output Config in the Input/Output menu will be changed to Source Point Trigger <p>If the user subsequently goes into the Trig 1 Out menu and selects a different Trigger Output, the Point Trigger will revert to SW Trigger.</p>
Readback	Ext Trigger 1
Initial S/W Revision	A.06.01

Ext Trigger 2

Analyzer and source point trigger synchronization is setup using the analyzer Trigger 2 Output and Trigger 2 Input. The Source is stepped via Trigger 2 Output. The Analyzer waits for source to settle via Trigger 2 Input.

Key Path	Source, Source Setup, Point Trigger
Mode	SA
Example	:SOUR:TRIG:TYP EXT2
Dependencies	This key is blanked out on CXA as there is only one trigger input
Couplings	<p>With an acquired source, selecting this point trigger mode overrides existing external trigger 2 output level, slope, and delay, and external trigger 2 type and polarity.</p> <p>External trigger 2 input level = 1.20 V</p> <p>External trigger 2 input slope = Positive</p> <p>External trigger 2 input delay = Off</p> <p>External trigger 2 output type = Source Point Trigger</p> <p>External trigger 2 output polarity = Positive</p> <p>When this selection is made:</p> <ul style="list-style-type: none"> - The External 2 key in the Trigger menu (under the Trigger hardkey) is grayed out and, if External 2 was previously selected, it will be changed to Free Run. - Trig 2 Out selected under Output Config in the Input/Output menu will be changed to Source Point Trigger - If the user subsequently goes into the Trig 2 Out menu and selects a different Trigger Output, the Point Trigger will revert to SW Trigger.
Readback	Ext Trigger 2
Initial S/W Revision	A.06.01

Show Source Capabilities & Settings

Shows the capabilities of the currently selected Source. The menu is useful for displaying source capabilities such as frequency and amplitude ranges. In addition, the results of the source control sweep algorithms can be viewed. This gives information of the source range required for a given analyzer sweep range. This can be used dynamically as a way of configuring the sweep settings.

Key Path	Source, Source Setup
Mode	SA
Dependencies	If no source is selected this key is grayed out.
Initial S/W Revision	A.06.01

Source Preset

The Source Preset key forces all the settings in the analyzer's Source State to their preset condition.

The Source State is the set of Source settings that is maintained and remembered by the analyzer for use in the Tracking Source Mode. The Source State variables are controlled and set in the menus under the Source front panel key. These settings include:

- RF Output Off
- Amplitude = - 10 dBm
- Amplitude Step = Auto
- Power Sweep = 0 dB
- Amplitude Offset = 0 dB
- Source Sweep Reverse = Off
- Multiplier Numerator = 1
- Multiplier Denominator = 1
- Freq Offset = 0 Hz
- Point trigger is set to "Ext1"

The Source State is saved along with the state of the current Mode when you save a State, and is recalled when that Mode State is recalled.

When the analyzer first starts up, a Source Preset is performed. In the Input/Output menu, Restore Input/Output Defaults will also perform a Source Preset.

A Mode Preset, from modes that support the External Source, will turn the RF Off but will **not** perform a Source Preset. By the same token, Source Preset does **not** perform a Mode Preset.

Source Preset does **not** change the Source Mode nor the selection of which physical source is being used, nor does it release the current source (the source remains under the control of the analyzer) nor exit the Source menu.

Key Path	Source
Mode	SA
Remote Command	:SOURce:PRESet
Example	:SOUR:PRES
Preset	Initiates a Source Preset
State Saved	No
Initial S/W Revision	A.06.01

SPAN X Scale

There are no functions associated with this key in the Harmonics measurement.

Key Path	Front-panel key
Initial S/W Revision	Prior to A.02.00

Sweep/Control

Accesses a menu that allows you to set the measurement Dwell time.

Key Path	Front-panel key
Initial S/W Revision	Prior to A.02.00

Dwell Time

Selects the length of time in which the spectrum analyzer sweeps when measuring the fundamental. Additional overhead time is required by the analyzer that impacts the sweep rate, but is not calculated as part of the dwell time.

Reducing the sweep time increases the rate of sweeps.

The dwell time normally changes with the resolution bandwidth, so by default the dwell time varies with each harmonic. If Dwell Time Auto is off, the harmonics will have the same dwell time unless the Range Table is used.

Key Path	Sweep/Control
Remote Command	[:SENSe]:HARMonics:SWEEptime <time> [:SENSe]:HARMonics:SWEEptime? [:SENSe]:HARMonics:SWEEptime:AUTO OFF ON 0 1 [:SENSe]:HARMonics:SWEEptime:AUTO?
Example	HARM:SWE 100 us sets the dwell time for the fundamental to 100 us
Couplings	If the dwell time is set to Auto, the dwell time will be 200 divided by the resolution bandwidth, to a minimum of 10 ms. If the range table is active, the time for each harmonic is determined by that harmonic's individual dwell time setting (which includes an auto toggle).
Preset	The actual preset dwell time depends upon the results of the first sweep operation, since the sweep time is Auto, and the auto rule depends upon the detected optimal RBW.
Min	100 us
Max	4000 s
Initial S/W Revision	A.04.00
Preset	ON

System

See "System" on page 431

Trace/Detector

This key enables selection of trace max hold characteristics.

Key Path	Front-panel key
Remote Command	<code>[:SENSe] :HARMonics :TRACe :TYPE WRITe MAXHold</code>
Preset	The Harmonics trace is set to Clear Write and all trace points are cleared.
Initial S/W Revision	Prior to A.02.00

Clear Write

In Clear Write type each trace update replaces the old data in the trace with new data.

When in Clear Write, if a measurement-related instrument setting is changed, a new sweep is initiated but the trace is not cleared. When the trace is in Clear Write, the average detector is used, and the metrics are calculated based on the average value of the zero-span trace.

Key Path	Trace/Detector
Example	HARM:TRAC:TYPE WRIT sets the trace to clear write
Initial S/W Revision	Prior to A.02.00

Max Hold

Makes the harmonic trace represent the maximum data value on a point-by-point basis of the new trace data and the previous trace data. Similarly, the harmonics metrics are held at the highest value observed. Max hold enables a simplified (albeit lower-speed) measurement of the harmonics of a pulsed signal.

Pressing the Max Hold key or sending the :TRAC:TYPE MAXH command sets the trace type to Max Hold. The max hold trace uses peak detection, and the metrics are calculated using the peak value of the measured trace.

When in Max Hold, if a measurement-related instrument setting is changed, the Max Hold sequence restarts and a new sweep is initiated but the trace is not cleared.

Key Path	Trace/Detector
Example	HARM:TRAC:TYPE MAXHold sets the trace to max hold
Initial S/W Revision	Prior to A.02.00

Trigger

See ["Trigger" on page 529](#)

Free Run

See ["Free Run " on page 537](#)

Video

See ["Video \(IF Envelope\) " on page 538](#)

Trigger Level

See ["Trigger Level" on page 538](#)

Trig Slope

See ["Trig Slope" on page 539](#)

Trig Delay

See ["Trig Delay" on page 540](#)

X Axis Relative to Trigger

See ["X Axis Relative to Trigger" on page 583](#)

Line

See ["Line" on page 2814](#)

Trig Slope

See ["Trig Slope" on page 2814](#)

Trig Delay

See ["Trig Delay" on page 543](#)

X Axis Relative to Trigger

See ["X Axis Relative to Trigger" on page 583](#)

External 1

See ["External 1" on page 2828](#)

Trigger Level

See ["Trigger Level" on page 2828](#)

Trig Slope

See ["Trig Slope" on page 2829](#)

Trig Delay

See ["Trig Delay" on page 546](#)

X Axis Relative to Trigger

See ["X Axis Relative to Trigger" on page 583](#)

Zero Span Delay Comp

See ["Zero Span Delay Comp On/Off " on page 2816](#)

External 2

See ["External 2 " on page 2829](#)

Trigger Level

See ["Trigger Level" on page 2830](#)

Trig Slope

See ["Trig Slope" on page 2831](#)

Trig Delay

See ["Trig Delay " on page 549](#)

X Axis Relative to Trigger

See ["X Axis Relative to Trigger" on page 583](#)

Zero Span Delay Comp

See ["Zero Span Delay Comp On/Off" on page 2818](#)

RF Burst

See ["RF Burst" on page 2831](#)

Absolute Trigger

See ["Absolute Trigger Level" on page 2832](#)

Relative Trigger

See ["Relative Trigger Level" on page 2833](#)

Trig Slope

See ["Trigger Slope" on page 2834](#)

Trig Delay

See ["Trig Delay" on page 554](#)

X Axis Relative to Trigger

See ["X Axis Relative to Trigger" on page 583](#)

Zero Span Delay Comp

See ["Zero Span Delay Comp On/Off" on page 2834](#)

Periodic Timer

See ["Periodic Timer \(Frame Trigger\)" on page 2823](#)

Period

See ["Period" on page 2824](#)

Offset

See ["Offset" on page 2825](#)

Offset Adjust (Remote Command Only)

See ["Offset Adjust \(Remote Command Only\)" on page 2826](#)

Reset Offset Display

See ["Reset Offset Display" on page 2827](#)

Sync Source

See ["Sync Source" on page 2827](#)

Off

See ["Off" on page 2828](#)

External 1

See ["External 1" on page 2828](#)

Trigger Level

See ["Trigger Level" on page 2828](#)

Trig Slope

See ["Trig Slope" on page 2829](#)

External 2

See ["External 2 " on page 2829](#)

Trigger Level

See ["Trigger Level" on page 2830](#)

Trig Slope

See ["Trig Slope" on page 2831](#)

RF Burst

See ["RF Burst" on page 2831](#)

Absolute Trigger

See ["Absolute Trigger Level" on page 2832](#)

Relative Trigger

See ["Relative Trigger Level" on page 2833](#)

Trig Slope

See ["Trigger Slope" on page 2834](#)

Zero Span Delay Comp

See ["Zero Span Delay Comp On/Off" on page 2834](#)

Trig Delay

See ["Trig Delay" on page 568](#)

X Axis Relative to Trigger

See ["X Axis Relative to Trigger" on page 583](#)

Sync Holdoff

See ["Sync Holdoff" on page 1289](#)

Baseband I/Q

See ["Baseband I/Q " on page 570](#)

I/Q Mag

See ["I/Q Mag" on page 570](#)

Trigger Level

See ["Trigger Level" on page 570](#)

Trig Slope

See ["Trig Slope" on page 571](#)

Trig Delay

See ["Trig Delay" on page 571](#)

X Axis Relative to Trigger

See ["X Axis Relative to Trigger" on page 583](#)

I (Demodulated)

See ["I \(Demodulated\)" on page 572](#)

Trigger Level

See ["Trigger Level" on page 573](#)

Trig Slope

See ["Trig Slope" on page 573](#)

Trig Delay

See ["Trig Delay" on page 573](#)

X Axis Relative to Trigger

See ["X Axis Relative to Trigger" on page 583](#)

Q (Demodulated)

See ["Q \(Demodulated\)" on page 575](#)

Trigger Level

See ["Trigger Level" on page 575](#)

Trig Slope

See ["Trig Slope" on page 575](#)

Trig Delay

See ["Trig Delay" on page 576](#)

X Axis Relative to Trigger

See ["X Axis Relative to Trigger" on page 583](#)

Input I

See ["Input I" on page 577](#)

Trigger Level

See ["Trigger Level" on page 577](#)

Trig Slope

See ["Trig Slope" on page 578](#)

Trig Delay

See ["Trig Delay" on page 578](#)

X Axis Relative to Trigger

See ["X Axis Relative to Trigger" on page 583](#)

Input Q

See ["Input Q" on page 579](#)

Trigger Level

See ["Trigger Level" on page 579](#)

Trig Slope

See ["Trig Slope" on page 580](#)

Trig Delay

See ["Trig Delay" on page 580](#)

X Axis Relative to Trigger

See ["X Axis Relative to Trigger" on page 583](#)

Auxiliary Channel I/Q Mag

See ["Auxiliary Channel I/Q Mag" on page 581](#)

Trigger Level

See ["Trigger Level" on page 582](#)

Trig Slope

See ["Trig Slope" on page 582](#)

Trig Delay

See ["Trig Delay" on page 582](#)

X Axis Relative to Trigger

See ["X Axis Relative to Trigger" on page 583](#)

Trigger Center Frequency

See ["Trigger Center Frequency" on page 583](#)

Trigger Bandwidth

See ["Trigger Bandwidth" on page 584](#)

TV

See ["TV" on page 2835](#)

TV Line

See ["TV Line" on page 2836](#)

Field

See ["Field" on page 2836](#)

Entire Frame

See ["Entire Frame" on page 2837](#)

Field One

See ["Field One" on page 2837](#)

Field Two

See ["Field Two" on page 2837](#)

Standard

See ["Standard" on page 2838](#)

NTSC-M

See ["NTSC-M" on page 2838](#)

NTSC-Japan

See ["NTSC-Japan" on page 2839](#)

NTSC-4.43

See ["NTSC-4.43" on page 2839](#)

PAL-M

See ["PAL-M" on page 2839](#)

PAL-N

See ["PAL-N" on page 2839](#)

PAL-N Combin

See ["PAL-N-Combin" on page 2839](#)

PAL-B,D,G,H,I

See ["PAL-B,D,G,H,I" on page 2839](#)

PAL-60

See ["PAL-60" on page 2840](#)

SECAM-L

See ["SECAM-L" on page 2840](#)

Auto/Holdoff

See ["Auto/Holdoff" on page 590](#)

Auto Trig

See ["Auto Trig" on page 590](#)

Trig Holdoff

See ["Trig Holdoff" on page 591](#)

Holdoff Type

See ["Holdoff Type" on page 591](#)

User Preset

Accesses a menu that gives you the following three choices:

- **User Preset** – recalls a state previously saved using the Save User Preset function.
- **User Preset All Modes** – presets all of the modes in the analyzer
- **Save User Preset**– saves the current state for the current mode

Key Path	Front-panel key
Backwards Compatibility Notes	<p>User Preset is actually loading a state, and in legacy analyzers, it was possible to load a state without affecting the trace data, limit lines or correction data. Similarly it was possible to do a User Preset without affecting the trace data, limit lines or correction data.</p> <p>In the X-Series, “state” always includes all of this data; so whenever state is loaded, or User Preset is executed, all of the traces, limit lines and corrections are affected. Although this differs from previous behavior, it is desirable behavior, and should not cause adverse issues for users.</p> <p>On ESA and PSA, User Preset affected the entire instrument’s state. In the X-Series, User Preset only recalls the state for the active mode. There is a User Preset file for each mode. User Preset can never cause a mode switch as it can in legacy analyzers. If you want to recall all modes to their user preset file state, you will need to do a User Preset after mode switching into each mode.</p> <p>User Preset recalls mode state which can now include data like traces; whereas on ESA and PSA, User Preset did not affect data.</p>
Initial S/W Revision	Prior to A.02.00

User Preset

User Preset sets the state of the currently active mode back to the state that was previously saved for this mode using the Save User Preset menu key or the SCPI command, **SYST:PRES:USER:SAV**. **It not only recalls the** Mode Preset settings, but it also recalls all of the mode persistent settings, and the Input/Output system setting that existed at the time Save User Preset was executed.

If a Save User Preset has not been done at any time, User Preset recalls the default user preset file for the currently active mode. The default user preset files are created if, at power-on, a mode detects there is no user preset file. There will never be a scenario when there is no user preset file to restore. For each mode, the default user preset state is the same state that would be saved if a Save User Preset is performed in each mode right after doing a Restore Mode Default and after a Restore Input/Output Defaults.

The User Preset function does the following:

- Aborts the currently running measurement.
- Sets the mode State to the values defined by Save User Preset.

- Makes the saved measurement for the currently running mode the active measurement.
- Brings up the saved menu for the power-on mode.
- Clears the input and output buffers.
- Sets the Status Byte to 0.

Key Path	User Preset
Remote Command	:SYSTem:PRESet:USER
Example	:SYST:PRES:USER
Notes	:SYST:PRES:USER:SAVE is used to save the current state as the user preset state. Clears all pending OPC bits. The Status Byte is set to 0. Pressing the User Preset front-panel key while already in the User Preset menu will cause the User Preset to get executed
Couplings	A user preset will cause the currently running measurement to be aborted and cause the saved measurement to be active. Recalling a User Preset file has the same issues that recalling a Save State file has. Some settings may need to be limited and therefore re-coupled, since the capabilities of the mode may have changes when the User Preset file was last saved.
Initial S/W Revision	Prior to A.02.00

User Preset All Modes

Recalls all of the User Preset files for each mode, switches to the power-on mode, and activates the saved measurement from the power-on mode User Preset file.

NOTE

When the instrument is secured, all of the user preset files are converted back to their default user preset files.

The User Preset function does the following:

- Aborts the currently running measurement.
- Switches the Mode to the power-on mode.
- Restores the User Preset files for each mode.
- Makes the saved measurement for the power-on mode the active measurement.
- Brings up the saved menu for the power-on mode.
- Clears the input and output buffers.
- Sets the Status Byte to 0.

Key Path	User Preset
----------	-------------

Remote Command	:SYSTem:PRESet:USER:ALL
Example	:SYST:PRES:USER:SAVE :SYST:PRES:USER:ALL
Notes	Clears all pending OPC bits. The Status Byte is set to 0. :SYST:PRES:USER:SAVE is used to save the current state as the user preset state.
Couplings	A user preset will cause the currently running measurement to be aborted, cause a mode switch to the power-on mode, and cause the saved measurement to be active in the power-on mode. Recalling a User Preset file has the same issues that recalling a Save State file has. Some settings may need to be limited and therefore re-coupled, since the capabilities of the mode may have changes when the User Preset file was last saved.
Initial S/W Revision	Prior to A.02.00

Save User Preset

Saves the currently active mode and its State. You can recall this User Preset file by pressing the User Preset menu key or sending the SYST:PRES:USER remote command. This same state is also saved by the Save State function.

Key Path	User Preset
Remote Command	:SYSTem:PRESet:USER:SAVE
Example	:SYST:PRES:USER:SAVE
Notes	:SYST:PRES:SAVE creates the same file as if the user requested a *SAV or a MMEM:STOR:STAT, except User Preset Save does not allow the user to specify the filename or the location of the file.
Initial S/W Revision	Prior to A.02.00

View/Display

Opens a menu that enables you to access the Display functions.

See "[Harmonic Measurement Views](#)" on page 3286 for more information

Key Path	Front-panel key
Initial S/W Revision	Prior to A.02.00

Harmonic Measurement Views

There is only one view for the harmonics measurement, which displays zero-span traces corresponding to the fundamental and the measured harmonics. When a measurement restart requires an auto tune, this view is displayed without table data or traces, and the fundamental frequency is displayed as "---". As the data is collected, the data is displayed appropriately.

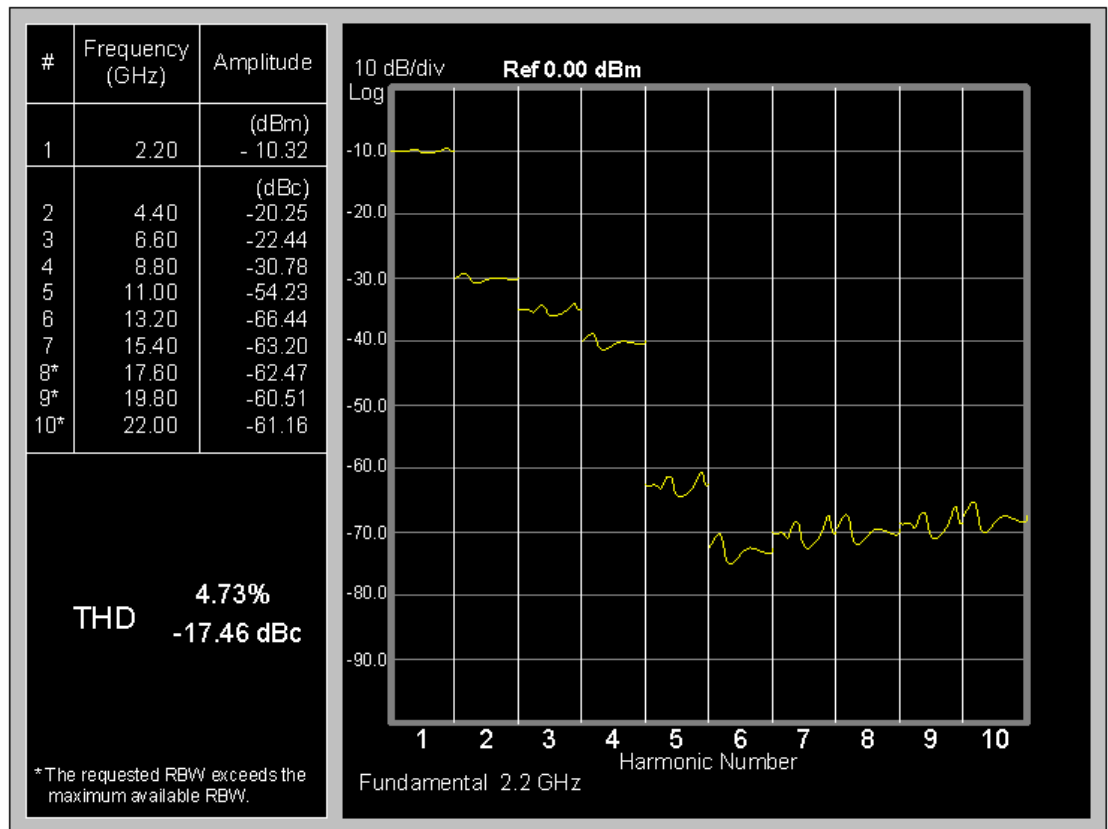

The fundamental and each harmonic is measured at zero span, and the measured trace is displayed in the appropriate column within the graticule (thus, the graticule shows the most recent measurement of each harmonic). Simultaneously, the frequency and measured power at each harmonic are displayed in a result table, along with the Total Harmonic Distortion (THD).

Most of the text is in 10 point Arial. The footnote is 8 point, the word “THD” in 14 point, and the THD result in 12 point. The THD percentage is calculated in voltage.

The frequency uses 3 significant figures for the fundamental (displaying in KHz, MHz, or GHz as appropriate), and identical resolution and units for the harmonics. The amplitude has a resolution of 0.01 dB; zeros in the 10s or 100s column should not be shown. Decimal points should line up in columns.

A “*” in the result table indicates that the requested resolution bandwidth exceeds the maximum resolution bandwidth of the instrument. If a harmonic would be outside the frequency range of the instrument, the frequency is shown and “---” is displayed in the amplitude column. If the * is not present, the explanatory note shown at the bottom of the result table should not be visible.

Only a single trace is supported in either the preliminary or the primary harmonic view.

The fundamental amplitude is shown in the current Y Axis Unit and harmonics 2–10 are displayed in dBc.

Display

The Display menu is common to most measurements, and is used for configuring items on the display. Some Display menu settings apply to all the measurements in a mode, and some only to the current measurement. Those under the **System Display Settings** key apply to all measurements in all modes.

Key Path	Display
Key Path	View/Display
Initial S/W Revision	Prior to A.02.00

Annotation

Turns on and off various parts of the display annotation. The annotation is divided up into four categories:

13. Meas Bar: This is the measurement bar at the top of the screen. It does not include the settings panel or the Active Function. Turning off the Meas Bar turns off the settings panel and the Active Function. When the Meas Bar is off, the graticule area expands to fill the area formerly occupied by the Meas Bar.
14. Screen Annotation: this is the annotation and annunciation around the graticule, including any annotation on lines (such as the display line, the threshold line, etc.) This does NOT include the marker number or the N dB result. When off, the graticule expands to fill the entire graticule area.
15. Trace annotation: these are the labels on the traces, showing their detector (or their math mode).

16. Active Function annotation: this is the active function display in the meas bar, and all of the active function values displayed on softkeys.

See the figure below. Each type of annotation can be turned on and off individually.

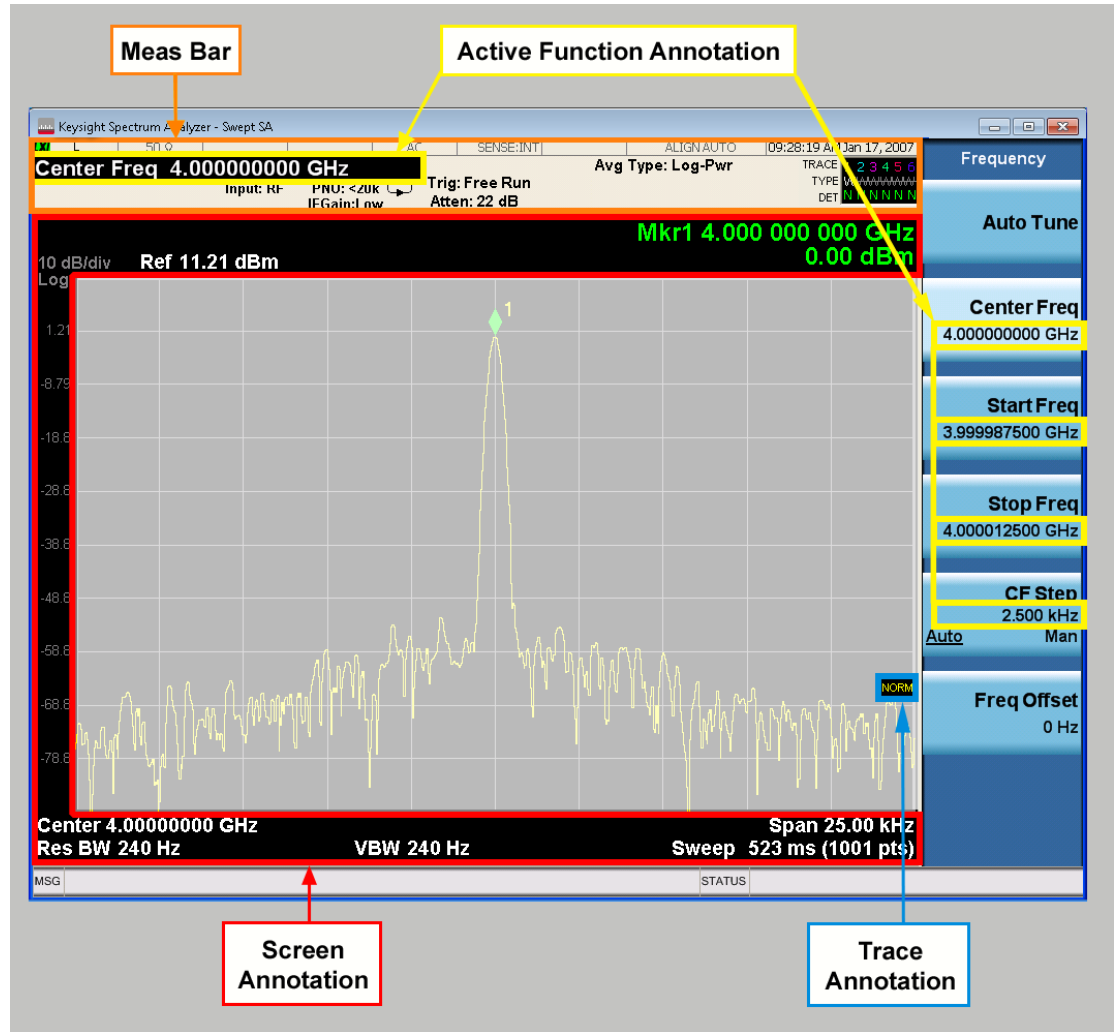

Key Path	View/Display, Display
Initial S/W Revision	Prior to A.02.00

Meas Bar On/Off

This function turns the Measurement Bar on and off, including the settings panel. When off, the graticule area expands to fill the area formerly occupied by the Measurement Bar.

Key Path	View/Display, Display, Annotation
Remote Command	:DISPlay:ANNOtation:MBAR[:STATe] OFF ON 0 1

	:DISPlay:ANNotation:MBAR[:STATe]?
Example	DISP:ANN:MBAR OFF
Dependencies	Grayed out and forced to OFF when System Display Settings, Annotation is set to Off.
Preset	On This should remain Off through a Preset when System DisplaySettings, Annotation is set to Off.
State Saved	Saved in instrument state.
Initial S/W Revision	Prior to A.02.00

Screen

This controls the display of the annunciation and annotation around the graticule, including any annotation on lines (such as the display line, the threshold line, etc.) and the y-axis annotation. This does NOT include marker annotation (or the N dB result). When off, the graticule expands to fill the entire graticule area, leaving only the 1.5% gap above the graticule as described in the Trace/Detector chapter.

Key Path	View/Display, Display, Annotation
Remote Command	:DISPlay:ANNotation:SCReen[:STATe] OFF ON 0 1 :DISPlay:ANNotation:SCReen[:STATe]?
Example	DISP:ANN:SCR OFF
Dependencies	Grayed-out and forced to OFF when System Display Settings, Annotation is set to Off.
Preset	On This should remain Off through a Preset when System DisplaySettings, Annotation is set to Off
State Saved	Saved in instrument state.
Initial S/W Revision	Prior to A.02.00

Trace

Turns on and off the labels on the traces, showing their detector (or their math mode) as described in the Trace/Detector section.

If trace math is being performed with a trace, then the trace math annotation will replace the detector annotation.

Key Path	View/Display, Display, Annotation
Remote Command	:DISPlay:ANNotation:TRACe[:STATe] ON OFF 1 0 :DISPlay:ANNotation:TRACe[:STATe]?
Example	DISP:ANN:TRAC OFF
Preset	Off
State Saved	Saved in instrument state.
Initial S/W Revision	Prior to A.02.00

Active Function Values On/Off

Turns on and off the active function display in the Meas Bar, and all of the active function values displayed on the softkeys.

Note that all of the softkeys that have active functions have these numeric values blanked when this function is on. This is a security feature..

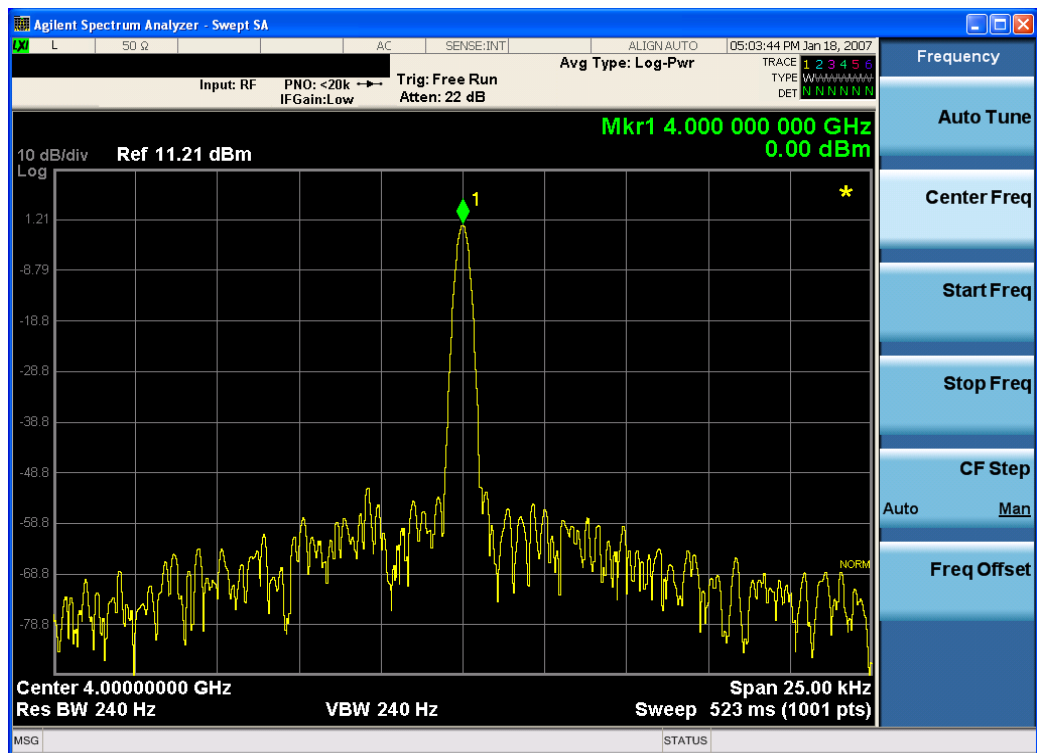

Key Path	View/Display, Display, Annotation
Remote Command	:DISPlay:ACTivefunc[:STATE] ON OFF 1 0 :DISPlay:ACTivefunc[:STATE]?
Example	DISP:ACT OFF
Dependencies	Grayed out and forced to OFF when System Display Settings, Annotation is set to Off.
Preset	On This should remain Off through a Preset when System DisplaySettings, Annotation is set to Off
State Saved	Saved in instrument state.
Initial S/W Revision	Prior to A.02.00

Title

Displays menu keys that enable you to change or clear a title on your display.

Key Path	View/Display, Display
Initial S/W Revision	Prior to A.02.00

Change Title

Writes a title into the "measurement name" field in the banner, for example, "Swept SA".

Press Change Title to enter a new title through the alpha editor. Press Enter or Return to complete the entry. Press ESC to cancel the entry and preserve your existing title.

The display title will replace the measurement name. It remains for this measurement until you press **Change Title** again, or you recall a state, or a Preset is performed. A title can also be cleared by pressing **Title**, **Clear Title**.

NOTE

Notice the inclusion of the <measurement> parameter in the command below. Because each measurement remembers the Display Title, the command must be qualified with the measurement name. For the Swept SA measurement this is not the case; no <measurement> parameter is used when changing the Display Title for the Swept SA measurement.

Key Path	View/Display, Display, Title
Mode	All
Remote Command	:DISPlay:<measurement>:ANNotation:TITLe:DATA <string> :DISPlay:<measurement>:ANNotation:TITLe:DATA?
Example	DISP:ANN:TITL:DATA "This Is My Title" This example is for the Swept SA measurement in the Spectrum Analyzer mode. The SANalyzer <measurement> name is not used. DISP:ACP:ANN:TITL:DATA "This Is My Title" This example is for Measurements other than Swept SA. Both set the title to: This Is My Title
Notes	Pressing this key cancels any active function. When a title is edited the previous title remains intact (it is not cleared) and the cursor goes at the end so that characters can be added or BKSP can be used to go back over previous characters.
Preset	No title (measurement name instead)
State Saved	Saved in instrument state.
Initial S/W Revision	Prior to A.02.00

Clear Title

Clears a title from the front-panel display. Once cleared, the title cannot be retrieved. After the title is cleared, the current Measurement Name replaces it in the title bar.

Key Path	View/Display, Display, Title
Example	<p>The following commands clear the title and restore the measurement's original title:</p> <pre>DISP:ANN:TITL:DATA ""</pre> <p>This example is for the Swept SA measurement in the Spectrum Analyzer mode. The SANalyzer <measurement> name is not used.</p> <pre>DISP:ACP:ANN:TITL:DATA ""</pre> <p>This example is for ACP; in measurements other than Swept SA the measurement name is required.</p>
Notes	Uses the :DISPlay:<measurement>:ANNotation:TITLe:DATA <string> command with an empty string (in the Swept SA, the <measurement> is omitted).
Preset	Performed on Preset.
Initial S/W Revision	Prior to A.02.00

Graticule

Pressing Graticule turns the display graticule On or Off. It also turns the graticule y-axis annotation on and off.

Key Path	View/Display, Display
Remote Command	<pre>:DISPlay:WINDow[1]:TRACe:GRATicule:GRID[:STATe] OFF ON 0 1</pre> <pre>:DISPlay:WINDow[1]:TRACe:GRATicule:GRID[:STATe]?</pre>
Example	DISP:WIND:TRAC:GRAT:GRID OFF
Notes	The graticule is the set of horizontal and vertical lines that make up the grid/divisions for the x-axis and y-axis.
Preset	On
State Saved	Saved in instrument state
Initial S/W Revision	Prior to A.02.00

System Display Settings

These settings are "Mode Global" – they affect all modes and measurements and are reset only by **Restore Misc Defaults** or **Restore System Defaults** under System.

Key Path	View/Display, Display
Initial S/W Revision	Prior to A.02.00

Annotation Local Settings

This is a Mode Global override of the meas local annotation settings. When it is **All Off**, it forces **ScreenAnnotation, Meas Bar, Trace, and Active Function Values** settings to be **OFF** for all measurements in all modes. This provides the security based "annotation off" function of previous analyzers; hence it uses the legacy SCPI command.

When it is **All Off**, the **Screen, Meas Bar, Trace, and Active Function Values** keys under the **Display, Annotation** menu are grayed out and forced to **Off**. When **Local Settings** is selected, you are able to set the local annotation settings on a measurement by measurement basis.

Key Path	View/Display, Display, System Display Settings
Remote Command	:DISPlay:WINDow[1]:ANNotation[:ALL] OFF ON 0 1 :DISPlay:WINDow[1]:ANNotation[:ALL]?
Example	:DISP:WIND:ANN OFF
Preset	On (Set by Restore Misc Defaults)
State Saved	Not saved in instrument state.
Backwards Compatibility Notes	The WINDow parameter and optional subopcode is included for backwards compatibility but ignored – all windows are equally affected.
Initial S/W Revision	Prior to A.02.00

Themes

Accesses a menu of functions that enable you to choose the theme to be used when saving the screen image.

The **Themes** option is the same as the **Themes** option under the **Display** and **Page Setup** dialogs. It allows you to choose between themes to be used when saving the screen image.

Key Path	Save, Screen Image
Remote Command	:MMEMory:STORe:SCReen:THEMe TDColor TDMonochrome FCOLOR FMONochrome :MMEMory:STORe:SCReen:THEMe?
Example	:MMEM:STOR:SCR:THEM TDM
Preset	3D Color; Is not part of Preset, but is reset by Restore Misc Defaults or Restore System Defaults All and survives subsequent running of the modes.
Readback	3D Color 3D Mono Flat Color Flat Mono
Backwards Compatibility Notes	In ESA and PSA we offer the choice of "Reverse Bitmap" or "Reverse Metafile" when saving screen images. This is much like the "Flat Color" theme available in X-Series. Also, if you selected Reverse Bitmap AND a black & white screen image, that would be much like "Flat Monochrome". In other words, each of the X-Series themes has a similar screen image type in ESA/PSA. But they are not identical.
Initial S/W Revision	Prior to A.02.00

3D Color

Selects a standard color theme with each object filled, shaded and colored as designed.

Key Path	Save, Screen Image, Themes
Example	MMEM:STOR:SCR:THEM TDC
Readback	3D Color
Initial S/W Revision	Prior to A.02.00

3D Monochrome

Selects a format that is like 3D color but shades of gray are used instead of colors.

Key Path	Save, Screen Image, Themes
Example	MMEM:STOR:SCR:THEM TDM
Readback	3D Mono
Initial S/W Revision	Prior to A.02.00

Flat Color

Selects a format that is best when the screen is to be printed on an ink printer.

Key Path	Save, Screen Image, Themes
Example	MMEM:STOR:SCR:THEM FCOL
Readback	Flat Color
Initial S/W Revision	Prior to A.02.00

Flat Monochrome

Selects a format that is like Flat Color. But only black is used (no colors, not even gray), and no fill.

Key Path	Save, Screen Image, Themes
Example	MMEM:STOR:SCR:THEM FMON
Readback	Flat Mono
Initial S/W Revision	Prior to A.02.00

Backlight

Accesses the display backlight on/off keys. This setting may interact with settings under the Windows "Power" menu.

When the backlight is off, pressing ESC, TAB, SPACE, ENTER, UP, DOWN, LEFT, RIGHT, DEL, BKSP, CTRL, or ALT turns the backlight on without affecting the application. Pressing any other key will turn backlight on and could potentially perform the action as well.

Key Path	View/Display, Display, System Display Settings
Remote Command	:DISPlay:BACKlight ON OFF :DISPlay:BACKlight?
Preset	ON (Set by Restore Misc Defaults)
Initial S/W Revision	Prior to A.02.00

Backlight Intensity

An active function used to set the backlight intensity. It goes from 0 to 100 where 100 is full on and 0 is off. This value is independent of the values set under the Backlight on/off key.

Key Path	View/Display, Display, System Display Settings
Remote Command	:DISPlay:BACKlight:INTensity <integer> :DISPlay:BACKlight:INTensity?
Example	DISP:BACK:INT 50
Preset	100 (Set by Restore Misc Defaults)
Min	0
Max	100
Initial S/W Revision	Prior to A.02.00

18 List Sweep Measurement

The List Sweep measurement is designed for fast measurement throughput. It lets you remotely extract amplitude values for multiple detectors at known frequencies. You can configure the analyzer to make a list of single-point measurements. This list can then be run multiple times saving analyzer setup time and reducing I/O overhead and traffic. The measurements are all performed in zero-span. For more information, see ["List Sweep Measurement Description" on page 3297](#).

Remote Commands:

:CONFigure:LIST

:INITiate:LIST

:FETCh:LIST?

:READ:LIST?

Example	Assume that only one detector is used for each point and the list length is 4: READ:LIST? -12.3, 34.5, 56.7,23.4 All returned values are in the internal unit of dBm.
Remote Command Notes	If inconsistent list length is detected, an error is returned instead of results.
Status Bits/OPC Dependencies	The Status Operation Register bit "Waiting for Trigger" is set at the same time when a new list point measurement is initiated. It is cleared when the trigger actually occurs (i.e. after the trigger event occurs and all the applicable trigger criteria have been met). While the Trigger bit is set/unset along with each triggering condition at each point, the Measurement bit is set once when the first point measurement is initiated. It is cleared only after all points measurement in the list are complete and results are available.
Remote Compatibility Info	These commands are implemented for R&S compatibility. SENSe:LIST:POWer? (without arguments) for READ:LIST? SENSe:LIST:POWer:RESult? For FETCh:LIST?
Initial S/W Revision	Prior to A.02.00

List Sweep Measurement Description

List Sweep can be selected using the front panel key or the remote command. Measurement setup control is only available remotely. While in the List Sweep measurement, the screen is blanked.

Any key press exits the measurement and returns to the default measurement for the mode. (Swept SA for SANalyzer mode.) To avoid accidental key presses exiting the measurement, you may want to lock out the front panel keys. There are two ways to lock out the front panel keys. Accessing the instrument over GPIB (IEEE-488) puts it in remote operation, or you can send the `SYSTEM:KLOCK ON` command.

Frequency List (Remote Command Only)

The command defines a list of analyzer center frequencies at which the measurements are made.

The query form queries the analyzer for the values in the frequency list.

Remote Command	<code>[:SENSe] : LIST : FREQuency <freq>{, <freq>}</code> <code>[:SENSe] : LIST : FREQuency ?</code>
Example	LIST:FREQ 1GHz,1.5GHz,2GHz,2.5GHz Sets a list of 4 frequencies.
Preset	Current center frequency value from previous measurement
State Saved	Saved in instrument state
Range	Same as center frequency range.
Initial S/W Revision	Prior to A.02.00

Remote Command	<code>[:SENSe] : LIST : FREQuency : POINts ?</code>
Example	LIST:FREQ:POIN?
Initial S/W Revision	Prior to A.02.00

Mechanical Attenuator List (Remote Command Only)

This command defines a list of analyzer mechanical attenuator settings at which the measurements are made.

NOTE

Changing the mechanical attenuator within the list should be avoided if possible, because it slows down the measurement and wears out the attenuator.

The query form queries the analyzer for the values in the mechanical attenuation list.

Remote Command	<code>[:SENSe] : LIST : ATTenuation <power>{, <power>}</code> <code>[:SENSe] : LIST : ATTenuation ?</code>
Example	LIST:ATT 10DB
Dependencies	If the requested setting is not valid, it is ignored and the previous setting is retained.
Preset	Current mechanical attenuation value from previous measurement
State Saved	Saved in State
Range	Same as the mechanical attenuator range.
Initial S/W Revision	Prior to A.02.00

Remote Command	<code>[:SENSe]:LIST:ATTenuation:POINTs?</code>
Example	<code>LIST:ATT:POIN?</code>
Initial S/W Revision	Prior to A.02.00

Electronic Attenuation List (Remote Command Only)

This command defines a list of analyzer electronic attenuator settings at which the measurements are made.

The query form queries the analyzer for the values in the electronic attenuation list.

Remote Command	<code>[:SENSe]:LIST:EATTenuation <power>{, <power>}</code> <code>[:SENSe]:LIST:EATTenuation?</code>
Example	<code>LIST:EATT 10DB</code>
Dependencies	If the required hardware option is not present, an error message would be issued. However, the error message does not prevent list sweep from execution if all other list settings are set properly.
Preset	Current electronic attenuation value from previous measurement
State Saved	Saved in instrument state
Range	Same as the electronic attenuator range.
Initial S/W Revision	Prior to A.02.00

Remote Command	<code>[:SENSe]:LIST:EATTenuation:POINTs?</code>
Example	<code>LIST:EATT:POIN?</code>
Initial S/W Revision	Prior to A.02.00

RBW Type List (Remote Command Only)

This command defines a list of analyzer RBW Type settings used for the measurements.

The query form queries the analyzer for the values in the RBW Type list.

Remote Command	<code>[:SENSe]:LIST:BANDwidth BWIDth:RESolution:TYPE <type>{, <type>}</code> <code>[:SENSe]:LIST:BANDwidth BWIDth:RESolution:TYPE?</code>
Example	<code>LIST:BAND:RES:TYPE GAUS</code> For this example, Types from Swept SA measurement include: GAUSSian FLATtop EMI
Preset	Current RBW Type setting from previous measurement
State Saved	Saved in instrument state
Range	Same as the RBW Types available in previous measurement.

Initial S/W Revision	Prior to A.02.00
----------------------	------------------

Remote Command	<code>[:SENSe]:LIST:BANDwidth BWIDth:RESolution:TYPE:POINts?</code>
-----------------------	--

Example	LIST:BAND:RES:TYPE:POIN?
----------------	--------------------------

Initial S/W Revision	Prior to A.02.00
----------------------	------------------

RBW List (Remote Command Only)

This command defines a list of analyzer RBW settings at which the measurements are made.

The query form queries the analyzer for the values in the RBW list.

Remote Command	<code>[:SENSe]:LIST:BANDwidth BWIDth:RESolution <freq>{, <freq>}</code> <code>[:SENSe]:LIST:BANDwidthBWIDth:RESolution?</code>
-----------------------	---

Example	LIST:BAND:RES 100KHZ
----------------	----------------------

Preset	Current RBW value from previous measurement
--------	---

State Saved	Saved in instrument state
-------------	---------------------------

Range	Same as the RBW values available in the previous measurement.
-------	---

Initial S/W Revision	Prior to A.02.00
----------------------	------------------

Remote Command	<code>[:SENSe]:LIST:BANDwidthBWIDth:RESolution:POINts?</code>
-----------------------	--

Example	LIST:BAND:RES:POIN?
----------------	---------------------

Initial S/W Revision	Prior to A.02.00
----------------------	------------------

VBW List (Remote Command Only)

This command defines a list of analyzer VBW settings at which the measurements are made.

The query form queries the analyzer for the values in the VBW list.

Remote Command	<code>[:SENSe]:LIST:BANDwidth BWIDth:VIDeo <freq>{, <freq>}</code> <code>[:SENSe]:LIST:BANDwidth BWIDth:VIDeo?</code>
-----------------------	--

Example	LIST:BAND:VID 10KHZ
----------------	---------------------

Preset	Current Video BW value from previous measurement
--------	--

State Saved	Saved in instrument state
Range	Same as the Video BW values available in the previous measurement.
Initial S/W Revision	Prior to A.02.00
Remote Command	<code>[:SENSe] :LIST :BANDwidth BWIDth :VIDeo :POINts ?</code>
Example	<code>LIST:BAND:VID:POIN?</code>
Initial S/W Revision	Prior to A.02.00

Sweep Time List (Remote Command Only)

This command defines a list of analyzer sweep times at which the measurements are made. In zero span measurements, this is the time required to measure a single point given the current setting for the number of points in the sweep.

The query form queries the analyzer for the values in the sweep time list.

Remote Command	<code>[:SENSe] :LIST :SWEep :TIME <time>{, <time>}</code> <code>[:SENSe] :LIST :SWEep :TIME ?</code>
Preset	Current Sweep Time value from previous measurement
State Saved	Saved in instrument state
Range	Same as the Sweep Time range available in the previous measurement.
Initial S/W Revision	Prior to A.02.00
Remote Command	<code>[:SENSe] :LIST :SWEep :TIME :POINts ?</code>
Example	<code>LIST:SWE:TIME:POIN?</code>
Initial S/W Revision	Prior to A.02.00

Trigger Delay List (Remote Command Only)

This command defines a list of analyzer trigger delay time used when making the measurements.

The query form queries the analyzer for the values in the trigger delay list.

Remote Command	<code>[:SENSe] :LIST :TRIGger :DELay <time>{, <time>}</code> <code>[:SENSe] :LIST :TRIGger :DELay ?</code>
Example	<code>LIST:TRIG:DEL 0.01S</code>

Preset	0 seconds
State Saved	Saved in instrument state
Range	Same as the Trigger Delay range for EXTERNAL1 trigger.
Initial S/W Revision	Prior to A.02.00

Remote Command	<code>[:SENSe] :LIST:TRIGger:DELaY:POINts?</code>
Example	<code>LIST:TRIG:DEL:POIN?</code>
Initial S/W Revision	Prior to A.02.00

Phase Noise Optimization (Remote Command Only)

This command defines a list of analyzer phase noise optimization settings at which the measurements are made.

Remote Command	<code>[:SENSe] :LIST:FREQuency:SYNTHeSis 1 2 3</code> <code>[:SENSe] :LIST:FREQuency:SYNTHeSis?</code> <code>[:SENSe] :LIST:FREQuency:SYNTHeSis:AUTO OFF ON 0 1</code> <code>[:SENSe] :LIST:FREQuency:SYNTHeSis:AUTO?</code>
Example	<code>LIST:FREQ:SYNT:AUTO OFF</code> <code>LIST:FREQ:SYNT 2</code>
Preset	Fast Tuning
State Saved	Saved in instrument state
Range	Fast Tuning (3) Best Phase Noise for offsets <20kHz (2) Best Phase Noise for offsets >30kHz (1)
Min	1
Max	3
Initial S/W Revision	Prior to A.02.00

Detector List (Remote Command Only)

This command defines a list of analyzer detector settings at which the measurements are made. The choice of detectors is different from the choice in other measurements.

The query form queries the analyzer for the values in the detector list.

Remote Command	<code>[:SENSe] :LIST:DETEctor <type>{, <type>}</code>
-----------------------	---

[:SENSe] :LIST:DETEctor?	
Example	LIST:DET POS
Remote Command Notes	<ul style="list-style-type: none"> • LAVG : average detector. Average detected on the log scale. • VAVG : average detector. Average detected on the voltage scale. • RMS: average detector. Average detected on the power (rms) scale. • NEGative: negative peak detector. • POSitive: positive peak detector. • SAMPlE: sample detector. • PKAV: Peak-AVER detector, a newly defined term, would allow the simultaneous measurement and two-point reporting of the results of the positive peak and the average detector (voltage scale). • PRMS: Peak-RMS detector, a newly defined term, would allow the simultaneous measurement and two-point reporting of the results of the positive peak and the average detector (rms scale). • DAVG: DualAvg detector is similarly a newly defined term that allows two-point reporting of simultaneously made measurements. With this detector, one result (the former) is average detected on the power (rms) scale, and one is average detected on the voltage scale.
Preset	LAVG
State Saved	Saved in instrument state
Range	LAVG VAVG RMS NEGative POSitive SAMPlE PKAV PRMS DAVG
Initial S/W Revision	Prior to A.02.00

[:SENSe] :LIST:DETEctor:POINts?	
Example	LIST:DET:POIN?
Initial S/W Revision	Prior to A.02.00

Trigger Source (Remote Command Only)

This command sets the source for the trigger that controls the start of each new measurement point in the list. The other trigger command :TRIGger:SOURce, is used to start the list .

The query form queries the analyzer for the values in the trigger source of the list sweep.

[:SENSe] :LIST:TRIGger:SOURce EXTernal1 EXTernal2 IMMEDIATE BUS	
[:SENSe] :LIST:TRIGger:SOURce?	
Example	LIST:TRIG:SOUR EXT2
Remote Command Notes	<ul style="list-style-type: none"> • EXTernal1 2: external sources • IMMEDIATE: free run • BUS: software controlled trigger

The BUS trigger is only in “List Sweep”. It specifies a common trigger source which allows a source and a receiver (analyzer) to coordinate triggering without requiring the connection of the trigger in and trigger out ports on the rear panels of the instruments.

Dependencies	If the list trigger source is set to BUS for all points, you need a trigger for each list item. For example, if there are three points in the list, you have to send *TRG or TRIG:IMM three times to execute the complete List Sweep measurement. If the list trigger source is not set to BUS, use *TRG or TRIG:IMM to start the list measurement.
Preset	IMMediate
State Saved	Saved in instrument state
Status Bits/OPC Dependencies	The trigger bit is set and cleared at each measurement point.
Initial S/W Revision	Prior to A.02.00

Remote Command	<code>[:SENSe] :LIST:TRIGger:SOURce:POINts?</code>
Example	<code>LIST:TRIG:SOUR:POIN?</code>
Remote Command Notes	Only one trigger source selection is allowed.
Initial S/W Revision	Prior to A.02.00

Trigger Holdoff (Remote Command Only)

Sets the holdoff time between triggers. When the trigger condition is satisfied, the trigger occurs, the delay begins, and the holdoff time begins. New trigger conditions are ignored until the holdoff time expires. For a free-running trigger, the holdoff value is the minimum time between triggers.

Remote Command	<code>[:SENSe] :LIST:TRIGger:HOLDoff <time></code> <code>[:SENSe] :LIST:TRIGger:HOLDoff?</code>
Example	<code>LIST:TRIG:HOLD 100MS</code>
Preset	0.0 s
State Saved	Saved in State
Min	0 s
Max	100 s
Initial S/W Revision	Prior to A.02.00

Remote Command	<code>[:SENSe] :LIST:TRIGger:HOLDoff:POINts?</code>
Example	<code>LIST:TRIG:HOLD:POIN?</code>
Remote Command Notes	Only one trigger holdoff selection is allowed.
Initial S/W Revision	Prior to A.02.00

Trigger Level (Remote Command Only)

Sets the value at which the selected trigger input will trigger a new sweep.

Remote Command	<code>[:SENSe]:LIST:TRIGger:LEVe1 <amp1></code> <code>[:SENSe]:LIST:TRIGger:LEVe1?</code>
Example	LIST:TRIG:LEV 0.4V
Preset	1.2 V
State Saved	Saved in instrument state
Min	-5 V
Max	5 V
Initial S/W Revision	Prior to A.02.00

Remote Command	<code>[:SENSe]:LIST:TRIGger:LEVe1:POINts?</code>
Example	LIST:TRIG:LEV:POIN?
Remote Command Notes	Only one trigger level selection is allowed.
Initial S/W Revision	Prior to A.02.00

Trigger Slope (Remote Command Only)

Controls the trigger polarity. It is set positive to trigger on a rising edge and negative to trigger on a falling edge.

Remote Command	<code>[:SENSe]:LIST:TRIGger:SLOPe POSitive NEGative</code> <code>[:SENSe]:LIST:TRIGger:SLOPe?</code>
Example	LIST:TRIG:SLOP NEG
Preset	POSitive
State Saved	Saved in instrument state
Range	Same as the Sweep Time range available in the previous measurement.
Initial S/W Revision	Prior to A.02.00

Remote Command	<code>[:SENSe]:LIST:TRIGger:SLOPe:POINts?</code>
Example	LIST:TRIG:SLOP:POIN?
Remote Command Notes	Only one trigger slope selection is allowed.
Initial S/W Revision	Prior to A.02.00

Sequencing (Remote Command Only)

Defines a sequence for stepping through the list. You must use LIST:SEQ or LIST:SEQ:AUTO before performing a measurement using the READ command. When lists are not of the same length (except lengths of 0 and 1) an error “Invalid List length” would be generated at sequencing time.

Remote Command	[:SENSe] :LIST:SEQuence <value>{ ,<value> } [:SENSe] :LIST:SEQuence? [:SENSe] :LIST:SEQuence:AUTO ON1 [:SENSe] :LIST:SEQuence:AUTO?
Example	LIST:SEQ 1,2,4,3
Remote Command Notes	LIST:SEQ: defines a sequence for stepping through the list. LIST:SEQ:AUTO: when on, the sequence is set to 1 through N, where N is the longest list.
Preset	Ascending order: 1 through N
Range	Depends on the number of frequency points in your list.
Initial S/W Revision	Prior to A.02.00

Remote Command	[:SENSe] :LIST:SEQuence:POINts?
Example	LIST:SEQ:POIN?
Initial S/W Revision	Prior to A.02.00



This information is subject to change without notice.

© Keysight Technologies 2011-2018

Edition 23, December 2018

N9060-90027

www.keysight.com