

Keysight V3500A Handheld RF Power Meter

Notices

Copyright Notice

© Keysight Technologies 2010 - 2019
No part of this manual may be reproduced in any form or by any means (including electronic storage and retrieval or translation into a foreign language) without prior agreement and written consent from Keysight Technologies as governed by United States and international copyright laws.

Manual Part Number

V3500-90001

Edition

Edition 8, October 14, 2019

Printed in:

Printed in Malaysia

Published by:

Keysight Technologies
Bayan Lepas Free Industrial Zone,
11900 Penang, Malaysia

Technology Licenses

The hardware and/or software described in this document are furnished under a license and may be used or copied only in accordance with the terms of such license.

Declaration of Conformity

Declarations of Conformity for this product and for other Keysight products may be downloaded from the Web. Go to <http://www.keysight.com/go/conformity>. You can then search by product number to find the latest Declaration of Conformity.

U.S. Government Rights

The Software is “commercial computer software,” as defined by Federal Acquisition Regulation (“FAR”) 2.101. Pursuant to FAR 12.212 and 27.405-3 and Department of Defense FAR Supplement (“DFARS”) 227.7202, the U.S. government acquires commercial computer software under the same terms by which the software is customarily provided to the public. Accordingly, Keysight provides the Software to U.S. government customers under its standard commercial license, which is embodied in its End User License Agreement (EULA), a copy of which can be found at <http://www.keysight.com/find/sweula>. The license set forth in the EULA represents the exclusive authority by which the U.S. government may use, modify, distribute, or disclose the Software. The EULA and the license set forth therein, does not require or permit, among other things, that Keysight: (1) Furnish technical information related to commercial computer software or commercial computer software documentation that is not customarily provided to the public; or (2) Relinquish to, or otherwise provide, the government rights in excess of these rights customarily provided to the public to use, modify, reproduce, release, perform, display, or disclose commercial computer software or commercial computer software documentation. No additional government requirements beyond those set forth in the EULA shall apply, except to the extent that those terms, rights, or licenses are explicitly required from all providers of commercial computer software pursuant to the FAR and the DFARS and are set forth specifically in writing elsewhere in the EULA. Keysight shall be under no obligation to update, revise or otherwise modify the Software. With respect to any technical data as defined by FAR 2.101, pursuant to FAR 12.211 and 27.404.2 and DFARS 227.7102, the U.S. government acquires no greater than Limited Rights as defined in FAR 27.401 or DFAR 227.7103-5 (c), as applicable in any technical data.

Warranty

THE MATERIAL CONTAINED IN THIS DOCUMENT IS PROVIDED “AS IS,” AND IS SUBJECT TO BEING CHANGED, WITHOUT NOTICE, IN FUTURE EDITIONS. FURTHER, TO THE MAXIMUM EXTENT PERMITTED BY APPLICABLE LAW, KEYSIGHT DISCLAIMS ALL WARRANTIES, EITHER EXPRESS OR IMPLIED, WITH REGARD TO THIS MANUAL AND ANY INFORMATION CONTAINED HEREIN, INCLUDING BUT NOT LIMITED TO THE IMPLIED WARRANTIES OF MERCHANTABILITY AND FITNESS FOR A PARTICULAR PURPOSE. KEYSIGHT SHALL NOT BE LIABLE FOR ERRORS OR FOR INCIDENTAL OR CONSEQUENTIAL DAMAGES IN CONNECTION WITH THE FURNISHING, USE, OR PERFORMANCE OF THIS DOCUMENT OR OF ANY INFORMATION CONTAINED HEREIN. SHOULD KEYSIGHT AND THE USER HAVE A SEPARATE WRITTEN AGREEMENT WITH WARRANTY TERMS COVERING THE MATERIAL IN THIS DOCUMENT THAT CONFLICT WITH THESE TERMS, THE WARRANTY TERMS IN THE SEPARATE AGREEMENT SHALL CONTROL.

Safety Information

CAUTION

















A CAUTION notice denotes a hazard. It calls attention to an operating procedure, practice, or the like that, if not correctly performed or adhered to, could result in damage to the product or loss of important data. Do not proceed beyond a CAUTION notice until the indicated conditions are fully understood and met.

WARNING

A WARNING notice denotes a hazard. It calls attention to an operating procedure, practice, or the like that, if not correctly performed or adhered to, could result in personal injury or death. Do not proceed beyond a WARNING notice until the indicated conditions are fully understood and met.

Safety Symbols

The following symbols on the instrument and in the documentation indicate precautions which must be taken to maintain safe operation of the instrument.

	Direct current (DC)		Equipment protected throughout by double insulation or reinforced insulation
	Alternating current (AC)		Off (mains supply)
	Both direct and alternating current		On (mains supply)
	Three-phase alternating current		Caution, risk of electric shock
	Earth (ground) terminal		Caution, risk of danger (refer to this manual for specific Warning or Caution information)
	Protective earth (ground) terminal		Caution, hot surface
	Frame or chassis (ground) terminal		Out position of a bi-stable push control
	Equipotentiality		In position of a bi-stable push control

Safety Considerations

Read the information below before using this instrument.

The following general safety precautions must be observed during all phases of operation, service, and repair of this instrument. Failure to comply with these precautions or with specific warnings elsewhere in this manual violates safety standards for design, manufacture, and intended use of the instrument. Keysight Technologies assumes no liability for the customer's failure to comply with these requirements.

WARNING

- Observe all markings on the instrument before connecting any wiring to the instrument.
- Do not operate the instrument in an explosive atmosphere or in the presence of flammable gases or fumes.
- Do not service or perform adjustments alone. Under certain condition, hazardous voltages may exist, even with the equipment switched off.
- To avoid dangerous electric shock, service personnel must not attempt internal service or adjustment unless another person, capable of rendering resuscitation or first aid, is present.
- Do not substitute parts or modify equipment to avoid the danger of introducing additional hazards. Return the instrument to Keysight Sales Office for service and repair to ensure the safety features are maintained.
- Do not operate damaged equipment as the safety protection features built into this instrument may have been impaired, either through physical damage, excessive moisture, or any other reason. Remove power and do not use the instrument until safe operation can be verified by service-trained personnel. If necessary, return the instrument to Keysight Technologies Sales and Service Office for service and repair to ensure the safety features are maintained.

CAUTION

Ensure proper insertion of battery in the power meter, and follow the correct polarity.

Environmental Conditions

The V3500A is designed for indoor use and in an area with low condensation. The table below shows the general environmental requirements for this instrument.

Environmental condition	Requirement
Temperature	Operating condition – 0 °C to 50 °C
	Storage condition – –10 °C to 70 °C
Humidity	Operating condition – Up to 80% RH at 35 °C (non-condensing)
Altitude	Up to 2000 m
Pollution degree	2

Regulatory Information

The V3500A complies with the following safety and Electromagnetic Compatibility (EMC) compliances:

- IEC 61326-2-1:2005/ EN 61326-2-1:2006
- Canada: ICES-001:2004
- Australia/New Zealand: AS/NZS CISPR11: 2004

Degradation of some instrument specifications can occur in the presence of ambient electromagnetic (EM) fields and noise that are coupled to the powerline or I/O cables of the instrument. The instrument will self-recover and operate to all specifications when the source of ambient EM field and noise are removed or when the instrument is protected from the ambient EM field or when the instrument cabling is shielded from the ambient EM noise.

Regulatory Markings

	<p>The CE mark is a registered trademark of the European Community. This CE mark shows that the product complies with all the relevant European Legal Directives.</p>		<p>The RCM mark is a registered trademark of the Australian Communications and Media Authority.</p>
<p>ICES/NMB-001</p>	<p>ICES/NMB-001 indicates that this ISM device complies with the Canadian ICES-001. Cet appareil ISM est conforme a la norme NMB-001 du Canada.</p>		<p>This instrument complies with the WEEE Directive (2002/96/EC) marking requirement. This affixed product label indicates that you must not discard this electrical or electronic product in domestic household waste.</p>

Waste Electrical and Electronic Equipment (WEEE) Directive

This instrument complies with the WEEE Directive marking requirement. This affixed product label indicates that you must not discard this electrical or electronic product in domestic household waste.

Product category:

With reference to the equipment types in the WEEE directive Annex 1, this instrument is classified as a “Monitoring and Control Instrument” product.

The affixed product label is as shown below.



Do not dispose in domestic household waste.

To return this unwanted instrument, contact your nearest Keysight Service Center, or visit <http://about.keysight.com/en/companyinfo/environment/takeback.shtml> for more information.

Sales and Technical Support

To contact Keysight for sales and technical support, refer to the support links on the following Keysight websites:

- www.keysight.com/find/V3500A
(product-specific information and support, software and documentation updates)
- www.keysight.com/find/assist
(worldwide contact information for repair and service)

Table of Contents

Safety Symbols	3
Safety Considerations	4
Environmental Conditions	5
Regulatory Information	6
Regulatory Markings	7
Waste Electrical and Electronic Equipment (WEEE) Directive	8
Product category:	8
Sales and Technical Support	8
1 Getting Started	
Introduction	18
Key Features	19
Initial Inspection	20
Standard purchase items	20
Optional purchase items	20
Handling Precaution	21
Setting-up Your Instrument	22
Connectivity	22
Power supply	25
2 Knowing your Instrument	
Product at a Glance	28
Product dimensions	28
The front panel keypad	29
How to navigate the menu system	31
How to power on the V3500A	33
Front Panel Operations	34
Measuring power	34
Zeroing the power meter	35
Setting the input frequency	35

Setting the measurement speed	36
Enabling and disabling high-speed mode	36
Saving the instrument state	37
Recalling the instrument state	38
Setting units: dBm or watts	38
Controlling the backlight	39
Setting the backlight auto-shutoff interval	39
Using relative offset function	39
3 Driver Installation and Commands	
System Requirements	42
Driver Installation	43
Installing USB driver	43
Installing USB driver (Windows 7)	49
Confirming the USB driver installation	53
Uninstalling the USB driver	58
Installing programming driver	60
Instrument Address	63
Remote USB Operation	64
Introduction	64
Bus connections	64
Remote USB commands	65
Basic driver commands	66
Basic V3500A commands	73
Averaging control commands	75
Measurement speed control commands	77
Unit of measurement commands	78
Relative Offset Commands	79
Miscellaneous commands	80
Examples	81
4 RF Measurement Basics	
Power Definition	104
Units of Measurement	105
Watts	105

Decibels	105
RF Power Measurement	106
Low frequency method	106
High frequency method	106
Power of various types of signals	108
Measurement accuracy	110

5 Characteristics and Specifications

THIS PAGE HAS BEEN INTENTIONALLY LEFT BLANK.

List of Figures

Figure 1-1	V3500A Handheld RF Power Meter with backlight turned on	18
Figure 1-2	V3500A with Type-N connector nut	22
Figure 1-3	Full serial number, USB type mini-B port, and external power connector	24
Figure 2-1	V3500A dimensions	28
Figure 2-2	V3500A front panel keypad	29
Figure 2-3	Menu map structure	31
Figure 4-1	Low frequency power measurement	106
Figure 4-2	High frequency power measurement	107
Figure 4-3	Example of pulse-modulated signals	109
Figure 4-4	Mismatch in power measurements	110

THIS PAGE HAS BEEN INTENTIONALLY LEFT BLANK.

List of Tables

Table 2-1	V3500A keypad functions	29
Table 2-2	Menu map structure description	32
Table 3-1	SETAVG command values	75

THIS PAGE HAS BEEN INTENTIONALLY LEFT BLANK.

1 Getting Started

Introduction	18
Key Features	19
Initial Inspection	20
Handling Precaution	21
Setting-up Your Instrument	22

This chapter introduces the key features of the V3500A Handheld RF Power Meter and prepares the power meter for initial setup.

Introduction

The Keysight V3500A Handheld RF Power Meter, 10 MHz to 6 GHz is a compact handheld instrument designed for making RF power measurements in both the field as well as research and development (R&D) laboratory environments. In the laboratory, the V3500A can be used as an RF power data logger by transferring data through its built-in USB interface to a computer, allowing you to perform trend or drift analysis. For use in the field, the compact size of the V3500A allows it to be placed in a toolkit. You do not have to carry both a power meter and a separate sensor module (the V3500A has a built-in sensor) when conducting measurement in the field.



Figure 1-1 V3500A Handheld RF Power Meter with backlight turned on

Key Features

- Easy to use interface with LCD display
- Economical single-function instrument
- Wideband (10 MHz to 6 GHz) average RF power measurements
- Compact size with a built-in display and sensor
- Universal Serial Bus (USB) control interface
- Flexibility of drawing operating power from an on-board battery, an optional external power supply, or a computer via the USB interface

Initial Inspection

When you receive your instrument, inspect the instrument for any obvious damage such as broken terminals or cracks, dents, and scratches on the casing that may occur during shipment.

If any damage is found, notify the nearest Keysight Sales Office immediately. The front of this manual contains the warranty information.

Standard purchase items

Verify that you have received the following items with your V3500A instrument. If anything is missing or damaged, please contact the nearest Keysight Sales Office.

- ✓ USB interface cable (Standard-A to Type-B), 2.5 meter

Optional purchase items

- ✓ Power supply (V3500A-PWR)
- ✓ Holster carrying case with shoulder strap (V3500A-SHL)
- ✓ USB interface cable (Standard-A to Type-B), 2.5 meter (V3500A-CA1)

Keep the original packaging in case the V3500A has to be returned to Keysight in the future. Also, include a brief description of the problem.

Handling Precaution

To maintain high-impedance isolation, ensure that the V3500A is handled carefully to avoid contamination from foreign materials such as body oil. Such contamination can reduce isolation resistance.

To avoid possible contamination, do not touch connector insulators. If the instrument becomes contaminated, it should be thoroughly cleaned. Refer to *Keysight V3500A Handheld RF Power Meter, 10 MHz to 6 GHz Service Guide* for more information.

Setting-up Your Instrument

Connectivity

You need to set-up the RF connector and USB port connections properly before making any measurements.

RF connector

Use the Type-N male RF connector with 50 Ω characteristic impedance (see [Figure 1-2](#)) to make RF signal connections.



Figure 1-2 V3500A with Type-N connector nut

Be sure to follow the following guidelines when making connections.

✓ Maximum input power limitations

Do not connect or apply any power level that is outside of the V3500A specifications. See “[Product Specifications](#)” on page 96 for a complete list of specifications.

✓ Connection for a power measurement

While holding the body of the power meter in one hand, turn the Type-N male connector nut to tighten the connection (do not turn the body of the V3500A). Continue to do so until the connection is hand-tight. It is important to turn the nut of the connector rather than the body of the power meter when tightening the connection.

NOTE

When connecting the Type-N connector of the V3500A to a Type-N female connector for a power measurement, observe proper practice for tightening the connection.

USB port

The V3500A has a USB 2.0 interface with mini-B port (see [Figure 1-3](#)). The V3500A can be remotely programmed over this USB interface.

In addition to remote programming, the V3500A can be powered by the USB port regardless of whether the batteries are present or connected to the external power supply (V3500A-PWR).

NOTE

The interface is USB 2.0 compatible with an interface speed of 12 Mbps.

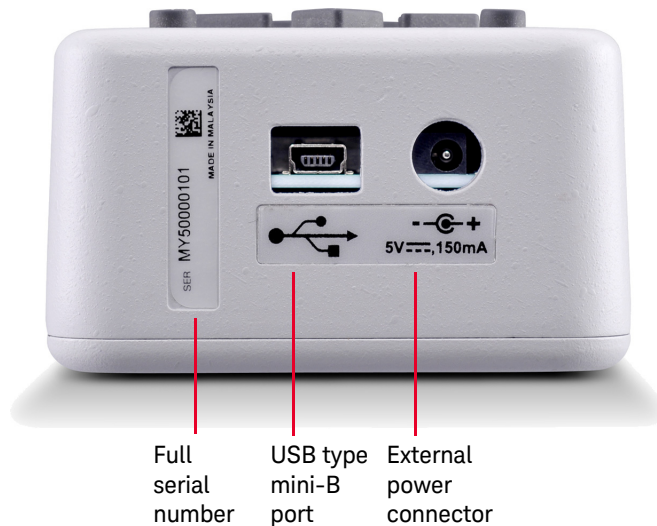

Figure 1-3 Full serial number, USB type mini-B port, and external power connector

Power supply

You can use either the battery power or the external power connector to power on your V3500A.

- Battery power

The V3500A can be powered by two AA batteries. If installed, the batteries will power the V3500A only if the external power supply and USB are not connected.

Refer to *Keysight V3500A Handheld RF Power Meter, 10 MHz to 6 GHz Service Guide* for more information.

- External power connector

The external power connector provides a connection for the optional external power supply (Model V3500A-PWR) (see [Figure 1-3](#)). If the external power supply is connected, the V3500A will be powered by the external power supply – regardless of whether the USB power or batteries are present.

CAUTION

Only connect the optional external power supply (V3500A-PWR) recommended to this connector. Instrument damage may result if improper power is applied.

The power supply is equipped with an AC line filter and provides a conditioned +5 VDC, 150 mA power source for the V3500A.

THIS PAGE HAS BEEN INTENTIONALLY LEFT BLANK.

2 Knowing your Instrument

Product at a Glance	28
Front Panel Operations	34

This chapter specifies the characteristics, environmental conditions, and specifications of the V3500A Handheld RF Power Meter. This chapter contains a brief description of the instrument outlook, front panel operation, and front panel procedure.

Product at a Glance

Product dimensions



Figure 2-1 V3500A dimensions

The front panel keypad

Figure 2-2 shows the location of the front panel keypad. Refer to Table 2-1 for front panel key description and usage.



Figure 2-2 V3500A front panel keypad

Table 2-1 V3500A keypad functions







Key	Description
<p>ZERO</p> 	<p>Press ZERO to measure the offset voltages in the signal path and zero the V3500A. This allows a more accurate measurement at low power levels. The V3500A RF input may be left disconnected when it is zeroed, or it may be connected to other hardware, but make sure that no signals are present on the RF input as this results in inaccurate readings. For example, if the V3500A is connected to a signal generator, turn off the signal generator's output before pressing the ZERO keypad. When the V3500A is zeroed, the display will show "Zeroing.....". The entire operation will take approximately 30 seconds.</p>
<p>FREQUENCY</p> 	<p>Press FREQUENCY to set the V3500A to the frequency of the input signal. There are two keypads for adjusting the frequency. The left arrow key decrements the present frequency in 10 MHz steps. Likewise, the right arrow key increments the present frequency in 10 MHz steps. The present frequency is displayed on the second line of the display. Pressing and holding one of the frequency keys down will change the frequency setting rapidly.</p>
<p>ON/OFF</p> 	<p>Press ON/OFF to turn on or turn off the V3500A.</p>

Table 2-1 V3500A keypad functions (continued)

Key	Description
	<p>Press MENU to enter the menu mode. The four arrow keypads are active in menu mode only. When the V3500A is in normal mode, the four arrow keypads are inactive.</p> <p>The up and down menu keypads select different menus. For example, these keypads can be used to change from the “Averaging” menu to “Units” menu.</p> <p>The left and right menu keypads allow users to adjust the settings in a given menu. For example, in the “Averaging” menu, these keys are used to select the number of averages performed by the V3500A.</p>
<p>HOLD</p> 	<p>Under normal mode, the V3500A power reading is updated continuously. In some cases, this may be undesirable. For example, the V3500A might be connected to a signal source in a location that makes it difficult to read the display. Press HOLD for the most recent reading to be frozen on the display and is no longer updated. This allows the user to disconnect the V3500A from the source and then read the display. Press HOLD again to disable the hold function and the display will once again be updated continuously. When the hold function is enabled, the letter "H" is displayed on the upper right-hand corner of the display.</p>
	<p>Press MENU to access any functions that are not available to the user directly from the front panel keypad. It also allows users to enter or exit the V3500A menus. Press MENU once causes the power display to be replaced with the menu display. The menu can be navigated with the menu navigation keypads. Press MENU again to exit the menu mode and the display will return to normal mode.</p>
<p>BACKLIGHT</p> 	<p>The V3500A display and keypads are backlit to allow visibility in dark environments.</p> <p>Press BACKLIGHT to turn on and off the LCD backlight display and keypads. In order to conserve battery power, the backlight will automatically be turned off after one minute delay (default setting). You can change the delay setting using the V3500A menus.</p>

How to navigate the menu system

NOTE

There is no “enter” keypad to activate a particular menu selection. Once the left or right menu keypads are used to select one of the choices in a menu, that choice is automatically activated.

Press **MENU** to toggle the display between normal and menu mode. Use the four arrow keypads surrounding the **MENU** keypad to navigate and make selections while in menu mode. Use the up and down menu arrow keypads to scroll through the available menus and make a selection.

The left and right menu arrow keypads are used to select available choices in menu mode. All menu commands are executed immediately when the choice is selected.

The menu map structure is shown in [Figure 2-3](#) and the description is shown in [Table 2-2](#). The menu items in <> brackets are the default menu values.

Averaging <Off> 2 4 8 16 32
Units <dBm> Watts
Shutdown 1m 5m 30m 1hr <Never>
BacklightOff <1m> 5m 10m 20m Never
Contrast 0% 10% 20% 30% 40% <50%> 60% 70% 80% 90% 100%
Save State <No> Save
Recall State <No> Recall
Meas mode <Norm> Fast
Firmware Rev V1.0.8
Serial Num 12345678
Rel Offset <Off> On

Figure 2-3 Menu map structure

Table 2-2 Menu map structure description

Menu	Description	Available Values	Default values
Averaging	Sets the averaging value.	Off, 2, 4, 8, 16, 32	Off
Units	Sets the measurement unit. Refer to “Setting units: dBm or watts” on page 38.	dBm, Watts	dBm
Shutdown	Sets the auto-shutoff interval. Refer to “Setting the backlight auto-shutoff interval” on page 39.	1m, 5m, 30m, 1hr, Never	Never
BacklightOff	Sets the duration prior to the backlight turning off automatically. Refer to “Controlling the backlight” on page 39.	1m, 5m, 10m, 20m, Never	1m (1 minute)
Contrast	Sets the LCD display contrast.	0%, 10%, 20%, 30%, 40%, 50%, 60%, 70%, 80%, 90%, 100%	50%
Save State	Enables or disables the save state. Refer to “Saving the instrument state” on page 37.	No, Save	No
Recall State	Enables or disables the recall state. Refer to “Recalling the instrument state” on page 38.	No, Recall	No
Meas mode	Selects between normal or fast mode. Refer to “Enabling and disabling high-speed mode” on page 36.	Norm, Fast	Norm
Firmware Rev	Shows the firmware revision used in the instrument.	–	–
Serial Num ^[a]	Shows the numerical serial number of the instrument (without prefix).	–	–
Rel Offset	Allows users to apply an offset value to the measurement. Refer to “Using relative offset function” on page 39.	Off, On	Off

[a] The numerical serial number displayed on the instrument is for reference only. For full serial number (with prefix), please refer to the printed label shown in **Figure 1-3 on page 7**.

Examples on how to navigate the menu system

- 1 Press down arrow keypad to change the active menu from “AVERAGING” to “UNITS” menu.
- 2 In the “AVERAGING” menu, the left and right menu keypads can turn averaging “Off” or select 2, 4, 8, 16, or 32 averages. If the present selection is <2>, and the right menu key is pressed, the active selection will be changed to <4> immediately.

How to power on the V3500A

Use the ON/OFF keypad to turn on or turn off the V3500A. While operating on battery power, the V3500A has a power auto-shutoff feature to preserve battery life. This feature automatically turns the power meter off after a certain duration. By default, the auto-shutoff feature time is disabled.

NOTE

The “SHUTDOWN” menu allows you to change the auto-shutoff interval.

Setting the power auto-shutoff interval

- 1 Press **MENU** to enter menu mode.
- 2 The menu system map as shown in [Figure 2-3](#) will be shown.
- 3 Scroll using the down arrow key until “Shutdown” is displayed.
- 4 Select your desired time-out interval using the left or right menu keypads.

NOTE

To disable the auto-shutoff function, select <Never> for the time-out interval under “Shutdown” menu.

Front Panel Operations

The V3500A Handheld RF Power Meter can be operated and programmed using the front panel. All commands and functions accessible through USB can also be accessed from the front panel.

Measuring power

Use the following procedure to measure the power of a signal with the best accuracy.

- 1 Set frequency reading.
Press left or right **FREQUENCY** keypads as needed to set an appropriate frequency. The V3500A can be set from 10 MHz to 6000 MHz in 10 MHz increments.

NOTE

The instrument returns to the default frequency value setting of 500 MHz after the instrument is turned off.

- 2 Zero the V3500A.
Refer to “Zeroing the power meter” on page 35 for more information.
- 3 Connect the V3500A RF input port to the signal to be measured. Refer to “RF connector” on page 5 for more information.

The top line of the display shows the measured power of the signal. The measured power will be updated continuously and displayed accordingly.

In the upper right-hand corner of the display, an “at” symbol (@) is displayed whenever a new measurement is completed and the results have been displayed. If this symbol changes to the letter “H”, the V3500A will hold the present reading (the instrument is in hold mode). Press **HOLD** to return to normal mode.

Zeroing the power meter

Zeroing the power meter improves the measurement accuracy of the V3500A significantly, especially at low power levels. After the power meter is turned on, you should always perform zeroing prior to making any measurements. The V3500A should be zeroed when it warms up, and periodically when the ambient temperature changes.

- 1 Prior to zeroing the V3500A, make sure all the RF power is removed from the V3500A RF input port. This can be done by disconnecting the RF input, or by disabling the output of any signal sources connected to V3500A.
- 2 Once all RF power is removed from the V3500A RF input port, press **ZERO**. The V3500A will display the message “Zeroing...” during the zeroing process. When the display returns to normal mode, zeroing is complete and measurements can be made.

Setting the input frequency

NOTE

The instrument returns to the default frequency value setting of 500 MHz after the instrument is turned off.

The V3500A has an internal calibration table that corrects for frequency response variations of its circuitry. For best accuracy, set the input signal frequency correctly.

- 1 Press **FREQUENCY** to set the input frequency. The left arrow decreases the frequency, and the right arrow increases the frequency value. The present frequency setting is displayed on the second line of the display when the display is in normal mode.
- 2 Holding either the left or right keypad down will cause the frequency to decrease or increase rapidly, allowing the user to quickly set the frequency to the desired value.

Setting the measurement speed

In normal operation speed, the V3500A will complete a power measurement in about 1 second (± 0.5 second depending on the power level of the input signal). Lower level signals take longer to measure than higher level signals. This is due to the fact that more filtering is required to get a good signal-to-noise ratio when measuring low-level signals.

If faster measurements are required, set the V3500A to high-speed mode. In this mode (for measurements greater than -30 dBm) the V3500A can make approximately 23 measurements per second.

In most cases, the normal measurement speed is the best choice. Measurement data filtering is greatly reduced in high-speed mode, resulting in significantly higher measurement noise than in normal mode.

Enabling and disabling high-speed mode

NOTE

The instrument returns to the default “Meas mode” setting of <Norm> when the instrument is turned off.

- 1** Press **MENU** to enter menu mode.
- 2** Scroll using the down menu arrow keypad until “Meas mode” menu is displayed.
- 3** Press the left or right menu arrow keypad to select the desired measurement speed mode. There are two available options:
 - <Norm>: Selects normal measurement speed mode
 - <Fast>: Selects high-speed mode

Saving the instrument state

NOTE

- The default “Save State” menu setting is <No>. Saving the state of the instrument places all menu values in the memory of the instrument so that it can be recalled after the cycling power. Frequency settings are not saved or recalled.
 - The “Save State” feature is only functional when the batteries are stored in the instrument.
-

- 1 Press **MENU** to enter menu mode.
- 2 Scroll using the down menu arrow keypad until “Save State” menu is displayed.

CAUTION

All menu commands are executed immediately when the choice is selected. Therefore, the Save State command is implemented as soon as the <Save> menu item is highlighted. There is no undo option— as soon as the <Save> menu item is selected, the current menu setting overwrite the previously saved settings.

- 3 Use the right arrow menu keypad to select <Save>. This will save the instrument state in the non-volatile memory of the V3500A.

Recalling the instrument state

NOTE

The default “Recall State” menu setting is <No>. Recalling the instrument state restores all stored menu values in the V3500A non-volatile memory. Frequency settings are not recalled.

- 1 Press **MENU** to enter menu mode.
- 2 Scroll using the down menu arrow keypad until “Recall State” menu is displayed.

CAUTION

All menu commands are executed immediately when the choice is selected. Therefore, the Recall State command is implemented as soon as the <Recall> menu item is highlighted. There is no undo option – as soon as the <Recall> menu item is selected, the saved menu setting overwrite the present settings.

- 3 Use the right arrow menu keypad to select <Recall>. This will recall the instrument state in the non-volatile memory of the V3500A.

Setting units: dBm or watts

NOTE

- When operating the V3500A in Watts mode using the front panel, it will display nW, μ W, mW, or W accordingly.
 - The instrument returns to the default dBm instrument after the instrument is turned off.
-

Refer to “Units of Measurement” on page 84 for information on dBm and watts.

- 1 Press **MENU** to enter menu mode.
- 2 Scroll using the down menu arrow keypad until “Units” menu is displayed.
- 3 Use the left or right arrow menu keypad to select your desired units, either <dBm> or <Watts>.

Controlling the backlight

The V3500A LCD display and keypads are backlit to allow visibility in dark environments. Press **BACKLIGHT** to turn on and off the backlight LCD display and keypads. The backlight will automatically be turned off after a certain length of time to preserve the battery life. The default time is one minute.

Setting the backlight auto-shutoff interval

NOTE

The instrument returns to the default “BacklightOff” menu setting of <1m> when the instrument is turned off.

- 1 Press **MENU** to enter menu mode.
- 2 Scroll using the down menu arrow keypad until “BacklightOff” menu is displayed.
- 3 Use the left or right arrow menu keypad to select your desired time interval. Select <Never> to disable the backlight’s auto-shutoff.

Using relative offset function

The relative offset function allows you to apply an offset value to the measurement. The relative offset values range from -99.99 dB to $+99.99$ dB with 0.01 dB resolution. When the relative offset function is turned on, the displayed power is limited to ± 99.99 dBm and 999.99 W.

Turning on the relative offset function

When “Rel Offset” is enabled, a flashing letter “O” is displayed on the upper right-hand corner of the V3500A.

- 1 Press **MENU** to enter menu mode.
- 2 Scroll using the down menu arrow until “Rel Offset” menu is displayed.
- 3 Use the right arrow menu keypad to select the <On> function from the submenu. Enter a relative offset value using steps shown in [Entering a relative offset value](#).
- 4 Press **MENU** to exit.

Entering a relative offset value

- 1 From the “Rel Offset” menu, use the right arrow menu keypad to select <Edit>. Notice that the up, down, left, and right arrow keypads are enabled.
- 2 Use any of the up, down, left, or right arrow keypads to edit the individual digits of the relative offset value and store the value.
- 3 Use the up and down arrow keypads to change the sign of the relative offset positive (+) or negative (-) value.
- 4 Press **MENU** to exit and store the relative offset value entered. The relative offset value entered will be applied to the measurement reading on the V3500A.

When the relative offset value function is enabled and the value is stored in the V3500A, the letter “O” will flash on the upper right-hand corner of the display. When the relative offset value is entered as 0.0, the “@” character will flash on the upper right-hand corner of the display, indicating that the relative offset function is not enabled.

NOTE

Powering the V3500A on or off erases any relative offset values entered.

Turning off the relative offset function

- 1 Press **MENU** to enter menu mode.
- 2 Scroll using the down menu arrow until “Rel Offset” menu is displayed.
- 3 Use the right arrow menu keypad to select the <Off> function.
- 4 Press **MENU** to exit. The “@” character will flash on the upper right-hand corner of the display, indicating that the relative offset function is turned off.

3 Driver Installation and Commands

System Requirements	42
Driver Installation	43
Instrument Address	63
Remote USB Operation	64

This chapter provides you the step-by-step programming driver installation procedure, remote USB operation, and basic drive commands of the V3500A Handheld RF Power Meter.

System Requirements

Prior to any installation, please ensure that your PC meets the following minimum system requirements.

Processor	1.6 GHz Pentium® IV or higher
Operating System	Any one of the following Microsoft® Windows® versions: <ul style="list-style-type: none">– Windows 2000 Professional (Service Pack 4) or later– Windows XP Professional or Home edition (Service Pack 1) or later– Windows Vista– Windows 7– Windows 10
Browser	Microsoft® Internet Explorer 5.01 or higher
Available Hard Disk Space	1 GB
Available RAM	512 MB or higher is recommended
Video	Super VGA (800x600) 256 colors or higher

Driver Installation

The V3500A drivers support the following Microsoft® operating systems:

- Windows 10
- Windows 7
- Windows Vista
- Windows XP
- Windows 2000

Verify that your PC meets the minimum system requirements as stated under “**System Requirements**” on page 42. Follow the steps below to install the V3500A programming drivers.

NOTE

The **setup.exe** file will automatically check and install the Microsoft .Net Framework if it is not installed on your PC.

Installing USB driver

USB driver installation allows you to install the low-level drivers that set up the physical communication link between the V3500A and the PC.

- 1 Download the driver from the Keysight’s Web site:
<http://www.keysight.com/main/software.jspx?ckey=sw287&lc=eng&cc=MY&nid=-536902449.928965&id=sw287>
- 2 Execute the file name **Keysight V3500A Driver Setup.exe** to install the V3500A software driver.

3 Driver Installation and Commands

- 3 If the Microsoft .Net Framework is not installed on your PC, the setup file will prompt you to install it.

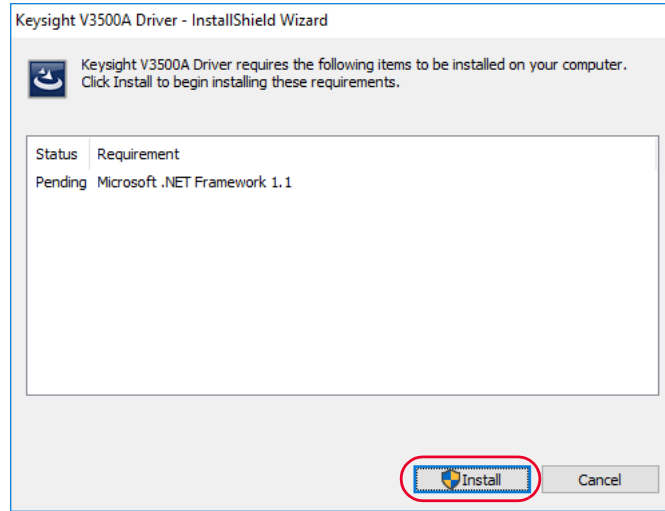

Click **Install** and follow the instructions as shown in the following images.

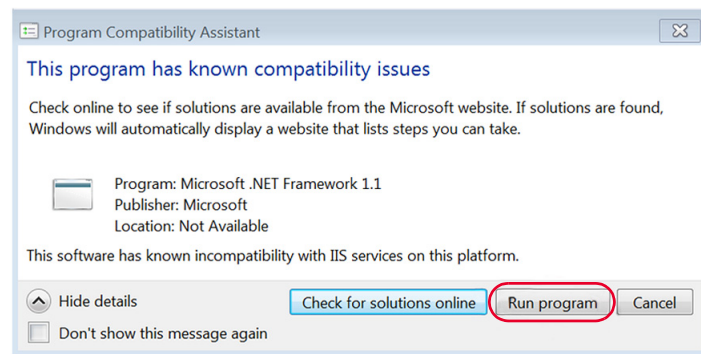
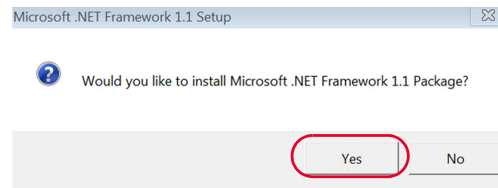

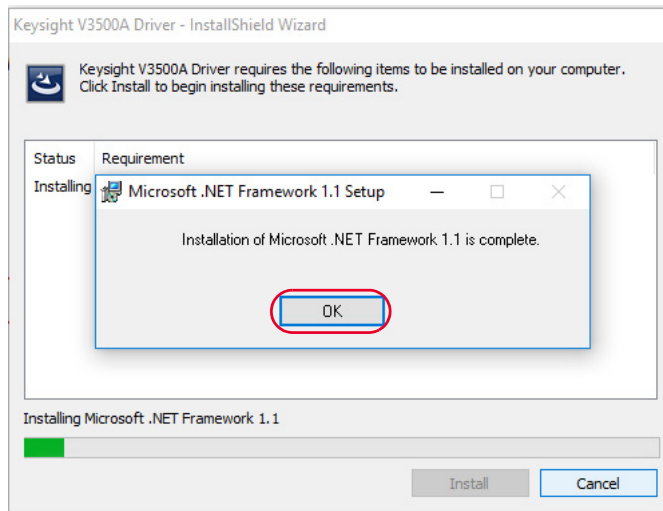
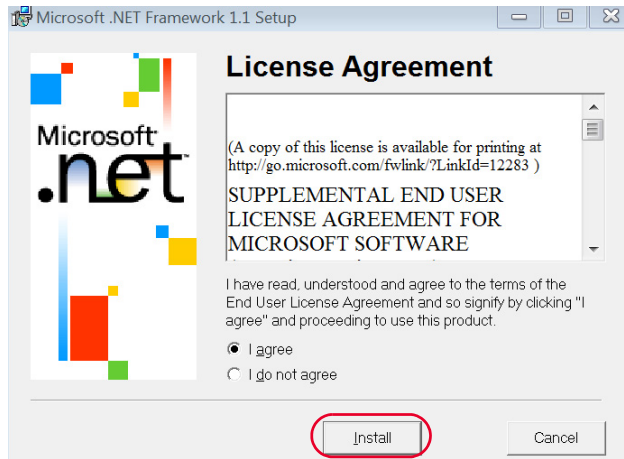

- 4 Connect the USB cable between the V3500A instrument and your PC. Then, connect the V3500A instrument to the required AC power and turn the instrument on.

- 5 Your PC will automatically detect the connected instrument and the **Welcome to the InstallShield Wizard for Keysight V3500A Driver** window will appear.

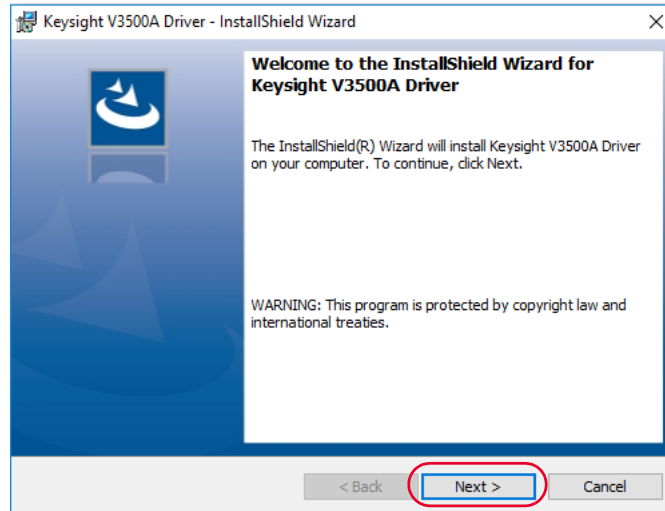

NOTE

- The V3500A should automatically be turned on when connected to the USB port of the PC. Turn the instrument on manually if it is not powered on.
- If the **Welcome to the InstallShield Wizard for Keysight V3500A Driver** window does not appear, cycle the power of the V3500A.
- For Windows 7, the PC will not be able to automatically detect the connected instrument. Refer to **“Installing USB driver (Windows 7)”** on page 49 for more information on installing the driver in Windows 7.

Click **Next** and follow the instructions as shown in the following images to complete the installation.

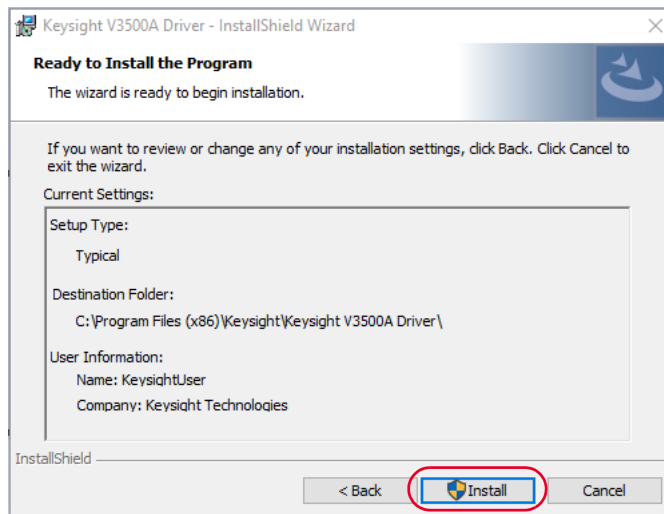
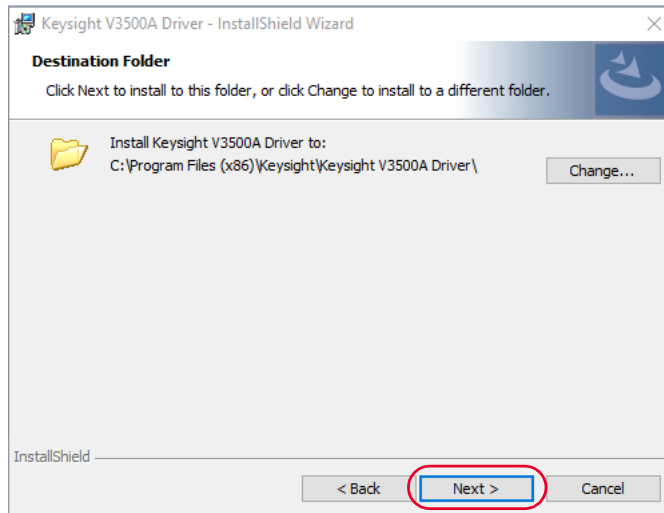

3 Driver Installation and Commands

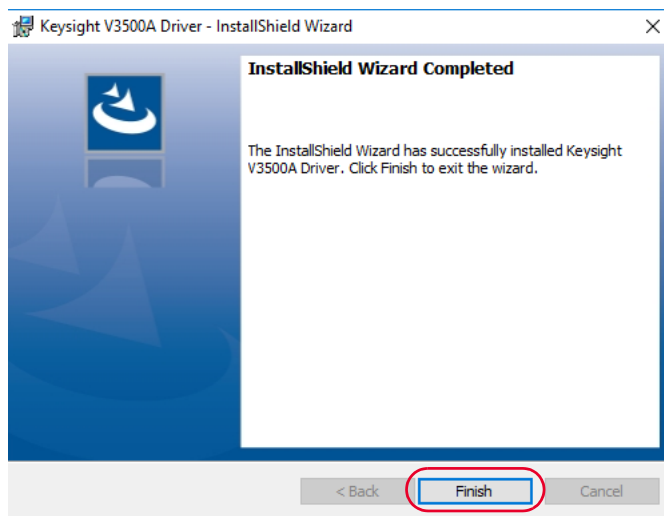

Installing USB driver (Windows 7)

NOTE

The Keysight V3500A Power Meter must be connected to the PC via USB before the driver can be seen under Other devices tab in the Device Manager window.

- 1 To install the driver for the connected instrument, go to **Device Manager**.
- 2 Under the **Other devices** tab, right-click **3500 Power Meter** and click **Update Driver Software...**

The **Update Driver Software** window will appear.

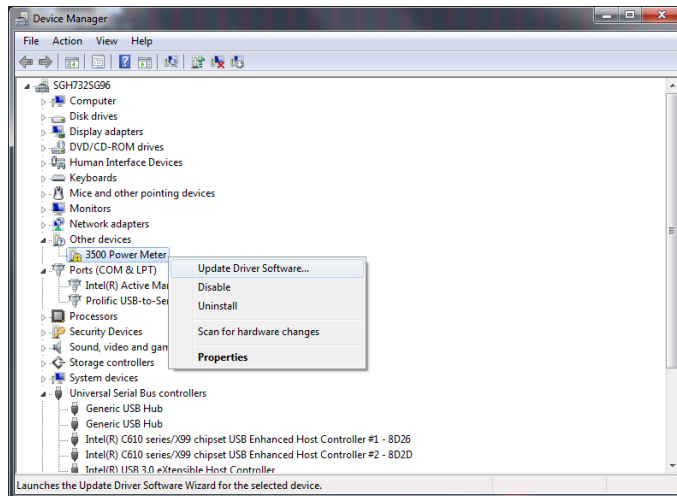

3 Driver Installation and Commands

- 3 Click **Browse my computer for driver software** to locate the V3500A USB Driver folder.

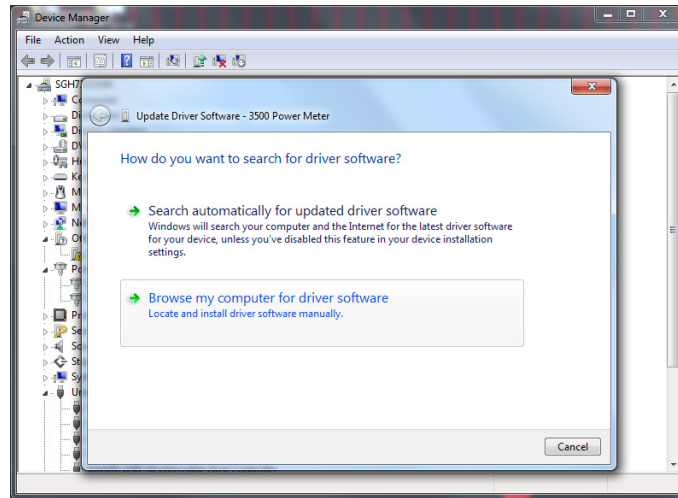

- 4 Select the **Keysight V3500A Driver** folder, and then click **Next**. The location of the folder is at C:\Program Files (x86)\Keysight.

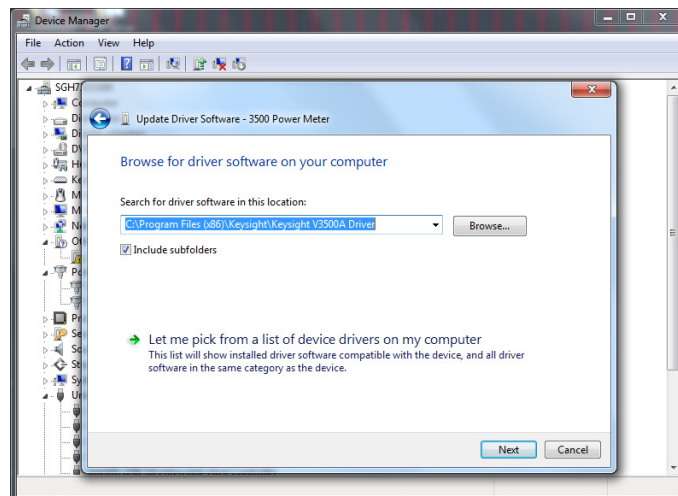

- 5 A **Windows Security** window will appear. Click **Install** to proceed with the installation.

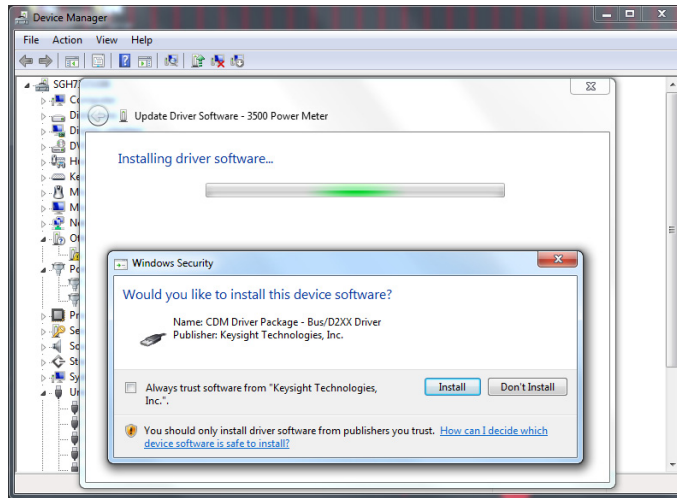

- 6 When the installation has completed, click **Close** to exit the installation.

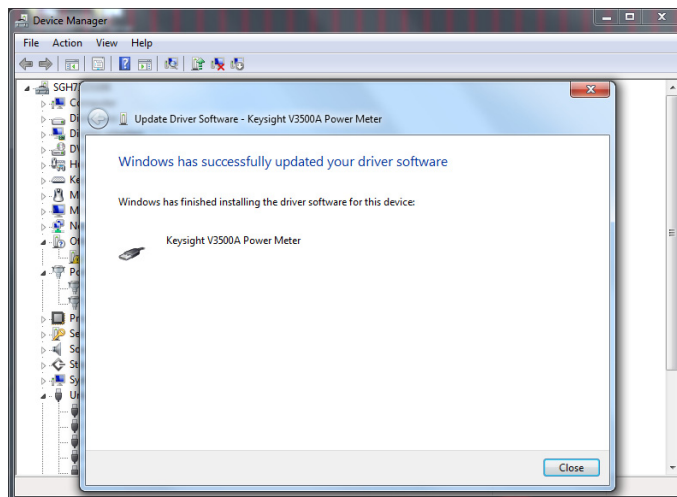

3 Driver Installation and Commands

- 7 Go back to the **Device Manager** window. Under the **Other devices** tab, repeat Step 2 to Step 6 for the driver installation of **USB Serial Port**.

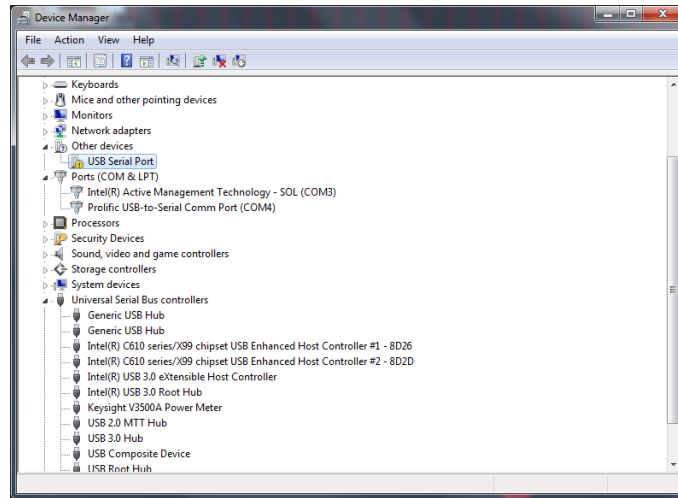

- 8 After all the installation have completed, the **Keysight V3500A Power Meter** will appear under both **Ports (COM & LPT)** and **USB controllers** tabs. This indicates that the drivers are correctly installed and present.

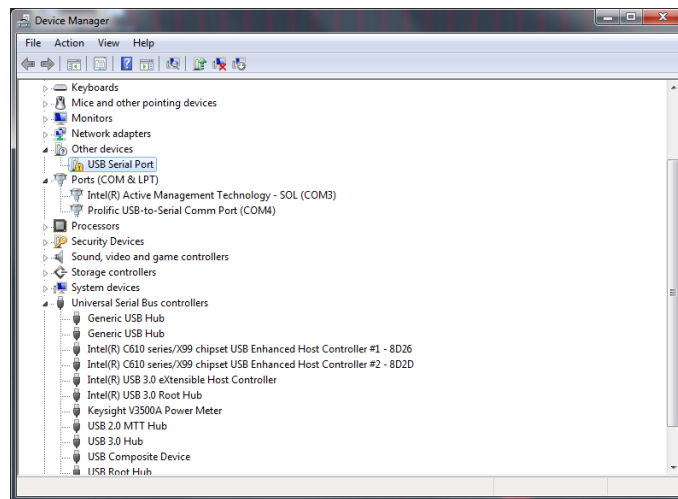

Confirming the USB driver installation

- 1 To confirm the USB driver installation is complete, go to **Start > Run** (on the Windows Start menu) and type `devmgmt.msc`. Click **OK**.
- 2 The Device Manager window will appear. Scroll down to **Ports (COM & LPT)** and **Universal Serial Bus controllers** to confirm the drivers are installed and present.

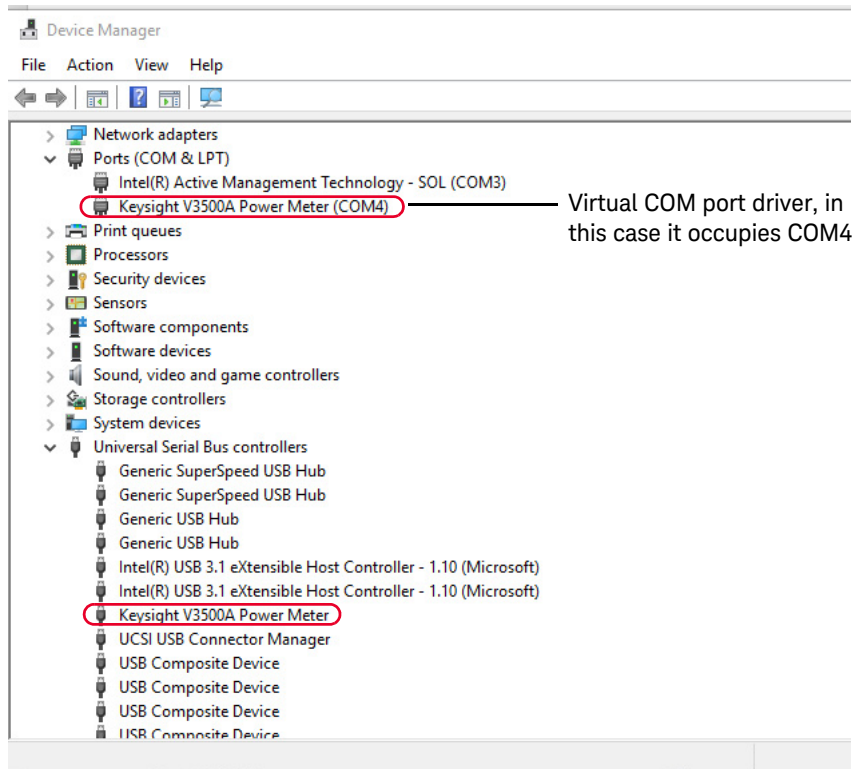

NOTE

If you are using multiple Keysight instruments, you may wish to unplug all but one, to ascertain the COM port number used by a particular instrument. You may also differentiate similar instruments by right-clicking on the device, viewing the Properties and the serial number of the instrument.

3 Driver Installation and Commands

- 3 Launch the **Keysight Connection Expert** by clicking the IO icon on your desktop toolbar.

Click **Refresh** to refresh the list of connected instruments. Click the option button (3 dots icon) under **COM4** and click **Add Instrument**.

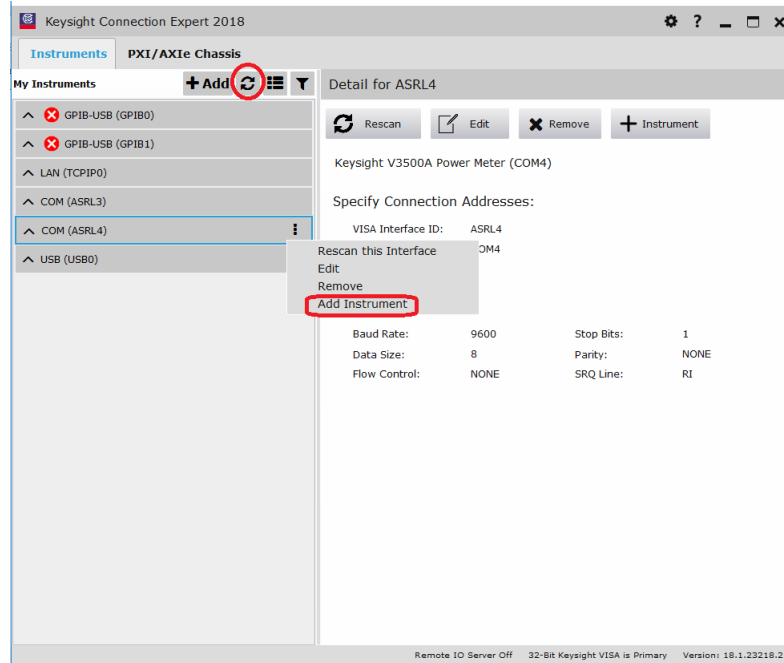

- 4 Select **Auto-identify this instrument** and click **OK**.

Add an RS-232 serial instrument [X]

Keysight V3500A Power Meter (COM4)

Specify Connection Addresses:

VISA Interface ID: ASRL4

SICL Interface ID: COM4

Logical Unit: 4

Configure Serial Properties:

Baud Rate: 9600 Stop Bits: 1

Data Size: 8 Parity: NONE

Flow Control: NONE SRQ Line: RI

Auto-Identify This Instrument

Verify Connection:

Test This VISA Address ASRL4::INSTR

OK Cancel

3 Driver Installation and Commands

- 5 Once the V3500A has been added, right-click and select **Send Commands To This Instrument**.

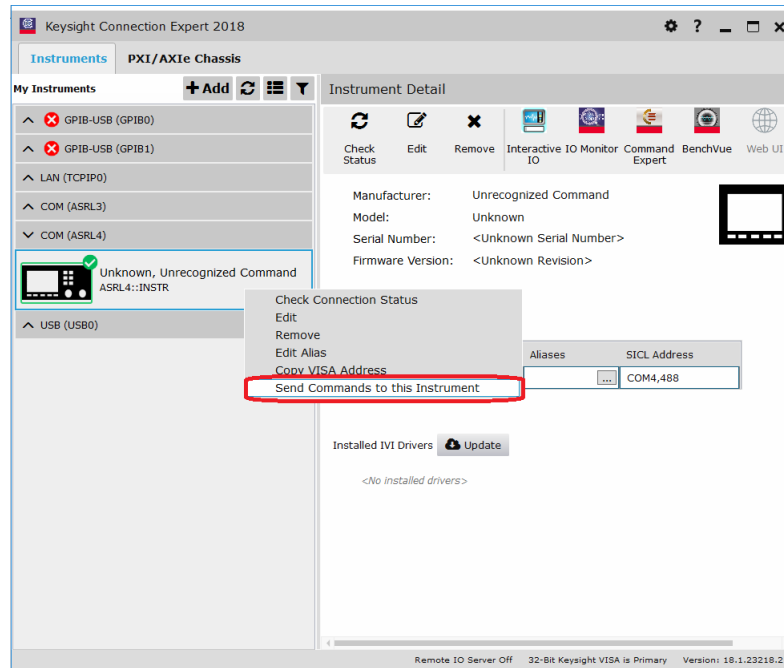

- 6 Type the command `pwr?` and click **Send & Read** to confirm that the V3500A is properly connected and ready to use.

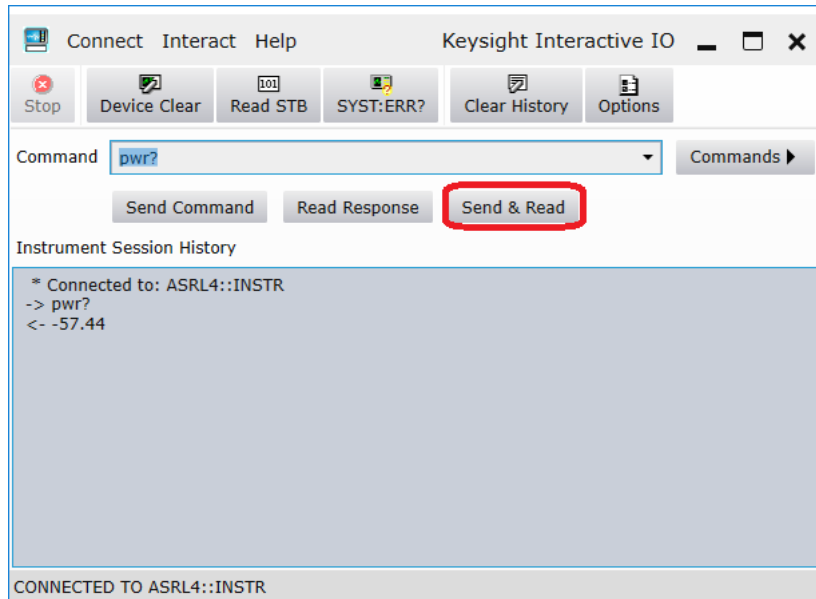

3 Driver Installation and Commands

Uninstalling the USB driver

- 1 Under Ports (COM & LPT) tab, right-click **Agilent V3500A PowerMeter** and click **Uninstall**.

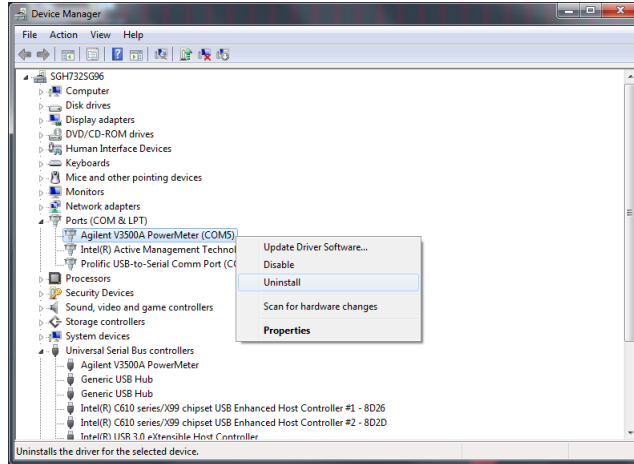

Remember to check the box before clicking **OK**.

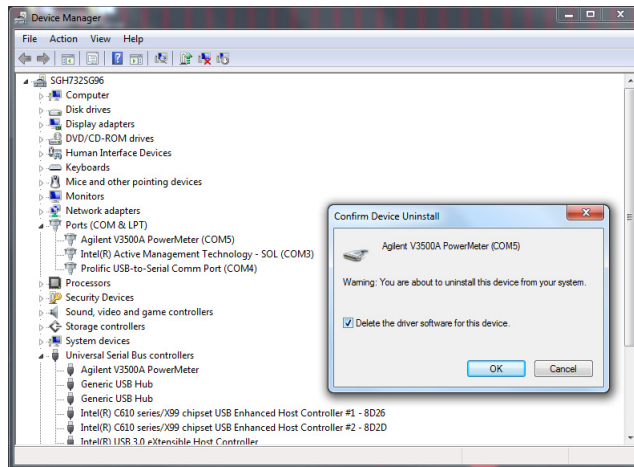

- 2 Under the **USB controllers** tab, right click **Agilent V3500A PowerMeter** and click **Uninstall**.

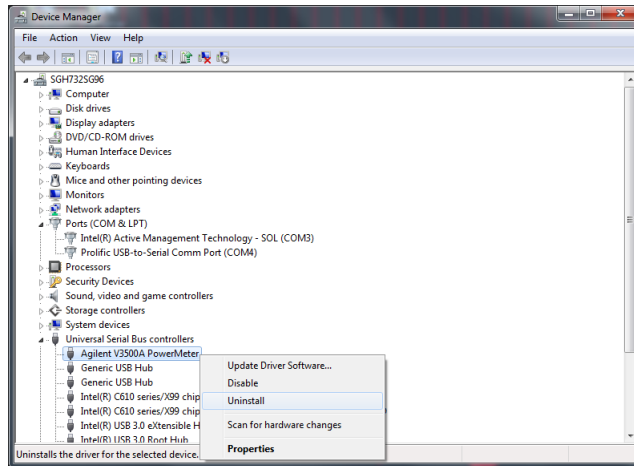

Remember to check the box before clicking **OK**.

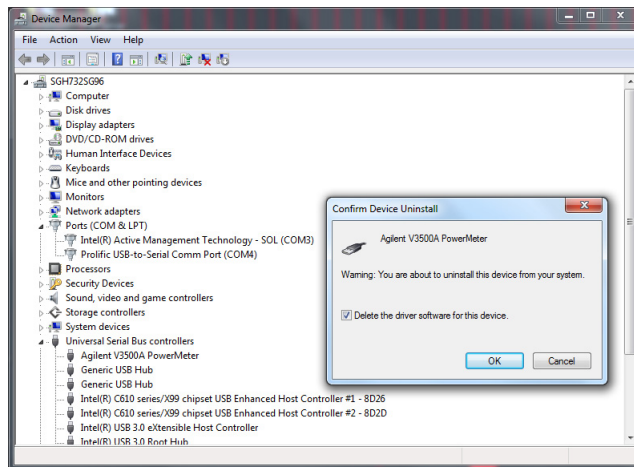

NOTE

Uninstall the driver according to sequence.

Installing programming driver

Programming driver installation allows you to install the high-level drivers that manage the USB interface and facilitate programming of the V3500A.

In order for your program to be able to communicate with the programming driver, it must be able to find the appropriate DLL. The method used to find the appropriate DLL is dependent on the software used to create your programs. Refer to the relevant sections below for further information.

- [When using Microsoft Visual Studio.NET](#)
- [When using Microsoft Visual Studio 6.0](#)

When using Microsoft Visual Studio.NET

In the installation directory, find the file name **KeysightV3500A.dll** and add a reference to this file in your project. The default setup places the KeysightV3500A.dll file in the following folder: **C:\Program Files\Keysight\Keysight V3500A Driver**. Refer to [Adding a reference \(Microsoft Visual Studio.NET\)](#) for more information.

NOTE

An alternative method would be to place a local copy of the KeysightV3500A.dll in your project directory and add a reference to this copy. If this alternative method is used, and an updated driver for the V3500A is later installed, the local copy in the project directory will not be updated (it will remain the earlier version of the driver).

- **Advantage:** when updating the V3500A driver, this method removes the risk that updating the V3500A driver that will break your software.
 - **Disadvantage:** when updating the V3500A driver, this method requires manual replacement of a copy of the new KeysightV3500A.dll in your project directory and also rebuilding code to take advantage of the new driver.
-

Adding a reference (Microsoft Visual Studio.NET)

The following procedure outlines how to add a reference while using Microsoft Visual Studio.NET. Adding a reference in other programming languages is similar.

- 1 In Microsoft Visual Studio.NET, select the desired project.
- 2 Under the **View** menu, select **Solution Explorer** (alternatively, press **Ctrl-Alt-L**).
- 3 In the **Solution Explorer**, click + sign next to the project to expand the project if necessary.
- 4 Right click **References** and click **Add References** to add the Reference.
- 5 In the **Add Reference** window, use **Browse** to locate the directory where the V3500A programming driver KeysightV3500A.dll is stored.
- 6 Double-click the KeysightV3500A.dll component.
- 7 Click on **OK** in the **Add Reference** window. KeysightV3500A should now appear under **References** in the **Solution Explorer** window.

When using Microsoft Visual Studio 6.0

The procedures for referencing the DLL differ for Visual Basic 6.0 and Visual C++ 6.0.

NOTE

In Microsoft Visual Studio 6.0, the KeysightV3500A.tlb file must be referenced in its install location – a reference to a local copy placed in your project directory cannot be used.

Adding a reference (Visual Basic 6.0)

- 1 Select the **Reference** menu in your Visual Basic 6.0 project under the **Project** menu. The References dialog box will open.

NOTE

The default setup places the KeysightV3500A.tlb file in the following folder:
C:\Program Files\Keysight\Keysight V3500A Driver.

- 2 Use **Browse** to locate the installation directory.
- 3 Select **KeysightV3500A.tlb**.

- 4 Click **Open**.
- 5 Verify that the V3500A driver has been added (is checked).
- 6 Click **OK**.

Adding a reference (Microsoft Visual C++ 6.0)

To add the reference in Visual C++ 6.0, make sure the program contains the following line (no other special steps are required to add the reference):

```
#import "C:\Program Files\Keysight\Keysight V3500A  
Driver\KeysightV3500A.tlb"  
no_namespace named_guids
```

NOTE

The above line is correct for an installation in the default directory. If installed in a different directory, modify the statement accordingly.

Instrument Address

When performing remote programming, the V3500A serial number is used as the unique address of the instrument. You can find the serial number of your instrument using one of the following methods:

- 1** Find the serial number on the back label of the V3500A. Look for an integer number in the range of 1 to 99,999,999.
- 2** Press **MENU** to enter menu mode and scroll using the down menu arrow until “Serial Num” menu is displayed. The number shown is the serial number of your instrument.
- 3** Retrieved from the firmware using the **SerialNumber** driver command.

Remote USB Operation

Introduction

The V3500A is USB programmable. Commands and functions accessible from the front panel are also available over USB, except the following:

- On and off
- Save state
- Recall state
- Shutdown time setting
- Backlight off time setting

The driver for the V3500A is not complicated – a few commands are necessary to initiate a connection and read and write from the instrument. Device programming is accomplished by sending and receiving strings over the USB. This programming model is very similar to GPIB programming.

Bus connections

You need to install the required drivers (See “[Driver Installation](#)” on page 43) before using the V3500A remotely. Then, connect the USB connector on the bottom side of the V3500A to the USB connector of the controller (see “[USB port](#)” on page 7).

Remote USB commands

You need to perform the following steps in order to perform remote USB commands with the V3500A.

- 1 Set the serial number in the software. The numerical serial number of the V3500A will be used as the instrument unique address for communication and can be found underneath the barcode on the back panel of the V3500A or displayed using the menu button (see [“How to navigate the menu system”](#) on page 13).
- 2 Initialize the V3500A.

NOTE

Refer to [“Basic V3500A commands”](#) on page 73 for more information.

Basic driver commands

In each driver command usage section, **myPM** is an instance of a power meter class that has been created. Refer to “**Basic V3500A commands**” on page 73 for language-specific sample applications.

Command Name	SerialNumber
Description	SerialNumber is a property used to control which specific V3500A instrument is accessed. SerialNumber is a 32-bit signed integer (1 to 99,999,999).
Usage	<p>C#.NET</p> <pre>int SN = 10973300; myPM.SerialNumber=SN;</pre> <p>Visual Basic.NET</p> <pre>Dim SN As Integer SN=10973300 myPM.SerialNumber=SN</pre> <p>Visual C++.NET</p> <pre>int SN=10973300; myPM->SerialNumber=SN;</pre> <p>Visual Basic 6.0</p> <pre>Dim SN As Long SN=10973300 myPM.SerialNumber=SN</pre> <p>Visual C++ 6.0</p> <pre>int SN=10973300; myPM->SerialNumber=SN;</pre>
Parameters	<p>myPM refers to the created V3500A object.</p> <p>SN is the serial number (32-bit signed integer) of the V3500A being checked.</p>

Command Name	IsDeviceAvailable()
Description	This <code>int</code> function checks the status of the device pointed to by <code>SerialNumber</code> .
Usage	<p>C#.NET</p> <pre>int SN=10973300; int MeterAvailable=myPM.IsDeviceAvailable(SN);</pre> <p>Visual Basic.NET</p> <pre>Dim SN As Integer SN=10973300 Dim MeterAvailable As Integer MeterAvailable = myPM.IsDeviceAvailable(SN)</pre> <p>Visual C++.NET</p> <pre>int SN=10973300; int MeterAvailable=myPM->IsDeviceAvailable(SN);</pre> <p>Visual Basic 6.0</p> <pre>Dim SN As Long SN=10973300 Dim MeterAvailable As Integer MeterAvailable=myPM.IsDeviceAvailable(SN)</pre> <p>Visual C++ 6.0</p> <pre>int SN = 10973300; int MeterAvailable=myPM.IsDeviceAvailable(SN);</pre>

Parameters	<p>myPM refers to the created V3500A object.</p> <p>SN is the serial number (32-bit signed integer) of the V3500A being checked.</p> <p>MeterAvailable is the integer variable created containing the device status.</p>
Return Value	<p>Returns a 32-bit integer with one of the following values:</p> <ul style="list-style-type: none">- 0: Unavailable – the device may have been opened by another program.- 1: Available.- -1: Absent—the device was not found.

Command Name	<code>Initialize()</code>
Description	This void function opens the link between the V3500A and the PC. The <code>SerialNumber</code> property must be set prior to executing.
Usage	<p>C#.NET</p> <pre>myPM.SerialNumber=10973300; myPM.Initialize();</pre> <p>Visual Basic.NET</p> <pre>myPM.SerialNumber=10973300 myPM.Initialize()</pre> <p>Visual C++.NET</p> <pre>myPM->SerialNumber=10973300; myPM->Initialize();</pre> <p>Visual Basic 6.0</p> <pre>myPM.SerialNumber=10973300 myPM.Initialize</pre> <p>Visual C++ 6.0</p> <pre>myPM.SerialNumber=10973300; myPM->Initialize();</pre>
Parameters	<code>myPM</code> refers to the created V3500A object.

Command Name	SendString
Description	<p>Use this command to send and receive string messages from the V3500A – all communication with the V3500A is accomplished using this command.</p> <p>C#.NET</p> <pre>string Reply=myPM.SendString("*RST\n");</pre> <p>Visual Basic.NET</p> <pre>Dim Reply As String Reply=myPM.SendString("*RST" & vbLf)</pre> <p>Visual C++.NET</p>
Usage	<pre>String * Reply; Reply=myPM->SendString("*RST\n");</pre> <p>Visual Basic 6.0</p> <pre>Dim Reply As String Reply = myPM.SendString("*RST" & vbCrLf)</pre> <p>Visual C++ 6.0</p> <pre>BSTR Reply; Reply=myPM->SendString("*RST\n");</pre>
Parameters	<p>myPM refers to the created V3500A object.</p>

Command Name	Close()
Description	<p>This command disconnects the program connection to the V3500A. After the connection is disconnected, the V3500A is available for use with other programs.</p> <p>C#.NET myPM.Close();</p> <p>Visual Basic.NET myPM.Close()</p> <p>Visual C++.NET myPM->Close();</p> <p>Visual Basic 6.0 myPM.Close</p> <p>Visual C++ 6.0 myPM->Close();</p>
Usage	
Parameters	myPM refers to the created V3500A object.

Command Name FindUninitializedDevices()**Description**

Use this command to return a string containing a listing of serial numbers of all uninitialized^[a] V3500A (comma-delimited). If no un-initialized V3500A are present, the string is empty.

C#.NET

```
string List;
List=myPM.FindUninitializedDevices();
```

Visual Basic.NET

```
Dim List As String
List = myPM.FindUninitializedDevices()
```

Visual C++.NET**Usage**

```
String * List;
List = myPM->FindUninitializedDevices();
```

Visual Basic 6.0

```
Dim List As String
List=myPM.FindUninitializedDevices()
```

Visual C++ 6.0

```
BSTR List;
List=myPM->FindUninitializedDevices();
```

myPM refers to the created V3500A object.

Parameters

List is the string variable containing the returned serial number(s).

[a] The statement "uninitialized V3500A" refers to power meters which are connected to your computer, but have not had the **Initialize()** function called on them. Also, when **Close()** is called on initialized devices, they return to the uninitialized state and are visible to the **FindUninitializedDevices()** command.

Basic V3500A commands

Command Name	Reset
Description	This command resets the V3500A to its factory power-on state.
Syntax	*RST<LF>
Response	OK
Command Name	Triggered power read
Description	This is the basic measurement command for the V3500A.
Syntax	*TRG<LF>
Response	<Value>
Return value	Returns the present V3500A reading.
Comments	The present read cycle of the V3500A is interrupted, and a new one is started. The measurement from the new cycle is returned.
Command Name	Non-triggered power read
Description	This command returns the present reading of the V3500A.
Syntax	PWR? <LF>
Response	<Value>
Comments	This is a non-triggered measurement. If the input power has changed during the present measurement cycle, the measured power may be unpredictable.

Command Name	Zero command
Description	This command zeroes the V3500A.
Syntax	ZERO<LF>
Response	OK
Comments	This internal correction routine removes offset errors in the measurement. This is necessary to preserve accuracy when measuring low-level signals.

Command Name	Set frequency
Description	This command sets the operating frequency of the V3500A.
Syntax	FREQ<Value><LF>
Response	OK
Comments	The instrument of measurement is Megahertz (MHz).

Averaging control commands

Command Name	Set averaging factor
Description	This command sets how many averages are taken before returning a power measurement.
Syntax	SETAVG<Value><LF>
Response	OK
Comments	The valid range of <Value> is 0 through 5 (see Table 3-1).

Table 3-1 SETAVG command values

<Value>	Number of averages taken
0	1 ^[a]
1	2
2	4
3	8
4	16
5	32

[a] Equivalent to averaging disabled.

NOTE

Sending a value using this command results in taking averages of 2^x measurements (where $x = \langle \text{Value} \rangle$).

For example:

- Sending SETAVG<1><LF> causes the average factor to take 2^1 or 2 measurements
- Sending SETAVG<2><LF> causes the average factor to take 2^2 or 4 measurements
- Sending SETAVG<3><LF> causes the average factor to take 2^3 or 8 measurements

When $\langle \text{Value} \rangle = 0$, (sending SETAVG 0), the number of measurements is set to 1, and is equivalent to averaging disabled.

Command Name	Get averaging factor
Description	This command reads and returns the averaging factor, which is equal to \log_2 (number of measurements per average).
Syntax	AVG?<LF>
Response	<Value>
Comments	A value of 0 is equivalent to having averaging turned off.

Measurement speed control commands

Command Name	Set normal speed mode
Description	This command sets the V3500A to normal speed mode.
Syntax	NMODE<LF>
Response	OK
Comments	Normal speed mode is the default mode of operation. The V3500A accuracy specifications apply in normal mode. Measurement speed is level-dependent.
Command Name	Set high speed mode
Description	This command sets the V3500A to high speed mode.
Syntax	HSMODE<LF>
Response	OK
Comments	High speed mode turns off all internal averaging and filtering. Measurement noise is higher (especially at low signal levels), but the measurement speed is much faster.

Unit of measurement commands

Command Name	dBm mode
Description	This command sets the V3500A to dBm mode.
Syntax	UDBM<LF>
Response	OK
Comments	Send this command to express the remote and front panel measurements in dBm.
Command Name	watts mode
Description	This command sets the V3500A to watts mode.
Syntax	UMW<LF>
Response	OK
Comments	Send this command to express remote measurements in units of watts, regardless of the units displayed on the front panel. The front panel display will express measurements in units of watts, milliwatts, or microwatts, as appropriate.

Relative Offset Commands

Command Name	Set relative offset
Description	This command sets a relative offset value.
Syntax	SETREL<Value><LF>
Command Name	Check for the relative offset value
Description	This command checks for and returns the set relative offset value.
Syntax	RELVAL?<LF>
Command Name	Turn relative offset on
Description	This command sets the relative offset to ON.
Syntax	RELON<LF>
Command Name	Turn relative offset off
Description	This command sets the relative offset to OFF.
Syntax	RELOFF<LF>
Command Name	Check status of the relative offset
Description	This command checks the status of the relative offset. If it is ON, a "1" is returned, and if it is OFF, a "0" is returned. If it is in EDIT mode, a "2" is returned.
Syntax	REL?<LF>

Miscellaneous commands

Command Name	Backlight on
Description	This command turns on the LCD display and keyboard backlight.
Syntax	BLON<LF>
Response	OK
Comments	The backlight will remain on for the length of time specified by the backlight timer. The timer is controllable from the front panel using the menu button (see “How to navigate the menu system” on page 13).

Command Name	Backlight off
Description	This command turns off the LCD display and keyboard backlight.
Syntax	BLOFF<LF>
Response	OK

Command Name	Get serial number
Description	This command returns the numeric serial number of the instrument.
Syntax	SN?<LF>
Response	<Value>

Command Name	Retrieve firmware revision
Description	This command returns the firmware revision.
Syntax	FWREV?<LF>

Examples

This section provides example programs that initialize the V3500A, make measurements, and close the V3500A. Examples are provided using the following programming language:

- [Microsoft Visual Studio.NET](#)
- [Microsoft Visual Basic 6.0](#)
- [Microsoft Visual C++ 6.0](#)

Microsoft Visual Studio.NET

The following examples are console applications. Follow the steps below to run in Microsoft Visual Studio.NET.

- 1** Create a new .NET console application project.
- 2** Delete the contents of the source file.
- 3** Copy the desired applicable example code into the source code file.
 - [“Example code using Microsoft C#.NET”](#) on page 82
 - [“Example code using Microsoft Visual Basic.NET”](#) on page 85
 - [“Example code using Microsoft Visual C++.NET”](#) on page 88
- 4** Add a reference to the DLL – refer to [“Adding a reference \(Microsoft Visual Studio.NET\)”](#) on page 61.

Example code using Microsoft C#.NET

This sample program shows how to program the V3500A using Microsoft C#.NET 2003.

```
using System;
namespace ExampleV3500A
{
    class Class1
    {
        [STAThread]
        static void Main(string[] args)
        {
            string Reply;
            double MeasuredPower;
            // The namespace for the V3500A driver is KeysightV3500A_NS.
            // First, create the V3500A object.
            KeysightV3500A_NS.KeysightV3500A myPM =new KeysightV3500A_NS.KeysightV3500A();
            // Set the serial number and check that the meter is available
            int SN=10973300; // Set this to the numerical serial number of your V3500A (without prefix)
            int MeterAvailable=myPM.IsDeviceAvailable(SN);
            // A return value of 1 means the V3500A is available.
            // A value of -1 means it is absent, and a value of 0 means it is unavailable (for example, it may be in
            use by another program).
            if (MeterAvailable != 1)
            {
                Console.WriteLine("PowerMeter not available; status={0}",MeterAvailable);
                return;
            }
            Console.WriteLine("V3500A serial number {0} is available", SN);
            myPM.SerialNumber=SN;
```

```
// Initialize the V3500A
try
{
myPM.Initialize();
}
// If initialization fails:
catch(Exception e)
{
    Console.WriteLine("Error initializing PowerMeter: "+e.Message);
    return;
}
Console.WriteLine("V3500A initialized");
// Now we can communicate with the V3500A.
// Configure the V3500A for a measurement:
try
{
    Reply=myPM.SendString("*RST\n"); // Reset the power meter
    CheckForOK(Reply);
    Reply=myPM.SendString("FREQ1000\n"); // Set the frequency to 1000 MHz
    CheckForOK(Reply);
}
// If an error occurred:
catch(Exception e2)
{
    Console.WriteLine("Error communicating with PowerMeter: "+e2.Message);
    return;
}
Console.WriteLine("V3500A configured");
```

3 Driver Installation and Commands

```
// Take a reading:
try
{
    Reply=myPM.SendString("*TRG\n");
    MeasuredPower=Convert.ToDouble(Reply);
}
// If an error occurred:
catch(Exception e3)
{
    Console.WriteLine("Error reading power from the PowerMeter:
"+e3.Message);
    return;
}
Console.WriteLine("Measured power was {0:F2} dBm",MeasuredPower);
}
static void CheckForOK(string Message)
{
    if (Message.Equals("OK"))
        return;
    else
    {
        Console.WriteLine("Expected an 'OK' from the V3500A; received:
"+Message);
    }
}
}
```

Example code using Microsoft Visual Basic.NET

This sample program shows how to program the Keysight V3500A PowerMeter using Microsoft Visual Basic .NET 2003

```

Module Module1
  Sub Main()
    Dim MeasuredPower As Double
    Dim Reply As String
    Dim SN As Integer
    Dim MeterAvailable As Integer

    ' The namespace for the V3500A driver is KeysightV3500_NS
    ' First, create the PowerMeter object
    Dim myPM As KeysightV3500A_NS.KeysightV3500A
    myPM = New KeysightV3500A_NS.Keysight3500A

    'Set the serial number and check that the meter is available
    SN = 10973300 'Set this to the numerical serial number of your V3500A (without prefix)
    MeterAvailable = myPM.IsDeviceAvailable(SN)

    ' A return value of 1 means the PowerMeter is available.
    ' A value of -1 means it is absent, and a value of 0 means it is unavailable (for example, it may be in use
    by another program).

    If (MeterAvailable <> 1) Then
      Dim Message As String
      Message = "PowerMeter is not available; status=" + MeterAvailable.ToString()
      Console.WriteLine(Message)
      Exit Sub
    End If

    Console.WriteLine("V3500A serial number {0} is available", SN)
    myPM.SerialNumber = SN
  
```

3 Driver Installation and Commands

```
' Initialize the PowerMeter
Try
    myPM.Initialize()
    ' If initialization fails:
Catch e As Exception
    Console.WriteLine("Error opening V3500A: " & e.Message)
Exit Sub
End Try
Console.WriteLine("V3500A initialized")

' Now we can communicate with the PowerMeter.
' Configure the PowerMeter for a measurement:
Try
    Reply = myPM.SendString("*RST" & vbLf) 'Reset the PowerMeter
    CheckForOK(Reply)
    Reply = myPM.SendString("FREQ1000" & vbLf) 'Set the frequency to 1000 MHz
    CheckForOK(Reply)
    ' If an error occurred:
Catch e2 As Exception
    Console.WriteLine("Error sending to V3500A: " & e2.Message)
Exit Sub
End Try
Console.WriteLine("V3500A configured")

' Take a reading:
Try
    Reply = myPM.SendString("*TRG" & vbLf) ' Trigger a power measurement
    MeasuredPower = Convert.ToDouble(Reply)
Catch e3 As Exception
    Console.WriteLine("Error reading power from V3500A: " & e3.Message)
```

```
        Exit Sub
    End Try
    Console.WriteLine("The measured power was " & MeasuredPower.ToString())
    ' Now that we're done, close the V3500A, making available for other users
    myPM.Close()
End Sub
Private Sub CheckForOK(ByVal Message As String)
    If (Message.Equals("OK")) Then
        Exit Sub
    End If
    Console.WriteLine("Expected an 'OK' from the V3500A, received: " & Message)
End Sub
End Module
```

Example code using Microsoft Visual C++.NET

// This sample program shows how to program the V3500A using Microsoft Visual C++.NET 2003

```
#include "stdafx.h"
using <mscorlib.dll>
using namespace System;
using namespace KeysightV3500A_NS;
int _tmain()
{
    String * Reply;
    double MeasuredPower;
    void CheckForOK(String * Msg);
    // The namespace for the V3500A driver is KeysightV3500A_NS.
    // First, create the V3500A object.
    KeysightV3500A_NS::KeysightV3500A *myPM =new KeysightV3500A();
    // Set the serial number and check that the meter is available.
    int SN=10973300; // Set this to the numerical serial number of your V3500A (without
    prefix)
    int MeterAvailable=myPM->IsDeviceAvailable(SN);
    // A return value of 1 means the V3500A is available.
    // A value of -1 means it is absent, and a value of 0 means it is unavailable (for example, it may be in use by
    another program).
    if (MeterAvailable != 1)
    {
        Console::WriteLine(S"PowerMeter not available; status={0}",__box(MeterAvailable));
        return 0;
    }
    Console::WriteLine("V3500A serial number {0} is available", __box(SN));
    myPM->SerialNumber=SN;
```



```

// Initialize the V3500A.
try
{
    myPM->Initialize();
}
// If initialization fails:
catch(Exception *e)
{
    Console::Write(S"Error initializing PowerMeter: ");
    Console::WriteLine(e->Message);
    return 0;
}
Console::WriteLine(S"V3500A initialized");
// Now we can communicate with the V3500A.
// Configure the V3500A for a measurement:
try
{
    Reply=myPM->SendString("*RST\n"); // Reset the power meter
    CheckForOK(Reply);
    Reply=myPM->SendString("FREQ1000\n"); // Set the frequency to 1000 MHz
    CheckForOK(Reply);
}
// If an error occurred:
catch(Exception *e2)
{
    Console::Write(S"Error communicating with PowerMeter: ");
    Console::WriteLine(e2->Message);
    return 0;
}

```

3 Driver Installation and Commands

```
}  
Console::WriteLine(S"V3500A configured for power measurement");  
// Take a reading:  
try  
{  
    Reply=myPM->SendString("*TRG\n");  
    MeasuredPower=Convert::ToDouble(Reply);  
}  
// If an error occurred:  
catch(Exception *e3)  
{  
    Console::Write(S"Error reading power from the PowerMeter: ");  
    Console::WriteLine(e3->Message);  
    return 0;  
}  
Console::WriteLine(S"Measured power was {0:F2} dBm", __box(MeasuredPower));  
return 1;  
}  
void CheckForOK(String * Message)  
{  
    if (Message->Equals("OK"))  
        return;  
    else  
    {  
        Console::Write(S"Expected an 'OK' from the V3500A; received: ");  
        Console::WriteLine(Message);  
    }  
}
```

Microsoft Visual Basic 6.0

This example section contains a Windows Forms application. Follow the steps below to run in Microsoft Visual Basic 6.0:

- 1** Create a new Windows Forms project.
- 2** Delete the source code of the newly created Windows Forms project.
- 3** Copy the following code into the source code file.
- 4** Create three controls on the form:
 - A button named btnReadPower
 - A button named btnExit
 - A text box named txtMessages
- 5** Add a reference to the DLL – refer to [“Adding a reference \(Visual Basic 6.0\)”](#) on page 61.

Example code using Microsoft Visual Basic 6.0

This sample program shows how to program the V3500A using Microsoft Visual Basic 6.0.

```

Dim myPM As New KeysightV3500A.KeysightV3500A
Dim Message As String
Private Sub btnExit_Click()
    myPM.Close
End
End Sub
Private Sub btnReadPower_Click()
    Dim MeasuredPower As Double
    Dim Reply As String
    ' Now we can communicate with the V3500A.
    ' Configure the V3500A for a measurement:
    On Error GoTo Err_Failed_Setup
    Reply = myPM.SendString("*RST" & vbCrLf) ' Reset the V3500A
    CheckForOK(Reply)
    Reply = myPM.SendString("FREQ1000" & vbCrLf) ' Set the frequency to 1000 MHz
    CheckForOK(Reply)
    Message = Message & "V3500A configured." & vbCrLf
    txtMessages.Text = Message
    'Take a reading:
    On Error GoTo Err_Failed_Read
    Reply = myPM.SendString("*TRG" & vbCrLf)
    Message = Message & "Measured power: " & Reply & " dBm." & vbCrLf
    txtMessages.Text = Message
Exit Sub
Err_Failed_Setup:

```

```

Message = Message & "Error configuring V3500A for measurement: " & Err.Description &
vbCrLf
txtMessages.Text = Message
Exit Sub
Err_Failed_Read:
Message = Message & "Error reading power from V3500A: " & Err.Description & vbCrLf
txtMessages.Text = Message
Exit Sub
Err_Failed_Send:
MsgBox("Error during send " & Err.Description)
End Sub
Private Sub CheckForOK(ByVal Msg As String)
Dim StringCompare As Integer
StringComp = StrComp(Msg, "OK")
If (StringCompare = 0) Then
Exit Sub
Else
Message = Message & "Expected an 'OK' from the V3500A; received: " & Msg & vbCrLf
txtMessages.Text = Message
End If
End Sub

Private Sub Form_Load()
Dim SN As Long
Dim MeterAvailable As Integer
Message = ""
' Attempt to register the V3500A DLL
On Error GoTo Err_DLL_Not_Registered

```

3 Driver Installation and Commands

```
Message = Message & "Successfully created V3500A object." & vbCrLf txtMessages.Text =
Message
' Set the serial number and check that the meter is available
SN = 10973300 ' Set this to the numerical serial number of your V3500A (without prefix)
MeterAvailable = myPM.IsDeviceAvailable(SN)
' A return value of 1 means the V3500A is available.
' A value of -1 means it is absent, and a value of 0 means it is unavailable (for example, it may be in use by
another program).
If (MeterAvailable <> 1) Then
    Message = Message & "PowerMeter is not available; status=" & MeterAvailable &
    vbCrLf
    txtMessages.Text = Message
    Exit Sub
End If
Message = Message & "V3500A serial number " & SN & " is available." & vbCrLf
txtMessages.Text = Message
myPM.SerialNumber = SN
' Initialize the V3500A
On Error GoTo Err_Failed_Initialize
myPm.Initialize
Message = Message & "V3500A successfully initialized." & vbCrLf
txtMessages.Text = Message
Exit Sub

Err_DLL_Not_Registered:
' Check to see if error 429 occurs
If Err.Number = 429 Then
    Message = Message & "Failed To Register V3500A DLL" & vbCrLf
Else
    Message = Message & "Error creating V3500A object: " & Err.Description & vbCrLf
```

```
End If
```

```
txtMessages.Text = Message
```

```
Exit Sub
```

```
Err_Failed_Initialize:
```

```
Message = Message & "Error initializing V3500A: " & Err.Description & vbCrLf
```

```
txtMessages.Text = Message
```

```
Exit Sub
```

```
End Sub
```

Microsoft Visual C++ 6.0

This example is a console application. Follow the steps below to run in Visual C++ 6.0:

- 1 Create a new Win32 Console Application.
- 2 Delete the source code of the newly created console application project.
- 3 Copy the following code into the source code file.

NOTE

Although Visual C++ 6.0 does not need any special steps to reference the DLL, make sure the code refers to the correct installation directory – refer to [“Adding a reference \(Microsoft Visual C++ 6.0\)”](#) on page 62. In the sample code below, the specific program statement regarding the driver file installation is in bold-face type style.

Example code using Microsoft Visual C++ 6.0

This sample program shows how to program the V3500A using Microsoft Visual C++ 6.0.

```
#include "stdafx.h"
#include <atlbase.h>
#include <atlconv.h>
#include <iostream.h>
#include <windows.h>
#include <stdio.h>

#pragma warning (disable: 4278)
#import "C:\Program Files\Keysight\Keysight V3500A Driver KeysightV3500A.tlb" \
no_namespace named_guids
void dump_com_error(_com_error &e);
void CheckForOK(BSTR Message);
```



```

int main(int argc, char* argv[])
{
    PMInterface *myPM = NULL;
    BSTR Reply=NULL;
    int MeterAvailable=0;
    int SN;
    USES_CONVERSION; // Enables use of ATL string conversion macros
    CoInitialize(NULL); // Initializes the COM library on the current thread
    // Create an instance of the V3500A driver:
    HRESULT hr = CoCreateInstance(CLSID_KeysightV3500A,NULL, CLSCTX_INPROC_SERVER,
    IID_PMInterface, reinterpret_cast<void**>(&myPM));
    if (FAILED(hr))
    {
        printf("Couldn't create an instance of the V3500A driver!... 0x%x\n", hr);
        return 0;
    }

    // Set the serial number and check that the meter is available
    SN=10973300; // Set this to the numerical serial number of your V3500A (without prefix)
    try
    {
        MeterAvailable=myPM->IsDeviceAvailable(SN);
    }
    catch (_com_error& e)
    {
        cout << "COM error on IsDeviceAvailable"<<endl;
        dump_com_error(e);
        return 0;
    }
}

```

3 Driver Installation and Commands

```
    }

// A return value of 1 from IsDeviceAvailable() means the V3500A is available.
// A value of -1 means it is absent, and a value of 0 means it is unavailable (for example, it may be in use by
another program).
if (MeterAvailable != 1)
{
    cout << "V3500A PowerMeter is not available; status= "<<MeterAvailable<<endl;
    return 0;
}
cout<<"V3500A serial number "<< SN << " is available"<<endl;
myPM->SerialNumber=SN;

// Initialize the V3500A
try
{
myPM->Initialize();
}
// This catches errors with COM:
catch (_com_error& e)
{
    cout << "COM error initializing V3500A:"<<endl;
    dump_com_error(e);
}
// This catches all other errors.
catch (...)
{
    cout << "Error initializing" << endl;
}
```

```

    return 0;
}
cout << "V3500A initialized" << endl;
// Setup the V3500A for a measurement:
try
{
    Reply=myPM->SendString("*RST\n"); // Reset the V3500A
    CheckForOK(Reply);
    Reply=myPM->SendString("FREQ1000\n"); // Set the frequency to 1000 MHz
    CheckForOK(Reply);
}
// This catches errors with COM:
catch (_com_error& e)
{
    cout << "COM error while programming V3500A:"<<endl;
    dump_com_error(e);
}
// This catches all other errors.
catch (...)
{
    cout << "Error programming V3500A" << endl;
}
cout << "V3500A configured for power measurement" << endl;

// Take a reading:
try
{
    Reply=myPM->SendString("*TRG\n");

```

3 Driver Installation and Commands

```
    cout << "Measured power: " << W2A(Reply) << endl;
}
catch (_com_error& e)
{
    cout << "COM error while making a power measurement with V3500A"<<endl;
    dump_com_error(e);
}
catch (...)
{
    cout << "Error reading power from V3500A" << endl;
}
myPM->Release();
myPM=NULL;
CoUninitialize();
return 1;
}

void dump_com_error(_com_error &e)
{
    _tprintf(_T("COM Error Information:\n"));
    _tprintf(_T("Code = %08lx\n"), e.Error());
    _tprintf(_T("Code meaning = %s\n"), e.ErrorMessage());
    _bstr_t bstrSource(e.Source());
    _bstr_t bstrDescription(e.Description());
    _tprintf(_T("Source = %s\n"), (LPCTSTR) bstrSource);
    _tprintf(_T("Description = %s\n"), (LPCTSTR) bstrDescription);
}
void CheckForOK(BSTR Message)
```

```
{
    USES_CONVERSION; // Enables use of ATL string conversion macros
    char ExpectedReturn[]="OK";
    char *ActualReturn=W2A(Message);
    int Result=strcmp(ActualReturn,ExpectedReturn);
    if (Result)
    {
        cout << "Expected an 'OK' from the V3500A, received " << W2A(Message) << endl;
    }
}
```

THIS PAGE HAS BEEN INTENTIONALLY LEFT BLANK.

4 RF Measurement Basics

Power Definition	104
Units of Measurement	105
RF Power Measurement	106

This chapter describes the RF measurement basics of the V3500A Handheld RF Power Meter.

Power Definition

In electrical circuits, power delivered to an electrical load can be defined as:

$$P = \frac{V^2}{R}$$

where

P is the delivered power.

V is the voltage applied to the load.

R is the resistance of the load.

When the power is in the form of an AC waveform, a more complex definition is needed. The cyclic power from the AC waveform varies with time. Although the power of an AC waveform delivered at a specific time can still be defined using the above formula, this does not adequately describe the AC waveform power delivered to a load. Power of an AC waveform delivered to an electrical load is equal to the mean power delivered over the course of one cycle of the sinusoidal waveform defined by:

$$P = \int_0^T (V_{\text{peak}} \cos((2\Pi t)/T))^2 / R dt$$

where

T is the period of the AC waveform.

Evaluating the integral, we can reduce this expression to:

$$P = \frac{V_0^2}{R}$$

where

V_0 is known as the root mean square (RMS) voltage of the sinusoid.

$$V_0 = \frac{V_{\text{peak}}}{\sqrt{2}}$$

Units of Measurement

RF power measurements can be expressed in either Watts or dBm. The V3500A can display results in either Watts or dBm.

Watts

Watts are the standard SI unit for power measurements. In electrical terms, one volt applied across a one-ohm resistor dissipates one watt of power.

Decibels

Decibels (abbreviated dB), are a logarithmic scale used to express power. Decibels are inherently a ratio measurement providing the relative magnitude of two different numbers.

For power measurements, the difference between two signals in decibels is:

$$10 \times \log_{10} \left(\frac{P_1}{P_0} \right)$$

where

P_1 and P_0 are the two power levels to be compared.

Absolute measurement can be made on the decibel scale by using a standard power level in place of P_0 . If P_0 is defined to be 1 milliwatt, the resulting units are called "dBm." Power expressed in dBm is calculated with the formula:

$$P_{\text{dBm}} = 10 \times \log_{10} \left(\frac{P_1}{1\text{mW}} \right)$$

RF Power Measurement

Low frequency method

At low frequencies, power delivered from an AC source to a load can be measured with an AC voltmeter connected across the load terminals (see [Figure 4-1](#)). The voltmeter provides a high enough input resistance that at low frequencies, the effective value of load resistance is not changed.

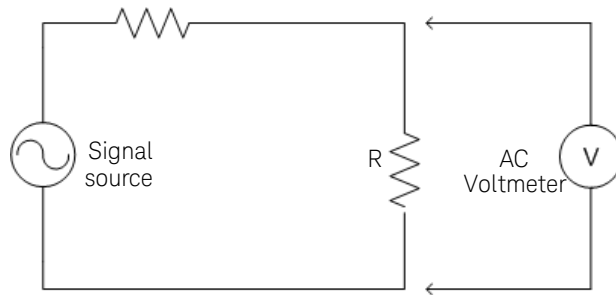

Figure 4-1 Low frequency power measurement

High frequency method

At high frequencies, the low frequency measurement technique produces inaccurate readings. To produce reliable results, a different method is required.

Inaccurate readings could be caused by parasitic capacitance in low frequency method. Parasitic capacitance causes the impedance of the shunt voltmeter to decrease, thereby behaving unpredictably with frequency.

The high frequency method replaces the AC Voltmeter (as described in the [Low frequency method](#)) with an RF power meter (the RF power meter has an internal, known load resistance). This effectively replaces the circuit's load resistor (R) with the characteristic impedance (Z_0) built-in to the RF power meter (see [Figure 4-2](#)).

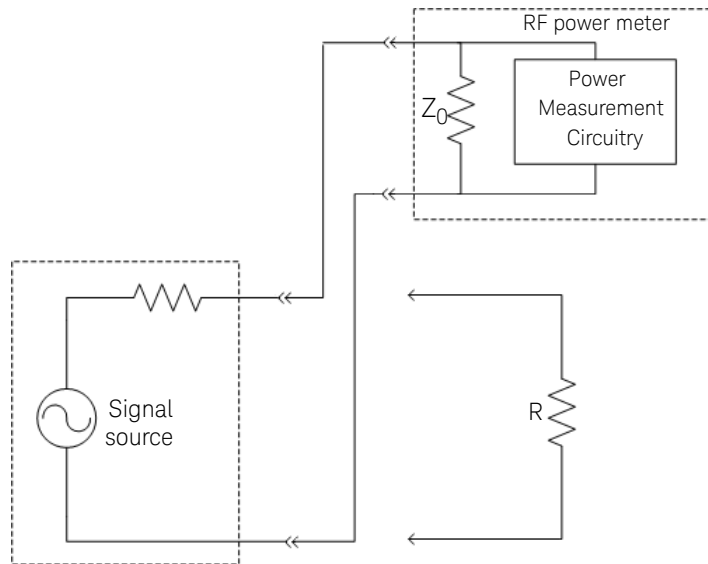

Figure 4-2 High frequency power measurement

RF circuits and systems are usually designed to work with a standard impedance value called the characteristic impedance (refer to Z_0 in [Figure 4-2](#)). Typical signal sources are designed to work with a load of the same impedance, Z_0 . Generally, the Z_0 value for RF circuits is $50\ \Omega$ or $75\ \Omega$, with $50\ \Omega$ being the most common. The internal load resistance of the power meter is designed to equal Z_0 .

Power of various types of signals

Continuous-wave signals

Continuous-wave (CW) signals are the simplest form of RF signal. CW signals consist of a constant sine wave. Power measurements on this type of wave result in a single numerical value.

Modulated signals

Modulated signals are sinusoids whose amplitude, phase, or frequency change with respect to time. Changes in either the phase or frequency do not change the power of the signal, but changes in amplitude causes change in the power level.

Two approaches can be taken to characterizing the power of modulated signals:

- Peak power meter

A peak power meter measures the power of the signal very rapidly (faster than the rate at which the modulation changes). The results can then be displayed in a graph of power versus time similar to an oscilloscope display. This approach has the advantage of displaying a great deal of information. One disadvantage is that the results can be difficult to interpret – especially for the complex modulation schemes in use today.

- Average power meter (the V3500A takes this approach)

An averaging power meter measures the power versus time of the signal, but then averages the result – condensing the measurement to a single number. The V3500A is an averaging power meter. In effect, the power meter performs the following calculation:

$$P_{\text{avg}} = \frac{1}{T} \int_0^T P(t) dt$$

where

$P(t)$ is the power of the modulated signal as a function of time.

In cases where the modulation format is known, the peak instantaneous power can be calculated from the average power.

Pulse-modulated signals

As an example, consider the pulse-modulated signal shown in [Figure 4-3](#).

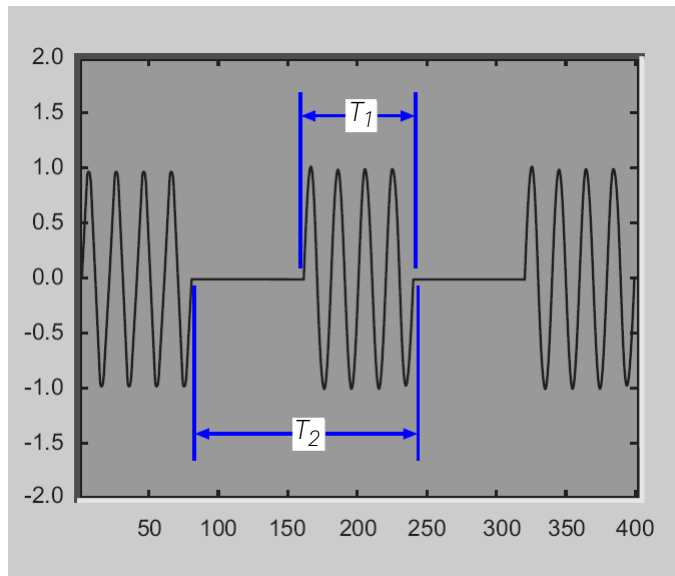

Figure 4-3 Example of pulse-modulated signals

T_1 is the pulse width of the signal – the time duration of the pulsed signal on state.

T_2 is the period of the waveform – how often the pulses occur.

Since the power is constant over the interval T_1 , and since the power is zero over the remainder of the interval T_2 , the average and peak power of pulse modulated signals are related by the equation:

$$P_{\text{peak}} = \frac{T_1}{T_2} P_{\text{avg}}$$

where

T_1 is the pulse width of the signal.

T_2 is the period of the waveform

In decibels, this would be expressed as:

$$P_{\text{peak, dB}} = 10 \times \log_{10}(T_2/T_1) + P_{\text{avg, dB}}$$

Measurement accuracy

Mismatch error

Mismatch error is one of the primary factors affecting power measurement accuracy. The goal is to measure the power that a source will deliver into a load of impedance Z_0 . The power meter is designed to have an impedance as close as possible to Z_0 . Since its impedance is not exactly Z_0 , the power delivered to the meter is not exactly equal to the power delivered to a perfect load.

Deriving the equations to calculate the mismatch error is beyond the scope of this document, but the results can be easily understood.

Consider the setup in [Figure 4-4](#). A source of output impedance Z_g is connected to a load of impedance Z_l .

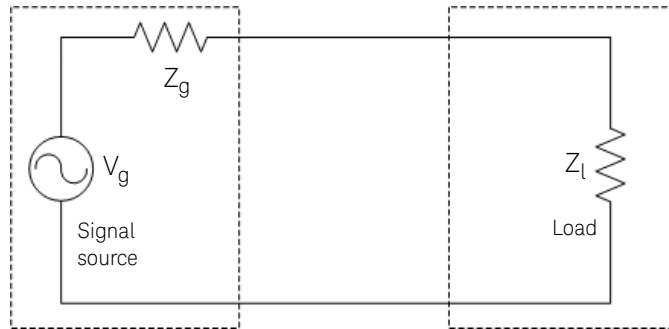

Figure 4-4 Mismatch in power measurements

The reflection coefficient of a device (Γ_g) is a measure of its impedance relative to Z_0 (Z_0 is the characteristic impedance of the system).

The reflection coefficient of the source (Γ_g) is defined as:

$$\Gamma_g = \frac{Z_g - Z_0}{Z_g + Z_0}$$

Similarly, the reflection coefficient (Γ_l) of the load is defined as:

$$\Gamma_l = \frac{Z_l - Z_0}{Z_l + Z_0}$$

If the source or load impedance is exactly equal to Z_0 , the corresponding reflection coefficient is zero. For simplicity, let's assume V_g is defined as:

$$V_g = \frac{Z_g + Z_0}{Z_0} \sqrt{Z_0}$$

With V_g defined as in the above equation – the source will deliver one watt to a load of impedance Z_0 . The power delivered to the actual load is then defined by:

$$P_{\text{load}} = \frac{1 - |\Gamma_l|^2}{|1 - \Gamma_g \Gamma_l|^2}$$

Into a perfect load of impedance Z_0 , the power delivered to the load is:

$$P_{\text{load}, Z_0} = 1$$

The mismatch error in the power measurement, then, is the ratio between P_{load, Z_0} and the power delivered to the actual load presented by the power meter is defined by:

$$\frac{P_{\text{load, meter}}}{P_{\text{load}, Z_0}} = \frac{1 - |\Gamma_{\text{meter}}|^2}{|1 - \Gamma_g \Gamma_{\text{meter}}|^2}$$

If the magnitude and phase of the source and load reflection coefficient are known, this mismatch error can be calculated and compensated for – completely eliminating mismatch uncertainty and an error term.

Alternatively, if just the magnitude of the power meter reflection coefficient is known, we can then exactly calculate the term in the numerator of the previous equation and remove its effect on measurement uncertainty. In that case, the equation becomes:

$$P_{\text{load}, Z_0} = |1 - \Gamma_g \Gamma_{\text{meter}}|^2 \times \frac{P_{\text{load, meter}}}{1 - |\Gamma_{\text{meter}}|^2}$$

The error term $|1 - \Gamma_g \Gamma_{\text{meter}}|^2$ depends on both the magnitude and phase of the source and load reflection coefficients. Frequently, the magnitude of the reflection coefficient is known or specified, but the phase is unknown. The error term will reach its maximum value when both reflection coefficients are real and 180° out of phase. This maximum error ratio is described by the equation:

$$\text{MaximumErrorRatio} = (1 + |\Gamma_g| |\Gamma_{\text{meter}}|)^2$$

The error term will reach its minimum when both reflection coefficients are real and in-phase. This minimum error ratio is described by the equation:

$$\text{MinimumErrorRatio} = (1 - |\Gamma_g| |\Gamma_{\text{meter}}|)^2$$

With this information – and knowing or estimating the reflection coefficient of the device under test – estimation of the mismatch measurement uncertainty is possible.

5 Characteristics and Specifications

NOTE

For the characteristics and specifications of the V3500A handheld RF power meter, refer to the datasheet at <http://literature.cdn.keysight.com/litweb/pdf/5990-5483EN.pdf>.

THIS PAGE HAS BEEN INTENTIONALLY LEFT BLANK.

Index

A

average
 power meter, 108
 RF power, 19
averaging, 32

B

backlight, 30, 32, 39
basic, 66, 73
bus connections, 64

C

commands
 averaging control, 75
 basic driver, 66
 basic V3500A, 73
 measurement speed control, 77
 miscellaneous, 80
 remote USB, 65
 unit of measurement, 78
connectivity, 22
connector
 external power, 25
 RF, 22
 Type-N, 22

D

dBm, 38
decibels, 105
dimensions, 28

E

error ratio
 maximum, 112
 minimum, 112
examples, 33, 79

F

features, 19

H

high frequency method, 106
high-speed mode, 36

I

inspection, 20
instrument state recalling, 38
saving, 37

K

keypad, 29

L

low frequency method, 106

M

measurement, 105
 accuracy, 110
 speed, 36, 77
 unit, 32
menu map, 31
mismatch error, 110

O

offset, 29, 39
operation
 front panel, 34

P

power
 connector, 25
 definition, 104
 limitations, 23

measurement, 106
supply, 25

pulse, 109
purchase items
 optional, 20
 standard, 20

R

relative, 39, 105, 110
requirements, 42
RF
 connector, 22
 measurement basics, 103
 power measurement, 106

S

setting, 33
 backlight auto-shutoff interval, 39
 input frequency, 35
 instrument, 22
 measurement speed, 36
 units, 38
signals, 108

U

units, 32, 38
USB, 24, 43, 49, 64, 65

W

watts, 38, 105

Z

zeroing, 29, 35

THIS PAGE HAS BEEN INTENTIONALLY LEFT BLANK.



This information is subject to change without notice. Always refer to the Keysight website for the latest revision.

© Keysight Technologies 2010 - 2019
Edition 8, October 14, 2019

Printed in Malaysia



V3500-90001

www.keysight.com