

Keysight M9331A  
Arbitrary Waveform Generator  
10-bit, 1.25 GS/s



# Introduction

The M9331A is a wideband arbitrary waveform generator (AWG) capable of creating digitally modulated waveforms for wideband communication systems. Each channel of the M9331A operates at 1.25 GS/s and features 10 bits of vertical resolution, which is ideal for compliance testing of digital radios targeted for use with emerging communication standards such as MB-OFDM ultra wideband, 802.11n, MIMO, and proprietary wideband formats.

- 1.25 GS/s and 10 bits of vertical resolution per channel provides wideband waveforms with exceptionally low EVM
- Dual output channels drive both single-ended and balanced designs without the need for baluns or hybrids
- Extended memory and advanced sequencing engine allows for extended simulations of complex waveform propagation models
- Multiple module synchronization provides multi-emitter simulations suitable for MIMO applications
- Multiple programmatic interfaces enable easy integration into existing test environments

## Generate Wide Bandwidth AND Low EVM Signals, Simultaneously

The M9331A is a 4 slot 3U PXI module that offers dual differential output channels to drive both single-ended and balanced designs. The AWG also supports advanced sequencing and triggering modes to create event-based signal simulations. Multiple M9331A modules can be synchronized for the generation of phase-coherent, multi-emitter scenarios. Waveform development tasks are simplified using the AWG's numerous programmatic interfaces including complete instrument control from the MATLAB® command line and from LabVIEW. When the M9331A is combined with a wideband I/Q upconverter, modulation bandwidths of 1 GHz can be realized at RF frequencies for signal simulations employed in functional testing of chip sets designed for modern digital communications radios.<sup>1</sup>

## Extended performance

The M9331A gives designers access to Digital-to-Analog Converter (DAC) technology capable of generating wideband digital communications signals with ultra-low EVM. Each module incorporates two high-speed DACs to create 500 MHz of signal bandwidth and  $\leq -50$  dBc SFDR across each channel. Users have the choice of driving their designs differentially from the DAC outputs or through multiple signal-conditioning paths. Although some AWGs require users to make a trade-off between the number of output channels and differential outputs, the M9331A provides both—allowing you to drive your designs and eliminating the need for baluns or hybrids in the test path. In addition, each channel can output waveforms as an IF or as a baseband signal for I/Q upconversion.

1. Keysight E8267D PSG signal generator with option 016 wide-band I/Q inputs.

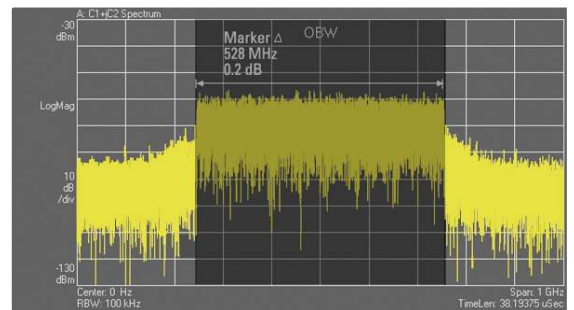

Figure 1a. Generate MB-OFDM compliant UWB waveforms.

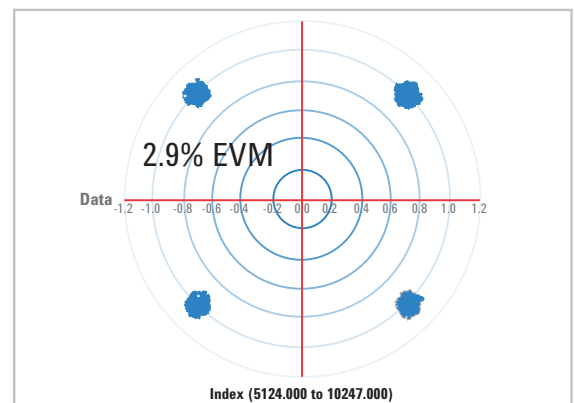

Figure 1b. Create UWB reference waveforms with low EVM.

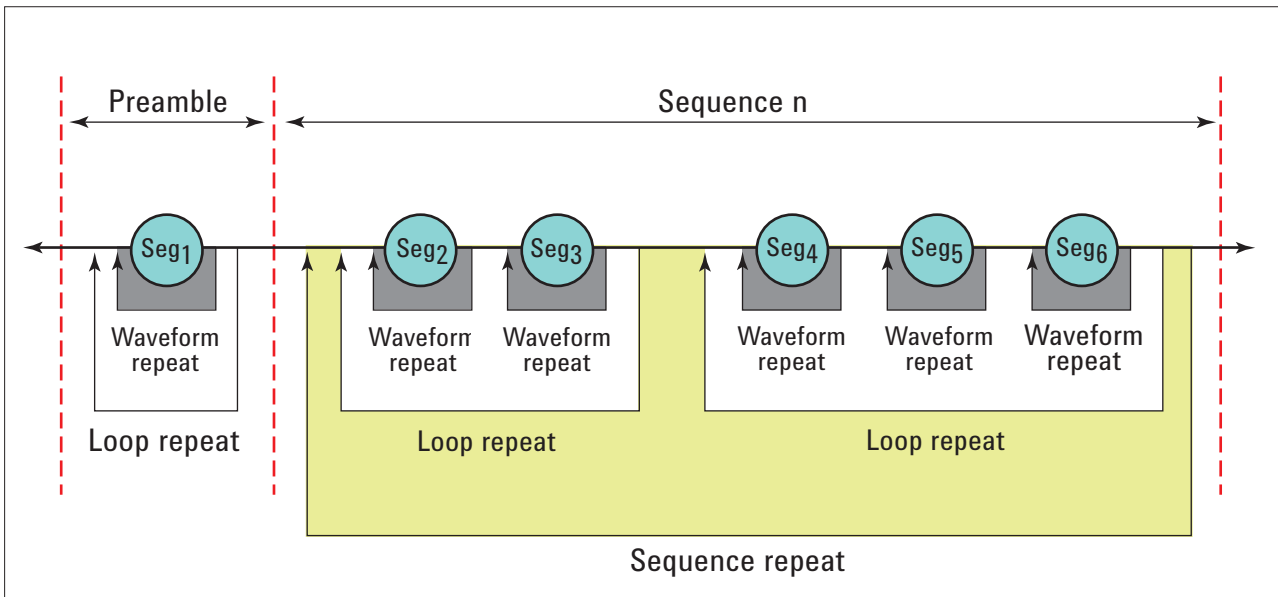

Figure 2. Create sophisticated signal scenarios by looping and nesting waveforms.

### Create long scenerio simulations

Multiply the effective size of on-board memory through the use of the M9331A's advanced sequencing engine. Uniquely define how waveform segments are played through looping and nesting of stored waveform models. This capability gives users the ability to simulate fading and other multi-path effects for extended periods of time. For users developing a large number of propagation models the PXI backplane substantially reduces waveform download times compared to traditional LAN and GPIB interfaces. The M9331A's complete waveform and sequencer memories can be typically reloaded in less than 1 second.



Figure 3. Multi-path effects can be simulated through propagation models.

## System stability

Create phase-coherent, multiemitter simulations using the M9331A's precision SYNC clock. A single M9331A can drive a total of eight AWG modules to synchronize their outputs on a sample-by-sample basis. Any number modules can be synchronized with simple driver hardware. The AWG also includes multiple front-panel trigger and markers for complete system synchronization.



Figure 4. Four M9331A modules fit conveniently inside an 18 slot PXI chassis.

## Ease-of-use

The M9331A's graphical user interface guides developers through module setup and waveform file transfers. Users can quickly configure the instrument's signal conditioning paths, marker and trigger lines, sample and reference clock sources and simple sequencing functions. More sophisticated sequencing functions are available through the instrument's numerous programmatic interfaces. The M9331A supports interfaces for MATLAB®, LabView, IVI-C, IVI-COM, and VEE framework.

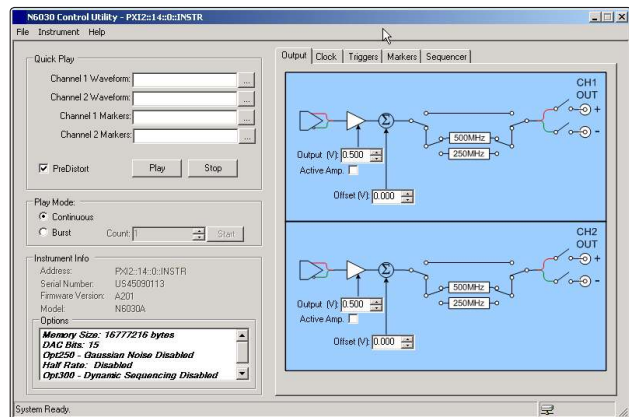

Figure 5. Directly import and play waveforms from the Quick Play menu.

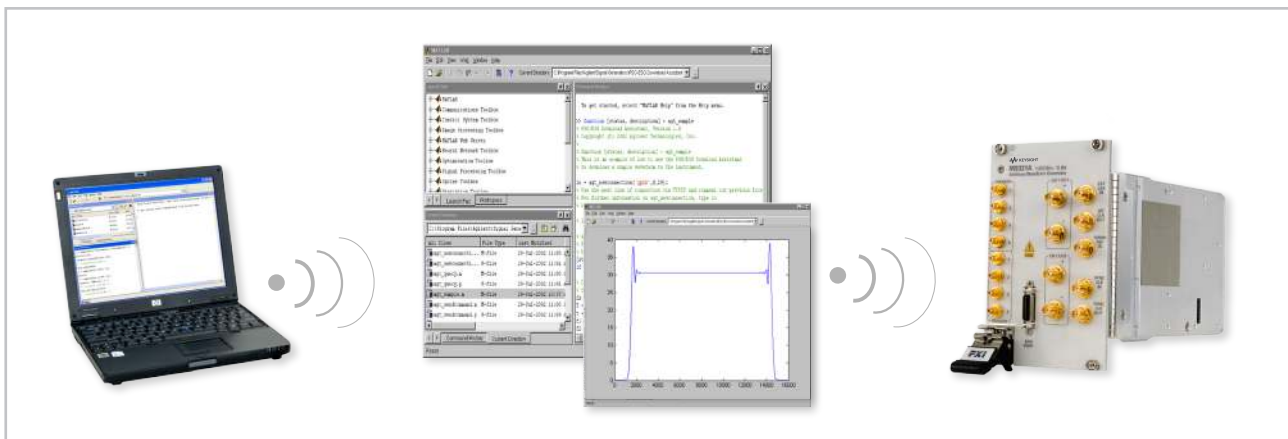
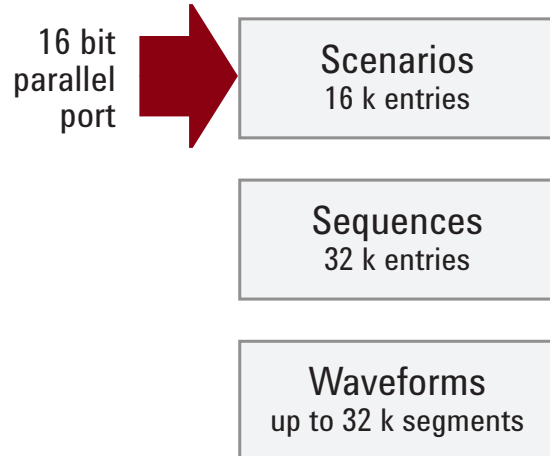

Figure 6. Play waveform files directly from the MATLAB command line.

# ENHANCED CAPABILITIES FOR THE M9330A SERIES!

## Dynamic Sequencing (Option 300)

The dynamic sequencing software enables radar and military communications engineers to build custom signal scenarios on the fly. Engineers can dynamically access up to 16k of previously stored sequences through a 16-bit interface and replay these complex waveforms to respond to changing threat environments, or to create signals where the next waveform to be played is not known in advance.



## Dynamic Synthesis (Option 330)

The direct digital synthesis (DDS) enables radar and emerging-communications engineers to create basic waveforms in the AWG's memory and then modify their behavior with profiles for amplitude modulation, phase modulation and frequency modulation. This enables engineers to simulate testing without the time and expense of field trials, such as in-flight and in-orbit testing. This option can also be used to simulate fading profiles in receiver testing for satellite and 4G signals, such as multiple input, multiple output formats (MIMO).

Figure 8. Create signals where the next waveform to be played is not known in advance.

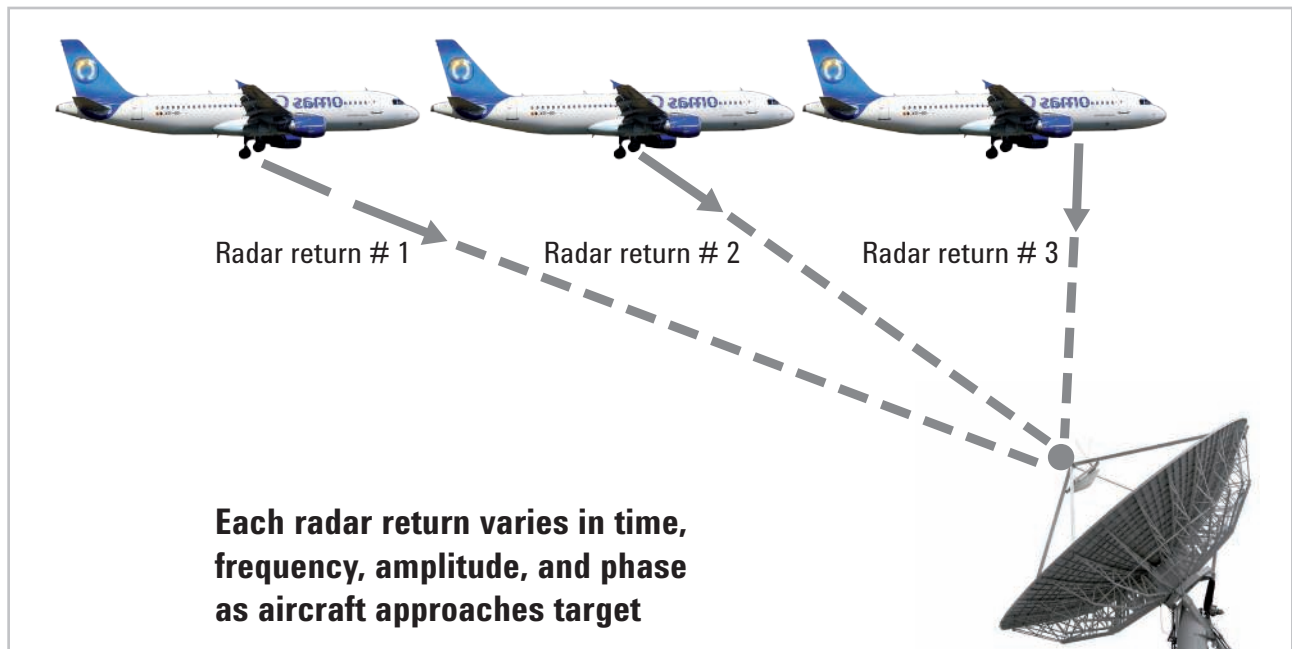

Figure 9. Define signals by carrier frequency and modulation – instant by instant.

# KEY CHARACTERISTICS

## Channels

Two independent channels available as baseband or IF outputs	CH1: Single-ended and differential CH2: Single-ended and differential
Modulation bandwidth	500 MHz per channel (1 GHz IQ bandwidth)
Resolution	10 bits (1/1024 levels)
Output spectral purity – (CH1 and CH2)	Harmonic distortion: <ul style="list-style-type: none"> <li>• <math>\leq -50</math> dBc for each channel DC to 500 MHz</li> </ul> Non-Harmonic spurious: <ul style="list-style-type: none"> <li>• <math>\leq -75</math> dBc for each channel 1 kHz to 500 MHz</li> <li>• Noise floor: <math>\leq -150</math> dBc/Hz across the channel band width</li> </ul>

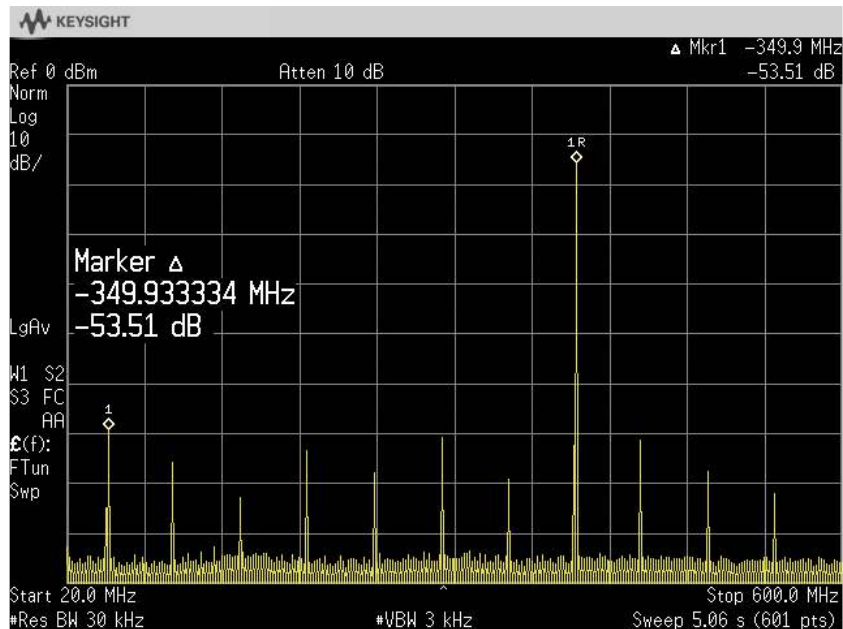

Figure 10. Excellent harmonic and spurious performance are available across the full bandwidth of each channel.

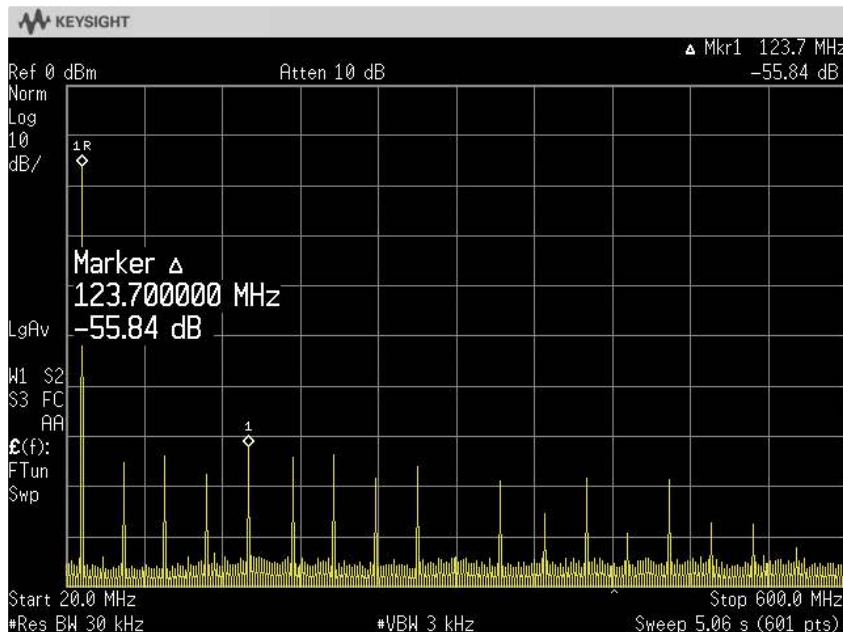

Figure 11. Spurious performance outstanding at low signal frequencies.

## KEY CHARACTERISTICS, CONTINUED

### Sample clock

Internal	Fixed 1.25 GS/s
Internal clock output	+3 dBm nominal
External clock input	Tunable 100 MS/s to 1.25 GS/s
External clock input drive level	+5 to -15 dBm typical
Phase noise characteristics	1 kHz: -95 dBc/Hz 10 kHz: -115 dBc/Hz 100 kHz: -138 dBc/Hz 1 MHz: -150 dBc/Hz
Noise floor	-150 dBc/Hz
Accuracy	Same as 10 MHz timebase input

### Frequency reference

Input drive level	+2 to +12 dBm into 50 ohms (+2 dBm nominal)
Waveform length	8 MS per channel (16 MS with option 016)
Minimum waveform length	128 samples
Waveform granularity	8 samples

### Segment

1 to 32 k unique segments can be defined consisting of waveform start and stop address, repetitions and marker enable flags.

### Segment loops

A total of 1 million (220) loops can be defined for each segment. Loops can be configured to advance in one of four modes:

- Single
  - The segment loop plays once and waits at the end of the loop for a trigger.
- Continuous
  - Segment loop is repeated continuously until a trigger is received.
- Auto
  - Automatically advances to the next segment after completing the specified number of loop repetitions.
- Repeat
  - The waveform loop repeats until the number of wave form loop repetitions is met.

### Sequences

Up to 32 k total unique waveform sequences can be defined. A sequence is a contiguous series of waveform segments.

### Advanced sequencing

Enables users to build and playback scenarios, which are comprised of one or more sequences.

### Scenarios

1 to 16 k pointers can be assigned to play pre-defined sequences. Sequence play begins with the first sequence entry and continues uninterrupted until the last entry is played. The table repeats until stopped.

## KEY CHARACTERISTICS CONTINUED

### Scenario jump modes

Scenario jumps determine how a sequence responds to a jump trigger. There are no discontinuities in a scenario jump other than those imposed by the waveform data. Three modes are available to control scenario jumps.

#### Jump immediate

- Jumps immediately to the next specific scenario address with a fixed latency.

#### End of waveform

- The current waveform (including repeats) is completed before jumping to a new scenario.

#### End of scenario

- The current scenario is completed before jumping to a new scenario. Jump latency is the longer of either the jump immediate latency or the length of the remaining scenario.

### Dynamic Sequencing (Option 300)

Input	20-pin mini-D connector
Input levels	All pins configured as 2.5 volt LVCMOS inputs. A logic low must fall within the $-0.2$ to $+0.5$ volts window. A logic high must be within the window of $+2.0$ to $+2.8$ volts.
Number of address bits	13 bits per channel
Total number of addressable	Scenarios 16k
Data rate for dynamic data	100 ns
Data latency	Same as front panel trigger inputs. Software pointers may also be used to point to pre-defined scenarios over the PCI backplane though latencies are not deterministic.

### Direct Digital Synthesis (Option 330)

Output frequency resolution	1 Hz
Frequency modulation	Deviation from 0 to 125 MHz (250 MHz peak-peak)
Phase modulation	Deviation from $-180$ to $+180$ degrees in 0.022 degree steps
Amplitude modulation	Modulation depth from 0 to 100% with 15 bit resolution
Single channel bandwidth	400 MHz (800 MHz I/Q)

### External triggers

Number of inputs	8 each (4 SMB female frontpanel connectors plus four software triggers over the PCI backplane from host processor)
Trigger polarity	Negative/positive
Trigger impedance	2k $\Omega$
Maximum input level	$\pm 4.5$ volts
Input sensitivity	250 mV
Trigger threshold	$-4.3$ volts to $+4.3$ volts
Trigger timing resolution	Sample clock/8 (6.4 ns at full rate)
Trigger latency	34* clock/8 (217.6 ns at full rate)
Trigger uncertainty	< 50 ps
Minimum trigger width	12.8 ns at full clock rate
Trigger delay	Programmable from 1 to 256 sync clock cycles with 1 sync clock cycle resolution <sup>1</sup>

1. A sync clock cycle is clock/8.



## KEY CHARACTERISTICS CONTINUED

### External markers

Markers can be defined for each waveform segment.

Number of outputs	4 each SMB female
Marker polarity	Negative, positive
Output impedance	50 $\Omega$
Marker low level	100 mV nominal into high impedance load
Marker high level	3.2 volts nominal into high impedance load
Marker timing resolution	Clock/8 (6.4 ns at full rate)
Marker latency	Marker precedes analog output and is adjustable in 2 sample clock period steps.
Marker latency repeatability	< 100 ps
Marker width	Programmable with from 1 to 256 sync clock cycles <sup>1</sup>
Marker delay	Programmable from -8 to 502 sample clock cycles, with 2 sample clock cycle resolution

### Module synchronization

Supports system scaling for any number of M9331A modules. A single module can support a fan-out of 8 M9331A modules for precise triggering and repeatability. Driver boards may be used to scale any number of modules.

Sync clock output level	800 mV p-p (50 $\Omega$ , AC coupled)
Sync clock input sensitivity	100 mV p-p minimum into

### Analog output

Output connector	SMA female												
Output impedance	50 $\Omega$												
Analog output levels	The following output levels are specified into 50 $\Omega$												
	<table border="1"> <thead> <tr> <th></th> <th>Single-ended</th> <th>Differential</th> </tr> </thead> <tbody> <tr> <td><b>Passive mode</b></td> <td>0.5 Vp-p</td> <td>N/A</td> </tr> <tr> <td><b>Active mode</b></td> <td>1 Vp-p with <math>\pm 0.2</math> V offset</td> <td>N/A</td> </tr> <tr> <td><b>Direct DAC mode</b></td> <td>N/A</td> <td>1 Vp-p (0 volt offset)</td> </tr> </tbody> </table>		Single-ended	Differential	<b>Passive mode</b>	0.5 Vp-p	N/A	<b>Active mode</b>	1 Vp-p with $\pm 0.2$ V offset	N/A	<b>Direct DAC mode</b>	N/A	1 Vp-p (0 volt offset)
	Single-ended	Differential											
<b>Passive mode</b>	0.5 Vp-p	N/A											
<b>Active mode</b>	1 Vp-p with $\pm 0.2$ V offset	N/A											
<b>Direct DAC mode</b>	N/A	1 Vp-p (0 volt offset)											
Corrected passband flatness	$\pm 0.5$ dB DC - 500 MHz (with 1.25 GHz clock)												
Corrected passband group delay	$\pm 150$ ps rms DC - 500 MHz (with 1.25 GHz clock)												
Reconstruction filters	500 MHz and 250 MHz realized as 7-pole Cauer Chebychev filters plus thru-line output												

### Pulse response

Rise time	(10 to 90%) : < 1 ns
Fall time	(10 to 90%) : < 1 ns
Amplitude	0.5 V pk-pk

1. A sync clock cycle is clock/8.

## GENERAL CHARACTERISTICS

### Power

Supply	+3.3 VDC, 11.2 W +5 VDC, 22 W +12 VDC, 5 W -12 VDC, 5 W
Total power	43.2 W

### Environmental

Samples of this product have been type tested in accordance with the Keysight Environmental Test Manual and verified to be robust against the environmental stresses of Storage, Transportation, and End-use; those stresses include but are not limited to temperature, humidity, shock vibration, altitude, and power line conditions. Test methods are aligned with IEC 60068-2 and levels are similar to MIL-PRF-28800F Class 3.

Operating temperature	0 °C to +55 °C
Storage temperature	-20 °C to +70 °C
Relative humidity	Type tested: 10 to 90% at 40 °C (non-condensing)
Altitude	0 to 2000m (6500 ft) above sea level
Safety	Designed for compliance to IEC 61010-1:2001
EMC	Meets the conducted and radiated emissions and immunity requirements of IEC 61326:2002 when tested with EMC shielded filler panels separating the controller and the M9331A module, and in all open slots. The RFI gaskets must be oriented to the right.
Weight	1.14 kg (2.5 lb)
Security	All user data stored in volatile memory
Dimensions	3U, 4 slot PXI module 8.1 x 13 x 21.6 cm (3.2 x 5.1 x 8.5 inches)
ISO compliance	This modular instrument is manufactured in an ISO-9001 registered facility in concurrence with Keysight Technologies commitment to quality.



## ORDERING INFORMATION

Model	Description
M9331A	Arbitrary waveform generator with 8 MS memory per channel

Option	Description
M9331A-016	Waveform memory expansion to 16 MSa per channel

M9330A-300	Enabling software for 16-bit dynamic sequencing
------------	---

M9330A-330	Direct digital synthesis software
------------	-----------------------------------



Figure 10. Keysight M9331A AWG with controller in PXI chassis

**NOTE:** For the M9331A to work properly, at least one PXI chassis and one PXI controller type must be available.

### Web resources

Visit our web sites for additional product information and literature.

M9331A Arbitrary waveform generator  
[www.keysight.com/find/mod-awg](http://www.keysight.com/find/mod-awg)

Signal simulation systems  
[www.keysight.com/find/signalsimulation](http://www.keysight.com/find/signalsimulation)

Aerospace and defense test and measurement products and services  
[www.keysight.com/find/ad](http://www.keysight.com/find/ad)

Test and measurement accessories  
[www.keysight.com/find/accessories](http://www.keysight.com/find/accessories)

**myKeysight**

[myKeysight](#)

[www.keysight.com/find/mykeysight](http://www.keysight.com/find/mykeysight)

A personalized view into the information most relevant to you.

**PXI**

[www.pxisa.org](http://www.pxisa.org)

PCI eXtensions for Instrumentation (PXI) modular instrumentation delivers a rugged, PC-based high-performance measurement and automation system.

DEKRA Certified  
ISO 9001:2008

[www.keysight.com/quality](http://www.keysight.com/quality)

Keysight Electronic Measurement Group

DEKRA Certified ISO 9001:2008

Quality Management System

**Keysight Channel Partners**

[www.keysight.com/find/channelpartners](http://www.keysight.com/find/channelpartners)

Get the best of both worlds: Keysight's measurement expertise and product breadth, combined with channel partner convenience.

PXI is a registered US trademark of PXI Systems Alliance.

[www.keysight.com/find/modular](http://www.keysight.com/find/modular)

For more information on Keysight Technologies' products, applications or services, please contact your local Keysight office. The complete list is available at: [www.keysight.com/find/contactus](http://www.keysight.com/find/contactus)

**Americas**

Canada	(877) 894 4414
Brazil	55 11 33 51 7010
Mexico	001 800 254 2440
United States	(800) 829 4444

**Asia Pacific**

Australia	1 800 629 485
China	800 810 0189
Hong Kong	800 938 693
India	1 800 112 929
Japan	0120 (421) 345
Korea	080 769 0800
Malaysia	1 800 888 848
Singapore	1 800 375 8100
Taiwan	0800 047 866
Other AP Countries	(65) 375 8100

**Europe & Middle East**

Belgium	32 (0) 2 404 93 40
Denmark	45 45 80 12 15
Finland	358 (0) 10 855 2100
France	0825 010 700* *0.125 €/minute
Germany	49 (0) 7031 464 6333
Ireland	1890 924 204
Israel	972-3-9288-504/544
Italy	39 02 92 60 8484
Netherlands	31 (0) 20 547 2111
Spain	34 (91) 631 3300
Sweden	0200-88 22 55
United Kingdom	44 (0) 118 927 6201

For other unlisted countries:

[www.keysight.com/find/contactus](http://www.keysight.com/find/contactus)

(BP-04-23-14)