

Keysight U8480 Series USB Thermocouple Power Sensor

Notices

Copyright Notice

© Keysight Technologies 2012-2022
No part of this manual may be reproduced in any form or by any means (including electronic storage and retrieval or translation into a foreign language) without prior agreement and written consent from Keysight Technologies as governed by United States and international copyright laws.

Manual Part Number

U8481-90002

Edition

Edition 8, April 21, 2022

Printed in:

Printed in Malaysia

Published by:

Keysight Technologies
Bayan Lepas Free Industrial Zone,
11900 Penang, Malaysia

Technology Licenses

The hardware and/or software described in this document are furnished under a license and may be used or copied only in accordance with the terms of such license.

Declaration of Conformity

Declarations of Conformity for this product and for other Keysight products may be downloaded from the Web. Go to <http://www.keysight.com/go/conformity>. You can then search by product number to find the latest Declaration of Conformity.

U.S. Government Rights

The Software is “commercial computer software,” as defined by Federal Acquisition Regulation (“FAR”) 2.101. Pursuant to FAR 12.212 and 27.405-3 and Department of Defense FAR Supplement (“DFARS”) 227.7202, the U.S. government acquires commercial computer software under the same terms by which the software is customarily provided to the public. Accordingly, Keysight provides the Software to U.S. government customers under its standard commercial license, which is embodied in its End User License Agreement (EULA), a copy of which can be found at <http://www.keysight.com/find/sweula>. The license set forth in the EULA represents the exclusive authority by which the U.S. government may use, modify, distribute, or disclose the Software. The EULA and the license set forth therein, does not require or permit, among other things, that Keysight: (1) Furnish technical information related to commercial computer software or commercial computer software documentation that is not customarily provided to the public; or (2) Relinquish to, or otherwise provide, the government rights in excess of these rights customarily provided to the public to use, modify, reproduce, release, perform, display, or disclose commercial computer software or commercial computer software documentation. No additional government requirements beyond those set forth in the EULA shall apply, except to the extent that those terms, rights, or licenses are explicitly required from all providers of commercial computer software pursuant to the FAR and the DFARS and are set forth specifically in writing elsewhere in the EULA. Keysight shall be under no obligation to update, revise or otherwise modify the Software. With respect to any technical data as defined by FAR 2.101, pursuant to FAR 12.211 and 27.404.2 and DFARS 227.7102, the U.S. government acquires no greater than Limited Rights as defined in FAR 27.401 or DFAR 227.7103-5 (c), as applicable in any technical data.

Warranty

THE MATERIAL CONTAINED IN THIS DOCUMENT IS PROVIDED “AS IS,” AND IS SUBJECT TO BEING CHANGED, WITHOUT NOTICE, IN FUTURE EDITIONS. FURTHER, TO THE MAXIMUM EXTENT PERMITTED BY APPLICABLE LAW, KEYSIGHT DISCLAIMS ALL WARRANTIES, EITHER EXPRESS OR IMPLIED, WITH REGARD TO THIS MANUAL AND ANY INFORMATION CONTAINED HEREIN, INCLUDING BUT NOT LIMITED TO THE IMPLIED WARRANTIES OF MERCHANTABILITY AND FITNESS FOR A PARTICULAR PURPOSE. KEYSIGHT SHALL NOT BE LIABLE FOR ERRORS OR FOR INCIDENTAL OR CONSEQUENTIAL DAMAGES IN CONNECTION WITH THE FURNISHING, USE, OR PERFORMANCE OF THIS DOCUMENT OR OF ANY INFORMATION CONTAINED HEREIN. SHOULD KEYSIGHT AND THE USER HAVE A SEPARATE WRITTEN AGREEMENT WITH WARRANTY TERMS COVERING THE MATERIAL IN THIS DOCUMENT THAT CONFLICT WITH THESE TERMS, THE WARRANTY TERMS IN THE SEPARATE AGREEMENT SHALL CONTROL.

Safety Information

CAUTION

A CAUTION notice denotes a hazard. It calls attention to an operating procedure, practice, or the like that, if not correctly performed or adhered to, could result in damage to the product or loss of important data. Do not proceed beyond a CAUTION notice until the indicated conditions are fully understood and met.

WARNING

A WARNING notice denotes a hazard. It calls attention to an operating procedure, practice, or the like that, if not correctly performed or adhered to, could result in personal injury or death. Do not proceed beyond a WARNING notice until the indicated conditions are fully understood and met.

Environmental Conditions

The U8480 Series is designed for indoor use and in an area with low condensation. The table below shows the general environmental requirements for this instrument.

Environmental condition	Requirement
Temperature	Operating condition - 0 °C to 55 °C
	Storage condition - -40 °C to 71 °C
Humidity	Operating condition - Up to 95% RH at 40 °C (non-condensing)
	Storage condition - Up to 90% RH at 65 °C (non-condensing)
Altitude	Up to 4600 m (15000 ft)

CAUTION





You may experience a warmer sensor body temperature for the U8480 Series than other Keysight power sensors. Rest assured that this does not affect the sensor performance.

Regulatory Information

The U8480 Series complies with the following Electromagnetic Compatibility (EMC) compliances:

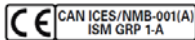
- IEC 61326-1 / EN 61326-1
- Canada: ICES/NMB-001
- Australia/New Zealand: AS/NZS CISPR11

Regulatory Markings

 <p>The RCM mark is a registered trademark of the Australian Communications and Media Authority.</p>	 <p>The CE mark is a registered trademark of the European Community. This CE mark shows that the product complies with all the relevant European Legal Directives. ICES/NMB-001 indicates that this ISM device complies with the Canadian ICES-001. Cet appareil ISM est conforme a la norme NMB-001 du Canada. ISM GRP.1 Class A indicates that this is an Industrial Scientific and Medical Group 1 Class A product.</p>
 <p>This symbol indicates the time period during which no hazardous or toxic substance elements are expected to leak or deteriorate during normal use. Forty years is the expected useful life of the product.</p>	 <p>This instrument complies with the WEEE Directive (2002/96/EC) marking requirement. This affixed product label indicates that you must not discard this electrical or electronic product in domestic household waste.</p>
 <p>This symbol is a South Korean Class A EMC Declaration. This is a Class A instrument suitable for professional use and in electromagnetic environment outside of the home.</p>	<p style="background-color: #cccccc;"> </p>

Waste Electrical and Electronic Equipment (WEEE) Directive 2002/96/EC

This instrument complies with the WEEE Directive (2002/96/EC) marking requirement. This affixed product label indicates that you must not discard this electrical or electronic product in domestic household waste.

Product category:

With reference to the equipment types in the WEEE directive Annex 1, this instrument is classified as a “Monitoring and Control Instrument” product.

The affixed product label is as shown below.



Do not dispose in domestic household waste.

To return this unwanted instrument, contact your nearest Keysight Service Center, or visit <http://about.keysight.com/en/companyinfo/environment/takeback.shtml> for more information.

Sales and Technical Support

To contact Keysight for sales and technical support, refer to the support links on the following Keysight websites:

- www.keysight.com/find/powersensors
(product-specific information and support, software and documentation updates)
- www.keysight.com/find/assist
(worldwide contact information for repair and service)

THIS PAGE HAS BEEN INTENTIONALLY LEFT BLANK.

Table of Contents

Environmental Conditions	3
Regulatory Information	4
Regulatory Markings	4
Waste Electrical and Electronic Equipment (WEEE) Directive 2002/96/ EC	5
Product category:	5
Sales and Technical Support	5
1 Getting Started	
Overview	14
Initial Inspection	15
Standard shipped items	15
Hardware Installation and Configuration	16
Connect the U8480 Series sensor	16
U8489A RF input port torque requirements	18
LED Indicator Sequence During Power-Up	19
Other LED indicators	19
Firmware Upgrade	20
2 General Operating Information	
Using the U8480 Series with the Keysight BenchVue	22
Quick start example to perform an average power measurement	24
U8480 Series Functions and Features	28
Zero and auto-calibration	28
Power sweep and frequency sweep	29
Gamma correction	30
S-parameter correction	32
Real-time measurement uncertainty	33
3 Characteristics and Specifications	

A Appendix

Appendix A: Typical Averaged Readings 40

List of Figures

Figure 1-1	U8480 Series sensor	14
Figure 1-2	Connect the U8480 Series sensor to the PC	16
Figure 1-3	Auto-locate a USB instrument in Keysight Connection Expert	17
Figure 1-4	U8489A RF input port torque requirements	18
Figure 2-1	Launch the Keysight BenchVue	22
Figure 2-2	Sweep connection diagram	29
Figure 2-3	DUT-to-U8480 Series connection diagram	30
Figure 2-4	Non-ideal 2-port device	32

THIS PAGE HAS BEEN INTENTIONALLY LEFT BLANK.

List of Tables

Table 1-1	Other LED indicators	19
Table 2-1	Worked example – 2 GHz; –13 dBm; typical values	34

THIS PAGE HAS BEEN INTENTIONALLY LEFT BLANK.

1 Getting Started

Overview	14
Initial Inspection	15
Hardware Installation and Configuration	16
LED Indicator Sequence During Power-Up	19
Firmware Upgrade	20

This chapter gets you started with the U8480 Series USB Thermocouple Power Sensor.

Overview

The U8480 Series is a USB-based standalone thermocouple power sensor and meter. The U8480 Series consists of five models:

- U8481A (DC to 18 GHz),
- U8485A (DC to 33 GHz),
- U8487A (10 MHz to 50 GHz),
- U8488A (10 MHz to 67 GHz),
- U8489A (DC to 120 GHz)

The U8480 Series is a heat-based power sensor that responds to the true average power of any signal format and allows direct measurement of average RF or microwave power through the heating effect it has on a terminating load. Depending on the model, the U8480 Series can measure power from -35 dBm to 20 dBm over a frequency range of DC to 120 GHz.

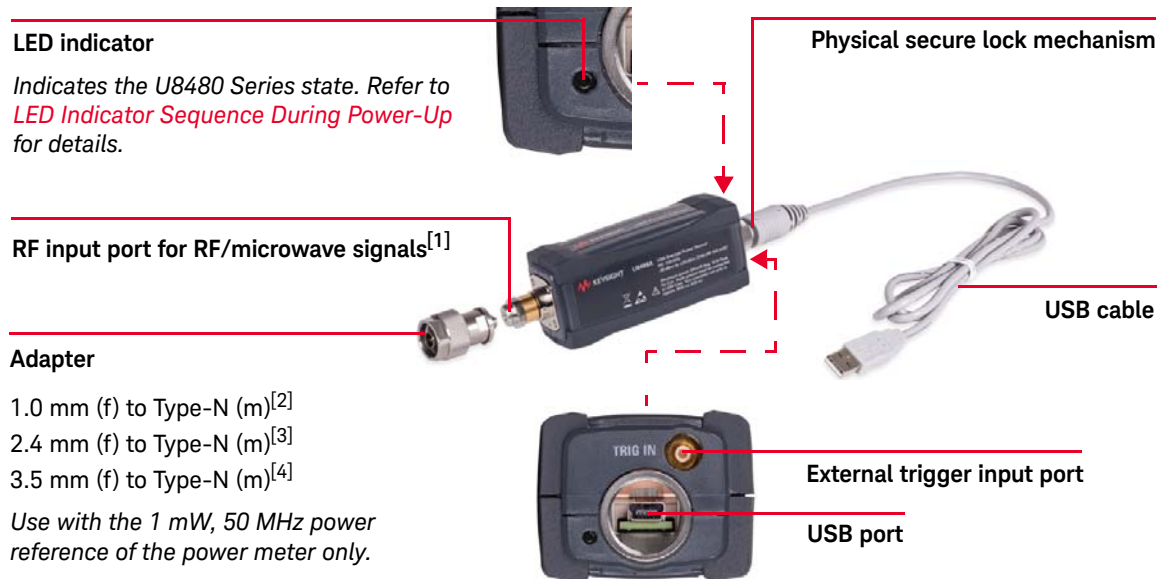

Figure 1-1 U8480 Series sensor

[1] For the U8489A, refer to [U8489A RF input port torque requirements](#).

[2] Only applicable for the U8489A.

[3] Only applicable for the U8487A and U8488A.

[4] Only applicable for the U8481A and U8485A.

Initial Inspection

When you receive your U8480 Series sensor, inspect the shipping container for damages. If the shipping container or packaging material is damaged, it should be kept until the contents of the shipment have been checked mechanically and electrically. If there is any mechanical damage, notify the nearest Keysight Sales and Service Office. Keep the damaged shipping materials (if any) for inspection by the carrier and a Keysight representative.

Standard shipped items

Verify that you have received the following items. If anything is missing or damaged, contact the nearest Keysight Sales Office.

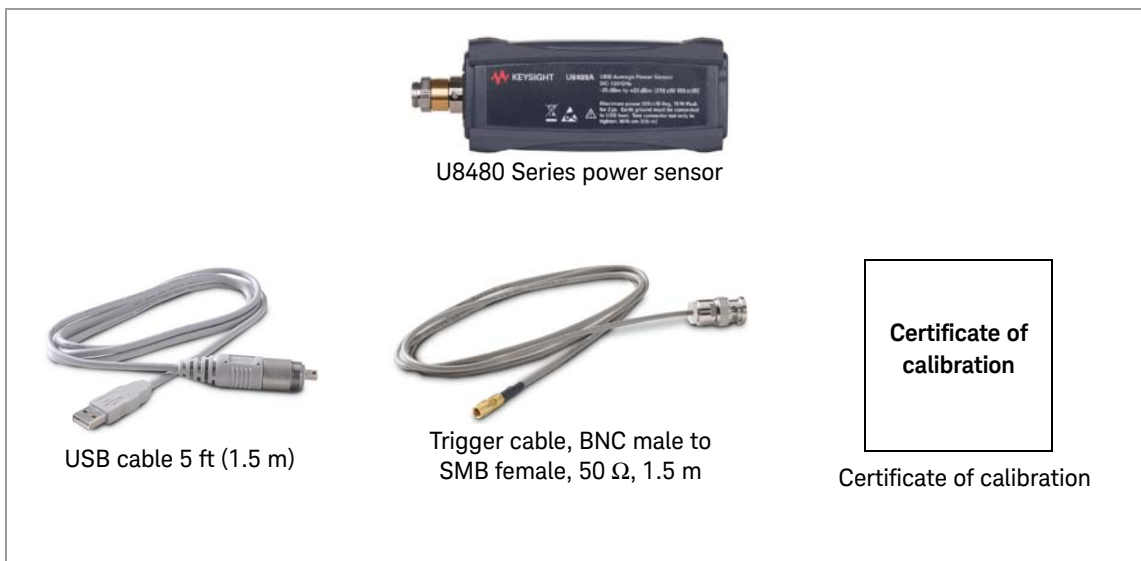

Hardware Installation and Configuration

Prior to using the U8480 Series, ensure that the following minimum requirements are met:

- PC with USB host capability
- Keysight IO Libraries Suite 16.0 or higher installed
- Keysight BenchVue installed

Connect the U8480 Series sensor

- 1 Connect the power sensor to the PC. The sensor driver is detected and installed automatically.

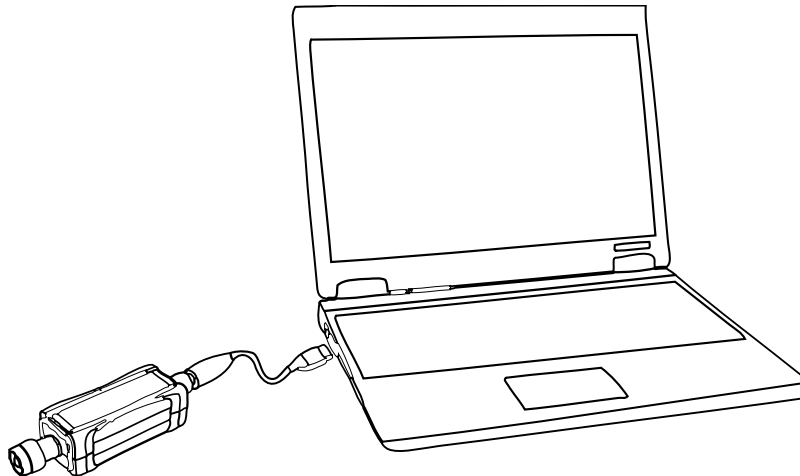

Figure 1-2 Connect the U8480 Series sensor to the PC

- 2 Launch the Keysight Connection Expert by selecting the IO icon (). Auto-locate the sensor as shown in [Figure 1-3](#). Click **Rescan** to start searching.

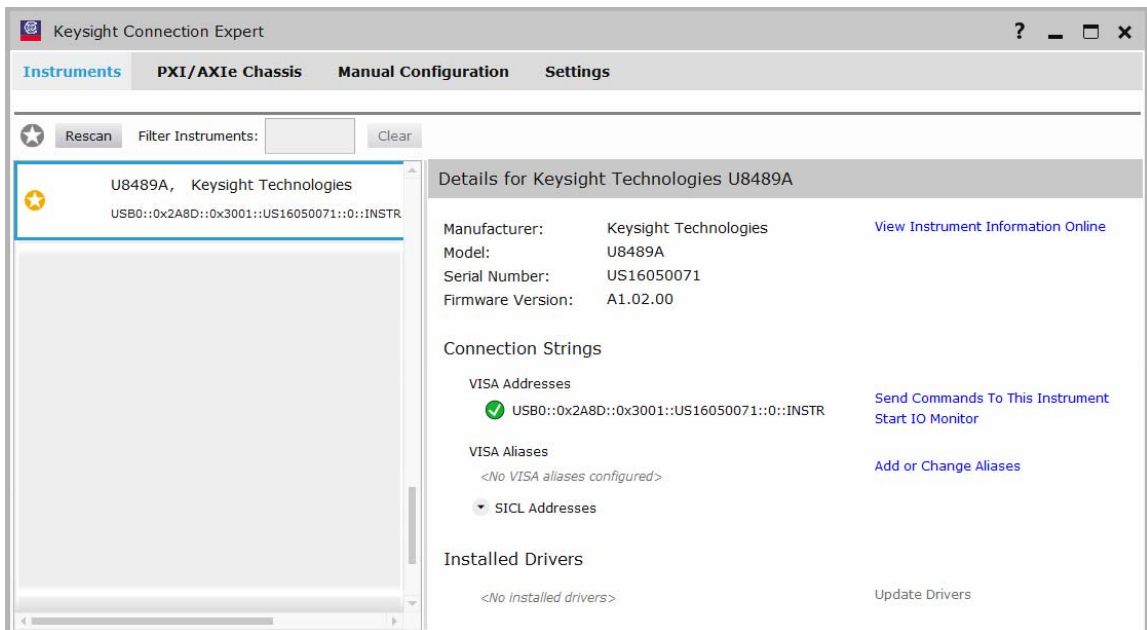

Figure 1-3 Auto-locate a USB instrument in Keysight Connection Expert

- 3** Click **Send Commands To This Instrument** > **Send & Read** to verify that the sensor is connected.
- 4** When the sensor is connected, go to [Chapter 2, "Using the U8480 Series with the Keysight BenchVue"](#) to launch the BenchVue Power Meter application, or proceed to operate the sensor via remote programming.

Operating the sensor remotely using SCPI commands

You can send SCPI commands to operate the sensor. Refer to the *U8480 Series Programming Guide* for details.

U8489A RF input port torque requirements

The RF input port of the U8489A has two threads (inner thread and outer thread), which have different torque requirements. The following diagram shows the torque requirements. Ensure that you do not use a torque value exceeding the maximum value to avoid damage to the input port.

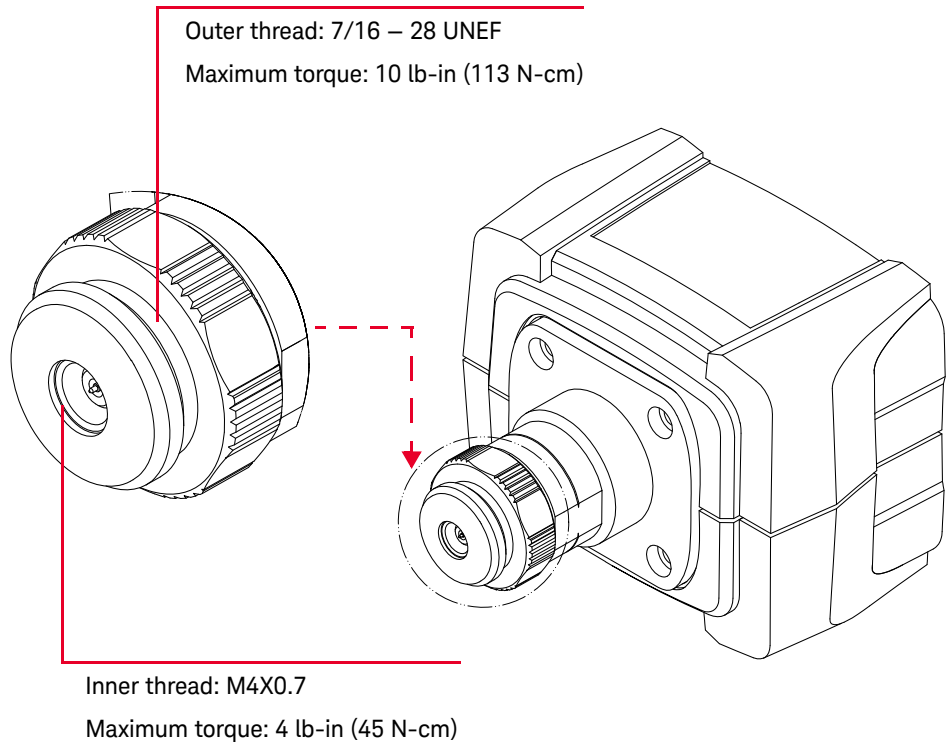
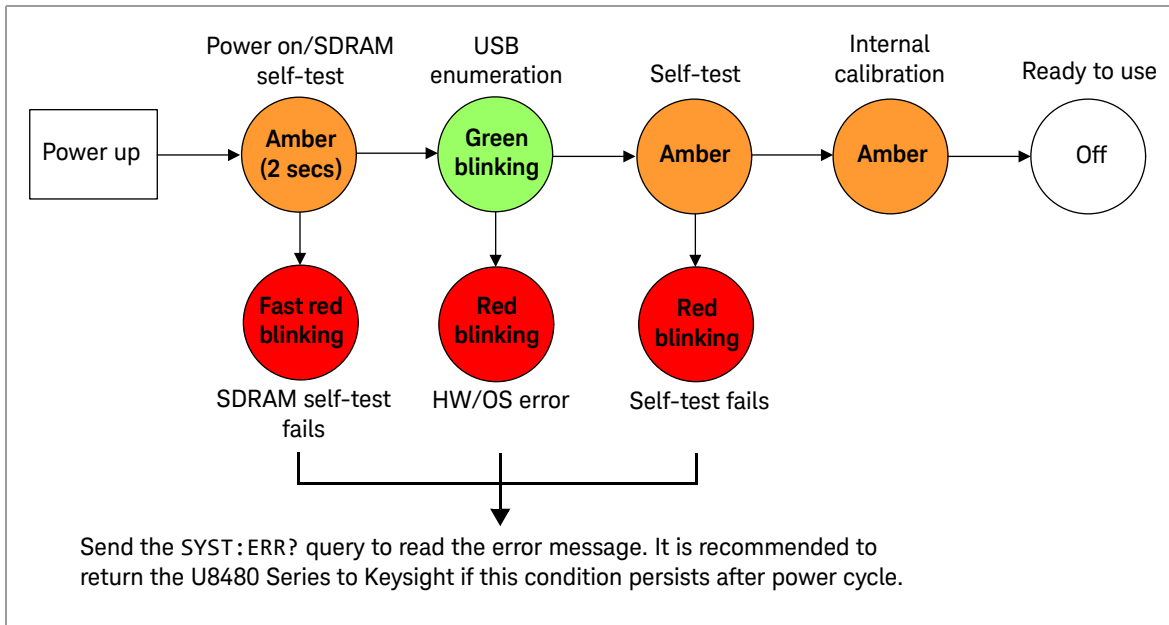



Figure 1-4 U8489A RF input port torque requirements

LED Indicator Sequence During Power-Up



Other LED indicators

Table 1-1 Other LED indicators

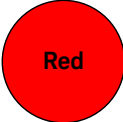
	Secure erase, flash formatting, or firmware update in progress.
	An error is present in the SCPI error queue including input overload. If the error queue is cleared (via the <code>*CLS</code> command) or the last error is read from the queue (via the <code>SYST:ERR?</code> query), the indicator will turn off.

Firmware Upgrade

To download the latest firmware version for the U8480 Series, go to www.keysight.com/find/pm_firmware. The latest firmware includes the executable file and help file for installing the Firmware Upgrade Utility application in order to upgrade the U8480 Series.

2 General Operating Information

Using the U8480 Series with the Keysight BenchVue	22
U8480 Series Functions and Features	28

This chapter describes the general operating information of the U8480 Series.

Using the U8480 Series with the Keysight BenchVue

The BenchVue Power Meter application provides a virtual operating interface for the U8480 Series. This chapter describes the U8480 Series functions in the BenchVue Power Meter application in general.

NOTE

For more information on how to configure each U8480 Series function or use each BenchVue Power Meter feature, refer to the *Keysight BenchVue Power Meter help documentation*.

Go to **Start > All Programs > Keysight > Keysight BenchVue > Keysight BenchVue** to launch the BenchVue Power Meter application.

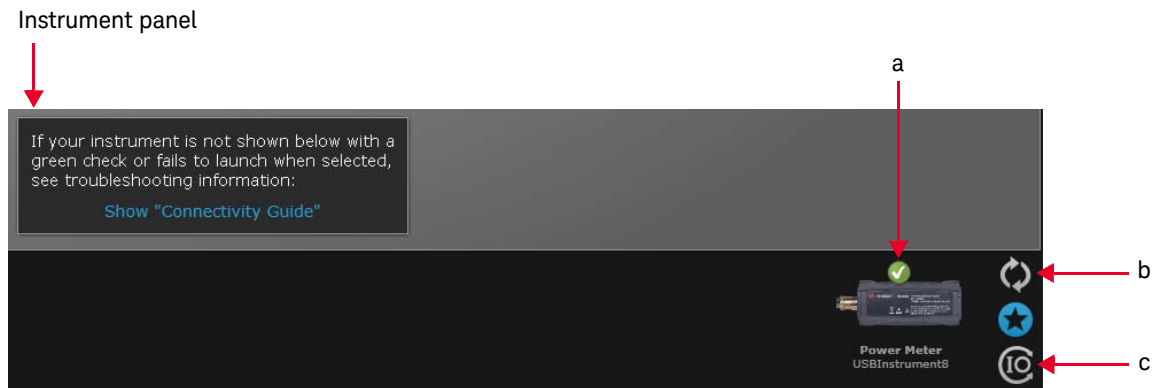



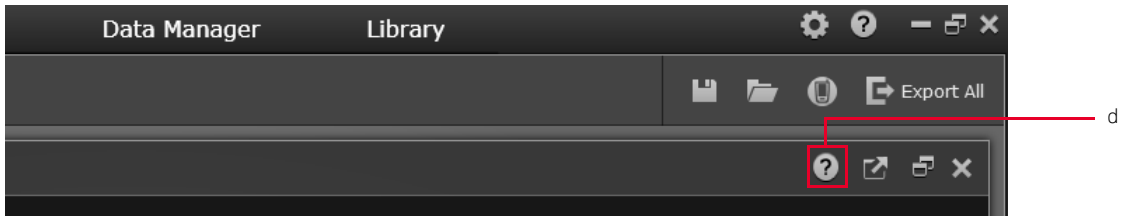

Figure 2-1 Launch the Keysight BenchVue

- a** Double-click the connected sensor () at the Instrument panel to start controlling the power sensor.
- b** If the sensor is found in the Keysight Connection Expert but is not shown in the BenchVue Instrument panel, select the refresh icon () to refresh the instrument list.
- c** If the sensor is not found, select the IO icon () to launch the Keysight Connection Expert to verify that the power sensor is connected properly.

When you launch the BenchVue Power Meter application, the Digital Meter is displayed by default.



- d** Click (?) to access the BenchVue Power Meter help documentation.

Quick start example to perform an average power measurement

The following example guides you on how to quickly measure average power via BenchVue.

It is assumed that the U8480 Series is already connected to a signal generator.

- 1 Set up the signal generator as follows:
 - Amplitude: 0 dBm
 - Frequency: 1 GHz
 - Modulation: Disabled
- 2 Turn on the RF output of the signal generator. Launch the BenchVue Power Meter application (refer to [page 21](#)).
- 3 Perform calibration and zeroing (with the RF output turned off) for an accurate measurement result.

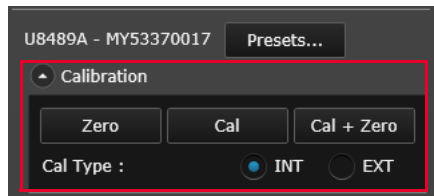

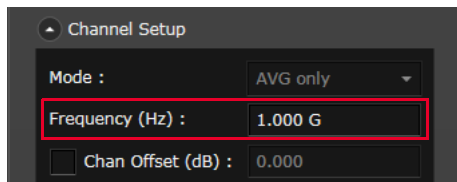

- 4 Set the frequency of the U8480 Series to 1 GHz.



- 5 You should be able to view the average power measurement results in the Digital Meter display view.





- a** Indicates acquisition of measurements in Run mode
- b** Indicates the measurement status
- c**  Change the title at the top of the display view
- d**  Reset the displayed Minimum/Maximum measured values
- d** Summary of alert limit conditions for the current measurement

6 To monitor the average power over a period of time, create a strip chart display view by clicking .

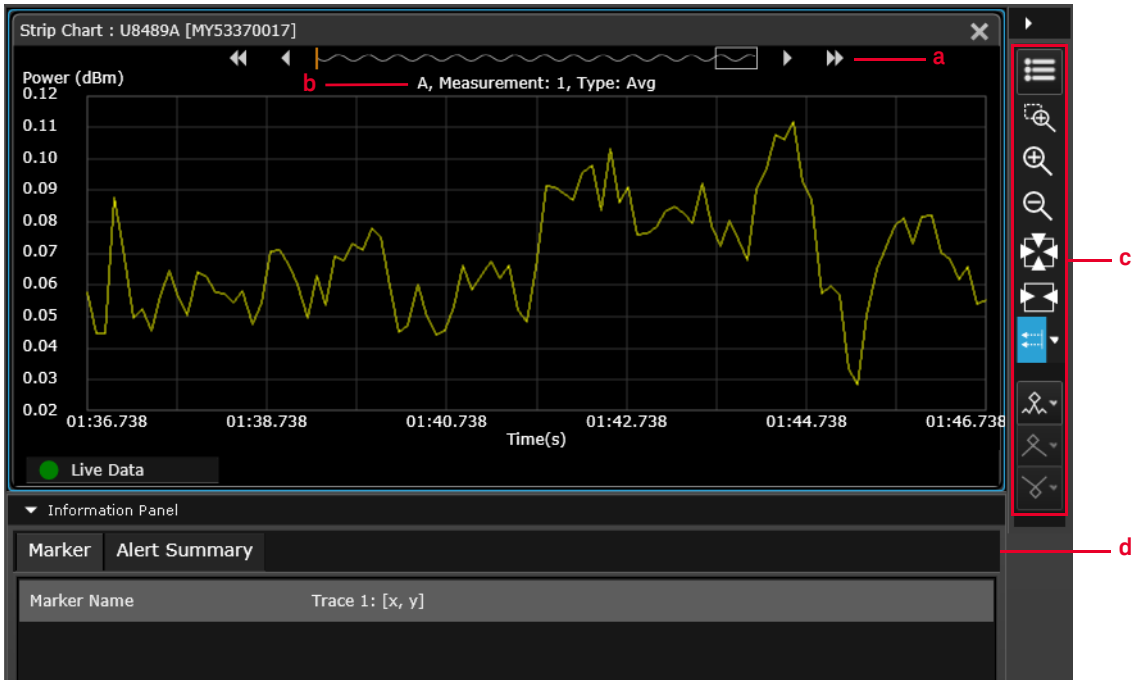

2 General Operating Information



- a** Data preview bar
 - b** Indicates the channel name, measurement number, and measurement type
 - c** Tools palette to provide control for the strip chart (refer to the BenchVue Power Meter help documentation for details)
 - d** Summary of marker measurements and alert limit conditions for the current measurement
- 7** Place a marker (or up to five markers) on the chart by clicking  to obtain the reading.

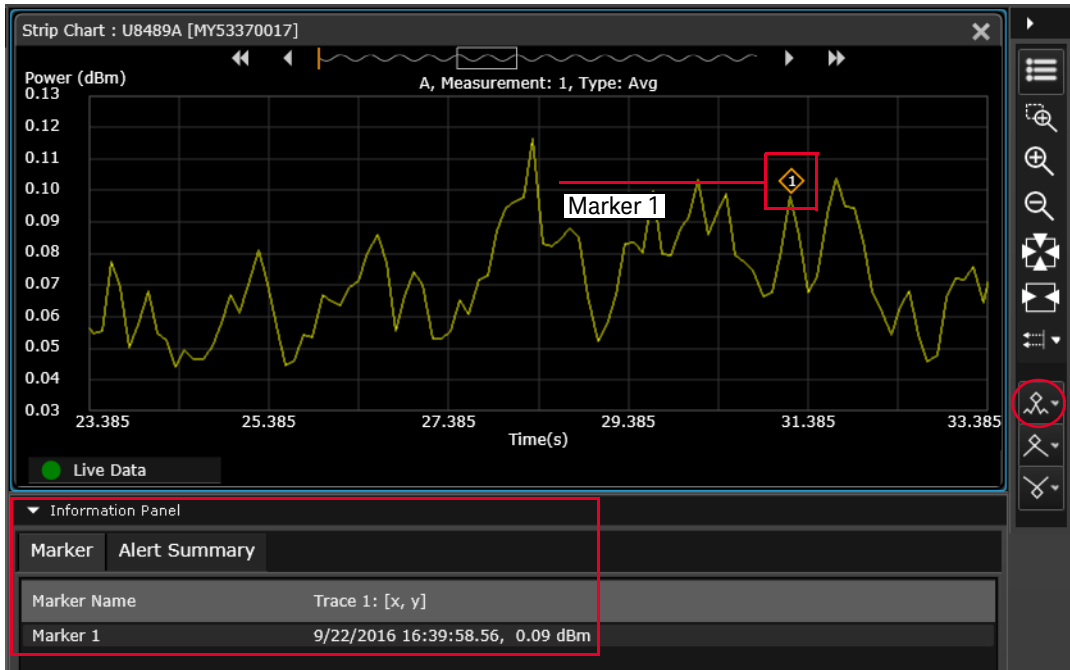

- 8 To save your measurement data, you can use the Export operation by clicking . This allows you to export a screen shot or a data log from the current bench application to various file options.

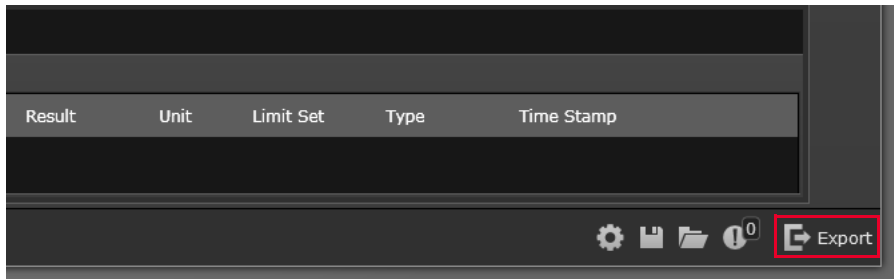

U8480 Series Functions and Features

Zero and auto-calibration

Zero the U8480 Series without the presence of input RF power, or auto-calibrate the U8480 Series.

Zeroing is recommended:

- upon power up.
- when a 5 °C change in temperature occurs.
- every 24 hours.
- prior to measuring low-level signals (for example, lowest 10 dB of the dynamic range).
- when switching from or to the fast measurement mode.

The U8480 Series performs an internal or external calibration. Internal calibration does not require a power reference, while external calibration enables the U8480 Series to perform calibration with a power reference.

The U8480 Series will perform auto-calibration every time it is powered up.

NOTE

You are advised to perform zeroing at the test port (without power applied) to obtain the best accuracy when measuring low power in a temperature-changing environment.

If input RF power to the U8480 Series is not turned off while zeroing is performed, error -231, Data questionable; ZERO ERROR will occur.

For more details on zeroing and auto-calibration, refer to the *U8480 Series Programming Guide*.

Power sweep and frequency sweep

The sweep feature allows you to make power measurements by quickly stepping through a series of frequencies or power levels. Below shows the connection diagram to perform a sweep.

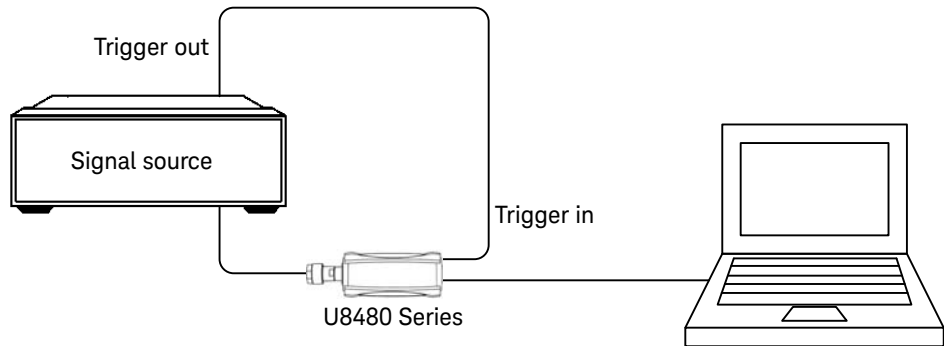

Figure 2-2 Sweep connection diagram

A proper dwell time must be set in the signal source to ensure all the measurement readings in the U8480 Series are settled before stepping through the next frequency point.

NOTE

It is recommended for the dwell time of the signal generator to be minimally set to the settling time, depending on the measurement mode and filter settings.

Gamma correction

NOTE

The gamma correction function is only available in power sensors with firmware version A1.01.06 and above.

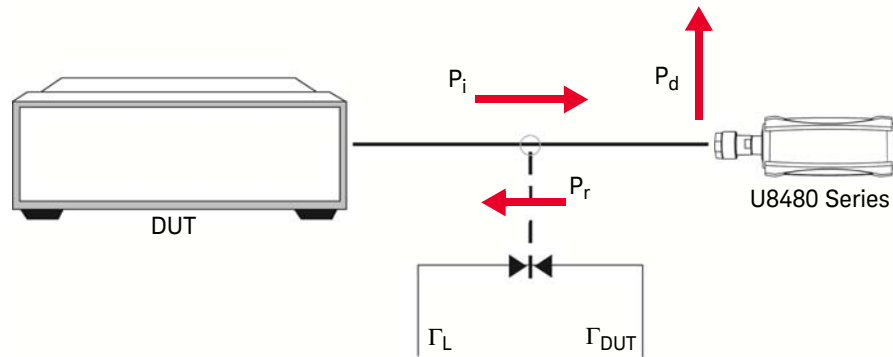

Figure 2-3 DUT-to-U8480 Series connection diagram

In a realistic measurement environment, the device-under-test (DUT) impedance or the reference impedance (Z_0) is not equal to the U8480 Series impedance. The mismatch in impedance values causes a portion of the signal voltage to be reflected. This is quantified by the reflection coefficient, or gamma (Γ). A portion of the incident power to the U8480 Series, P_i , is reflected back to the DUT as P_r . The remaining power, P_d , gets delivered to the U8480 Series. A generic DUT will reflect part of P_r back to the U8480 Series, and the reflected portion will be superimposed onto P_i . The nominal power, P_{z_0} – the power generated after factoring in Z_0 – may be calculated as follows:

$$P_{z_0} = P_i |1 - \Gamma_{DUT} \Gamma_L|^2$$

Gamma correction compensates for impedance mismatch via two options, which are Single Point Gamma and Table-based Gamma.

Single Point Gamma

Single Point Gamma correction is used when you have a known and constant frequency, so a single gamma value can be used for calculation. The value for Γ_{DUT} may be entered as a Single Point Gamma which may be applied across all measurement frequencies in the U8480 Series operating range.

Table-based Gamma

Table-based Gamma is used when there are multiple known frequencies, leading to multiple gamma values. This option supports a list of up to 1024 measurement frequency values.

NOTE

The U8480 Series supports up to three gamma tables that are retained across reset and power cycles.

The Γ_{L} values for factory calibration frequencies within the U8480 Series operating range are already preloaded in the U8480 Series. These Γ_{L} values are retained across reset and power cycles.

S-parameter correction

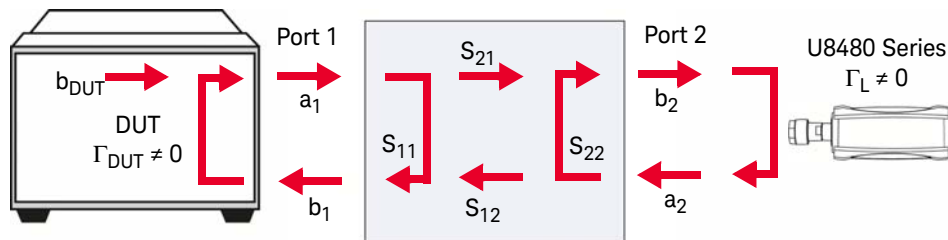

Figure 2-4 Non-ideal 2-port device

A device-under-test (DUT) that has n number of ports has n^2 S-parameters. These S-parameters represent reflected energy which interferes with the power measurements. These errors are usually caused by additional components such as attenuators, adapters, or matching pads, which are inserted between the DUT and the U8480 Series. Typically, DUTs are non-ideal, as illustrated in [Figure 2-4](#). When power is transmitted from the DUT, the U8480 Series will reflect a part of its incident wave back to the 2-port device. The 2-port device will reflect this wave back to the U8480 Series. The power from the DUT may therefore be calculated as follows:

$$b_{DUT} = b_2 \frac{(1 - S_{11}\Gamma_{DUT})(1 - S_{22}\Gamma_L)}{S_{21}} - S_{12}\Gamma_{DUT}\Gamma_L$$

The result is the same as if gamma correction was enabled. This feature enables you to correct for the effect of 2-port devices in your test setup. You may enter the S-parameter data for the DUT in the .S2P file format (magnitude-phase or dB-phase or real-imaginary).

NOTE

The U8480 Series supports one S-parameter table that is retained across reset and power cycles.

Real-time measurement uncertainty

NOTE

The real-time measurement uncertainty function is only available in power sensors with firmware version A1.01.06 and above.

The U8480 Series has a built-in measurement uncertainty (MU) calculator that is based on the MU method published in Keysight Application Note 64-1A (Fundamentals of RF and Microwave Power Measurements). All the related power sensor parameters for the MU calculations are uniquely kept in the internal memory of each U8480 Series. Only the reflection coefficient (Γ) of the DUT needs to be supplied. The MU is calculated dynamically based on the measured power levels, operating frequency, and temperature of the U8480 Series.

The U8480 Series recognizes the following sources of uncertainty in power measurement:

- Power sensor and DUT mismatch
- Power sensor zero set
- Power sensor zero drift
- Power sensor linearity
- Power sensor calibration factor uncertainty
- Power sensor internal calibration
- Power sensor measurement noise

The MU associated with the current frequency and measured power of the U8480 Series can be calculated based on these sources of uncertainty. For all calculations, the coverage factor and probability distribution values are kept constant. [Table 2-1](#) shows a worked example with typical values at 2 GHz and -13 dBm while adhering to ISO GUM.

Table 2-1 Worked example – 2 GHz; –13 dBm; typical values

Symbol	Source of uncertainty	Value \pm	Probability distribution	Divisor	Standard uncertainty
M_u	Power sensor and DUT mismatch	$ \Gamma_{DUT} = 0.111$ $ \Gamma_S = 0.074$	U-shape	$\sqrt{2}$	0.5820%
D	Power sensor zero drift	$5.500 \times 10^{-9} \text{ W}$	Gaussian	2	0.0055%
K_b	Power sensor calibration factor	0.91%	Gaussian	2	0.4550%
P_l	Power sensor linearity	0.00%	Gaussian	2	0.0000%
Z_s	Power sensor zero set	$2.50 \times 10^{-8} \text{ W}$	Gaussian	2	0.0249%
N	Power sensor noise	$4.50 \times 10^{-8} \text{ W}$	Gaussian	2	0.1176%
P_{cal}	Power sensor internal calibration	$5.20 \times 10^{-3}\%$	Gaussian	2	0.2600%
Combined Uncertainty – RSSed					0.79%
Expanded Uncertainty			Coverage factor, $K = 2$	1.58%	

You may opt for either Single Point Gamma, Table-based Gamma, or the S-parameter table as the source of your Γ_{DUT} value, dependent on your test setup:

- If Single Point Gamma is selected, the value of Γ_{DUT} is obtained from the Single Point Gamma value.
- If Table-based Gamma is selected, the value of Γ_{DUT} is obtained as a frequency-dependent value from the currently selected gamma table.
- If the S-parameter table is selected, the value of Γ_{DUT} is obtained from the S-parameter table.
- If you have a 2-port device connected to your U8480 Series, the value of Γ_{DUT} is taken as S_{22} of the 2-port device (refer to “S-parameter correction” on page 32 for an in-depth explanation); therefore, you should load the desired .S2P file into the U8480 Series and select the S-parameter table as the source of your Γ_{DUT} value.

The U8480 Series and DUT mismatch source of uncertainty will be not be factored into the calculation when:

- Gamma correction is already enabled.
- S-parameter correction is already enabled.
- Gamma correction and S-parameter correction are both enabled.

This is because the mismatch uncertainty would already have been corrected under Gamma or S-parameter correction.

NOTE

When the real-time measurement uncertainty is enabled, fast mode throughput will be reduced.

THIS PAGE HAS BEEN INTENTIONALLY LEFT BLANK.

3 Characteristics and Specifications

For the characteristics and specifications of the U8480 Series USB Thermocouple Power Sensor, refer to the datasheet at <http://literature.cdn.keysight.com/litweb/pdf/5991-1410EN.pdf>.

THIS PAGE HAS BEEN INTENTIONALLY LEFT BLANK.

A Appendix

Typical Averaged Readings 40

Appendix A: Typical Averaged Readings

Below shows the typical number of averages for each range and resolution when the U8480 Series is in the auto-average mode and set to the normal speed mode.

NOTE

Increasing the value of the measurement average reduces measurement noise but increases measurement time.

Dynamic range	Maximum power	Resolution setting				Number of averages
		1	2	3	4	
20 dBm	-----	1	1	2	8	↑ Number of averages ↓
10 dBm	-----	1	1	2	8	
0 dBm	-----	2	2	4	32	
-10 dBm	-----	2	2	16	256	
-20 dBm	-----	2	8	128	256	
-30 dBm	-----	4	64	256	512	
-35 dBm	-----					
	Minimum power					

The four resolution levels represent:

- 1, 0.1, 0.01, or 0.001 dBm respectively if the measurement suffix is dBm.
- 1, 2, 3, or 4 significant digits respectively if the measurement suffix is W.



This information is subject to change without notice. Always refer to the Keysight website for the latest revision.

© Keysight Technologies 2012-2022
Edition 8, April 21, 2022

Printed in Malaysia



U8481-90002

www.keysight.com