

Errata

Title & Document Type: 4262A LCR Meter Operating and Service Manual

Manual Part Number: 04262-90007

Revision Date: October 1983

HP References in this Manual

This manual may contain references to HP or Hewlett-Packard. Please note that Hewlett-Packard's former test and measurement, semiconductor products and chemical analysis businesses are now part of Agilent Technologies. We have made no changes to this manual copy. The HP XXXX referred to in this document is now the Agilent XXXX. For example, model number HP8648A is now model number Agilent 8648A.

About this Manual

We've added this manual to the Agilent website in an effort to help you support your product. This manual provides the best information we could find. It may be incomplete or contain dated information, and the scan quality may not be ideal. If we find a better copy in the future, we will add it to the Agilent website.

Support for Your Product

Agilent no longer sells or supports this product. You will find any other available product information on the Agilent Test & Measurement website:

www.tm.agilent.com

Search for the model number of this product, and the resulting product page will guide you to any available information. Our service centers may be able to perform calibration if no repair parts are needed, but no other support from Agilent is available.

OPERATING AND SERVICE MANUAL

4262A DIGITAL LCR METER

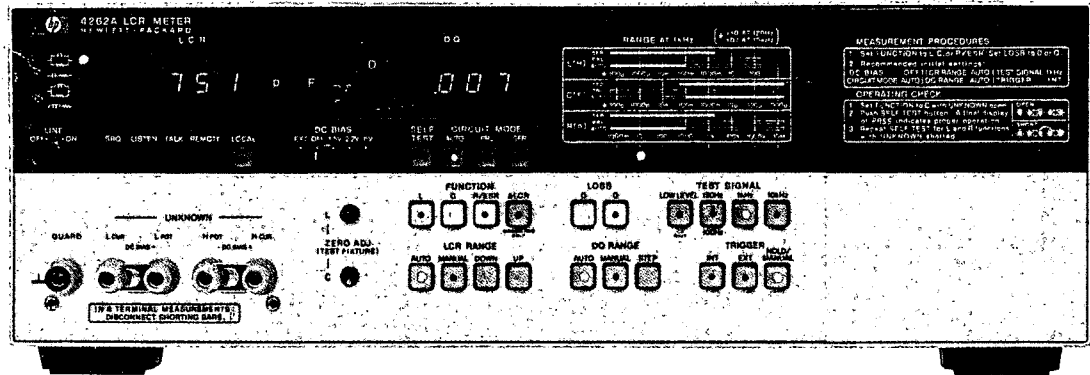

M A N U A L C H A N G E S

4262A

DIGITAL LCR METER

MANUAL IDENTIFICATION

Model Number:	4262A
Date Printed:	OCT. 1983
Part Number:	04262-90007

This supplement contains important information for correcting manual errors and for adapting the manual to instruments containing improvements made after the printing of the manual.

To use this supplement:
 Make all ERRATA corrections.
 Make all appropriate serial number related changes indicated in the tables below.

SERIAL PREFIX OR NUMBER	MAKE MANUAL CHANGES	SERIAL PREFIX OR NUMBER	MAKE MANUAL CHANGES
A11	1		

► NEW ITEM

ERRATA

Page 2-8, Table 2-1:
 Add the following item to the option 101 (HP-IB) components.

PN 2190-0577 2ea. Spring Washer

Page 3-22, Figure 3-9:
 Delete the following sentence from beneath the table in step 3:
 "*Bias current when +40V is applied to DC BIAS connector."

NOTE

Manual change supplements are revised as often as necessary to keep manuals as current and accurate as possible. Hewlett-Packard recommends that you periodically request the latest edition of this supplement. Free copies are available from all HP offices. When requesting copies quote the manual identification information from your supplement, or the model number and print date from the title page of the manual.

Date/Div: Sep. 19, 1984/33
 Page 1 of 4



- Page 4-24, Figure 4-9:
Correct the TTL outputs table in Figure 4-9 as follows:

Comparison	TTL output pins*		
	19	20	45
LCR			
HIGH	O.C.	LOW	LOW
IN	LOW	LOW	O.C.
LOW	LOW	O.C.	LOW
DQ			
HIGH	O.C.	LOW	LOW
IN	LOW	LOW	O.C.
LOW	LOW	O.C.	LOW

* TTL low-level output is indicated as LOW, and open-collector turn-off state is indicated as O.C.

- Page 8-47, Figure 8-29:
Change the part number for the power transformer to 9100-0865.

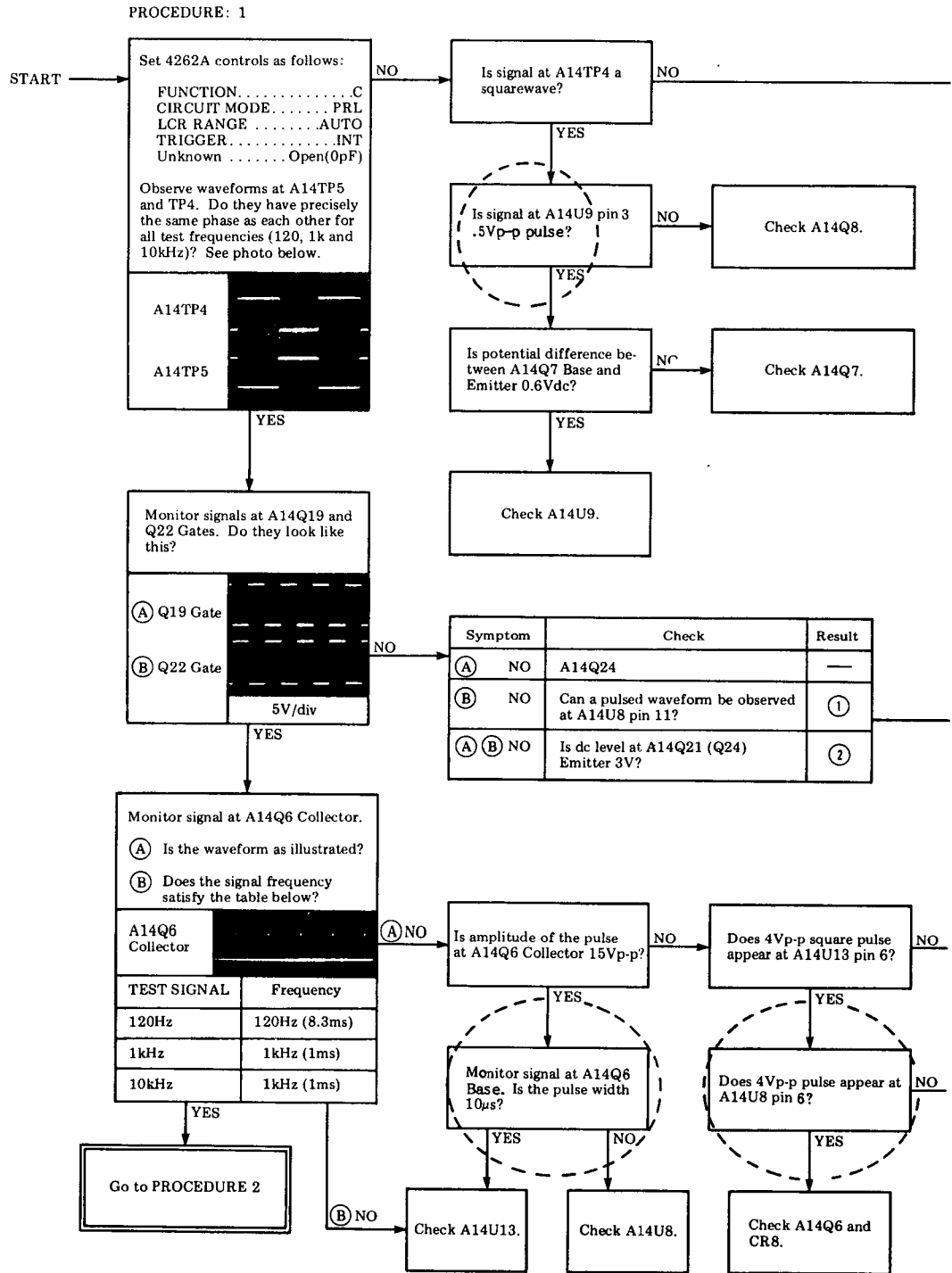

CHANGE 1

► Page 1-10, Table 1-4:

Change the recommended oscilloscope to the HP 1740A.

Table 6-3:

Change the table as shown below:

Reference Designation	HP Part Number	Description
A14 Q4	1855-0570	TRANSISTOR J-FET N-CHAN SI
R5 (ZERO ADJ L)	2100-4086	RESISTOR-VAR 500 10%
66	04262-24004	NUT-HEX-DBL-CHAM 1/4-32-THD
68	2190-0016	WASHER-LK INTL T NO.-3/8

Page 6-25:

Add a washer (reference designation ⑥) to the illustration, as shown below:

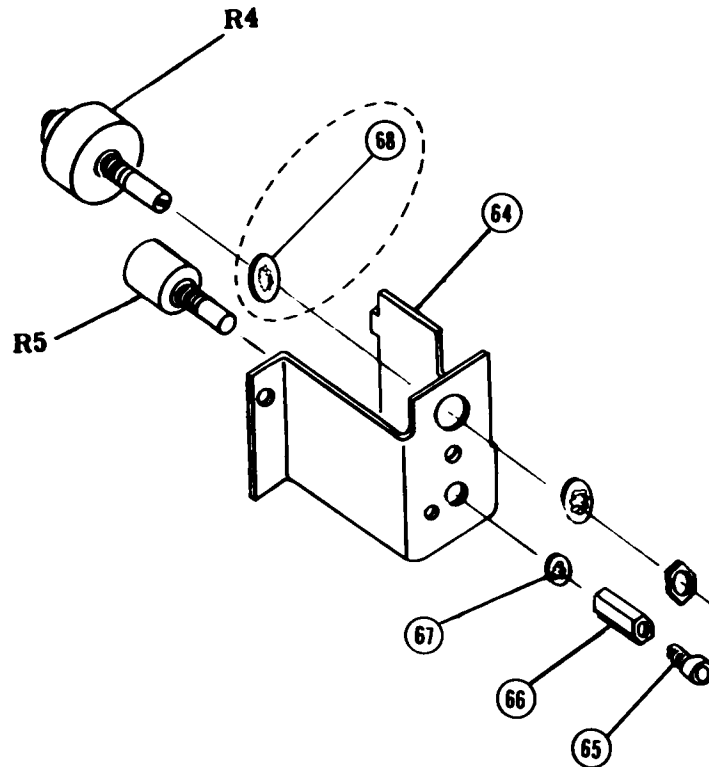



OPERATING AND SERVICE MANUAL

MODEL 4262A

LCR METER

(including Options 001, 004, 010, and 101)

SERIAL NUMBERS

This manual applies directly to instruments with serial numbers prefixed 2022J

With changes described in Section VII, this manual also applies to instruments with serial numbers prefixed 1710J, and 1739J.

For additional important information about serial numbers, see INSTRUMENTS COVERED BY MANUAL in Section I.

© COPYRIGHT: YOKOGAWA-HEWLETT-PACKARD, LTD., 1977
9-1, TAKAKURA-CHO, HACHIOJI-SHI, TOKYO, JAPAN

Manual Part No. 04262-90007
Microfiche Part No. 04262-90057

Printed: OCT. 1983

TABLE OF CONTENTS

Section	Title	Page	Section	Title	Page
I	GENERAL INFORMATION.....	1-1	3-30.	Terminal Configuration	3-10
1-1.	Introduction	1-1	3-32.	Offset Adjustment	3-10
1-4.	Description	1-1	3-40.	Option Operation	3-27
1-8.	Specifications	1-7	3-42.	Option 001: BCD Parallel Data Output	3-27
1-10.	Safety Considerations	1-7	3-44.	Output Data and Pin Assignment	3-27
1-13.	Instruments Covered by Manual	1-7	3-46.	Alternate Output of LCR and D/Q Data	3-27
1-18.	Options	1-8	3-47.	Output Timing	3-27
1-20.	Option 001	1-8	3-49.	Option 004-COMPARATOR	3-30
1-22.	Option 004	1-8	3-51.	Front Panel Features (Figure 3-42)	3-30
1-24.	Option 101	1-8	3-52.	LIMIT Setting Warning	3-31
1-26.	Option 010	1-8	3-53.	OUTPUT Connector Decision Output	3-31
1-28.	Other Options	1-8	3-60.	Option 101: HP-IB	3-32
1-31.	Accessories Supplied	1-8	3-62.	Connection to HP-IB Controller	3-32
1-33.	Equipment Available	1-8	3-63.	HP-IB Status Indicator	3-32
II	INSTALLATION	2-1	3-64.	LOCAL Switch	3-32
2-1.	Introduction	2-1	3-65.	HP-IB Interface Capabilities ..	3-32
2-3.	Initial Inspection.....	2-1	3-66.	Source and Acceptor Handshake: SH1, AH1..	3-32
2-5.	Preparation for Use	2-1	3-67.	Talker Capability: T5... ..	3-32
2-6.	Power Requirements	2-1	3-68.	Functions Related to Talker Capability	3-33
2-8.	Line Voltage and Fuse Selection	2-1	3-69.	Listener Capability: L4 .	3-33
2-10.	Power Cable	2-1	3-70.	Service Request Capability: SR1	3-33
2-14.	Interconnections	2-3	3-71.	Remote/Local Capability: RL1	3-36
2-16.	Operating Environment	2-3	3-72.	Device Clear Capability: DC1	3-36
2-19.	Installation Instructions	2-3	3-73.	Device Trigger Capability: DT1	3-36
2-21.	Installation of Options 907, 908 and 909	2-3	3-74.	ADDRESS Switch	3-36
2-23.	Storage and Shipment	2-3	3-75.	Remote Message Coding	3-36
2-24.	Environment	2-3	IV	PERFORMANCE TEST	4-1
2-26.	Packaging	2-3	4-1.	Introduction	4-1
2-29.	Option Installation	2-6	4-3.	Equipment Required	4-1
2-31.	Option 001 BCD Data Output Installation	2-6	4-5.	Test Record	4-1
2-32.	Option 004 Comparator Installation	2-6	4-7.	Calibration Cycle	4-1
2-33.	Coupling Option 004 Comparator with Option 001 BCD Data Output Installation	2-6	—	Preliminary Operations	4-2
2-34.	Option 101 HP-IB Remote Control and Data Output Installation... ..	2-6	—	Calibration of DUT's	4-4
III	OPERATION	3-1	4-9.	Measurement Frequency Test	4-7
3-1.	Introduction	3-1	4-10.	Capacitance Accuracy Test	4-8
3-3.	Panel Features	3-1	4-11.	Resistance/ESR Accuracy Test....	4-12
3-5.	Self Test (Basic Operating Check) ..	3-1	4-12.	Dissipation Factor Confirmation Check .	4-14
3-7.	Test Signals	3-6	4-13.	Inductance Accuracy Test	4-17
3-9.	Measurement Range	3-6	4-14.	Internal DC Bias Source Test	4-19
3-11.	Initial Display Test	3-7	4-15.	Offset Adjustment Test	4-20
3-13.	Initial Control Settings	3-7	4-16.	Comparator Test (Option 004 Only)	4-22
3-15.	D/Q Measurement	3-7	4-17.	HP-IB Interface Test (Option 101 Only)	4-25
3-17.	LCR Measurement	3-7			
3-19.	D/Q Blanking Function (Switch selectable function inside cabinet) .	3-9			
3-21.	General Component Measurement ..	3-9			
3-23.	Semiconductor Device Measurement	3-9			
3-25.	External DC Bias	3-9			
3-28.	External Triggering	3-9			

TABLE OF CONTENTS

Section	Title	Page	Section	Title	Page
V	ADJUSTMENT	5-1	8-11.	Basic Theory	8-2
5-1.	Introduction	5-1	—	Principles of Operation	8-4
5-3.	Safety Requirements	5-1	8-21.	Block Diagram Discussion	8-8
5-7.	Equipment Required	5-1	8-22.	Analog Section Discussion	8-8
5-9.	Factory Selected Components	5-1	8-23.	A11 Oscillator and	
5-12.	Adjustment Relationships	5-1		Source Resistor	8-8
5-14.	Adjustment Locations	5-1	8-25.	A12 Range Resistor.....	8-8
5-16.	DUT Adjustment Recommendations .	5-4	8-26.	A13 Process Amplifier...	8-8
5-18.	Initial Operating Procedure	5-5	8-27.	A14 Phase Detector and	
5-20.	DC Power Supply Adjustment.....	5-6		Integrator	8-8
5-21.	Nanoprocessor Operating Power		8-28.	Digital Control Section	8-10
	Voltage Adjustment	5-7	8-30.	A23 Processor and ROM	8-10
5-22.	A12 Board Offset Adjustment.....	5-8	8-31.	A21 Keyboard Control ..	8-11
5-23.	A13 Board Offset Adjustment.....	5-9	8-32.	A22 Display Control	
5-24.	A14 Phase Detector & Integrator			& RAM	8-11
	Adjustment	5-14	8-33.	A2 Display and Keyboard	8-11
5-25.	10kHz Measurement Accuracy		8-34.	Timing Diagram Discussion.....	8-12
	Adjustment	5-17	8-37.	Options	8-14
5-26.	C Zero ADJ Circuit Adjustment		8-39.	Option 001 BCD Data	
	(A12)	5-22		Output (A35)	8-14
VI	REPLACEABLE PARTS	6-1	8-40.	Option 004 Comparator	
6-1.	Introduction	6-1		(A4, A5 & A24).....	8-15
6-3.	Abbreviations	6-1	8-41.	Option 101 HP-IB	
6-5.	Replaceable Parts List	6-1		Compatible (A25).....	8-15
6-7.	Ordering Information	6-2	8-42.	Troubleshooting	8-16
6-12.	Direct Mail Order System	6-2	8-46.	Repair.....	8-26
VII	MANUAL CHANGES	7-1	8-47.	Removal of Q2 and Q3	8-26
7-1.	Introduction	7-1	8-48.	Line Switch (S1) Removal	8-26
7-3.	Manual Changes	7-1	8-49.	Protective Diode Replacement	
VIII	SERVICE	8-1		(CR4, CR5, CR6 and CR7).....	8-27
8-1.	Introduction	8-1	8-50.	ZERO ADJ Control Potentiometer	
8-3.	Theory of Operation	8-1		(R4 and R5) Replacement	8-27
8-5.	Troubleshooting	8-1	8-51.	A2 Keyboard and Display	
8-7.	Recommended Test Equipment	8-1		Board Disassembly	8-27
8-9.	Repair.....	8-1	8-52.	Keyboard Switch LED Replacement	8-28
			8-53.	Product Safety Checks.....	8-29

LIST OF TABLES

Number	Title	Page	Number	Title	Page
1-1.	Specifications	1-2	5-1.	Adjustable Components	5-2
1-2.	General Information	1-6	5-2.	Factory Selected Components	5-3
1-3.	Equipment Available	1-9	5-3.	DUT's Recommended for Making Adjustments	5-4
1-4.	Recommended Test Equipment	1-10	5-4.	Adjustment Requirements	5-5
2-1.	Option Components	2-8	6-1.	List of Reference Designators and Abbreviations	6-1
3-1.	Test Signal Level	3-6	6-2.	Manufacturers Code List	6-2
3-2.	Measurement Ranges	3-6	6-3.	Replaceable Parts	6-3
3-3.	Annunciation Display Meanings	3-12	6-4.	Option 010 Modification	6-24
3-4.	Unusual Operating Indications	3-21	7-1.	Manual Changes by Serial Number ..	7-1
3-60.	Remote Program Codes	3-32	7-2.	Summary of Changes by Assembly ..	7-1
3-61.	Remote Message Coding	3-33	8-1.	Currently Available Options	8-14
4-1.	Recommended Components for Accuracy Checks	4-6	8-2.	Symptoms Likely to Mislead	8-18
			8-3.	Front Panel Symptoms of Internal Control Misadjustment	8-19
			8-4.	Front Panel Isolation Procedure ..	8-20

LIST OF ILLUSTRATIONS

Number	Title	Page	Number	Title	Page
1-1.	Model 4262A and Accessories	1-1	4-4.	Dissipation Factor Confirmation Check Setups	4-14
1-2.	Serial Number Plate	1-7	4-5.	Inductance Accuracy Test Setup ...	4-17
2-1.	Voltage and Fuse Selection	2-2	4-6.	Internal DC Bias Source Test Setup	4-19
2-2.	Power Cable	2-4	4-7.	Offset Adjustment Test Setup	4-20
2-3.	Rack Mount Kit	2-5	4-8.	Comparator Test Setups	4-22
2-4.	Option Installation Illustrations	2-7	4-9.	Comparator Output (J6) data format	4-24
3-1.	Front Panel Features	3-2	4-10.	HP-IB Interface Test Setup	4-25
3-2.	Rear Panel Features	3-4	4-11.	SRQ Service Routing	4-29
3-3.	Test Fixture and Leads	3-8	5-1.	Power Supply Voltage Adjustment ...	5-6
3-4.	Measurement Error due to Misadjusted ZERO ADJ controls ..	3-10	5-2.	Nanoprocessor Operating Power Voltage Adjustment Location	5-7
3-5.	Conversion between Parallel and Series Equivalents	3-12	5-3.	A12 Board Offset Adjustment	5-8
3-6.	Relationship of Dissipation to Series and Parallel Resistance ...	3-13	5-4.	Waveform at A12Q11 Source	5-9
3-7.	General Component Measurements ..	3-15	5-5.	A13 Board Offset Adjustment	5-9
3-8.	Semiconductor Device Measurement	3-18	5-6.	Waveform at A13TP1	5-10
3-9.	External DC Bias Circuits	3-20	5-7.	Waveform at A13TP2	5-11
3-40.	Pin Assignments of Output Connector and Output Format	3-28	5-8.	Waveform at A13TP3	5-12
3-41.	Timing Chart of BCD Data Output ...	3-29	5-9.	A14 Phase Detector & Integrator Adjustment	5-13
3-42.	Front Panel Features	3-30	5-10.	A22S1 Switch Setting	5-14
3-43.	Option 004: COMPARATOR	3-30	5-11.	Zero Detector & APAO Adjustments	5-15
3-44.	Pin Location of Comparator Data Output	3-31	5-12.	10kHz Measurement Accuracy Adjustment	5-17
4-1.	Measurement Frequency Test Setup ...	4-7	5-13.	Offset Adjustment Setup	5-22
4-2.	Capacitance Accuracy Test Setup ...	4-8	6-1.	Major Mechanical Parts - Exploded View	6-23
4-3.	Resistance Accuracy Test Setup ...	4-12	6-2.	Mechanical Parts - Exploded View	6-25

CERTIFICATION

Hewlett-Packard Company certifies that this product met its published specifications at the time of shipment from the factory. Hewlett-Packard further certifies that its calibration measurements are traceable to the United States National Bureau of Standards, to the extent allowed by the Bureau's calibration facility, and to the calibration facilities of other International Standards Organization members.

WARRANTY

This Hewlett-Packard instrument product is warranted against defects in material and workmanship for a period of one year from date of shipment, except that in the case of certain components listed in Section 1 of this manual, the warranty shall be for the specified period. During the warranty period, Hewlett-Packard Company will, at its option, either repair or replace products which prove to be defective.

For warranty service or repair, this product must be returned to a service facility designated by HP. Buyer shall prepay shipping charges to HP and HP shall pay shipping charges to return the product to Buyer. However, Buyer shall pay all shipping charges, duties, and taxes for products returned to HP from another country.

HP warrants that its software and firmware designated by HP for use with an instrument will execute its programming instructions when properly installed on that instrument. HP does not warrant that the operation of the instrument, or software, or firmware will be uninterrupted or error free.

LIMITATION OF WARRANTY

The foregoing warranty shall not apply to defects resulting from improper or inadequate maintenance by Buyer, Buyer-supplied software or interfacing, unauthorized modification or misuse, operation outside of the environment specifications for the product, or improper site preparation or maintenance.

NO OTHER WARRANTY IS EXPRESSED OR IMPLIED. HP SPECIFICALLY DISCLAIMS THE IMPLIED WARRANTIES OF MERCHANTABILITY AND FITNESS FOR A PARTICULAR PURPOSE.

EXCLUSIVE REMEDIES

THE REMEDIES PROVIDED HEREIN ARE BUYER'S SOLE AND EXCLUSIVE REMEDIES. HP SHALL NOT BE LIABLE FOR ANY DIRECT, INDIRECT, SPECIAL, INCIDENTAL, OR CONSEQUENTIAL DAMAGES, WHETHER BASED ON CONTRACT, TORT, OR ANY OTHER LEGAL THEORY.

ASSISTANCE

Product maintenance agreements and other customer assistance agreements are available for Hewlett-Packard products.

For any assistance, contact your nearest Hewlett-Packard Sales and Service Office. Addresses are provided at the back of this manual.

SAFETY SYMBOLS

General Definitions of Safety Symbols Used On Equipment or In Manuals.



Instruction manual symbol: the product will be marked with this symbol when it is necessary for the user to refer to the instruction manual in order to protect against damage to the instrument.



Indicates dangerous voltage (terminals fed from the interior by voltage exceeding 1000 volts must be so marked).

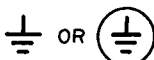

Protective conductor terminal. For protection against electrical shock in case of a fault. Used with field wiring terminals to indicate the terminal which must be connected to ground before operating equipment.



Low-noise or noiseless, clean ground (earth) terminal. Used for a signal common, as well as providing protection against electrical shock in case of fault. A terminal marked with this symbol must be connected to ground in the manner described in the installation (operating) manual, and before operating the equipment.

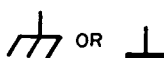

Frame or chassis terminal. A connection to the frame (chassis) of the equipment which normally includes all exposed metal structures.



Alternating current (power line).



Direct current (power line).



Alternating or direct current (power line).

WARNING

A **WARNING** denotes a hazard. It calls attention to a procedure, practice, condition or the like, which, if not correctly performed or adhered to, could result in injury or death to personnel.

CAUTION

The **CAUTION** sign denotes a hazard. It calls attention to an operating procedure, practice, condition or the like, which, if not correctly performed or adhered to, could result in damage to or destruction of part or all of the product.

Note

A **Note** denotes important information. It calls attention to a procedure, practice, condition or the like, which is essential to highlight.

LIST OF ILLUSTRATIONS

Number	Title	Page	Number	Title	Page
8-1.	Basic Block Diagram	8-2	8-37.	A13 Process Amplifier Board	
8-2.	Cp Measurement	8-3		Assembly Component Locations...	8-53
8-3.	Measurement Principles.....	8-7	8-38.	A13 Process Amplifier Board	
8-4.	Offset Control Principle.....	8-6		Assembly Schematic Diagram....	8-53
8-5.	DC Bias Circuit	8-6	8-39.	A14 Phase Detector & Integrator	
8-6.	Analog Section Block Diagram.....	8-9		Board Troubleshooting Tree(A) ...	8-54
8-7.	Digital Section Block Diagram.....	8-11	8-40.	A14 Phase Detector & Integrator	
8-8.	Timing Diagram.....	8-13		Board Troubleshooting Tree(B) ...	8-55
8-9.	Option Section Block Diagram.....	8-15	8-41.	A14 Phase Detector & Integrator	
8-10.	How to Use Troubleshooting Guides.	8-17		Board Assembly	
8-11.	Self Test Function	8-21		Component Locations	8-57
8-12.	Signature Analysis Guide	8-23	8-42.	A14 Phase Detector & Integrator	
8-13.	Protective Diode and ZERO ADJ			Board Assembly	
	Control Potentiometer			Schematic Diagram	8-57
	Replacement.....	8-26	8-43.	A21 Keyboard Control Board	
8-14.	A2 Keyboard and Display			Assembly Component Locations...	8-59
	Board Disassembly.....	8-27	8-44.	A21 Keyboard Control Board	
8-15.	Inserting Tubing into Switch Plunger	8-28		Assembly Schematic Diagram	8-59
8-16.	LED Installation in Switch	8-28	8-45.	A22 Display Control & RAM Board	
8-17.	Analog and Digital Section			Assembly Component Locations...	8-61
	Isolation Procedure	8-31	8-46.	A22 Display Control & RAM Board	
8-18.	Analog Section Troubleshooting			Assembly Schematic Diagram	8-61
	Procedure to Assembly Level.....	8-33	8-47.	A23 Processor & ROM Board	
8-19.	Digital Section Troubleshooting			Assembly Component Locations...	8-63
	Procedures	8-35	8-48.	A23 Processor & ROM Board	
8-20.	Schematic Diagram Notes.....	8-43		Assembly Schematic Diagram	8-63
8-21.	Assembly Locations.....	8-43	8-49.	A4 Thumbwheel Switch Board	
8-22.	Adjustment Locations	8-43		Assembly Component Locations...	8-65
8-23.	Front Panel Component Locations ..	8-44	8-50.	A5 Comparator Keyboard Board	
8-24.	Rear Panel Component Locations...	8-44		Assembly Component Locations...	8-65
8-25.	A2 Keyboard & Display Board		8-51.	A4 Thumbwheel Switch Board and	
	Assembly Component Locations...	8-45		A5 Comparator Keyboard Board	
8-26.	A2 Keyboard & Display Board			Assembly Schematic Diagram	8-65
	Assembly Schematic Diagram	8-45	8-52.	A24 Comparator Control Board	
8-27.	A9 Power Supply Board			Diagnostic Flow Diagram	8-66
	Troubleshooting Tree.....	8-46	8-53.	A24 Comparator Control Board	
8-28.	A9 Power Supply Board Assembly			Assembly Component Locations...	8-67
	Component Locations	8-47	8-54.	A24 Comparator Control Board	
8-29.	A9 Power Supply Board Assembly			Assembly Schematic Diagram	8-67
	Schematic Diagram	8-47	8-55.	A25 HP-IB Interface Board	
8-30.	A11 OSC & Source Resistor Board			Diagnostic Flow Diagram.....	8-68
	Troubleshooting Tree.....	8-48	8-56.	A25 HP-IB Interface Board	
8-31.	A11 OSC & Source Resistor Board			Assembly Component Locations...	8-69
	Assembly Component Locations ..	8-49	8-57.	A25 HP-IB Interface Board	
8-32.	A11 OSC & Source Resistor Board			Assembly Schematic Diagram	8-69
	Assembly Schematic Diagram	8-49	8-58.	A35 BCD Output Control Board	
8-33.	A12 Range Resistor Board			Diagnostic Flow Diagram	8-70
	Troubleshooting Tree	8-50	8-59.	A35 BCD Output Control Board	
8-34.	A12 Range Resistor Board Assembly			Assembly Component Locations...	8-71
	Component Locations	8-51	8-60.	A35 BCD Output Control Board	
8-35.	A12 Range Resistor Board			Assembly Schematic Diagram	8-71
	Assembly Schematic Diagram.....	8-51			
8-36.	A13 Process Amplifier Board				
	Troubleshooting Tree.....	8-52			

SECTION I GENERAL INFORMATION

1-1. INTRODUCTION.

1-2. This operating and service manual contains the information required to install, operate, test, adjust and service the Hewlett-Packard Model 4262A Digital LCR Meter. Figure 1-1 shows the instrument and supplied accessories. This section covers specifications, instrument identification, description, options, accessories, and other basic information.

1-3. Listed on the title page of this manual is a microfiche part number. This number can be used to order 4 x 6 inch microfilm transparencies of the manual. Each microfiche contains up to 60 photoduplicates of the manual pages. The microfiche package also includes the latest manual changes supplement as well as all pertinent service notes. To order an additional manual, use the part number listed on the title page of this manual.

1-4. DESCRIPTION.

1-5. The HP Model 4262A LCR Meter is a general

purpose, fully automatic test instrument designed to measure the parameters of an impedance element with high accuracy and speed. The 4262A measures capacitance, inductance, resistance (equivalent series resistance) and dissipation factor or quality factor over a wide range at test frequencies of 120Hz, 1kHz and 10kHz employing a five-terminal connection configuration between the component and the instrument. The measuring circuit for the device to be measured is capable of both parallel and series equivalent circuit measurements and the measured values are displayed by the two three-full digits LED displays on the front panel. A convenient diagnostic function, also featured in the 4262A, is actuated by a SELF TEST switch. This confirms functional operation of the instrument.

1-6. The measuring range for capacitance is from 0.01pF to 19.99mF, inductance from 0.01μH to 1999H, and resistance from 1mΩ to 19.99MΩ, which are measured with a basic accuracy of 0.2 to 0.3% depending on test signal level, frequency, and measuring equivalent circuit, and at typical measuring speeds of 220 to 260 milliseconds at

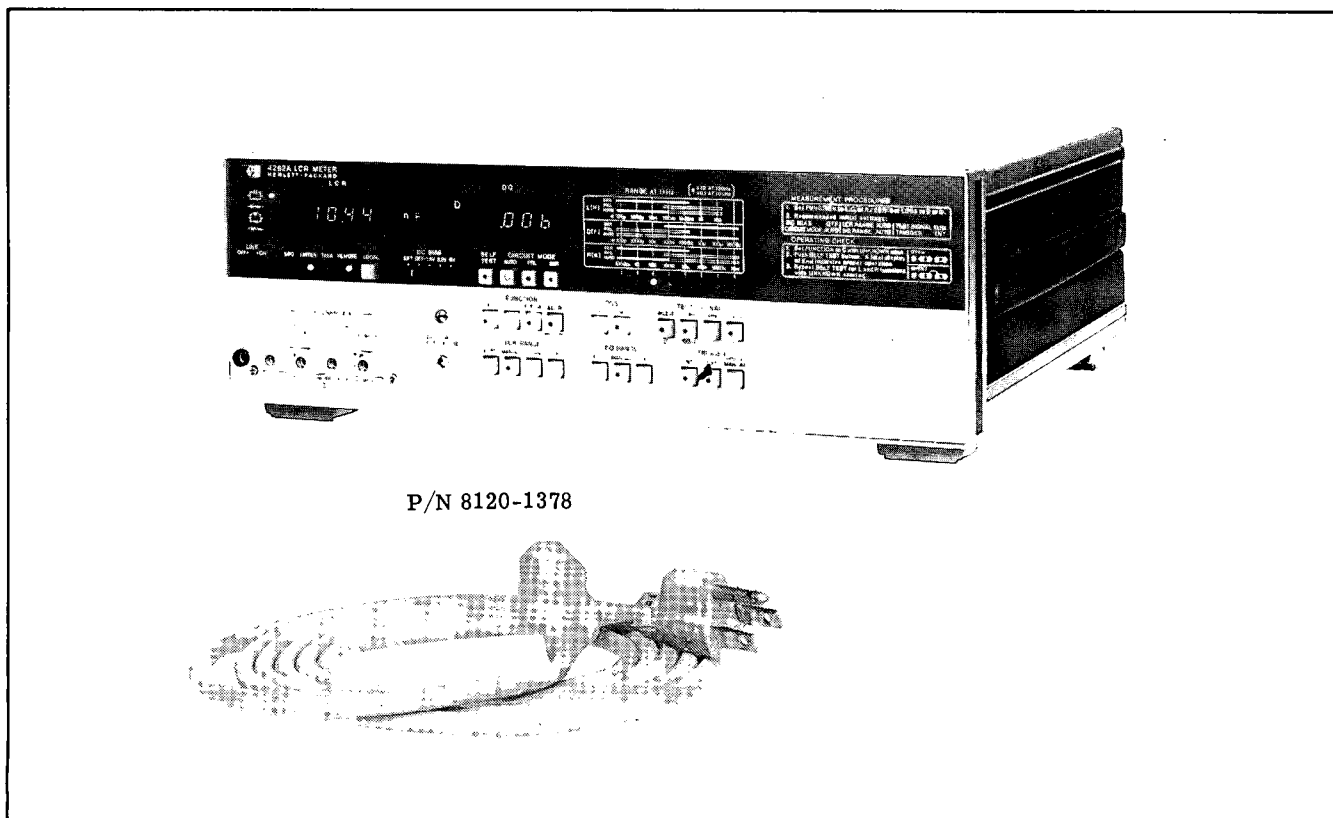

Figure 1-1. Model 4262A and Accessories.

Table 1-1. Specifications (Sheet 1 of 4).

COMMON SPECIFICATIONS

Parameters Measured: C - D or Q (1/D)
L - D or Q (1/D)
R (ESR) (Loss measurement can be negated by switch on internal board).

Display: 3-1/2 Digit, Maximum Display 1999
(When D value is more than 10, maximum display is 199).

Measurement Circuit Modes:
Auto, Parallel, and Series

Measurement Terminals: 5-terminal configuration (high and low terminals for both potential and current leads plus guard).

Range Modes: LCR - Auto and Manual
(up-down)
DQ - Auto and Manual (step)

Measurement Frequencies: 120(100)Hz, 1kHz
and 10kHz $\pm 3\%$.

Test Signal Level: Normal level: 1Vrms.
Low level : 50mVrms (parallel capacitance mode only)

Warm-up Time: 15 minutes

Deviation Measurement: When Δ LCR key is depressed, the existing measured value is stored as a reference value and displayed value is offset to zero. The range is held and deviation is displayed as the difference between the referenced value and subsequent result. (Deviation spread in counts from -999 to 1999).

Offset Adjustment: Stray capacitance and residual inductance of test jig can be compensated for as follows:

C: up to 10pF
L: up to 1 μ H

Self Test: Annunciates either Pass, or Fail for performance in each of the five basic ranges.

DC Bias:
Internal: 1.5V, 2.2V, 6V (Selectable at front panel). Accuracy $\pm 5\%$
External: External DC bias connector on rear panel. Maximum +40V.

Trigger: Internal, External, or Manual

GENERAL

Operating Temperature & Humidity:
0°C to 55°C at 95% RH(to 40°C)













Power Requirements: 100/120/220V $\pm 10\%$,
240V +5% -10% 48 - 66Hz

Power Consumption: 55VA with any option

Dimensions: 426(W) x 147(H) x 345(D)mm
(16-3/4" x 5-3/4" x 13-3/4")

Weight: Approximately 8kg (Std)

Table 1-1. Specifications (Sheet 2 of 4).

C-D, C-Q MEASUREMENT										
Ranges	C	120Hz	1000pF	10.00nF	100.0nF	1000nF	10.00μF	100.0μF	1000μF	10.00mF
		1kHz	100.0pF	1000pF	10.00nF	100.0nF	1000nF	10.00μF	100.0μF	1000μF
		10kHz	10.00pF	100.0pF	1000pF	10.00nF	100.0nF	1000nF	10.00μF	100.0μF
	D	.001~19.9 (2 Ranges)								
	Q *1	0.05~1000 (4 Ranges)								
Test Signal Level *2		1V or 50mV (LOW LEVEL)								
		10μA 100μA 1mA 10mA 40mA								
	AUTO	Same as  Mode				Same as  Mode				
C Accuracy *3		0.2% + 1 counts				(Test signal level; 1V)				
		0.5% + 3 counts	0.3% + 2 counts				(Test signal level; 50mV)			
		(At 120Hz, 1kHz) 0.3% + 2 counts				0.5% + 2 counts	1% + 2 counts *4			
		(At 10kHz) 0.3% + 2 counts				1% + 2		5% + 2		
	AUTO	Same as  Mode				Same as  Mode				
D(1/Q) Accuracy *3		0.2% + (2 + 200/Cx) counts				At 120Hz, 1kHz (Test signal level; 1V)				
		0.5% + (2 + 200/Cx) counts				At 10kHz				
		0.3% + (2 + 1000/Cx) counts				At 120Hz, 1kHz (Test signal level; 50mV)				
		1.0% + (2 + 1000/Cx) counts				At 10kHz				
		(At 120Hz, 1kHz) 0.3% + (2 + Cx/500) counts				1% + (5 * Cx/500)				
		(At 10kHz) 0.5% + (2 + Cx/500) counts				1% + (5 * Cx/500)		5% + (5 * Cx/500)		
	AUTO	Same as  Mode				Same as  Mode				

- *1 Calculated from D value as a reciprocal number.
- *2 Typical data, varies with value of D and number of counts.
- *3 ±(% of reading + counts). Cx is capacitance readout in counts. This accuracy only applies for D values to 1.999. (For higher D values, refer to General Information).
- *4 (5% + 2 counts) at 1kHz.

Accuracy applies over a temperature range of 23°C ± 5°C (At 0°C to 55°C, error doubles).

Note: C accuracy for higher D values are unspecified.

Table 1-1. Specifications (Sheet 3 of 4).

L-D, L-Q MEASUREMENT									
Ranges	L	120Hz 1kHz 10kHz	1000μH 100.0μH 10.00μH	10.00mH 1000μH 100.0μH	100.0mH 10.00mH 1000μH	1000mH 100.0mH 10.00mH	10.00H 1000mH 100.0mH	100.0H 10.00H 1000mH	1000H 100.0H 10.00H
	D	.001 ~ 19.9 (2 Ranges)							
	Q* ¹	0.05 ~ 1000 (4 Ranges)							
Test Signal Level * ²		1V							
		40mA	10mA	1mA	100μA	10μA			
	AUTO	Same as Mode				Same as Mode			
L Accuracy * ³		(At 120Hz, 1kHz)		0.3% + 2 counts		1% + 2 counts			
		(At 10kHz)		0.3% + 2 counts		1% + 2		5% + 2	
		0.2% + 2 counts					(At 120Hz, 1kHz)		
		0.3% + 2	0.2% + 2 counts					(At 10kHz)	
AUTO	Same as Mode				Same as Mode				
D(1/Q) Accuracy		(At 120Hz, 1kHz)		0.3% + (3 + Lx/500)		1% + (3 + Lx/500)			
		(At 10kHz)		0.5% + (3 + Lx/500)		1% + (3 + $\frac{Lx}{500}$)	5% + (5 + $\frac{Lx}{500}$)		
		0.2% + (3 + 200/Lx) counts					(At 120Hz, 1kHz)		
		0.5% + (3 + 200/Lx) counts					(At 1kHz)		
AUTO	Same as Mode				Same as Mode				

*1 Calculated from D value as a reciprocal number.

*2 Typical data, varies with value of D and number of counts.

*3 ±(% of reading + counts). Lx is inductance readout in counts. This accuracy only applies for D values to 1.999.

Accuracy applies over a temperature range of 23°C ± 5°C. (At 0°C to 55°C, error doubles).

R/ESR MEASUREMENT

Ranges	120Hz R/ESR 1kHz 10kHz	1000mΩ	10.00Ω	100.0Ω	1000Ω	10.00kΩ	100.0kΩ	1000kΩ	10.00MΩ
Test Signal Level * ¹		1V							
		40mA	10mA	1mA	100μA	10μA			
	AUTO	Same as Mode				Same as Mode			
Accuracy * ²		0.3% + 2 counts * ³							
		0.2% + 2 counts							
	AUTO	Same as Mode				Same as Mode			

*1 Typical data, varies with number of counts.

*2 ±(% of reading + counts).

*3 (0.5% + 2 counts) on 10.00MΩ range at 10kHz.

** Measurement range for ESR (equivalent series resistance) is from 1mΩ to 19.99kΩ (typical), which varies with series capacitance and inductance value . . . refer to "REFERENCE DATA".

Accuracy applies over a temperature range of 23°C ± 5°C. (At 0°C to 55°C, error doubles.)

Table 1-1. Specifications (Sheet 4 of 4).

OPTIONS

Option 001: Simultaneous BCD output of LCR and DQ data (positive true). Max. sink current 16mA. Mating connector (P/N 1251-0086). (Alternate BCD output of LCR and DQ data selectable by switch on internal board).

Option 004: Digital comparator (can not be used with OPT 101). Compares measured value with high and low limit settings for LCR or DQ and provides HIGH, IN, LOW comparison outputs.

Limit setting range: 0000 - 1999 for each limit switch.

Comparison output: Visual, relay contact, and TTL level.

Visual: 3 LED's indicate HIGH(red), IN (green), or LOW (red).

Relay contacts:

SPST contacts to circuit common for each HIGH, IN and LOW output.

TTL level:

Open collector circuits to high level (open) for each HIGH, IN and LOW outputs (fanout max. 30mA).

Option 101: HP-IB data output & remote control.

Remotely controllable functions:

Function (L, C, R/ESR, ΔLCR)

Loss (D, Q)

LCR range

DQ range

Circuit mode

Test frequency & level

Trigger

Self test

Data output: C - D/Q, L - D/Q, R/ESR

Internal function allowable subsets:

SH1, AH1, T5, L4, RL1, DC1, SR1 and DT1.

Data output format: Either of two formats may be selected. Switchable at rear panel (no + sign outputs).

Format A.

SFFT±N.NNNE+NN, SF±N.NN(CR)(LF)

Format B.

SFFT±N.NNNE+NN(CR)(LF)

SF±N.NN(CR)(LF)

SFFT

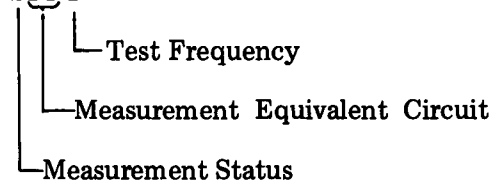

SF

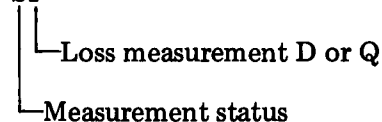

Option 010: 100Hz test frequency instead of 120Hz.

ACCESSORIES AVAILABLE

16061A: Test fixture, direct coupled, 5-terminal. Two kinds of inserts are included for components with either axial or radial leads. Usable on all ranges of 4262A.

16062A: Test cable with alligator clips, 4-terminal. Useable for low impedance measurements. Measurement range at 1kHz is $L \leq 2H$, $C \geq 200nF$ and $R \leq 10k\Omega$. [For L and C measurements, these ranges increase by x10 at 120(100)Hz and decrease by same factor at 10kHz].

16063A: Test cable with alligator clips, 3-terminal. Useable for high impedance measurements. Measurement range at 1kHz is $L \geq 3mH$, $C \leq 10\mu F$ and $R \geq 200\Omega$. [For L and C measurement, these ranges increase by x10 at 120(100)Hz and decrease by same factor at 10kHz].

Table 1-2. General Information.

Measurement Times (typical):

For a 1000 count measurement on a low loss component on a fixed range:

Test Frequency	Function	Meas. Time
1kHz, 10kHz	C/L	220-260ms
	R	120-160ms
120(100)Hz	C/L	900ms
	R	700mS

When autorange is selected the following times per range step must be added to the above times:

1kHz, 10kHz	45ms/180ms
120(100)Hz	150ms/670ms

When U-CL is displayed, the faster ranging time is selected.

Reading Rate:

Internal - Approx. 30ms between end of measurement and start of next cycle.

External - Measurement cycle is initiated by external trigger input.

High D Factor Accuracies:

Typical
(≥ 2 , on 10.00 range).

Circuit Mode	Accuracy
	$5\% + (2 + 1000/C_x)$
	$5\% + (5 + C_x/500)$
	$5\% + (5 + L_x/500)$
	$5\% + (3 + 200/L_x)$

ESR (Equivalent Series Resistance) Measurement:

Following tables show ESR measurement range for capacitors and inductors.

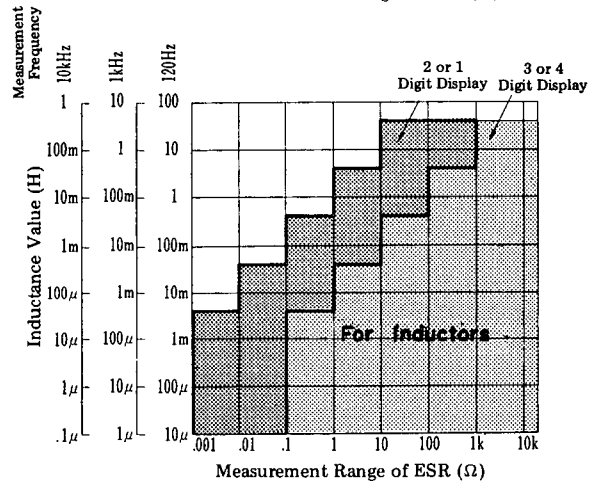
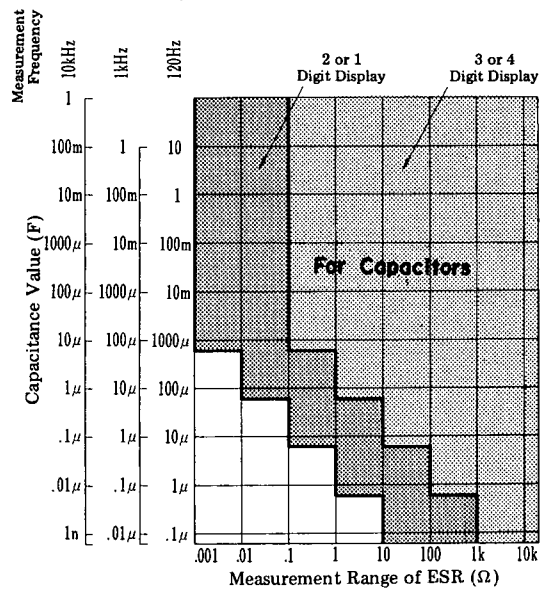

MEASURING TIME

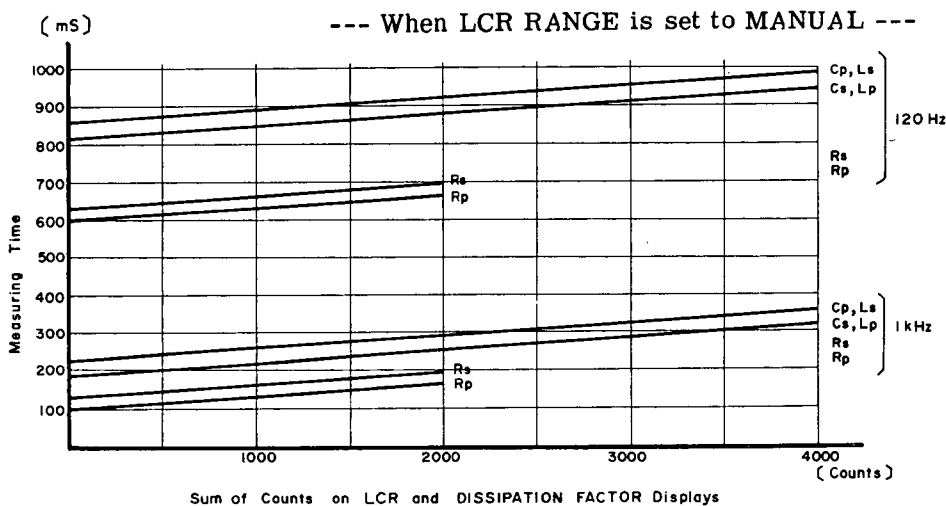

1kHz and 10kHz and about 900 milliseconds at 120Hz. The wide range capability of the 4262A enables a measurement range from small capacitances such as mica capacitors and the parasitic capacitance of a semiconductor device through high capacitances such as the measurement of electrolytic capacitors to be covered. A wide range of inductance measurements from the inductance of a high frequency transformer to that of a power transformer can be measured. The wide resistance range permits the measurement of wire-wound resistors through the measurement of solid resistors. In parallel capacitance measurements, either a test signal level of 1Vrms, or 50mVrms can be selected.

1-7. The 4262A has the capability of making capacitance, inductance, and resistance deviation measurements. This function is enabled by pushing the Δ LCR switch to display the deviation of a reference value. When the Δ LCR switch is depressed the reference value is obtained and memorized from the preceding measurement. The practical use of this feature is evident when it is desired to make a measurement on a variable capacitor: First, the minimum value is measured, then the Δ LCR button is pushed. Minimum to maximum capacitance is now displayed as the capacitor is rotated through its range. For parallel capacitance measurements, test signal levels of either 1Vrms or 50mVrms may be selected. Other versatile 4262A capabilities and features are, for example, the use of internal and external dc bias voltages, LC zero adjustment, and options providing BCD output, HP-IB interfacing capability, or a comparator function.

1-8. SPECIFICATIONS.

1-9. Complete specifications of the Model 4262A LCR Meter are given in Table 1-1. These specifications are the performance standards or limits against which the instrument is tested. The test procedures for the specifications are covered in Section IV Performance Tests. Table 1-2 lists gen-

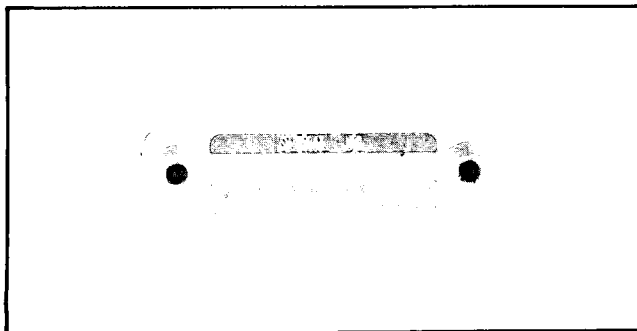

Figure 1-2. Serial Number Plate.

eral information. General information is not specifications but is typical characteristics included as additional information for the operator. When the 4262A LCR Meter is shipped from the factory, it meets the specifications listed in Table 1-1.

1-10. SAFETY CONSIDERATIONS.

1-11. The Model 4262A LCR Meter has been designed to conform to the safety requirements of an IEC (International Electromechanical Committee) Safety Class I instrument and is shipped from the factory in a safe condition.

1-12. This operating and service manual contains information, cautions, and warnings which must be followed by the user to ensure safe operation and to maintain the instrument in a safe condition.

1-13. INSTRUMENTS COVERED BY MANUAL.

1-14. Hewlett-Packard uses a two-section nine character serial number which is marked on the serial number plate (Figure 1-2) attached to the instrument rear panel. The first four digits and the letter are the serial prefix and the last five digits are the suffix. The letter placed between the two sections identifies country where instrument was manufactured. The prefix is the same for all identical instruments; it changes only when a change is made to the instrument. The suffix, however, is assigned sequentially and is different for each instrument. The contents of this manual apply to instruments with the serial number prefix(es) listed under SERIAL NUMBERS on the title page.

1-15. An instrument manufactured after the printing of this manual may have a serial number prefix that is not listed on the title page. This unlisted serial number prefix indicates the instrument is different from those described in this manual. The manual for this new instrument may be accompanied by a yellow Manual Changes supplement or have a different manual part number. This supplement contains "change information" that explains how to adapt the manual to the newer instrument.

1-16. In addition to change information, the supplement may contain information for correcting errors (called Errata) in the manual. To keep this manual as current and accurate as possible, Hewlett-Packard recommends that you periodically request the latest Manual Changes supplement. The supplement for this manual is identified with this manual's print date and part number, both of which appear on the manual's title page. Complimentary copies of the supplement are available from Hewlett-Packard. If the serial prefix or number of an instrument is lower than that on title page of this manual, see Section VII Manual Changes.

1-17. For information concerning a serial number prefix that is not listed on the title page or in the Manual Changes supplement, contact your nearest Hewlett-Packard office.

1-18. OPTIONS.

1-19. Options for the Model 4262A LCR Meter are available for adding the following capabilities:

- Option 001: BCD Parallel Data Output.
- Option 004: Comparator. A comparator function providing GO/NO-GO judgement with HIGH and LOW limits for LCR and D/Q.
- Option 101: HP-IB Interface.
- Option 010: 100Hz Test Frequency. (instead of 120Hz)
- Options 907, 908 or 909 are handle or rack mount kits. See paragraph 1-29 for details.
- Option 910: Extra Manual.

1-20. OPTION 001.

1-21. The 4262A option 001 provides separate BCD parallel data output for L, C, R/ESR and dissipation factor or quality factor simultaneously from the two rear panel connectors. With this option, external data processing devices such as a digital printer can be used with the 4262A.

1-22. OPTION 004.

1-23. The 4262A Option 004 provides for GO/NO-GO judgement by comparing L, C, R/ESR and D/Q values to HIGH and LOW limits. Three judgement outputs are provided: LED lamp display, relay contacts, or TTL level voltages (open collectors):

- HIGH . . . measured value is not less than HIGH limit.
- IN . . . measured value is less than HIGH limit and not less than LOW limit.
- LOW . . . measured value is less than LOW limit.

1-24. OPTION 101.

1-25. The 4262A Option 101 provides interfacing functions to both transfer L, C, R/ESR and D/Q data to HP Interface Bus line and to receive remote control signals from HP Interface Bus line.

1-26. OPTION 010.

1-27. The 4262A Option 010 provides test frequencies of 100Hz, 1kHz, and 10kHz (100Hz is used instead of standard 120Hz). All other electrical performance is the same as that of standard instrument.

1-28. OTHER OPTIONS.

1-29. The following options provides mechanical parts necessary for rack mounting and hand carrying:

- Option 907: Front Handle Kit.
- Option 908: Rack Flange Kit.
- Option 909: Rack Flange and Front Handle Kit.

The installation procedures for these options are detailed in section II.

1-30. The 4262A Option 910 provides an extra copy of the operating and service manual.

1-31. ACCESSORIES SUPPLIED.

1-32. Figure 1-1 shows the HP Model 4262A LCR Meter, power cord (HP Part No. 8120-1378), and fuses (HP Part No. 2110-0007 and 2110-0202).

1-33. ACCESSORIES AVAILABLE.

1-34. For effective and easy measurement, three styles of fixtures and leads for the measurement of various components are available. These are listed in Table 1-1. A brief description of each of these fixtures and leads is given in Table 1-3. Refer to Section III Figure 3-3 on page 3-8 for detailed information on these devices.

Table 1-3. Accessories Available.

Model	Description
<p>HP 16061A</p>  <p>The image shows two black plastic test fixtures with metal leads, and a white instruction card. The card is titled '16061A TEST FIXTURE' and includes a diagram of a component being tested, with labels for 'LOW DC BIAS' and 'HIGH DC BIAS'.</p>	<p>Test Fixture (direct coupled type) for general measurement of both axial and vertical lead components.</p>
<p>HP 16062A</p>  <p>The image shows a set of test leads with alligator clips at one end and various connectors at the other. There are three black leads and one white lead, all bundled together.</p>	<p>Test Leads (with alligator clips) useful for low inductance, high capacitance or low resistance (less than 10kΩ) measurements.</p>
<p>HP 16063A</p>  <p>The image shows a set of test leads similar to HP 16062A, but with different connectors. There are three black leads and one white lead, all bundled together.</p>	<p>Test Leads (with alligator clips) for general component measurement and especially useful for high impedance measurements.</p>
<p>HP P/N 5060-4017</p>  <p>The image shows two identical extender boards. Each board has a row of 16 gold-plated pins at the top and 16 corresponding vertical leads extending downwards. A small label between the boards reads '5060-4017'.</p>	<p>Extender Board used for 4262A troubleshooting.</p>

Table 1-4. Recommended Test Equipment.

Instrument	Critical Specifications	Recommended Model	*Use
Frequency Counter	Frequency Range: 40Hz to 10kHz Sensitivity: 50mVrms min.	HP 5300A/ w 5306A	P
Capacitance Standard (See para. 4-3)	Capacitance Values: 100pF, 1000pF, 10nF, 100nF, 1000nF and 10μF	GR Type 1413 GR Type 1417	P, A
Resistance Standard (See para. 4-3)	Resistance Values: 1kΩ, 10kΩ, 100kΩ and 10MΩ	GR Type 1443-Y	P, A
Inductance Standard (See Para. 4-3)	Inductance Value: 100mH	GR Type 1482-L	P
DC Voltmeter	Voltage Range: 1V to 10V Sensitivity: 10mV min.	HP 5300A/ w 5306A	P, A
Oscilloscope	Bandwidth: 10MHz min. Vertical Sensitivity: 5mV/div. Horizontal Sweep Rate: 1μs/div.	HP 180C/ w 1801A/ w 1821A	A, T
Signature Analyzer		HP 5004A	T
Current Tracer		HP 547A	T
Service Kit	Signature Analysis Test Board	HP P/N: 04262-87002	T
DUT Box	Comprises L, C and R components whose values are calibrated at 120Hz and 1kHz.	HP 16361A	P, A
DUT Box	Comprises L, C and R components whose values are calibrated at 10kHz.	HP 16362A	P, A
*P=Performance Test A=Adjustments T=Troubleshooting			

SECTION II INSTALLATION

2-1. INTRODUCTION.

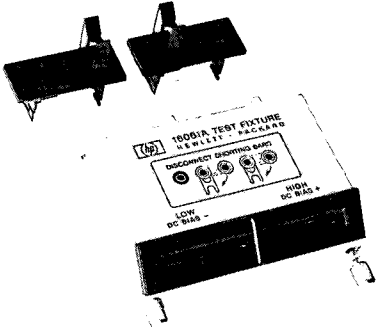
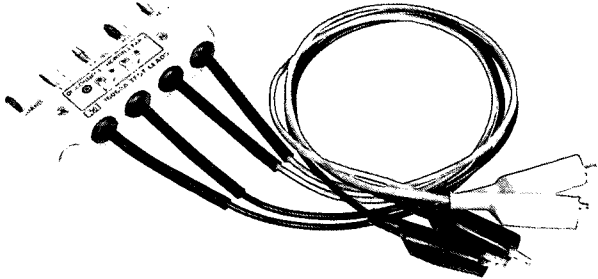
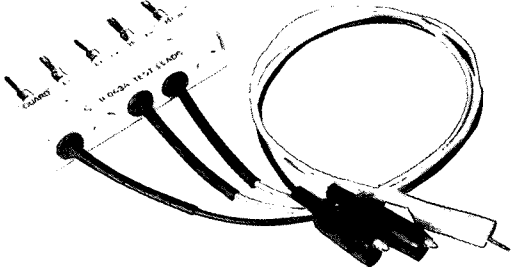
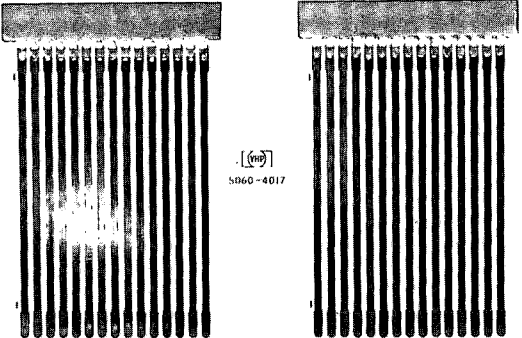
2-2. This section provides installation instructions for the Model 4262A LCR Meter. The section also includes information on initial inspection and damage claims, preparation for using the 4262A, packaging, storage, and shipment.

2-3. INITIAL INSPECTION.

2-4. The 4262A LCR Meter, as shipped from the factory, meets all the specifications listed in Table 1-1. On receipt, inspect the shipping container for damage. If the shipping container or cushioning material is damaged, notify the carrier as well as the Hewlett-Packard office and be sure to keep the shipping materials for carrier's inspection until the contents of the shipment have been checked for completeness and the instrument has been checked mechanically and electrically. The contents of the shipment should be as shown in Figure 1-1. The procedures for checking the general electrical operation are given in Section III (Paragraph 3-5 Basic Operating Check) and the procedures for checking the 4262A LCR Meter against its specifications are given in Section IV. Firstly, do the self test. If the 4262A LCR Meter is electrically questionable, then do the Performance Tests to determine whether the 4262A has failed or not. If contents are incomplete, if there is mechanical damage or defects (scratches, dents, broken switches, etc.), or if the performance does not meet the self test or performance tests, notify the nearest Hewlett-Packard office (see list at back of this manual). The HP office will arrange for repair or replacement without waiting for claim settlement.

2-5. PREPARATION FOR USE.

2-6. POWER REQUIREMENTS.

2-7. The 4262A requires a power source of 100, 120, 220 Volts ac $\pm 10\%$, or 240 Volts ac $+5\%$, -10% , 48 to 66 Hz single phase. Power consumption is approximately 55 watts.

WARNING

IF THIS INSTRUMENT IS TO BE ENERGIZED VIA AN EXTERNAL AUTOTRANSFORMER FOR VOLTAGE REDUCTION, BE SURE THAT THE COMMON TERMINAL IS CONNECTED TO THE NEUTRAL POLE OF THE POWER SUPPLY.

2-8. LINE VOLTAGE AND FUSE SELECTION.

CAUTION

BEFORE TURNING THE 4262A LINE SWITCH TO ON, VERIFY THAT THE INSTRUMENT IS SET TO THE VOLTAGE OF THE POWER SUPPLIED.

2-9. Figure 2-1 provides instructions for line voltage and fuse selection. The line voltage selection card and the proper fuse are factory installed for the voltage appropriate to instrument destination.

CAUTION

USE PROPER FUSE FOR LINE VOLTAGE SELECTED.

CAUTION

MAKE SURE THAT ONLY FUSES FOR THE REQUIRED RATED CURRENT AND OF THE SPECIFIED TYPE ARE USED FOR REPLACEMENT. THE USE OF MENDED FUSES AND THE SHORT-CIRCUITING OF FUSE-HOLDERS MUST BE AVOIDED.

2-10. POWER CABLE.

2-11. To protect operating personnel, the

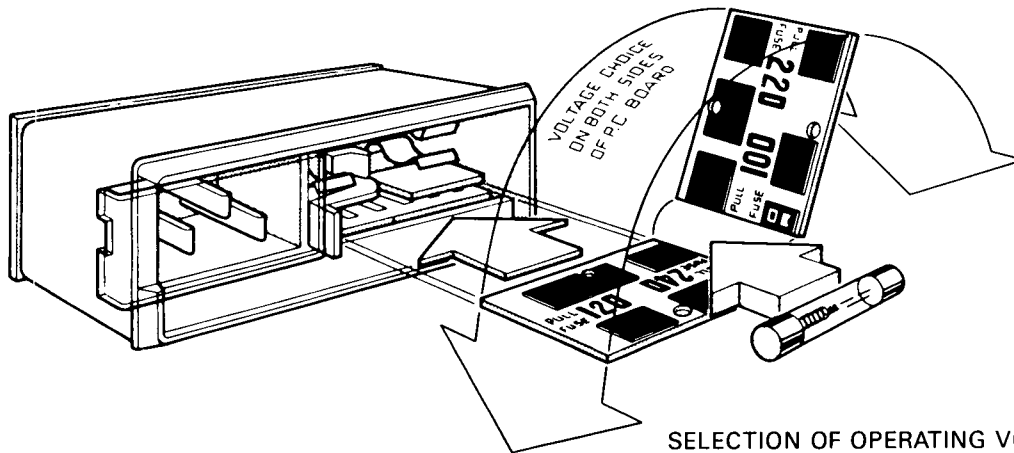

Operating voltage is shown in module window and is usually set to 120V at factory.

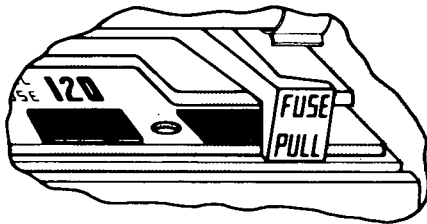

SELECTION OF OPERATING VOLTAGE

1. Disconnect power cable and slide module window to left.
2. Pull FUSE PULL lever and rotate to left. This removes line fuse.
3. Select operation voltage by orienting PC board to position desired voltage on top-left side. Push board firmly into module slot.
4. Rotate FUSE PULL lever back to its normal position and re-insert fuse in holder be careful to select correct fuse value.

Operating Voltage	Fuse	
	HP Part No.	Description
100Vac or 120Vac	2110-0007	1 A 250V Slow Blow
220Vac or 240Vac	2110-0202	0.5A 250V Slow Blow

Figure 2-1. Voltage and Fuse Selection.

National Electrical Manufacturer's Association (NEMA) recommends that the instrument panel and cabinet be grounded. The Model 4262A is equipped with a three-conductor power cable which, when plugged into an appropriate receptacle, grounds the instrument. The offset pin on the power cable is the ground wire.

2-12. To preserve the protection feature when operating the instrument from a two contact outlet, use a three prong to two prong adapter (HP Part No. 1251-8196) and connect the green grounding tab on the adapter to power line ground.

CAUTION

THE MAINS PLUG MUST ONLY BE INSERTED IN A SOCKET OUTLET PROVIDED WITH A PROTECTIVE EARTH CONTACT. THE PROTECTIVE ACTION MUST NOT BE NEGATED BY THE USE OF AN EXTENSION CORD (POWER CABLE) WITHOUT PROTECTIVE CONDUCTOR (GROUNDING).

2-13. Figure 2-2 shows the available power cords, which may be used in various countries including the standard power cord furnished with the instrument. HP Part number, applicable standards for power plug, power cord color, electrical characteristics and countries using each power cord are listed in the figure. If assistance is needed for selecting the correct power cable, contact nearest Hewlett-Packard office.

2-14. Interconnections.

2-15. When an external bias is applied to the sample capacitor through DC BIAS input connectors on the 4262A rear panel, both plus and minus sides of the external power supply should be connected to the plus and minus sides of the 4262A EXT DC BIAS connector, respectively.

CAUTION

THE MAINS PLUG MUST BE INSERTED BEFORE EXTERNAL CONNECTIONS ARE MADE TO MEASURING AND/OR CONTROL CIRCUITS.

2-16. Operating Environment.

2-17. Temperature. The instrument may be operated in temperatures from 0°C to +55°C.

2-18. Humidity. The instrument may be operated in environments with relative humidities to 95% to 40°C. However, the instrument should be protected from temperature extremes which cause condensation within the instrument.

2-19. Installation Instructions.

2-20. The HP Model 4262A can be operated on the bench or in a rack mount. The 4262A is ready for bench operation as shipped from the factory. For bench operation a two-leg instrument stand is used. For use, the instrument stands are designed to be pulled towards the front of instrument.

2-21. Installation of Options 907, 908 and 909.

2-22. The 4262A can be installed in a rack and be operated as a component of a measurement system. Rack mounting information for the 4262A is presented in Figure 2-3.

2-23. STORAGE AND SHIPMENT.

2-24. Environment.

2-25. The instrument may be stored or shipped in environments within the following limits:

Temperature -40°C to +75°C
Humidity to 95%
Altitude 50,000ft

The instrument should be protected from temperature extremes which cause condensation inside the instrument.

2-26. Packaging.

2-27. Original Packaging. Containers and materials identical to those used in factory packaging are available through Hewlett-Packard offices. If the instrument is being returned to Hewlett-Packard for servicing, attach a tag indicating the type of service required, return address, model number, and full serial number. Also mark the container FRAGILE to assure careful handling. In any correspondence, refer to the instrument by model number and full serial number.

2-28. Other Packaging. The following general instructions should be used for re-packing with commercially available materials:

- a. Wrap instrument in heavy paper or plastic. If shipping to Hewlett-Packard office or service center, attach tag indicating type of service required, return address, model number, and full serial number.
- b. Use strong shipping container. A double-wall carton made of 350 pound test material is adequate.
- c. Use enough shock absorbing material (3 to 4 inch layer) around all sides of instrument to provide firm cushion and prevent movement inside container. Protect control panel with cardboard.
- d. Seal shipping container securely.
- e. Mark shipping container FRAGILE to ensure careful handling.
- f. In any correspondence, refer to instrument by model number and full serial number.

<p>OPTION 900</p> <p style="text-align: right;">United Kingdom</p>  <p>Plug : BS 1363A, 250V Cable : HP 8120-1351</p>	<p>OPTION 901</p> <p style="text-align: right;">Australia/New Zealand</p>  <p>Plug : NZSS 198/AS C112, 250V Cable : HP 8120-1369</p>
<p>OPTION 902</p> <p style="text-align: right;">European Continent</p>  <p>Plug : CEE-VII, 250V Cable : HP 8120-1689</p>	<p>OPTION 903</p> <p style="text-align: right;">U.S./Canada</p>  <p>Plug : NEMA 5-15P, 125V, 15A Cable : HP 8120-1378</p>
<p>OPTION 905*</p> <p style="text-align: right;">Any country</p>  <p>Plug : CEE 22-VI, 250V Cable : HP 8120-1396</p>	<p>OPTION 906</p> <p style="text-align: right;">Switzerland</p>  <p>Plug : SEV 1011.1959-24507 Type 12, 250V Cable : HP 8120-2104</p>
<p>OPTION 912</p> <p style="text-align: right;">Denmark</p>  <p>Plug : DHCR 107, 220V Cable : HP 8120-2956</p>	<p>* Plug option 905 is frequently used for interconnecting system components and peripherals.</p> <p>NOTE: Each option number includes a 'family' of cords and connectors of various materials and plug body configurations (straight, 90° etc.)</p>

Figure 2-2. Power Cables Supplied.

Option	Kit Part Number	Parts Included	Part Number	Q'ty	Remarks
907	Handle Kit 5061-0089	Front Handle Trim Strip #8-32 x 3/8 Screw	③ 5060-9899 ④ 5060-8896 2510-0195	2 2 6	9.525mm
908	Rack Flange Kit 5061-0077	Rack Mount Flange #8-32 x 3/8 Screw	② 5020-8862 2510-0193	2 6	9.525mm
909	Rack Flange & Handle Kit 5061-0083	Front Handle Rack Mount Flange #8-32 x 3/8 Screw	③ 5060-9899 ⑤ 5020-8874 2510-0194	2 2 6	15.875mm

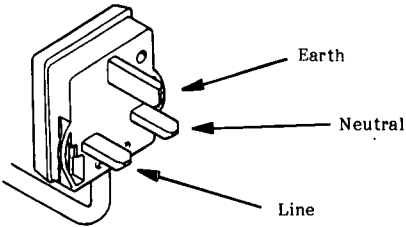
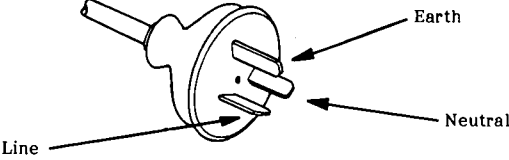
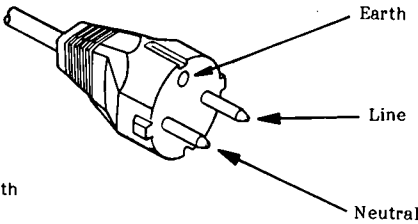
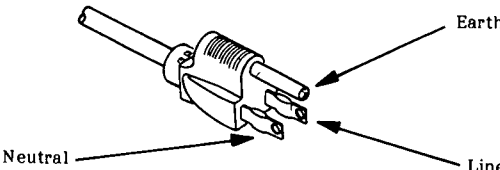
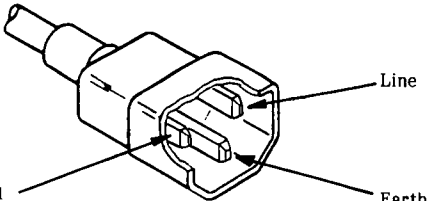
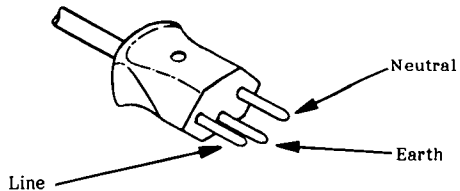
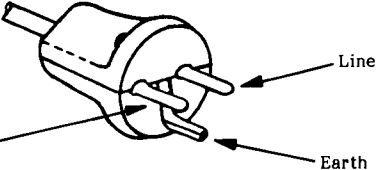
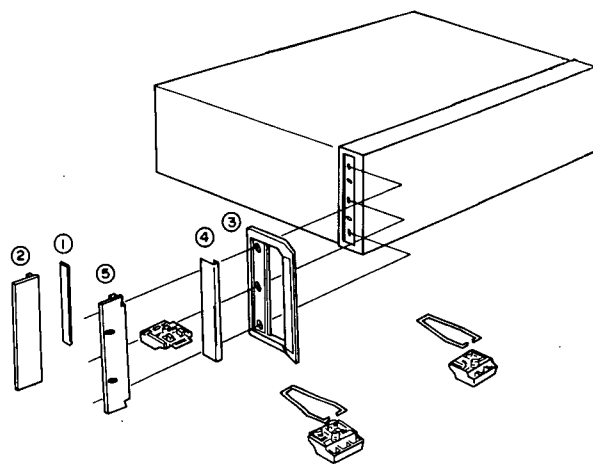

1. Remove adhesive-backed trim strips ① from side at right and left front of instrument.
2. HANDLE INSTALLATION: Attach front handle ③ to sides at right and left front of instrument with screws provided and attach trim ④ to handle.
3. RACK MOUNTING: Attach rack mount flange ② to sides at right and left front of instrument with screws provided.
4. HANDLE AND RACK MOUNTING: Attach front handle ③ and rack mount flange ⑤ together to sides at right and left front of instrument with screws provided.
5. When rack mounting (3 and 4 above), remove all four feet (lift bar at inner side of foot, and slide foot toward the bar).

Figure 2-3. Rack Mount Kit

2-29. OPTION INSTALLATION.

2-30. When it is desired to add one or two of the available optional features to a standard 4262A instrument, perform the installation as follows:

Refer to option installation illustrations on facing page.

- a. Push LINE switch to off.
- b. Remove instrument top cover.
- c. Follow the appropriate paragraph below.

2-31. OPTION 001 BCD DATA OUTPUT INSTALLATION.

- a. Remove the left side middle and lower blind covers from the rear panel.
- b. Install two 50-pin connector assemblies in the openings.
- c. Set BCD switch of SW1 on A23 board assembly (RED/ORANGE GUIDE, P/N: 04262-66523 or 04262-66623) from OFF to opposite position. This board is located third from front on the right side.
- d. Connect cable attached to A23 board (shown below) between A23 and A35 BCD Option board assemblies (P/N: 04262-66535). Install A35 in RED/GREEN GUIDE option receptacle.
- e. Plug 2 each flat cable assemblies from A35 BCD Option board into connector boards of rear panel connector assemblies.
- f. Install instrument top cover.

2-32. OPTION 004 COMPARATOR INSTALLATION.

Refer to Fig 2-4 for installation procedure.

2-33. COUPLING OPTION 004 COMPARATOR WITH OPTION 001 BCD DATA OUTPUT INSTALLATION.

- a. Set CMP (comparator) and BCD option switches of SW1 ON A23 board assemblies (RED/ORANGE GUIDE, P/N: 04262-66523 or 04262-66623) from OFF to opposite position. This board is located third from front on the right side.
- b. Connect cables attached to A23 board between A23 and A24 comparator option BCD board assembly. No other cable assembly change is necessary for this combination of options.
- c. Refer to Paragraphs 2-31 and 2-32 for other installation procedures.

2-34. OPTION 101 HP-IB REMOTE CONTROL AND DATA OUTPUT INSTALLATION.

- a. Remove right side blind covers from rear panel.
- b. Install connector board assembly (P/N: 04262-66503) in the opening and mount with washers and nuts included with assembly.
- c. Set the HP-IB switch of SW1 on A23 board assembly from OFF to opposite position. The A23 board is located on the right side third from front.
- d. Connect cable assembly attached to A25 board between A23 and A25 HP-IB option board assemblies (P/N: 04262-66525). Install A25 in RED/GREEN GUIDE option receptacle.
- e. Plug flat cable assembly from connector board assembly P/N: 04262-66503 into A25 board assembly (installed in RED/GREEN GUIDE receptacle).

OPTION 101 IS NOT COMPATIBLE
WITH OPTIONS 001 AND 004.

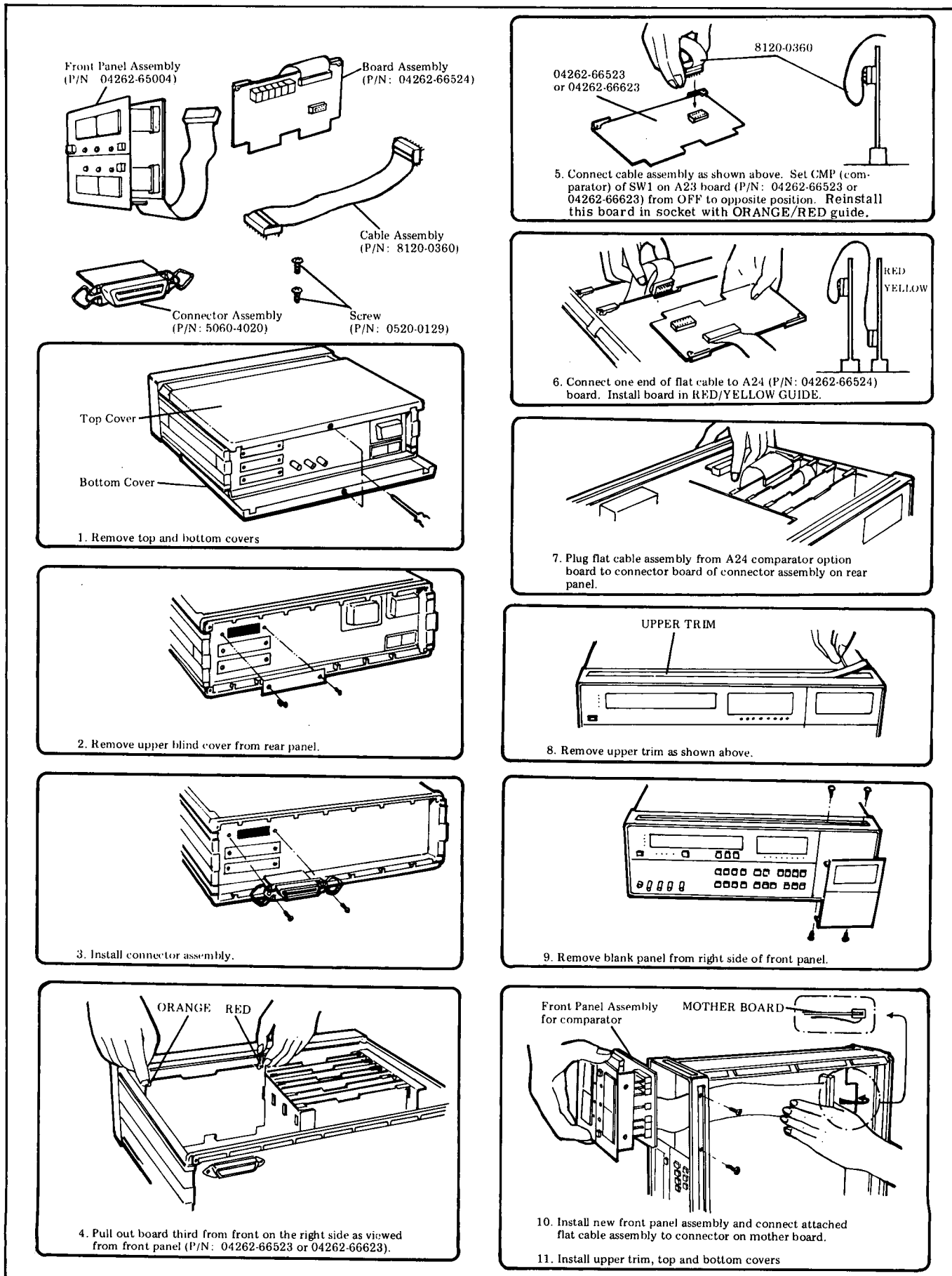

Figure 2-4. Option Installation Illustrations.

Table 2-1. Option Components

Option	Function	Components		
		HP Part No.	Q'ty	Description
001	BCD Data Output	04262-66535	1	A35 Board Assembly
		5060-4020	2	Connector Board Assembly
		8120-0360	1	Flat Cable Assembly
004	Comparator	04262-66544	1	A4 Board Assembly
		04262-66505	1	A5 Board Assembly
		04262-66524	1	A24 Board Assembly
		3100-1201	2	Thumbwheel Switch
		5060-4020	1	Connector Board Assembly
		8120-0360	1	Flat Cable Assembly
		04262-24003	1	Standoff
010	100Hz Test Frequency	04262-66911	1	A11 Board Assembly
		04262-66914	1	A14 Board Assembly
101	HP-IB	04262-66525	1	A25 Board Assembly
		04262-66503	1	A3 Board Assembly
		8120-0360	1	Flat Cable Assembly
		0380-0644	2	Stud for A3 Board Assembly

Note: To mount Connector Board assemblies, use rear panel blank plate retaining screws (Part No. 0520-0129) removed for the option installation.

SECTION III OPERATION

3-1. INTRODUCTION.

3-2. This section provides the operating information to acquaint the user with the 4262A LCR Meter. Basic product features and characteristics, measurement procedures for various applications, an operational check of the fundamental electrical functions, and operator maintenance information is presented in this section. Operating cautions throughout the text should be carefully observed.

3-3. PANEL FEATURES.

3-4. Front and rear panel features for the 4262A are described in Figures 3-1 and 3-2. Description numbers match the numbers on the photographs. Other detailed information for panel displays and controls are covered in the Operating Instructions (paragraph 3-7).

3-5. SELF TEST (Basic Operating Check).

WARNING

ANY INTERRUPTION OF THE PROTECTIVE GROUNDING CONDUCTOR INSIDE OR OUTSIDE THE INSTRUMENT OR DISCONNECTION OF THE PROTECTIVE EARTH TERMINAL IS LIKELY TO CAUSE THE INSTRUMENT TO BE DANGEROUS. INTENTIONAL INTERRUPTION IS PROHIBITED.

WARNING

WHENEVER IT IS LIKELY THAT THE PROTECTION OFFERED BY FUSES HAS BEEN IMPAIRED, THE INSTRUMENT MUST BE MADE INOPERATIVE AND BE SECURED AGAINST ANY UNINTENDED OPERATION.

CAUTION

BEFORE ANY OTHER CONNECTION IS MADE, THE PROTECTIVE EARTH TERMINAL MUST BE CONNECTED TO A PROTECTIVE GROUNDING CONDUCTOR.

3-6. Functional operation of the Model 4262A should be confirmed by the SELF TEST switch before measuring samples of interest. This test can

be done under all conditions of FUNCTION and TEST SIGNAL settings. Tests under certain combined conditions of FUNCTION and TEST SIGNAL settings are done for five ranges. A test for a range ends with a display of PASS (normal operation) or FAIL (abnormal operation) and then next range test is started. Range shifting for this test is done automatically from lower to higher.



All the combinations of FUNCTION and TEST SIGNAL switch settings are listed below. Even if the FUNCTION or TEST SIGNAL switch settings are limited for proposed sample measurement, all combined conditions should be tested.

Pushbutton Switch Setting *	UNKNOWN** Connectors
(C), (120Hz), (SELF TEST)***	Open between HIGH side and Low side
(C), (1 kHz), (SELF TEST)	
(C), (10 kHz), (SELF TEST)	
(C), (LOW LEVEL), (10 kHz), (SELF TEST)	
(C), (LOW LEVEL), (1 kHz), (SELF TEST)	
(C), (LOW LEVEL), (120Hz), (SELF TEST)	
(L), (120Hz), (SELF TEST)	Short between HIGH side and LOW side.
(L), (1 kHz), (SELF TEST)	
(L), (10 kHz), (SELF TEST)	
(R/ESR), (10 kHz), (SELF TEST)	
(R/ESR), (1 kHz), (SELF TEST)	
(R/ESR), (120Hz), (SELF TEST)	

* When FUNCTION or TEST SIGNALS switch setting is changed, the SELF TEST switch is automatically disabled. Therefore, whenever a new setting is made, push the SELF TEST switch again.

For ** see page 3-5

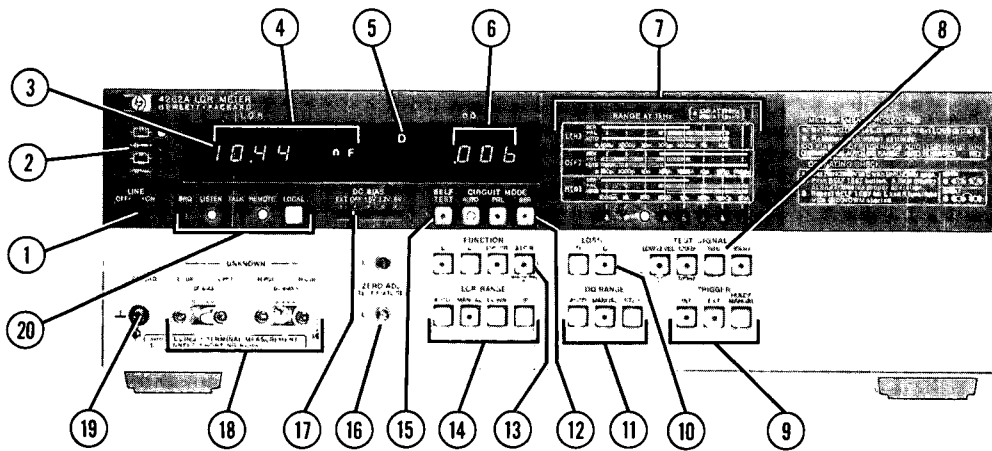

- ① **LINE ON/OFF switch:** Turns instrument on and readies instrument for measurement
- ② **Circuit Mode Indicator:** LED lamp, next to equivalent measuring circuit being used, lights. Sample connected to UNKNOWN terminals ⑱ is measured in an equivalent circuit selected by FUNCTION ⑬ and CIRCUIT MODE ⑫ switches and is indicated by appropriate LED lamp. Equivalent circuits are shown as electronic circuit symbols at the left of indicator lamps. Desired circuit parameter of component is measured in one of the following selected circuit modes:

Parallel capacitance	
Parallel resistance	
Series capacitance	
Series resistance	
Parallel inductance	
Series inductance	
Series resistance	

- ③ **Trigger Lamp:** Turns on during sample measuring period. Turns off during period when instrument is not taking measurement (or hold period). There is one turn-on-and-off cycle per measurement. This lamp turns on and off repeatedly when TRIGGER ⑨ is set to INT.

- ④ **LCR Display:** Inductance, capacitance or resistance value including the decimal point and unit is displayed in 3-½ digit decimal number from 0000 to 1999. If the sample value exceeds 1999 in a selected range, O-F(Over-Flow) appears in this display. This display also shows PASS or FAIL when SELF TEST is performed.
- ⑤ **D/Q Indicator:** In a capacitance or inductance measurement, this indicator indicates which of D (dissipation factor) or Q (quality factor) is displayed in D/Q display ⑥. In resistance measurement, this indicator is also lit (however, D or Q indication has no meaning and D/Q display ⑥ is left blank).
- ⑥ **D/Q Display:** Value for dissipation factor or quality factor is displayed in capacitance and/or inductance measurement. In resistance measurement, this display is kept blank.
- ⑦ **RANGE Indicator:** The range automatically or manually selected is indicated by LED lamp. The table printed above the LED array shows the measurement ranges of the Model 4262A.
- ⑧ **TEST SIGNAL** These pushbuttons enable selection of measurement frequency—120Hz, 1kHz or 10kHz and that of low test voltage of the signal applied to sample to be tested. LOW LEVEL switch is effective only in parallel capacitance measurements, supplying a test voltage of 50mVrms. For units equipped with option 010, arrow on pushbutton (120Hz) points to 100Hz.

Figure 3-1. Front Panel Features (sheet 1 of 2).

- ⑨ **TRIGGER:** These pushbuttons select trigger mode, INT, EXT or HOLD/MANUAL. INT key provides internal trigger which enables instrument to make repeated automatic measurements. In external trigger mode (EXT), trigger signal should be applied to either of following two connectors: (1) EXT TRIGGER input connector on the rear panel (2) 50 pin connector of Option 001 or 004 on the rear panel. HOLD/MANUAL trigger mode provides trigger signal for one measurement cycle when this key is depressed.
- ⑩ **LOSS:** These pushbuttons select whether D or Q value is displayed in the D/Q display ⑥ in capacitance or inductance measurements.
- ⑪ **D/Q RANGE:** These pushbuttons select ranging method for loss measurement. AUTO: Optimum D/Q range is selected by internal logic circuit. MANUAL: D/Q range is fixed to a range. Range change is done by depressing the STEP key on the right.
- ⑫ **CIRCUIT MODE:** Appropriate circuit mode for taking a measurement is selected and set with these pushbuttons. A parallel equivalent circuit is selected by PRL key and series equivalent circuit by SER key. When AUTO key is pushed, the instrument automatically selects the appropriate parallel or series equivalent circuit.
- ⑬ **FUNCTION:** These pushbuttons select electrical circuit parameter to be measured as follows:
- C: Capacitance together with dissipation factor (D) or quality factor (Q).
- L: Inductance with dissipation factor (D) or quality factor (Q).
- R/ESR: Resistance or Equivalent Series Resistance.
- △LCR: Difference in L, C, or R value between the value of the sample under test and the internally stored value obtained by a measurement just before △LCR key is depressed.
- ⑭ **LCR RANGE:** These pushbuttons select ranging method for LCR measurement. AUTO: Optimum range for the sample value is automatically selected.
- MANUAL: Measurement range is fixed (even when the sample connected to the UNKNOWN terminals is changed). Range change is done by depressing DOWN or UP key on the right.
- ⑮ **SELF TEST:** This pushbutton performs automatic check for checking the basic operation of Model 4262A. If normal operation is confirmed, "PASS" is displayed in LCR display ④. If wrong performance is detected, a display of "FAIL" appears. See paragraph 3-5 for details.
- ⑯ **ZERO Adjustment Controls:** These adjustments provide proper compensation for cancelling stray capacitance and residual inductance which are present when a test fixture is mounted on the UNKNOWN terminals. Connectors are kept open for cancelling stray capacitance and shorted for cancelling residual inductance.
- ⑰ **DC BIAS Selector Switch:** This switch permits selection of internal DC bias voltage applied to sample (1.5Vdc, 2.2Vdc, or 6.0Vdc). When switch is set to EXT, it is used to apply external bias voltage from rear DC BIAS input connectors. OFF position is selected if no bias voltage is necessary.
- ⑱ **UNKNOWN Terminals:** Consist of four terminals: High current terminal (H_{CUR}), High potential terminal (H_{POT}), Low potential terminal (L_{POT}) and Low current terminal (L_{CUR}). A five-terminal configuration is constructed by adding the GUARD terminal ⑲. A three-terminal configuration is constructed by shorting High terminals and Low terminals together with shorting bars. Under DC Bias operation, the high terminals have a positive DC voltage with respect to LOW terminals.
- ⑲ **GUARD Terminal:** This is connected to chassis ground of instrument and can be used as Guard terminal for increasing accuracy in certain measurements.
- ⑳ **HP-IB Status Indicator and LOCAL switch.** LED lamps for SRQ, LISTEN, TALK, and REMOTE which indicate status of interface between the 4262A (Option 101) and HP-IB controller. LOCAL switch enables front panel controls instead of remote control signals from HP-IB line.

Figure 3-1. Front Panel Features (sheet 2 of 2).

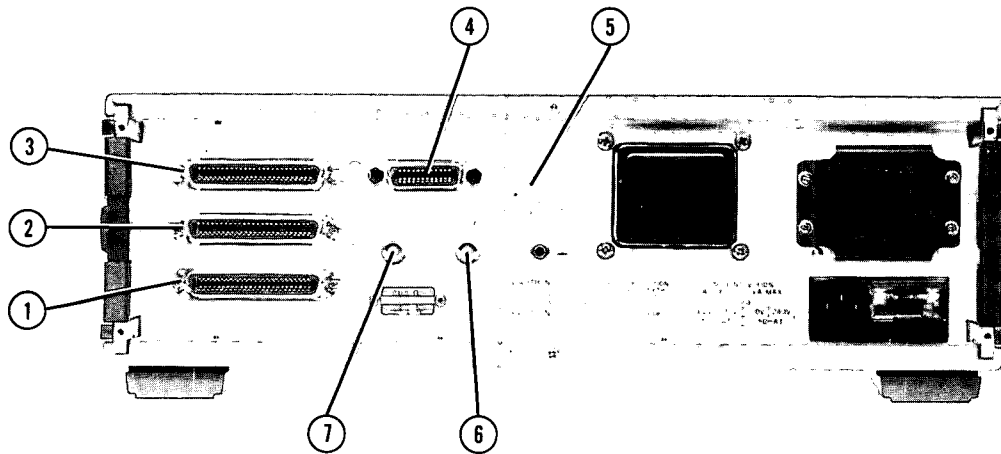

- ① **BCD D/Q DATA OUTPUT Connector:** BCD parallel data of measured dissipation factor (D) or quality factor (Q) are outputted through this 50 pin connector installed on the 4262A Option 001.
- ② **BCD LCR DATA OUTPUT Connector:** With Option 001, BCD parallel data for inductance, capacitance and resistance measured values are outputted through this 50 pin connector.
- ③ **COMPARATOR OUTPUT Connector:** The 4262A Option 004 provides comparator decision outputs for LCR and D/Q through this 50 pin connector.
- ④ **HP-IB Digital Bus Connector:** This 24 pin connector conveys bus signals and remote programming instructions to the 4262A Option 101 and transmits data from the 4262A Option 101 to the bus.
- ⑤ **Address Switch:** This seven section switch sets address code of 4262A Option 101 and TALK ONLY or ADDRESSABLE mode of operation.
- ⑥ **EXT DC BIAS Connector:** External dc bias voltage can be applied to the sample up to the maximum voltage of plus 40V through this connector.
- ⑦ **EXT TRIGGER Connector:** This connector is used for externally triggering the instrument by inputting an external trigger signal. TRIGGER SWITCH on front panel should be set to EXT.

Figure 3-2. Rear Panel Features.

** Two HIGH side terminals and two LOW side terminals should be connected with the shorting strap, for each configuration of the UNKNOWN terminals. When the UNKNOWN terminal configuration is not appropriate, for example, shorted (C) or open (L), display will show FAIL 1 (because they result from different causes, FAIL 2 or FAIL 3 are rarely displayed).



*** Setting change required is only the underlined switch setting.

If FAIL is displayed, check the UNKNOWN terminal configurations as follows:

- (1) That the two HIGH side terminals (H_{CUR} - H_{POT}) and the two LOW side terminals (L_{CUR} - L_{POT}) are properly shorted.
- (2) That short or open conditions properly exist between HIGH and LOW side terminals.
- (3) That GUARD terminal is isolated (open) from both of HIGH and LOW terminals.

If FAIL is still displayed (under the above condition), notify the nearest Hewlett-Packard office with information detailing which combination of settings show FAIL.

During SELF TEST, other controls are automatically set as follows:

CIRCUIT MODE SER when FUNCTION is set to L or R/ESR. PRL when FUNCTION is set to C.

LOSS D
LCR RANGE MANUAL
D/Q RANGE MANUAL
TRIGGER INT

NOTE

TO ENSURE CORRECT RESULTS OF SELF-TEST OPERATION IN L AND R MEASUREMENT FUNCTIONS, CONNECT ALL (HIGH AND LOW SIDE) UNKNOWN TERMINALS TOGETHER WITH A LOW IMPEDANCE STRAP (IF THIS SHORT-CIRCUIT IS MADE AT THE ENDS OF THE TEST LEADS, CORRECT RESULTS MAY NOT OCCUR).

3-7. TEST SIGNALS.

3-8. Three test signal frequencies are available: these are 120Hz, 1kHz and 10kHz sinusoidal waveforms which have a frequency accuracy of 3%. The typical voltage applied to the sample or current flowing through the sample is specified in Table 3-1 for all test signal frequencies. A constant test voltage is supplied to the sample when measuring parallel parameters Lp, Cp, and Rp. The constant current method is adopted for the measurement of Ls, Cs, and Rs. The 50mVrms test voltage is used only for Cp measurement.

3-9. MEASUREMENT RANGE.

3-10. As given in Table 3-2, the 4262A has wide measurement ranges. Seven or eight ranges are available (depending upon measurement function) and the appropriate range is automatically selected for the value of sample connected to the 4262A UNKNOWN terminals. For applications which require a fixed measurement range (such applications are sometimes needed, for example, in inductance measurements), manual range control is push-button selectable. Four or five ranges, however, are used in the series and parallel equivalent circuit measurement modes. When the CIRCUIT MODE is set to AUTO, the 4262A will automatically select the appropriate circuit mode, range over the measurement ranges shadowed in Table 3-2, settle on the proper range, and measure the sample.

Table 3-1. Sample Voltage or Current.

RANGE	CIRCUIT MODE					
	Ls	Lp	Cs	Cp	Rs	Rp
1	40mA rms	————	————	1V rms (50mV rms)*	40mA rms	————
2	10mA rms	————	————	1V rms (50mV rms)*	10mA rms	————
3	1mA rms	————	————	1V rms (50mV rms)*	1mA rms	————
4	100 μA rms	1V rms	10 μA rms	1V rms (50mV rms)*	100 μA rms	1V rms
5	10 μA rms	1V rms	100 μA rms	1V rms (50mV rms)*	10 μA rms	1V rms
6	————	1V rms	1 μA rms	————	————	1V rms
7	————	1V rms	10mA rms	————	————	1V rms
8	————	————	40mA rms	————	————	1V rms

*When TEST SIGNAL is set to LOW LEVEL.

Table 3-2. Measurement Ranges.

CIRCUIT MODE	TEST SIGNAL Frequency	Range							
		1	2	3	4	5	6	7	8
Lp	120 Hz				0000 mH	00.00 H	000.0 H	0000 H	
	1 kHz				000.0 mH	0000 mH	00.00 H	000.0 H	
	10 kHz				00.00 mH	000.0 mH	0000 mH	00.00 H	
Ls	120 Hz	0000 μH	00.00 mH	000.0 mH	0000 mH	00.00 H			
	1 kHz	000.0 μH	0000 μH	00.00 mH	000.0 mH	0000 mH			
	10 kHz	00.00 μH	000.0 μH	0000 μH	00.00 mH	000.0 mH			
Cp	120 Hz	0000 pF	00.00 nF	000.0 nF	0000 nF	00.00 μF			
	1 kHz	000.0 pF	0000 pF	00.00 nF	000.0 nF	0000 nF			
	10 kHz	00.00 pF	000.0 pF	0000 pF	00.00 nF	000.0 nF			
Cs	120 Hz				0000 nF	00.00 μF	000.0 μF	0000 μF	00.00 mF
	1 kHz				000.0 nF	0000 nF	00.00 μF	000.0 μF	0000 μF
	10 kHz				00.00 nF	000.0 nF	0000 nF	00.00 μF	000.0 μF
Rp	120 Hz				0000 Ω	00.00 kΩ	000.0 kΩ	0000 kΩ	00.00 MΩ
	1 kHz				0000 Ω	00.00 kΩ	000.0 kΩ	0000 kΩ	00.00 MΩ
	10 kHz				0000 Ω	00.00 kΩ	000.0 kΩ	0000 kΩ	00.00 MΩ
Rs	120 Hz	0000 mΩ	00.00 Ω	000.0 Ω	0000 Ω	00.00 kΩ			
	1 kHz	0000 mΩ	00.00 Ω	000.0 Ω	0000 Ω	00.00 kΩ			
	10 kHz	0000 mΩ	00.00 Ω	000.0 Ω	0000 Ω	00.00 kΩ			

Note: 0000μH indicates a range of 0001μH to 1999μH (and similarly for F and Ω).

3-11. INITIAL DISPLAY TEST.

3-12. The Model 4262A automatically performs a front panel LED display test for a few seconds after instrument is tuned on (after LINE button is depressed). The display test sequence is:

1. All front panel indicator lamps, except numeric segments and multiplier indicator lamps will illuminate. (SRQ, LISTEN, TALK and REMOTE lamps illuminate only when HP-IB option is installed).
2. Front panel pushbutton LED's and indicator lamps indicate that automatic initial settings (see Paragraph 3-13 which follows) have been set. Simultaneously, the LCR DISPLAY and DQ DISPLAY readouts are tested. All numeric displays show figures of 8 (8) and multiplier indicators (p n μ m k M) light in turn.
3. Range indicator lamps step from right (upper range) to left (lower range). When steps 1, 2 and 3 have been completed, the trigger lamp begins to flash. Figures on numeric displays change to meaningful numbers showing that the 4262A is ready to take a measurement.

3-13. INITIAL CONTROL SETTINGS.

3-14. One of the sophisticated features of the 4262A is its automatic initial control setting function. After the instrument is turned on, the front panel control functions are automatically set as follows:

```

SELF TEST.....OFF
CIRCUIT MODE..... AUTO
FUNCTION..... C
LCR RANGE ..... AUTO
LOSS..... D
DQ RANGE ..... AUTO
TEST SIGNAL ..... 1kHz
TRIGGER..... INT
    
```

As these initial settings provide the general capacitance measurement conditions applicable to a broad range of capacitance measurements, a capacitance can be usually measured by merely connecting the sample to the UNKNOWN terminals. Inductance or resistance can be measured by pressing the L FUNCTION or R/ESR FUNCTION buttons, as appropriate. When a different measurement is to be attempted, press appropriate pushbuttons and select desired functions.

3-15. D/Q MEASUREMENT.

3-16. The Model 4262A makes a loss measurement along with capacitance or inductance measurements on each measurement cycle. The measured loss factor is displayed in the form of the dissipation (D) or quality (Q) factor of the sample. The D or Q function is pushbutton selectable in both L and C measurements. D and Q measurement ranges are:

D: 2 ranges	.001 to 1.999
	0.01 to 19.9
Q: 4 ranges	.050 to 1.996
	0.05 to 19.61
	.001 to 166.7
	001 to 1000

The D range, appropriate to the value of the sample is automatically selected. Alternately, a manual D range control is pushbutton selectable. Quality factor (Q) is calculated as a reciprocal dissipation number from the measured D value. Hence, the Q readout display will skip some numbers when low dissipation samples are measured. For example, when the dissipation measured is .010, the quality factor display is 100. When dissipation is .009, the quality factor reading is 111 (Q readings of 101 to 110 are not obtained). On the high D measurement range, the readout is displayed in 3 digits.

3-17. ΔLCR MEASUREMENT.

3-18. When many components of similar value are to be tested, it is sometimes more practicable to measure the difference between the value of the sample and a predetermined reference value. The ΔLCR function permits repetitive calculation of the difference between the reference and each individual sample and to display the result on the LCR DISPLAY. When the ΔLCR FUNCTION button is pressed, the inductance, capacitance, or resistance value of the sample is stored in an internal memory. The 4262A will now display the difference between the stored value and the measured value of a sample connected to UNKNOWN. The LCR RANGE is automatically held in MANUAL for the duration of ΔLCR measurements (if another pushbutton is inadvertently pressed, the ΔLCR measurement function will be reset and will require reactivating).

Accessory Model	Characteristics																																																																				
<p>16061A Test Fixture</p>  <p>Five terminal construction test fixture.</p>	<p>This fixture facilitates easy measurement of general type components with axial or vertical leads. To install fixture, disconnect shorting bars between high terminals and between low terminals. Insert fixture screws to firmly attach fixture to instrument. Two kinds of inserts are included (for components with either axial or vertical leads).</p> <p>DUT range (at 1kHz)</p> <table border="1" data-bbox="678 472 1409 772"> <thead> <tr> <th></th> <th>pF</th> <th>μH</th> <th>Ω</th> <th>10</th> <th>100</th> <th>nF</th> <th>mH</th> <th>kΩ</th> <th>10</th> <th>100</th> <th>μF</th> <th>H</th> <th>MΩ</th> <th>10</th> <th>100</th> </tr> </thead> <tbody> <tr> <td>C</td> <td></td> <td></td> <td></td> <td colspan="12">_____</td> </tr> <tr> <td>L</td> <td></td> <td></td> <td></td> <td colspan="12">_____</td> </tr> <tr> <td>R</td> <td></td> <td></td> <td></td> <td colspan="12">_____</td> </tr> </tbody> </table>		pF	μ H	Ω	10	100	nF	mH	k Ω	10	100	μ F	H	M Ω	10	100	C				_____												L				_____												R				_____															
	pF	μ H	Ω	10	100	nF	mH	k Ω	10	100	μ F	H	M Ω	10	100																																																						
C				_____																																																																	
L				_____																																																																	
R				_____																																																																	
<p>16062A Test Leads</p>  <p>Test Leads for four terminal measurement (does not contain guard conductor).</p>	<p>The 16062A is especially useful when measuring low impedances. DUT values measurable with the 16062A are diagrammed below. If the measuring sample is more than approx. 300μF at 1kHz or less than approx. 100μH at 1kHz, it is recommended that the respective potential leads and current leads be twisted together.</p> <p>Measurable DUT ranges (at 1kHz)</p> <table border="1" data-bbox="678 1060 1409 1354"> <thead> <tr> <th></th> <th>pF</th> <th>μH</th> <th>Ω</th> <th>10</th> <th>100</th> <th>nF</th> <th>mH</th> <th>kΩ</th> <th>10</th> <th>100</th> <th>μF</th> <th>H</th> <th>MΩ</th> <th>10</th> <th>100</th> </tr> </thead> <tbody> <tr> <td>C</td> <td></td> <td></td> <td></td> <td></td> <td></td> <td></td> <td></td> <td></td> <td colspan="7">_____</td> <td></td> <td></td> </tr> <tr> <td>L</td> <td></td> <td></td> <td></td> <td colspan="12">_____</td> <td></td> </tr> <tr> <td>R</td> <td></td> <td></td> <td></td> <td colspan="12">_____</td> <td></td> </tr> </tbody> </table>		pF	μ H	Ω	10	100	nF	mH	k Ω	10	100	μ F	H	M Ω	10	100	C									_____									L				_____													R				_____												
	pF	μ H	Ω	10	100	nF	mH	k Ω	10	100	μ F	H	M Ω	10	100																																																						
C									_____																																																												
L				_____																																																																	
R				_____																																																																	
<p>16063A Test Leads</p>  <p>Coaxial test leads with guard conductor for three terminal measurement.</p>	<p>The 16063A is particularly useful when measuring high impedances. DUT values measurable with the 16063A are diagrammed below. This test lead set is not intended to be used for the accurate measurement of small capacitances (less than approx. 100pF) due to the residual capacitance of the leads.</p> <p>Measurable DUT ranges (at 1kHz)</p> <table border="1" data-bbox="678 1648 1409 1932"> <thead> <tr> <th></th> <th>pF</th> <th>μH</th> <th>Ω</th> <th>10</th> <th>100</th> <th>nF</th> <th>mH</th> <th>kΩ</th> <th>10</th> <th>100</th> <th>μF</th> <th>H</th> <th>MΩ</th> <th>10</th> <th>100</th> </tr> </thead> <tbody> <tr> <td>C</td> <td></td> <td></td> <td></td> <td></td> <td></td> <td colspan="10">_____</td> <td></td> </tr> <tr> <td>L</td> <td></td> <td></td> <td></td> <td></td> <td></td> <td colspan="10">_____</td> <td></td> </tr> <tr> <td>R</td> <td></td> <td></td> <td></td> <td colspan="12">_____</td> <td></td> </tr> </tbody> </table>		pF	μ H	Ω	10	100	nF	mH	k Ω	10	100	μ F	H	M Ω	10	100	C						_____											L						_____											R				_____													
	pF	μ H	Ω	10	100	nF	mH	k Ω	10	100	μ F	H	M Ω	10	100																																																						
C						_____																																																															
L						_____																																																															
R				_____																																																																	

Figure 3-3. Test Fixture and Leads.

3-19. D/Q Blanking Function (Switch selectable function inside cabinet).

3-20. The D/Q blanking function permits deactivating the D/Q measurement as desired. If operator has no need of D/Q measurement data, and alternatively desires to make higher speed LCR measurements, the switch for this function may be set. When the D/Q function is deactivated, measurement time is shortened to approximately 220 to 250 milliseconds (at 120Hz) and to 80 to 110 milliseconds (at 1kHz and 10kHz) as compared to standard measuring times (which includes a D/Q measurement). The D/Q deactivating switch is located on the A23 board assembly. To select this function, change setting of the switch as follows:

- a. Remove top cover.
- b. Take out A23 board (red and orange colored extractors).
- c. The selection switch is mounted near left edge of the A23 board.
- d. Change position of the switch as illustrated below.
- e. Reinstall the A23 board in its normal position.
- f. Replace top cover.

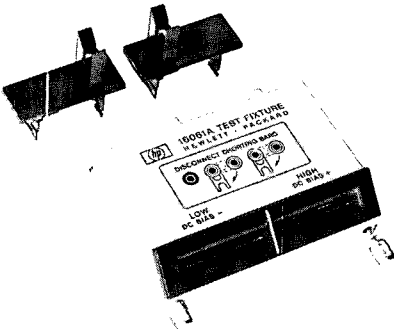
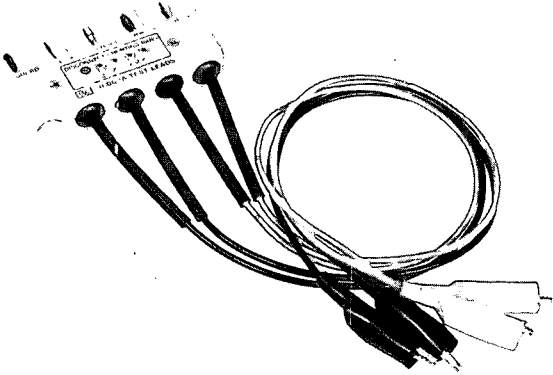
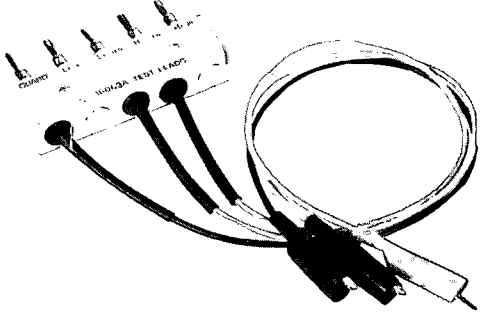
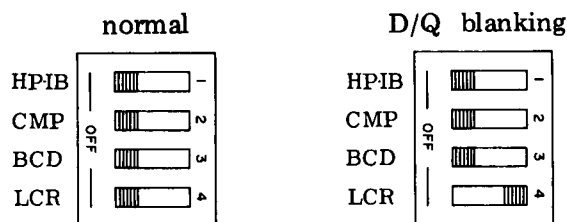

3-21. General Component Measurement.

3-22. Figure 3-7 shows the operating procedures for measuring an L, C or R (inductance, capacitance or resistance) circuit component. Almost all discrete circuit components (inductors, capacitors or resistors) except for components having special shapes or dimensions can be measured with this setup. Special components may be measured by using Test Leads 16062A or 16063A or by specially designed user built fixtures instead of 16061A Test Fixture.

3-23. Semiconductor Device Measurement.

3-24. The procedures for using the 4262A semiconductor device measurement capabilities are described in Figure 3-8. For example, the junction (interterminal) capacitance of diodes, collector output capacitance of transistors, etc., can easily and accurately be measured (with and without dc bias).

3-25. External DC Bias.

3-26. A special biasing circuit using external voltage or current bias, as needed for capacitor or inductor measurements, is illustrated in Figure 3-9. The figure shows sample circuitry appropriate to 4262A applications. Biasing circuits must avoid permitting dc current to flow into the 4262A as dc current increases the measurement error and the excess current sometimes may cause damage to the instrument. When applying a dc voltage to capacitors, be sure applied voltage does not exceed maximum working voltage and that you are observing polarity of capacitor. Note that the external bias voltage is present at H_{CUR} and H_{POT} terminals.

3-27. Bias Voltage Settling Time. When a measurement with dc bias voltage superposed is performed, it takes some time for voltage across sample to reach a certain percentage of applied (desired) voltage. Figure 3-9 shows time for dc bias voltage to reach more than 99% of applied voltage and for 4262A to display a stable value. If the bias voltage across sample is not given sufficient time to settle, the displayed value may fluctuate or O-F may be displayed. Read measured value after display settles.

3-28. External Triggering.

3-29. For triggering the 4262A externally, connect an external triggering device to the rear panel EXT TRIGGER connector (BNC type) and press EXT TRIGGER button. The 4262A can be triggered by a TTL level signal that changes from low (0V) to high level (+5V). Triggering can be also done by alternately shorting and opening the center conductor of the EXT TRIGGER connector to ground (chassis).

Note

The center conductor of the EXT TRIGGER connector is normally at high level (no input).

3-30. TERMINAL CONFIGURATION.

IMPORTANT :

3-31. Connection of DUT. The 4262A Unknown terminals consists of five binding post (type) connectors: H_{CUR}, H_{POT}, L_{CUR}, L_{POT} and GUARD. By connecting the stationary shorting straps to appropriate terminals, the UNKNOWN terminals can be adopted for the desired measurement terminal configuration: the two, three, four or five terminal method.

For measurements of samples having a medium order of impedance (100Ω to 10kΩ), the convenient two terminal method is suited to measurement requirements for good accuracy as well as for ease in connecting the sample. When converting to two terminals, shorting straps are attached to the UNKNOWN H_{CUR} and H_{POT} terminals, and L_{CUR} and L_{POT} terminals, respectively.

High impedance samples (greater than 1kΩ) -- which includes low capacitance, high inductance and high resistance -- should be measured by the three terminal method to eliminate the effects of stray capacitances on the measurements. For this purpose, the guard conductor of the sample is connected to the instrument GUARD terminal.

In the measurement of low impedance samples (less than 1kΩ), efforts should be made to eliminate the effects of contact resistance, lead resistance, residual inductance and other residual parameters in the measuring apparatus. Four terminal configuration measurements allow stable, accurate measurement of high capacitance, low inductance and low resistance samples at minimum incremental errors in the measurement of low impedance samples. In the four terminal method, the shorting straps are disconnected to separate potential leads from current leads. Thereby, the characteristics of the sample can be precisely determined by the instrument irrespective of the various residual parameters present in the measuring signal current path. To ensure the best accuracy, the potential leads should be connected near to the sample.

The five terminal method, which adds the guard conductor to the four terminal configuration, expands the applicable measurement range into the higher impedance regions. Thus, this method covers a broad range of measurements from low to high impedance samples at the measuring frequency of the 4262A.

When test fixtures and test leads used have a shielding conductor and are designed to consider residual impedance, the measurement limitations described above for the individual terminal configurations can vary to some extent depending on the particular characteristics of the fixture and connections. Three accessories, the 16061A Test Fixture, the 16062A Test Leads, and the 16063A Test Leads are available. The characteristics of these accessories and applicable measurement ranges are outlined in Figure 3-3. These accessories make it easy to construct the desired terminal configuration.

FOR CERTAIN TERMINAL MEASUREMENT CONFIGURATIONS, THE H_{CUR} TERMINAL MUST BE CONNECTED TO H_{POT} TERMINAL AND THE L_{CUR} TERMINAL CONNECTED TO THE L_{POT} TERMINAL. OTHERWISE, THE DISPLAYS WILL HAVE NO MEANING AND THE LIFE OF THE RELAYS USED IN THE INSTRUMENT WILL SOMETIMES BE SHORTENED.

Note

The 4262A can not measure a sample which has one lead connected to earth (grounded).

3-32. OFFSET ADJUSTMENT.

3-33. Since test fixtures and test leads have different inherent stray capacitances and residual inductances, the measured value obtained with respect to the same sample may possibly differ depending on the test fixture (leads) used. These residual factors can be read from the 4262A display by properly terminating (short or open) the measurement terminals of the test jig. The front panel C ZERO ADJ and L ZERO ADJ controls permit compensation for these residual factors and can eliminate measurement errors due to the test jig. The capacitance or inductance readout can be set to zero for the particular test jig used with the instrument. In capacitance and inductance measurements, an incomplete offset adjustment causes two types errors:

- 1) Deviation from zero counts.

When a small capacity or a small inductance is measured, the measured capacitance (inductance) value becomes the sum of the capacitance (inductance) of sample and the stray capacitance (residual inductance) of test jig. The effects of the residual factors are:

$$C_m = C_x + C_{st}$$
$$L_m = L_x + L_{res}$$

Where, subscripts are

- m: measured value.
- x: value of sample.
- st: stray capacitance.
- res: residual inductance.

Both C_{st} and L_{res} cause the same measurement error and are independent of sample value.

2) Influence on high capacitance and high inductance measurements.

When a high inductance (a high capacitance) is measured, the residual factors in the test jig also contribute a measurement error. The affect of stray capacitance or residual inductance on measurement parameters are:

Stray capacitance	→ Offsets high inductance measurements.
Residual inductance	→ Offsets high capacitance measurements.

These measurement errors increase in proportional to the square of the test signal frequency. The effects of the residual factors can be expressed as follows:

$$C_m = \frac{C_x}{1 - \omega^2 C_x L_{res}}$$

or $\left(\frac{C_m - C_x}{C_m} \approx \omega^2 C_x L_{res} \right)$

$$L_m = \frac{L_x}{1 - \omega^2 L_x C_{st}}$$

or $\left(\frac{L_m - L_x}{L_m} \approx \omega^2 L_x C_{st} \right)$

In a 10kHz measurement, for the measurement error to be less than 0.1%, the product of Cx and Lres (Lx and Cst) should be less than 0.25×10^{-12} . The relationship between the residual factors of the test jig and measurement accuracies are graphically shown in Figure 3-4.

The 4262A ZERO ADJ controls cover the following capacitance and inductance offset adjustment ranges:

- C ZERO ADJ: up to 10pF
- L ZERO ADJ: up to 1μH

An offset adjustment should always be performed before measurements are taken.

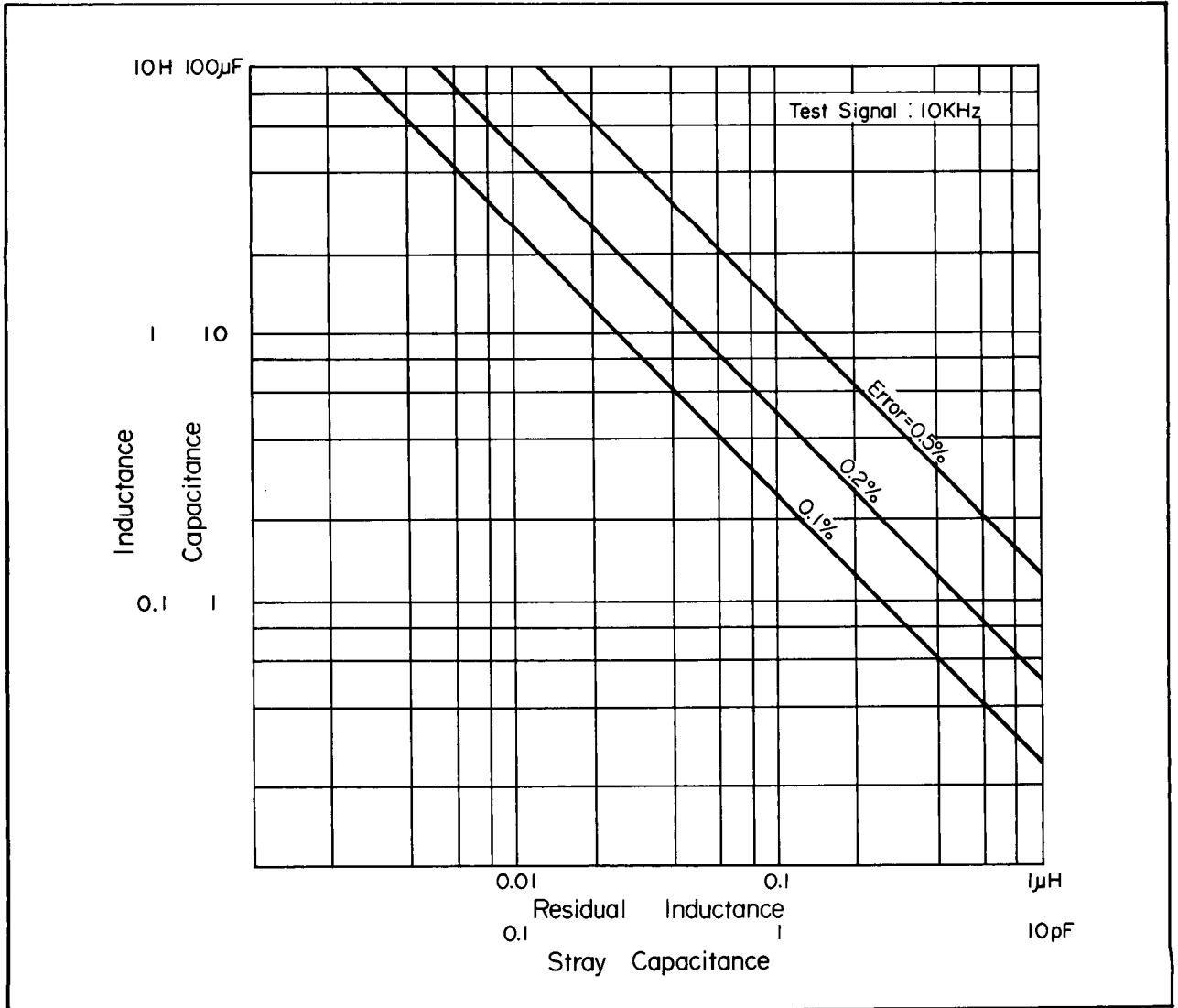

Figure 3-4. Measurement Error due to Misadjusted ZERO ADJ Controls.

Measurement Parameter Conversions

Parameter values for a component measured in a parallel equivalent circuit and that measured in series equivalent circuit are different from each other. For example, the parallel capacitance of a given component is not equal to the series capacitance of that component. Figure A shows the relationships between parallel and series parameters for various values of D. Applicable diagrams and equations are given in the chart. For example, a parallel capacitance (Cp) of 1000pF with a dissipation factor of 0.5, is equivalent to a series capacitance (Cs) value of 1250pF at 1kHz. As shown in Figure A, inductance or capacitance values for parallel and series equivalents are almost identical when the dissipation factor is less than 0.01. The letter D in Figure A represents dissipation factor and is calculated by the equations presented in Table A for each circuit mode. The dissipation factor of a component always has the same dissipation factor at





a given frequency for both parallel equivalent and series equivalent circuits.

Note

Dissipation factors displayed when CIRCUIT MODE is switched between PRL and SER may exhibit slight differences due to the measurement accuracy of the 4262A.

The reciprocal of the dissipation factor (D) is quality factor (Q) and D is often represented as $\tan \delta$ which is the tangent of the dissipation angle (δ). Figure 3-6 is a graphical presentation of the equations in Table A. For example, a series inductance of 1000 μ H which has a dissipation factor of 0.5 at 1kHz has a series resistance of 3.14 ohms.

Table A. Dissipation Factor Equations.

Circuit Mode	Dissipation Factor	Conversion to other modes
Cp mode 	$D = \frac{1}{2\pi f C_p R_p} (= \frac{1}{Q})$	$C_s = (1 + D^2)C_p, R_s = \frac{D^2}{1 + D^2} \cdot R_p$
Cs mode 	$D = 2\pi f C_s R_s (= \frac{1}{Q})$	$C_p = \frac{1}{1 + D^2} C_s, R_p = \frac{1 + D^2}{D^2} \cdot R_s$
Lp mode 	$D = \frac{2\pi f L_p R_p}{R_p} (= \frac{1}{Q})$	$L_s = \frac{1}{1 + D^2} L_p, R_s = \frac{D^2}{1 + D^2} \cdot R_p$
Ls mode 	$D = \frac{R_s}{2\pi f L_s} (= \frac{1}{Q})$	$L_p = (1 + D^2)L_s, R_p = \frac{1 + D^2}{D^2} \cdot R_s$

*f: Test signal frequency.

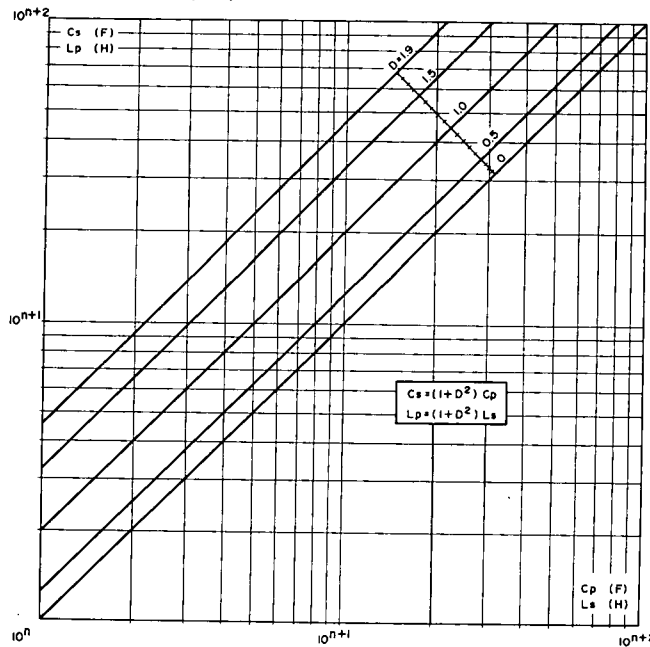

Where n stands for a free integer.

Figure A. Relationships between Parallel and Series Parameters.

Figure 3-5. Conversion Between Parallel and Series Equivalents.

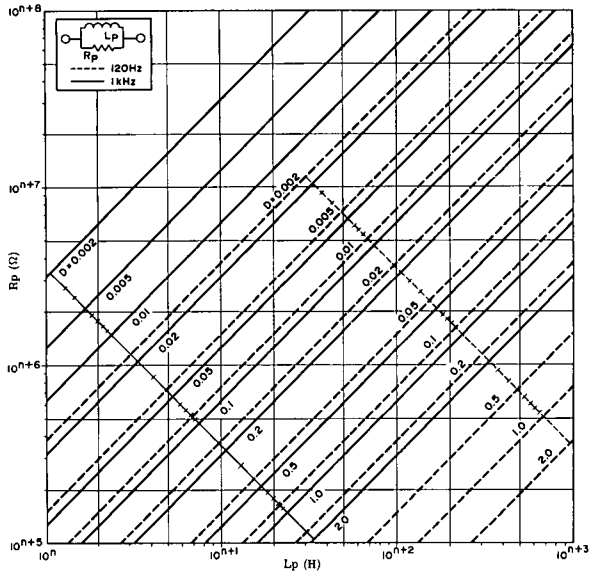

Parallel Inductance - Parallel Resistance
(A)

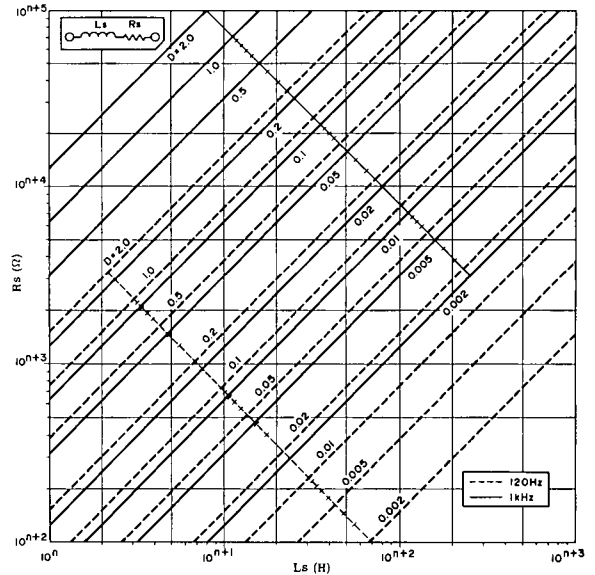

Series Inductance - Series Resistance
(B)

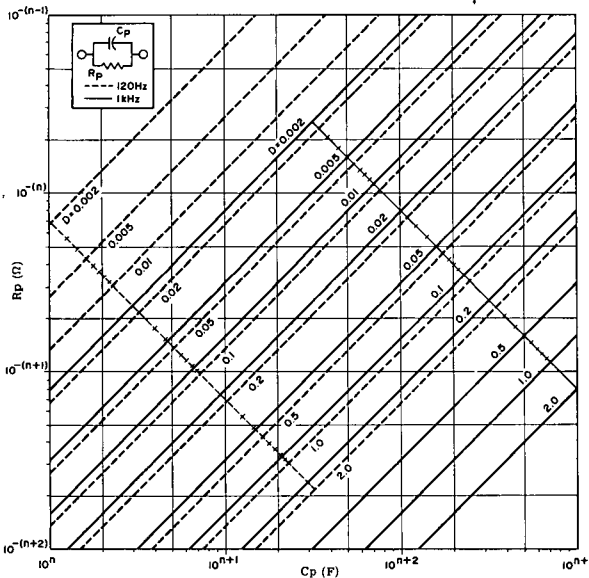

Parallel Capacitance - Parallel Resistance
(C)

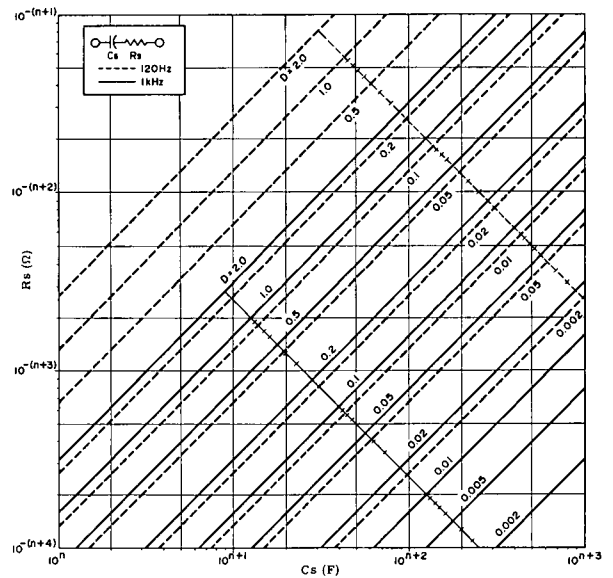

Series Capacitance - Series Resistance
(D)

When n represents a free integer.

To obtain the graph for 10kHz test frequency, add 1 to n on resistance scales.

Figure 3-6. Relationship of Dissipation to Series and Parallel Resistance.

Table 3-3. Annunciation Display Meanings.

LCR	DISPLAY	DQ	Indicated Condition	Action
	0 - F		FUNCTION has been inappropriately set.	Change 4262A FUNCTION to L, C or R suitable for the sample being measured.
			Measured L or C value exceeds 1999 counts. DQ display indicates that DQ measurement has been omitted.	Set 4262A to: CIRCUIT MODE: AUTO LCR RANGE: AUTO
			Measured R value exceeds 1999 counts.	Try changing TEST SIGNAL to 120, 1k or 10kHz.
	1234	0 - F	Measured D/Q value exceeds the upper range limit (1999 counts). Accuracy of LCR readings may not be within specifications.	Set 4262A DQ RANGE to AUTO. Try changing TEST SIGNAL to 120, 1k or 10kHz.
(any LCR reading)		(overflowed)		
	U - CL		CIRCUIT MODE setting is not suitable for the sample being measured.	Set 4262A to: CIRCUIT MODE: AUTO LCR RANGE: AUTO
			Measured L, C or R value is extremely large or small compared with the selected range.	Try changing TEST SIGNAL to 120, 1k or 10kHz.
	78		When Measured L or C value is less than 80 counts, DQ measurement is omitted.	Set 4262A LCR RANGE to AUTO. Try changing TEST SIGNAL to 120, 1k or 10kHz.
(less than 80 counts)				
		0 12	In Δ LCR measurement, the difference between the preset value and the measured value of the sample exceeds -999 counts.	_____
			In Δ LCR measurement, the calculated difference exceeds -999 counts. In addition, the value of measured sample is less than 80 counts.	_____
Minus (-) is displayed.			Minus display sometimes occurs when sample having a value around zero is measured.	Zero count display is meaningful when minus (-) display repeatedly turns on and off.
			Sometimes a minus display occurs when a capacitor (or inductor) is measured in L (or C) FUNCTION.	Change to appropriate FUNCTION.
			Offset adjustment signal applied is too great (causes minus display).	Readjust offset signal for proper magnitude.

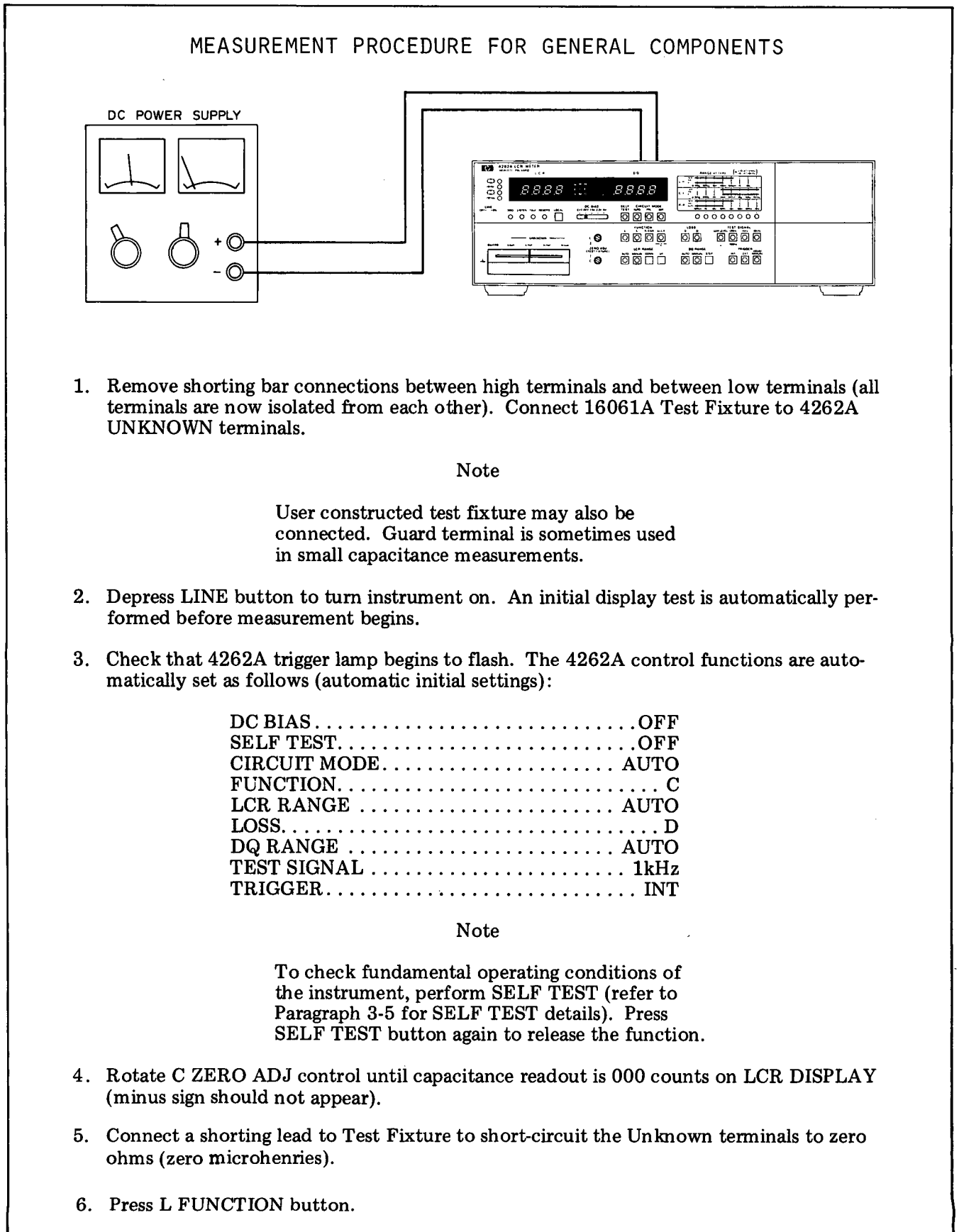

Figure 3-7. General Component Measurements (Sheet 1 of 3).

7. Rotate L ZERO ADJ control until inductance readout is 000 counts on LCR DISPLAY.

Note

To achieve more critical zero adjustments, when 10kHz test signal frequency is used, perform the capacitance and inductance zero offset adjustments (steps 4, 5, 6 and 7) at 10kHz.

8. Remove shorting lead from 16061A.
9. Select desired FUNCTION, either L, C or R/ESR.
10. Connect sample to be measured (L, C or R) to Test Fixture.
11. Model 4262A will automatically display value of unknown.

Note

If O-F, U-CL, minus (-) or blank display occurs, see Table 3-3 for solution. Measured values for semiconductor devices are sometimes unreliable when TEST SIGNAL LOW LEVEL pushbutton is in its normal (1V) state (button lamp is not lit). In these instances, follow Figure 3-8 for semiconductor device measurement.

Note

If manual triggering is required, press HOLD/MANUAL button. Each time the button is pressed, the instrument is triggered.

12. If internal DC bias is required, set DC BIAS switch to 1.5V, 2.2V or 6V: If not, OFF position should be selected.

Note

DC bias application may only be used for capacitance measurements.

CAUTION

POSITIVE POLE OF ELECTROLYTIC CAPACITOR MUST BE CONNECTED TO HIGH TERMINALS AS PLUS BIAS VOLTAGE IS APPLIED TO HIGH TERMINALS WITH RESPECT TO LOW TERMINALS.

Note

An external bias voltage up to +40V may be applied to EXT DC BIAS rear panel connector. Connect DC power supply to EXT DC BIAS connector. Set DC BIAS switch to EXT.

CAUTION

EXTERNAL DC BIAS AT EXT BIAS CONNECTOR MUST NEVER EXCEED +40V.

13. Read measured value on display.

Note

It is usually recommended that the LCR RANGE be set to MANUAL and to hold the range when measuring multiple samples having almost the same value. Range hold operation will somewhat shorten measurement time.

Note

Series resistance of electrolytic capacitors, inductors or transformers can be measured in series R/ESR measurement mode. In these cases, the number of digits is sometimes reduced. On the other hand, resistance can, of course, be indirectly measured with the C/L FUNCTION and calculated from one of the following equations:

$$R_s = D/\omega C_s \text{ (Cs-D measurement)}$$

$$R_s = \omega L_s \cdot D \text{ (Ls-D measurement)}$$

$$R_s = \omega L_p \cdot \frac{D}{1 + D^2} \text{ (Lp-D measurement)}$$

The above relationships are graphically shown in Figure 3-6.

CAUTION

DO NOT CONNECT A CHARGED CAPACITOR (EXCEEDING 40V) DIRECTLY TO THE UNKNOWN TERMINALS AS A DUT.

CAUTION

NEVER APPLY A DC VOLTAGE DIRECTLY BETWEEN THE UNKNOWN H AND L TERMINALS WITHOUT PROPER PROTECTION AGAINST A POSSIBLE HARMFUL CURRENT. DC VOLTAGE MUST NOT BE APPLIED TO THE L TERMINAL WITH RESPECT TO GROUND.

Figure 3-7. General Component Measurements (Sheet 3 of 3).

Junction Capacitance Measurement

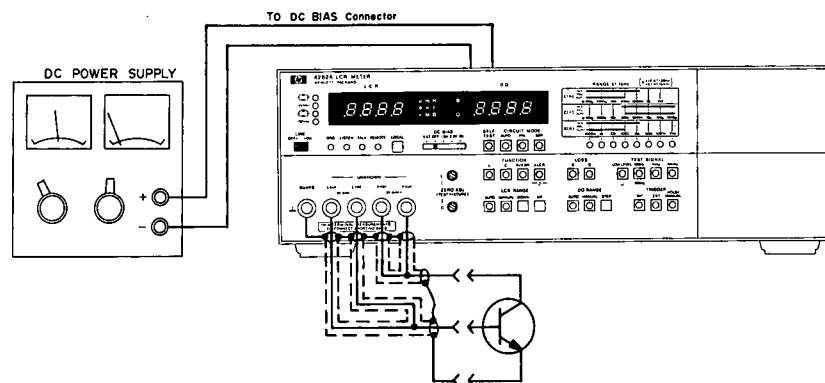

Setup -

The figure above is a typical test setup used for measuring base-collector junction capacitance (C_{ob}) of an NPN transistor. For this measurement, test leads or fixture may be user designed. If external DC bias is not necessary, arrangement and procedures associated with this function may be deleted from setup.

Procedure -

1. Press **LINE** button to turn instrument on. After the initial display test, trigger lamp will begin to flash and the 4262A functions are automatically set as follows:

SELF TEST.	OFF
CIRCUIT MODE.	AUTO
FUNCTION.	C
LCR RANGE	AUTO
LOSS.	D
DQ RANGE	AUTO
TEST SIGNAL	1kHz
TRIGGER.	INT

2. Press **TEST SIGNAL LOW LEVEL** and **PRL CIRCUIT MODE** buttons. The test signal level is now 50mV and the parallel equivalent circuit mode is selected.

Note

A semiconductor junction capacitance measurement must be made with a low level test signal. If desired, TEST SIGNAL frequency may be set to 10kHz.

3. Adjust **C ZERO ADJ** control for zero counts on **LCR DISPLAY**.

Note

If necessary, apply DC bias voltage internally or externally at rear panel **EXT DC BIAS** connector. External DC bias source should be stable with low noise. Set **DC BIAS** switch in **EXT** position during application of external DC bias.

Figure 3-8. Semiconductor Device Measurement (Sheet 1 of 2).

CAUTION

NEVER APPLY AN EXTERNAL DC BIAS OVER +40V.

4. Connect Semiconductor device to test lead or to fixture. To obtain reliable measurement results, observe the following:

Note

- a. It is impossible to measure junction capacitance when bias current flows through sample.
- b. If lead length of device allows, it is recommended that the device be connected directly to UNKNOWN terminals.

5. Read displayed values. Loss factor of the sample will be simultaneously displayed on DQ DISPLAY.

Note

When using manual trigger, press HOLD/MANUAL button. Each time the button is pressed, the instrument is triggered. When measuring multiple samples whose values are about the same, it is recommended that the LCR RANGE be set to MANUAL and that the range be held.

Parameter Measured	Connections to 4262A
Base-collector junction capacitance (Cob)- Emitter current = 0	
Base-collector junction capacitance (Cre)- Common emitter	
FET gate capacitance	
Diode junction capacitance Note: Hot carrier diodes and germanium diodes sometimes cannot be measured.	

Figure 3-8. Semiconductor Device Measurement (Sheet 2 of 2).

External DC Voltage Bias Circuits ($40V < , < 200V$)

1. Connect external dc bias source as shown in diagram.

CAUTION

DO NOT APPLY DC VOLTAGE EXCEEDING 200VOLTS OR 4262A CIRCUITRY WILL BE DAMAGED.

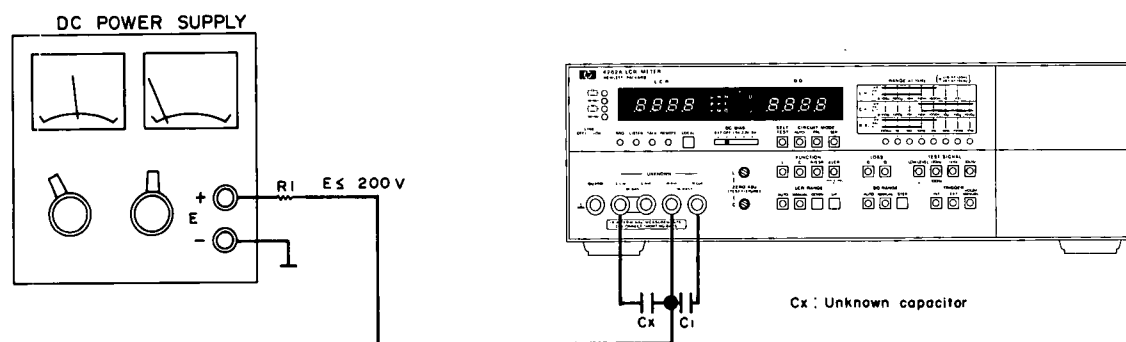

Note

+E voltage is applied to Cx in figure. -E voltage can be applied to Cx in this figure. In the above arrangement, the polarity of Cx and C1 must be taken into consideration.

CAUTION

NEVER SHORT BETWEEN HPOT AND LOW TERMINALS WHEN R1 IS SMALLER THAN 1kΩ. MAKE SURE THAT UNKNOWN CAPACITOR IS NOT DEFECTIVE BEFORE CONNECTING TO INSTRUMENT.

TO AVOID HARMFUL SURGE CURRENT WHICH MAY FLOW THROUGH INTERNAL CIRCUITRY WHEN A HIGH VOLTAGE DC BIAS IS SUDDENLY APPLIED, IT IS RECOMMENDED THAT DC BIAS BE GRADUALLY INCREASED FROM A LOWER VOLTAGE.

Note

Ripple or noise of external dc bias source should be as low as possible. The low frequency noise of bias source should be less than 1mVrms for a TEST SIGNAL level of 50mV (LOW LEVEL) and 30mVrms for 1V.

Figure 3-9. External DC Bias Circuit (Sheet 1 of 3).

2. Minimum values for both C1 (dc blocking capacitor) and R1 are given in table below:

Note

Insulation resistance for Cx must be greater than a certain minimum value. Refer to Table 3-4 for unusual operating indications.

Range (at 120Hz)	1000pF	10.00nF	100.0nF	1000nF	10.00μF
Minimum C1	0.01μF	0.1μF	1μF	10μF	10.00μF
Minimum R1	300kΩ	100kΩ	10kΩ	1kΩ	100Ω

In 1kHz(10kHz) measurement, multiply both range value and value of C1 by 1/10 (1/100). If the calculated value of C1 is less than 0.01μF, use 0.01μF capacitor.

Note

DC withstand voltage for C1 capacitor must be greater than dc applied voltage E. Also observe polarity of capacitor C1 with respect to applied voltage.

3. Set 4262A controls as follows:

SELF TEST.....OFF
 FUNCTION.....C
 CIRCUIT MODE.....PRL
 Other controls..... any setting

4. Read displayed value after allowing time for bias voltage to settle. Typical settling times are:

120Hz: 6 to 7 seconds.
 1kHz/10kHz: 2 to 3 seconds.

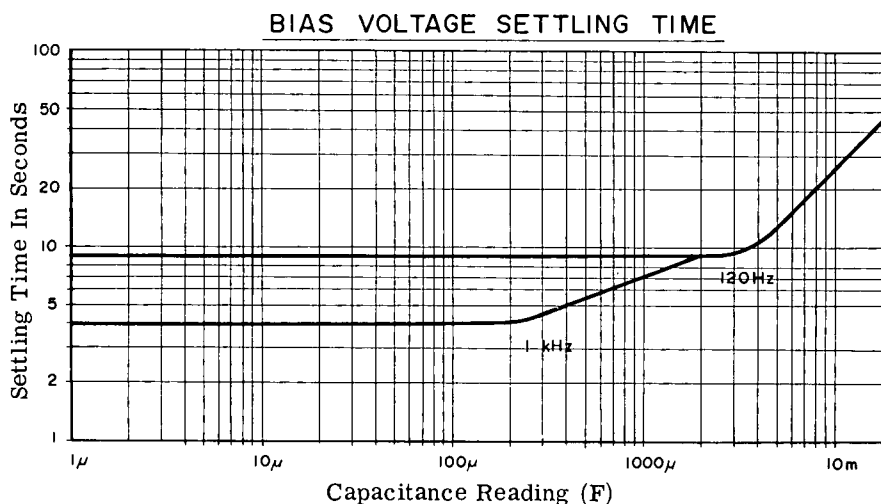

If C1 and R1 which are larger than those given in table on above are connected, longer settling times are necessary.

Figure 3-9. External DC Bias Circuit (Sheet 2 of 3).

Using Current Bias (for inductors).

1. Connect dc power supply as shown below:

Note

DC power supply should be floated from ground.

If cable between low terminals of 4262A and power supply is relatively long, it should be shielded cable. The outer conductor is connected to GUARD terminal.

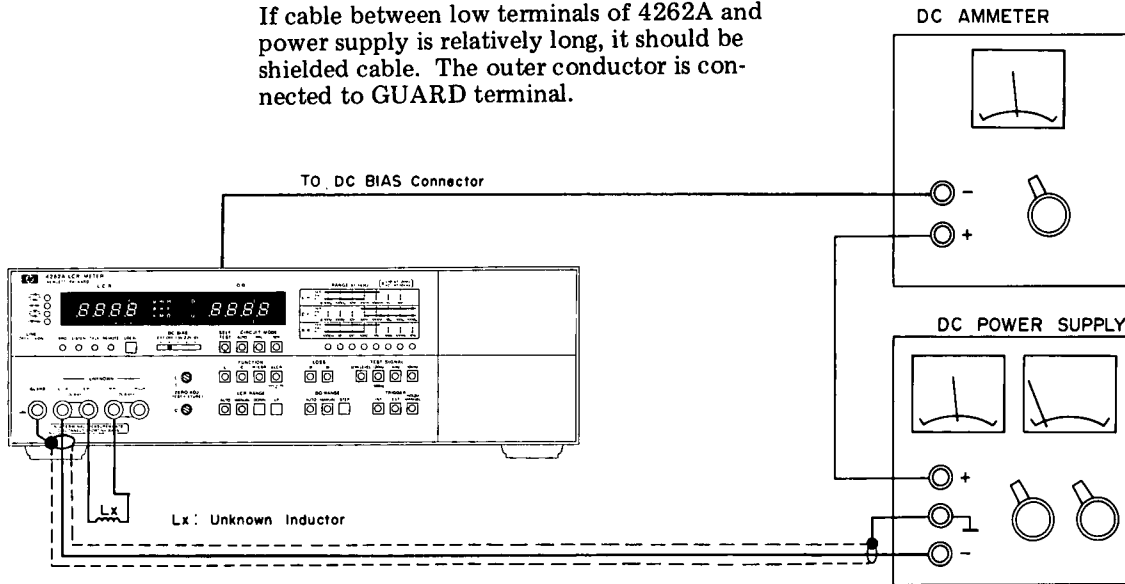

2. Set 4262A controls as follows:

DC BIAS EXT
 FUNCTION L
 CIRCUIT MODE PRL or SER
 LCR RANGE MANUAL
 Other controls any settings

Note

First, determine appropriate range by connecting sample with no dc bias current applied. Then hold the range.

3. Recommended inductance ranges and maximum bias currents are:

Range (at 120Hz)	1000 μ H	10.00 mH	100.0 mH	1000 mH	10.00 H	100.0 H
CIRCUIT MODE	SER			PARA		
Maximum Bias Current*	40mA	36mA	13mA	40mA	36mA	13mA

*Bias current when +40V is applied to DC BIAS connector.

In 1kHz(10kHz) measurement, multiply range value by 1/10 (1/100).

CAUTION

DC BIAS OVER +40 VOLTS MUST NOT BE APPLIED TO EXTERNAL DC BIAS INPUT CONNECTOR.

Figure 3-9. External DC Bias Circuit (Sheet 3 of 3).

Table 3-4. Unusual Operating Indications (Sheet 1 of 4).

Indication:	Cause of trouble:
<p>A. Same sample sometimes shows quite different values between PRL and SER CIRCUIT MODE measurements.</p> <p>B. The decimal point moves and measurement unit changes.</p>	<p>A and/or B may occur in the following cases:</p> <p>Resistance of low loss inductor or capacitor being measured in R FUNCTION.</p> <p>Inductance of lossy inductor or capacitance of lossy capacitor being measured in L or C FUNCTION.</p>
<p>What to do:</p>	
<p>A. Do not set CIRCUIT MODE to AUTO. Set CIRCUIT MODE to a PRL or SER setting that shows a valid display.</p> <p>B. Set LCR RANGE to MANUAL. Manually settle the instrument on an appropriate range.</p>	
Indication:	Cause of trouble:
<p>The displayed value fluctuates on minimum capacitance, maximum inductance or maximum resistance ranges in either PRL or SER circuit modes.</p>	<p>Here are some of the reasons why this happens:</p> <p>A. A large size sample is being measured.</p> <p>B. A high voltage power line or similar exists near the 4262A.</p> <p>C. The 4262A and sample are connected together with relatively long, non-shielded cable.</p>
<p>What to do:</p>	
<p>1. Enclose sample in metal case. Connect case electrically to 4262A GUARD terminal as illustrated.</p> <p>2. Use shielded cable for connection between sample and the instrument. Connect cable shield to GUARD.</p>	
<p style="text-align: center;">UNKNOWN</p> <p style="text-align: center;">GUARD L CUR L POT H POT H CUR</p> <p style="text-align: center;">DC BIAS - DC BIAS +</p> <p style="text-align: center;">Cx</p> <p style="text-align: center;">Metal Case</p>	

Table 3-4. Unusual Operating Indications (Sheet 2 of 4).

Indication:

When measuring a low impedance (small inductance, resistance or high capacitance), measurement error is excessive.

Cause of trouble:

1. Excessive residual impedance (inductance, capacitance or resistance) of test leads in a two terminal measurement.
2. Mutual test lead induction between current leads (H_{CUR} and L_{CUR}) and potential leads (H_{POT} and L_{POT}).

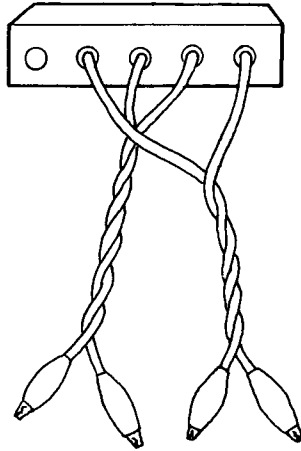

What to do:

Use test leads in four-terminal configuration and measure.

Twist current leads (H_{CUR} and L_{CUR}) together. Do the same with potential leads (H_{POT} and L_{POT}).

Additional error is presented as $\omega^2 L_r C_x \times 100$ (%) for C measurement, where:

- $\omega = 2\pi f$
- $f =$ test frequency
- $L_r =$ residual inductance
- $C_x =$ unknown capacitance

Indication:

Measurement error is excessive when high impedance (high inductance, small capacitance) is measured.

Cause of trouble:

	Measurement	Cause of error
	High Inductance	Stray capacitance between High and Low leads.
	Small Capacitance	Stray capacitance between High and Low leads.

What to do:

Use shielded cable for connection between sample and 4262A UNKNOWN terminals. Connect outer conductor to GUARD terminal.

Adjust C ZERO ADJ control properly to compensate for stray capacitance.

Table 3-4. Unusual Operating Indications (Sheet 3 of 4).

Indication:

Excessive measurement error.

Measurement Frequency	Allowable Stray Capacitance Magnitude
120Hz	100nF
1kHz	1000pF
10kHz	200pF

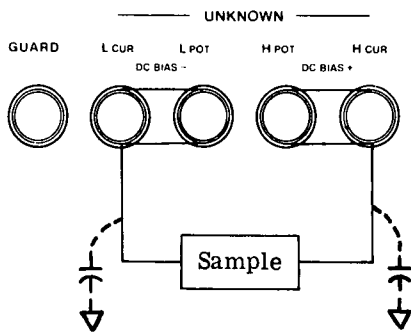

Cause of trouble:

Cause A .

Effect of Low terminal capacitance with respect to ground.

Sometimes the measurement can not be performed when a relatively large capacitance between L_{POT} terminal and ground exists. Allowable magnitudes for stray capacitance without additional error are given in figure at left.

Cause B .

Effect of High terminal capacitance with respect to ground. The stray capacitance will reduce test signal level applied to the sample measured during capacitance measurement. This decrease in signal level will not produce an additional error even when measurement signal level is reduced to a third of its nominal level. It is necessary, of course, that special care be taken to use the proper test signal level when a device is measured whose parameters may be affected by the test signal level. Display fluctuations may sometimes appear.

Indication:

Internal resistance of a battery can not be measured.

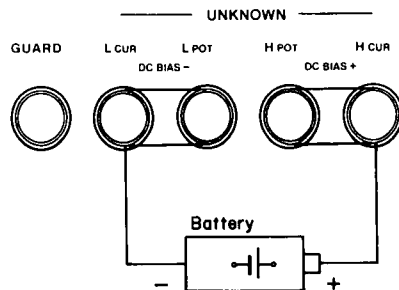

What to do:

1. Connect sample battery (observe polarity) as illustrated.
2. Batteries up to 40V are measured under no load conditions.
3. If battery voltage exceeds 4V, set DC BIAS to EXT
4. Since the internal resistance of a battery is relatively low, use the four-terminal measurement configuration.

Table 3-4. Unusual Operating Indications (Sheet 4 of 4).

Indication:

Cause of trouble:

When a sample (for example, an iron core inductor) is measured in AUTO of CIRCUIT MODE, the instrument repeats range selection and does not complete the measurement depending upon level of test current used.	The measurement reading of sample depends on the level of measurement test signal applied.
---	--

What to do:

Set LCR RANGE to MANUAL. Manually settle the instrument on an appropriate range.
--

Indication:

When a capacitor is measured with dc bias voltage applied, an abnormal display occurs.	There are limitations to the permissible insulation resistance of a capacitor measured with dc bias. See table below.
--	---

MODE		RANGE				
1kHz	Cp	100.0pF	1000pF	10.00nF	100.0nF	1000nF
	Cs	100.0nF	1000nF	10.00μF	100.0μF	1000μF
Permissible insulation resistance (Ri)		30MΩ	3000kΩ	300kΩ	30kΩ	3000Ω

Note

In 120Hz(10kHz) measurement, multiply range value by 10(1/10).

Ri given in above table is applicable for a dc bias of 40 V. When the bias voltage is less than 40V, Ri limit is $RiVb/40$ (Ω) where Ri is value given in the table and Vb is applied dc bias voltage.

3-40. OPTION OPERATION.

3-41. Operating instructions for Options 001, 004, and 101 are described in the following paragraphs.

3-42. OPTION 001: BCD PARALLEL DATA OUTPUT.

3-42. The 4262A Option 001 provides parallel BCD outputs for LCR display, D/Q display and information for various control settings. These outputs are fed to two 50 pin connectors on the rear panel.

3-44. Output Data and Pin Assignment.

3-45. The 4262A Option 001 provides eight kinds of output data:

- (1) FUNCTION and CIRCUIT MODE.
- (2) Test Signal Frequency (LOW LEVEL or normal is excluded).
- (3) Annunciator: Normal, Overflow, Uncal, (LCR and D/Q are not annunciated).
- (4) Unit: p, n, μ , m, k, M, D, Q (judgement whether capacitance, inductance or resistance depends on output of FUNCTION switch setting information).
- (5) Decimal Point.
- (6) Polarity.
- (7) Displayed value.
- (8) Other Input/Output Signals.

The signal pin assignments for the 50 pin connector are shown in Figure 3-40. When these signals are fed to digital printer, the print-out is given as a 10 digit decimal number.

3-46. Alternate Output of LCR and D/Q Data.
BCD outputs for LCR and D/Q data of 4262A Option 001 can be alternately supplied through one 50 pin BCD LCR DATA OUTPUT connector on rear panel. This alternate output is enabled by changing slide switch setting on printed circuit board P/N 04262-66535. PC board 04262-66535 is located nearest to the rear panel in the right hand row of PC boards. Normal setting of the four section slide switch for parallel output and the setting for alternate output are illustrated below.

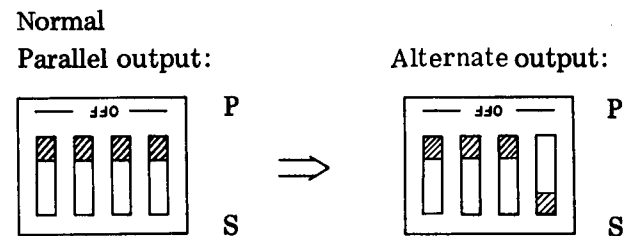

3-47. Output Timing.

3-48. Timing charts for parallel (simultaneous) output and alternate output are shown in Figure 3-41.

Note: Figure in circle indicates column number.

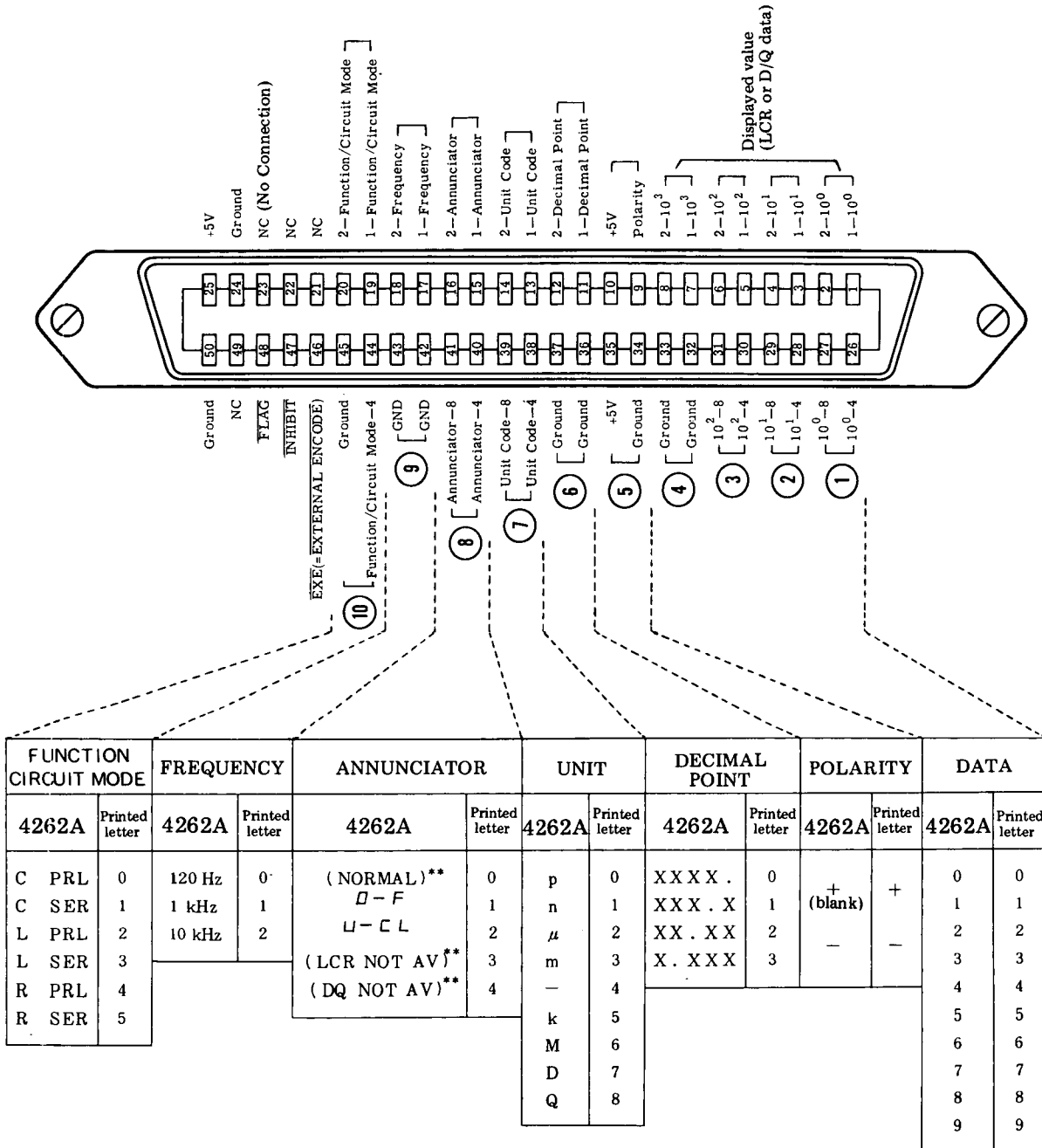

* When annunciation is other than NORMAL, printed number for DATA is 2000.
** These are not displayed.

Figure 3-40. Pin Assignments of Output Connector and Output Format.

Parallel output:

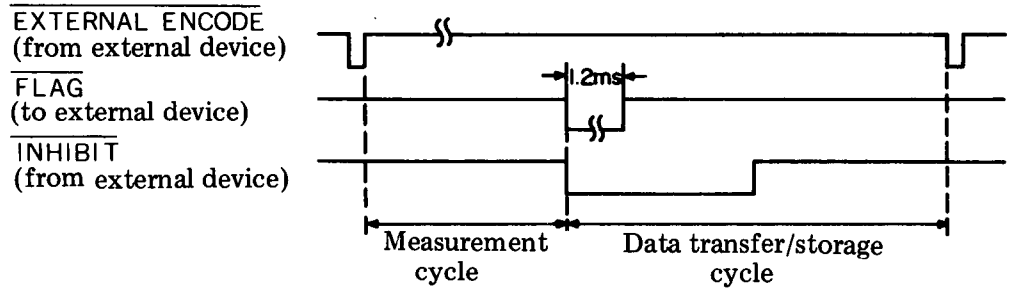

Alternate output:

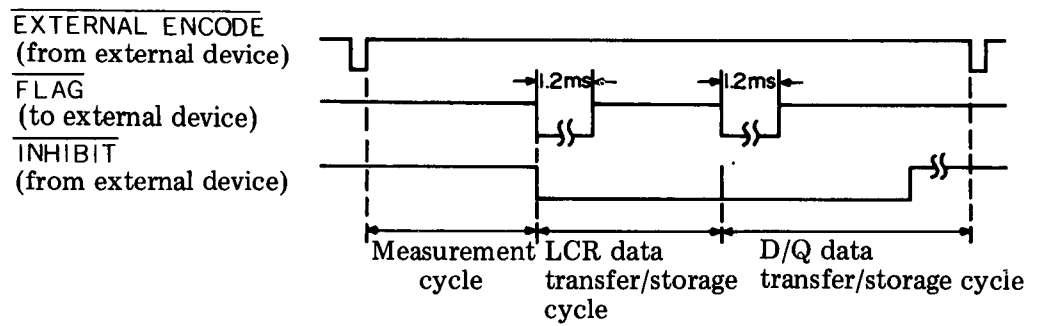

Figure 3-41. Timing Chart of BCD Data Output.

3-49. OPTION 004- COMPARATOR.

3-50. The 4262A Option 004 (shown in Figure 3-43) provides:

- (a) HIGH and LOW limits setting for comparison of LCR and D/Q measured data.
- (b) LED visual decision output lamps display of results of HIGH and LOW limit comparisons.
- (c) TTL outputs and relay outputs for HIGH, IN, and LOW decision outputs.

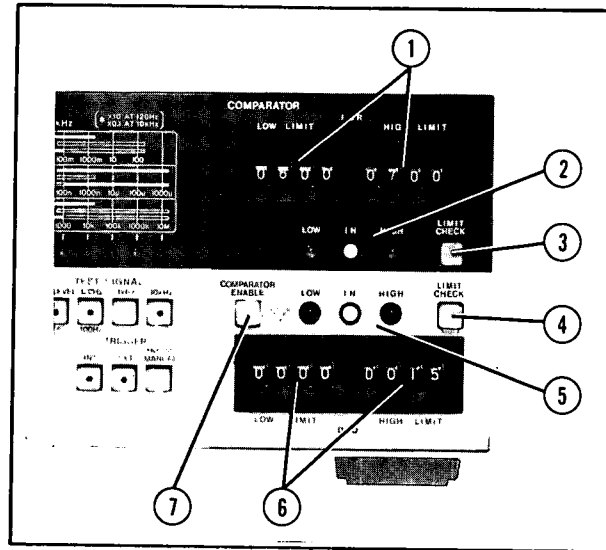

Figure 3-42. Front Panel Features

3-51. Front Panel Features (Figure 3-42).

(1) LCR LIMIT Switch: Two four-digit switches provide HIGH and LOW limit values with which measured LCR value is compared. Setting range is from 0000 to 1999.

(2) LCR Decision Output Lamp: Results of comparison are indicated by LED lamps as follows:

HIGH: (measured value \geq High limit)

IN: (Low limit \leq measured value
 $<$ High limit)

LOW: (measured value $<$ Low limit)

(3) LCR LIMIT CHECK Switch: While this switch is depressed, HIGH and LOW limit values set by LCR LIMIT switches (1) are displayed in LCR and D/Q displays. During this period, three LCR decision output lamps are lit. Comparator must be enabled display limits.

(4) D/Q LIMIT CHECK Switch: While this switch is depressed, HIGH and LOW limit values set by D/Q LIMIT switches (6) are displayed in LCR and D/Q displays. During this period, three D/Q lamps of decision outputs are lit.

(5) D/Q Decision Output Lamp: Results of comparison is indicated by LED lamps as follows:

HIGH:(measured value \geq High limit)

IN: (Low limit \leq measured value
 $<$ High limit)

LOW: (measured value $<$ Low limit)

(6) D/Q LIMIT Switch: Two four-digit switches provide HIGH and LOW limit values with which measured D/Q value is compared. Setting range is from 0000 to 1999.

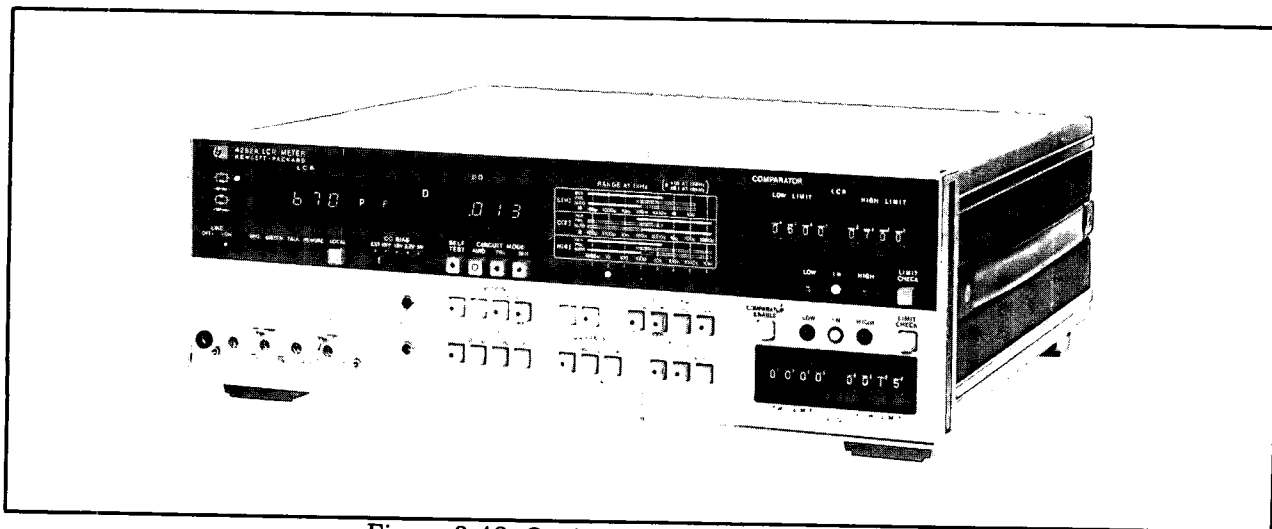

Figure 3-43. Option 004: COMPARATOR.

(7) **COMPARATOR ENABLE Switch:** This switch enables the Option 004 to compare measured data with HIGH and LOW limits under a fixed range condition (LCR or D/Q RANGE switch set to MANUAL). If LCR RANGE switch or D/Q switch is set to AUTO, depressing COMPARATOR ENABLE switch changes LCR or D/Q RANGE switch setting to MANUAL. If AUTO key of LCR or D/Q RANGE switch is depressed while COMPARATOR ENABLE switch is ON, one measurement cycle is done in AUTO ranging and the range is fixed to that selected in this measurement cycle.

Relay Contact Ratings

	AC	DC
Contact Resistance	100mΩ	100mΩ
Maximum Permissible Power	30VA	20W
Maximum Permissible Voltage	110V	30V
Maximum Permissible Current	0.3A	1A
Actuation Life	> 10 million	> 1 million

3-52. LIMIT Setting Warning: If HIGH LIMIT setting is lower than LOW LIMIT setting, HIGH and LOW lamps of decision output repeatedly turn ON and OFF to warn operator to change LIMIT setting.

Decision Output Data Format

Decisions	Relay output pins			TTL output pins		
	DQ LCR 13 17	DQ LCR 14 18	DQ LCR 39 43	DQ LCR 15 19	DQ LCR 16 20	DQ LCR 41 45
HI	S	O	O	H	L	L
IN	O	O	S	L	L	H
LO	O	S	O	L	H	L

3-53. DATA OUTPUT Connector Decision Output: Decision outputs in TTL open collector signal and in relay contact are supplied through COMPARATOR OUTPUT connector on the rear panel. Signal pin assignment is given in Figure 3-44.

WARNING !

DO NOT APPLY AC LINE VOLTAGE TO RELAY OUTPUT CONNECTOR PIN TO SWITCH LINE CURRENT. For such relay applications, remotely control an external relay with relay output.

S: Short O: Open
Referenced to common (pin 38 or 42).
TTL Output sink current: 30mA max.

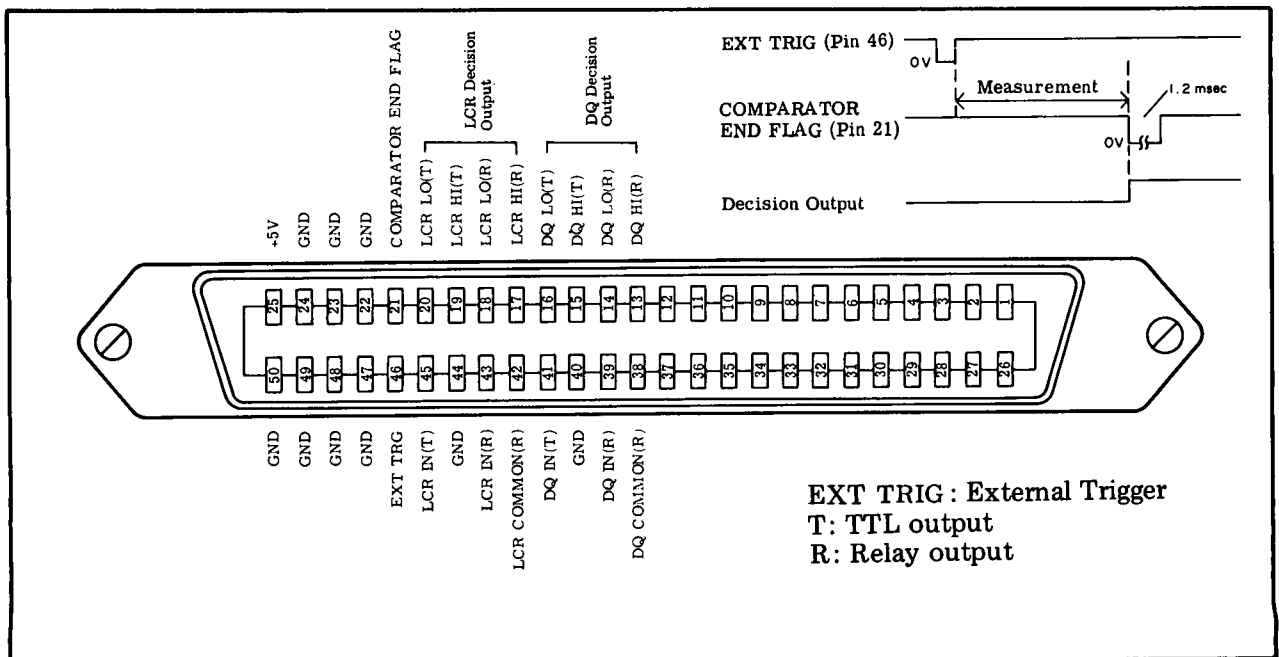

Figure 3-44. Comparator Data Output Pin Locations.

3-60. OPTION 101: HP-IB.

3-61. The 4262A Option 101 provides interface capabilities in accordance with IEEE-STD-488-1975 recommendations.

3-62. Connection to HP-IB Controller: The 4262A Option 101 can be connected to an HP-IB Controller (HP calculator) via HP-IB digital bus connector on the rear panel of the 4262A and the bus connector of the Bus I/O card installed in calculator.

3-63. HP-IB Status Indicator: The four LED lamps of the HP-IB Status Indicator (located below the LCR display) show which HP-IB condition the 4262A is in:

- SRQ: SRQ signal put on HP-IB line from 4262A. See paragraph 3-70 for details.
- LISTEN: 4262A is set to listen. See paragraph 3-69 for details.
- TALK: The 4262A is set to talk. See paragraph 3-67 for details.
- Remote: The 4262A is remotely controlled. See paragraph 3-71 for details.

3-64. LOCAL Switch: This switch disables remote control and enables setting measurement conditions by front panel controls (pushbutton switches). REMOTE lamp of HP-IB status indicator turns off when LOCAL switch is depressed. (When Local Lock Out does not function).

3-65. HP-IB INTERFACE CAPABILITIES: The 4262A Opt 101 has the following eight bus interface functions:

- SH1: Source Handshake Capability.
- AH1: Acceptor Handshake Capability.
- T5: Talker (the 4262A sends measurement data to the bus).
- L4: Listener (the 4262A receives remote control signals from the bus).
- SR1: Service Request Capability.
- RL1: Remote/Local Capability.
- DC1: Device Clear Capability.
- DT1: Device Trigger Capability.

3-66. Source and Acceptor Handshake:
 SH1, AH1.

Three Bus handshake lines (DAV, NRFD and NDAC) perform Source and/or Acceptor handshake functions.

- (1) DAV (Data Valid). DIO (Data Input Output) line is available.
- (2) NRFD (Not Ready For Data). Listener preparation for receiving data from Talker is not yet completed.

(3) NDAC (Not Data Accepted). Listener has not yet received data from Talker.

3-67. Talker Capability: T5.

When set to Talker by MTA (My Talk Address) signal from controller, the 4262A sends measurement data to the Bus in one of three types of output formats:

Type A: Ordinary output format. Address switch on the rear panel set to FMT A.

$\frac{S}{(1)} \frac{FC}{(2)} \frac{F}{(3)} \frac{-NN.NNE-NN}{(4)} \frac{, SF}{(5)(1)(6)} \frac{N.NNN}{(7)} \frac{CRLF}{(8)}$

Type B: Output format used for Model 5150A HP-IB Digital Recorder. Address switch on the rear panel set to FMT B.

$\frac{S}{(1)} \frac{FC}{(2)} \frac{F}{(3)} \frac{-NN.NNE-NN}{(4)} \frac{CRLF}{(8)} \frac{SF}{(1)(6)} \frac{N.NNN}{(7)} \frac{CRLF}{(8)}$

Type C: Output format used in resistance measurement or LCR ONLY measurement when no D/Q data is to be outputted. Selection of this format is automatically done in accordance with FUNCTION switch setting.

$\frac{S}{(1)} \frac{FC}{(2)} \frac{F}{(3)} \frac{-NN.NNE-NN}{(4)} \frac{CRLF}{(8)}$

The numbered elements of output data are described below:

(1) Status:

- N. Normal
 - O. Overflow
 - U. Uncal
 - X. LCRNA or DNA
- (NA: Not Available)

(2) Function and Circuit Mode:

FUNCTION	MEASURE- MENT	CIRCUIT MODE
CP	C	PRL
CS	C	SER
LP	L	PRL
LS	L	SER
RP	R	PRL
RS	R/ESR	SER

(3) Frequency:

- A. 120Hz (100Hz)
- B. 1kHz
- C. 10kHz

- (4) LCR Data
- (5) Data Delimiter
- (6) Loss

D. Dissipation Factor measurement
Q. Quality Factor measurement

- (7) DQ Data
- (8) Data Terminator

3-68. Functions Related to Talker Capability.

EOI (End Or Identify): When multiple byte data of Source Handshake has been sent, the 4262A provides EOI to the bus.

Talk Only Mode: When ADDRESS switch is set to TALK ONLY "1" position, the 4262A is set to Talker regardless of address code.

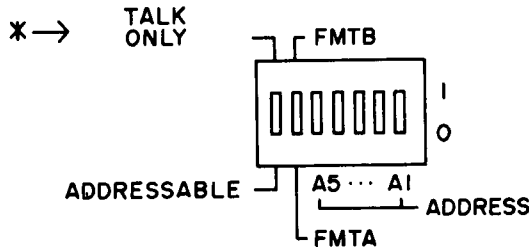

Talk Address Disabled by Listen Address:

MTA (My Talk Address) is automatically disabled when MLA (My Listen Address) is set. MTA (My Talk Address) is otherwise disabled by IFC (Interface Clear) signal, OTA (Other Talk Address) signal or UTA (Untalk Address) signal.

3-69. Listener Capability: L4.

To receive Remote Program signal or Addressed Command signal, the 4262A is set to Listener by an MLA (My Listen Address) signal from the bus.

- (1) Remote Program signal: Remote program codes for the 4262A are listed in Table 3-60.
- (2) Addressed Command signal: When the 4262A receives command signals GET, GTL, or SDC, it is set to Listener and controlled by command signals. These command signals are valid regardless of the status (remote or local).

GET (Group Execute Trigger): When the 4262A receives this command, it is triggered regardless of front panel TRIGGER switch setting.

GTL (Go to Local). The 4262A is set to LOCAL by this command to enable front panel control.

SDC (Selected Device Clear): When this command is accepted, front panel controls are set to initial conditions (the same conditions that are automatically set after turn-on of power switch).

Listen status is automatically disabled when MTA (My Talk Address) is received. Listen status is otherwise disabled by IFC (Interface Clear) signal or ULA (Unlisten Address) signal.

3-70. Service Request Capability: SR1.

The 4262A sends an SRQ (Service Request) signal whenever it is set in one of the six possible RQS (Request Status) states. It does this by responding to a serial poll of the controller by setting an STB (Status Byte) signal on the bus. The 7th bit of this 8 bit signal establishes whether or not a service request exists. The remainder of the 8-bit signal identifies the character of the SRQ.

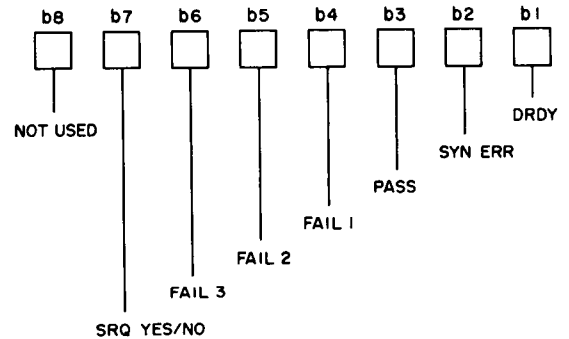

SRQ (Service Request) is disabled when RQS (Request Status) or STB (Status Byte) is set to 00000000 or when STB (Status Byte) signal transfer is completed.

Request Statuses (RQS) of the 4262A:

- (1) DRDY (Data Ready): When the 4262A completes a measurement cycle, this status bit is set. This status is set without serial polling if NOT DATA READY is set.
- (2) SYN ERR (SYNtaxis ERRor): When the 4262A receives an erroneous Remote Program Code which is not listed in Table 3-60, this status bit is set.
- (3) PASS (Self Test Pass): When PASS is displayed in Self Test done by remote control, this status bit is set.
- (4) FAIL 1 (Self Test Fail 1): When FAIL 1 is displayed in Self Test done by remote control, this status bit is set.
- (5) FAIL 2 (Self Test Fail 2): When FAIL 2 is displayed in Self Test done by remote control, this status bit is set.
- (6) FAIL 3 (Self Test Fail 3): When FAIL 3 is displayed in Self Test done by remote control, this status bit is set.

Table 3-60. Remote Program Codes.

	CONTROL			Program Code
Function	L			F 1
	C			F 2
	R/ESR			F 3
Circuit Mode	AUTO			C 1
	PRL			C 2
	SER			C 3
Loss	D			L 1
	Q			L 2
Frequency	120 Hz			H 1
	1 kHz			H 2
	10 kHz			H 3
Trigger	INT			T 1
	EXT			T 2
	HOLD/MANUAL			T 3
Self Test	OFF			S 0
	ON			S 1
Δ LCR	OFF			M 0
	ON			M 1
Cp Low Level	OFF			P 0
	ON			P 1
* Data Ready RQS Mode	OFF			D 0
	ON			D 1
LCR Range at 1 kHz	(C)	(L)	(R)	
	100 p	100 μ	1000 m	R 1
	1000	1000	10	R 2
	10 n	10 m	100	R 3
	100	100	1000	R 4
	1000	1000	10 k	R 5
	10 μ	10	100 k	R 6
	100	100	1000 k	R 7
	1000	—	10 M	R 8
— AUTO —			R 9	
DQ Range	(D)	(Q)		
	—	1000		N 1
	—	100.0		N 2
	10.00	10.00		N 3
	1.000	1.000		N 4
— AUTO —			N 5	
* Data Ready RQS Mode is automatically disabled when Remote Status is changed to Local Status.				

Table 3-61. Remote Message Coding.

		CLASS	D I O							
			8	7	6	5	4	3	2	1
DCL	device clear	UC	X	0	0	1	0	1	0	0
GET	group execute trigger	AC	X	0	0	0	1	0	0	0
GTL	go to local	AC	X	0	0	0	0	0	0	1
LLO	local lock out	UC	X	0	0	1	0	0	0	1
MLA	my listen address	AD	X	0	1	L	L	L	L	L
						5	4	3	2	1
MTA	my talk address	AD	X	1	0	T	T	T	T	T
						5	4	3	2	1
OTA	other talk address	AD	(OTA = TAG $\overline{\text{M}}$ MTA)							
SDC	selected device clear	AC	X	0	0	0	0	0	1	0
SPD	serial poll disable	UC	X	0	0	1	1	0	0	1
SPE	serial poll enable	UC	X	0	0	1	1	0	0	0
STB	status byte	ST	S	X	S	S	S	S	S	S
UNL	unlisten	AD	X	0	1	1	1	1	1	1
UNT	untalk	AD	X	1	0	1	1	1	1	1
CLASS			UC : Universal Command AC : Addressed Command AD : Address ST : Status Byte							

3-71. Remote/Local Capability: RL1.

The 4262A goes to Remote Status only when it accepts Listen address with REN (Remote Enable) line in the Bus lines set to "1". Remote status is not obtained if REN line is set to "1" after Listen address is received. Remote status is returned to Local status when one of following conditions is present:

- (1) REN line is set to "0".
- (2) LOCAL switch on front panel is depressed.
- (3) GTL (Go To Local) command is received.

Local Lock Out: LLO

Local Lock Out inhibits the function of LOCAL switch. This LLO command is a universal command and is valid when REN line is set to "1". LLO command is disabled when REN line is set to "0"

3-72. Device Clear Capability: DC1.

The 4262A is set to initial conditions (the same conditions that are automatically set after turn-on of power switch), when it accepts DCL (Device Clear) command—universal command—or SDC (Selected Device Clear)—addressed command.

3-73. Device Trigger Capability: DT1.

The 4262A is triggered regardless of TRIGGER switch setting when it accepts GET command—address command.

3-74. ADDRESS Switch: ADDRESS switch on the rear panel sets Listen/Talk address. Five section or five bit switch provides 30 settings from 00000 to 11110.

A 5	A 4	A 3	A 2	A 1		
0	0	0	0	0	0
		1				1
1	1	1	1	0	30

3-75. Remote Message Coding: Interface Bus Command signals for the 4262A are listed in Table 3-61.

SECTION IV

PERFORMANCE TESTS

4-1. INTRODUCTION.

4-2. This section provides the check procedures to verify the 4262A specifications listed in Table 1-1. All tests can be performed without access to the interior of the instrument. A simpler operational test is presented in Section III under Self Test (paragraph 3-5). The performance test procedures in this section can also be used to do an incoming inspection of the instrument and to verify whether the instrument meets its specified performance after troubleshooting or making adjustments. If specifications are found to be out of limits, check that controls are properly set, and then proceed to adjustments or troubleshooting.

Note

Allow a 15-minute warm-up and stabilization period before conducting any performance test.

4-3. EQUIPMENT REQUIRED.

4-4. Equipment required for the performance tests is listed in Table 1-4 Recommended Test Equipment in Section I. Any equipment whose characteristics equal the critical specifications given in the table may be substituted for the recommended model(s).

Accuracy checks in this section use standard LCR components as the samples to be connected to the 4262A. Accessories 16361A and 16362A can be utilized for this purpose. These accessory models are DUT (device under test) boxes from which the desired component can be selected and connected to the 4262A through cables by use of a

rotary switch. If models 16361A/16362A are unavailable, use the discrete components recommended in Table 4-1.

Note

All components used as standards should be calibrated by an instrument whose specifications are traceable to NBS, PTB, LNE, NRC, JEMIC, or equivalent standards group; or all components should be calibrated directly by an authorized calibration organization such as NBS. The calibration cycle should be determined by the stability specification for each component.

4-5. TEST RECORD.

4-6. Results of the performance tests may be tabulated on the Test Record at the end of these procedures. The Test Record lists all the tested specifications and their acceptable limits. Test results recorded at incoming inspection can be used for comparison in periodic maintenance and troubleshooting and after repairs or adjustments.

4-7. CALIBRATION CYCLE.

4-8. This instrument requires periodic verification of performance. Depending on the use and environmental conditions, the instrument should be checked with the following performance tests at least once every year. To maximize the "up time" of the instrument, the recommended preventive maintenance frequency for the 4262A is twice a year.

PRELIMINARY OPERATIONS

Before beginning performance test, adjustment, or calibration of 4262A, check fundamental operating conditions of the instrument and perform display ZERO adjustments in accord with the following procedures:

- 1) Confirm that power line power voltage in use is appropriate for the instrument operating power voltage.
- 2) Depress LINE pushbutton and confirm that all the front panel displays and indicators momentarily illuminate. The 4262A functions are automatically set to capacitance measurement mode.
- 3) ZERO offset adjustment should be made whenever a test fixture or DUT box is connected to 4262A UNKNOWN terminals. Adjust C ZERO ADJ and L ZERO ADJ controls so as to fully compensate for stray capacitance and residual inductance of equipment connected to UNKNOWN terminals. Adjustment procedures to adjust for individual test equipment used are provided in steps 3-a and 3-b which follow.

3-a) 16361A/16362A or user built DUT box.

1. Disconnect shorting bars from 4262A UNKNOWN terminals. Connect test leads between 4262A UNKNOWN terminals and DUT box.
2. Set 4262A FUNCTION to C. Set TEST SIGNAL frequency as appropriate to DUT box being used.
3. Set range control of DUT box to open-circuit position (2pF range on 16361A or 1pF range on 16362A). The 4262A is automatically set to its lowest capacitance measurement mode range.
4. Adjust C ZERO ADJ control so that capacitance readout on 4262A LCR display is identical to calibrated value of DUT box range.
5. Set 4262A FUNCTION to L.
6. Set range control of DUT box to short-circuit position (20m Ω range on 16361A or on 16362A).
7. Adjust L ZERO ADJ control for 000 counts on LCR display.

Note

To permit easy adjustment of ZERO ADJ controls for an individual DUT box, each DUT box should be equipped with short and open circuit ranges which provide 0 μ H and 0pF (practical values), respectively.

PRELIMINARY OPERATIONS

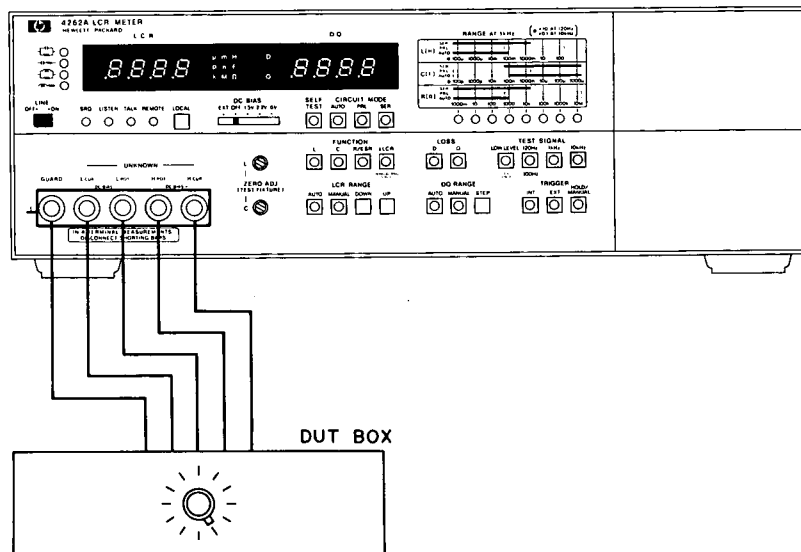

3-b) 16061A or other test fixtures.

1. Disconnect shorting bars from 4262A UNKNOWN terminals and attach test fixture to UNKNOWN.
2. No DUT should be connected to the test fixture.
3. The 4262A is automatically set to lowest capacitance range in measurement mode. Set 4262A TEST SIGNAL frequency to 10kHz.
4. Adjust C ZERO ADJ control for 000 counts on LCR display.
5. Set 4262A FUNCTION to L.
6. Connect a shorting lead to test fixture to short-circuit the measurement terminals.
7. Adjust L ZERO ADJ control for 000 counts on LCR display.

Note

When positions or mutual distance between Test Fixture contacts are changed, or contacts are changed to a different type, again perform ZERO adjustments.

CALIBRATION OF DUT'S

Either user built DUT's or substitution standards with accuracies which satisfy the requirements may be used for performance testing and calibration of the 4262A. The DUT's recommended for making the tests and adjustments can be accuracy certified in accord with the calibration procedure detailed below. This calibration procedure applies to all alternate DUT's which do not carry public or testing laboratory certification.

[CAPACITANCE CALIBRATION]



Measure the DUT or substitution standard capacity with a precision capacitance bridge that meets the calibration accuracy and frequency requirements. For testing or calibrating dissipation factor of DUT, use equipment with required dissipation measuring capability and verify the exact calibration frequency to permit compensating D value for the difference in measuring frequency between individual Model 4262A's and the calibration equipment. If the frequency error is less than 3%, compensation is not required for dissipation factors of 0.01 and below.

[RESISTANCE CALIBRATION]

Use a metal film resistor of appropriate value for each DUT to maintain a constant resistance over a wide range of frequencies. Measure the resistance with a high accuracy DMM. When measuring 1kΩ and below, use a 4 terminal measurement configuration.

[DISSIPATION FACTOR CALIBRATION]

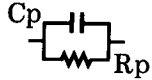
DUT's used as D standards can be built with precisely measured components. The dissipation factor of the DUT is determined by an exact calculation from the calibrated values of each components in accord with the following equations:

Circuit Mode	Derivation of D
	$D = 1/\omega C_p R_p$
	$D = \omega C_s R_s$

Note

For easier calibration of dissipation, use accurately calibrated resistors rather than capacitors.

CALIBRATION OF DUT'S

To minimize the calculation error, the inherent dissipation of the capacitor should be 0.001 or below. When using polystyrene or silvered mica type capacitors (dissipation factor is generally very low), the residual factors will not affect the derivation of accurate dissipation factors. If dissipation of capacitor alone is greater than 0.001, the effective value of the DUT is calculated in accord with the following equation:

$$D_s = D_c + D_r \quad (D_r \ll D_c, D_r < 0.01)$$

where, D_s is actual dissipation factor of DUT.
 D_c is calculated D value (excludes inherent dissipation).
 D_r is inherent dissipation of capacitor.

Compensate the dissipation factor for the measuring frequencies of individual 4262A being tested or calibrated. Convert the D value of the calibration frequency to that of the actual 4262A measuring frequency in accord with the following equations:

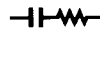
$D_m = X \cdot D_s$		$x = \frac{f_c}{f_m}$	D_m : D value at 4262A measuring frequency. D_s : D value at calibration frequency. f_m : 4262A measuring frequency f_c : Calibration frequency.
		$x = \frac{f_m}{f_c}$	

Note

To accurately measure frequencies f_m and f_c , use a reciprocal counter or calculate reciprocal number of period.

[CALIBRATION EQUIPMENT]

The recommended model and required performance of calibration equipment is listed below:

Instrument	Required Performance	Recommended Model
Capacitance Bridge	Capacitance Accuracy: 0.1% Dissipation Factor Accuracy: 0.1% (Resolution 0.0001)	GR 1620-A
DMM	Resistance Accuracy: 0.02%	HP 3490A HP 3455A
Freq. Counter	Reciprocal counter Resolution: 0.01Hz	HP 5300A/5307A HP 5323A

Table 4-1. Recommended Components for Accuracy Checks.

Component *1	HP Part Number	Alternate Source	Required Calibration Accuracy
Capacitor:			
100pF	0160-0336	HP Model 4440B GR Type 1413	0.05%
1000pF	0160-3766		
10nF	0160-0408		
100nF	0160-1571		
1000nF	0160-3645	SOSHIN TM-520C GR Type 1417	0.2%
10μF	0160-3563		0.25%
1000μF	_____		
10mF	_____		
Resistor:			
1kΩ	0698-3491	GR Type 1433-Y	0.05%
10kΩ	0698-6360		
100kΩ	0698-4158		
10MΩ	0698-8194		
Inductor:	100mH	GR Type 1482-L	0.05%
Dissipation Factor:			**2
1000nF in parallel with 887Ω (D ≈ 1.50 at 120Hz)	0160-3645 0698-4464	(D=1/ωCR)	Capacitors . . . 0.1% Resistors . . . 0.02%
100nF in parallel with 887Ω (D ≈ 1.79 at 1kHz)	0160-1571 0698-4464		
10nF in parallel with 887Ω (D ≈ 1.79 at 10kHz)	0160-3171 0698-4464		

*1 The components listed above or used as standards should be calibrated before they are utilized.

**2 For easier calibration of dissipation to the required accuracy (0.1%), use accurately calibrated resistors rather than capacitors (use a high accuracy DMM to measure resistors).

Proper method and procedure for calibrating the DUT's is given in "Calibration of DUT's"
(Page 4-4).

PERFORMANCE TESTS

4-9. MEASUREMENT FREQUENCY TEST.

DESCRIPTION:

This test verifies the accuracy of the measurement frequencies that are applied to an unknown sample connected to the 4262A.

SPECIFICATIONS:

Measurement Frequencies: 120Hz ± 3%
 1kHz ± 3%
 10kHz ± 3%

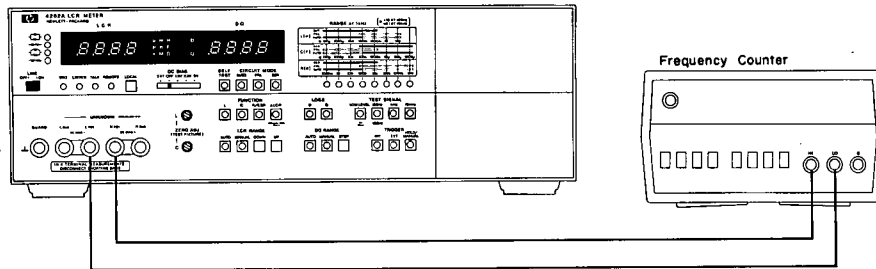

Figure 4-1. Measurement Frequency Test Setup.

EQUIPMENT:

Frequency Counter HP 5300A/w 5306A

PROCEDURE:

1. Connect frequency counter to the 4262A UNKNOWN terminals as shown in Figure 4-1.
2. Set range of frequency counter as appropriate for measuring 4262A test frequencies of 120Hz, 1kHz and 10kHz.
3. Read display output of frequency counter when 4262A TEST SIGNAL is set to 120Hz, 1kHz or 10kHz.
4. Frequency readouts must be within the following limits (record measured frequency in table below as the data is used in paragraph 4-12):

TEST SIGNAL	Test Limits	Counter Readout
120Hz	116.4 - 123.6Hz	
1kHz	970 - 1030 Hz	
10kHz	9700 - 10300 Hz	

Note

Test limits in table above do not take into account reading error caused by measurement error in test equipment.

Note

If this test fails, refer to Service Sheet 11 in Section VIII for troubleshooting.

PERFORMANCE TESTS

4-10. CAPACITANCE ACCURACY TEST.

DESCRIPTION:

This test checks capacitance measurement accuracy for zero and full scale displays at three test frequencies and at two signal levels. The test is made by connecting a stable capacitor more accurate than the 4262A to the instrument and reading the display to verify that the 4262A meets its measurement accuracy specifications. Check all ranges in Cp mode and one range in Cs mode at each frequency (120Hz, 1kHz and 10kHz) to guarantee C measurement accuracy since all variable elements (range resistors and detecting phases) needed for C measurement are thus checked. In this test, almost all ranges, from the lowest through the highest ranges, are being verified.

Note

If the following tests satisfy the accuracy specifications, all the accuracy specifications listed in Table 1-1 are guaranteed.

Capacitance Accuracy Test Ranges

TEST SIGNAL		CIRCUIT MODE	RANGE						
Freq.	Level		10.00pF	100.0pF	1.000pF	10.00nF	100.0nF	1000nF	10.00μF
120Hz	LOW LEVEL	PRL	X	X	X	X	X	X	X
	normal	PRL	X	X	X	X	X	X	X
		SER	X	X	X	X	X	X	X
1kHz	LOW LEVEL	PRL	X	X	X	X	X	X	X
	normal	PRL	X	X	X	X	X	X	X
		SER	X	X	X	X	X	X	X
10kHz	LOW LEVEL	PRL	X	X	X	X	X	X	X
	normal	PRL	X	X	X	X	X	X	X
		SER	X	X	X	X	X	X	X

TEST SIGNAL level:

LOW LEVEL50mV
normal 1V

Tests for dissipation factor accuracy with above capacitance standards should be done at the same time as capacitance tests

Check all parallel (PRL) mode ranges. It is sufficient to check any one range in series (SER) mode.

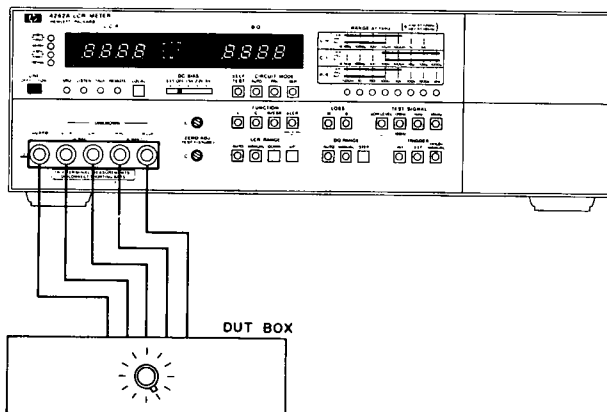

Figure 4-2. Capacitance Accuracy Test Setup.

PERFORMANCE TESTS

SPECIFICATIONS:

C-D/Q MEASUREMENT ACCURACIES.

Range	120Hz 1kHz 10kHz	1000pF 100.0pF 10.00pF	10.00nF 1000pF 100.0pF	100.0nF 100.0nF 1000pF	1000nF 100.0nF 100.0nF	10.00μF 1000nF 100.0nF	100.0μF 100.0μF 1000nF	1000μF 100.0μF 100.0μF	10.00mF 1000μF 100.0μF		
C Accuracy*1		0.2% + 1 count					(Test signal level: 1V)				
		0.5% + 3 counts	0.3% + 2 counts					(Test signal level: 50mV)			
		(At 120Hz, 1kHz)		0.3% + 2 counts		0.5% + 2 counts	1% + *2		5% + 2		
D (1/Q) Accuracy*1		0.2% + (2 + 200/Cx) counts					At 120Hz, 1kHz				
		0.5% + (2 + 200/x) counts					At 10kHz				
		0.3% + (2 + 1000/Cx) counts					At 120Hz, 1kHz				
D (1/Q) Accuracy*1		1.0% + (2 + 1000/Cx) counts					At 10kHz				
		(At 120Hz, 1kHz)		0.3% + (2 + Cx/500) counts		1% + (5 + Cx/500)		5% + (5 + Cx/500)			
		(At 10kHz)		0.5% + (2 + 200/Lx) counts		1% + (5 + Cx/500)		5% + (5 + Cx/500)			
	AUTO	Same as Mode				Same as Mode					

*1 ±(% of reading + counts). Cx is capacitance readout in counts. This accuracy only applies for D values to 1.999.

*2 (5% + 2 counts) at 1kHz.

Accuracy applies over a temperature range of 23°C ±5°C (at 0°C to 55°C, error doubles).

EQUIPMENT:

DUT Box..... HP 16361A/16362A
 Test Leads..... HP P/N 16361-61605

Note

User built test fixture or DUT box may be used instead of those HP provides. If user supplied, the residual impedance and stray capacitance of the fixture and box must be taken into account.

PROCEDURE:

1. Connect Test Leads (HP P/N 16361-61605) between 4262A UNKNOWN terminals and HP 16361A DUT Box (see Figure 4-2). When TEST SIGNAL frequency is 10kHz, use HP 16362A in place of HP 16361A.

2. Set 4262A controls as follows:

DC BIAS.....OFF
 FUNCTION..... C
 LCR RANGE..... AUTO
 LOSS..... D
 D/Q RANGE..... AUTO
 TRIGGER..... INT

PERFORMANCE TESTS

3. Confirm that the table on page 4-11 is satisfied when the measurements are made by changing TEST SIGNAL, CIRCUIT MODE and DUT as given in the table. Record capacitance and dissipation factor readings in blank spaces provided in table.

Note

Error caused by stability of standard component is not taken into account for test limits in the table.

Test limits in parentheses are those for dissipation factor measurement value.

If tests fail, proceed to Section V ADJUSTMENTS or Section VIII SERVICE.

PERFORMANCE TESTS

TEST SIGNAL		CIRCUIT	16361A/16362A RANGE								
Freq.	level	MODE	10pF*1	100pF	1000pF	10nF	100nF	1000nF	10μF	1000μF	10mF
120Hz	LOW LEVEL	PRL		C. V. ±4 counts (——)	C. V. ±8 counts (——)	C. V. ±5 counts (±3 counts)	C. V. ±5 counts (±3 counts)	C. V. ±5 counts (±3 counts)	C. V. ±5 counts (±3 counts)		
	normal	PRL		C. V. ±2 counts (±4 counts)	C. V. ±3 counts (±3 counts)	C. V. ±3 counts (±3 counts)	C. V. ±3 counts (±3 counts)	C. V. ±3 counts (±3 counts)	C. V. ±3 counts (±3 counts)		
		SER						C. V. ±3 counts (±3 counts)	C. V. ±5 counts (±4 counts)	C. V. ±5 counts (±4 counts)	C. V. ±7 counts (±4 counts)
1kHz	LOW LEVEL	PRL		C. V. ±8 counts (——)	C. V. ±5 counts (±3 counts)	C. V. ±5 counts (±3 counts)	C. V. ±5 counts (±3 counts)	C. V. ±5 counts (±3 counts)			
	normal	PRL		C. V. ±3 counts (±3 counts)	C. V. ±3 counts (±3 counts)	C. V. ±3 counts (±3 counts)	C. V. ±3 counts (±3 counts)	C. V. ±3 counts (±3 counts)			
		SER					C. V. ±3 counts (±3 counts)	C. V. ±5 counts (±4 counts)	C. V. ±5 counts (±4 counts)	C. V. ±5 counts (±4 counts)	C. V. ±2 counts (±7 counts)
10kHz	LOW LEVEL	PRL		C. V. ±8 counts (——)	C. V. ±5 counts (±4 counts)	C. V. ±5 counts (±3 counts)	C. V. ±5 counts (±3 counts)	C. V. ±5 counts (±3 counts)			
	normal	PRL		C. V. ±3 counts (±3 counts)	C. V. ±3 counts (±3 counts)	C. V. ±3 counts (±3 counts)	C. V. ±3 counts (±3 counts)	C. V. ±3 counts (±3 counts)			
		SER				C. V. ±3 counts (±3 counts)	C. V. ±5 counts (±4 counts)	C. V. ±5 counts (±4 counts)	C. V. ±5 counts (±4 counts)	C. V. ±12 counts (±7 counts)	

TEST SIGNAL level: LOW LEVEL 50mV
normal 1V

*1 HP 16362A Only
**2 C. V. = Calibrated Value of Standard Component.

PERFORMANCE TESTS

4-11. RESISTANCE/ESR ACCURACY TEST.**

DESCRIPTION:

This test verifies that resistance measurement accuracies for 4262A tested meets the specifications listed below. Although R measurement accuracies are actually guaranteed when C measurement accuracies meet the specifications, almost all ranges in Rp mode are checked in this test.

Note

Resistance accuracy has only to be proved for one resistor of about full scale value on any one range to verify specifications for 120Hz, 1kHz and 10kHz.

SPECIFICATION:

RESISTANCE/ESR ACCURACY SPECIFICATIONS

Ranges	120Hz 1kHz 10kHz	1000mΩ	10.00Ω	100.0Ω	1000Ω	10.00kΩ	100.0kΩ	1000kΩ	10.00MΩ
Accuracy *1		0.3% + 2 counts *2							
		0.2% + 2 counts							
	AUTO	Same as Mode				Same as Mode			

*1 ±(% of reading + counts).

*2 (5% +2 counts) on 10.00MΩ range at 10kHz.

** Measurement range for ESR (equivalent series resistance) is from 1mΩ to 19.99kΩ (typical), which varies with series capacitance or inductance value refer to "REFERENCE DATA" on page 1-6.

Accuracy applies over a temperature range of 23°C ±5°C. (at 0°C to 55°C, error doubles).

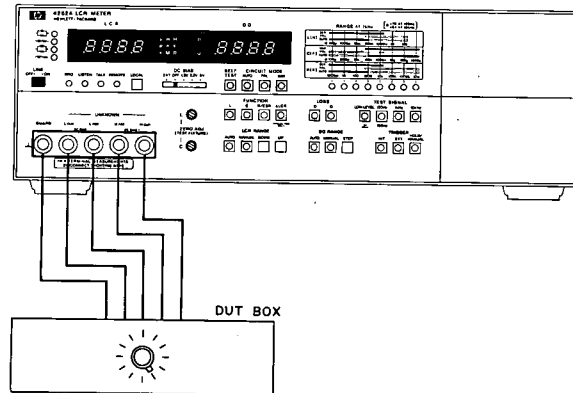

Figure 4-3. Resistance Accuracy Test Setup

EQUIPMENT:

- DUT Box HP 16361A
- Test Leads HP P/N 16361-61605

Note

User built fixture/leads or DUT box can be used. If user supplied, the residual resistance must be considered.

PERFORMANCE TESTS

PROCEDURE:

1. Connect Test Leads (HP P/N 16361-61605) between 4262A UNKNOWN terminals and HP 16361A DUT Box (see Figure 4-3).

2. Set 4262A controls as follows:

DC BIAS OFF
 CIRCUIT MODE PRL
 FUNCTION R/ESR
 LCR RANGE AUTO
 TEST SIGNAL 1kHz
 TRIGGER INT

3. Check that the resistance measurement accuracies meet specifications according to table below:

DUT	1kΩ	10kΩ	100kΩ	10MΩ
Test Limits	C. V. ±5 counts	C. V. ±5 counts	C. V. ±5 counts	C. V. ±5 counts
R Readout				

C. V. = Calibrated Value of Standard Component

Note

Error caused by stability of standard component is not taken into account for test limits in table above.

Note

If this test fails, go to Section V or Section VIII for the troubleshooting.

PERFORMANCE TESTS

4-12. DISSIPATION FACTOR CONFIRMATION CHECK





DESCRIPTION:

This test verifies that a tested 4262A satisfies dissipation factor measurement accuracies. Only one Dissipation Factor ($D = 1.8$) is checked for 120Hz, 1kHz and 10kHz in this check because only one detecting phase needs to be checked. All other factors influencing D accuracy were checked in paragraph 4-10.

Note

Dissipation factor accuracy for only one D standard which has a D value of approximately 1.8 need be proved to guarantee D accuracy. This test also verifies that 4262A correctly calculates Q factor as a reciprocal number of Dissipation Factor. Only one Q factor corresponding to a D value of approximately 1.8 is checked in this test. D accuracy in measuring inductance does not need to be checked because detecting phase accuracy is equated with that for capacitance measurement.

C-D ACCURACY SPECIFICATIONS

Range	Frequency / Capacitance										
	120Hz	1000pF	10.00nF	100.0nF	1000nF	10.00μF	100.0μF	1000μF	10.00mF	1000mF	
	1kHz	100.0pF	1000pF	10.00nF	100.0nF	1000nF	10.00μF	100.0μF	1000μF	1000μF	
	10kHz	10.00pF	100.0pF	1000pF	10.00nF	100.0nF	1000nF	10.00μF	100.0μF	100.0μF	
D (1/Q) Accuracy *1		0.2% + (2 + 200/Cx) counts					At 120Hz, 1kHz				
		0.5% + (2 + 200/Cx) counts					(Test signal level: 1V) At 10kHz				
		0.3% + (2 + 1000/Cx) counts					At 120Hz, 1kHz				
		1.0% + (2 + 1000/Cx) counts					(Test signal level: 50mV) At 10kHz				
AUTO	Same as  Mode					Same as  Mode					

*1 ±(% of reading + counts). Cx is capacitance readout in counts.

Accuracy applies over temperature range of 23°C ±5°C. (At 0°C to 55°C, error doubles)
This accuracy only applies for D values to 1.999.

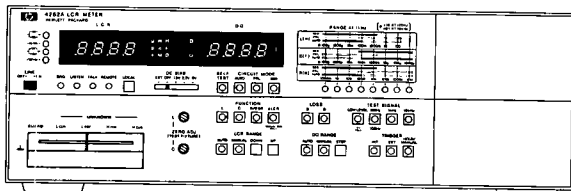

16061A

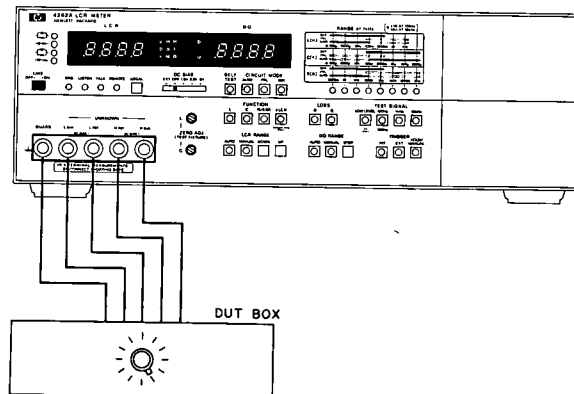

(a) (b)
Figure 4-4. Dissipation Factor Accuracy Test Setups.

PERFORMANCE TESTS

EQUIPMENT:

Test Fixture HP 16061A
 DUT HP 16361A/16362A
 Test Leads.....HP P/N 16361-61605

Note

HP 16361A and HP 16362A DUT Boxes are equipped with D standards (D = 1.8) calibrated at 1kHz and 10kHz frequencies, respectively. For the test at 120Hz frequency or if DUT box is not available, it is recommended that the following DUT's be used as D standards:

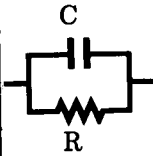
DUT	Freq.	Values of components	Calculated D	Tolerance*
	120Hz	C : 1000nF (HP P/N 0160-3645) R : 887Ω (HP P/N 0698-4464)	1.495	±0.030
	1kHz	C : 100nF (HP P/N 0160-1571) R : 887Ω (HP P/N 0698-4464)	1.794	±0.036
	10kHz	C : 10nF (HP P/N 0160-3171) R : 887Ω (HP P/N 0698-4464)	1.794	±0.036

* After calibrating capacitance C to within 0.1% and resistance R to within 0.02%, the dissipation factor tolerance is ±0.002 for each DUT.

PROCEDURE:

1. Connect DUT to 4262A.

Note





To facilitate connecting recommended DUT's, attach HP 16061A Test Fixture to 4262A UNKNOWN terminals [see Figure 4-4 (a)]. When HP 16361A/16362A DUT Box is used for this test, connect Test Leads (HP P/N 16361-61605) between 4262A UNKNOWN terminals and DUT Box as shown in Figure 4-4 (b).

2. Set 4262A controls as follows:

DC BIAS.....OFF
 CIRCUIT MODE.....PRL
 FUNCTION..... C
 LOSS..... D
 LCR RANGE AUTO
 D/Q RANGE..... AUTO
 TRIGGER..... INT

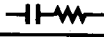

PERFORMANCE TESTS

3. Check D accuracies according to following table:

Freq	Circuit Mode	Test Level	D Test Limits	D Reading
120Hz		Low Level	Calibrated Value X ± 8 counts	
		normal	Calibrated Value X ± 6 counts	
1kHz		Low Level	Calibrated Value X ± 8 counts	
		normal	Calibrated Value X ± 6 counts	
		normal	Calibrated Value X ± 9 counts	
10kHz		Low Level	Calibrated Value X ± 21 counts	
		normal	Calibrated Value X ± 11 counts	
		normal	Calibrated Value X ± 13 counts	

Note

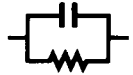
X in above table is produced by test frequency error and may be determined from the following equations:

	$x = \frac{f_n}{f_x}$
	$x = \frac{f_x}{f_n}$

... where f_n is nominal measurement frequency and f_x is measurement frequency from paragraph 4-9.

Note

Error caused by stability of standard component is not taken into account for test limits in table above.

4. Set 4262A TEST SIGNAL frequency to 1kHz and connect appropriate DUT to 4262A (Set 16361A LCR RANGE to D = 1.8). Note dissipation readout on D/Q display.
5. Push 4262A LOSS Q button.
6. Confirm that displayed Q factor is correct reciprocal number of dissipation.

Note

The 4262A rounds fractions of 5 or greater below the LSD to the next higher digit and drops any fractions of 4 or less. For example, if the actual dissipation is .0135, the display will read .014. If the actual dissipation is .0134, the display will read .013. If the test fails, refer to Section VIII Service.

PERFORMANCE TESTS

4-13. INDUCTANCE ACCURACY TEST.

DESCRIPTION:

This test verifies that inductance measurement accuracy satisfies the specifications listed below. L accuracy is proved to meet the specification when the results obtained in the accuracy checks of paragraphs 4-9 through 4-12 satisfy the specifications. This test is performed to confirm the L accuracy specification.

Note

Inductance accuracy has only to be proved for one inductor of about full scale value on any one range to verify specifications for all three test frequency (120Hz, 1kHz and 10kHz).

SPECIFICATIONS:

INDUCTANCE ACCURACY SPECIFICATIONS

Range	120Hz 1kHz 10kHz	1000μH 100.0μH 10.00μH	10.00mH 1000μH 100.0μH	100.0mH 10.00mH 1000μH	1000mH 100.0mH 10.00mH	10.00H 1000mH 100.0mH	100.0H 10.00H 1000mH	1000H 100.0H 10.00H	
L Accuracy *1		(At 120Hz, 1kHz)		0.3% + 2 counts		1% + 2 counts			
		(At 10kHz)		0.3% + 2 counts		1% + 2	5% + 2		
		0.2% + 2 counts					(At 120Hz, 1kHz)		
		0.3% + 2	0.2% + 2 counts				(At 10kHz)		
AUTO	Same as Mode				Same as Mode				

*1 ±(% of reading + counts).
Accuracy applied over temperature range of 23°C ±5°C (at 0°C to 55°C, error doubles).
This accuracy only applies for D values to 1.999.

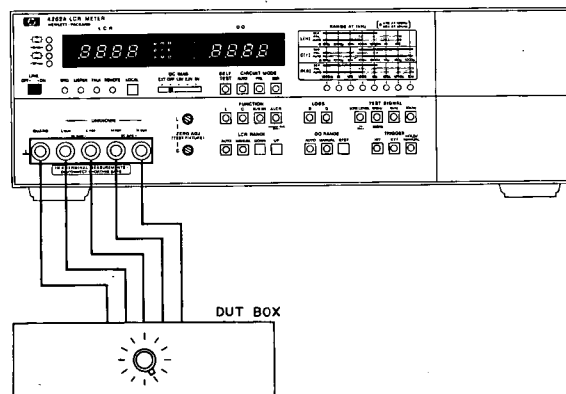

Figure 4-5 Inductance Accuracy Test Setup.

PERFORMANCE TESTS

EQUIPMENT:

DUT Box. HP 16361A/16362A
 Test Leads. HP P/N 16361-61605

Note

User built test fixture/leads or DUT box must take residual impedance into consideration.

PROCEDURE:

1. Connect Test Leads (HP P/N 16361-61605) between 4262A UNKNOWN terminals and HP 16361A DUT Box (see Figure 4-5). When TEST SIGNAL frequency is 10kHz, use HP 16362A in place of HP 16361A.
2. Set 4262A controls as follows:

DC BIAS. OFF
 FUNCTION. L
 LOSS. D
 LCR RANGE AUTO
 D/Q RANGE. AUTO
 TRIGGER. INT

3. Set HP 16361A/16362A LCR RANGE to 100mH.
4. Confirm that L accuracy is within the test limits shown in table below:

Note

Test limits below are given for 100mH inductance measurement. If another inductance value is measured, refer to SPECIFICATIONS above.

TEST SIG Freq.	CIRCUIT MODE	TEST Limits	L Readout
120Hz	PRL	Calibrated Value ± 3 counts	
	SER	Calibrated Value ± 4 counts	
1kHz	PRL	Calibrated Value ± 5 counts	
	SER	Calibrated Value ± 4 counts	
10kHz	PRL	Calibrated Value ± 5 counts	
	SER	Calibrated Value ± 4 counts	

Note

Error caused by stability of standard component is not taken into account for test limits in table above. If this test fails, refer to Section VIII, Service.

PERFORMANCE TESTS

4-14. INTERNAL DC BIAS SOURCE TEST.

DESCRIPTION:

This test verifies that the internal dc bias source will apply the specified bias values to the device under test.

SPECIFICATIONS:

DC bias, Internal Source: 1.5V ±5%, 2.2V ±5%, 6V ±5%

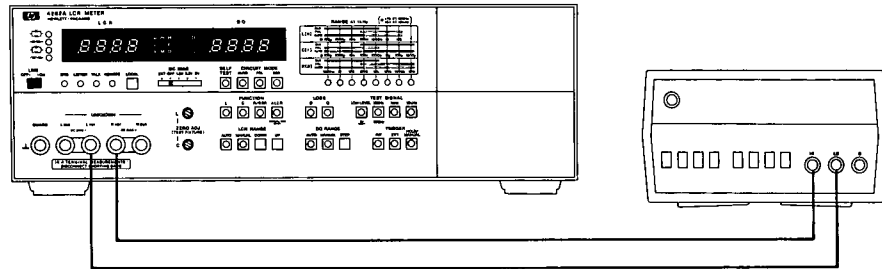

Figure 4-6. Internal DC Bias Source Test Setup.

EQUIPMENT:

DC Voltmeter HP 5300A/w5306A

PROCEDURE:

1. Connect DC Voltmeter to 4262A UNKNOWN terminals as shown in Figure 4-6.
2. Set 4262A controls as follows:

FUNCTION C
 CIRCUIT MODE PRL
 Other Controls any position

Note

Do not connect anything to UNKNOWN terminals.

3. Test limits are shown below. Read dc voltmeter output with DC BIAS switch set as follows:

DC BIAS Switch Setting	Test Limits	Voltmeter Readout
1.5V	1.425V thru 1.575V	
2.2V	2.09 V thru 2.31 V	
6 V	5.7 V thru 6.3 V	

Note

Reading error caused by measurement error of test equipment is not taken into account for test limits in table above.

4. If tests fail, proceed to Troubleshooting in Section VIII.

PERFORMANCE TESTS

3. Rotate C ZERO ADJ control fully cw.
4. Verify that capacitance readout on 4262A LCR display is within 0.00 to 0.30 counts.
5. Disconnect shorting bars from 4262A UNKNOWN terminals and connect Test Leads (HP P/N 16361-61605) between 4262A UNKNOWN terminals and 16362A DUT Box as shown in Figure 4-7.

Note

If 16362A is not available, connect an 18pF capacitor (HP P/N 0160-2263) directly to UNKNOWN terminals (without disconnecting shorting bars).

6. Set 16362A LCR RANGE to 19pF.
 7. Note capacitance readout on 4262A LCR display.
 8. Rotate C ZERO ADJ control fully ccw.
 9. Verify that capacitance readout on 4262A LCR display reduces count more than 10.30 counts as compared to count obtained in step 7.
 10. Remove Test Leads (or DUT) from UNKNOWN terminals.
- (2) L ZERO ADJ test
11. Set 4262A FUNCTION to L.
 12. Connect shorting bars on 4262A UNKNOWN terminals for doing a two terminal measurement. Connect a shorting lead to UNKNOWN terminals so that H and L terminals are short circuited.
 13. Rotate L ZERO ADJ control fully cw.
 14. Verify that inductance readout on 4262A LCR display is within 0.00 and 0.02 counts.
 15. Disconnect shorting lead from 4262A UNKNOWN terminals and connect a 5.6 μ H inductor (HP P/N 9100-1618) directly to UNKNOWN terminals as a DUT (without disconnecting shorting bars).
 16. Note inductance readout on 4262A LCR display.
 17. Rotate L ZERO ADJ control fully ccw.
 18. Verify that inductance readout on 4262A LCR display reduces count more than 1.02 counts as compared to count obtained in step 16.

PERFORMANCE TESTS

4-16. COMPARATOR TEST (OPTION 004 ONLY).

DESCRIPTION:

This test verifies that the built-in 5 digit digital comparator makes the correct comparison between the digits set into the thumbwheel switch and the displayed counts. Comparison output data at COMPARATOR OUTPUT connector (rear panel) is also checked by this test.

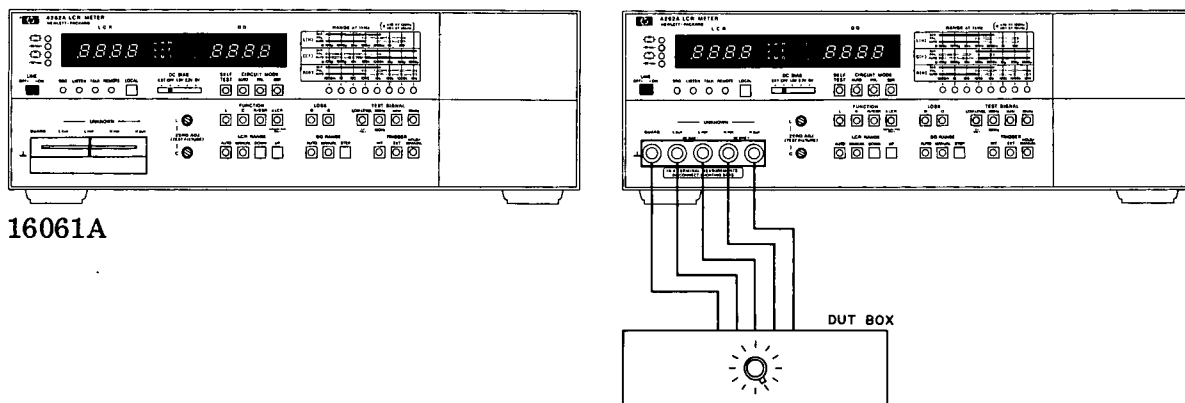

Figure 4-8. Comparator Test Setup.

EQUIPMENT:

- DUT Box. HP 16361A (100pF)
- Test Leads. HP P/N 16361-61605

PROCEDURE:

1. Connect Test Leads (HP P/N 16361-61605) between 4262A UNKNOWN terminals and 16361A DUT Box as shown in Figure 4-8. If DUT Box is not available, attach 16061A Test Fixture to 4262A UNKNOWN terminals and use a 100pF capacitor as a DUT.
2. Set 4262A controls as follows:
 - DC BIAS. OFF
 - CIRCUIT MODE. AUTO
 - FUNCTION. C
 - TEST SIGNAL 1kHz
 - LCR RANGE AUTO
 - TRIGGER. INT
3. Set 16361A LCR RANGE to 100pF.
4. Push COMPARATOR ENABLE button (simultaneously, the LCR RANGE and DQ RANGE will be automatically changed to MANUAL).
5. Set LCR HIGH LIMIT switch to "1000" and LOW LIMIT switch to "0950".
6. Verify HIGH and LOW LIMIT settings by pushing and holding upper LIMIT CHECK pushbutton.
7. Adjust ZERO ADJ C control for a display reading of "949" (or less) counts.

PERFORMANCE TESTS

8. LOW lamp should be lit. Verify circuit configuration on COMPARATOR OUTPUT connector (J6) according to Figure 4-9.
9. Adjust ZERO ADJ C control cw for a display reading of "950" (up to "999").
10. IN lamp should be lit. Verify relay contact and TTL output as in step 8.
11. ADJUST ZERO ADJ C control cw for a display reading of "1000" or more.
12. HIGH lamp should be lit. Verify relay contact and TTL output as in step 8.
13. Set 16361A LCR RANGE to D = 1.8 and 4262A LCR RANGE manually to $1\mu\text{F}$.

Note

If HP 16361A is not available, use a D factor sample as shown below.

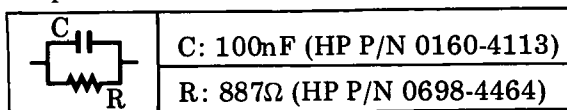

14. Push D/Q RANGE AUTO button.

Note

The 4262A D/Q RANGE is automatically set to an appropriate range and successively reset to MANUAL.

15. Set appropriate numbers into D/Q LIMIT switches. Change the set numbers and check comparison outputs with Figure 4-9.

PERFORMANCE TESTS

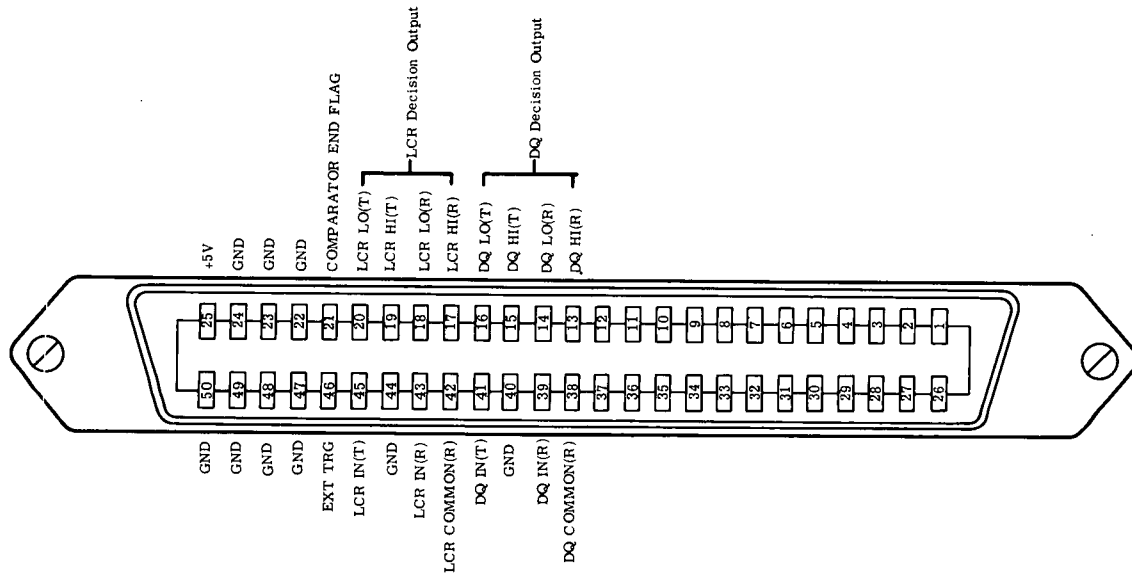

Comparison	Relay output pins			TTL output pins		
LCR	17 - 42	18 - 42	43 - 42	19 - 44	20 - 44	45 - 44
HIGH	Short	Open	Open	ON	OFF	OFF
IN	Open	Open	Short	OFF	OFF	ON
LOW	Open	Short	Open	OFF	ON	OFF
DQ	13 - 38	14 - 38	39 - 38	15 - 40	16 - 40	41 - 40
HIGH	Short	Open	Open	ON	OFF	OFF
IN	Open	Open	Short	OFF	OFF	ON
LOW	Open	Short	Open	OFF	ON	OFF

Figure 4-9. DATA OUTPUT (J6) comparator output data format.

PERFORMANCE TESTS

4-17. HP-IB INTERFACE TEST (OPTION 101 ONLY).

DESCRIPTION:

This test verifies that the HP-IB circuitry has the capability to correctly communicate between external HP-IB devices and the 4262A through the interface bus cable.

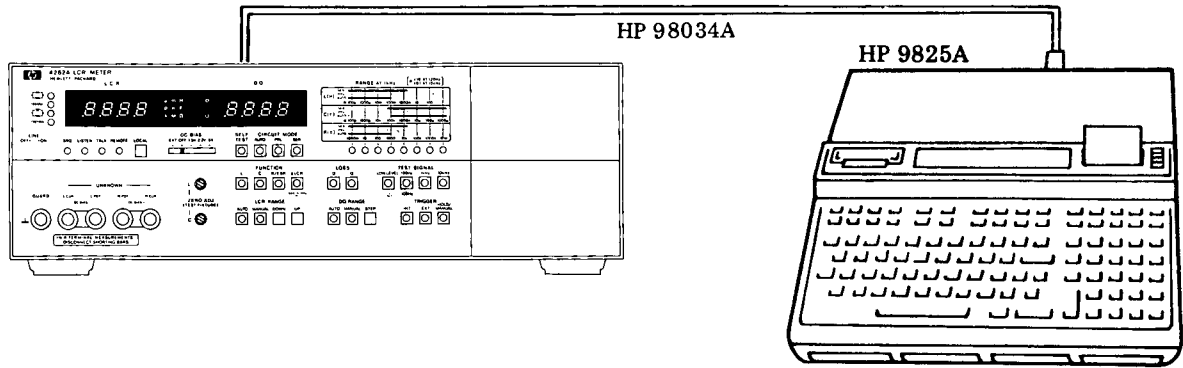

Figure 4-10. HP-IB Interface Test Setup.

EQUIPMENT:

- Calculator HP 9825A
- ROM HP 98210A,
98213A or 98214A
- Interface Card with cable HP 98034A

PROCEDURE:

1. Connect 98034A Interface Card with cable between 9825A I/O slot and 4262A rear panel HP-IB connector. Install required ROM blocks in 9825A ROM slots.
2. Set 98034A Select Code Switch dial to select code 7 (using a screwdriver).
3. Set 4262A rear panel ADDRESS switch to address number 17 in binary code (refer to Paragraph 3-68).
4. Load test program (shown on Pages 4-26 through 4-35) in calculator.
5. Execute the program. Check that 4262A display, calculator display, and printed data are consistent with the results described for each program.
6. Perform steps 4 and 5 with respect to individual test programs and verify that 4262A and calculator correctly communicate through the HP-IB interface.

Note

Connect appropriate sample(s) to 4262A UNKNOWN terminals as necessary (and observe whether printout is correct).

PERFORMANCE TESTS

TEST PROGRAM 1

[PURPOSE]

This test verifies that system controller remotely sets 4262A TEST SIGNAL and TRIGGER and successively accesses the measured data for printing.

[PROGRAMMING]

- | | |
|--|--|
| 0: prt "MEASURED DATA
RECEIVED";spc 3 | 0) Commands calculator to print MEASURED DATA RECEIVED and successively to space three lines. |
| 1: dev "4262A",717 | 1) Defines 717 (= Interface Select Code 7, address 17) as address code for 4262A in the programming. |
| 2: rem 7 | 2) Sets REN (Remote Enable) line of the Bus line to "1". Enables remote control. |
| 3: cli 7 | 3) Sets IFC (Interface Clear) line of Bus line to "1". Sets interface select code 7 to its initial conditions. |
| 4: clr "4262A" | 4) Sets 4262A to its initial conditions. (Device Clear: ref to Para 3-72). |
| 5: wrt "4262A","H3T3";wait 1000 | 5) Addresses calculator to talk and 4262A to listen. Program code string sets device: TEST SIGNAL 10kHz, and TRIGGER to HOLD/MANUAL (ref to Para 3-69). |
| 6: trg "4262A" | 6) Triggers 4262A (ref to Para 3-73). |
| 7: red "4262A",A,B | 7) Addresses calculator to listen and 4262A to talk. Takes incoming data and stores LCR measurement data in register A and DQ data in register B (ref to Para 3-67). |
| 8: flt 3 | 8) Designates printer print format and floating decimal point (3 digits below decimal point). |
| 9: prt "LCR DATA=" ,A,
"DQ DATA=" ,B | 9) Prints LCR and DQ data. |
| 10: spc 3 | 10) Commands printer to line space three vertical lines to put entire recording into proper cutting position. |
| 11: end | |
| *32657 | |

[RESULTS]

The 4262A REMOTE lamp lights. LISTEN and TALK lamps alternately light once. Calculator prints measured LCR and DQ values.

PERFORMANCE TESTS

TEST PROGRAM 2

[PURPOSE]

This test verifies that system controller sets 4262A TEST SIGNAL and TRIGGER and prints the measured data along with the 4262A functional status codes.

[PROGRAMMING]

```

0: prt " MEASURED DATA RECEIVED ";spc 3
1: rem 7
2: cli 7
3: clr 717
4: wrt 717,"H3P1T3";wait 1000
5: trg 717
6: fmt 4b,f,2b,f
7: red 717,A,B,C,D,E,F,G,H
8: fxd 0;prt "S=",A,"F=",B,
  "C=",C,"F=",D
9: flt 3;prt "N=",E
10: fxd 0;prt "S=",F,"F=",G
11: flt 3;prt "N=",H
12: spc 3
13: end
*15961

```

3) Sets device address code 717 (4262A) for initial conditions.

4) Addresses calculator to talk and device of address code 717 (4262A) to listen. Program code string sets device TEST SIGNAL to 10kHz, LOW LEVEL, and TRIGGER to HOLD/MANUAL (ref to Table 3-60).

6) Designates format for data in program step 7.

7) Addresses calculator to listen and 4262A to talk. Takes incoming data A, B, C, D, F and G in binary code and translates them into decimal code. Takes data E and H in free field format. Stores data items in the registers specified in the variable lists.

8-11) Prints data in fixed or floating decimal point format. Data items are:

A: Status,	B: Function,
C: Circuit Mode,	D: Frequency,
E: LCR Data,	F: DQ Status,
G: DQ Function,	H: DQ Data.

Refer to Paragraph 3-67 and Table 3-60.

[RESULTS]

The 4262A REMOTE lamp lights. LISTEN and TALK lamps alternately light once. Calculator prints 4262A functional codes along with the measured LCR and DQ data.

PERFORMANCE TESTS

TEST PROGRAM 3

[PURPOSE]

This test verifies that 4262A notifies system controller of the Request Status (RQS) and that demands of the Service Request (SRQ) are processed according to programmed service routing.

[PROGRAMMING]

```
0: prt "MEASURED DATA RECEIVED -DATA READY RQS MODE"; spc 3
1: oni 7, "SRQ"
2: rem 7
3: cli 7
4: clr 717
5: wrt 717, "H3D1T3"; wait 1000
6: trg 717
7: "LOOP":eir 7,128
8: if bit(0,B)=1;gto "READ"
9: gto "LOOP"
10: "SRQ":rds(717)→B
11: if bit(6,B)=1;jmp 2
12: prt "OTHER DEVICE SRQ"; spc 3
13: "IRET":eir 7,128
14: iret
15: "READ":red 717,A,B
16: flt 3;prt "LCR DATA=",A,
    "DQ DATA=",B
17: spc 3
18: end
*22913
```

1) Designates label (SRQ) for service routing to be performed when an interrupt is set by a device on select code 7 Bus Line.

5) Addresses calculator to talk and 4262A to listen. Program code string set device: TEST SIGNAL 10kHz, Data Ready RQS Mode to ON (ref to Para 3-70), and TRIGGER to HOLD/MANUAL.

7) Labels LOOP. Enables Service Request to be sent from device on select code 7 Bus Line. Checks status of SRQ line on the Bus Line.

8) If the last bit of Status Byte (corresponding to Data Ready — ref to Para 3-70) is 1, goes to program step 15 labeled READ.

Note

When status of the SRQ line becomes 1, the programming sequence phase changes from cycling through steps 7, 8, and 9 and successively goes to step 10. Steps 10 through 14 comprise the service routing to process interrupt (Service Request) phase. See Figure 4-11 for programming flow diagram.

10) Labels SRQ. Takes Status Byte responding to serial poll of calculator and stores data in register B.

11) Verifies that SRQ YES/NO line of Status Byte is actually 1 (ref to Para 3-70).

PERFORMANCE TESTS

- 13) Again enables acceptance of SRQ from device because SRQ is disabled when Status Byte signal transfer is completed (re to Para 3-70).
- 14) After service subroutine is completed, return to the step that follows step 7, 8, or 9 as appropriate to main programming sequence.

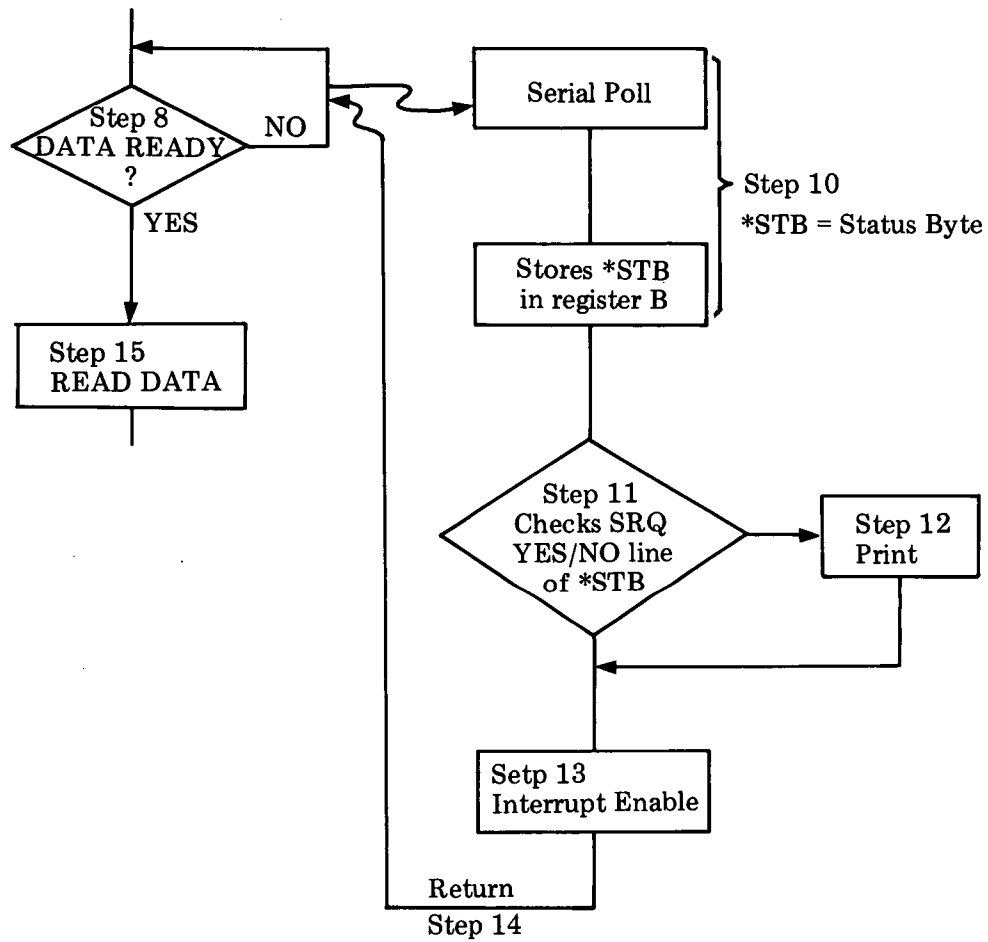

Figure 4-11 SRQ Service Routing.

[RESULTS]

Calculator prints LCR and DQ values of the sample measured by 4262A (test frequency 10kHz). Verifies that 4262A SRQ lamp lights momentarily. Press calculator RUN button again to repeat checks. If calculator prints OTHER DEVICE SRQ, interface is faulty.

PERFORMANCE TESTS

TEST PROGRAM 4

[PURPOSE]

This test confirms that 4262A FUNCTION, LOSS, and TEST SIGNAL functions are fully controlled by system controller.

[PROGRAMMING]

Annotation is omitted.

```
0: prt "ENTER REMOTE PROGRAM CODE ";spc 3
1: fmt 1,4f1.0
2: rem 7
3: cli 7
4: clr 717
5: ent "FUNCTION?(1,2,3)",A
6: ent "LOSS?(1,2)",B
7: ent "FREQUENCY?(1,2,3)",C
8: wrt 717.1,"F",A,"L",B,"H",C,"T3";wait 1000
9: trg 717
10: red 717,D,E
11: flt 3;prt "LCR DATA=",D,"DQ DATA=",E
12: spc 3
13: end
*31495
```

[RESULT]

The 4262A REMOTE lamp lights. LISTEN and TALK lamps alternately light once. Calculator prints LCR and DQ values. Confirms that 4262A functions were correctly set (check the printed data).

PERFORMANCE TESTS

TEST PROGRAM 5

[PURPOSE]

This test verifies that 4262A self test function can be remotely controlled.

[PROGRAMMING]

```

0: prt "REMOTE SELF TEST";spc 3
1: oni 7,"SRQ"
2: rem 7
3: cli 7
4: clr 717
5: wrt 717,"S1"
6: "LOOP":eir 7,128
7: if bit(2,A)=1;dsp "PASS"
8: if bit(3,A)=1;dsp "FAIL 1"
9: if bit(4,A)=1;dsp "FAIL 2"
10: if bit(5,A)=1;dsp "FAIL 3"
11: gto "LOOP"
12: "SRQ":beep;rds(717)→A
13: if bit(6,A)=1;gto "IRET"
14: prt "OTHER DEVICE
    SRQ";spc 3
15: "IRET":eir 7,128
16: iret
17: end
*14058

```

5) Addresses calculator to talk and 4262A to listen.
Sets device to SELF TEST mode.

7, 8, 9, 10)

Checks status of the third through sixth bit of Status Byte signal and displays its contents (ref to Para 3-70).

12) Labels SRQ. Takes Status Byte responding to serial poll of calculator and stores data in register A. Simultaneously beeps in announcement.

[RESULT]

The 4262A performs self test. Letters "PASS" flash on both 4262A and calculator displays.

PERFORMANCE TESTS

TEST PROGRAM 6

[PURPOSE]

This test verifies that system controller takes the incoming data in character (ASCII) code and prints the data in accord with the format shown in Paragraph 3-67.

[PROGRAMMING]

```
0: prt "RECEIVING MEASURED DATA when using STRING-ADV. ROM";spc 3
1: dim A$(25)
2: rem 7
3: cli 7
4: clr 717
5: wrt 717,"H3T3";wait 1000
6: trg 717
7: red 717,A$
8: prt A$
9: spc 3
10: end
*671
```

1) Establish dimension of 25 character memory capacity for using string variables.

7) Takes incoming data (measured data) in character (ASCII) code.

8) Prints data in character code.

[RESULT]

The measured data and 4262A functional status code are printed in accord with the format shown in Paragraph 3-67.

PERFORMANCE TESTS

TEST PROGRAM 7**[PURPOSE]**

This test verifies that 4262A FUNCTION, FREQUENCY and TRIGGER can be controlled in character (ASCII) code and that the measured data is printed in accord with the format shown in Paragraph 3-67.

[PROGRAMMING]

Annotation is omitted.

```
0: prt "ENTER REMOTE PROGRAM CODE when using STRING-ADV ROM";spc 3
1: dim A$(20),B$(25)
2: rem 7
3: cli 7
4: ent "PROGRAM CODE ? (as F2H3T3)",A$
5: wrt 717,A$;wait 1000
6: trg 717
7: red 717,B$
8: prt B$
9: spc 3
10: end
*3337
```

[RESULTS]

The 4262A REMOTE lamp lights. LISTEN and TALK lamps alternately light once. Calculator prints LCR and DQ values. Confirms that 4262A functions were correctly set (check the printed data).

PERFORMANCE TESTS

TEST PROGRAM 8

[PURPOSE]

This program checks function of 4262A ADDRESS switch (rear panel) and verifies that the address code set into the switch provides access to the 4262A by the system controller.

Note

To perform this test, set ADDRESS switch (ref to Para 3-68) according to calculator display and, after setting the switch, press calculator CONT button.

[PROGRAMMING]

Annotation is omitted.

```
0: prt "REM ADDRESS TEST";spc 3
1: dsp "Set up SW *ADDRESSABLE ";beep;stp
2: rem 7
3: cli 7;clr 7
4: dsp "Set up A5-A1=00000";beep;stp
5: 700→A;gsb "CHK"
6: dsp "Set up A5-A1=00001";beep;stp
7: 701→A;gsb "CHK"
8: dsp "Set up A5-A1=00010";beep;stp
9: 702→A;gsb "CHK"
10: dsp "Set up A5-A1=00100";beep;stp
11: 704→A;gsb "CHK"
12: dsp "Set up A5-A1=01000";beep;stp
13: 708→A;gsb "CHK"
14: dsp "Set up A5-A1=10000";beep;stp
15: 716→A;gsb "CHK"
16: dsp "Set up A5-A1=10001";beep;stp
17: 717→A;gsb "CHK"
18: prt "TEST END";spc 3
19: end
20: "CHK":dsp "Check *LISTEN=1 *REMOTE=1";beep;wrt A;wait 2000
21: dsp "Check *TALK=1 *REMOTE=1";beep;red A;wait 2000
22: cli 7
23: ret
*11359
```

[RESULT]

Both 4262A LISTEN and REMOTE lamps illuminate for two seconds. Successively, both TALK and REMOTE lamps light for two seconds. Calculator prints TEST END.

PERFORMANCE TESTS

TEST PROGRAM 9

Checks that 4262A functions change at intervals of 1 second as follows:

```

0: prt "REMOTE/LOCAL TEST";spc 3
1: cli 7
2: rem 7
3: llo 7
4: beep;clr 717;wrt 717,"F1H1"; 1)FUNCTION: L, TEST SIGNAL: 120Hz.
   wait 1000
5: beep;lcl 717;wait 1000           2)FUNCTION: C, CIRCUIT MODE: PRL, TEST
6: beep;wrt 717,"F2C2H2L2T2";     SIGNAL: 1kHz, LOSS: Q, TRIGGER: EXT.
   wait 1000                       3)FUNCTION: R/ESR, CIRCUIT MODE: SER,
7: beep;lcl 7;wait 1000           TEST SIGNAL: 10kHz, TRIGGER: HOLD/
8: rem 7                             MANUAL.
9: beep;wrt 717,"F3C3H3T3";       Calculator prints TEST END.
   wait 1000
10: clr 717
11: cli 7
12: lcl 7
13: prt "TEST END";spc 3
14: end
*15032

```

Note

llo in step 3: Local Lockout; causes 4262A
LOCAL function to be invalid.

TEST PROGRAM 10

Checks that 4262A range indicator lamps light (in turn) each for 1 second.

```

0: prt "REMOTE RANGING TEST";spc 3
1: fmt 1,fl.0
2: rem 7
3: cli 7
4: clr 717
5: l→A
6: "LOOP":wrt 717.1,"R",A
7: beep;wait 1000
8: if (A+l→A)#9;gto "LOOP"
9: clr 717
10: prt "TEST END";spc 3
11: end
*6328

```

Hewlett-Packard
 Model 4262A
 LCR METER
 Serial No. _____

Tested by _____

Data _____

Paragraph Number	Test	Results		
		Minimum	Actual	Maximum
4-9	MEASUREMENT FREQUENCY TEST			
	120Hz	116.4	_____	123.6
	1kHz	970	_____	1030
	10kHz	9700	_____	10300
4-10	CAPACITANCE ACCURACY TEST			
	120Hz PRL LOW LEVEL			
	100pF	C. V. * - 4 counts	_____	C. V. + 4 counts
	1000pF	C. V. - 8 counts	_____	C. V. + 8 counts
	10nF	C. V. - 5 counts	_____	C. V. + 5 counts
	100nF	C. V. - 5 counts	_____	C. V. + 5 counts
	1000nF	C. V. - 5 counts	_____	C. V. + 5 counts
	10μF	C. V. - 5 counts	_____	C. V. + 5 counts
	120Hz PRL 1V			
	100pF	C. V. - 2 counts	_____	C. V. + 2 counts
	1000pF	C. V. - 3 counts	_____	C. V. + 3 counts
	10nF	C. V. - 3 counts	_____	C. V. + 3 counts
	100nF	C. V. - 3 counts	_____	C. V. + 3 counts
	1000nF	C. V. - 3 counts	_____	C. V. + 3 counts
	10μF	C. V. - 3 counts	_____	C. V. + 3 counts
	120Hz SER 1V			
	100nF	C. V. - 3 counts	_____	C. V. + 3 counts
	1000nF	C. V. - 5 counts	_____	C. V. + 5 counts
	10μF	C. V. - 5 counts	_____	C. V. + 5 counts
	100μF	C. V. - 7 counts	_____	C. V. + 7 counts
	10mF	C. V. - 12 counts	_____	C. V. + 12 counts
	1kHz PRL LOW LEVEL			
	100pF	C. V. - 8 counts	_____	C. V. + 8 counts
	1000pF	C. V. - 5 counts	_____	C. V. + 5 counts
10nF	C. V. - 5 counts	_____	C. V. + 5 counts	
100nF	C. V. - 5 counts	_____	C. V. + 5 counts	
1000nF	C. V. - 5 counts	_____	C. V. + 5 counts	

*C. V. = Calibrated Value.

Paragraph Number	Test	Results			
		Minimum	Actual	Maximum	
4-10	CAPACITANCE ACCURACY TEST (Continued)				
	1kHz PRL 1V	100pF	C. V. - 3 counts	_____	C. V. + 3 counts
		1000pF	C. V. - 3 counts	_____	C. V. + 3 counts
		10nF	C. V. - 3 counts	_____	C. V. + 3 counts
		100nF	C. V. - 3 counts	_____	C. V. + 3 counts
		1000nF	C. V. - 3 counts	_____	C. V. + 3 counts
	1kHz SER 1V	10nF	C. V. - 3 counts	_____	C. V. + 3 counts
		100nF	C. V. - 5 counts	_____	C. V. + 5 counts
		1000nF	C. V. - 5 counts	_____	C. V. + 5 counts
		10 μ F	C. V. - 5 counts	_____	C. V. + 5 counts
		1000 μ F	C. V. - 52 counts	_____	C. V. + 52 counts
	10kHz PRL LOW LEVEL				
		10pF	C. V. - 8 counts	_____	C. V. + 8 counts
		100pF	C. V. - 5 counts	_____	C. V. + 5 counts
		1000pF	C. V. - 5 counts	_____	C. V. + 5 counts
		10nF	C. V. - 5 counts	_____	C. V. + 5 counts
		100nF	C. V. - 5 counts	_____	C. V. + 5 counts
	10kHz PRL 1V	10pF	C. V. - 3 counts	_____	C. V. + 3 counts
		100pF	C. V. - 3 counts	_____	C. V. + 3 counts
		1000pF	C. V. - 3 counts	_____	C. V. + 3 counts
		10nF	C. V. - 3 counts	_____	C. V. + 3 counts
		100nF	C. V. - 3 counts	_____	C. V. + 3 counts
	10kHz SER 1V	1000pF	C. V. - 3 counts	_____	C. V. + 3 counts
		10nF	C. V. - 5 counts	_____	C. V. + 5 counts
		100nF	C. V. - 5 counts	_____	C. V. + 5 counts
		1000nF	C. V. - 5 counts	_____	C. V. + 5 counts
		10 μ F	C. V. - 12 counts	_____	C. V. + 12 counts

*C. V. = Calibrated Value.

Paragraph Number	Test	Results		
		Minimum	Actual	Maximum
4-11	RESISTANCE ACCURACY TEST			
	1kΩ	C. V.* - 5 counts	_____	C. V. + 5 counts
	10kΩ	C. V. - 5 counts	_____	C. V. + 5 counts
	100kΩ	C. V. - 5 counts	_____	C. V. + 5 counts
	10MΩ	C. V. - 5 counts	_____	C. V. + 5 counts
4-13	INDUCTANCE ACCURACY TEST (100mH)			
	120Hz PRL	C. V. - 3 counts	_____	C. V. + 3 counts
	SER	C. V. - 4 counts	_____	C. V. + 4 counts
	1kHz PRL	C. V. - 5 counts	_____	C. V. + 5 counts
	SER	C. V. - 4 counts	_____	C. V. + 4 counts
	10kHz PRL	C. V. - 5 counts	_____	C. V. + 5 counts
	SER	C. V. - 4 counts	_____	C. V. + 4 counts
4-14	INTERNAL DC BIAS SOURCE TEST			
	1.5V	1.425	_____	1.575
	2.2V	2.09	_____	2.31
	6 V	5.7	_____	6.3

*C. V. = Calibrated Value.

SECTION V ADJUSTMENT

5-1. INTRODUCTION.

5-2. This section provides the information needed to adjust the 4262A to its specifications (listed in Table 1-1). Prime purpose of adjustment is to return the instrument to its peak operating capabilities after repairs have been made. The instrument should be tested and adjusted when a part or component has been replaced. Adjustments sometimes restore an instrument to its normal operating conditions without the necessity of repairs. Adjustment procedures can also be performed periodically to maintain top operating performance. Recommended adjustment schedule for the 4262A is every 12 months. All adjustable components referred to in individual tests are summarized in Table 5-1 and adjustments locations are identified pictorially on the foldout sheets in Section VIII. If proper performance cannot be achieved after adjustment procedures have been performed, refer to troubleshooting procedures beginning with paragraph 8-42.

Note

Before performing any adjustments, warm up instrument for more than 60 minutes to stabilize operating conditions.

5-3. SAFETY REQUIREMENTS.

5-4. Although the instrument has been designed in accordance with international safety standards, this manual contains information, cautions, and warnings which must be followed to ensure safe operation and to keep the instrument in safe condition (see Sections II and III). Adjustments described in this section should be performed only by qualified service personnel.

WARNING

ANY INTERRUPTION OF THE PROTECTIVE (GROUNDED) CONDUCTOR (INSIDE OR OUTSIDE THE INSTRUMENT) OR DISCONNECTION OF THE PROTECTIVE EARTH TERMINAL IS LIKELY TO MAKE THE INSTRUMENT DANGEROUS. INTENTIONAL INTERRUPTION IS PROHIBITED.

5-5. The opening of covers for removal of parts, except those to which access can be gained by hand, is likely to expose live parts. Accessible terminals may also be live.

5-6. Capacitors inside instrument may still be charged even if instrument has been disconnected from its source of supply.

WARNING

ADJUSTMENTS DESCRIBED HEREIN ARE PERFORMED WITH POWER SUPPLIED TO THE INSTRUMENT AFTER PROTECTIVE COVERS HAVE BEEN REMOVED. ENERGY EXISTING AT MANY POINTS MAY, IF CONTACTED, RESULT IN PERSONAL INJURY.

5-7. EQUIPMENT REQUIRED.

5-8. The equipment needed to adjust the Model 4262A is listed in Table 1-4 (Page 1-6). This equipment should always be calibrated to satisfy its own specifications and those of the required characteristics. If the recommended model is not available, any instrument that has specifications equal to or better than required specifications may be substituted.

5-9. FACTORY SELECTED COMPONENTS.

5-10. Factory selected components can be recognized by an asterisk near the reference designator on the schematic diagrams in Section VIII (a nominal value is shown). Section VI, Replaceable Parts, lists the part number of the nominal value component. If the nominal value of the selected component is changed, the Manual Changes supplement, supplied with this manual, will list the change to update the manual. Table 5-2 lists all factory selected components with their nominal value ranges and their influence on instrument performance.

5-11. Adjustable components, with reference designators, are listed in Table 5-1. The table gives the name of the control to be adjusted and the purpose of its adjustment.

5-12. ADJUSTMENT RELATIONSHIPS.

5-13. The adjustment procedures, beginning with paragraph 5-20, should be performed in step sequence as they are interactive. Neglecting or changing procedures may make it impossible to gain best 4262A performance. Table 5-4 shows alignment procedures required when repairing the instrument (replacement of a component or board). The adjustments in Table 5-4 assume that no other adjustments were attempted prior to board or component replacement.

5-14. ADJUSTMENT LOCATIONS.

5-15. For reference, overall adjustment location illustrations are given in Figure 8-22. The locations of individual board assemblies are denoted in board assembly component location illustrations included on each foldout service sheet.

Table 5-1. Adjustable Components.

Reference Designator	Name of Control	Purpose
A9R6 (Para. 5-20)	+12V	To set output of +12V dc power supply.
A12R1 (Para. 5-22)	_____	To eliminate any dc offset voltage in A12 Range Resistor Amplifier in order to maximize measurement accuracy on each range.
A12C3 (Para. 5-25)	_____	To eliminate measurement error due to stray capacitances on A12 board assembly. Maximizes measurement accuracies of 10kHz measurement.
A12C11 (Para. 5-26)	_____	To properly set C ZERO ADJ control range.
A13C1 (Para. 5-25)	_____	To eliminate measurement error due to phase error in A12 Range Resistor Amplifier output. Maximizes measurement accuracies of 10kHz measurement.
A13R1 (Para 5-23) A13R2 (Para. 5-23) A13R66 (Para. 5-23)	OFS-1 OFS-2 OFS-3	To eliminate any dc offset voltage in A13 Process Amplifier in order to maximize measurement accuracies on each range.
A13R67 (Para. 5-24)	OFS-4	To adjust reference phase of phase detector to minimize measurement errors.
A14R1 (Para. 5-24)	ZOF	To adjust timing of integrator output zero detection in order to accurately set full scale display count.
A14R15 (Para. 5-24)	APAO	To adjust auto phase adjustment circuit output level. Minimizes measurement errors due to phase detector error.
A23R12 (Para 5-21)	VR1	To properly set operating power voltage to nanoprocessor integrated circuit.

Table 5-2. Factory Selected Components.

Reference Designator	Nominal Value Range	Effect on Performance
A11R16	HP P/N: 0757-0440, R:FXD 7.5k Ω ▶ HP P/N: 0698-3259, R:FXD 7.87k Ω HP P/N: 0757-0441, R:FXD 8.25k Ω	Changes test signal level. If signal level is too high, use less resistance; if too low, use more resistance.
A12C1 (Para. 5-23.)	HP P/N: 0160-0159, C:FXD 6800pF ▶ HP P/N: 0160-0160, C:FXD 8200pF HP P/N: 0160-0161, C:FXD 10000pF	Minimizes dissipation measurement error on *100nF (100 μ F) and *10 μ H (10mH) ranges at 10kHz measurement. Refer to Paragraph 5-23 (2).
A12C2 (Para. 5-23)	▶ HP P/N: 0140-0190, C:FXD 39pF HP P/N: 0160-2201, C:FXD 51pF	Minimizes dissipation measurement error on 100pF (100nF) and *10mH (10H) ranges at 10kHz measurement. Refer to Paragraph 5-23 (4).
A12C3 (Para. 5-23)	▶ HP P/N: 0121-0059, C:VAR 2 - 8pF HP P/N: 0121-0036, C:VAR 5.5 - 18pF	Changes adjustment range for dissipation measurement error on *10pF (10nF) and 100mH ranges at 10kHz measurement. Refer to Paragraph 5-23 (3).
A12C14	HP P/N: 0160-2199, C:FXD 30pF ▶ HP P/N: 0160-2307, C:FXD 47pF	Rejects parasitic oscillation of A12U2 OP AMP in measuring 10m Ω resistor at 10kHz.
A13C1 (Para. 5-23)	▶ HP P/N: 0121-0059, C:VAR 2 - 8pF HP P/N: 0121-0036, C:VAR 5.5 - 18pF	Changes adjustment range for dissipation measurement error on all ranges at 10kHz measurement. Refer to paragraph 5-23 (1).
A13C5	▶ HP P/N: 0160-2251 5.6pF HP P/N: 0160-2253 6.8pF	Changes the phase delay of A13U3B OP AMP.
A13C23	▶ HP P/N: 0160-0134 220pF	Changes the feedback signal amount of A13U5B OP AMP.
A14C5	▶ HP P/N: 0160-2307, C:FXD 47pF HP P/N: 0140-0205, C:FXD 62pF HP P/N: 0160-2202, C:FXD 75pF HP P/N: 0160-2203, C:FXD 91pF	Eliminates switching transient noise from A14 phase detector output. Nominal value is usually used.







Note: Component marked (▶) in table is usually used.

* Ranges in PRL mode for capacitance and in SER mode for inductance. Values in () are ranges in SER mode for capacitance and in PRL mode for inductance.

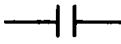
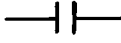
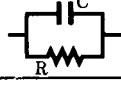
**5-16. DUT ADJUSTMENT
 RECOMMENDATIONS.**

5-17. If HP 16361A/16362A DUT Boxes or substitute devices are not available, user built DUT's with required characteristics may be used to adjust or to calibrate the 4262A. When it is desired to adjust the 4262A to perform to its specifications, the recommended DUT may be selected from Table 5-3. To establish accuracies appropriate for comparing the 4262A performance to its specifications, calibrate the DUT's to the accuracies given in the table. Refer to "CALIBRATION OF DUT's" (Page 4-4) for proper DUT calibration methods.

Table 5-3. DUT's Recommended for making Adjustments.

Paragraph	DUT	Component	HP Part Number	Calibration Accuracy	Required Characteristics
5-24		C: 10nF	0160-0408	0.1%	D < 0.001 at 1kHz
		C: 1000pF	0160-3766	0.1%	D < 0.001 at 1kHz
		C: 10nF R: 10kΩ	0160-0408 0698-6360	*D: 0.1% (at 1kHz)	
5-25		C: 100pF R: 100kΩ	0160-0336 0698-4158	*D: 0.1% (at 10kHz)	
		C: 1000pF R: 10kΩ	0160-3766 0698-6360	*D: 0.1% (at 10kHz)	
		C: 10nF R: 3kΩ	0160-0408 0698-6348	*D: 0.1% (at 10kHz)	
		C: 100nF R: 100Ω	0160-4113 0698-6323	*D: 0.1% (at 10kHz)	
		C: 100nF R: 300Ω	0160-4113 0698-6346	*D: 0.1% (at 10kHz)	
5-26		C: 18pF R: 8.66kΩ	0160-2263 0698-3498	*D: 0.1% (at 10kHz)	

* For easier calibration of dissipation to the required accuracy, use accurately calibrated resistors rather than capacitors (use a high accuracy DMM to measure resistors).

5-18. INITIAL OPERATING PROCEDURE.

5-19. Preparatory to adjusting the 4262A, do the following to locate and to gain access to the adjustment controls. This procedure facilitates a comprehensive adjustment of instrument.

[FUNDAMENTAL OPERATING CHECKS]

Confirm that instrument power line module is set for local power line voltage. Check front panel displays using "PRELIMINARY OPERATIONS" on Page 4-2. Offset control should be individually set for "zero" display for DUT Boxes or Test Fixtures as they are connected to 4262A UNKNOWN terminals. After attaching or interchanging test equipment, adjust front panel ZERO ADJ controls in accord with the procedure in "PRELIMINARY OPERATIONS".

[TOP COVER REMOVAL]

WARNING

**WHEN TOP COVER IS REMOVED
LIVE PARTS ARE EXPOSED.**

Remove top cover as follows:

- a. Loosen the retaining screw at rear of top cover until screw is free.
- b. Pull top cover towards the rear and lift off.

WARNING

**TO INSURE PERSONAL SAFETY
FROM POSSIBLE ELECTRICAL
SHOCK HAZARDS AND RE-
SULTANT INJURY, USE INSU-
LATED ADJUSTMENT TOOL.**

Table 5-4. Adjustment Requirements.

Assembly Repaired or Replaced	Required Adjustments
A1 (04262-66501) A2 (04262-66502) A3 (04262-66503) A4 (04262-66504) A5 (04262-66505)	None
A9 (04261-77009)	Para. 5-18
A11(04262-66511)	None
A12(04262-66512)	Para. 5-20 and 5-22 thru 5-24
A13(04262-66513)	Para. 5-21 thru 5-23
A14(04262-66514)	Para. 5-22 and 5-23
A21(04262-66521) A22(04262-66522)	None
A23(04262-66623)	Para. 5-19 (only if A23U1 is replaced)
A24(04262-66524) A25(04262-66525) A35(04262-66535)	None

ADJUSTMENT

5-20. DC POWER SUPPLY ADJUSTMENT.

PURPOSE:

To adjust regulated +12V DC Supply (A9).

Note

Only +12V DC supply can be adjusted.

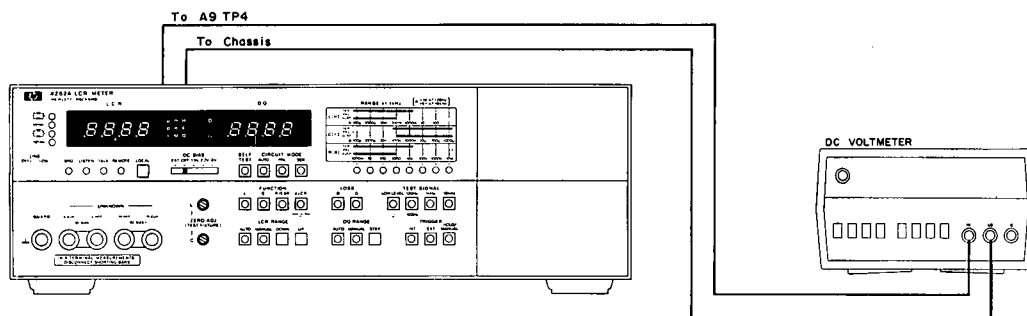

Figure 5-1. Power Supply Voltage Adjustment.

EQUIPMENT:

DC VoltmeterHP5300A/w5306A

PROCEDURE:

- a. Connect DC voltmeter plus input to test point A9TP4 (+12V) and minus input to 4262A chassis with dual banana plug to alligator clip cable. See Figure 5-1.
- b. Set DC Voltmeter range as appropriate for measuring +12 volts.
- c. Adjust “+12V” potentiometer A9R6 for +12 volts±0.05 volts (see Figure 8-22 for location).
- d. After adjustment of +12V, check dc voltages at test points listed below:

Test Point	Voltage Limits
A9TP5	-12V ±0.15V
A9TP6	+5V ±0.15V

- e. Remove cables and DC voltmeter from 4262A.

Notes

1. DC supply voltage ripple should be equal to or less than the allowable limits given below.

DC supply voltage	Ripple voltage
+12V at A9TP4	< 30mVp-p
-12V at A9TP5	< 30mVp-p
+5V at A9TP6	< 50mVp-p

ADJUSTMENT

2. This adjustment is not affected by any other adjustment. If this adjustment fails to bring any of the output voltages to their specified values, refer to Section VIII Service Sheet No. 9 for troubleshooting.

5-21. NANOPROCESSOR OPERATING POWER VOLTAGE ADJUSTMENT.

PURPOSE:

This adjustment adjusts the operating power voltage to the nanoprocessor integrated circuit on A23 Nanoprocessor and ROM Assembly to its prescribed value.

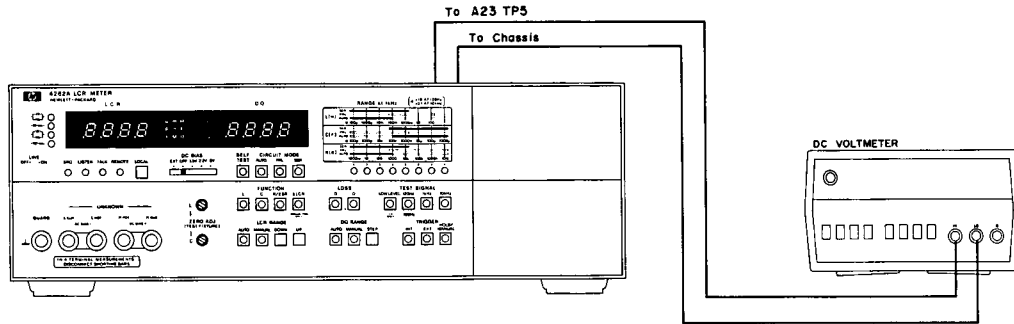

Figure 5-2. Nanoprocessor Operating Power Voltage Adjustment Location.

EQUIPMENT:

DC Voltmeter HP 5300A/w5306A

PROCEDURE:

- a. Connect DC voltmeter plus input to test point A23TP4 and minus input to 4262A chassis with dual banana plug to alligator clip cable. See Figure 5-2.

Note

The prescribed operating power voltage to the nanoprocessor IC (A23U1) is stamped on the IC ceramic case as shown in illustration at left.

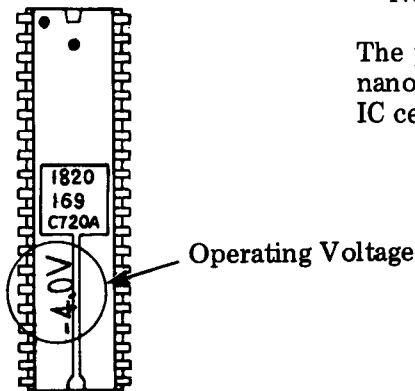

- b. Set DC Voltmeter range as appropriate for measuring the prescribed operating voltage of A23U1 nanoprocessor.
- c. Adjust VR1 potentiometer A23R14 for the prescribed voltage to within $\pm 0.1V_{dc}$.
- d. Remove cables and DC voltmeter from 4262A.

ADJUSTMENT

5-22. A12 BOARD OFFSET ADJUSTMENT.

PURPOSE:

This adjustment eliminates any residual dc offset voltage from range resistor amplifier to maximize accuracy of measurement.

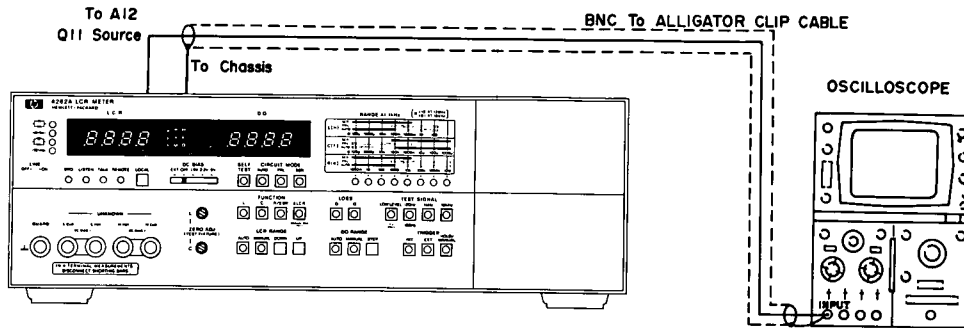

Figure 5-3. A12 Board Offset Adjustment.

EQUIPMENT:

Oscilloscope HP 180C/w1801A/w1821A
(Use 10:1 probe)

PROCEDURE:

- a. Connect BNC to dual alligator clip cable between oscilloscope and transistor A12Q11* source on the A12 Range Resistor Board Assembly (See Figure 5-3).

* (Junction of A12R36 and R41)

- b. Set 4262A controls as follows:

DC BIAS OFF
 SELF TEST OFF
 FUNCTION C
 CIRCUIT MODE PRL
 LOSS D
 TEST SIGNAL 1kHz
 LCR RANGE MANUAL
 (Set to 100pF range)
 DQ RANGE AUTO
 TRIGGER INT

- c. Connect nothing (open, $\infty \Omega$) to UNKNOWN terminals.

Note

High terminals (HPOT and H_{CUR}) and Low terminals (LCUR and LPOT), respectively, must be connected together.

- d. Set oscilloscope control as follows:

VOLTS/DIV 0.01V
 TIME/DIV 0.5msec
 TRIGGER INT
 SWEEP MODE AUTO
 Input GND

ADJUSTMENT

- e. Adjust position control of oscilloscope so that baseline is centered on the CRT.
- f. Set oscilloscope input mode to dc.
- g. Adjust potentiometer A12R1 until dc level of displayed waveform is 0mV \pm 10mV. Refer to Figure 5-4 which shows well-adjusted waveform.

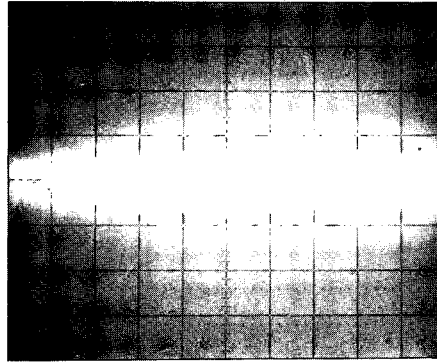

Figure 5-4. Waveform at A12Q11 Source.

Note

If adjustment is not successful, see Section VIII service sheet for troubleshooting.

5-23. A13 BOARD OFFSET ADJUSTMENT.

PURPOSE:

This adjustment eliminates any residual dc offset voltage from the A13 Process Amplifier Board Assembly.

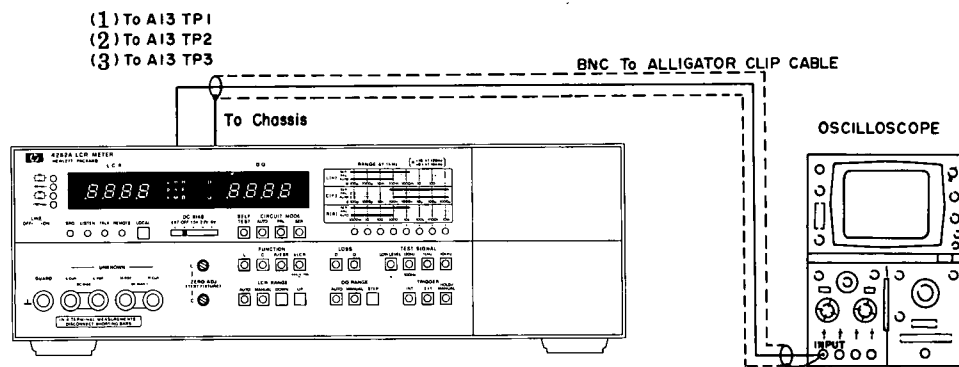

Figure 5-5. A13 Board Offset Adjustment.

EQUIPMENT:

Oscilloscope HP 180C/w1801A/w1821A

ADJUSTMENT

PROCEDURE:

Note

The A12 board offset adjustment (paragraph 5-22) must precede these adjustments. The adjustments in these steps can be performed separately, but steps (1) and (2) must be performed prior to step (3).

(1) OFS - 1 ADJUSTMENT.

a. Connect BNC to dual alligator clip cable between oscilloscope and 4262A test point A13TP1 and 4262A chassis (see Figure 5-5).

b. Set 4262A controls as follows:

DC BIAS	OFF
SELF TEST	OFF
FUNCTION	L
CIRCUIT MODE	SER
LOSS	D
TEST SIGNAL	1kHz
LCR RANGE	MANUAL
	(Set to 100mH range)
DQ RANGE	AUTO
TRIGGER	INT

c. Short-circuit the four UNKNOWN terminals together.

d. Set oscilloscope controls as follows:

VOLTS/DIV	0.005V
TIME/DIV	0.5msec
TRIGGER	INT
SWEEP MODE	AUTO
InputGND

e. Adjust position control of oscilloscope so that baseline is centered on the CRT.

f. Set oscilloscope INPUT to DC.

g. Adjust "OFS-1" potentiometer A13R1 until dc level of displayed waveform is 0mV \pm 1mV. Refer to Figure 5-6 which shows well adjusted waveform.

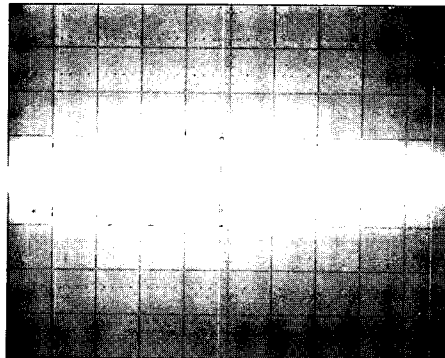

Figure 5-6. Waveform at A13TP1.

ADJUSTMENT

(2) OFS - 2 ADJUSTMENT.

- a. Connect BNC to dual alligator clip cable (or 1:1 oscilloscope probe) between oscilloscope and 4262A test point A13TP2 and 4262A chassis (see Figure 5-5).
- b. Change 4262A controls as follows:

FUNCTION..... C
 CIRCUIT MODE..... PRL
 LCR RANGEMANUAL
 (Set to 100pF range)

- c. Connect nothing (open, $\infty \Omega$) to UNKNOWN terminals.

Note

High terminals (HPOT and HCUR) and Low terminals (LCUR and LPOT), respectively, must be connected together.

- d. Adjust "OFS-2" potentiometer A13R2 until dc level of displayed waveform is within 0mV \pm 1mV. Refer to Figure 5-7 which shows well adjusted waveform.

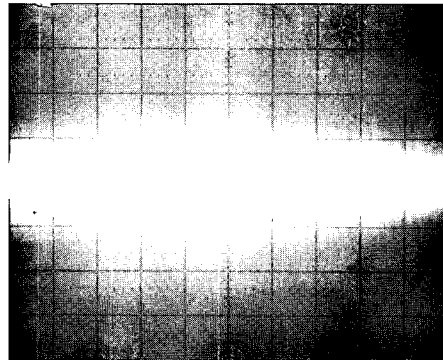

Figure 5-7. Waveform at A13TP2.

(3) OFS - 3 ADJUSTMENT.

- a. Use 10:1 oscilloscope probe for this adjustment. Connect oscilloscope probe to 4262A test point A13TP3 and ground clip lead of probe to 4262A chassis.
- b. Change 4262A controls as follows:

TEST SIGNAL 1kHz, LOW LEVEL
 LCR RANGEMANUAL
 (set to 1000pF range)

ADJUSTMENT

- c. Adjust "OFS-3" potentiometer A13R66 until dc level of displayed waveform is $0\text{mV} \pm 10\text{mV}$. Refer to Figure 5-8 which shows well adjusted waveform.

Note

Signal observed may be somewhat noisy.
Adjust offset control so that signal is equally
balanced around 0 volts dc.

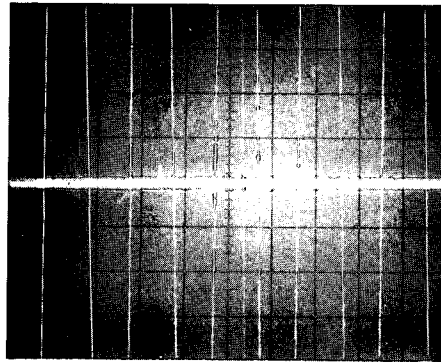

Figure 5-8. Waveform at A13TP3.

ADJUSTMENT

5-24. A14 PHASE DETECTOR & INTEGRATOR ADJUSTMENT.

PURPOSE:

These adjustments eliminate phase error in the phase detector and properly set timing of zero detector to minimize measurement error.

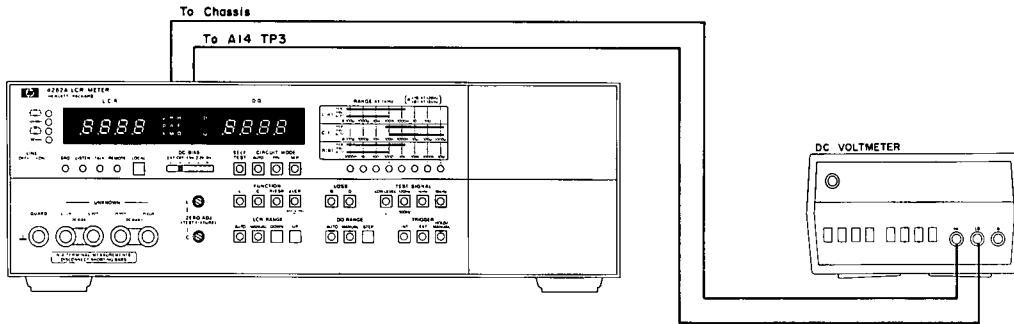

Figure 5-9. A14 Phase Detector & Integrator Adjustment.

EQUIPMENT:

- DC Voltmeter HP 5300A/w 5306A
- DUT Box..... HP 16361A
- Test Leads.....HP P/N 16361-61605

Note

If DUT box is not available, it is recommended that the following DUT's be used as standards:

DUT	Values of components	Calculated D (1kHz)	Required Calibration Accuracy
	C: 10nF (HP P/N: 0160-0408)	$D < 0.001$	0.1%
	C: 1000pF (HP P/N: 0160-3766)	$D < 0.001$	0.1%
	C: 10nF (HP P/N: 0160-0408) R: 10kΩ (HP P/N: 0698-6360)	1.592	D: 0.1%

The components listed above should be calibrated before use. Refer to "Calibration of DUT's" on page 4-4 for proper DUT calibration method.

ADJUSTMENT

PROCEDURE:

(1) OFS - 4 ADJUSTMENT.

- a. Connect DC voltmeter minus input to test point A14TP3 and plus input to 4262A chassis with dual banana plug to alligator clip cable. See Figure 5-9.
- b. Set DC voltmeter range as appropriate for measuring +3 volts.
- c. Set integrator test switch A22S1 (located at upper right on A22 Display Control and RAM Board Assembly) to TEST 1 position. See Figure 5-10 which shows location of switch S1.

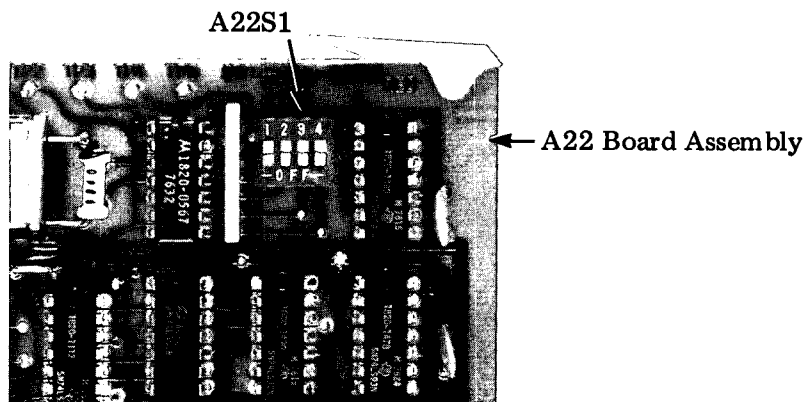

Figure 5-10. A22S1 Switch Setting.

- d. Set 4262A controls as follows:

DC BIAS	OFF
SELF TEST	OFF
FUNCTION	C
CIRCUIT MODE	PRL
LOSS	D
TEST SIGNAL	1kHz
LCR RANGE	AUTO
DQ RANGE	AUTO
TRIGGER	INT

- e. Connect nothing (open, $\infty \Omega$) to UNKNOWN terminals.

Note

High terminals (HPOT and HCUR) and Low terminals (LCUR and LPOT), respectively, must be connected together.

- f. Adjust "OFS-4" potentiometer A13R67 for +2 volts ± 0.5 volts (the voltage is actually negative).

ADJUSTMENT

(2) ZERO DETECTOR & APAO ADJUSTMENT.

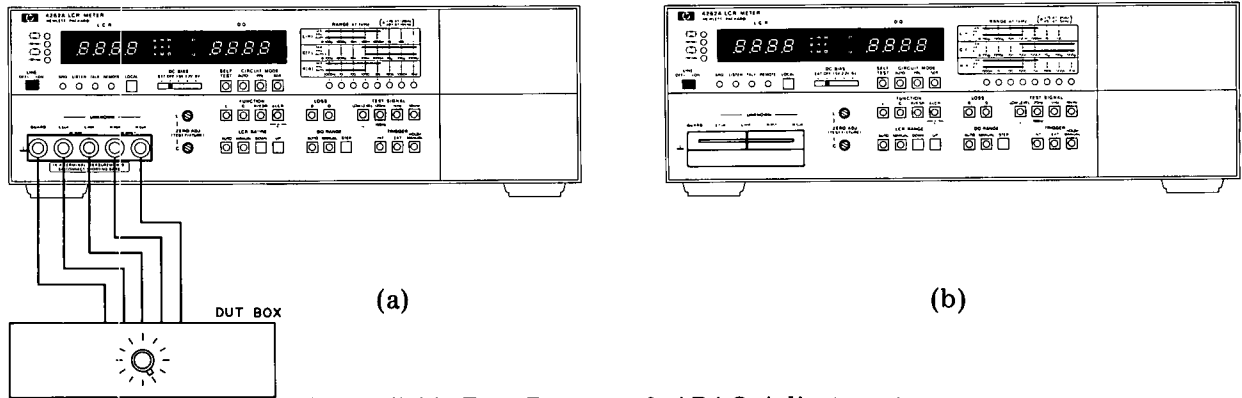

Figure 5-11. Zero Detector & APAO Adjustments.

Note

If DUT Box is available, use procedure A. If not, use procedure B.

PROCEDURE A.

- a. Adjust "ZOF" potentiometer A14R1 for 1000 counts ± 1 count on 4262A LCR display.
- b. Adjust "APAO" potentiometer A14R15 for .000 to .001 count on 4262A DQ display.
- c. Set 4262A TEST SIGNAL control successively to each test frequency and test signal level shown in Table 5-5 and confirm that DC voltmeter readings are within 0 to +4 volts at each control setting. Also confirm that 4262A LCR display and DQ display are within the tolerances described in steps a and b.

Table 5-5. TEST SIGNAL Settings.

Frequency	Low Level
120Hz	off
1kHz	off
10kHz	off
120Hz	on
1kHz	on
10kHz	on

Note

If result of confirmation check is not satisfactory, readjust "OFS-4" potentiometer A13R67 for any voltage between +1 volt and +3 volts to satisfy the requirements of step c. If this adjustment fails to bring the voltage at A14TP3 to within its tolerance or to satisfy the confirmation check, refer to Section VIII for troubleshooting.

ADJUSTMENT

- d. Reset integrator test switch A22S1 to off.
- e. Connect Test Leads (HP P/N: 16361-61605) between 4262A UNKNOWN terminals and 16361A DUT Box as shown in Figure 5-11 (a).
- f. Set 16361A LCR RANGE to 1000pF.
- g. Note dissipation factor readout on DQ display.
- h. Manually change 4262A LCR RANGE to 10nF.
- i. The change in dissipation factor readout between that obtained in step g and that in step h should be less than ± 1 count. If not satisfactory, readjust "ZOF" potentiometer A14R1 (step a).
- j. Set 4262A LCR RANGE to AUTO.
- k. Set 16361A LCR RANGE to $D = 1.8$.
- l. Verify that DQ display count is the calibrated value of 16361A within ± 3 counts. If this test fails, readjust "APAO" potentiometer A14R15 (step b).

PROCEDURE B.

- a. Set integrator test switch A22S1 to off.
- b. Attach HP 16061A Test Fixture to 4262A UNKNOWN terminals as shown in Figure 5-11 (b).
- c. Connect 10nF capacitor to the 16061A as DUT.
- d. Manually set 4262A LCR RANGE to 10nF.
- e. Adjust "ZOF" potentiometer A14R1 for the calibrated value of DUT ± 1 count on 4262A LCR display.
- f. Adjust "APAO" potentiometer A14R15 for .000 count on 4262A DQ display.
- g. Connect a 1000pF capacitor in place of the 10nF capacitor as DUT.
- h. Adjust "ZOF" potentiometer A14R1 for .000 count on 4262A DQ display.
- i. Connect a 10nF capacitor with 10k Ω parallel resistance ($D \approx 1.59$) in place of the 1000pF capacitor.
- j. Adjust "APAO" potentiometer A14R15 for the calibrated D value of DUT ± 2 counts on 4262A DQ display.

ADJUSTMENT

5-25. 10kHz MEASUREMENT ACCURACY ADJUSTMENT.

PURPOSE:

This adjustment eliminates measurement error due to stray capacitances on A12 and A13 board assemblies and maximizes measurement accuracies at 10kHz measurement.

Note

Each of the following adjustments are inter-related. To achieve correct adjustments, do not change adjustment procedure or sequence.

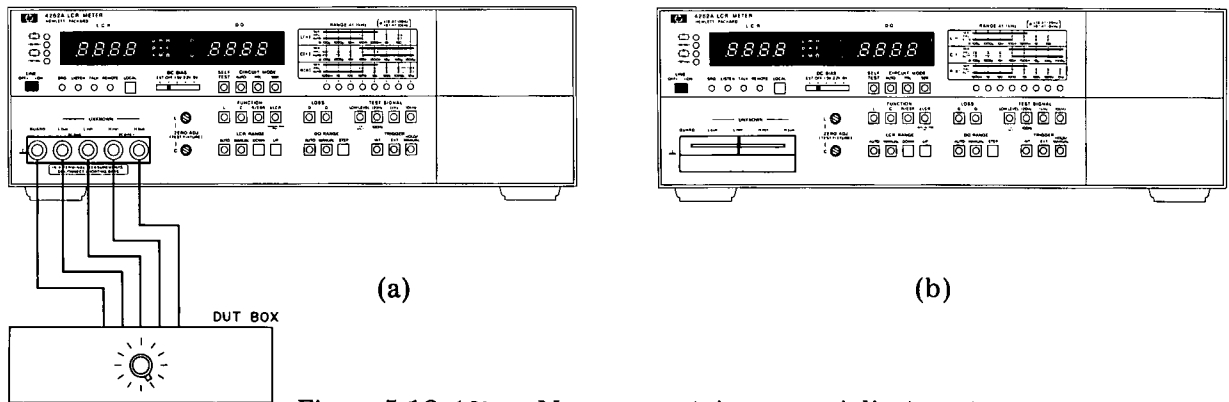

Figure 5-12. 10kHz Measurement Accuracy Adjustment.

EQUIPMENT:

- DUT Box..... HP 16362A
- Test Leads..... HP P/N: 16361-61605
- DUT's..... See Note below.

Note

It is recommended that the following DUT's be used as dissipation factor standards. DUT's marked with a dot (•) in the table are included in the 16362A DUT Box.

DUT	Values of components	Calculated D (at 10kHz)	Required Calibration Accuracy
	•C1: 100pF (HP P/N: 0160-0336) R1: 100kΩ (HP P/N: 0698-4158)	1.592	D... 0.1% [C... 0.1%]* [R... 0.02%]
	•C2: 1000pF (HP P/N: 0160-3766) R2: 10kΩ (HP P/N: 0698-6360)	1.592	
	C3: 10nF (HP P/N: 0160-0408) R3: 3kΩ (HP P/N: 0698-6348)	1.885	
	•C4: 100nF (HP P/N: 0160-4113) R4: 100Ω (HP P/N: 0698-6323)	1.592	
	C5: 100nF (HP P/N: 0160-4113) R5: 300Ω (HP P/N: 0698-6346)	1.885	

*After calibrating capacitances to within 0.1% and resistances to within 0.02%, the dissipation factor tolerance is ±0.002 for each DUT. Refer to "Calibration of DUT's" on page 4-2 for the proper DUT calibration method.

ADJUSTMENT

PROCEDURE:

(1) A13C1 Adjustment.

a. Connect Test Leads (HP P/N 16361-61605) between 4262A UNKNOWN terminals and 16362A DUT Box as shown in Figure 5-12 (a). If DUT Box is not available, attach 16061A Test Fixture to 4262A UNKNOWN terminals [see Figure 5-12 (b)].

b. Set 4262A controls as follows:

```

DC BIAS.....OFF
SELF TEST.....OFF
FUNCTION..... C
CIRCUIT MODE..... PRL
LOSS..... D
TEST SIGNAL ..... 10kHz
LCR RANGE ..... AUTO
DQ RANGE ..... AUTO
TRIGGER..... INT
    
```

c. Rotate both C and L ZERO ADJ controls fully cw.

d. Set 16362A LCR RANGE to 1000pF D = 1.8 or connect the following sample, as an alternate DUT, to 16061A:

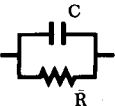
DUT	Values of components
	C: 1000pF (HP P/N: 0160-3766)
	R: 10kΩ (HP P/N: 0698-6360)

e. Adjust capacitor A13C1 for the calibrated value of the 16362A (or DUT) ±3 counts on 4262A DQ display.

Note

If this adjustment fails to bring dissipation factor readout to within the tolerance, change A13C1 to 5.5/18pF capacitor (HP P/N: 0121-0036) and try adjustment again.





(Confirmation Check)

Note

If 16362A is available, perform the following check. If not, proceed to A12C1 adjustment which follows.

ADJUSTMENT

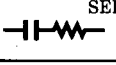
- f. Verify that the table below is satisfied when the tests are made by changing DUT and CIRCUIT MODE (as given in table):

16362A LCR RANGE	4262A CIRCUIT MODE	Capacitance Readout	Dissipation Factor Readout
1000pF D=0.01		*C. V. ± 2 counts	*C. V. ± 2 counts
1000pF D=1.8		Approx. 1100 counts	*C. V. ± 3 counts
100nF D=1.8		Approx. 500 counts	*C. V. ± 5 counts
1μF D=0.01		*C. V. ± 2 counts	*C. V. ± 2 counts

■ *C. V. = Calibrated Value of DUT.

- g. If table test fails, repeat step e.

(2) A12C1 Adjustment.

Note

The following A12C1 Adjustment needs to be performed only when A12R4 is replaced.

- a. Set 16362A LCR RANGE to 100nF D = 1.8 or connect the following sample, as an alternate DUT, to 16061A.

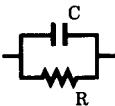
	C: 100nF (HP P/N: 0160-4113)
	R: 100Ω (HP P/N: 0698-6323)

- b. Verify that the dissipation factor readout on 4262A DQ display is the calibrated value of the DUT within a tolerance of ± 3 counts. If not within tolerance, change A12C1 to an appropriate value selected from the adjustment range below:

6800pF	HP P/N: 0160-0159
8200pF	HP P/N: 0160-0160
10000pF	HP P/N: 0160-0161

Note

Nominal value is 6800pF. Increasing A12C1 by 1000pF increases display 2 counts.

(3) A12C3 Adjustment.

- a. Remove Test Leads and attach 16061A Test Fixture to 4262A UNKNOWN terminals.
 b. Connect the following DUT to 16061A.

	C: 10nF (HP P/N: 0160-0408)
	R: 3kΩ (HP P/N: 0698-6348)

ADJUSTMENT

- c. Note dissipation factor readout on 4262A DQ display.
- d. Change 4262A CIRCUIT MODE to SER.
- e. Adjust A12C3 so that capacitance readout on 4262A CRL display is the calibrated value of DUT ± 2 counts and the difference in dissipation factor readout between steps c and d is less than ± 5 counts.

Note

If adjustment is not successful, change A12C3 to 5.5/18pF capacitor (HP P/N: 0121-0036) and try adjustment again.

(4) A12C2 Adjustment.

- a. Connect the following DUT to 16061A.

	C: 100nF (HP P/N: 0160-4113)
	R: 300Ω (HP P/N: 0698-6346)

- b. Set 4262A CIRCUIT MODE to PRL.
- c. Note dissipation factor readout on 4262A DQ display.
- d. Change 4262A CIRCUIT MODE to SER.
- e. Verify that 4262A displays the following:
 - 1) Capacitance readout of CRL display should be the calibrated value of DUT ± 2 counts.
 - 2) The difference in dissipation factor readout between steps c and d should be less than ± 5 counts.
- f. If either 1) or 2) are not satisfied, change A12C2 to an appropriate value selected from the adjustment range below:

30pF	HP P/N: 0160-2139
39pF	HP P/N: 0140-0190
51pF	HP P/N: 0160-2201
62pF	HP P/N: 0140-0205

Note

Nominal value is 39pF. Increasing A12C2 by 10pF decreases capacitance and dissipation factor readouts 2 and 3 counts respectively.

ADJUSTMENT

(Confirmation check)

Note

If 16362A DUT Box is available, use procedure A. If not, use procedure B.

PROCEDURE A.

- g. Remove 16061A from 4262A UNKNOWN terminals and connect Test Leads (HP P/N: 16361-61605) between 4262A UNKNOWN terminals and 16362A DUT Box as shown in Figure 5-12 (a).
- h. Set 16362A LCR RANGE to 1pF position.
- i. Set 4262A CIRCUIT MODE to PRL.
- j. Adjust C ZERO ADJ potentiometer for calibrated value of 16362A on 4262A LCR display.
- k. Set 16362A LCR RANGE to 100pF D = 1.8.
- l. Verify that dissipation factor readout on 4262A DQ display is the calibrated value of 16362A ± 5 counts.

Note

If this confirmation check fails, repeat A12C2 adjustment.

PROCEDURE B.

- g. Set 4262A CIRCUIT MODE to PRL.
- h. Connect nothing to 16061A Test Fixture.
- i. Adjust C ZERO ADJ potentiometer for 0.00 counts (10pF range) on 4262A LCR display.
- j. Connect the following DUT to 16061A.

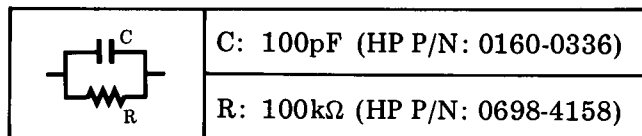

- k. Verify that dissipation factor readout on 4262A DQ display is the calibrated value of DUT ± 5 counts.

Note

If this confirmation check fails, repeat A12C2 adjustment.

ADJUSTMENT

5-26. C ZERO ADJ CIRCUIT ADJUSTMENT (A12).

PURPOSE:

To adjust C ZERO ADJ control range.

Note

No adjustment is required for L ZERO ADJ control.

EQUIPMENT:

DUT Box. 16362A
Test Leads. HP P/N: 16361-61605

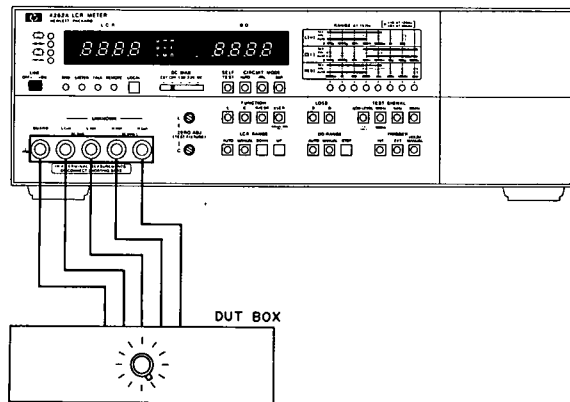

Figure 5-13. Offset Adjustment Setup.

PROCEDURE:

1. Connect Test Leads (HP P/N: 16361-61605) between 4262A UNKNOWN terminals and 16362A DUT Box as shown in Figure 5-13. If 16362A is not available, attach 16061A Test Fixture to UNKNOWN terminals.

2. Set 4262A controls as follows:

DC BIAS OFF
 SELF TEST OFF
 FUNCTION C
 CIRCUIT MODE PRL
 LOSS D
 TEST SIGNAL 10kHz
 LCR RANGE AUTO
 DQ RANGE AUTO
 TRIGGER INT

3. Set 16362A LCR RANGE to 19pF or connect the following DUT to 16061A:

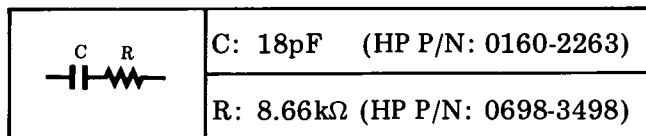

ADJUSTMENT

4. Note capacitance and dissipation factor readout on 4262A display.
5. Rotate 4262A C ZERO ADJ control ccw until capacitance readout on LCR display is half that obtained in step 4 within a tolerance of ± 3 counts.
6. Adjust A12C11 until dissipation factor readout becomes double that obtained in step 4 within a tolerance of ± 2 counts.

Note

Because A12C11 and C ZERO ADJ controls interact with each other, maintain capacitance readout obtained in step 5 by controlling C ZERO ADJ until A12C11 is properly adjusted.

SECTION VI REPLACEABLE PARTS

6-1. INTRODUCTION.

6-2. This section contains information for ordering parts. Table 6-1 lists abbreviations used in the parts list and throughout the manual. Table 6-3 lists all replaceable parts in reference designator order. Table 6-2 contains the names and addresses that correspond to the manufacturer's code numbers.

6-3. ABBREVIATIONS.

6-4. Table 6-1 lists abbreviations used in parts list, schematics and throughout the manual. In some cases, two forms of abbreviations are used, one in all capital letters, and one in partial capitals or no capitals. This occurs because the abbreviations in parts list are always all capitals. However, in the schematics and in other parts of the manual, other abbreviation forms with both lower case and upper case letters are used.

6-5. REPLACEABLE PARTS LIST.

6-6. Table 6-3 is a list of replaceable parts and is organized as follows:

- a. Electrical assemblies and their components in alphanumeric order by reference designation.
- b. Chassis-mounted parts in alphanumeric order by reference designation.
- c. Miscellaneous parts.
- d. Illustrated parts breakdowns, if appropriate.

The information for each part includes:

- a. The Hewlett-Packard part number.
- b. The total quantity (Qty) in the instrument.

Table 6-1. List of Reference Designators and Abbreviations

REFERENCE DESIGNATORS			
A = assembly B = motor BT = battery C = capacitor CP = coupler CR = diode DL = delay line DS = device signaling (lamp)	E = misc electronic part F = fuse FL = filter J = jack K = relay L = inductor M = meter MP = mechanical part	P = plug Q = transistor R = resistor RT = thermistor S = switch T = transformer TB = terminal board TP = test point	U = integrated circuit V = vacuum, tube, neon bulb, photocell, etc. VR = voltage regulator W = cable X = socket Y = crystal
ABBREVIATIONS			
A = amperes A. F. C. = automatic frequency control AMPL = amplifier B. F. O. = beat frequency oscillator BE CU = beryllium copper BH = binder head BP = bandpass BRS = brass BWO = backward wave oscillator CCW = counter-clockwise CER = ceramic CMO = cabinet mount only COEF = coefficient COM = common COMP = composition COMPL = complete CONN = connector CP = cadmium plate CRT = cathode-ray tube CW = clockwise DEPC = deposited carbon DR = drive ELECT = electrolytic ENCAP = encapsulated EXT = external F = farads f = femto = 10 ⁻¹⁵ FH = flat head FIL H = fillister head FXD = fixed G = giga = 10 ⁹ GE = germanium GL = glass GRD = ground(ed)	H = henries HEX = hexagonal HG = mercury HR = hour(s) Hz = hertz IF = intermediate freq. IMPG = impregnated INCD = incandescent INCL = include(s) INS = insulation(ed) INT = internal k = kilo = 1000 LH = left hand LIN = linear taper LK WASH = lock washer LOG = logarithmic taper LPF = low pass filter m = milli = 10 ⁻³ M = meg = 10 ⁶ MET FLM = metal film MET OX = metallic oxide MFR = manufacturer MINAT = miniature MOM = momentary MTG = mounting MY = "mylar" n = nano = 10 ⁻⁹ N/C = normally closed NE = neon NI PL = nickel plate N/O = normally open NPO = negative positive zero (zero temperature coefficient)	NPN = negative-positive-negative NRFR = not recommended for field replacement NSR = not separately replaceable OBD = order by description OH = oval head OX = oxide P = peak PC = printed circuit p = pico = 10 ⁻¹² PH BRZ = phosphor bronze PHL = Phillips PIV = peak inverse voltage PNP = positive-negative-positive P/O = part of POLY = polystyrene PORC = porcelain POS = position(s) POT = potentiometer PP = peak-to-peak PT = point PWV = peak working voltage RECT = rectifier RF = radio frequency RH = round head or right hand RMO = rack mount only RMS = root-mean square	RWV = reverse working voltage S-B = slow-blow SCR = screw SE = selenium SECT = section(s) SEMICON = semiconductor SI = silicon SIL = silver SL = slide SPG = spring SPL = special SST = stainless steel SR = split ring STL = steel TA = tantalum TD = time delay TGL = toggle THD = thread TI = titanium TOL = tolerance TRIM = trimmer TWT = traveling wave tube μ = micro = 10 ⁻⁶ VAR = variable VDCW = dc working volts W/ = with W = watts WIV = working inverse voltage WW = wirewound W/O = without

0001-9700

- c. A description of the part.
- d. A typical manufacturer of the part in a five-digit code.
- e. The manufacturer's number for the part.

The total quantity for each part is given only once - at the first appearance of the part number in the list.

6-7. ORDERING INFORMATION.

6-8. To order a part listed in the replaceable parts table, give the Hewlett-Packard part number, indicate the quantity required, and address the order to the nearest Hewlett-Packard office.

6-9. To order a part that is not listed in the replaceable parts table, state the full instrument model and serial number, the description and function of the part, and the number of parts required. Address your order to the nearest Hewlett-Packard office.

6-12. DIRECT MAIL ORDER SYSTEM.

6-13. Within the USA, Hewlett-Packard can supply parts through a direct mail order system. Advantages of using the system are:

- a. Direct ordering and shipment from the HP Parts Center in Mountain View, California.
- b. No maximum or minimum on any mail order (there is a minimum order amount for parts ordered through a local HP Office when the orders require billing and invoicing).
- c. Prepaid transportation (there is a small handling charge for each order).
- d. No invoices - to provide these advantages, a check or money order must accompany each order.

6-14. Mail order forms and specific ordering information is available through your local HP Office. Addresses and phone numbers are located at the back of this manual.

Table 6-2. Manufacturers Code List.

MFR NO.	MANUFACTURER NAME	ADDRESS	ZIP CODE
0024E	JERMYN INDUSTRIES		
0138J	AMP INC	HARRISBURG PA	
0160G	ALLEN-BRADLEY CO	MILWAUKEE WI	
0169H	TEXAS INSTR INC SEMICOND COMPNY DIV	DALLAS TX	
03888	KDI PYROFILM CORP	WHIPPANY NJ	07981
0203G	MOTOROLA SEMICONDUCTOR PRODUCTS	PHOENIX AZ	
0217B	AIRCO SPEER ELEK DIV AIR RDCN CO	NOGALES AZ	
0223G	FAIRCHILD SEMICONDUCTOR DIV	MOUNTAIN VIEW CA	
07933	RAYTHEON CO SEMICONDUCTOR DIV HQ	MOUNTAIN VIEW C	94040
0248C	CTS OF BERNE INC	BERNE IN	
0248D	CTS KEENE INC	PASO ROBLES CA	
0291J	SIGNETICS CORP	SUNNYVALE CA	
0299E	MEPCO/ELECTRA CORP	MINERAL WELLS TX	
0325I	STANFORD APPLIED ENGINEERING INC	SANTA CLARA CA	
0329B	CORNING GLASS WORKS (BRADFORD)	BRADFORD PA	
0340F	NATIONAL SEMICONDUCTOR CORP	SANTA CLARA CA	
0341B	CORNING GLASS WORKS (WILMINGTON)	WILMINGTON NC	
28480	HP DIV 00 CORPORATE	PALO ALTO CA	
0365A	MEPCO/ELECTRA CORP	SAN DIEGO CA	
0374D	BOURNS INC TRIMPOT PROD DIV	RIVERSIDE CA	
0379D	ADVANCED MICRO DEVICES INC	SUNNYVALE CA	
0379I	HARRIS SEMICON DIV HARRIS-INTERTYPE	MELBOURNE FL	
0420J	SPRAGUE ELECTRIC CO	NORTH ADAMS MA	
0450G	TRW ELEK COMPONENTS CINCH DIV	ELK GROVE VLGE IL	
72136	ELECTRO MOTIVE CORP SUB IEC	WILLIMANTIC CT	06226
73138	BECKMAN INSTRUMENTS INC HELIPOT DIV	FULLERTON CA	92634
73899	J F D ELECTRONICS CORP	BROOKLYN NY	11219
04678	TRW INC PHILADELPHIA DIV	PHILADELPHIA PA	
76381	3M COMPANY	ST PAUL MN	55101
0552D	DALE ELECTRONICS INC	COLUMBUS NE	
28480	NO M/F DESCRIPTION FOR THIS MFG NUMBER		

Table 6-3. Replaceable Parts.

Reference Designation	HP Part Number	Qty	Description	Mfr Code	Mfr Part Number	
A1	04262-66501	1	MOTHER BOARD ASSEMBLY	28480	04262-66501	
	04262-26501	1	PC BOARD, BLANK	28480	04262-26501	
A1J1	1251-3004	1	CONNECTOR 40-PIN M RECTANGULAR	76381	3432-2002	
A1XA9R	1251-1886		CONNECTOR-PC EDGE 15=CONT/ROW 2=ROWS	0450G	252-15-30-340	
A1XA11L	1251-1886		CONNECTOR-PC EDGE 15=CONT/ROW 2=ROWS	0450G	252-15-30-340	
A1XA11R	1251-1886		CONNECTOR-PC EDGE 15=CONT/ROW 2=ROWS	0450G	252-15-30-340	
A1XA12L	1251-1886		CONNECTOR-PC EDGE 15=CONT/ROW 2=ROWS	0450G	252-15-30-340	
A1XA12R	1251-1886		CONNECTOR-PC EDGE 15=CONT/ROW 2=ROWS	0450G	252-15-30-340	
A1XA13L	1251-1886		CONNECTOR-PC EDGE 15=CONT/ROW 2=ROWS	0450G	252-15-30-340	
A1XA13R	1251-1886		CONNECTOR-PC EDGE 15=CONT/ROW 2=ROWS	0450G	252-15-30-340	
A1XA14L	1251-1886		CONNECTOR-PC EDGE 15=CONT/ROW 2=ROWS	0450G	252-15-30-340	
A1XA14R	1251-1886		CONNECTOR-PC EDGE 15=CONT/ROW 2=ROWS	0450G	252-15-30-340	
A1XA21L	1251-1886		CONNECTOR-PC EDGE 15=CONT/ROW 2=ROWS	0450G	252-15-30-340	
A1XA21R	1251-1886		CONNECTOR-PC EDGE 15=CONT/ROW 2=ROWS	0450G	252-15-30-340	
A1XA22L	1251-1886		CONNECTOR-PC EDGE 15=CONT/ROW 2=ROWS	0450G	252-15-30-340	
A1XA22R	1251-1886		CONNECTOR-PC EDGE 15=CONT/ROW 2=ROWS	0450G	252-15-30-340	
A1XA23L	1251-1886		CONNECTOR-PC EDGE 15=CONT/ROW 2=ROWS	0450G	252-15-30-340	
A1XA23R	1251-1886		CONNECTOR-PC EDGE 15=CONT/ROW 2=ROWS	0450G	252-15-30-340	
A1XA24L	1251-1886		CONNECTOR-PC EDGE 15=CONT/ROW 2=ROWS	0450G	252-15-30-340	
A1XA24R	1251-1886		CONNECTOR-PC EDGE 15=CONT/ROW 2=ROWS	0450G	252-15-30-340	
A1XA25L	1251-1886		CONNECTOR-PC EDGE 15=CONT/ROW 2=ROWS	0450G	252-15-30-340	
A1XA25R	1251-1886		CONNECTOR-PC EDGE 15=CONT/ROW 2=ROWS	0450G	252-15-30-340	
A2	04262-66502	1	KEYBOARD & DISPLAY ASSEMBLY	28480	04262-66502	
	04262-26502	1	PC BOARD, BLANK	28480	04262-26502	
A2C1	0180-0291	0	CAPACITOR-FXD 10F±10% 35VDC 1A	0420J	1500105X9035A2	
A2D51	1990-0486	37	LED-VISIBLE LUM-INT=1MCD IF=20MA-MAX	28480	1990-0486	
A2D52	1990-0486		LED-VISIBLE LUM-INT=1MCD IF=20MA-MAX	28480	1990-0486	
A2D53	1990-0486		LED-VISIBLE LUM-INT=1MCD IF=20MA-MAX	28480	1990-0486	
A2D54	1990-0486		LED-VISIBLE LUM-INT=1MCD IF=20MA-MAX	28480	1990-0486	
A2D55	1990-0452		DISPLAY-NUM SEG 1=CHAR .3-H	28480	1990-0452	
A2D56	1990-0434	7	DISPLAY-NUM SEG 1=CHAR .3-H	28480	1990-0434	
A2D57	1990-0434		DISPLAY-NUM SEG 1=CHAR .3-H	28480	1990-0434	
A2D58	1990-0434		DISPLAY-NUM SEG 1=CHAR .3-H	28480	1990-0434	
A2D59	1990-0517		15	LED-VISIBLE LUM-INT=3MCD IF=20MA-MAX	28480	1990-0517
A2D510	1990-0517			LED-VISIBLE LUM-INT=3MCD IF=20MA-MAX	28480	1990-0517
A2D511	1990-0517			LED-VISIBLE LUM-INT=3MCD IF=20MA-MAX	28480	1990-0517
A2D512	1990-0517			LED-VISIBLE LUM-INT=3MCD IF=20MA-MAX	28480	1990-0517
A2D513	1990-0517	LED-VISIBLE LUM-INT=3MCD IF=20MA-MAX		28480	1990-0517	
A2D514	1990-0517	LED-VISIBLE LUM-INT=3MCD IF=20MA-MAX	28480	1990-0517		
A2D515	1990-0517	LED-VISIBLE LUM-INT=3MCD IF=20MA-MAX	28480	1990-0517		
A2D516	1990-0517	LED-VISIBLE LUM-INT=3MCD IF=20MA-MAX	28480	1990-0517		
A2D517	1990-0517	LED-VISIBLE LUM-INT=3MCD IF=20MA-MAX	28480	1990-0517		
A2D518	1990-0517	LED-VISIBLE LUM-INT=3MCD IF=20MA-MAX	28480	1990-0517		
A2D519	1990-0517	LED-VISIBLE LUM-INT=3MCD IF=20MA-MAX	28480	1990-0517		
A2D520	1990-0434	DISPLAY-NUM SEG 1=CHAR .3-H	28480	1990-0434		
A2D521	1990-0434	DISPLAY-NUM SEG 1=CHAR .3-H	28480	1990-0434		
A2D522	1990-0434	DISPLAY-NUM SEG 1=CHAR .3-H	28480	1990-0434		
A2D523	1990-0434	DISPLAY-NUM SEG 1=CHAR .3-H	28480	1990-0434		
A2D524	1990-0486	LED-VISIBLE LUM-INT=1MCD IF=20MA-MAX	28480	1990-0486		
A2D525	1990-0486	LED-VISIBLE LUM-INT=1MCD IF=20MA-MAX	28480	1990-0486		
A2D526	1990-0486	LED-VISIBLE LUM-INT=1MCD IF=20MA-MAX	28480	1990-0486		
A2D527	1990-0486	LED-VISIBLE LUM-INT=1MCD IF=20MA-MAX	28480	1990-0486		
A2D528	1990-0665	LED-VISIBLE LUM-INT=1MCD IF=20MA-MAX	28480	1990-0665		
A2D529	1990-0665	LED-VISIBLE LUM-INT=1MCD IF=20MA-MAX	28480	1990-0665		
A2D530	1990-0665	LED-VISIBLE LUM-INT=1MCD IF=20MA-MAX	28480	1990-0665		
A2D531	1990-0665	LED-VISIBLE LUM-INT=1MCD IF=20MA-MAX	28480	1990-0665		
A2D542	1990-0486	LED-VISIBLE LUM-INT=1MCD IF=20MA-MAX	28480	1990-0486		
A2D533	1990-0486	LED-VISIBLE LUM-INT=1MCD IF=20MA-MAX	28480	1990-0486		
A2D534	1990-0486	LED-VISIBLE LUM-INT=1MCD IF=20MA-MAX	28480	1990-0486		
A2D535	1990-0486	LED-VISIBLE LUM-INT=1MCD IF=20MA-MAX	28480	1990-0486		
A2D536	1990-0486	LED-VISIBLE LUM-INT=1MCD IF=20MA-MAX	28480	1990-0486		
A2D537	1990-0486	LED-VISIBLE LUM-INT=1MCD IF=20MA-MAX	28480	1990-0486		
A2D538	1990-0486	LED-VISIBLE LUM-INT=1MCD IF=20MA-MAX	28480	1990-0486		
A2D539	1990-0486	LED-VISIBLE LUM-INT=1MCD IF=20MA-MAX	28480	1990-0486		
A2D540	1990-0665	LED-VISIBLE LUM-INT=1MCD IF=20MA-MAX	28480	1990-0665		
A2D541	1990-0665	LED-VISIBLE LUM-INT=1MCD IF=20MA-MAX	28480	1990-0665		
A2D542	1990-0665	LED-VISIBLE LUM-INT=1MCD IF=20MA-MAX	28480	1990-0665		
A2D543	1990-0665	LED-VISIBLE LUM-INT=1MCD IF=20MA-MAX	28480	1990-0665		
A2D544	1990-0665	LED-VISIBLE LUM-INT=1MCD IF=20MA-MAX	28480	1990-0665		
A2D545	1990-0665	LED-VISIBLE LUM-INT=1MCD IF=20MA-MAX	28480	1990-0665		

See introduction to this section for ordering information

Table 6-3. Replaceable Parts (Cont'd).

Reference Designation	HP Part Number	Qty	Description	Mfr Code	Mfr Part Number
A20S46	1990-0665		LED-VISIBLE LUM-INT=1MCD IF=20MA=MAX	28480	1990-0665
A20S47	1990-0665		LED-VISIBLE LUM-INT=1MCD IF=20MA=MAX	28480	1990-0665
A20S48	1990-0665		LED-VISIBLE LUM-INT=1MCD IF=20MA=MAX	28480	1990-0665
A20S49	1990-0665		LED-VISIBLE LUM-INT=1MCD IF=20MA=MAX	28480	1990-0665
A20S50	1990-0665		LED-VISIBLE LUM-INT=1MCD IF=20MA=MAX	28480	1990-0665
A20S51	1990-0665		LED-VISIBLE LUM-INT=1MCD IF=20MA=MAX	28480	1990-0665
A20S52	1990-0665		LED-VISIBLE LUM-INT=1MCD IF=20MA=MAX	28480	1990-0665
A20S53	1990-0665		LED-VISIBLE LUM-INT=1MCD IF=20MA=MAX	28480	1990-0665
A20S54	1990-0665		LED-VISIBLE LUM-INT=1MCD IF=20MA=MAX	28480	1990-0665
A20S55	1990-0665		LED-VISIBLE LUM-INT=1MCD IF=20MA=MAX	28480	1990-0665
A20S56	1990-0665		LED-VISIBLE LUM-INT=1MCD IF=20MA=MAX	28480	1990-0665
A2J1	1200-0638	8	SOCKET-IC 14-CONT DIP-SLDR	0325I	
A2J2	1200-0638		SOCKET-IC 14-CONT DIP-SLDR	0325I	
A2J3	1200-0638		SOCKET-IC 14-CONT DIP-SLDR	0325I	
A2J4	1200-0638		SOCKET-IC 14-CONT DIP-SLDR	0325I	
A2J5	1200-0638		SOCKET-IC 14-CONT DIP-SLDR	0325I	
A2J6	1200-0638		SOCKET-IC 14-CONT DIP-SLDR	0325I	
A2J7	1200-0638		SOCKET-IC 14-CONT DIP-SLDR	0325I	
A2J8	1200-0638		SOCKET-IC 14-CONT DIP-SLDR	0325I	
A2K1	0683-4715	37	RESISTOR 470 5% .25W FC TC=400/+600	0160G	C84715
A2K2	0683-4715		RESISTOR 470 5% .25W FC TC=400/+600	0160G	C84715
A2K3	0683-4715		RESISTOR 470 5% .25W FC TC=400/+600	0160G	C84715
A2K4	0683-4715		RESISTOR 470 5% .25W FC TC=400/+600	0160G	C84715
A2K5	0683-2715	20	RESISTOR 270 5% .25W FC TC=400/+600	0160G	C82715
A2K6	0683-2715		RESISTOR 270 5% .25W FC TC=400/+600	0160G	C82715
A2K7	0683-2715		RESISTOR 270 5% .25W FC TC=400/+600	0160G	C82715
A2K8	0683-2715		RESISTOR 270 5% .25W FC TC=400/+600	0160G	C82715
A2K9	0683-2715		RESISTOR 270 5% .25W FC TC=400/+600	0160G	C82715
A2K10	0683-2715		RESISTOR 270 5% .25W FC TC=400/+600	0160G	C82715
A2K11	0683-4715		RESISTOR 470 5% .25W FC TC=400/+600	0160G	C84715
A2K12	0683-4715		RESISTOR 470 5% .25W FC TC=400/+600	0160G	C84715
A2K13	0683-4715		RESISTOR 470 5% .25W FC TC=400/+600	0160G	C84715
A2K14	0683-4715		RESISTOR 470 5% .25W FC TC=400/+600	0160G	C84715
A2K15	0683-4715		RESISTOR 470 5% .25W FC TC=400/+600	0160G	C84715
A2K16	0683-4715		RESISTOR 470 5% .25W FC TC=400/+600	0160G	C84715
A2K17	0683-4715		RESISTOR 470 5% .25W FC TC=400/+600	0160G	C84715
A2K18	0683-4715		RESISTOR 470 5% .25W FC TC=400/+600	0160G	C84715
A2S1	5060-9436	28	SWITCH, PUSHBUTTON	28480	5060-9436
	5041-0342	2	KEY CAP	28480	5041-0342
A2S2	5060-9436	1	SLIDE ASSEMBLY	28480	5060-9436
	5020-3440	1	SPRING/PETENT	28480	5020-3440
A2S3	5060-9436	4	SWITCH, PUSHBUTTON	28480	5060-9436
	5041-0351		KEY CAP	28480	5041-0351
A2S4	5060-9436		SWITCH, PUSHBUTTON	28480	5060-9436
	5041-0351		KEY CAP	28480	5041-0351
A2S5	5060-9436		SWITCH, PUSHBUTTON	28480	5060-9436
	5041-0351		KEY CAP	28480	5041-0351
A2S6	5060-9436		SWITCH, PUSHBUTTON	28480	5060-9436
	5041-0351		KEY CAP	28480	5041-0351
A2S7	5060-9436	6	SWITCH, PUSHBUTTON	28480	5060-9436
	5041-0252		KEY CAP	28480	5041-0252
A2S8	5060-9436		SWITCH, PUSHBUTTON	28480	5060-9436
	5041-0252		KEY CAP	28480	5041-0252
A2S9	5060-9436		SWITCH, PUSHBUTTON	28480	5060-9436
	5041-0252		KEY CAP	28480	5041-0252
A2S10	5060-9436	11	SWITCH, PUSHBUTTON	28480	5060-9436
	5041-0318		KEY CAP	28480	5041-0318
A2S11	5060-9436		SWITCH, PUSHBUTTON	28480	5060-9436
	5041-0252		KEY CAP	28480	5041-0252
A2S12	5060-9436		SWITCH, PUSHBUTTON	28480	5060-9436
	5041-0252		KEY CAP	28480	5041-0252
A2S13	5060-9436		SWITCH, PUSHBUTTON	28480	5060-9436
	5041-0318		KEY CAP	28480	5041-0318
A2S14	5060-9436	1	SWITCH, PUSHBUTTON	28480	5060-9436
	5041-0408		KEY CAP	28480	5041-0408
A2S15	5060-9436		SWITCH, PUSHBUTTON	28480	5060-9436
	5041-0318		KEY CAP	28480	5041-0318
A2S16	5060-9436		SWITCH, PUSHBUTTON	28480	5060-9436
	5041-0318		KEY CAP	28480	5041-0318
A2S17	5060-9436		SWITCH, PUSHBUTTON	28480	5060-9436
	5041-0318		KEY CAP	28480	5041-0318
A2S18	5060-9436		SWITCH, PUSHBUTTON	28480	5060-9436
	5041-0318		KEY CAP	28480	5041-0318
A2S19	5060-9436	4	SWITCH, PUSHBUTTON	28480	5060-9436
	5041-0309		KEY CAP	28480	5041-0309
A2S20	5060-9436		SWITCH, PUSHBUTTON	28480	5060-9436
	5041-0309		KEY CAP	28480	5041-0309
A2S21	5060-9436		SWITCH, PUSHBUTTON	28480	5060-9436
	5041-0318		KEY CAP	28480	5041-0318

See introduction to this section for ordering information

Table 6-3. Replaceable Parts (Cont'd).

Reference Designation	HP Part Number	Qty	Description	Mfr Code	Mfr Part Number
A2S22	5060-9436 5041-0318		SWITCH, PUSHBUTTON KEY CAP	28480 28480	5060-9436 5041-0318
A2S23	5060-9436 5041-0309		SWITCH, PUSHBUTTON KEY CAP	28480 28480	5060-9436 5041-0309
A2S24	5060-9436 5041-0318		SWITCH, PUSHBUTTON KEY CAP	28480 28480	5060-9436 5041-0318
A2S25	5060-9436 5041-0318		SWITCH, PUSHBUTTON KEY CAP	28480 28480	5060-9436 5041-0318
A2S26	5060-9436 5041-0318		SWITCH, PUSHBUTTON KEY CAP	28480 28480	5060-9436 5041-0318
A2U1	1820-1200	5	IC INV TTL LS HEX 1-INP	0169H	SN74LS05N
A2U2	1820-0491	4	IC DCDR TTL BCD-TO-DEC 4-TO-10-LINE	0169H	SN74145N
A2U3	1820-0491		IC DCDR TTL BCD-TO-DEC 4-TO-10-LINE	0169H	SN74145N
A2U4	1820-0491		IC DCDR TTL BCD-TO-DEC 4-TO-10-LINE	0169H	SN74145N
A2W1	8120-0365	1	CABLE ASSEMBLY, 40-PIN	28480	8120-0365
A2W2	8120-0362	1	CABLE ASSEMBLY, 34-PIN	28480	8120-0362
A3	04262-66503 04262-26503	1 1	HP-IR CONNECTOR BOARD ASSEMBLY PC BOARD, BLANK	28480 28480	04262-66503 04262-26503
A3J1	1251-3283	1	CONNECTOR 24-PIN F MICRORIBBON	28480	1251-3283
A3J2	1200-0485	1	SOCKET-IC 14-PIN PC MOUNTING	28480	1200-0485
A3S1	3101-1973	1	SWITCH-SL 7-1A-NS DIP-SLIDE-ASSY .1A	02480	11P-1028
A3W1	04262-61609	1	CABLE ASSEMBLY		
A4 (OPTION 004)	04262-66544 04262-26544	1 1	THUMBWHEEL SWITCH BOARD ASSEMBLY PC BOARD, BLANK	28480 28480	
A4J1	1251-0923	16	CONNECTOR, PC 2 x 11 CONTACT	28480	
A4J2	1251-0923		CONNECTOR, PC 2 x 11 CONTACT	28480	
A4J3	1251-0923		CONNECTOR, PC 2 x 11 CONTACT	28480	
A4J4	1251-0923		CONNECTOR, PC 2 x 11 CONTACT	28480	
A4J5	1251-0923		CONNECTOR, PC 2 x 11 CONTACT	28480	
A4J6	1251-0923		CONNECTOR, PC 2 x 11 CONTACT	28480	
A4J7	1251-0923		CONNECTOR, PC 2 x 11 CONTACT	28480	
A4J8	1251-0923		CONNECTOR, PC 2 x 11 CONTACT	28480	
A4J9	1251-0923		CONNECTOR, PC 2 x 11 CONTACT	28480	
A4J10	1251-0923		CONNECTOR, PC 2 x 11 CONTACT	28480	
A4J11	1251-0923		CONNECTOR, PC 2 x 11 CONTACT	28480	
A4J12	1251-0923		CONNECTOR, PC 2 x 11 CONTACT	28480	
A4J13	1251-0923		CONNECTOR, PC 2 x 11 CONTACT	28480	
A4J14	1251-0923		CONNECTOR, PC 2 x 11 CONTACT	28480	
A4J15	1251-0923		CONNECTOR, PC 2 x 11 CONTACT	28480	
A4J16	1251-0923		CONNECTOR, PC 2 x 11 CONTACT	28480	
A4J17	1200-0607	5	SOCKET-IC 16-CONT DIP-SLDR	0138J	
A4W1	8120-0364	1	CABLE ASSEMBLY, FLAT	28480	8120-0364
A5 (OPTION 004)	04262-66505 04262-26505	1 1	COMPARATOR KEYBOARD ASSEMBLY PC BOARD, BLANK	28480 28480	04262-66505 04262-26505
A5D51	1990-0517	2	LED-VISIBLE LUM-INT=3MCD IF=20MA-MAX	28480	1990-0517
A5D52	1990-0521		LED-VISIBLE LUM-INT=2.2MCD IF=50MA-MAX	28480	1990-0521
A5D53	1990-0517		LED-VISIBLE LUM-INT=3MCD IF=20MA-MAX	28480	1990-0517
A5D54	1990-0517		LED-VISIBLE LUM-INT=3MCD IF=20MA-MAX	28480	1990-0517
A5D55	1990-0521		LED-VISIBLE LUM-INT=2.2MCD IF=50MA-MAX	28480	1990-0521
A5D56	1990-0517		LED-VISIBLE LUM-INT=3MCD IF=20MA-MAX	28480	1990-0517
A5D57	1990-0665		LED-VISIBLE LUM-INT=1.0MCD IF=20MA-MAX		
A5S1	5060-9436 5041-0342		SWITCH, PUSHBUTTON KEY CAP	28480 28480	5060-9436 5041-0342
A5S2	5060-9436 5041-0309		SWITCH, PUSHBUTTON KEY CAP	28480 28480	5060-9436 5041-0309
A5S3	5060-9436 5041-0252		SWITCH, PUSHBUTTON KEY CAP	28480 28480	5060-9436 5041-0252
A5W1	8120-0361	1	CABLE ASSEMBLY	28480	8120-0361
A6			NOT ASSIGNED		
A7			NOT ASSIGNED		
A8			NOT ASSIGNED		

See introduction to this section for ordering information

Table 6-3. Replaceable Parts (Cont'd).

Reference Designation	HP Part Number	Qty	Description	Mfr Code	Mfr Part Number
A9	04261-77009 04261-87009	1 1	POWER SUPPLY BOARD ASSEMBLY PC BOARD, BLANK	28480 28480	04261-77009 04261-87009
A9C1	0180-1057	3	CAPACITOR:FXD 2200 UF 16VDCW AL ELECT	28480	0180-1057
A9C2	0180-1057		CAPACITOR:FXD 2200 UF 16VDCW AL ELECT	28480	0180-1057
A9C3	0180-1057		CAPACITOR:FXD 2200 UF 16VDCW AL ELECT	28480	0180-1057
A9C4	0180-1056	2	CAPACITOR:FXD 1000 UF 25VDC AL ELECT	28480	0180-1056
A9C5	0180-1056		CAPACITOR:FXD 1000 UF 25VDC AL ELECT	28480	0180-1056
A9C6	0140-0200	2	CAPACITOR:FXD 390PF +-5% 300VDC MICA0+70	72136	DM15F391J0300WV1CR
A9C7	0180-0814	3	CAPACITOR:FXD 100UF +100-10% 16VDCW AL	28480	0180-0814
A9C8	0180-0814		CAPACITOR:FXD 100UF +100-10% 16VDCW AL	28480	0180-0814
A9C9	0180-0814		CAPACITOR:FXD 100UF +100-10% 16VDCW AL	28480	0180-0814
A9CR1	1901-0237	2	DIODE:SI, RECTIFIER BRIDGE, 200V	28480	1901-0237
A9CR2	1901-0237		DIODE:SI, RECTIFIER BRIDGE, 200V	28480	1901-0237
A9Q1	1A54-0039	1	TRANSISTOR NPN 2N3053S SI TO-39 PD=1W	0203G	2N3053
A9Q2	5080-3078	20	TRANSISTOR NPN SI		
A9Q3	5080-3078		TRANSISTOR NPN SI		
A9Q4	5080-3078		TRANSISTOR NPN SI		
A9R1	0811-2771	1	RESISTOR .18 3% 3W PW TC0+-90	05520	R5-2H
A9R2	0811-1746	2	RESISTOR .36 5% 2W PW TC0+-800	0467B	RWH2-36/100-J
A9R3	0683-1025	20	RESISTOR 1K 5% .25W FC TC=-400/+600	0160G	CB1025
A9R4	0811-1746		RESISTOR .36 5% 2W PW TC0+-800	0467B	RWH2-36/100-J
A9R5	0757-0436	1	RESISTOR 5.11K 1% .125W F TC0+-100	0329H	C4-1/8-T0=5111-F
A9R6	2100-2521	1	RESISTOR-TRMR 2K 10% C SIDE-ADJ 1-TRN	0365A	E750X202
A9R7	0757-0440	1	RESISTOR 7.5K 1% .125W F TC0+-100	0329H	C4-1/8-T0=7501-F
A9R8	0757-0289	1	RESISTOR 13.3K 1% .125W F TC0+-100	0299E	MF4C1/8-T0=1332-F
A9R9	0698-0020	1	RESISTOR 9.51K 1% .125W F TC0+-100	0329H	C4-1/8-T0=9531-F
A9R10	0757-0442	4	RESISTOR 10K 1% .125W F TC0+-100	0329H	C4-1/8-T0=1002-F
A9R11	0757-0442		RESISTOR 10K 1% .125W F TC0+-100	0329H	C4-1/8-T0=1002-F
A9R12	0698-3155	5	RESISTOR 4.64K 1% .125W F TC0+-100	0329H	C4-1/8-T0=4641-F
A9R13	0698-3155		RESISTOR 4.64K 1% .125W F TC0+-100	0329H	C4-1/8-T0=4641-F
A9R14	0698-3431	1	RESISTOR 25.7 1% .125W F TC0+-100	0388B	PME55-1/8-T0=257-F
A9R15	0757-0420	1	RESISTOR 750 1% .125W F TC0+-100	0329H	C4-1/8-T0=751-F
A9R16	0698-3427	1	RESISTOR 13.3 1% .125W F TC0+-100	0388B	PME55-1/8-T0=133-F
A9R17	0757-0317	2	RESISTOR 1.33K 1% .125W F TC0+-100	0329H	C4-1/8-T0=1331-F
A9R18	0757-0159		RESISTOR 1K 1% .5W		
A9R19	0683-7529		RESISTOR 7.5K 5% .25W		
A9U1	1A26-0271	4	IC 741 OP AMP	0340F	LM741CN
A9U2	5080-3834	1	IC 723 V RGLTR		
A9U3	1A26-0271		IC 741 OP AMP	0340F	LM741CN
A9U4	1A26-0271		IC 741 OP AMP	0340F	LM741CN
		9	A9 MISCELLANEOUS PARTS		
	5040-3304 04261-50022	5 1	HOLDER, CAPACITOR SUPPORTER, BOARD	28480 28480	5040-3304 04261-50022
A10			NOT ASSIGNED		
A11	04262-66511 04262-26511	1 1	OSCILLATOR & SOURCE RESISTOR BOARD ASSY PC BOARD, BLANK	28480 28480	04262-66511 04262-26511
A11C1	0180-2396	1	CAPACITOR:FXD 1000UF+75-10% 75VDC AL	0420J	39D108G075JP4
A11C2	0180-2200	1	CAPACITOR:FXD 43PF +-5% 300VDC	28480	0180-2200
A11C3	0180-1051	20	CAPACITOR, FXD 100 UF 16V M	28480	0180-1051
A11C4	0180-1051		CAPACITOR, FXD 100 UF 16V M	28480	0180-1051
A11C5	0180-1052	4	CAPACITOR, FXD 220 UF 6.3V M	28480	0180-1052
A11C6	0180-1051		CAPACITOR, FXD 100 UF 16V M	28480	0180-1051
A11C7	0180-1051		CAPACITOR, FXD 100 UF 16V M	28480	0180-1051
A11C8	0160-5819	3	CAPACITOR, FXD 3300 PF 50V		
A11C9	0160-5819		CAPACITOR, FXD 3300 PF 50V		
A11C10	0180-0228	2	CAPACITOR:FXD 22UF+-10% 15VDC TA	0420J	150D226X901502
A11C11	0180-0228		CAPACITOR:FXD 22UF+-10% 15VDC TA	0420J	150D226X901502
A11C12	0180-1052		CAPACITOR, FXD 220 UF 6.3V M	28480	0180-1052
A11CR1	1902-0688	3	DIODE-ZNR 53.6V 2% DO-15 PD=1W TC=+.061%	0203G	SZ 11213-351
A11CR2	1901-0025	10	DIODE-GEN PRP 100V 200MA DO-7	28480	1901-0025
A11CR3	1901-0025		DIODE-GEN PRP 100V 200MA DO-7	28480	1901-0025
A11CR4	1901-0025		DIODE-GEN PRP 100V 200MA DO-7	28480	1901-0025
A11CR5	1901-0025		DIODE-GEN PRP 100V 200MA DO-7	28480	1901-0025
A11CR6	1901-0040		DIODE-SWITCHING 30V 50MA 2NS DO-35	28480	1901-0040
A11CR7	1901-0040		DIODE-SWITCHING 30V 50MA 2NS DO-35	28480	1901-0040
A11CR8	1902-3037	1	DIODE-ZNR 3.16V 2% DO-7 PD=.4W TC=+.064%	0203G	FZ7256
A11CR9	1902-3149	6	DIODE-ZNR 9.09V 5% DO-7 PD=.4W TC=+.057%	0223G	
A11CR10	1901-0040		DIODE-SWITCHING 30V 50MA 2NS DO-35	28480	1901-0040
A11CR11	1901-0040		DIODE-SWITCHING 30V 50MA 2NS DO-35	28480	1901-0040
A11CR12	1901-0040		DIODE-SWITCHING 30V 50MA 2NS DO-35	28480	1901-0040
A11CR13	1901-0040		DIODE-SWITCHING 30V 50MA 2NS DO-35	28480	1901-0040
A11CR14	1902-0688		DIODE-ZNR 53.6V 2% DO-15 PD=1W		
A11CR15	1902-0688		DIODE-ZNR 53.6V 2% DO-15 PD=1W		

See introduction to this section for ordering information

Table 6-3. Replaceable Parts (Cont'd).

Reference Designation	HP Part Number	Qty	Description	Mfr Code	Mfr Part Number
A11K1	0490-0234	3	RELAY, REED	28480	
A11K2	0490-0234		RELAY, REED	28480	
A11K3	0490-0234		RELAY, REED	28480	
A11K4	0490-0226	1	RELAY, REED	28480	0490-0226
A11Q1	5080-3078		TRANSISTOR NPN SI PD=300MW FT=200MHZ	28480	1854-0071
A11Q2	1853-0020	26	TRANSISTOR PNP SI PD=300MW FT=150MHZ	28480	1853-0020
A11Q3	5080-3078		TRANSISTOR NPN SI PD=300MW FT=200MHZ	28480	1854-0071
A11Q4	1855-0082	1	TRANSISTOR MOSFET P-CHAN D-MODE SI	28480	1855-0082
A11Q5	5080-3078		TRANSISTOR NPN SI PD=300MW FT=200MHZ	28480	1854-0071
A11Q6	5080-3078		TRANSISTOR NPN SI PD=300MW FT=200MHZ	28480	1854-0071
A11Q7	5080-3078		TRANSISTOR NPN SI PD=300MW FT=200MHZ	28480	1854-0071
A11Q8	5080-3078		TRANSISTOR NPN SI PD=300MW FT=200MHZ	28480	1854-0071
A11Q9	5080-3830	22	TRANSISTOR J-FET N-CHAN D-MODE SI		
A11Q10	5080-3830		TRANSISTOR J-FET N-CHAN D-MODE SI		
A11Q11	1855-0268	9	TRANSISTOR J-FET N-CHAN D-MODE SI	28480	1885-0268
A11Q12	1855-0268		TRANSISTOR J-FET N-CHAN D-MODE SI	28480	1885-0268
A11Q13	1853-0020		TRANSISTOR PNP SI PD=300MW FT=150MHZ	28480	1853-0020
A11Q14	5080-3078		TRANSISTOR NPN SI PD=300MW FT=200MHZ	28480	1854-0071
A11Q15	1853-0020		TRANSISTOR PNP SI PD=300MW FT=150MHZ	28480	1853-0020
A11Q16	1853-0020		TRANSISTOR PNP SI PD=300MW FT=150MHZ	28480	1853-0020
A11R1	0768-0001	1	RESISTOR 1K 10% 3W MO TC=0+/-250	0341H	FP3-3=250=1001-K
A11R2	0683-3335	39	RESISTOR 33K 5% .25W FC TC=400/+800	0160G	CR3335
A11R3	0698-4418	1	RESISTOR 205 1% .125W F TC=0+/-100	0329B	C4-1/8-T0=205K-F
A11R4	0683-5605	23	RESISTOR 56 5% .25W FC TC=400/+500	0160G	CR5605
A11R5	0683-5605		RESISTOR 56 5% .25W FC TC=400/+500	0160G	CR5605
A11R6	0757-0465	4	RESISTOR 100K 1% .125W F TC=0+/-100	0329B	C4-1/8-T0=100K-F
A11R7	0757-0442		RESISTOR 10K 1% .125W F TC=0+/-100	0329B	C4-1/8-T0=100K-F
A11R8	0698-0083	2	RESISTOR 1.96K 1% .125W F TC=0+/-100	0329B	C4-1/8-T0=1961-F
A11R9	0698-0083		RESISTOR 1.96K 1% .125W F TC=0+/-100	0329B	C4-1/8-T0=1961-F
A11R10	0757-0405	2	RESISTOR 162 1% .125W F TC=0+/-100	0329B	C4-1/8-T0=162K-F
A11R11	0757-0405		RESISTOR 162 1% .125W F TC=0+/-100	0329B	C4-1/8-T0=162K-F
A11R12	0683-2705	2	RESISTOR 27 5% .25W FC TC=400/+500	0160G	CR2705
A11R13	0683-2705		RESISTOR 27 5% .25W FC TC=400/+500	0160G	CR2705
A11R14	0683-1535	3	RESISTOR 15K 5% .25W FC TC=400/+800	0160G	CR1535
A11R15	0683-1535		RESISTOR 15K 5% .25W FC TC=400/+800	0160G	CR1535
A11R16	0698-4471	1	RESISTOR 7.87K 1% .125W F TC=0+/-100 *FACTORY SELECTED PAINT		
A11R17	0757-0442		RESISTOR 10K 1% .125W F TC=0+/-100	0329B	C4-1/8-T0=100K-F
A11R18	0698-4420	1	RESISTOR 226 1% .125W F TC=0+/-100	0329B	C4-1/8-T0=226K-F
A11R19	0698-4442	2	RESISTOR 4.42K 1% .125W F TC=0+/-100	0329B	C4-1/8-T0=4421-F
A11R20	0698-3155		RESISTOR 4.64K 1% .125W F TC=0+/-100	0329B	C4-1/8-T0=4641-F
A11R21	0757-0278	1	RESISTOR 1.78K 1% .125W F TC=0+/-100	0329B	C4-1/8-T0=1781-F
A11R22	0683-3335		RESISTOR 33K 5% .25W FC TC=400/+800	0160G	CR3335
A11R23	0757-0281		RESISTOR 2.74K 1% .25W F TC=0+/-100		
A11R24	0683-3335		RESISTOR 33K 5% .25W FC TC=400/+800	0160G	CR3335
A11R25	0698-4498	2	RESISTOR 53.6K 1% .125W F TC=0+/-100	0329B	C4-1/8-T0=5362-F
A11R26	0698-1427	2	RESISTOR 400K .5% .25W	28480	0698-1427
A11R27	0757-0437		RESISTOR 4.75K 1% .125W F TC=0+/-100		
A11R28	0757-0459		RESISTOR 56.2K 1% .125W F TC=0+/-100		
A11R29	0698-1427		RESISTOR 400K .5% .25W	28480	0698-1427
A11R30	0698-4444		RESISTOR 4.87K 1% .125W F TC=0+/-100		
A11R31	0683-8225	1	RESISTOR 8.2K 5% .25W FC TC=400/+700	0160G	CR8225
A11R32	0683-4725	13	RESISTOR 4.7K 5% .25W FC TC=400/+700	0160G	CR4725
A11R33	0683-3335		RESISTOR 33K 5% .25W FC TC=400/+800	0160G	CR3335
A11R34	0757-0443	1	RESISTOR 11K 1% .125W F TC=0+/-100	0329B	C4-1/8-T0=1102-F
A11R35	0757-0416	3	RESISTOR 511 1% .125W F TC=0+/-100	0329B	C4-1/8-T0=511K-F
A11R36	0698-3154	1	RESISTOR 4.22K 1% .125W F TC=0+/-100	0329B	C4-1/8-T0=4221-F
A11R37	0683-5625	11	RESISTOR 5.6K 5% .25W FC TC=400/+700	0160G	CR5625
A11R38	0683-3335		RESISTOR 33K 5% .25W FC TC=400/+800	0160G	CR3335
A11R39	0683-7525	1	RESISTOR 7.5K 5% .25W FC TC=400/+700	0160G	CR7525
A11R40	0683-3335		RESISTOR 33K 5% .25W FC TC=400/+800	0160G	CR3335
A11R41	0683-3335		RESISTOR 33K 5% .25W FC TC=400/+800	0160G	CR3335
A11R42	0683-3335		RESISTOR 33K 5% .25W FC TC=400/+800	0160G	CR3335
A11R43	0683-3335		RESISTOR 33K 5% .25W FC TC=400/+800	0160G	CR3335
A11R44	0757-0486	4	RESISTOR 750K 1% .125W F TC=0+/-100	0552D	CMF=55-1
A11R45	0757-0486		RESISTOR 750K 1% .125W F TC=0+/-100	0552D	CMF=55-1
A11R46	0757-0486		RESISTOR 750K 1% .125W F TC=0+/-100	0552D	CMF=55-1
A11R47	0683-3335		RESISTOR 33K 5% .25W FC TC=400/+800	0160G	CR3335
A11R48	0683-3335		RESISTOR 33K 5% .25W FC TC=400/+800	0160G	CR3335
A11R49	0683-3335		RESISTOR 33K 5% .25W FC TC=400/+800	0160G	CR3335
A11R50	0683-3335		RESISTOR 33K 5% .25W FC TC=400/+800	0160G	CR3335
A11R51	0683-3335		RESISTOR 33K 5% .25W FC TC=400/+800	0160G	CR3335
A11R52	0683-3335		RESISTOR 33K 5% .25W FC TC=400/+800	0160G	CR3335
A11R53	0683-5605		RESISTOR 56 5% .25W		

See introduction to this section for ordering information

Table 6-3. Replaceable Parts (Cont'd).

Reference Designation	HP Part Number	Qty	Description	Mfr Code	Mfr Part Number
A11T1 A11T2	9100-0866 9100-0866	2	TRANSFORMER, PULSE TDK412N4 TRANSFORMER, PULSE TDK412N4	28480 28480	9100-0866 9100-0866
A11U1 A11U2 A11U3	1826-0043 1826-0319 1826-0326	5 6	IC OP AMP IC OP AMP IC OP AMP	0340F 07933	LF356M RC45580N
A12	04262-66612 04262-26612	1 1	RANGE RESISTOR BOARD ASSEMBLY PC BOARD, BLANK	28480 28480	04262-66612 04262-26612
A12C1 A12C2*	0160-0159 0140-0190	1 1	CAPACITOR-FXD 6R00PF +/-10% 200VDC POLYE CAPACITOR-FXD 39PF +/-5% 300VDC *FACTORY SELECTED PART	0420J 72136	292P68292 DM15E390J0300WVICR
A12C3*	0121-0059	2	CAPACITOR-V TRMR-CER 2=8PF 350V PC-MTG *FACTORY SELECTED PART	73899	DV11PR6A
A12C4 A12C5 A12C6 A12C7 A12C8	0180-1051 0180-1051 0150-0050 0150-0050 0150-0050	6	CAPACITOR, FXD 100 UF 16V M CAPACITOR, FXD 100 UF 16V M CAPACITOR-FXD 1000PF +80=20% 1KVDC CER CAPACITOR-FXD 1000PF +80=20% 1KVDC CER CAPACITOR-FXD 1000PF +80=20% 1KVDC CER	28480 28480 28480 28480 28480	0180-1051 0180-1051 0150-0050 0150-0050 0150-0050
A12C9 A12C10 A12C11 A12C12 A12C13	0150-0050 0150-0050 0121-0105 0180-0269 0160-2150	1 1 1 1 1	CAPACITOR-FXD 1000PF +80=20% 1KVDC CER CAPACITOR-FXD 1000PF +80=20% 1KVDC CER CAPACITOR-V TRMR-CER 9=35PF 200V PC-MTG CAPACITOR-FXD 1UF+75=10% 150VDC AL CAPACITOR-FXD 33PF +/-5% 300VDC	28480 28480 73899 0420J 28480	0150-0050 0150-0050 DV11PR35D 300105G150RA2 0160-2150
A12C14* A12C15 A12C16 A12C17 A12C18	0160-2307 0180-1051 0180-1051 0180-1051 0180-1051	3	CAPACITOR-FXD 47PF +/-5% 300VDC CAPACITOR, FXD 100 UF 16V M CAPACITOR, FXD 100 UF 16V M CAPACITOR, FXD 100 UF 16V M CAPACITOR, FXD 100 UF 16V M	28480 28480 28480 28480	0180-1051 0180-1051 0180-1051 0180-1051
A12C19 A12C20	0180-1051 0180-1051	1 1	CAPACITOR, FXD 100 UF 16V M CAPACITOR, FXD 100 UF 16V M	28480 28480	0180-1051 0180-1051
A12CR1 A12CR2 A12CR3 A12CR4 A12CR5	1901-0040 1901-0040 1901-0040 1901-0040 1901-0040	60	DIODE-SWITCHING 30V 50MA 2NS 00-35 DIODE-SWITCHING 30V 50MA 2NS 00-35 DIODE-SWITCHING 30V 50MA 2NS 00-35 DIODE-SWITCHING 30V 50MA 2NS 00-35 DIODE-SWITCHING 30V 50MA 2NS 00-35	28480 28480 28480 28480 28480	1901-0040 1901-0040 1901-0040 1901-0040 1901-0040
A12CR6 A12CR7 A12CR8 A12CR9 A12CR10	1901-0040 1901-0040 1901-0040 1901-0040 1901-0040		DIODE-SWITCHING 30V 50MA 2NS 00-35 DIODE-SWITCHING 30V 50MA 2NS 00-35 DIODE-SWITCHING 30V 50MA 2NS 00-35 DIODE-SWITCHING 30V 50MA 2NS 00-35 DIODE-SWITCHING 30V 50MA 2NS 00-35	28480 28480 28480 28480 28480	1901-0040 1901-0040 1901-0040 1901-0040 1901-0040
A12CR11 A12CR12 A12CR13 A12CR14 A12CR15	1901-0040 1901-0040 1902-3149 1901-0040 1901-0040		DIODE-SWITCHING 30V 50MA 2NS 00-35 DIODE-SWITCHING 30V 50MA 2NS 00-35 DIODE-ZNR 9.09V 5% 00-7 PD=.4W TC=+.057K DIODE-SWITCHING 30V 50MA 2NS 00-35 DIODE-SWITCHING 30V 50MA 2NS 00-35	28480 28480 0223G 28480 28480	1901-0040 1901-0040 F27256 1901-0040 1901-0040
A12CR16 A12CR17 A12CR18 A12CR19 A12CR20	1901-0040 1901-0040 1901-0040 1901-0040 1901-0040		DIODE-SWITCHING 30V 50MA 2NS 00-35 DIODE-SWITCHING 30V 50MA 2NS 00-35 DIODE-SWITCHING 30V 50MA 2NS 00-35 DIODE-SWITCHING 30V 50MA 2NS 00-35 DIODE-SWITCHING 30V 50MA 2NS 00-35	28480 28480 28480 28480 28480	1901-0040 1901-0040 1901-0040 1901-0040 1901-0040
A12CR21 A12CR22	1901-0376 1901-0376		DIODE-GEN PRP DIODE-GEN PRP	28480 28480	1901-0040
A12K1	0490-0237	1	RELAY, REED 2A	26480	0490-0237
A12Q1 A12Q2 A12Q3 A12Q4 A12Q5	1855-0223 1855-0223 1855-0223 1855-0128 1855-0223	1	TRANSISTOR J-FET N-CHAN D-MODE SI TRANSISTOR J-FET N-CHAN D-MODE SI TRANSISTOR J-FET N-CHAN D-MODE SI TRANSISTOR J-FET N-CHAN SI TRANSISTOR J-FET N-CHAN D-MODE SI	28480	
A12Q6 A12Q7 A12Q8 A12Q9 A12Q10	1855-0223 1855-0223 1855-0223 1855-0223 1855-0223		TRANSISTOR J-FET N-CHAN D-MODE SI TRANSISTOR J-FET N-CHAN D-MODE SI TRANSISTOR J-FET N-CHAN D-MODE SI TRANSISTOR J-FET N-CHAN D-MODE SI TRANSISTOR J-FET N-CHAN D-MODE SI		
A12Q11 A12Q12 A12Q13 A12Q14 A12Q15	1855-0223 5080-3078 5080-3078 5080-3835 1854-0013	6 1	TRANSISTOR J-FET N-CHAN D-MODE SI TRANSISTOR NPN SI PD=300MW FT=200MHZ TRANSISTOR NPN SI PD=300MW FT=200MHZ TRANSISTOR J-FET 2N5245 N-CHAN D-MODE SI TRANSISTOR NPN 2N2218A SI TO-5 PD=800MW	28480 28480 0169H 0203G	1854-0071 1854-0071 2N5245 2N2218A
A12Q16 A12Q17 A12Q18 A12Q19 A12Q20	1853-0012 1853-0020 1853-0020 1853-0020 5080-3078	2	TRANSISTOR PNP 2N2904A SI TO-39 PD=600MW TRANSISTOR PNP SI PD=300MW FT=150MHZ TRANSISTOR PNP SI PD=300MW FT=150MHZ TRANSISTOR PNP SI PD=300MW FT=150MHZ TRANSISTOR NPN SI PD=300MW FT=200MHZ	0169H 28480 28480 28480 28480	2N2904A 1853-0020 1853-0020 1853-0020 1854-0071
A12Q21 A12Q22 A12Q23	1853-0020 1853-0020 1853-0020		TRANSISTOR PNP SI PD=300MW FT=150MHZ TRANSISTOR PNP SI PD=300MW FT=150MHZ TRANSISTOR PNP SI PD=300MW FT=150MHZ	28480 28480 28480	1853-0020 1853-0020 1853-0020

See introduction to this section for ordering information

Table 6-3. Replaceable Parts (Cont'd).

Reference Designation	HP Part Number	Qty	Description	Mfr Code	Mfr Part Number
A12R1	2100-2514	1	RESISTOR-TRMR 20K 10X C SIDE=ADJ 1-TRN	0365A	ET50W203
A12R2	0683-1055	35	RESISTOR 1M 5% .25W FC TC=+800/+900	0160G	CB1055
A12R3	0683-1055		RESISTOR 1M 5% .25W FC TC=+800/+900	0160G	CB1055
A12R4	0698-2298	1	RESISTOR 10 .05% .33W	28480	0698-2298
A12R5	0698-2294	1	RESISTOR 100 .1 .05%	28480	0698-2294
A12R6	0698-2296	1	RESISTOR 1010.1 .05%	28480	0698-2296
A12R7	0698-2214	1	RESISTOR-FXD 10.0K OHM 0.05% 1/8W MF	28480	0698-2214
A12R8	0698-7847	1	RESISTOR 1.111K .1% .125W F TC=0+-100		
A12R9	0698-2225	1	RESISTOR-FXD 90.0K OHM 0.05% 1/8W MF	28480	0698-2225
A12R10	0698-3329	1	RESISTOR 10K .5% .125W F TC=0+-100	03888	PME55=1/8-T0=1002=D
A12R11	0683-3335		RESISTOR 33K 5% .25W FC TC=+400/+800	0160G	CB3335
A12R12	0683-4705	4	RESISTOR 47 5% .25W FC TC=+400/+500	0160G	CB4705
A12R13	0683-4705		RESISTOR 47 5% .25W FC TC=+400/+500	0160G	CB4705
A12R14	0683-1055		RESISTOR 1M 5% .25W FC TC=+800/+900	0160G	CB1055
A12R15	0683-1055		RESISTOR 1M 5% .25W FC TC=+800/+900	0160G	CB1055
A12R16	0683-1055		RESISTOR 1M 5% .25W FC TC=+800/+900	0160G	CB1055
A12R17	0683-1055		RESISTOR 1M 5% .25W FC TC=+800/+900	0160G	CB1055
A12R18	0683-1055		RESISTOR 1M 5% .25W FC TC=+800/+900	0160G	CB1055
A12R19	0683-1055		RESISTOR 1M 5% .25W FC TC=+800/+900	0160G	CB1055
A12R20	0683-1055		RESISTOR 1M 5% .25W FC TC=+800/+900	0160G	CB1055
A12R21	0683-1055		RESISTOR 1M 5% .25W FC TC=+800/+900	0160G	CB1055
A12R22	0683-1055		RESISTOR 1M 5% .25W FC TC=+800/+900	0160G	CB1055
A12R23	0683-2225		RESISTOR 2.2K 5% .25W FC TC=-400/+800		
A12R24	0683-2225		RESISTOR 2.2K 5% .25W FC TC=-400/+800		
A12R25	0683-2225		RESISTOR 2.2K 5% .25W FC TC=-400/+800		
A12R26	0683-2225		RESISTOR 2.2K 5% .25W FC TC=-400/+800		
A12R27	0683-2225		RESISTOR 2.2K 5% .25W FC TC=-400/+800		
A12R28	0683-1035	21	RESISTOR 10K 5% .25W FC TC=+400/+700	0160G	CB1035
A12R29	0683-5655		RESISTOR 5.6M 5% .25W FC TC=+900/+1100	0160G	CB5655
A12R30	0757-0442	2	RESISTOR 10K 1% .25X FC TC=+400/+700		
A12R31	0757-0433	4	RESISTOR 3.32K 1% .125W FC TC=-400/+700		
A12R32	0683-1065	1	RESISTOR 10M 5% .25W FC TC=+900/+1100	0160G	CB1065
A12R33	0683-1055		RESISTOR 1M 5% .25W FC TC=+800/+900	0160G	CB1055
A12R34	0757-0394	2	RESISTOR 51.1 1% .125W F TC=0+-100	03298	C4=1/8-T0=51K1-F
A12R35	0683-1035		RESISTOR 10K 5% .25W FC TC=+400/+700	0160G	CB1035
A12R36	0683-0275	2	RESISTOR 2.7 5% .25W FC TC=+400/+500	0160G	CB2765
A12R37	0683-4705		RESISTOR 47 5% .25W FC TC=+400/+500	0160G	CB4705
A12R38	0683-4705		RESISTOR 47 5% .25W FC TC=+400/+500	0160G	CB4705
A12R39	0757-0494		RESISTOR 51.1 1% .125W F TC=0+-100	03298	C4=1/8-T0=51K1-F
A12R40	0683-1035		RESISTOR 10K 5% .25W FC TC=+400/+700	0160G	CB1035
A12R41	0683-0275		RESISTOR 2.7 5% .25W FC TC=+400/+500	0160G	CB2765
A12R42	0757-1090	2	RESISTOR 261 1% .5W F TC=0+-100	0299E	HF7C1/2-T0=261H-F
A12R43	0757-1090		RESISTOR 261 1% .5W F TC=0+-100	0299E	HF7C1/2-T0=261H-F
A12R44	0683-3335		RESISTOR 33K 5% .25W FC TC=+400/+800	0160G	CB3335
A12R45	0683-3335		RESISTOR 33K 5% .25W FC TC=+400/+800	0160G	CB3335
A12R46	0683-1035		RESISTOR 10K 5% .25W FC TC=+400/+800		
A12R47	0683-1035		RESISTOR 10K 5% .25W FC TC=+400/+800		
A12R48	0683-1035		RESISTOR 10K 5% .25W FC TC=+400/+800		
A12R49	0683-1035		RESISTOR 10K 5% .25W FC TC=+400/+800		
A12R50	0683-1035		RESISTOR 10K 5% .25W FC TC=+400/+800		
A12R51	0698-4105		RESISTOR 13.3 1% .25W		
A12R52	0757-0401		RESISTOR 100 1% .125W		
A12U1	1826-0326		IC OP AMP	07933	RC4558DN
A12U2	1826-0089	1	IC 2525 OP AMP	03791	HA2-2525-5
A13	04262-66513	1	PROCESS AMPLIFIER BOARD ASSEMBLY	28480	04262-66513
	04262-26513	1	PC BOARD, BLANK	28480	04262-26513
A13C1+	0121-0036		CAPACITOR-V TRMR-CER 5.5-18pF		
			*FACTORY SELECTED PART		
A13C2	0160-1586	3	CIFXD MY 0.1 UF 10% 100VDCW	28480	0160-1586
A13C3	0160-2254	1	CAPACITOR-FXD 7.5PF +-25PF 500VDC	28480	0160-2254
A13C4	0160-1586		CIFXD MY 0.1 UF 10% 100VDCW	28480	0160-1586
A13C5*	0160-2261		CAPACITOR-FXD 15pF		
A13C6			NOT ASSIGNED		
A13C7	0180-1051		CAPACITOR, FXD 100 UF 16V M	28480	0180-1051
A13C8	0180-1051		CAPACITOR, FXD 100 UF 16V M	28480	0180-1051
A13C9	0160-2055	8	CAPACITOR-FXD .01UF +80-20% 100VDC CER	28480	0160-2055
A13C10	0160-2055		CAPACITOR-FXD .01UF +80-20% 100VDC CER	28480	0160-2055
A13C11	0180-1051		CAPACITOR, FXD 100 UF 16V M	28480	0180-1051
A13C12	0180-1051		CAPACITOR, FXD 100 UF 16V M	28480	0180-1051
A13C13	0160-2055		CAPACITOR-FXD .01UF +80-20% 100VDC CER	28480	0160-2055
A13C14	0160-2055		CAPACITOR-FXD .01UF +80-20% 100VDC CER	28480	0160-2055
A13C15	0150-0050		CAPACITOR-FXD 1000PF +80-20% 1KVDC CER	28480	0150-0050
A13C16	0140-0200		CAPACITOR-FXD 390PF +-5% 300VDC MICA0+70	72136	DM15F391J0300WV1CR
A13C17	0160-2055		CAPACITOR-FXD .01UF +80-20% 100VDC CER	28480	0160-2055
A13C18	0160-2055		CAPACITOR-FXD .01UF +80-20% 100VDC CER	28480	0160-2055
A13C19	0180-1051		CAPACITOR, FXD 100 UF 16V M	28480	0180-1051

See introduction to this section for ordering information

Table 6-3. Replaceable Parts (Cont'd).

Reference Designation	HP Part Number	Qty	Description	Mfr Code	Mfr Part Number
A13C20	0160-1051		CAPACITOR, FXD 100 UF 16V M	28480	0160-1051
A13C21	0160-2055		CAPACITOR-FXD .01UF +80-20% 100VDC CER	28480	0160-2055
A13C22	0160-2055		CAPACITOR-FXD .01UF +80-20% 100VDC CER	28480	0160-2055
A13C23*	0160-0134		CAPACITOR-FXD 220PF 5% 200V		
A13CR1	1901-0033	2	DIODE-GEN PRP 180V 200MA DO-7	28480	1901-0033
A13CR2	1901-0033		DIODE-GEN PRP 180V 200MA DO-7	28480	1901-0033
A13CR3	1901-0040		DIODE-SWITCHING 30V 50MA 2NS DO-35	28480	1901-0040
A13CR4	1901-0040		DIODE-SWITCHING 30V 50MA 2NS DO-35	28480	1901-0040
A13CR5	1901-0040		DIODE-SWITCHING 30V 50MA 2NS DO-35	28480	1901-0040
A13CR6	1901-0040		DIODE-SWITCHING 30V 50MA 2NS DO-35	28480	1901-0040
A13CR7	1901-0040		DIODE-SWITCHING 30V 50MA 2NS DO-35	28480	1901-0040
A13CR8	1901-0040		DIODE-SWITCHING 30V 50MA 2NS DO-35	28480	1901-0040
A13CR9	1901-0040		DIODE-SWITCHING 30V 50MA 2NS DO-35	28480	1901-0040
A13CR10	1901-0040		DIODE-SWITCHING 30V 50MA 2NS DO-35	28480	1901-0040
A13CR11	1901-0040		DIODE-SWITCHING 30V 50MA 2NS DO-35	28480	1901-0040
A13CR12	1901-0040		DIODE-SWITCHING 30V 50MA 2NS DO-35	28480	1901-0040
A13CR13	1901-0040		DIODE-SWITCHING 30V 50MA 2NS DO-35	28480	1901-0040
A13CR14	1901-0040		DIODE-SWITCHING 30V 50MA 2NS DO-35	28480	1901-0040
A13CR15	1902-0041	6	DIODE-ZNR 5.11V 5% DO-7 PD=.4W TC=-.009%	0203G	SZ 10939-98
A13CR16	1902-0041		DIODE-ZNR 5.11V 5% DO-7 PD=.4W TC=-.009%	0203G	SZ 10939-98
A13CR17	1902-0049	3	DIODE-ZNR 6.19V 5% DO-7 PD=.4W TC=-.022%	0223G	FZ7240
A13CR18	1901-0040		DIODE-SWITCHING 30V 50MA 2NS DO-35	28480	1901-0040
A13CR19	1901-0040		DIODE-SWITCHING 30V 50MA 2NS DO-35	28480	1901-0040
A13CR20	1902-3149		DIODE-ZNR 9.09V 5% DO-7 PD=.4W TC=-.057%	0223G	FZ7256
A1301	5080-3830		TRANSISTOR J-FET N-CHAN D-MODE SI		
A1302	5080-3830		TRANSISTOR J-FET N-CHAN D-MODE SI		
A1303	5080-3830		TRANSISTOR J-FET N-CHAN D-MODE SI		
A1304	5080-3830		TRANSISTOR J-FET N-CHAN D-MODE SI		
A1305	5080-3830		TRANSISTOR J-FET N-CHAN D-MODE SI		
A1306	5080-3830		TRANSISTOR J-FET N-CHAN D-MODE SI	28480	1855-0091
A1307	1853-0020		TRANSISTOR PNP SI PD=300MW FT=150MHZ	28480	1853-0020
A1308	1853-0020		TRANSISTOR PNP SI PD=300MW FT=150MHZ	28480	1853-0020
A1309	1853-0020		TRANSISTOR PNP SI PD=300MW FT=150MHZ	28480	1853-0020
A13010	1853-0020		TRANSISTOR PNP SI PD=300MW FT=150MHZ	28480	1853-0020
A13011	1853-0020		TRANSISTOR PNP SI PD=300MW FT=150MHZ	28480	1853-0020
A13012	1853-0020		TRANSISTOR PNP SI PD=300MW FT=150MHZ	28480	1853-0020
A13013	1853-0020		TRANSISTOR PNP SI PD=300MW FT=150MHZ	28480	1853-0020
A13014	1853-0020		TRANSISTOR PNP SI PD=300MW FT=150MHZ	28480	1853-0020
A13015	1853-0020		TRANSISTOR PNP SI PD=300MW FT=150MHZ	28480	1853-0020
A13016	1855-0062		TRANSISTOR J-FET N-CHAN D-MODE SI	28480	1855-0062
A13017	1855-0062		TRANSISTOR J-FET N-CHAN D-MODE SI	28480	1855-0062
A13018	1855-0062		TRANSISTOR J-FET N-CHAN D-MODE SI	28480	1855-0062
A13019	1855-0062		TRANSISTOR J-FET N-CHAN D-MODE SI	28480	1855-0062
A13R1	2100-2516	4	RESISTOR-TMR 100K 10% C SIDE-ADJ 1-TRN	73138	62-231-1
A13R2	2100-2516		RESISTOR-TMR 100K 10% C SIDE-ADJ 1-TRN	73138	62-231-1
A13R3	0683-1035		RESISTOR 10K 5% .25W FC TC=-400/+700	0160G	CB1035
A13R4	0683-1035		RESISTOR 10K 5% .25W FC TC=-400/+700	0160G	CB1035
A13R5	0683-1055		RESISTOR 1M 5% .25W FC TC=-800/+900	0160G	CB1055
A13R6	0698-2206	2	RESISTOR-FXD 100 OHM 0.05% 1/8W MF	28480	0698-2206
A13R7	0698-2207	2	RESISTOR-FXD 900 OHM 0.05% 1/8W MF	28480	0698-2207
A13R8	0683-1055		RESISTOR 1M 5% .25W FC TC=-800/+900	0160G	CB1055
A13R9	0698-2206		RESISTOR-FXD 100 OHM 0.05% 1/8W MF	28480	0698-2206
A13R10	0698-2207		RESISTOR-FXD 900 OHM 0.05% 1/8W MF	28480	0698-2207
A13R11	0683-1055		RESISTOR 1M 5% .25W FC TC=-800/+900	0160G	CB1055
A13R12	0698-2297	4	RESISTOR 3.01K .05%	28480	0698-2297
A13R13	0698-2297		RESISTOR 3.01K .05%	28480	0698-2297
A13R14	0698-2297		RESISTOR 3.01K .05%	28480	0698-2297
A13R15	0698-2297	2	NOT ASSIGNED	03298	C4-1/8-T0-1333-F
A13R16	0698-2297		RESISTOR 3.01K .05%	28480	0698-2297
A13R17	0683-1055		RESISTOR 1M 5% .25W FC TC=-800/+900	0160G	CB1055
A13R18	0698-2297		RESISTOR 3.01K .05%	28480	0698-2297
A13R19	0698-2297		RESISTOR 3.01K .05%	28480	0698-2297
A13R20	0698-2297		RESISTOR 3.01K .05%	28480	0698-2297
A13R21			NOT ASSIGNED		
A13R22			NOT ASSIGNED	03298	C4-1/8-T0-1333-F
A13R23	0698-2297		RESISTOR 3.01K .05%	28480	0698-2297
A13R24	0683-1035		RESISTOR 10K 5% .25W FC TC=-400/+700	0160G	CB1035
A13R25	0683-1035	6	RESISTOR 10K 5% .25W FC TC=-400/+700	0160G	CB1035
A13R26			NOT ASSIGNED		
A12R27	0683-5605		RESISTOR 10 5% .25W FC TC=-400/+500	0160G	CB1005
A13R28	0683-5605		RESISTOR 10 5% .25W FC TC=-400/+500	0160G	CB1005
A13R29	0683-1025		RESISTOR 1K 5% .25W FC TC=-400/+600	0160G	CB1025
A13R30	0683-2235	22	RESISTOR 22K 5% .25W FC TC=-400/+800	0160G	CB2235
A13R31	0683-5605		RESISTOR 10 5% .25W FC TC=-400/+500	0160G	CB1005

See introduction to this section for ordering information

Table 6-3. Replaceable Parts (Cont'd).

Reference Designation	HP Part Number	Qty	Description	Mfr Code	Mfr Part Number
A13R32	0683-5605		RESISTOR 10 5% .25W FC TC=-400/+500	0160G	CR1005
A13R33	0683-1055		RESISTOR 1M 5% .25W FC TC=-800/+900	0160G	CR1055
A13R34	0683-1055		RESISTOR 1M 5% .25W FC TC=-800/+900	0160G	CR1055
A13R35	0683-1055		RESISTOR 1M 5% .25W FC TC=-800/+900	0160G	CR1055
A13R36	0683-1055		RESISTOR 1M 5% .25W FC TC=-800/+900	0160G	CR1055
A13R37	0683-1055		RESISTOR 1M 5% .25W FC TC=-800/+900	0160G	CR1055
A13R38	0683-1055		RESISTOR 1M 5% .25W FC TC=-800/+900	0160G	CR1055
A13R39	0683-1055		RESISTOR 1M 5% .25W FC TC=-800/+900	0160G	CR1055
A13R40	0683-1055		RESISTOR 1M 5% .25W FC TC=-800/+900	0160G	CR1055
A13R41	0683-1025		RESISTOR 1K 5% .25W FC TC=-400/+600	0160G	CR1025
A13R42	0683-1035		RESISTOR 10K 5% .25W FC TC=-400/+700	0160G	CR1035
A13R43	0683-1235	4	RESISTOR 12K 5% .25W FC TC=-400/+800	0160G	CR1235
A13R44	0683-1235		RESISTOR 12K 5% .25W FC TC=-400/+800	0160G	CR1235
A13R45	0683-1235		RESISTOR 12K 5% .25W FC TC=-400/+800	0160G	CR1235
A13R46	0683-1235		RESISTOR 12K 5% .25W FC TC=-400/+800	0160G	CR1235
A13R47	0683-1055		RESISTOR 1M 5% .25W FC TC=-800/+900	0160G	CR1055
A13R48	0683-2235		RESISTOR 22K 5% .25W FC TC=-400/+800	0160G	CR2235
A13R49	0683-2235		RESISTOR 22K 5% .25W FC TC=-400/+800	0160G	CR2235
A13R50	0683-2235		RESISTOR 22K 5% .25W FC TC=-400/+800	0160G	CR2235
A13R51	0683-2235		RESISTOR 22K 5% .25W FC TC=-400/+800	0160G	CR2235
A13R52	0683-2235		RESISTOR 22K 5% .25W FC TC=-400/+800	0160G	CR2235
A13R53	0683-2235		RESISTOR 22K 5% .25W FC TC=-400/+800	0160G	CR2235
A13R54	0683-2235		RESISTOR 22K 5% .25W FC TC=-400/+800	0160G	CR2235
A13R55	0683-2235		RESISTOR 22K 5% .25W FC TC=-400/+800	0160G	CR2235
A13R56	0683-2235		RESISTOR 22K 5% .25W FC TC=-400/+800	0160G	CR2235
A13R57	0683-2235		RESISTOR 22K 5% .25W FC TC=-400/+800	0160G	CR2235
A13R58	0683-2235		RESISTOR 22K 5% .25W FC TC=-400/+800	0160G	CR2235
A13R59	0683-2235		RESISTOR 22K 5% .25W FC TC=-400/+800	0160G	CR2235
A13R60	0683-2235		RESISTOR 22K 5% .25W FC TC=-400/+800	0160G	CR2235
A13R61	0683-2235		RESISTOR 22K 5% .25W FC TC=-400/+800	0160G	CR2235
A13R62	0683-2235		RESISTOR 22K 5% .25W FC TC=-400/+800	0160G	CR2235
A13R63	0683-2235		RESISTOR 22K 5% .25W FC TC=-400/+800	0160G	CR2235
A13R64	0683-2235		RESISTOR 22K 5% .25W FC TC=-400/+800	0160G	CR2235
A13R65	0683-2235		RESISTOR 22K 5% .25W FC TC=-400/+800	0160G	CR2235
A13R66	2100-2516		RESISTOR-TRMR 100K 10% C SIDE=ADJ 1-TRN	7313A	02-231-1
A13R67	2100-2516		RESISTOR-TRMR 100K 10% C SIDE=ADJ 1-TRN	7313B	02-231-1
A13R68	0683-1025		RESISTOR 1K 5% .25W FC TC=-400/+600	0160G	CR1025
A13R69	0683-1045	3	RESISTOR 100K 5% .25W FC TC=-400/+800	0160G	CR1045
A13R70	0683-1025		RESISTOR 1K 5% .25W FC TC=-400/+600	0160G	CR1025
A13R71	0683-3935	2	RESISTOR 39K 5% .25W FC TC=-400/+800	0160G	CR3945
A13R72	0683-1035		RESISTOR 10K 5% .25W FC TC=-400/+700	0160G	CR1035
A13R73	0683-1045		RESISTOR 100K 5% .25W FC TC=-400/+800	0160G	CR1045
A13R74	0683-1035		RESISTOR 10K 5% .25W FC TC=-400/+700	0160G	CR1035
A13R75	0683-1025		RESISTOR 1K 5% .25W FC TC=-400/+600	0160G	CR1025
A13R76	0683-1025		RESISTOR 1K 5% .25W FC TC=-400/+600	0160G	CR1025
A13R77	0683-1025		RESISTOR 1K 5% .25W FC TC=-400/+600	0160G	CR1025
A13R78	0683-2235		RESISTOR 22K 5% .25W FC TC=-400/+800	0160G	CR2235
A13R79	0683-4725		RESISTOR 4.7K 5% .25W FC TC=-400/+700	0160G	CR4725
A13R80	0683-1025		RESISTOR 1K 5% .25W FC TC=-400/+600	0160G	CR1025
A13R81	0683-1055		RESISTOR 1M 5% .25W FC TC=-800/+900	0160G	CR1055
A13R82	0683-1825	5	RESISTOR 1.8K 5% .25W FC TC=-400/+700	0160G	CR1825
A13R83	0683-2235		RESISTOR 22K 5% .25W FC TC=-400/+800	0160G	CR2235
A13R84	0683-1825		RESISTOR 1.8K 5% .25W FC TC=-400/+700	0160G	CR1825
A13R85	0683-2235		RESISTOR 22K 5% .25W FC TC=-400/+800	0160G	CR2235
A13R86	0683-1055		RESISTOR 1M 5% .25W FC TC=-800/+900	0160G	CR1055
A13R87	0683-1025		RESISTOR 1K 5% .25W FC TC=-400/+600	0160G	CR1025
A13R88	0683-1015	7	RESISTOR 100 5% .25W FC TC=-400/+500	0160G	CR1015
A13R89	0683-1015		RESISTOR 100 5% .25W FC TC=-400/+500	0160G	CR1015
A13U1	5080-3069		IC OP AMP	0340F	LF356H
A13U2	5080-3069		IC OP AMP	0340F	LF356H
A13U3	1A26-0217	2	IC OP AMP	07933	RC4558T
A13U4	1A26-0217		IC OP AMP	07933	RC4558T
A13U5	1A26-0326		IC OP AMP	07933	RC4558UN
A13U6	1A26-0326		IC OP AMP	07933	RC4558UN
A13U7	1A20-0321	2	IC 710 COMPARATOR	0223G	710HC
A13U8	1A20-0125	1	IC 711 COMPARATOR	0223G	711HC
A14	04262-66514	1	PHASE DETECTOR & INTEGRATOR BOARD ASSY	28480	04262-66514
	04262-26514	1	PC BOARD, BLANK	28480	04262-26514
A14C1	0160-1603	2	CtFXD MY 1 UF 10% 100VDCW	28480	0160-1603
A14C2	0160-1674	1	CAPACITOR .33 UF 5% 200VDCW	28480	0160-1674
A14C3	0160-1603		CtFXD MY 1 UF 10% 100VDCW	28480	0160-1603
A14C4	0150-0075	1	CAPACITOR-FXD 4700PF +100-0% 500VDC CER	28480	0150-0075
A14C5*	0160-2307	1	CAPACITOR-FXD 47PF +-5% 300VDC *FACTORY SELECTED PART	28480	0160-2307

See introduction to this section for ordering information

Table 6-3. Replaceable Parts (Cont'd).

Reference Designation	HP Part Number	Qty	Description	Mfr Code	Mfr Part Number
A14C6	0160-0207	2	CIFXD MY 0,01 UF 5% 200VDCW	28480	0160-0207
A14C7	0160-1587	1	CAPACITOR, FXD POLY 0,33 UF 5% 200WVDC	28480	0160-1587
A14C8	0170-0040	2	CIFXD MY 0,047 UF 5% 200VDCW	28480	0170-0040
A14C9	0170-0040		CIFXD MY 0,047 UF 5% 200VDCW	28480	0170-0040
A14C10	0160-1586		CIFXD MY 0,1 UF 10% 100VDCW	28480	0160-1586
A14C11	0160-0207		CIFXD MY 0,01 UF 5% 200VDCW	28480	0160-0207
A14C12	0160-5819		CAPACITOR, 3300 PF 50V		
A14C13	0160-0127	2	CAPACITOR-FXD 1UF +-20% 25VDC CER	28480	0160-0127
A14C14	0180-1052		CAPACITOR 220 UF 6,3V M	28480	0180-1052
A14C15	0160-2055	28	CAPACITOR-FXD ,01UF +80-20% 100VDC CER		
A14C16	0160-2055		CAPACITOR-FXD ,01UF +80-20% 100VDC CER		
A14C17	0160-2055		CAPACITOR-FXD ,01UF +80-20% 100VDC CER		
A14C18	0160-2055		CAPACITOR-FXD ,01UF +80-20% 100VDC CER		
A14C19			NOT ASSIGNED		
A14C20			NOT ASSIGNED		
A14C21	0180-1051		CAPACITOR, FXD 100 UF 16V M	28480	0180-1051
A14C22	0180-1051		CAPACITOR, FXD 100 UF 16V M	28480	0180-1051
A14C23	0180-1052		CAPACITOR 220 UF 6,3V M	28480	0180-1052
A14C24	0160-0127		CAPACITOR-FXD 1UF +-20% 25VDC CER	28480	0160-0127
A14C24			NOT ASSIGNED		
A14C25	0160-2261	1	C-FXD 15dF 5% 500V		
A14C26			NOT ASSIGNED		
A14C27			NOT ASSIGNED		
A14C28			NOT ASSIGNED		
A14C29			NOT ASSIGNED		
A14C30			NOT ASSIGNED		
A14C31			NOT ASSIGNED		
A14C31			NOT ASSIGNED		
A14CR1	1901-0040		DIODE-SWITCHING 30V 50MA 2NS DO-35	28480	1901-0040
A14CR2	1901-0040		DIODE-SWITCHING 30V 50MA 2NS DO-35	28480	1901-0040
A14CR3	1902-3059	1	DIODE-ZNR 3,83V 5% DO-7 PDS,4W TC=+.051%	0203G	SZ 10939-82
A14CR4	1902-0049		DIODE-ZNR 6,19V 5% DO-7 PDS,4W TC=+.022%	0223G	FZ7240
A14CR5	1901-0040		DIODE-SWITCHING 30V 50MA 2NS DO-35	28480	1901-0040
A14CR6			NOT ASSIGNED		
A14CR7	1901-0040		DIODE-SWITCHING 30V 50MA 2NS DO-35	28480	1901-0040
A14CR8	1902-3149		DIODE-ZNR 9,09V 5% DO-7 PDS,4W TC=+.057%	0223G	FZ7256
A14CR9	1902-3074	1	DIODE-ZNR 4,32V 2% DO-7 PDS,4W TC=+.035%	0203G	SZ 10939-78
A14CR10	1901-0040		DIODE-SWITCHING 30V 50MA 2NS DO-35	28480	1901-0040
A14CR11	1901-0040		DIODE-SWITCHING 30V 50MA 2NS DO-35	28480	1901-0040
A14CR12	1901-0040		DIODE-SWITCHING 30V 50MA 2NS DO-35	28480	1901-0040
A14CR13	1901-0040		DIODE-SWITCHING 30V 50MA 2NS DO-35	28480	1901-0040
A14CR14	1902-0048	2	DIODE-ZNR 6,81V 5% DO-7 PDS,4W TC=+.043%	0223G	FZ7244
A14CR15	1901-0040		DIODE-SWITCHING 30V 50MA 2NS DO-35	28480	1901-0040
A14CR16	1901-0040		DIODE-SWITCHING 30V 50MA 2NS DO-35	28480	1901-0040
A14CR17	1902-0049		DIODE-ZNR 6,19V 5% DO-7 PDS,4W TC=+.022%	0223G	FZ7240
A14CR18	1901-0040		DIODE-SWITCHING 30V 50MA 2NS DO-35	28480	1901-0040
A14CR19	1901-0040		DIODE-SWITCHING 30V 50MA 2NS DO-35	28480	1901-0040
A14CR20	1902-3149		DIODE-ZNR 9,09V 5% DO-7 PDS,4W TC=+.057%	0223G	FZ7256
A14CR22	1902-3149		DIODE-ZNR 9,09V 5% DO-7 PDS,4W TC=+.057%	0223G	FZ7256
A14CR23	1902-3125	1	DIODE-ZNR 6,98V 2% DO-7 PDS,4W TC=+.045%	0223G	FZ7445
A14Q1	1855-0062		TRANSISTOR J-FET N-CHAN D-MODE SI	28480	1855-0062
A14Q2	5080-3830		TRANSISTOR J-FET N-CHAN D-MODE SI	28480	1855-0091
A14Q3	5080-3830		TRANSISTOR J-FET N-CHAN D-MODE SI	28480	1855-0091
A14Q4	1855-0119	1	TRANSISTOR J-FET N-CHAN SI	28480	1855-0119
A14Q5	5080-3835		TRANSISTOR J-FET 2N5245 N-CHAN D-MODE SI	0169H	2N5245
A14Q6	1853-0020		TRANSISTOR PNP SI PDS300MW FT=150MHZ	28480	1853-0020
A14Q7	1854-0023	1	TRANSISTOR NPN SI TU=18 PDS360MW	28480	1854-0023
A14Q8	5080-3078		TRANSISTOR NPN SI PDS300MW FT=200MHZ	28480	1854-0071
A14Q9	5080-3830		TRANSISTOR J-FET N-CHAN D-MODE SI	28480	1855-0091
A14Q10	1853-0020		TRANSISTOR PNP SI PDS300MW FT=150MHZ	28480	1853-0020
A14Q11	5080-3078		TRANSISTOR NPN SI PDS300MW FT=200MHZ	28480	1854-0071
A14Q12	1853-0020		TRANSISTOR PNP SI PDS300MW FT=150MHZ	28480	1853-0020
A14Q13	5080-3078		TRANSISTOR NPN SI PDS300MW FT=200MHZ	28480	1854-0071
A14Q14	1853-0020		TRANSISTOR PNP SI PDS300MW FT=150MHZ	28480	1853-0020
A14Q15	1853-0020		TRANSISTOR PNP SI PDS300MW FT=150MHZ	28480	1853-0020
A14Q16	1855-0062		TRANSISTOR J-FET N-CHAN D-MODE SI	28480	1855-0062
A14Q17	1855-0062		TRANSISTOR J-FET N-CHAN D-MODE SI	28480	1855-0062
A14Q18	5080-3830		TRANSISTOR J-FET N-CHAN D-MODE SI	28480	1855-0091
A14Q19	5080-3835		TRANSISTOR J-FET 2N5245 N-CHAN D-MODE SI	0169H	2N5245
A14Q20	5080-3835		TRANSISTOR J-FET 2N5245 N-CHAN D-MODE SI	0169H	2N5245
A14Q21	1853-0034	2	TRANSISTOR PNP SI TU=18 PDS360MW	28480	1853-0034
A14Q22	5080-3835		TRANSISTOR J-FET 2N5245 N-CHAN D-MODE SI	0169H	2N5245
A14Q23	5080-3835		TRANSISTOR J-FET 2N5245 N-CHAN D-MODE SI	0169H	2N5245
A14Q24	1853-0034		TRANSISTOR PNP SI TU=18 PDS360MW	28480	1853-0034
A14Q25	1853-0020		TRANSISTOR PNP SI PDS300MW FT=150MHZ	28480	1853-0020

See introduction to this section for ordering information

Table 6-3. Replaceable Parts (Cont'd).

Reference Designation	HP Part Number	Qty	Description	Mfr Code	Mfr Part Number
A14Q26	1853-0020		TRANSISTOR PNP SI PD=300MH FT=150MHZ	28480	1853-0020
A14R1	2100-2522	2	RESISTOR-TRMR 10K 10% C SIDE=ADJ 1=TRN	0365A	ET50X103
A14R2	0683-1525	1	RESISTOR 1.5K 5% .25W FC TC=-400/+700	0160G	CB1525
A14R3	0683-1055		RESISTOR 1M 5% .25W FC TC=-800/+900	0160G	CB1055
A14R4	0683-4725		RESISTOR 4.7K 5% .25W FC TC=-400/+700	0160G	CB4725
A14R5	0757-1094	1	RESISTOR 1.47K 1% .125W F TC=0+-100	0329B	C4=1/8-T0=1471-F
A14R6	0757-0290	1	RESISTOR 6.19K 1% .125W F TC=0+-100	0299E	MF4C1/8-T0=6191-F
A14R7	0757-0349	1	RESISTOR 22.6K 1% .125W F TC=0+-100	0329B	C4=1/8-T0=2262-F
A14R8	0683-1055		RESISTOR 1M 5% .25W FC TC=-800/+900	0160G	CB1055
A14R9	0683-1055		RESISTOR 1M 5% .25W FC TC=-800/+900	0160G	CB1055
A14R10	0683-1055		RESISTOR 1M 5% .25W FC TC=-800/+900	0160G	CB1055
A14R11	0683-1535		RESISTOR 15K 5% .25W FC TC=-400/+800	0160G	CB1535
A14R12	0698-3157	2	RESISTOR 19.6K 1% .125W F TC=0+-100	0329B	C4=1/8-T0=1962-F
A14R13	0757-0465		RESISTOR 100K 1% .125W F TC=0+-100	0329B	C4=1/8-T0=1003-F
A14R14	0683-5655		RESISTOR 5.6M 5% .25W FC TC=-900/+1100	0160G	CB5655
A14R15	2100-2522		RESISTOR-TRMR 10K 10% C SIDE=ADJ 1=TRN	0365A	ET50X103
A14R16	0683-1045		RESISTOR 100K 5% .25W FC TC=-400/+800	0160G	CB1045
A14R17	0683-2225	3	RESISTOR 2.2K 5% .25W FC TC=-400/+700	0160G	CB2225
A14R18	0698-3161	1	RESISTOR 38.3K 1% .125W F TC=0+-100	0329B	C4=1/8-T0=3832-F
A14R19	0683-4745	1	RESISTOR 470K 5% .25W FC TC=-800/+900	0160G	CB4745
A14R20	0757-0416		RESISTOR 511 1% .125W F TC=0+-100	0329B	C4=1/8-T0=511R-F
A14R21	0757-0416		RESISTOR 511 1% .125W F TC=0+-100	0329B	C4=1/8-T0=511R-F
A14R22	0698-3151	1	RESISTOR 2.87K 1% .125W F TC=0+-100	0329B	C4=1/8-T0=2872-F
A14R23	0683-1055		RESISTOR 1M 5% .25W FC TC=-800/+900	0160G	CB1055
A14R24	0683-3335		RESISTOR 33K 5% .25W FC TC=-400/+800	0160G	CB3335
A14R25	0683-2745	1	RESISTOR 270K 5% .25W FC TC=-800/+900	0160G	CB2745
A14R26	0683-3335		RESISTOR 33K 5% .25W FC TC=-400/+800	0160G	CB3335
A14R27	0683-3335		RESISTOR 33K 5% .25W FC TC=-400/+800	0160G	CB3335
A14R28	0683-3335		RESISTOR 33K 5% .25W FC TC=-400/+800	0160G	CB3335
A14R29	0698-3439	1	RESISTOR 178 1% .125W F TC=0+-100	0329B	C4=1/8-T0=178R-F
A14R30	0698-3226	2	RESISTOR 6.49K 1% .125W F TC=0+-100	0329B	C4=1/8-T0=6491-F
A14R31	0698-3226		RESISTOR 6.49K 1% .125W F TC=0+-100	0329B	C4=1/8-T0=6491-F
A14R32	0683-1025		RESISTOR 1K 5% .25W FC TC=-400/+800	0160G	CB1025
A14R33	0698-4505	1	RESISTOR 71.5K 1% .125W F TC=0+-100	0329B	C4=1/8-T0=7152-F
A14R34	0683-1035		RESISTOR 10K 5% .25W FC TC=-400/+700	0160G	CB1035
A14R35	0757-0279	1	RESISTOR 3.16K 1% .125W F TC=0+-100	0329B	C4=1/8-T0=3161-F
A14R36	0698-4433	1	RESISTOR 2.26K 1% .125W F TC=0+-100	0329B	C4=1/8-T0=2261-F
A14R37	0757-0465		RESISTOR 100K 1% .125W F TC=0+-100	0329B	C4=1/8-T0=1003-F
A14R38	0683-3325		RESISTOR 3.3K 5% .25W FC TC=-400/+700	0160G	CB3325
A14R39	0698-3155		RESISTOR 4.64K 1% .125W F TC=0+-100	0329B	C4=1/8-T0=4641-F
A14R40	0757-0401	2	RESISTOR 100 1% .125W F TC=0+-100	0329B	C4=1/8-T0=101-F
A14R41	0757-0401		RESISTOR 100 1% .125W F TC=0+-100	0329B	C4=1/8-T0=101-F
A14R42	0683-1055		RESISTOR 1M 5% .25W FC TC=-800/+900	0160G	CB1055
A14R43	0683-1055		RESISTOR 1M 5% .25W FC TC=-800/+900	0160G	CB1055
A14R44	0698-3157		RESISTOR 19.6K 1% .125W F TC=0+-100	0329B	C4=1/8-T0=1962-F
A14R45	0757-0465		RESISTOR 100K 1% .125W F TC=0+-100	0329B	C4=1/8-T0=1003-F
A14R46	0683-1035		RESISTOR 10K 5% .25W FC TC=-400/+700	0160G	CB1035
A14R47	0683-1035		RESISTOR 10K 5% .25W FC TC=-400/+700	0160G	CB1035
A14R48	0683-1035		RESISTOR 10K 5% .25W FC TC=-400/+700	0160G	CB1035
A14R49	0683-3325		RESISTOR 3.3K 5% .25W FC TC=-400/+700	0160G	CB3325
A14R50	0683-3325		RESISTOR 3.3K 5% .25W FC TC=-400/+700	0160G	CB3325
A14R51	0683-3335		RESISTOR 33K 5% .25W FC TC=-400/+800	0160G	CB3335
A14R52	0683-3335		RESISTOR 33K 5% .25W FC TC=-400/+800	0160G	CB3335
A14R53	0683-3335		RESISTOR 33K 5% .25W FC TC=-400/+800	0160G	CB3335
A14R54	0683-3335		RESISTOR 33K 5% .25W FC TC=-400/+800	0160G	CB3335
A14R55	0683-3335		RESISTOR 33K 5% .25W FC TC=-400/+800	0160G	CB3335
A14R56	0683-3335		RESISTOR 33K 5% .25W FC TC=-400/+800	0160G	CB3335
A14R57	0683-4725		RESISTOR 4.7K 5% .25W FC TC=-400/+700	0160G	CB4725
A14R58	0698-4157	2	RESISTOR 10K 1% .125W F TC=0+-50	0329B	NC55
A14R59	0698-4157		RESISTOR 10K 1% .125W F TC=0+-50	0329B	NC55
A14R60	0698-6943	2	RESISTOR 20K 1% .125W F TC=0+-50	0329B	NC55
A14R61	0698-6943		RESISTOR 20K 1% .125W F TC=0+-50	0329B	NC55
A14R62	0698-0083	2	RESISTOR 1.96K 1% .25W FC TC=-400/+700		
A14R63	0757-0401	2	RESISTOR 100 1% .25W FC TC=-400/+700		
A14R64	0698-0083		RESISTOR 1.96K 1% .25W FC TC=-400/+700		
A14R65	0757-0401		RESISTOR 100 1% .25W FC TC=-400/+700		
A14R66	0683-3335		RESISTOR 33K 5% .25W FC TC=-400/+800	0160G	CB3335
A14R67	0683-1245	1	RESISTOR 120K 5% .25W FC TC=-800/+900	0160G	CB1245
A14R68	0683-4735		RESISTOR 47K 5% .25W FC TC=-400/+800	0160G	CB4735
A14R69	0683-3335		RESISTOR 33K 5% .25W FC TC=-400/+800	0160G	CB3335
A14R70	0683-4725		RESISTOR 4.7K 5% .25W FC TC=-400/+700	0160G	CB4725
A14R71	0683-2265		RESISTOR 22M 5% .25W		
A14R72	0757-1094		RESISTOR 1.47K 1% .125W		
A14U1	1826-1071	2	IC:LIN OP, AMPL, FET=INPT	28480	LF411CH
A14U2	1826-0271		IC 741 OP AMP	0340F	LM741CN
A14U3	1820-0321		IC 710 COMPARTOR	0223G	710MC
A14U4	1826-1071		IC:LIN OP, AMPL, FET=INPT	28480	LF411CH
A14U5	1826-0326		IC OP AMP	07933	RC0558DN

See introduction to this section for ordering information

Table 6-3. Replaceable Parts (Cont'd).

Reference Designation	HP Part Number	Qty	Description	Mfr Code	Mfr Part Number
A1406	1A26-0319		IC OP AMP	0340F	LF356H
A1407	1A26-0326		IC OP AMP	07933	RC45580N
A1408	1A20-0054	1	IC GATE TTL NAND QUAD 2-INP	0223G	7400PC
A1409	5080-3832	1	IC MISC TTL	0203G	MC4044P
A14010	1A26-01A0	1	IC 555	0291J	NE555V
A14011	1A20-0379	1	IC GATE TTL M AND-OR	0223G	74H52PC
A14012	1A20-0075	1	IC FF TTL J-K PULSE CLEAR DUAL	0223G	7473PC
A14013	1A20-1210	2	IC GATE TTL LS AND-OR-INV DUAL 2-INP	0169H	SN74LS51N
A14014	1A20-1210		IC GATE TTL LS AND-OR-INV DUAL 2-INP	0169H	SN74LS51N
A14015	1A20-1490	5	IC CNTR TTL LS DECD ASYNCHRO	0169H	SN74LS90N
A15			NOT ASSIGNED		
A16			NOT ASSIGNED		
A17			NOT ASSIGNED		
A18			NOT ASSIGNED		
A19			NOT ASSIGNED		
A20			NOT ASSIGNED		
A21	04262-66521	1	KEYBOARD & DISPLAY BOARD ASSEMBLY	28480	04262-66521
	04262-26521	1	PC BOARD, BLANK	28480	04262-26521
A21C1	01A0-0291		CAPACITOR-FXD 1UF+/-10% 35VDC TA	0420J	150D105X9035A2
A21C2	0160-2055		CAPACITOR-FXD .01UF +R0=20% 100VDC CER		
A21C3	0160-2055		CAPACITOR-FXD .01UF +R0=20% 100VDC CER		
A21C4	0160-2055		CAPACITOR-FXD .01UF +R0=20% 100VDC CER		
A21C5	01A0-0376	1	CAPACITOR-FXD .47UF+/-10% 35VDC TA	0420J	150D474X9035A2
A21C6	0160-0197	6	CAPACITOR-FXD 2.2UF+/-10% 20VDC TA	0420J	150D225X9020A2
A21C7	01A0-0197		CAPACITOR-FXD 2.2UF+/-10% 20VDC TA	0420J	150D225X9020A2
A21C8	01A0-0197		CAPACITOR-FXD 2.2UF+/-10% 20VDC TA	0420J	150D225X9020A2
A21C9	01A0-0197		CAPACITOR-FXD 2.2UF+/-10% 20VDC TA	0420J	150D225X9020A2
A21C10	01A0-0198	1	CAPACITOR-FXD 200PF +/-5% 300VDC MICA	72136	DM15F201J0300MV1CR
A21CR1	1901-0040		DIODE-SWITCHING 30V 50MA 2NS DO-35	28480	1901-0040
A21CR2	1901-0040		DIODE-SWITCHING 30V 50MA 2NS DO-35	28480	1901-0040
A21CR3	1901-0040		DIODE-SWITCHING 30V 50MA 2NS DO-35	28480	1901-0040
A21CR4	1901-0040		DIODE-SWITCHING 30V 50MA 2NS DO-35	28480	1901-0040
A21CR5	1901-0040		DIODE-SWITCHING 30V 50MA 2NS DO-35	28480	1901-0040
A21CR6	1901-0040		DIODE-SWITCHING 30V 50MA 2NS DO-35	28480	1901-0040
A21CR7	1901-0040		DIODE-SWITCHING 30V 50MA 2NS DO-35	28480	1901-0040
A21J1	1251-0541	2	CONNECTOR 34-PIN M RECTANGULAR	76381	3431-1002
A21Q1	1854-0019	1	TRANSISTOR NPN SJ TU-18 PD=360mw	28480	1854-0019
A21R1	0683-4715		RESISTOR 470 5% .25W FC TC=400/+600	0160G	CR4715
A21R2	0683-4715		RESISTOR 470 5% .25W FC TC=400/+600	0160G	CR4715
A21R3	0683-4715		RESISTOR 470 5% .25W FC TC=400/+600	0160G	CR4715
A21R4	0683-4715		RESISTOR 470 5% .25W FC TC=400/+600	0160G	CR4715
A21R5	0683-4715		RESISTOR 470 5% .25W FC TC=400/+600	0160G	CR4715
A21R6	0683-3305	1	RESISTOR 33 5% .25W FC TC=400/+500	0160G	CR3305
A21R7	0683-1015		RESISTOR 100 5% .25W FC TC=400/+500	0160G	CR1015
A21R8	0683-1015		RESISTOR 100 5% .25W FC TC=400/+500	0160G	CR1015
A21R9	0683-1015		RESISTOR 100 5% .25W FC TC=400/+500	0160G	CR1015
A21R10	0683-4715		RESISTOR 470 5% .25W FC TC=400/+600	0160G	CR4715
A21R11	0683-4715		RESISTOR 470 5% .25W FC TC=400/+600	0160G	CR4715
A21R12	0683-4715		RESISTOR 470 5% .25W FC TC=400/+600	0160G	CR4715
A21R13	0683-4715		RESISTOR 470 5% .25W FC TC=400/+600	0160G	CR4715
A21R14	0683-4715		RESISTOR 470 5% .25W FC TC=400/+600	0160G	CR4715
A21R15	0683-4715		RESISTOR 470 5% .25W FC TC=400/+600	0160G	CR4715
A21R16	0683-1015		RESISTOR 100 5% .25W FC TC=400/+500	0160G	CR1015
A21R17	0683-1015		RESISTOR 100 5% .25W FC TC=400/+500	0160G	CR1015
A21R18	0683-4715		RESISTOR 470 5% .25W FC TC=400/+600	0160G	CR4715
A21R19	0683-4715		RESISTOR 470 5% .25W FC TC=400/+600	0160G	CR4715
A21R20	0683-4715		RESISTOR 470 5% .25W FC TC=400/+600	0160G	CR4715
A21R21	0683-4715		RESISTOR 470 5% .25W FC TC=400/+600	0160G	CR4715
A21R22	0683-4715		RESISTOR 470 5% .25W FC TC=400/+600	0160G	CR4715
A21R23	0683-4715		RESISTOR 470 5% .25W FC TC=400/+600	0160G	CR4715
A21R24	0683-4715		RESISTOR 470 5% .25W FC TC=400/+600	0160G	CR4715
A21R25	0683-4715		RESISTOR 470 5% .25W FC TC=400/+600	0160G	CR4715

See introduction to this section for ordering information

Table 6-3. Replaceable Parts (Cont'd).

Reference Designation	HP Part Number	Qty	Description	Mfr Code	Mfr Part Number
A21R26	0683-4715		RESISTOR 470 5% .25W FC TC=400/+600	0160G	CB4715
A21R27	0683-3935		RESISTOR 39K 5% .25W FC TC=400/+800	0160G	CB3935
A21R28	0683-1035		RESISTOR 10K 5% .25W FC TC=400/+700	0160G	CB1035
A21R29	0683-1035		RESISTOR 10K 5% .25W FC TC=400/+700	0160G	CB1035
A21R30	0683-1035		RESISTOR 10K 5% .25W FC TC=400/+700	0160G	CB1035
A21R31	0683-1035		RESISTOR 10K 5% .25W FC TC=400/+700	0160G	CB1035
A21R32	1810-0164	5	NETWORK-RES 9-PIN-SIP .15-PIN-SPCG	28480	1810-0164
A21U1	1820-1415	2	IC SCHMITT-TRIG TTL LS NAND DUAL 4-INP	0169H	SN74LS13N
A21U2	1820-1279	1	IC CNTR TTL LS DECD UP/DOWN SYNCHRO	0169H	SN74LS190N
A21U3	1820-0261	1	IC MV TTL MONOSTBL		SN74121N
A21U4	1820-1200		IC INV TTL LS HEX 1-INP	0169H	SN74LS05N
A21U5	1820-1200		IC INV TTL LS HEX 1-INP	0169H	SN74LS05N
A21U6	1820-1200		IC INV TTL LS HEX 1-INP	0169H	SN74LS05N
A21U7	1820-1195	15	IC FF TTL LS D-TYPE POS=EDGE=TRIG COM	0379D	AM74LS175A
A21U8	1820-1195		IC FF TTL LS D-TYPE POS=EDGE=TRIG COM	0379D	AM74LS175A
A21U9	1820-1198	1	IC GATE TTL LS NAND QUAD 2-INP	0169H	SN74LS03N
A21U10	1820-1197	8	IC GATE TTL LS NAND QUAD 2-INP	0169H	SN74LS00N
A21U11	1820-1081	18	IC DRVR TTL BUS DRVR QUAD 1-INP	0379D	AM8726
A21U12	1820-1470	8	IC MUXR/DATA=SEL TTL LS 2-TO-1-LINE QUAD	0379D	SN74LS157N
A21U13	1820-1197		IC GATE TTL LS NAND QUAD 2-INP	0169H	SN74LS00N
A21U14	1820-1112	7	IC FF TTL LS D-TYPE POS=EDGE=TRIG	0169H	SN74LS74N
A21U15	1820-1195		IC FF TTL LS D-TYPE POS=EDGE=TRIG COM	0379D	AM74LS175A
A21U16	1820-1195		IC FF TTL LS D-TYPE POS=EDGE=TRIG COM	0379D	AM74LS175A
A21U17	1820-1195		IC FF TTL LS D-TYPE POS=EDGE=TRIG COM	0379D	AM74LS175A
A21U18	1820-1195		IC FF TTL LS D-TYPE POS=EDGE=TRIG COM	0379D	AM74LS175A
A21U19	1820-1195		IC FF TTL LS D-TYPE POS=EDGE=TRIG COM	0379D	AM74LS175A
A21U20	1820-1245	2	IC DCDR TTL LS 2-TO-4-LINE DUAL 2-INP	0169H	SN74LS155N
A21U21	1820-1195		IC FF TTL LS D-TYPE POS=EDGE=TRIG COM	0379D	AM74LS175A
A21U22	1820-1081		IC DRVR TTL BUS DRVR QUAD 1-INP	0379D	AM8726
A21U23	1820-1470		IC MUXR/DATA=SEL TTL LS 2-TO-1-LINE QUAD	0379D	SN74LS157N
A21U24	1820-1473	1	IC ENCDR TTL 8-INP	0169H	SN74148N
A21U25	1820-1201	5	IC GATE TTL LS AND QUAD 2-INP	0169H	SN74LS08N
A22	04262-66522 04262-26522	2	DISPLAY CONTROL & RAM BOARD ASSEMBLY PC BOARD, BLANK	28480 28480	04262-66522 04262-26522
A22C1	0180-0291		CAPACITOR-FXD 1UF +/-10% 35VDC TA	0420J	150D105X9035A2
A22C2	0160-2055		CAPACITOR-FXD .01UF +80-20% 100VDC CER		
A22C3	0160-2055		CAPACITOR-FXD .01UF +80-20% 100VDC CER		
A22C4	0160-2055		CAPACITOR-FXD .01UF +80-20% 100VDC CER		
A22C5	0160-2055		CAPACITOR-FXD .01UF +80-20% 100VDC CER		
A22C6	0160-2204		CAPACITOR-FXD 100PF +/-5% 300VDC MICA0+70	28480	0160-2204
A22C7	0160-2261	2	CAPACITOR-FXD 15PF +/-5% 500VDC CER0+30	28480	0160-2261
A22C8	0160-0939		CAPACITOR-FXD 430PF +/-5% 300VDC MICA0+70	28480	0160-0939
A22C9	0180-0291		CAPACITOR-FXD 1UF +/-10% 35VDC TA	0420J	150D105X9035A2
A22C10	0160-0939		CAPACITOR-FXD 430PF +/-5% 300VDC MICA0+70	28480	0160-0939
A22C11	0160-0939		CAPACITOR-FXD 430PF +/-5% 300VDC MICA0+70	28480	0160-0939
A22C12	0160-2205		CAPACITOR-FXD 120PF +/-5% 300VDC MICA0+70	28480	0160-2205
A22C13	0150-0121		CAPACITOR-FXD .1UF +80-20% 50VDC CER	28480	0150-0121
A22C14	0150-0121		CAPACITOR-FXD .1UF +80-20% 50VDC CER	28480	0150-0121
A22C15	0150-0121		CAPACITOR-FXD .1UF +80-20% 50VDC CER	28480	0150-0121
A22C16	0150-0121		CAPACITOR-FXD .1UF +80-20% 50VDC CER	28480	0150-0121
A22C17	0150-0121		CAPACITOR-FXD .1UF +80-20% 50VDC CER	28480	0150-0121
A22C18	0150-0121		CAPACITOR-FXD .1UF +80-20% 50VDC CER	28480	0150-0121
A22C19	0150-0121		CAPACITOR-FXD .1UF +80-20% 50VDC CER	28480	0150-0121
A22C20	0150-0121		CAPACITOR-FXD .1UF +80-20% 50VDC CER	28480	0150-0121
A22C21	0180-1743		CAPACITOR-FXD 0.1uF 35VDC TA		
A22C22	0160-2205		CAPACITOR-FXD 120pF 5% 300VDC MICA		
A22CR1	1902-0041		DIODE-ZNR 5.11V 5% DO-7 PD=.4W TC=-.009%	0203G	SZ 10939-9A
A22J1	1200-0541	5	SOCKET-IC 24-CONT DIP-SLDR		
A22Q1	1853-0084	8	TRANSISTOR PNP 2N4918 SI PD=30W FT=3MHZ	0203G	2N4918
A22Q2	1853-0084		TRANSISTOR PNP 2N4918 SI PD=30W FT=3MHZ	0203G	2N4918
A22Q3	1853-0084		TRANSISTOR PNP 2N4918 SI PD=30W FT=3MHZ	0203G	2N4918
A22Q4	1853-0084		TRANSISTOR PNP 2N4918 SI PD=30W FT=3MHZ	0203G	2N4918
A22Q5	1853-0084		TRANSISTOR PNP 2N4918 SI PD=30W FT=3MHZ	0203G	2N4918
A22Q6	1853-0084		TRANSISTOR PNP 2N4918 SI PD=30W FT=3MHZ	0203G	2N4918
A22Q7	1853-0084		TRANSISTOR PNP 2N4918 SI PD=30W FT=3MHZ	0203G	2N4918
A22Q8	1853-0084		TRANSISTOR PNP 2N4918 SI PD=30W FT=3MHZ	0203G	2N4918
A22R1	0683-2715		RESISTOR 270 5% .25W FC TC=400/+600	0160G	CB2715
A22R2	0683-2715		RESISTOR 270 5% .25W FC TC=400/+600	0160G	CB2715
A22R3	0683-2715		RESISTOR 270 5% .25W FC TC=400/+600	0160G	CB2715
A22R4	0683-2715		RESISTOR 270 5% .25W FC TC=400/+600	0160G	CB2715
A22R5	0683-2715		RESISTOR 270 5% .25W FC TC=400/+600	0160G	CB2715
A22R6	0683-2715		RESISTOR 270 5% .25W FC TC=400/+600	0160G	CB2715
A22R7	0683-2715		RESISTOR 270 5% .25W FC TC=400/+600	0160G	CB2715
A22R8	0683-2715		RESISTOR 270 5% .25W FC TC=400/+600	0160G	CB2715
A22R9	0683-6805		RESISTOR 68 5% .25W FC TC=400/+500	0160G	CB6805
A22R10	0683-6805		RESISTOR 68 5% .25W FC TC=400/+500	0160G	CB6805

See introduction to this section for ordering information

Table 6-3. Replaceable Parts (Cont'd).

Reference Designation	HP Part Number	Qty	Description	Mfr Code	Mfr Part Number
A22R11	0683-6805		RESISTOR 68 5% .25W FC TC=-400/+500	0160G	CB6805
A22R12	0683-6805		RESISTOR 68 5% .25W FC TC=-400/+500	0160G	CB6805
A22R13	0683-6805		RESISTOR 68 5% .25W FC TC=-400/+500	0160G	CB6805
A22R14	0683-6805		RESISTOR 68 5% .25W FC TC=-400/+500	0160G	CB6805
A22R15	0683-6805		RESISTOR 68 5% .25W FC TC=-400/+500	0160G	CB6805
A22R16	0683-6805		RESISTOR 68 5% .25W FC TC=-400/+500	0160G	CB6805
A22R17	0683-2725	2	RESISTOR 2.7K 5% .25W FC TC=-400/+700	0160G	CB2725
A22R18	0683-1825		RESISTOR 1.8K 5% .25W FC TC=-400/+700	0160G	CB1825
A22R19	0683-4725		RESISTOR 4.7K 5% .25W FC TC=-400/+700	0160G	CB4725
A22R20	1810-0121	2	NETWORK-RES 9-PIN-SIP .15-PIN-SPCG	28480	1810-0121
A22R21	1810-0205	2	NETWORK-RES 8-PIN-SIP .1-PIN-SPCG	0248C	750-81-R4.7K
A22R22	1810-0206		NETWORK-RES 8-PIN-SIP .1-PIN-SPCG	0374D	4308R-101-105S
A22R23	0683-1025		RESISTOR 1K 5% .25W FC TC=-400/+600	0160G	CB1025
A22R24	0683-1025		RESISTOR 1K 5% .25W FC TC=-400/+600	0160G	CB1025
A22R25	0683-1025		RESISTOR 1K 5% .25W FC TC=-400/+600	0160G	CB1025
A22R26	0683-1025		RESISTOR 1K 5% .25W FC TC=-400/+600	0160G	CB1025
A22R27	0683-1025		RESISTOR 1K 5% .25W FC TC=-400/+600	0160G	CB1025
A22R28	0683-1025		RESISTOR 1K 5% .25W FC TC=-400/+600	0160G	CB1025
A22R29	0683-1025		RESISTOR 1K 5% .25W FC TC=-400/+600	0160G	CB1025
A22R30	0683-1025		RESISTOR 1K 5% .25W FC TC=-400/+600	0160G	CB1025
A22R31		8	NOT ASSIGNED		
A22R32			NOT ASSIGNED		
A22R33			NOT ASSIGNED		
A22R34			NOT ASSIGNED		
A22R35			NOT ASSIGNED		
A22R36			NOT ASSIGNED		
A22R37			NOT ASSIGNED		
A22R38			NOT ASSIGNED		
A22R39	1810-0164		NETWORK-RES 9-PIN-SIP .15-PIN-SPCG	28480	1810-0164
A22S1	3101-0299	4	SWITCH, SLIDE 4-SPST	28480	3101-0299
A22U1	1820-0738	1	IC DCOR TTL 2-TO-4-LINE DUAL 2-INP	0203G	MC74155P
A22U2	1820-1194	2	IC CNTR TTL LS BIN UP/DOWN SYNCHRO	0379D	AM74LS193PC
A22U3	1820-1199	7	IC INV TTL LS HEX 1-INP	0169H	SN74LS04N
A22U4	1820-1201		IC GATE TTL LS AND QUAD 2-INP	0169H	SN74LS08N
A22U5	1820-1688	2	IC DCOR TTL HCD-TO-7-SEG	0169H	SN74LS247N
A22U6	5080-3068		IC MV TTL DUAL		
A22U7	1820-1490		IC CNTR TTL LS DECD ASYNCHRO	0169H	SN74LS90N
A22U8	1858-0033	2	TRANSISTOR	28480	1858-0033
A22U9	1820-0628		IC SN7489N 64-BIT RAM TTL	0340F	DM7489N
A22U10	1820-1470		IC MUXR/DATA-SEL TTL LS 2-TO-1-LINE QUAD	0379D	SN74LS157N
A22U11	1820-1425	2	IC SCHMITT-TRIG TTL LS NAND QUAD 2-INP	0169H	SN74LS132N
A22U12	1820-1112		IC FF TTL LS D-TYPE POS-EDGE-TRIG	0169H	SN74LS74N
A22U13	1820-1197		IC GATE TTL LS NAND QUAD 2-INP	0169H	SN74LS00N
A22U14	1820-1490		IC CNTR TTL LS DECD ASYNCHRO	0169H	SN74LS90N
A22U15	1820-1478	2	IC CNTR TTL LS BIN ASYNCHRO	0169H	SN74LS93N
A22U16	1858-0033		TRANSISTOR	28480	1858-0033
A22U17	1820-0628		IC SN7489N 64-BIT RAM TTL	0340F	DM7489N
A22U18	1820-1470		IC MUXR/DATA-SEL TTL LS 2-TO-1-LINE QUAD	0379D	SN74LS157N
A22U19	1820-10A1		IC DRVR TTL BUS DRVR QUAD 1-INP	0379D	AM8T26
A22U20	1820-10A1		IC DRVR TTL BUS DRVR QUAD 1-INP	0379D	AM8T26
A22U21	1820-1196		IC FF TTL LS D-TYPE POS-EDGE-TRIG COM	0379D	AM74LS174N
A22U22	1818-0135	2	IC MC 6810L-1 1K RAM NMOS	0203G	MC6810L-1
A22Y1	0410-0209		CRYSTAL, QUARTZ	28480	0410-0209

See introduction to this section for ordering information

Table 6-3. Replaceable Parts (Cont'd).

Reference Designation	HP Part Number	Qty	Description	Mfr Code	Mfr Part Number
A23	04262-66623 04262-26623		PROCESSOR & ROM BOARD ASSEMBLY PC BOARD, BLANK	28480 28480	04262-66623 04262-26623
A23C1	0160-2202		CAPACITOR-FXD 75pF 5% 300VDC		
A23C2	0180-2141		CAPACITOR-FXD 3.3uF +-10% 50VDC TA		
A23C3	0180-0291		CAPACITOR-FXD 1uF +-10% 35VDC TA	0420J	150D105X9035A2
A23C4	0180-0197		CAPACITOR-FXD 2.2uF +-10% 20VDC TA	0420J	150D225X9020A2
A23C5	0180-0197		CAPACITOR-FXD 2.2uF +-10% 20VDC TA	0420J	150D225X9020A2
A23C6	0180-0229		CAPACITOR-FXD 33uF +-10% 10VDC TA	0420J	150D336X9010B2
A23C7	0160-2055		CAPACITOR-FXD .01uF +80-20% 100VDC CER		
A23C8	0160-2055		CAPACITOR-FXD .01uF +80-20% 100VDC CER		
A23C9	0160-2055		CAPACITOR-FXD .01uF +80-20% 100VDC CER		
A23C10	0160-2055		CAPACITOR-FXD .01uF +80-20% 100VDC CER		
A23CR1	1901-0040		DIODE-SWITCHING 30V 50MA 2NS DO-35	28480	1901-0040
A23CR2	1901-0040		DIODE-SWITCHING 30V 50MA 2NS DO-35	28480	1901-0040
A23CR3	1902-3158		DIODE, ZENER, 9.76V	0223G	FZ7459
A23CR4	1902-0048		DIODE, ZENER, 6.81V	0223G	FZ7244
A23J1	1200-0853		SOCKET-IC 16-CONT DIP-SLDR		
A23J2	1200-0541		SOCKET-IC 24-CONT DIP-SLDR	28480	1200-0541
A23J3	1200-0541		SOCKET-IC 24-CONT DIP-SLDR	28480	1200-0541
A23J4	1200-0654		SOCKET-IC 40-CONT DIP-SLDR	28480	
A23Q1	1853-0089		TRANSISTOR PNP 2N4917 SI PD=200MW FT=450MHZ		2N4917
A23Q2	5080-3078		TRANSISTOR NPN SI PD=300MW FT=200MHZ		
A23Q3	1854-0477		TRANSISTOR NPN 2222A SI TO=18 PD=500MW	0223G	2N2222A
A23Q4	1854-0215		TRANSISTOR NPN SI PD=350MW FT=300MHZ	0203G	SPS3611
A23R1	0683-4725		RESISTOR 4.7K 5% .25W FC TC=-400/+700	0160G	CB4725
A23R2	0683-4725		RESISTOR 4.7K 5% .25W FC TC=-400/+700	0160G	CB4725
A23R3	0683-1025		RESISTOR 1k 5% .25W FC TC=-400/+600	0160G	CB1025
A23R4	0683-1025		RESISTOR 1k 5% .25W FC TC=-400/+600	0160G	CB1025
A23R5	0683-1035		RESISTOR 10k 5% .25W FC TC=-400/+700	0160G	CB1035
A23R6	0683-1055		RESISTOR 1M 5% .25W FC TC=-800/+900	0160G	CB1055
A23R7	0683-1845		RESISTOR 180K 5% .25W FC TC=-800/+900	0160G	CB1845
A23R8	0683-1035		RESISTOR 10k 5% .25W FC TC=-400/+700	0160G	CB1035
A23R9	0698-3430		RESISTOR 21.5 1% .125W F TC=0+-100	03888	RME 55-1/8-T0-21R5-F
A23R10	0683-5615		RESISTOR 560 5% .25W FC TC=-400/+600	0160G	CB5615
A23R11	0683-5625		RESISTOR 5.6K 5% .25W FC TC=-400/+700	0160G	CB5625
A23R12	1810-0164		NETWORK-RES 9-PIN-SIP .15-PIN-SPCG	28480	1810-0164
A23R13			NOT ASSIGNED		
A23R14	2100-2633		RESISTOR-TRMR 1k 10% C SIDE-ADJ 1-TRN	0365A	ET50X102
A23S1	3101-0299		SWITCH SLIDE 4-SPST	28480	3101-0299
A23U1	1820-1691		IC MICROPROC MOS	28480	1820-1691
A23U2	1820-1197		IC GATE TTL LS NAND QUAD 2-INP	0169H	SN74LS00N
A23U3	1820-2053		IC DCDR TTL LS 4-TO-16-LINE 4-INP		74LS154N
A23U4	1820-2053		IC DCDR TTL LS 4-TO-16-LINE 4-INP		74LS154N
A23U5	1820-1081		IC DRVR TTL BUS DRVR QUAD 1-INP	0379D	AM8T26
A23U6	1820-1081		IC DRVR TTL BUS DRVR QUAD 1-INP	0379D	AM8T26
A23U7	1820-1195		IC FF TTL LS D-TYPE POS-EDGE-TRIG COM	0379D	AM74LS175A
A23U8	1820-1196		IC FF TTL LS D-TYPE POS-EDGE-TRIG COM	0379D	AM74LS174N
A23U9	1820-1112		IC FF TTL LS D-TYPE POS-EDGE-TRIG	0169H	SN74LS74N
A23U10	1820-0471		IC INV TTL HEX 1-INP	0223G	7406PC
A23U11	1820-1195		IC FF TTL LS D-TYPE POS-EDGE-TRIG COM	0379D	AM74LS175A
A23U12	1820-1201		IC GATE TTL LS AND QUAD 2-INP	0169H	SN74LS08N
A23U13	1820-1197		IC GATE TTL LS NAND QUAD 2-INP	0169H	SN74LS00N
A23U14	1820-1199		IC INV TTL LS HEX 1-INP	0169H	SN74LS04N
A23U15	04262-85009		IC, ROM MOS		
A23U16	04262-85010		IC, ROM MOS		
A24 (OPTION 004)	04262-66524 04262-26524	1 1	COMPARATOR CONTROL BOARD ASSEMBLY PC BOARD, BLANK	28480 28480	04262-66524 04262-26524
A24C1	0160-0229		CAPACITOR-FXD 33uF +-10% 10VDC TA	0420J	150D336X9010B2
A24C2	0160-0229		CAPACITOR-FXD 33uF +-10% 10VDC TA	0420J	150D336X9010B2
A24C3	0160-2055		CAPACITOR-FXD .01uF +80-20% 100VDC CER		

See introduction to this section for ordering information

Table 6-3. Replaceable Parts (Cont'd).

Reference Designation	HP Part Number	Qty	Description	Mfr Code	Mfr Part Number
A24CR1	1901-0040		DIODE-SWITCHING 30V 50MA 2NS DO-35	28480	1901-0040
A24CR2	1901-0040		DIODE-SWITCHING 30V 50MA 2NS DO-35	28480	1901-0040
A24CR3	1901-0040		DIODE-SWITCHING 30V 50MA 2NS DO-35	28480	1901-0040
A24CR4	1901-0040		DIODE-SWITCHING 30V 50MA 2NS DO-35	28480	1901-0040
A24CR5	1901-0040		DIODE-SWITCHING 30V 50MA 2NS DO-35	28480	1901-0040
A24CR6	1901-0040		DIODE-SWITCHING 30V 50MA 2NS DO-35	28480	1901-0040
A24J1	1200-0853		SOCKET-IC 16-CONT DIP-SLDR		
A24K1	0490-0235	6	RELAY, REED	28480	0490-0235
A24K2	0490-0235		RELAY, REED	28480	0490-0235
A24K3	0490-0235		RELAY, REED	28480	0490-0235
A24K4	0490-0235		RELAY, REED	28480	0490-0235
A24K5	0490-0235		RELAY, REED	28480	0490-0235
A24K6	0490-0235		RELAY, REED	28480	0490-0235
A24L1	9100-1616	1	COTL=MLD 5,0UH 10% Q#45 ,1550x,375LG	02178	15-4435-1K
A24Q1	5080-3078		TRANSISTOR NPN SI PD=300MW FT=200MHZ		
A24Q2	5080-3078		TRANSISTOR NPN SI PD=300MW FT=200MHZ		
A24R1	0683-4715		RESISTOR 470 5% .25W FC TC=-400/+600	0160G	CR4715
A24R2	0683-4725		RESISTOR 4,7K 5% .25W FC TC=-400/+700	0160G	CR4725
A24R3	0683-4725		RESISTOR 4,7K 5% .25W FC TC=-400/+700	0160G	CR4725
A24R4	0683-4725		RESISTOR 4,7K 5% .25W FC TC=-400/+700	0160G	CR4725
A24R5	0683-4725		RESISTOR 4,7K 5% .25W FC TC=-400/+700	0160G	CR4725
A24R6	0683-2715		RESISTOR 270 5% .25W FC TC=-400/+600	0160G	CR2715
A24R7	0683-2715		RESISTOR 270 5% .25W FC TC=-400/+600	0160G	CR2715
A24R8	0683-2715		RESISTOR 270 5% .25W FC TC=-400/+600	0160G	CR2715
A24R9	0683-2715		RESISTOR 270 5% .25W FC TC=-400/+600	0160G	CR2715
A24R10	0683-2715		RESISTOR 270 5% .25W FC TC=-400/+600	0160G	CR2715
A24R11	0683-2715		RESISTOR 270 5% .25W FC TC=-400/+600	0160G	CR2715
A24R12	1810-0164		NETWORK=RES 9-PIN-SIP ,15-PIN-SPCG	28480	1810-0164
A24U1	1820-1112		IC FF TTL LS D-TYPE POS-EDGE-TRIG	0169H	SN74LS74N
A24U2	1820-1200		IC INV TTL LS HEX 1-INP	0169H	SN74LS05N
A24U3	1820-1196		IC FF TTL LS D-TYPE POS-EDGE-TRIG COM	0379D	AM74LS174N
A24U4	1820-1194		IC INV TTL LS HEX 1-INP	0169H	SN74LS04N
A24U5	1820-1194		IC INV TTL LS HEX 1-INP	0169H	SN74LS04N
A24U6	1820-1015		IC SCHMITT-TRIG TTL LS NAND DUAL 4-INP	0169H	SN74LS13N
A24U7	1820-1041		IC DRVR TTL BUS DRVR QUAD 1-INP	0379D	AM8126
A24U8	1820-0471		IC INV TTL HEX 1-INP	0223G	7406PC
A24U9	1820-0666	2	IC REP TTL NON-INV HEX 1-INP	0223G	7407PC
A24U10	1820-0491		IC DCDW TTL RCD=TO=DEC 4=TO=10=LINE	0169H	SN74145N
A24U11	1820-1195		IC FF TTL LS D-TYPE POS-EDGE-TRIG COM	0379D	AM74LS175A
A24U12	1820-1041		IC DRVR TTL BUS DRVR QUAD 1-INP	0379D	AM8126
A24U13	1820-1041		IC DRVR TTL BUS DRVR QUAD 1-INP	0379D	AM8126
A24W1	04261-72009	3	CABLE ASSEMBLY	28480	04261-72009
A25 (OPTION 101)	04262-66525	1	HP-IR INTERFACE BOARD ASSEMBLY	28480	04262-66525
	04262-26525	1	PC BOARD, BLANK	28480	04262-26525
A25C1	0160-0291		CAPACITOR-FXD 1UF +-10% 35VDC TA	0420J	150D105X9035A2
A25C2	0160-2055		CAPACITOR-FXD .01UF +80-20% 100VDC CER		
A25C3	0160-2055		CAPACITOR-FXD .01UF +80-20% 100VDC CER		
A25C4	0160-2055		CAPACITOR-FXD .01UF +80-20% 100VDC CER		
A25C5	0160-2204		CAPACITOR-FXD 100PF +-5% 300VDC MICA0+70		
A25C6	0160-2204		CAPACITOR-FXD 100PF +-5% 300VDC MICA0+70	28480	0160-2204
A25C7	0160-0153	1	CAPACITOR-FXD 1000PF +-10% 200VDC POLYE	0420J	292P10292
A25J1	1251-0541		CONNECTOR 34-PIN M RECTANGULAR	76381	3431-1002
A25J2	1200-0853		SOCKET-IC 16-CONT DIP-SLDR		
A25Q1	5080-3078		TRANSISTOR NPN SI PD=300MW FT=200MHZ		
A25R1	0683-4715		RESISTOR 470 5% .25W FC TC=-400/+600	0160G	CR4715
A25R2	0683-4715		RESISTOR 470 5% .25W FC TC=-400/+600	0160G	CR4715
A25R3	0683-4715		RESISTOR 470 5% .25W FC TC=-400/+600	0160G	CR4715
A25R4	0683-4715		RESISTOR 470 5% .25W FC TC=-400/+600	0160G	CR4715
A25R5	0683-1825		RESISTOR 1,8K 5% .25W FC TC=-400/+700	0160G	CR1825
A25R6	1810-0136	2	NETWORK=RES 10-PIN-SIP ,1-PIN-SPCG	28480	1810-0136
A25R7	1810-0125	1	NETWORK=RES 8-PIN-SIP ,125-PIN-SPCG	0248C	750
A25U1	1820-1197		IC GATE TTL LS NAND QUAD 2-INP	0169H	SN74LS00N
A25U2	1820-1558	2	IC MISC TTL+ QUAD	0203G	MC3441P
A25U3	1820-1558		IC MISC TTL+ QUAD	0203G	MC3441P
A25U4	1820-1199		IC INV TTL LS HEX 1-INP	0169H	SN74LS04N
A25U5	1820-0269	1	IC GATE TTL NAND QUAD 2-INP	0223G	7403PC

See introduction to this section for ordering information

Table 6-3. Replaceable Parts (Cont'd).

Reference Designation	HP Part Number	Qty	Description	Mfr Code	Mfr Part Number
A25U6	1820-1199		IC INV TTL LS HEX 1-INP	0169H	SN74LS04N
A25U7	1820-1201		IC GATE TTL LS AND QUAD 2-INP	0169H	SN74LS08N
A25U8	1820-1195		IC FF TTL LS D-TYPE POS-EDGE-TRIG COM	0379D	AM74LS175A
A25U9	1820-1195		IC FF TTL LS D-TYPE POS-EDGE-TRIG COM	0379D	AM74LS175A
A25U10	1820-1470		IC MUXR/DATA-SEL TTL LS 2-TO-1-LINE QUAD	0379D	SN74LS157N
A25U11	1820-1470		IC MUXR/DATA-SEL TTL LS 2-TO-1-LINE QUAD	0379D	SN74LS157N
A25U12	1820-1195		IC FF TTL LS D-TYPE POS-EDGE-TRIG COM	0379D	AM74LS175A
A25U13	1820-1195		IC FF TTL LS D-TYPE POS-EDGE-TRIG COM	0379D	AM74LS175A
A25U14	1820-1081		IC DRVR TTL BUS DRVR QUAD 1-INP	0379D	AM8T26
A25U15	1820-1081		IC DRVR TTL BUS DRVR QUAD 1-INP	0379D	AM8T26
A25U16	1820-1081		IC DRVR TTL BUS DRVR QUAD 1-INP	0379D	AM8T26
A25U17	1820-1081		IC DRVR TTL BUS DRVR QUAD 1-INP	0379D	AM8T26
A25U18	1820-1081		IC DRVR TTL BUS DRVR QUAD 1-INP	0379D	AM8T26
A25U19	1820-1081		IC DRVR TTL BUS DRVR QUAD 1-INP	0379D	AM8T26
A25U20	1820-0328	1	IC GATE TTL NOR QUAD 2-INP	0223G	7402PC
A25U21	1820-1112		IC FF TTL LS D-TYPE POS-EDGE-TRIG	0169H	SN74LS74N
A25U22	1820-1112		IC FF TTL LS D-TYPE POS-EDGE-TRIG	0169H	SN74LS74N
A26			NOT ASSIGNED		
A27			NOT ASSIGNED		
A28			NOT ASSIGNED		
A29			NOT ASSIGNED		
A30			NOT ASSIGNED		
A31			NOT ASSIGNED		
A32			NOT ASSIGNED		
A33			NOT ASSIGNED		
A34			NOT ASSIGNED		
A35 (OPTION 001)	04262-66535	1	BCD OUTPUT CONTROL BOARD ASSEMBLY	28480	04262-66535
	04262-26535	1	PC BOARD, BLANK	28480	04262-26535
A35C1	0160-2199		CAPACITOR-FXD 30PF +-5% 300VDC	28480	0160-2199
A35C2	0160-2199		CAPACITOR-FXD 30PF +-5% 300VDC	28480	0160-2199
A35C3	0180-0229		CAPACITOR-FXD 33UF+-10% 10VDC TA	0420J	1500330x901082
A35C4	0160-2055		CAPACITOR-FXD .01UF +80-20% 100VDC CER		
A35C5	0160-2055		CAPACITOR-FXD .01UF +80-20% 100VDC CER		
A35C6	0160-2055		CAPACITOR-FXD .01UF +80-20% 100VDC CER		
A35C7	0160-2055		CAPACITOR-FXD .01UF +80-20% 100VDC CER		
A35C8	0160-2055		CAPACITOR-FXD .01UF +80-20% 100VDC CER		
A35CR1	1902-0041		DIODE-ZNR 5.11V 5% DO-7 PDS,4W TC=+.009%	0203G	SZ 10434-98
A35CR2	1902-0041		DIODE-ZNR 5.11V 5% DO-7 PDS,4W TC=+.009%	0203G	SZ 10434-98
A35J1	1200-0853		SOCKET-IC 16-CONT DIP-SLDR		
A35L1	9100-1611	1	COIL-MLD 220MH 20% Q=50 ,155DX,375LG	0217R	15-4415-2M
A35R1	0683-5625		RESISTOR 5,6K 5% .25W FC TC=+400/+700	0160G	C85625
A35R2	0683-5625		RESISTOR 5,6K 5% .25W FC TC=+400/+700	0160G	C85625
A35R3	0683-5625		RESISTOR 5,6K 5% .25W FC TC=+400/+700	0160G	C85625
A35R4	0683-5625		RESISTOR 5,6K 5% .25W FC TC=+400/+700	0160G	C85625
A35R5	0683-5625		RESISTOR 5,6K 5% .25W FC TC=+400/+700	0160G	C85625
A35R6	0683-5625		RESISTOR 5,6K 5% .25W FC TC=+400/+700	0160G	C85625
A35R7	0683-5625		RESISTOR 5,6K 5% .25W FC TC=+400/+700	0160G	C85625
A35R8	0683-2225		RESISTOR 2,2K 5% .25W FC TC=+400/+700	0160G	C82225
A35R9	0683-2225		RESISTOR 2,2K 5% .25W FC TC=+400/+700	0160G	C82225
A35P10	0683-5625		RESISTOR 5,6K 5% .25W FC TC=+400/+700	0160G	C85625
A35R11	0683-5625		RESISTOR 5,6K 5% .25W FC TC=+400/+700	0160G	C85625
A35R12	1810-0136		NETWORK-RES 10-PIN-SIP .1-PIN-SPCG	28480	1810-0136
A35S1	3101-0299		SWITCH, SLIDE 4-8PST	28480	3101-0299
A35S2	3101-1273		SWITCH, DPDT-NS		
A35U1	1820-1423	1	IC MV TTL LS MONOSTBL RETRIG DUAL	0169H	SN74LS123N
A35U2	1820-0077	1	IC FF TTL D-TYPE POS-EDGE-TRIG CLEAR	0223G	7474PC
A35U3	1820-1197		IC GATE TTL LS NAND QUAD 2-INP	0169H	SN74LS00N
A35U4	1820-0294	8	IC SHF-RGTR TTL R-S SERIAL-IN PNL OUT	0340F	DM8570N
A35U5	1820-0294		IC SHF-RGTR TTL R-S SERIAL-IN PNL OUT	0340F	DM8570N

See introduction to this section for ordering information

Table 6-3. Replaceable Parts (Cont'd).

Reference Designation	HP Part Number	Qty	Description	Mfr Code	Mfr Part Number
A35U6	1820-0294		IC SHF=RGTR TTL R=S SERIAL-IN PRL OUT	0340F	DM8570N
A35U7	1820-0294		IC SHF=RGTR TTL R=S SERIAL-IN PRL OUT	0340F	DM8570N
A35U8	1820-0668		IC BFR TTL NON-INV HEX 1-INP	0223G	7407PC
A35U9	1820-0294		IC SHF=RGTR TTL R=S SERIAL-IN PRL OUT	0340F	DM8570N
A35U10	1820-1081		IC DRVR TTL BUS DRVR QUAD 1-INP	0379D	AMHT26
A35U11	1820-0294		IC SHF=RGTR TTL R=S SERIAL-IN PRL OUT	0340F	DM8570N
A35U12	1820-0294		IC SHF=RGTR TTL R=S SERIAL-IN PRL OUT	0340F	DM8570N
A35U13	1820-0294		IC SHF=RGTR TTL R=S SERIAL-IN PRL OUT	0340F	DM8570N
A35W1	04261-72009		CABLE ASSEMBLY	28480	04261-72009
A35W2	04261-72009		CABLE ASSEMBLY	28480	04261-72009
CHASSIS MOUNTED COMPONENTS					
C1	0160-4259	1	CAPACITOR FXD .22UF 10%		
C2	0160-1586	2	CAPACITOR FXD .1UF 200VDC		
C3	0160-1586		CAPACITOR FXD .1UF 200VDC		
CR1, CR2	1901-0496	2	DIODE:RECTIFIER POWER		
CR3	1902-1232	1	DIODE:ZNR IN3997AR 5.6V PD = 10W		
CR4 ~ CR7	1901-0033	4	DIODE Ge 180V 200mA		
F1	2110-0007	1	FUSE 1A 250V		
	2110-0202	1	FUSE .5A 250V		
J6, J7, J8	5060-4020	3	CONNECTOR ASSEMBLY, 50 CONTACTS (OPT. 001/004)		
A3	04262-66503	1	CONNECTOR BOARD ASSEMBLY, HP-IB (OPT. 101)		
	0380-0644	2	SCREW, STAND OFF WASHER SP		
	2190-0034	2	WASHER SP		
Q1, Q2, Q3	1854-0063	3	TRANSISTOR NPN 2N3055		
R1	0683-1025		RESISTOR 1k 5% .25W		
R2, R3	0698-3391	2	RESISTOR 21.5 1% .5W		
R4	2100-1250	1	RESISTOR-VAR 500 20%		
R5	2100-1832	1	RESISTOR-VAR 500 10%		
S1	3101-2216	1	SWITCH:LINE		
S2, S4	3100-1201	2	SWITCH:THUMBWHEEL (OPT. 004)		
CABLE ASSEMBLIES					
WT	8120-0360	1	FLAT CABLE ASSY (OPT. 001, 004, 101)		
	04262-61601	1	CABLE ASSEMBLY, Lc, 19cm		
	04262-61602	1	CABLE ASSEMBLY, Lp, 19cm		
	04262-61603	1	CABLE ASSEMBLY, Hc, 16cm		
	04262-61604	1	CABLE ASSEMBLY, Hp, 22cm		
	04262-61605	1	CABLE ASSEMBLY, Hp, 18cm		
	04262-61901	1	CABLE ASSEMBLY, LINE SWITCH		
MISCELLANEOUS					
	5001-0439	2	TRIM, SIDE		
	5040-7202	1	TRIM, TOP		
	04261-40024	1	LAMP HOUSE, UNIT INDICATOR		
	04262-40002	1	WINDOW		
	04262-85001	1	ANNUNCIATOR FILM, UNIT		
TOOL	8710-0340		SCREWDRIVER (FURNISHED)		

See introduction to this section for ordering information



Table 6-3. Replaceable Parts (Cont'd).

Reference Designation	HP Part Number	Qty	Description	Mfr Code	Mfr Part Number
CHASSIS PARTS					
1	5040-7219	2	CAP HANDLE FRONT		
2	2680-0172	4	SCREW-MACH 10-32 .375-IN-LG		
3	5060-9935	2	COVER, SIDE		
4	5060-9802	2	HANDLE		
5	2360-0115	6	SCREW-MACH 6-32 .312-IN-LG		
6	5040-7220	2	CAP HANDLE REAR		
7	0370-2159	1	KNOB,PUSHBUTTON LINE		
8	5040-7201	4	FOOT, FULL/HALF MODULE		
9	1460-1345	2	STAND TILT		
10	5060-9845	1	COVER, BOTTOM		
11	5040-7023	1	ROD, PUSHBUTTON		
12	04262-00602	1	DECK, LEFT		
13	04262-00606	1	PLATE, LINE SWITCH		
14	2510-0192	16	SCREW-MACH 8-32 .25-IN-LG		
15	5020-8804	1	FRAME, REAR		
16	5040-3318	1	COVER, L MODULE		
17	0960-0443	1	LINE MODULE		
18	04262-00205	1	PANEL, REAR		
19	1200-0041	3	SOCKET, TRANSISTOR		
20	0340-0833	1	COVER, TRANSISTOR		
21	2190-0020	2	SCREW		
22					
23	2510-0135	4	SCREW-MACH 8-32 2.25-IN-LG		
24	3050-0139	8	WASHER FL MTLC NO.-8		
25	7100-0129	1	COVER, POWER TRANSFORMER		
26(J9, J10)	1250-0118	2	CONNECTOR, BNC		
27	9100-0865	1	TRANSFORMER, POWER		
28	2360-0113	8	SCREW-MACH 6-32 .25-IN-LG		
29	5060-9833	1	COVER, TOP		
30	2190-0016	3	WASHER-LK INTL T NO. -3/8		
31	2950-0001	2	NUT-HEX-DBL-CHAM 3/8-32-THD		
32	2580-0004	4	NUT-HEX-DBL-CHAM 8-32-THD		
33	2190-0087	4	WASHER-LK HLCL NO.-8		
34	3050-0239	4	WASHER-FL NM NO. -8		
35	04262-00603	1	DECK, CENTER		
36	04262-00605	5	PLATE, SHIELD		
37	5020-8835	4	STRUT CORNER		
38	04262-00604	1	DECK, RIGHT		
39	2360-0333	1	SCREW-MACH 6-32 .25-IN-LG		
40	5020-8803	1	FRAME, FRONT		
41	04262-00204	1	SUB PANEL, FRONT (STD)		
41	04262-00214	1	SUB PANEL, FRONT (OPT. 004)		
42	04262-00202	1	PANEL, FRONT (STD)		
42	04262-00212	1	PANEL, FRONT (OPT. 004)		
43	04262-00203	1	SUB PANEL, FRONT		
44	04262-00201	1	PANEL, FRONT (HP)		
44	04262-00211	1	PANEL, FRONT (YHP)		
45 (J2 - J5)	1510-0090	4	BINDING POST GRAY		
46	5000-4206	2	SHORTING LINK		
47 (J1)	1510-0107	1	BINDING POST BLK		
48	2190-0016	2	WASHER-LK INTL T NO. -3/8		
49	2950-0043	5	NUT-HEX-DBL-CHAM 3/8-32-THD		
50	0370-0451	1	BEZEL, PUSHBUTTON LINE		
51	7120-1254	1	TRADE MARK (HP)		
51	7120-0478	1	TRADE MARK (YHP)		
52	04262-00607	1	PLATE, BLIND		
53	2360-0115	2	SCREW-MACH 6-32 .312-IN-LG		
54	0520-0129	6	SCREW-MACH 2-56 .312-IN-LG		
55	04262-00608	3	PLATE, BLIND		
56	2420-0006	2	NUT-HEX-W/LKWR 6-32-THD		
57	0624-0045	6	SCREW-TPG 6-20 .375-IN-LG		
58	2190-0008	6	WASER-LK EXT T NO. -6		
59	0340-0458	3	INSULATOR, TRANSISTOR		
60	1200-0080	4	INSULATOR, DIODE		
61	3050-0226	2	WASHER-FL MTLC NO. -10		
62	0360-0270	3	SOLDER LUG		
63	2740-0003	3	NUT-HEX-W/LKWR 10-32-THD		
64	04262-01201	1	PLATE, ANGLE		
65	1490-0848	1	BUSHING		
66	0590-0061	1	NUT-HEX-DBL-CHAM 1/4-32-THD		
67	2190-0060	1	WASHER-LK INTL T NO. -1/4		

See introduction to this section for ordering information

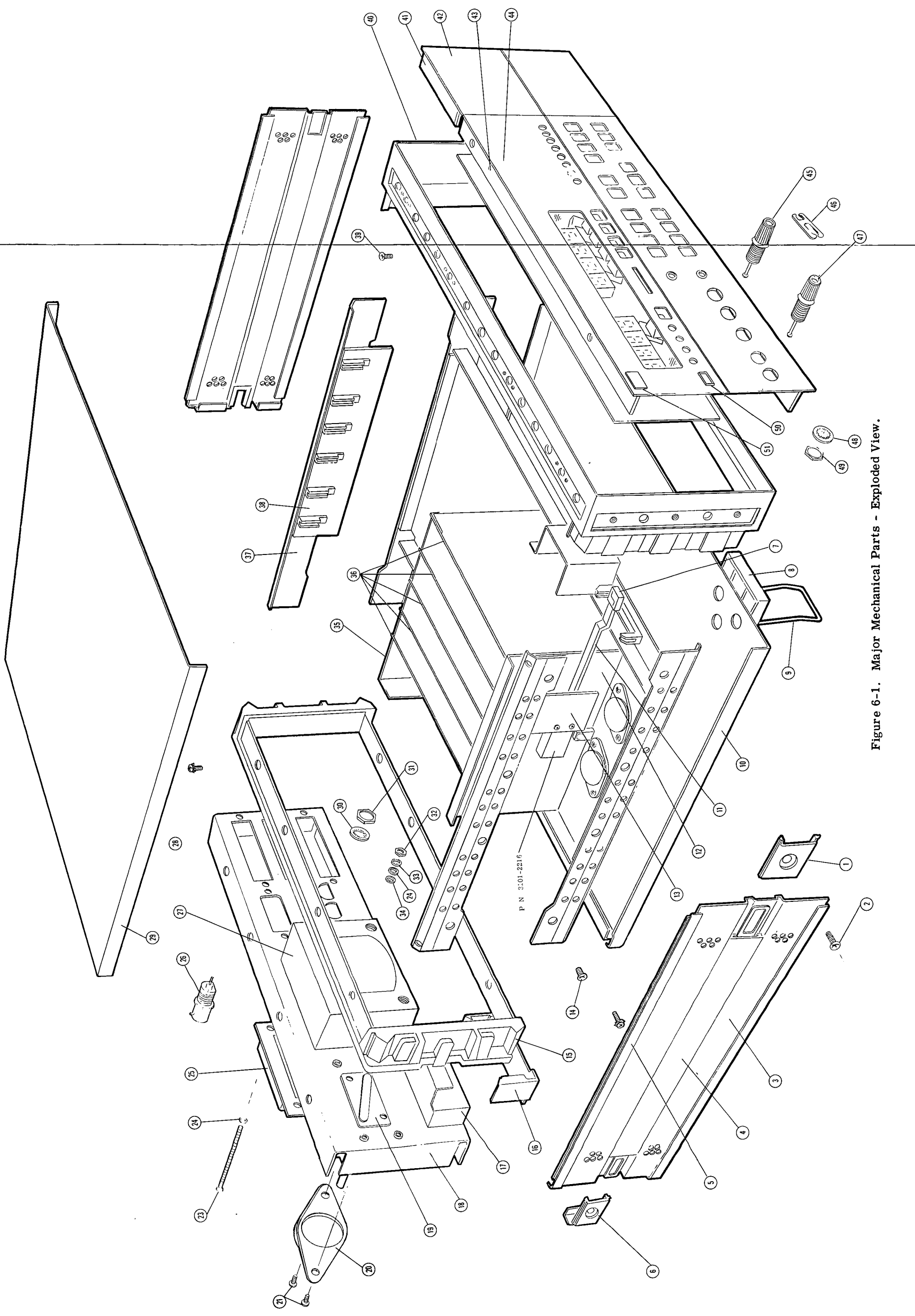

Figure 6-1. Major Mechanical Parts - Exploded View.

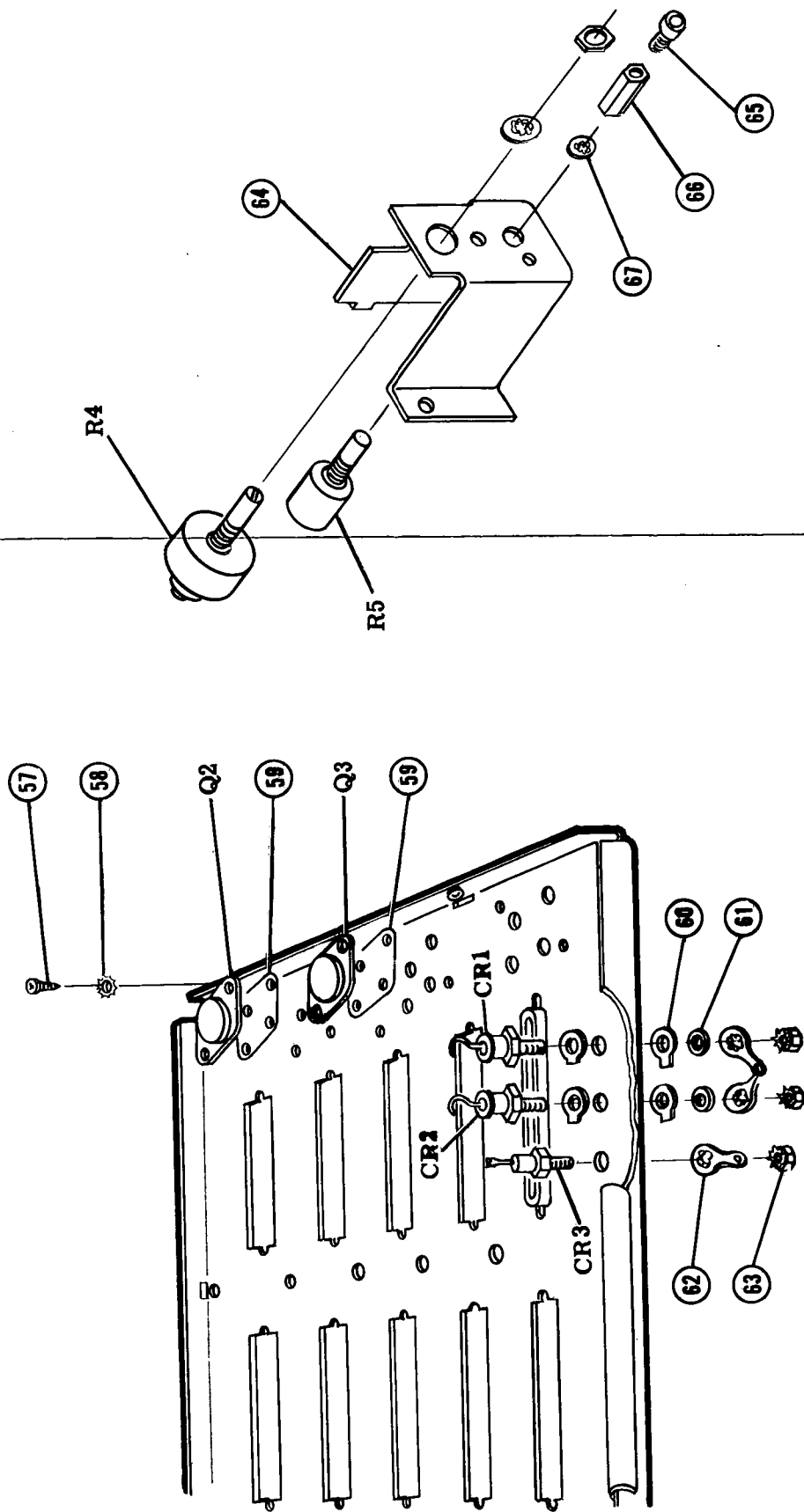

Figure 6-2. Mechanical Parts - Exploded View.

Table 6-4. Option 010 Modification

Reference Designation	HP Part Number	Qty	Description
A11 (OPTION 010) A11C8 A11C9 A11R25 A11R26 A11R27 A11R28 A11R29 A11R30	04262-66911 0160-5821 0160-5821 0698-4494 0698-2228 0757-0279 0757-0123 0698-2228 0757-0279		OSCILLATOR & SOURCE RESISTOR BOARD ASSY CAPACITOR, FXD 5000pF .25% 50V CAPACITOR, FXD 5000pF .25% 50V RESISTOR 35.7K 1% RESISTOR 318.3K .5% RESISTOR 3.16K 1% RESISTOR 34.8K 1% RESISTOR 318.3K .5% RESISTOR 3.16K 1% other parts are same as 04262-66511
A14 (OPTION 010) A14C7 A14R33	04262-66914 0160-1554 0698-4511		PHASE DETECTOR & INTEGRATOR BOARD ASSY CAPACITOR, FXD .47UF 200V RESISTOR 86.6K 1% other parts are same as 04262-66514

SECTION VII MANUAL CHANGES

7-1. INTRODUCTION.

7-2. This section contains information for adapting this manual to instruments to which the contents do not directly apply. The following paragraphs explain how to adapt this manual to apply to older instruments with a lower serial prefix.

7-3. MANUAL CHANGES.

7-4. To adapt this manual to your particular instrument, refer to Table 7-1 and make all of the manual changes listed opposite your instrument serial number. Perform these changes in the summary by assembly.

7-5. If your instrument serial number is not listed on the title page of this manual or in Table 7-1 to the right, it may be documented in a yellow MANUAL CHANGES supplement. For additional information about serial number coverage, refer to INSTRUMENT COVERED BY MANUAL in Section I.

Table 7-1. Manual Changes by Serial Number.

Serial Prefix or Number	Make Manual Changes
1710J00260 and below	1, 2, 3
1710J00340 and below	2, 3
1739J00600 and below	3, 5
1739J02280 and below	4, 5
2022J03750 and below	5

Table 7-2. Summary of Changes by Assembly (Continued on Page 7-2).

CHANGE	Assembly							
	A1	A2	A3	A4	A5	A9	A11	A12
1								
2								
3								04262- 26512
4								04262- 66612
5								

Table 7-2. Summary of Changes by Assembly (Continued).

CHANGE	Assembly								
	A13	A14	A21	A22	A23	A24	A25	A35	No Prefix
1				04262-66522					
2					04262-66623				
3									
4									
5					U15 U16				

CHANGE 1

Pages 6-16 and 6-17, Table 6-3, Replaceable Parts,
Change A22 board parts list to Table A.

Page 8-61, Figure 8-46, A22 schematic diagram,
Partially change Figure 8-46 as shown in Figure A.

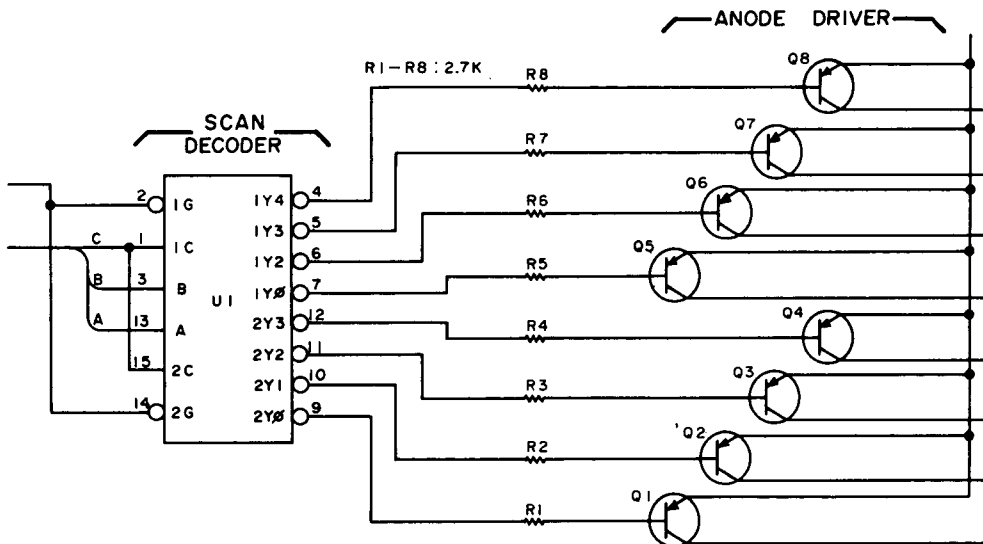

Figure A.

Table A.

Reference Designation	HP Part Number	Qty	Description	Mfr Code	Mfr Part Number
A22	04262-66522 04262-26522	2	DISPLAY CONTROL & RAM BOARD ASSEMBLY PC BOARD, BLANK	28480 28480	04262-66522 04262-26522
A22C1 A22C2 A22C3 A22C4 A22C5	0160-0291 0160-2055 0160-2055 0160-2055 0160-2055		CAPACITOR-FXD 1UF+/-10% 35VDC TA CAPACITOR-FXD .01UF +80-20% 100VDC CER CAPACITOR-FXD .01UF +80-20% 100VDC CER CAPACITOR-FXD .01UF +80-20% 100VDC CER CAPACITOR-FXD .01UF +80-20% 100VDC CER	0426J	150D105X9035A2
A22C6 A22C7 A22C8 A22C9 A22C10	0160-2204 0160-2261 0160-0939 0160-0291 0160-0939	4 6	CAPACITOR-FXD 100PF +/-5% 300VDC MICA0+70 CAPACITOR-FXD 15PF +/-5% 500VDC CER0+30 CAPACITOR-FXD 430PF +/-5% 300VDC MICA0+70 CAPACITOR-FXD 1UF+/-10% 35VDC TA CAPACITOR-FXD 430PF +/-5% 300VDC MICA0+70	28480 28480 28480 0420J 28480	0160-2204 0160-2261 0160-0939 150D105X9035A2 0160-0939
A22C11 A22C12	0160-0939 0160-2205	2	CAPACITOR-FXD 430PF +/-5% 300VDC MICA0+70 CAPACITOR-FXD 120PF +/-5% 300VDC MICA0+70	28480 28480	0160-0939 0160-2205
A22CR1	1902-0041		DIODE-ZNR 5.11V 5% D0-7 P0.4% TC=-.009%	0203G	S7 10939-9H
A22J1	1200-0541	1	SOCKET-IC 24-CONT DIP-SLDR		
A22G1 A22G2 A22G3 A22G4 A22G5	1853-0107 1853-0107 1853-0107 1853-0107 1853-0107	8	TRANSISTOR, PNP SI TRANSISTOR, PNP SI TRANSISTOR, PNP SI TRANSISTOR, PNP SI TRANSISTOR, PNP SI	28480 28480 28480 28480 28480	1853-0107 1853-0107 1853-0107 1853-0107 1853-0107
A22G6 A22G7 A22G8	1853-0107 1853-0107 1853-0107		TRANSISTOR, PNP SI TRANSISTOR, PNP SI TRANSISTOR, PNP SI	28480 28480 28480	1853-0107 1853-0107 1853-0107
A22H1 A22H2 A22H3 A22H4 A22H5	0683-2735 0683-2735 0683-2735 0683-2735 0683-2735	8	RESISTOR 27K 5% .25W FC TC=-400/+400 RESISTOR 27K 5% .25W FC TC=-400/+400 RESISTOR 27K 5% .25W FC TC=-400/+400 RESISTOR 27K 5% .25W FC TC=-400/+400 RESISTOR 27K 5% .25W FC TC=-400/+400	0160G 0160G 0160G 0160G 0160G	CH2735 CH2735 CH2735 CH2735 CH2735
A22H6 A22H7 A22H8 A22H9 A22H10	0683-2735 0683-2735 0683-2735 0683-5605 0683-5605		RESISTOR 27K 5% .25W FC TC=-400/+400 RESISTOR 27K 5% .25W FC TC=-400/+400 RESISTOR 27K 5% .25W FC TC=-400/+400 RESISTOR 56 5% .25W FC TC=400/+500 RESISTOR 56 5% .25W FC TC=400/+500	0160G 0160G 0160G 0160G 0160G	CH2735 CH2735 CH2735 CH5605 CH5605
A22H11 A22H12 A22H13 A22H14 A22H15	0683-5605 0683-5605 0683-5605 0683-5605 0683-5605		RESISTOR 56 5% .25W FC TC=400/+500 RESISTOR 56 5% .25W FC TC=400/+500 RESISTOR 56 5% .25W FC TC=400/+500 RESISTOR 56 5% .25W FC TC=400/+500 RESISTOR 56 5% .25W FC TC=400/+500	0160G 0160G 0160G 0160G 0160G	CH5605 CH5605 CH5605 CH5605 CH5605
A22H16 A22H17 A22H18 A22H19 A22H20	0683-5605 0683-2725 0683-1825 0683-4725 1810-0121		RESISTOR 56 5% .25W FC TC=400/+500 RESISTOR 2.7K 5% .25W FC TC=400/+700 RESISTOR 1.8K 5% .25W FC TC=400/+700 RESISTOR 4.7K 5% .25W FC TC=400/+700 NETWORK-RES 9-PIN-SIP .15-PIN-SPCG	0160G 0160G 0160G 0160G 28480	CH5605 CH2725 CH1825 CH4725 1810-0121
A22H21 A22H22 A22R39	1810-0205 1810-0206 1810-0164	2	NETWORK-RES 8-PIN-SIP .1-PIN-SPCG NETWORK-RES 8-PIN-SIP .1-PIN-SPCG NETWORK-RES 9-PIN-SIP .15-PIN-SPCG	0248C 0374D 28480	750-81-84.7K 4308N-101-1035 1810-0164
A22S1	3101-0299		SWITCH, SLIDE 4-SPST	28480	3101-0299
A22U1 A22U2 A22U3 A22U4 A22U5	1820-1245 1820-1194 1820-1199 1820-1201 1820-1688		IC CDOR TTL LS 2-TO-4-LINE DUAL 2-INP IC CNTR TTL LS MIN UP/DOWN SYNCHRO IC INV TTL LS HEX 1-INP IC GATE TTL LS AND QUAD 2-INP IC CDOR TTL MCD-TO-7-SEL	0169H 0379D 0169H 0169H 0169H	SN74LS155N AM74LS193PL SN74LS04N SN74LS08N SN74LS247N
A22U6 A22U7 A22U8 A22U9 A22U10	1820-0567 1820-1490 1858-0033 1820-0628 1820-1470	2 4	IC MV TTL DUAL IC CNTR TTL LS DECD ASYNCHRO TRANSISTOR FT5712M IC SN7489N 64-BIT RAM TTL IC MUXR/DATA-SEL TTL LS 2-TO-1-LINE QUAD	0203G 0169H 28480 0340F 0379D	MC4024P SN74LS90H DM7489N SN74LS157N
A22U11 A22U12 A22U13 A22U14 A22U15	1820-1425 1820-1112 1820-1197 1820-1490 1820-1478		IC SCHMITT-TRIG TTL LS NAND QUAD 2-INP IC FF TTL LS D-TYPE POS-EDGE-TRIG IC GATE TTL LS NAND QUAD 2-INP IC CNTR TTL LS DECD ASYNCHRO IC CNTR TTL LS BIN ASYNCHRO	0169H 0169H 0169H 0169H 0169H	SN74LS132N SN74LS74N SN74LS00N SN74LS90N SN74LS93N
A22U16 A22U17 A22U18 A22U19 A22U20	1858-0033 1820-0628 1820-1470 1820-10A1 1820-10B1		TRANSISTOR FT5712M IC SN7489N 64-BIT RAM TTL IC MUXR/DATA-SEL TTL LS 2-TO-1-LINE QUAD IC DRVR TTL BUS DRVR QUAD 1-INP IC DRVR TTL BUS DRVR QUAD 1-INP	28480 0340F 0379D 0379D 0379D	DM7489N SN74LS157N AM8126 AM8126
A22U21 A22U22	1820-1196 1818-0135	4	IC FF TTL LS D-TYPE POS-EDGE-TRIG COM IC MC 6810L-1 1K RAM NMOS	0379D 0203G	AM74LS174N MC6810L-1
A22Y1	0410-0209	2	CRYSTAL, QUARTZ	28480	0410-0209

See introduction to this section for ordering information

CHANGE 2

Page 6-17, Table 6-3, Replaceable Parts,
Change A23 board parts list to Table B.

Page 8-63, Figure 8-47, A23 Component Locations,
Change Figure 8-47 to Figure B.

Page 8-63, Figure 8-48, A23 schematic diagram,
Change Figure 8-48 to Figure C.

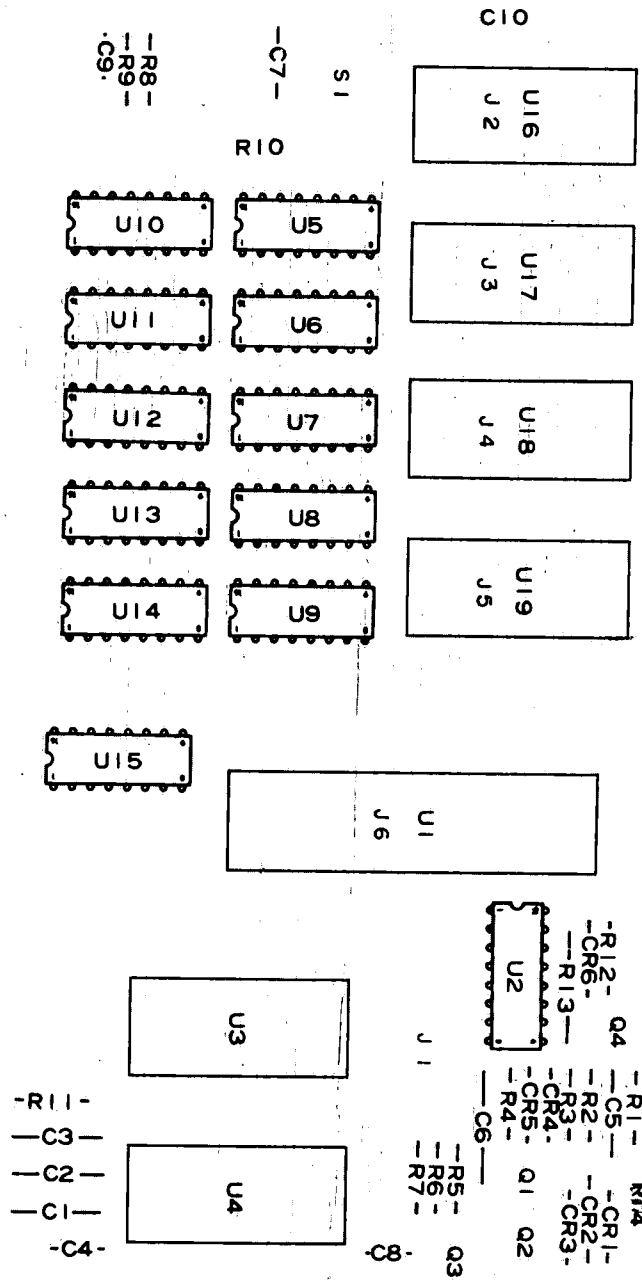

Figure B.

Table B.

Reference Designation	HP Part Number	Qty	Description	Mfr Code	Mfr Part Number
A23	04262-66523 04262-26523	1 1	PROCESSOR & ROM BOARD ASSEMBLY PC BOARD, BLANK	28480 28480	04262-66523 04262-26523
A23C1	0180-0291		CAPACITOR-FXD 1UF+-10% 35VDC TA	0420J	1500105X9035A2
A23C2	0180-0197		CAPACITOR-FXD 2.2UF+-10% 20VDC TA	0420J	1500225X4020A2
A23C3	0180-0197		CAPACITOR-FXD 2.2UF+-10% 20VDC TA	0420J	1500225X9020A2
A23C4	0160-2055		CAPACITOR-FXD .01UF +80-20% 100VDC CER	0420J	1500105X9035A2
A23C5	0180-0291		CAPACITOR-FXD 1UF+-10% 35VDC TA		
A23C6	0180-2141	1	CAPACITOR-FXD 3.3UF+-10% 6VDC TA	0420J	1500336X9010A2
A23C7	0180-0229	4	CAPACITOR-FXD 33UF+-10% 10VDC TA		
A23C8	0160-2055		CAPACITOR-FXD .01UF +80-20% 100VDC CER		
A23C9	0160-2055		CAPACITOR-FXD .01UF +80-20% 100VDC CER		
A23C10	0160-2055		CAPACITOR-FXD .01UF +80-20% 100VDC CER		
A23CP1	1902-315A	1	DIODE, ZENER, 9.76V	0223G	FZ7459
A23CP2	1902-1299	1	DIODE, ZENER, 3.3V	0203G	SZ11213-1
A23CR3	1902-0048		DIODE-ZNR 6.21V 5% DO-7 PD=4W TC=+.043%	0223G	FZ7244
A23CR4	1901-0040		DIODE-SWITCHING 50V 50MA 2NS DO-35	28480	1901-0040
A23CR5	1901-0040		DIODE-SWITCHING 30V 50MA 2NS DO-35	28480	1901-0040
A23CR6	1902-3107	1	DIODE-ZNR 5.76V 2% DO-7 PD=4W TC=+.017%	0203G	SZ 10939-114
A23J1	1200-0853		SOCKET-IC 16-CONT DIP-SLDR		
A23J2	1200-0541		SOCKET-IC 24-CONT DIP-SLDR	28480	1200-0541
A23J3	1200-0541		SOCKET-IC 24-CONT DIP-SLDR	28480	1200-0541
A23J4	1200-0541		SOCKET-IC 24-CONT DIP-SLDR	28480	1200-0541
A23J5	1200-0541	1	SOCKET-IC 24-CONT DIP-SLDR	28480	1200-0541
A23J6	1200-0654		SOCKET-IC 40-CONT DIP-SLDR		
A23Q1	5080-3078		TRANSISTOR NPN SI PD=300MW FT=200MHZ	0203G	SPS 3-11
A23Q2	1854-0215	1	TRANSISTOR NPN SI PD=350MW FT=300MHZ	0223G	242222A
A23Q3	1854-0477	1	TRANSISTOR NPN 2N2222A SI TU=1A PD=500MW	0169H	242904A
A23Q4	1853-0012		TRANSISTOR PNP 2N2904A SI TU=1A PD=600MW		
A23R1	06A3-1035		RESISTOR 10K 5% .25W FC TC=400/+700	0160G	CM1035
A23R2	06A3-1845	1	RESISTOR 180K 5% .25W FC TC=400/+900	0160G	CM1845
A23R3	06A3-1055		RESISTOR 1K 5% .25W FC TC=400/+900	0160G	CM1055
A23R4	06A3-1035		RESISTOR 10K 5% .25W FC TC=400/+700	0160G	CM1035
A23R5	06A3-5625		RESISTOR 5.6K 5% .25W FC TC=400/+700	0160G	CM5625
A23R6	069A-3430	1	RESISTOR 21.5 1% .125W F TC=0/+100	0386B	FM55-1/8-10-21R5-1
A23R7	06A3-5615	1	RESISTOR 560 5% .25W FC TC=400/+600	0160G	CM5615
A23R8	06A3-0725		RESISTOR 4.7K 5% .25W FC TC=400/+700	0160G	CM4725
A23R9	06A3-0725		RESISTOR 4.7K 5% .25W FC TC=400/+700	0160G	CM4725
A23R10	1810-0164		NETWORK-PFS 9-PIN=51P .15-PIN=5PC6	28480	1810-0164
A23R11	06A3-1025		RESISTOR 1K 5% .25W FC TC=400/+600	0160G	CM1025
A23R12	0757-041P	1	RESISTOR 619 1% .125W F TC=0/+100	0329H	CM-1/8-TU=619K-F
A23R13	069A-3391	1	RESISTOR 21.5 1% .5A F TC=0/+100	0552D	CMF-05-2
A23R14	2100-2633	1	RESISTOR-TMR 1K 10% C SIDE=ADJ 1-TWR	0365A	ETS02102
A23S1	3101-0299		SWITCH, SLIDE 4-SPST	28480	3101-0299
A23U1	1820-1691	1	IC MICPROC MGS	28480	1820-1691
A23U2	1820-1197		IC GATE TTL LS NAND QUAD 2-INP	0169H	SN74LS00N
A23U3	1820-0702	2	IC DCDR TTL L 4-TU=16-LINE 4-INP	0223G	43L11PC
A23U4	1820-0702		IC DCDR TTL L 4-TU=16-LINE 4-INP	0223G	43L11PC
A23U5	1820-1081		IC DRVR TTL BUS DRVR QUAD 1-INP	0379D	AM6125
A23U6	1820-1081		IC DRVR TTL BUS DRVR QUAD 1-INP	0379D	AM6125
A23U7	1820-1195		IC FF TTL LS D-TYPE POS-EDGE-TRIG COM	0379D	AM74LS175A
A23U8	1820-1196		IC FF TTL LS D-TYPE POS-EDGE-TRIG COM	0379D	AM74LS174N
A23U9	1820-1418	1	IC DCDR TTL LS MCD=10-DEC 4-TU=10-LINE	0169H	SN74LS42N
A23U10	1820-0471	2	IC INV TTL HEX 1-INP	0223G	7406PC
A23U11	1820-1195		IC FF TTL LS D-TYPE POS-EDGE-TRIG COM	0379D	AM74LS175A
A23U12	1820-1201		IC GATE TTL LS AND QUAD 2-INP	0169H	SN74LS08N
A23U13	1820-1197		IC GATE TTL LS NAND QUAD 2-INP	0169H	SN74LS00N
A23U14	1820-1199		IC INV TTL LS HEX 1-INP	0169H	SN74LS04N
A23U15	1820-1112		IC FF TTL LS D-TYPE POS-EDGE-TRIG	0169H	SN74LS174N
A23U16	04262-85002	1	IC, ROM INTEL 2708	28480	04262-85002
A23U17	04262-85003	1	IC, ROM INTEL 2708	28480	04262-85003
A23U18	04262-85004	1	IC, ROM INTEL 2708	28480	04262-85004
A23U19	04262-85005	1	IC, ROM INTEL 2708	28480	04262-85005

See introduction to this section for ordering information

CHANGE 3

Page 8-51, Figure 8-34. A12 Component Locations,
Change Figure 8-34 to Figure D.

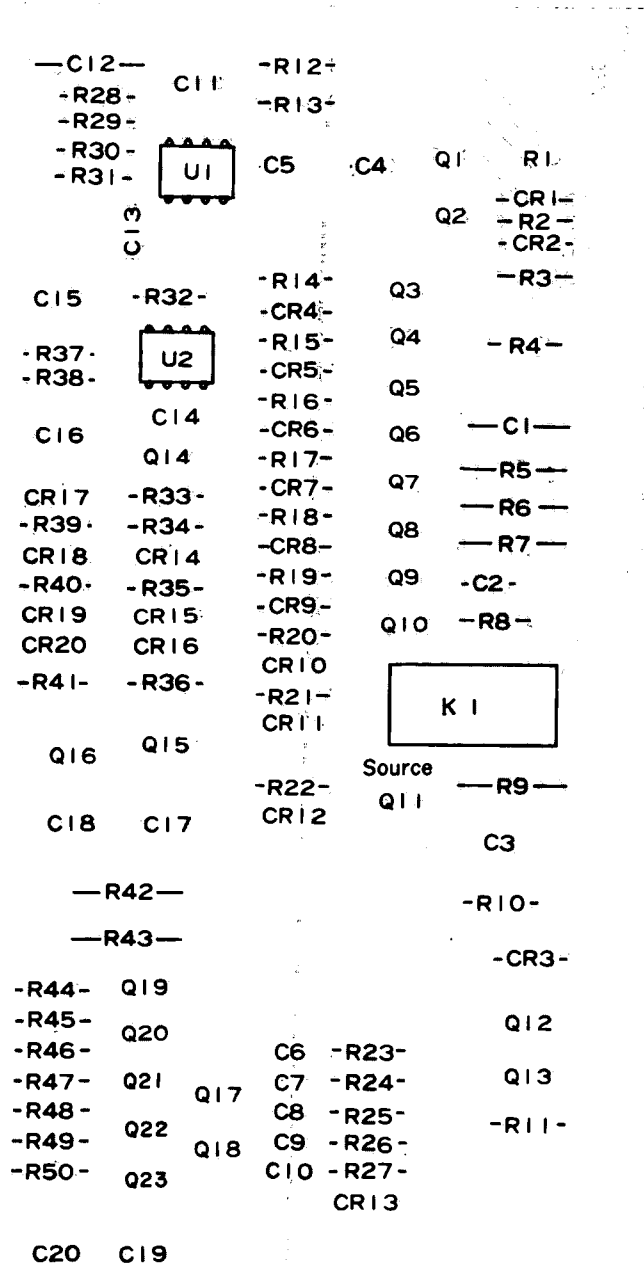

Figure D.

CHANGE 4

Page 6-8, Table 6-3, Replace Parts,
Change A12 board parts list to Table C.

Page 8-51, Figure 8-34. A12 Component Locations,
Change Figure 8-34 to Figure E.

Page 8-51, Figure 8-35. A12 Schematic diagram,
Change Figure 8-35 to Figure F.

Table C.

Reference Designation	HP Part Number	Qty	Description	Mfr Code	Mfr Part Number
A12	04262-66512	1	RANGE RESISTOR BOARD ASSEMBLY	28480	04262-66612
	04262-26512	1	PC BOARD, BLANK	28480	04262-26612
A12C1	0160-0159	1	CAPACITOR-FXD 6800PF +/-10% 200VDC POLYE	0420J	292P68292
A12C2*	0140-0190	1	CAPACITOR-FXD 39PF +/-5% 300VDC *FACTORY SELECTED PART	72136	DM15E390J0300WVICR
A12C3*	0121-0059	2	CAPACITOR-V TRMR-CER 2-8PF 350V PC-MTG *FACTORY SELECTED PART	73899	0V11P48A
A12C4	0180-1051		CAPACITOR, FXD 100 UF 16V M	28480	0180-1051
A12C5	0180-1051		CAPACITOR, FXD 100 UF 16V M	28480	0180-1051
A12C6	0150-0050	6	CAPACITOR-FXD 1000PF +/-80-20% 1KVDC CER	28480	0150-0050
A12C7	0150-0050		CAPACITOR-FXD 1000PF +/-80-20% 1KVDC CER	28480	0150-0050
A12C8	0150-0050		CAPACITOR-FXD 1000PF +/-80-20% 1KVDC CER	28480	0150-0050
A12C9	0150-0050		CAPACITOR-FXD 1000PF +/-80-20% 1KVDC CER	28480	0150-0050
A12C10	0150-0050		CAPACITOR-FXD 1000PF +/-80-20% 1KVDC CER	28480	0150-0050
A12C11	0121-0105	1	CAPACITOR-V TRMR-CER 9-35PF 200V PC-MTG	73899	0V11PR35D
A12C12	0180-0269	1	CAPACITOR-FXD 1UF +/-75-10% 150VDC AL	0420J	30D105G1508A2
A12C13	0160-2150	1	CAPACITOR-FXD 33PF +/-5% 300VDC	28480	0160-2150
A12C14*	0160-2307	3	CAPACITOR-FXD 47pF +/-5% 300VDC		
A12C15	0180-1051		CAPACITOR, FXD 100 UF 16V M	28480	0180-1051
A12C16	0180-1051		CAPACITOR, FXD 100 UF 16V M	28480	0180-1051
A12C17	0180-1051		CAPACITOR, FXD 100 UF 16V M	28480	0180-1051
A12C18	0180-1051		CAPACITOR, FXD 100 UF 16V M	28480	0180-1051
A12C19	0180-1051		CAPACITOR, FXD 100 UF 16V M	28480	0180-1051
A12C20	0180-1051		CAPACITOR, FXD 100 UF 16V M	28480	0180-1051
A12CR1	1901-0040	60	DIODE-SWITCHING 30V 50MA 2NS 00-35	28480	1901-0040
A12CR2	1901-0040		DIODE-SWITCHING 30V 50MA 2NS 00-35	28480	1901-0040
A12CR3	1901-0040		DIODE-SWITCHING 30V 50MA 2NS 00-35	28480	1901-0040
A12CR4	1901-0040		DIODE-SWITCHING 30V 50MA 2NS 00-35	28480	1901-0040
A12CR5	1901-0040		DIODE-SWITCHING 30V 50MA 2NS 00-35	28480	1901-0040
A12CR6	1901-0040		DIODE-SWITCHING 30V 50MA 2NS 00-35	28480	1901-0040
A12CR7	1901-0040		DIODE-SWITCHING 30V 50MA 2NS 00-35	28480	1901-0040
A12CR8	1901-0040		DIODE-SWITCHING 30V 50MA 2NS 00-35	28480	1901-0040
A12CR9	1901-0040		DIODE-SWITCHING 30V 50MA 2NS 00-35	28480	1901-0040
A12CR10	1901-0040		DIODE-SWITCHING 30V 50MA 2NS 00-35	28480	1901-0040
A12CR11	1901-0040		DIODE-SWITCHING 30V 50MA 2NS 00-35	28480	1901-0040
A12CR12	1901-0040		DIODE-SWITCHING 30V 50MA 2NS 00-35	28480	1901-0040
A12CR13	1902-3149		DIODE-ZNR 9.09V 5% 00-7 PD=4W TC=+.05%	0223G	F27256
A12CR14	1901-0040		DIODE-SWITCHING 30V 50MA 2NS 00-35	28480	1901-0040
A12CR15	1901-0040		DIODE-SWITCHING 30V 50MA 2NS 00-35	28480	1901-0040
A12CR16	1901-0040		DIODE-SWITCHING 30V 50MA 2NS 00-35	28480	1901-0040
A12CR17	1901-0040		DIODE-SWITCHING 30V 50MA 2NS 00-35	28480	1901-0040
A12CR18	1901-0040		DIODE-SWITCHING 30V 50MA 2NS 00-35	28480	1901-0040
A12CR19	1901-0040		DIODE-SWITCHING 30V 50MA 2NS 00-35	28480	1901-0040
A12CR20	1901-0040		DIODE-SWITCHING 30V 50MA 2NS 00-35	28480	1901-0040
A12K1	0490-0237	1	RELAY, REED 2A	28480	0490-0237
A12Q1	5080-3830		TRANSISTOR J-FET N-CHAN D-MODE SI		
A12Q2	5080-3830		TRANSISTOR J-FET N-CHAN D-MODE SI		
A12Q3	5080-3830		TRANSISTOR J-FET N-CHAN D-MODE SI		
A12Q4	1855-0128	1	TRANSISTOR J-FET N-CHAN SI	28480	
A12Q5	5080-3830		TRANSISTOR J-FET N-CHAN D-MODE SI		
A12Q6	5080-3830		TRANSISTOR J-FET N-CHAN D-MODE SI		
A12Q7	5080-3830		TRANSISTOR J-FET N-CHAN D-MODE SI		
A12Q8	5080-3830		TRANSISTOR J-FET N-CHAN D-MODE SI		
A12Q9	5080-3830		TRANSISTOR J-FET N-CHAN D-MODE SI		
A12Q10	5080-3830		TRANSISTOR J-FET N-CHAN D-MODE SI		
A12Q11	5080-3830		TRANSISTOR J-FET N-CHAN D-MODE SI		
A12Q12	5080-3078		TRANSISTOR NPN SI PD=300MW FT=200MHZ		
A12Q13	5080-3078		TRANSISTOR NPN SI PD=300MW FT=200MHZ		
A12Q14	5080-3835	6	TRANSISTOR J-FET 2N5245 N-CHAN D-MODE SI	0169H	2N5245
A12Q15	1854-0013	1	TRANSISTOR NPN 2N2218A SI TO-5 PD=800MW	0203G	2N2218A
A12Q16	1853-0012	2	TRANSISTOR PNP 2N2904A SI TO-18 PD=600MW	0169H	2N2904A
A12Q17	1853-0020		TRANSISTOR PNP SI PD=300MW FT=150MHZ	28480	1853-0020
A12Q18	1853-0020		TRANSISTOR PNP SI PD=300MW FT=150MHZ	28480	1853-0020
A12Q19	1853-0020		TRANSISTOR PNP SI PD=300MW FT=150MHZ	28480	1853-0020
A12Q20	5080-3078		TRANSISTOR NPN SI PD=300MW FT=200MHZ	28480	
A12Q21	1853-0020		TRANSISTOR PNP SI PD=300MW FT=150MHZ	28480	1853-0020
A12Q22	1853-0020		TRANSISTOR PNP SI PD=300MW FT=150MHZ	28480	1853-0020
A12Q23	1853-0020		TRANSISTOR PNP SI PD=300MW FT=150MHZ	28480	1853-0020

See introduction to this section for ordering information
*Indicates factory selected value

Table C . (Cont'd).

Reference Designation	HP Part Number	Qty	Description	Mfr Code	Mfr Part Number
A12R1	2100-2514	1	RESISTOR-TRMR 20K 10X C SIDE=ADJ 1-TRM	0365A	E750W203
A12R2	06A3-1055	35	RESISTOR 1M 5% .25W FC TC=-800/+900	0160G	CB1055
A12R3	06A3-1055		RESISTOR 1M 5% .25W FC TC=-800/+900	0160G	CB1055
A12R4	0698-2298	1	RESISTOR 10 .05% .33W	28480	0698-2298
A12R5	0698-2294	1	RESISTOR 100 .1 .05%	28480	0698-2294
A12R6	0698-2296	1	RESISTOR 1010.1 .05%	28480	0698-2296
A12R7	0698-2214	1	RESISTOR:FXD 10.0K OHM 0.05% 1/8W MF	28480	0698-2214
A12R8	0698-5408	1	RESISTOR 1.111K .1% .125W F TC=0+-100		
A12R9	0698-2225	1	RESISTOR:FXD 90.0K OHM 0.05% 1/8W MF	28480	0698-2225
A12R10	0698-3329	1	RESISTOR 10K .5% .125W F TC=0+-100	03888	PME55=1/8-T0=1002=D
A12R11	0683-3335		RESISTOR 33K 5% .25W FC TC=-400/+800	0160G	CB3335
A12R12	0683-4705	4	RESISTOR 47 5% .25W FC TC=-400/+500	0160G	CB4705
A12R13	0683-4705		RESISTOR 47 5% .25W FC TC=-400/+500	0160G	CB4705
A12R14	0683-1055		RESISTOR 1M 5% .25W FC TC=-800/+900	0160G	CB1055
A12R15	0683-1055		RESISTOR 1M 5% .25W FC TC=-800/+900	0160G	CB1055
A12R16	0683-1055		RESISTOR 1M 5% .25W FC TC=-800/+900	0160G	CB1055
A12R17	0683-1055		RESISTOR 1M 5% .25W FC TC=-800/+900	0160G	CB1055
A12R18	0683-1055		RESISTOR 1M 5% .25W FC TC=-800/+900	0160G	CB1055
A12R19	0683-1055		RESISTOR 1M 5% .25W FC TC=-800/+900	0160G	CB1055
A12R20	0683-1055		RESISTOR 1M 5% .25W FC TC=-800/+900	0160G	CB1055
A12R21	0683-1055		RESISTOR 1M 5% .25W FC TC=-800/+900	0160G	CB1055
A12R22	0683-1055		RESISTOR 1M 5% .25W FC TC=-800/+900	0160G	CB1055
A12R23	0683-3335		RESISTOR 33K 5% .25W FC TC=-400/+800		
A12R24	0683-3335		RESISTOR 33K 5% .25W FC TC=-400/+800		
A12R25	0683-3335		RESISTOR 33K 5% .25W FC TC=-400/+800		
A12R26	0683-3335		RESISTOR 33K 5% .25W FC TC=-400/+800		
A12R27	0683-3335		RESISTOR 33K 5% .25W FC TC=-400/+800		
A12R28	0683-1035	21	RESISTOR 10K 5% .25W FC TC=-400/+700	0160G	CB1035
A12R29	0683-5655	2	RESISTOR 5.6M 5% .25W FC TC=-900/+1100	0160G	CB5655
A12R30	0683-1035		RESISTOR 10K 5% .25W FC TC=-400/+700		
A12R31	0683-3325	4	RESISTOR 3.3K 5% .25W FC TC=-400/+700		
A12R32	0683-1065	1	RESISTOR 10M 5% .25W FC TC=-900/+1100	0160G	CB1065
A12R33	0683-1055		RESISTOR 1M 5% .25W FC TC=-800/+900	0160G	CB1055
A12R34	0757-0394	2	RESISTOR 51.1 1% .125W F TC=0+-100	03298	C4=1/8-T0=51K1=F
A12R35	0683-1035		RESISTOR 10K 5% .25W FC TC=-400/+700	0160G	CB1035
A12R36	0683-0275	2	RESISTOR 2.7 5% .25W FC TC=-400/+500	0160G	CB2765
A12R37	0683-4705		RESISTOR 47 5% .25W FC TC=-400/+500	0160G	CB4705
A12R38	0683-4705		RESISTOR 47 5% .25W FC TC=-400/+500	0160G	CB4705
A12R39	0757-0494		RESISTOR 51.1 1% .125W F TC=0+-100	03298	C4=1/8-T0=51K1=F
A12R40	0683-1035		RESISTOR 10K 5% .25W FC TC=-400/+700	0160G	CB1035
A12R41	0683-0275		RESISTOR 2.7 5% .25W FC TC=-400/+500	0160G	CB2765
A12R42	0757-1090	2	RESISTOR 261 1% .5W F TC=0+-100	0299E	MF7C1/2-T0=261K=F
A12R43	0757-1090		RESISTOR 261 1% .5W F TC=0+-100	0299E	MF7C1/2-T0=261K=F
A12R44	0683-3335		RESISTOR 33K 5% .25W FC TC=-400/+800	0160G	CB3335
A12R45	0683-3335		RESISTOR 33K 5% .25W FC TC=-400/+800	0160G	CB3335
A12R46	0683-3335		RESISTOR 33K 5% .25W FC TC=-400/+800		
A12R47	0683-3335		RESISTOR 33K 5% .25W FC TC=-400/+800		
A12R48	0683-3335		RESISTOR 33K 5% .25W FC TC=-400/+800		
A12R49	0683-3335		RESISTOR 33K 5% .25W FC TC=-400/+800		
A12R50	0683-3335		RESISTOR 33K 5% .25W FC TC=-400/+800		
A12U1	1826-0326	1	IC OP AMP	07933	RC4558DN
A12U2	1826-0089		IC 2525 OP AMP	03791	HA2-2525-5

See introduction to this section for ordering information

CHANGE 5

Page 6-17, Table 6-3, Replaceable Parts

Change part numbers for A23 U15 and U16 to 1818-0423 and 1818-0424, respectively.

Page 8-63, Figure 8-47, A23 Component Locations,
Change Figure 8-47 to Figure G.

Page 8-63, Figure 8-48, A23 schematic diagram,
Partially change Figure 8-48 as shown in Figure H.

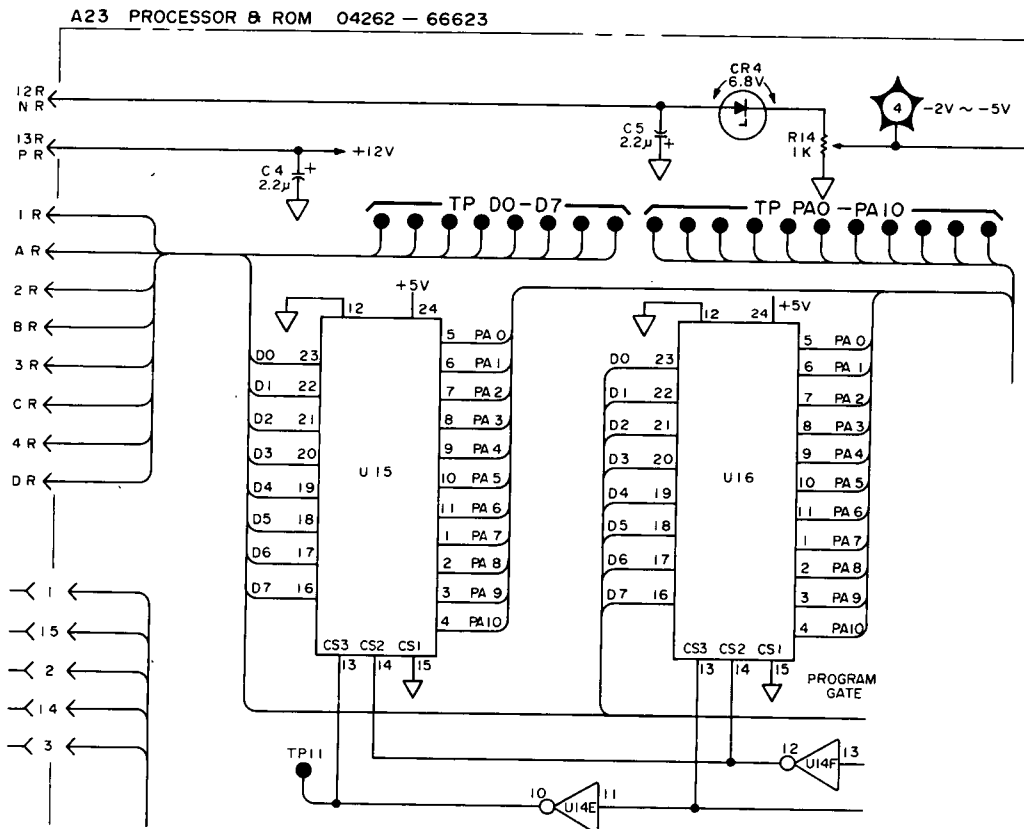

Figure H.

Section VII
Figure C.

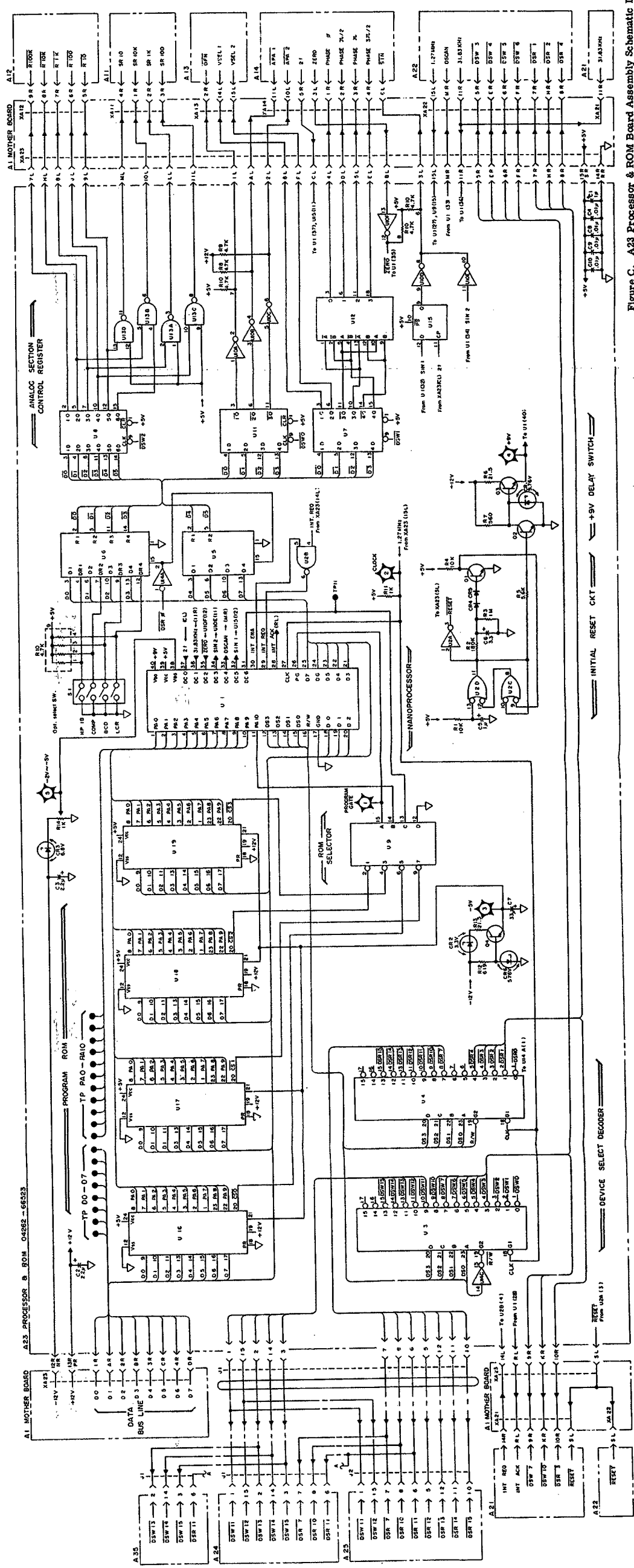

Figure C. A23 Processor & ROM Board Assembly Schematic Diagram.

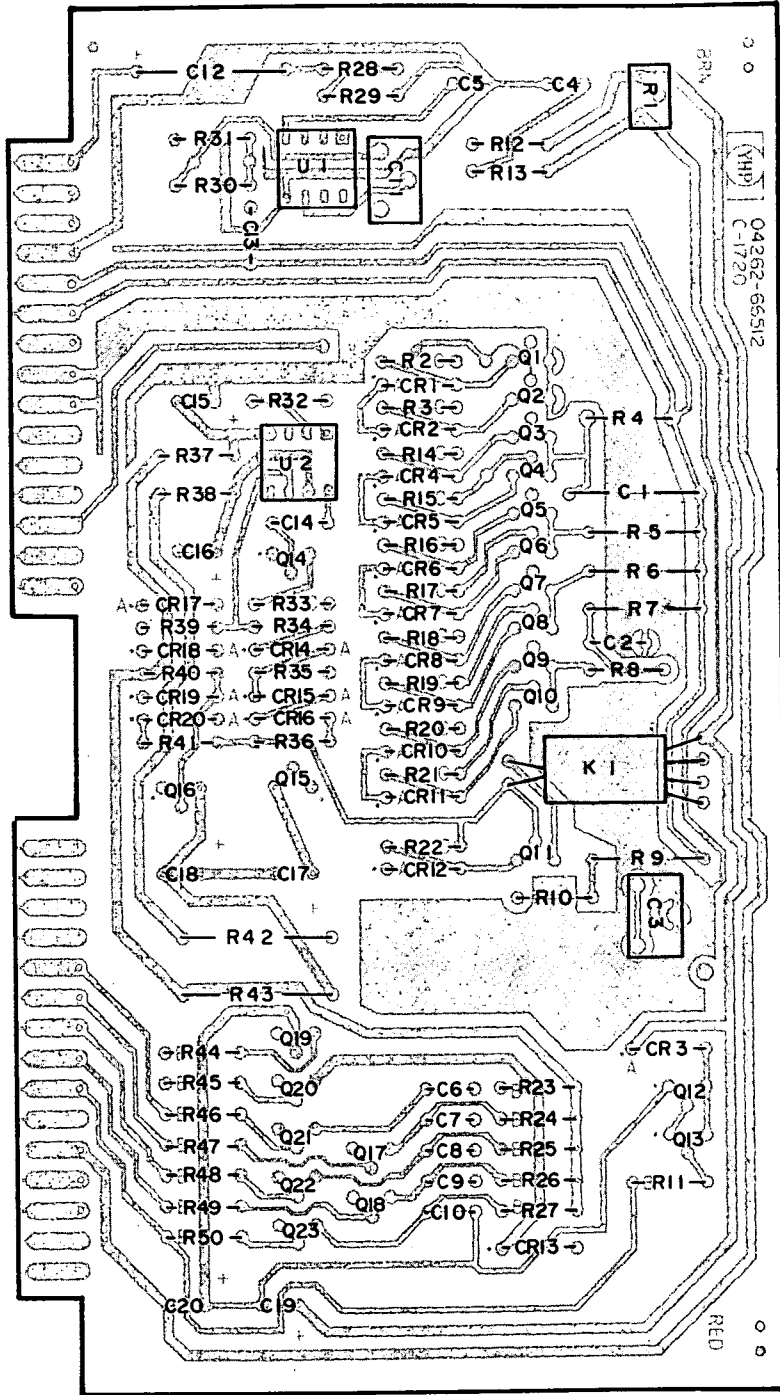

Figure E.

Section VII
Figure F.

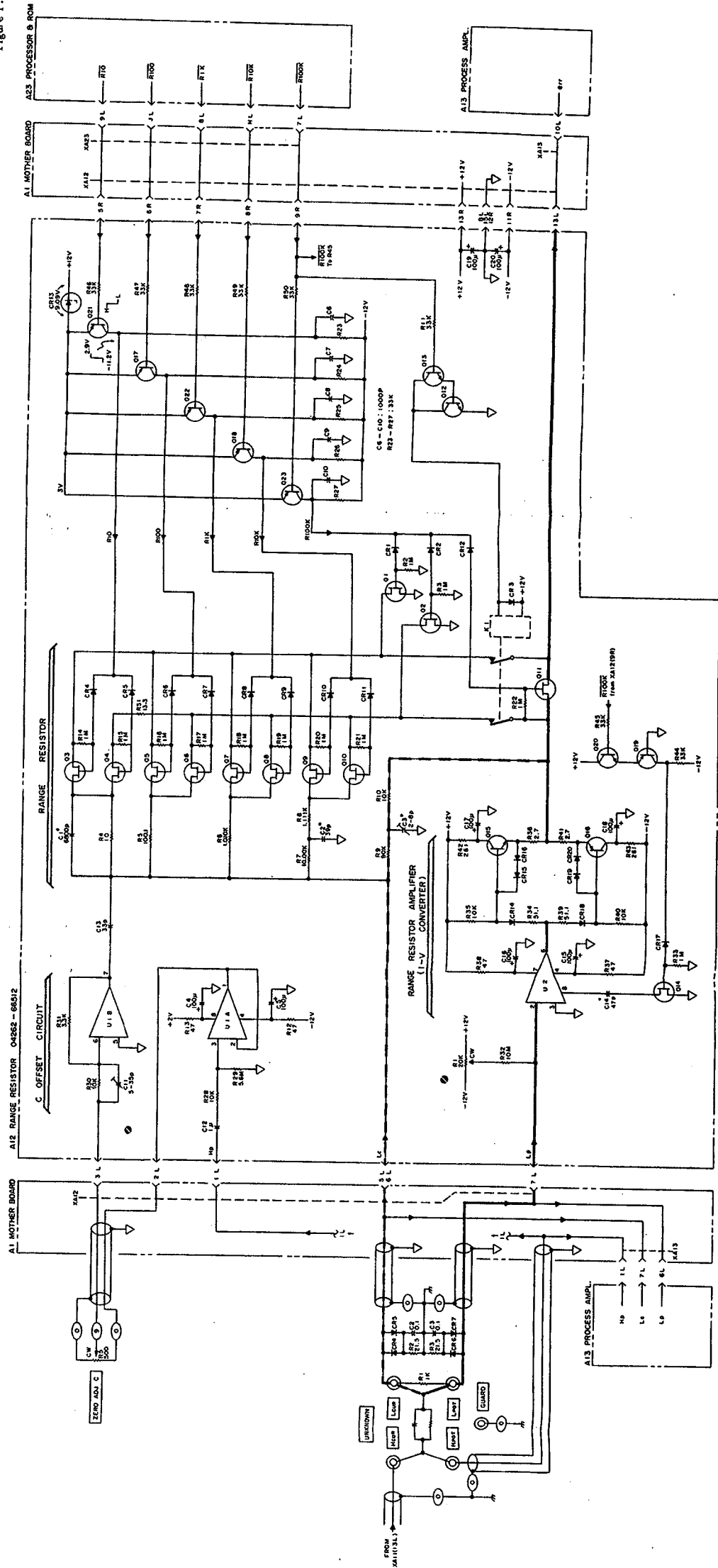

Figure F.

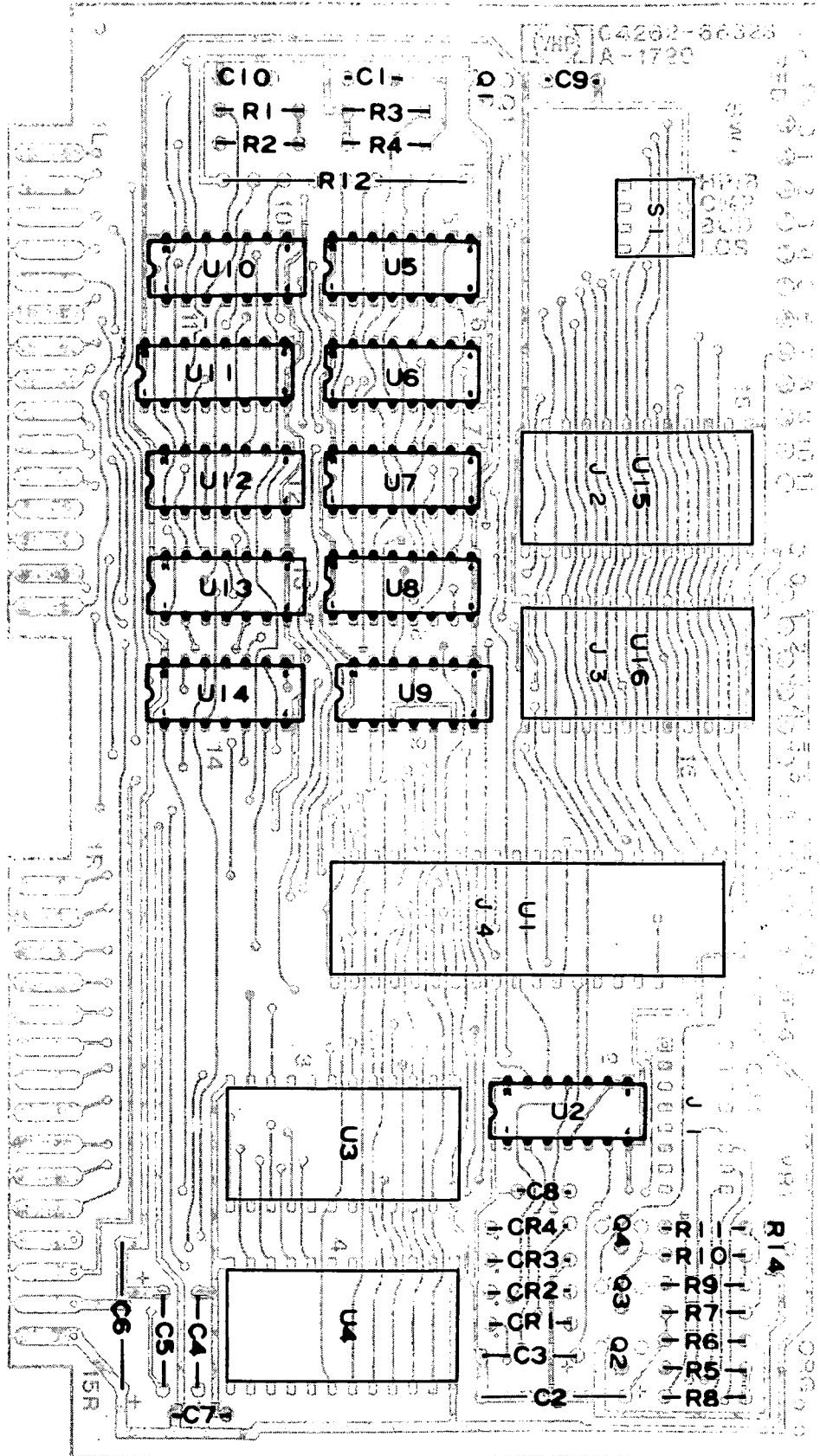

Figure G.

SECTION VIII SERVICE

8-1. INTRODUCTION.

8-2. This manual section provides the information and instructions required for servicing the HP Model 4262A LCR Meter. Included are Theory of Operation and Troubleshooting Guide with Circuit Schematics. The Theory of Operation describes fundamental principles and circuit operating theory of the 4262A with block diagrams. Circuit schematics, locator illustrations, troubleshooting guide, circuit analysis and other technical data necessary for repairs are integrated into the service sheet foldouts. An illustration of the instrument interior is shown in Figure 8-21.

Note

When the instrument circuitry includes expanded capabilities provided by optional equipment, refer to paragraphs entitled OPTIONS for specific option service information.

WARNING

TROUBLESHOOTING AND REPAIR ARE ALLOWED FOR QUALIFIED TECHNICAL PERSONNEL ONLY. IF YOUR INSTRUMENT FAILS, REFER INSTRUMENT TO SERVICE PERSONNEL. H-P SERVICE OFFICES OFFER YOU THE BEST ANSWER TO YOUR PROBLEM. A GUIDE TO YOUR LOCAL H-P SERVICE OFFICES MAY BE FOUND ON THE BACK COVER OF THIS MANUAL.

8-3. THEORY OF OPERATION.

8-4. This theory of operation has been organized into three sections: basic theory, a block diagram discussion, and circuit analysis. The basic theory, beginning with paragraph 8-11, explains the concepts and fundamental theory of the 4262A instrument technique adapted for accurately measuring the DUT and for fully achieving automated measurement performance. The block diagram discussion describes the overall circuit operating theory of the 4262A with block-to-block signal flow. Included are block and timing diagrams. The

circuit analysis provides a detailed description of how the circuit on each board functions. For reference convenience, when servicing the instrument, a circuit description is included in the service sheets.

8-5. TROUBLESHOOTING.

8-6. This troubleshooting guide provides instructions and information for locating a faulty circuit instrument component that requires service. All instructions consider the safety of service personnel who will perform the procedures. These diagnostic guides are in the form of step-by-step procedures with flow diagrams. The board level troubleshooting diagrams are the procedures for isolating the problem to an individual malfunctioning circuit board assembly. The guides for locating a defective component are given on the individual board service sheets and integrate service support data: test point locations, waveform illustrations, voltage data, timing diagrams, and other technical information in addition to providing schematic diagrams for each board. To facilitate easy troubleshooting of the 4262A digital section, the troubleshooting guide for the logic circuit employs a signature analysis technique incorporating the concept of data stream analysis. A guideline to signature analysis is provided in Figure 8-12.

8-7. RECOMMENDED TEST EQUIPMENT.

8-8. The test equipment required to perform operations outlined in this section is listed in Table 1-4 (Section I). The table includes: type of instrument required, critical specifications, use, and recommended model. If the recommended model is not available, equipment which meets or exceeds critical specifications listed may be substituted.

8-9. REPAIR.

8-10. Repair explanations tell how to replace defective circuit components. The recommended replacement procedures for components and parts which require special repair, replacement tools, or test equipment should be observed. Correct disassembly and the exchange procedures for such special parts are outlined in Paragraphs 8-46 through 8-52. To prevent damage from improper repair procedure, refer to the appropriate manual section before proceeding with repair.

8-11. BASIC THEORY.

8-12. Figure 8-1 is the basic block diagram of the 4262A showing mainly the analog measurement section. It illustrates how the 4262A measures inductance L, capacitance C, resistance R and/or dissipation factor D. In this figure, the dotted lines denote the directions of control signals to and from the nanoprocessor centered control circuit. A measuring test signal from the oscillator is applied (at level E1) through the source resistor to both the unknown device and the range resistor R_r. Amplifier R_r causes the same current that flows through the unknown device to flow through R_r and operates as a current to voltage converter. The effect of the R_r amplifier is to produce a voltage (E2) equal in phase to and exactly proportional to the current that flows through the unknown device. This amplifier drives the junction of the unknown device and R_r to zero volts (virtual ground); thus R_r does not affect the unknown device current. The voltage E2 represents the vector current which flows through unknown device at test signal level E1. E1 and E2 completely define the electrical characteristics of the DUT (Device Under Test) at a given test level and frequency. The details of how the measured values are derived from the ratio of E1 and E2 are discussed in Paragraph 8-16.

8-13. Voltages E1 and E2, across the unknown device and R_r, respectively, are connected to selector switches S1 and S2. These switches have two

important functions: first, S1 selects either E1 or E2 as the voltage to drive the four phase generator [this also establishes the measurement mode - either series or parallel which is automatically or manually set (PARA or SER - as selected at the front panel)] and, secondly, S2 selects either E1 or E2 as the measurement voltage to charge or discharge the integrator (as appropriate to the measurement function and mode - i. e. C_p, C_s, L_p, L_s, R_p or R_s) in the Vector Voltage-Ratio Measurement Section.

The Vector Voltage-Ratio Measurement Section calculates the measured value for L, C, R or D by ascertaining the voltage ratio between E1 and E2 through a dual-slope (type) analog to digital conversion technique. (This technique is popularly used in digital voltmeters). The section also processes the E1 and E2 signal flow to make the desired measurement. Selection of either an L, C, R or D measurement and an appropriate equivalent measuring circuit is established by setting detector phase reference and by S1 and S2 switch operation timing. The analog section receives its measurement instructions from the digital section. A detailed operating description of the Vector Voltage-Ratio Measurement Section is given in Paragraph 8-15.

8-14. Appropriate values for the source and range resistors, R_o and R_r, are selected with respect to the impedance of unknown device. In a series equivalent circuit measurement (L_s, C_s or R_s), the

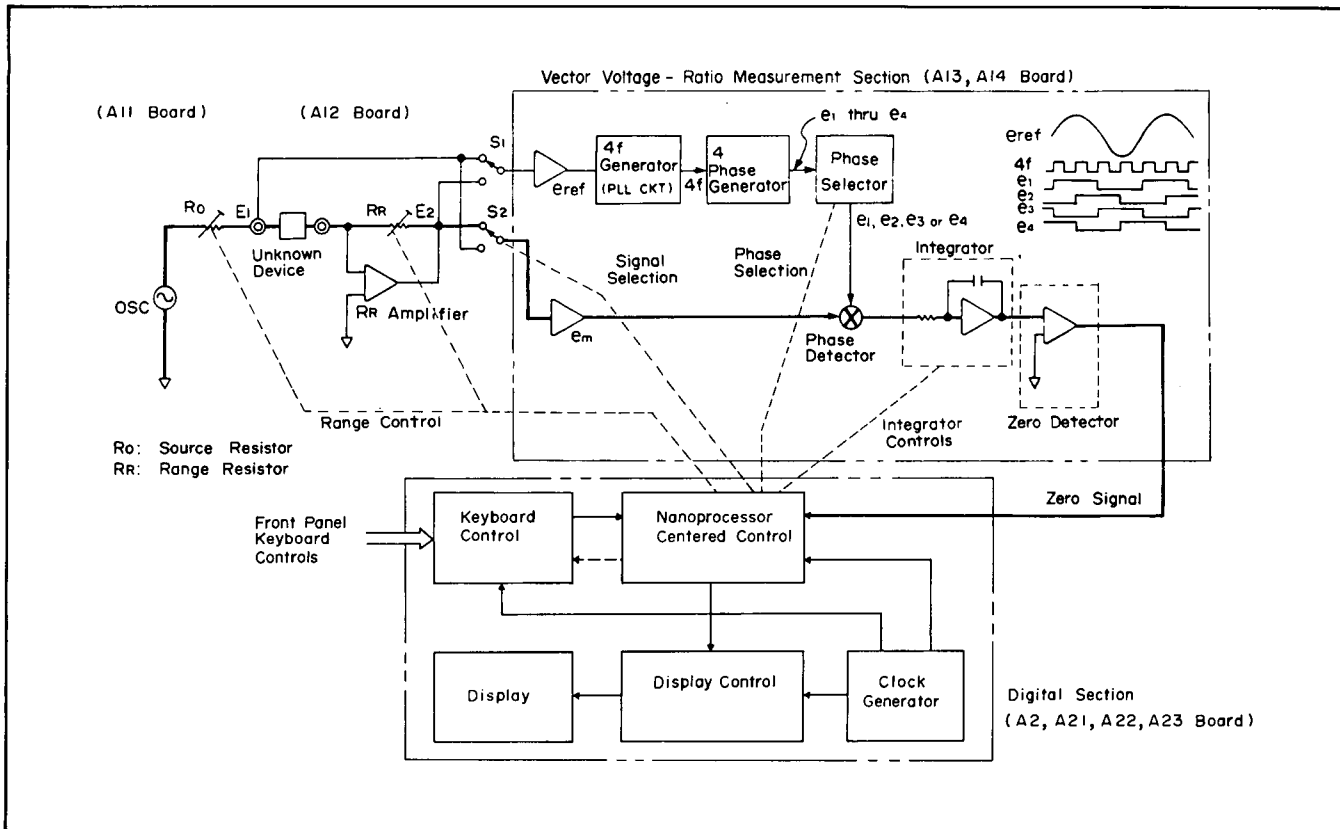

Figure 8-1. Basic Block Diagram.

impedance of the unknown is usually low and R_o is set to a value much greater than the impedance of the unknown device to achieve a constant current drive. On the other hand, for a parallel equivalent circuit measurement (L_p , C_p or R_p), the impedance of the unknown device is usually high so R_o is set to a much smaller value than the impedance of the unknown. Thus, a constant voltage drive is realized. The resistance values for R_o and R_r are always equal.

8-15. Here is a brief discussion of Vector Voltage-Ratio Measurement Section operation. The e_m signal selected by S2 (from either E1 or E2) is detected by a phase detector that outputs the rectangular component or in-phase component to an integrator. Phase detector drive signals e_1 through e_4 are produced in the following manner: a 4f signal is generated from an e_{ref} signal (at a frequency of f) as selected by switch S1. This creates signals e_1 through e_4 , each being different by 90 degrees in phase from one another (a 4 phase generator). As a PLL (Phase Lock Loop) circuit is used for generating the reference phase signal to minimize measurement error, the phase of signals E1 through E4 is very accurate. One of these signals, as directed by the digital circuitry, detects the e_m measurement signal. Phase detector output is a vector component signal representing the capacitive, reactive, or other characteristic of unknown to be measured.

8-16. This paragraph discusses the parallel capacitance C_p measurement principle. To simplify the explanation, the example used here is that of measuring an ideal capacitor. See Figure 8-2, C_p Measurement. During time T_1 , Switch S2 selects E2 and the integrator is charged by that portion of the E2 sinusoidal waveform which is synchronously phase detected by the e_2 pulse train. Both S1 and S2

switches select the E1 signal that is fed to discharge the integrator after being phase-detected by the e_1 signal. Since time period T_2 , for the integrator to discharge to zero volts, is proportional to the value of C_x , C_x can be directly obtained from the contents of a counter if the values for R_r and T_1 are properly and accurately set. A zero detector signals the digital section to establish a counted number corresponding to C_x each time the integrator output crosses the zero level. Other measurements are done similar to the C_p measurement.

8-17. The analog section of the 4262A is controlled by nanoprocessor centered control which manages the various sequences required to perform the desired measurements. Range control, selection of measurement mode, and timing of the A-D conversion processes are governed by the nanoprocessor. The nanoprocessor also acts as a computing device and calculates deviation ΔLCR and the quality factor of sample (mathematical operation) as well as counting the L, C, R and D values converted into time periods.

8-18. The functions set by pushing front panel pushbuttons are inputted to the nanoprocessor through the keyboard control. The keyboard switches are assigned individual addresses for discrimination. When a panel control pushbutton is depressed, the keyboard control identifies the address of switch and causes the nanoprocessor to treat the "interruption" of the function it recognizes by the address code. The nanoprocessor gives priority to specific pushbutton functions so as to be able to restrict improper control settings. Keyboard operation is monitored by and in-part managed by nanoprocessor programming. This is partly to assist the operator and partly to prevent misoperation.

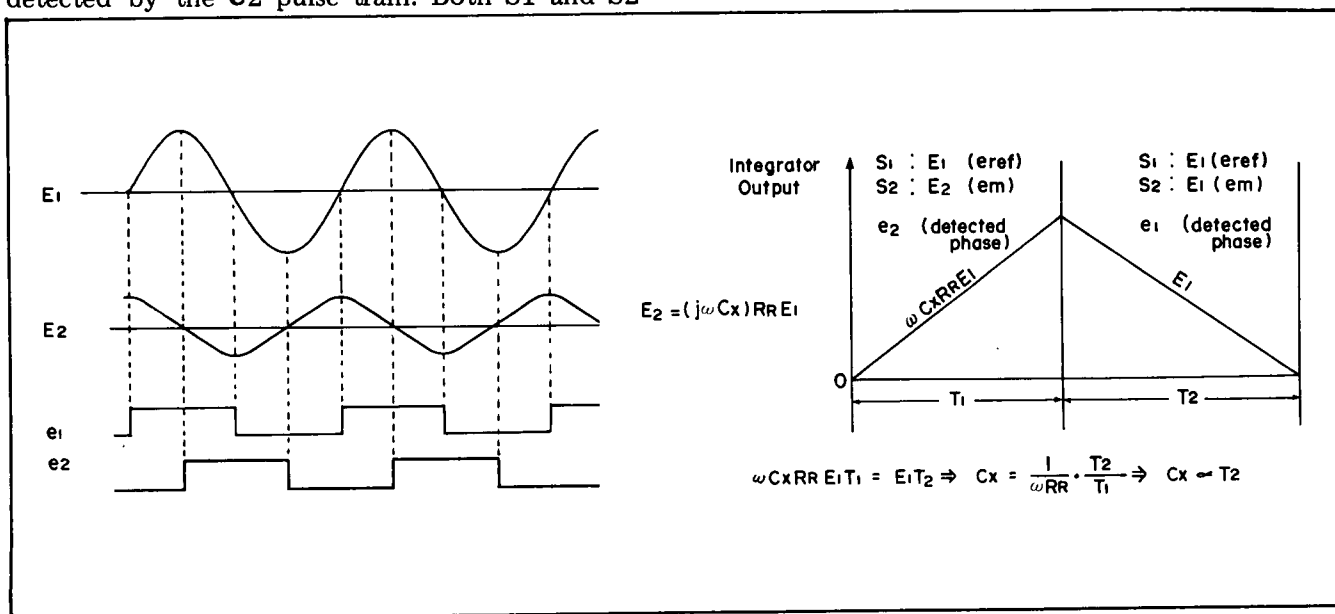

Figure 8-2. C_p Measurement.

PRINCIPLES OF OPERATION

The following outlines 4262A measurement principles using some equations to aid and acquaint you with the basic concepts of the unit. To simplify explanation in general, only the principles for C-D (capacitance and dissipation factor) measurements are discussed here. The measurement principles for other impedance paramters can be deduced by a similar course of reasoning.

In Cp - D measurements, since a constant test voltage is applied to the unknown, the DUT generally presents a high impedance to the test signal. The following equation shows the relationship beteen voltage E1 at the "H" terminal (voltage across the DUT) and range resistor amplifier output voltage E2 (voltage across range resistor):

$$-E2 = (Gp + j\omega Cp) Rr \cdot E1 \dots\dots\dots \text{eq. 8-1}$$

where, Gp is parallel conductance
 Cp is unknown capacitance
 Rr is value of range resistor
 ω is angular frequency of test signal

The phase detector separately extracts the real and the imaginary voltage components of E2 (represented by formulas GpRrE1 and jω CpRrE1, respectively). Figure A is a vector diagram of phase detector output voltage.

During the charging cycle T1, the phase detector detects the 90 degree phase component of the E2 signal. Thus, the integrator output voltage becomes:

$$k1\omega CpRrE1T1 \dots\dots\dots \text{eq. 8-2}$$

where, k1 is a constant value determined by 4262A circuitry.

Following the E2 signal, the E1 signal is applied to the phase detector and the discharge cycle begins. The phase detector detects a signal whose magnitude is E1/10 (that is, the E1 signal is attenuated to 1/10 to develop the appropriate time T2 for discharging the integrator) by phase detection of the signal in phase with E1. The resulting change in integrator output voltage developed by the E1/10 signal is:

$$-k1 \frac{E1}{10} T2 \dots\dots\dots \text{eq. 8-3}$$

The integrator output eventually reaches zero volts (as a result of the charge and discharge cycle). Thus, the sum of the voltages given in equations 8-2 and 8-3 is zero. And,

$$k\omega CpRrE1T1 = k1 \frac{E1}{10} T2 \dots\dots\dots \text{eq. 8-4}$$

Cp is derived from equation 8-4 as follows:

$$Cp = \frac{T2}{10\omega RrT1} \dots\dots\dots \text{eq. 8-5}$$

(ω = 2πfm)

To eliminate ω from equation 8-5, the 4262A establishes a constant charging time T1 as follows:

$$T1 = k2 \frac{1}{fm} \dots\dots\dots \text{eq. 8-6}$$

where k2 is a constant value (for each test signal frequency).

Equation 8-5 then becomes:

$$Cp = \frac{T2}{20k2\pi Rr} \dots\dots\dots \text{eq. 8-7}$$

This is how the measurement frequency is cancelled out of the equation for the measured capacitance value. The discharge period, T2, is measured by counting clock fc whose frequency is constant at 31.83kHz (its period is 31.4μsec = 10π x 10-6 sec).

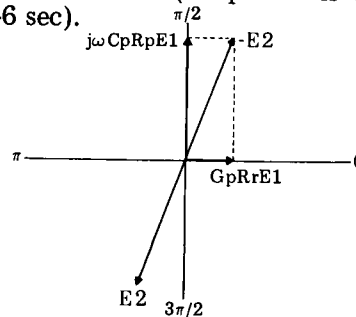

Figure A.

Thus, if n is the number of counts for fc, T2 can be expressed as follows:

$$T2 = n \cdot 10\pi \times 10^{-6} \text{ (seconds)} \dots\dots\dots \text{eq. 8-8}$$

And, if equation 8-8 is substituted in equation 8-7,

$$Cp = n \cdot \frac{10^{-6}}{2k2Rr} \dots\dots\dots \text{eq. 8-9}$$

This equation means that discharge period T2 (number of counts for fc) is directly equal to the mantissa of a measured Cp value (note that Rr = 10^m; and m is an integer).

For example, if a 1200pF capacitor is measured at a measurement frequency of 1kHz, the 4262A automatically selects 10kΩ as the Rr and constant k2 is 50. Therefore, equation 8-9 may be written as:

$$C_p = n \cdot \frac{10^{-6}}{2k_2R_r} = n \cdot \frac{10^{-6}}{2 \times 50 \times 10 \times 10^3} = n \cdot 10^{-12}$$

Consequently,

$$n = C_p \times 10^{12} = (1200 \times 10^{-12}) \times 10^{12} = 1200$$

The 4262A will display 1200 counts and the "pF" unit lamp will light.

In a D measurement cycle, the integrator is charged for period T3 by the E2 signal as detected by a detection phase in phase with E2. Integrator output voltage rises to k1GpRrE1T3. During the discharge cycle T4, the detection phase is different by 90 degrees as referred to E2. The discharge voltage becomes k1ωCpRrE1T4. From these integrator voltage changes in the D measurement cycle, the following equation may be composed:

$$k_1G_pR_rE_1T_3 = k_1\omega C_pR_rE_1T_4 \dots \text{eq. 8-10}$$

Dissipation factor D is derived as follows:

$$D = \frac{G_p}{\omega C_p} = \frac{T_4}{T_3} \dots \text{eq. 8-11}$$

The period T3 is constant and is equal to 1000 $\frac{1}{f_c}$ (fc = 31.83kHz). If n stands for number of counts for fc during period T4, T4 is equal to n $\cdot \frac{1}{f_c}$. Thus, equation 8-11 may be converted to:

$$D = \frac{T_4}{T_3} = \frac{n \cdot \frac{1}{f_c}}{1000 \cdot \frac{1}{f_c}} = \frac{n}{1000}$$

Therefore, n = 1000D.

If D value for the unknown is 1.2, n will become 1200 which will be displayed at the front panel with the decimal point. Figure 8-3 shows the expanded forms of calculations for impedance parameters.

As shown in Figure 8-3, two kinds of integrator waveforms exist. These two distinctive integrator operations may be examined with respect to Cp and Cs measurement modes. For a Cs - D measurement, a constant current drive is applied to the unknown. Voltage E2 is a constant value drop across Rr and E1 is a variable voltage produced by DUT. The following equation shows the relationship between voltages E1 and E2:

$$-E_1 = \left(\frac{R_s}{R_r} + \frac{1}{j\omega C_s R_r} \right) \cdot E_2 \dots \text{eq. 8-12}$$

The reference phase for the phase detector is now taken from E2 signal. During charging cycle T1, the phase detector detects input voltage E1/10 by a detection phase in phase with E2. The integrator output voltage becomes:

$$k_1 \cdot \frac{E_2}{10} \cdot T_1 \dots \text{eq. 8-13}$$

The integrator charges to a constant voltage regardless the value of the DUT. During integrator discharge cycle, the phase detector detects E1 signals with a detection signal that is different in phase by 90 degrees with respect to the E2 signal. The resulting integrator output voltage change is:

$$-k_1 \cdot \frac{E_2}{\omega C_s R_r} \cdot T_2 \dots \text{eq. 8-14}$$

Therefore,

$$k_1 \frac{E_2}{10} T_1 = k_1 \frac{E_2}{\omega C_s R_r} T_2 \dots \text{eq. 8-15}$$

Cs is derived from equation 8-15 as follows:

$$C_s = \frac{10}{\omega R_r} \cdot \frac{T_2}{T_1} \dots \text{eq. 8-16}$$

Substituting T1 in equation 8-6 produces:

$$C_s = \frac{10}{2\pi k_2 R_r} T_2 \dots \text{eq. 8-17}$$

Since T2 is counted by a 31.83kHz (its period is 10π x 10⁻⁶ sec) clock, equation 8-17 is:

$$C_s = n \cdot \frac{100}{2k_2R_r} \times 10^{-6} \dots \text{eq. 8-18}$$

where, n is number of clock counts.

If 4262A measurement frequency is 1kHz, Rr is 1kΩ, and k2 is 5, equation 8-18 becomes:

$$C_s = n \cdot \frac{100}{2 \times 5 \times 10^3} \times 10^{-6} = 10n \times 10^{-9} (F)$$

When the capacitance of the unknown is 10μF, the 4262A displays 10.00 counts and the μF unit lamp lights.

8-19. Display Control converts the measurement data signals from the nanoprocessor to display component signals which are so coded that corresponding numeric figures are displayed on the 7 segment LED displays. The measurement data is momentarily stored in a memory in this section and sent, in turn, to the matrix drive of each digit of the displays. The alphabetic PASS FAIL, U-CL, and O-F annunciators are illuminated directly on the display by annunciation signals coded by the nanoprocessor. This section also includes a clock generator which employs a crystal resonator to provide the digital section with accurate timing.

8-20. The nanoprocessor centered control and other digital sections are connected to a data bus line (8 bit) on which the measurement data and nanoprocessor I/O signals are transferred. This data bus line serves the overall digital section including the optional sections when the instrument is equipped with HP-IB Compatible (Option 101), BCD Data Output (Option 001), or Comparator (Option 004) option. The timing of the handshakes with system controller (such as a calculator), data transfer, and comparative data are also managed via the data bus line by the nanoprocessor. The operating principles of the option sections are discussed in the paragraphs entitled Options.

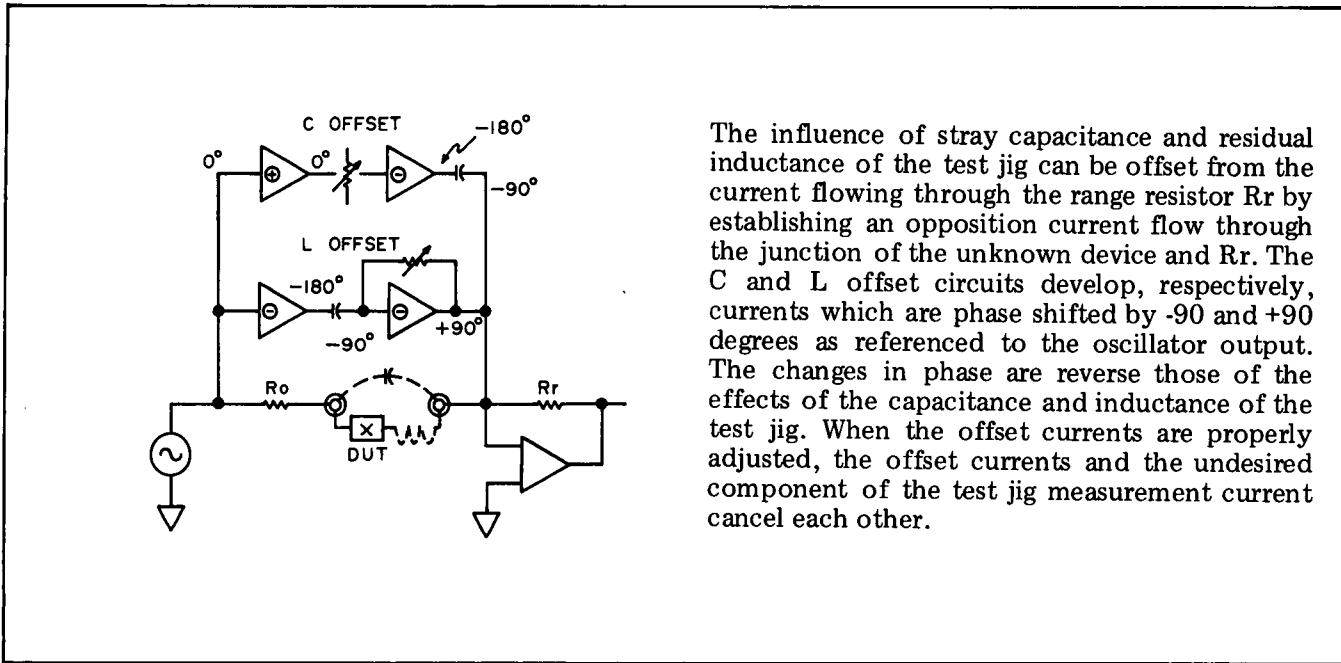

The influence of stray capacitance and residual inductance of the test jig can be offset from the current flowing through the range resistor R_r by establishing an opposition current flow through the junction of the unknown device and R_r . The C and L offset circuits develop, respectively, currents which are phase shifted by -90 and $+90$ degrees as referenced to the oscillator output. The changes in phase are reverse those of the effects of the capacitance and inductance of the test jig. When the offset currents are properly adjusted, the offset currents and the undesired component of the test jig measurement current cancel each other.

Figure 8-4. Offset Control Principle.

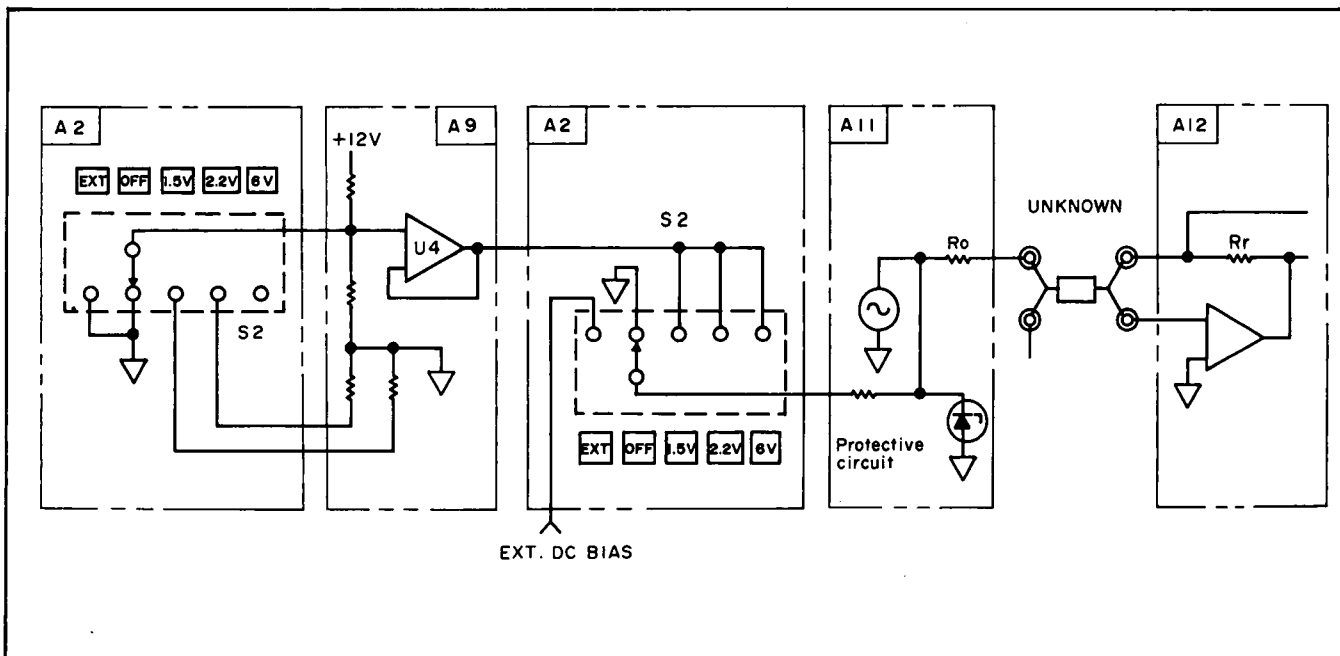

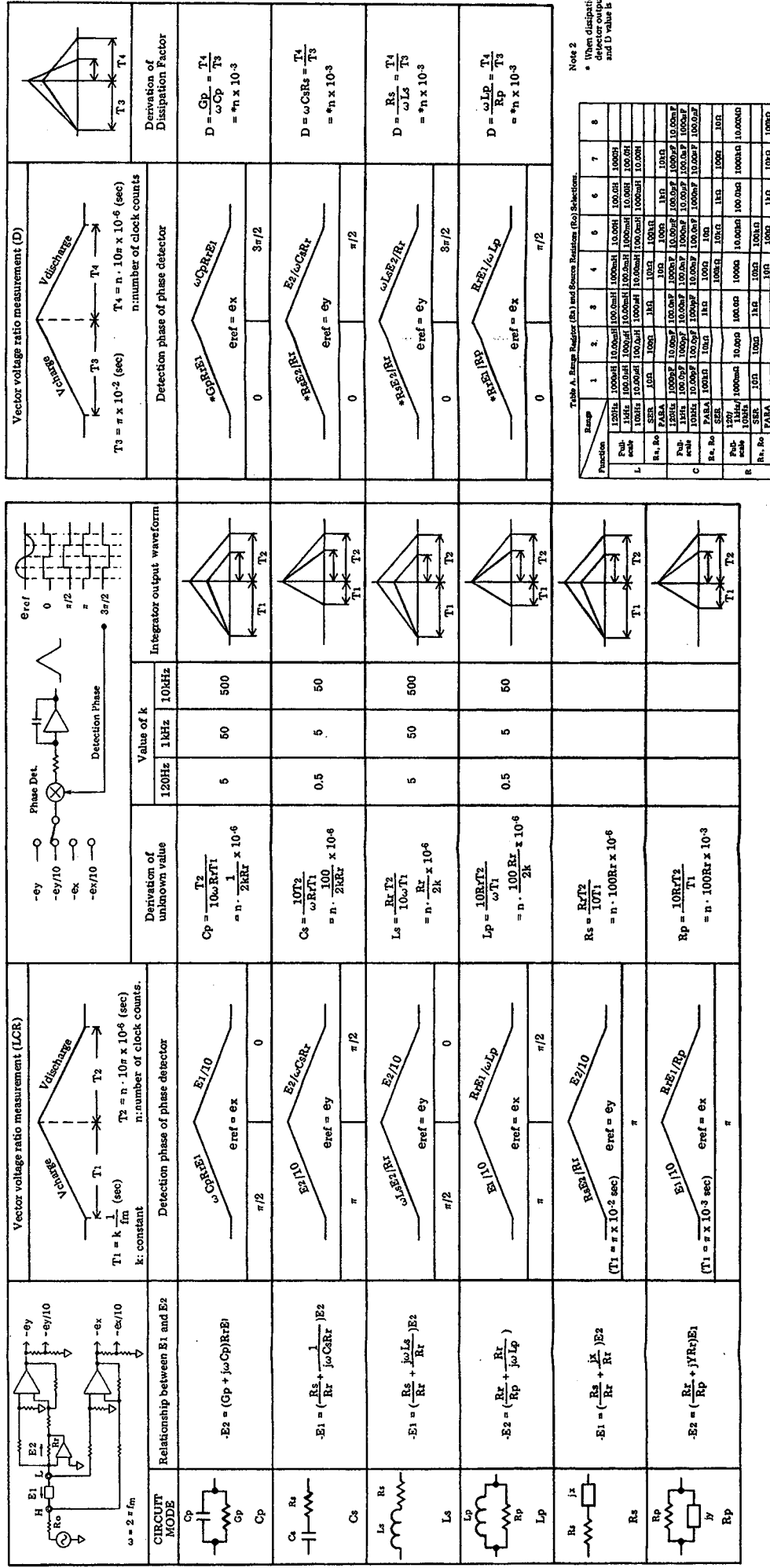

Figure 8-5. DC Bias Circuit.

Model 4262A

 **Figure 8-3**
Measurement Principles
SEE INSIDE



Note 2
* When dissipation factor range is 20, the phase detector output voltage is attenuated by 1/10 and D value is multiplied by 10.

Table A. Range Selector (Ra) and Source Resistor (Rs) Selections.

Function	1	2	3	4	5	6	7	8
Pub. scale	120Hz	1000Hz	10.00MHz	100.00MHz	1000.00MHz	10.00MHz	100.00MHz	1000.00MHz
L. scale	100.00MHz	10.00MHz	100.00MHz	10.00MHz	100.00MHz	10.00MHz	100.00MHz	10.00MHz
Ra, Rs	1000Ω	100Ω	10Ω	100Ω	10Ω	100Ω	10Ω	100Ω
Pub. scale	1000Ω	100Ω	10Ω	100Ω	10Ω	100Ω	10Ω	100Ω
L. scale	100.00MHz	10.00MHz	100.00MHz	10.00MHz	100.00MHz	10.00MHz	100.00MHz	10.00MHz
Ra, Rs	1000Ω	100Ω	10Ω	100Ω	10Ω	100Ω	10Ω	100Ω
Pub. scale	1000Ω	100Ω	10Ω	100Ω	10Ω	100Ω	10Ω	100Ω
L. scale	100.00MHz	10.00MHz	100.00MHz	10.00MHz	100.00MHz	10.00MHz	100.00MHz	10.00MHz
Ra, Rs	1000Ω	100Ω	10Ω	100Ω	10Ω	100Ω	10Ω	100Ω

Figure 8-3. Measurement Principles.

8-21. BLOCK DIAGRAM DISCUSSION.

8-22. Analog Section Discussion.

These paragraphs describe how each individual circuit section operates to establish L, C, R and D measurement values as controlled by the digital section. Figure 8-6 is a schematic block diagram of the 4262A analog section. The table in Figure 8-6 shows the range and source resistor values selected by range and function controls.

8-23. A11 Oscillator and Source Resistor.

The test signal is generated by an amplitude stabilized Wien Bridge type oscillator. Oscillator output is fed through an attenuator (A11R18 and R19) to a power amplifier. Attenuator switch A3Q3 turns on only when a Cp measurement is being made and the TEST SIGNAL LOW LEVEL button is pushed. The oscillator signal from the secondary of transformer T2 is designed to have a low output impedance via source resistor Ro to the unknown device (Cx in diagram). Transformer T2 isolates the power amplifier from dc bias voltages which can be applied to unknown device. The A11 Board includes an L Offset Control circuit which provides a compensation circuit to compensate for residual inductance of test leads or fixture. The operating principle of the L Offset Control is diagrammed in Figure 8-4.

8-24. The unknown connection is basically a four terminal (five terminals including GUARD terminal) configuration method. The GUARD terminal is connected directly to the instrument chassis. Circuit common for all PC boards is also eventually connected to the chassis. DC bias voltages up to +40 volts (+6V internally) can be applied to unknown device. The DC bias circuit is illustrated in Figure 8-5.

8-25. A12 Range Resistor.

The current that flows through Cx also flows through range resistor Rr. The range resistor amplifier causes the voltage across Rr to represent (exactly) the current flow through Cx. Ro and Rr are selected by a range control signal from the digital section. The table in Figure 8-6 describes how the resistors are controlled. C Offset Control circuit is capable of compensating for stray capacitance up to 10pF (see Figure 8-4 for operating principle).

8-26. A13 Process Amplifier.

The very precise voltage across Cx and Rr are fed to differential amplifiers (A13U1 through U4). C2 and C4 are dc blocking capacitors. This assembly processes these signals to feed the Eref signal (reference phase signal used for phase detection) and the Em signal (signal measured by the integrator) to the A6 board. The two input signals are selected according to specific measurement rules and are used as Eref and Em signals. The Eref signal is chosen at the same time that the measurement cir-

cuit mode is selected. Setting the CIRCUIT MODE to PRL selects the voltage across Cx as the Eref signal. When the CIRCUIT MODE is set to SER, the voltage across Rr is selected as the Eref signal. In the AUTO measurement mode, the Eref signal selection is done automatically and applied in a manner similar to the above. The selected Eref signal is amplified by A13U5A and is wave-shaped by A13U5B and U7 which also adjusts the phase angle of Eref by a control input (APAO signal) from A14 Board.

The Em signal is selected by FET switches A13Q2, Q3, Q5, and Q6 which are, in turn, controlled by signal selection signals from the digital section. The method of selecting the Em signal is graphically shown in Figure 8-8 Timing Diagrams. The selected Em signal is amplified by A13U6A, U6B and becomes an input signal for the phase detector on A14 Board. The switches A13Q19 and Q18 turn on and off respectively to interrupt the Em signal flow during integrator offset control period. When TEST SIGNAL LOW button is pushed and lights (this pushbutton functions in Cp measurement mode only), the gain of amplifiers A13U5A and U6B is increased. Thus, the voltage levels of Eref and Em signals remain the same as when making a measurement at the nominal (high) test signal level. An SAT detector detects any Em signal level that exceeds approximately ± 5 volts and transfers such SAT signals to digital section.

8-27. A14 Phase Detector and Integrator.

The A14 Board consists of three major circuit sections: PLL Reference Phase Generator, Phase Detector, and Integrator. The specific end functions of the two input signals, Eref and Em are to establish a ZERO signal whose time interval is equivalent to the desired measurement quantity. This ZERO signal is fed to A23 Board to be manipulated by the nanoprocessor.

The Reference Phase Generator produces four reference phase signals each being different by 90 degrees in phase one from the other (these four signals are phase shifted respectively 0, $\pi/2$, π and $3\pi/2$ in radius vector as referred to the input signal Eref.). The reference phase signals are individually selected in a manner peculiar to the measurement modes (four types). The selected reference phase signal is fed to the Phase Detector to drive switches A14Q19, Q20, Q22 and A23 of the Phase Detector. The method of selecting the reference phase signal is illustrated in Figure 8-8 Timing Diagram. To establish the very accurate 90° phase difference, the Reference Phase Generator employs a Phase Locked Loop (PLL) circuit consisting of a local phase detector (PD), filter, and voltage controlled oscillator (VCO). Thus measurement error is minimized. An explanation of Reference Phase Generator operation is given on Service Sheet 14.

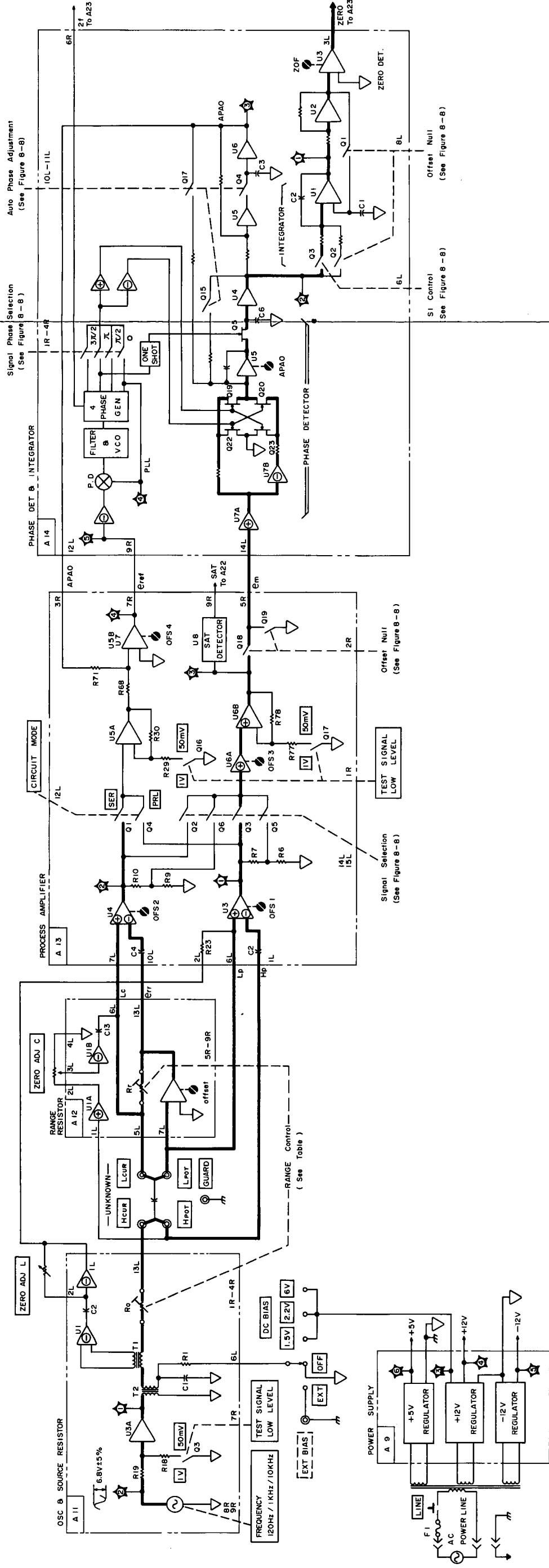

The input signal e_m to the Phase Detector is a vector voltage representing the impedance of the unknown device. The voltage components of the e_m signal are detected. These components correspond to the phase angles ($0, \pi/2, \pi$ or $3\pi/2$) established by the reference phase signal. Consequently, the phase detector outputs are voltage components which represent the resistive, capacitive, or inductive characteristics of the unknown device. The phase detector output is converted to dc by a smoothing circuit which adopts the period averaging technique to accelerate transient response to the input signals. The special combination of this technique is to speed measurements at the 120Hz test frequency. An explanation of the period averaging technique is given on Service Sheet 14.

The Integrator is charged and discharged by input signals (dc) fed from the Phase Detector. The Zero Detector notes the time that the output of the Integrator crosses the zero level and sends a ZERO signal to the Digital Section (A23 Board). For accurate integrator operation, an integrator Offset Null sequence is executed before integrator charging is begun. Offset Null control details are described on Service Sheet 14.

The phase detector output is provided through A14U5 and U6 to A13 Board as an APAO (Auto Phase Adjustment Output) signal for the period of the auto phase adjustment. In this sequential period, the reference phase signals are adjusted to minimize any phase error which cause a measurement error. The operating principle of the auto phase adjustment is given on Service Sheet 14.

Table A. Range Resistor (R_r) and Source Resistor (R_o) Selections.

Function	Range								
	1	2	3	4	5	6	7	8	
L	Full-scale	120Hz	1000μH	10.00mH	100.0mH	1000mH	10.00H	1000H	
		1kHz	100.0μH	1000μH	10.00mH	100.0mH	1000mH	10.00H	100.0H
		10kHz	10.00μH	100.0μH	1000μH	10.00mH	100.0mH	1000mH	10.00H
C	R _r , R _o	SER	10Ω	100Ω	1kΩ	10kΩ	100kΩ	1kΩ	10kΩ
		PARA	100Ω	10kΩ	100kΩ	10MΩ	100MΩ	10GΩ	100GΩ
	Full-scale	120Hz	1000pF	10.00nF	100.0nF	1000nF	10.00μF	100.0μF	10.00mF
R	R _r , R _o	1kHz	100.0pF	1000pF	10.00nF	100.0nF	10.00μF	100.0μF	1000μF
		10kHz	10.00pF	100.0pF	1000pF	10.00nF	100.0nF	10.00μF	100.0μF
	Full-scale	10kHz	1.0kΩ	10kΩ	100kΩ	100kΩ	10kΩ	100Ω	10Ω

Figure 8-6. Analog Section Block Diagram.

8-28. DIGITAL CONTROL SECTION.

8-29. Paragraphs 8-29 discusses how the 4262A digital section controls the analog section to measure LCR and D values of unknown device and how the built-in nanoproccessor creates unique performance in the 4262A. Figure 8-7 is the basic block diagram of 4262A digital section. All analog section control signals except for Test Signal and Circuit Mode Control Signals are sequentially outputted from A23 Processor & ROM in accord with nanoproccessor programming. The A21 Keyboard Control establishes the measurement function as selected when the front panel control keys are appropriately depressed. The A21 section also stores annunciation data and transfers it to A2 Display and Keyboard to display the annunciation information. A22 Display Control and RAM converts measured data transmitted from A23 into signals appropriate for display on the numeric displays (A2). The A21, A22, and A23 sections are connected to the bidirectional DATA BUS LINE (8 bit).

8-30. A23 PROCESSOR AND ROM.

A23 board consists of Nanoproccessor (A23U1) located in the center of the digital section, Program Control ROM (U15 and U16), Data Bus Driver/Receiver (U5 and U6), Device Select Decoder (U3 and U4), and Analog Section Control Register (U7, U8 and U11). The Nanoproccessor governs the various sequences and timing of the digital section and also sends properly timed measurement control signals to the analog section. For control and data processing, the Nanoproccessor has four major input/output data bus lines: Program Address, Device Select Code, Direct Control Flag, and Data Bus lines. The nanoproccessor programs are filed in the Program Control ROM which has a 4 kilobyte total memory capacity. To extract measurement control instructions from the Program Control ROM, the Nanoproccessor sequentially addresses the ROM through the PROGRAM ADDRESS BUS line (11 bit). The measurement control instructions outputted from the ROM are momentarily stored in the Analog Section Control Register when the Data Bus Driver/Receiver is set to receiver mode. The analog section control signals which are outputted from the Analog Section Control Register are shown on the block diagram. For accurate timing control of integrator operations, the integrator switch control, ZERO signal, and $2f$ (= double the test signal frequency) signals are transmitted directly from/to the Nanoproccessor through the Direct Control Flag bus line (bidirectional bus line).

The Nanoproccessor accesses its program data simultaneously by addressing the ROM while the ROM outputs the nanoproccessor program codes. When the ROM outputs an analog section control signal or while measured data is being transferred through the Data Bus line, the Nanoproccessor is not accessing. The Nanoproccessor sequentially executes program steps in accord with the program data given by the ROM. Various timing in the digital section is controlled by Device Select Code signals (4 bit). These timing control signals are decoded to DSR (Device Select: Read) and DSW (Device Select: Write) signals and manipulate the individual devices, respectively, of the digital section as follows:

- DSR: Causes Register or Memory to output data or sets Data Bus Driver/Receiver to driver mode. Nanoproccessor accesses (reads) the data sent from Memory or Data Bus Driver/receiver.
- DSW: Enables Register or Memory to store data or sets Data Bus Driver/Receiver to receiver mode. Nanoproccessor sends (writes out) data to Register, Memory or Data Bus Driver/Receiver.

The Device Select Decoder (U3 and U4) each have 15 DSR and DSW output ports.

When 4262A function is selected or changed, the INT. REQ (INTerrupt REQuest) control line goes to high level. This INT. REQ signal requests the Nanoproccessor to pause before proceeding with the nanoproccessor program and to manage the function control prior to program processes. The INT. REQ control line is always active so as to allow for servicing of interrupt requests. The INT. ACK (INTerrupt ACKnowledge) line momentarily goes high to make the vector address line valid. The Nanoproccessor accesses the vector address code (VA0 and VA1) to discriminate which control (or controller) originated the interrupt request. When the INT ACK line is at high level, interrupt control data is inputted to the nanoproccessor via A21 Keyboard Control. Successively, the INT ENA (INTerrupt ENable) output line is set to "disable" status so as not to allow a second interruption before the present interrupt is processed and ends. The INT ENA line is also controlled in the program execute phase (specifically, this output line performs a "handshake" function when the 4262A is used as a component in an HP-IB system).



Figure 8-7
Digital Section Block Diagram

SEE INSIDE

The Nanoprocessor is synchronized with the 1.27MHz Clock and calculates the measured quantity as a number counted toward the 31.83kHz (100k/πHz) secondary clock pulse. To identify which, if any, option is installed and being used in the instrument, the Nanoprocessor accesses the option code from the option selection switch setting when the Data Bus Driver/Receiver is set to driver mode by a DSR signal. The Nanoprocessor controls the option section in accord with the nanoprocessor programs as appropriate to the selected option.

8-31. A21 KEYBOARD CONTROL.

The A21 Keyboard Control is composed of two major sections: one is the interrupt control consisting of the Interrupt Priority Encoder (U24), Multiplexer (U12 & U23), Row Scan Counter (U2), Gate (U1) and Flip-Flops (U3 & U14); the other is the Annunciator Register (U7, U8, U15 through U21) which stores and transfers manifold annunciation data (keyboard pushbutton indication, range indication, circuit mode indication, etc.).

The Row Scan Counter outputs periodic ROW signals (3 bit) to A2 board as driven by 31.83kHz secondary clock. These ROW signals are decoded to the keyboard scan signals which cause, in turn, specific groups of keys to become valid. Each group of control keys is enabled, in sequence, to perform its function. When a keyboard pushbutton is pressed, the output logic of U1 goes high and subsequently the Row Scan Counter stops. The contents of the ROW Scan Counter and the column number given by CLM Ø through CLM 3 signals are coordinated with the address of the key depressed. Simultaneously, U1 activates Flip-Flops U3 and U14 causing the INT Ø signal to be outputted. The Interrupt Priority Encoder converts its INT Ø through INT 3 input signals into the vector address signals (4 bit octal code) as appropriate for nanoprocessor input. INT 1, 2, and 3 signals are present only when the 4262A is equipped with option(s). The INT REQ signal is sent to A23 and the INT ACK signal actuates the Multiplexer so that the vector address and keyboard address signals pass through the Multiplexer toward the DATA BUS line.

The Annunciator Register stores manifold annunciation data which are serially transferred from the Nanoprocessor to each register file of IC's U7, U8 and U15 through U21. Specifically, U15 stores test signal annunciation data and, additionally, originates the test signal control signals which direct the Low Level, 120kHz, 1kHz and 10kHz measurement functions. U8 also originates the CMS (Circuit Mode Selection) signal. When the nano-

processor is transferring the annunciation data, the Data Bus Driver/Receiver is set to receiver mode.

8-32. A22 DISPLAY CONTROL & RAM.

A22 section consists of three major circuits: Display control, Extender RAM and Clock generator. The Display control does conversion and storage of measured data to be displayed on the seven segment numeric display. When the Nanoprocessor begins to transfer measured counts (8 bit BCD signal), the Data Bus Driver/Receiver (U19 & U20) is set to receiver mode. L, C or R count data passes through the Data Bus Driver/Receiver and D or Q count data follows. These signals are simultaneously routed to both the Multiplexer (U10 & U18) and the BCD to Seven Segment Decoder (U5). When the measured data is being transferred, the Multiplexer continues selecting BCD to seven segment decoder output signals from its two channel input signals. Other signals, fed directly from the Data Bus Driver/Receiver, are disregarded. Thus, the measured data is translated into segment data which is coded as appropriate for driving the seven segment numeric displays and, is successively stored in the Display Register File (U9 & U17) to accomplish matrix drive of display. The Display Register File outputs the display segment signals which alternately illuminate the numeric figure of each measured count digit of the displays. These display segment signals are amplified to supply sufficient current to the LED displays (cathode driver output signals CAT1 - CAT8). The Scan Decoder U1 outputs periodic anode scan signals which activate, in sequence, the display for each digit. Both the Display Register File and the Scan Decoder are simultaneously driven by Scan Counter U2.

Alphabetic annunciations— PASS, FAIL, O-F and U-CL— are displayed in the following manner: the nanoprocessor encodes annunciation contents so that the annunciation data comprises the display segment signals appropriate for displaying annunciation figures. The annunciation data passes through the Data Bus Driver/Receiver and is inputted to the Multiplexer. In the annunciation execute phase, the Multiplexer selects the annunciation data and disregards the (unnecessary) signals from the BCD to Seven Segment Decoder. The Display Register File stores the annunciation data which coincides directly with the display segment signals. The Data Bus Driver/Receiver can be set to driver mode when the Integrator test switch is set to TST position or the instrument is triggered externally. The Extender RAM (U22) performs supplementary storage of data which is inputted or outputted to/from the Nanoprocessor. The Nanoprocessor sends address signals to the Address Register (U21) before storing data in the

Extender RAM. When data is transferred to the RAM, the DSW signal actuates the RAM and the Address Register addresses the RAM to assign individual memories for storing the data. When a DSR signal actuates the RAM, the Nanoprocessor causes the RAM to output stored data. The RAM writes out data as addressed by signals inputted at the RAM ADDRESS signal port.

The clock pulse generator oscillates at 2.54MHz and is frequency stabilized by a crystal resonator. Divider U12 counts down the 2.54MHz basic clock by one half (to 1.27MHz) and provides the nanoprocessor with a stable time base for synchronizing various circuit timing. The Down Counter (U7, U14 and U15) produces the 31.83kHz frequency whose value coincides with the reciprocal number of pi ($\pi = 3.14159---$). This particular frequency is significant in derivation of the measured value. The secondary clock signal is fed to the Nanoprocessor for calculating the value of the DUT. Additionally, the Down Counter drives the Scan Counter (U2) which produces display timing signals.

8-33. A2 DISPLAY AND KEYBOARD.

A2 section includes the Keyboard Control, Displays, and certain decoders. The Keyboard Control manipulates the Keyboard Scan signals sent from the Scan Decoder (U4) and outputs the resulting CLM (CoLuMn) signals. All annunciator data except for alphabetic annunciations are transmitted from the A21 section. Because the range and multiplier annunciator data has been coded to minimum bit size, the Decoder Drivers U3 and U4 translate them so as to illuminate proper indicators. The Unit and DQ annunciator signals are fed, respectively, via the Function and Loss indicators assembled in the keyboard pushbutton. The numeric displays are independently driven by the A22 section.

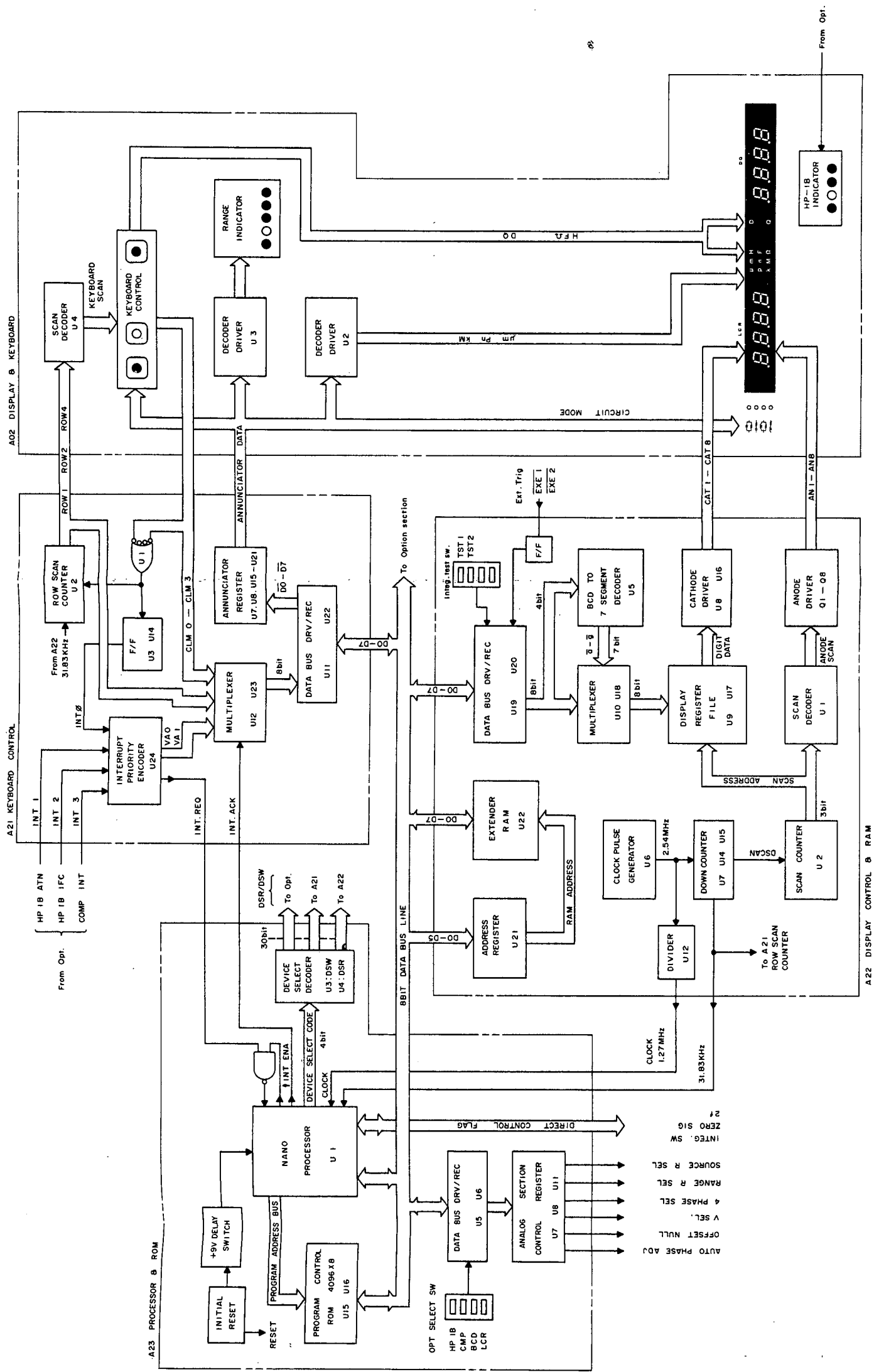

Figure 8-7. Digital Section Block Diagram.

8-34. TIMING DIAGRAM DISCUSSION.

8-35. Figure 8-8 presents a timing diagram for the 4262A. The upper part of the diagram shows output waveforms of the integrator, execute time for each measurement sequence, and main control signals which direct the vector voltage ratio measurement. As may be seen from the diagram, the instrument first measures the L/C or R value and then the dissipation (D) and Q (calculated from D) factors. Approximately three seconds after the LINE switch is depressed to turn the instrument on, power voltage (V_{GG}) is applied to the nanoprocessor through a delay switch (A23 board). The nanoprocessor is simultaneously set to its initial conditions ready for beginning the display test which precedes measurement. When the display test ends, the processor sets the 4262A to a predetermined measurement mode (automatic initial settings) and a capacitance measurement is initiated. When LCR and DQ ranges are set to AUTO, the autoranging recycle repeats until an LCR range suitable for the sample is selected. A front panel range indicator lamp lights and step-shifts to left or right. The displays show blanking signs (- - -) during autoranging period. If the sample is too large (in PRL mode) or too small a value (in SER mode) compared to the range, the Saturation Detector (A13) send a SAT signal to the nanoprocessor. Range is shifted just after Offset Null operations are completed (instrument does not cycle through steps in remaining measurement sequence). This permits faster ranging. Setting LCR RANGE to MANUAL bypasses autoranging cycle.

When a range is selected in which integrator discharge time interval is within 162 and 1820 clock periods (limits), the measurement sequence proceeds with an L/C/R measurement cycle. To minimize vector voltage ratio measurement error, Offset Null and Auto Phase Adjustment sequences precede integrator charge/discharge (by phase detected DUT signal). During Offset Null period, A13Q19 turns on and Q18 turns off to interrupt the ϕ_m signal transfer. At this time, any output of the integrator caused by residual phase detector output voltage and integrator output offset voltage is fed back to the input of the integrator to reduce the output of the integrator to zero. And this feedback voltage is stored in a memory capacitor during the measurement to eliminate any measurement error

due to residual phase detector and integrator voltages. Refer to service sheet 14 for offset null control details.

At each integrator operating sequence change, a HOLD TIME is provided to prevent a switching transient waveform from entering the integrator and/or to permit full discharge of the integrator capacitor (from previous integrator operation). Now, an Auto Phase Adjustment consisting of two periods begins. During these periods, to minimize measurement error, the phase detector phase reference is precisely set. APA1 (Auto Phase Adjustment 1) and APA2 control signals administer switches A14Q13, Q14 and Q15 timing to accomplish phase adjustment of ϕ_{ref} signal (A14TP1) for establishing exact detection phases of Phase Detector. The Integrator disregards this phase adjustment sequence. Refer to service sheet 14 for auto phase adjustment details.

When an integrator charge period is initiated, the DUT signal (synchronously phase detected) is applied to the integrator input. The Integrator is charged with the incoming signal (dc) for a constant time interval (see table in timing diagram). Two kinds of integrator waveforms are developed depending on measurement function and circuit mode. In the C_p measurement mode, integrator output voltage is increased as its charge is proportional to the DUT current (voltage across R_r) and is decreased as its discharge is proportional to the (constant) voltage across the DUT (constant decay rate). On the other hand, in the C_s measurement mode, the integrator rapidly charges in a short time — the constant voltage across R_r representing the current flowing through the DUT. The integrator discharge depends on the voltage across the DUT (and is proportional to DUT). Detailed integrator operation peculiar to each measurement mode group is described in "Principles of Operation" on Page 8-4. The nanoprocessor counts the time of a 31.83kHz ($10000/\pi$ kHz) clock for the time required to discharge the integrator until integrator output voltage reaches the zero level. When integrator output voltage crosses the zero level, a zero detector transfers the ZERO signal to the nanoprocessor. The Nanoprocessor stops counting and stores a number corresponding to the L, C or R value of DUT in its internal registers.

Successively, the D measurement cycle begins. The D autoranging recycle is done or repeats once to set instrument to appropriate D range. After an offset null sequence for D measurement, the integrator begins to charge — its incoming voltage being proportional to the conductance or resistance of the DUT. Discharge time is proportional to the reactance of the DUT. To calculate the ratio of the real to the imaginary part of the DUT current (voltage across DUT when circuit mode is SER), the integrator is charged when the detection phase of the detected output is at "90" degrees. In R measurements, the D measurement cycle is omitted. Since the electrical response time for each measurement frequency is different and the charge cycle time is sometimes a function of this frequency, the sequence execute times are different for measurement frequencies of 120Hz, 1kHz and 10kHz. Note that the execute time for the discharge sequence is variable.

8-36. The table shown in the lower part of the diagram explains how voltage E_m is selected by the instrument (either from voltage across R_r or the voltage across the UNKNOWN) and how the detection phase for the phase detection, employed in either PRL and SER circuit modes, is selected. Both upper and lower sections of the waveform timing diagram have the same time scale. -Ex, -Ex/10, -Ey and -Ey/10 in the E_m column are names for voltages shown in diagram Note 2. Diagram Note 3 shows the phase relationships of the voltages applied to phase detector FET switches A14Q19, Q20, Q22 and Q23 (detection phase) along with the phase of E_{ref} signal at A14 TP5. The detection phase is sequentially selected by PHASE control signals ($\phi \sim 3\pi/2$) which are transmitted to 4 Phase Selector on A14 board (from A23 Nanoprocessor & ROM board).

Note

Labels H1 through H10 in the timing diagram denote the timing for trigger used when troubleshooting instrument using A23 service board (service kit 04262-87001). The 4262A measurement sequence can be stopped at or resumed from the desired point from among these triggering points by pushing specific 4262A front panel buttons.

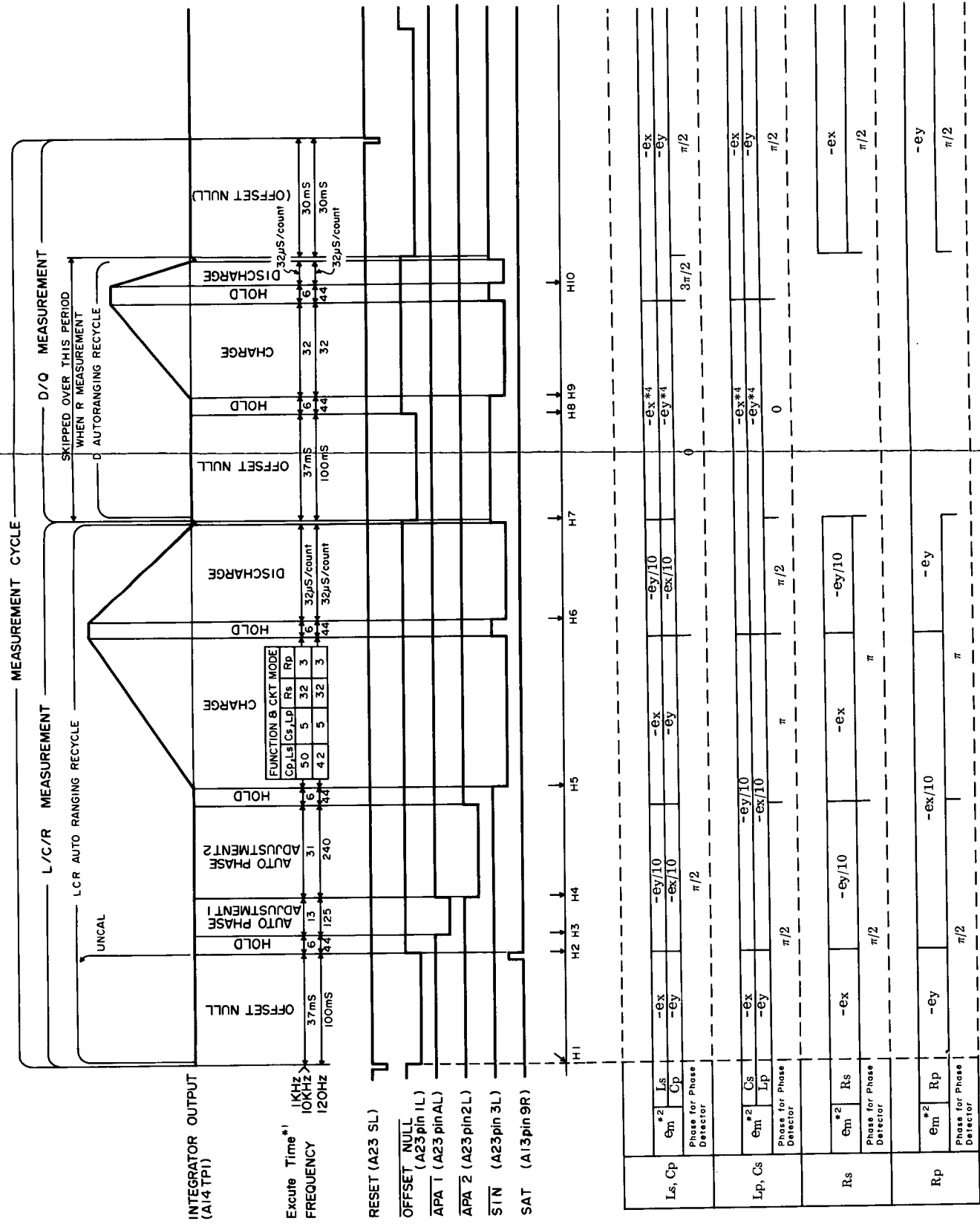

Note 1. Unit for execute time is msec except for discharge sequence.

Note 2. Selection of E_m .

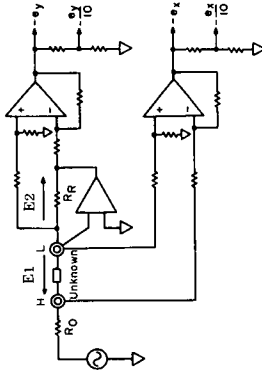

E_m	VSEL 1*	VSEL 2*
-Ex	0	0
-Ey	1	0
-Ex/10	0	1
-Ey/10	1	1

* Gating signals for A13 FET switches.

Note 3. Phase for Phase Detector

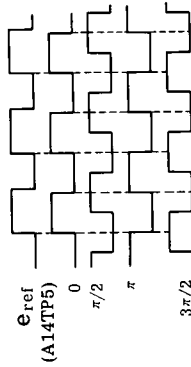

Note 4. When dissipation factor range is 20, the -Ex and -Ey are attenuated by 1/10.

Figure 8-8. Timing Diagram.

8-37. OPTIONS.

8-38. The theory of operation for the 4262A optional circuits is outlined in the following paragraphs. The currently available options (001, 004 and 101) with a summary of their functions and the material furnished are listed in Table 8-1.

Figure 8-9 is a block diagram showing the option section when all available optional equipment is installed. The basic instrument and the individual option sections are interconnected by 8 bit data bus lines through which both measured and control data are transferred.

8-39. OPTION 001 BCD DATA OUTPUT (A35).

Option 001 BCD OUTPUT CONTROL (A35) consists of a Data Bus Driver/Receiver and two shift Register Files which momentarily store the measured data for simultaneous transfer of the complete data to BCD DATA OUTPUT connectors. Timing control of the A35 circuitry is done by nanoprocesor Device Select signals DSR11, DSW13, DSW14 and DSW15. When 4262A TRIGGER function is set to EXT, the instrument can be triggered by an EXE (external encode) signal inputted from either BCD DATA OUTPUT connector J7 or J8 (pin 46). After a measurement cycle ends, a DSR11 pulse signal sets Data Bus Driver/Receiver U10 to driver mode. As long as the DSR11 signal is valid, the switch setting of the SER/PRL switch (A35S1) has access to the nanoprocesor for assigning the output data format in parallel (simultaneous) or serial (alternate) sequences. The data output timing for both simultaneous and alternate sequencing is diagrammed on Page 8-70. To simplify the explanation, only the parallel output sequence is discussed here. The measured data is stored in the shift registers in syn-

chronism with DSW13 and DSW14 pulses (each outputted 8 times during the data transfer cycle). The Data Bus Driver/Receiver is set to receiver mode to allow the measured data to pass through the device. First, a DSW13 pulse train causes the shift registers U9, U11, U12 and U13 to store the LCR data which is simultaneously transferred with the pulse train. Successively, a DSW14 pulse train actuates shift registers U4, U5, U6 and U7 to store the sequentially transferred DQ data. One shot multivibrators U1A/B generate an output pulse train consisting of pulses that are somewhat shorter than the input DSW pulses. This eliminates the possibility of the shift register not storing the input data because of a DSW signal timing error. One transfer data group is stored in the first 1/8 stack of each shift register when triggered by the rising edge of the one shot multivibrator output pulse. Thus, a total of 16DSW pulses complete storage of all data in the shift register file during the data transfer phase. Next, a DSW15 pulse activates the "two times" Flip Flop U2 — one delayed for 1.2 msec after the other. Thus, the Flip Flop generates FLAG pulse which commands the external recorder to print the measured data concurrently presented at the LCR and DQ BCD output connectors. After the FLAG signal is transferred, a periodic DSR11 pulse actuates the Data Bus Driver/Receiver and frequently sets it to driver mode to monitor the status of the INHIBIT signal outputted by the external recorder. The DSR11 pulse train continues until the nanoprocesor senses a change in the logic of the INHIBIT signal (meaning that printing is complete). In alternate data output format, the data storage and output cycle for LCR precedes that for DQ. Hence, Device Select signals are alternately provided for both an LCR and a DQ output cycle [as shown in Timing Diagram (Page 8-70)].

Table 8-1. Currently Available Options.

OPTION	FUNCTION	MATERIAL
OPT. 001 BCD DATA OUTPUT	Provides measured LCR and DQ data with Polarity, Decimal Point, Unit, and measurement status in BCD code at rear panel connectors.	A35 BCD OUTPUT CONTROL (04262-66535)
OPT. 004 COMPARATOR	Built-in comparator compares measured value with LCR and DQ HIGH and LOW limits. Provides decision data in display and by Relay and TTL output.	A24 COMPARATOR CONTROL (04262-66524) A4 THUMBWHEEL SWITCH (04262-66504) A5 COMPARATOR KEYBOARD (04262-66505)
OPT. 101 HP-IB COMPATIBLE	Provides system interface capabilities in accordance with IEEE-STD-488-1975 recommendations.	A25 HP-IB INTERFACE (04262-66525) A3 HP-IB CONNECTOR (04262-66503)



Option Section Block Diagram

SEE INSIDE

Figure 8-9

8-40. OPTION 004 COMPARATOR (A4, A5, & A24). Option 004 adds A24 COMPARATOR CONTROL and the front panel control unit comprised of A4 Thumbwheel Switch and A5 Comparator Keyboard. The A24 Comparator Control manages the control data set into the panel controls as well as the decision data transferred from the nanoprocessor so that comparison results are provided (in three output configurations). The panel control functions are managed in the following manner: An instrument equipped with option 004 includes a front panel control assembly which includes four 4 digit thumbwheel switches used to assign the desired respective limits of L, C or R and D or Q. The thumbwheel switch assembly provides output data for each digit in a 4 bit code which corresponds to the set number indicated in the control panel window. To transmit the high and low limit data from the thumbwheel switch assembly through an 8 bit digit data transmission line, the thumbwheel switches are assigned 8 addresses (each set of four digits occupies two addresses). The nanoprocessor alternately accesses the thumbwheel switch output code in the order of their address numbers. First, Data Bus Driver/Receiver is set to receiver mode and a 4 bit address code is stored in the Limit Switch Select Code Register U11. The Decoder U10 sets its output logic (SS0) to low level in response to the 4 bit address code (output logic of the SS1 through SS7 outputs stay at high level). The SS0 signal causes the 8 bit digit data to change depending on the setting of the most significant digit and third digit of the LCR HIGH LIMIT switch that is first addressed. The digit data is transferred to the nanoprocessor (passing through the Data Bus Driver/Receiver set to driver mode).

Successively, the other digit data is transferred in like manner. The commands of all pushbutton controls on the A5 Comparator Keyboard are processed during the interruption phase. The Interrupt Flag circuit directs the nanoprocessor to act on the interrupt request. When a comparator keyboard control pushbutton is pressed, Gate U6A sets its output logic to high level. This causes Flip Flop U1A to generate an INT 3 output pulse. The INT 3 signal is sent to A21 Keyboard Control circuit which forwards the interrupt requests to the nanoprocessor. At this point, the comparator keyboard signals access the nanoprocessor via the Data Bus Driver U7.

The nanoprocessor compares the measured values with the limit numbers (values) and stores the decision data — the results of the comparison in Annunciator Register U3. The decision data is inputted, in parallel, to the TTL, Relay and Indicator Lamp drivers.

8-41. OPTION 101 HP-IB COMPATIBLE (A25). An instrument equipped with Option 101 HP-IB Compatibility includes the A25 HP-IB INTERFACE board which provides the circuitry to enable intercommunications with external devices in accord with IEEE-STD-488-1975 recommendations. The A25 circuitry is basically composed of data bus driver/receivers and data registers which provide the timely actions for handling the HP-IB data bus input/output and control bus input/output flow as directed by the nanoprocessor. Since the circuit configuration is of general HP-IB design and since general instructions on HP-IB interface is otherwise readily available, a detailed circuit description is not given in this manual.

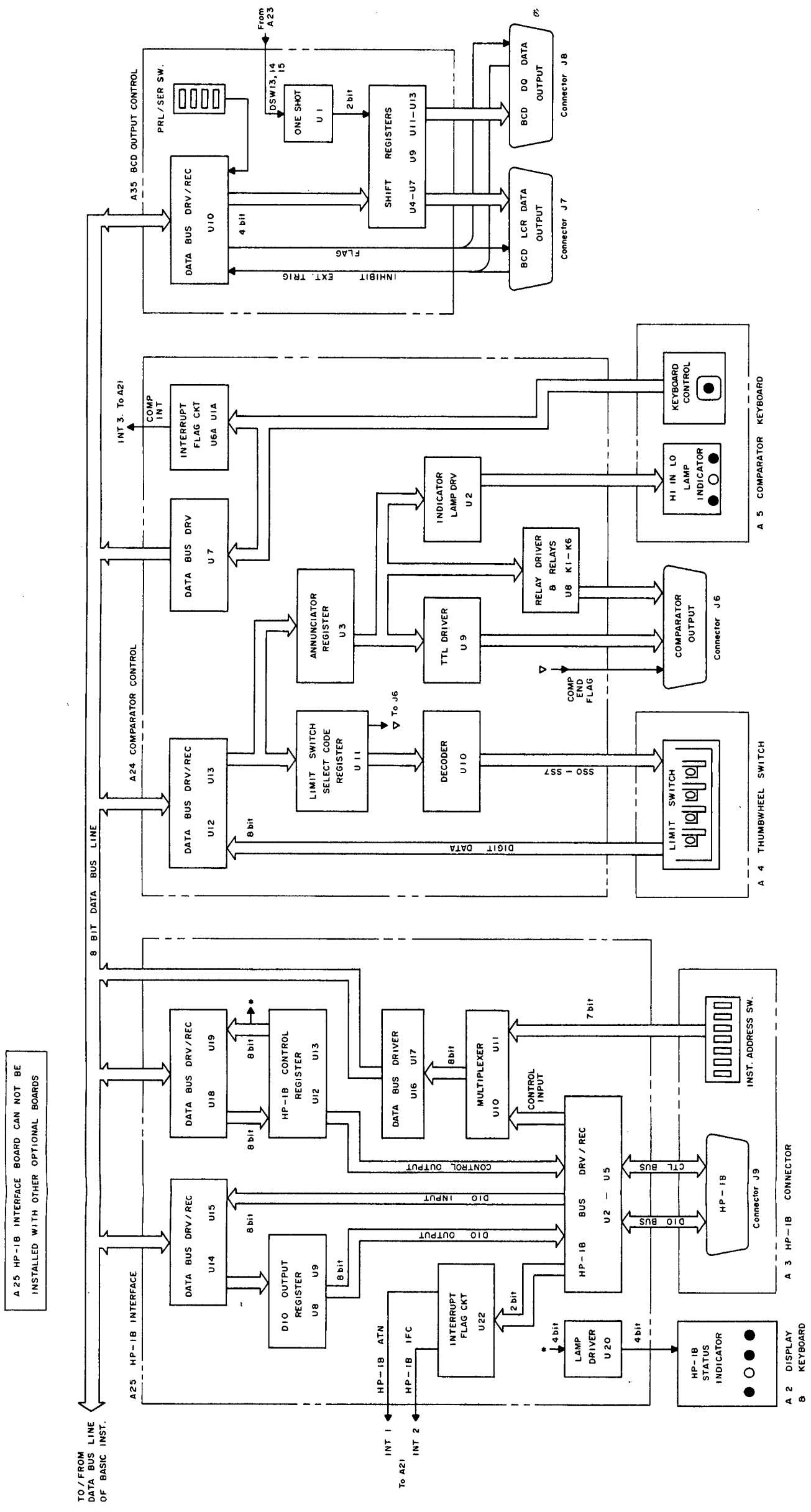

Figure 8-9. Option Section Block Diagram.

8-42. TROUBLESHOOTING.

CAUTION

THE OPENING OF COVERS OR THE REMOVAL OF PARTS, EXCEPT THOSE TO WHICH ACCESS CAN BE GAINED BY HAND, IS LIKELY TO EXPOSE LIVE PARTS. IN ADDITION, ACCESSIBLE TERMINALS MAY ALSO BE LIVE.

THE APPARATUS SHALL BE DISCONNECTED FROM ALL VOLTAGE SOURCES BEFORE ANY ADJUSTMENT, PARTS REPLACEMENT, OR MAINTENANCE AND REPAIR ARE PERFORMED FOR WHICH THE INSTRUMENT MUST BE OPENED. IF, AFTERWARDS, ANY ADJUSTMENT, MAINTENANCE OR REPAIR OF THE OPENED INSTRUMENT UNDER VOLTAGE IS REQUIRED, IT SHALL BE CARRIED OUT ONLY BY A SKILLED PERSON WHO IS AWARE OF THE HAZARD INVOLVED.

8-43. When 4262A is inoperative or readings for the sample connected to the UNKNOWN terminals are incorrect, you should first check power line voltage used and next the behavior of instrument with respect to the DUT when a measurement is attempted. The two may be incompatible. In addition, check for appropriate test leads or fixture. Determining whether the trouble is in an external device connected to the instrument or is in the actual instrument is primary and a fundamental procedure which must precede troubleshooting the LCR Meter. Occasionally, the unknown sample may have characteristics not measurable by the 4262A. Table 8-2 lists the examples of symptoms likely to mislead. You should also be concerned about the operating environmental conditions in which the instrument is operated. Surrounding magnetic fields or the presence of a strong radiowave will sometimes disturb the measurement. To isolate any instrument trouble from the above possibilities, perform the following examinations:

- 1) Measure a sample whose characteristics and value (L, C or R and D/Q value) are known to be measurable with the 4262A. Thus, if the problem is restricted to difficulty in measuring a particular sample, it might suggest that the sample is not measurable with the 4262A.

- 2) Next, connect sample directly to the UNKNOWN terminals without using any test fixture or test leads. Any external equipment being used with 4262A should be disconnected from the connectors of the 4262A. These tests isolate troubles on the external equipment or test jig from those on the instrument.
- 3) Securely ground the instrument to earth. If environmental conditions are suspected, change the location of instrument.
- 4) Use a four terminal connection configuration and measure a sample. An improper connection to unknown will cause a measurement error.
- 5) Properly terminate UNKNOWN terminals (short or open circuit), and press SELF TEST button. Confirm that normal PASS annunciator readouts occur on the LCR DISPLAY.

8-44. Figure 8-10, "How to Use Troubleshooting Guides", is helpful when starting to troubleshoot the 4262A. This flow diagram shows the fundamental procedures which breakdown the trouble possibilities to the component level. The troubleshooting guides are divided into the following major procedures:

Power Supply Section Isolation Procedure (Fig. 8-17).

Basically used for checking internal dc power supply voltages of the instrument. The guide for checking the power supply section is included in Figure 8-17.

Option Section Isolation Procedure (Fig. 8-17).

This procedure, which is used to isolate the option section from the overall unit, is included in Figure 8-17. If the instrument is a standard unit equipped with no option, omit this procedure.

Analog and Digital Section Isolation Procedure (Fig. 8-17).

The troubleshooting guide in Figure 8-17 describes how to distinguish whether the faulty assembly is located in the analog or in the digital section. In conjunction with the troubleshooting flow diagram of Figure 8-17, the built-in self test function is used to assist in isolating the analog section from the digital section. To study the self test function, refer to Figure 8-11.

Analog Section Troubleshooting Procedure to Assembly Level (Fig. 8-18).

The troubleshooting flow diagram in Figure 8-18 helps to isolate a faulty board assembly in the analog section. The built-in self test function is also helpful in troubleshooting to the assembly level.

Component Level Troubleshooting Guides.

Component level troubleshooting guides are provided for each major assembly (other than for A21, A22 and A23 boards of the digital control section) in the service sheets. Procedures for narrowing down the trouble possibilities in A21, A22 and A23 boards to the component level are covered in "Digital Section Troubleshooting Guide". Refer to guideline below.

Digital Section Troubleshooting Guide.

The search for and location of a faulty component in the digital control section is done in accord with the troubleshooting flow diagrams in Figure 8-19. To facilitate an "easy to make" failure diagnosis, a "signature analysis" method was adopted for troubleshooting both the digital and option sections. When diagnosing with this method, a Signature Analyzer (HP 5004A) is necessary to properly employ the procedures and associated signature maps (see service sheets). Refer to Figure 8-12 for signature analysis guidelines.

8-45. Table 8-3 describes typical front panel symptoms present when 4262A internal controls

(adjustable points) are not well-adjusted. A search for and interpretation of trouble symptoms by operating front panel controls is important and often gives hints as to trouble location. Table 8-4, Front Panel Isolation Procedure provides such an approach to troubleshooting. These primary troubleshooting procedures are supplemental to and should be used with the main procedures in the flow diagrams.

WARNING

WHENEVER IT IS LIKELY THAT THE PROTECTION PROVIDED BY THE FUSE HAS BEEN IMPAIRED, THE INSTRUMENT MUST BE SECURED AGAINST ANY UNINTENDED OPERATION.

CAUTION

CAPACITORS INSIDE THE INSTRUMENT MAY STILL BE CHARGED EVEN THOUGH THE INSTRUMENT HAS BEEN DISCONNECTED FROM ALL VOLTAGE SOURCES. BE SURE THAT ONLY FUSES OF THE REQUIRED RATED CURRENT AND THE SPECIFIED TYPE ARE USED FOR REPLACEMENT. THE USE OF REPAIRED FUSES AND THE SHORT-CIRCUITING OF FUSE HOLDERS MUST BE AVOIDED.

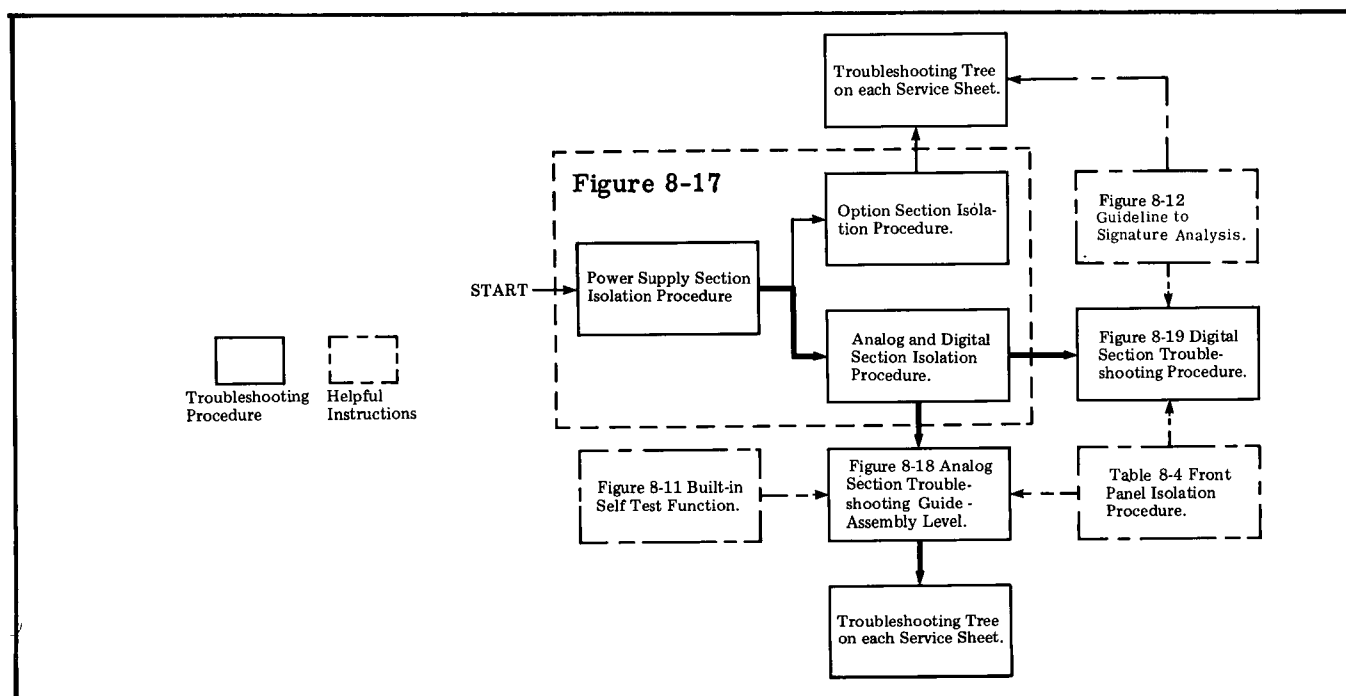

Figure 8-10. How To Use Troubleshooting Guides.

Table 8-2. Symptoms Likely to Mislead.

Category	Symptoms	Probable cause
L MEASUREMENT	When LCR RANGE setting is in AUTO, the range is shifted alternately up and down between two ranges and does not settle on a specific range.	This symptom occurs when the inductance of an inductor with core changes because of the current flowing through the coil.
	Measured values differ depending on the range selected.	Permeability of inductor core changes with measurement signal level (current), which differs for each range. (Measure in MANUAL ranging mode.) See Note below.
	Measured values differ depending on the selected test signal frequencies. Specifically, a large difference exists between the measured value at 120Hz and that at another test signal frequency.	This symptom is because of a difference in the permeability of the inductor core developed by two different measurement frequencies.
C MEASUREMENT	When measuring a small capacitance at 120Hz test signal frequency, measured counts on the LCR DISPLAY fluctuates by several counts.	Interference of ac frequency hum noise. Check for any ac line cables close to the test leads. Check for grounding of the instrument chassis.
R MEASUREMENT	Both LCR and D/Q DISPLAYS are blank (- - -) with respect to the sample connected to the UNKNOWN terminals.	The DUT is a wirewound resistor having a large inductance. (Note that some standard resistors are used only with dc current and their calibrated values are so certified.)
Common to all LCR MEASUREMENTS	When measuring an inductance, capacitance or resistance of a large value, a measurement error over the specified limits occurs.	C OFFSET control (related to inductance and resistance measurements) or L OFFSET control (related to capacitance measurement) is misadjusted.

Note: For example, if value of sample is 187.0μH on the 100μH range, the auto ranging function moves to 1000μH range. Then the sample may develop a lower inductance at the applied measurement signal on the 1000μH range. It may, for example, develop an inductance of 160.0μH that is suitable for measurement on 100μH range. The range will again be reset to the 100μH range and, as a result will repeat (auto range) up and down between the lower and the higher ranges.

Table 8-3. Front Panel Symptoms of Internal Control Misadjustment.

Adjustment	Symptom
A12R1	When TEST SIGNAL setting is LOW LEVEL, autoranging operation sometimes does not work well.
A12C3	Measurement accuracy of 10kHz measurements is lower on the highest L and R measurement ranges or the lowest C measurement range.
A12C11	C ZERO ADJ control range is improper.
A13C1	The 10kHz measurement error is excessive.
A13R1 (OFS-1)	When making a measurement in the series equivalent mode, the measurement accuracy is sometimes lower (due to improper dc level at A13TP3).
A13R2 (OFS-2)	When making a measurement in the parallel equivalent mode, the measurement error is sometimes excessive (due to improper dc level at A13TP3) — especially when TEST SIGNAL is set to LOW LEVEL.
A13R66 (OFS-3)	Measurement accuracy will become lower when offset voltage at A13U6 pin 7 is not zero volts. This is usually more noticeable when TEST SIGNAL is set to LOW LEVEL.
A13R67 (OFS-4)	D measurement error sometimes exceeds specifications (impossible to automatically adjust the detection phase of phase detector). This symptom is present when auto phase adjustment signal at A14TP3 exceeds 0 ± 3 volts.
A14R1 (ZOF)	Measurement errors for both LCR and D/Q values has increased. The error is maximum at count displays of 1999 for all three measurement functions (Cs, Lp and Rp).
A14R15 (APAO)	D measurement has significant error (detection phase error).
A23R12 (VR1)	Instrument is inoperative or measurement sometimes stops.

Table 8-4. Front Panel Isolation Procedure.

Symptoms	Probable Faulty Board
ZERO ADJ L control malfunctions but measurement is made correctly.	A11
Measured value is incorrect at a particular range setting.	A11, A12
Measurement is not made correctly when TEST SIGNAL setting is at LOW LEVEL.	A11, A13 Note 1
Displayed count is unstable and fluctuates several counts at 120Hz measurement.	A11, A14
ZERO ADJ C control malfunctions but measurement is made correctly.	A12
Autoranging operation skips a particular range.	A12
U-CL is displayed on every range.	A13
Measurement is made only in either PRL or SER mode.	A13
Display count changes randomly.	A14
Figure(s) in numeric display is (are) defective.	A2
An indicator lamp does not light.	A2, A21
Pushbutton controls do not work (always invalid).	A2, A21, A23
An indicator lamp stays lit.	A21
All numeric display are blank.	A22
Trigger lamp does not light or stays lit.	A22, A23
Autorange control is inoperative.	A23

Note 1: If test signal voltage at H_{CUR} terminal is correct (140mVp-p), A13 board is faulty. If not, A11 board is faulty.

SELF TEST FUNCTION

Pressing the SELF TEST button (located at left in line with the CIRCUIT MODE selection buttons) directs the instrument to begin a sequence of instrument operated self-test functions. This is an outline of how to use the self test function for failure diagnosis.

Automatic self test settings:

An appropriate equivalent circuit mode (either to SER or PRL) is automatically selected for the duration of the self test. Since self testing is done in a particular equivalent circuit mode for each of the measurement parameters (L, C and R), auto testing is limited to the ranges specified for these circuit modes. The table below shows measurement ranges tested by self-test function. However, since, during self test, all instrument measurement functions are brought into action (including all the range resistors), this test is broad check of overall instrument performance for all ranges.

Table 8-5. Self Test Ranges.

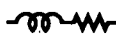
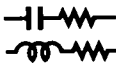
Range	Cs 	Ls 	Rs 
1	100pF	100μH	1000mΩ
2	1000pF	1000μH	10Ω
3	10nF	10mH	100Ω
4	100nF	100mH	1000Ω
5	1000nF	1000mH	10kΩ

Note

Multiply range by 10 at 120Hz and by 0.1 at 10kHz test signal frequencies.

How the self test function operates:

To perform the self test, the instrument simulates a measurement of either zero or infinite impedance. For these tests, the UNKNOWN terminals are appropriately terminated (short or open). Under these test conditions, the integrator develops an output voltage corresponding to a 1000 count display (full scale) for the LCR measurement test cycle and a 000 count display for the DQ measurement test cycle. The nanoprocessor monitors the 1000 and 000 counts calculated from the integrator output. If either or both of the counted numbers differ by more than 5 counts from their respective nominal values, a FAIL annunciation is displayed on the LCR DISPLAY. The nanoprocessor also monitors a SAT signal from Saturation Detector (A13) to further categorize the failures into other subdivisions.

Figure 8-11. Self Test Function (sheet 1 of 2).

Self Test Diagnostic Guide

Table 8-6 "Self Test Displays and Trouble Possibilities" is helpful in troubleshooting the analog section. No pushbuttons except for the FUNCTION and TEST SIGNAL controls should be depressed while the self test is being performed (if a pushbutton is inadvertently pressed, the self test function will be reset and will require reactivating).

Table 8-6. Self Test Displays and Trouble Possibilities.

Display	Source of FAIL signal	Probable Cause of Trouble
FAIL 1	Process Amplifier has been saturated by a signal of excessive amplitude. Saturation Detector is generating SAT signal.	<ol style="list-style-type: none"> 1. One of the range resistor selection switches on the A12 board is defective. 2. One of the signal selection switches on the A13 board is defective. 3. Saturation Detector on A13 board is faulty. 4. A13Q17 is always conducting (display will change to PASS when LOW LEVEL button is pressed).
FAIL 2	Integrator has developed an incorrect output voltage in an LCR measurement cycle.	<ol style="list-style-type: none"> 1. Test signal is not present at HCUR terminal. A11 board is faulty. 2. A12 range resistor amplifier is faulty. 3. An amplifier or an active switch on A13 board is faulty. 4. PLL circuit or Phase Selector in A14 board is faulty. 5. Phase Detector or Integrator on A14 board is faulty. 6. Auto Phase Adjustment malfunctioning. 7. Integrator Offset Null control malfunctioning.
FAIL 3	Integrator has developed an incorrect output voltage in the D/Q measurement cycle.	(A23 Processor and ROM board assembly) is faulty.

Note: The trouble possibilities outlined in the table above presupposes that the digital control section is operating correctly. A FAIL indication can also be generated by trouble in the digital section.

Figure 8-11. Self Test Function (sheet 2 of 2).

Digital Section Troubleshooting Using Signature Analyzer.

The advantage of troubleshooting based on "Signature Analysis" is accuracy and ease in finding failures. It is generally difficult to search for an error by means of observing waveforms on an oscilloscope for the reason that bit trains in a digital circuit seem to be much the same whichever is observed. Specifically, to find the errors in stream of a large bit size (or word length) data takes much time and requires the use of an instrument such as a logic state analyzer. Hewlett-Packard has proposed a method called "Signature Analysis" which recognizes the bit pattern measured in a 4 digit hexa-decimal code (signature) for running an easy diagnostic test program. With the Signature Analyzer (HP 5004A), the signatures are displayed in a readable 4 digit-figure set of alphanumeric figures (0 1 2 3 4 5 6 7 8 9 A C F H P U). The signature analysis is based the usual signal tracing method followed in troubleshooting an analog circuit. According to signature analysis, devices in a digital circuit are checked with the signal analyzer by comparing signal input and output signatures to and from each device for the "correct" signature denoted in the service manual signature map. If a signature is not identical, the troubleshooter need only trace the bit train in opposite direction to the signal flow and, when a device is noted which generates an erratic signature despite a correct input, the component may be regarded as faulty. One additional important consideration, since the actual program ROM board (P/N: 04262-66523) in the 4262A does not include a self-test program for signature analysis (as part of the program ROM), a troubleshooting board is required when diagnosing with the Signature Analyzer.

When the troubleshooting board is installed in the instrument, a test program is written out from a special ROM which activates overall the digital control circuit, and, if included, any optional circuits. For convenience in troubleshooting the 4262A, this signature test board is supplied as Service Kit (04262-87002).

HOW TO USE THE SIGNATURE ANALYZER TEST BOARD.

Note

Use either procedure 1 or 2 depending upon instrument serial number.

1. Serial numbers 1710J00340 and below.
 - a. Remove A11, A12, A13 and A14 boards from instrument.
 - b. Take out A23 Board.
 - c. Disconnect A23U16 (ROM) from socket J2 and put aside.
 - d. Disconnect signature program ROM from socket J3 (labeled TEST ROM) on test board and install the ROM in place of A23U16.
 - e. Reinstall A23 Board in its normal position.

Note

When testing ROM's with A23 board assembly, install the ROM in socket J1 (labeled 2708A) on the test board. Install the test board in place of A13 board assembly. Observe signatures at test points D0 through D7 on the board and follow troubleshooting procedures. Test board flat cable need not be connected anywhere.

Figure 8-12. Signature Analysis Guide (sheet 1 of 3).

- f. Turn instrument off and on (press LINE button) to reset digital control circuit and to return test program to its initial address line.

2. Serial numbers 1739J00341 and above.

- a. Remove A11, A12, A13 and A14 boards from instrument.
- b. Install Signature test board in place of A13 board.
- c. Take out the A23 board.
- d. Disconnect A23U15 (ROM) from socket J2 and put aside.
- e. Connect 24 pin plug of the test board flat cable assembly to socket J2 on A23 board.
- f. Reinstall A23 board in its normal position.
- g. Turn instrument off and on (press LINE button) to reset digital control circuit and to return test program to its initial address line.

Note

When testing ROM's on A23 board assembly, install the ROM in socket J2 (labeled 2316A) on test board. Observe signatures at test points D0 through D7 on the board and follow troubleshooting procedures. Test board flat cable may be left connected to A23 board.

SIGNATURE ANALYZER TECHNIQUE.

An active digital hand-held logic tracer coupled with an active pod (with four miniature clip connection leads) is sufficient for detecting the test signal and for development of the signature on the Signature Analyzer display. The active probe has access to the desired node in the circuit being tested and transfers this input data to the analyzer. The four input leads of the test cable active pod, connect the gate signals — START, STOP, and CLOCK — from the instrument being tested to the analyzer. The remaining lead is connected to instrument GND. The START signal is an open "window" (measurement gate) signal which causes the signature analyzer to prepare for receiving data via the active probe. The STOP signal causes the window to close. The CLOCK is taken from the time base of the instrument and permits receiving input data and gate signals in synchronization. Polarity of the gate signal active (enable) edges (positive or negative) can be selected by the front panel controls of the signature analyzer. Probing points and connection locations of START, STOP and CLOCK leads are designated on the troubleshooting flow diagrams.

Note

Use an -hp- Model 547A Current Tracer to trace a "stuck" node current.

Figure 8-12. Signature Analysis Guide (sheet 2 of 3).

Signature Analysis Diagnostic Flow Diagram Notes.

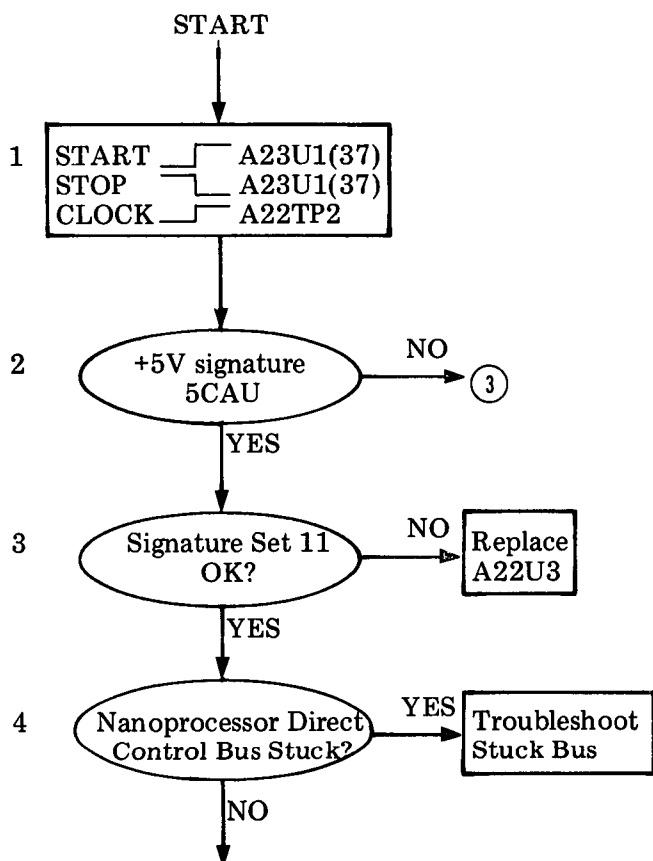

1. Both START and STOP signals are taken from A23U1 pin 37. CLOCK signal is taken from A22TP2. Front panel control settings for Signature Analyzer are:

START button: released (■)
STOP button: depressed (■)
CLOCK button: released (■)

2. Checks that signature of +5V supply is 5CAU. If incorrect, go to Flow Diagram number 3.

3. Compares actual signatures with signature set ⑪ on the signature map (see Figure B). If not identical, replace A22U3.

4. Check signatures with respect to nanoprocessor direct control bus line. If incorrect, check every component on faulty bus line.

Figure A. Diagnostic Flow Diagram Notes.

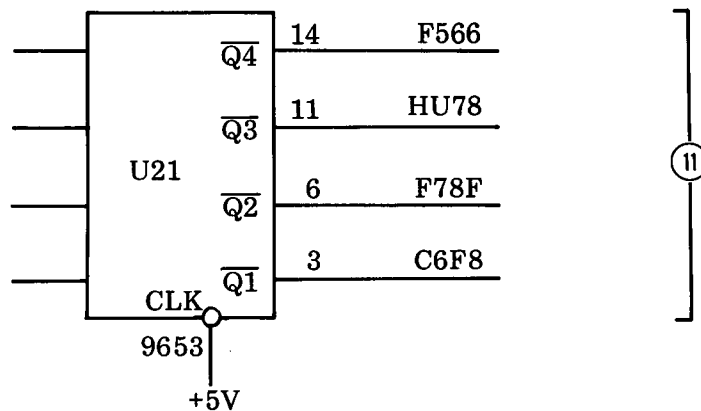

Figure B. Signature Map Notes.

8-46. REPAIR.

WARNING

BEFORE PROCEEDING WITH REPAIR, BE SURE THAT INSTRUMENT IS DISCONNECTED FROM POWER LINE!

8-47. REMOVAL OF Q2 or Q3.

- a. Fully loosen top cover retaining screw located at rear of instrument and lift off top cover.
- b. Remove left handle mounting screws (2). Slide left side panel toward the rear of instrument and take off.
- c. Remove the two transistor retaining screws.
- d. Lift out transistor.
- e. Install new transistor. To maintain good thermal diffusion, use fresh silicone paste on transistor and insulator sheet.

8-48. LINE SWITCH (S1) REMOVAL.

- a. Perform steps a and b of paragraph 8-47, removal of Q2 and Q3.
- b. Remove the two screws which fasten LINE switch S1 to plate on side frame.
- c. Remove the cable clamp screw (located at center near top of side frame).
- d. Pull LINE switch toward the rear of instrument and take out switch with extender shaft from instrument.
- e. Pull extender shaft out of switch shaft. Unsolder cable from switch.
- f. Install new switch. Envelop the switch with heat contractible tubing.

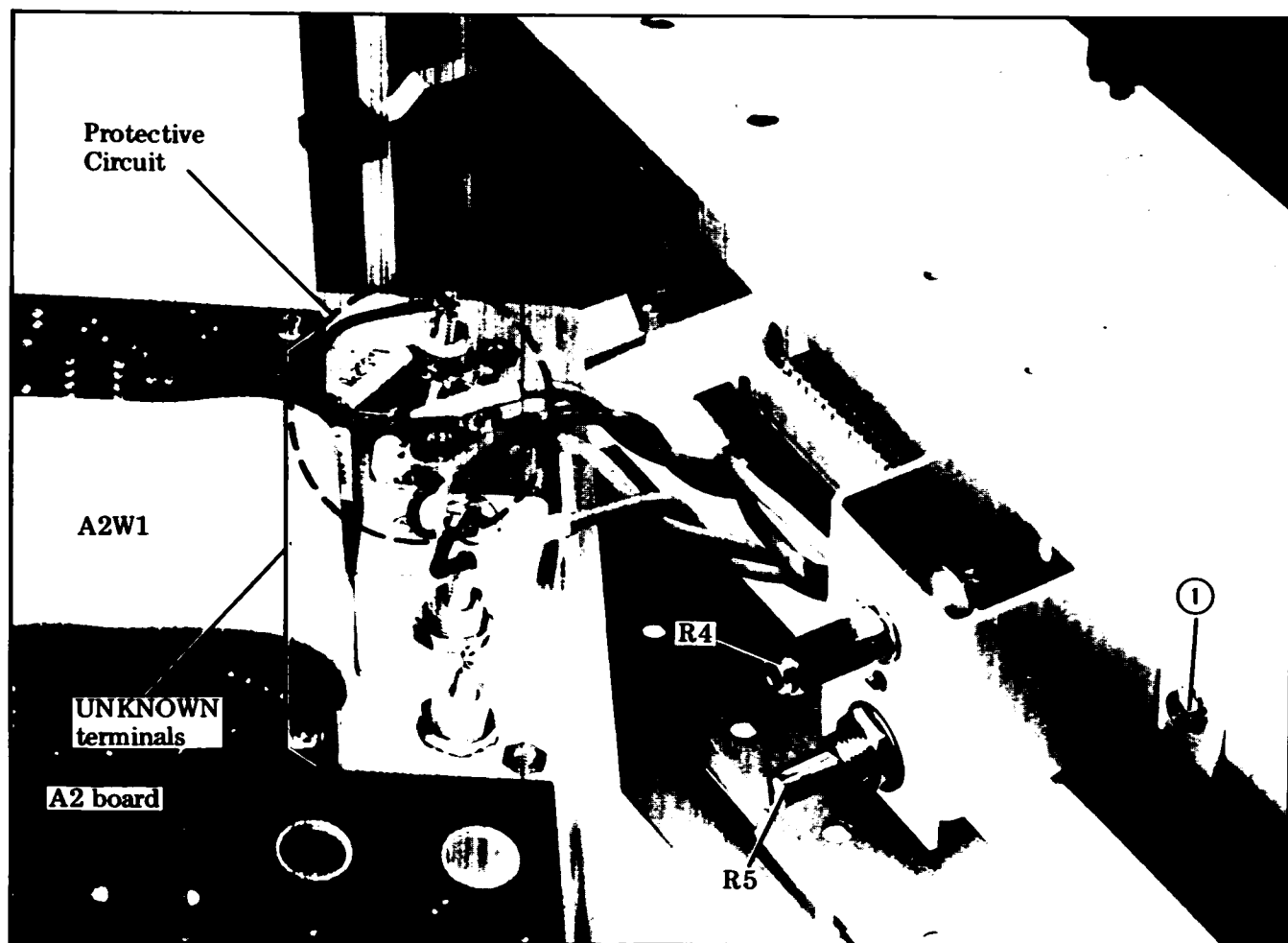

Figure 8-13. Protective Diode and ZERO ADJ Control Potentiometer Replacement.

**8-49. PROTECTIVE DIODE REPLACEMENT
 (CR4, CR5, CR6 and CR7).**

To replace protective circuit diodes connected to UNKNOWN terminals (Low side), perform the following procedure:

- a. Remove top trim strip from front frame (use a screwdriver to lift out the trim).
- b. Remove the two left hand screws from among the four screws located at the top side of the front frame.
- c. Turn instrument upside down.
- d. Remove the two right-hand screws from among the four screws located at bottom side of the front frame.
- e. Carefully pull unknown terminal binding posts forward and front panel assembly out.

CAUTION

DO NOT USE EXCESSIVE FORCE OR WIRE CONNECTIONS TO UNKNOWN TERMINALS MAY BREAK.

- f. Disconnect flat cable 40 pin connector A2W2 from the plug mated with A21 board assembly. See Figure 8-14.

- g. Disconnect flat cable 40 pin connector A2W1 from the plug mated with mother board. See Figure 8-14.
- h. Unsolder wire leads to diode and disconnect diode from the binding post soldering lugs of UNKNOWN terminals.
- i. Install new diode. Solder wire leads to new diode.

8-50. ZERO ADJ CONTROL POTENTIOMETER (R4 and R5) REPLACEMENT.

- a. Perform steps a through g of paragraph 8-49 Protective Diode Replacement.
- b. Remove retaining screw (1) shown in Figure 8-13.
- c. Remove the potentiometer retaining nut and unsolder wiring leads to the potentiometer.
- d. Install new potentiometer.

8-51. A2 KEYBOARD AND DISPLAY BOARD DISASSEMBLY.

- a. Perform steps a through g of paragraph 8-49 Protective Diode Replacement.
- b. Remove the 8 screws (1 through 8) in Figure 8-14) fastening A2 board to front panel.

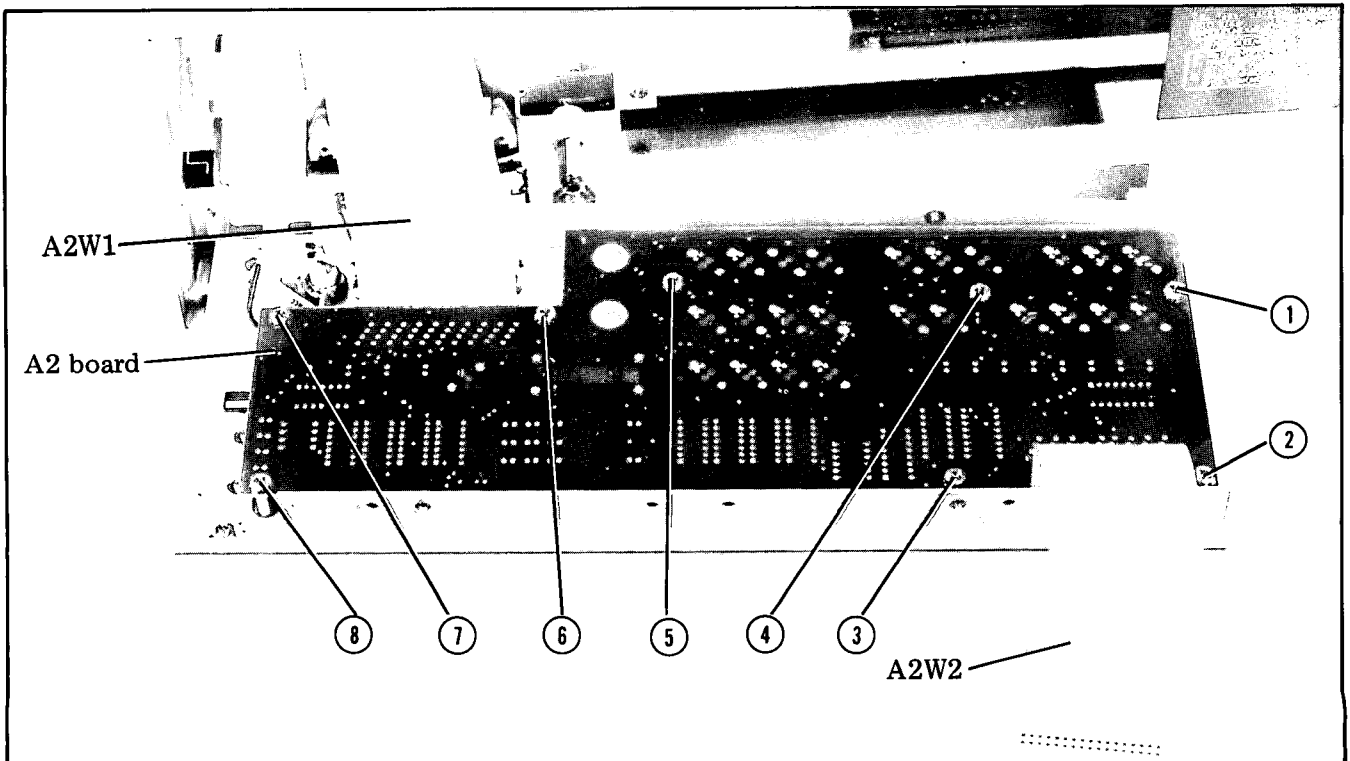

Figure 8-14. A2 Keyboard and Display Board Disassembly.

8-52. KEYBOARD SWITCH LED REPLACEMENT.

- a. Perform steps a through g of paragraph 8-49, Protective Diode Replacement.
- b. Remove 8 screws (① through ⑧ in Figure 8-14) fastening A2 board to front panel.
- c. Take out A2 board from instrument.
- d. Remove pushbutton switch by melting plastic legs of the switch. Use tool HP P/N 5951-8516.
- e. Unsolder defective LED.
- f. To assure that the newly installed LED will not rub against the switch plunger (when pushbutton is pressed), a soldering guide is required. Fabricate a soldering guide from a piece of 3.18mm (0.125 inch) internal diameter, thin walled plastic tubing 4.76mm (3/16 inch) in length. If tubing is not available, use a 4.76mm strip of paper rolled to make up an approximate I. D. of 3.18mm.
- g. Insert tubing (or rolled paper) into bottom of plunger of new switch (see Figure 8-15).
- h. Insert the new LED into bottom of switch plunger containing tubing.
- i. Rotate LED (in bottom of switch plunger) so that the shortest lead passes through the P. C. board mounting hole (identified with dot marking). See Figure 8-16.

- j. Install switch and LED combination onto A2 board assembly.
- k. Grasp LED leads (back side of A2 board) and pull LED flush against front side of A2 board.
- l. Solder LED to A2 board assembly.

CAUTION

WHILE SOLDERING LED, PRESS SWITCH AGAINST FRONT SURFACE OF A2 BOARD ASSEMBLY. BE CAREFUL NOT TO MELT PLASTIC LEGS OF SWITCH OR TO CONTAMINATE IT WITH SOLDERING FLUX.

- m. Take off switch and remove tubing (or rolled paper) from switch plunger. Clean any residual flux from A2 board assembly.
- n. Mount switch over LED and operate switch several times to assure that switch plunger does not rub against LED, and that the light-pipe in key-cap does not contact LED before switch plunger bottoms.

Note

If the results of step n are not satisfactory, repeat the LED installation procedure.

- o. Install switch (over new LED) onto A2 board assembly.

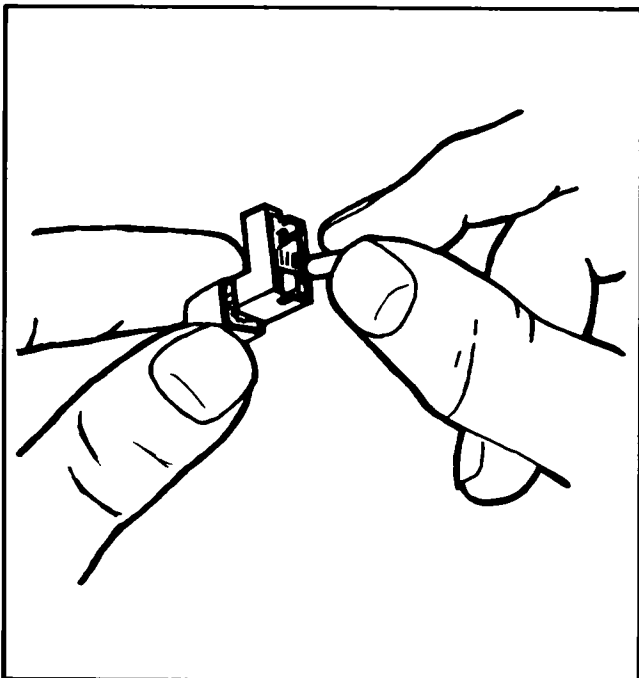

Figure 8-15. Inserting Tubing Into Switch Plunger.

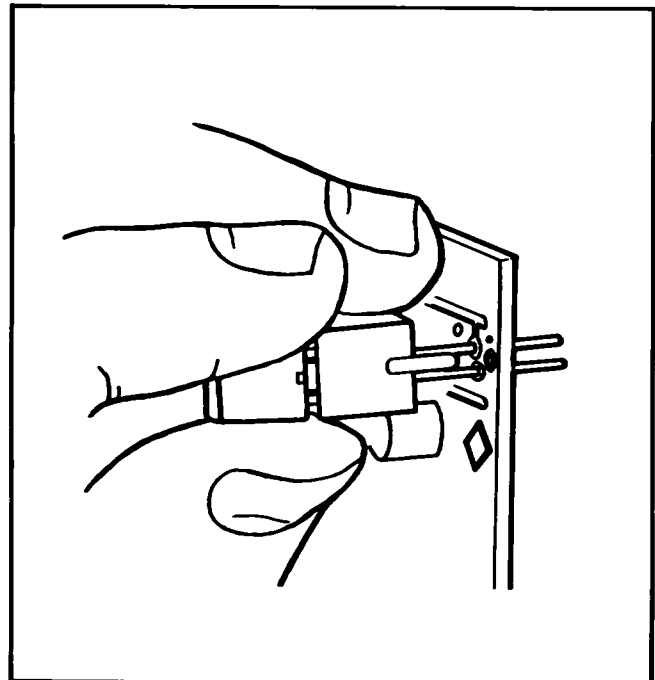

Figure 8-16. LED Installation in Switch.

8-53. PRODUCT SAFETY CHECKS.**WARNING**

WHENEVER IT APPEARS LIKELY THAT SAFETY PROTECTIVE PROVISIONS HAVE BEEN IMPAIRED, THE APPARATUS SHALL BE MADE INOPERATIVE AND BE SECURED AGAINST ANY UNINTENDED OPERATION. THE PROTECTION IS LIKELY TO BE COMPROMISED IF, FOR EXAMPLE:

- THE APPARATUS SHOWS VISIBLE DAMAGE.
- THE INSTRUMENT FAILS TO PERFORM THE INTENDED MEASUREMENT.
- THE UNIT HAS UNDERGONE PROLONGED STORAGE UNDER UNFAVORABLE CONDITIONS.
- THE INSTRUMENT HAS SUFFERED SEVERE TRANSPORT STRESS.

8-54. The following five checks are recommended to verify the product safety of the 4262A LCR Meter (these checks may also be done to check for product safety after troubleshooting and repair). When such checks are needed, perform the following:

1. Visually inspect interior of instrument for any signs of abnormal, internally generated heat, such as discolored printed circuit boards or components, damaged insulation, or evidence of arcing. Determine and remedy cause of any such condition.
2. Using a suitable ohmmeter, check resistance from instrument enclosure to ground pin on power cord plug. The reading must be less than 0.5 ohm. Flex the power cord while making this measurement to determine whether intermittent discontinuities exist.
3. Check GUARD terminal on front panel using procedure (2).
4. Disconnect instrument from power source. Turn power switch to on. Check resistance from instrument enclosure to line and neutral (tied together). The minimum acceptable resistance is two megohms. Replace any component which fails or causes a failure.
5. Check line fuse to verify that a correctly rated fuse is installed.

TROUBLESHOOTING FLOW DIAGRAMS

Figure 8-17. Analog and Digital Section Isolation Procedure	8-31
Figure 8-18. Analog Section Troubleshooting Procedure to Assembly Level	8-33
Figure 8-19. Digital Section Troubleshooting Procedures	8-35
Flow Diagram A. Primary Diagnostic Flow Diagram	8-35
Flow Diagram B. Program ROM Diagnostic Flow Diagram	8-35
Flow Diagram C. A23 Board Diagnostic Flow Diagram (Nanoprocessor and Device Select Decoder)	8-37
Flow Diagram D. A23 Board Diagnostic Flow Diagram (Analog Section Control Signals)	8-38
Flow Diagram E. A22 Board Diagnostic Flow Diagram (Clock and RAM)	8-39
Flow Diagram F. A22 Board Diagnostic Flow Diagram (Display Control)	8-40
Flow Diagram G. A21 Board Diagnostic Flow Diagram	8-41
Flow Diagram H. A21 Board Diagnostic Flow Diagram	8-42



Figure 8-17
Analog and Digital Sections Isolation Procedure

SEE INSIDE

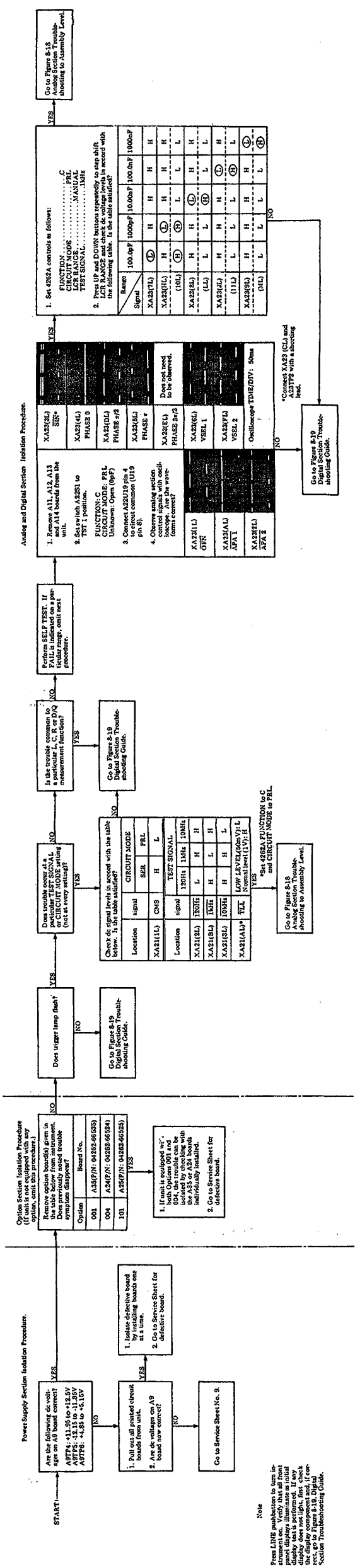

Figure 8-17. Analog and Digital Sections Isolation Procedure.

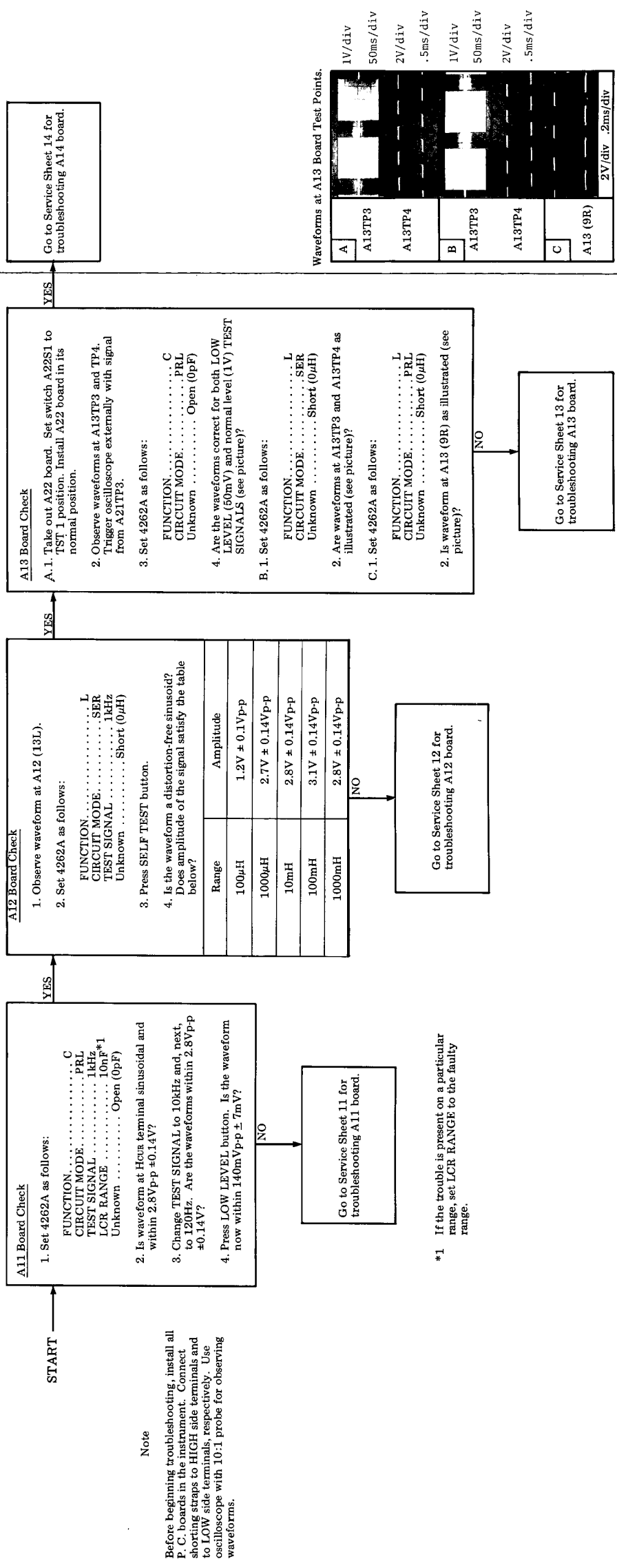

Figure 8-18. Analog Section Troubleshooting Procedure to Assembly Level.

Figure 8-19
Digital Section Troubleshooting Procedures.
Flow Diagram A
Flow Diagram B



SEE INSIDE

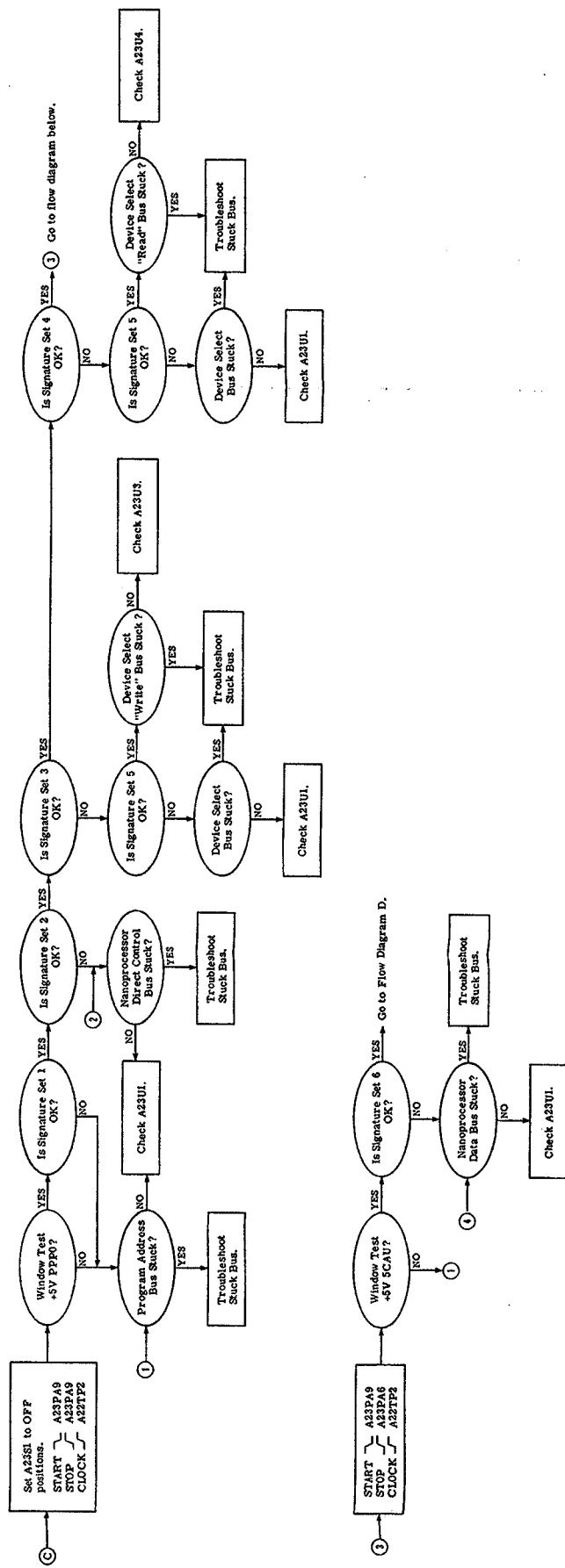

Figure 8-19. Digital Section Troubleshooting Procedures.
Flow Diagram C. A23 Board Diagnostic Flow Diagram.
(Nanoprocessor and Device Select Decoder)

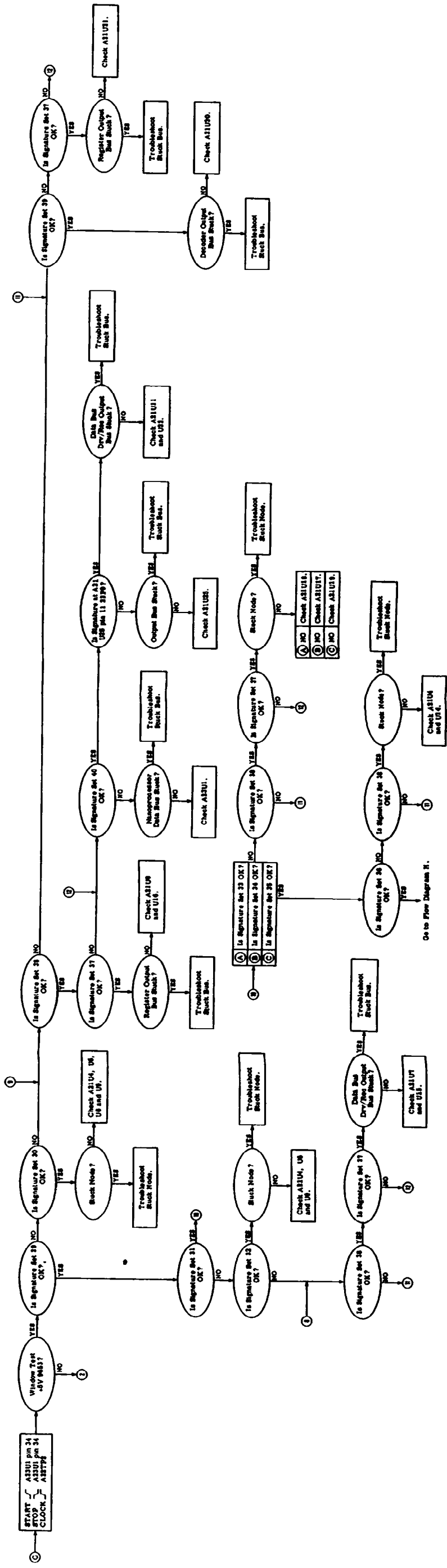





Figure 8-19. Digital Section Troubleshooting Procedure.
Flow Diagram G. A31 Board Diagnostic Flow Diagram.

Table A. Keyboard Switch Test Signature.

Key*	U22(3)D0	U22(6)D1	U22(10)D2	U22(13)D3	U11(3)D4	U11(6)D5	U11(10)D6	U11(13)D7
LOCAL	U0U7	35U8	H64U	4548	5754	209F	H4H9	2FH7
SELF TEST	U0U7	35U8	H64U	4548	9974	PPCF	H4H9	2FH7
CMD AUTO	U0U7	35U8	H64U	4548	9974	209F	1AU9	2FH7
CMD PRL	U0U7	UCH8	H64U	4548	5754	209F	H4H9	2FH7
CMD SER	U0U7	UCH8	H64U	4548	9974	PPCF	H4H9	2FH7
FUNC L	U0U7	UCH8	H64U	4548	9974	209F	1AU9	2FH7
FUNC C	U0U7	35U8	186U	4548	5754	209F	H4H9	2FH7
FUNC R	U0U7	35U8	186U	4548	9974	PPCF	H4H9	2FH7
FUNC Δ LCR	U0U7	35U8	186U	4548	9974	209F	1AU9	2FH7
LCR RNG AUTO	U0U7	UCH8	186U	4548	5754	209F	H4H9	2FH7
LCR RNG MANUAL	U0U7	UCH8	186U	4548	9974	PPCF	H4H9	2FH7
LCR RNG DOWN	U0U7	UCH8	186U	4548	9974	209F	1AU9	2FH7
LCR RNG UP	U0U7	35U8	H64U	8C68	5754	209F	H4H9	2FH7
LOSS D	U0U7	35U8	H64U	8C68	9974	PPCF	H4H9	2FH7
LOSS Q	U0U7	35U8	H64U	8C68	9974	209F	1AU9	2FH7
DQ RNG AUTO	U0U7	UCH8	H64U	8C68	5754	209F	H4H9	2FH7
DQ RNG MANUAL	U0U7	UCH8	H64U	8C68	9974	PPCF	H4H9	2FH7
DQ RNG STEP	U0U7	UCH8	H64U	8C68	9974	209F	1AU9	2FH7
TEST SIG LOW LEVEL	U0U7	35U8	186U	8C68	5754	209F	H4H9	2FH7
TEST SIG 120Hz	U0U7	35U8	186U	8C68	9974	PPCF	H4H9	2FH7
TEST SIG 1kHz	U0U7	35U8	186U	8C68	9974	209F	1AU9	2FH7
TEST SIG 10kHz	U0U7	UCH8	186U	8C68	5754	209F	H4H9	2FH7
TRIG INT	U0U7	UCH8	186U	8C68	9974	PPCF	H4H9	2FH7
TRIG EXT	U0U7	UCH8	186U	8C68	9974	209F	1AU9	2FH7
TRIG HOLD/MANUAL	U0U7	35U8	H64U	4548	9974	209F	H4H9	P2U7

Signature Analyzer Settings:

START	A23PA8	
STOP	A23PA8	
CLOCK	A22TP2	
Window Test (+5V): 72A7		

* Depressing the keys listed will result in the signatures defined in Table A.

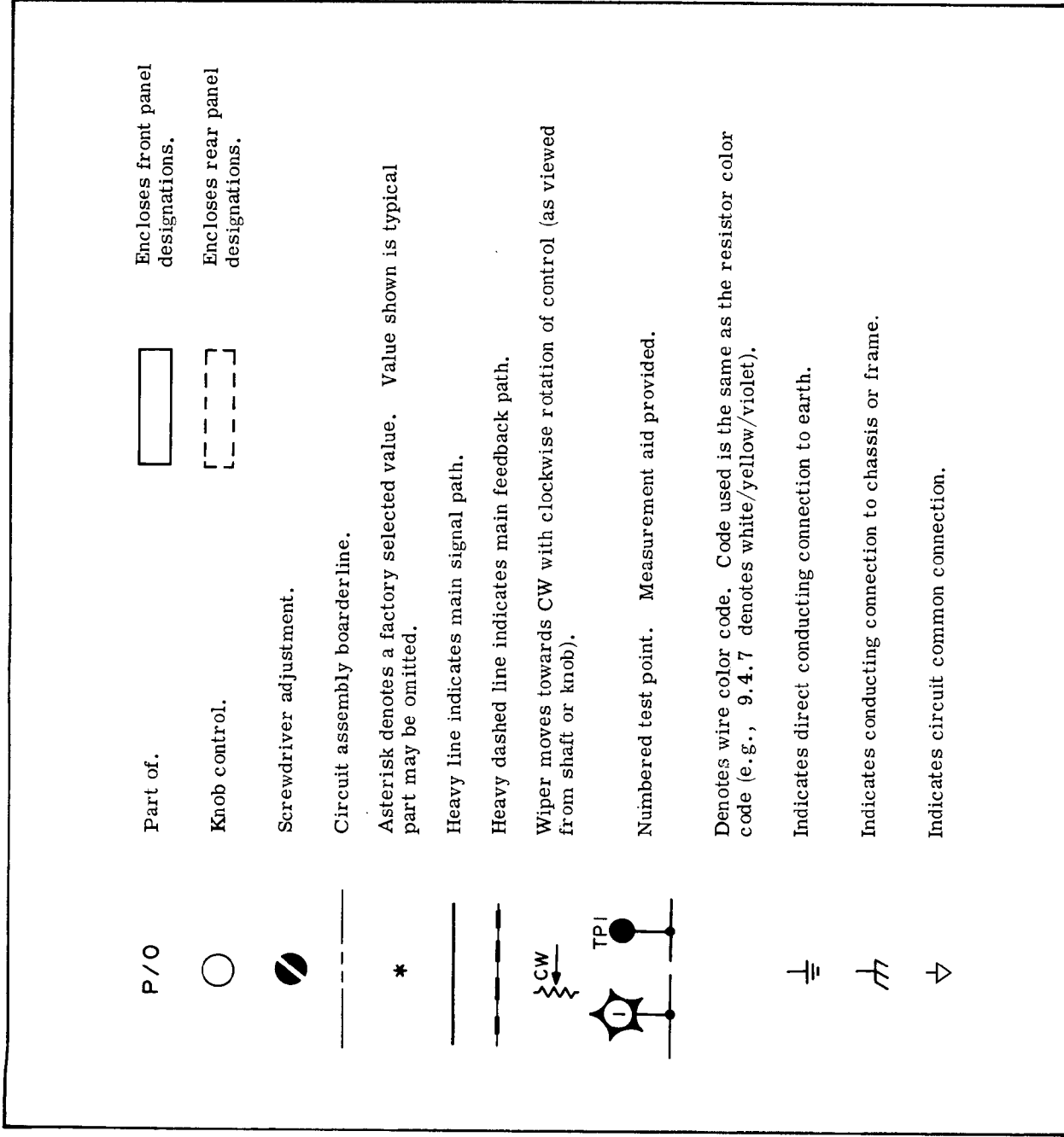

Figure 8-20. Schematic Diagram Notes.

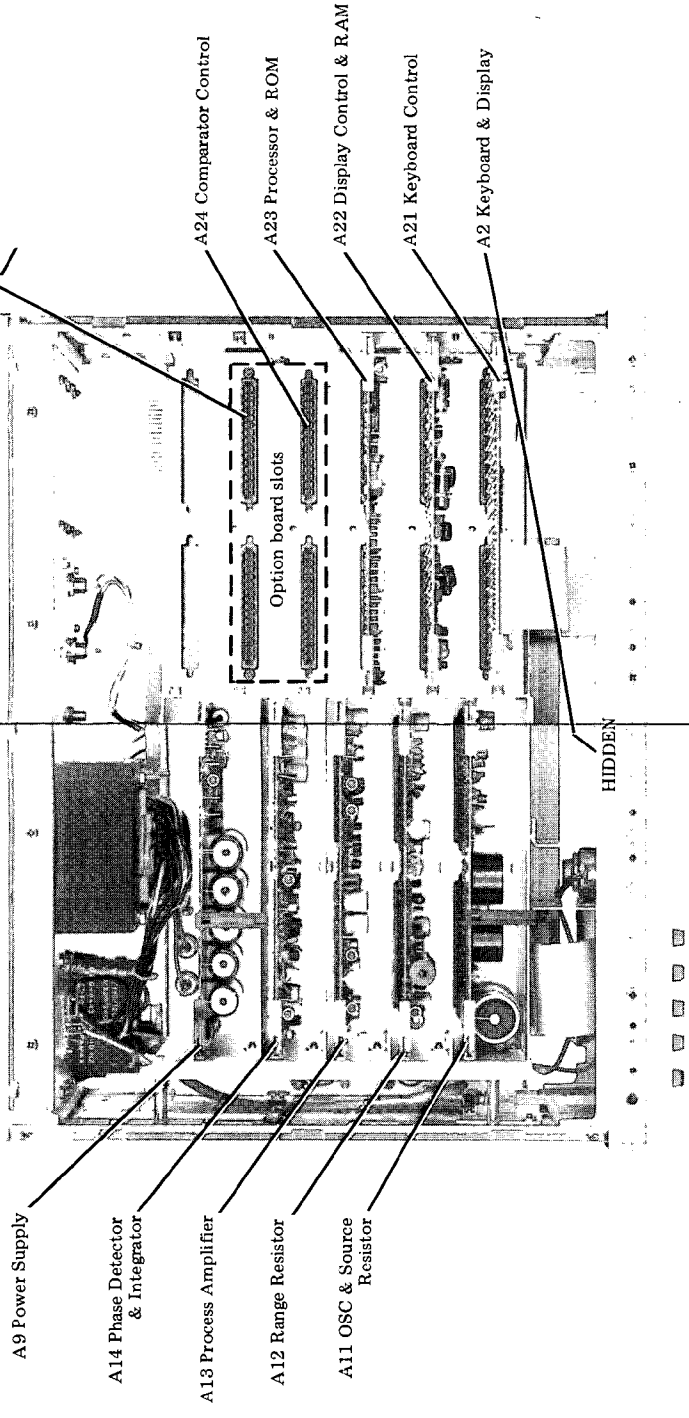

Figure 8-21. Assembly Locations.

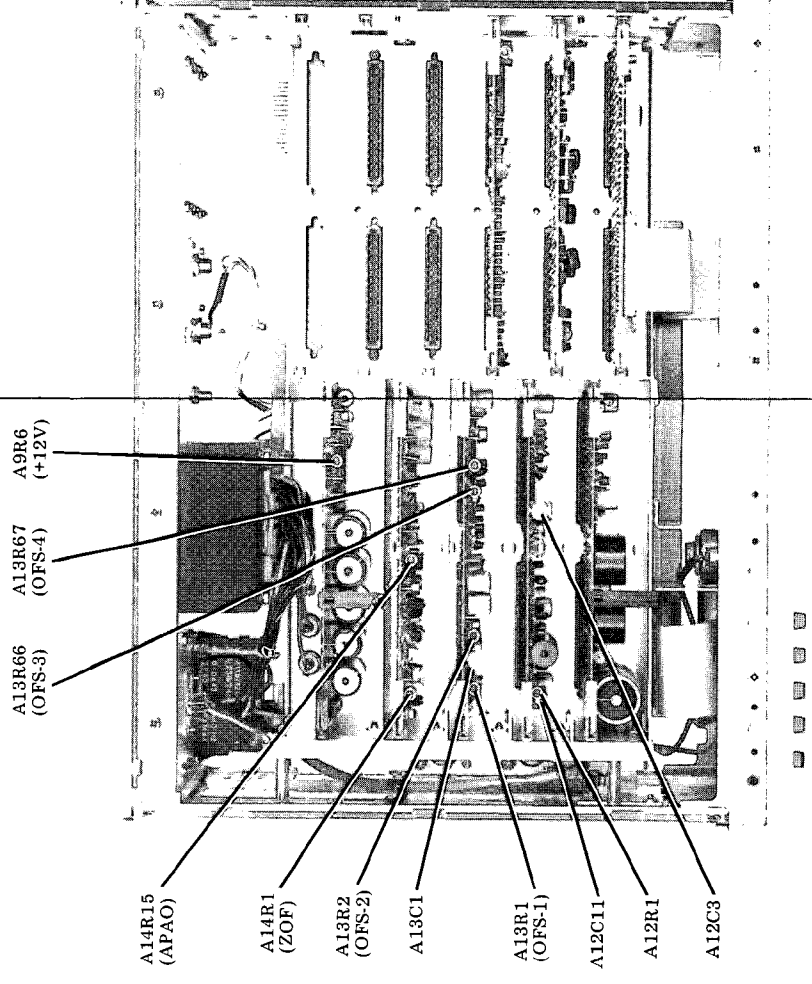

Figure 8-22. Adjustment Locations.

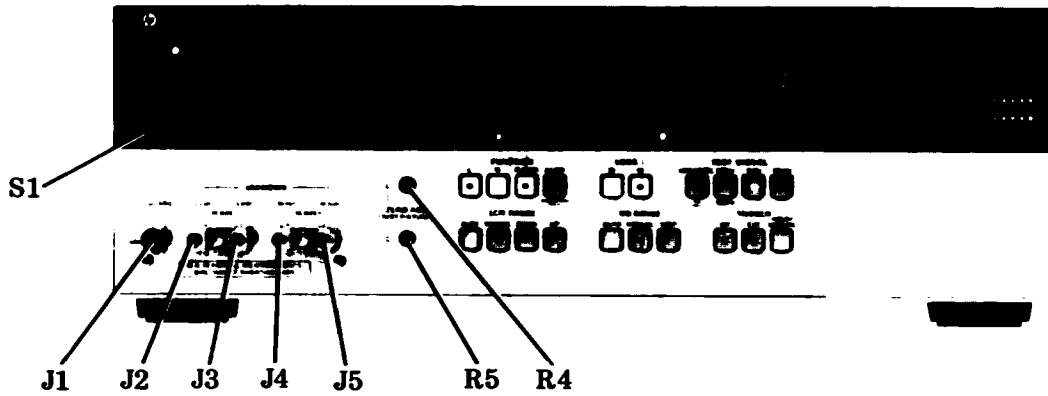

Figure 8-23. Front Panel Component Locations.

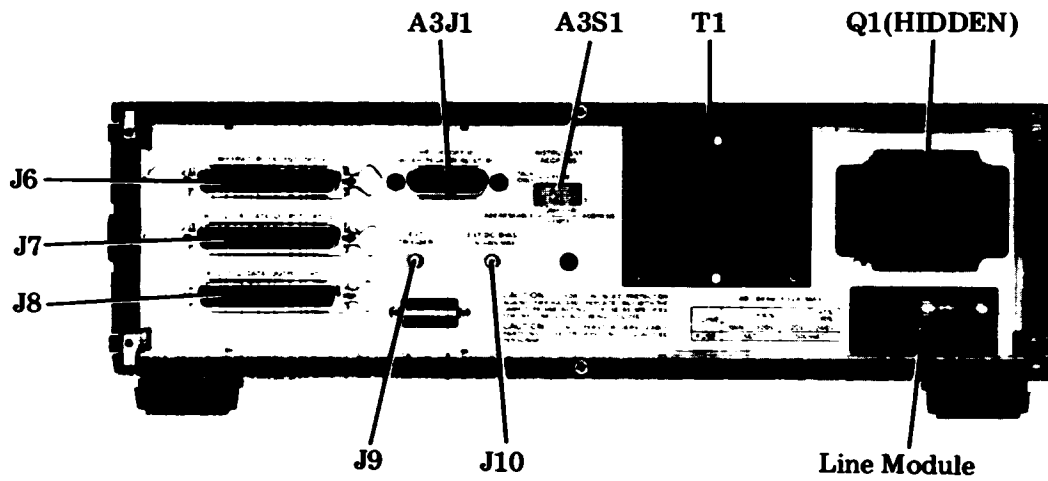

Figure 8-24. Rear Panel Component Locations.

◀ A9 Board Troubleshooting Tree
Under Fold

◀ **A2** Keyboard & Display
SERVICE SHEET 2
SEE INSIDE

8-45

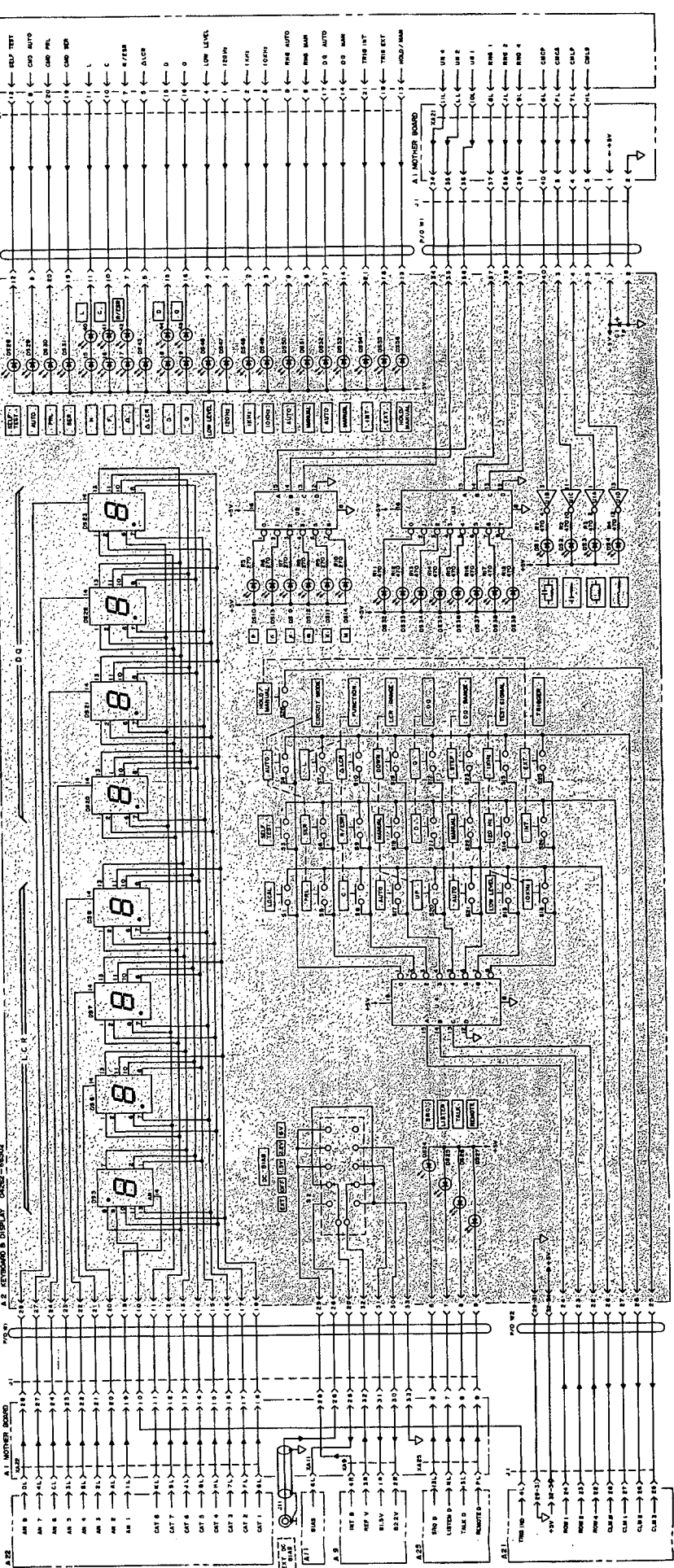

Figure 8-26. A2 Keyboard & Display Board Assembly Schematic Diagram.

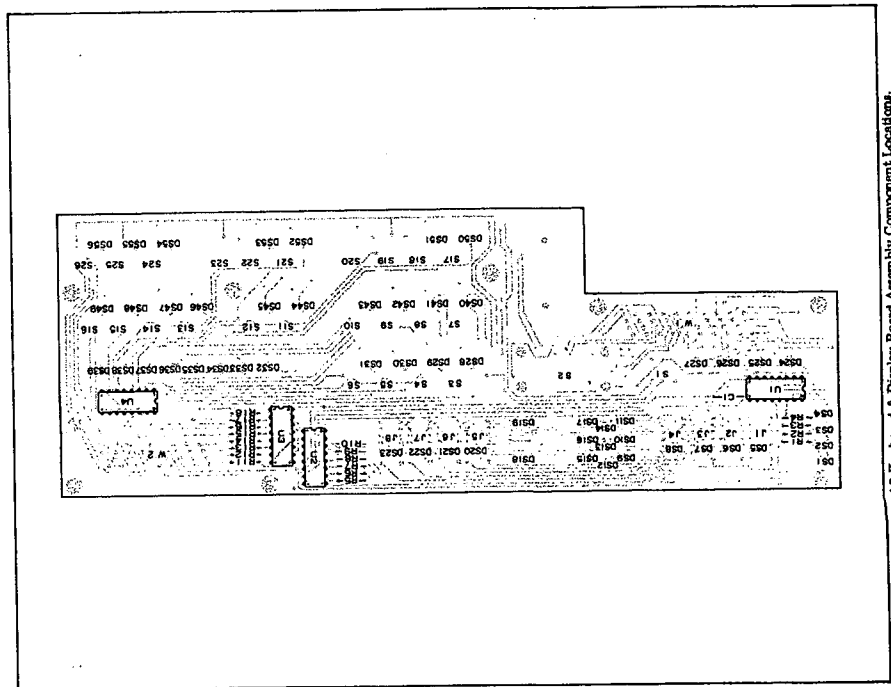

Figure 8-25. A3 Keyboard & Display Board Assembly Component Locations.

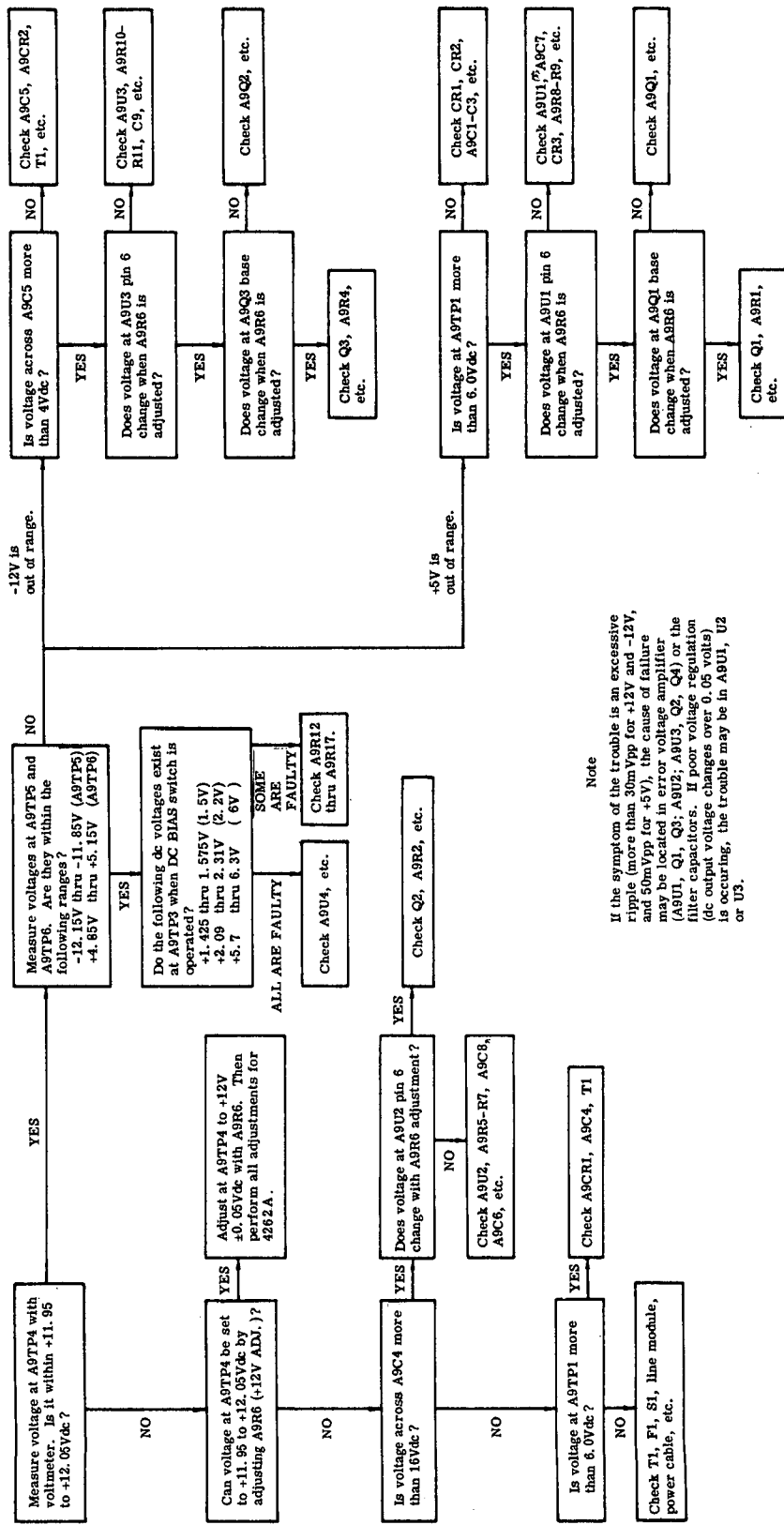

Figure 8-27. A9 Power Supply Board Troubleshooting Tree.

◀ A11 Board Troubleshooting Tree
Under Fold

◀ **A9** Power Supply
SERVICE SHEET 9
SEE INSIDE

8-47

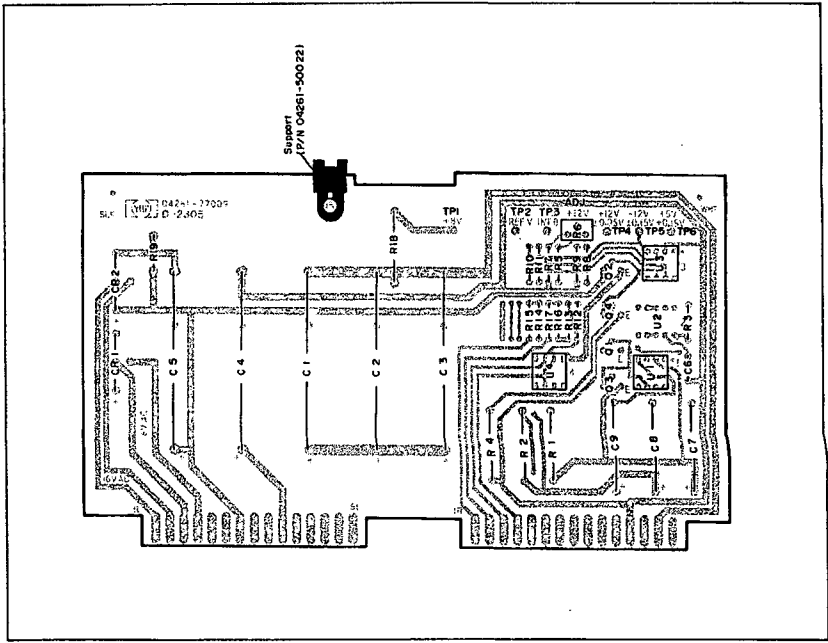

Figure 8-28. A9 Power Supply Board Assembly Component Locations.

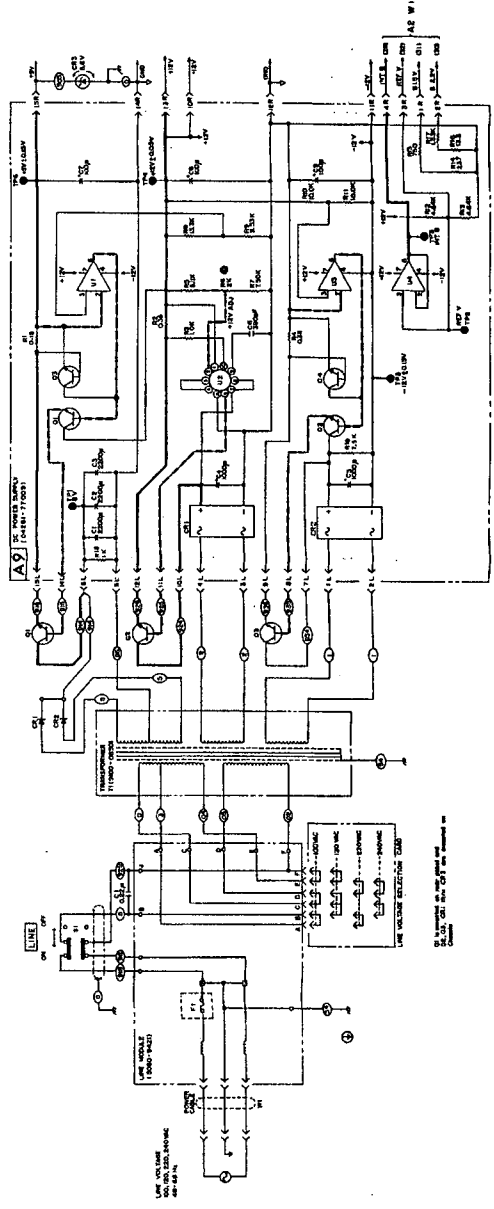

Figure 8-29. A9 Power Supply Board Assembly Schematic Diagram.

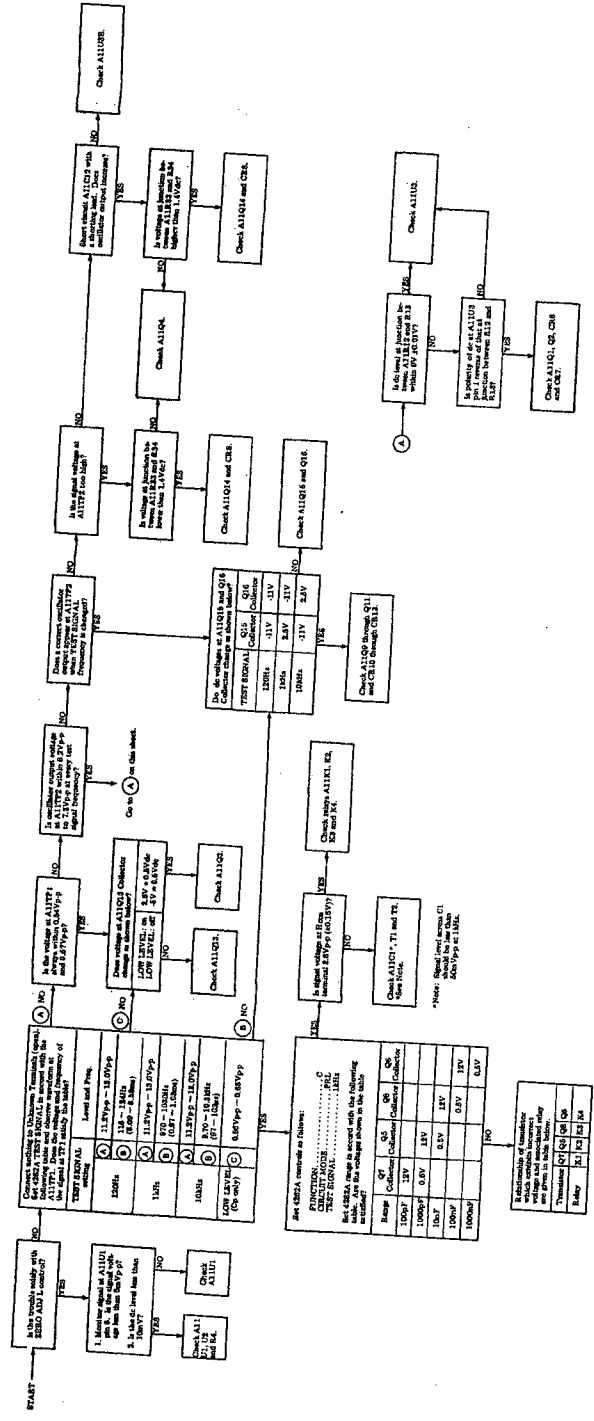



Figure 8-30. AI1 OSC & Source Resistor Board Troubleshooting Tree

A11 BOARD CIRCUIT DESCRIPTION.

The Wien bridge oscillator frequency is derived from the equation: $1/(2\pi\sqrt{RaRbC8C9})$. Associated resistances Ra and Rb are selected from resistors R25 through R30 by active switches Q9 through Q12 to set desired test signal frequency (both Ra and Rb have the same value). The relationships of the switches to the oscillation frequency are shown in the table with the circuit diagram. Automatic level control circuit Q4 and Q14 operates to maintain a constant oscillator output level against changes in oscillator circuit parameters and supply voltage as follows: if the oscillator output level rises above 6.8Vp-p, Q14 is turned on for a longer period, the voltage across C12 increases, and Q3 is moved nearer to an OFF condition. Therefore, the feedback to U3B increases, and the gain of U3B is decreased to lower its output level to the proper amplitude. This provides stable amplitude characteristics to the oscillator. The table below shows the relationship of selected source and range resistors to 4262A FUNCTION, CIRCUIT MODE, and RANGE settings. At any setting, both the range resistor Rr and source resistor Ro have the same value. Note that the 100Ω and 10Ω source resistances include the total series resistance of the range resistors and the output resistance of transformers T1 and T2.

Table A. Range Resistor (RR) and Source Resistor (Ro) Selections.

Function		Range	1	2	3	4	5	6	7	8
		L	Full-scale	120Hz	1000μH	10.00mH	100.0mH	1000mH	10.00H	100.0H
1kHz	100.0μH			1000μH	10.00mH	100.0mH	1000mH	10.00H	100.0H	
10kHz	10.00μH			100.0μH	1000μH	10.00mH	100.0mH	1000mH	10.00H	
RR, Ro	SER		10Ω	100Ω	1kΩ	10kΩ	100kΩ			
	PARA					10Ω	100Ω	1kΩ	10kΩ	
C	Full-scale	120Hz	1000pF	10.00nF	100.0nF	1000nF	10.00μF	100.0μF	1000μF	10.00mF
		1kHz	100.0pF	1000pF	10.00nF	100.0nF	1000nF	10.00μF	100.0μF	1000μF
		10kHz	10.00pF	100.0pF	1000pF	10.00nF	100.0nF	1000nF	10.00μF	100.0μF
	RR, Ro	PARA	100kΩ	10kΩ	1kΩ	100Ω	10Ω			
		SER				100kΩ	10kΩ	1kΩ	100Ω	10Ω
R	Full-scale	120/ 1kHz/ 10kHz	1000mΩ	10.00Ω	100.0Ω	1000Ω	10.00kΩ	100.0kΩ	1000kΩ	10.00MΩ
	RR, Ro	SER	10Ω	100Ω	1kΩ	10kΩ	100kΩ			
		PARA				10Ω	100Ω	1kΩ	10kΩ	100kΩ

 **A12 Board Troubleshooting Tree
Under Fold**

 **A11** **OSC & Source Resistor
SERVICE SHEET 11**
SEE INSIDE

8-49

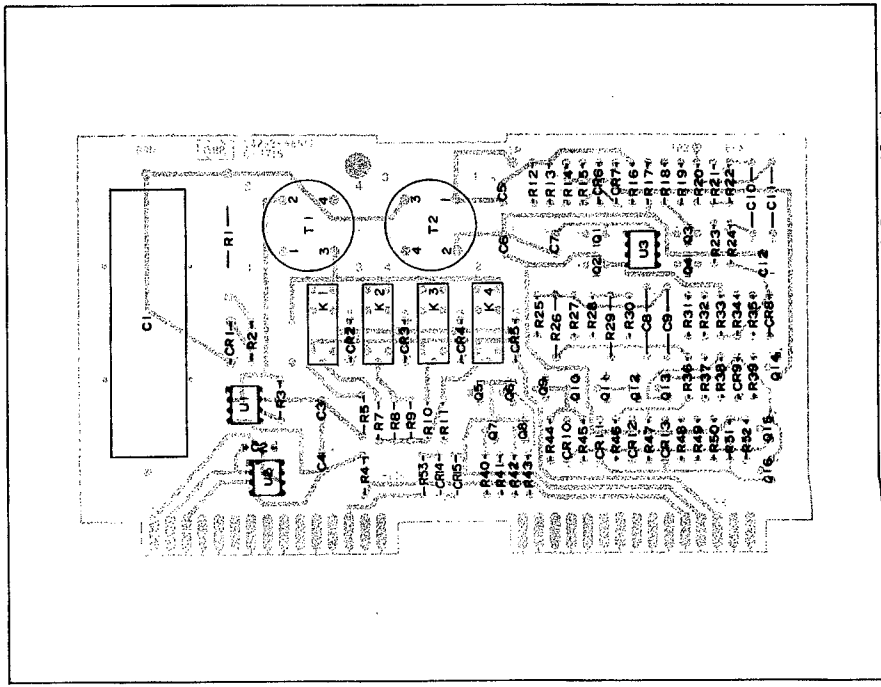

Figure 8-31. A11 OSC & Source Resistor Board Assembly Component Locations.

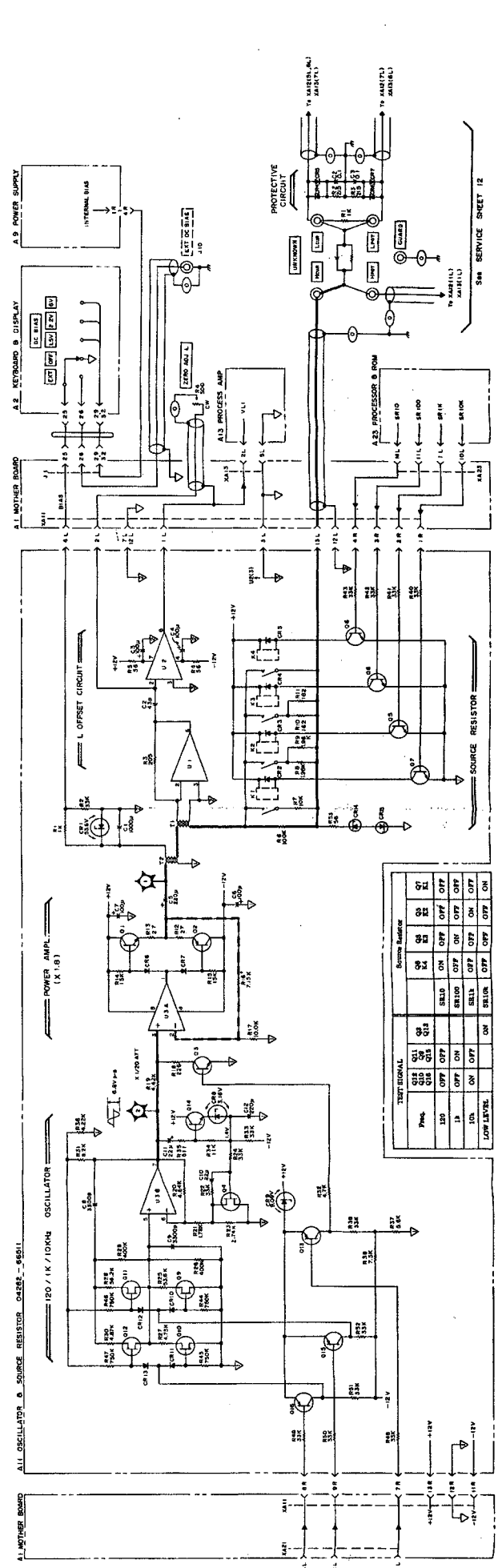
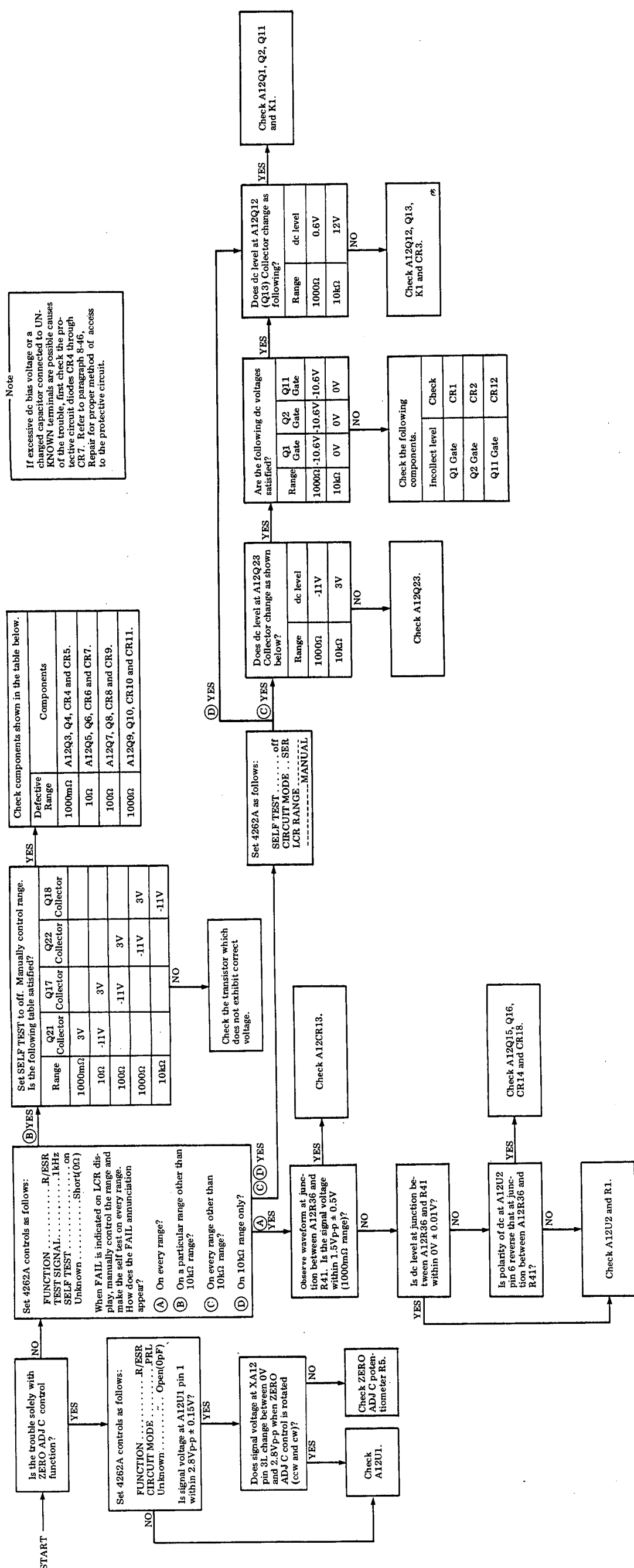

Figure 8-32. A11 OSC & Source Resistor Board Assembly Schematic Diagram.



Note

If excessive dc bias voltage or a charged capacitor connected to UNKNOWN terminals are possible causes of the trouble, first check the protective circuit diodes CR4 through CR7. Refer to paragraph 8-46. Repair for proper method of access to the protective circuit.

Figure 8-33. A12 Range Resistor Board Troubleshooting Tree.

A12 BOARD CIRCUIT DESCRIPTION.

Table A below shows the relationship of selected range resistors to 4262A FUNCTION, CIRCUIT MODE and RANGE settings. Range selector switches (active switches) Q3 through Q10 and associated switches Q1, Q2, Q11 and K1 (relay) are controlled to select the range resistance which will provide an appropriate full scale range (see table with circuit schematic). Two switches concurrently act to enable detection of an exact voltage drop across the range resistor regardless of the resistance of the range selection switch through which the range resistor current flows. For example, both Q3 and Q4 turn on to sense the voltage drop and to simultaneously route the DUT current flow through range resistor R4 (10 Ω). R4 and Q4 compose a feedback loop in the Range Resistor amplifier on the selected range. The exact voltage drop across R4 is routed through Switch Q3 (K1: ON, Q11: OFF). The selectable 10 Ω , 100 Ω , 1k Ω and 10k Ω range resistances are always placed in parallel with the permanent 100k Ω range resistance (R9 plus R10). The 100k Ω range resistance alone is selected by causing Q11 to turn on, K1 to deenergize, and its contacts to open. The open contacts of K1 also interrupt the error current flowing through the stray capacitance in the range resistor circuit. This eliminates any error current effect on the circuit being used (R9, R10 and C3) on this range. In addition, to further reduce the error current, Q1 and Q2 conduct the current flowing through the stray capacitance of the relay contacts to ground.

Table A. Range Resistor (R_R) and Source Resistor (R_o) Selections.

Function		Range	1	2	3	4	5	6	7	8	
L	Full-scale	120Hz	1000 μ H	10.00mH	100.0mH	1000mH	10.00H	100.0H	1000H		
		1kHz	100.0 μ H	1000 μ H	10.00mH	100.0mH	1000mH	10.00H	100.0H		
		10kHz	10.00 μ H	100.0 μ H	1000 μ H	10.00mH	100.0mH	1000mH	10.00H		
	R _R , R _o	SER	10 Ω	100 Ω	1k Ω	10k Ω	100k Ω				
		PARA				10 Ω	100 Ω	1k Ω	10k Ω		
C	Full-scale	120Hz	1000pF	10.00nF	100.0nF	1000nF	10.00 μ F	100.0 μ F	1000 μ F	10.00mF	
		1kHz	100.0pF	1000pF	10.00nF	100.0nF	1000nF	10.00 μ F	100.0 μ F	1000 μ F	
		10kHz	10.00pF	100.0pF	1000pF	10.00nF	100.0nF	1000nF	10.00 μ F	100.0 μ F	
	R _R , R _o	PARA	100k Ω	10k Ω	1k Ω	100 Ω	10 Ω				
		SER				100k Ω	10k Ω	1k Ω	100 Ω	10 Ω	
R	Full-scale	120/ 1kHz/ 10kHz	1000m Ω	10.00 Ω	100.0 Ω	1000 Ω	10.00k Ω	100.0k Ω	1000k Ω	10.00M Ω	
	R _R , R _o	SER	10 Ω	100 Ω	1k Ω	10k Ω	100k Ω				
		PARA				10 Ω	100 Ω	1k Ω	10k Ω	100k Ω	

◀ A13 Board Troubleshooting Tree
Under Fold

◀ **A12** Range Resistor
SERVICE SHEET 12
SEE INSIDE

8-51

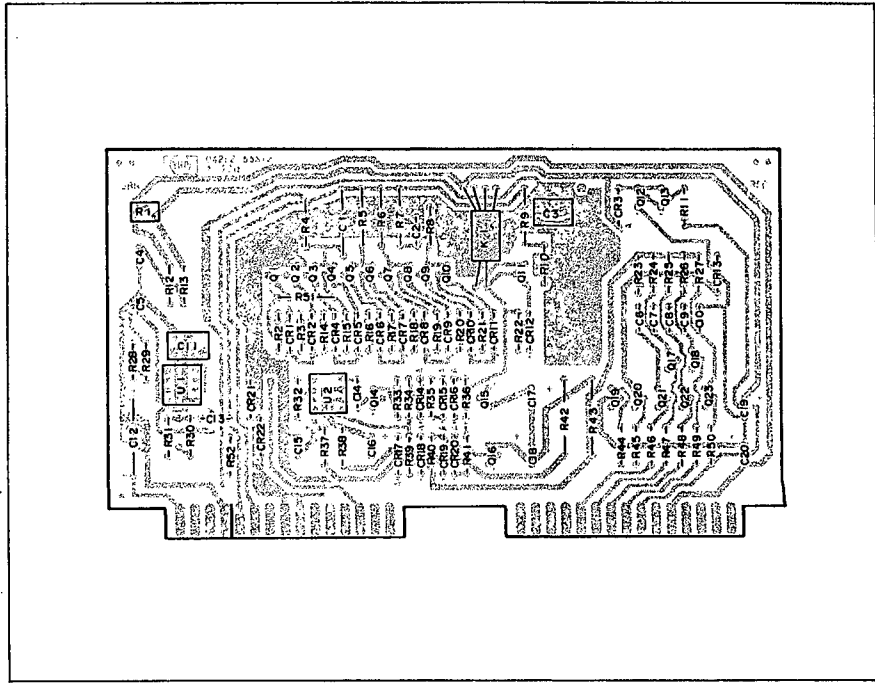

Figure 8-34. A12 Range Resistor Board Assembly Component Locations.

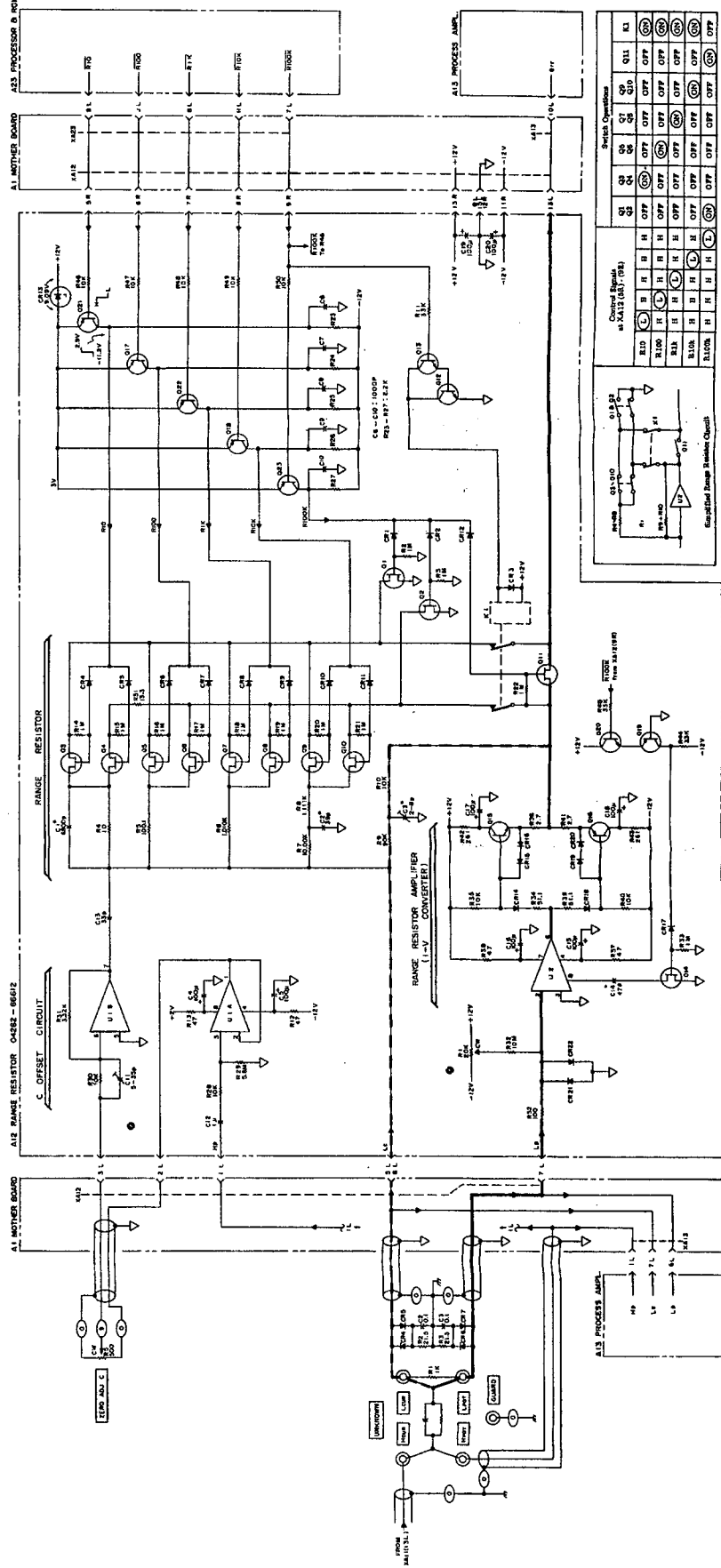

Figure 8-35. A12 Range Resistor Board Assembly Schematic Diagram.

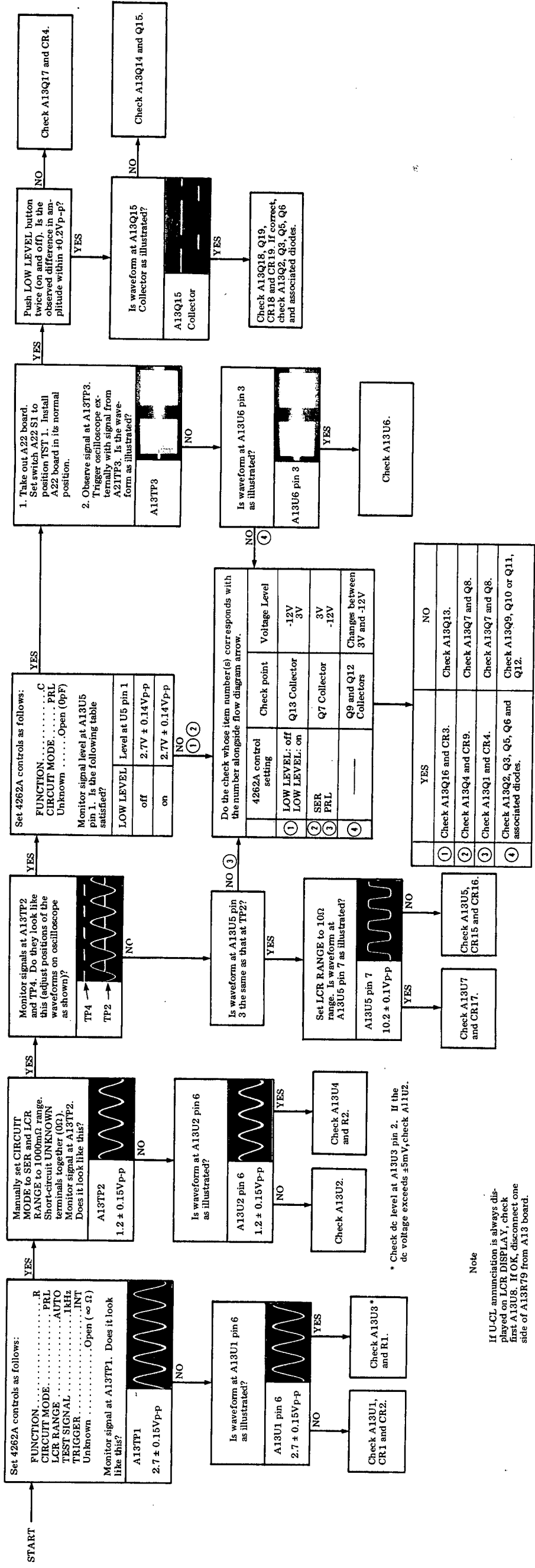

Figure 8-36. A13 Process Amplifier Board Troubleshooting Tree.

A13 BOARD CIRCUIT DESCRIPTION.

The input circuitry of the A13 board is composed of impedance converters and differential amplifiers which sense the exact voltage drops across the DUT (E1) and across range resistor (E2). The choice of the e_{ref} and e_m signals by Q1 through Q6 depends upon the FUNCTION and CIRCUIT MODE settings. Switches Q1 and Q4 select the phase detector phase references (e_{ref}) from either e_x or e_y (representing E1 and E2, respectively) differential amplifier outputs as directed by the CMS (Circuit Mode Selection) signal. Switches Q2, Q3, Q5 and Q6 sequentially select the e_m signal (as components of the measured quantity) from among the e_x , $e_x/10$, e_y and $e_y/10$ signals. The method of the selection, relative to the measurement mode, is graphically illustrated in Figure 8-8 Timing Diagram. When the TEST SIGNAL function is set to LOW LEVEL, both Q16 and Q17 turn on. To maintain the amplitudes of e_{ref} and e_m signals the same as in taking a measurement with a standard test signal level, the amplification factors of amplifiers U5A and U6B are now increased by 20 times. If the amplitude of U6B output (e_m) exceeds $\pm 5.2V$ peak, the window comparator U8 outputs a SAT (saturation) pulse which signals that an improper FUNCTION or RANGE setting is being attempted for measuring the unknown device. Switches Q18 and Q19 operate during the integrator null offset sequence (refer to Page 8-56 for the null offset control details). An APAO (Auto Phase Adjustment

Output) signal, added to the e_{ref} signal at the input stage of the Phase Shifter U5B causes a change in the phase of the e_{ref} signal. This phase change on the APAO voltage is determined by a comparison of the phase shifter output to the zero level. Circuit operating theory of the Phase Shifter is given in the following paragraph.

AUTO PHASE ADJUSTMENT (Phase Control).

This paragraph should be read along with the general description of the auto phase adjustment (on service sheet 14). A DC input (APAO) to the Phase Shifter is added to the ac input signal (e_{ref}) for the purpose of shifting the ac waveform upwards or downwards depending on the dc input level (as illustrated in Figure A). Additionally, the phase shifter reverses polarity of the signal. The phase shifter output is wave-shaped to a square wave which changes its polarity every time that the phase shifter output waveform crosses the zero level. The waveforms drawn in solid lines in Figure A are those that exist when 0V dc input (APAO) is applied. Waveforms in dotted lines are those that are present when a plus dc input (APAO) is applied. When an ac signal with a certain dc (APAO) level is inputted, the duty factor of the e_{ref} signal is shifted (narrowed or widened) as the phase shifter output is wave-shaped with respect to a fixed (0V) reference. Therefore, the phase of the PLL output used for phase detection will vary since the PLL circuit detects only the trailing edge of an e_{ref} signal.

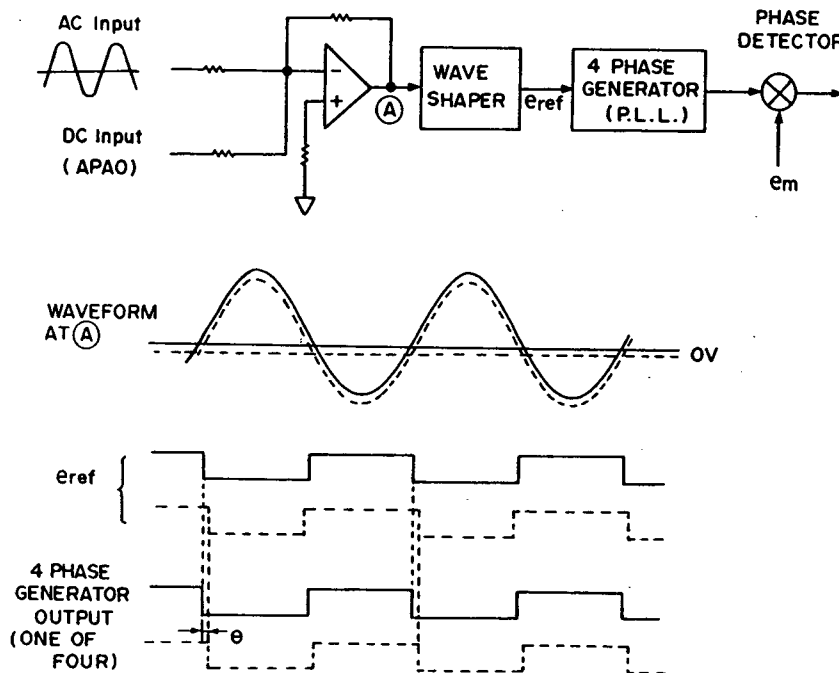

Figure A. Phase Control.

◀ A14 Board Troubleshooting Tree
Under Fold

◀ **A13** Process Amplifier
SERVICE SHEET 13
SEE INSIDE

8-53

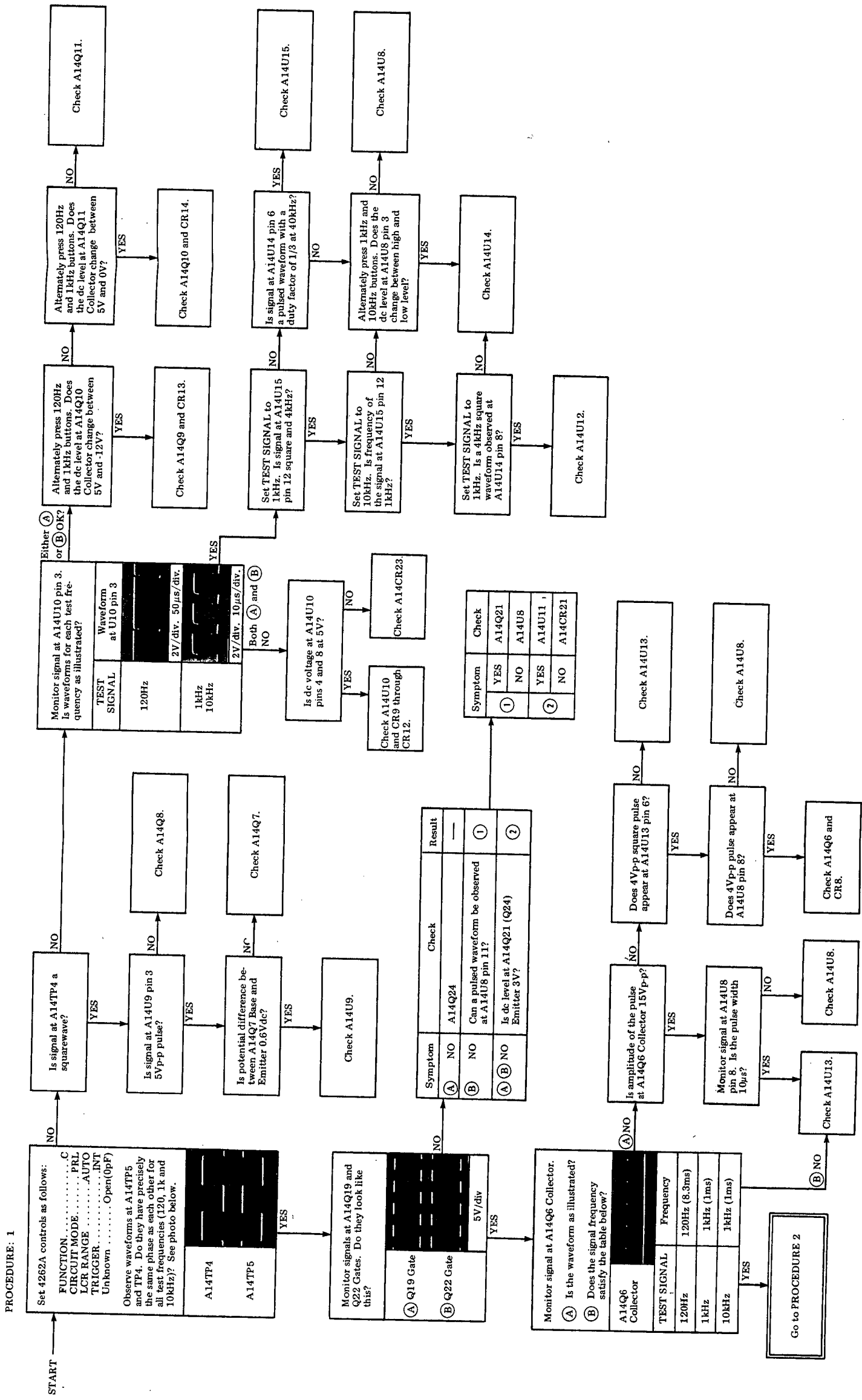

Figure 8-39. A14 Phase Detector & Integrator Board Troubleshooting Tree (A).

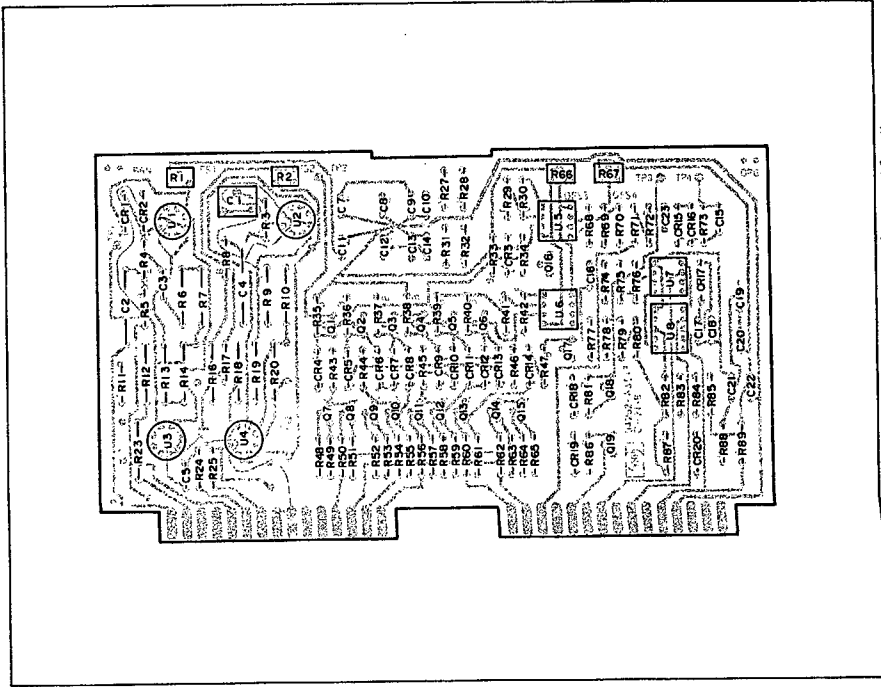

Figure 8-37. A13 Process Amplifier Board Assembly Component Locations.

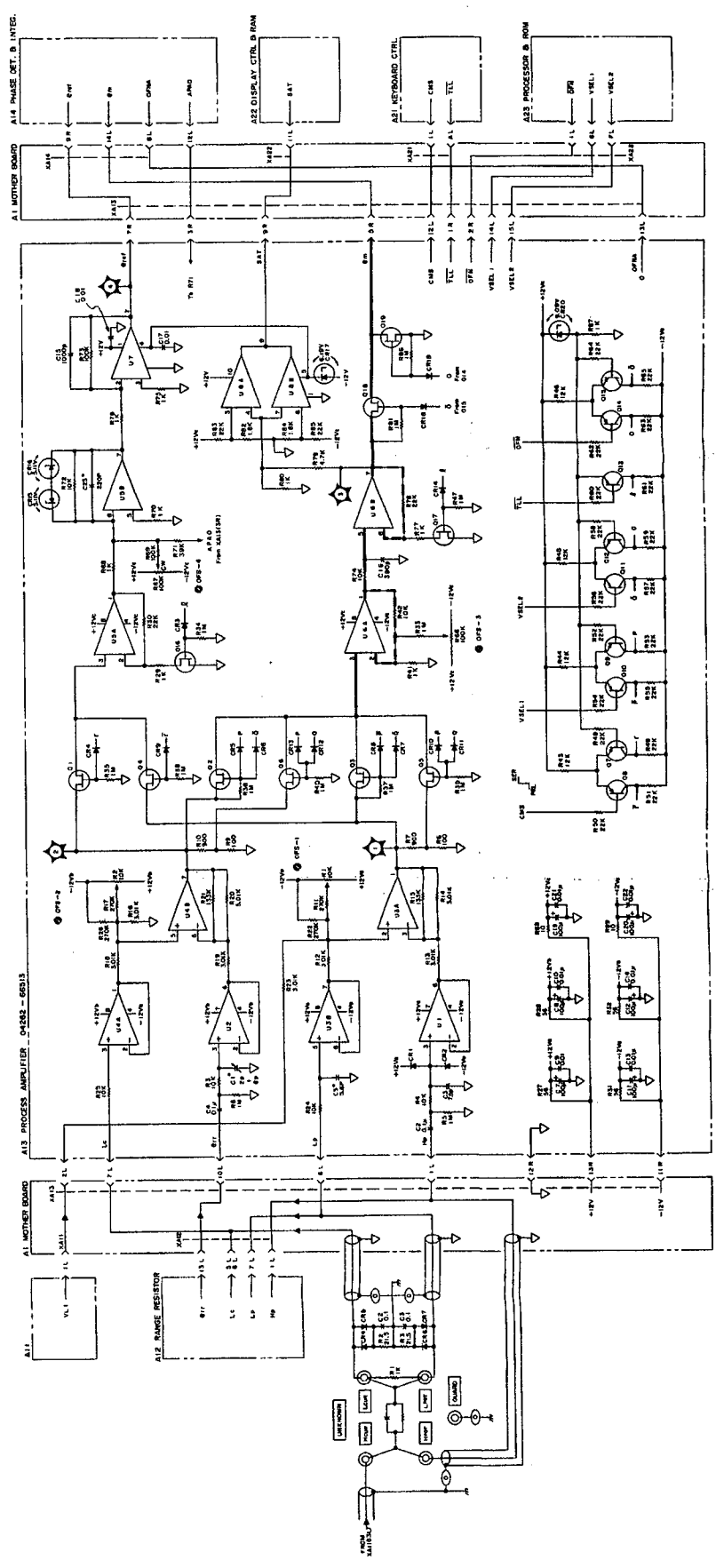

Figure 8-38. A13 Process Amplifier Board Assembly Schematic Diagram.

A14 BOARD CIRCUIT DESCRIPTION.

AUTO PHASE ADJUSTMENT.

By using a feedback control technique in the Auto Phase Adjustment period, the phase of the Phase Locked Loop circuit is automatically adjusted to minimize detection phase error. This paragraph describes how the phase error is eliminated during APA (Auto Phase Adjustment) cycle periods 1 and 2. The basics of the auto phase adjustment circuit are diagrammed in Figure A. In the APA 2 period, the same signal is applied to both the phase detector and the phase shifter. The four phase generator outputs a 90 degree phase shifted pulse. Assuming that the detection phase is accurate, the average level of the phase detector output should necessarily be zero. If any phase error exists between the e_m and e_{ref} signal channels, the phase detector outputs an E_1 signal which is the integrator output for such error signal. Because SW3 is open, the period averaging circuit functions as an ordinary integrator. APA amplifier (A14U5A and U6) which follow develop an APAO signal (dc) proportional to E_1 and supply it to the phase shifter. In response to the APAO voltage, the phase shifter output tends to lower the E_1 level. The phase error of detection phase is thus minimized (refer to phase shifter circuit description on service sheet 13). The APA2 cycle is performed by LOOP 2 (SW1: OFF, SW2: ON, SW3: OFF) as denoted in the diagram. After the APA2 period, SW3 is closed and SW2 is turned off to memorize the dc voltage stored in capacitor C. The memory capacitor C maintains the dc voltage to continuously provide an effective APAO signal during the measurement cycle. In the APA1 (Auto Phase Adjustment cycle 1) period which is done prior to APA2, SW1 is closed and the current flow through the LOOP 1 charges the capacitors in the period averaging circuit. APA1 control is provided to accelerate development of an appropriate APAO signal during the APA2 period and helps to reduce the time of the auto phase adjustment cycle.

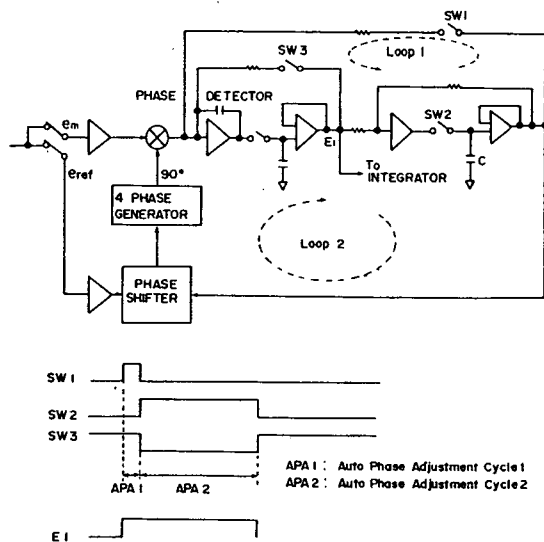

Figure A. Auto Phase Adjustment.

A14 BOARD CIRCUIT DESCRIPTION.

PERIOD AVERAGING CIRCUIT.

A period averaging technique was adopted to get pure dc voltage at high speed from a rectified ac signal having a large ripple component. Generally, a filtering circuit has a long transient response time in converting a low frequency burst input signal to a pure dc voltage. The period averaging technique enables a dc output voltage to be produced which is almost equal, (in a precise fashion) to the final value in only several periods of the input ac signal. The 4262A employs the period averaging circuit for smoothing the phase detector output to a dc and for combining specified measurement accuracies and provides an improved measurement speed at the 120Hz test frequency. Figure B shows the full-wave rectified current input signal of this circuit. During the first T (time) period, the input current charges the integrator capacitor C1 (A14C8 in the actual circuit. In a 120Hz measurement, Q18 conducts to add C7 in parallel with C8). At the end of this period, the integrator output E1 is proportional to the dc current of the input signal (since T is equal to one period of the input ac signal). After the first T period, voltage E1 is memorized as a charge on C2 (A14C6) when switch SW (A14Q5) is momentarily closed, and E0 (period averaging circuit output) becomes a step function. As the feedback current (IF) from E0 to the integrator input is designed to be almost equal to I_{DC} (input current to the period averaging circuit) in magnitude, the difference between I_{DC} and IF is integrated during the next (T) integrating period so that output voltage E0 becomes exactly proportional to I_{DC} . After four or five periods, E0 will be a pure dc signal having no ac component and be precisely proportional to (I_{DC}) the input current.

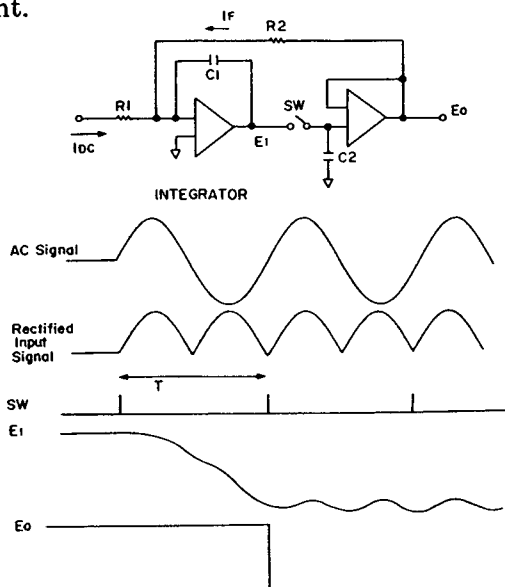

Figure B. Period Averaging Circuit.

A14 BOARD CIRCUIT DESCRIPTION.

PHASE LOCKED LOOP (PLL) CIRCUIT
AND 4 PHASE GENERATOR.

Figure C shows the block diagram of the phase locked loop circuit used to establish an accurate detection phase in the phase detector. The PLL technique was incorporated to develop an input to the Four Phase Generator which satisfies the requirements of phase and frequency accuracies for establishing the exact relationships between the four phase generator output and the measurement signal. When the PLL control is off, the VCO oscillates at a frequency close to 40 times the frequency of the input signal (e_{ref}) to the Phase Shifter. In the 120Hz measurement setting, the frequency of VCO output becomes 4.8kHz. A 1/10 down counter U15 and the Four Phase Generator U12 (a 1/4 down counter) count down the VCO output frequency to 120Hz. This becomes the frequency of the feedback signal e_f to the local phase detector (LPD) U9. The output voltage of the LPD (converted to a dc by Low Pass Filter Q7 and Q8) directs the oscillation of VCO so that the difference in both frequency and phase between the two input signals (e_{ref} and e_f) to the LPD tends to become minimum. Eventually, both the phase and frequency of the four phase generator output (one of four) is precisely the same as that of the e_{ref} signal (120Hz). In a 1kHz measurement frequency setting, switch Q9 is turned off to change the oscillation frequency of the VCO to 40kHz. In a manner similar to that for the 120Hz measurement, the four phase generator output is fixed to the exact frequency of e_{ref} signal (1kHz). When measurement frequency is switched to 10kHz, the 40kHz VCO output passes through the gate circuitry (U14) and bypasses the 1/10 down counter. Thus, the frequency of the feedback signal e_f

becomes 10kHz. The frequency of the four phase generator input is always four times the e_{ref} signal frequency. The $4f$ pulse train is converted to four square wave signals, each having an exact phase difference of 0° , 90° , 180° and 270° with respect to the negative edge of the e_{ref} signal. The U13 Gate circuitry periodically creates a short pulse which drives sampling switch (Q5) of the period averaging circuit in synchronism with the measurement signal. In a 10kHz measurement, the four phase generator output is fed to the 1/10 down counter whose output is inputted to gate circuitry U13. The U13 output is a 1msec (1kHz) pulse train which drives the sampling switch Q5 at a rate of once in 20 periods of the period averaging circuit input (phase detector output) signal. The periodic rate is sufficient for period averaging of the high frequency input signal.

INTEGRATOR NULL OFFSET CONTROL.

During the offset null sequence period, the Amplifier output offset voltages present in the phase detector and the integrator stages are reduced to zero at the integrator output. While the offset null is being performed, switches A13Q18 and Q19 interrupt e_m signal transfer to the Phase Detector. Simultaneously, A14Q1 and Q2 turn on. Q2 provides the integrator with a lower input resistance and advances charging to achieve a shorter null offset control period. The Integrator produces a dc output which represents the accumulated charge of the offset voltages. The integrator output is stored in capacitor C1 to maintain its voltage during the measurement cycle. Any incoming voltage to the integrator is referenced to the voltage across the charged capacitor. Thus, any offset voltages present are eliminated and are not a factor in the integrator output.

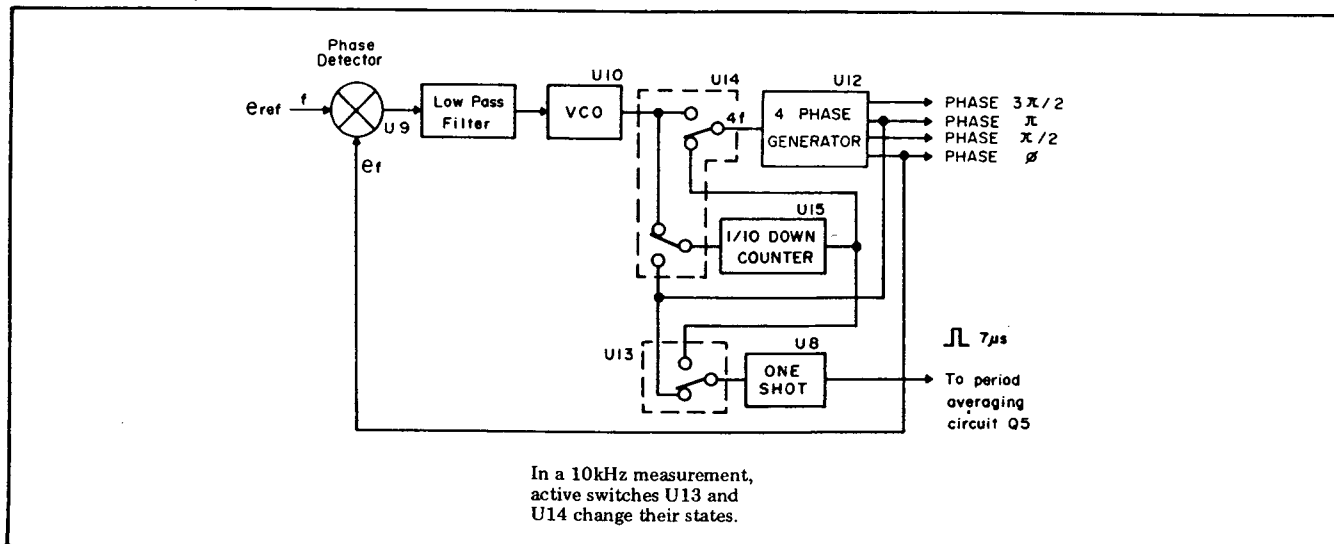

Figure C. Phase Locked Loop Circuit Block Diagram.

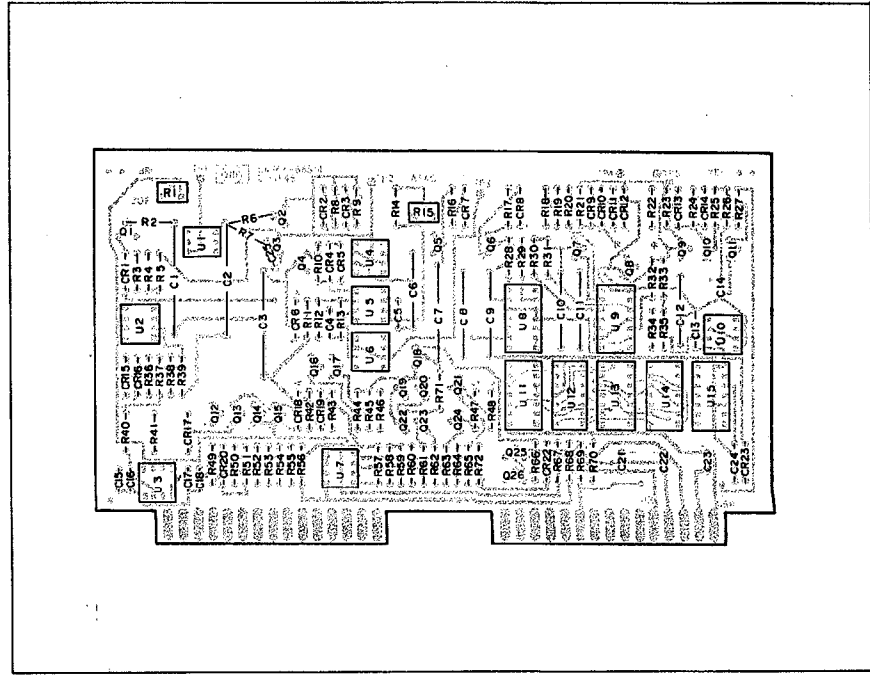

Figure 8-41. A14 Phase Detector & Integrator Board Assembly Component Locations.

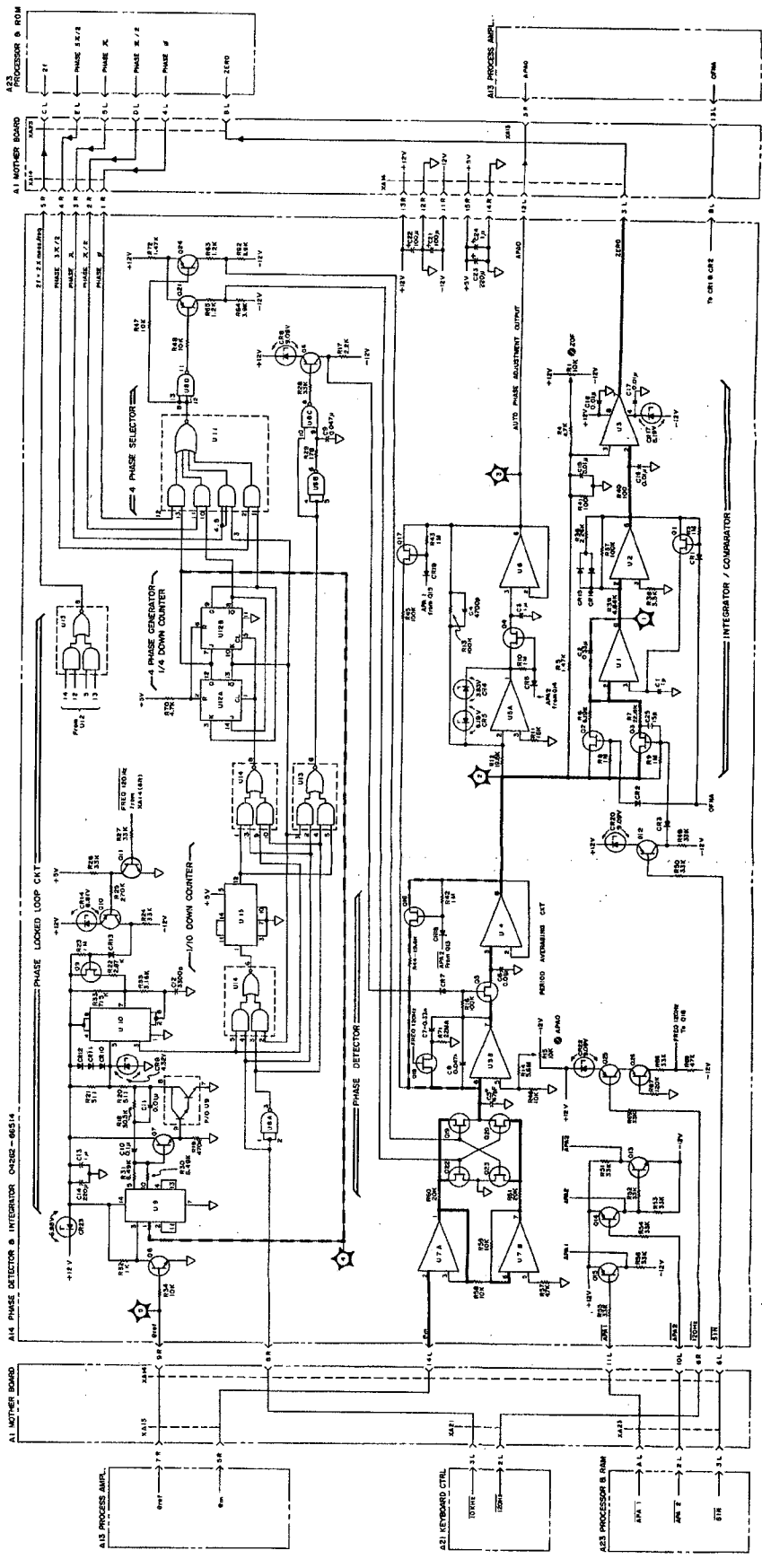

Figure 8-42. A14 Phase Detector & Integrator Board Assembly Schematic Diagram.

A21 Keyboard Control
SERVICE SHEET 21

SEE INSIDE

8-59

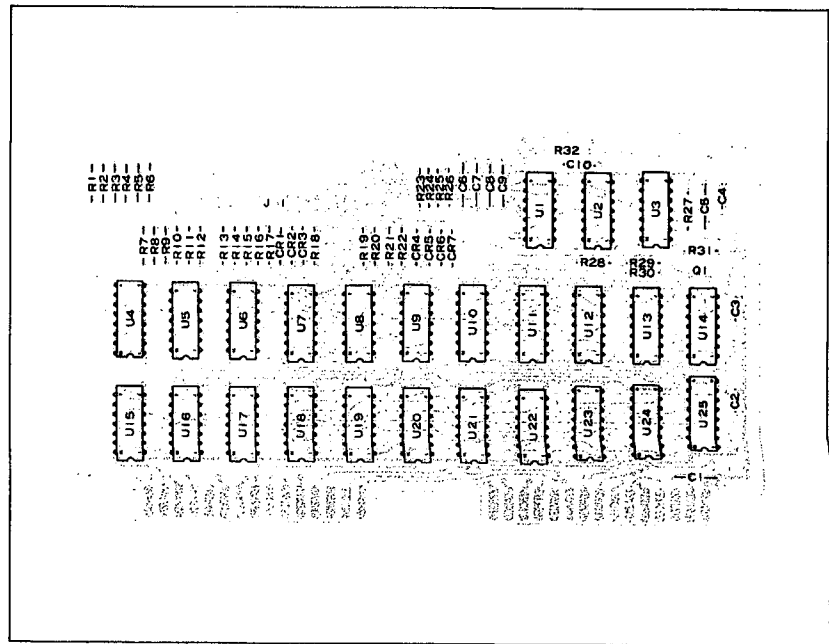

Figure 8-43. A21 Keyboard Control Board Assembly Component Locations.

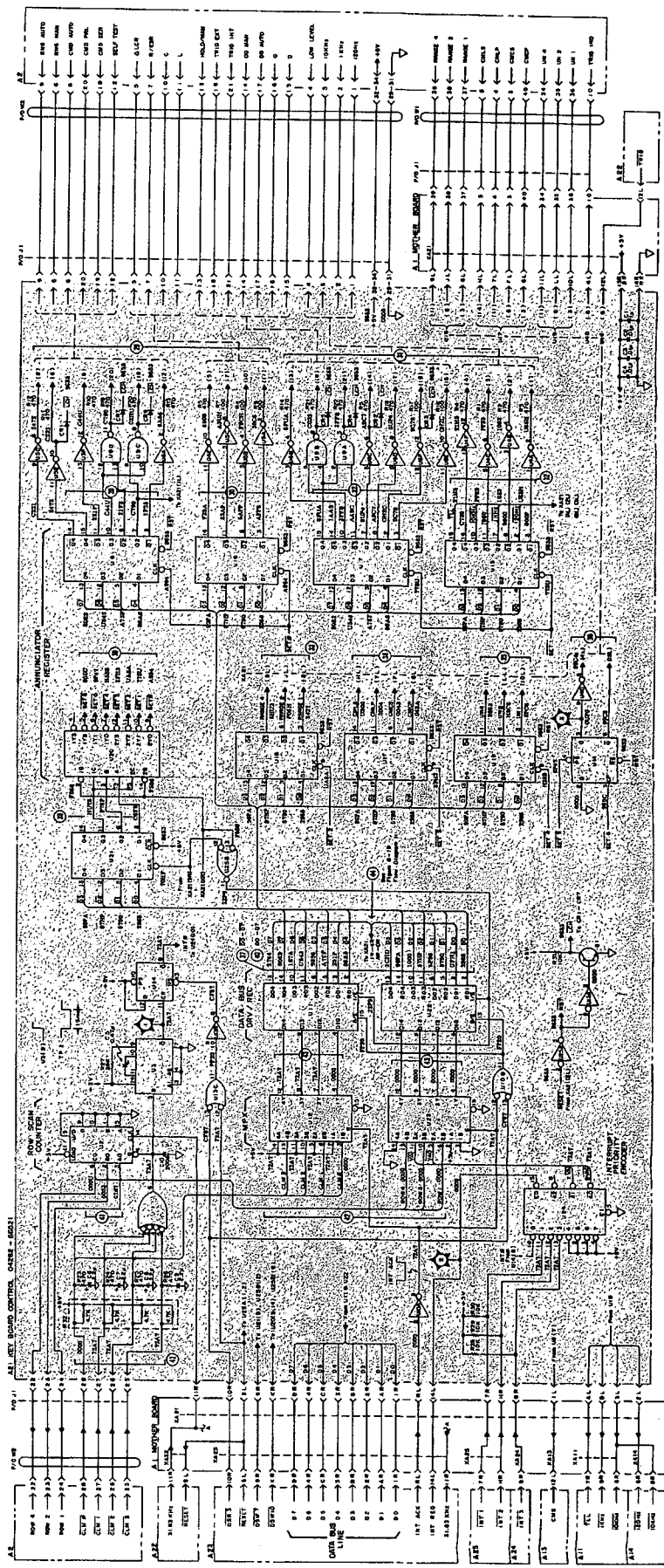
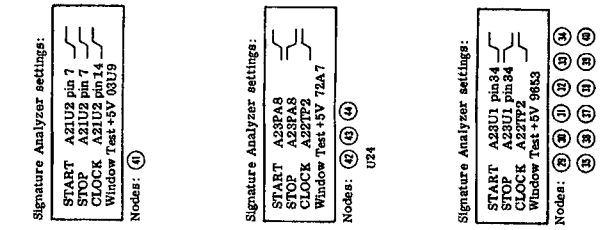

Figure 8-44. A21 Keyboard Control Board Assembly Schematic Diagram.

0

C

C

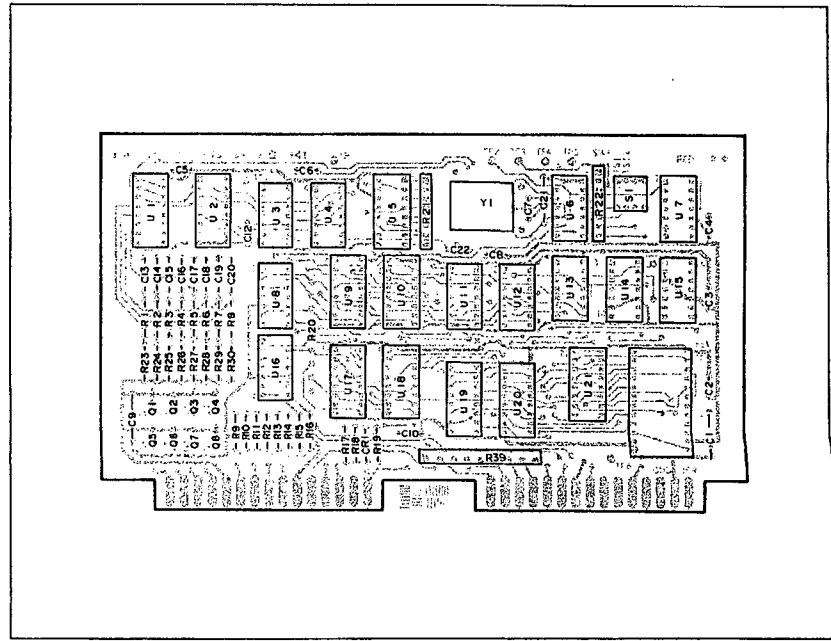

Figure 8-45. A22 Display Control & RAM Board Assembly Component Locations.

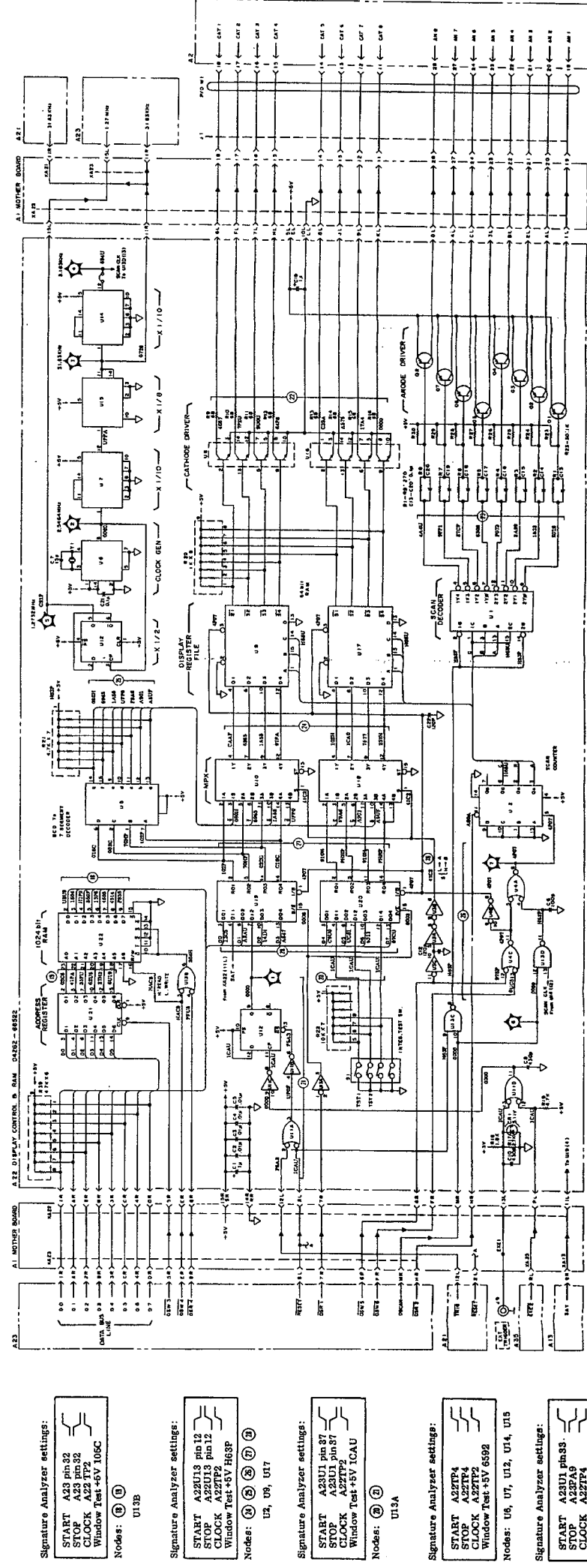

Figure 8-46. A22 Display Control & RAM Board Assembly Schematic Diagram.

- | | | | | |
|---|---|--|---|---|
| <p>Signature Analyzer settings:</p> <p>START A23 pin32
 STOP A23 pin32
 CLOCK A23 TP2
 Window Test +5V I06C</p> <p>Nodes: (B) (E)
 U13B</p> | <p>Signature Analyzer settings:</p> <p>START A23U13 pin12
 STOP A23U13 pin12
 CLOCK A22TP2
 Window Test +5V H6SP</p> <p>Nodes: (A) (C) (D) (F)
 U7, U9, U17</p> | <p>Signature Analyzer settings:</p> <p>START A23U1 pin37
 STOP A23U1 pin37
 CLOCK A22TP2
 Window Test +5V ICAU</p> <p>Nodes: (B) (D)
 U13A</p> | <p>Signature Analyzer settings:</p> <p>START A22TP4
 STOP A22TP4
 CLOCK A23 TP2
 Window Test +5V 6592</p> <p>Nodes: U6, U7, U12, U14, U15</p> | <p>Signature Analyzer settings:</p> <p>START A23U1 pin33
 STOP A23PA9
 CLOCK A22TP4
 Window Test +5V U9H5</p> <p>Nodes: (C) (D)</p> |
|---|---|--|---|---|

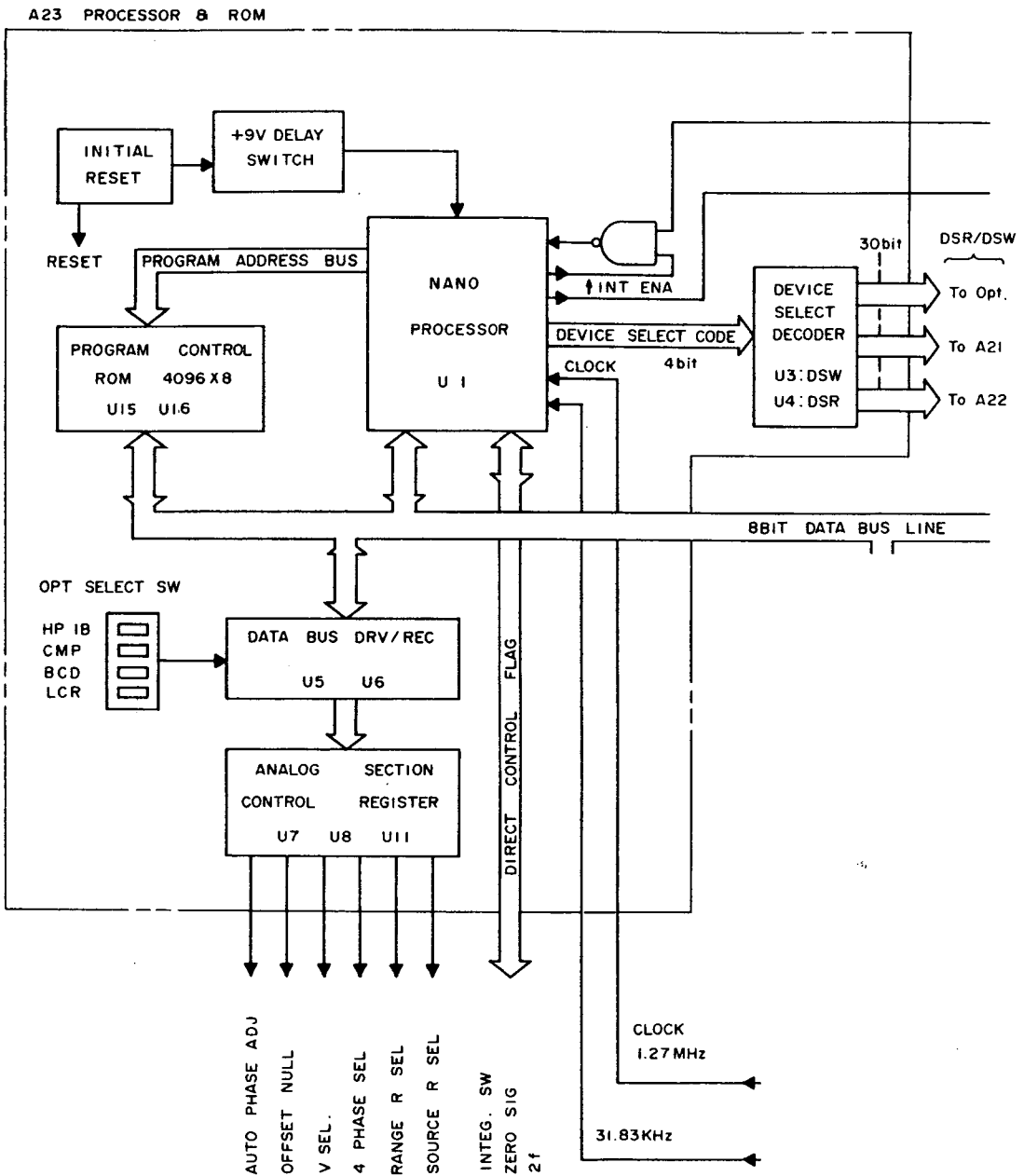

Figure A. A23 Processor & ROM Block Diagram.

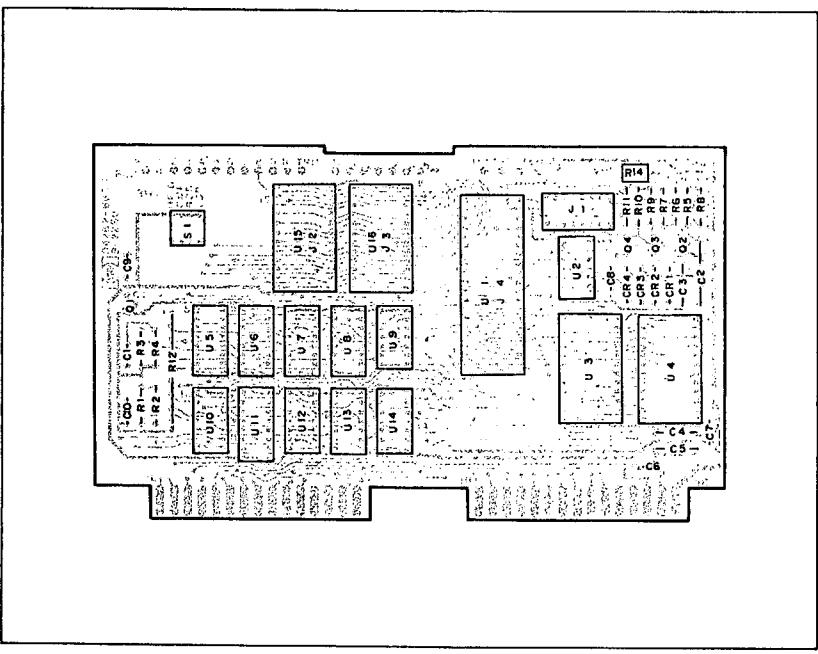

Figure 8-47. A23 Processor & ROM Board Assembly Component Locations.

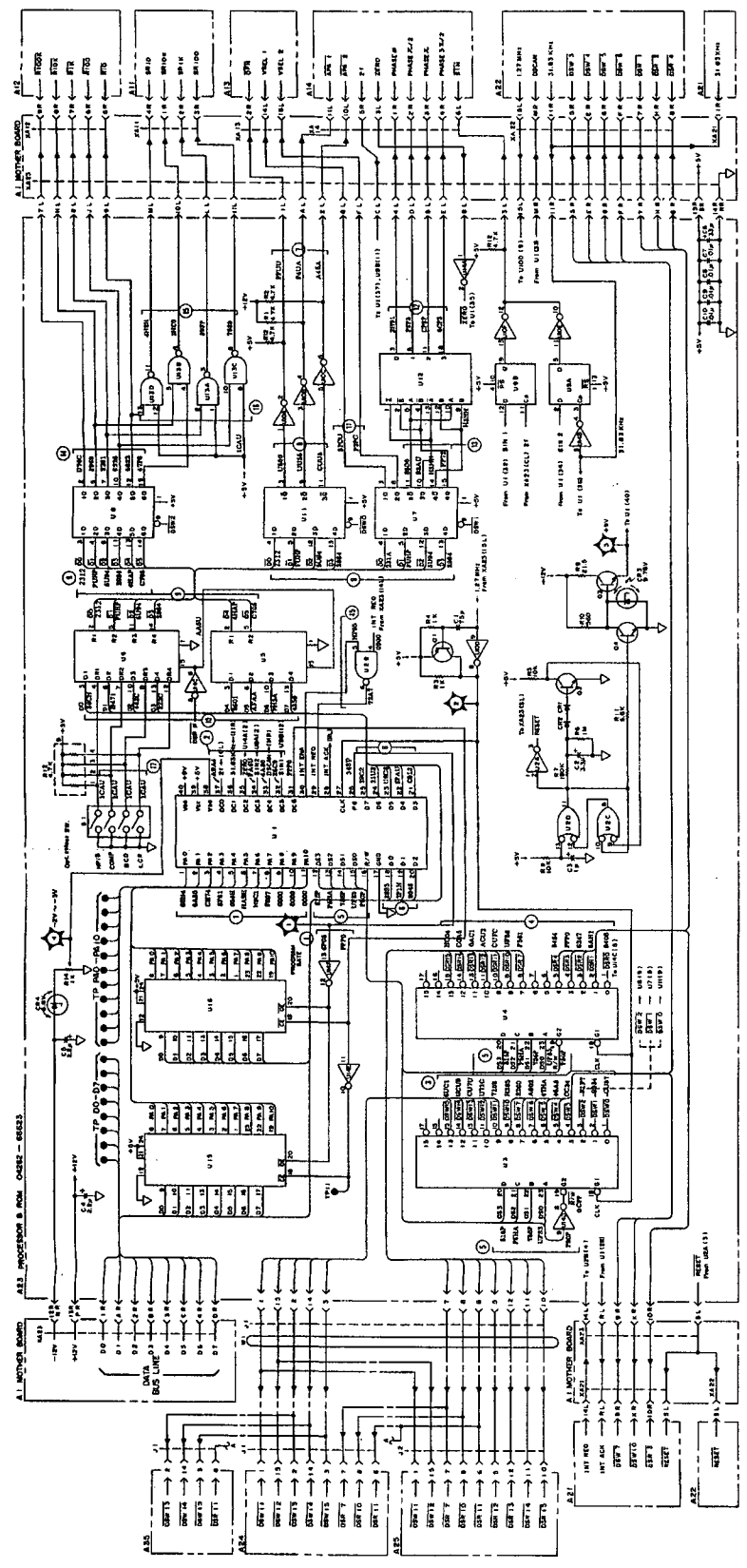

Figure 8-48. A23 Processor & ROM Board Assembly Schematic Diagram.

Signature Analyzer settings:

- START A23PA9
- STOP A23PA9
- CLOCK A23TP2
- Window Test +5V PPO

Nodes: (1) (2) (3) (4) (5)

Signature Analyzer settings:

- START A23PA8
- STOP A23PA8
- CLOCK A23TP2
- Window Test +5V 72A7

Nodes: (6)

Signature Analyzer settings:

- START A23PA6
- STOP A23PA6
- CLOCK A23TP2
- Window Test +5V 5CAU

Nodes: (7)

Signature Analyzer settings:

- START A23U1 pin87
- STOP A23U1 pin87
- CLOCK A23TP2
- Window Test +5V 1CAU

Nodes: (8) (9) (10) (11) (12) (13) (14) (15) (16) (17)

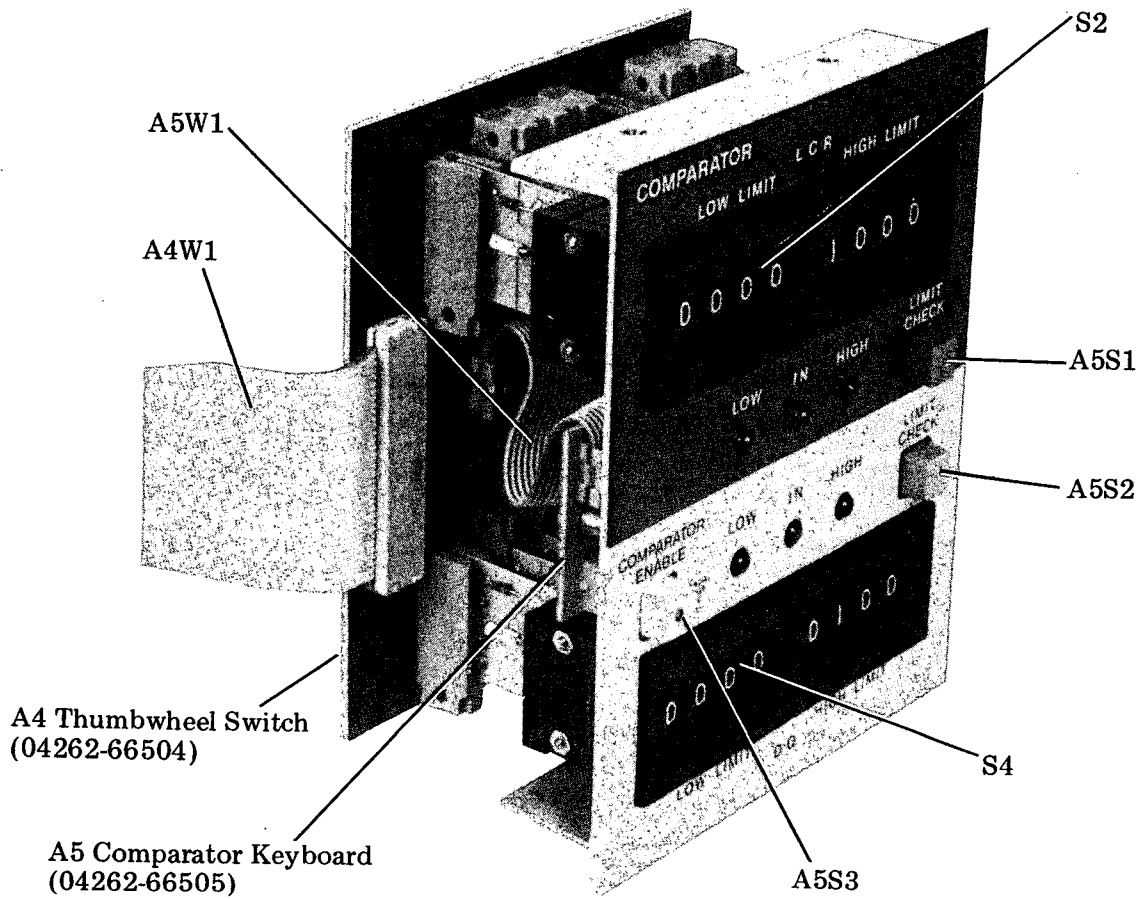
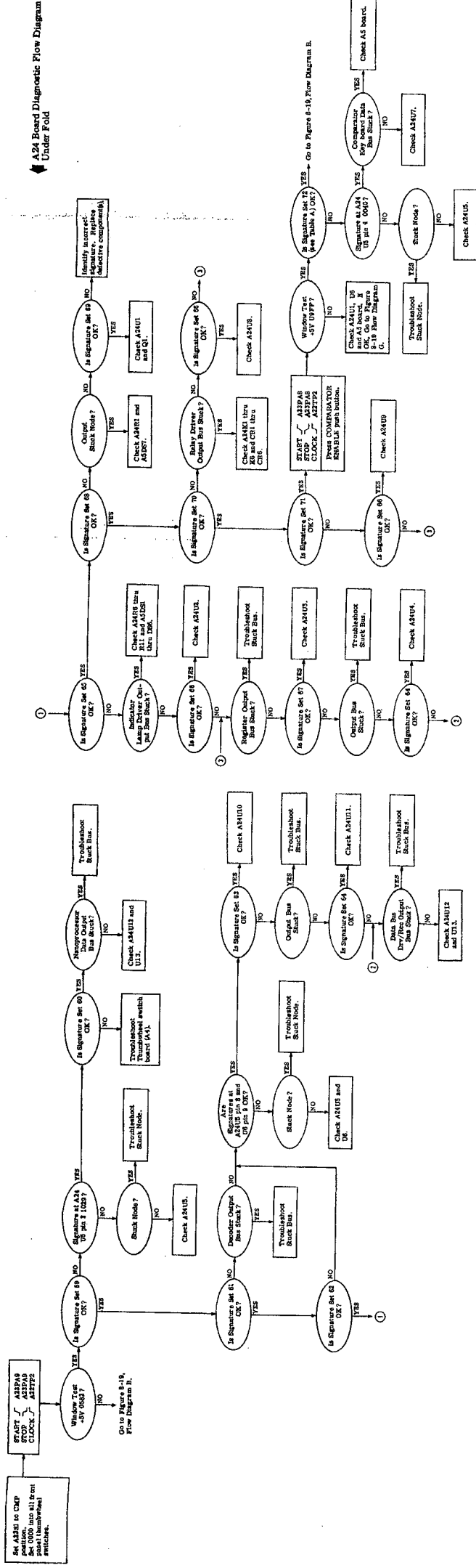

Figure A. Comparator Control Panel Assembly Component Locations.

A24 Board Diagnostic Flow Diagram
Under Fold



Thum wheel Switch
A24A, A24B, A24C, A24D, A24E, A24F, A24G, A24H, A24I, A24J, A24K, A24L, A24M, A24N, A24O, A24P, A24Q, A24R, A24S, A24T, A24U, A24V, A24W, A24X, A24Y, A24Z
SEE NEXT

Figure 8-52. A24 Comparator Control Board Diagnostic Flow Diagram.

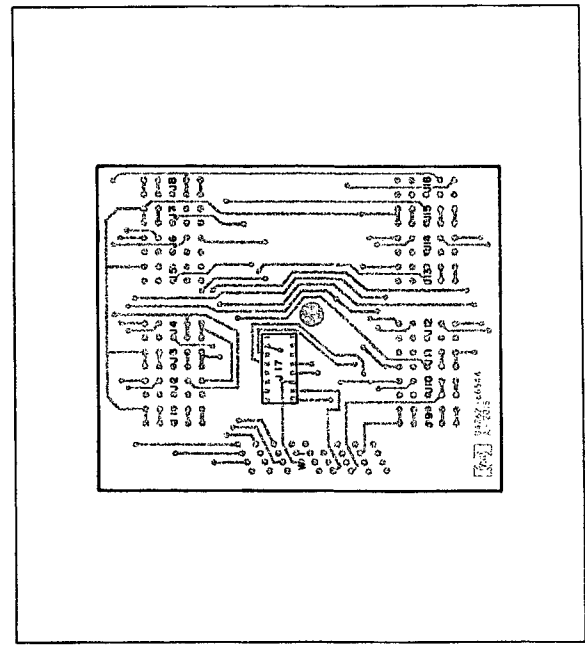

Figure 8-49. A4 Thumbwheel Switch Board Assembly Component Locations.

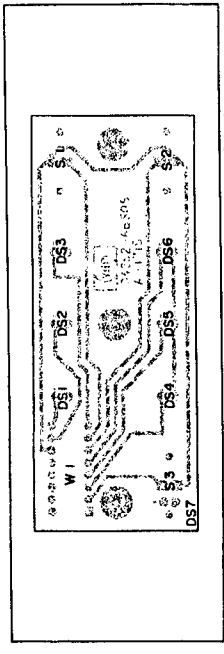

Figure 8-50. A5 Comparator Keyboard Board Assembly Component Locations.

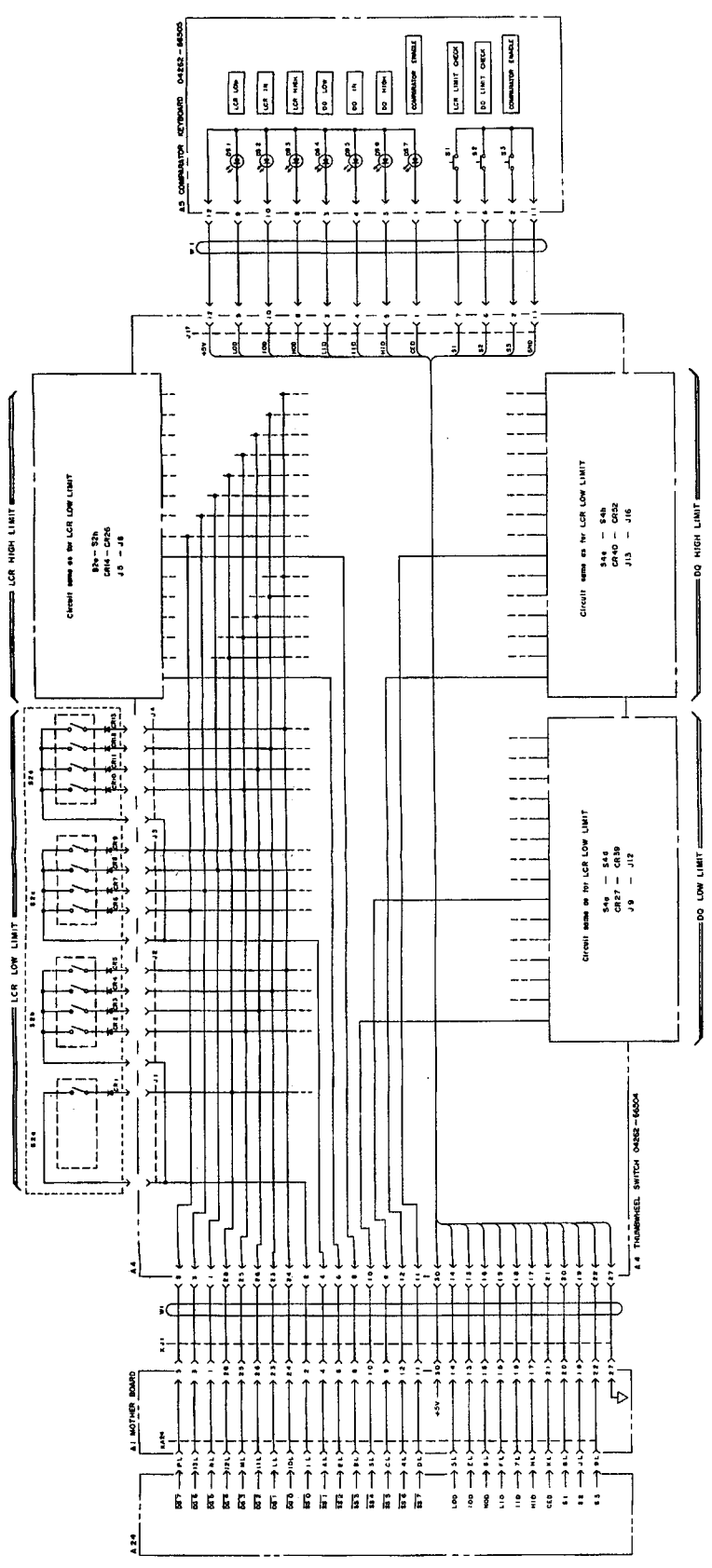

Figure 8-51. A4 Thumbwheel Switch Board and A5 Comparator Keyboard Board Assembly Schematic Diagram.

Table A. Comparator Keyboard Test Signatures.

Keyboard Switch	U7(3) D0	U7(6) D1	U7(10) D2
LCR LIMIT CHK	AF4C	AF08	AF08
DQ LIMIT CHK	AF0C	AF48	AF08
CMP ENA	AF0C	AF08	AF48

Window Test (+5V): U9FF

Note

To observe window test signature, continue pressing COMPARATOR ENABLE button for the duration of the initial window test. Then, press pushbuttons in accord with Table A above. Signatures for each individual circuit node can be observed while the appropriate button is being pushed.

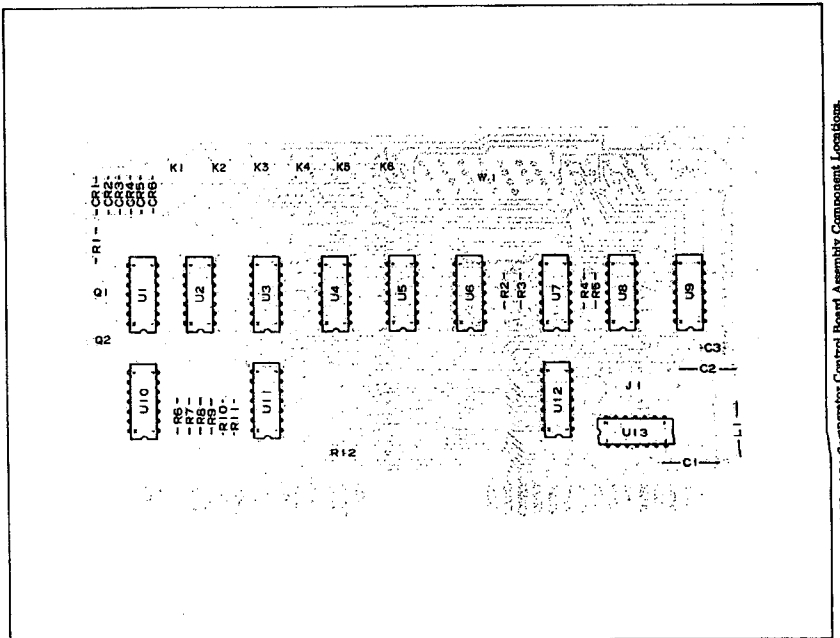

Figure 8-53. A24 Comparator Control Board Assembly Component Location.

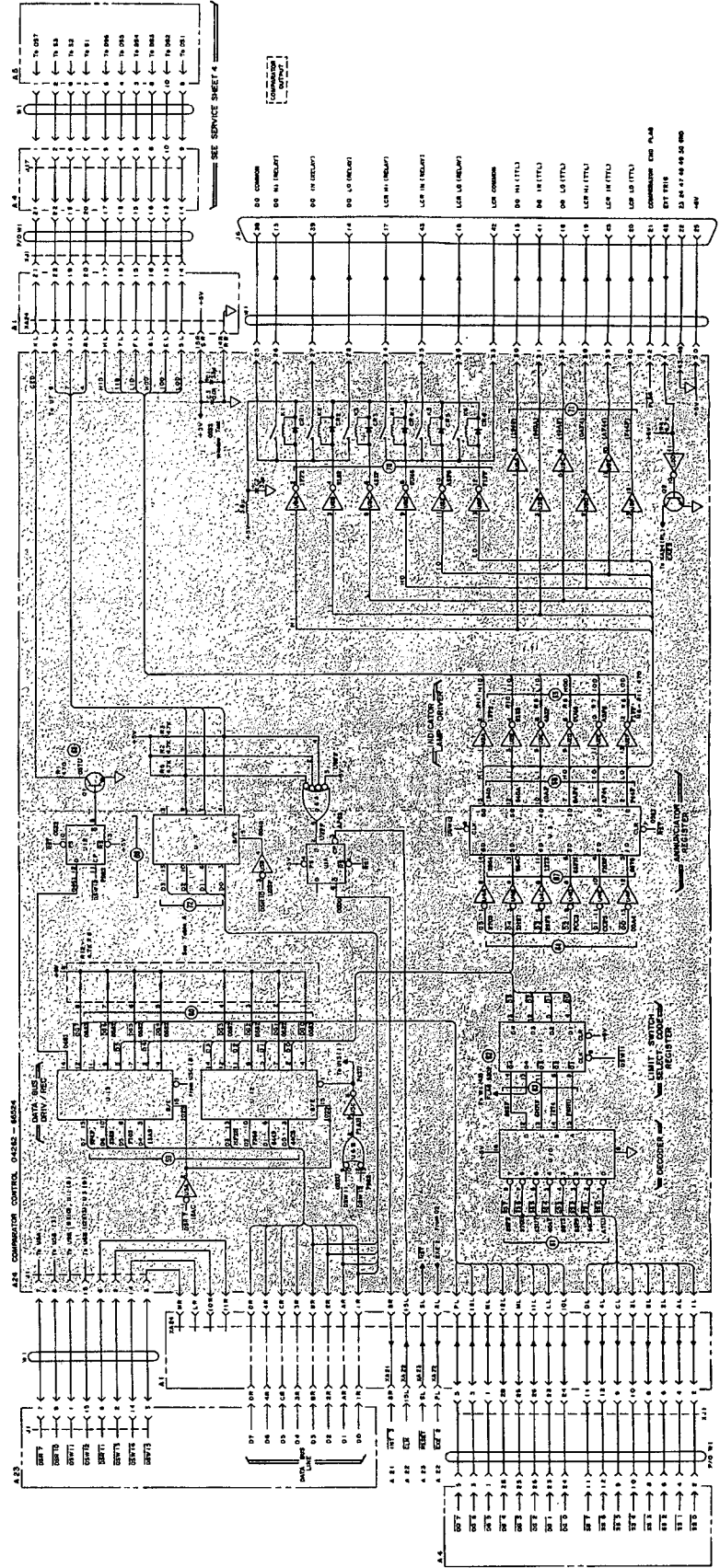

Figure 8-54. A24 Comparator Control Board Assembly Schematic Diagram.

◀ **A35 Board Diagnostic Flow Diagram**
Under Fold

◀ **A25** **HP-IB Interface**
SERVICE SHEET 25
SEE INSIDE

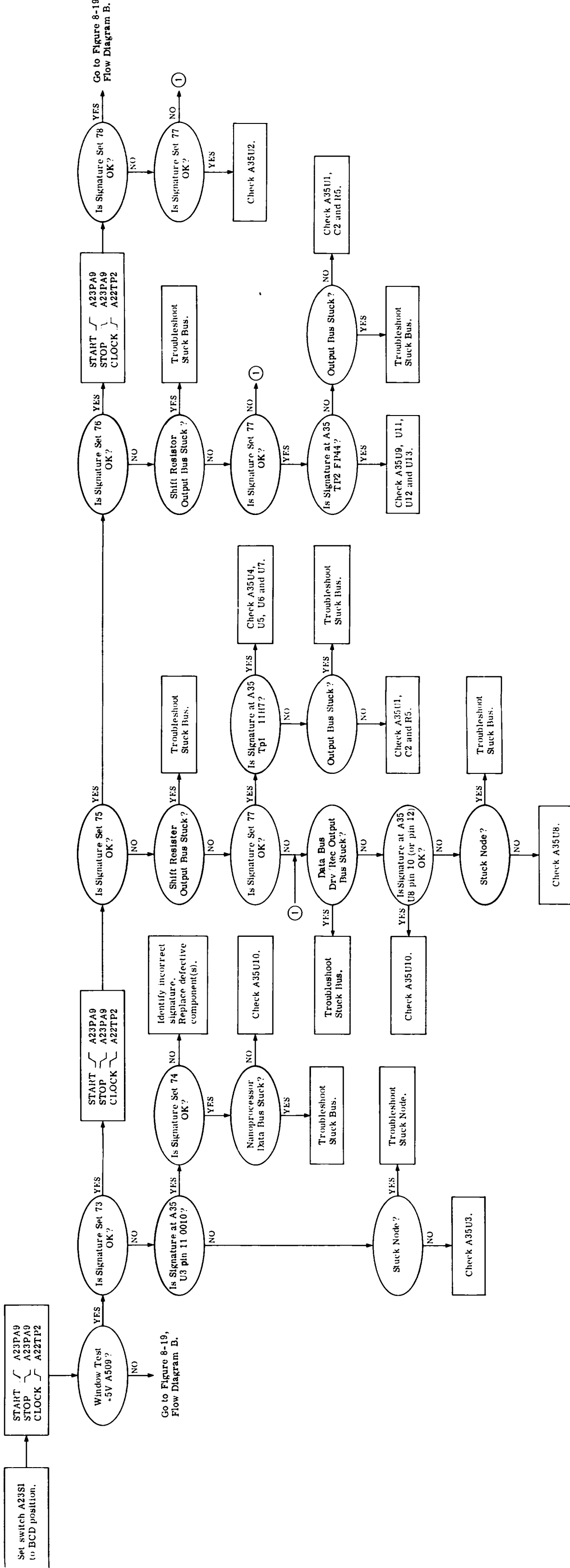

Figure 8-58. A35 BCD Output Control Board Diagnostic Flow Diagram.

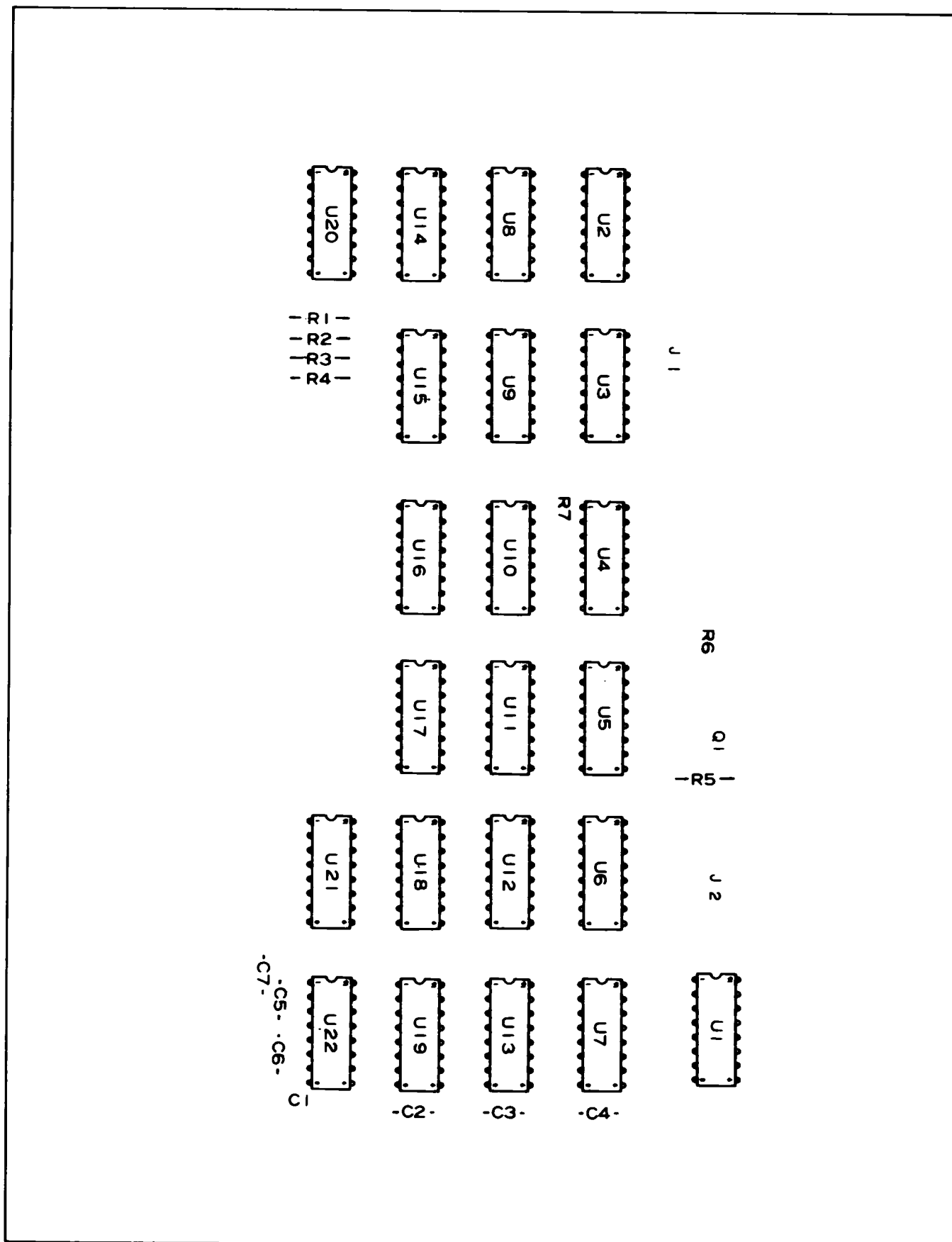



Figure 8-56. A25 HP-IB Interface Board Assembly Component Locations.

Signature Analyzer settings:

START	A23PA8	
STOP	A23PA8	
CLOCK	A22TP2	
Window Test +5V	72A7	

Nodes: U22, U7B, U7D

Signature Analyzer settings:

START	A23PA9	
STOP	A23PA9	
CLOCK	A22TP2	
Window Test +5V	23HC	

Nodes: (46) (47) (48) (49) (50) (51)
(52) (53) (54) (55) (56) (57)
(58)

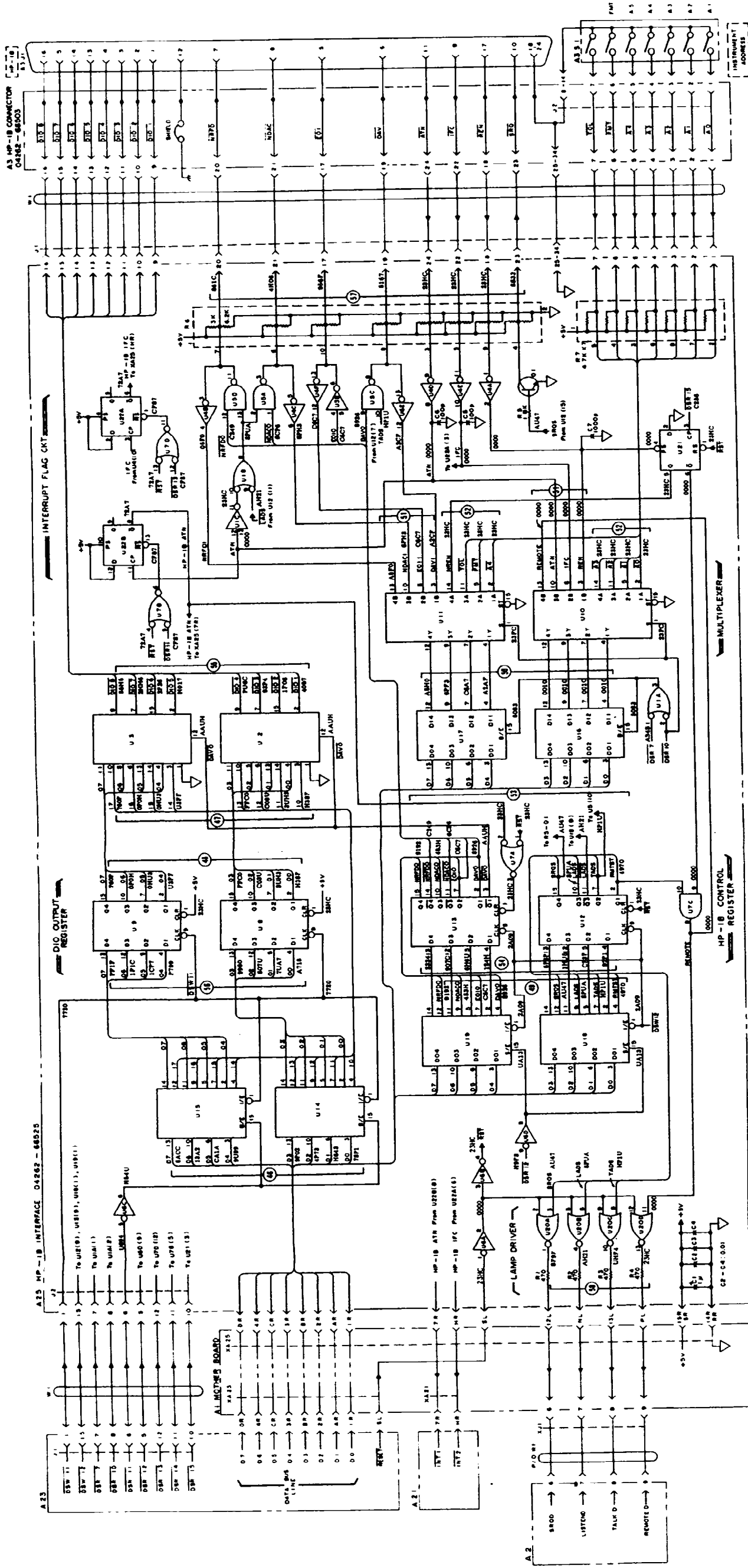

Figure 8-57. A25 HP-IB Interface Board Assembly Schematic Diagram.

←A35 BCD Output Control
SERVICE SHEET 35
SEE INSIDE

8-71

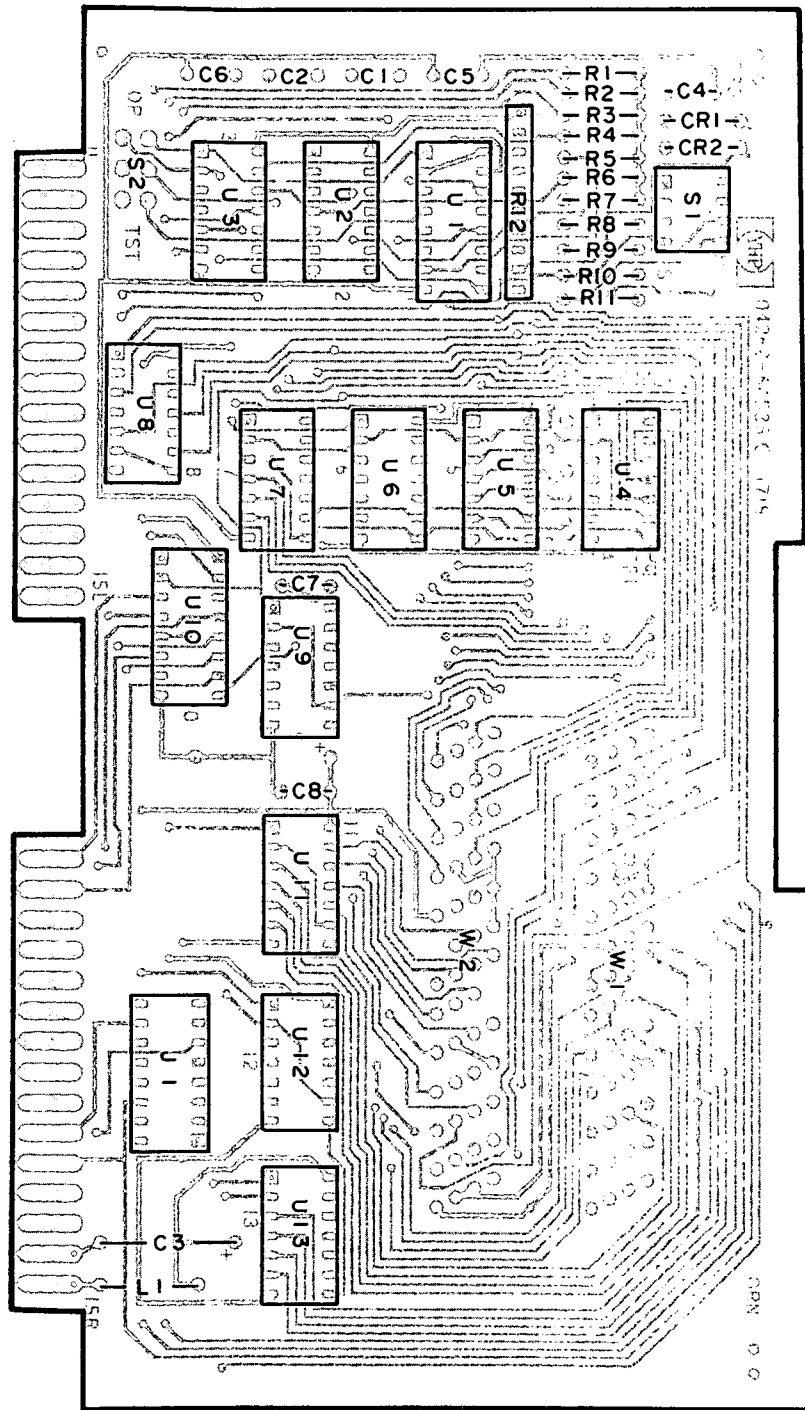





Figure 8-59. A35 BCD Output Control Board Assembly Component Locations.

Signature Analyzer settings:

START	A23PA9	
STOP	A23PA9	
CLOCK	A22TP2	
*CLOCK		
Window Test +5V A509		

Nodes: (73) (74) (75) (76) (77) (78)

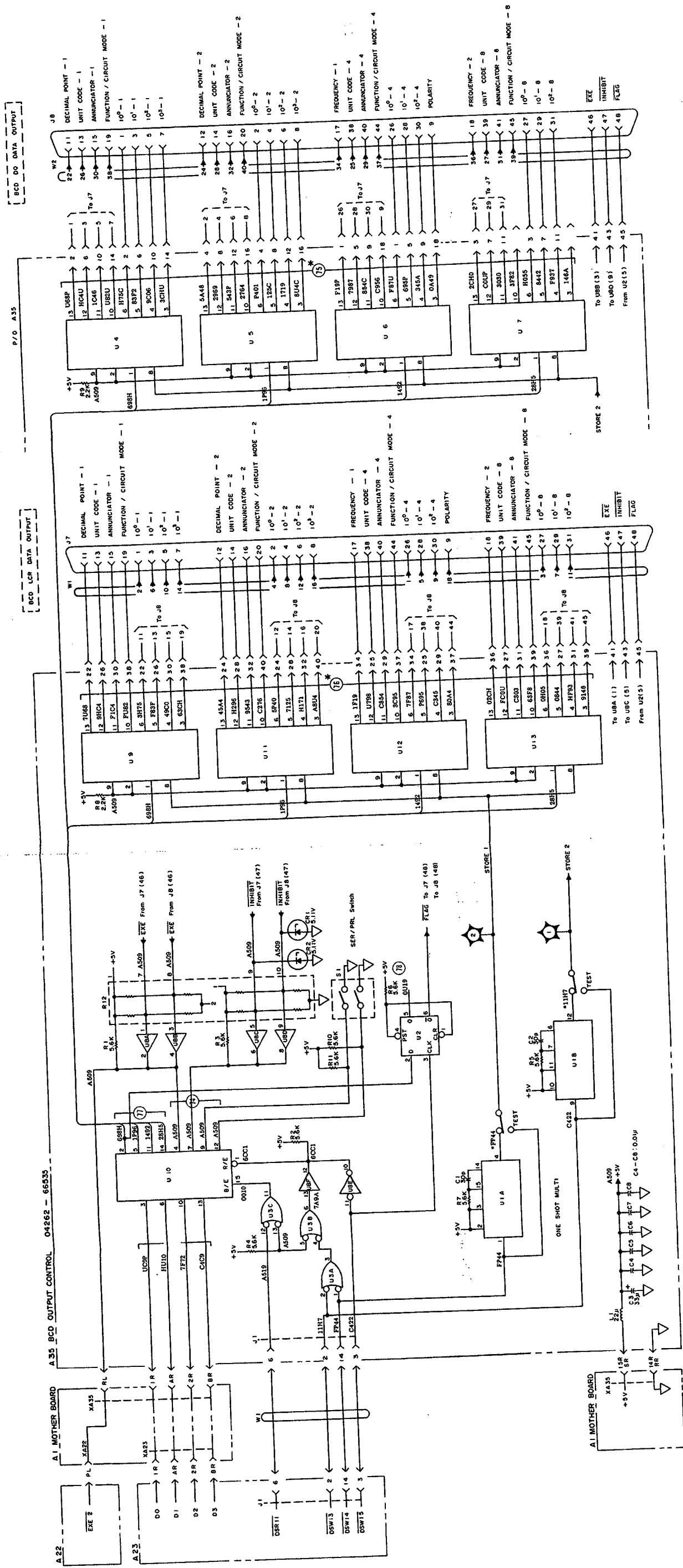

Figure 8-60. A35 BCD Output Control Board Assembly Schematic Diagram.