

Errata

Title & Document Type: 3589A Spectrum/Network Analyzer Quick Start Guide

Manual Part Number: 03589-90002

Revision Date: July 1991

HP References in this Manual

This manual may contain references to HP or Hewlett-Packard. Please note that Hewlett-Packard's former test and measurement, semiconductor products and chemical analysis businesses are now part of Agilent Technologies. We have made no changes to this manual copy. The HP XXXX referred to in this document is now the Agilent XXXX. For example, model number HP8648A is now model number Agilent 8648A.

About this Manual

We've added this manual to the Agilent website in an effort to help you support your product. This manual provides the best information we could find. It may be incomplete or contain dated information, and the scan quality may not be ideal. If we find a better copy in the future, we will add it to the Agilent website.

Support for Your Product

Agilent no longer sells or supports this product. You will find any other available product information on the Agilent Test & Measurement website:

www.tm.agilent.com

Search for the model number of this product, and the resulting product page will guide you to any available information. Our service centers may be able to perform calibration if no repair parts are needed, but no other support from Agilent is available.

HP 3589A Quick Start Guide

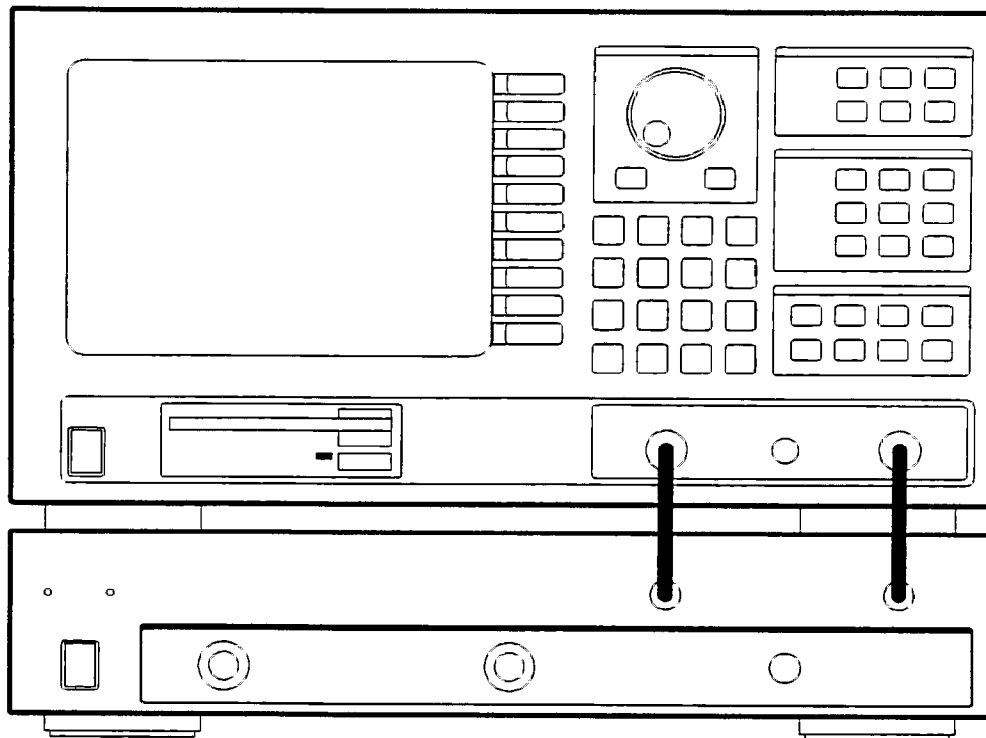

HP Part Number 03589-90002
Microfiche Part Number 03589-90200
Printed in U.S.A.

Print Date: July 1991
© Hewlett-Packard Company, 1991.
All rights reserved.
8600 Soper Hill Road Everett,
Washington 98205-1298 U.S.A.

HP3589A Front Panel

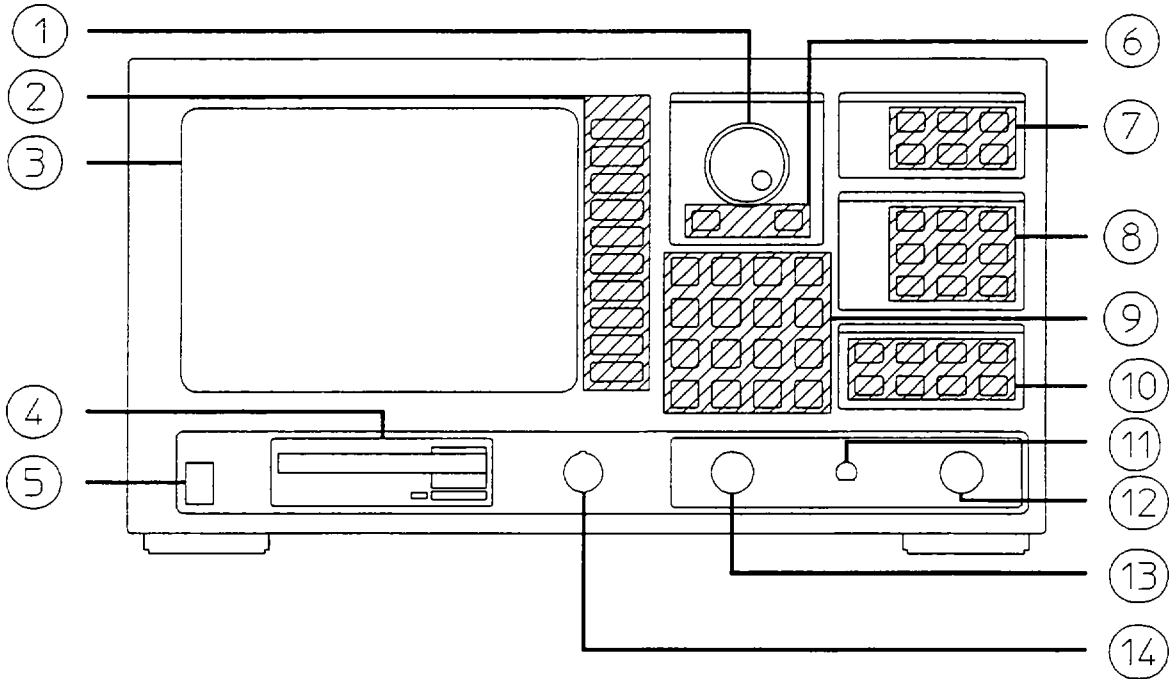

HP35689A Front Panel

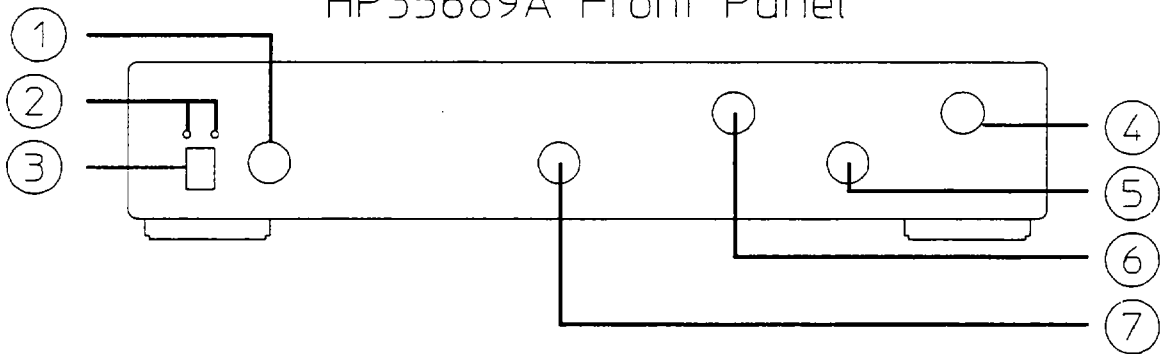

HP 3589A Front Panel

1-The knob's primary purpose is to move a marker along the trace. But you can also use it to change values during numeric entry, move a cursor during text entry, or select a hypertext link in help topics.

2-A softkey's function changes as different menus are displayed. Its current function is determined by the video label to its left, on the analyzer's screen.

3-The analyzer's screen is divided into two main areas. The menu area, a narrow column at the screen's right edge, displays softkey labels. The data area, the remaining portion of the screen, displays traces and other data.

4-Use a 3.5 inch flexible disk (DS,DD) in this disk drive to save your work.

5-The POWER switch turns the analyzer on and off.

6-Use the MARKER hardkeys and their menus to control marker positioning and marker functions, including limit testing.

7-Use the DISPLAY hardkeys and their menus to select and manipulate trace data, and to select display options for that data.

8-Use the MEASUREMENT hardkeys and their menus to control the analyzer's receiver and source, and to specify other measurement parameters.

9-Use the numeric-entry hardkeys to change the value of numeric parameters or to enter characters in text strings.

10-Use the SYSTEM hardkeys and their menus to control various system functions (online help, plotting, presetting, and so on).

11-The PROBE POWER connector provides power for an HP 41800A Active Probe.

12-The INPUT connector routes your test signal or DUT output to the analyzer's receiver. Input impedance is selectable: either 50 ohms or 1 megohm

13-The SOURCE connector routes the analyzer's source output to your DUT. Output impedance is 50 ohms.

14-The KEYBOARD connector allows you to attach an optional keyboard to the analyzer. The keyboard is most useful for writing and editing HP Instrument BASIC programs.

HP 35689A/B Front Panel

1-The PORT 1 connector is routed to the analyzer's source when the FORWARD indicator is lit. It is routed to the receiver when the REVERSE indicator is lit.

2-The direction indicators show you which port connector is routed to the analyzer's source. The left indicator is lit when the left port is connected, the right indicator is lit when the right port is connected.

3-The POWER switch turns the test set on and off.

4-The OUTPUT connector must be attached to the analyzer's INPUT connector for all measurements made with the test set.

5-The SPECTRUM INPUT connector allows you to make spectrum measurements without disconnecting the test set.

6-The test set's INPUT connector must be attached to the analyzer's SOURCE connector for all measurements made with the test set.

7-The PORT 2 connector is routed to the analyzer's receiver when the FORWARD indicator is lit. It is routed to the source when the REVERSE indicator is lit.

In This Book

This book introduces you to the HP 3589A Spectrum/Network Analyzer and the HP 35689A/B S-Parameter Test Set. The introduction comes in the form of several quick tasks that will have you making measurements in no time.

The tasks are grouped into six sections. The Basics will get you started. Setting Up shows you how to initialize some important settings. Working with the Display shows you how to control some important display options. Making Measurements shows you how to make several basic measurements. Saving and Plotting shows you how to use some basic disk and plotting functions. Automating Measurements introduces two of the analyzer's measurement automation features.

If you need additional information while you are performing one of these tasks, use the analyzer's online help system—a task in The Basics shows you how.

Table of Contents

The Basics

To turn on the analyzer	2
To display help for a key	3
To preset the analyzer	4
To select a measurement type	5
To type a text string	6
To change a numeric parameter	7
To move the main marker	8

Setting Up

To set the analyzer's HP-IB address	10
To set up your plotter	11
To set the analyzer's clock	12
To select the default disk	13
To select a 75 ohm adapter	14

Working with the Display

To select the active trace	16
To display two traces	17
To select trace data	18
To scale trace data	19
To display the instrument state	20

Making Measurements

To measure a wideband spectrum	22
To measure a narrowband spectrum	24
To measure normalized transmission	26
To measure S21	28
To lower the noise floor	30
To increase frequency resolution	31

Saving and Plotting Data

To format a flexible disk	34
To save a trace to a file	35
To recall a trace from a file	36
To plot screen contents	37

Automating Measurements

To create a limit line	40
To enable limit testing	41
To record a measurement sequence	42
To execute a recorded measurement sequence	43

Index



The Basics

Even if you decide to skip the rest of this manual, be sure to read through and perform the tasks in this section. Understanding these tasks is very important if you want to get the most out of your HP 3589A and HP 35689A/B.

To turn on the analyzer

- 1 Depress the top of the main power switch on your HP 35689A/B if you have one connected to your analyzer.
- 2 Depress the top of the main power switch on your HP 3589A.

The main power switch for each device is located in the lower-left corner of its front panel. The top of each power switch is labelled “|”. You turn on the HP 35689A/B first so it can be properly configured when you turn on the analyzer.

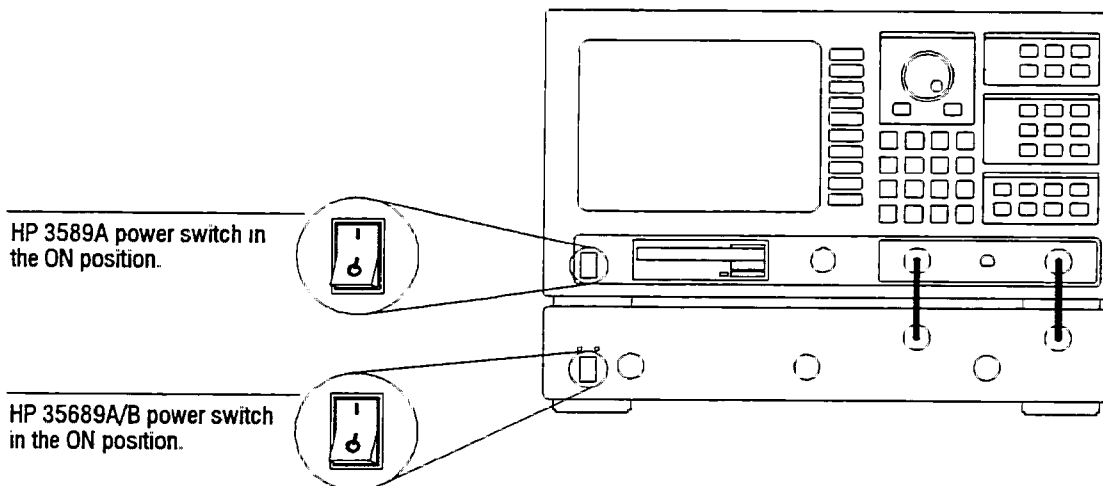

To display help for a key

- 1 Press [**Help**].
- 2 Press any hardkey or softkey—except [**Preset**].
- 3 Press the down-arrow or up-arrow hardkey to page.
- 4 Repeat steps 2 and 3 for each key you want help on.
- 5 Press [**0**] on the numeric keypad to quit online Help.

The first time you press [**Help**], take just a few moments to read the help overview. It's only four pages long, and it includes descriptions of advanced help features—like the index and cross-reference “links”—that can help you locate the information you need more quickly.

Pressing [**Preset**] always returns the analyzer to its preset state. If you press any other key when help is enabled, the analyzer displays a help topic describing the key's function. For help on the preset state, select “Preset hardkey.” from the help index.

When you quit help, the analyzer restores the menu that was displayed before you enabled help.

Topic title shows you which topic is displayed.

```

Topic:  Help hardkey.

How to use online Help

-----
To do this:                               Press this key:
-----
Turn help on.....{ Help }
Turn help off.....{ 0 }
Get help on a key.....[ <key> ]
Jump to a topic.....{ 4 }
Return to previous topic.....{ 7 }
Go to index.....{ 1 }
Display next page.....{ down arrow }
Display previous page.....{ up arrow }
Select help topic or link.....Turn the knob
Print the current screen.....{ 8 }

See the next pages for detailed instructions on using
online help. (Press the down-arrow key to display the
next page.)

Pg 1 of 4

Prev Topic-7      Print-8      Prev Page-↑      Index-1
Jmp To Topic-4    Next Page-↓    Next Page-↓    Quit-0
  
```

Legend shows you which help functions are assigned to the numeric keypad.

Page number shows you which page is displayed.

To preset the analyzer

- Press [**Preset**].

You can preset the analyzer to return it to a known state. This known state provides a convenient starting point when you are setting up a new measurement.

The following illustration lists the states of important parameters after you preset the analyzer. (You can display this listing on your analyzer by pressing [**Format**] [**SETUP STATE**].) For more information on the analyzer's preset state, use online help.

Setup state after pressing
[**Preset**].

MEASUREMENT	Type: Swept Spectrum	Peak Det. On Low Dist: Off
FREQUENCY	Center: 75 050 000 Hz Span: 149 900 000 Hz	
SWEEP	Time: 260.80 mSec Type: Linear	Mode: Auto Oversweep: On
GATED SWEEP	Trigger: Edge Gate Length: 1 m5 Delay Mode: Auto	Polarity: Positive Gate Delay: 130 u5
RES BW	Value: 17 000 Hz Vid Filt: Off	Coupling: On Video BW: 26 000 Hz
NOISE	Bandwidth: 18 146 Hz	Correction: 42.6 dB
SOURCE	Status: Off Impedance: 50 Ohms	Level: -10 dBm
INPUT	Range: -20 dBm Impedance: 50 Ohm	Autorange: On
TRIGGER	Type: Free Run Polarity: Negative	Arm: Auto
AVERAGE	Type: Off	Number: 10

To select a measurement type

- Press [**Meas Type**], then press [SWEPT SPECTRUM], [NARROW BAND ZOOM], or [SWEPT NETWORK].

The analyzer can make measurements that fall into three broad categories: swept spectrum, FFT-based spectrum (called narrowband zoom), and swept network. These categories are referred to as measurement types. Several other measurement parameters are automatically altered when you switch between types, so you should select a type before specifying other measurement parameters.

For more information on the three measurement types, use online help.

Use swept spectrum to analyze broadband or narrowband signals. Measurement data is magnitude-only.

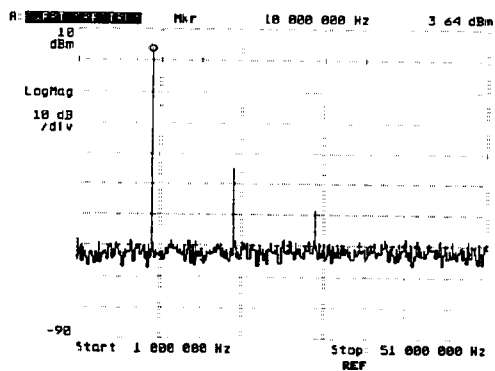

Use narrowband zoom to greatly reduce measurement times for narrowband signals. Measurement data is magnitude-only.

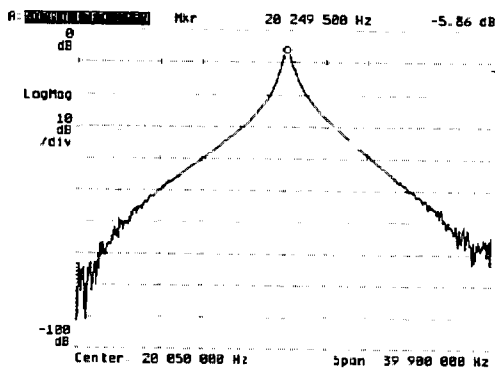
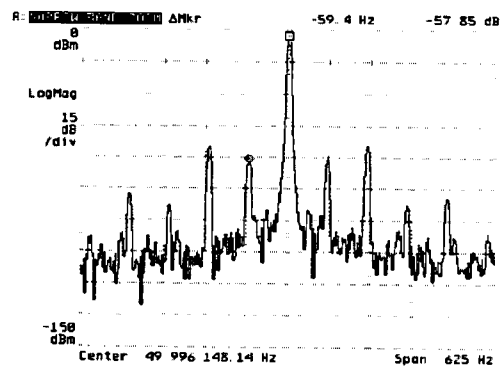

Use swept network to analyze the response of a device to input signals. Measurement data is complex.

To change a numeric parameter

- 1 Press a softkey that displays a numeric-entry prompt (for example [CENTER]).
- 2 Press one of the arrow hardkeys.
 - or
 - Turn the knob before the prompt is removed.
 - or
 - Type a value with the number hardkeys.
- 3 Press [ENTER] or a unit softkey to complete the entry if you typed a number.

When you press a softkey that controls a numeric parameter, the analyzer activates the key (shown by highlighting) and displays a numeric-entry prompt. The prompt is removed after a short time if you don't change the value, but the softkey remains active. An active softkey is always ready to accept entry from the arrow or number hardkeys, even when the prompt is not displayed.

The arrow hardkeys and the knob both change a numeric parameter by stepping it through successive values. In some cases, you can specify the size of the step. The knob is more convenient if you need to step a parameter quickly through many successive values, but the prompt *must* be displayed before you start turning the knob.

Decrease a value by turning the knob counter-clockwise or pressing the down-arrow hardkey.

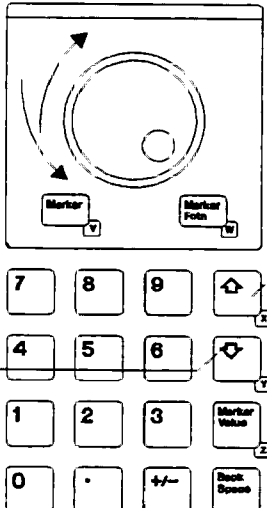

Increase a value by turning the knob clockwise or pressing the up-arrow hardkey.

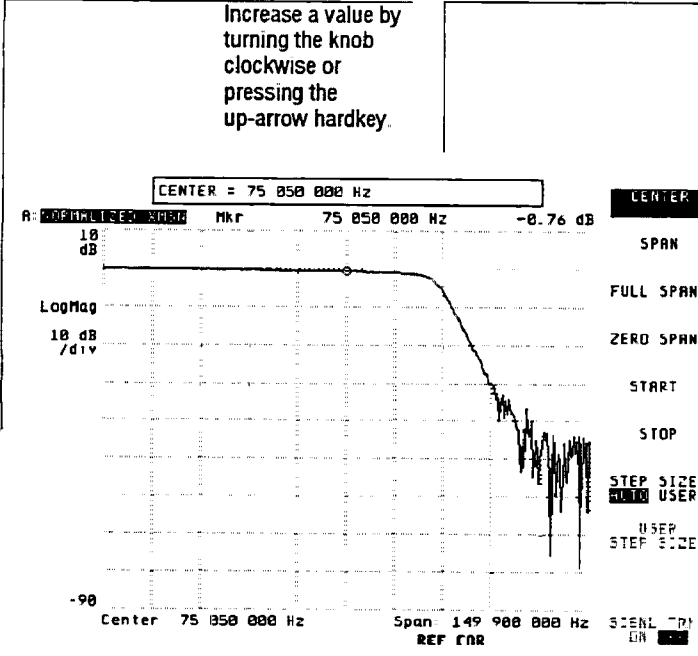

This numeric-entry prompt is displayed when you press [Freq] [CENTER].

Highlighting (also called inverse video) shows that [CENTER] is the active softkey.

[Back Space] backs up over mistakes.

To move the main marker

- 1 Press [**Marker**].
- 2 Turn the knob.

You can easily determine the x- and y-axis values of any point on a trace. Just move the main marker to the point of interest and read its value from the marker readout.

You don't always need to press [**Marker**] before you turn the knob, but it's a good habit to develop. The knob has two primary functions outside of text entry: moving the main marker and changing the value of numeric parameters. When you press [**Marker**], you ensure that the knob is assigned to moving the marker.

There are actually several ways to move the main marker; turning the knob is just the most common. You can press the arrow keys or enter an x-axis position (although in these cases you must press [**Marker**] first). You can also press one of the marker search softkeys. For more information on marker movement, see online help for the softkeys grouped under the [**Marker**] hardkey.

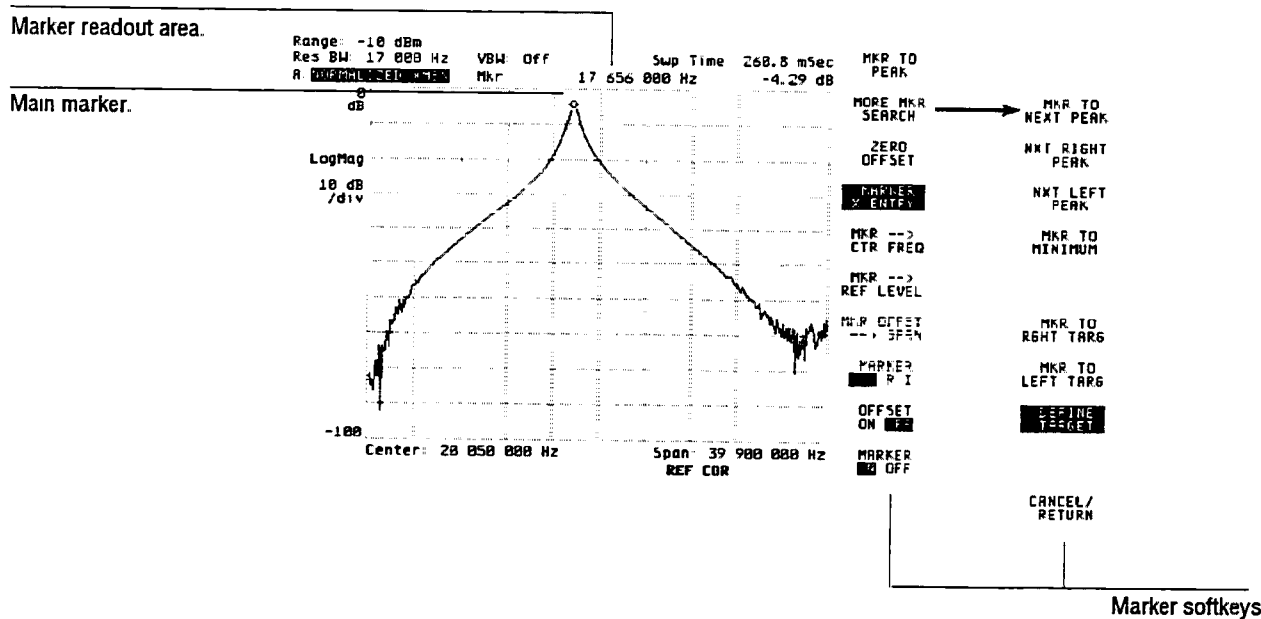



Setting Up

This section does *not* show you how to install your analyzer or S-parameter test set. If you have just unpacked one or both and want to make all the proper connections (power, frequency reference, analyzer/test set interconnections), refer to your *HP 3589A Performance Test Guide*.

This section *does* show you how to initialize some important settings that you will rarely need to change. The settings are stored in the analyzer's battery-backed memory, so they are not lost when you turn the analyzer off or when you press [**Preset**].

To set the analyzer's HP-IB address

- 1 Press [**Local/HP-IB**].
- 2 Press [ANALYZER ADDRESS] <num> [ENTER].

You can create an HP-IB system by connecting your analyzer to other devices with HP-IB cables. For example, you create a simple HP-IB system when you connect the analyzer to an HP-IB plotter. To make the system function properly, you must assign a unique address to each attached device—even the analyzer.

Enter <num> using the numeric keypad. Valid values include all integers from 0 through 30. The [ENTER] softkey is displayed when you begin entering <num>.

To set up your plotter

- 1 Connect the HP-IB ports of your plotter and analyzer with an HP-IB cable.
- 2 Turn on the plotter.
- 3 Determine the plotter's HP-IB address.
- 4 On the analyzer, press [**Local/HP-IB**] [PERIPHERL ADDRESSES] [PLOTTER ADDRESS] <num> [ENTER].

CAUTION

The analyzer's HP-IB mounting studs are metric-threaded, so you should *only* use cables with metric-threaded lock screws. Metric-threaded lock screws are black, while English-threaded lock screws are silver.

Refer to your plotter's documentation if you don't know how to turn it on or determine its HP-IB address. When you determine the address, write it down; this is the value you will substitute for <num> in step 4.

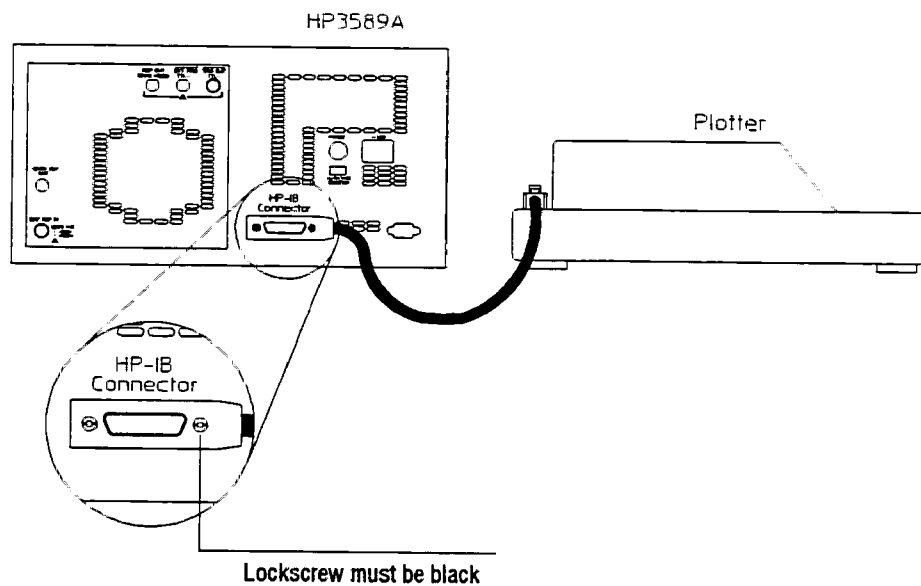

To set the analyzer's clock

- 1 Press [**Special Fctn**] [NON-VOL SETUP].
- 2 Press [TIME HHMM] <time> [ENTER].
- 3 Press [DATE MMDDYY] <date> [ENTER].

You can set the analyzer's battery-backed clock to match the current time and date. After you set the clock, it maintains the time and date—even when the analyzer is turned off.

Enter <time> and <date> using the numeric keypad. Use a 24-hour format for <time> and a month-day-year format for <date>. The [ENTER] softkey is displayed when you begin entering either parameter. Here are some examples:

- 8:05 am—Press [TIME HHMM] 0805 [ENTER].
- 3:42 pm—Press [TIME HHMM] 1542 [ENTER].
- August 3, 1991—Press [DATE MMDDYY] 080391 [ENTER].

Time and date are included in the top-right corner when you plot or print a complete trace.

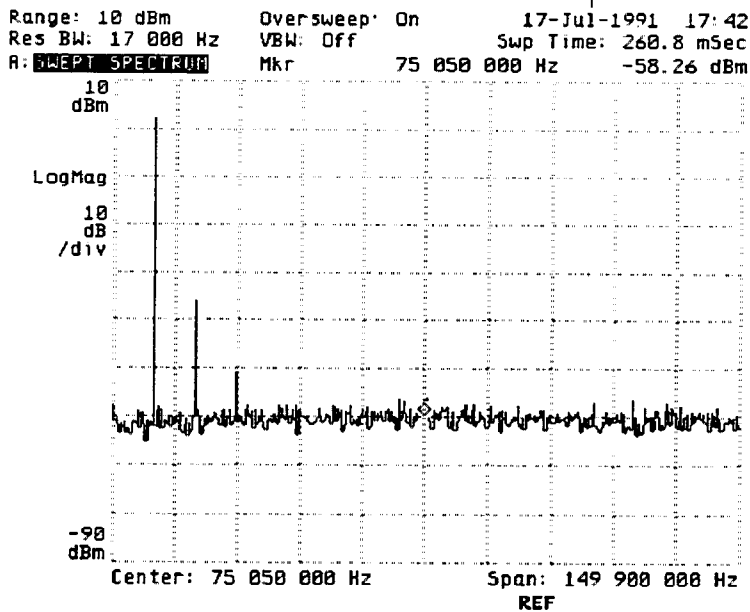

To select the default disk

- 1 Press [**Disk Util**] [DEFAULT DISK].
or
Press [**Save/Recall**] [DEFAULT DISK].
- 2 Press [NON-VOL RAM DISK], [VOLATILE RAM DISK], or [INTERNAL DISK].

Your default disk selection tells the analyzer which disk to use when it is saving and recalling files. You can use online help to learn more about these options, but here's a quick summary:

- [NON-VOL RAM DISK] selects a portion of the analyzer's battery-backed RAM. This "disk" only holds 63 kilobytes of data, but the data is not lost when you turn off the analyzer.
- [VOLATILE RAM DISK] selects a portion of RAM that is *not* battery-backed. Data on this "disk" is lost when you turn off the analyzer, but it has two advantages: you can format it to hold much more data than the non-volatile RAM disk, and file operations are much faster than on the internal disk.
- [INTERNAL DISK] selects the analyzer's internal disk drive. This drive stores data on 3.5-inch flexible disks (double-sided, double-density). The disks can be formatted to hold up to 788 kilobytes of data. For more information, see "To format a flexible disk" later in this manual.

To select a 75 ohm adapter

- 1 Press [**Special Fctn**] [NON-VOL SETUP] [75 OHM SETUP].
- 2 Press [25 OHM ADAPTER] or [MINIMUM LOSS PAD] to match the adapter you will use for 75 ohm measurements.

When you make measurements without an HP 35689A/B S-Parameter Test Set, you must specify the impedances of the analyzer's SOURCE and INPUT connectors. (You specify these impedances under the [**Source**] and [**Range/Input**] hardkeys.) If you specify 75 ohm impedances, the analyzer automatically adjusts the actual output amplitude and the displayed input amplitude to correct for losses through 50-to-75 ohm adapters. The amplitude adjustments depend on your selection in step 2:

- Press [25 OHM ADAPTER] if you will use an N-to-BNC adapter followed by a 25 ohm BNC adapter barrel on each connector.
- Press [MINIMUM LOSS PAD] if you will use a 50-to-75 ohm minimum loss pad on each connector.

Be careful when you are using both 50 and 75 ohm Type-N connectors. The diameter of the 50 ohm center pin is about twice that of the 75 ohm center pin. You can damage a 75 ohm female connector by attaching it to a 50 ohm male connector.

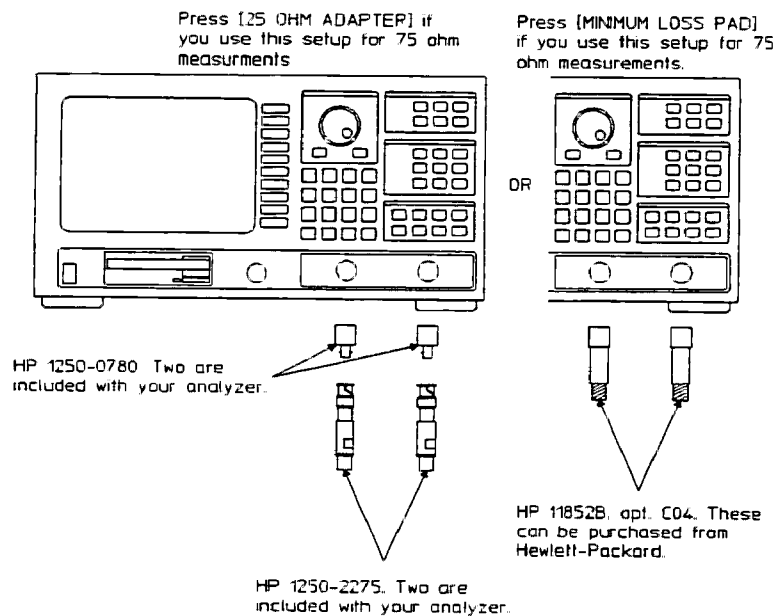

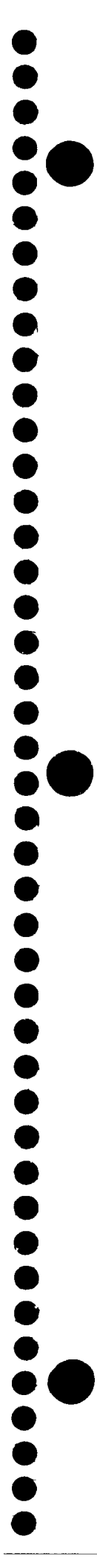

Working with the Display

This section shows you how to control important display options. It will be easier for you to analyze data if you know how to control these options.

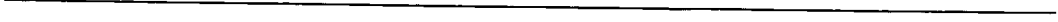

To select the active trace

- Press [**Active Trace**].

The analyzer has two independent trace buffers: trace A and trace B. You have several options for selecting and displaying a trace's contents, but you must activate the trace before you can change these options. (For example, most of the options available under the MARKER and DISPLAY hardkey groups only affect the active trace.) When you press [**Active Trace**], the analyzer alternately activates trace A and trace B.

The active trace is the only trace displayed if you have selected the single-trace display format (by pressing [**Format**] [SINGLE]). For information on displaying both traces at once, see the next task.

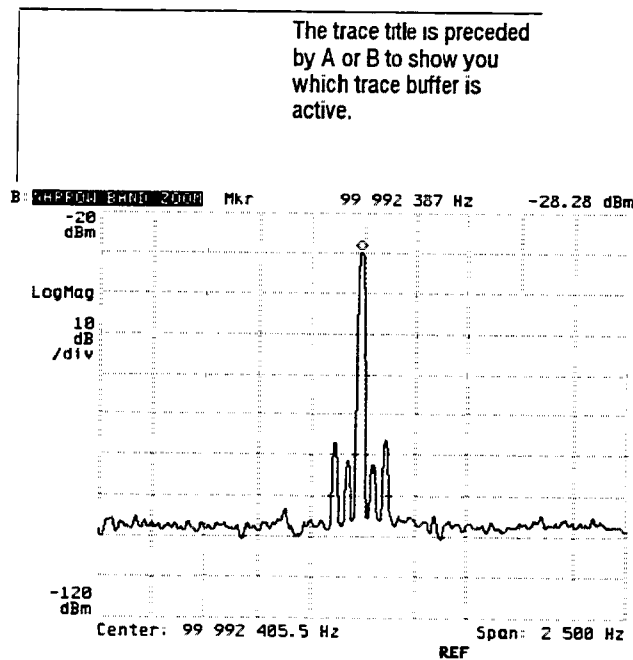

To display two traces

- 1 Press [**Format**].
- 2 Press [**UPPER/LOWER**].
or
Press [**FRONT/BACK**].

Even when you display trace A and trace B together, only one of them can be active at a given time. The analyzer uses different fonts (character styles) to show you which trace is active. It uses plain characters to annotate the active trace and ghosted (half-bright) characters to annotate the inactive trace. See the previous task if you don't understand what it means to activate a trace.

Upper/lower trace format.

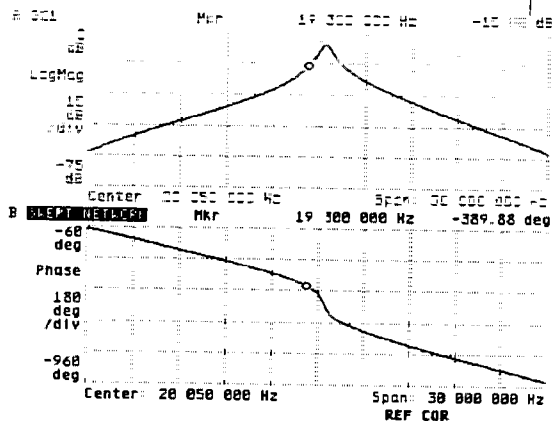

Ghosted characters in trace annotation indicate that trace A is inactive.

Front/back trace format.

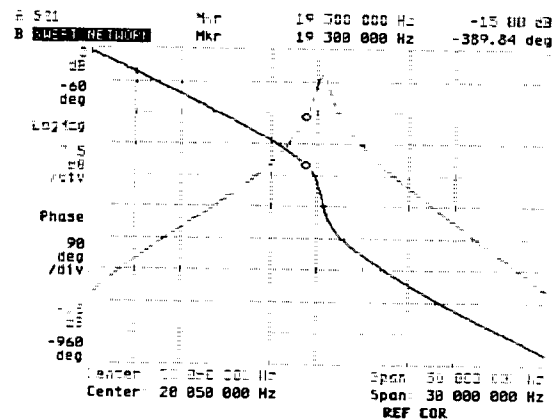

To select trace data

- 1 Press [**Active Trace**] if the trace you want to change is not currently active.
- 2 Press [**Trace Data**], then one of the trace data softkeys (shown in the illustration).

Several softkeys in the Trace Data menu just display sub-menus. When you press one of these softkeys, you must also press a softkey in its sub-menu to select trace data. If trace data isn't available, its softkey label is ghosted (displayed using half-bright characters). The availability of trace data is limited by two things:

- your selection of a measurement type (See "To select a measurement type" earlier in this manual.)
- the presence or absence of an HP 35689A/B S-Parameter Test Set

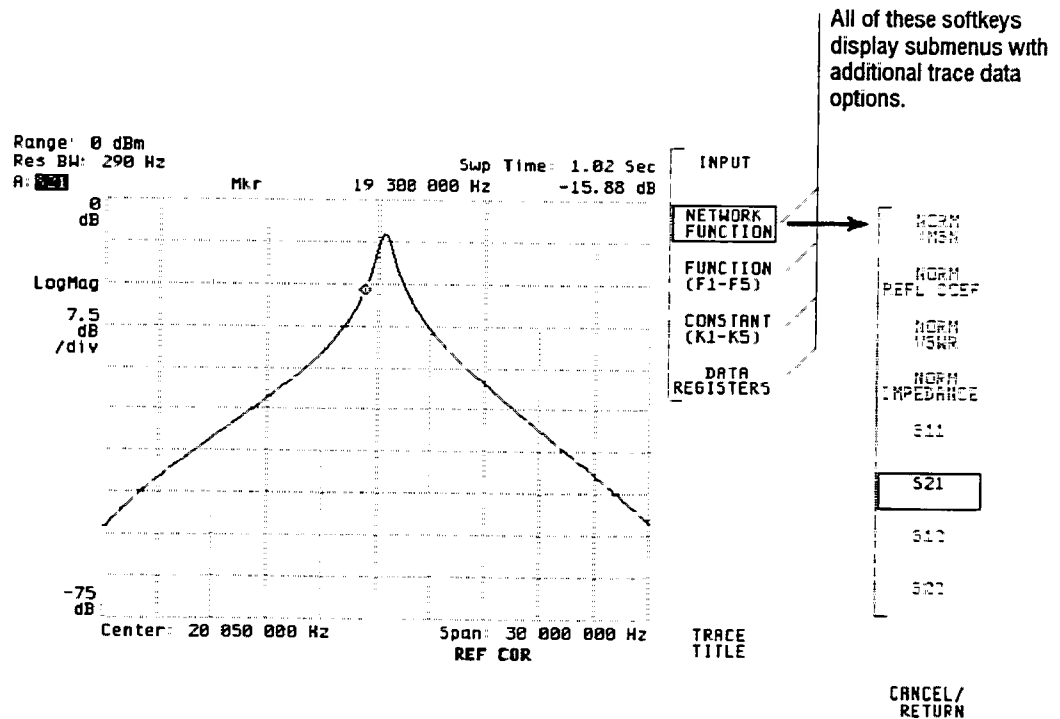

To scale trace data

- 1 Press [**Active Trace**] if the trace you want to scale is not currently active.
- 2 Press [**Scale**] [**AUTO SCALE**].

Autoscaling provides a convenient starting point when you are scaling trace data. It displays the entire trace within the bounds of the active trace area. From this starting point, you can easily reposition and expand a trace by modifying the values of other scaling softkeys. Here's how you can use some of these softkeys:

- Use [**REFERENCE LEVEL**] to move a trace up and down within rectangular trace types. Use it to expand and compress a trace around the center point within the polar trace type.
- Use [**VERTICAL/DIV**] to expand and compress a trace around the reference line within rectangular trace types. Use it as an alternate way to expand and compress a trace around the center point within the polar trace type.
- Use [**REF LEVEL POSITION**] to position the reference line vertically within rectangular trace types.

To learn more about the scaling softkeys, use online help.

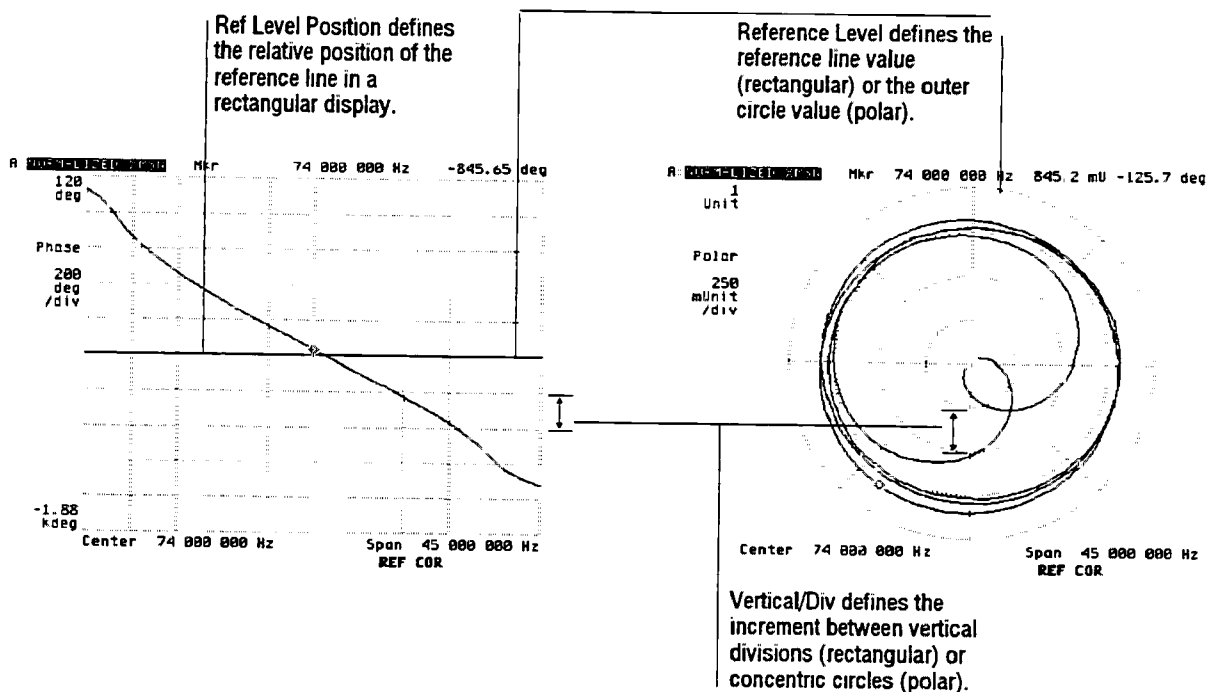

To display the instrument state

- Press [**Format**] [SETUP STATE].

The instrument state is a list that summarizes the current states of important measurement parameters. There are several ways you can use the list. You can:

- quickly check the current setup
- document the setup (The list can be plotted or printed.)
- alter some parameters while viewing the setup

When you learn to switch between the analyzer's three measurement types, you may notice that the list contents are different for each type. This just reflects the fact that some parameters are either unimportant or unused for a particular measurement type.

Swept spectrum instrument state

MEASUREMENT	Type: Swept Spectrum	Peak Det: On	Low Dist: Off
FREQUENCY	Center: 75 050 000 Hz	Span: 149 900 000 Hz	
SWEEP	Time: 268.80 mSec	Mode: Auto	Oversweep: On
	Type: Linear		
GATED SWEEP	Trigger: Edge	Polarity: Positive	
	Gate Length: 1 m5	Gate Delay: 130 u5	
	Delay Mode: Auto		
RES BW	Value: 17 000 Hz	Coupling: On	Video BW: 26 000 Hz
	Vid Filtr: Off		
NOISE	Bandwidth: 18 146 Hz	Correction: 42.6 dB	
SOURCE	Status: Off	Level: -10 dBm	
	Impedance: 50 Ohms		
INPUT	Range: -20 dBm	Autorange: On	
	Impedance: 50 Ohm		
TRIGGER	Type: Free Run	Arm: Auto	
	Polarity: Negative		
AVERAGE	Type: Off	Number: 10	

Narrowband zoom instrument state.

MEASUREMENT	Type: Narrow Band Zoom	Low Dist: Off
FREQUENCY	Center: 75 050 000 Hz	Span: 40 000 Hz
RES	Time: 10.00 mSec	
RESOLUTION	Value: 360 Hz	Zoom: High Accuracy
NOISE	Bandwidth: 388.98 Hz	Correction: 25.6 dB
SOURCE	Status: Off	Level: -10 dBm
	Impedance: 50 Ohms	
INPUT	Range: -20 dBm	Autorange: On
	Impedance: 50 Ohm	
TRIGGER	Type: Free Run	Arm: Auto
	Polarity: Negative	
AVERAGE	Type: Off	Number: 10



Making Measurements

This section shows you how to make several basic measurements. Each of the first three measurements are made using different measurement types, but all can be made either with or without an HP 35689A/B S-Parameter Test Set. The last measurement uses the swept network measurement type and requires a test set. The two final tasks show you how to control two parameters that are important during spectrum measurements.

To measure a wideband spectrum

You can measure a wideband spectrum either with or without the HP 35689A/B S-Parameter Test Set. The setup illustration shows you both options. However, since the test set's performance is not specified below 100 kHz, you should *not* use it for measurements that include lower frequencies.

1 Initialize the analyzer.

Press [**Preset**].

2 Connect your DUT (as shown in the illustration).

3 Specify the measurement parameters.

Press [**Freq**] [**CENTER**] <num> <unit>, then press [**SPAN**] <num> <unit>. If you are *not* using the test set, press [**Range/Input**], then press [**50 OHMS**] or [**75 OHMS**] to match your DUT impedance.

See "To select a 75 ohm adapter" for more information on 75 ohm measurements. See "To change numeric parameters" if you don't know how to enter <num> and <unit>.

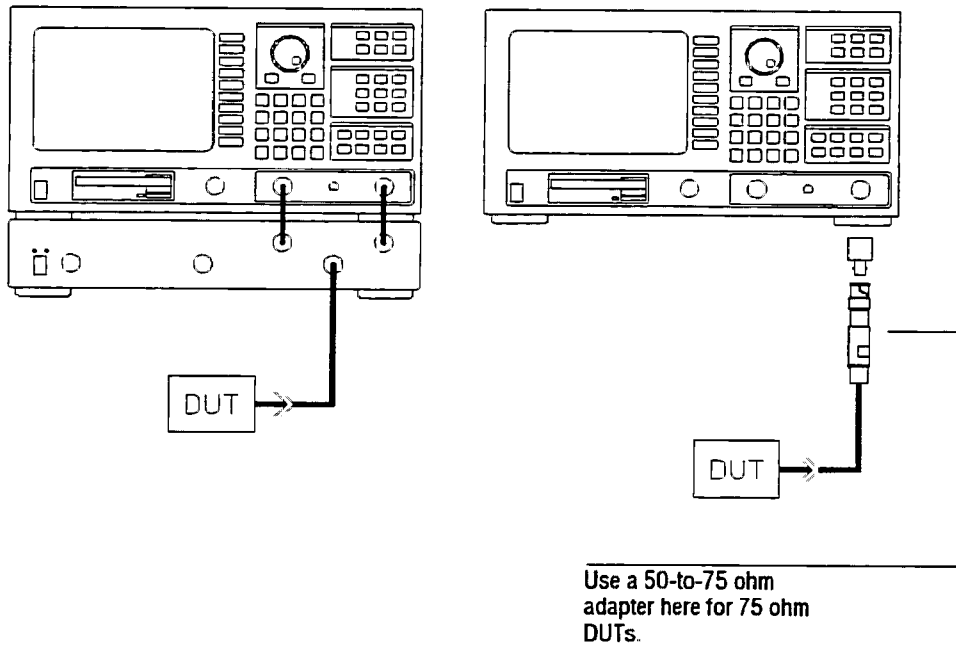

4 Measure the DUT.

Press [**Meas Restart**].

5 Configure the display.

Press [**Scale**] [AUTO SCALE].

When you press [**Preset**], the analyzer does several things to simplify your wideband spectrum measurement:

- It selects the measurement type you need by selecting the [SWEPT SPECTRUM] softkey. With this softkey selected, the HP 3589A functions as a traditional swept-tuned spectrum analyzer.
- It checks for the presence or absence of a test set and sets the state of the [TEST SET IN/OUT] softkey to match. This ensures that the analyzer will measure your DUT at the proper connector: the test set's SPECTRUM INPUT connector if the test set is present; the analyzer's INPUT connector if the test set is absent.
- It sets the [AUTORANGE ON/OFF] softkey to ON. When autoranging is on, the analyzer continuously monitors the level of your test signal and selects the best range setting for that signal.

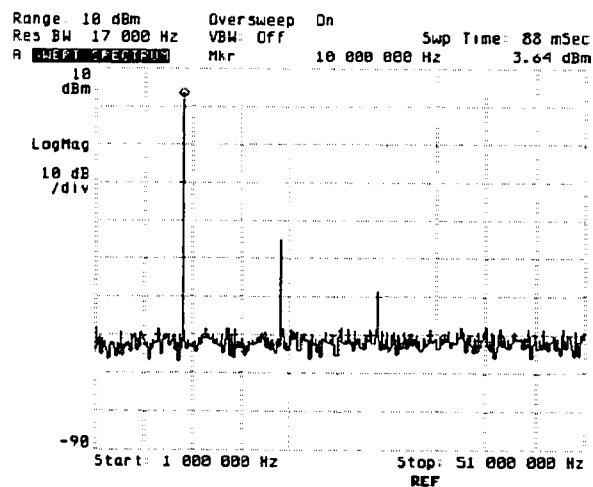

To measure a narrowband spectrum

You can measure a narrowband spectrum either with or without the HP 35689A/B S-Parameter Test Set. The setup illustration shows you both options. However, since the test set's performance is not specified below 100 kHz, you should *not* use it for measurements that include lower frequencies.

1 Initialize the analyzer.

Press [**Preset**].

Press [**Meas Type**] [NARROW BAND ZOOM].

2 Connect your DUT (as shown in the illustration).

3 Specify the measurement parameters.

Press [**Freq**] [CENTER] <num> <unit>, then press [SPAN] <num> <unit>.

If you are *not* using the test set, press [**Range/Input**], then press [50 OHMS] or [75 OHMS] to match your DUT impedance.

See "To select a 75 ohm adapter" for more information on 75 ohm measurements. See "To change numeric parameters" if you don't know how to enter <num> and <unit>.

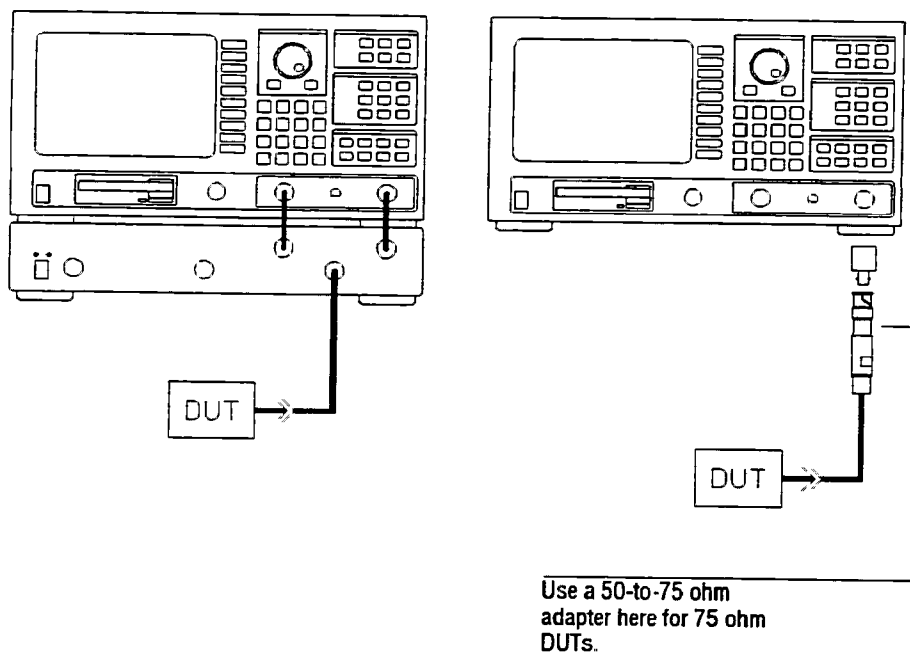

4 Measure the DUT.

Press [**Meas Restart**].

5 Configure the display.

Press [**Scale**] [AUTO SCALE].

The only difference between this task and the previous task, "To measure a wideband spectrum," is your selection of the narrowband zoom measurement type in step 1. This difference gives you a big advantage: measurement times are much shorter than they would be for comparable swept spectrum measurements.

Along with the advantage come some restrictions on the frequency span. When [NARROW BAND ZOOM] is selected, the [SPAN] softkey is limited to 16 discrete values. The values range from 1.22 Hz to 40 kHz and are derived from the following formula:

$$\frac{40,000}{2^n}$$

The range of integer values for n is 0 through 15.

If the span restrictions are unacceptable for a given narrowband measurement, you can always select the swept spectrum measurement type: just press [**Meas Type**] [SWEEP SPECTRUM]. Measurements will be slower, but spans will be much less restricted.

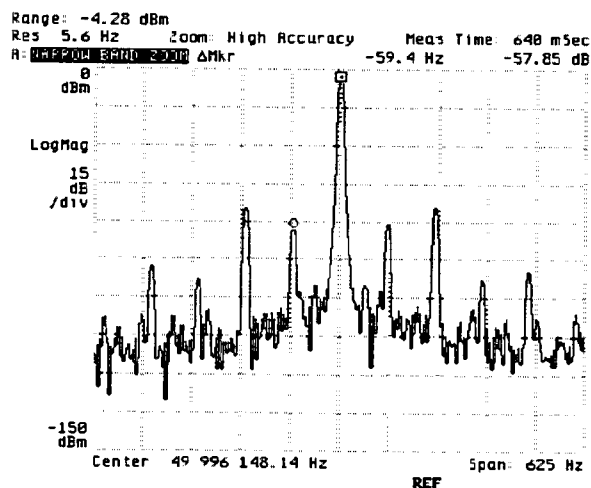

To measure normalized transmission

You can measure normalized transmission either with or without the HP 35689A/B S-Parameter Test Set. The setup illustration shows you both options.

1 Initialize the analyzer.

Press [**Preset**].
Press [**Meas Type**] [SWEPT NETWORK].

2 Specify the measurement parameters.

Press [**Freq**] [START] <num> <unit>, then press [STOP] <num> <unit>.
If you are *not* using the test set, press [**Range/Input**], then press [50 OHMS] or [75 OHMS] to match your DUT impedance.
Press [**Range/Input**] [RANGE] <num> <unit>.
Press [**Source**] [SOURCE AMPLITUDE] <num> <unit>.

See "To select a 75 ohm adapter" for more information on 75 ohm measurements. See "To change numeric parameters" if you don't know how to enter <num> and <unit>.

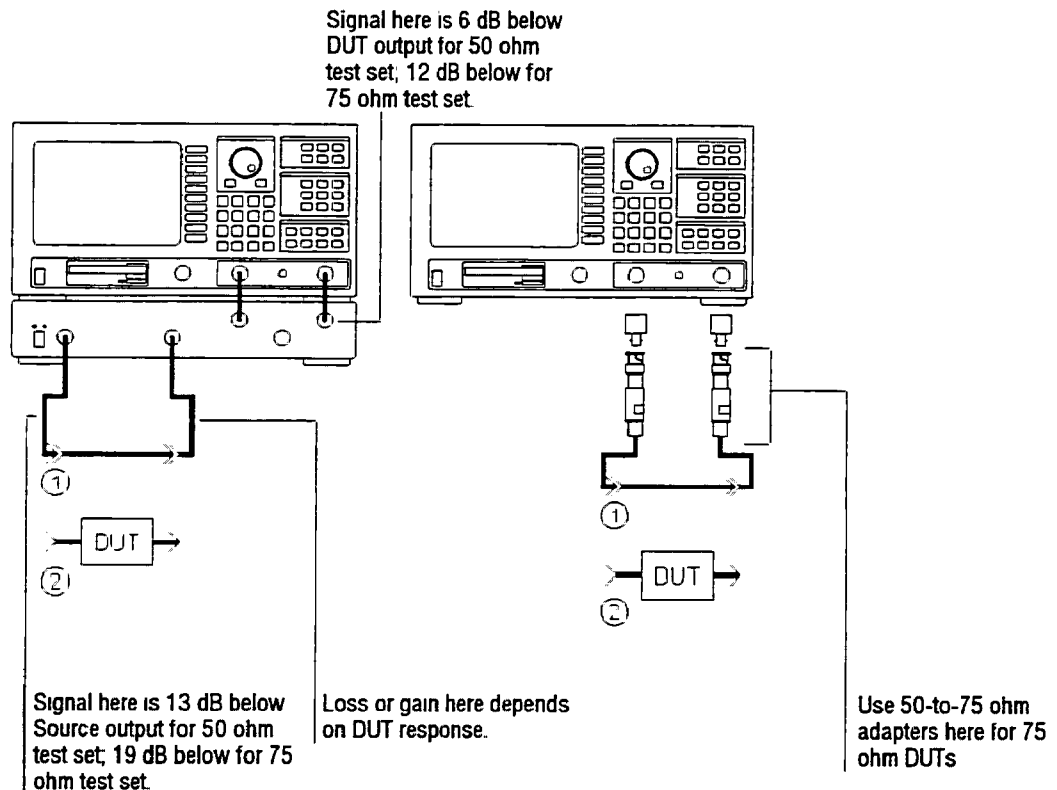

3 Calibrate your measurement.

Insert a through connection between the PORT 1 and PORT 2 cables.
 Press [**Meas Type**] [MEAS CALIBRATE] [XMSN NORM (THRU)].

4 Measure the DUT.

Replace the through connection with your DUT.
 Press [**Meas Restart**].

5 Configure the display.

Press [**Scale**] [AUTO SCALE].

You need to watch for three indicators at the bottom of the screen when you measure normalized transmission: RNG, OVLD, and COR. If RNG or OVLD come on during steps 3 or 4, the analyzer's input is being overdriven and your results will be compromised. To correct the problem, select a higher input range or a lower source amplitude in step 2.

COR is displayed when you have successfully calibrated your measurement. It tells you that the correction data is valid for the current setup. COR is changed to COR? when the correction data is no longer valid. You will see this change if you specify new measurement parameters *after* you calibrate the measurement.

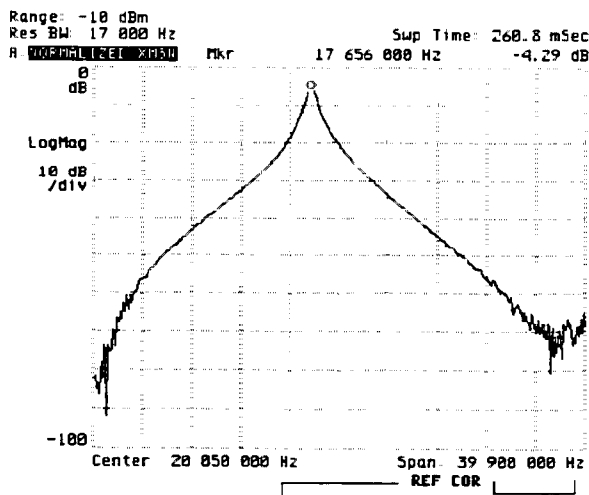

COR is displayed here when calibration corrections are valid, COR? when they are not

RNG and OVLD are displayed here when the input is being overdriven.

To measure S₂₁

The S₂₁ measurement is similar to the normalized transmission measurement, but it allows you to remove more of the system errors from your measurement setup. The S₂₁ measurement requires an S-parameter test set. Use the HP 35689A to measure 50 ohm devices; use the HP 35689B to measure 75 ohm devices.

1 Initialize the analyzer.

Press [**Preset**].
Press [**Meas Type**] [SWEPT NETWORK].

2 Specify the measurement parameters.

Press [**Freq**] [START] <num> <unit>, then press [STOP] <num> <unit>.
Press [**Range/Input**] [RANGE] <num> <unit>.
Press [**Source**] [SOURCE AMPLITUDE] <num> <unit>.

See "To change numeric parameters" if you don't know how to enter <num> and <unit>.

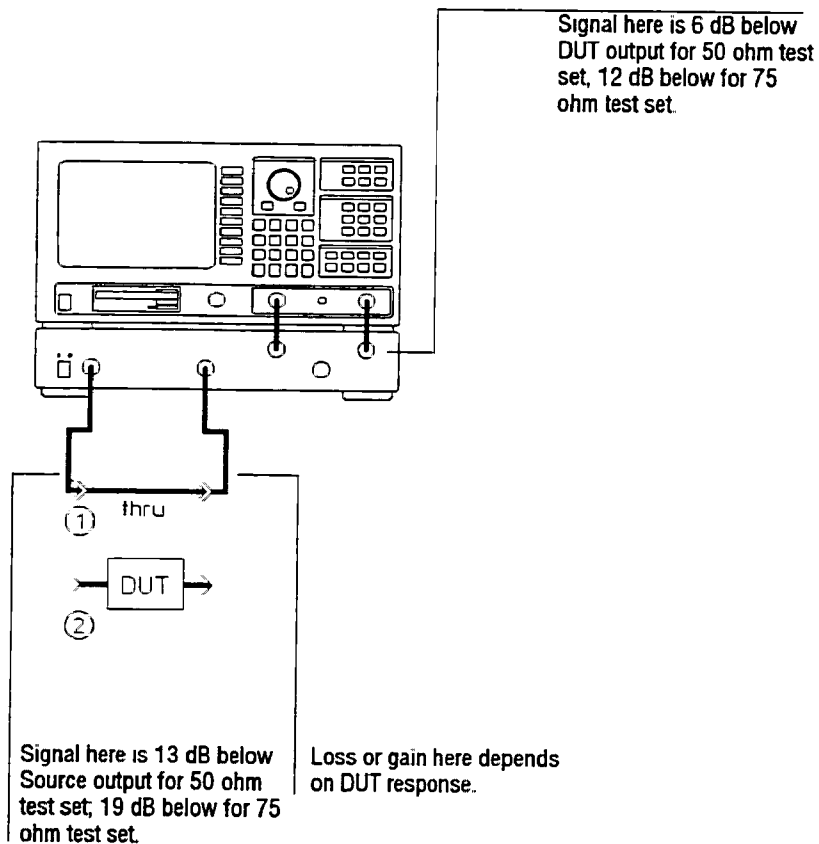

3 Calibrate your measurement.

Insert a through connection between the PORT 1 and PORT 2 cables.
 Press [**Meas Type**] [MEAS CALIBRATE] [S21 CAL] [PORT 1->2 THRU].

4 Measure the DUT.

Replace the through connection with your DUT.
 Press [PORT 1 REF (DUT)] [S21 CAL DONE].
 Press [**Meas Restart**].

5 Configure the display.

Press [**Scale**] [AUTO SCALE].

Remember that the HP 3589A is a single-channel analyzer: it doesn't have a separate reference channel for measurements—like S₂₁—that display the ratio of two signals. Instead, the HP 3589A uses a stored reference trace for these measurements. Pressing [PORT 1 REF (DUT)] in step 4 stores a new reference trace. If you change from one DUT to another after calibrating your measurement, you don't need to recalibrate, but you must *always* store a new reference trace for the new DUT.

Review the summary of the previous task—"To measure normalized transmission." It contains important information that also applies to this task.

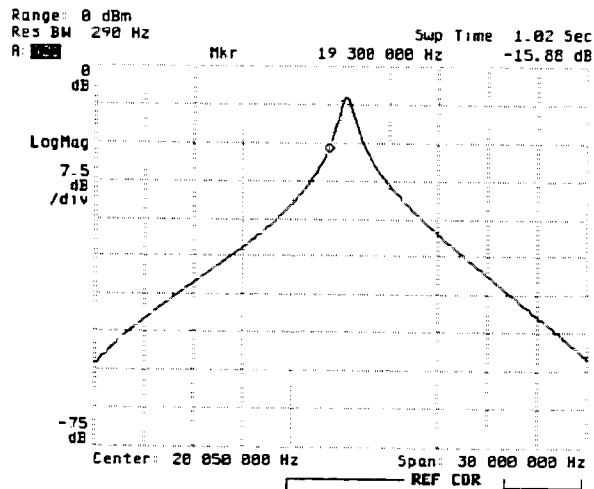

COR is displayed here when calibration corrections are valid; COR? when they are not

RNG and OVLD are displayed here when the input is being overdriven

To lower the noise floor

- 1 Press the [**Res BW**] hardkey.
- 2 Press the [RES BW] softkey, then press the down-arrow hardkey if the swept spectrum measurement type is selected.
or
 Press the [HI RES ZOOM] softkey if the narrowband zoom measurement type is selected.

Low-level spectral components can be hidden by the noise floor during both types of spectrum measurements. You can reveal these components by limiting the amount of noise energy that's detected during a measurement. Use narrower resolution bandwidths to limit noise during swept spectrum measurements. Use the high-resolution zoom type to limit noise during narrowband zoom measurements.

There's a penalty for using narrower resolution bandwidths during swept spectrum measurements. The analyzer must use longer sweep times to provide calibrated results. You can select a resolution bandwidth that provides the best compromise between a shorter sweep time and a lower noise floor for each measurement situation.

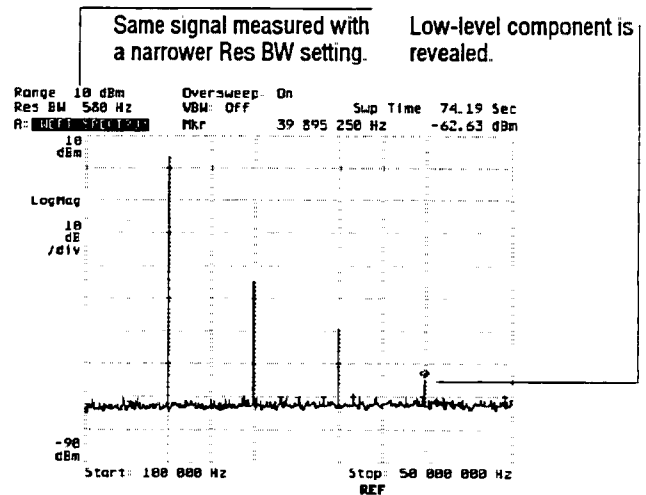
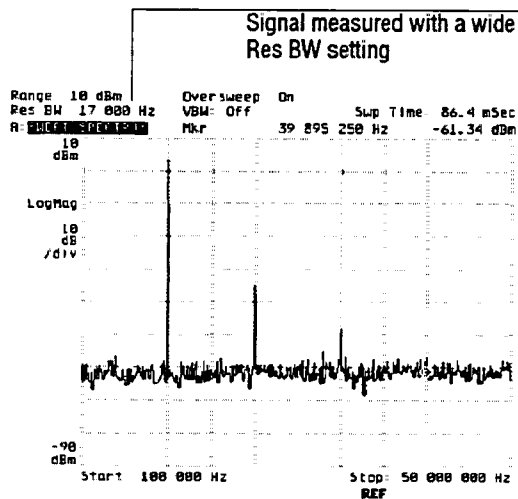



Saving and Plotting Data

This section shows you how to perform some basic disk operations and how to plot the contents of the analyzer's screen.

To format a flexible disk

- 1 Insert a 3.5-inch flexible disk into the analyzer's internal disk drive.
- 2 Press [**Disk Util**] [DEFAULT DISK] [INTERNAL DISK].
- 3 Press [**Disk Util**] [FORMAT DISK] [FORMAT OPTION] 0 [ENTER].
- 4 Press [INTRLEAVE FACTOR] 1 [ENTER].
- 5 Press [PERFORM FORMAT] [ENTER].

CAUTION

You can damage both the disk and the drive if you attempt to eject a disk when the "FORMAT DISK In Progress" message is displayed or when the disk's "busy" light is on.

You must format a 3.5-inch flexible disk before you can use it to store HP 3589A data. Use a double-sided, double-density disk that is *not* write-protected. (See the illustration.) The analyzer takes about one and a half minutes to format a disk and is unavailable for other tasks during that time.

In steps 3 and 4, you are setting the disk formatting parameters to their default values. For more information on the formatting parameters, use online help.

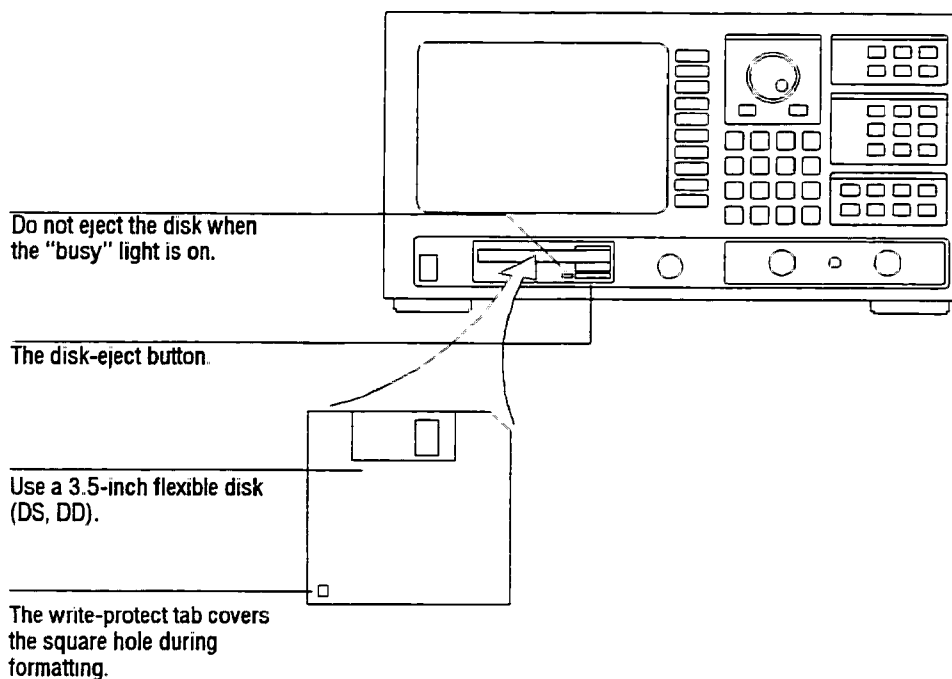

To save a trace to a file

- 1 Press [**Active Trace**] if the trace you want to save is not currently active.
- 2 Press [**Save/Recall**] [SAVE TRACE] [INTO FILE].
- 3 Type a file name, then press [ENTER].

After you've entered a file name, the analyzer saves the active trace to a file on the default disk. For more information on typing a file name and selecting the default disk, see "To type a text string" and "To select the default disk" earlier in this manual.

To recall a trace from a file

- 1 Press [**Save/Recall**], then press [CATALOG ON/OFF] to highlight ON.
- 2 Turn the knob to highlight the file you want to recall.
- 3 Press [RECALL TRACE] [FROM FILE INTO D1] [ENTER].
- 4 Press [**Active Trace**] if the trace you want to replace is not currently active.
- 5 Press [**Trace Data**] [DATA REGISTERS] [D1].

It's generally easier to recall a trace if you display the disk catalog and highlight the trace file first. When you do this, the prompt that's displayed when you press [FROM FILE INTO D1] already contains the correct file name. You only need to press [ENTER] to recall the file. If you don't display the catalog first, you will need to type the correct file name into the prompt before you press enter.

The analyzer always recalls a trace into a data register. Steps 4 and 5 allow you to view the recalled trace by selecting the contents of that register for display.

The analyzer recalls the highlighted file.

Range 28 dBm
Res BW 298 Hz

Swp Time 1.02 Sec

INT: 02/22/20 12:32:09	AVAILABLE SPACE 578048		
FILE NAME	SIZE	TYPE	LPST CHANGED
osc49	2816	BDAT	07/19/91 10:34:59
sbands49	2816	BDAT	07/19/91 10:37:23
80F1170	4352	BDAT	07/19/91 10:38:07
bdF1170	4352	BDAT	07/19/91 10:39:31
ul1m70	11776	BDAT	07/19/91 11:36:52
111m70	11776	BDAT	07/19/91 11:35:38
xmsn1	3872	BDAT	07/19/91 11:39:49
zoom1	3872	BDAT	07/19/91 11:40:25

FROM FILE INTO D1

FROM FILE INTO D2

FROM FILE INTO D3

FROM FILE INTO D4

FROM FILE INTO D5

FROM FILE INTO D6

FROM FILE INTO D7

MORE

CATALOG ON OFF

CANCEL/RETURN

REF COR

To plot screen contents

- 1 Set up your plotter if you haven't already.
- 2 Press [**Local/HP-IB**] [SYSTEM CONTRLLR].
- 3 Press [**Plot/Print**] [PLOT ALL].

The analyzer is only able to initiate plotting if it is attached to an HP-IB plotter and designated as the system controller. If you haven't already set up your plotter, see "To set up your plotter" earlier in this manual. All of the screen's contents, except the softkey labels, are plotted when you complete this task.

Plot of screen contents.

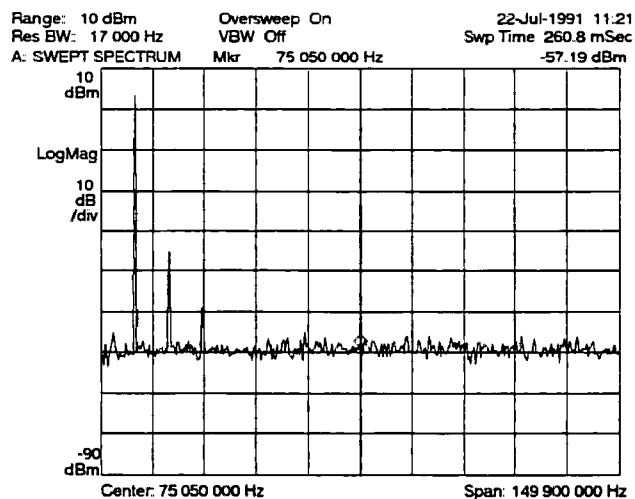



Automating Measurements

This section gives you a brief introduction to two of the analyzer's measurement automation features: limit testing, and keystroke recording. Limit testing is a standard feature that's available under the [**Marker Fctn**] hardkey. Keystroke recording is an optional feature that's available under the [**BASIC**] hardkey when you order option 1C2, HP Instrument BASIC.

To create a limit line

- 1 Press [**Marker Fctn**] [LIMIT TEST], then press [DEFINE UPPER LIM] or [DEFINE LOWER LIM].
- 2 Turn the knob to place the limit marker at the beginning of your limit line. (Press [MOVE MKR HORIZONTAL] and [MOVE MKR VERTICAL] to control the knob's effect on the marker.)
- 3 Press [START SEGMENT].
- 4 Turn the knob to place the limit marker at the end of your limit line.
- 5 Press [FINISH SEGMENT].
- 6 Press [**Marker Fctn**] or some other hardkey to exit the Define Lim menu.

This task, as written, shows you how to create a single-segment limit line. However, you can modify the task to create a multi-segment line. Just repeat steps 4 and 5 several times before completing step 6.

The limit you create is stored in the active trace's upper or lower limit register—depending on which key you press in step 1. You can evaluate a trace against the limit by enabling limit testing, as shown in the next task, "To enable limit testing."

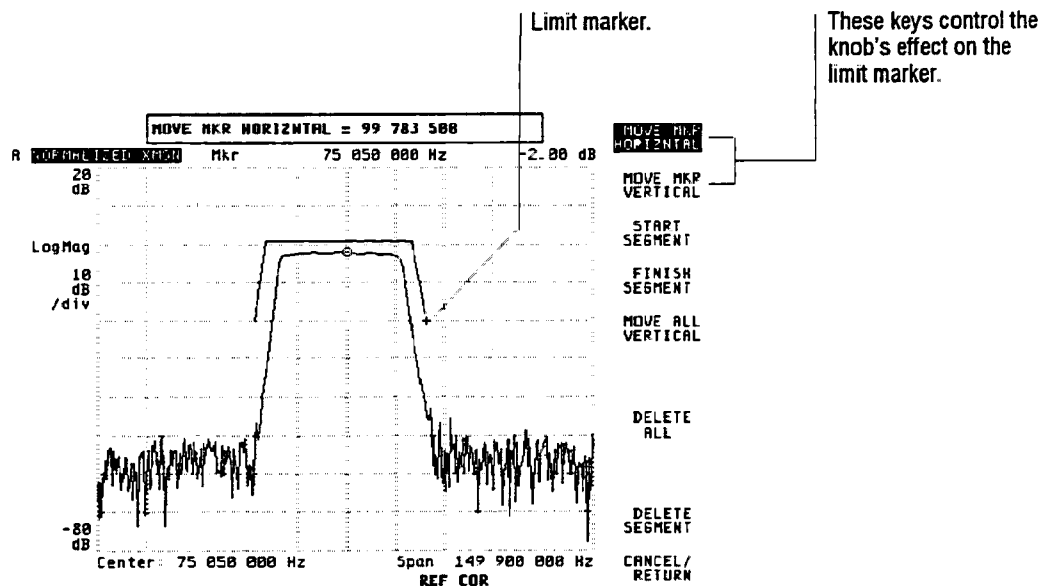

To enable limit testing

- 1 Press [**Marker Fctn**] [LIMIT TEST], then press [TEST EVAL ON/OFF] to highlight ON.
- 2 If you want the analyzer to display the limits during testing, press [LINES ON/OFF] to highlight ON.
- 3 If you want the analyzer to beep when your trace fails the limit test, press [FAIL BEEP ON/OFF] to highlight ON.

Limit testing allows the analyzer to evaluate a trace against the contents of an upper and a lower limit register. You can load the registers by defining a limit line (see "To define a limit line") or by recalling a previously defined limit from a file (use the Recall Lim softkeys under the [**Save/Recall**] hardkey).

When limit testing is enabled, the trace is evaluated each time it is updated—at the end of a measurement. If any point on the trace falls above an upper limit or below a lower limit, the trace fails the test. The results of the test are displayed in the lower-left corner of the trace area.

[BEEPER ON/OFF], located under the [**Special Fctn**] hardkey, must also be set to ON if you want the analyzer to beep when your trace fails a limit test.

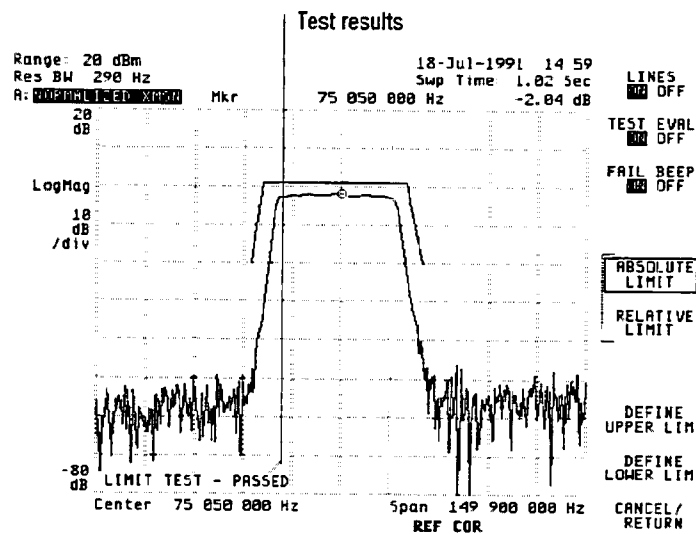

To record a measurement sequence

- 1 Press [**BASIC**] [UTILITIES] [SCRATCH] [SCRATCH].
- 2 Press [PERFORM SCRATCH].
- 3 Press [**BASIC**] [ENABLE RECORDING].
- 4 Press the keys in your measurement sequence.
- 5 Press [**BASIC**] to end recording.

When you record a measurement sequence with HP Instrument BASIC, the analyzer converts key-presses to equivalent HP-IB commands. The commands are then inserted into BASIC program lines in the analyzer's program buffer. The first two steps of this task just clear the program buffer so your measurement sequence won't be inserted into an existing program. The last three steps actually record your key-presses.

There are several things you must do if you want your recorded program to produce more consistent results. The most important is to make [**Preset**] the first key you press in step 4. [**Preset**] eliminates many unknowns by returning most analyzer parameters to their default states. To learn more, see *Using HP Instrument BASIC with the HP 3589A*.

<p>Recorded BASIC program is displayed when you press [BASIC] [EDIT].</p>	<p>HP-IB commands equivalent to your key-presses are enclosed in quotes.</p>	
<pre> 1 ASSIGN @Hp3589a TO 800 2 OUTPUT @Hp3589a "SYST: PRES" 3 OUTPUT @Hp3589a "ABDR: INIT CONT ON: *WAI" 4 OUTPUT @Hp3589a "MARK1: MAX" 5 OUTPUT @Hp3589a "MARK1: FUNC: FCO ON" 6 OUTPUT @Hp3589a "ABDR: INIT CONT ON: *WAI" 7 OUTPUT @Hp3589a "FREQ: CENT (MARK1: X: FCO? I: MARK1 X 8 OUTPUT @Hp3589a "MARK1: FUNC: FCO OFF" 9 OUTPUT @Hp3589a "INST: SEL FFT" 10 OUTPUT @Hp3589a "FREQ: SPAN 625 Hz" 11 OUTPUT @Hp3589a "ABDR: INIT CONT ON: *WAI" 12 OUTPUT @Hp3589a "DISP1: Y: AUTO ONCE" 13 OUTPUT @Hp3589a "AVER ON: AVER: TYPE RMS" 14 END </pre>	<pre> ENTER INSERT SPACE INSERT LINE DELETE LINE RECALL LINE DELETE CHARACTER TYPING UTILITIES GOTO LINE END EDIT </pre>	

To execute a recorded measurement sequence

- Press [**BASIC**] [RUN].

This task runs the program currently loaded in the analyzer's program buffer. If your program is stored on one of the analyzer's disks, you will need to load it into the buffer before running it. (You can recall programs with the [RECALL PROGRAM] softkey, located under the [**Save/Recall**] hardkey.)

Once your program is running, you can stop it by pressing one of three keys:

- Press [**BASIC**] to PAUSE the program.
- Press [**Local/HP-IB**] to STOP the program.
- Press [**Preset**] to STOP the program and preset the analyzer.

See *Using HP Instrument BASIC with the HP 3589A* for more information on pausing and stopping a program.

Index

!

- 25 ohm adapter barrel 14
- 75 ohm adapter, selecting 14

A

- active trace, selecting 16
- address
 - analyzer 10
 - plotter 11
- autoscaling 19

B

- bandwidth, resolution 30-31
- BASIC
 - recording a program 42
 - running a program 43

C

- clock, setting 12
- COR/COR? indicator 27

D

- date, setting 12
- disk
 - formatting 34
 - selecting default 13
- display
 - activating a trace 16
 - instrument state selection 20
 - plotting contents 37
 - scaling data 19
 - trace data selection 18
 - two-trace format 17

E

- entering
 - numbers 7
 - text 6

F

- file
 - recalling from disk 36
 - saving to disk 35
- formatting a disk 34
- frequency span 31

H

- help, online 3
- HP Instrument BASIC
 - recording a program 42
 - running a program 43
- HP-IB
 - analyzer address 10
 - plotter address 11

I

- impedance adapter, selecting 14
- instrument state display 20
- internal disk 13

K

- keystroke recording 42

L

limit line
 creating 40
 displaying 41
limit marker 40
limit testing 41

M

marker
 moving limit 40
 moving main 8
measurement type
 narrowband zoom 5, 24-25
 swept network 5, 26-29
 swept spectrum 5, 22-23
minimum loss pad 14

N

narrowband zoom measurement 5, 24-25
noise floor, lowering 30
nonvolatile RAM disk 13
normalized transmission measurement
26-27
numbers, entering 7

O

online help 3
OVL indicator 27

P

plotter, setting up 11
plotting screen contents 37
power switch
 HP 35689A/B 2
 HP 3589A 2
preset 4
program
 recording 42
 running 43

R

recalling a trace 36
recording keystrokes 42
reference measurement 29
resolution bandwidth 30-31
resolution, increasing 31
RNG indicator 27
running a program 43

S

S21 measurement 28-29
saving a trace 35
scaling displayed data 19
span, setting 31
state display 20
swept network measurement 5, 26-29
swept spectrum measurement 5, 22-23

T

text, typing 6
time, setting 12
trace
 activating 16
 displaying two 17
 recalling from disk 36
 saving to disk 35
 selecting data 18
trace title 6
transmission measurement
 normalized 26-27
 S21 28-29
typing text 6

V

volatile RAM disk 13

W

wideband spectrum measurement 22-23