

Keysight MIPI[®] M-PHY[®] Conformance Test Application

Methods of
Implementation

Notices

© Keysight Technologies 2020

No part of this manual may be reproduced in any form or by any means (including electronic storage and retrieval or translation into a foreign language) without prior agreement and written consent from Keysight Technologies as governed by United States and international copyright laws.

Trademarks

MIPI® service marks and logo marks are owned by MIPI Alliance, Inc. and any use of such marks by Keysight Technologies is under license. Other service marks and trade names are those of their respective owners.

Software Version

Version 02.40.0000

Edition

February 2020

Available in electronic format only

Keysight Technologies
1900 Garden of the Gods Road
Colorado Springs, CO 80907 USA

Warranty

THE MATERIAL CONTAINED IN THIS DOCUMENT IS PROVIDED "AS IS," AND IS SUBJECT TO BEING CHANGED, WITHOUT NOTICE, IN FUTURE EDITIONS. FURTHER, TO THE MAXIMUM EXTENT PERMITTED BY APPLICABLE LAW, KEYSIGHT DISCLAIMS ALL WARRANTIES, EITHER EXPRESS OR IMPLIED WITH REGARD TO THIS MANUAL AND ANY INFORMATION CONTAINED HEREIN, INCLUDING BUT NOT LIMITED TO THE IMPLIED WARRANTIES OF MERCHANTABILITY AND FITNESS FOR A PARTICULAR PURPOSE. KEYSIGHT SHALL NOT BE LIABLE FOR ERRORS OR FOR INCIDENTAL OR CONSEQUENTIAL DAMAGES IN CONNECTION WITH THE FURNISHING, USE, OR PERFORMANCE OF THIS DOCUMENT OR ANY INFORMATION CONTAINED HEREIN. SHOULD KEYSIGHT AND THE USER HAVE A SEPARATE WRITTEN AGREEMENT WITH WARRANTY TERMS COVERING THE MATERIAL IN THIS DOCUMENT THAT CONFLICT WITH THESE TERMS, THE WARRANTY TERMS IN THE SEPARATE AGREEMENT WILL CONTROL.

Technology Licenses

The hardware and/or software described in this document are furnished under a license and may be used or copied only in accordance with the terms of such license.

Restricted Rights Legend

If software is for use in the performance of a U.S. Government prime contract or subcontract, Software is delivered and licensed as "Commercial computer software" as defined in DFAR 252.227-7014 (June 1995), or as a "commercial item" as defined in FAR 2.101(a) or as "Restricted computer software" as defined in FAR 52.227-19 (June 1987) or any equivalent agency regulation or contract clause. Use, duplication or disclosure of Software is subject to Keysight Technologies' standard commercial license terms, and non-DOD Departments and Agencies of the U.S. Government will receive no greater than Restricted Rights as defined in FAR 52.227-19(c)(1-2) (June 1987). U.S. Government users will receive no greater than Limited Rights as defined in FAR

52.227-14 (June 1987) or DFAR 252.227-7015 (b)(2) (November 1995), as applicable in any technical data.

Safety Notices

CAUTION

A CAUTION notice denotes a hazard. It calls attention to an operating procedure, practice, or the like that, if not correctly performed or adhered to, could result in damage to the product or loss of important data. Do not proceed beyond a CAUTION notice until the indicated conditions are fully understood and met.

WARNING

A WARNING notice denotes a hazard. It calls attention to an operating procedure, practice, or the like that, if not correctly performed or adhered to, could result in personal injury or death. Do not proceed beyond a WARNING notice until the indicated conditions are fully understood and met.

MIPI® M-PHY® Conformance Test Application – At A Glance

The Keysight D9040MPHC MIPI M-PHY Conformance Test Application allows the testing of all MIPI devices with the Keysight Infiniium oscilloscope based on the MIPI Alliance Standard for M-PHY specification. MIPI stands for Mobile Industry Processor Interface. The MIPI alliance is a collaboration of mobile industry leader with the objective to define and promote open standards for interfaces to mobile application processors.

The MIPI M-PHY Conformance Test Application:

- Lets you select individual or multiple tests to run.
- Lets you identify the device being tested and its configuration.
- Shows you how to make oscilloscope connections to the device under test.
- Automatically checks for proper oscilloscope configuration.
- Automatically sets up the oscilloscope for each test.
- Provides detailed information for each test that has been run, and lets you specify the thresholds at which marginal or critical warnings appear.
- Creates a printable HTML report of the tests that have been run.

NOTE

The tests performed by the MIPI M-PHY Conformance Test Application are intended to provide a quick check of the electrical health of the DUT. This testing is not a replacement for an exhaustive test validation plan.

Required Equipment and Software

Required Hardware for testing

In order to run the D9040MPHC MIPI M-PHY Conformance Test Application, you need the following equipment:

- Keysight Infiniium Series Oscilloscopes

Data rate	Minimum bandwidth	Minimum Channels	Compatible oscilloscopes
Gear1 (up to 1.46 Gbps)	6 GHz	2	9000, V-Series, Z-Series, and UXR-Series
Gear2 (up to 2.92 Gbps)	12 GHz	2	9000, V-Series, Z-Series, and UXR-Series
Gear3 (up to 5.83 Gbps)	20 GHz	2	V-Series, Z-Series, and UXR-Series
Gear4 (up to 11.66 Gbps)	25 GHz	2	V-Series, Z-Series, and UXR-Series

- Other hardware, probes, and accessories

Model number	Description	Quantity
1169B	InfiniiMax II 12 GHz differential probe amplifier for PWM, G1, G2 testing	2
E2669B	Differential probe connectivity kit (contains needed probe header)	1
15443A	Matched cable pair, 2 x SMA(m) to SMA(m) cable included	1
N7010A	Active termination adopter for Gear3, Gear4 testing	2

- Keyboard, qty = 1, (provided with the Keysight Infiniium oscilloscope).
- Mouse, qty = 1, (provided with the Keysight Infiniium oscilloscope).
- Keysight also recommends using a second monitor to view the automated test application.

Required Software for testing

- Keysight D9040MPHC MIPI M-PHY Conformance Test Application software.
- The minimum version of Infiniium oscilloscope software (see the D9040MPHC test application release notes).

For the list of licenses required to run this application, refer to the Data Sheet for this application.

In This Book

This manual describes the tests that are performed by the MIPI M-PHY Conformance Test Application in more detail.

- **Chapter 1**, “Installing the MIPI M-PHY Conformance Test Application” describes how to install and license the automated test application software (if it was purchased separately).
- **Chapter 2**, “Preparing to Take Measurements” describes how to start the MIPI M-PHY Conformance Test Application and gives a brief overview of how it is used.
- **Chapter 3**, “TX Signaling and Timing Electrical Tests” contains an overview on the signaling and timing electrical tests for high-speed and low-speed (pulse-width modulation) transmitters.
- **Chapter 4**, “High-Speed Transmitter (HS-TX) Tests v3.0” describes the signaling and timing electrical tests for high-speed transmitters (HS-TX) for CTS version 3.0.
- **Chapter 5**, “High-Speed Transmitter (HS-TX) Tests v4.0 and v4.1” describes the signaling and timing electrical tests for high-speed transmitters (HS-TX) for CTS versions 4.0 and 4.1.
- **Chapter 6**, “Pulse Width Modulation (PWM-TX) Transmitter Tests” describes the signaling and timing electrical tests for low-speed pulse width modulation transmitters (PWM-TX) for CTS versions 3.0, 4.0, and 4.1.
- **Chapter 7**, “UFS Host Controller Reference Clock Tests” describes the UFS Host Controller Reference Clock (Informative) tests for CTS versions 4.0 and 4.1.
- **Chapter 8**, “Calibrating the Infiniium Oscilloscope and Probe” describes how to calibrate the oscilloscope in preparation for running the MIPI M-PHY automated tests.
- **Chapter 9**, “InfiniMax Probing” describes the probe amplifier and probe head recommendations for MIPI M-PHY conformance testing.

See Also

- The MIPI M-PHY Conformance Test Application’s online help, which describes:
 - Starting the MIPI M-PHY conformance test application.
 - Creating or opening a test project.
 - Setting up the MIPI M-PHY test environment.
 - Selecting tests.
 - Configuring selected tests.
 - Defining compliance limits.
 - Connecting the oscilloscope to the DUT.
 - Running tests.
 - Automating the application.
 - Viewing test results.
 - Viewing/exporting/printing the HTML test report.
 - Saving test projects.
 - Installing/removing add-ins.
 - Controlling the application via a remote PC.
 - Using a second monitor.

Contents

MIPI® M-PHY® Conformance Test Application – At A Glance	4
Required Equipment and Software	5
In This Book	6
1 Installing the MIPI M-PHY Conformance Test Application	
Installing the Software	20
Installing the License Key	21
Using Keysight License Manager 5	21
Using Keysight License Manager 6	22
2 Preparing to Take Measurements	
Calibrating the Oscilloscope	26
Starting the MIPI M-PHY Conformance Test Application	27
Online Help Topics	30
3 TX Signaling and Timing Electrical Tests	
Overview	32
Electrical Signaling and Timing Characteristics	36
Test availability in the Compliance Test Application	37
4 High-Speed Transmitter (HS-TX) Tests v3.0	
Probing for High-Speed Transmitter Electrical Tests	40
Test Procedure	40
Test 1.1.1 Unit Interval and Frequency Offset (f_OFFSET_TX)	42
Test Overview	42
Test ID	42
Test Availability Conditions	42
Test Modes	43
Test Procedure	43
Test Results	43
Test Reference	44

Test 1.1.2 Common-Mode AC Power Spectral Magnitude Limit (PSDCM)	45
Test Overview	45
Test ID	45
Test Availability Conditions	45
Test Modes	45
Test Procedure	45
Test Results	45
Test Reference	46
Test 1.1.3 PREPARE Length (THS-PREPARE)	47
Test Overview	47
Test ID	47
Test Availability Conditions	47
Test Modes	47
Test Procedure	47
Test Results	48
Test Reference	48
Test 1.1.4 Common-Mode DC Output Voltage Amplitude (VCM_TX)	49
Test Overview	49
Test ID	49
Test Availability Conditions	49
Test Modes	50
Test Procedure	50
Test Results	51
Test Reference	51
Test 1.1.5 Differential DC Output Voltage Amplitude (VDIF_DC_TX)	52
Test Overview	52
Test ID	52
Test Availability Conditions	52
Test Modes	52
Test Procedure	52
Test Results	53
Test Reference	53
Test 1.1.6 G1 and G2 Differential AC Eye (TEYE_TX, VDIF_AC_TX)	54
Test Overview	54
Test ID	54
Test Availability Conditions	54
Test Modes	55
Test Procedure	55
Test Results	59
Test Reference	59

Test 1.1.7 G3 Differential AC Eye (TEYE_HS_G3_TX, VDIF_AC_HS_G3_TX)	60
Test Overview	60
Test ID	60
Test Availability Conditions	60
Test Modes	61
Test Procedure	61
Test Results	65
Test Reference	65
Test 1.1.8 20% / 80% Rise and Fall Times (TR_HS_TX and TF_HS_TX)	66
Test Overview	66
Test ID	66
Test Availability Conditions	66
Test Modes	66
Test Procedure	67
Test Results	67
Test Reference	67
Test 1.1.9 Lane-to-Lane Skew (TL2L_SKEW_HS_TX)	68
Test Overview	68
Test ID	68
Test Availability Conditions	68
Test Modes	69
Test Procedure	69
Test Results	69
Test Reference	69
Test 1.1.10 Slew Rate Control Range (SRDIF_TX[MAX] and SRDIF_TX[MIN])	70
Test Overview	70
Test ID	70
Test Availability Conditions	70
Test Modes	70
Test Procedure	71
Test Results	71
Test Reference	71
Test 1.1.11 Slew Rate State Monotonicity	72
Test Overview	72
Test ID	72
Test Availability Conditions	72
Test Modes	72
Test Procedure	73
Test Results	73
Test Reference	73

Test 1.1.12 Slew Rate State Resolution (Δ SRDIF_TX) 74

- Test Overview 74
- Test ID 74
- Test Availability Conditions 74
- Test Modes 74
- Test Procedure 75
- Test Results 75
- Test Reference 75

Test 1.1.13 Intra-Lane Output Skew (TINTRA_SKEW_TX) 76

- Test Overview 76
- Test ID 76
- Test Availability Conditions 76
- Test Modes 76
- Test Procedure 76
- Test Results 77
- Test Reference 77

Test 1.1.14 Transmitter Pulse Width (TPULSE_TX) 78

- Test Overview 78
- Test ID 78
- Test Availability Conditions 78
- Test Modes 78
- Test Procedure 78
- Test Results 79
- Test Reference 79

Test 1.1.15 Total Jitter (TJTX) 80

- Test Overview 80
- Test ID 80
- Test Availability Conditions 80
- Test Modes 80
- Test Procedure 80
- Test Results 81
- Test Reference 81

Test 1.1.16 Short-Term Total Jitter (STTJTX) 82

- Test Overview 82
- Test ID 82
- Test Availability Conditions 82
- Test Modes 82
- Test Procedure 82
- Test Results 83
- Test Reference 83

Test 1.1.17 Deterministic Jitter (DJTX)	84
Test Overview	84
Test ID	84
Test Availability Conditions	84
Test Modes	84
Test Procedure	85
Test Results	86
Test Reference	86
Test 1.1.18 Short-Term Deterministic Jitter (STDJTX)	87
Test Overview	87
Test ID	87
Test Availability Conditions	87
Test Modes	87
Test Procedure	88
Test Results	88
Test Reference	88
5 High-Speed Transmitter (HS-TX) Tests v4.0 and v4.1	
 Probing for High-Speed Transmitter Electrical Tests	90
Test Procedure	90
 Test 1.1.1 Unit Interval and Frequency Offset (f_OFFSET_TX)	92
Test Overview	92
Test ID	92
Test Availability Conditions	92
Test Modes	93
Test Procedure	93
Test Results	93
Test Reference	94
 Test 1.1.2 Common-Mode AC Power Spectral Magnitude Limit (PSDCM)	95
Test Reference	95
 Test 1.1.3 PREPARE Length (THS-PREPARE)	95
Test Reference	95
 Test 1.1.4 Common-Mode DC Output Voltage Amplitude (VCM_TX)	95
Test Reference	95
 Test 1.1.5 Differential DC Output Voltage Amplitude (VDIF_DC_TX)	95
Test Reference	95

Test 1.1.6 G1 and G2 Differential AC Eye (TEYE_TX, VDIF_AC_TX)	96
Test Overview	96
Test ID	96
Test Availability Conditions	96
Test Modes	97
Test Procedure	97
Test Results	102
Test Reference	103
Test 1.1.7 G3 and G4 Differential AC Eye (TEYE_HS_G3/G4_TX, VDIF_AC_HS_G3/G4_TX)	104
Test Overview	104
Test ID	104
Test Availability Conditions	104
Test Modes	106
Test Procedure	107
Test Results	114
Test Reference	114
Test 1.1.8 20% / 80% Rise and Fall Times (TR_HS_TX and TF_HS_TX)	115
Test Availability Conditions	115
Test Reference	115
Test 1.1.9 Lane-to-Lane Skew (TL2L_SKEW_HS_TX)	116
Test Availability Conditions	116
Test Reference	117
Test 1.1.10 Slew Rate Control Range (SRDIF_TX[MAX] and SRDIF_TX[MIN])	118
Test Availability Conditions	118
Test Reference	118
Test 1.1.11 Slew Rate State Monotonicity	119
Test Availability Conditions	119
Test Reference	119
Test 1.1.12 Slew Rate State Resolution (ΔSRDIF_TX)	120
Test Availability Conditions	120
Test Reference	120
Test 1.1.13 Intra-Lane Output Skew (TINTRA_SKEW_TX)	121
Test Reference	121
Test 1.1.14 Transmitter Pulse Width (TPULSE_TX)	121
Test Availability Conditions	121
Test Reference	121

Test 1.1.15 Total Jitter (TJTX)	122
Test Overview	122
Test ID	122
Test Availability Conditions	122
Test Modes	122
Test Procedure	122
Test Results	123
Test Reference	123
Test 1.1.16 Short-Term Total Jitter (STTJTX)	124
Test Overview	124
Test ID	124
Test Availability Conditions	124
Test Modes	124
Test Procedure	124
Test Results	125
Test Reference	125
Test 1.1.17 Deterministic Jitter (DJTX)	126
Test Overview	126
Test ID	126
Test Availability Conditions	126
Test Modes	126
Test Procedure	127
Test Results	128
Test Reference	128
Test 1.1.18 Short-Term Deterministic Jitter (STDJTX)	128
Test Reference	128

6 Pulse Width Modulation (PWM-TX) Transmitter Tests

Test 1.2.1 Transmit Bit Duration (TPWM_TX)	130
Test Overview	130
Test ID	130
Test Availability Conditions	130
Test Modes	131
Test Procedure	131
Test Results	133
Test References	133

Test 1.2.2 Transmit Ratio (kPWM_TX)	134
Test Overview	134
Test ID	134
Test Availability Conditions	134
Test Modes	135
Test Procedure	136
Test Results	137
Test References	137
Test 1.2.3 PREPARE Length (TPWM-PREPARE)	138
Test Overview	138
Test ID	138
Test Availability Conditions	138
Test Modes	138
Test Procedure	138
Test Results	139
Test References	139
Test 1.2.4 Common-Mode DC Output Voltage Amplitude (VCM_TX)	140
Test Overview	140
Test ID	140
Test Availability Conditions	140
Test Modes	141
Test Procedure	141
Test Results	143
Test References	143
Test 1.2.5 Differential DC Output Voltage Amplitude (VDIF_DC_TX)	144
Test Overview	144
Test ID	144
Test Availability Conditions	144
Test Modes	144
Test Procedure	144
Test Results	145
Test References	145
Test 1.2.6 Minimum Differential AC Eye Opening (TEYE_TX)	146
Test Overview	146
Test ID	146
Test Availability Conditions	146
Test Modes	146
Test Procedure	146
Test Results	147
Test References	147

Test 1.2.7 Maximum Differential AC Output Voltage Amplitude (VDIF_AC_TX)	148
Test Overview	148
Test ID	148
Test Availability Conditions	148
Test Modes	148
Test Procedure	148
Test Results	149
Test References	149
Test 1.2.8 20% / 80% Rise and Fall Times (TR_PWM_TX and TF_PWM_TX)	150
Test Overview	150
Test ID	150
Test Availability Conditions	150
Test Modes	150
Test Procedure	151
Test Results	151
Test References	151
Test 1.2.9 Lane-to-Lane Skew (TL2L_SKEW_PWM_TX)	152
Test Overview	152
Test ID	152
Test Availability Conditions	152
Test Modes	153
Test Procedure	153
Test Results	153
Test References	153
Test 1.2.10 Transmit Bit Duration Tolerance (TOLPWM_TX, TOLPWM_G1_LR_TX)	154
Test Overview	154
Test ID	154
Test Availability Conditions	154
Test Modes	155
Test Procedure	155
Test Results	157
Test References	157
Test 1.2.11 GO Minor Duration (TPWM_MINOR_GO_TX)	158
Test Overview	158
Test ID	158
Test Availability Conditions	158
Test Modes	158
Test Procedure	159
Test Results	159
Test References	159

7 UFS Host Controller Reference Clock Tests

Reference Clock Output High Voltage (VOH)	162
Test Overview	162
Test ID	162
Test Availability Conditions	162
Test Procedure	162
Test Results	162
Test References	162
Reference Clock Output Low Voltage (VOL)	163
Test Overview	163
Test ID	163
Test Availability Conditions	163
Test Procedure	163
Test Results	163
Test References	163
Reference Clock Output Clock Rise Time (ToRise)	164
Test Overview	164
Test ID	164
Test Availability Conditions	164
Test Procedure	164
Test Results	164
Test References	164
Reference Clock Output Clock Fall Time (ToFall)	165
Test Overview	165
Test ID	165
Test Availability Conditions	165
Test Procedure	165
Test Results	165
Test References	165
Reference Clock Frequency Error (Ferror)	166
Test Overview	166
Test ID	166
Test Availability Conditions	166
Test Procedure	166
Test Results	167
Test References	167

Reference Clock Duty Cycle (Tdc)	168
Test Overview	168
Test ID	168
Test Availability Conditions	168
Test Procedure	168
Test Results	168
Test References	168
Reference Clock Phase Noise (N)	169
Test Overview	169
Test ID	169
Test Availability Conditions	169
Test Procedure	169
Test Results	169
Test References	169
Reference Clock Noise Floor Density (Ndensity)	170
Test Overview	170
Test ID	170
Test Availability Conditions	170
Test Procedure	170
Test Results	170
Test References	170
8 Calibrating the Infiniium Oscilloscope and Probe	
Required Equipment for Oscilloscope Calibration	172
Internal Calibration	173
Required Equipment for Probe Calibration	176
Probe Calibration	177
Connecting the Probe for Calibration	177
Verifying the Connection	179
Running the Probe Calibration and Deskew	181
Verifying the Probe Calibration	184

9 InfiniiMax Probing

1 Installing the MIPI M-PHY Conformance Test Application

Installing the Software / 20
Installing the License Key / 21

If you purchased the D9040MPHC MIPI M-PHY Conformance Test Application separately, you must install the software and license key.

Installing the Software

- 1 Make sure you have the minimum version of Infiniium oscilloscope software (see the D9040MPHC test application release notes) by selecting **Help>About Infiniium...** from the main menu.
- 2 To obtain the MIPI M-PHY Conformance Test Application, go to Keysight web site: <http://www.keysight.com/en/pc-1152185/oscilloscope-software>.
- 3 Navigate to the MIPI M-PHY Conformance Test Application software download.
- 4 Follow the instructions to download and install the application software.

Installing the License Key

For the list of licenses required to run this application, refer to the Data Sheet for this application.

To procure a license, you require the Host ID information that is displayed in the Keysight License Manager application installed on the same machine where you wish to install the license.

Using Keysight License Manager 5

To view and copy the Host ID from Keysight License Manager 5:

- 1 Launch Keysight License Manager on your machine, where you wish to run the Test Application and its features.
- 2 Copy the Host ID that appears on the top pane of the application. Note that x indicates numeric values.

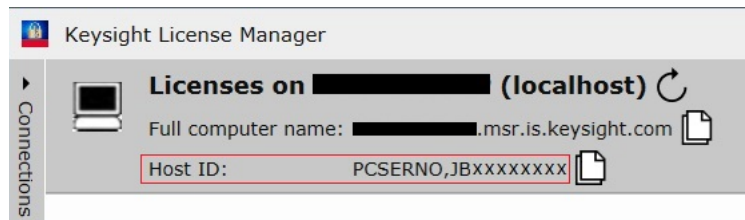

Figure 1 Viewing the Host ID information in Keysight License Manager 5

To install one of the procured licenses using Keysight License Manager 5 application,

- 1 Save the license files on the machine, where you wish to run the Test Application and its features.
- 2 Launch Keysight License Manager.
- 3 From the configuration menu, use one of the options to install each license file.

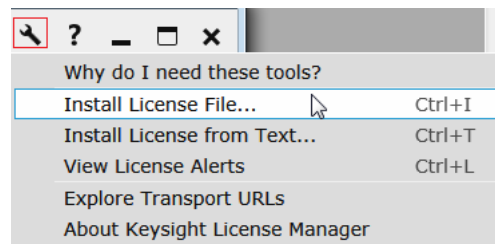

Figure 2 Configuration menu options to install licenses on Keysight License Manager 5

For more information regarding installation of procured licenses on Keysight License Manager 5, refer to [Keysight License Manager 5 Supporting Documentation](#).

Using Keysight License Manager 6

To view and copy the Host ID from Keysight License Manager 6:

- 1 Launch Keysight License Manager 6 on your machine, where you wish to run the Test Application and its features.
- 2 Copy the Host ID, which is the first set of alphanumeric value (as highlighted in Figure 3) that appears in the Environment tab of the application. Note that x indicates numeric values.

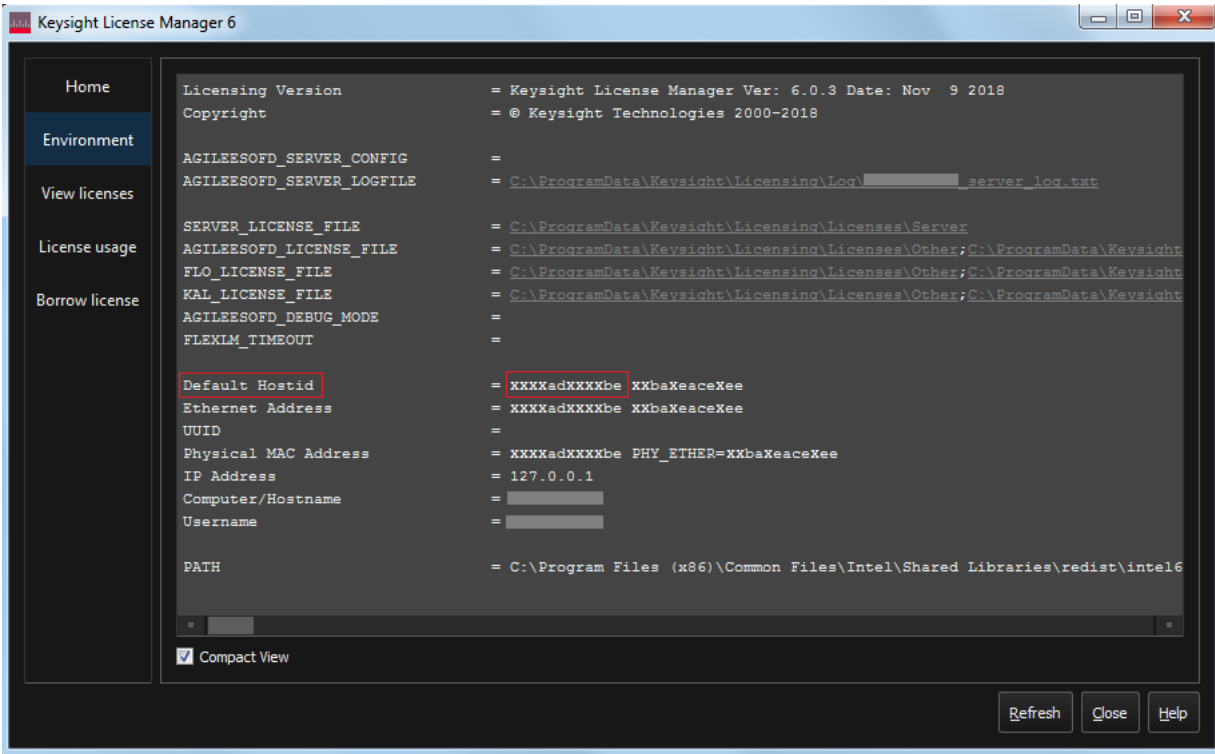

Figure 3 Viewing the Host ID information in Keysight License Manager 6

To install one of the procured licenses using Keysight License Manager 6 application,

- 1 Save the license files on the machine, where you wish to run the Test Application and its features.
- 2 Launch Keysight License Manager 6.
- 3 From the Home tab, use one of the options to install each license file.

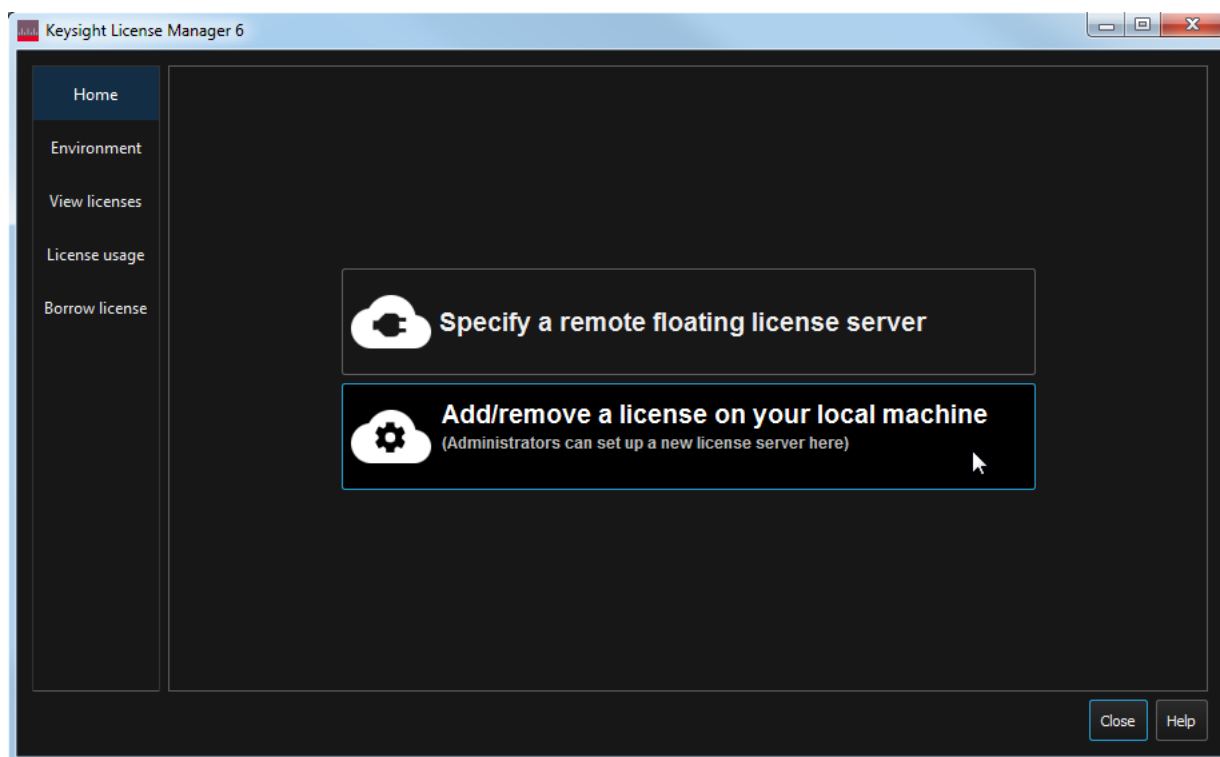

Figure 4 Home menu options to install licenses on Keysight License Manager 6

For more information regarding installation of procured licenses on Keysight License Manager 6, refer to [Keysight License Manager 6 Supporting Documentation](#).

2 Preparing to Take Measurements

Calibrating the Oscilloscope / 26

Starting the MIPI M-PHY Conformance Test Application / 27

Before running the MIPI M-PHY automated tests, you should calibrate the oscilloscope and probe. No test fixture is required for this MIPI M-PHY application. After the oscilloscope and probe have been calibrated, you are ready to start the MIPI M-PHY Conformance Test Application and perform the measurements.

Calibrating the Oscilloscope

- If you have not already calibrated the oscilloscope and probe, see [Chapter 8](#), “Calibrating the Infiniium Oscilloscope and Probe.”

NOTE

If the ambient temperature changes more than 5 degrees Celsius from the calibration temperature, internal calibration should be performed again. The delta between the calibration temperature and the present operating temperature is shown in the Utilities>Calibration menu.

NOTE

If you switch cables between channels or other oscilloscopes, it is necessary to perform cable and probe calibration again. Keysight recommends that, once calibration is performed, you label the cables with the channel on which they were calibrated.

Starting the MIPI M-PHY Conformance Test Application

From the Infiniium oscilloscope's main menu, click **Analyze>Automated Test Apps>D9040MPHC MIPI M-PHY Test App**.

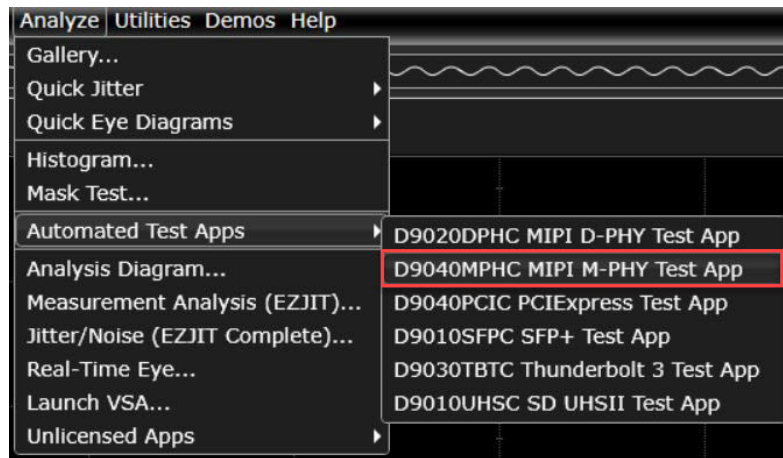

Figure 5 Starting the MIPI M-PHY Conformance Test Application

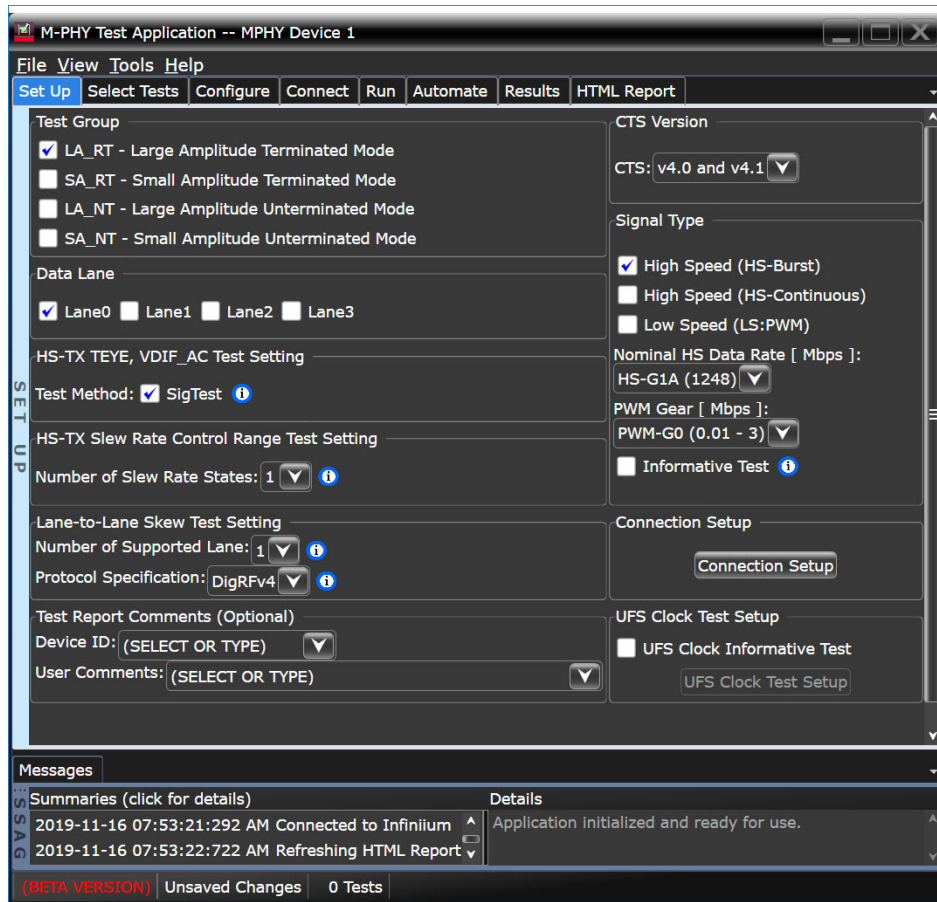

Figure 6 MIPI M-PHY Test Application main window

NOTE

If the D9040MPHC MIPI M-PHY Test App does not appear in the Automated Test Apps menu, the MIPI M-PHY Conformance Test Application has not been installed (see [Chapter 1](#), “Installing the MIPI M-PHY Conformance Test Application”).

[Figure 5](#) shows the procedure to launch the MIPI M-PHY Conformance Test Application and [Figure 6](#) shows the MIPI M-PHY Conformance Test Application main window. The tabs in the main pane show the steps you take in running the automated tests:

Tab	Description
Set Up	Lets you identify and set up the test environment, including information about the device under test.
Select Tests	Lets you select the tests you want to run. The tests are organized hierarchically so you can select all tests in a group. After tests are run, status indicators show which tests have passed, failed, or not been run, and there are indicators for the test groups.
Configure	Lets you configure test parameters. This information appears in the HTML report.
Connect	Shows you how to connect the oscilloscope to the device under test for the tests to be run.
Run Tests	Starts the automated tests. If the connections to the device under test need to be changed while multiple tests are running, the tests pause, show you how to change the connection, and wait for you to confirm that the connections have been changed before continuing.
Automation	Lets you construct scripts of commands that drive execution of the application.
Results	Contains more detailed information about the tests that have been run. You can change the thresholds at which marginal or critical warnings appear.
HTML Report	Shows a compliance test report that can be printed.

NOTE

The configuration options shown under the Set Up tab of the MIPI M-PHY Conformance Test Application main window dictate the availability of various tests. You may have to select more than one configuration option to make some tests available, else they appear unavailable/disabled. To know more about the configurable options under the Set Up tab that must be selected for each test, refer to the section, “Test Availability Conditions” under each test.

Online Help Topics

For information on using the MIPI M-PHY Conformance Test Application, see its online help (which you can access by choosing **Help>Contents...** from the application's main menu).

The MIPI M-PHY Conformance Test Application's online help describes:

- Starting the MIPI M-PHY Conformance Test Application.
- Creating or opening a test project.
- Setting up the MIPI M-PHY test environment.
- Selecting tests.
- Configuring selected tests.
- Defining compliance limits.
- Connecting the oscilloscope to the device under test (DUT).
- Running tests.
- Automating the application.
- Viewing test results.
- Viewing/exporting/printing the HTML test report.
- Saving test projects.
- Installing/removing add-ins.
- Controlling the application via a remote PC.
- Using a second monitor.

3 TX Signaling and Timing Electrical Tests

Overview / 32

Electrical Signaling and Timing Characteristics / 36

The Keysight D9040MPHC MIPI M-PHY Conformance Test Application enables compliance testing of the High-Speed Transmitter (HS-TX) and Pulse Width Modulation Transmitter (PWM-TX), in adherence to the MIPI M-PHY specifications.

Overview

Some important aspects of the MIPI M-PHY specifications are:

- Improved power efficiency through:
 - BURST mode operation.
 - Multiple modes of transmission, applied over a large range of data rates, using various schemes for bit signaling and clocking for different ranges of bandwidth.
 - Multiple power saving modes, by trading-off of power consumption against recovery time.
- Use of multiple transmission speed ranges/rates per BURST mode to scale down bandwidth according to the needs of the application and to mitigate any problems due to interference. The high-speed mode has a fixed rate of transmission whereas the low-speed mode has flexible rates of transmission within a bandwidth range.
- Use of Symbol coding (8b10b) for spectral conditioning, clock recovery, and in-band control options for both PHY and Protocol Layers.
- Modification in clocking schemes such that M-PHY operates with independent local reference clocks on either side (both ends of the transmitter and receiver) and also derives benefits of a shared reference clock.
- Enabling Optical transmission through a low-complexity system for electro-optical signal conversion for optical data transport within interconnection between various MODULES.
- Increase in Signal Transmission Distance by optimizing M-PHY, for data transport within short interconnects (that are less than 10 centimeters) but also extending transmission up to a meter using a good quality interconnecting device or even to a further distance using optical converters and optical waveguides.
- Easy configuration with differences in supported functionality (to reduce cost) and the ability to tune for best performance (for better implementation) without hampering interoperability.

For CTS versions 4.0 and 4.1, refer to the M-PHY Specification v4.1 (01Dec2016). (See [Table 1](#))

Table 1 Transmitter Electrical Signaling and Timing Tests and corresponding MIPI M-PHY Standard Reference

Test Name	Standard Reference (M-PHY Physical Layer Conformance Test Suite)
“Test 1.1.1 Unit Interval and Frequency Offset (f_OFFSET_TX)” on page 92	CTSv4.1
“Test 1.1.2 Common-Mode AC Power Spectral Magnitude Limit (PSDCM)” on page 95	Informative Test
“Test 1.1.3 PREPARE Length (THS-PREPARE)” on page 95	CTSv4.1
“Test 1.1.4 Common-Mode DC Output Voltage Amplitude (VCM_TX)” on page 95	CTSv4.1
“Test 1.1.5 Differential DC Output Voltage Amplitude (VDIF_DC_TX)” on page 95	CTSv4.1
“Test 1.1.6 G1 and G2 Differential AC Eye (TEYE_TX, VDIF_AC_TX)” on page 96	CTSv4.1 [For Test IDs 801, 701, 1821, 1721] Informative Test [For Test IDs 841, 741, 1841, 1741]
“Test 1.1.7 G3 and G4 Differential AC Eye (TEYE_HS_G3/G4_TX, VDIF_AC_HS_G3/G4_TX)” on page 104	CTSv4.1 [For Test IDs 802, 702, 1822, 1823, 1722, 1843, 1844, 1743] Informative Test [For Test IDs 842, 742, 1842, 1742, 1845, 1846, 1745]
“Test 1.1.8 20% / 80% Rise and Fall Times (TR_HS_TX and TF_HS_TX)” on page 115	CTSv4.1
“Test 1.1.9 Lane-to-Lane Skew (TL2L_SKEW_HS_TX)” on page 116	CTSv4.1

Test Name	Standard Reference (M-PHY Physical Layer Conformance Test Suite)
“Test 1.1.10 Slew Rate Control Range (SRDIF_TX[MAX] and SRDIF_TX[MIN])” on page 118	CTSv4.1
“Test 1.1.11 Slew Rate State Monotonicity” on page 119	CTSv4.1
“Test 1.1.12 Slew Rate State Resolution (Δ SRDIF_TX)” on page 120	CTSv4.1
“Test 1.1.13 Intra-Lane Output Skew (TINTRA_SKEW_TX)” on page 121	CTSv4.1
“Test 1.1.14 Transmitter Pulse Width (TPULSE_TX)” on page 121	CTSv4.1
“Test 1.1.15 Total Jitter (TJTX)” on page 122	CTSv4.1
“Test 1.1.16 Short-Term Total Jitter (STTJTX)” on page 124	CTSv4.1
“Test 1.1.17 Deterministic Jitter (DJTX)” on page 126	CTSv4.1
“Test 1.1.18 Short-Term Deterministic Jitter (STDJTX)” on page 128	CTSv4.1
“Test 1.2.1 Transmit Bit Duration (TPWM_TX)” on page 130	CTSv4.1
“Test 1.2.2 Transmit Ratio (kPWM_TX)” on page 134	CTSv4.1
“Test 1.2.3 PREPARE Length (TPWM-PREPARE)” on page 138	CTSv4.1
“Test 1.2.4 Common-Mode DC Output Voltage Amplitude (VCM_TX)” on page 140	CTSv4.1
“Test 1.2.5 Differential DC Output Voltage Amplitude (VDIF_DC_TX)” on page 144	CTSv4.1
“Test 1.2.6 Minimum Differential AC Eye Opening (TEYE_TX)” on page 146	CTSv4.1
“Test 1.2.7 Maximum Differential AC Output Voltage Amplitude (VDIF_AC_TX)” on page 148	CTSv4.1
“Test 1.2.8 20% / 80% Rise and Fall Times (TR_PWM_TX and TF_PWM_TX)” on page 150	CTSv4.1
“Test 1.2.9 Lane-to-Lane Skew (TL2L_SKEW_PWM_TX)” on page 152	CTSv4.1
“Test 1.2.10 Transmit Bit Duration Tolerance (TOLPWM_TX, TOLPWM_G1_LR_TX)” on page 154	CTSv4.1
“Test 1.2.11 G0 Minor Duration (TPWM_MINOR_G0_TX)” on page 158	CTSv4.1

For the UFS Host Controller Reference Clock (Informative) tests, refer to the JEDEC Universal Flash Storage (UFS) v3.0 specification (Jan2018). (See [Table 2](#))

Table 2 UFS Host Controller Reference Clock Tests and corresponding JEDEC UFS v3.0 Specification Reference

Test Name	Standard Reference (JEDEC Universal Flash Storage (UFS) specification)
“Reference Clock Output High Voltage (VOH)” on page 162	Informative Test
“Reference Clock Output Low Voltage (VOL)” on page 163	Informative Test
“Reference Clock Output Clock Rise Time (ToRise)” on page 164	Informative Test

Test Name	Standard Reference (JEDEC Universal Flash Storage (UFS) specification)
“Reference Clock Output Clock Fall Time (ToFall)” on page 165	Informative Test
“Reference Clock Frequency Error (Ferror)” on page 166	Informative Test
“Reference Clock Duty Cycle (Tdc)” on page 168	Informative Test
“Reference Clock Phase Noise (N)” on page 169	Informative Test
“Reference Clock Noise Floor Density (Ndensity)” on page 170	Informative Test

For CTS version 3.0, see [Table 3](#) to refer to the respective MIPI M-PHY Conformance Test Suite (CTS) versions for each of the tests.

Table 3 Transmitter Electrical Signaling and Timing Tests and corresponding MIPI M-PHY Standard Reference (CTS v3.0)

Test Name	Standard Reference (M-PHY Physical Layer Conformance Test Suite)
“Test 1.1.1 Unit Interval and Frequency Offset (f_OFFSET_TX)” on page 42	CTSv3.00r15
“Test 1.1.2 Common-Mode AC Power Spectral Magnitude Limit (PSDCM)” on page 45	CTSv3.00r15
“Test 1.1.3 PREPARE Length (THS-PREPARE)” on page 47	CTSv3.00r15
“Test 1.1.4 Common-Mode DC Output Voltage Amplitude (VCM_TX)” on page 49	CTSv3.00r15
“Test 1.1.5 Differential DC Output Voltage Amplitude (VDIF_DC_TX)” on page 52	CTSv3.00r15
“Test 1.1.6 G1 and G2 Differential AC Eye (TEYE_TX, VDIF_AC_TX)” on page 54	CTSv3.0r18 [For Test IDs 801, 701, 1821, 1721] Informative Test [For Test IDs 841, 741, 1841, 1741]
“Test 1.1.7 G3 Differential AC Eye (TEYE_HS_G3_TX, VDIF_AC_HS_G3_TX)” on page 60	CTSv3.0r18 [For Test IDs 802, 702, 1822, 1823, 1722] Informative Test [For Test IDs 842, 742, 1842, 1742]
“Test 1.1.8 20% / 80% Rise and Fall Times (TR_HS_TX and TF_HS_TX)” on page 66	CTSv3.00r15
“Test 1.1.9 Lane-to-Lane Skew (TL2L_SKEW_HS_TX)” on page 68	CTSv3.00r15
“Test 1.1.10 Slew Rate Control Range (SRDIF_TX[MAX] and SRDIF_TX[MIN])” on page 70	CTSv3.00r15
“Test 1.1.11 Slew Rate State Monotonicity” on page 72	CTSv3.00r15
“Test 1.1.12 Slew Rate State Resolution (Δ SRDIF_TX)” on page 74	CTSv3.00r15
“Test 1.1.13 Intra-Lane Output Skew (TINTRA_SKEW_TX)” on page 76	CTSv3.00r15
“Test 1.1.14 Transmitter Pulse Width (TPULSE_TX)” on page 78	CTSv3.00r15
“Test 1.1.15 Total Jitter (TJTX)” on page 80	CTSv3.0r18 (11Dec2014)
“Test 1.1.16 Short-Term Total Jitter (STTJTX)” on page 82	CTSv3.0r18 (11Dec2014)
“Test 1.1.17 Deterministic Jitter (DJTX)” on page 84	CTSv3.0r18 (11Dec2014)

Test Name	Standard Reference (M-PHY Physical Layer Conformance Test Suite)
“Test 1.1.18 Short-Term Deterministic Jitter (STDJTX)” on page 87	CTSV3.0r18 (11Dec2014)
“Test 1.2.1 Transmit Bit Duration (TPWM_TX)” on page 130	CTSV3.00r15
“Test 1.2.2 Transmit Ratio (kPWM_TX)” on page 134	CTSV3.00r15
“Test 1.2.3 PREPARE Length (TPWM-PREPARE)” on page 138	CTSV3.00r15
“Test 1.2.4 Common-Mode DC Output Voltage Amplitude (VCM_TX)” on page 140	CTSV3.00r15
“Test 1.2.5 Differential DC Output Voltage Amplitude (VDIF_DC_TX)” on page 144	CTSV3.00r15
“Test 1.2.6 Minimum Differential AC Eye Opening (TEYE_TX)” on page 146	CTSV3.00r15
“Test 1.2.7 Maximum Differential AC Output Voltage Amplitude (VDIF_AC_TX)” on page 148	CTSV3.00r15
“Test 1.2.8 20% / 80% Rise and Fall Times (TR_PWM_TX and TF_PWM_TX)” on page 150	CTSV3.00r15
“Test 1.2.9 Lane-to-Lane Skew (TL2L_SKEW_PWM_TX)” on page 152	CTSV3.00r15
“Test 1.2.10 Transmit Bit Duration Tolerance (TOLPWM_TX, TOLPWM_G1_LR_TX)” on page 154	CTSV3.00r15
“Test 1.2.11 G0 Minor Duration (TPWM_MINOR_G0_TX)” on page 158	CTSV3.00r15

Electrical Signaling and Timing Characteristics

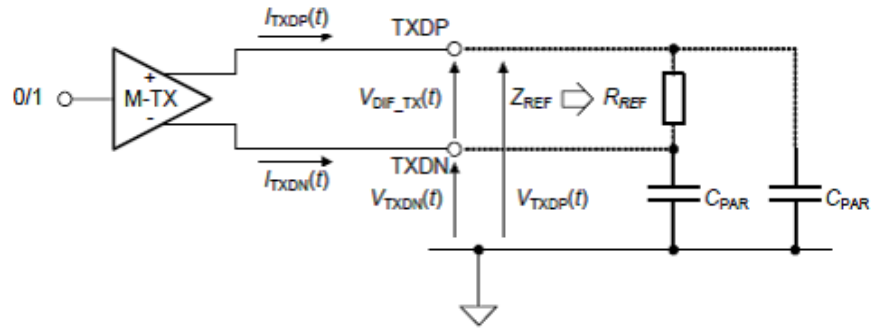

Figure 7 An M-TX Circuit Diagram showing PIN voltages, PIN currents and Reference Loads

Figure 7 shows the M-TX Circuit Diagram. The common signaling and timing characteristics, including the PIN and signal definitions of an M-TX are:

- The common M-TX characteristics apply to the HS-TX, PWM-TX and SYS-TX FUNCTIONS, which refer to the various operating modes of M-PHY; that is, High Speed mode, Low Speed mode and System mode, respectively.
- The M-TX drives a differential output signal with a low voltage through PINS TXDP and TXDN, either into a terminated or an unterminated load; where TXDP and TXDN are the positive and negative output PINS respectively. The low voltage swing of the differential signal, driven by M-TX, has either a large amplitude or a small amplitude. The amplitude of the signal doubles when the M-TX drives the signal into an unterminated load as compared to when the signal is driven through a terminated load.

Figure 8 shows the differential output signals with large and small amplitudes for the terminated and unterminated states. All single-ended voltage levels are relative to the ground voltage on the M-TX.

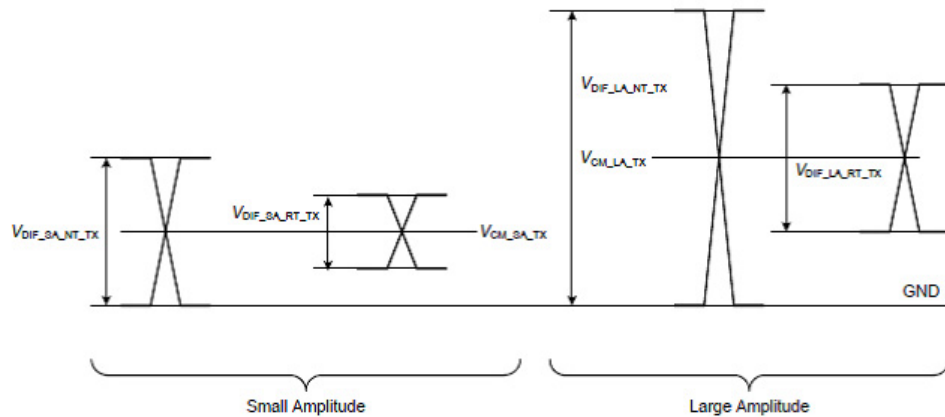

Figure 8 M-TX Signal Levels

Test availability in the Compliance Test Application

In the Keysight D9040MPHC MIPI M-PHY Conformance Test Application, the settings of some of the configurable options affect the availability of tests. Some tests are affected when the settings for more than one configurable options are changed, such that even if one of the options causes a test to be disabled, that test will be unavailable. The configurable options that affect the M-PHY tests in the Compliance Test Application are:

- 1 CTS
- 2 Test Group
 - a LA_RT
 - b SA_RT
 - c LA_NT
 - d SA_NT
- 3 Signal Type
 - a HS Burst
 - b HS Continuous
 - c LS PWM
- 4 Nominal HS Data Rate [Mbps]
- 5 PWM Gear [Mbps]
- 6 Test Method - SigTest
- 7 Number of Supported Lane
- 8 Protocol Specification
- 9 Number of Slew Rate States
- 10 Informative Test
- 11 Probing Method
 - a Active Probe (Differential Probe)
 - b Active Probe (Active Termination Adapter)
 - c Active Probe (Active Termination Adapter) [Manual]
 - d Direct Connect
- 12 Connection Type
 - a Single-Ended
 - b Differential
- 13 UFS Clock Informative Test

To know more about the affect of the configurable options on the Test IDs for specific tests, refer to the “Test Availability” section under each test in the following chapters of this MOI document.

Figure 9 shows the various configurable options in the **Set Up** tab.

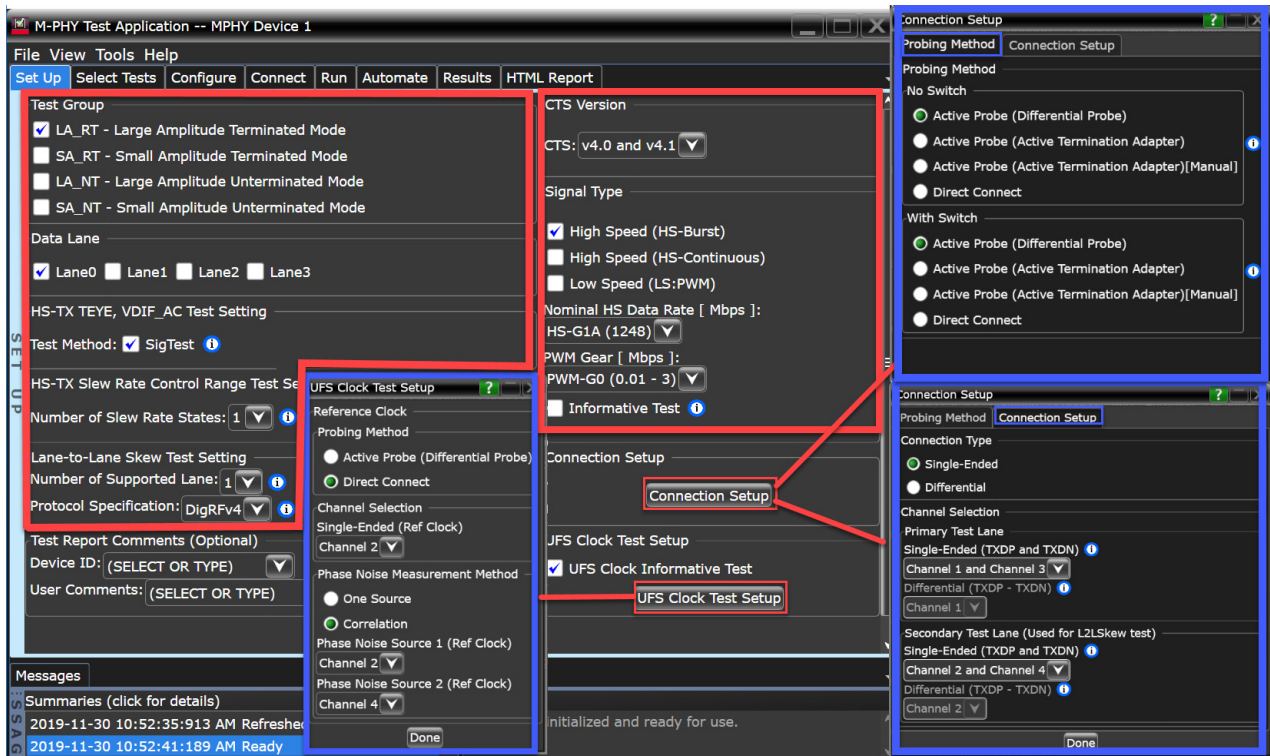

Figure 9 Configurable options in the Set Up tab

4 High-Speed Transmitter (HS-TX) Tests v3.0

Probing for High-Speed Transmitter Electrical Tests	/ 40
Test 1.1.1 Unit Interval and Frequency Offset (f_OFFSET_TX)	/ 42
Test 1.1.2 Common-Mode AC Power Spectral Magnitude Limit (PSDCM)	/ 45
Test 1.1.3 PREPARE Length (THS-PREPARE)	/ 47
Test 1.1.4 Common-Mode DC Output Voltage Amplitude (VCM_TX)	/ 49
Test 1.1.5 Differential DC Output Voltage Amplitude (VDIF_DC_TX)	/ 52
Test 1.1.6 G1 and G2 Differential AC Eye (TEYE_TX, VDIF_AC_TX)	/ 54
Test 1.1.7 G3 Differential AC Eye (TEYE_HS_G3_TX, VDIF_AC_HS_G3_TX)	/ 60
Test 1.1.8 20% / 80% Rise and Fall Times (TR_HS_TX and TF_HS_TX)	/ 66
Test 1.1.9 Lane-to-Lane Skew (TL2L_SKEW_HS_TX)	/ 68
Test 1.1.10 Slew Rate Control Range (SRDIF_TX[MAX] and SRDIF_TX[MIN])	/ 70
Test 1.1.11 Slew Rate State Monotonicity	/ 72
Test 1.1.12 Slew Rate State Resolution (Δ SRDIF_TX)	/ 74
Test 1.1.13 Intra-Lane Output Skew (TINTRA_SKEW_TX)	/ 76
Test 1.1.14 Transmitter Pulse Width (TPULSE_TX)	/ 78
Test 1.1.15 Total Jitter (TJTX)	/ 80
Test 1.1.16 Short-Term Total Jitter (STTJTX)	/ 82
Test 1.1.17 Deterministic Jitter (DJTX)	/ 84
Test 1.1.18 Short-Term Deterministic Jitter (STDJTX)	/ 87

This section provides the Methods of Implementation (MOIs) for the signaling and timing electrical tests for high-speed transmitters (HS-TX) using an Keysight Infiniium oscilloscope, InfiniiumMax probes, and the MIPI M-PHY Conformance Test Application.

Probing for High-Speed Transmitter Electrical Tests

When performing the HS Tx tests, the MIPI M-PHY Conformance Test Application prompts you to make the proper connections, if you have not already done so. The connections for the HS Tx tests may look similar to the following diagram. Refer to the Connect tab in the MIPI M-PHY Conformance Test Application for the exact number of probe connections.

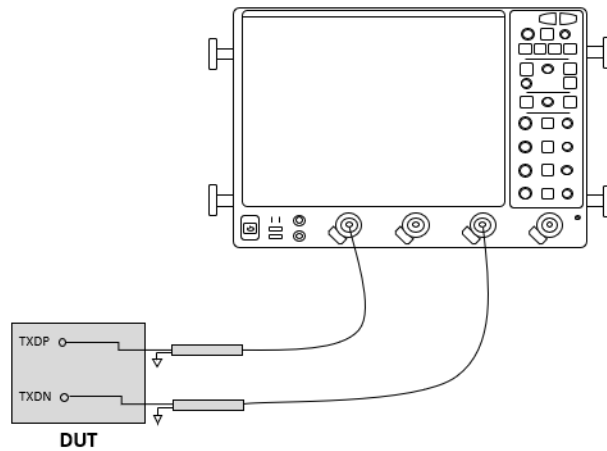

Figure 10 Probing for High-Speed Transmitter Electrical Tests

You can identify the channels used for each signal in the **Configure** tab of the MIPI M-PHY Conformance Test Application. (The channels shown in [Figure 10](#) are just examples).

For more information on the probe amplifiers and probe heads, see [Chapter 9](#), “InfiniiMax Probing,” starting on page 187.

Test Procedure

- 1 Start the automated test application as described in [“Starting the MIPI M-PHY Conformance Test Application”](#) on page 27.
- 2 In the MIPI M-PHY Conformance Test Application, click the **Set Up** tab.
- 3 Select the Test Group, and then enter the Device ID.
- 4 Click the **Select Tests** tab and check the tests you want to run. Check the parent node or group to check all the available tests within the group.

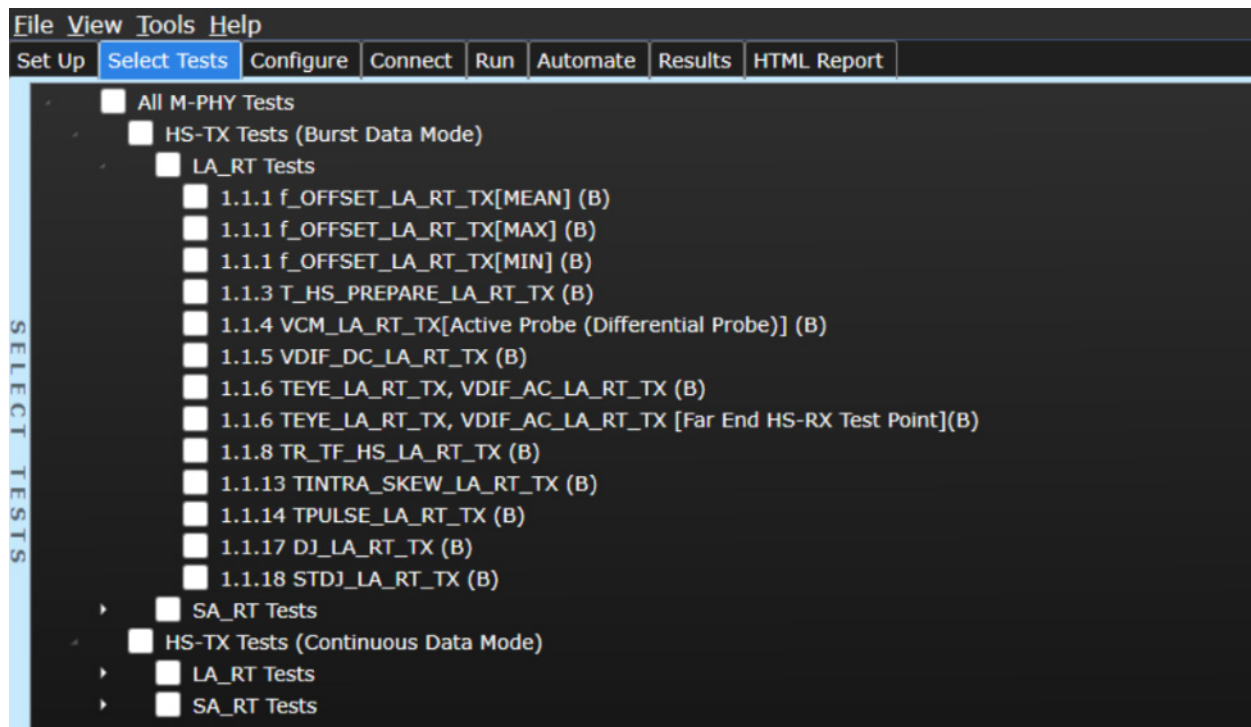

Figure 11 Selecting High-Speed Transmitter Electrical Tests

- 5 Follow the MIPI M-PHY Conformance Test Application's task flow to set up the configuration options, run the tests, and view the tests results.

Test 1.1.1 Unit Interval and Frequency Offset ($f_{\text{OFFSET_TX}}$)

Test Overview

The purpose of the Unit Interval and Frequency Offset ($f_{\text{OFFSET_TX}}$) test is to verify that the Frequency Offset ($f_{\text{OFFSET_TX}}$) of the HS-TX of the DUT is within the conformance limits of the MIPI M-PHY standard specification.

Test ID

- 817 [1.1.1 $f_{\text{OFFSET_LA_RT_TX}}$ [MEAN] (B)]
- 827 [1.1.1 $f_{\text{OFFSET_LA_RT_TX}}$ [MAX] (B)]
- 828 [1.1.1 $f_{\text{OFFSET_LA_RT_TX}}$ [MIN] (B)]
- 717 [1.1.1 $f_{\text{OFFSET_SA_RT_TX}}$ [MEAN] (B)]
- 727 [1.1.1 $f_{\text{OFFSET_SA_RT_TX}}$ [MAX] (B)]
- 728 [1.1.1 $f_{\text{OFFSET_SA_RT_TX}}$ [MIN] (B)]
- 1817 [1.1.1 $f_{\text{OFFSET_LA_RT_TX}}$ [MEAN] (C)]
- 1827 [1.1.1 $f_{\text{OFFSET_LA_RT_TX}}$ [MAX] (C)]
- 1828 [1.1.1 $f_{\text{OFFSET_LA_RT_TX}}$ [MIN] (C)]
- 1717 [1.1.1 $f_{\text{OFFSET_SA_RT_TX}}$ [MEAN] (C)]
- 1727 [1.1.1 $f_{\text{OFFSET_SA_RT_TX}}$ [MAX] (C)]
- 1728 [1.1.1 $f_{\text{OFFSET_SA_RT_TX}}$ [MIN] (C)]

Test Availability Conditions

Table 4 shows the options on the MIPI M-PHY Conformance Test Application, which are available for you to configure, for the Test IDs associated with the Unit Interval and Frequency Offset ($f_{\text{OFFSET_TX}}$) test.

Table 4 Test Availability Conditions for the Unit Interval and Frequency Offset test

Test ID	Configurable Options						
	Test Group				Signal Type		
	LA_RT	SA_RT	LA_NT	SA_NT	HS BURST	HS Continuous	LS PWM
817	✓	×	×	×	✓	×	×
827	✓	×	×	×	✓	×	×
828	✓	×	×	×	✓	×	×
717	×	✓	×	×	✓	×	×
727	×	✓	×	×	✓	×	×
728	×	✓	×	×	✓	×	×
1817	✓	×	×	×	×	✓	×
1827	✓	×	×	×	×	✓	×
1828	✓	×	×	×	×	✓	×

Test ID	Configurable Options						
	Test Group				Signal Type		
	LA_RT	SA_RT	LA_NT	SA_NT	HS BURST	HS Continuous	LS PWM
1717	x	✓	x	x	x	✓	x
1727	x	✓	x	x	x	✓	x
1728	x	✓	x	x	x	✓	x

Test Modes

- HS BURST
- HS Continuous

Test Procedure

- 1 Trigger the DIF-P (or DIF-N) region on the HS Burst data signal to acquire a test waveform. On an HS Continuous signal, a test waveform triggers automatically without searching for the DIF-P (or DIF-N) region.
- 2 A differential signal is generated for TXDP and TXDN, which is used for processing of data.
- 3 Use the **Unit Interval** feature on the Infiniium Oscilloscope to measure the UI data of the differential test signal.
- 4 To filter the measured UI data, apply a 2nd order Butterworth low pass test filter of 2.0 MHz bandwidth.
- 5 Determine the maximum, minimum and mean values of the Unit Interval from the array of the filtered Unit Interval data.
- 6 Use the following equation to calculate the Frequency Offset ($f_{\text{OFFSET_TX}}$) in units of ppm, for the final test result:

$$f_{\text{OFFSET_TX}} = [1/\text{UI} - \text{DR}_{\text{HS}}] / [\text{DR}_{\text{HS}} / 1\text{E}6]$$

where, DR_{HS} is the nominal TX bit rate for the HS RATE and GEAR data, as shown in [Table 5](#).

Table 5 HS-BURST RATE Series and GEARS

RATE A-Series (Mbps)	RATE B-Series (Mbps)	High-Speed GEARS
1248	1457.6*	HS-G1 (A/B)
2496	2915.2*	HS-G2 (A/B)
4992	5830.4*	HS-G3 (A/B)

* The B-Series RATEs shown are not integer multiples of common reference frequencies 19.20 MHz or 26.00 MHz. Instead, these RATEs are within the tolerance range of 2000 ppm.

Test Results

The calculated value for $f_{\text{OFFSET_TX}}$ of the test signal must be within the conformance limit as specified in the CTS Specification mentioned under the References section.

Test Reference

Refer to Test 1.1.1 of the M-PHY Physical Layer Conformance Test Suite v3.0r15 (24July2014).

Test 1.1.2 Common-Mode AC Power Spectral Magnitude Limit (PS_{DCM})

Test Overview

The purpose of the Common-Mode AC Power Spectral Magnitude Limit (PS_{DCM}) test is to verify that the Common-Mode AC Power Spectral Magnitude of the HS-TX of the DUT is within the conformance limits of the MIPI M-PHY standard specification.

Test ID

- 816 [1.1.2 PSDCM_LA_RT_TX (B)]
- 716 [1.1.2 PSDCM_SA_RT_TX (B)]

Test Availability Conditions

Table 6 shows the options on the MIPI M-PHY Conformance Test Application, which are available for you to configure, for the Test IDs associated with the Common-Mode AC Power Spectral Magnitude Limit (PS_{DCM}) test.

Table 6 Test Availability Conditions for the Common-Mode AC Power Spectral Magnitude Limit test*

Test ID	Configurable Options												
	Test Group				Signal Type			HS Data Rate			Informative Test		
	LA_RT	SA_RT	LA_NT	SA_NT	HS BURST	HS Continuous	LS PWM	Gear 1 Rates [<=1.5] Gbps	Gear 2 Rates [1.5 < x <=3.5] Gbps	Gear 3 Rates [>3.5] Gbps	Depen den cy	Ena bled	Disa bled
816	✓	✗	✗	✗	✓	✗	✗	✓	✗	✗	NA	✓	✗
716	✗	✓	✗	✗	✓	✗	✗	✓	✗	✗	NA	✓	✗

* Additionally, this test is applicable only on Single-ended connections.

Test Modes

- HS BURST

Test Procedure

- 1 Trigger the DIF-P (or DIF-N) region on the HS Burst data signal to acquire a test waveform.
- 2 A Common-Mode signal is generated for TXDP and TXDN, which is used for processing of data.
- 3 Generate the Common-Mode Power Spectrum of the test signal using a MATLAB UDF script.
- 4 Evaluate the computed power spectrum plot against the Common-Mode limit, as defined in the MIPI M-PHY CTS standards.
- 5 Use the PASS or FAIL status of the test for the final test result.

Test Results

The final test result for the Common-Mode AC Power Spectral Magnitude Limit (PS_{DCM}) test must be within the conformance limit as specified in the CTS Specification mentioned under the References section.

Test Reference

Refer to Test 1.1.2 of the M-PHY Physical Layer Conformance Test Suite v3.0r15 (24July2014).

Test 1.1.3 PREPARE Length ($T_{HS-PREPARE}$)

Test Overview

The purpose of the Prepare Length ($T_{HS-PREPARE}$) test is to verify that the longevity (or length) of the DUT's transmitted $T_{HS-PREPARE}$ period is consistent with the value indicated by its TX_HS_PREPARE_LENGTH configuration attribute on the MIPI M-PHY test application.

Test ID

- 818 [1.1.3 T_HS_PREPARE_LA_RT_TX (B)]
- 718 [1.1.3 T_HS_PREPARE_SA_RT_TX (B)]

Test Availability Conditions

Table 7 shows the options on the MIPI M-PHY Conformance Test Application, which are available for you to configure, for the Test IDs associated with the Prepare Length ($T_{HS-PREPARE}$) test.

Table 7 Test Availability Conditions for the Prepare Length test

Test ID	Configurable Options						
	Test Group				Signal Type		
	LA_RT	SA_RT	LA_NT	SA_NT	HS BURST	HS Continuous	LS PWM
818	✓	×	×	×	✓	×	×
718	×	✓	×	×	✓	×	×

Test Modes

- HS BURST

Test Procedure

- 1 Perform the following tests as a prerequisite to running the Prepare Length ($T_{HS-PREPARE}$) test:

Table 8 Prerequisite tests for Prepare Length ($T_{HS-PREPARE}$) test

Test IDs	Prerequisite Test Name	Corresponding Prerequisite Test IDs
818	Unit Interval and Frequency Offset (f_{OFFSET_TX})	817
718	Unit Interval and Frequency Offset (f_{OFFSET_TX})	717

Measure the Unit Interval and Data Rates. The application saves the test results.

- 2 Trigger the DIF-P (or DIF-N) region on the HS Burst data signal to acquire a test waveform.
- 3 A differential signal is generated for TXDP and TXDN, which is used for processing of data.
- 4 Use the **Pulse Width** feature on the Infiniium Oscilloscope to find and measure the largest region, which indicates $T_{HS-PREPARE}$, on the test signal. Use the largest measured value to calculate the final test result.

- 5 Convert the measured $T_{\text{HS-PREPARE}}$ width from the units of Unit Interval (UI) to units of Symbol Interval (SI), by dividing the value of the $T_{\text{HS-PREPARE}}$ width by $[10 * (\text{measured UI})]$. Round off the result to the nearest integer value.
- 6 Derive the dynamic test limit using the value of HS_PREPARE_LENGTH, which you manually set under the **Configure** tab of the compliance application.
- 7 Use the calculated value of $T_{\text{HS-PREPARE}}$ in SI units for the final test result.

Test Results

The calculated value for $T_{\text{HS-PREPARE}}$ for the test signal must be within the conformance limit as specified in the CTS Specification mentioned under the References section.

Test Reference

Refer to Test 1.1.3 of the M-PHY Physical Layer Conformance Test Suite v3.0r15 (24July2014).

Test 1.1.4 Common-Mode DC Output Voltage Amplitude (V_{CM_TX})

Test Overview

The purpose of the Common-Mode DC Output Voltage Amplitude (V_{CM_TX}) test is to verify that the Common-Mode DC Output Voltage Amplitude (V_{CM_TX}) of the HS-TX of the DUT is within the conformance limits of the MIPI M-PHY standard specification.

Test ID

- 803 [1.1.4 VCM_LA_RT_TX[Active Probe (Differential Probe)] (B)]
- 833 [1.1.4 VCM_LA_RT_TX[Direct Connect] (B)]
- 834 [1.1.4 VCM_LA_RT_TX[Active Probe (Active Termination Adapter)] (B)]
- 835 [1.1.4 VCM_LA_RT_TX[Active Probe (Active Termination Adapter) - Manual] (B)]
- 703 [1.1.4 VCM_SA_RT_TX[Active Probe (Differential Probe)] (B)]
- 733 [1.1.4 VCM_SA_RT_TX[Direct Connect] (B)]
- 734 [1.1.4 VCM_SA_RT_TX[Active Probe (Active Termination Adapter)] (B)]
- 735 [1.1.4 VCM_SA_RT_TX[Active Probe (Active Termination Adapter) - Manual] (B)]

Test Availability Conditions

Table 9 shows the options on the MIPI M-PHY Conformance Test Application, which are available for you to configure, for the Test IDs associated with the Common-Mode DC Output Voltage Amplitude (V_{CM_TX}) test.

Table 9 Test Availability Conditions for the Common-Mode DC Output Voltage Amplitude test

Test ID	Configurable Options										
	Test Group				Signal Type			Probing Method*			
	LA_RT	SA_RT	LA_NT	SA_NT	HS BURST	HS Continuous	LS PWM	Active Probe (Differential Probe)	Active Probe (Active Termination Adapter)	Active Probe (Active Termination Adapter) [Manual]	Direct Connect
803	✓	×	×	×	✓	×	×	✓	×	×	×
833	✓	×	×	×	✓	×	×	×	×	×	✓
834	✓	×	×	×	✓	×	×	×	✓	×	×
835	✓	×	×	×	✓	×	×	×	×	✓	×
703	×	✓	×	×	✓	×	×	✓	×	×	×
733	×	✓	×	×	✓	×	×	×	×	×	✓
734	×	✓	×	×	✓	×	×	×	✓	×	×
735	×	✓	×	×	✓	×	×	×	×	✓	×

* Additionally, this test is applicable only on Single-ended connections.

Test Modes

- HS BURST

Test Procedure

For Test IDs 803, 703 (Probing Method - [Active Probe (Differential Probe)]):

- 1 Trigger the DIF-P (or DIF-N) region on the HS Burst data signal to acquire a test waveform.
- 2 Generate the Common-Mode signal (V_{CM}) for TXDP and TXDN using a MATLAB UDF script, in order to remove all the DIF-P and DIF-N regions from the test signal.
- 3 Use the following equation to calculate the Common-Mode signal voltage (V_{CM}):

$$V_{CM} = (V_P + V_N) / 2$$

where, V_P and V_N are the range of voltage levels at TXDP and TXDN respectively.

- 4 Use the **Histogram** feature on the Infiniium Oscilloscope to measure the values of the maximum, minimum and mean voltage of the derived Common-Mode test signal.
- 5 Use the calculated value of the mean V_{CM} for the final test result.

For Test IDs 834, 734 (Probing Method - [Active Probe (Active Termination Adapter)]):

- 1 Execute the N7010A Calibration using the “N7010A Calibration Setup” form on the Setup tab to determine the V_{term} value for the selected channels.
- 2 Trigger the DIF-P (or DIF-N) region on the HS Burst data signal to acquire a test waveform.
- 3 Generate the Common-Mode signal (V_{CM}) for TXDP and TXDN using a MATLAB UDF script, in order to remove all the DIF-P and DIF-N regions from the test signal.
- 4 Use the following equation to calculate the Common-Mode signal voltage:

$$V_{CM} = (V_P + V_N) / 2$$

where, V_P and V_N are the range of voltage levels at TXDP and TXDN respectively.

- 5 Use the **Histogram** feature on the Infiniium Oscilloscope to measure the maximum, minimum and mean voltage values of the derived Common-Mode test signal.
- 6 Use the measured mean V_{CM} value for the final test result.

For Test IDs 835, 735 (Probing Method - [Active Probe (Active Termination Adapter) - Manual]):

- 1 Use the **Probe Configuration** feature on the Infiniium Oscilloscope to set the termination voltage of the Active Termination Adapter for the selected channels.
- 2 Trigger the DIF-P (or DIF-N) region on the HS Burst data signal to acquire a test waveform.
- 3 Generate the Common-Mode signal (V_{CM}) for TXDP and TXDN using a MATLAB UDF script, in order to remove all the DIF-P and DIF-N regions from the test signal.
- 4 Use the following equation to calculate the Common-Mode signal voltage (V_{CM}):

$$V_{CM} = (V_P + V_N) / 2$$

where, V_P and V_N are the range of voltage levels at TXDP and TXDN respectively.

- 5 Use the **Histogram** feature on the Infiniium Oscilloscope to measure the values of the maximum, minimum and mean voltage of the derived Common-Mode test signal.
- 6 Use the calculated value of the mean V_{CM} for the final test result.

For Test IDs 833, 733 (Probing Method - [Direct Connect]):

- 1 Trigger the DIF-P (or DIF-N) region on the HS Burst data signal to acquire a test waveform.
- 2 Generate the Common-Mode signal ($V_{CM_RSE_TX}$) for TXDP and TXDN using a MATLAB UDF script, in order to remove all the DIF-P and DIF-N regions from the test signal.
- 3 Use the following equation to calculate the Common-Mode signal voltage ($V_{CM_RSE_TX}$):

$$V_{CM_RSE_TX} = [(V_P + V_N) / 2] * \{(R_{SE_TX} + R_{in_scope}) / R_{in_scope}\}$$

where,

V_P and V_N are the range of voltage levels at TXDP and TXDN respectively.

R_{SE_TX} is the configurable option in the RSE_TX settings of the **Set Up** tab in the test application. The default value for R_{SE_TX} is 50 ohm.

R_{in_scope} is 50 ohm.

- 4 Use the **Histogram** feature on the Infiniium Oscilloscope to measure the values of the maximum, minimum and mean voltage of the derived Common-Mode test signal.
- 5 Use the calculated value of the mean $V_{CM_RSE_TX}$ for the final test result.

Test Results

The calculated values for V_{CM} or $V_{CM_RSE_TX}$ for the test signal must be within the conformance limit as specified in the CTS Specification mentioned under the References section.

Test Reference

Refer to Test 1.1.4 of the M-PHY Physical Layer Conformance Test Suite v3.0r15 (24July2014).

Test 1.1.5 Differential DC Output Voltage Amplitude ($V_{DIF_DC_TX}$)

Test Overview

The purpose of the Differential DC Output Voltage Amplitude ($V_{DIF_DC_TX}$) test is to verify that the Differential DC Output Voltage Amplitude of the HS-TX of the DUT is within the conformance limits of the MIPI M-PHY standard specification.

Test ID

- 800 [1.1.5 VDIF_DC_LA_RT_TX (B)]
- 700 [1.1.5 VDIF_DC_SA_RT_TX (B)]

Test Availability Conditions

Table 10 shows the options on the MIPI M-PHY Conformance Test Application, which are available for you to configure, for the Test IDs associated with the Differential DC Output Voltage Amplitude ($V_{DIF_DC_TX}$) test.

Table 10 Test Availability Conditions for the Differential DC Output Voltage Amplitude test

Test ID	Configurable Options						
	Test Group				Signal Type		
	LA_RT	SA_RT	LA_NT	SA_NT	HS BURST	HS Continuous	LS PWM
800	✓	×	×	×	✓	×	×
700	×	✓	×	×	✓	×	×

Test Modes

- HS BURST

Test Procedure

- 1 Trigger the DIF-P (or DIF-N) region on the HS Burst data signal to acquire a test waveform.
- 2 A differential signal is generated for TXDP and TXDN, which is used for processing of data.
- 3 Find the largest DIF-P and DIF-N region on the differential signal.
- 4 From the DIF-P and DIF-N regions found, measure the mean values of V_{DIF_P} and V_{DIF_N} .
- 5 Use the following equation to calculate the nominal value of V_{DIF} :

$$\text{Nominal } V_{DIF} = \left[\frac{(\text{Maximum Conformance Limit} - \text{Minimum Conformance Limit})}{2} + \text{Minimum Conformance Limit} \right]$$

where,

the values for Maximum Conformance Limit and Minimum Conformance Limit for the Differential DC Output Voltage Amplitude are available in the CTS Specification.

- 6 Measure the worst value for V_{DIF} between V_{DIF_P} and V_{DIF_N} . The worst value falls on the 'worst' margin with respect to the calculated nominal value.

Test Results

The measured value for V_{DIF_DC} for the test signal must be within the conformance limit as specified in the CTS Specification mentioned under the References section.

Test Reference

Refer to Test 1.1.5 of the M-PHY Physical Layer Conformance Test Suite v3.0r15 (24July2014).

Test 1.1.6 G1 and G2 Differential AC Eye (T_{EYE_TX} , $V_{DIF_AC_TX}$)

Test Overview

For Test IDs 801, 701, 1821, 1721 (CTSv3.0r18)

The purpose of the G1 and G2 Differential AC Eye (T_{EYE_TX} , $V_{DIF_AC_TX}$) test is to verify that the HS-TX of the DUT meets the MIPI M-PHY standard specifications for the Transmitter Eye Opening (T_{EYE_TX}) and the maximum & minimum Differential AC Output Voltage Amplitude ($V_{DIF_AC_TX}$) for HS-G1 and HS-G2.

For Test IDs 841, 741, 1841, 1741 (Informative Test)

The G1 and G2 Differential AC Eye (T_{EYE_TX} , $V_{DIF_AC_TX}$) test is considered as Informative test. These tests leverage the test algorithm from the MIPI M-PHY Physical Layer Conformance Test Suite v3.00r18 Test 1.1.6 with RX Mask used.

Test ID

- 801 [1.1.6 TEYE_LA_RT_TX, VDIF_AC_LA_RT_TX (B)]
- 701 [1.1.6 TEYE_SA_RT_TX, VDIF_AC_SA_RT_TX (B)]
- 1821 [1.1.6 TEYE_LA_RT_TX, VDIF_AC_LA_RT_TX (C)]
- 1721 [1.1.6 TEYE_SA_RT_TX, VDIF_AC_SA_RT_TX (C)]
- 841 [1.1.6 TEYE_LA_RT_TX, VDIF_AC_LA_RT_TX [Far End HS-RX Test Point] (B)]
- 741 [1.1.6 TEYE_SA_RT_TX, VDIF_AC_SA_RT_TX [Far End HS-RX Test Point] (B)]
- 1841 [1.1.6 TEYE_LA_RT_TX, VDIF_AC_LA_RT_TX [Far End HS-RX Test Point] (C)]
- 1741 [1.1.6 TEYE_SA_RT_TX, VDIF_AC_SA_RT_TX [Far End HS-RX Test Point] (C)]

Test Availability Conditions

Table 11 shows the options on the MIPI M-PHY Conformance Test Application, which are available for you to configure, for the Test IDs associated with the G1 and G2 Differential AC Eye (T_{EYE_TX} , $V_{DIF_AC_TX}$) test.

Table 11 Test Availability Conditions for the G1 and G2 Differential AC Eye test

Test ID	Configurable Options												
	Test Group				Signal Type			HS Data Rate			Informative Test		
	LA_RT	SA_RT	LA_NT	SA_NT	HS BURST	HS Continuous	LS PWM	Gear 1 Rates [≤ 1.5] Gbps	Gear 2 Rates [$1.5 < x \leq 3.5$] Gbps	Gear 3 Rates [> 3.5] Gbps	Dependency	Enabled	Disabled
801	✓	✗	✗	✗	✓	✗	✗	✓	✓	✗			
841	✓	✗	✗	✗	✓	✗	✗	✓	✓	✗	NA	✓	✗
701	✗	✓	✗	✗	✓	✗	✗	✓	✓	✗			
741	✗	✓	✗	✗	✓	✗	✗	✓	✓	✗	NA	✓	✗
1821	✓	✗	✗	✗	✗	✓	✗	✓	✓	✗			

Test ID	Configurable Options												
	Test Group				Signal Type			HS Data Rate			Informative Test		
	LA_RT	SA_RT	LA_NT	SA_NT	HS BURST	HS Continuous	LS PWM	Gear 1 Rates [≤ 1.5] Gbps	Gear 2 Rates [$1.5 < x \leq 3.5$] Gbps	Gear 3 Rates [> 3.5] Gbps	Dependency	Enabled	Disabled
1841	✓	×	×	×	×	✓	×	✓	✓	×	NA	✓	×
1721	×	✓	×	×	×	✓	×	✓	✓	×			
1741	×	✓	×	×	×	✓	×	✓	✓	×	NA	✓	×

Test Modes

- HS BURST
- HS Continuous

Test Procedure

For Test IDs 801, 701, 1821, 1721 (CTSv3.0r18)

- 1 Perform the following tests as a prerequisite to running the G1 and G2 Differential AC Eye (T_{EYE_TX} , $V_{DIF_AC_TX}$) test:

Table 12 Prerequisite tests for G1 and G2 Differential AC Eye Opening (T_{EYE_TX} , $V_{DIF_AC_TX}$) test

Test IDs	Prerequisite Test Name	Corresponding Prerequisite Test IDs
801	Unit Interval and Frequency Offset (f_{OFFSET_TX})	817
701	Unit Interval and Frequency Offset (f_{OFFSET_TX})	717
1821	Unit Interval and Frequency Offset (f_{OFFSET_TX})	1817
1721	Unit Interval and Frequency Offset (f_{OFFSET_TX})	1717

Measure the Unit Interval and Data Rates. The application saves the test results.

- 2 Trigger the DIF-P (or DIF-N) region on the HS Burst data signal to acquire a test waveform. On an HS Continuous signal, a test waveform triggers automatically without searching for the DIF-P (or DIF-N) region.
- 3 Generate the differential signal for TXDP and TXDN using a MATLAB UDF script, in order to remove all the DIF-P and DIF-N regions from the test signal. The generated differential signal for HS Burst data is used for processing of data. In case of HS Continuous data, since there are no DIF-P or DIF-N regions in the test signal, generate the differential signal without using the MATLAB UDF script.
- 4 Verify T_{EYE_TX} and $V_{DIF_AC_TX}$ using the procedures described in the following sections:

Procedure for HS-G1 testing

Figure 12 shows that for this test, the horizontal position of the 0.244UI interval is allowed to be shifted horizontally within the eye.

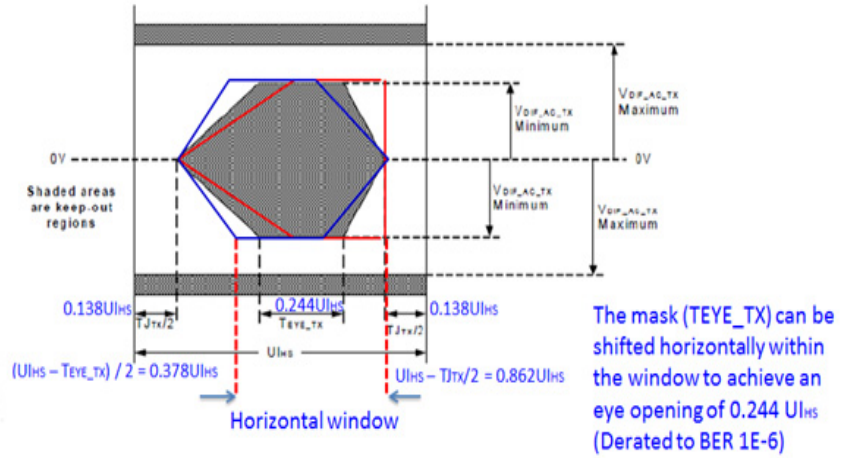

Figure 12 Eye Diagram for HS-G1 testing

- a For the HS Burst signal, generate the Eye Diagram using the acquired differential signal. For HS Continuous signal, acquire 3E6 UIs and generate the Eye Diagram.
- b Use the **Histogram** feature on the Infiniium Oscilloscope to measure the eye opening between 0.378UI and 0.862UI at the minimum V_{DIF_AC} levels for the positive case. Assign the values as “left_top” and “right_top”, shown in Figure 13. Then, measure the eye opening for the negative case. Assign the values as “left_bottom” and “right_bottom”, shown in Figure 13.

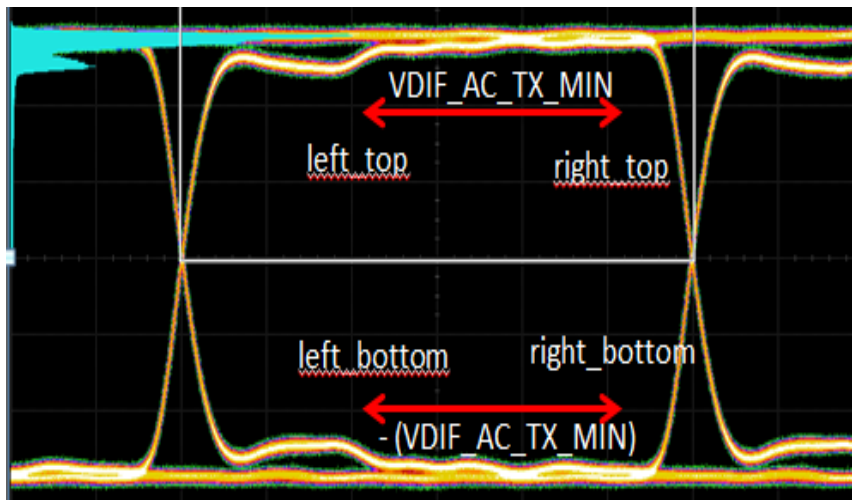

Figure 13 Left_top, Left_bottom, Right_top and Right_bottom measurements on the Eye Diagram

- c Determine the position of the mask using the equation:

$$T_{EYE_TX_mid_point} = [Worst(left_top, left_bottom) + Worst(right_top, right_bottom)] / 2$$

The eye mask is placed and centered at the value of $T_{EYE_TX_mid_point}$ measured, shown in Figure 14.

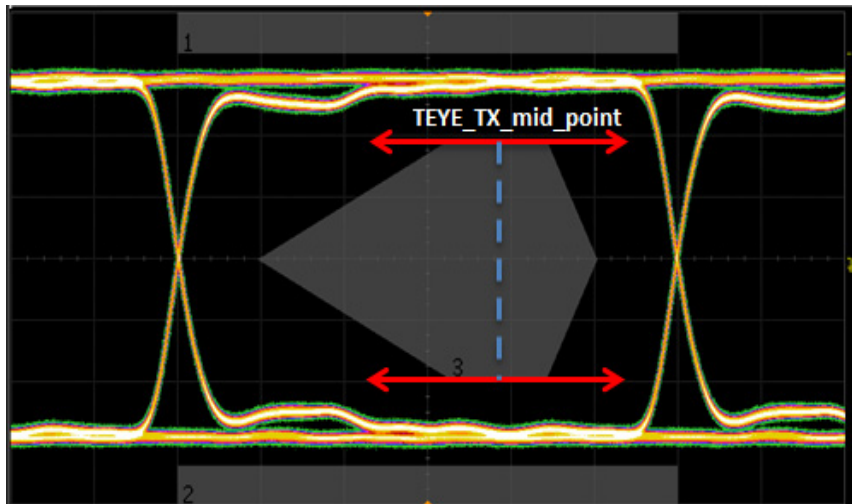

Figure 14 $T_{EYE_TX_mid_point}$ measurement on the eye diagram

Procedure for HS-G2 testing

Figure 15 shows that for this test, the horizontal position of the 0.244UI interval is fixed and centered at UI/2 position.

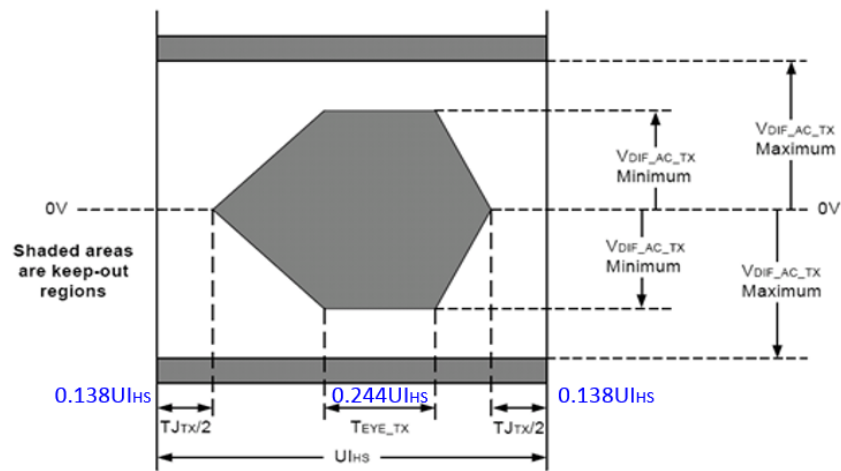

Figure 15 Eye Diagram for HS-G2 testing

- a Center the Eye Mask in the middle of the generated Eye Diagram.

Test Procedure (Contd.)

- 5 Construct the Eye Mask using the prorated values given in Table 13.

Table 13 Prorated values for Eye Mask

Parameter	Normal Mask (1E-10)	Prorated Mask (1E-6)
T_{EYE_TX}	200mUI	244mUI
$V_{DIF_AC_LA_TX_MIN}$	140mV	143mV
$V_{DIF_AC_LA_TX_MAX}$	250mV	250mV
$V_{DIF_AC_SA_TX_MIN}$	80mV	83mV
$V_{DIF_AC_SA_TX_MAX}$	140mV	140mV
$T_{JTX/2}$	160mUI	138mUI

- 6 Run the “Mask Testing” feature on the Infiniium Oscilloscope.
- 7 Use the Mask violation result and PASS/FAIL status for the final test result.

For Test IDs 841, 741, 1841, 1741 (Informative Test)

- 1 Measure the Unit Interval and Data Rates. The application saves the test results.
- 2 Trigger the DIF-P (or DIF-N) region on the HS Burst data signal to acquire a test waveform. On an HS Continuous signal, a test waveform triggers automatically without searching for the DIF-P (or DIF-N) region.
- 3 Generate the differential signal for TXDP and TXDN using a MATLAB UDF script, in order to remove all the DIF-P and DIF-N regions from the test signal. The generated differential signal for HS Burst data is used for processing of data. In case of HS Continuous data, since there are no DIF-P or DIF-N regions in the test signal, generate the differential signal without using the MATLAB UDF script.
- 4 To verify T_{EYE_TX} and $V_{DIF_AC_TX}$, center the Eye Mask in the middle of the generated eye diagram, shown in Figure 16.

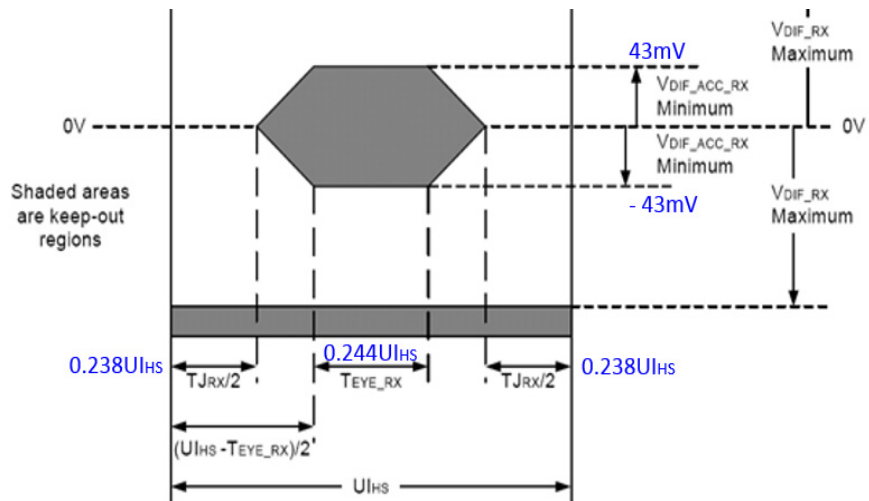

Figure 16 Centering Eye Mask in the Eye Diagram for G1 and G2 Differential AC Eye Informative test

- 5 Run the “Mask Testing” feature on the Infiniium Oscilloscope.
 - For HS Burst signal: Single acquisition
 - For HS Continuous signal: Multiple acquisitions (3E6 UIs)
- 6 Use the Mask violation result and PASS/FAIL status for the final test result.

Test Results

The generated eye diagram shall not violate the eye mask as specified in the CTS Specification mentioned under the References section.

Test Reference

For Test IDs 801, 701, 1821, and 1721, refer to Test 1.1.6 of the M-PHY Physical Layer Conformance Test Suite v3.0r18 (11Dec2014).

Test 1.1.7 G3 Differential AC Eye ($T_{EYE_HS_G3_TX}$, $V_{DIF_AC_HS_G3_TX}$)

Test Overview

For Test IDs 802, 702, 1822, 1823, 1722 (CTSv3.0r18)

The purpose of this test is to verify that the HS-TX of the DUT meets the MIPI M-PHY standard specifications for the Transmitter Eye Opening ($T_{EYE_HS_G3_TX}$) and the maximum and minimum Differential AC Output Voltage Amplitude ($V_{DIF_AC_HS_G3_TX}$, $V_{DIF_AC_TX}$) for HS-G3.

For Test IDs 842, 742, 1842, 1742 (Informative Test)

This test is considered as Informative test. These tests leverage the test algorithm from the MIPI M-PHY Physical Layer Conformance Test Suite v3.00r17 Test 1.1.7 with RX Mask used.

Test ID

- 802 [1.1.7 TEYE_G3_LA_RT_TX, VDIF_AC_G3_LA_RT_TX (B)]
- 702 [1.1.7 TEYE_G3_SA_RT_TX, VDIF_AC_G3_SA_RT_TX (B)]
- 1822 [1.1.7 TEYE_G3_LA_RT_TX, VDIF_AC_G3_LA_RT_TX [CH1] [0dB] (C)]
- 1823 [1.1.7 TEYE_G3_LA_RT_TX, VDIF_AC_G3_LA_RT_TX [CH2] [6dB] (C)]
- 1722 [1.1.7 TEYE_G3_SA_RT_TX, VDIF_AC_G3_SA_RT_TX [CH1] [3.5dB] (C)]
- 842 [1.1.7 TEYE_G3_LA_RT_TX, VDIF_AC_G3_LA_RT_TX [Far End HS-RX Test Point] (B)]
- 742 [1.1.7 TEYE_G3_SA_RT_TX, VDIF_AC_G3_SA_RT_TX [Far End HS-RX Test Point] (B)]
- 1842 [1.1.7 TEYE_G3_LA_RT_TX, VDIF_AC_G3_LA_RT_TX [Far End HS-RX Test Point] (C)]
- 1742 [1.1.7 TEYE_G3_SA_RT_TX, VDIF_AC_G3_SA_RT_TX [Far End HS-RX Test Point] (C)]

Test Availability Conditions

Table 14 shows the options on the MIPI M-PHY Conformance Test Application, which are available for you to configure, for the Test IDs associated with the G3 Differential AC Eye ($T_{EYE_HS_G3_TX}$, $V_{DIF_AC_HS_G3_TX}$) test.

Table 14 Test Availability Conditions for the G3 Differential AC Eye test

Configurable Options		Test IDs								
		802	842	702	742	1822	1823	1842	1722	1742
Test Group	LA_RT	✓	✓	×	×	✓	✓	✓	×	×
	SA_RT	×	×	✓	✓	×	×	×	✓	✓
	LA_NT	×	×	×	×	×	×	×	×	×
	SA_NT	×	×	×	×	×	×	×	×	×
Signal Type	HS Burst	✓	✓	✓	✓	×	×	×	×	×
	HS Continuous	×	×	×	×	✓	✓	✓	✓	✓
	LS PWM	×	×	×	×	×	×	×	×	×

Configurable Options		Test IDs								
		802	842	702	742	1822	1823	1842	1722	1742
HS Data Rate	'A' Series	Note 1		Note 1		Note 1	Note 1		Note 1	
	'B' Series	✓		✓		✓	✓		✓	
	Gear 1 rates [<=1.5] Gbps	×	×	×	×	×	×	×	×	×
	Gear 2 rates [1.5<x<=3.5] Gbps	×	×	×	×	×	×	×	×	×
	Gear 3 rates [>3.5] Gbps	✓	✓	✓	✓	✓	✓	✓	✓	✓
Informative Test	Dependency	Note 2	NA	Note 2	NA	Note 2	Note 2	NA	Note 2	NA
	Enabled	✓	✓	✓	✓	✓	✓	✓	✓	✓
	Disabled	×	×	×	×	×	×	×	×	×

Note 1: Dependency on [Informative Test] option settings

Note 2: Not Applicable for HS 'B' Series Gear rates.

Test Modes

- HS BURST
- HS Continuous

Test Procedure

For Test IDs 802, 702

- 1 Perform the following tests as a prerequisite to running the G3 Differential AC Eye ($T_{EYE_HS_G3_TX}$, $V_{DIF_AC_HS_G3_TX}$) test:

Table 15 Prerequisite tests for G3 Differential AC Eye Opening ($T_{EYE_HS_G3_TX}$, $V_{DIF_AC_HS_G3_TX}$) test

Test IDs	Prerequisite Test Name	Corresponding Prerequisite Test IDs
802	Unit Interval and Frequency Offset (f_{OFFSET_TX})	817
702	Unit Interval and Frequency Offset (f_{OFFSET_TX})	717

Measure the Unit Interval and Data Rates. The application saves the test results.

- 2 Trigger the DIF-P (or DIF-N) region on the HS Burst data signal to acquire a test waveform.
- 3 Generate the differential signal for TXDP and TXDN using a MATLAB UDF script, in order to remove all the DIF-P and DIF-N regions from the test signal. The generated differential signal for HS Burst data is used for processing of data.

- 4 Use the InfiniiSim function on the Infiniium Oscilloscope to embed the reference channel.
 - a The 'short' channel (CH1) reference channel is embedded for Small Amplitude signal type (Test ID: 702).
 - b The 'long' channel (CH2) reference channel is embedded for Large Amplitude signal type (Test ID: 802).
- 5 To verify T_{EYE_TX} and $V_{DIF_AC_TX}$, center the Eye Mask in the middle of the generated eye diagram, shown in Figure 17.

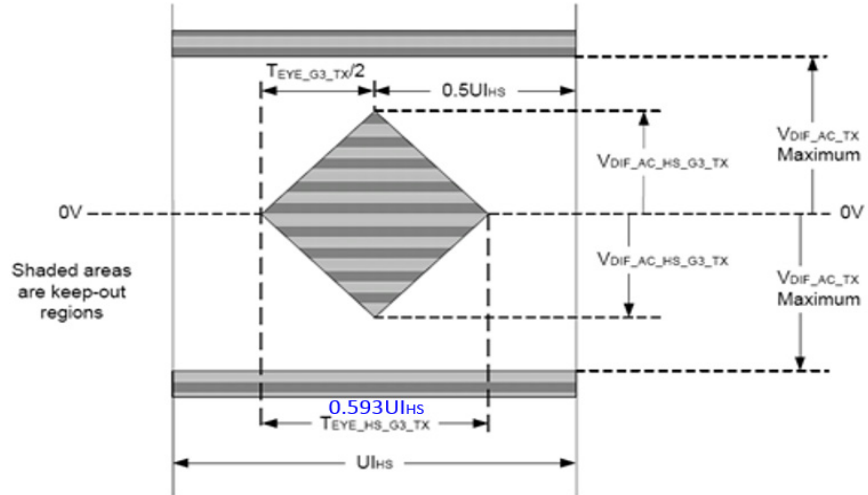

Figure 17 Centering Eye Mask in the Eye Diagram for HS-G3 testing

- 6 Construct the Eye Mask using the prorated values given in Table 16.

Table 16 Prorated values for Eye Mask

Parameter	Amplitude	Termination	Reference Load	Conf. Min.	Conf. Max.
$V_{DIF_AC_HS_G3_TX}$	Large + Small	Terminated	CH1/2 + R_{REF-RT}	45mV	NA
$V_{DIF_AC_LA_TX}$	Large	Terminated	CH1/2 + R_{REF-RT}	NA	250mV
$V_{DIF_AC_SA_TX}$	Small	Terminated	CH1/2 + R_{REF-RT}	NA	140mV
$T_{EYE_HS_G3_TX}$	Large + Small	Terminated	CH1/2 + R_{REF-RT}	0.593UI	NA

- 7 Run the "Mask Testing" feature on the Infiniium Oscilloscope.
 - For HS Burst signal: Single acquisition
 - For HS Continuous signal: Multiple acquisitions (3E6 UIs)
- 8 Use the Mask violation result and PASS/FAIL status for the final test result.

For Test IDs 1822, 1722

- 1 Perform the following tests as a prerequisite to running the G3 Differential AC Eye ($T_{EYE_HS_G3_TX}$, $V_{DIF_AC_HS_G3_TX}$) test:

Table 17 Prerequisite tests for G3 Differential AC Eye Opening ($T_{EYE_HS_G3_TX}$, $V_{DIF_AC_HS_G3_TX}$) test

Test IDs	Prerequisite Test Name	Corresponding Prerequisite Test IDs
1822	Unit Interval and Frequency Offset (f_{OFFSET_TX})	1817
1722	Unit Interval and Frequency Offset (f_{OFFSET_TX})	1717

Measure the Unit Interval and Data Rates. The application saves the test results.

- 2 Trigger the HS Continuous data signal to acquire a test waveform.
- 3 Generate the differential signal for TXDP and TXDN for processing of data.
- 4 Use the InfiniiSim function on the Infiniium Oscilloscope to embed the reference channel.
 - a The 'short' channel (CH1) reference channel is embedded for Small Amplitude signal with 3.5 dB emphasis level. (Test ID: 1722).
 - b The 'short' channel (CH1) reference channel is embedded for Small Amplitude signal with 0 dB emphasis level. (Test ID: 1822).
 - c The 'long' channel (CH2) reference channel is embedded for Large Amplitude signal type with 6.0 dB emphasis level (Test ID: 1823).
- 5 To verify T_{EYE_TX} and $V_{DIF_AC_TX}$, center the Eye Mask in the middle of the generated eye diagram, shown in Figure 18.

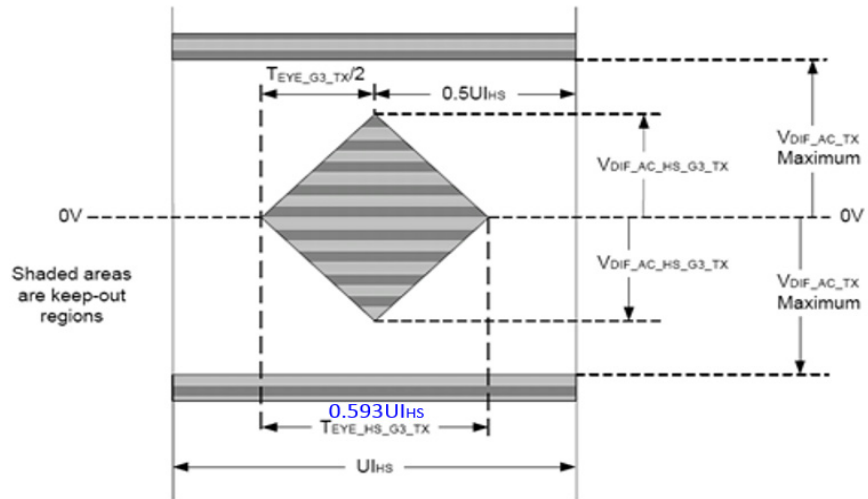

Figure 18 Centering Eye Mask in the Eye Diagram for HS-G3 testing

- 6 Construct the Eye Mask using the prorated values given in Table 18.

Table 18 Prorated values for Eye Mask

Parameter	Amplitude	Termination	Reference Load	Conf. Min.	Conf. Max.
$V_{DIF_AC_HS_G3_TX}$	Large + Small	Terminated	CH1/2 + R_{REF-RT}	45mV	NA
$V_{DIF_AC_LA_TX}$	Large	Terminated	CH1/2 + R_{REF-RT}	NA	250mV
$V_{DIF_AC_SA_TX}$	Small	Terminated	CH1/2 + R_{REF-RT}	NA	140mV
$T_{EYE_HS_G3_TX}$	Large + Small	Terminated	CH1/2 + R_{REF-RT}	0.593UI	NA

- 7 Run the “Mask Testing” feature on the Infiniium Oscilloscope.
 - For HS Burst signal: Single acquisition
 - For HS Continuous signal: Multiple acquisitions (3E6 UIs)
- 8 Use the Mask violation result and PASS/FAIL status for the final test result.

For Test IDs 842, 742, 1842, 1742 (Informative Test)

- 1 Measure the Unit Interval and Data Rates. The application saves the test results.
- 2 Trigger the DIF-P (or DIF-N) region on the HS Burst data signal to acquire a test waveform. On an HS Continuous signal, a test waveform triggers automatically without searching for the DIF-P (or DIF-N) region.
- 3 Generate the differential signal for TXDP and TXDN using a MATLAB UDF script, in order to remove all the DIF-P and DIF-N regions from the test signal. The generated differential signal for HS Burst data is used for processing of data. In case of HS Continuous data, since there are no DIF-P or DIF-N regions in the test signal, generate the differential signal without using the MATLAB UDF script.
- 4 To verify T_{EYE_TX} and $V_{DIF_AC_TX}$, center the Eye Mask in the middle of the generated eye diagram, shown in Figure 19.

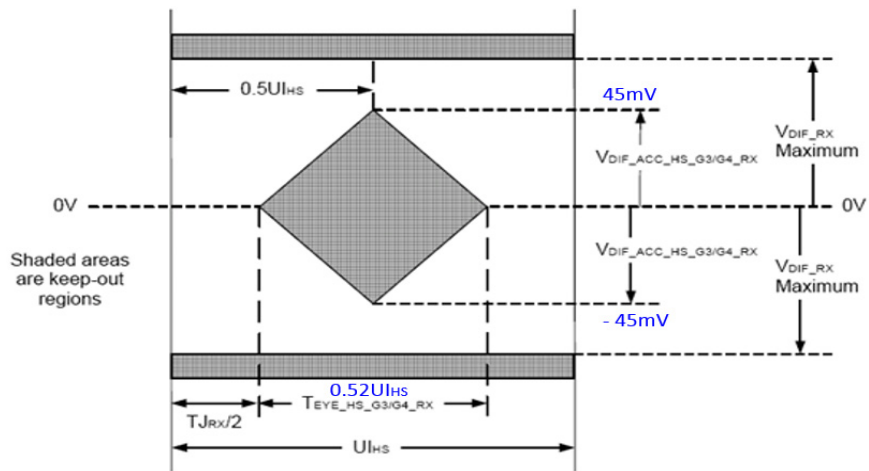

Figure 19 Centering Eye Mask in the Eye Diagram for G3 Differential AC Eye Informative test

- 5 Run the “Mask Testing” feature on the Infiniium Oscilloscope.
 - For HS Burst signal: Single acquisition
 - For HS Continuous signal: Multiple acquisitions (3E6 UIs)
- 6 Use the Mask violation result and PASS/FAIL status for the final test result.

Test Results

The generated eye diagram shall not violate the eye mask as specified in the CTS Specification mentioned under the References section.

Test Reference

For Test IDs 802, 702, 1822, 1823, and 1722, refer to Test 1.1.7 of the M-PHY Physical Layer Conformance Test Suite v3.0r18 (11Dec2014).

Test 1.1.8 20% / 80% Rise and Fall Times ($T_{R_HS_TX}$ and $T_{F_HS_TX}$)

Test Overview

The purpose of the 20% / 80% Rise and Fall Times ($T_{R_HS_TX}$ and $T_{F_HS_TX}$) test is to verify that the 20% to 80% Rise and Fall Times of the HS-TX of the DUT are within the conformance limits according to the MIPI M-PHY standards.

Test ID

- 804 [1.1.8 TR_TF_HS_LA_RT_TX (B)]
- 704 [1.1.8 TR_TF_HS_SA_RT_TX (B)]
- 1804 [1.1.8 TR_TF_HS_LA_RT_TX (C)]
- 1704 [1.1.8 TR_TF_HS_SA_RT_TX (C)]

Test Availability Conditions

Table 19 shows the options on the MIPI M-PHY Conformance Test Application, which are available for you to configure, for the Test IDs associated with the 20% / 80% Rise and Fall Times ($T_{R_HS_TX}$ and $T_{F_HS_TX}$) test.

Table 19 Test Availability Conditions for the 20%/80% Rise and Fall Times test

Test ID	Configurable Options									
	Test Group				Signal Type			Informative Test		
	LA_RT	SA_RT	LA_NT	SA_NT	HS BURST	HS Continuous	LS PWM	Dependency	Enabled	Disabled
804	✓	×	×	×	✓	×	×			
704	×	✓	×	×	✓	×	×			
1804	✓	×	×	×	×	✓	×	NA	✓	×
1704	×	✓	×	×	×	✓	×	NA	✓	×

Test Modes

- HS BURST
- HS Continuous

Test Procedure

- 1 Perform the following tests as a prerequisite to running the 20% / 80% Rise and Fall Times ($T_{R_HS_TX}$ and $T_{F_HS_TX}$) test:

Table 20 Prerequisite tests for 20%/80% Rise and Fall Times ($T_{R_HS_TX}$ and $T_{F_HS_TX}$) test

Test IDs	First Prerequisite Test Name	Corresponding Prerequisite Test IDs	Second Prerequisite Test Name	Corresponding Prerequisite Test IDs
804	Unit Interval and Frequency Offset ($f_{\text{OFFSET_TX}}$)	817	DC Output Voltage Amplitude ($V_{\text{DIF_DC_TX}}$)	800
704	Unit Interval and Frequency Offset ($f_{\text{OFFSET_TX}}$)	717	DC Output Voltage Amplitude ($V_{\text{DIF_DC_TX}}$)	700
1804	Unit Interval and Frequency Offset ($f_{\text{OFFSET_TX}}$)	1817	NA	NA
1704	Unit Interval and Frequency Offset ($f_{\text{OFFSET_TX}}$)	1717	NA	NA

Measure the Unit Interval and Data Rates with respect to $f_{\text{OFFSET_TX}}$ tests and measure $V_{\text{DIF_DC}}$ with respect to $V_{\text{DIF_DC_TX}}$ tests. The application saves the test results.

- 2 Trigger the DIF-P (or DIF-N) region on the HS Burst data signal to acquire a test waveform. On an HS Continuous signal, a test waveform triggers automatically without searching for the DIF-P (or DIF-N) region.
- 3 A differential signal is generated for TXDP and TXDN, which is used for processing of data.
- 4 Search the differential signal for those locations, which have a data pattern of '0011' and '1100' and isolate such locations. To define the number of '0011' and '1100' data patterns that are used for processing, use the **Number of 0011 and 1100 Patterns** setting under the **Configure** tab of the test application.
- 5 For the HS Burst data mode, use the 80%/20% reference levels, defined by the measured 0/100% $V_{\text{DIF_DC}}$ values in the prerequisite test, to measure the rise and fall times on the isolated data patterns. For the HS Continuous data mode, measure $V_{\text{DIF_DC}}$ within the Rise Time (T_R) and Fall Time (T_F) test instead of running a prerequisite test.
- 6 Calculate the average of the measured rise time and fall time values and use the smaller of the two values for the final test result.

Test Results

The calculated values for T_{R_HS} and T_{F_HS} for the test signal must be within the conformance limit as specified in the CTS Specification mentioned under the References section.

Test Reference

Refer to Test 1.1.8 of the M-PHY Physical Layer Conformance Test Suite v3.0r15 (24July2014).

Test 1.1.9 Lane-to-Lane Skew ($T_{L2L_SKEW_HS_TX}$)

Test Overview

The purpose of the Lane-to-Lane Skew ($T_{L2L_SKEW_HS_TX}$) test is to verify that the skew between any two HS-TX lanes of the DUT is less than the maximum permissible conformance limit for the highest supported HS-GEAR, according to the MIPI M-PHY standard specification.

Test ID

- 819 [1.1.9 T_L2L_SKEW_HS_2LANE_LA_RT_TX]
- 820 [1.1.9 T_L2L_SKEW_HS_3LANE_LA_RT_TX]
- 821 [1.1.9 T_L2L_SKEW_HS_4LANE_LA_RT_TX]

Test Availability Conditions

Table 21 shows the options on the MIPI M-PHY Conformance Test Application, which are available for you to configure, for the Test IDs associated with the Lane-to-Lane Skew ($T_{L2L_SKEW_HS_TX}$) test.

Table 21 Test Availability Conditions for the Lane-to-Lane Skew test*

Configurable Options	Test IDs			
	819	820	821	
Test Group	LA_RT	✓	✓	✓
	SA_RT	×	×	×
	LA_NT	×	×	×
	SA_NT	×	×	×
Signal Type	HS Burst	✓	✓	✓
	HS Continuous	×	×	×
	LS PWM	×	×	×
HS Data Rate	A Series	Dependent on the Informative Test setting.		
	B Series	✓	✓	✓
Number of Supported Lane	1	×	×	×
	2	✓	×	×
	3	×	✓	×
	4	×	×	✓
Protocol Specification	DigRFv4	Enabled for HS-G1 and HS-G2; disabled for HS-G3		
	LLI	✓	✓	✓
	UniPro	✓	✓	✓
	SSIC	✓	✓	✓

Configurable Options	Test IDs		
	819	820	821
Dependency	Not applicable for HS B Series Gear Rates.		
Informative Test			
Enabled	✓	✓	✓
Disabled	×	×	×

* Additionally, this test is available only when the **Switch Matrix** feature on the test application is in Disabled state.

Test Modes

- HS BURST

Test Procedure

- 1 Trigger the DIF-P (or DIF-N) region on the HS Burst data signal to acquire a test waveform for all required data lanes.
- 2 A differential signal is generated for all data lanes of TXDP and TXDN, which is used for processing of data.
- 3 Search and isolate the Marker0 data pattern in the differential signal for each test lane data.
- 4 Measure the skew for all rising and falling transitions found in the Marker0 data pattern between data lanes with respect to Lane 0. Use the average of the measured skew values for each pair of lanes for further processing. Note that you must measure the skew values only from the applicable Lane-to-Lane combinations. To configure this option, use the **Number of Supported Lane** setting in the **Set Up** tab of the test application.

For example, let us consider A, B and C to be the skew values for lane to lane combinations, such that:

$$\text{Skew}(L1\text{-to-}L0) = A$$

$$\text{Skew}(L2\text{-to-}L0) = B$$

$$\text{Skew}(L3\text{-to-}L0) = C$$

- 5 Using the skew data associated with Lane 0, calculate the Lane-to-Lane Skew values for all other lane combinations, such as Lane 2 to Lane 1, and so on.

$$\text{Skew}(L2\text{-to-}L1) = B - A$$

$$\text{Skew}(L3\text{-to-}L1) = C - A$$

$$\text{Skew}(L3\text{-to-}L2) = B - C$$

- 6 Use the value derived from the worst Lane-to-Lane Skew with the largest deviation for the final test result.

Test Results

The calculated values for the Lane-to-Lane Skew for the test signal must be within the conformance limit as specified in the CTS Specification mentioned under the References section.

Test Reference

Refer to Test 1.1.9 of the M-PHY Physical Layer Conformance Test Suite v3.0r15 (24July2014).

Test 1.1.10 Slew Rate Control Range (SR_{DIF_TX}[MAX] and SR_{DIF_TX}[MIN])

Test Overview

The purpose of the Slew Rate Control Range (SR_{DIF_TX}[MAX] and SR_{DIF_TX}[MIN]) test is to verify that the Slew Rate (SR_{DIF_TX}) of the HS-TX of the DUT can be suitably adjusted across the minimum required range of values for HS-G1, according to the MIPI M-PHY standards.

Test ID

- 806 [1.1.10 SR_DIF_LA_RT_TX[MAX] (B)]
- 807 [1.1.10 SR_DIF_LA_RT_TX[MIN] (B)]
- 706 [1.1.10 SR_DIF_SA_RT_TX[MAX] (B)]
- 707 [1.1.10 SR_DIF_SA_RT_TX[MIN] (B)]

Test Availability Conditions

Table 22 shows the options on the MIPI M-PHY Conformance Test Application, which are available for you to configure, for the Test IDs associated with the Slew Rate Control Range (SR_{DIF_TX}[MAX] and SR_{DIF_TX}[MIN]) test.

Table 22 Test Availability Conditions for the Slew Rate Control Range test

Configurable Options	Test IDs				
	806	807	706	707	
Test Group	LA_RT	✓	✓	×	×
	SA_RT	×	×	✓	✓
	LA_NT	×	×	×	×
	SA_NT	×	×	×	×
Signal Type	HS Burst	✓	✓	✓	✓
	HS Continuous	×	×	×	×
	LS PWM	×	×	×	×
HS Data Rate	Gear 1 Rates [≤ 1.5] Gbps	✓	✓	✓	✓
	Gear 2 Rates [$1.5 < x \leq 3.5$] Gbps	Dependent on the Informative Test setting.			
	Gear 3 Rates [> 3.5] Gbps				
Number of Slew Rate States	1	×	×	×	×
	>1	✓	✓	✓	✓
Informative Test	Dependency	Not applicable for HS Gear 1 Rates.			
	Enabled	✓	✓	✓	✓
	Disabled	×	×	×	×

Test Modes

- HS BURST

Test Procedure

- 1 Perform the following tests as a prerequisite to running the Slew Rate Control Range ($SR_{DIF_TX[MAX]}$ and $SR_{DIF_TX[MIN]}$) test:

Table 23 Prerequisite tests for Slew Rate Control Range ($SR_{DIF_TX[MAX]}$ and $SR_{DIF_TX[MIN]}$) test

Test IDs	Prerequisite Test Name	Corresponding Prerequisite Test IDs
806	DC Output Voltage Amplitude ($V_{DIF_DC_TX}$)	800
706	DC Output Voltage Amplitude ($V_{DIF_DC_TX}$)	700
807	Slew Rate Control Range ($SR_{DIF_TX[MAX]}$)	806
707	Slew Rate Control Range ($SR_{DIF_TX[MAX]}$)	706

Measure V_{DIF_DC} . The application saves the test results.

- 2 Trigger the DIF-P (or DIF-N) region on the HS Burst data signal to acquire a test waveform.
- 3 A differential signal is generated for TXDP and TXDN, which is used for processing of data.
- 4 Search the differential signal for those locations, which have a data pattern of '0011' and isolate such locations. To define the number of '0011' data patterns that are used for processing, use the **Number of 0011 and 1100 Patterns** setting under the **Configure** tab of the test application.
- 5 Use the 80%/20% reference levels, defined by the measured 0/100% V_{DIF_DC} values in the prerequisite test, to measure the rise time on the isolated data patterns.
- 6 Use the average of the measured rise time values to calculate the value for Slew Rate for the given Slew Rate state.
- 7 Use the Slew Rate values to calculate the Slew Rate State Resolution.
- 8 Repeat steps 2 to 7 to calculate the Slew Rate State Resolution for all required Slew Rate states. To configure the number of Slew Rate states, use the **Number of Slew Rate States** setting under the **Set Up** tab in the test application.
- 9 Check for monotonicity of all the measured Slew Rate values.
- 10 Use the measured minimum values (from Test IDs: 807 and 707) and maximum values (from Test IDs: 806 and 706) for the Slew Rate for the final test result.

Test Results

The calculated values for Slew Rate (SR_{DIF_TX}) for the test signal must be within the conformance limit as specified in the CTS Specification mentioned under the References section.

Test Reference

Refer to Test 1.1.10 of the M-PHY Physical Layer Conformance Test Suite v3.0r15 (24July2014).

Test 1.1.11 Slew Rate State Monotonicity

Test Overview

The purpose of the Slew Rate State Monotonicity test is to verify that the Slew Rate Control states of the HS-TX of the DUT support the monotonically decreasing Slew Rate settings for HS-G1, according to the MIPI M-PHY standards.

Test ID

- 808 [1.1.11 SR_DIF_LA_RT_TX Monotonicity (B)]
- 708 [1.1.11 SR_DIF_SA_RT_TX Monotonicity (B)]

Test Availability Conditions

Table 24 shows the options on the MIPI M-PHY Conformance Test Application, which are available for you to configure, for the Test IDs associated with the Slew Rate State Monotonicity test.

Table 24 Test Availability Conditions for the Slew Rate State Monotonicity test

Configurable Options		Test IDs	
		808	708
Test Group	LA_RT	✓	×
	SA_RT	×	✓
	LA_NT	×	×
	SA_NT	×	×
Signal Type	HS Burst	✓	✓
	HS Continuous	×	×
	LS PWM	×	×
HS Data Rate	Gear 1 Rates [≤ 1.5] Gbps	✓	✓
	Gear 2 Rates [$1.5 < x \leq 3.5$] Gbps	Dependent on the Informative Test setting.	
	Gear 3 Rates [> 3.5] Gbps		
Number of Slew Rate States	1	×	×
	>1	✓	✓
Informative Test	Dependency	Not applicable for HS Gear 1 Rates.	
	Enabled	✓	✓
	Disabled	×	×

Test Modes

- HS BURST

Test Procedure

- 1 Perform the following tests as a prerequisite to running the Slew Rate State Monotonicity test:

Table 25 Prerequisite tests for Slew Rate State Monotonicity test

Test IDs	Prerequisite Test Name	Corresponding Prerequisite Test IDs
808	Slew Rate Control Range (SR _{DIF_TX(MAX)})	806
708	Slew Rate Control Range (SR _{DIF_TX(MAX)})	706

- 2 Use the prerequisite tests mentioned above to implement the procedural steps in order to determine the monotonicity of the Slew Rates.
- 3 Use the PASS or FAIL status of the test for the final test result.

Test Results

The measured Slew Rate State Monotonicity for the test signal must be within the conformance limit as specified in the CTS Specification mentioned under the References section.

Test Reference

Refer to Test 1.1.11 of the M-PHY Physical Layer Conformance Test Suite v3.0r15 (24July2014).

Test 1.1.12 Slew Rate State Resolution (ΔSR_{DIF_TX})

Test Overview

The purpose of the Slew Rate State Resolution (ΔSR_{DIF_TX}) test is to verify that the Slew Rate State Resolution (ΔSR_{DIF_TX}) of the HS-TX Slew Rate Control of the DUT conforms to the specifications of the MIPI M-PHY standards.

Test ID

- 809 [1.1.12 $\Delta SR_{DIF_LA_RT_TX}$ Resolution (B)]
- 709 [1.1.12 $\Delta SR_{DIF_SA_RT_TX}$ Resolution (B)]

Test Availability Conditions

Table 26 shows the options on the MIPI M-PHY Conformance Test Application, which are available for you to configure, for the Test IDs associated with the Slew Rate State Resolution (ΔSR_{DIF_TX}) test.

Table 26 Test Availability Conditions for the Slew Rate State Resolution test

Configurable Options		Test IDs	
		809	709
Test Group	LA_RT	✓	×
	SA_RT	×	✓
	LA_NT	×	×
	SA_NT	×	×
Signal Type	HS Burst	✓	✓
	HS Continuous	×	×
	LS PWM	×	×
HS Data Rate	Gear 1 Rates [≤ 1.5] Gbps	✓	✓
	Gear 2 Rates [$1.5 < x \leq 3.5$] Gbps	Dependent on the Informative Test setting.	
	Gear 3 Rates [> 3.5] Gbps		
Number of Slew Rate States	1	×	×
	>1	✓	✓
Informative Test	Dependency	Not applicable for HS Gear 1 Rates.	
	Enabled	✓	✓
	Disabled	×	×

Test Modes

- HS BURST

Test Procedure

- 1 Perform the following tests as a prerequisite to running the Slew Rate State Resolution (ΔSR_{DIF_TX}) test:

Table 27 Prerequisite tests for Slew Rate State Resolution (ΔSR_{DIF_TX}) test

Test IDs	Prerequisite Test Name	Corresponding Prerequisite Test IDs
809	Slew Rate Control Range ($SR_{DIF_TX[MAX]}$ and $SR_{DIF_TX[MIN]}$)	806
709	Slew Rate Control Range ($SR_{DIF_TX[MAX]}$ and $SR_{DIF_TX[MIN]}$)	706

- 2 Use the prerequisite tests mentioned above to implement the procedural steps in order to determine the Slew Rate State Resolution.
- 3 Use the PASS or FAIL status of the test for the final test result.

Test Results

The measured value for ΔSR_{DIF_TX} for the test signal must be within the conformance limit as specified in the CTS Specification mentioned under the References section.

Test Reference

Refer to Test 1.1.12 of the M-PHY Physical Layer Conformance Test Suite v3.0r15 (24July2014).

Test 1.1.13 Intra-Lane Output Skew ($T_{\text{INTRA_SKEW_TX}}$)

Test Overview

The purpose of the Intra-Lane Output Skew ($T_{\text{INTRA_SKEW_TX}}$) test is to verify that the Intra-Lane Output Skew ($T_{\text{INTRA_SKEW_TX}}$) of the HS-TX of the DUT is within the conformance limits according to the MIPI M-PHY standards.

Test ID

- 810 [1.1.13 TINTRA_SKEW_LA_RT_TX (B)]
- 710 [1.1.13 TINTRA_SKEW_SA_RT_TX (B)]

Test Availability Conditions

Table 28 shows the options on the MIPI M-PHY Conformance Test Application, which are available for you to configure, for the Test IDs associated with the Intra-Lane Output Skew ($T_{\text{INTRA_SKEW_TX}}$) test.

Table 28 Test Availability Conditions for the Intra-Lane Output Skew test*

Test ID	Configurable Options						
	Test Group				Signal Type		
	LA_RT	SA_RT	LA_NT	SA_NT	HS BURST	HS Continuous	LS PWM
810	✓	×	×	×	✓	×	×
710	×	✓	×	×	✓	×	×

* Additionally, this test is applicable only on Single-ended connections.

Test Modes

- HS BURST

Test Procedure

- 1 Perform either of the following tests as a prerequisite to running the Intra-Lane Output Skew ($T_{\text{INTRA_SKEW_TX}}$) test:

Table 29 Prerequisite tests for Intra-Lane Output Skew ($T_{\text{INTRA_SKEW_TX}}$) test

Test IDs	Prerequisite Test Name	Corresponding Prerequisite Test IDs
810	Unit Interval and Frequency Offset ($f_{\text{OFFSET_TX}}$)	817
710	Unit Interval and Frequency Offset ($f_{\text{OFFSET_TX}}$)	717

Measure the Unit Interval and Data Rates. The application saves the test results.

- 2 Trigger the DIF-P (or DIF-N) region on the HS Burst data signal to acquire a test waveform.
- 3 A Common-Mode signal (V_{CM}) is generated for TXDP and TXDN.

- 4 Measure the average value for V_{CM} and use this value to set the measurement threshold for the Skew measurement on the Infiniium Oscilloscope.
- 5 Measure the Skew between TXDP and TXDN for all rise and fall transitions in the test signal.
- 6 Calculate and use the mean value of Skew for the final test result.

Test Results

The calculated value for $T_{INTRA_SKEW_TX}$ for the test signal must be within the conformance limit as specified in the CTS Specification mentioned under the References section.

Test Reference

Refer to Test 1.1.13 of the M-PHY Physical Layer Conformance Test Suite v3.0r15 (24July2014).

Test 1.1.14 Transmitter Pulse Width (T_{PULSE_TX})

Test Overview

The purpose of the Transmitter Pulse Width (T_{PULSE_TX}) test is to verify that the Pulse Width (T_{PULSE_TX}) of the HS-TX of the DUT is within the conformance limits according to the MIPI M-PHY standards.

Test ID

- 811 [1.1.14 TPULSE_LA_RT_TX (B)]
- 711 [1.1.14 TPULSE_SA_RT_TX (B)]

Test Availability Conditions

Table 30 shows the options on the MIPI M-PHY Conformance Test Application, which are available for you to configure, for the Test IDs associated with the Transmitter Pulse Width (T_{PULSE_TX}) test.

Table 30 Test Availability Conditions for the Transmitter Pulse Width test

Test ID	Configurable Options						
	Test Group				Signal Type		
	LA_RT	SA_RT	LA_NT	SA_NT	HS BURST	HS Continuous	LS PWM
811	✓	×	×	×	✓	×	×
711	×	✓	×	×	✓	×	×

Test Modes

- HS BURST

Test Procedure

- 1 Perform either of the following tests as a prerequisite to running the Transmitter Pulse Width (T_{PULSE_TX}) test:

Table 31 Prerequisite tests for Transmitter Pulse Width (T_{PULSE_TX}) test

Test IDs	Prerequisite Test Name	Corresponding Prerequisite Test IDs
811	Unit Interval and Frequency Offset (f_{OFFSET_TX})	817
711	Unit Interval and Frequency Offset (f_{OFFSET_TX})	717

Measure the Unit Interval and Data Rates. The application saves the test results.

- 2 Trigger the DIF-P (or DIF-N) region on the HS Burst data signal to acquire a test waveform.
- 3 A differential signal is generated for TXDP and TXDN, which is used for processing of data.
- 4 Use the **Positive Pulse Width (+ Width)** and the **Negative Pulse Width (– Width)** feature on the Infiniium Oscilloscope to measure all pulse widths on the differential signal.

- 5 Identify and report the minimum positive pulse and the minimum negative pulse. Use the lowest among the two reported values for the final test result, after its unit is converted from seconds to UI.

Test Results

The measured value for T_{PULSE_TX} for the test signal must be within the conformance limit as specified in the CTS Specification mentioned under the References section.

Test Reference

Refer to Test 1.1.14 of the M-PHY Physical Layer Conformance Test Suite v3.0r15 (24July2014).

Test 1.1.15 Total Jitter (TJ_{TX})

Test Overview

The purpose of the Total Jitter (TJ_{TX}) test is to verify that the Total Jitter (TJ_{TX}) of the HS-TX of the DUT is within the conformance limits according to the MIPI M-PHY standards.

Test ID

- 1812 [1.1.15 TJ_LA_RT_TX (C)]
- 1712 [1.1.15 TJ_SA_RT_TX (C)]

Test Availability Conditions

Table 32 shows the options on the MIPI M-PHY Conformance Test Application, which are available for you to configure, for the Test IDs associated with the Total Jitter (TJ_{TX}) test.

Table 32 Test Availability Conditions for the Total Jitter test

Test ID	Configurable Options									
	Test Group				Signal Type			Informative Test		
	LA_RT	SA_RT	LA_NT	SA_NT	HS BURST	HS Continuous	LS PWM	Dependency	Enabled	Disabled
1812	✓	×	×	×	×	✓	×	NA	✓	×
1712	×	✓	×	×	×	✓	×	NA	✓	×

Test Modes

- HS Continuous

Test Procedure

- 1 Perform either of the following tests as a prerequisite to running the Total Jitter (TJ_{TX}) test:

Table 33 Prerequisite tests for Total Jitter (TJ_{TX}) test

Test IDs	Prerequisite Test Name	Corresponding Prerequisite Test IDs
1812	Unit Interval and Frequency Offset (f _{OFFSET_TX})	1817
1712	Unit Interval and Frequency Offset (f _{OFFSET_TX})	1717

- 1 Measure the Unit Interval and Data Rates. The application saves the test results.
- 2 Trigger the HS Continuous data signal to acquire a test waveform.
- 3 A differential signal is generated for TXDP and TXDN, which is used for processing of data.

- 4 Set up clock recovery to use the “2nd Order PLL” method with one of the listed -3dB cut-off frequencies for the corresponding HS Data Rates:

Cut-off Frequency	HS Data Rate
2.0 MHZ	HS Gear 1 A/B series
4.0 MHZ	HS Gear 2 A/B series
8.0 MHZ	HS Gear 3 A/B series

- 5 Use the **EZJIT Complete** feature on the Infiniium Oscilloscope to measure the TJ, DJ and RJ values of the test signal.
- 6 Use the measured value for TJ for the final test result.

Test Results

The measured value for Total Jitter (TJ_{TX}) for the test signal must be within the conformance limit as specified in the CTS Specification mentioned under the References section.

Test Reference

Refer to Test 1.1.15 of the M-PHY Physical Layer Conformance Test Suite v3.0r18 (11Dec2014).

Test 1.1.16 Short-Term Total Jitter (STTJ_{TX})

Test Overview

The purpose of the Short-Term Total Jitter (STTJ_{TX}) test is to verify that the Short-Term Total Jitter (STTJ_{TX}) of the HS-TX of the DUT is within the conformance limits according to the MIPI M-PHY standards.

Test ID

- 1814 [1.1.16 STTJ_LA_RT_TX (C)]
- 1714 [1.1.16 STTJ_SA_RT_TX (C)]

Test Availability Conditions

Table 34 shows the options on the MIPI M-PHY Conformance Test Application, which are available for you to configure, for the Test IDs associated with the Short-Term Total Jitter (STTJ_{TX}) test.

Table 34 Test Availability Conditions for the Short-Term Total Jitter test

Test ID	Configurable Options									
	Test Group				Signal Type			Informative Test		
	LA_RT	SA_RT	LA_NT	SA_NT	HS BURST	HS Continuous	LS PWM	Dependency	Enabled	Disabled
1814	✓	×	×	×	×	✓	×	NA	✓	×
1714	×	✓	×	×	×	✓	×	NA	✓	×

Test Modes

- HS Continuous

Test Procedure

- 1 Perform either of the following tests as a prerequisite to running the Short-Term Total Jitter (STTJ_{TX}) test:

Table 35 Prerequisite tests for Short-Term Total Jitter (STTJ_{TX}) test

Test IDs	Prerequisite Test Name	Corresponding Prerequisite Test IDs
1814	Unit Interval and Frequency Offset (f _{OFFSET_TX})	1817
1714	Unit Interval and Frequency Offset (f _{OFFSET_TX})	1717

- 2 Measure the Unit Interval and Data Rates. The application saves the test results.
- 2 Trigger the HS Continuous data signal to acquire a test waveform.
- 3 A differential signal is generated for TXDP and TXDN, which is used for processing of data.

- 4 Set up clock recovery to use the “2nd Order PLL” method with one of the listed -3dB cut-off frequencies for the corresponding HS Data Rates:

Cut-off Frequency	HS Data Rate
2.0 MHZ	HS Gear 1 A/B series
4.0 MHZ	HS Gear 2 A/B series
8.0 MHZ	HS Gear 3 A/B series

- 5 Set up a High-pass filter with a cut-off frequency of $1/(30 * U_{I_{HS}})$ to measure jitter.
- 6 Use the **EZJIT Complete** feature on the Infiniium Oscilloscope to measure the TJ, DJ and RJ values of the test signal.
- 7 Use the measured value for TJ for the final test result.

Test Results

The measured value for Short-Term Total Jitter (STTJ_{TX}) for the test signal must be within the conformance limit as specified in the CTS Specification mentioned under the References section.

Test Reference

Refer to Test 1.1.16 of the M-PHY Physical Layer Conformance Test Suite v3.0r18 (11Dec2014).

Test 1.1.17 Deterministic Jitter (DJ_{TX})

Test Overview

The purpose of the Deterministic Jitter (DJ_{TX}) test is to verify that the Deterministic Jitter (DJ_{TX}) of the HS-TX of the DUT is within the conformance limits according to the MIPI M-PHY standards.

Test ID

- 813 [1.1.17 DJ_LA_RT_TX (B)]
- 713 [1.1.17 DJ_SA_RT_TX (B)]
- 1813 [1.1.17 DJ_LA_RT_TX (C)]
- 1713 [1.1.17 DJ_SA_RT_TX (C)]

Test Availability Conditions

Table 36 shows the options on the MIPI M-PHY Conformance Test Application, which are available for you to configure, for the Test IDs associated with the Deterministic Jitter (DJ_{TX}) test.

Table 36 Test Availability Conditions for the Deterministic Jitter test

Test ID	Configurable Options									
	Test Group				Signal Type			Informative Test		
	LA_RT	SA_RT	LA_NT	SA_NT	HS BURST	HS Continuous	LS PWM	Dependency	Enabled	Disabled
813	✓	×	×	×	✓	×	×	NA	✓	×
713	×	✓	×	×	✓	×	×	NA	✓	×
1813	✓	×	×	×	×	✓	×	NA	✓	×
1713	×	✓	×	×	×	✓	×	NA	✓	×

Test Modes

- HS Burst
- HS Continuous

Test Procedure

For Test IDs: 813, 713 (HS Burst Data)

- 1 Perform the following tests as a prerequisite to running the Deterministic Jitter (DJ_{TX}) test:

Table 37 Prerequisite tests for Deterministic Jitter (DJ_{TX}) test

Test IDs	Prerequisite Test Name	Corresponding Prerequisite Test IDs
813	Unit Interval and Frequency Offset (f_{OFFSET_TX})	817
713	Unit Interval and Frequency Offset (f_{OFFSET_TX})	717

- Measure the Unit Interval and Data Rates. The application saves the test results.
- 2 Trigger the DIF-P region on the HS Burst data signal to acquire a test waveform.
- 3 A differential signal is generated for TXDP and TXDN, which is used for processing of data.
- 4 Use the differential test signal as the waveform source to enable the Time Interval Error (TIE) feature on the Infiniium Oscilloscope.
- 5 Set up clock recovery to use the “Constant Frequency” method.
- 6 Set up a High-pass filter with one of the listed -3dB cut-off frequencies for the corresponding HS Data Rates to measure TIE:

Cut-off Frequency	HS Data Rate
2.0 MHZ	HS Gear 1 A/B series
4.0 MHZ	HS Gear 2 A/B series
8.0 MHZ	HS Gear 3 A/B series

- 7 Repeat steps 2 to 6 for ten times to calculate the average value for the peak to peak TIE.
- 8 Use the average value for peak to peak TIE for the final DJ test result.

For Test IDs: 1813, 1713 (HS Continuous Data)

- 1 Perform the following tests as a prerequisite to running the Deterministic Jitter (DJ_{TX}) test:

Table 38 Prerequisite tests for Deterministic Jitter (DJ_{TX}) test

Test IDs	First Prerequisite Test Name	Corresponding Prerequisite Test IDs	Second Prerequisite Test Name	Corresponding Prerequisite Test IDs
1813	Unit Interval and Frequency Offset (f_{OFFSET_TX})	1817	Total Jitter (TJ_{TX})	1812
1713	Unit Interval and Frequency Offset (f_{OFFSET_TX})	1717	Total Jitter (TJ_{TX})	1712

- Measure the Unit Interval and Data Rates with respect to f_{OFFSET_TX} tests and measure values for TJ, DJ and RJ with respect to TJ_{TX} tests. The application saves the test results.
- 2 Use the measured value for DJ in the prerequisite test (for TJ_{TX}) for the final test result.

Test Results

The measured value for Deterministic Jitter (DJ_{TX}) for the test signal must be within the conformance limit as specified in the CTS Specification mentioned under the References section.

Test Reference

Refer to Test 1.1.17 of the M-PHY Physical Layer Conformance Test Suite v3.0r18 (11Dec2014).

Test 1.1.18 Short-Term Deterministic Jitter (STDJ_{TX})

Test Overview

The purpose of the Short-Term Deterministic Jitter (STDJ_{TX}) test is to verify that the Short-Term Deterministic Jitter (STDJ_{TX}) of the HS-TX of the DUT is within the conformance limits according to the MIPI M-PHY standards.

Test ID

- 815 [1.1.18 STDJ_LA_RT_TX (B)]
- 715 [1.1.18 STDJ_SA_RT_TX (B)]
- 1815 [1.1.18 STDJ_LA_RT_TX (C)]
- 1715 [1.1.18 STDJ_SA_RT_TX (C)]

Test Availability Conditions

Table 39 shows the options on the MIPI M-PHY Conformance Test Application, which are available for you to configure, for the Test IDs associated with the Short-Term Deterministic Jitter (STDJ_{TX}) test.

Table 39 Test Availability Conditions for the Short-Term Deterministic Jitter test

Test ID	Configurable Options									
	Test Group				Signal Type			Informative Test		
	LA_RT	SA_RT	LA_NT	SA_NT	HS BURST	HS Continuous	LS PWM	Dependency	Enabled	Disabled
815	✓	×	×	×	✓	×	×	NA	✓	×
715	×	✓	×	×	✓	×	×	NA	✓	×
1815	✓	×	×	×	×	✓	×	NA	✓	×
1715	×	✓	×	×	×	✓	×	NA	✓	×

Test Modes

- HS Burst
- HS Continuous

Test Procedure

For Test IDs: 815, 715 (HS Burst Data)

- 1 Perform the following tests as a prerequisite to running the Short-Term Deterministic Jitter (STDJ_{TX}) test:

Table 40 Prerequisite tests for Short-Term Deterministic Jitter (STDJ_{TX}) test

Test IDs	Prerequisite Test Name	Corresponding Prerequisite Test IDs
815	Unit Interval and Frequency Offset (f _{OFFSET_TX})	817
715	Unit Interval and Frequency Offset (f _{OFFSET_TX})	717

- Measure the Unit Interval and Data Rates. The application saves the test results.
- 2 Trigger the DIF-P region on the HS Burst data signal to acquire a test waveform.
- 3 A differential signal is generated for TXDP and TXDN, which is used for processing of data.
- 4 Use the differential test signal as the waveform source to enable the Time Interval Error (TIE) feature on the Infiniium Oscilloscope.
- 5 Set up clock recovery to use the “Constant Frequency” method.
- 6 Set up a High-pass filter with a cut-off frequency of 1/(30 * UI_{HS}) to measure TIE.
- 7 Repeat steps 2 to 6 for ten times to calculate the average value for the peak to peak TIE.
- 8 Use the average value for peak to peak TIE for the final DJ test result.

For Test IDs: 1815, 1715 (HS Continuous Data)

- 1 Perform the following tests as a prerequisite to running the Short-Term Deterministic Jitter (STDJ_{TX}) test:

Table 41 Prerequisite tests for Short-Term Deterministic Jitter (STDJ_{TX}) test

Test IDs	First Prerequisite Test Name	Corresponding Prerequisite Test IDs	Second Prerequisite Test Name	Corresponding Prerequisite Test IDs
1815	Unit Interval and Frequency Offset (f _{OFFSET_TX})	1817	Short-Term Total Jitter (STTJ _{TX})	1814
1715	Unit Interval and Frequency Offset (f _{OFFSET_TX})	1717	Short-Term Total Jitter (STTJ _{TX})	1714

- Measure the Unit Interval and Data Rates with respect to f_{OFFSET_TX} tests and measure values for TJ, DJ and RJ with respect to STTJ_{TX} tests. The application saves the test results.
- 2 Use the measured value for DJ in the prerequisite test (for STTJ_{TX}) for the final test result.

Test Results

The measured value for Short-Term Deterministic Jitter (STDJ_{TX}) for the test signal must be within the conformance limit as specified in the CTS Specification mentioned under the References section.

Test Reference

Refer to Test 1.1.18 of the M-PHY Physical Layer Conformance Test Suite v3.0r18 (11Dec2014).

5 High-Speed Transmitter (HS-TX) Tests v4.0 and v4.1

Probing for High-Speed Transmitter Electrical Tests /	90
Test 1.1.1 Unit Interval and Frequency Offset (f_OFFSET_TX) /	92
Test 1.1.2 Common-Mode AC Power Spectral Magnitude Limit (PSDCM) /	95
Test 1.1.3 PREPARE Length (THS-PREPARE) /	95
Test 1.1.4 Common-Mode DC Output Voltage Amplitude (VCM_TX) /	95
Test 1.1.5 Differential DC Output Voltage Amplitude (VDIF_DC_TX) /	95
Test 1.1.6 G1 and G2 Differential AC Eye (TEYE_TX, VDIF_AC_TX) /	96
Test 1.1.7 G3 and G4 Differential AC Eye (TEYE_HS_G3/G4_TX, VDIF_AC_HS_G3/G4_TX) /	104
Test 1.1.8 20% / 80% Rise and Fall Times (TR_HS_TX and TF_HS_TX) /	115
Test 1.1.9 Lane-to-Lane Skew (TL2L_SKEW_HS_TX) /	116
Test 1.1.10 Slew Rate Control Range (SRDIF_TX[MAX] and SRDIF_TX[MIN]) /	118
Test 1.1.11 Slew Rate State Monotonicity /	119
Test 1.1.12 Slew Rate State Resolution (Δ SRDIF_TX) /	120
Test 1.1.13 Intra-Lane Output Skew (TINTRA_SKEW_TX) /	121
Test 1.1.14 Transmitter Pulse Width (TPULSE_TX) /	121
Test 1.1.15 Total Jitter (TJTX) /	122
Test 1.1.16 Short-Term Total Jitter (STTJTX) /	124
Test 1.1.17 Deterministic Jitter (DJTX) /	126
Test 1.1.18 Short-Term Deterministic Jitter (STDJTX) /	128

This section provides the Methods of Implementation (MOIs) for the signaling and timing electrical tests for high-speed transmitters (HS-TX) using an Keysight Infiniium oscilloscope, InfiniiumMax probes, and the MIPI M-PHY Conformance Test Application.

Probing for High-Speed Transmitter Electrical Tests

When performing the HS Tx tests, the MIPI M-PHY Conformance Test Application prompts you to make the proper connections, if you have not already done so. The connections for the HS Tx tests may look similar to the following diagram. Refer to the Connect tab in the MIPI M-PHY Conformance Test Application for the exact number of probe connections.

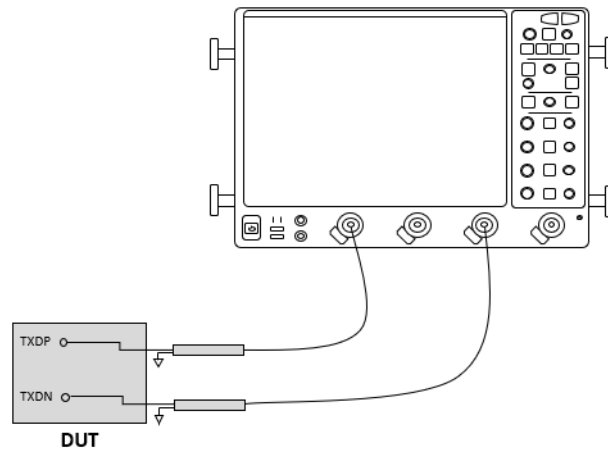

Figure 20 Probing for High-Speed Transmitter Electrical Tests

You can identify the channels used for each signal in the **Configure** tab of the MIPI M-PHY Conformance Test Application. (The channels shown in [Figure 20](#) are just examples).

For more information on the probe amplifiers and probe heads, see [Chapter 9](#), “InfiniiMax Probing,” starting on page 187.

Test Procedure

- 1 Start the automated test application as described in [“Starting the MIPI M-PHY Conformance Test Application”](#) on page 27.
- 2 In the MIPI M-PHY Conformance Test Application, click the **Set Up** tab.
- 3 Select the CTS version as **v4.0 and v4.1**.
- 4 Select the Test Group, and then enter the Device ID.
- 5 Click the **Select Tests** tab and check the tests you want to run. Check the parent node or group to check all the available tests within the group.

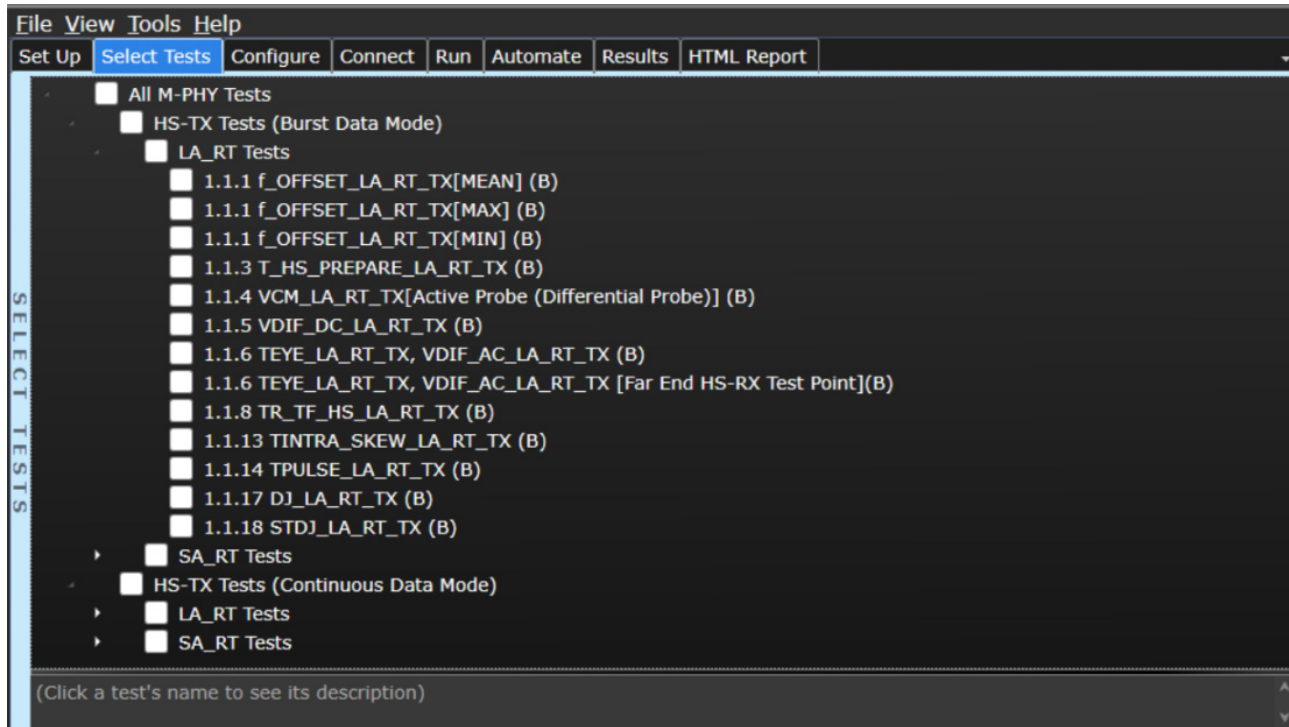

Figure 21 Selecting High-Speed Transmitter Electrical Tests

- 6 Follow the MIPI M-PHY Conformance Test Application's task flow to set up the configuration options, run the tests, and view the tests results.

Test 1.1.1 Unit Interval and Frequency Offset ($f_{\text{OFFSET_TX}}$)

Test Overview

The purpose of the Unit Interval and Frequency Offset ($f_{\text{OFFSET_TX}}$) test is to verify that the Frequency Offset ($f_{\text{OFFSET_TX}}$) of the HS-TX of the DUT is within the conformance limits of the MIPI M-PHY standard specification.

Test ID

- 817 [1.1.1 $f_{\text{OFFSET_LA_RT_TX}}$ [MEAN] (B)]
- 827 [1.1.1 $f_{\text{OFFSET_LA_RT_TX}}$ [MAX] (B)]
- 828 [1.1.1 $f_{\text{OFFSET_LA_RT_TX}}$ [MIN] (B)]
- 717 [1.1.1 $f_{\text{OFFSET_SA_RT_TX}}$ [MEAN] (B)]
- 727 [1.1.1 $f_{\text{OFFSET_SA_RT_TX}}$ [MAX] (B)]
- 728 [1.1.1 $f_{\text{OFFSET_SA_RT_TX}}$ [MIN] (B)]
- 1817 [1.1.1 $f_{\text{OFFSET_LA_RT_TX}}$ [MEAN] (C)]
- 1827 [1.1.1 $f_{\text{OFFSET_LA_RT_TX}}$ [MAX] (C)]
- 1828 [1.1.1 $f_{\text{OFFSET_LA_RT_TX}}$ [MIN] (C)]
- 1717 [1.1.1 $f_{\text{OFFSET_SA_RT_TX}}$ [MEAN] (C)]
- 1727 [1.1.1 $f_{\text{OFFSET_SA_RT_TX}}$ [MAX] (C)]
- 1728 [1.1.1 $f_{\text{OFFSET_SA_RT_TX}}$ [MIN] (C)]

Test Availability Conditions

Table 42 shows the options on the MIPI M-PHY Conformance Test Application, which are available for you to configure, for the Test IDs associated with the Unit Interval and Frequency Offset ($f_{\text{OFFSET_TX}}$) test.

Table 42 Test Availability Conditions for the Unit Interval and Frequency Offset test

Test ID	Configurable Options						
	Test Group				Signal Type		
	LA_RT	SA_RT	LA_NT	SA_NT	HS BURST	HS Continuous	LS PWM
817	✓	×	×	×	✓	×	×
827	✓	×	×	×	✓	×	×
828	✓	×	×	×	✓	×	×
717	×	✓	×	×	✓	×	×
727	×	✓	×	×	✓	×	×
728	×	✓	×	×	✓	×	×
1817	✓	×	×	×	×	✓	×
1827	✓	×	×	×	×	✓	×
1828	✓	×	×	×	×	✓	×

Test ID	Configurable Options						
	Test Group				Signal Type		
	LA_RT	SA_RT	LA_NT	SA_NT	HS BURST	HS Continuous	LS PWM
1717	x	✓	x	x	x	✓	x
1727	x	✓	x	x	x	✓	x
1728	x	✓	x	x	x	✓	x

Test Modes

- HS BURST
- HS Continuous

Test Procedure

- 1 Trigger the DIF-P (or DIF-N) region on the HS Burst data signal to acquire a test waveform. On an HS Continuous signal, a test waveform triggers automatically without searching for the DIF-P (or DIF-N) region.
- 2 A differential signal is generated for TXDP and TXDN, which is used for processing of data.
- 3 Use the **Unit Interval** feature on the Infiniium Oscilloscope to measure the UI data of the differential test signal.
- 4 To filter the measured UI data, apply a 2nd order Butterworth low pass test filter of 2.0 MHz bandwidth.
- 5 Determine the maximum, minimum and mean values of the Unit Interval from the array of the filtered Unit Interval data.
- 6 Use the following equation to calculate the Frequency Offset ($f_{\text{OFFSET_TX}}$) in units of ppm, for the final test result:

$$f_{\text{OFFSET_TX}} = [1/\text{UI} - \text{DR}_{\text{HS}}] / [\text{DR}_{\text{HS}} / 1\text{E6}]$$

where, DR_{HS} is the nominal TX bit rate for the HS RATE and GEAR data, as shown in [Table 43](#).

Table 43 HS-BURST RATE Series and GEARS

RATE A-Series (Mbps)	RATE B-Series (Mbps)	High-Speed GEARS
1248	1457.6*	HS-G1 (A/B)
2496	2915.2*	HS-G2 (A/B)
4992	5830.4*	HS-G3 (A/B)
9984	11660.8	HS-G4 (A/B)

* The B-Series RATEs shown are not integer multiples of common reference frequencies 19.20 MHz or 26.00 MHz. Instead, these RATEs are within the tolerance range of 2000 ppm.

Test Results

The calculated value for $f_{\text{OFFSET_TX}}$ of the test signal must be within the conformance limit as specified in the CTS Specification mentioned under the References section.

Test Reference

Refer to Section 5.1.2.11, Table 16 of the M-PHY Specification v4.1 (01Dec2016).

Test 1.1.2 Common-Mode AC Power Spectral Magnitude Limit (PS_{DCM})

For more information, refer to "Test 1.1.2 Common-Mode AC Power Spectral Magnitude Limit (PS_{DCM})" on page 45.

Test Reference

This is an informative test.

Test 1.1.3 PREPARE Length ($T_{HS-PREPARE}$)

For more information, refer to "Test 1.1.3 PREPARE Length ($T_{HS-PREPARE}$)" on page 47.

Test Reference

Refer to Section 4.7.2.1, Table 51 of the M-PHY Specification v4.1 (01Dec2016).

Test 1.1.4 Common-Mode DC Output Voltage Amplitude (V_{CM_TX})

For more information about this test, refer to "Test 1.1.4 Common-Mode DC Output Voltage Amplitude (V_{CM_TX})" on page 49.

Test Reference

Refer to Section 5.1.1.2, Table 15 of the M-PHY Specification v4.1 (01Dec2016).

Test 1.1.5 Differential DC Output Voltage Amplitude ($V_{DIF_DC_TX}$)

For more information about this test, refer to "Test 1.1.5 Differential DC Output Voltage Amplitude ($V_{DIF_DC_TX}$)" on page 52.

Test Reference

Refer to Section 5.1.1.2, Table 15 of the M-PHY Specification v4.1 (01Dec2016).

Test 1.1.6 G1 and G2 Differential AC Eye (T_{EYE_TX} , $V_{DIF_AC_TX}$)

Test Overview

For Test IDs 801, 701, 1821, 1721

The purpose of the G1 and G2 Differential AC Eye (T_{EYE_TX} , $V_{DIF_AC_TX}$) test is to verify that the HS-TX of the DUT meets the MIPI M-PHY standard specifications for the Transmitter Eye Opening (T_{EYE_TX}) and the maximum & minimum Differential AC Output Voltage Amplitude ($V_{DIF_AC_TX}$) for HS-G1 and HS-G2.

For Test IDs 841, 741, 1841, 1741 (Informative Test)

For these Test IDs, the G1 and G2 Differential AC Eye (T_{EYE_TX} , $V_{DIF_AC_TX}$) test is considered as Informative test. These tests leverage the test algorithm from the MIPI M-PHY Physical Layer Conformance Test Suite with RX Mask used.

Test ID

- 801 [1.1.6 TEYE_LA_RT_TX, VDIF_AC_LA_RT_TX (B)]
- 701 [1.1.6 TEYE_SA_RT_TX, VDIF_AC_SA_RT_TX (B)]
- 1821 [1.1.6 TEYE_LA_RT_TX, VDIF_AC_LA_RT_TX (C)]
- 1721 [1.1.6 TEYE_SA_RT_TX, VDIF_AC_SA_RT_TX (C)]
- 841 [1.1.6 TEYE_LA_RT_TX, VDIF_AC_LA_RT_TX [Far End HS-RX Test Point] (B)]
- 741 [1.1.6 TEYE_SA_RT_TX, VDIF_AC_SA_RT_TX [Far End HS-RX Test Point] (B)]
- 1841 [1.1.6 TEYE_LA_RT_TX, VDIF_AC_LA_RT_TX [Far End HS-RX Test Point] (C)]
- 1741 [1.1.6 TEYE_SA_RT_TX, VDIF_AC_SA_RT_TX [Far End HS-RX Test Point] (C)]

Test Availability Conditions

Table 44 shows the options on the MIPI M-PHY Conformance Test Application, which are available for you to configure, for the Test IDs associated with the G1 and G2 Differential AC Eye (T_{EYE_TX} , $V_{DIF_AC_TX}$) test.

Table 44 Test Availability Conditions for the G1 and G2 Differential AC Eye test

Test ID	Configurable Options												
	Test Group				Signal Type			HS Data Rate			Informative Test		
	LA_RT	SA_RT	LA_NT	SA_NT	HS BURST	HS Continuous	LS PWM	Gear 1 Rates [≤ 1.5] Gbps	Gear 2 Rates [$1.5 < x \leq 3.5$] Gbps	Gear 3 Rates [> 3.5] Gbps	Dependency	Enabled	Disabled
801	✓	×	×	×	✓	×	×	✓	✓	×	NA	✓	×
841	✓	×	×	×	✓	×	×	✓	✓	×	NA	✓	×
701	×	✓	×	×	✓	×	×	✓	✓	×	NA	✓	×
741	×	✓	×	×	✓	×	×	✓	✓	×	NA	✓	×
1821	✓	×	×	×	×	✓	×	✓	✓	×			

Test ID	Configurable Options												
	Test Group				Signal Type			HS Data Rate			Informative Test		
	LA_RT	SA_RT	LA_NT	SA_NT	HS BURST	HS Continuous	LS PWM	Gear 1 Rates [≤ 1.5] Gbps	Gear 2 Rates [$1.5 < x \leq 3.5$] Gbps	Gear 3 Rates [> 3.5] Gbps	Dependency	Enabled	Disabled
1841	✓	×	×	×	×	✓	×	✓	✓	×	NA	✓	×
1721	×	✓	×	×	×	✓	×	✓	✓	×			
1741	×	✓	×	×	×	✓	×	✓	✓	×	NA	✓	×

Test Modes

- HS BURST
- HS Continuous

Test Procedure

For Test IDs 801, 701, 1821, 1721

- 1 Perform the following tests as a prerequisite to running the G1 and G2 Differential AC Eye (T_{EYE_TX} , $V_{DIF_AC_TX}$) test:

Table 45 Prerequisite tests for G1 and G2 Differential AC Eye Opening (T_{EYE_TX} , $V_{DIF_AC_TX}$) test

Test IDs	Prerequisite Test Name	Corresponding Prerequisite Test IDs
801	Unit Interval and Frequency Offset (f_{OFFSET_TX})	817
701	Unit Interval and Frequency Offset (f_{OFFSET_TX})	717
1821	Unit Interval and Frequency Offset (f_{OFFSET_TX})	1817
1721	Unit Interval and Frequency Offset (f_{OFFSET_TX})	1717

Measure the Unit Interval and Data Rates. The application saves the test results.

- 2 Trigger the DIF-P (or DIF-N) region on the HS Burst data signal to acquire a test waveform. On an HS Continuous signal, a test waveform triggers automatically without searching for the DIF-P (or DIF-N) region.
- 3 Generate the differential signal for TXDP and TXDN using a MATLAB UDF script, in order to remove all the DIF-P and DIF-N regions from the test signal. The generated differential signal for HS Burst data is used for processing of data. In case of HS Continuous data, since there are no DIF-P or DIF-N regions in the test signal, generate the differential signal without using the MATLAB UDF script.
- 4 Use the “Specification Version” configuration option in Configure tab to determine the targeted BER to be used for this test.
For the selection of “v4.0” for “Specification Version” configuration option, the prorated mask targeted at BER 1E-10 will be applied. For the selection of “v4.1” for “Specification Version” configuration option, the prorated mask targeted at BER 1E-12 will be applied.

- 5 Verify T_{EYE_TX} and $V_{DIF_AC_TX}$ using the procedures described in the following sections:

Procedure for HS-G1 testing

Prorated Mask (targeted at BER 1E-10) for CTS v4.0

Figure 22 shows that for this test, the horizontal position of the 0.243UI interval is allowed to be shifted horizontally within the eye.

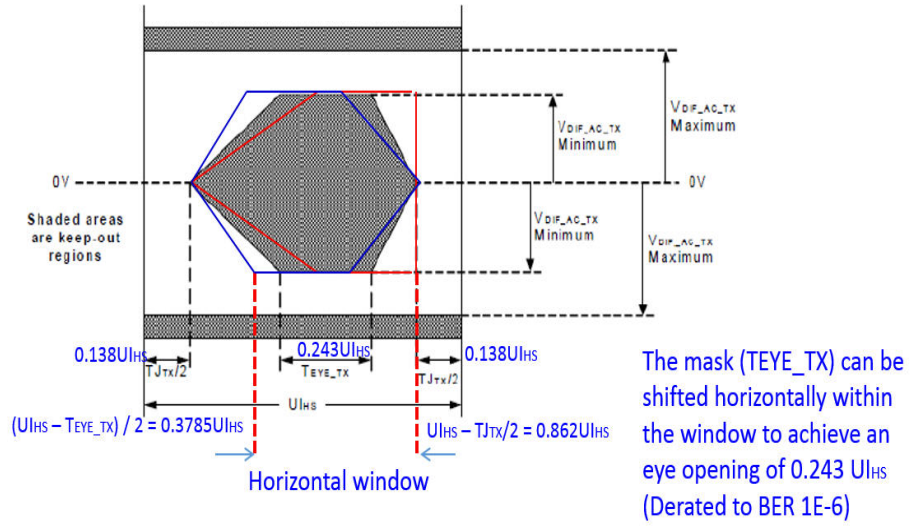

Figure 22 Eye Diagram for HS-G1 testing

- a For the HS Burst signal, generate the Eye Diagram using the acquired differential signal. For HS Continuous signal, acquire 3E6 UIs and generate the Eye Diagram.
- b Use the **Histogram** feature on the Infiniium Oscilloscope to measure the eye opening between 0.3785UI and 0.862UI at the minimum V_{DIF_AC} levels for the positive case. Assign the values as “left_top” and “right_top”, shown in Figure 23. Then, measure the eye opening for the negative case. Assign the values as “left_bottom” and “right_bottom”, shown in Figure 23.

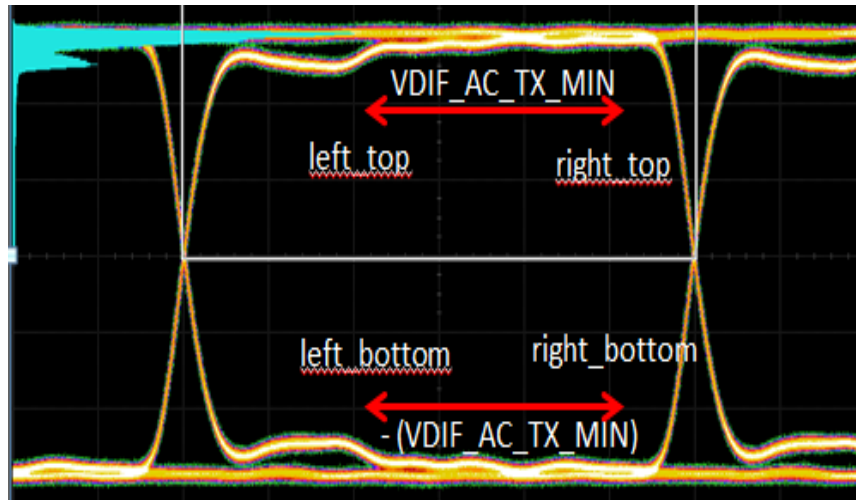

Figure 23 Left_top, Left_bottom, Right_top and Right_bottom measurements on the Eye Diagram

- c Determine the position of the mask using the equation:

$$T_{\text{EYE_TX_mid_point}} = [\text{Worst}(\text{left_top}, \text{left_bottom}) + \text{Worst}(\text{right_top}, \text{right_bottom})] / 2$$

The eye mask is placed and centered at the value of $T_{\text{EYE_TX_mid_point}}$ measured, shown in Figure 24.

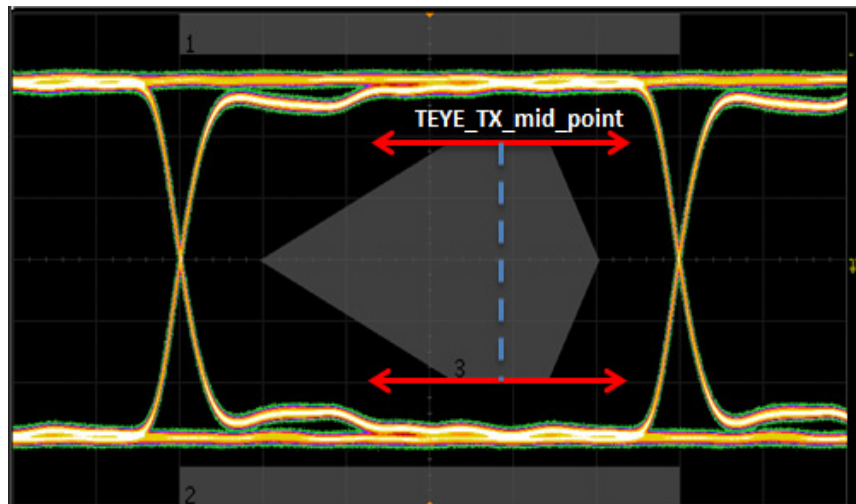

Figure 24 $T_{\text{EYE_TX_mid_point}}$ measurement on the eye diagram

Prorated Mask (targeted at BER 1E-12) for CTS v4.1

Figure 25 shows that for this test, the horizontal position of the 0.255UI interval is allowed to be shifted horizontally within the eye.

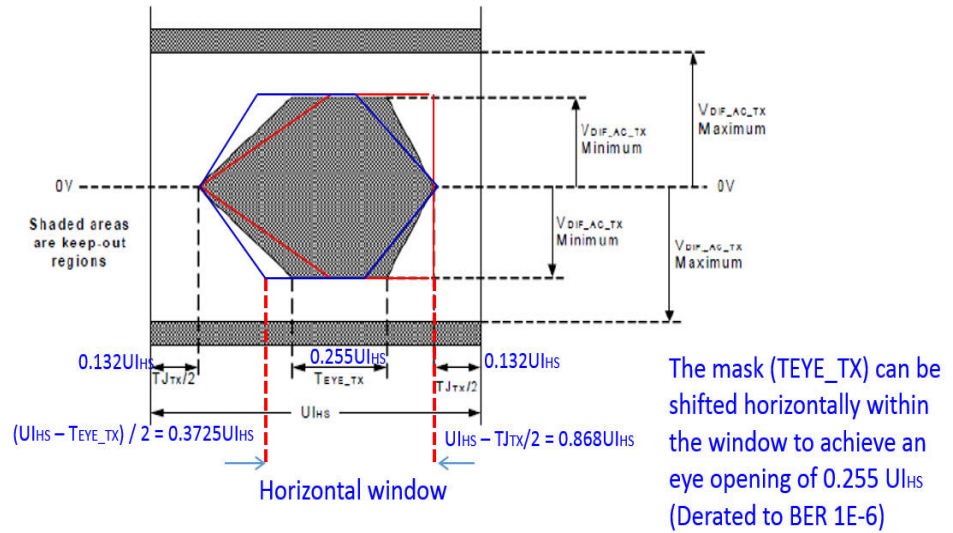

Figure 25 Eye Diagram for HS-G1 testing

- a For the HS Burst signal, generate the Eye Diagram using the acquired differential signal. For HS Continuous signal, acquire 3E6 UIs and generate the Eye Diagram.
- b Use the **Histogram** feature on the Infiniium Oscilloscope to measure the eye opening between 0.3725UI and 0.868UI at the minimum V_{DIF_AC} levels for the positive case. Assign the values as “left_top” and “right_top”, shown in Figure 26. Then, measure the eye opening for the negative case. Assign the values as “left_bottom” and “right_bottom”, shown in Figure 26.

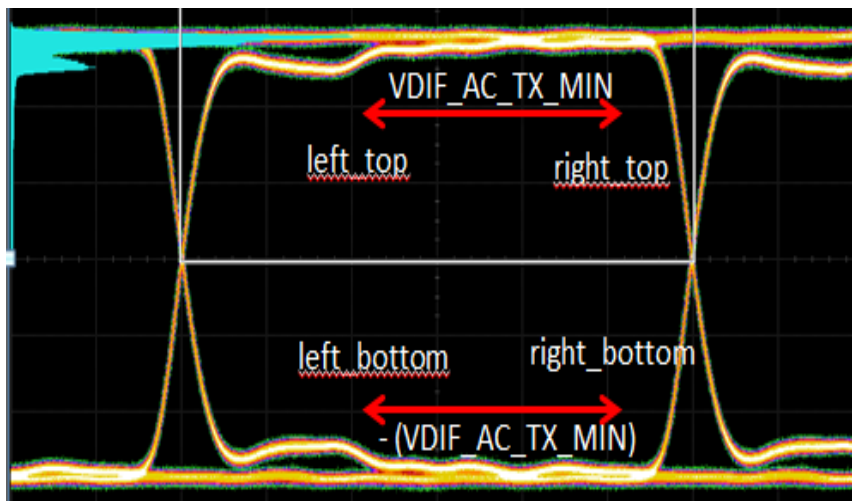

Figure 26 Left_top, Left_bottom, Right_top and Right_bottom measurements on the Eye Diagram

- c Determine the position of the mask using the equation:

$$T_{EYE_TX_mid_point} = [Worst(left_top, left_bottom) + Worst(right_top, right_bottom)] / 2$$

The eye mask is placed and centered at the value of $T_{EYE_TX_mid_point}$ measured, shown in Figure 27.

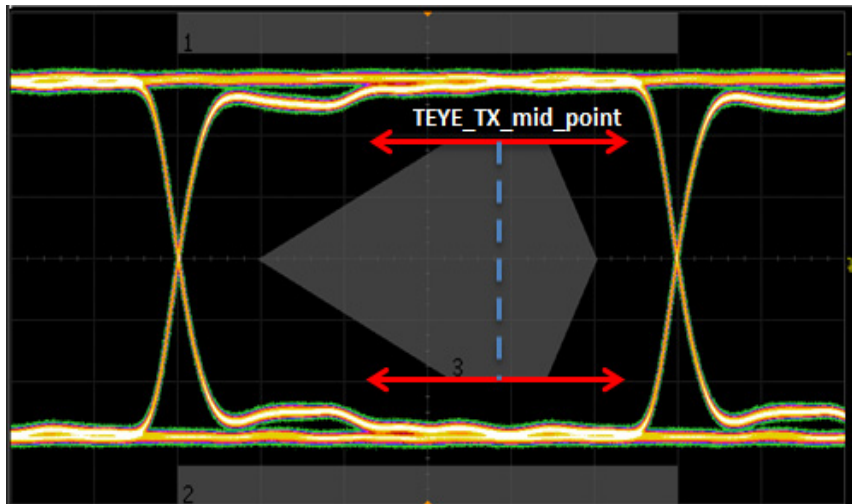

Figure 27 $T_{EYE_TX_mid_point}$ measurement on the eye diagram

Procedure for HS-G2 testing

Prorated Mask (targeted at BER 1E-10) for CTS v4.0

Figure 28 shows that for this test, the horizontal position of the 0.243UI interval is fixed and centered at UI/2 position.

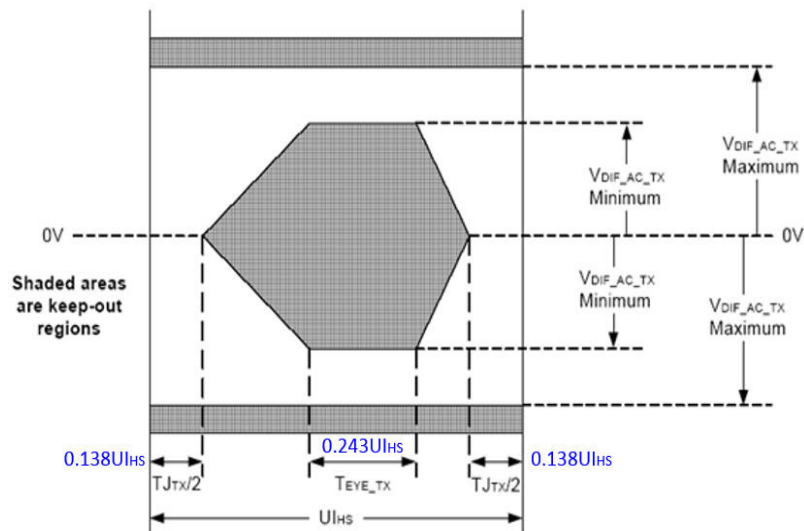

Figure 28 Eye Diagram for HS-G2 testing

- a Center the Eye Mask in the middle of the generated Eye Diagram.

Prorated Mask (targeted at BER 1E-12) for CTS v4.1

Figure 29 shows that for this test, the horizontal position of the 0.255UI interval is fixed and centered at UI/2 position.

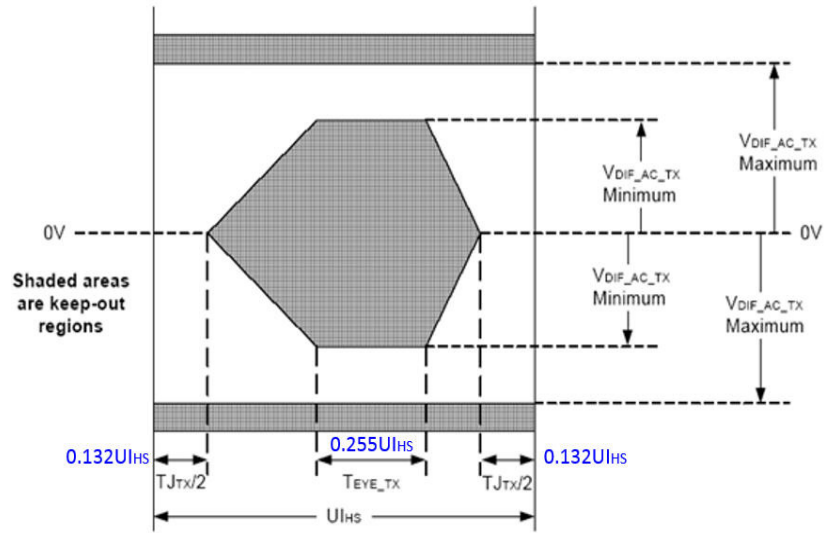

Figure 29 Eye Diagram for HS-G2 testing

- a Center the Eye Mask in the middle of the generated Eye Diagram.

Test Procedure (Contd.)

- 6 Construct the Eye Mask using the prorated values given in Table 46 for a targeted BER of BER 1E-10 and for a targeted BER of BER 1E-12.

Table 46 Prorated values for Eye Mask

Parameter	Normal Mask	Prorated Mask (1E-10)	Prorated Mask (1E-12)
T_{EYE_TX}	200mUI	243mUI	255mUI
$V_{DIF_AC_LA_TX_MIN}$	140mV	143mV	145mV
$V_{DIF_AC_LA_TX_MAX}$	310mV	310mV	310mV
$V_{DIF_AC_SA_TX_MIN}$	80mV	83mV	85mV
$V_{DIF_AC_SA_TX_MAX}$	200mV	200mV	200mV
$T_{JTX/2}$	160mUI	138mUI	132mUI

- 7 Run the “Mask Testing” feature on the Infiniium Oscilloscope.
- 8 Use the Mask violation result and PASS/FAIL status for the final test result.

For Test IDs 841, 741, 1841, 1741 (Informative Test)

Refer to “For Test IDs 841, 741, 1841, 1741 (Informative Test)” on page 54.

Test Results

The generated eye diagram shall not have greater than one incursion into the prorated mask as specified in the CTS Specification mentioned under the References section.

Test Reference

Refer to M-PHY Specification v4.1 (01Dec2016).

Test 1.1.7 G3 and G4 Differential AC Eye ($T_{EYE_HS_G3/G4_TX}$, $V_{DIF_AC_HS_G3/G4_TX}$)

Test Overview

For Test IDs 802, 702, 1822, 1823, 1722

The purpose of this test is to verify that the HS-TX of the DUT meets the MIPI M-PHY standard specifications for the Transmitter Eye Opening ($T_{EYE_HS_G3_TX}$) and the maximum and minimum Differential AC Output Voltage Amplitude ($V_{DIF_AC_HS_G3_TX}$) for HS-G3.

For Test IDs 1843, 1844, 1743

The purpose of this test is to verify that the HS-TX of the DUT meets the MIPI M-PHY standard specifications for the Transmitter Eye Opening ($T_{EYE_HS_G4_TX}$) and the maximum & minimum Differential AC Output Voltage Amplitude ($V_{DIF_AC_HS_G4_TX}$) for HS-G4.

Test IDs 842, 742, 1842, 1742, 1845, 1846, 1745 (Informative Test)

Test ID

- 802 [1.1.7 TEYE_G3_LA_RT_TX, VDIF_AC_G3_LA_RT_TX (B)]
- 702 [1.1.7 TEYE_G3_SA_RT_TX, VDIF_AC_G3_SA_RT_TX (B)]
- 1822 [1.1.7 TEYE_G3_LA_RT_TX, VDIF_AC_G3_LA_RT_TX [CH1] [0dB] (C)]
- 1823 [1.1.7 TEYE_G3_LA_RT_TX, VDIF_AC_G3_LA_RT_TX [CH2] [6dB] (C)]
- 1722 [1.1.7 TEYE_G3_SA_RT_TX, VDIF_AC_G3_SA_RT_TX [CH1] [3.5dB] (C)]
- 842 [1.1.7 TEYE_G3_LA_RT_TX, VDIF_AC_G3_LA_RT_TX [Far End HS-RX Test Point] (B)]
- 742 [1.1.7 TEYE_G3_SA_RT_TX, VDIF_AC_G3_SA_RT_TX [Far End HS-RX Test Point] (B)]
- 1842 [1.1.7 TEYE_G3_LA_RT_TX, VDIF_AC_G3_LA_RT_TX [Far End HS-RX Test Point] (C)]
- 1742 [1.1.7 TEYE_G3_SA_RT_TX, VDIF_AC_G3_SA_RT_TX [Far End HS-RX Test Point] (C)]
- 1843 [1.1.7 TEYE_G4_LA_RT_TX, VDIF_AC_G4_LA_RT_TX [CH1] [0dB] [SigTest] (C)]
- 1844 [1.1.7 TEYE_G4_LA_RT_TX, VDIF_AC_G4_LA_RT_TX [CH2] [6dB] [SigTest] (C)]
- 1743 [1.1.7 TEYE_G4_SA_RT_TX, VDIF_AC_G4_SA_RT_TX [CH1] [3.5dB] [SigTest] (C)]
- 1845 [1.1.7 TEYE_G4_LA_RT_TX, VDIF_AC_G4_LA_RT_TX [CH1] [0dB] (C)]
- 1846 [1.1.7 TEYE_G4_LA_RT_TX, VDIF_AC_G4_LA_RT_TX [CH2] [6dB] (C)]
- 1745 [1.1.7 TEYE_G4_SA_RT_TX, VDIF_AC_G4_SA_RT_TX [CH1] [3.5dB] (C)]

Test Availability Conditions

Table 47 and Table 48 show the options on the MIPI M-PHY Conformance Test Application, which are available for you to configure, for the Test IDs associated with the G3 and G4 Differential AC Eye ($T_{EYE_HS_G3/G4_TX}$, $V_{DIF_AC_HS_G3/G4_TX}$) test.

Table 47 Test Availability Conditions for the G3 and G4 Differential AC Eye test

Configurable Options		Test IDs								
		802	842	702	742	1822	1823	1842	1843	1844
Test Group	LA_RT	✓	✓	×	×	✓	✓	✓	✓	✓
	SA_RT	×	×	✓	✓	×	×	×	×	×
	LA_NT	×	×	×	×	×	×	×	×	×
	SA_NT	×	×	×	×	×	×	×	×	×
Signal Type	HS Burst	✓	✓	✓	✓	×	×	×	×	×
	HS Continuous	×	×	×	×	✓	✓	✓	✓	✓
	LS PWM	×	×	×	×	×	×	×	×	×
HS Data Rate	'A' Series					Note 1	Note 1		Note 1	Note 1
	'B' Series					✓	✓		✓	✓
	Gear 1 rates [≤ 1.5] Gbps	×	×	×	×	×	×	×	×	×
	Gear 2 rates [$1.5 < x \leq 3.5$] Gbps	×	×	×	×	×	×	×	×	×
	Gear 3 rates [> 3.5] Gbps	✓	✓	✓	✓	✓	✓	✓	×	×
	Gear 4 rates	×	×	×	×	×	×	×	✓	✓
Test Method - SigTest	Enabled								✓	✓
	Disabled								×	×
Informative Test	Dependency	NA	NA	NA	NA	Note 2	Note 2	NA	Note 2	Note 2
	Enabled	✓	✓	✓	✓	✓	✓	✓	✓	✓
	Disabled	×	×	×	×	×	×	×	×	×

Note 1: Dependency on [Informative Test] option settings

Note 2: Not Applicable for HS 'B' Series Gear rates.

Table 48 Test Availability Conditions for the G3 and G4 Differential AC Eye test (contd.)

Configurable Options							
		1722	1742	1743	1845	1846	1745
Test Group	LA_RT	x	x	x	✓	✓	x
	SA_RT	✓	✓	✓	x	x	✓
	LA_NT	x	x	x	x	x	x
	SA_NT	x	x	x	x	x	x
Signal Type	HS Burst	x	x	x	x	x	x
	HS Continuous	✓	✓	✓	✓	✓	✓
	LS PWM	x	x	x	x	x	x
HS Data Rate	'A' Series	Note 1		Note 1			
	'B' Series	✓		✓			
	Gear 1 rates [≤ 1.5] Gbps	x	x	x	x	x	x
	Gear 2 rates [$1.5 < x \leq 3.5$] Gbps	x	x	x	x	x	x
	Gear 3 rates [> 3.5] Gbps	✓	✓	x	x	x	x
	Gear 4 rates	x	x	✓	✓	✓	✓
Test Method - SigTest	Enabled			✓	x	x	x
	Disabled			x	✓	✓	✓
Informative Test	Dependency	Note 2	NA	Note 2	NA	NA	
	Enabled	✓	✓	✓	✓	✓	✓
	Disabled	x	x	x	x	x	x

Note 1: Dependency on [Informative Test] option settings

Note 2: Not Applicable for HS 'B' Series Gear rates.

Test Modes

- HS BURST
- HS Continuous

Test Procedure

For Test IDs 802, 702

- 1 Perform the following tests as a prerequisite to running the G3 Differential AC Eye ($T_{EYE_HS_G3_TX}$, $V_{DIF_AC_HS_G3_TX}$) test:

Table 49 Prerequisite tests for G3 Differential AC Eye Opening ($T_{EYE_HS_G3_TX}$, $V_{DIF_AC_HS_G3_TX}$) test

Test IDs	Prerequisite Test Name	Corresponding Prerequisite Test IDs
802	Unit Interval and Frequency Offset (f_{OFFSET_TX})	817
702	Unit Interval and Frequency Offset (f_{OFFSET_TX})	717

Measure the Unit Interval and Data Rates. The application saves the test results.

- 2 Trigger the DIF-P (or DIF-N) region on the HS Burst data signal to acquire a test waveform.
- 3 Generate the differential signal for TXDP and TXDN using a MATLAB UDF script, in order to remove all the DIF-P and DIF-N regions from the test signal. The generated differential signal for HS Burst data is used for processing of data.
- 4 Use the InfiniiSim function on the Infiniium Oscilloscope to embed the reference channel.
 - a The 'short' channel (CH1) reference channel is embedded for Small Amplitude signal type (Test ID: 702).
 - b The 'long' channel (CH2) reference channel is embedded for Large Amplitude signal type (Test ID: 802).
- 5 Use the "Specification Version" configuration option in Configure tab to determine the targeted BER to be used for this test.
 For the selection of "v4.0" for "Specification Version" configuration option, the prorated mask targeted at BER 1E-10 will be applied. For the selection of "v4.1" for "Specification Version" configuration option, the prorated mask targeted at BER 1E-12 will be applied.
- 6 To verify $T_{EYE_HS_G3_TX}$ and $V_{DIF_AC_HS_G3_TX}$, center the Eye Mask in the middle of the generated eye diagram, shown in Figure 30.

Prorated Mask (targeted at BER 1E-10)

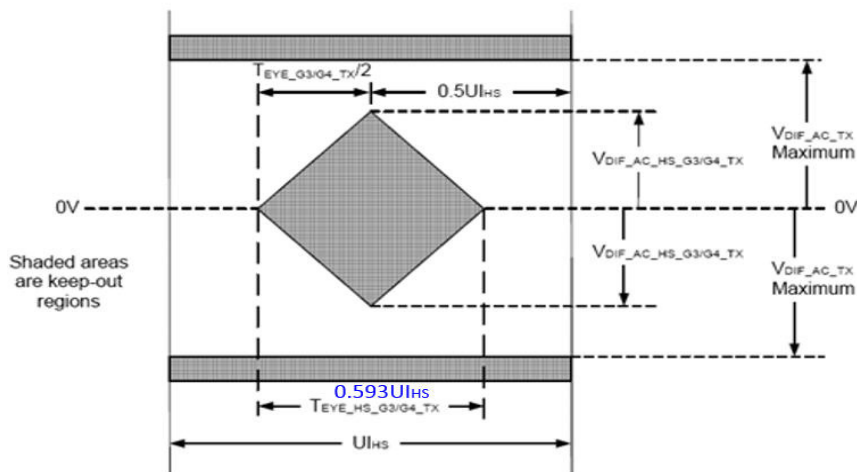

Figure 30 Centering Eye Mask in the Eye Diagram

Construct the Eye Mask using the prorated values given in [Table 50](#).

Table 50 Prorated values for Eye Mask

Parameter	Amplitude	Termination	Conf. Min.	Conf. Max.
$V_{DIF_AC_HS_G3/G4_TX}$	Large + Small	Terminated	45mV	NA
$V_{DIF_AC_LA_TX}$	Large	Terminated	NA	310mV
$V_{DIF_AC_SA_TX}$	Small	Terminated	NA	200mV
$T_{EYE_HS_G3_TX}$	Large + Small	Terminated	0.593UI	NA
$T_{EYE_HS_G4_TX}$	Large + Small	Terminated	0.543UI	NA

Prorated Mask (targeted at BER 1E-12)

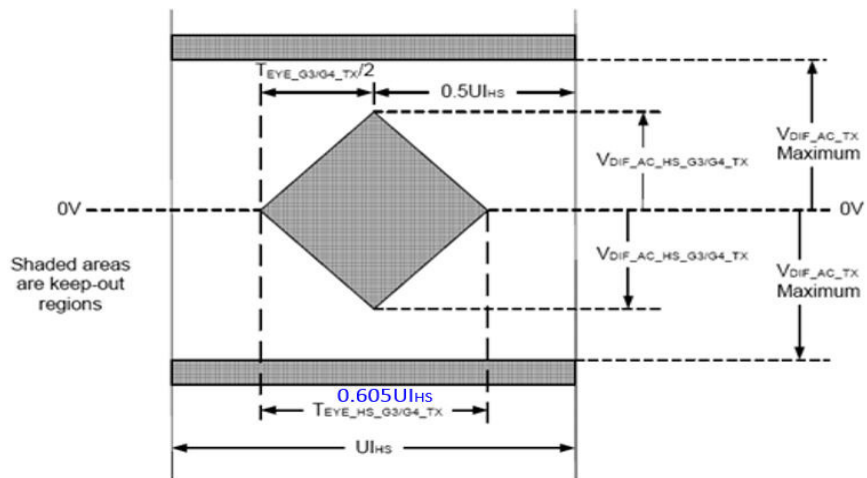

Figure 31 Centering Eye Mask in the Eye Diagram

Construct the Eye Mask using the prorated values given in [Table 51](#).

Table 51 Prorated values for Eye Mask

Parameter	Amplitude	Termination	Conf. Min.	Conf. Max.
$V_{DIF_AC_HS_G3/G4_TX}$	Large + Small	Terminated	47mV	NA
$V_{DIF_AC_LA_TX}$	Large	Terminated	NA	310mV
$V_{DIF_AC_SA_TX}$	Small	Terminated	NA	200mV
$T_{EYE_HS_G3_TX}$	Large + Small	Terminated	0.605UI	NA
$T_{EYE_HS_G4_TX}$	Large + Small	Terminated	0.555UI	NA

- 7 Run the “Mask Testing” feature on the Infiniium Oscilloscope.
 - For HS Burst signal: Single acquisition

- 8 Use the Mask violation result and PASS/FAIL status for the final test result.

For Test IDs 1822, 1823, 1722

- 1 Perform the following tests as a prerequisite to running this test:

Table 52 Prerequisite tests for G3 Differential AC Eye Opening ($T_{EYE_HS_G3_TX}$, $V_{DIF_AC_HS_G3_TX}$) test

Test IDs	Prerequisite Test Name	Corresponding Prerequisite Test IDs
1822	Unit Interval and Frequency Offset (f_{OFFSET_TX})	1817
1722	Unit Interval and Frequency Offset (f_{OFFSET_TX})	1717

Measure the Unit Interval and Data Rates. The application saves the test results.

- 2 Trigger on the HS Continuous data signal to acquire a test waveform.
- 3 Generate the differential signal for TXDP and TXDN. The generated signal is used for processing.
- 4 Use the InfiniiSim function on the Infiniium Oscilloscope to embed the reference channel.
 - a The 'short' channel (CH1) reference channel is embedded for Small Amplitude signal with 3.5 dB emphasis level. (Test ID: 1722).
 - b The 'short' channel (CH1) reference channel is embedded for Large Amplitude signal with 0 dB emphasis level. (Test ID: 1822).
 - c The 'long' channel (CH2) reference channel is embedded for Large Amplitude signal with 6.0 dB emphasis level. (Test ID: 1823).
- 5 Use the "Specification Version" configuration option in Configure tab to determine the targeted BER to be used for this test.
 For the selection of "v4.0" for "Specification Version" configuration option, the prorated mask targeted at BER 1E-10 will be applied. For the selection of "v4.1" for "Specification Version" configuration option, the prorated mask targeted at BER 1E-12 will be applied.
- 6 To verify T_{EYE_TX} and $V_{DIF_AC_TX}$ for different targeted BER, use the following procedures:
 - a. Center the Eye Mask in the middle of the generated eye diagram, as shown in the figures:

Prorated Mask (targeted at BER 1E-10)

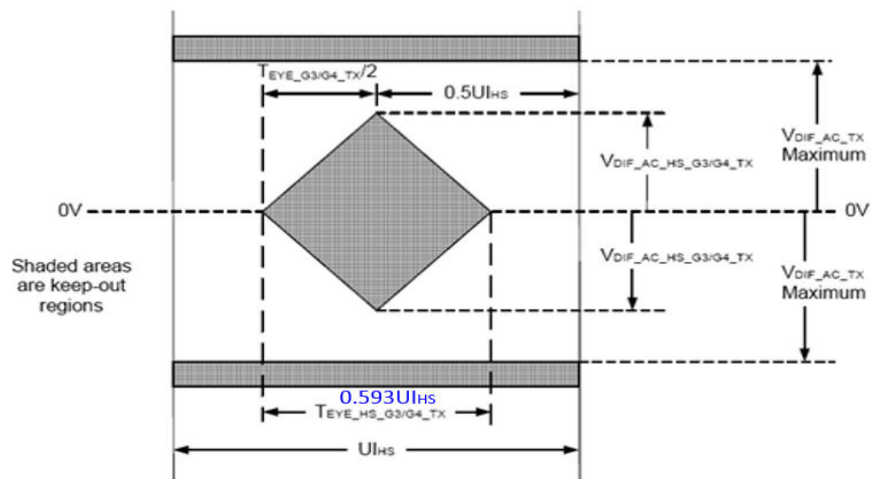

Figure 32 Centering Eye Mask in the Eye Diagram

Construct the Eye Mask using the prorated values given in [Table 53](#).

Table 53 Prorated values for Eye Mask

Parameter	Amplitude	Termination	Conf. Min.	Conf. Max.
$V_{DIF_AC_HS_G3/G4_TX}$	Large + Small	Terminated	45mV	NA
$V_{DIF_AC_LA_TX}$	Large	Terminated	NA	310mV
$V_{DIF_AC_SA_TX}$	Small	Terminated	NA	200mV
$T_{EYE_HS_G3_TX}$	Large + Small	Terminated	0.593UI	NA
$T_{EYE_HS_G4_TX}$	Large + Small	Terminated	0.543UI	NA

Prorated Mask (targeted at BER 1E-12)

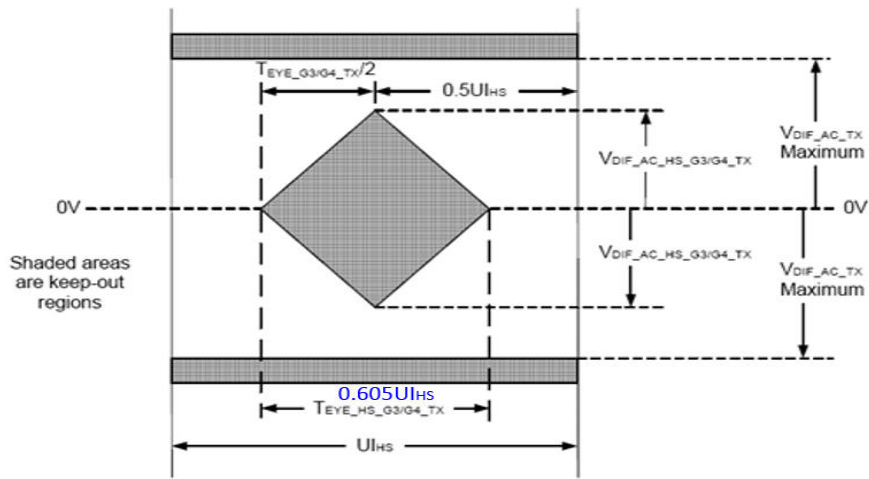

Figure 33 Centering Eye Mask in the Eye Diagram

Construct the Eye Mask using the prorated values given in [Table 54](#).

Table 54 Prorated values for Eye Mask

Parameter	Amplitude	Termination	Conf. Min.	Conf. Max.
$V_{DIF_AC_HS_G3/G4_TX}$	Large + Small	Terminated	47mV	NA
$V_{DIF_AC_LA_TX}$	Large	Terminated	NA	310mV
$V_{DIF_AC_SA_TX}$	Small	Terminated	NA	200mV
$T_{EYE_HS_G3_TX}$	Large + Small	Terminated	0.605UI	NA
$T_{EYE_HS_G4_TX}$	Large + Small	Terminated	0.555UI	NA

- 7 Run the “Mask Testing” feature on the Infiniium Oscilloscope.
 - For HS Continuous signal: Multiple acquisitions (3E6 UIs)
- 8 Use the Mask violation result and PASS/FAIL status for the final test result.

For Test IDs 842, 742, 1842, 1742 (Informative Test)

- 1 Measure the Unit Interval and Data Rates. The application saves the test results.
- 2 Trigger the DIF-P (or DIF-N) region on the HS Burst data signal to acquire a test waveform. On an HS Continuous signal, a test waveform triggers automatically without searching for the DIF-P (or DIF-N) region.
- 3 Generate the differential signal for TXDP and TXDN using a MATLAB UDF script, in order to remove all the DIF-P and DIF-N regions from the test signal. The generated differential signal for HS Burst data is used for processing of data. In case of HS Continuous data, since there are no DIF-P or DIF-N regions in the test signal, generate the differential signal without using the MATLAB UDF script.
- 4 To verify T_{EYE_TX} and $V_{DIF_AC_TX}$, center the Eye Mask in the middle of the generated eye diagram, shown in Figure 34.

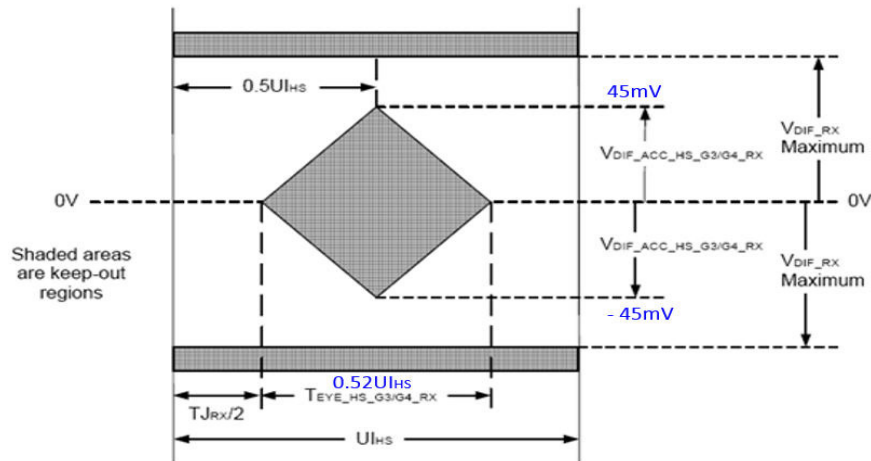

Figure 34 Centering Eye Mask in the Eye Diagram

- 5 Run the “Mask Testing” feature on the Infiniium Oscilloscope.
 - For HS Burst signal: Single acquisition
 - For HS Continuous signal: Multiple acquisitions (3E6 UIs)
- 6 Use the Mask violation result and PASS/FAIL status for the final test result.

For Test IDs 1845, 1846, 1745 (Informative Test)

- 1 Perform the following tests as a prerequisite to running this test:

Test IDs	Prerequisite Test Name	Corresponding Prerequisite Test IDs
1845, 1846	Unit Interval and Frequency Offset (f_{OFFSET_TX})	1817
1745	Unit Interval and Frequency Offset (f_{OFFSET_TX})	1717

- 2 Measure the Unit Interval and Data Rates. The application saves the test results.
- 3 Trigger on the HS Continuous data signal to acquire a test waveform.
- 4 Generate the differential signal for TXDP and TXDN. The generated signal is used for processing.

- 5 Use the InfiniiSim function on the Infiniium Oscilloscope to embed the reference channel and package model.
 - a The 'short' channel (CH1) reference channel and package model transfer function file are embedded for Small Amplitude signal with 3.5 dB emphasis level. (Test ID: 1745).
 - b The 'short' channel (CH1) reference channel and package model transfer function file are embedded for Large Amplitude signal with 0 dB emphasis level. (Test ID: 1845).
 - c The 'long' channel (CH2) reference channel and package model transfer function file are embedded for Large Amplitude signal with 6.0 dB emphasis level. (Test ID: 1846).
- 6 Enable real time eye on differential signal.
- 7 Enable CTLE feature from Infiniium on the real time eye by applying each CTLE setting extracted from default CTLE Setting File. Find the optimal CTLE setting based on the user selected "CTLE Optimization Criterion" configuration variable. By default, the highest "Eye Area" is used.

NOTE The "CTLE Setting File" and "CTLE Optimization Criterion" values are configurable in the Configure tab.

- 8 Enable DFE feature from Infiniium on the CTLE output and use the optimal tap value determined from Infiniium through optimization.
- 9 Use the "Specification Version" configuration option in Configure tab to determine the targeted BER to be used for this test.

For the selection of "v4.0" for "Specification Version" configuration option, the prorated mask targeted at BER 1E-10 will be applied.

For the selection of "v4.1" for "Specification Version" configuration option, the prorated mask targeted at BER 1E-12 will be applied.
- 10 To verify T_{EYE_TX} and $V_{DIF_AC_TX}$ for different targeted BER, use the following procedures:
 - a. Center the Eye Mask in the middle of the generated eye diagram, as shown in the figures:

Prorated Mask (targeted at BER 1E-10)

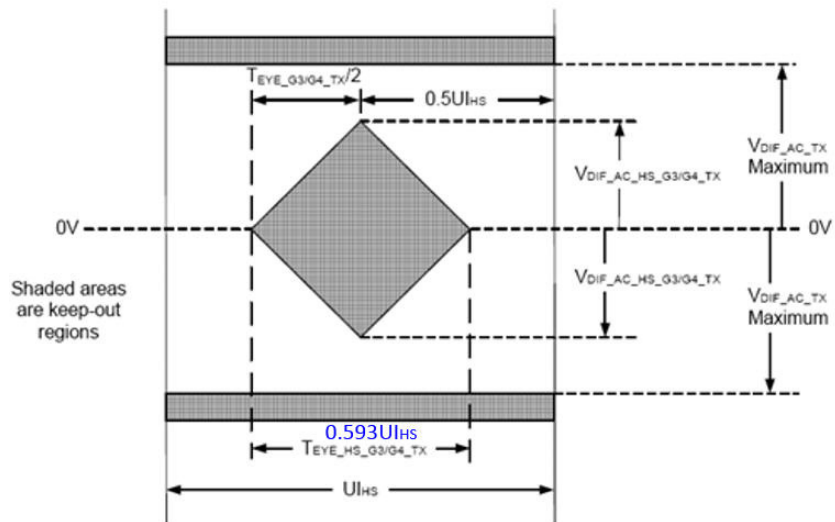

Figure 35 Centering Eye Mask in the Eye Diagram

Construct the Eye Mask using the prorated values given in [Table 55](#).

Table 55 Prorated values for Eye Mask

Parameter	Amplitude	Termination	Conf. Min.	Conf. Max.
$V_{DIF_AC_HS_G3/G4_TX}$	Large + Small	Terminated	45mV	NA
$V_{DIF_AC_LA_TX}$	Large	Terminated	NA	310mV
$V_{DIF_AC_SA_TX}$	Small	Terminated	NA	200mV
$T_{EYE_HS_G3_TX}$	Large + Small	Terminated	0.593UI	NA
$T_{EYE_HS_G4_TX}$	Large + Small	Terminated	0.543UI	NA

Prorated Mask (targeted at BER 1E-12)

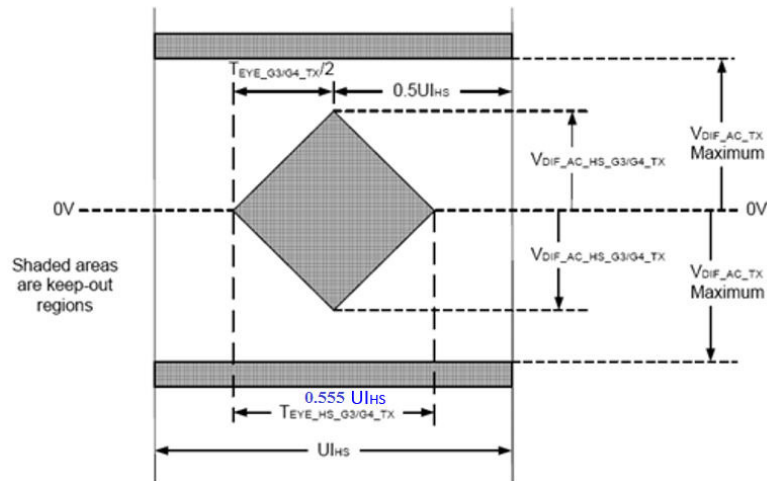

Figure 36 Centering Eye Mask in the Eye Diagram
Construct the Eye Mask using the prorated values given in Table 56.

Table 56 Prorated values for Eye Mask

Parameter	Amplitude	Termination	Conf. Min.	Conf. Max.
$V_{DIF_AC_HS_G3/G4_TX}$	Large + Small	Terminated	47mV	NA
$V_{DIF_AC_LA_TX}$	Large	Terminated	NA	310mV
$V_{DIF_AC_SA_TX}$	Small	Terminated	NA	200mV
$T_{EYE_HS_G3_TX}$	Large + Small	Terminated	0.605UI	NA
$T_{EYE_HS_G4_TX}$	Large + Small	Terminated	0.555UI	NA

- 11 Run the “Mask Testing” feature on the Infiniium Oscilloscope with multiple acquisitions to accumulate 3E6 UIs.
- 12 Use the Mask violation result and PASS/FAIL status for the final test result.

For Test IDs 1843, 1844, 1743

- 1 Trigger on the HS Continuous data signal to acquire a test waveform of 1E6 UIs.
- 2 Use the InfiniiSim function on the Infiniium Oscilloscope for embedding the reference channel and package model to perform testing for the following three test cases:
 - a The 'short' channel (CH1) reference channel and package model are embedded for Small Amplitude signal with 3.5 dB emphasis level. (Test ID: 1745)
 - b The 'short' channel (CH1) reference channel and package model are embedded for Large Amplitude signal with 0 dB emphasis level. (Test ID: 1845)
 - c The 'long' channel (CH2) reference channel and package model are embedded for Large Amplitude signal with 6.0 dB emphasis level. (Test ID: 1846)
- 3 Execute the SigTest Tool to run the mask testing.
- 4 Report the overall final test result as PASS/FAIL.

Test Results

The generated eye diagram shall not have greater than one incursion into the prorated mask specified in the CTS Specification mentioned under the References section.

Test Reference

Refer to M-PHY Specification v4.1 (01Dec2016).

Test 1.1.8 20% / 80% Rise and Fall Times ($T_{R_HS_TX}$ and $T_{F_HS_TX}$)

For more information, refer to "Test 1.1.8 20% / 80% Rise and Fall Times ($T_{R_HS_TX}$ and $T_{F_HS_TX}$)" on page 66.

Test Availability Conditions

Table 57 shows the options on the MIPI M-PHY Conformance Test Application, which are available for you to configure, for the Test IDs associated with the 20% / 80% Rise and Fall Times ($T_{R_HS_TX}$ and $T_{F_HS_TX}$) test.

Table 57 Test Availability Conditions for the 20%/80% Rise and Fall Times test

Test ID	Configurable Options									
	Test Group				Signal Type			Informative Test		
	LA_RT	SA_RT	LA_NT	SA_NT	HS BURST	HS Continuous	LS PWM	Dependency	Enabled	Disabled
804	✓	×	×	×	✓	×	×		✓	×
704	×	✓	×	×	✓	×	×		✓	×
1804	✓	×	×	×	×	✓	×	NA	✓	×
1704	×	✓	×	×	×	✓	×	NA	✓	×

Test Reference

Refer to Section 5.1.2.1, Table 16 of the M-PHY Specification v4.1 (01Dec2016).

Test 1.1.9 Lane-to-Lane Skew ($T_{L2L_SKEW_HS_TX}$)

For more information, refer to "Test 1.1.9 Lane-to-Lane Skew ($T_{L2L_SKEW_HS_TX}$)" on page 116.

Test Availability Conditions

Table 58 shows the options on the MIPI M-PHY Conformance Test Application, which are available for you to configure, for the Test IDs associated with the Lane-to-Lane Skew ($T_{L2L_SKEW_HS_TX}$) test.

Table 58 Test Availability Conditions for the Lane-to-Lane Skew test*

Configurable Options		Test IDs		
		819	820	821
Test Group	LA_RT	✓	✓	✓
	SA_RT	×	×	×
	LA_NT	×	×	×
	SA_NT	×	×	×
Signal Type	HS Burst	✓	✓	✓
	HS Continuous	×	×	×
	LS PWM	×	×	×
HS Data Rate	A Series	Dependent on the Informative Test setting.		
	B Series	✓	✓	✓
Number of Supported Lane	1	×	×	×
	2	✓	×	×
	3	×	✓	×
	4	×	×	✓
Protocol Specification	DigRFv4	Enabled for HS-G1, HS-G2, HS-G3 Disabled for HS-G4	Enabled for HS-G1, HS-G2, HS-G3 Disabled for HS-G4	Enabled for HS-G1, HS-G2, HS-G3 Disabled for HS-G4
	LLI	Enabled for HS-G1, HS-G2, HS-G3 Disabled for HS-G4	Enabled for HS-G1, HS-G2, HS-G3 Disabled for HS-G4	Enabled for HS-G1, HS-G2, HS-G3 Disabled for HS-G4
	UniPro	✓	✓	✓
	SSIC	Enabled for HS-G1, HS-G2, HS-G3 Disabled for HS-G4	Enabled for HS-G1, HS-G2, HS-G3 Disabled for HS-G4	Enabled for HS-G1, HS-G2, HS-G3 Disabled for HS-G4
	M-PCIe	Enabled for HS-G1, HS-G2, HS-G3 Disabled for HS-G4	Enabled for HS-G1, HS-G2, HS-G3 Disabled for HS-G4	Enabled for HS-G1, HS-G2, HS-G3 Disabled for HS-G4
Informative Test	Dependency	Not applicable for HS B Series Gear Rates.		
	Enabled	✓	✓	✓
	Disabled	×	×	×

* Additionally, this test is available only when the **Switch Matrix** feature on the test application is in Disabled state.

Test Reference

Refer to Section 5.1.2.4 of the M-PHY Specification v4.1 (01Dec2016).

Test 1.1.10 Slew Rate Control Range (SR_{DIF_TX[**MAX**]} and SR_{DIF_TX[**MIN**]})

For more information, refer to "Test 1.1.10 Slew Rate Control Range (SR_{DIF_TX[**MAX**]} and SR_{DIF_TX[**MIN**]})" on page 70.

Test Availability Conditions

Table 59 shows the options on the MIPI M-PHY Conformance Test Application, which are available for you to configure, for the Test IDs associated with the Slew Rate Control Range (SR_{DIF_TX[**MAX**]} and SR_{DIF_TX[**MIN**]}) test.

Table 59 Test Availability Conditions for the Slew Rate Control Range test

Configurable Options	Test IDs				
	806	807	706	707	
Test Group	LA_RT	✓	✓	×	×
	SA_RT	×	×	✓	✓
	LA_NT	×	×	×	×
	SA_NT	×	×	×	×
Signal Type	HS Burst	✓	✓	✓	✓
	HS Continuous	×	×	×	×
	LS PWM	×	×	×	×
HS Data Rate	Gear 1 Rates [≤ 1.5] Gbps	✓	✓	✓	✓
	Gear 2 Rates [$1.5 < x \leq 3.5$] Gbps				
	Gear 3 Rates [> 3.5] Gbps	Dependent on the Informative Test setting.			
	Gear 4 Rates				
Number of Slew Rate States	1	×	×	×	×
	>1	✓	✓	✓	✓
Informative Test	Dependency	Not applicable for HS Gear 1 Rates.			
	Enabled	✓	✓	✓	✓
	Disabled	×	×	×	×

Test Reference

Refer to Section 5.1.2.2, Table 16 of the M-PHY Specification v4.1 (01Dec2016).

Test 1.1.11 Slew Rate State Monotonicity

For more information, refer to “[Test 1.1.11 Slew Rate State Monotonicity](#)” on page 72.

Test Availability Conditions

[Table 60](#) shows the options on the MIPI M-PHY Conformance Test Application, which are available for you to configure, for the Test IDs associated with the Slew Rate State Monotonicity test.

Table 60 Test Availability Conditions for the Slew Rate State Monotonicity test

	Configurable Options	Test IDs	
		808	708
Test Group	LA_RT	✓	×
	SA_RT	×	✓
	LA_NT	×	×
	SA_NT	×	×
Signal Type	HS Burst	✓	✓
	HS Continuous	×	×
	LS PWM	×	×
HS Data Rate	Gear 1 Rates [≤ 1.5] Gbps	✓	✓
	Gear 2 Rates [$1.5 < x \leq 3.5$] Gbps		
	Gear 3 Rates [> 3.5] Gbps	Dependent on the Informative Test setting.	
	Gear 4 Rates		
Number of Slew Rate States	1	×	×
	>1	✓	✓
Informative Test	Dependency	Not applicable for HS Gear 1 Rates.	
	Enabled	✓	✓
	Disabled	×	×

Test Reference

Refer to the M-PHY Specification v4.1 (01Dec2016).

Test 1.1.12 Slew Rate State Resolution (ΔSR_{DIF_TX})

For more information, refer to "Test 1.1.12 Slew Rate State Resolution (ΔSR_{DIF_TX})" on page 74.

Test Availability Conditions

Table 61 shows the options on the MIPI M-PHY Conformance Test Application, which are available for you to configure, for the Test IDs associated with the Slew Rate State Resolution (ΔSR_{DIF_TX}) test.

Table 61 Test Availability Conditions for the Slew Rate State Resolution test

Configurable Options		Test IDs	
		809	709
Test Group	LA_RT	✓	×
	SA_RT	×	✓
	LA_NT	×	×
	SA_NT	×	×
Signal Type	HS Burst	✓	✓
	HS Continuous	×	×
	LS PWM	×	×
HS Data Rate	Gear 1 Rates [≤ 1.5] Gbps	✓	✓
	Gear 2 Rates [$1.5 < x \leq 3.5$] Gbps		
	Gear 3 Rates [> 3.5] Gbps	Dependent on the Informative Test setting.	
	Gear 4 Rates		
Number of Slew Rate States	1	×	×
	>1	✓	✓
Informative Test	Dependency	Not applicable for HS Gear 1 Rates.	
	Enabled	✓	✓
	Disabled	×	×

Test Reference

Refer to the M-PHY Specification v4.1 (01Dec2016).

Test 1.1.13 Intra-Lane Output Skew ($T_{\text{INTRA_SKEW_TX}}$)

For more information, refer to "Test 1.1.13 Intra-Lane Output Skew ($T_{\text{INTRA_SKEW_TX}}$)" on page 76.

Test Reference

Refer to Section 5.1.2.3, Table 16 of the M-PHY Specification v4.1 (01Dec2016).

Test 1.1.14 Transmitter Pulse Width ($T_{\text{PULSE_TX}}$)

For more information, refer to "Test 1.1.14 Transmitter Pulse Width ($T_{\text{PULSE_TX}}$)" on page 78.

Test Availability Conditions

Table 62 shows the options on the MIPI M-PHY Conformance Test Application, which are available for you to configure, for the Test IDs associated with the Transmitter Pulse Width ($T_{\text{PULSE_TX}}$) test.

Table 62 Test Availability Conditions for the Transmitter Pulse Width test

Test ID	Configurable Options									
	Test Group				Signal Type			Informative Test		
	LA_RT	SA_RT	LA_NT	SA_NT	HS BURST	HS Continuous	LS PWM	Dependency	Enabled	Disabled
811	✓	×	×	×	✓	×	×	NA	✓	×
711	×	✓	×	×	✓	×	×	NA	✓	×

Test Reference

Refer to Section 5.1.2.6, Table 16 of the M-PHY Specification v4.1 (01Dec2016).

Test 1.1.15 Total Jitter (TJ_{TX})

Test Overview

The purpose of the Total Jitter (TJ_{TX}) test is to verify that the Total Jitter (TJ_{TX}) of the HS-TX of the DUT is within the conformance limits according to the MIPI M-PHY standards.

Test ID

- 1812 [1.1.15 TJ_LA_RT_TX (C)]
- 1712 [1.1.15 TJ_SA_RT_TX (C)]

Test Availability Conditions

Table 63 shows the options on the MIPI M-PHY Conformance Test Application, which are available for you to configure, for the Test IDs associated with the Total Jitter (TJ_{TX}) test.

Table 63 Test Availability Conditions for the Total Jitter test

Test ID	Configurable Options									
	Test Group				Signal Type			Informative Test		
	LA_RT	SA_RT	LA_NT	SA_NT	HS BURST	HS Continuous	LS PWM	Dependency	Enabled	Disabled
1812	✓	×	×	×	×	✓	×	NA	✓	×
1712	×	✓	×	×	×	✓	×	NA	✓	×

Test Modes

- HS Continuous

Test Procedure

- 1 Perform either of the following tests as a prerequisite to running the Total Jitter (TJ_{TX}) test:

Table 64 Prerequisite tests for Total Jitter (TJ_{TX}) test

Test IDs	Prerequisite Test Name	Corresponding Prerequisite Test IDs
1812	Unit Interval and Frequency Offset ($f_{\text{OFFSET_TX}}$)	1817
1712	Unit Interval and Frequency Offset ($f_{\text{OFFSET_TX}}$)	1717

- Measure the Unit Interval and Data Rates. The application saves the test results.
- 2 Trigger the HS Continuous data signal to acquire a test waveform.
- 3 A differential signal is generated for TXDP and TXDN, which is used for processing of data.

- 4 Set up clock recovery to use the “2nd Order PLL” method with one of the listed -3dB cut-off frequencies for the corresponding HS Data Rates:

Cut-off Frequency	HS Data Rate
2.0 MHZ	HS Gear 1 A/B series
4.0 MHZ	HS Gear 2 A/B series
8.0 MHZ	HS Gear 3 A/B series Or HS Gear 4 A/B series

- 5 Use the **EZJIT Complete** feature on the Infiniium Oscilloscope to measure the TJ, DJ and RJ values of the test signal. Use the “Specification Version” configuration option in the Configure tab to determine the targeted BER value to be used for this test.
 For the selection of “v4.0” for “Specification Version” configuration option, the jitter measurement is targeted at BER 1E-10.
 For the selection of “v4.1” for “Specification Version” configuration option, the jitter measurement is targeted at BER 1E-12.
- 6 Use the measured value for TJ for the final test result.

Test Results

The measured value for Total Jitter (TJ_{TX}) for the test signal must be within the conformance limit as specified in the CTS Specification mentioned under the References section.

Test Reference

Refer to Section 5.1.2.7, Table 16 of the M-PHY Specification v4.1 (01Dec2016).

Test 1.1.16 Short-Term Total Jitter (STTJ_{TX})

Test Overview

The purpose of the Short-Term Total Jitter (STTJ_{TX}) test is to verify that the Short-Term Total Jitter (STTJ_{TX}) of the HS-TX of the DUT is within the conformance limits according to the MIPI M-PHY standards.

Test ID

- 1814 [1.1.16 STTJ_LA_RT_TX (C)]
- 1714 [1.1.16 STTJ_SA_RT_TX (C)]

Test Availability Conditions

Table 65 shows the options on the MIPI M-PHY Conformance Test Application, which are available for you to configure, for the Test IDs associated with the Short-Term Total Jitter (STTJ_{TX}) test.

Table 65 Test Availability Conditions for the Short-Term Total Jitter test

Test ID	Configurable Options									
	Test Group				Signal Type			Informative Test		
	LA_RT	SA_RT	LA_NT	SA_NT	HS BURST	HS Continuous	LS PWM	Dependency	Enabled	Disabled
1814	✓	×	×	×	×	✓	×	NA	✓	×
1714	×	✓	×	×	×	✓	×	NA	✓	×

Test Modes

- HS Continuous

Test Procedure

- 1 Perform either of the following tests as a prerequisite to running the Short-Term Total Jitter (STTJ_{TX}) test:

Table 66 Prerequisite tests for Short-Term Total Jitter (STTJ_{TX}) test

Test IDs	Prerequisite Test Name	Corresponding Prerequisite Test IDs
1814	Unit Interval and Frequency Offset (f _{OFFSET_TX})	1817
1714	Unit Interval and Frequency Offset (f _{OFFSET_TX})	1717

- 2 Measure the Unit Interval and Data Rates. The application saves the test results.
- 3 Trigger the HS Continuous data signal to acquire a test waveform.
- 4 A differential signal is generated for TXDP and TXDN, which is used for processing of data.

- 4 Set up clock recovery to use the “2nd Order PLL” method with one of the listed -3dB cut-off frequencies for the corresponding HS Data Rates:

Cut-off Frequency	HS Data Rate
2.0 MHZ	HS Gear 1 A/B series
4.0 MHZ	HS Gear 2 A/B series
8.0 MHZ	HS Gear 3 A/B series Or HS Gear 4 A/B series

- 5 Set up a High-pass filter with a cut-off frequency of $1/(30 * U_{I_{HS}})$ to measure jitter.
- 6 Use the **EZJIT Complete** feature on the Infiniium Oscilloscope to measure the TJ, DJ and RJ values of the test signal. Use the “Specification Version” configuration option in the Configure tab to determine the targeted BER value to be used for this test.
For the selection of “v4.0” for “Specification Version” configuration option, the jitter measurement is targeted at BER 1E-10.
For the selection of “v4.1” for “Specification Version” configuration option, the jitter measurement is targeted at BER 1E-12.
- 7 Use the measured value for TJ for the final test result.

Test Results

The measured value for Short-Term Total Jitter (STTJ_{TX}) for the test signal must be within the conformance limit as specified in the CTS Specification mentioned under the References section.

Test Reference

Refer to Section 5.1.2.7, Table 16 of the M-PHY Specification v4.1 (01Dec2016).

Test 1.1.17 Deterministic Jitter (DJ_{TX})

Test Overview

The purpose of the Deterministic Jitter (DJ_{TX}) test is to verify that the Deterministic Jitter (DJ_{TX}) of the HS-TX of the DUT is within the conformance limits according to the MIPI M-PHY standards.

Test ID

- 813 [1.1.17 DJ_LA_RT_TX (B)]
- 713 [1.1.17 DJ_SA_RT_TX (B)]
- 1813 [1.1.17 DJ_LA_RT_TX (C)]
- 1713 [1.1.17 DJ_SA_RT_TX (C)]

Test Availability Conditions

Table 67 shows the options on the MIPI M-PHY Conformance Test Application, which are available for you to configure, for the Test IDs associated with the Deterministic Jitter (DJ_{TX}) test.

Table 67 Test Availability Conditions for the Deterministic Jitter test

Test ID	Configurable Options									
	Test Group				Signal Type			Informative Test		
	LA_RT	SA_RT	LA_NT	SA_NT	HS BURST	HS Continuous	LS PWM	Dependency	Enabled	Disabled
813	✓	×	×	×	✓	×	×	NA	✓	×
713	×	✓	×	×	✓	×	×	NA	✓	×
1813	✓	×	×	×	×	✓	×	NA	✓	×
1713	×	✓	×	×	×	✓	×	NA	✓	×

Test Modes

- HS Burst
- HS Continuous

Test Procedure

For Test IDs: 813, 713 (HS Burst Data)

- 1 Perform the following tests as a prerequisite to running the Deterministic Jitter (DJ_{TX}) test:

Table 68 Prerequisite tests for Deterministic Jitter (DJ_{TX}) test

Test IDs	Prerequisite Test Name	Corresponding Prerequisite Test IDs
813	Unit Interval and Frequency Offset (f_{OFFSET_TX})	817
713	Unit Interval and Frequency Offset (f_{OFFSET_TX})	717

Measure the Unit Interval and Data Rates. The application saves the test results.

- 2 Trigger the DIF-P region on the HS Burst data signal to acquire a test waveform.
- 3 A differential signal is generated for TXDP and TXDN, which is used for processing of data.
- 4 Use the differential test signal as the waveform source to enable the Time Interval Error (TIE) feature on the Infiniium Oscilloscope.
- 5 Set up clock recovery to use the “Constant Frequency” method.
- 6 Set up a High-pass filter with one of the listed -3dB cut-off frequencies for the corresponding HS Data Rates to measure TIE:

Cut-off Frequency	HS Data Rate
2.0 MHZ	HS Gear 1 A/B series
4.0 MHZ	HS Gear 2 A/B series
8.0 MHZ	HS Gear 3 A/B series Or HS Gear 4 A/B series

- 7 Repeat steps 2 to 6 for ten times to calculate the average value for the peak to peak TIE.
- 8 Use the average value for peak to peak TIE for the final DJ test result.

For Test IDs: 1813, 1713 (HS Continuous Data)

Refer to “[For Test IDs: 1813, 1713 \(HS Continuous Data\)](#)” on page 85.

Test Results

The measured value for Deterministic Jitter (DJ_{TX}) for the test signal must be within the conformance limit as specified in the CTS Specification mentioned under the References section.

Test Reference

Refer to Section 5.1.2.7, Table 16 of the M-PHY Specification v4.1 (01Dec2016).

Test 1.1.18 Short-Term Deterministic Jitter ($STDJ_{TX}$)

For more information, refer to "[Test 1.1.18 Short-Term Deterministic Jitter \(\$STDJ_{TX}\$ \)](#)" on page 87.

Test Reference

Refer to Section 5.1.2.7, Table 16 of the M-PHY Specification v4.1 (01Dec2016).

6 Pulse Width Modulation (PWM-TX) Transmitter Tests

- Test 1.2.1 Transmit Bit Duration (TPWM_TX) / 130
- Test 1.2.2 Transmit Ratio (kPWM_TX) / 134
- Test 1.2.3 PREPARE Length (TPWM-PREPARE) / 138
- Test 1.2.4 Common-Mode DC Output Voltage Amplitude (VCM_TX) / 140
- Test 1.2.5 Differential DC Output Voltage Amplitude (VDIF_DC_TX) / 144
- Test 1.2.6 Minimum Differential AC Eye Opening (TEYE_TX) / 146
- Test 1.2.7 Maximum Differential AC Output Voltage Amplitude (VDIF_AC_TX) / 148
- Test 1.2.8 20% / 80% Rise and Fall Times (TR_PWM_TX and TF_PWM_TX) / 150
- Test 1.2.9 Lane-to-Lane Skew (TL2L_SKEW_PWM_TX) / 152
- Test 1.2.10 Transmit Bit Duration Tolerance (TOLPWM_TX, TOLPWM_G1_LR_TX) / 154
- Test 1.2.11 GO Minor Duration (TPWM_MINOR_GO_TX) / 158

This section provides the Methods of Implementation (MOIs) for signaling and timing electrical tests for low-speed pulse width modulation transmitters (PWM-TX) using an Keysight Infiniium oscilloscope, InfiniiMax probes, and the MIPI M-PHY Conformance Test Application.

This section covers tests for versions 3.0, 4.0, and 4.1.

Test 1.2.1 Transmit Bit Duration ($T_{\text{PWM_TX}}$)

Test Overview

The purpose of the Transmit Bit Duration ($T_{\text{PWM_TX}}$) test is to verify that the Transmit Bit Duration ($T_{\text{PWM_TX}}$) of the PWM-TX of the DUT is within the conformance limits of the MIPI M-PHY standard specification.

Test ID

- 406 [1.2.1 TPWM-TX_LA_RT_TX [MEAN]]
- 416 [1.2.1 TPWM-TX_LA_RT_TX [MAX]]
- 426 [1.2.1 TPWM-TX_LA_RT_TX [MIN]]
- 306 [1.2.1 TPWM-TX_SA_RT_TX [MEAN]]
- 316 [1.2.1 TPWM-TX_SA_RT_TX [MAX]]
- 326 [1.2.1 TPWM-TX_SA_RT_TX [MIN]]
- 206 [1.2.1 TPWM-TX_LA_NT_TX [MEAN]]
- 216 [1.2.1 TPWM-TX_LA_NT_TX [MAX]]
- 226 [1.2.1 TPWM-TX_LA_NT_TX [MIN]]
- 106 [1.2.1 TPWM-TX_SA_NT_TX [MEAN]]
- 116 [1.2.1 TPWM-TX_SA_NT_TX [MAX]]
- 126 [1.2.1 TPWM-TX_SA_NT_TX [MIN]]

Test Availability Conditions

Table 69 shows the options on the MIPI M-PHY Conformance Test Application, which are available for you to configure, for the Test IDs associated with the Transmit Bit Duration ($T_{\text{PWM_TX}}$) test.

Table 69 Test Availability Conditions for the Transmit Bit Duration test

Test ID	Configurable Options						
	Test Group				Signal Type		
	LA_RT	SA_RT	LA_NT	SA_NT	HS BURST	HS Continuous	LS PWM
406	✓	×	×	×	×	×	✓
416	✓	×	×	×	×	×	✓
426	✓	×	×	×	×	×	✓
306	×	✓	×	×	×	×	✓
316	×	✓	×	×	×	×	✓
326	×	✓	×	×	×	×	✓
206	×	×	✓	×	×	×	✓
216	×	×	✓	×	×	×	✓
226	×	×	✓	×	×	×	✓
106	×	×	×	✓	×	×	✓
116	×	×	×	✓	×	×	✓
126	×	×	×	✓	×	×	✓

Test Modes

- LS PWM

Test Procedure

For Test IDs 406, 306, 206 and 106 ($T_{P_{PWM}[\text{Mean}]}$ tests):

- 1 Trigger the DIF-P (or DIF-N) region on the PWM Burst data signal to acquire a test waveform.
- 2 A differential signal is generated for TXDP and TXDN, which is used for processing of data.
- 3 Search the differential signal and isolate the location of all rising and falling edges.
- 4 Measure $T_{P_{PWM}}$ for the test signal based on the time difference between the falling edges. Record the minimum, maximum and mean values for $T_{P_{PWM}}$.

- 5 Measure T_{PWM_MAJOR} and T_{PWM_MINOR} intervals for every PWM bit identified, in order to determine the PWM-b0 and PWM-b1 bits. See Figure 37, which shows an example to identify PWM-b0 and PWM-b1 bits.

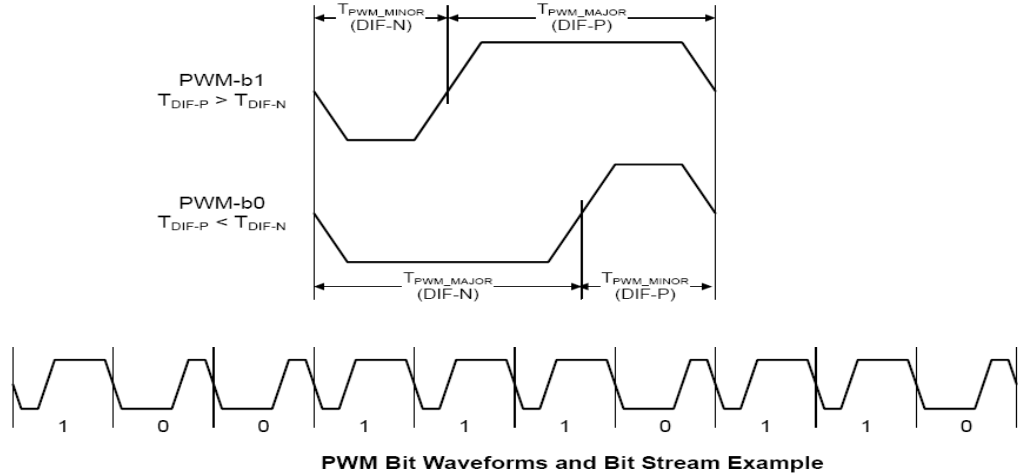

Figure 37 PWM Bit Waveforms and Bit Stream Example to identify PWM-b0 and PWM-b1 bits

- 6 Use the following equations to calculate the k_{PWM} values. Record the minimum, maximum and mean values for k_{PWM} :

$$k_{PWM_Gx_TX(b0)} = T_{PWM_MAJOR_TX(b0)} / T_{PWM_MINOR_TX(b0)}$$

$$k_{PWM_Gx_TX(b1)} = T_{PWM_MAJOR_TX(b1)} / T_{PWM_MINOR_TX(b1)}$$

where, k_{PWM} is the Transmit Ratio.

- 7 Use the T_{PWM_Min} , T_{PWM_Max} and T_{PWM_Mean} values in the following equations to calculate the Transmit Bit Duration Tolerance (TOL_{PWM}) values. Record the TOL_{PWM_Min} and TOL_{PWM_Max} values:

$$TOL_{PWM_Min} = T_{PWM_Min} / T_{PWM_Mean}$$

$$TOL_{PWM_Max} = T_{PWM_Max} / T_{PWM_Mean}$$

- 8 Measure the minimum T_{PWM_MINOR} interval values from all the PWM-b0 and PWM-b1 bits identified.
- 9 Use the measure value of $T_{PWM[Mean]}$ for the final test result.

For Test IDs 416, 316, 216 and 116 ($T_{PWM[Max]}$ tests):

- 1 Perform the following tests as a prerequisite to running the $T_{PWM[Max]}$ test:

Table 70 Prerequisite tests for $T_{PWM[Max]}$ test

Test IDs	Prerequisite Test Name	Corresponding Prerequisite Test IDs
416	$T_{PWM[Mean]}$	406
316	$T_{PWM[Mean]}$	306
216	$T_{PWM[Mean]}$	206
116	$T_{PWM[Mean]}$	106

Measure $T_{PWM[Mean, Max, Min]}$. The application saves the test results.

- 2 Use the measured values for $T_{PWM[Max]}$ for the final test result.

For Test IDs 426, 326, 226 and 126 ($T_{PWM[Min]}$ tests):

- 1 Perform the following tests as a prerequisite to running the $T_{PWM[Min]}$ test:

Table 71 Prerequisite tests for $T_{PWM[Min]}$ test

Test IDs	Prerequisite Test Name	Corresponding Prerequisite Test IDs
426	$T_{PWM[Mean]}$	406
326	$T_{PWM[Mean]}$	306
226	$T_{PWM[Mean]}$	206
126	$T_{PWM[Mean]}$	106

Measure $T_{PWM[Mean, Max, Min]}$. The application saves the test results.

- 2 Use the measured values for $T_{PWM[Min]}$ for the final test result.

Test Results

The calculated values for T_{PWM} for the test signal must be within the conformance limit as specified in the CTS Specification mentioned under the References section.

Test References

- See Test 1.2.1 in M-PHY Physical Layer Conformance Test Suite v3.0r15 (24July2014).
- See Section 5.1.3.1, Table 17 in M-PHY Specification v4.1 (01Dec2016).

Test 1.2.2 Transmit Ratio ($k_{\text{PWM_TX}}$)

Test Overview

The purpose of the Transmit Ratio ($k_{\text{PWM_TX}}$) test is to verify that the PWM Transmit Ratio ($k_{\text{PWM_TX}}$) of the PWM-TX of the DUT is within the conformance limits of the MIPI M-PHY standard specification.

Test ID

- 408 [1.2.2 $k_{\text{PWM_TX_LA_RT_TX}}$ [MEAN]]
- 418 [1.2.2 $k_{\text{PWM_TX_LA_RT_TX}}$ [MAX]]
- 428 [1.2.2 $k_{\text{PWM_TX_LA_RT_TX}}$ [MIN]]
- 308 [1.2.2 $k_{\text{PWM_TX_SA_RT_TX}}$ [MEAN]]
- 318 [1.2.2 $k_{\text{PWM_TX_SA_RT_TX}}$ [MAX]]
- 328 [1.2.2 $k_{\text{PWM_TX_SA_RT_TX}}$ [MIN]]
- 208 [1.2.2 $k_{\text{PWM_TX_LA_NT_TX}}$ [MEAN]]
- 218 [1.2.2 $k_{\text{PWM_TX_LA_NT_TX}}$ [MAX]]
- 228 [1.2.2 $k_{\text{PWM_TX_LA_NT_TX}}$ [MIN]]
- 108 [1.2.2 $k_{\text{PWM_TX_SA_NT_TX}}$ [MEAN]]
- 118 [1.2.2 $k_{\text{PWM_TX_SA_NT_TX}}$ [MAX]]
- 128 [1.2.2 $k_{\text{PWM_TX_SA_NT_TX}}$ [MIN]]

Test Availability Conditions

Table 72 shows the options on the MIPI M-PHY Conformance Test Application, which are available for you to configure, for the Test IDs associated with the Transmit Ratio ($k_{\text{PWM_TX}}$) test.

Table 72 Test Availability Conditions for the Transmit Ratio test

Test ID	Configurable Options									
	Test Group				Signal Type			PWM Gear		
	LA_RT	SA_RT	LA_NT	SA_NT	HS BURST	HS Continuous	LS PWM	Gear 0 Rates [0.999 < x <= 3] Gbps	Gear 1 Rates [3 < x <= 9] Gbps	Gear 2 - Gear 7 Rates [> 9] Gbps
408	✓	×	×	×	×	×	✓	×	✓	✓
418	✓	×	×	×	×	×	✓	×	✓	✓
428	✓	×	×	×	×	×	✓	×	✓	✓
308	×	✓	×	×	×	×	✓	×	✓	✓
318	×	✓	×	×	×	×	✓	×	✓	✓
328	×	✓	×	×	×	×	✓	×	✓	✓
208	×	×	✓	×	×	×	✓	×	✓	✓
218	×	×	✓	×	×	×	✓	×	✓	✓
228	×	×	✓	×	×	×	✓	×	✓	✓

Test ID	Configurable Options									
	Test Group				Signal Type			PWM Gear		
	LA_RT	SA_RT	LA_NT	SA_NT	HS BURST	HS Continuous	LS PWM	Gear 0 Rates [0.999 < x <= 3] Gbps	Gear 1 Rates [3 < x <= 9] Gbps	Gear 2 - Gear 7 Rates [> 9] Gbps
108	x	x	x	✓	x	x	✓	x	✓	✓
118	x	x	x	✓	x	x	✓	x	✓	✓
128	x	x	x	✓	x	x	✓	x	✓	✓

Test Modes

- LS PWM

Test Procedure

For Test IDs 408, 308, 208 and 108 ($k_{\text{PWM}[\text{Mean}]}$ tests):

- 1 Perform the following tests as a prerequisite to running the $k_{\text{PWM}[\text{Mean}]}$ test:

Table 73 Prerequisite tests for $k_{\text{PWM}[\text{Mean}]}$ test

Test IDs	Prerequisite Test Name	Corresponding Prerequisite Test IDs
408	$T_{\text{PWM}[\text{Mean}]}$	406
308	$T_{\text{PWM}[\text{Mean}]}$	306
208	$T_{\text{PWM}[\text{Mean}]}$	206
108	$T_{\text{PWM}[\text{Mean}]}$	106

Measure $k_{\text{PWM}[\text{Mean, Max, Min}]}$. The application saves the test results.

- 2 Use the measured values for $k_{\text{PWM}[\text{Mean}]}$ for the final test result.

For Test IDs 418, 318, 218 and 118 ($k_{\text{PWM}[\text{Max}]}$ tests):

- 1 Perform the following tests as a prerequisite to running the $k_{\text{PWM}[\text{Max}]}$ test:

Table 74 Prerequisite tests for $k_{\text{PWM}[\text{Max}]}$ test

Test IDs	Prerequisite Test Name	Corresponding Prerequisite Test IDs
418	$T_{\text{PWM}[\text{Mean}]}$	406
318	$T_{\text{PWM}[\text{Mean}]}$	306
218	$T_{\text{PWM}[\text{Mean}]}$	206
118	$T_{\text{PWM}[\text{Mean}]}$	106

Measure $k_{\text{PWM}[\text{Mean, Max, Min}]}$. The application saves the test results.

- 2 Use the measured values for $k_{\text{PWM}[\text{Max}]}$ for the final test result.

For Test IDs 428, 328, 228 and 128 ($k_{\text{PWM}[\text{Min}]}$ tests):

- 1 Perform the following tests as a prerequisite to running the $k_{\text{PWM}[\text{Min}]}$ test:

Table 75 Prerequisite tests for $k_{\text{PWM}[\text{Min}]}$ test

Test IDs	Prerequisite Test Name	Corresponding Prerequisite Test IDs
428	$T_{\text{PWM}[\text{Mean}]}$	406
328	$T_{\text{PWM}[\text{Mean}]}$	306
228	$T_{\text{PWM}[\text{Mean}]}$	206
128	$T_{\text{PWM}[\text{Mean}]}$	106

Measure $k_{\text{PWM}[\text{Mean, Max, Min}]}$. The application saves the test results.

- 2 Use the measured values for $k_{\text{PWM}[\text{Min}]}$ for the final test result.

Test Results

The measured values for k_{PWM} for the test signal must be within the conformance limit as specified in the CTS Specification mentioned under the References section.

Test References

- See Test 1.2.2 in M-PHY Physical Layer Conformance Test Suite v3.0r15 (24July2014).
- See Section 5.1.3.1, Table 17 in M-PHY Specification v4.1 (01Dec2016).

Test 1.2.3 PREPARE Length ($T_{\text{PWM-prepare}}$)

Test Overview

The purpose of the PREPARE Length ($T_{\text{PWM-prepare}}$) test is to verify that the longevity (or length) of the DUT's transmitted PWM-PREPARE period is consistent with the value indicated by its TX_LS_PREPARE_LENGTH configuration attribute.

Test ID

- 410 [1.2.3 TPWM-TX_LA_RT_TX]
- 310 [1.2.3 TPWM-TX_SA_RT_TX]
- 210 [1.2.3 TPWM-TX_LA_NT_TX]
- 110 [1.2.3 TPWM-TX_SA_NT_TX]

Test Availability Conditions

Table 76 shows the options on the MIPI M-PHY Conformance Test Application, which are available for you to configure, for the Test IDs associated with the PREPARE Length ($T_{\text{PWM-prepare}}$) test.

Table 76 Test Availability Conditions for the PREPARE Length test

Test ID	Configurable Options						
	Test Group				Signal Type		
	LA_RT	SA_RT	LA_NT	SA_NT	HS BURST	HS Continuous	LS PWM
410	✓	×	×	×	×	×	✓
310	×	✓	×	×	×	×	✓
210	×	×	✓	×	×	×	✓
110	×	×	×	✓	×	×	✓

Test Modes

- LS PWM

Test Procedure

- 1 Trigger the DIF-P (or DIF-N) region on the PWM Burst data signal to acquire a test waveform.
- 2 A differential signal is generated for TXDP and TXDN, which is used for processing of data.
- 3 Search the test signal and isolate the first valid PWM burst data.
- 4 Search the isolated PWM Burst data and measure the $T_{\text{PWM-prepare}}$ region. Also, measure the mean T_{PWM} (Transmit Bit Duration) for the same burst data.
- 5 Divide the value of the measured $T_{\text{PWM-prepare}}$ width by the value of the measured T_{PWM} to convert its unit from seconds to Unit Interval (UI).
- 6 Divide the value of the calculated $T_{\text{PWM-prepare}}$ width by $(10 * T_{\text{PWM}})$ to convert its unit from UI to Symbol Interval (SI). Round off the resulting value to the nearest integer.

- 7 Derive the dynamic test limit based on the following user configurable input values, set under the **Configure** tab of the test application.
 - a Optical Media Converter (OMC)
 - b TX_LS_PREPARE_LENGTH
 - c MC_LS_PREPARE_LENGTH
 - d TLINE_RESET_DETECT
- 8 Report the measured value of $T_{\text{PWM-PREPARE}}$ in SI units for the final test result.

Test Results

The measured value for $T_{\text{PWM-PREPARE}}$ for the test signal must be within the conformance limit as specified in the CTS Specification mentioned under the References section.

Test References

- See Test 1.2.3 in M-PHY Physical Layer Conformance Test Suite v3.0r15 (24July2014).
- See Section 4.7.2.1, Table 51 in M-PHY Specification v4.1 (01Dec2016).

Test 1.2.4 Common-Mode DC Output Voltage Amplitude (V_{CM_TX})

Test Overview

The purpose of the Common-Mode DC Output Voltage Amplitude (V_{CM_TX}) test is to verify that the Common-Mode DC Output Voltage Amplitude (V_{CM_TX}) of the PWM-TX of the DUT is within the conformance limits of the MIPI M-PHY standard specification.

Test ID

- 403 [1.2.4 VCM_LA_RT_TX[Active Probe (Differential Probe)]]
- 433 [1.2.4 VCM_LA_RT_TX[Direct Connect]]
- 434 [1.2.4 VCM_LA_RT_TX[Active Probe (Active Termination Adapter)]]
- 435 [1.2.4 VCM_LA_RT_TX[Active Probe (Active Termination Adapter) - Manual]]
- 303 [1.2.4 VCM_SA_RT_TX[Active Probe (Differential Probe)]]
- 333 [1.2.4 VCM_SA_RT_TX[Direct Connect]]
- 334 [1.2.4 VCM_SA_RT_TX[Active Probe (Active Termination Adapter)]]
- 335 [1.2.4 VCM_SA_RT_TX[Active Probe (Active Termination Adapter) - Manual]]
- 203 [1.2.4 VCM_LA_NT_TX[Active Probe (Differential Probe)]]
- 233 [1.2.4 VCM_LA_NT_TX[Direct Connect]]
- 234 [1.2.4 VCM_LA_NT_TX[Active Probe (Active Termination Adapter)]]
- 235 [1.2.4 VCM_LA_NT_TX[Active Probe (Active Termination Adapter) - Manual]]
- 103 [1.2.4 VCM_SA_NT_TX[Active Probe (Differential Probe)]]
- 133 [1.2.4 VCM_SA_NT_TX[Direct Connect]]
- 134 [1.2.4 VCM_SA_NT_TX[Active Probe (Active Termination Adapter)]]
- 135 [1.2.4 VCM_SA_NT_TX[Active Probe (Active Termination Adapter) - Manual]]

Test Availability Conditions

Table 77 shows the options on the MIPI M-PHY Conformance Test Application, which are available for you to configure, for the Test IDs associated with the Common-Mode DC Output Voltage Amplitude (V_{CM_TX}) test.

Table 77 Test Availability Conditions for the Common-Mode DC Output Voltage Amplitude test

Test ID	Configurable Options										
	Test Group				Signal Type			Probing Method*			
	LA_RT	SA_RT	LA_NT	SA_NT	HS BURST	HS Continuous	LS PWM	Active Probe (Differential Probe)	Active Probe (Active Termination Adapter)	Active Probe (Active Termination Adapter) [Manual]	Direct Connect
403	✓	✗	✗	✗	✗	✗	✓	✓	✗	✗	✗
433	✓	✗	✗	✗	✗	✗	✓	✗	✗	✗	✓
434	✓	✗	✗	✗	✗	✗	✓	✗	✓	✗	✗

Test ID	Configurable Options										
	Test Group				Signal Type			Probing Method*			
	LA_RT	SA_RT	LA_NT	SA_NT	HS BURST	HS Continuous	LS PWM	Active Probe (Differential Probe)	Active Probe (Active Termination Adapter)	Active Probe (Active Termination Adapter) [Manual]	Direct Connect
435	✓	×	×	×	×	×	✓	×	×	✓	×
303	×	✓	×	×	×	×	✓	✓	×	×	×
333	×	✓	×	×	×	×	✓	×	×	×	✓
334	×	✓	×	×	×	×	✓	×	✓	×	×
335	×	✓	×	×	×	×	✓	×	×	✓	×
203	×	×	✓	×	×	×	✓	✓	×	×	×
233	×	×	✓	×	×	×	✓	×	×	×	✓
234	×	×	✓	×	×	×	✓	×	✓	×	×
235	×	×	✓	×	×	×	✓	×	×	✓	×
103	×	×	×	✓	×	×	✓	✓	×	×	×
133	×	×	×	✓	×	×	✓	×	×	×	✓
134	×	×	×	✓	×	×	✓	×	✓	×	×
135	×	×	×	✓	×	×	✓	×	×	✓	×

* Additionally, this test is applicable only on Single-ended connections.

Test Modes

- LS PWM

Test Procedure

For Test IDs 403, 303, 203, 103 (Probing Method - [Active Probe (Differential Probe)]):

- 1 Trigger the DIF-P (or DIF-N) region on the PWM Burst data signal to acquire a test waveform.
- 2 Generate the Common-Mode signal (V_{CM}) for TXDP and TXDN using a MATLAB UDF script, in order to remove all the DIF-P and DIF-N regions from the test signal.
- 3 Use the following equation to calculate the Common-Mode signal voltage (V_{CM}):

$$V_{CM} = (V_P + V_N) / 2$$

where, V_P and V_N are the range of voltage levels at TXDP and TXDN respectively.

- 4 Use the **Histogram** feature on the Infiniium Oscilloscope to measure the values of the maximum, minimum and mean voltage of the derived Common-Mode test signal.
- 5 Use the calculated value of the mean V_{CM} for the final test result.

For Test IDs 434, 334, 234, 134 (Probing Method - [Active Probe (Active Termination Adapter)]):

- 1 Execute the N7010A Calibration using the “N7010A Calibration Setup” form on the Setup tab to determine the V_{term} value for the selected channels.
- 2 Trigger the DIF-P (or DIF-N) region on the PWM Burst data signal to acquire a test waveform.
- 3 Generate the Common-Mode signal (V_{CM}) for TXDP and TXDN using a MATLAB UDF script, in order to remove all the DIF-P and DIF-N regions from the test signal.
- 4 Use the following equation to calculate the Common-Mode signal voltage (V_{CM}):

$$V_{CM} = (V_P + V_N) / 2$$

where, V_P and V_N are the range of voltage levels at TXDP and TXDN respectively.

- 5 Use the **Histogram** feature on the Infiniium Oscilloscope to measure the maximum, minimum and mean voltage values of the derived Common-Mode test signal.
- 6 Use the measured value of the mean V_{CM} for the final test result.

For Test IDs 435, 335, 235, 135 (Probing Method - [Active Probe (Active Termination Adapter) - Manual]):

- 1 Use the **Probe Configuration** feature on the Infiniium Oscilloscope to set the termination voltage of the Active Termination Adapter for the selected channels.
- 2 Trigger the DIF-P (or DIF-N) region on the PWM Burst data signal to acquire a test waveform.
- 3 Generate the Common-Mode signal (V_{CM}) for TXDP and TXDN using a MATLAB UDF script, in order to remove all the DIF-P and DIF-N regions from the test signal.
- 4 Use the following equation to calculate the Common-Mode signal voltage (V_{CM}):

$$V_{CM} = (V_P + V_N) / 2$$

where, V_P and V_N are the range of voltage levels at TXDP and TXDN respectively.

- 5 Use the **Histogram** feature on the Infiniium Oscilloscope to measure the values of the maximum, minimum and mean voltage of the derived Common-Mode test signal.
- 6 Use the calculated value of the mean V_{CM} for the final test result.

For Test IDs 433, 333, 233, 133 (Probing Method - [Direct Connect]):

- 1 Trigger the DIF-P (or DIF-N) region on the PWM Burst data signal to acquire a test waveform.
- 2 Generate the Common-Mode signal ($V_{CM_RSE_TX}$) for TXDP and TXDN using a MATLAB UDF script, in order to remove all the DIF-P and DIF-N regions from the test signal.
- 3 Use the following equation to calculate the Common-Mode signal voltage ($V_{CM_RSE_TX}$):

$$V_{CM_RSE_TX} = [(V_P + V_N) / 2] * \{(R_{SE_TX} + R_{in_scope}) / R_{in_scope}\}$$

where,

V_P and V_N are the range of voltage levels at TXDP and TXDN respectively.

R_{SE_TX} is the configurable option in the RSE_TX settings of the **Set Up** tab in the test application. The default value for R_{SE_TX} is 50 ohm.

R_{in_scope} is 50 ohm.

- 4 Use the **Histogram** feature on the Infiniium Oscilloscope to measure the values of the maximum, minimum and mean voltage of the derived Common-Mode test signal.
- 5 Use the calculated value of the mean $V_{CM_RSE_TX}$ for the final test result.

Test Results

The calculated values for V_{CM} or $V_{CM_RSE_TX}$ for the test signal must be within the conformance limit as specified in the CTS Specification mentioned under the References section.

Test References

- See Test 1.2.4 in M-PHY Physical Layer Conformance Test Suite v3.0r15 (24July2014).
- See Section 5.1.1.2, Table 15 in M-PHY Specification v4.1 (01Dec2016).

Test 1.2.5 Differential DC Output Voltage Amplitude ($V_{DIF_DC_TX}$)

Test Overview

The purpose of the Differential DC Output Voltage Amplitude ($V_{DIF_DC_TX}$) test is to verify that the Differential DC Output Voltage Amplitude ($V_{DIF_DC_TX}$) of the PWM-TX of the DUT is within the conformance limits of the MIPI M-PHY standard specification.

Test ID

- 400 [1.2.5 VDIF_DC_LA_RT_TX]
- 300 [1.2.5 VDIF_DC_SA_RT_TX]
- 200 [1.2.5 VDIF_DC_LA_NT_TX]
- 100 [1.2.5 VDIF_DC_SA_NT_TX]

Test Availability Conditions

Table 78 shows the options on the MIPI M-PHY Conformance Test Application, which are available for you to configure, for the Test IDs associated with the Differential DC Output Voltage Amplitude ($V_{DIF_DC_TX}$) test.

Table 78 Test Availability Conditions for the Differential DC Output Voltage Amplitude test

Test ID	Configurable Options						
	Test Group				Signal Type		
	LA_RT	SA_RT	LA_NT	SA_NT	HS BURST	HS Continuous	LS PWM
400	✓	×	×	×	×	×	✓
300	×	✓	×	×	×	×	✓
200	×	×	✓	×	×	×	✓
100	×	×	×	✓	×	×	✓

Test Modes

- LS PWM

Test Procedure

- 1 Trigger the DIF-P (or DIF-N) region on the PWM Burst data signal to acquire a test waveform.
- 2 A differential signal is generated for TXDP and TXDN, which is used for processing of data.
- 3 Find the largest DIF-P and DIF-N region on the differential signal.
- 4 From the DIF-P and DIF-N regions found, measure the mean values of V_{DIF_P} and V_{DIF_N} .
- 5 Use the following equation to calculate the nominal value of VDIF:

$$\text{Nominal VDIF} = \left[\frac{(\text{Maximum Conformance Limit} - \text{Minimum Conformance Limit})}{2} + \text{Minimum Conformance Limit} \right]$$

where,

the values for Maximum Conformance Limit and Minimum Conformance Limit for the Differential DC Output Voltage Amplitude are available in the CTS Specification.

- 6 Measure the worst value for VDIF between V_{DIF_P} and V_{DIF_N} . The worst value falls on the 'worst' margin with respect to the calculated nominal value.

Test Results

The measured value for V_{DIF_DC} for the test signal must be within the conformance limit as specified in the CTS Specification mentioned under the References section.

Test References

- See Test 1.2.5 in M-PHY Physical Layer Conformance Test Suite v3.0r15 (24July2014).
- See Section 5.1.1.2, Table 15 in M-PHY Specification v4.1 (01Dec2016).

Test 1.2.6 Minimum Differential AC Eye Opening (T_{EYE_TX})

Test Overview

The purpose of the Minimum Differential AC Eye Opening (T_{EYE_TX}) test is to verify that the PWM-TX of the DUT meets the requirements for the Transmitter Eye Opening (T_{EYE_TX}), at the minimum Differential AC Output Voltage Amplitude levels, according to the MIPI M-PHY standard specification.

Test ID

- 401 [1.2.6 TEYE_LA_RT_TX]
- 301 [1.2.6 TEYE_SA_RT_TX]
- 201 [1.2.6 TEYE_LA_NT_TX]
- 101 [1.2.6 TEYE_SA_NT_TX]

Test Availability Conditions

Table 79 shows the options on the MIPI M-PHY Conformance Test Application, which are available for you to configure, for the Test IDs associated with the Minimum Differential AC Eye Opening (T_{EYE_TX}) test.

Table 79 Test Availability Conditions for the Minimum Differential AC Eye Opening test

Test ID	Configurable Options									
	Test Group				Signal Type				Informative Test	
	LA_RT	SA_RT	LA_NT	SA_NT	HS BURST	HS Continuous	LS PWM	Dependency	Enabled	Disabled
401	✓	×	×	×	×	×	✓	NA	✓	×
301	×	✓	×	×	×	×	✓	NA	✓	×
201	×	×	✓	×	×	×	✓	NA	✓	×
101	×	×	×	✓	×	×	✓	NA	✓	×

Test Modes

- LS PWM

Test Procedure

- 1 Trigger the DIF-P (or DIF-N) region on the PWM Burst data signal to acquire a test waveform.
- 2 Generate the differential signal for TXDP and TXDN using a MATLAB UDF script, in order to remove all the DIF-P and DIF-N regions from the test signal. The generated differential signal is used for processing of data.
- 3 Use the differential test signal to generate the PWM Eye diagram. You can obtain three PWM Eye regions in the generated PWM Eye diagram by treating the PWM signaling as NRZ signaling at 3 times the PWM bit rate. See Figure 38.
- 4 Use the **Histogram** feature on the Infiniium Oscilloscope to measure the Eye Width and T_{EYE_TX} at the minimum V_{DIF_AC} levels for both the positive and negative cases in all three PWM Eye regions that you obtained.

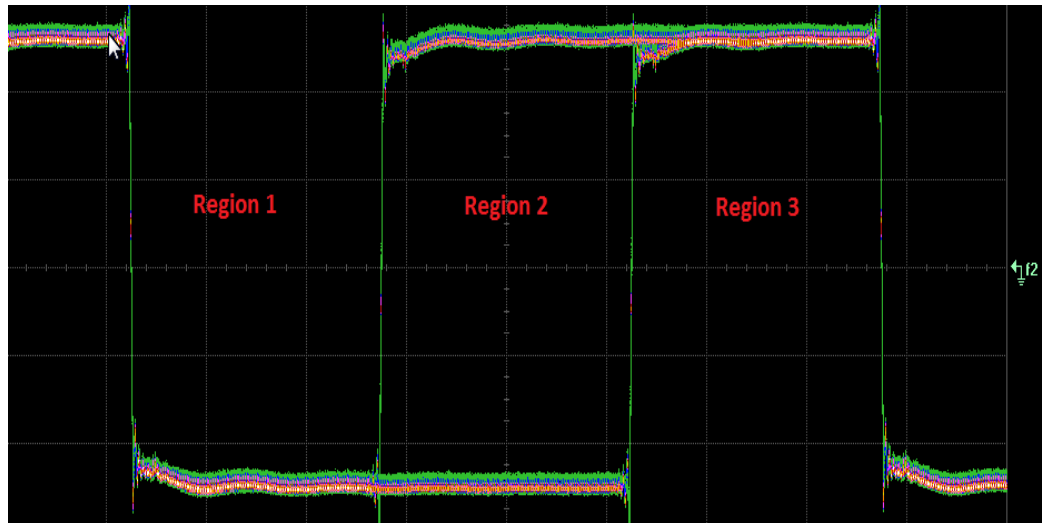

Figure 38 Sample PWM Eye Diagram

- 5 Use the worst T_{EYE_TX} for the final test result.

Test Results

The measured value for T_{EYE_TX} for the test signal must be within the conformance limit as specified in the CTS Specification mentioned under the References section.

Test References

- See Test 1.2.6 in M-PHY Physical Layer Conformance Test Suite v3.0r15 (24July2014).
- See Section 5.1.1.2 in M-PHY Specification v4.1 (01Dec2016).

Test 1.2.7 Maximum Differential AC Output Voltage Amplitude ($V_{DIF_AC_TX}$)

Test Overview

The purpose of the Maximum Differential AC Output Voltage Amplitude ($V_{DIF_AC_TX}$) test is to verify that the PWM-TX of the DUT meets the requirements for the maximum differential AC output voltage amplitude, according to the MIPI M-PHY standard specification.

Test ID

- 402 [1.2.7 VDIF_AC_LA_RT_TX]
- 302 [1.2.7 VDIF_AC_SA_RT_TX]
- 202 [1.2.7 VDIF_AC_LA_NT_TX]
- 102 [1.2.7 VDIF_AC_SA_NT_TX]

Test Availability Conditions

Table 80 shows the options on the MIPI M-PHY Conformance Test Application, which are available for you to configure, for the Test IDs associated with the Maximum Differential AC Output Voltage Amplitude ($V_{DIF_AC_TX}$) test.

Table 80 Test Availability Conditions for the Maximum Differential AC Output Voltage Amplitude test

Test ID	Configurable Options						
	Test Group				Signal Type		
	LA_RT	SA_RT	LA_NT	SA_NT	HS BURST	HS Continuous	LS PWM
402	✓	×	×	×	×	×	✓
302	×	✓	×	×	×	×	✓
202	×	×	✓	×	×	×	✓
102	×	×	×	✓	×	×	✓

Test Modes

- LS PWM

Test Procedure

- 1 Trigger the DIF-P (or DIF-N) region on the PWM Burst data signal to acquire a test waveform.
- 2 Generate the differential signal for TXDP and TXDN using a MATLAB UDF script, in order to remove all the DIF-P and DIF-N regions from the test signal. The generated differential signal is used for processing of data.
- 3 Use the differential test signal to generate the PWM Eye diagram. You can obtain three PWM Eye regions in the generated PWM Eye diagram by treating the PWM signaling as NRZ signaling at 3 times the PWM bit rate. See [Figure 39](#).

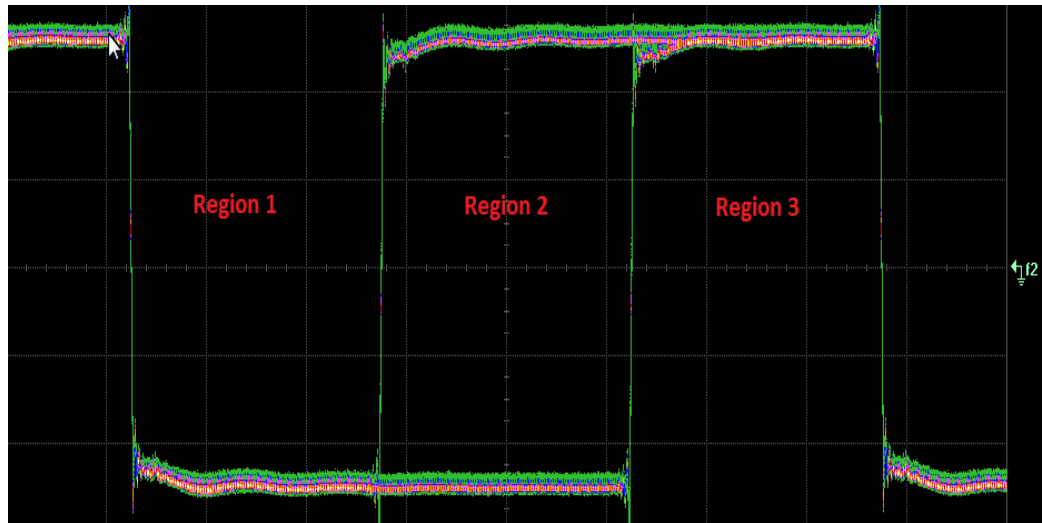

Figure 39 Sample PWM Eye Diagram

- 4 Use the **Histogram** feature on the Infiniium Oscilloscope to measure the highest positive and the lowest negative values from the entire PWM Eye diagram, which includes all three PWM Eye regions.
- 5 Use the worst $V_{DIF_AC_TX}$ for the final test result.

Test Results

The measured value for V_{DIF_AC} for the test signal must be within the conformance limit as specified in the CTS Specification mentioned under the References section.

Test References

- See Test 1.2.7 in M-PHY Physical Layer Conformance Test Suite v3.0r15 (24July2014).
- See Section 5.1.1.2, Table 15 in M-PHY Specification v4.1 (01Dec2016).

Test 1.2.8 20% / 80% Rise and Fall Times ($T_{R_PWM_TX}$ and $T_{F_PWM_TX}$)

Test Overview

The purpose of the 20% / 80% Rise and Fall Times ($T_{R_PWM_TX}$ and $T_{F_PWM_TX}$) test is to verify that the 20% to 80% Rise and Fall Times ($T_{R_PWM_TX}$ and $T_{F_PWM_TX}$) of the PWM-TX of the DUT are within the conformance limits, according to the MIPI M-PHY standard specification.

Test ID

- 404 [1.2.8 TR_TF_PWM_LA_RT_TX]
- 304 [1.2.8 TR_TF_PWM_SA_RT_TX]
- 204 [1.2.8 TR_TF_PWM_LA_NT_TX]
- 104 [1.2.8 TR_TF_PWM_SA_NT_TX]

Test Availability Conditions

Table 81 shows the options on the MIPI M-PHY Conformance Test Application, which are available for you to configure, for the Test IDs associated with the 20% / 80% Rise and Fall Times ($T_{R_PWM_TX}$ and $T_{F_PWM_TX}$) test.

Table 81 Test Availability Conditions for the 20%/80% Rise and Fall Times test

Test ID	Configurable Options						
	Test Group				Signal Type		
	LA_RT	SA_RT	LA_NT	SA_NT	HS BURST	HS Continuous	LS PWM
404	✓	×	×	×	×	×	✓
304	×	✓	×	×	×	×	✓
204	×	×	✓	×	×	×	✓
104	×	×	×	✓	×	×	✓

Test Modes

- LS PWM

Test Procedure

- 1 Perform the following tests as a prerequisite to running the 20% / 80% Rise and Fall Times ($T_{R_PWM_TX}$ and $T_{F_PWM_TX}$) test:

Table 82 Prerequisite tests for 20%/80% Rise and Fall Times ($T_{R_PWM_TX}$ and $T_{F_PWM_TX}$) test

Test IDs	Prerequisite Test Name	Corresponding Prerequisite Test IDs
404	T_{PWM}	406
304	T_{PWM}	306
204	T_{PWM}	206
104	T_{PWM}	106

Measure T_{PWM} . The application saves the test results.

Table 83 Prerequisite tests for 20%/80% Rise and Fall Times ($T_{R_PWM_TX}$ and $T_{F_PWM_TX}$) test

Test IDs	Prerequisite Test Name	Corresponding Prerequisite Test IDs
404	V_{DIF_DC}	400
304	V_{DIF_DC}	300
204	V_{DIF_DC}	200
104	V_{DIF_DC}	100

Measure V_{DIF_DC} . The application saves the test results.

- 2 Trigger the DIF-P (or DIF-N) region on the PWM Burst data signal to acquire a test waveform.
- 3 A differential signal is generated for TXDP and TXDN, which is used for processing of data.
- 4 Use the 80%/20% reference levels, which is defined by the measured 0/100% V_{DIF_DC} values in the prerequisite test, to measure the rise and fall time on the differential signal.
- 5 Calculate the average value of the measured rise time and fall time and use the larger of the two values for the final test result.

Test Results

The measured values for $T_{R_PWM_TX}$ and $T_{F_PWM_TX}$ for the test signal must be within the conformance limit as specified in the CTS Specification mentioned under the References section.

Test References

- See Test 1.2.8 in M-PHY Physical Layer Conformance Test Suite v3.0r15 (24July2014).
- See Section 5.1.3.2, Table 17 in M-PHY Specification v4.1 (01Dec2016).

Test 1.2.9 Lane-to-Lane Skew ($T_{L2L_SKEW_PWM_TX}$)

Test Overview

The purpose of the Lane-to-Lane Skew ($T_{L2L_SKEW_PWM_TX}$) test is to verify that the Lane-to-Lane Skew ($T_{L2L_SKEW_PWM_TX}$) of the PWM-TX lanes of the DUT is within the conformance limit, according to the MIPI M-PHY standard specification.

Test ID

- 219 [1.2.9 T_L2L_SKEW_PWM_2LANE_LA_NT_TX]
- 220 [1.2.9 T_L2L_SKEW_PWM_3LANE_LA_NT_TX]
- 221 [1.2.9 T_L2L_SKEW_PWM_4LANE_LA_NT_TX]

Test Availability Conditions

Table 84 shows the options on the MIPI M-PHY Conformance Test Application, which are available for you to configure, for the Test IDs associated with the Lane-to-Lane Skew ($T_{L2L_SKEW_PWM_TX}$) test for CTS v3.0.

Table 85 shows the corresponding options for CTS v4.0 and v4.1.

Table 84 Test Availability Conditions for the Lane-to-Lane Skew test* (v3.0)

Test ID	Configurable Options														
	Test Group				Signal Type			Number of Supported Lane				Protocol Specification			
	LA_RT	SA_RT	LA_NT	SA_NT	HS BURST	HS Continuous	LS PWM	1	2	3	4	DigRFv4	LLI	Uni Pro	SSIC
219	x	x	✓	x	x	x	✓	x	✓	x	x	x	x	✓	x
220	x	x	✓	x	x	x	✓	x	x	✓	x	x	x	✓	x
221	x	x	✓	x	x	x	✓	x	x	x	✓	x	x	✓	x

* Additionally, this test is available only when the **Switch Matrix** feature on the test application is in Disabled state.

Table 85 Test Availability Conditions for the Lane-to-Lane Skew test* (v4.0 and v4.1)

Test ID	Configurable Options															
	Test Group				Signal Type			Number of Supported Lane				Protocol Specification				
	LA_RT	SA_RT	LA_NT	SA_NT	HS BURST	HS Continuous	LS PWM	1	2	3	4	DigR Fv4	LLI	Uni Pro	SSIC	M-P Cle
219	x	x	✓	x	x	x	✓	x	✓	x	x	x	x	✓	x	x
220	x	x	✓	x	x	x	✓	x	x	✓	x	x	x	✓	x	x
221	x	x	✓	x	x	x	✓	x	x	x	✓	x	x	✓	x	x

* Additionally, this test is available only when the **Switch Matrix** feature on the test application is in Disabled state.

Test Modes

- LS PWM

Test Procedure

- 1 Trigger the DIF-P (or DIF-N) region on the PWM Burst data signal to acquire a test waveform for all required data lanes.
- 2 A differential signal is generated for all data lanes of TXDP and TXDN, which is used for processing of data.
- 3 Measure the skew for all rising and falling transitions found in the burst data pattern between data lanes with respect to Lane 0. Use the average of the measured skew values for each pair of lanes for further processing. Note that you must measure the skew values only from the applicable Lane-to-Lane combinations. To configure this option, use the **Number of Supported Lane** setting in the **Set Up** tab of the test application.

For example, let us consider A, B and C to be the skew values for lane to lane combinations, such that:

$$\text{Skew(L1-to-L0)} = A$$

$$\text{Skew(L2-to-L0)} = B$$

$$\text{Skew(L3-to-L0)} = C$$

- 4 Using the skew data associated with Lane 0, calculate the Lane-to-Lane Skew values for all other lane combinations, such as Lane 2 to Lane 1, and so on.

$$\text{Skew(L2-to-L1)} = B - A$$

$$\text{Skew(L3-to-L1)} = C - A$$

$$\text{Skew(L3-to-L2)} = B - C$$

- 5 Use the value derived from the worst Lane-to-Lane Skew with the largest deviation for the final test result.

Test Results

The calculated values for the Lane-to-Lane Skew for the test signal must be within the conformance limit as specified in the CTS Specification mentioned under the References section.

Test References

- See Test 1.2.9 in M-PHY Physical Layer Conformance Test Suite v3.0r15 (24July2014).
- See Section 5.1.3.3 in M-PHY Specification v4.1 (01Dec2016).

Test 1.2.10 Transmit Bit Duration Tolerance (TOL_{PWM_TX} , $TOL_{PWM_G1_LR_TX}$)

Test Overview

The purpose of the Transmit Bit Duration Tolerance (TOL_{PWM_TX} , $TOL_{PWM_G1_LR_TX}$) test is to verify that the Transmit Bit Duration Tolerance (TOL_{PWM_TX}) of the PWM-TX of the DUT is within the conformance limits of the MIPI M-PHY standard specification.

Test ID

- 407 [1.2.10 TOLPWM-G1-TX_LA_RT_TX [MAX]]
- 417 [1.2.10 TOLPWM-TX_LA_RT_TX [MAX]]
- 427 [1.2.10 TOLPWM-G1-TX_LA_RT_TX [MIN]]
- 437 [1.2.10 TOLPWM-TX_LA_RT_TX [MIN]]
- 307 [1.2.10 TOLPWM-G1-TX_SA_RT_TX [MAX]]
- 317 [1.2.10 TOLPWM-TX_SA_RT_TX [MAX]]
- 327 [1.2.10 TOLPWM-G1-TX_SA_RT_TX [MIN]]
- 337 [1.2.10 TOLPWM-TX_SA_RT_TX [MIN]]
- 207 [1.2.10 TOLPWM-G1-TX_LA_NT_TX [MAX]]
- 217 [1.2.10 TOLPWM-TX_LA_NT_TX [MAX]]
- 227 [1.2.10 TOLPWM-G1-TX_LA_NT_TX [MIN]]
- 237 [1.2.10 TOLPWM-TX_LA_NT_TX [MIN]]
- 107 [1.2.10 TOLPWM-G1-TX_SA_NT_TX [MAX]]
- 117 [1.2.10 TOLPWM-TX_SA_NT_TX [MAX]]
- 127 [1.2.10 TOLPWM-G1-TX_SA_NT_TX [MIN]]
- 137 [1.2.10 TOLPWM-TX_SA_NT_TX [MIN]]

Test Availability Conditions

Table 86 shows the options on the MIPI M-PHY Conformance Test Application, which are available for you to configure, for the Test IDs associated with the Transmit Bit Duration Tolerance (TOL_{PWM_TX} , $TOL_{PWM_G1_LR_TX}$) test.

Table 86 Test Availability Conditions for the Transmit Bit Duration Tolerance test

Test ID	Configurable Options									
	Test Group				Signal Type			PWM Gear		
	LA_RT	SA_RT	LA_NT	SA_NT	HS BURST	HS Continuous	LS PWM	Gear 0 Rates [0.999 < x <= 3] Gbps	Gear 1 Rates [3 < x <= 9] Gbps	Gear 2 - Gear 7 Rates [> 9] Gbps
407	✓	✗	✗	✗	✗	✗	✓	✗	✓	✗
417	✓	✗	✗	✗	✗	✗	✓			
427	✓	✗	✗	✗	✗	✗	✓	✗	✓	✗
437	✓	✗	✗	✗	✗	✗	✓			
307	✗	✓	✗	✗	✗	✗	✓	✗	✓	✗

Test ID	Configurable Options									
	Test Group				Signal Type			PWM Gear		
	LA_RT	SA_RT	LA_NT	SA_NT	HS BURST	HS Continuous	LS PWM	Gear 0 Rates [0.999 < x <= 3] Gbps	Gear 1 Rates [3 < x <= 9] Gbps	Gear 2 - Gear 7 Rates [> 9] Gbps
317	x	✓	x	x	x	x	✓			
327	x	✓	x	x	x	x	✓	x	✓	x
337	x	✓	x	x	x	x	✓			
207	x	x	✓	x	x	x	✓	x	✓	x
217	x	x	✓	x	x	x	✓			
227	x	x	✓	x	x	x	✓	x	✓	x
237	x	x	✓	x	x	x	✓			
107	x	x	x	✓	x	x	✓	x	✓	x
117	x	x	x	✓	x	x	✓			
127	x	x	x	✓	x	x	✓	x	✓	x
137	x	x	x	✓	x	x	✓			

Test Modes

- LS PWM

Test Procedure

For Test IDs 407, 307, 207 and 107 (TOL_{PWM-G1[Max]} tests):

- 1 Trigger the DIF-P (or DIF-N) region on the PWM Burst data signal to acquire a test waveform.
- 2 A differential signal is generated for TXDP and TXDN, which is used for processing of data.
- 3 Search the differential signal and isolate the location of all rising and falling edges on the differential signal.
- 4 Measure T_{PWM} for the test signal based on the time difference between the falling edges. Record the minimum, maximum and mean values for T_{PWM}.
- 5 Use the recorded values for T_{PWM_Min}, T_{PWM_Max} and T_{PWM_Mean} to calculate the values for Transmit Bit Duration Tolerance (TOL_{PWM}) using the following equations:

$$TOL_{PWM_G1_Min} = T_{PWM_Min} / T_{PWM_Mean}$$

$$TOL_{PWM_G1_Max} = T_{PWM_Max} / T_{PWM_Mean}$$

Record the values for TOL_{PWM_Min} and TOL_{PWM_Max}.

- 6 Use the measured values for TOL_{PWM-G1[Max]} for the final test result.

For Test IDs 417, 317, 217 and 117 ($TOL_{PWM[Max]}$ tests):

- 1 Perform the following tests as a prerequisite to running the $TOL_{PWM[Max]}$ test:

Table 87 Prerequisite tests for $TOL_{PWM[Max]}$ test

Test IDs	Prerequisite Test Name	Corresponding Prerequisite Test IDs
417	$T_{PWM[Mean]}$	406
317	$T_{PWM[Mean]}$	306
217	$T_{PWM[Mean]}$	206
117	$T_{PWM[Mean]}$	106

Measure the values for $TOL_{PWM[Max, Min]}$. The application saves the test results.

- 2 Use the measured values for $TOL_{PWM[Max]}$ for the final test result.

For Test IDs 427, 327, 227 and 127 ($TOL_{PWM-G1[Min]}$ tests):

- 1 Perform the following tests as a prerequisite to running the $TOL_{PWM-G1[Min]}$ test:

Table 88 Prerequisite tests for $TOL_{PWM-G1[Min]}$ test

Test IDs	Prerequisite Test Name	Corresponding Prerequisite Test IDs
427	$TOL_{PWM_G1[Max]}$	407
327	$TOL_{PWM_G1[Max]}$	307
227	$TOL_{PWM_G1[Max]}$	207
127	$TOL_{PWM_G1[Max]}$	107

Measure the values for $TOL_{PWM-G1[Max, Min]}$. The application saves the test results.

- 2 Use the measured values for $TOL_{PWM-G1[Min]}$ for the final test result.

For Test IDs 437, 337, 237 and 137 ($TOL_{PWM[Min]}$ tests):

- 1 Perform the following tests as a prerequisite to running the $TOL_{PWM[Min]}$ test:

Table 89 Prerequisite tests for $TOL_{PWM[Min]}$ test

Test IDs	Prerequisite Test Name	Corresponding Prerequisite Test IDs
437	$T_{PWM[Mean]}$	406
337	$T_{PWM[Mean]}$	306
237	$T_{PWM[Mean]}$	206
137	$T_{PWM[Mean]}$	106

Measure the values for $TOL_{PWM[Min]}$. The application saves the test results.

- 2 Use the measured values for $TOL_{PWM[Min]}$ for the final test result.

Test Results

The measured values for TOL_{PWM} for the test signal must be within the conformance limit as specified in the CTS Specification mentioned under the References section.

Test References

- See Test 1.2.10 in M-PHY Physical Layer Conformance Test Suite v3.0r15 (24July2014).
- See Section 5.1.3.1, Table 17 in M-PHY Specification v4.1 (01Dec2016).

Test 1.2.11 G0 Minor Duration ($T_{\text{PWM_MINOR_G0_TX}}$)

Test Overview

The purpose of the G0 Minor Duration ($T_{\text{PWM_MINOR_G0_TX}}$) test is to verify that the PWM-G0 Minor Duration ($T_{\text{PWM_MINOR_G0_TX}}$) of the PWM-TX of the DUT is within the conformance limits of the MIPI M-PHY standard specification.

Test ID

- 409 [1.2.11 TPWM-MINOR-G0-TX_LA_RT_TX]
- 309 [1.2.11 TPWM-MINOR-G0-TX_SA_RT_TX]
- 209 [1.2.11 TPWM-MINOR-G0-TX_LA_NT_TX]
- 109 [1.2.11 TPWM-MINOR-G0-TX_SA_NT_TX]

Test Availability Conditions

Table 90 shows the options on the MIPI M-PHY Conformance Test Application, which are available for you to configure, for the Test IDs associated with the G0 Minor Duration ($T_{\text{PWM_MINOR_G0_TX}}$) test.

Table 90 Test Availability Conditions for the G0 Minor Duration test

Test ID	Configurable Options									
	Test Group				Signal Type			PWM Gear		
	LA_RT	SA_RT	LA_NT	SA_NT	HS BURST	HS Continuous	LS PWM	Gear 0 Rates [0.999 < x <= 3] Gbps	Gear 1 Rates [3 < x <= 9] Gbps	Gear 2 - Gear 7 Rates [> 9] Gbps
409	✓	×	×	×	×	×	✓	✓	×	×
309	×	✓	×	×	×	×	✓	✓	×	×
209	×	×	✓	×	×	×	✓	✓	×	×
109	×	×	×	✓	×	×	✓	✓	×	×

Test Modes

LS PWM

Test Procedure

- 1 Perform the following tests as a prerequisite to running the G0 Minor Duration ($T_{\text{PWM_MINOR_GO_TX}}$) test:

Table 91 Prerequisite tests for $T_{\text{PWM_MINOR_GO_TX}}$ test

Test IDs	Prerequisite Test Name	Corresponding Prerequisite Test IDs
409	$T_{\text{PWM[Mean]}}$	406
309	$T_{\text{PWM[Mean]}}$	306
209	$T_{\text{PWM[Mean]}}$	206
109	$T_{\text{PWM[Mean]}}$	106

Measure the values for $T_{\text{PWM_MINOR_GO[Min]}}$. The application saves the test results.

- 2 Use the measured values for $T_{\text{PWM_MINOR_GO[Min]}}$ for the final test result.

Test Results

The measured values for $T_{\text{PWM_MINOR}}$ for the test signal must be within the conformance limit as specified in the CTS Specification mentioned under the References section.

Test References

- See Test 1.2.11 in M-PHY Physical Layer Conformance Test Suite v3.0r15 (24July2014).
- See Section 5.1.3.1, Table 17 in M-PHY Specification v4.1 (01Dec2016).

7 UFS Host Controller Reference Clock Tests

Reference Clock Output High Voltage (VOH) /	162
Reference Clock Output Low Voltage (VOL) /	163
Reference Clock Output Clock Rise Time (ToRise) /	164
Reference Clock Output Clock Fall Time (ToFall) /	165
Reference Clock Frequency Error (Ferror) /	166
Reference Clock Duty Cycle (Tdc) /	168
Reference Clock Phase Noise (N) /	169
Reference Clock Noise Floor Density (Ndensity) /	170

This section provides the Methods of Implementation (MOIs) for UFS Host Controller Reference Clock tests using a Keysight Infiniium oscilloscope, InfiniiMax probes, and the MIPI M-PHY Conformance Test Application.

This section covers tests for versions 4.0 and 4.1.

Reference Clock Output High Voltage (VOH)

Test Overview

The purpose of this test is to verify that UFS Reference Clock Output High Voltage (VOH) is within the compliance limits as specified in the JEDEC Universal Flash Storage (UFS) v3.0 specification.

The DC Output High Voltage (VOH) is defined as below.

Parameter	Symbol	Min	Max	Unit
DC Output High Voltage	V_{OH}	$0.75 \cdot V_{CCQ}$		V

The VCCQ is defined as per Figure 6.7 in the JEDEC Universal Flash Storage (UFS) v3.0 specification (Jan2018).

Test ID

- 3000 [Reference Clock Output High Voltage (VOH)]

Test Availability Conditions

Table 92 shows the option on the MIPI M-PHY Conformance Test Application, which is available for you to configure, to enable the Reference Clock Output High Voltage (VOH) test.

Table 92 Test Availability Condition for the Reference Clock Output High Voltage (VOH) test

Test ID	UFS Clock Informative Test	
	Enabled	Disabled
3000	✓	✗

Test Procedure

- 1 Trigger on Reference clock single-ended signal with affordable probe method.
- 2 Capture the Reference clock single-ended signal.
- 3 Measure VCCQ using the oscilloscope's VTOP measurement.
- 4 Measure VSS using the oscilloscope's VBASE measurement.
- 5 Calculate the VPP based on the equation below.
 $VPP = VCCQ - VSS$
- 6 Calculate the VOH and VOL values based on the equations below:
 $VOH = (0.75 \cdot VPP) + VSS$
 $VOL = (0.25 \cdot VPP) + VSS$
- 7 Report the measured VOH value.

Test Results

The measured VOH value for the test signal shall be within the conformance limit as specified in the specification mentioned under the Test References section.

Test References

- See Table 6.6 in JEDEC Universal Flash Storage (UFS) v3.0 specification (Jan2018).

Reference Clock Output Low Voltage (VOL)

Test Overview

The purpose of this test is to verify that UFS Reference Clock Output Low Voltage (VOL) is within the compliance limits as specified in the JEDEC Universal Flash Storage (UFS) v3.0 specification.

The DC Output Low Voltage (VOL) is defined as below.

Parameter	Symbol	Min	Max	Unit
DC Output Low Voltage	V_{OL}		$0.25 \cdot V_{CCQ}$	V

The VCCQ is defined as per Figure 6.7 in the JEDEC Universal Flash Storage (UFS) v3.0 specification (Jan2018).

Test ID

- 3001 [Reference Clock Output Low Voltage (VOL)]

Test Availability Conditions

Table 93 shows the option on the MIPI M-PHY Conformance Test Application, which is available for you to configure, to enable the Reference Clock Output Low Voltage (VOL) test.

Table 93 Test Availability Condition for the Reference Clock Output Low Voltage (VOL) test

Test ID	UFS Clock Informative Test	
	Enabled	Disabled
3001	✓	✗

Test Procedure

- 1 This test requires the following prerequisite test:
Reference Clock Output High Voltage (VOH) (Test ID: 3000): The VOH, VOL measurements are performed and test results are stored.
- 2 Report the measured VOL value.

Test Results

The measured VOL value for the test signal shall be within the conformance limit as specified in the specification mentioned under the Test References section.

Test References

- See Table 6.6 in JEDEC Universal Flash Storage (UFS) v3.0 specification (Jan2018).

Reference Clock Output Clock Rise Time (ToRise)

Test Overview

The purpose of this test is to verify that UFS Reference Clock Output Rise Time (ToRise) is within the compliance limits as specified in the JEDEC Universal Flash Storage (UFS) v3.0 specification.

The Output Clock Rise Time (ToRise) is defined as below.

Parameter	Symbol	Min	Max	Unit
Output Clock Rise Time	t_{ORISE}		2	ns

The rise time is defined as 20% – 80% of the window defined by VOH and VOL as per Figure 6.7 in the JEDEC Universal Flash Storage (UFS) v3.0 specification (Jan2018).

Test ID

- 3002 [Reference Clock Output Clock Rise Time (ToRise)]

Test Availability Conditions

Table 94 shows the option on the MIPI M-PHY Conformance Test Application, which is available for you to configure, to enable the Reference Clock Output Clock Rise Time (ToRise) test.

Table 94 Test Availability Condition for the Reference Clock Output Clock Rise Time (ToRise) test

Test ID	UFS Clock Informative Test	
	Enabled	Disabled
3002	✓	✗

Test Procedure

- 1 This test requires the following prerequisite test:
Reference Clock Output High Voltage (VOH) (Test ID: 3000): The VOH, VOL measurements are performed and test results are stored.
- 2 Calculate the 80% and 20% threshold voltage based on the reference voltage VOH and VOL.
- 3 Set the calculated 80% and 20% threshold values as upper and lower measurement thresholds.
- 4 Measure the rise time and fall time from the entire captured waveform.
- 5 Report the measured mean rise time value as ToRise.

Test Results

The measured ToRise value for the test signal shall be faster than the conformance limit as specified in the specification mentioned under the References section.

Test References

- See Table 6.6 in JEDEC Universal Flash Storage (UFS) v3.0 specification (Jan2018).

Reference Clock Output Clock Fall Time (ToFall)

Test Overview

The purpose of this test is to verify that UFS Reference Clock Output Fall Time (ToFall) is within the compliance limits as specified in the JEDEC Universal Flash Storage (UFS) v3.0 specification.

The Output Clock Fall Time (ToFALL) is defined as below.

Parameter	Symbol	Min	Max	Unit
Output Clock Fall Time	t_{OFALL}		2	ns

The fall time is defined as 80% - 20% of the window defined by VOH and VOL as per Figure 6.7 in the JEDEC Universal Flash Storage (UFS) v3.0 specification (Jan2018).

Test ID

- 3003 [Reference Clock Output Clock Fall Time (ToFall)]

Test Availability Conditions

Table 95 shows the option on the MIPI M-PHY Conformance Test Application, which is available for you to configure, to enable the Reference Clock Output Clock Fall Time (ToFall) test.

Table 95 Test Availability Condition for the Reference Clock Output Clock Fall Time (ToFall) test

Test ID	UFS Clock Informative Test	
	Enabled	Disabled
3003	✓	✗

Test Procedure

- 1 This test requires the following prerequisite test.
Reference Clock Output Rise Time (ToRise) (Test ID: 3002): The ToRise, ToFall measurements are performed and test results are stored.
- 2 Report the measured ToFall value.

Test Results

The measured ToFall value for the test signal shall be faster than the conformance limit as specified in the specification mentioned under the References section.

Test References

- See Table 6.6 in JEDEC Universal Flash Storage (UFS) v3.0 specification (Jan2018).

Reference Clock Frequency Error (Ferror)

Test Overview

The purpose of this test is to verify that UFS Reference Clock Frequency Error (Ferror) is within the compliance limits as specified in the JEDEC Universal Flash Storage (UFS) v3.0 specification.

For this test, it is not specified where to set reference level of frequency; however, the test uses the same method as Duty Cycle measurement where the calculated VMID is used as reference level to measure frequency based on Table 6.4 NOTE 4 from JEDEC Universal Flash Storage (UFS) v3.0 specification.

The Frequency Error (Ferror) is defined as below.

Parameter	Symbol	Min	Max	Unit
Frequency Error	fERROR	-150	+150	ppm

Test ID

- 3004 [Reference Clock Frequency Error (Ferror)]

Test Availability Conditions

Table 96 shows the option on the MIPI M-PHY Conformance Test Application, which is available for you to configure, to enable the Reference Clock Frequency Error (Ferror) test.

Table 96 Test Availability Condition for the Reference Clock Frequency Error (Ferror) test

Test ID	UFS Clock Informative Test	
	Enabled	Disabled
3004	✓	✗

Test Procedure

- 1 This test requires the following prerequisite test:
Reference Clock Output High Voltage (VOH) (Test ID: 3000): The VOH, VOL measurements are performed and test results are stored.
- 2 Calculate the VMID value from the VOH and VOL values based on the equation below.
$$VMID = (VOH + VOL)/2$$
- 3 Set the VOH, VMID, and VOL values as the upper, middle, and lower measurement thresholds.
- 4 Measure the frequency from the entire captured waveform using the oscilloscope's frequency measurement.
- 5 Turn on frequency measurement trend.
- 6 Apply 2nd order with 2MHz cut-off frequency Butterworth filter on the frequency measurement trend to improve dynamic range of oscilloscope and reduce oscilloscope noise.
- 7 Measure the minimum and maximum frequency values from filtered frequency measurement trend and denote results as FMax and FMin.
- 8 Calculate the frequency error values in terms of ppm based on the equation below.
 - $Error_MAX_PPM = ((FMax - Frequency_UserProvided) / FMax) * 1E+06$
 - $Error_MIN_PPM = ((FMin - Frequency_UserProvided) / FMin) * 1E+06$

- 9 Find the worst value between `Error_MAX_PPM` and `Error_MIN_PPM`.
- 10 Report the worst value as `Error`.

Test Results

The measured `Error` value for the test signal shall be within the conformance limit as specified in the specification mentioned under the References section.

Test References

- See Table 6.4 in JEDEC Universal Flash Storage (UFS) v3.0 specification (Jan2018).

Reference Clock Duty Cycle (Tdc)

Test Overview

The purpose of this test is to verify that UFS Reference Clock Duty Cycle (Tdc) is within the compliance limits as specified in the JEDEC Universal Flash Storage (UFS) v3.0 specification.

The Duty Cycle (Tdc) is defined as below.

Parameter	Symbol	Min	Max	Unit
Duty Cycle	t _{DC}	45	55	%

Test ID

- 3005 [Reference Clock Duty Cycle (Tdc)]

Test Availability Conditions

Table 97 shows the option on the MIPI M-PHY Conformance Test Application, which is available for you to configure, to enable the Reference Clock Duty Cycle (Tdc) test.

Table 97 Test Availability Condition for the Reference Clock Duty Cycle (Tdc) test

Test ID	UFS Clock Informative Test	
	Enabled	Disabled
3005	✓	✗

Test Procedure

- 1 This test requires the following prerequisite test:
Reference Clock Output High Voltage (VOH) (Test ID: 3000): The VOH, VOL measurements are performed and test results are stored.
- 2 Calculate the VMID value from the VOH and VOL values based on the equation below.
 $VMID = (VOH + VOL)/2$
- 3 Set the VOH, VMID and VOL values as upper, middle, and lower measurement thresholds.
- 4 Measure the duty cycle from the entire captured waveform using the oscilloscope's Duty Cycle measurement.
- 5 Report the measured mean duty cycle value.

Test Results

The measured Tdc value for the test signal shall be within the conformance limit as specified in the specification mentioned under the References section.

Test References

- See Table 6.4 in JEDEC Universal Flash Storage (UFS) v3.0 specification (Jan2018).

Reference Clock Phase Noise (N)

Test Overview

The purpose of this test is to verify that UFS Reference Clock Phase Noise is within the compliance limits as specified in the JEDEC Universal Flash Storage (UFS) v3.0 specification.

This test shall measure integrated single side band phase noise from 50 KHz to 10 MHz as per Table 6.4, NOTE 5 from JEDEC Universal Flash Storage (UFS) v3.0 specification.

The Phase Noise is defined as below.

Parameter	Symbol	Min	Max	Unit
Phase Noise	N		-66	dBc

Test ID

- 3006 [Reference Clock Phase Noise (N)]

Test Availability Conditions

Table 98 shows the option on the MIPI M-PHY Conformance Test Application, which is available for you to configure, to enable the Reference Clock Phase Noise (N) test.

Table 98 Test Availability Condition for the Reference Clock Phase Noise (N) test

Test ID	UFS Clock Informative Test	
	Enabled	Disabled
3006	✓	✗

Test Procedure

- 1 Trigger on Reference clock single-ended signal with affordable probe method and measurement method.
- 2 Capture the Reference clock signal.
- 3 Turn on Phase Noise Analysis. Set single side band phase noise band from 50KHz to 10MHz from clock frequency.
- 4 Measure Phase Noise (N).
- 5 Report the measured Phase Noise result.

Test Results

The measured N value for the test signal shall be within the conformance limit as specified in the specification mentioned under the References section.

Test References

- See Table 6.4 in JEDEC Universal Flash Storage (UFS) v3.0 specification (Jan2018).

Reference Clock Noise Floor Density (Ndensity)

Test Overview

The purpose of this test is to verify that UFS Reference Clock Noise Floor Density (Ndensity) is within the compliance limits as specified in the JEDEC Universal Flash Storage (UFS) v3.0 specification.

This test shall measure integrated single side band phase noise using user set frequency up to 10MHz to measure White noise floor as per Table 6.4, NOTE 6 from JEDEC Universal Flash Storage (UFS) v3.0 specification. It has not been defined where should be the start of white noise floor, as default is set up from 5 MHz to 10 MHz.

The Noise Floor Density is defined as below.

Parameter	Symbol	Min	Max	Unit
Noise Floor Density	Ndensity		-140	dBc/Hz

Test ID

- 3007 [Reference Clock Noise Floor Density (Ndensity)]

Test Availability Conditions

Table 99 shows the option on the MIPI M-PHY Conformance Test Application, which is available for you to configure, to enable the Reference Clock Noise Floor Density (Ndensity) test.

Table 99 Test Availability Condition for the Reference Clock Noise Floor Density (Ndensity) test

Test ID	UFS Clock Informative Test	
	Enabled	Disabled
3007	✓	✗

Test Procedure

- 1 Trigger on Reference clock single-ended signal with affordable probe method and measurement method.
- 2 Capture the Reference clock signal.
- 3 Turn on Phase Noise Analysis. Set single side band phase noise band from Start frequency (default: 5 MHz) to 10 MHz from clock frequency. The Start frequency is configurable using *Ref Clk Phase Noise Floor Start Frequency, Hz* configurable option in the Configure tab.
- 4 Using post processing method, extract Phase Noise graph and calculate the mean value within the given bandwidth.
- 5 Report the mean Noise Floor density result as Ndensity.

Test Results

The measured Ndensity value for the test signal shall be within the conformance limit as specified in the specification mentioned under the References section.

Test References

- See Table 6.4 in JEDEC Universal Flash Storage (UFS) v3.0 specification (Jan2018).

8 Calibrating the Infiniium Oscilloscope and Probe

Internal Calibration / 173
Required Equipment for Probe Calibration / 176
Probe Calibration / 177
Verifying the Probe Calibration / 184

This section describes the calibration procedures for Keysight Infiniium Oscilloscopes other than the UXR-series oscilloscopes. For the calibration information related to the UXR-series oscilloscopes, refer to *Keysight Infiniium UXR Real-Time Oscilloscopes User's Guide*.

Additionally, probe calibration and de-skew steps have been described in this section. To get more information, you can refer to the respective probes documentation.

Required Equipment for Oscilloscope Calibration

To calibrate the Infiniium oscilloscope in preparation for running the MIPI M-PHY automated tests, you need the following equipment:

- Keyboard, qty = 1, (provided with the Keysight Infiniium oscilloscope).
- Mouse, qty = 1, (provided with the Keysight Infiniium oscilloscope).
- Precision 3.5 mm BNC to SMA male adapter, Keysight p/n 54855-67604, qty = 2 (provided with the Keysight Infiniium oscilloscope).
- Calibration cable (provided with the Keysight Infiniium oscilloscopes). Use a good quality 50 Ω BNC cable.

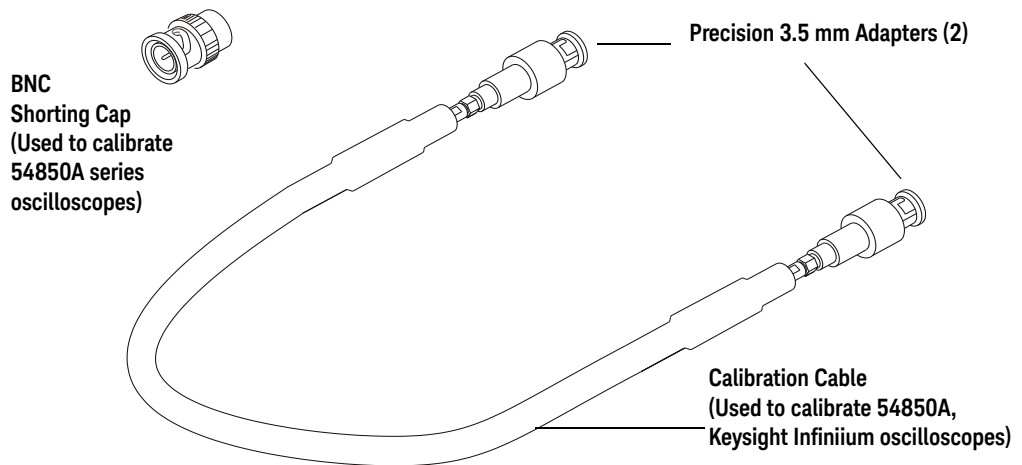

Figure 40 Accessories Provided with the Keysight Infiniium Oscilloscope

Internal Calibration

This will perform an internal diagnostic and calibration cycle for the oscilloscope. For the Keysight oscilloscope, this is referred to as Calibration. This Calibration will take about 20 minutes. Perform the following steps:

- 1 Set up the oscilloscope with the following steps:
 - a Connect the keyboard, mouse, and power cord to the rear of the oscilloscope.
 - b Plug in the power cord.
 - c Turn on the oscilloscope by pressing the power button located on the lower left of the front panel.
 - d Allow the oscilloscope to warm up at least 30 minutes prior to starting the calibration procedure in step 3 below.
- 2 Locate and prepare the accessories that will be required for the internal calibration:
 - a Locate the BNC shorting cap.
 - b Locate the calibration cable.
 - c Locate the two Keysight precision SMA/BNC adapters.
 - d Attach one SMA adapter to the other end of the calibration cable – hand tighten snugly.
 - e Attach another SMA adapter to the other end of the calibration cable – hand tighten snugly.
- 3 Referring to [Figure 41](#) below, perform the following steps:
 - a Click the **Utilities>Calibration** menu to open the Calibration dialog box.

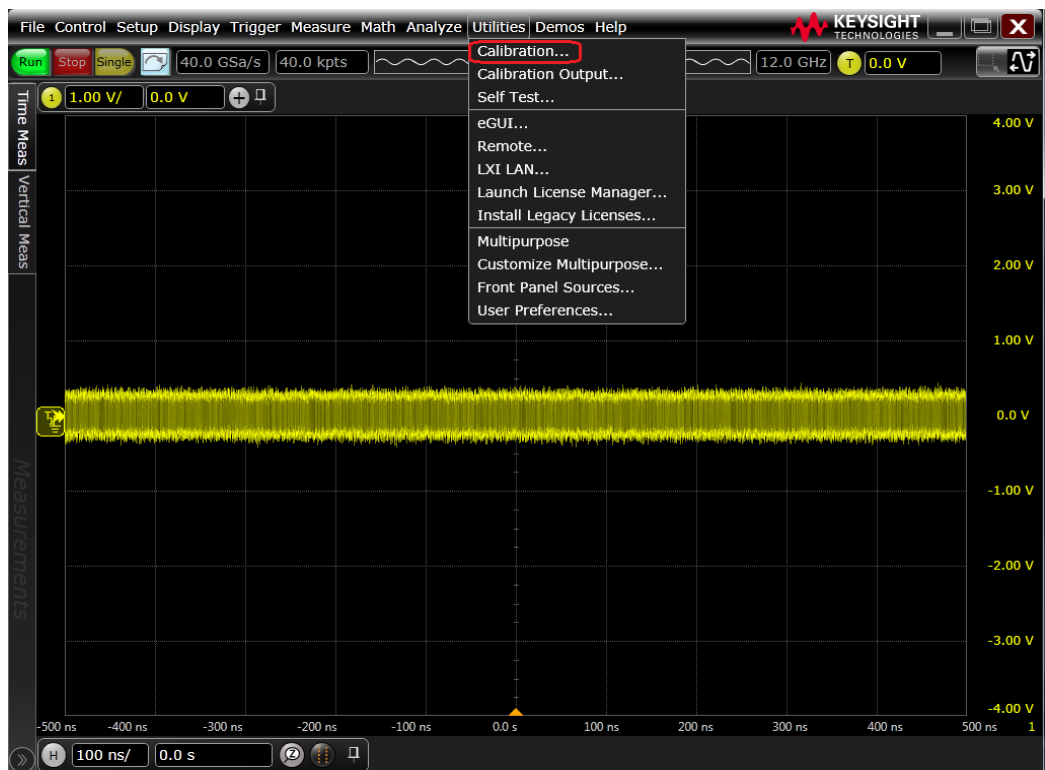

Figure 41 Accessing the Calibration Menu

- 4 Referring to Figure 42 below, perform the following steps to start the calibration:
 - b Uncheck the **Cal Memory Protect** checkbox.
 - c Click the **Start** button to begin the calibration.



Figure 42 Oscilloscope Calibration Process

- d During the calibration of channel 1, if you are prompted to perform a Time Scale Calibration, as shown in Figure 43 below.

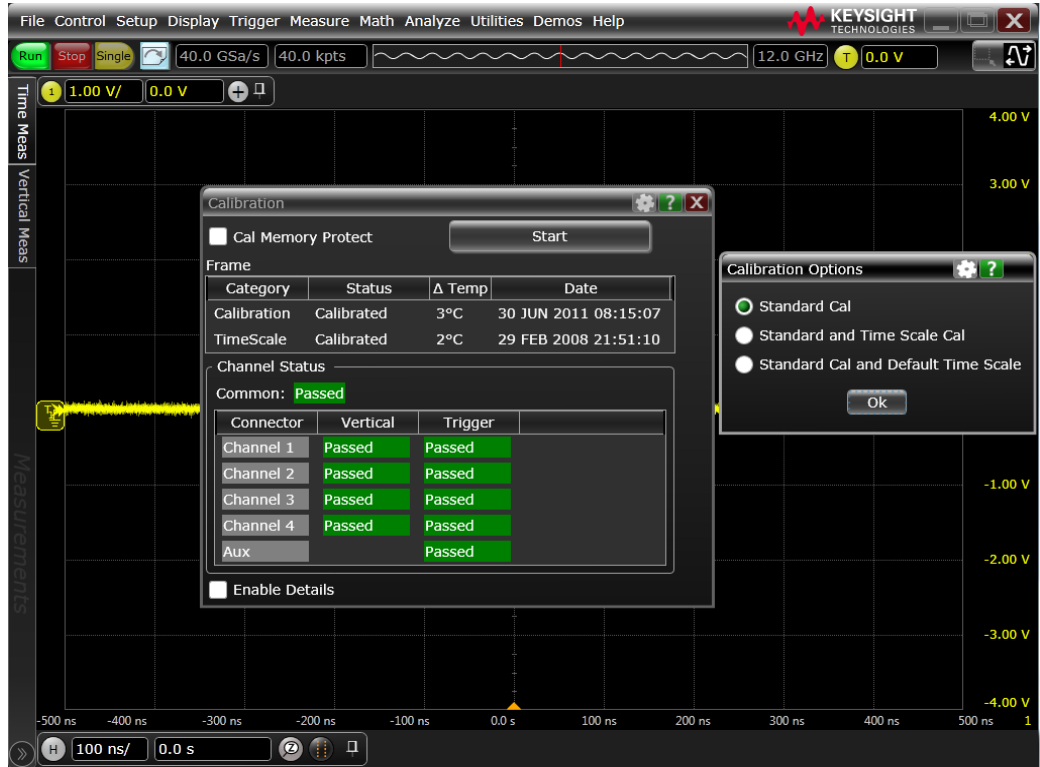

Figure 43 Calibration Options to perform Time Scale Calibration

- e Select the **Standard Cal and Default Time Scale** radio button to continue the calibration, using the Factory default calibration factors.
- f When the calibration procedure is complete, you will be prompted with a Calibration Complete message window. Click the **OK** button to close this window.
- g Confirm that the Vertical and Trigger Calibration Status for all Channels passed.
- h Click the **Close** button to close the calibration window.
- i The internal calibration is completed.
- j Read the NOTE below.

NOTE

These steps do not need to be performed every time a test is run. However, if the ambient temperature changes more than 5 degrees Celsius from the calibration temperature, this calibration should be performed again. The delta between the calibration temperature and the present operating temperature is shown in the Utilities>Calibration menu.

Required Equipment for Probe Calibration

Before performing the compliance tests, you should calibrate the probes. Calibration of the solder-in probe heads consists of a vertical calibration and a skew calibration. The vertical calibration should be performed before the skew calibration. Both calibrations should be performed for best probe measurement performance.

The calibration procedure requires the following parts.

- BNC (male) to SMA (male) adapter
- Deskew fixture
- 50 Ω SMA terminator

Probe Calibration

Connecting the Probe for Calibration

For the following procedure, refer to [Figure 44](#) below.

- 1 Connect BNC (male) to SMA (male) adapter to the deskew fixture on the connector closest to the yellow pincher.
- 2 Connect the 50 Ω SMA terminator to the connector farthest from the yellow pincher.
- 3 Connect the BNC side of the deskew fixture to the Aux Out BNC of the Infiniium oscilloscope.
- 4 Connect the probe to an oscilloscope channel.
- 5 To minimize the wear and tear on the probe head, it should be placed on a support to relieve the strain on the probe head cables.
- 6 Push down the back side of the yellow pincher. Insert the probe head resistor lead underneath the center of the yellow pincher and over the center conductor of the deskew fixture. The negative probe head resistor lead or ground lead must be underneath the yellow pincher and over one of the outside copper conductors (ground) of the deskew fixture. Make sure that the probe head is approximately perpendicular to the deskew fixture.
- 7 Release the yellow pincher.

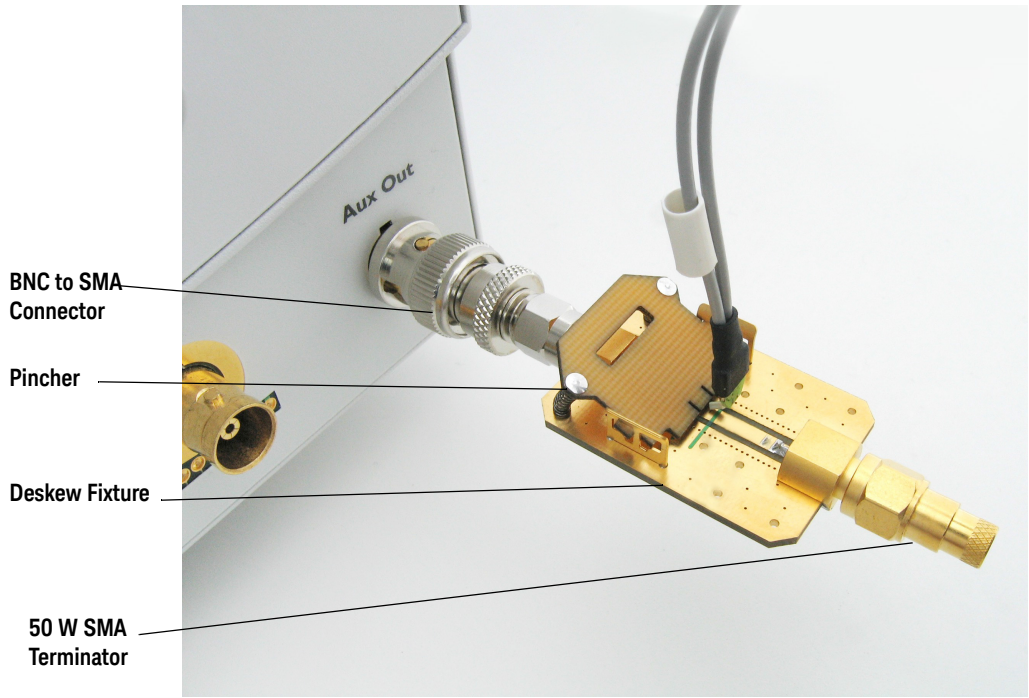

Figure 44 Solder-in Probe Head Calibration Connection Example

Verifying the Connection

- 1 On the Infiniium oscilloscope, press the autoscale button on the front panel.
- 2 Set the volts per division to 100 mV/div.
- 3 Set the horizontal scale to 1.00 ns/div.
- 4 Set the horizontal position to approximately 3 ns. You should see a waveform similar to that in [Figure 45](#) below.

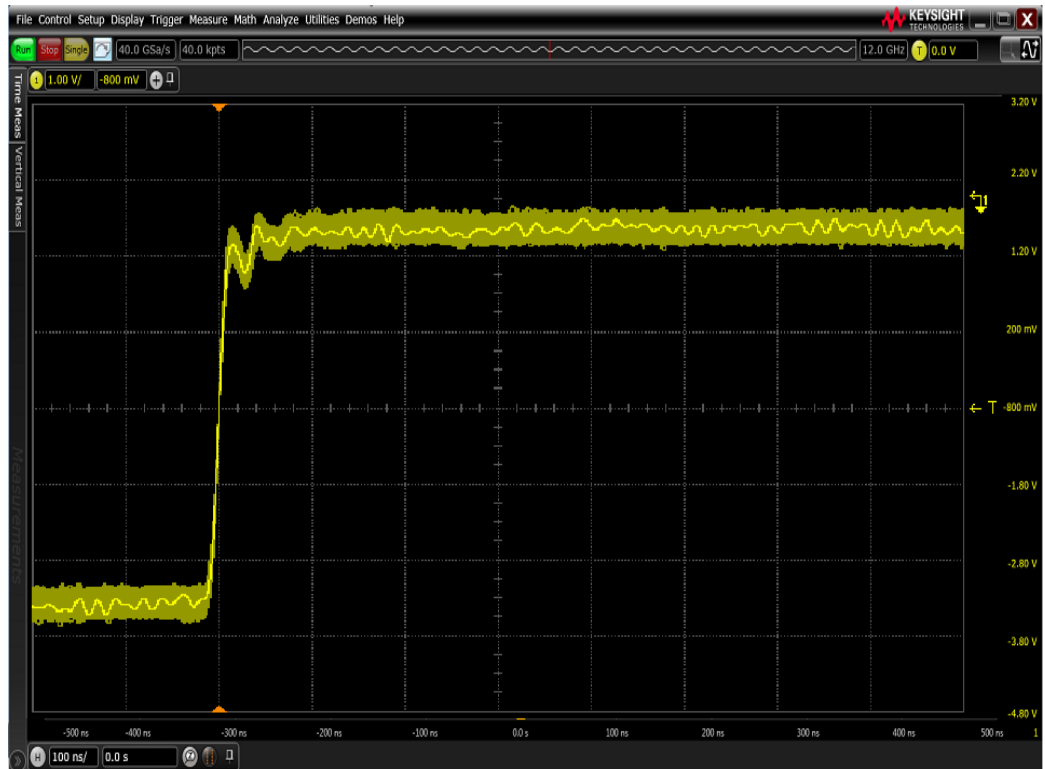

Figure 45 Good Connection Waveform Example

If you see a waveform similar to that of Figure 46 below, then you have a bad connection and should check all of your probe connections.

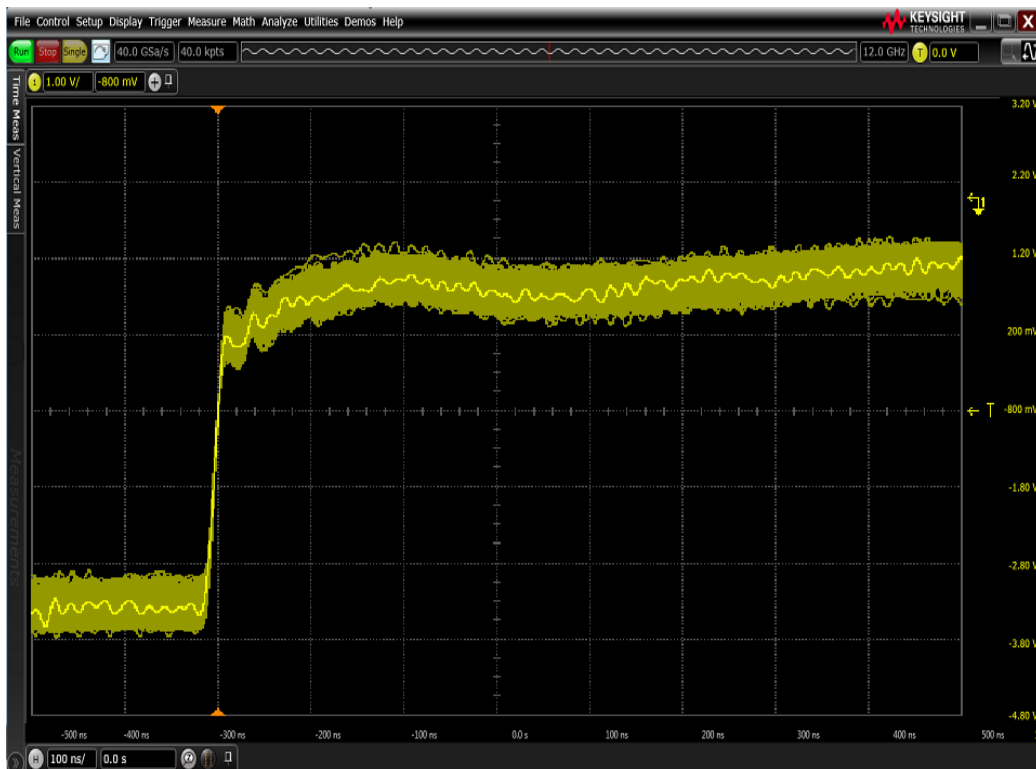

Figure 46 Bad Connection Waveform Example

Running the Probe Calibration and Deskew

- 1 On the Infiniium oscilloscope in the Setup menu, select the channel connected to the probe, as shown in Figure 47.

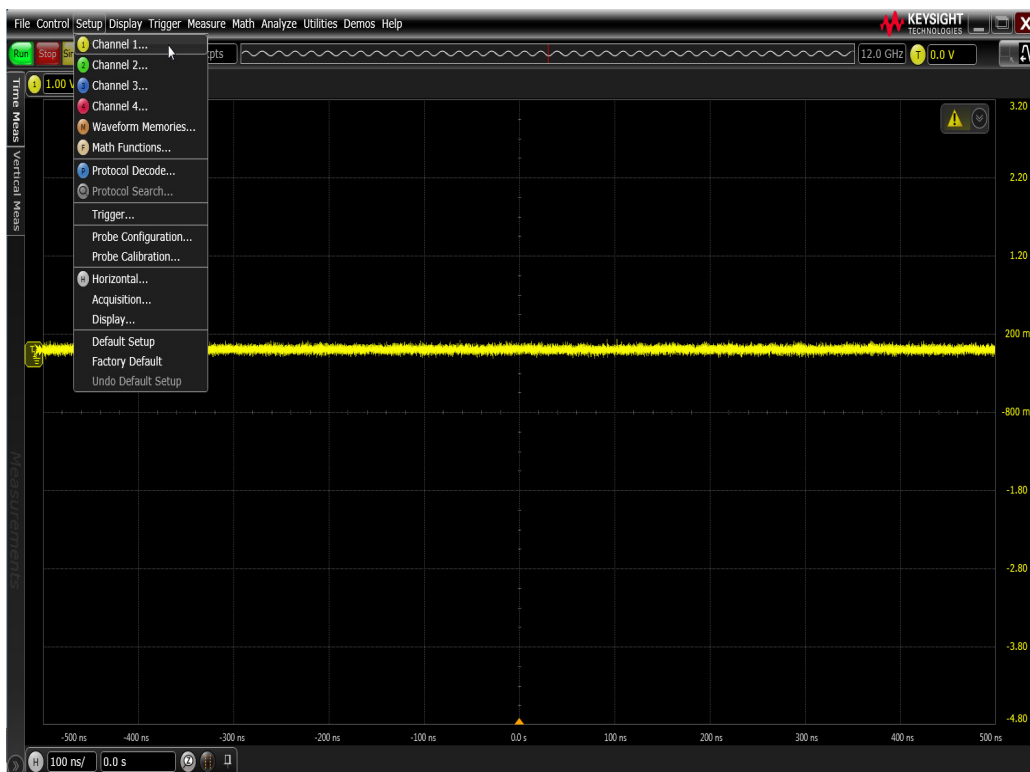

Figure 47 Channel Setup Window.

- 2 In the Channel Setup dialog box, select the Probes... button, as shown in Figure 48.

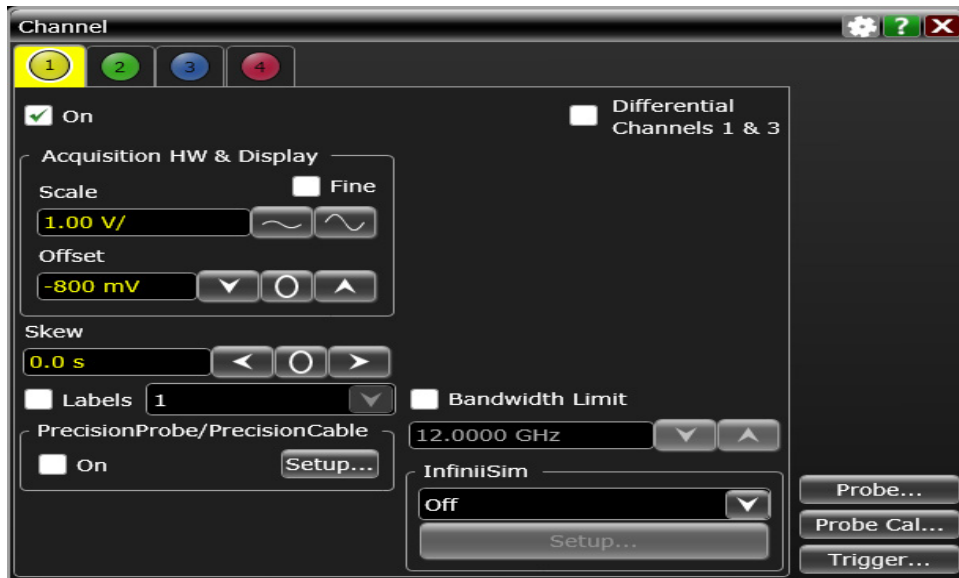

Figure 48 Channel Dialog Box

- 3 In the Probe Setup dialog box, select the Calibrate Probe... button.

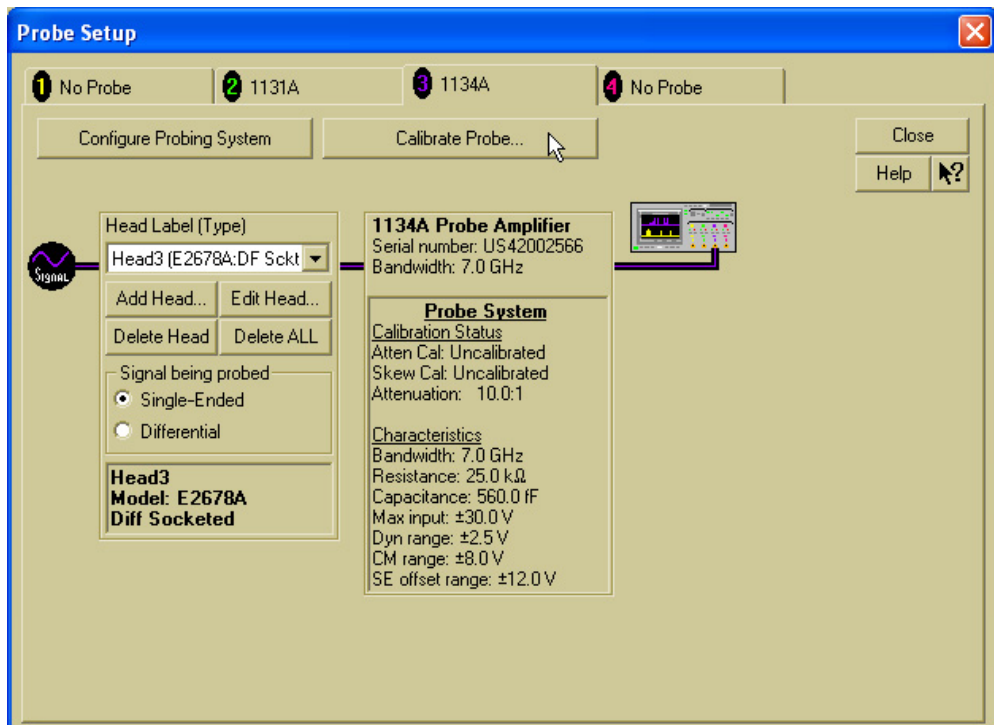

Figure 49 Probe Setup Window.

- 4 In the Probe Calibration dialog box, select the Calibrated Atten/Offset radio button.
- 5 Select the Start Atten/Offset Calibration... button and follow the on-screen instructions for the vertical calibration procedure.

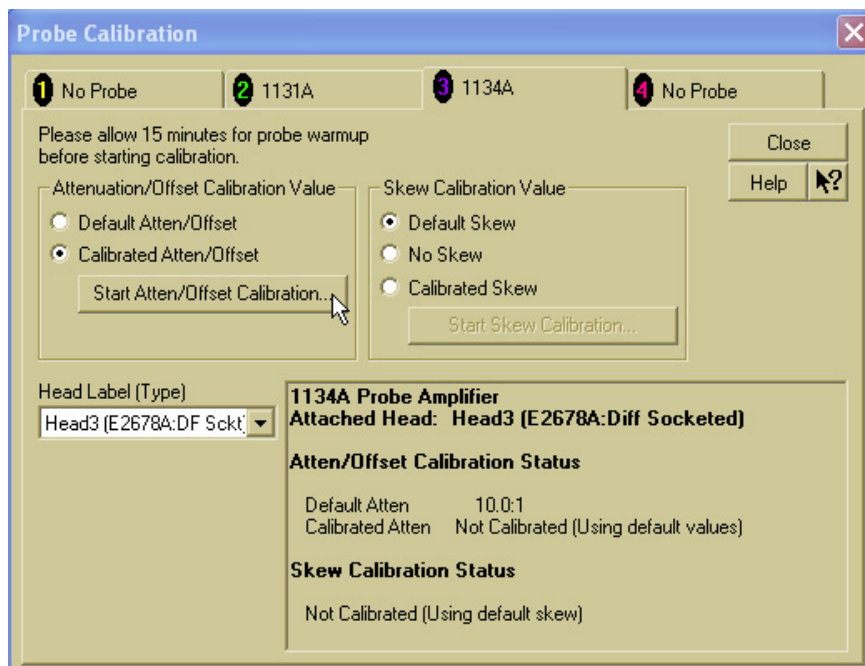

Figure 50 Probe Calibration Window.

- 6 Once the vertical calibration has successfully completed, select the Calibrated Skew... button.
- 7 Select the Start Skew Calibration... button and follow the on-screen instructions for the skew calibration.

At the end of each calibration, the oscilloscope will prompt you if the calibration was or was not successful.

Verifying the Probe Calibration

If you have successfully calibrated the probe, it is not necessary to perform this verification. However, if you want to verify that the probe was properly calibrated, the following procedure will help you verify the calibration.

The calibration procedure requires the following parts:

- BNC (male) to SMA (male) adapter
- SMA (male) to BNC (female) adapter
- BNC (male) to BNC (male) 12-inch cable such as the Keysight 8120-1838
- Keysight 54855-61620 calibration cable (Infiniium oscilloscopes with bandwidths of 6 GHz and greater only)
- Keysight 54855-67604 precision 3.5 mm adapters (Infiniium oscilloscopes with bandwidths of 6 GHz and greater only)
- Deskew fixture

For the following procedure, refer to [Figure 51](#).

- 1 Connect BNC (male) to SMA (male) adapter to the deskew fixture on the connector closest to the yellow pincher.
- 2 Connect the SMA (male) to BNC (female) to the connector farthest from the yellow pincher.
- 3 Connect the BNC (male) to BNC (male) cable to the BNC connector on the deskew fixture to one of the unused oscilloscope channels. For Infiniium oscilloscopes with bandwidths of 6 GHz and greater, use the 54855-61620 calibration cable and the two 54855-64604 precision 3.5 mm adapters.
- 4 Connect the BNC side of the deskew fixture to the Aux Out BNC of the Infiniium oscilloscope.
- 5 Connect the probe to an oscilloscope channel.
- 6 To minimize the wear and tear on the probe head, it should be placed on a support to relieve the strain on the probe head cables.
- 7 Push down on the back side of the yellow pincher. Insert the probe head resistor lead underneath the center of the yellow pincher and over the center conductor of the deskew fixture. The negative probe head resistor lead or ground lead must be underneath the yellow pincher and over one of the outside copper conductors (ground) of the deskew fixture. Make sure that the probe head is approximately perpendicular to the deskew fixture.
- 8 Release the yellow pincher.
- 9 On the oscilloscope, press the autoscale button on the front panel.
- 10 Select Setup menu and choose the channel connected to the BNC cable from the pull-down menu.
- 11 Select the Probes... button.
- 12 Select the Configure Probe System button.
- 13 Select User Defined Probe from the pull-down menu.
- 14 Select the Calibrate Probe... button.
- 15 Select the Calibrated Skew radio button.
- 16 Once the skew calibration is completed, close all dialog boxes.

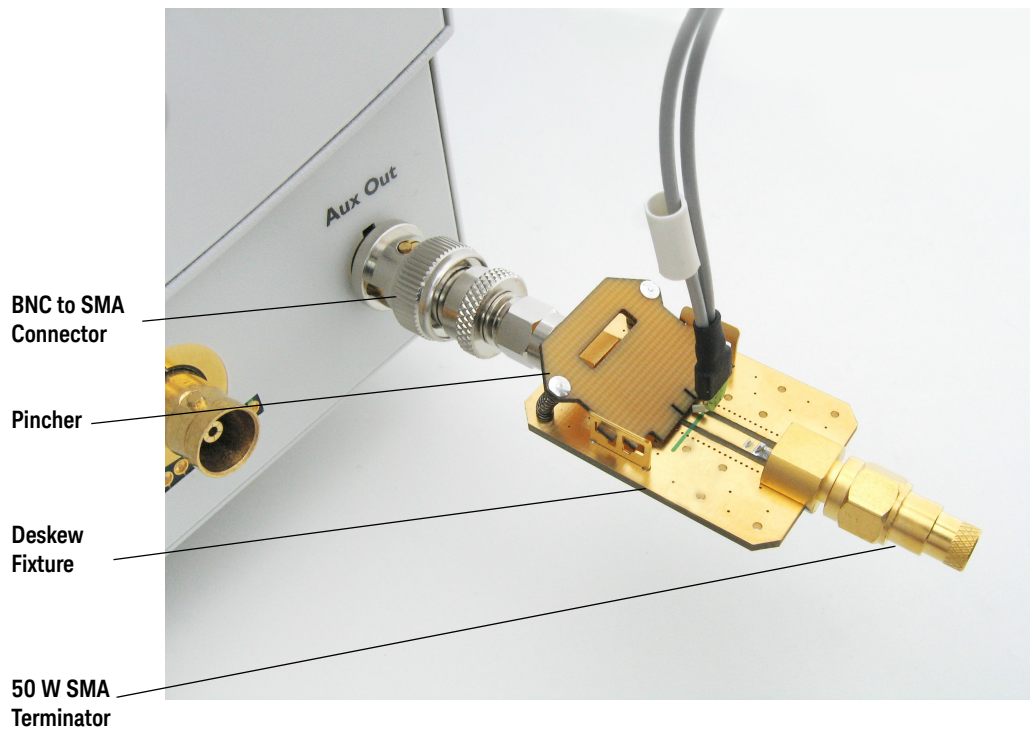

Figure 51 Probe Calibration Verification Connection Example

- 17 Select the Start Skew Calibration... button and follow the on-screen instructions.
- 18 Set the vertical scale for the displayed channels to 100 mV/div.
- 19 Set the horizontal range to 1.00 ns/div.
- 20 Set the horizontal position to approximately 3 ns.
- 21 Change the vertical position knobs of both channels until the waveforms overlap each other.
- 22 Select the Setup menu choose Acquisition... from the pull-down menu.
- 23 In the Acquisition Setup dialog box enable averaging. When you close the dialog box, you should see waveforms similar to that in [Figure 52](#).

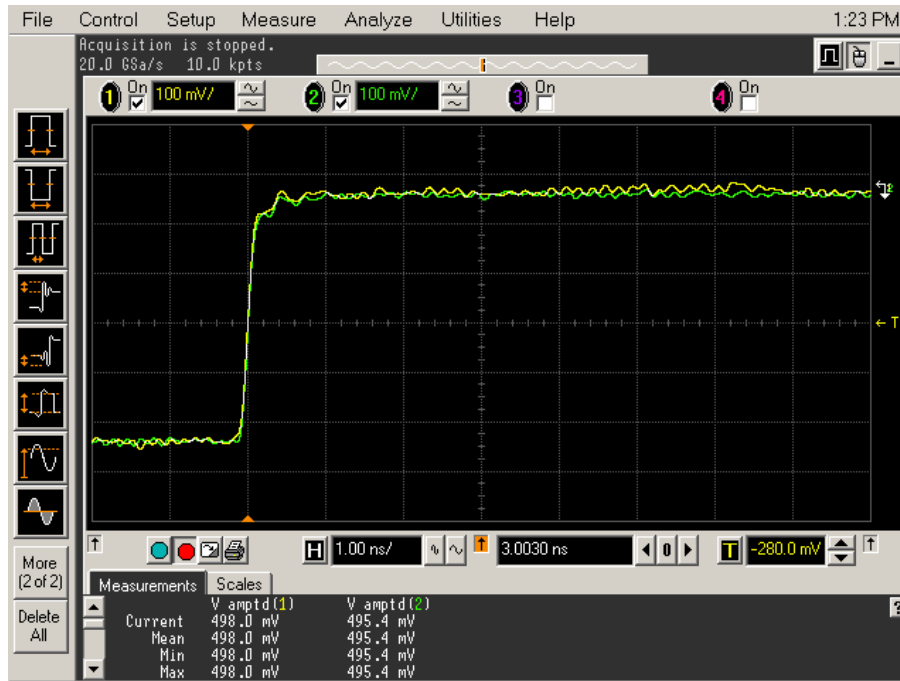

Figure 52 Calibration Probe Waveform Example

NOTE

Each probe is calibrated with the oscilloscope channel to which it is connected. Do not switch probes between channels or other oscilloscopes, or it will be necessary to calibrate them again. It is recommended that the probes be labeled with the channel on which they were calibrated.

9 InfiniiMax Probing



Figure 53 1134B InfiniiMax Probe Amplifier

Keysight recommends 116xA/B or 113xA/B probe amplifiers, which range from 3.5 GHz to 12 GHz.

Keysight also recommends the E2677A/B differential solder-in probe head. Other probe head options include N5381A/B InfiniiMax II 12 GHz differential solder-in probe head, N5425A/B InfiniiMax ZIF probe head and N5426A ZIF Tips.



Figure 54 E2677A/B / N5381A/B Differential Solder-in Probe Head

Table 100 Probe Head Characteristics (with 1134B probe amplifier)

Probe Head	Model Number	Differential Measurement (BW, input C, input R)	Single-Ended Measurement (BW, input C, input R)
Differential Solder-in	E2677A/B	7 GHz, 0.27 pF, 50 kOhm	7 GHz, 0.44 pF, 25 kOhm

Used with 1168A/B or 1169A/B probe amplifier, the E2677A/B differential solder-in probe head provides 10 GHz and 12 GHz bandwidth respectively.

