

Keysight AXIe based Logic Analysis and Protocol Test Modules

Installation Guide

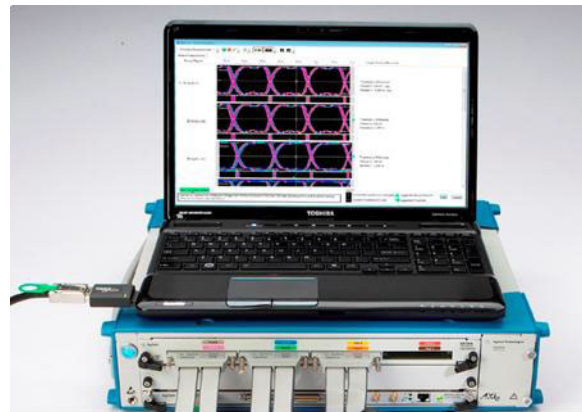

Notices

© Keysight Technologies 2008-2016, 2022

No part of this manual may be reproduced in any form or by any means (including electronic storage and retrieval or translation into a foreign language) without prior agreement and written consent from Keysight Technologies as governed by United States and international copyright laws.

Manual Part Number

U4000-97000

Available in electronic format only.

Edition

Eighth Edition, April 2022

Keysight Technologies
1900 Garden of the Gods Road
Colorado Springs, CO 80907 USA

Sales and Technical Support

To contact Keysight for sales and technical support, refer to the "support" links on the following Keysight web resources:

www.keysight.com/find/(product-specific information and support, software and documentation updates)

www.keysight.com/find/assist (worldwide contact information for repair and service)

Information on preventing damage to your Keysight equipment can be found at www.keysight.com/find/tips.

Declaration of Conformity

Declarations of Conformity for this product and for other Keysight products may be downloaded from the Web. Go to <http://www.keysight.com/go/conformity> and click on "Declarations of Conformity." You can then search by product number to find the latest Declaration of Conformity.

Warranty

THE MATERIAL CONTAINED IN THIS DOCUMENT IS PROVIDED "AS IS," AND IS SUBJECT TO BEING CHANGED, WITHOUT NOTICE, IN FUTURE EDITIONS. FURTHER, TO THE MAXIMUM EXTENT PERMITTED BY APPLICABLE LAW, KEYSIGHT DISCLAIMS ALL WARRANTIES, EITHER EXPRESS OR

IMPLIED WITH REGARD TO THIS MANUAL AND ANY INFORMATION CONTAINED HEREIN, INCLUDING BUT NOT LIMITED TO THE IMPLIED WARRANTIES OF MERCHANTABILITY AND FITNESS FOR A PARTICULAR PURPOSE. KEYSIGHT SHALL NOT BE LIABLE FOR ERRORS OR FOR INCIDENTAL OR CONSEQUENTIAL DAMAGES IN CONNECTION WITH THE FURNISHING, USE, OR PERFORMANCE OF THIS DOCUMENT OR ANY INFORMATION CONTAINED HEREIN. SHOULD KEYSIGHT AND THE USER HAVE A SEPARATE WRITTEN AGREEMENT WITH WARRANTY TERMS COVERING THE MATERIAL IN THIS DOCUMENT THAT CONFLICT WITH THESE TERMS, THE WARRANTY TERMS IN THE SEPARATE AGREEMENT WILL CONTROL.

Technology Licenses

The hardware and/or software described in this document are furnished under a license and may be used or copied only in accordance with the terms of such license.

U.S. Government Rights

The Software is "commercial computer software," as defined by Federal Acquisition Regulation ("FAR") 2.101. Pursuant to FAR 12.212 and 27.405-3 and Department of Defense FAR Supplement ("DFARS") 227.7202, the U.S. government acquires commercial computer software under the same terms by which the software is customarily provided to the public. Accordingly, Keysight provides the Software to U.S. government customers under its standard commercial license, which is embodied in its End User License Agreement (EULA), a copy of which can be found at <http://www.keysight.com/find/sweula>. The license set forth in the EULA represents the exclusive authority by which the U.S. government may use, modify, distribute, or disclose the Software. The EULA and the license set forth therein, does not require or permit, among other things, that Keysight: (1) Furnish technical information related to commercial computer software or commercial computer software documentation that is not customarily provided to the public; or (2) Relinquish to, or otherwise provide, the government rights in excess of these rights customarily provided to the public to use, modify, reproduce, release, perform, display, or disclose

commercial computer software or commercial computer software documentation. No additional government requirements beyond those set forth in the EULA shall apply, except to the extent that those terms, rights, or licenses are explicitly required from all providers of commercial computer software pursuant to the FAR and the DFARS and are set forth specifically in writing elsewhere in the EULA. Keysight shall be under no obligation to update, revise or otherwise modify the Software. With respect to any technical data as defined by FAR 2.101, pursuant to FAR 12.211 and 27.404.2 and DFARS 227.7102, the U.S. government acquires no greater than Limited Rights as defined in FAR 27.401 or DFAR 227.7103-5 (c), as applicable in any technical data.

Safety Notices

CAUTION

A CAUTION notice denotes a hazard. It calls attention to an operating procedure, practice, or the like that, if not correctly performed or adhered to, could result in damage to the product or loss of important data. Do not proceed beyond a CAUTION notice until the indicated conditions are fully understood and met.

WARNING

A WARNING notice denotes a hazard. It calls attention to an operating procedure, practice, or the like that, if not correctly performed or adhered to, could result in personal injury or death. Do not proceed beyond a WARNING notice until the indicated conditions are fully understood and met.

Safety Information

Keysight Technologies certifies that this product met its published specifications at the time of shipment from the factory. Keysight Technologies further certifies that its calibration measurements are traceable to the United States National Institute of Standards and Technology to the extent allowed by that organization's calibration facility, and to the calibration facilities of other International Standards Organization members.

Additional Information for Test and Measurement Equipment

To comply with EMC regulations, supplied or recommended cables must be used on all appropriate connections. Otherwise, the user has to ensure that, under operating conditions, the Radio Interference Limits are still met at the border of the user's premises.

To ensure continued compliance to radiated emissions standards, all RJ45 connections must be made using shielded Category 5 (STP) cables.

CAUTION

Do NOT block vents: To ensure adequate cooling and ventilation, leave a gap of at least 50mm (2") around all vent holes.

Do NOT operate with empty slots: To ensure proper cooling and avoid damaging equipment, fill any empty slots with the AXLe filler panel module,

Do NOT stack free-standing chassis: For benchtop use, do not stack chassis. Stacked chassis should be rack-mounted. Exception—the bumpers, if installed on both chassis, are designed to safely stack one M9502A atop an M9502A or M9505A.

All RFI gaskets must remain in place: Any damaged gaskets must be replaced.

All modules are grounded through the chassis: During installation, tighten the module's retaining screws to secure the module to the chassis and to make the ground connection

WARNING

The following general safety precautions must be observed during all phases of operation, service, and repair of this product. Failure to comply with these precautions or with specific warnings elsewhere in this manual violates safety standards of design, manufacture, and intended use of the product. Keysight Technologies assumes no liability for the customer's failure to comply with these requirements.

Before Applying Power Verify that all safety precautions are taken. Make all connections to the unit before applying power. Note the instrument's external markings described under "Safety Symbols".

Ground the Equipment: For safety, Class 1 equipment (equipment having a protective earth terminal), an uninterruptible safety ground must be provided from the mains power source to the product input wiring terminals or supplied power cable. Before operating the equipment, guard against electric shock in case of fault by always using the provided 3-conductor power cords to connect the equipment to a grounded power outlet.

DO NOT use in hazardous environments: Do not operate the product in an explosive atmosphere or in the presence of flammable gases or fumes. This product is designed for indoor use only.

Keep away from live circuits: Operating personnel must not remove equipment covers or shields. Procedures involving the removal of covers and shields are for use by service-trained personnel only. Under certain conditions, dangerous voltages may exist even with the equipment switched off. To avoid dangerous electrical shock, DO NOT perform procedures involving cover or shield removal unless you are qualified to do so.

DO NOT operate damaged equipment: Whenever it is possible that the safety protection features built into this product have been impaired, either through physical damage, excessive moisture, or any other reason, REMOVE POWER and do not use the product until safe operation can be verified by service-trained personnel. If necessary, return the product to an Keysight Technologies Sales and Service Office for service and repair to ensure the safety features are maintained.

DO NOT substitute parts or modify equipment: Because of the danger of introducing additional hazards, do not install substitute parts or perform any unauthorized modification to the product. Return the product to an Keysight Technologies Sales and Service Office for service and repair to ensure features are maintained.







DO NOT clean with fluids: Doing so may make the equipment unsafe for use. Power down the equipment and disconnect the power cord before cleaning. To clean, use a soft dry cloth.

DO NOT block the primary disconnect: The primary disconnect device is the appliance connector/power cord when a chassis used by itself, but when installed into a rack or system the disconnect may be impaired and must be considered part of the installation.

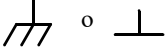
Modules can become hot during use: DO NOT touch any of the components on a module as you remove it from the chassis. Beware especially of the power module, which is situated at the rear of the module.

Safety Symbols

Table 1 Safety Symbol

Symbol	Description
	If you see this symbol on a product, you must refer to this guide for specific Warning or Caution information to avoid personal injury or damage to the product
	Frame or chassis ground terminal. Typically connects to the equipment's metal frame
	Alternating current (AC)
	Direct current (DC)
	Standby. This device is not completely disconnected from the AC mains when its power switch is off
	Indicates the field wiring terminal that must be connected to ground before operating the equipment. Protects against electrical shock in case of fault
	Indicates hazardous voltages and potential for electrical shock.
	Indicates that antistatic precautions should be taken.

Compliance and Environmental Information

Table 2 Compliance Information





Safety Symbol	Description
	CSA is the Canadian certification mark to demonstrate compliance with the Safety requirements.
	The C-tick mark is a registered trademark of the Spectrum Management Agency of Australia. This signifies compliance with the Australia EMC Framework regulations under the terms of the Radio Communication Act of 1992.
	Notice for European Community: CE compliance marking to the EU Safety and EMC Directives. ISM GRP-1A classification according to the international EMC standard. ICES/NMB-001 compliance marking to the Canadian EMC standard.
	This is the symbol for an Industrial, Scientific, and Medical Group 1 Class A product
	ICES/NMB-001 indicates that this ISM device complies with the Canadian ICES-001

Table 3 Environmental Information

Safety Symbols	Description
	Notice for the European Community: This product complies with the WEEE Directive (2002/96/EC) marking requirements. The affixed label indicates that you must not discard this electrical/electronic product in domestic household waste. <i>Product Category: With reference to the requirement types in the WEEE Directive Annex I, this product is classed as a "Monitoring and Control Instrumentation" product.</i> Do not dispose in domestic household waste.
	To return unwanted products, contact your local Keysight office, or see www.keysight.com/environment/product/ for more information.

About This Guide

This guide provides detailed information for setting up the Keysight AXIe based logic analysis and protocol test modules in the Keysight AXIe chassis. The guide also provides instructions on how to establish connectivity among the components of a typical setup.

The guide describes the hardware components and features of these AXIe based instrument modules that are installed in the slots of the Keysight AXIe chassis. It also includes information on the software components of these modules needed to configure, control, and use these modules.

Overall, the objective of this guide is to provide instructions for making an AXIe based instrument module functional and usable in the Keysight AXIe chassis.

Contents

1 Introduction to Setup Components

AXIe Chassis	10
Supported AXIe Based Logic Analysis and Protocol Test Modules	10
AXIe Embedded System Module (ESM)	11
AXIe Based Logic Analysis and Protocol Test Modules	12
U4154A /B Logic Analyzer Module	13
U4164A Logic Analyzer Module	17
U4301A/B PCIe 8 Gbps Gen3 Protocol Analyzer Module	19
U4421A MIPI D-PHY Protocol Analyzer and Exerciser Module	22
U4431A MIPI M-PHY Protocol Analyzer Module	26
Host Computer	29
Keysight M9536A AXIe Embedded Controller Module	29
Keysight M9537A AXIe High Performance Embedded Controller Module	29

2 Setting up the Hardware

Verify Basic Chassis and Module Operation	32
Perform the Complete Hardware Setup	33
Planning Considerations	33
Install the Instrument/Embedded Controller Module(s) in the AXIe Chassis	36
To install the instrument/embedded controller module into the chassis	36
To remove an instrument/embedded controller module from the chassis	37
To create a logic analyzer multi-card set	38
Set up the Keysight AXIe Chassis	44
Connect the AXIe Chassis to a Host computer	45
To connect a laptop/desktop host PC via PCIe	45
To connect a laptop/desktop host PC via USB	46
To connect an AXIe Embedded Controller Module to Chassis	46
Connect the Instrument Module to DUT	48
U4154A/B Module	48
U4164A Module	50
U4301A/B Module	51
U4421A Module	52
U4431A Module	56
Power up the Connected Hardware Components	57
Verify the Hardware Setup	59

3 Installing Software Components

Hardware and Software Requirements for the Host Computer	62
Installing Keysight Logic and Protocol Analyzer Software	63
Installing Chassis Device Drivers and Keysight I/O Libraries Suite	64
Networking the Host Computer and AXIe Chassis	65
Network requirements	65
PCIe/USB Connection Requirements	65
Chassis LAN Connector	66
Point-to-point LAN	66
Single chassis scenario	67
Multiple chassis connected to a single host PC in a non multiframe scenario	68
Multiframe scenario with one chassis per host PC	69
Multiframe scenario with multiple chassis per host PC	70
Upgrading Chassis Firmware	72
Step 1 - Connect the AXIe Chassis to the Host PC	73
Step 2 - Perform the firmware upgrade	73
Step 5 - Restart the chassis and host PC	79
Step 6 - Verify the firmware upgrade	79
Upgrading a Module's Backplane Interface FPGA Firmware	80
Upgrading a Module's BMC (IPMC) Firmware	84
Initiating a BMC Firmware Upgrade Manually	86
Installing Additional Software Packages	87
Downloading Additional Software Packages	87
U4154A/B Additional Software Packages	87
Setting up Communication between the Host PC and ESM of the AXIe chassis	88

4 Accessing Instrument Module Documents

5 Troubleshooting and Service

Servicing a Module	92
Troubleshooting USB Connectivity Issues	93
Troubleshooting ESM Connectivity Issues	94
Troubleshooting Host Computer related Problems	97

1 Introduction to Setup Components

AXIe Chassis / 10

AXIe Based Logic Analysis and Protocol Test Modules / 12

Host Computer / 29

The chapter introduces you to Keysight's AXIe-based logic analysis and protocol test modules that can be installed as instrument modules in the Keysight's AXIe chassis. It also introduces you to the concept of using a host computer to communicate with the chassis and installed modules.

AXle Chassis

The Keysight AXle chassis is a modular instrument chassis that supports complex and high density testing. The chassis provides slots for installing multiple AXle based instrument modules such as the U4154A/B and U4431A modules. Besides providing a frame for the installation of these instrument modules, the AXle chassis also provides power, a cooling system, a PCIe Gen2 local data bus, a Gigabit LAN interconnect and a cabled PCIe connection for host PC connectivity.

The following models of the Keysight AXle chassis are available that support the AXle based instrument modules:

- M9502A – a portable 2-slot AXle chassis suitable for small system testing.
- M9505A - a 5-Slot AXle chassis

Refer to the *Keysight M9502A/M9505A AXle Chassis Startup Guide* to get detailed information about these models of AXle chassis.



Figure 1 M9502A 2-slot AXle Chassis and M9505A 5-slot chassis

Supported AXle Based Logic Analysis and Protocol Test Modules

You can install the following logic analysis and protocol test modules in the M9502A / M9505A AXle chassis.

- U4154A /U4154B Logic Analyzer module
- U4164A Logic Analyzer module
- U4301A / U4301B PCIe Gen 3 8 Gbps Protocol Analyzer module
- U4421A MIPI D-PHY Protocol Analyzer and Exerciser module
- U4431A MIPI M-PHY Protocol Analyzer module

These modules can co-exist in different slots of an AXle chassis. For modules that support multi-card setup, you can install multiple modules cabled together to form a multi-card set in a chassis. For instance, you can install two U4154A modules in a chassis and cable these together to act as one single logical module. You can also install three U4154B modules in a chassis and cable these together to act as one single logical module.

However, you cannot merge U4154A, U4154B, or U4164A modules in a multi-card set in a chassis.

For details on the features and hardware components of each of the above-mentioned modules, refer to ["AXle Based Logic Analysis and Protocol Test Modules"](#) on page 12.

AXIe Embedded System Module (ESM)

The bottom slot of the AXIe chassis has the Embedded System Module (ESM) which is factory-installed. The ESM has a PCIe x8, Gen1 and Gen2 compliant interface to connect an external host computer to the chassis.



Figure 2 M9505-00130 AXIe ESM

The ESM:

- runs the chassis embedded operating system which manages all internal tasks and communications.
- tracks inserted modules and manages power requirements.
- monitors chassis temperature and controls variable-speed chassis fans.
- monitors module sensors and reports component failures to a system log.
- acts as a Gigabit Ethernet switch; forwards frames along the backplane.
- connects an external host computer to the chassis.
- synchronizes timing across all modules through the Keysight Trigger Bus, using an internal or external clock source.

Refer to the *Keysight M9502A/M9505A AXIe Chassis Startup Guide* to get detailed information about ESM.

The AXIe ESM is available as the standard ESM or the USB ESM.

- Standard ESM - The standard ESM (part number M9505-00130) provides a PCIe x8, Gen1 and Gen2 compliant interface to connect an external host computer to the chassis via PCIe connectivity.



Figure 3 M9505-00130 AXIe Standard ESM

- USB ESM - The USB ESM (part number M9505-00230) is available as a licensed option (U20). This ESM provides a USB 2.0 port in addition to the standard PCIe port to allow you to connect an external host computer to the chassis either via USB or PCIe connectivity.



Figure 4 M9505-00230 AXIe USB ESM

At a time, either PCIe or USB port can be used in this ESM. When you use the PCIe port, the USB port is automatically disabled till the PCIe port is in use.

AXIe Based Logic Analysis and Protocol Test Modules

The instrument modules that you install in a Keysight AXIe chassis are recognized by the model number and name located on their front panel.

Each supported module has some standard hardware and software features that are available with a standard license of that module. Some upgraded features/components of a module are licensed and are only available when you purchase a license for that feature.

The following sections describe each of the supported AXIe based logic analysis and protocol testing modules in detail.

U4154A /B Logic Analyzer Module

The Keysight U4154A/B Logic Analyzer is an instrument module that can be installed into one of the module slots of a Keysight AXIe chassis (M9502A portable 2-slot chassis or M9505A 5-slot chassis).

U4154A/B module is an AXIe based high speed state and timing logic analyzer. It provides measurement capabilities, probing, and application support and analysis tools for digital testing and debugging.

These modules connects to a System Under Test (SUT) via pod connector cables and probes to make real-time measurements.

U4154A



Figure 5 U4154A Module

Features

- 136 channels per module. Expandable to 272 channels by installing and connecting two U4154A modules in slots of an AXIe chassis as a two-card set.
- Memory depth ranging from 2 M to 200 M (depending on the memory depth license option that you purchased).
- Support for timing and state acquisition modes.
- Timing Zoom at 12.5 GHz.
- Eye scan feature for determining optimal threshold voltage and sample position settings for individual channels of U4154A.

U4154B

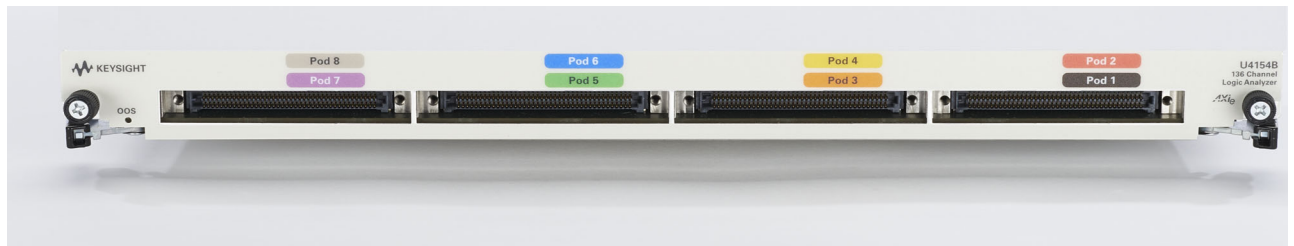

Figure 6 U4154B Module

Features

- 136 channels per module. Expandable to 408 channels in Full Channel mode and 204 channels in Half Channel mode by installing and connecting three U4154B modules in slots of an AXIe chassis as a three-card set.

- Supports three U4154B modules in a multi-card set in the AXIe chassis. This enables DDR4 interposers to perform full data capture at speeds >2.5 Gb/s.
- Has improved clock qualifiers to capture traces out of reset. U4154B has Pod 7, Pod 5, Pod 4, Pod 3 and Pod 2 clock qualifiers on the clocking module. U4154B provides an additional new clock enable on Pod 7 of the clocking module to allow 'OR' qualification of upto 4 DDR memory CKE clock qualifiers AND qualified with RESET.
- Memory depth ranging from 2 M to 200 M (depending on the memory depth license option that you purchased).
- Support for timing and state acquisition modes.
- Timing Zoom at 12.5 GHz.
- Eye scan feature for determining optimal threshold voltage and sample position settings for individual channels of U4154B.

Refer to the *Keysight Logic and Protocol Analyzer Online Help* installed and integrated with the Keysight Logic and Protocol Analyzer software to learn about how to use this module.

NOTE U4154B modules do not merge into module sets with the U4154A modules.

The following topics describe this module and some of the accessories that are used in its setup.

U4154A/B Module Components

NOTE U4154A module's components are similar to U4154B module.

The following figure displays the front panel of the U4154B module with its various components labeled.

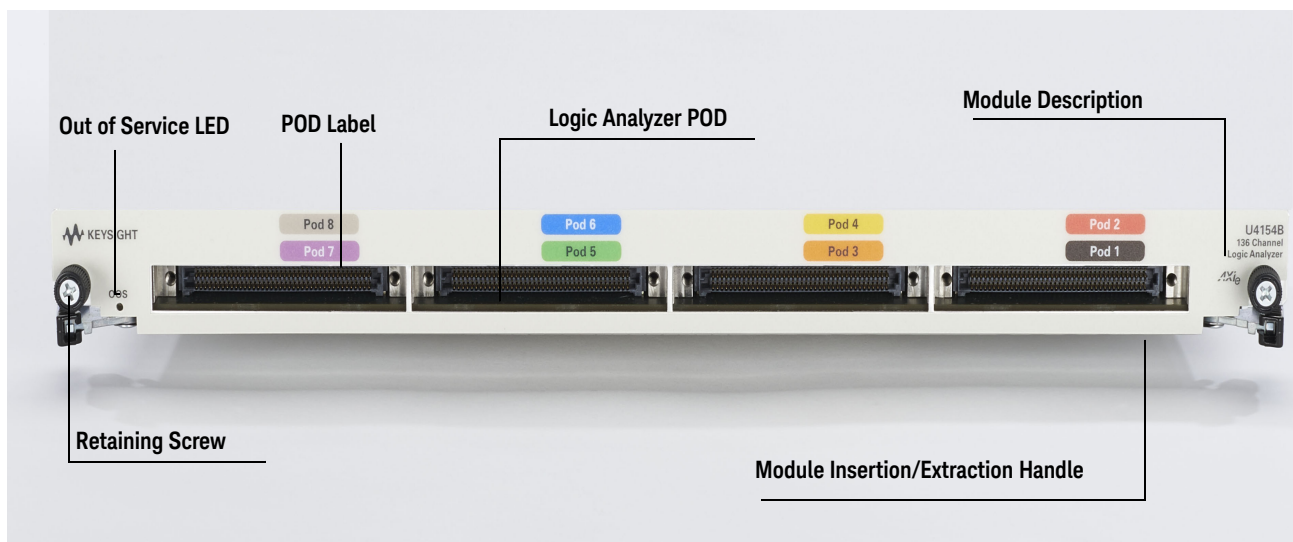

Figure 7 U4154B module

As displayed in [Figure 7](#), the U4154A/B module has the following components.

Component	Description
OOS (Out of Service) LED	Indicates the power-ready status of the U4154A/B module. This LED turns red during the power-on-self-test phase of the chassis boot cycle. The LED then turns off when the U4154A /B module is in a power-ready state. The LED turns red again only when a power fault condition occurs for the module. <ul style="list-style-type: none"> ▪ Red, steady - If the LED remains red and does not turn off, then it indicates a power fault condition. In such a situation, the module may require repair/service. Contact your Keysight representative to replace or service the module. ▪ Off - The module has detected no power failures and is in a power-ready status.
Logic Analyzer Pods	The module has eight pod inputs labeled as Pod 1-8 in different colors. You use these pod inputs to connect the U4154A/B module to probes via Pod connector cables. Each pod has 16 data channels and a clock channel.
Pod labels	A colored label assigned to each pod input on the front panel of the module. You should match the color coding used in these pod labels with the color coding for the labels that you put on the pod cables.
Retaining screws	The screws on both ends of the module are used to retain the module tightly inside the AXIe chassis slot once you have fully placed it inside the chassis. To remove the module, you first need to loosen these screws ensuring that these screws disengage completely.
Module Insertion/Extraction Handles	The handles on both sides of the module to insert or eject the module from the slot of the AXIe chassis.
Serial Number (on top of module)	Uniquely identifies the U4154A /B module. When contacting Keysight support, report this number so that any manufacturing information or past servicing associated with the module can be noted. The serial number is also provided in a Code 128 bar code for inventory purposes.
Module Description	Identifies the module's product number and title. When contacting Keysight support, report this information.

CAUTION

Components on the U4154A/B module are sensitive to static electricity. Therefore, take necessary anti-static precautions, such as wear a grounded wrist strap, to minimize the possibility of electrostatic damage.

Refer to the topic ["Install the Instrument/Embedded Controller Module\(s\) in the AXIe Chassis"](#) on page 36 to learn how to install this module in one of the slots of AXIe chassis.

Pod Connector Cables

The Keysight U4201A / 90-pin pod connector cable is used to connect the U4154A/B module to the probes which then connect to the DUT/SUT. The module connector on one end of the cable is installed in the relevant pod input on the front panel of the Logic Analyzer module. The other end of the cable is connected to the probes.

The following figure displays a typical 90-pin U4201A cable followed by a figure displaying this cable connected to the Keysight Differential Soft Touch and Flying Lead Set probes.



Figure 8 U4201A 90-pin Pod Connector Cable



Figure 9 U4201A 90-pin Pod Connector Cable connected to Differential Soft Touch and Flying Lead Set Probes

You can order these pod connector cables from the Options and Accessories tab on www.keysight.com/find/U4154A/ and www.keysight.com/find/U4154B/.

Refer to the topic “[Connect the Instrument Module to DUT](#)” on page 48 to know how to connect the module with probes using the U4201A cables.

Probes

Probing is the key to effective and efficient use of the U4154A/B logic analyzer modules. Keysight Technologies offers a wide variety of probing accessories that support general-purpose and application-specific measurement needs. Keysight Technologies provides reliable, electrically and mechanically unobtrusive probes that make it easy to connect your U4154A/B logic analyzer to your system under test. For more information on Keysight probes:

- Go to www.keysight.com/find/logic_analyzer_probes for the most up-to-date information on probe compatibility with a given logic analyzer and purchasing information.
- Go to www.keysight.com and search for Probing Solutions for Logic Analyzers (publication 5968-4632E) for a catalog of detailed probing information.

Refer to the topic “[Connect the Instrument Module to DUT](#)” on page 48 to know how to get introductory information on probe connectivity.

U4164A Logic Analyzer Module

The Keysight U4164A Logic Analyzer is an instrument module that can be installed into one of the module slots of a Keysight AXIe chassis (M9502A portable 2-slot chassis or M9505A 5-slot chassis).

U4164A is a 136 channel AXIe based high speed state and timing logic analyzer with new features such as:

- DDR4 and LPDDR4 probing for data rates over 2.5 Gb/s using the new Quad sampling state mode and single touch probing
- deeper memory
- ¼ channel 10GHz Timing mode
- deskew of timing traces by individual channels

It allows maximum DQ visibility with simultaneous Read and Write traffic capture for DDR4 and LPDDR4 without overloading the system under test. It supports up to 4 Gb/s State Mode and 10 GHz Timing Mode.

For detailed information on U4164A, refer to the U4164A Logic Analyzer Notes topic in the Logic and Protocol Analyzer online help.



Figure 10 Three U4164A Modules installed in upper slots of a M9505A 5-slot chassis.

Features

- 136 channels per module. Expandable to 272 channels and 408 channels by installing and connecting two U4164A modules or three U4164A modules respectively in slots of an AXIe chassis as a multi-card set.
- Memory depth ranging from 2 M to 400 M (depending on the memory depth license option that you purchased).
- Support for Full Channel, Half Channel, and the new Quarter Channel timing modes.
- Supports four state speeds. 700 Mb/s (350 MHz) is the standard (default) state speed. Licensed speed options include 1.4 Mb/s (700 MHz), 2.8 Gb/s (1.4 GHz), and 4 Gb/s (2.5 GHz).
- Supports Master, Dual Sample, and the new Quad Sample clock modes for state acquisition modes. Dual Sample provides two thresholds that can be assigned as separate offsets to capture two samples per clock edge with different thresholds. Quad sample provides separate rising and falling edge samples of both read and write DDR/LPDDR DQ signals for data rates up to 4 Gb/s from a single probe point. It provides four samples per clock edge with two different threshold offsets, that is, two samples per threshold offset.
- Timing Zoom at 12.5 GHz.

- Supports the new Clock Hysteresis feature to avoid false sampling on noisy clock inputs where a differential clock input turns off and floats to zero volts.

Refer to the *Keysight Logic and Protocol Analyzer Online Help* installed and integrated with the Keysight Logic and Protocol Analyzer software to learn about how to use this module.

NOTE

U4164A modules do not merge into module sets with the U4154A or U4154B modules.

U4164A Module Components

NOTE

U4164A module's components are similar to the U4154A / U4154B module (see [page 14](#)).

Refer to the topic "[Install the Instrument/Embedded Controller Module\(s\) in the AXIe Chassis](#)" on page 36 to learn how to install this module in one of the slots of AXIe chassis.

U4164A Pod Connector Cables , Probes, and Interposers

A variety of Keysight probing options are available for U4164A.

- DDR2, 3, and 4 interposers
- General purpose soft touch connectorless, flying leads, Samtec, and Mictor probes. These probes require the U4201A 90-pin pod connector cable to connect the U4164A module to the probes.
- Direct Connect probes that connect directly to the U4164A module.

Refer to the **U4164A Data Sheet (5992-1057EN)** on www.keysight.com to get a list of supported interposers, probes, and cables for U4164A. Details of how to set up these interposers, probes, and cables are in their respective user guides available on the probe's/interposer's page on www.keysight.com.

You can order these probes and interposers from the Options and Accessories tab on www.keysight.com/find/U4164A/.

U4301A/B PCIe 8 Gbps Gen3 Protocol Analyzer Module

The Keysight U4301A/B PCIe 8 Gbps Gen3 Protocol Analyzer module (hereafter referred to as the U4301A/B module) lets you capture and decode PCI Express data and view it in a Protocol Viewer window of the Keysight Logic and Protocol Analyzer software.

Features

- Supports all the three PCIe speeds - Gen1, Gen2, and Gen3
- Supports link widths from x1 to x16
- A single module can support unidirectional (upto x16) as well as bidirectional (upto x8) setups
- Provides a number of viewers such as Lane Viewer and Protocol Viewer
- Supports 4 states in trigger sequences
- Accurate probing using the Keysight's ESP (Equalization Snoop Probe) technology

Refer to the *Keysight Logic and Protocol Analyzer Online Help* installed and integrated with the Keysight Logic and Protocol Analyzer software to learn about how to use this module.

Refer to the PCI Express Gen3 Hardware and Probing Guide to know about the probing options available for PCI Express Gen3 devices and how to make probe connections from the device under test (DUT) to the U4301A/B module. The guide is available on www.keysight.com and is also installed with the Keysight Logic and Protocol Analyzer software.

NOTE

U4301A module's components are similar to U4301B module.

U4301B Module Components

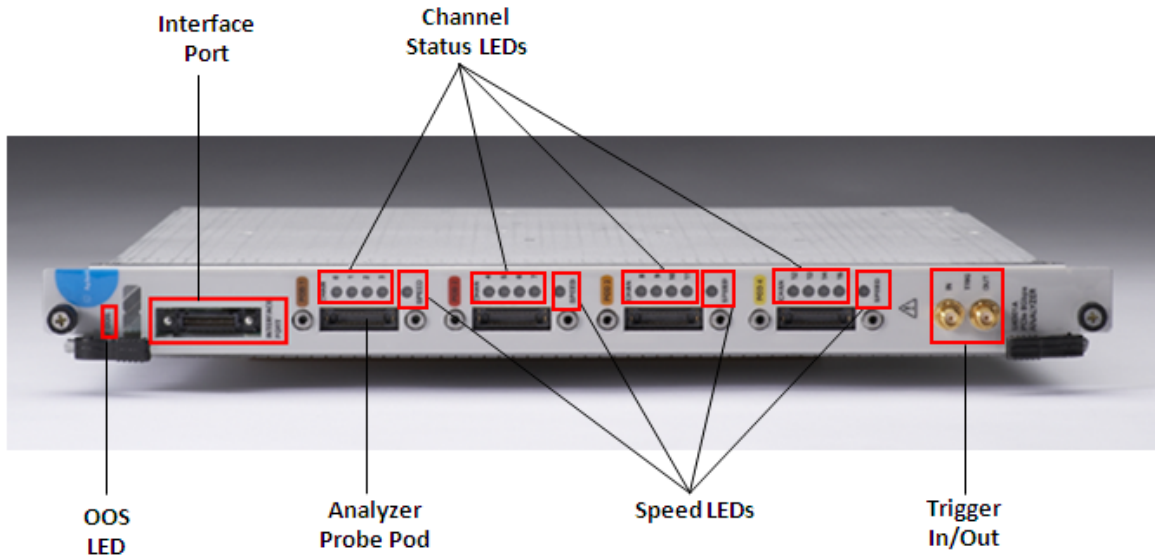

Figure 11 U4301B Module

As shown in [Figure 9](#), the U4301A/B module has the following components:

Component	Description
Interface Port	This component is used to share information with another U4301A Analyzer module in the same chassis. The features of this component are not yet supported.
Pods 1-4	The module has four Pod inputs labeled as Pod 1-4 in different colors. You use these pod inputs to connect the U4301A module to probes to create a unidirectional (upstream or downstream and upto x16) or a bidirectional (upto x8) setup.
Channel Status LEDs	<p>Each pod input on the module provides four channels. For each of these channels, a channel status LED is provided making it a total of 16 channel LEDs on the module. These 16 LEDs, labeled 0 to 15, are used to indicate the status of each channel. The following color coding is used for these LEDs to indicate the channel status.</p> <ul style="list-style-type: none"> ▪ Red - This means that there are no signals or the lane is electrically idle. ▪ Blinking Red - This means that there is no frame sync on the lane. ▪ Orange - This means that the data on the lane is not de-skewed. ▪ Green - This means that the data on the lane is de-skewed. ▪ Off - This means that the lane is not configured. Based on the link width that you select in the U4301 Connection Setup tab of the Logic and Protocol Analyzer GUI, the number of lanes on the U4301 module are used. The LEDs of only the used lanes glow. For example, if you are using the x4 link width, then the LEDs of only four channels will glow and the rest of the LEDs will be off. All Channel Status LEDs will be off until the host computer has established a connection to the chassis and module and the Logic and Protocol Analyzer application has started.

Component	Description
Speed LEDs	<p>Each pod has a speed LED making it a total of four speed LEDs for a U4301A Analyzer module. These LEDs indicate the link speed associated with the pod channels. Out of these four speed LEDs, the speed LED of only that pod glows on which the logical lane 0 is present. The remaining three speed LEDs will be off. In case of a x8 bidirectional configuration of a U4301A module, the speed LEDs of only those two pods glow on which the logical lane 0 is present for upstream and downstream directions. The remaining two speed LEDs will be off. For instance, if pod1 has logical lane 0 for the upstream direction and pod3 has logical lane 0 for the downstream direction, then the speed LEDs of only these two pods will glow.</p> <p>The following color coding is used to interpret the status of the speed LED of the pod on which the logical lane 0 is present.</p> <ul style="list-style-type: none"> ▪ Off - This means that the system is not configured. ▪ Red - This means that the link speed is not detected or not configured. ▪ Yellow - This means that the link speed is 2.5 Gb/s. ▪ Green - This means that the link speed is 5 Gb/s. ▪ Blue - This means that the link speed is 8 Gb/s. <p>If you selected a fixed speed (Gen1, Gen2, or Gen3) for U4301A in the Capture setup tab of the Logic and Protocol Analyzer GUI, then the speed LED will glow according to the selected speed. If you selected the Auto speed option, then the speed LED will glow according to the detected speed.</p>
Trigger In/Out	<p>These connectors are used to listen to an external trigger in from a device or to send an external trigger out to another device. However, these connectors on the U4301A module are not currently functional. Instead of using these connectors, you can use the Trigger In/Out connectors located on the Embedded System Module (ESM) of the Keysight AXIe chassis to send or receive external trigger in and out events.</p> <p>The following are some important points about the Trigger In/Out connectors:</p> <ul style="list-style-type: none"> ▪ The Trigger In connector of the AXIe chassis has an adjustable threshold input of +/-5V range and 250 mV minimum swing. ▪ The Trigger Out connector of the AXIe chassis extends the parallel trigger bus to external instruments. The trigger out characteristics are 3.3V CMOS, 50W line drive, and 3-state. ▪ Maximum trigger input voltage should not exceed 3.3 V. ▪ Trigger Out and 10 MHz Out have nominal output level of 2.0 V with 20 ns minimum pulse width. ▪ Minimum Trigger In duration is 20 ns.
OOS (Out of Service) LED	<p>Indicates the power-ready status of the U4301A module. This LED may turn red during the power-on-self-test phase of the chassis boot cycle. The LED then turns off when the U4301A module is in a power-ready state. The LED turns red again only when a power fault condition occurs for the module.</p> <ul style="list-style-type: none"> ▪ Red, steady - If the LED remains red and does not turn off, then it indicates a power fault condition. In such a situation, the module may require repair/service. Contact your Keysight representative to replace or service the module. ▪ Off - The module has detected no power failures and is in a power-ready status.

NOTE

Older U4301A modules (with serial number prior to MY51090147) display a different OOS LED functionality. In these modules, the OOS LED remains turned off until the module is in a power-ready status. It remains illuminated as long as there is no power fault condition present in the module.

WARNING

Do not directly touch any component on the U4301A/B module. It may be hot.

CAUTION

Components on the U4301A/B module are sensitive to static electricity. Therefore, take necessary anti-static precautions, such as wear a grounded wrist strap, to minimize the possibility of electrostatic damage.

U4421A MIPI D-PHY Protocol Analyzer and Exerciser Module

The Keysight U4421A MIPI D-PHY Protocol Analyzer and Exerciser module (hereafter referred to as the U4421A module) provides digital serial stimulus and acquisition capabilities to test and debug a D-PHY component independently or an integrated D-PHY based mobile design. This module can emulate a master D-PHY component to provide stimulus to a D-PHY endpoint. You can also use this module to capture D-PHY traffic and then analyze and debug D-PHY packets using various Keysight tools and viewers available in the Keysight Logic and Protocol Analyzer GUI.

Features

- A single U4421A module can be used to provide stimulus as well as capture and analyze D-PHY data.
- Supports decoding of CSI-2 and DSI protocols
- Can capture HS and LP data simultaneously
- Supports x1 to x4 link width
- Provides a clock lane and upto four data lanes
- Can capture D-PHY protocol traffic at a rate of upto 1.5Gps
- Provides a number of viewers such as Lane Viewer and Protocol Viewer for viewing the captured D-PHY data

Refer to the *Keysight Logic and Protocol Analyzer Online Help* installed and integrated with the Keysight Logic and Protocol Analyzer software to learn how to use this module.

Refer to the U4421A MIPI D-PHY Protocol Analyzer and Exerciser - Hardware and Probing Guide to know about the probing options available for D-PHY devices and how to make probe connections from the device under test (DUT) to the U4421A module. The guide is available on www.keysight.com and is also installed with the Keysight Logic and Protocol Analyzer software.

U4421A Module Components

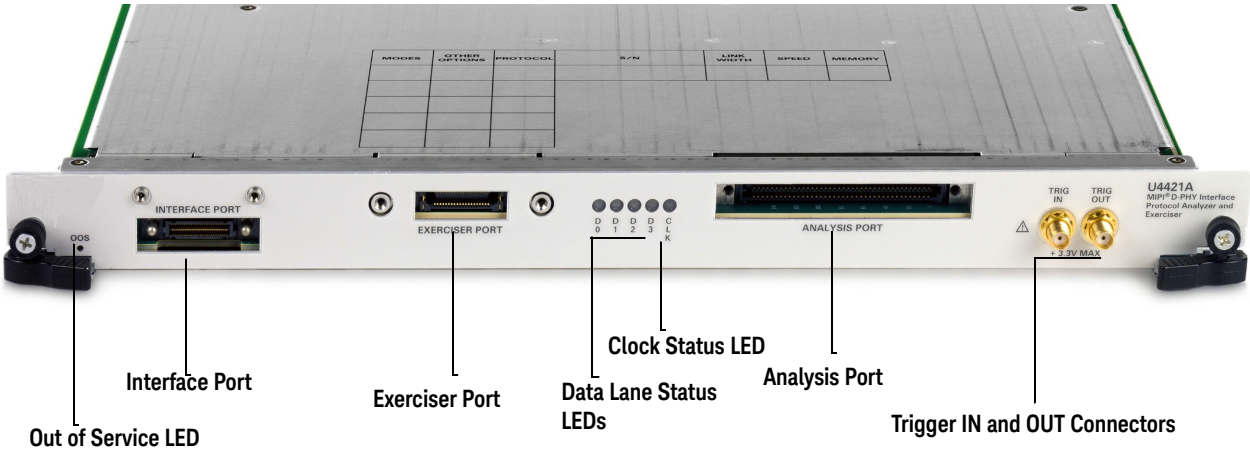

Figure 12 U4421A Module

As shown in **Figure 12**, the U4421A module has the following components:

Component	Description
Interface Port	This component is used to share information with another U4421A module in the same chassis. The features of this component are not yet supported.
Exerciser Port	This component is used to connect the U4421A module with a DUT using the Keysight U4422A SMA stimulus probing cable. You use this component when you plan to use the U4421A module as an Exerciser to provide stimulus to the DUT.
Lane Status LEDs	<p>The module supports four lanes. For each of these lanes, a lane status LED is provided, labeled 0 to 3, to indicate the status of the lane. The following color coding is used for these LEDs to indicate the lane status.</p> <ul style="list-style-type: none"> ▪ Red - This means that the lane is in the STOP state with LP11. ▪ Blinking Red - This means that the lane is in the STOP state with LP00. This lane status usually indicates: <ul style="list-style-type: none"> • LP lines are not probed • ultra-low power mode ▪ Green - This means that the lane has moved to LP00 via a HS request and it is waiting for the sync pattern. This lane status occurs when something is wrong, for instance, incorrect probing setup or the lane not receiving correct HS data. ▪ Blinking Green - This means that the line is between HS sync and HS exit. and the lane is receiving HS data. ▪ Yellow - This means that the lane is in the Escape mode and data is being transmitted from master to slave. Escape mode includes bus turn around (BTA), escape mode data transmission, and ULPM request. ▪ Blinking Yellow - This means that the lane is in the Escape mode and data is being transmitted from slave to master. Escape mode includes bus turn around (BTA), escape mode data transmission, and ULPM request. ▪ Off - This means that the lane is not configured/available. Based on the link width that you select in the U4421 Connection Setup tab of the Logic and Protocol Analyzer GUI, the number of lanes on the U4421A module are used. The LEDs of only the used lanes glow. For example, if you are using the x2 link width, then the LEDs of only two lanes being used will glow and the rest of the LEDs will be off. <p>All Lane Status LEDs will be off until the host computer has established a connection to the chassis and module and the Logic and Protocol Analyzer application has started.</p>
Clock Status LED	<p>This LED indicates the status of the clock lane. The following LED color coding is used to indicate the state activity on the clock lane.</p> <ul style="list-style-type: none"> ▪ Red - This means that the lane is in the STOP state with LP11. ▪ Blinking Red - This means that the lane is in the STOP state with LP00. This lane status usually indicates: <ul style="list-style-type: none"> • LP lines are not probed • ultra-low power mode ▪ Green - This means that the line is between HS sync and HS exit. and the lane is receiving HS data. ▪ Yellow - This means that the lane is in the Escape mode which includes bus turn around (BTA), escape mode data transmission, and ULPM request. <p>The Clock Status LED will be off until the host computer has established a connection to the chassis and module and the Logic and Protocol Analyzer application has started.</p>

Component	Description
Analysis Port	This component is used to connect the U4421A module with Keysight differential flying lead or soft touch probe via a U4201A 90-pin cable. You use this component when you plan to use the U4421A module as an Analyzer to capture and analyze data from DUT.
Trigger In/Out	<p>These connectors are used to listen to an external trigger in from a device or to send an external trigger out to another device. However, these connectors on the U4421A module are not currently functional. Instead of using these connectors, you can use the Trigger In/Out connectors located on the Embedded System Module (ESM) of the Keysight AXIe chassis to send or receive external trigger in and out events.</p> <p>The following are some important points about the Trigger In/Out connectors:</p> <ul style="list-style-type: none"> ▪ The Trigger In connector of the AXIe chassis has an adjustable threshold input of +/-5V range and 250 mV minimum swing. ▪ The Trigger Out connector of the AXIe chassis extends the parallel trigger bus to external instruments. The trigger out characteristics are 3.3V CMOS, 50W line drive, and 3-state. ▪ Maximum trigger input voltage should not exceed 3.3 V. ▪ Trigger Out and 10 MHz Out have nominal output level of 2.0 V with 20 ns minimum pulse width. ▪ Minimum Trigger In duration is 20 ns.
OOS (Out of Service) LED	<p>Indicates the power-ready status of the U4421A module. This LED may turn red during the power-on-self-test phase of the chassis boot cycle. The LED then turns off when the U4421A module is in a power-ready state. The LED turns red again only when a power fault condition occurs for the module.</p> <ul style="list-style-type: none"> ▪ Red, steady - If the LED remains red and does not turn off, then it indicates a power fault condition. In such a situation, the module may require repair/service. Contact your Keysight representative to replace or service the module. ▪ Off - The module has detected no power failures and is in a power-ready status.

WARNING

Do not directly touch any component on the U4421A module. It may be hot.

CAUTION

Components on the U4421A module are sensitive to static electricity. Therefore, take necessary anti-static precautions, such as wear a grounded wrist strap, to minimize the possibility of electrostatic damage.

U4431A MIPI M-PHY Protocol Analyzer Module

The U4431A MIPI M-PHY Analyzer module is an acquisition module that captures and decodes data as per MIPI M-PHY standards including UniPro and UFS. For the display and analysis of the captured data, the U4431A module presents the data in a Protocol Viewer, Waveform Viewer, and a Listing Data view.

You can use a single U4431A module to capture M-PHY traffic on a:

- unidirectional link (either Tx or Rx sublink)
- or a bidirectional link (Tx and Rx sublinks)

A single U4431A module supports data capture for a link width of up to 4 lanes per sublink.

Refer to the *Keysight Logic and Protocol Analyzer Online Help* installed and integrated with the Keysight Logic and Protocol Analyzer software to learn how to use this module.

Refer to the *U4431A MIPI M-PHY Protocol Analyzer - Hardware and Probing Guide* to know about the probing options available for M-PHY devices and how to make probe connections from the device under test (DUT) to the U4431A module. The guide is available on www.keysight.com and is also installed with the Keysight Logic and Protocol Analyzer software.

U4431A Module Components

The following figure displays a U4431A module with its components labeled.

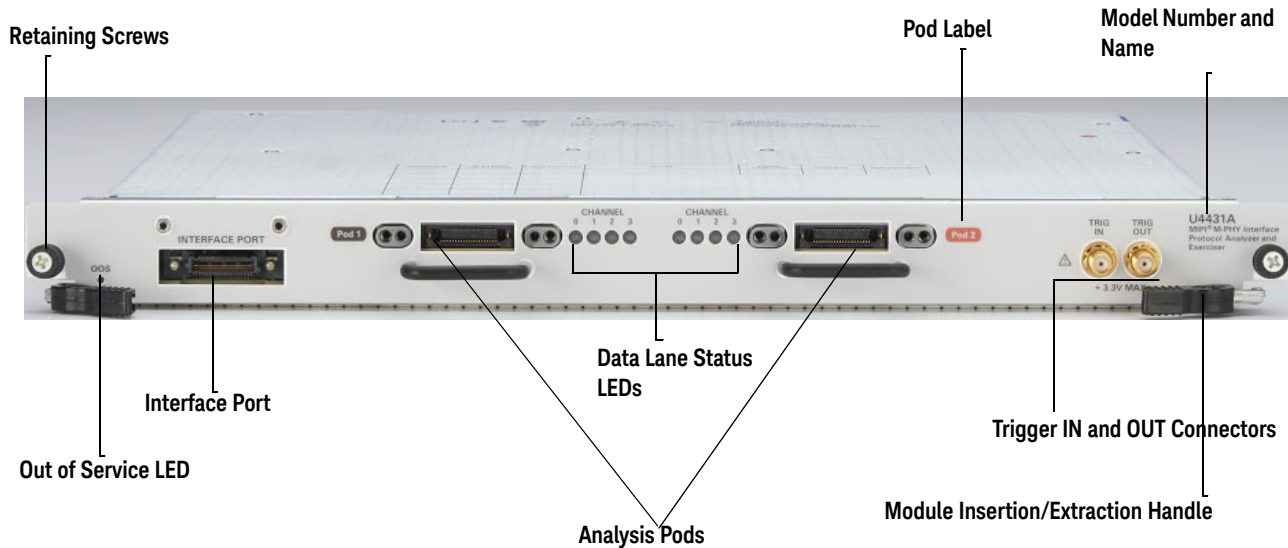

Figure 13 U4431A Module

As shown in the above figure, the U4431A module has the following components:

Component	Description
OOS (Out of Service) LED	<p>Indicates the power-ready status of the U4431A module. This LED may turn red during the power-on-self-test phase of the chassis boot cycle. The LED then turns off when the U4431A module is in a power-ready state. The LED turns red again only when a power fault condition occurs for the module.</p> <ul style="list-style-type: none"> ▪ Red, steady - If the LED remains red and does not turn off, then it indicates a power fault condition. In such a situation, the module may require repair/service. Contact your Keysight representative to replace or service the module. ▪ Off - The module has detected no power failures and is in a power-ready status.
Interface Port	<p>This component is used to share information with another U4431A module in the same chassis. The features of this component are not yet supported.</p>
Analysis Pods	<p>This component is used to connect the U4431A module with a Keysight U4433A differential ZIF flying lead probe. You use this component to capture and analyze data from DUT. Refer to the U4431A MIPI M-PHY Protocol Analyzer - Hardware and Probing Guide to know about the U4433A differential ZIF flying lead probe.</p>
Pod label	<p>A colored label assigned to each pod input on the front panel of the module. You should match the color coding used in these pod labels with the color coding for the labels that you put on the pod cables.</p>
Data Lane Status LEDs	<p>Each analysis pod on the module supports probing one to four lanes of a sublink. For each of these lanes, a lane status LED is provided, labeled 0 to 3, to indicate the status of the lane. The following color coding is used for these LEDs to indicate the lane status.</p> <ul style="list-style-type: none"> ▪ Red - This means that the lane is in the ultra-low power state (HIBERN8). ▪ Blinking Red - This means that the lane state is unknown. This can happen when the U4431A module is in the process of syncing up to the current link configurations. ▪ Green - This means that the lane is transmitting HS-BURST in HS-MODE. ▪ Blinking Green - This means that the lane is in the STALL state - the power saving state in HS-MODE. ▪ Yellow - This means that the lane is transmitting LS-BURST in LS-MODE. ▪ Blinking Yellow - This means that the lane is in the SLEEP state - the power saving state in LS-MODE. ▪ Off - This means that the lane is not configured/available. Based on the link width that you select in the U4431 Connection Setup tab of the Logic and Protocol Analyzer GUI, the number of lanes on the U4431A module are used. The LEDs of only the used lanes glow. For example, if you are using the x2 link width, then the LEDs of only two lanes being used will glow and the rest of the LEDs will be off. <p>All Lane Status LEDs will be off until the host computer has established a connection to the chassis and module and the Logic and Protocol Analyzer application has started.</p>
Trigger In/Out	<p>These connectors are used to listen to an external trigger in from a device or to send an external trigger out to another device. However, these connectors on the U4431A module are not currently functional. Instead of using these connectors, you can use the Trigger In/Out connectors located on the Embedded System Module (ESM) of the Keysight AXIe chassis to send or receive external trigger in and out events.</p> <p>The following are some important points about the Trigger In/Out connectors:</p> <ul style="list-style-type: none"> ▪ The Trigger In connector of the AXIe chassis has an adjustable threshold input of +/-5V range and 250 mV minimum swing. ▪ The Trigger Out connector of the AXIe chassis extends the parallel trigger bus to external instruments. The trigger out characteristics are 3.3V CMOS, 50W line drive, and 3-state. ▪ Maximum trigger input voltage should not exceed 3.3 V. ▪ Trigger Out and 10 MHz Out have nominal output level of 2.0 V with 20 ns minimum pulse width. ▪ Minimum Trigger In duration is 20 ns.
Retaining Screws	<p>The screws on both ends of the module are used to retain the module tightly inside the AXIe chassis slot once you have fully placed it inside the chassis. To remove the module, you first need to loosen these screws ensuring that these screws disengage completely.</p>
Module Insertion/Extraction Handles	<p>The handles on both sides of the module to insert or eject the module from the slot of the AXIe chassis.</p>
Module Number and Name	<p>Identifies the module's product number and title. When contacting Keysight support, report this information.</p>

WARNING

Do not directly touch any component on the U4431A module. It may be hot.

CAUTION

Components on the U4431A module are sensitive to static electricity. Therefore, take necessary anti-static precautions, such as wear a grounded wrist strap, to minimize the possibility of electrostatic damage.

Host Computer

A host computer is used to:

- communicate with the ESM of the AXIe chassis to allow you to monitor and control the chassis.
- host all the software components of the instrument modules needed to control, configure, and use the modules.

A host computer can be:

- the Keysight M9536A AXIe Embedded Controller module.
- the Keysight M9537A AXIe High Performance Embedded Controller module.
- a laptop with a PCIe ExpressCard slot.
- a desktop PC with a x8 or wider PCIe slot for the cabled PCIe adapter card.

Refer to the Keysight's recommended list of host computers at

<http://cp.literature.keysight.com/litweb/pdf/5990-7632EN.pdf> that are compatible with the Keysight AXIe chassis.

Keysight M9536A AXIe Embedded Controller Module

The M9536A AXIe Embedded Controller module is a one slot module that you can install in the AXIe chassis like any other instrument module. This module acts as a host computer when installed in the AXIe chassis. You must install it in the slot 1 of chassis.

The following figure displays this module.



Figure 14 M9536A AXIe Embedded Controller Module

Refer to the topic **"Connect the AXIe Chassis to a Host computer"** on page 45 to know how to connect host computer to the AXIe chassis.

Keysight M9537A AXIe High Performance Embedded Controller Module

The M9537A AXIe High Performance Embedded Controller module is a second-generation AXIe embedded controller which enables new capabilities such as AXIe wide PCIe support, multiple 4K video outputs, and optional high speed disk cache.

This module is a one slot module that you can install in the AXIe chassis like any other instrument module. This module acts as a host computer when installed in the AXIe chassis. You must install it in the slot 1 of chassis. It provides a Gen 3 x16 PCIe link to the AXIe backplane providing up to 16 GB/s max data bandwidth from CPU to AXIe backplane.

The following figure displays this module.



Figure 15 M9537A AXIe High Performance Embedded Controller Module

Refer to the topic ["Connect the AXIe Chassis to a Host computer"](#) on page 45 to know how to connect a Keysight AXIe embedded controller module to an AXIe chassis.

2 Setting up the Hardware

Verify Basic Chassis and Module Operation /	32
Perform the Complete Hardware Setup /	33
Install the Instrument/Embedded Controller Module(s) in the AXIe Chassis /	36
To create a logic analyzer multi-card set /	38
Set up the Keysight AXIe Chassis /	44
Connect the AXIe Chassis to a Host computer /	45
Connect the Instrument Module to DUT /	48
Power up the Connected Hardware Components /	57
Verify the Hardware Setup /	59

This chapter describes the tasks that you need to perform to complete the hardware setup of the instrument module.

Verify Basic Chassis and Module Operation

It is assumed that you have already verified the basic power up operation of the chassis and module by following the steps outlined in the *AXIe based Logic Analysis and Protocol Test Modules Quick Start Guide* (available as a printed document with the module shipment and in electronic format on www.keysight.com).

Broadly, you should have done the following:

- 1 Inspected the chassis and module shipments for any damaged or missing item as per the shipping list.
- 2 Installed the module in a slot of chassis for the basic verification of the module.
- 3 Connected the chassis to a laptop, desktop, or an embedded host controller.
- 4 Connected the chassis to an external power supply.
- 5 Powered up the chassis and then the host computer to verify the basic power up of chassis and module.

Perform the Complete Hardware Setup

Now that you have verified the basic operation of chassis and module(s), you can proceed with planning and implementing the complete setup of these based on your specific requirements.

Planning Considerations

Type of Setup Needed

The following section describes and illustrates various setup combinations in which you can install the AXIe based instrument modules.

Independent Modules

You can install same or different AXIe based modules as independent modules in a Keysight AXIe chassis. (Maximum five independent modules in a 5-slot chassis and two independent modules in a 2-slot chassis).

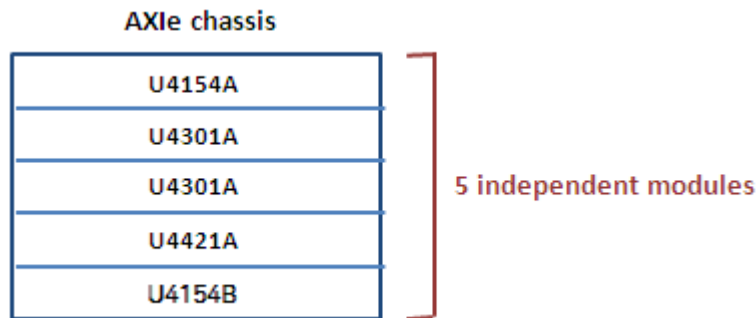

Multi-module Setup

You can install modules in a multi-module setup in which multiple modules interconnect in the chassis via cables to form a multi-card set representing one logical module. This feature is available only for specific module types, for instance, U4154A, U4154B, and U4164A. If a multi-module setup is needed, you should first connect the modules together before proceeding with installing these in the chassis.

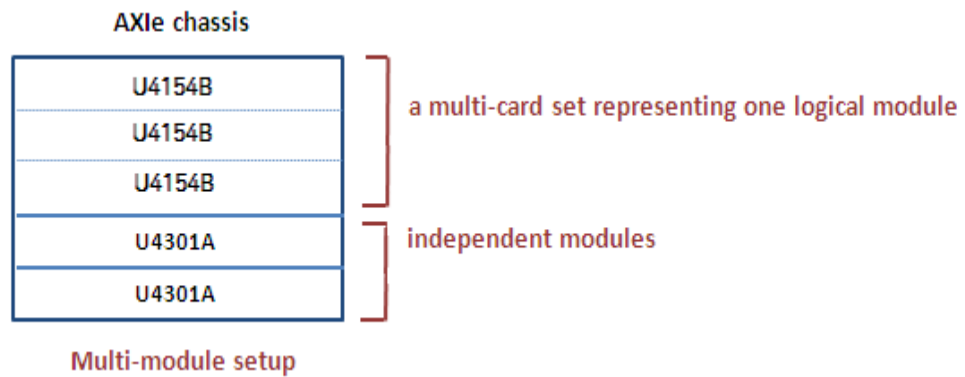

Multiframe Setup

You can install modules in a multiframe setup in which multiple chassis are interconnected to expand the measurement capabilities of the instrument. Multiframe enables the ability to control multiple instrument modules from a single location and can provide a common timebase for correlating measurements. You can interconnect multiple Keysight AXIe chassis, a Keysight AMP chassis, or other Keysight standalone Logic Analysis systems via one or more multi-frame cables.

NOTE You can include only one AMP chassis in a multiframe setup. If you plan to include an AMP chassis, ensure that this chassis is designated as the master chassis in the multiframe chain.

In a multiframe setup, each connected chassis provides slots to install modules either independently as single modules or a group of modules cabled together to operate as a single module.

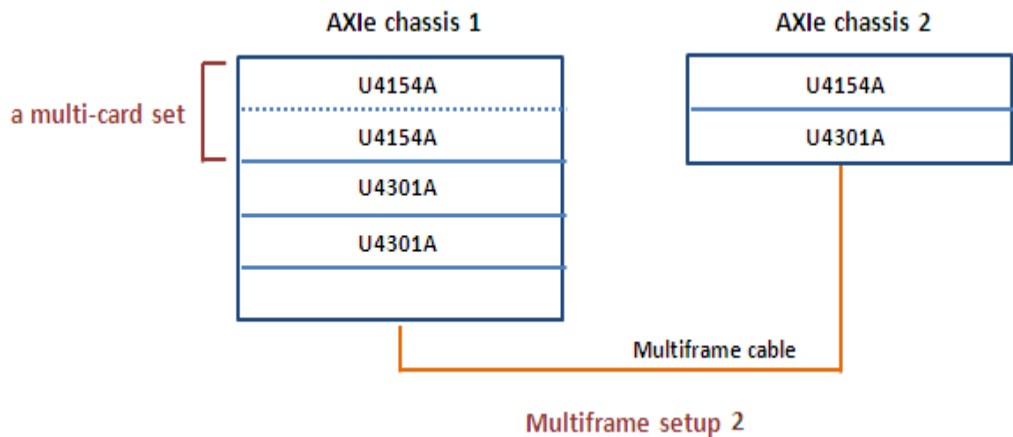
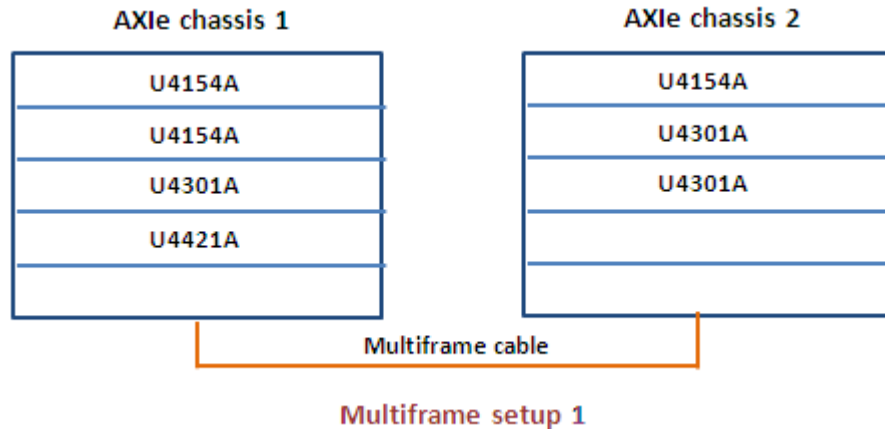

Modules Organization in Slots

You should install the instrument modules that are frequently inserted and removed in top slots of chassis. Utilize bottom slots for modules that are not often removed. If planning to use Keysight's AXIe Embedded Controller module as the host computer, reserve slot 1 for its installation.

Mounting the Chassis

Decide whether you would need a rackmounted or a benchtop configuration for the chassis. If you plan to rackmount the chassis, plan to remove the attached bumpers before installing modules in the chassis.

Install the Instrument/Embedded Controller Module(s) in the AXIe Chassis

The AXIe chassis and instrument module come in separate shipments. The module is not pre-installed in the chassis. This step involves carefully inserting the module in an empty slot of a Keysight AXIe chassis. The slots are identified by the slot numbers written on the front panel of the chassis.

NOTE

If you plan to use the Keysight AXIe Embedded Controller Module as the host computer, then you must reserve slot 1 of the chassis for this module's installation. This module comes in a separate shipment.

CAUTION

- The instrument modules are not hot swappable. You must power down the AXIe chassis and host PC before inserting, replacing, or removing a module.
- The enclosure surface of the instrument module may become hot during use. If you need to remove the module, first power down the AXIe chassis, allow the module to cool, and then pull the module out of the chassis.

To install the instrument/embedded controller module into the chassis

- 1 First, remove the filler panel module that covers the slot in which you want to install the module. Loosen the retaining screws on both sides of the filler panel module until the filler panel module is completely disengaged. Then gently pull the module out of the chassis holding the screws.



Figure 16 AXIe Chassis Filler Module

- 2 Locate the module insertion/extraction handles at both ends of the instrument module. Extend the ends of both handles, by pulling them inwards towards each other. Then fully open the handles by pivoting them out towards you.
- 3 Align the module's PCA board with the guide rails on both ends of the AXIe chassis. If the module has metal plates covering the board, be sure to insert the PCA board and not the metal plates into the rails.
- 4 Push the module into the chassis slot until the leading edges of the insertion/extraction latches rest against the front surface of the chassis. The insertion/extraction latch handles should be perpendicular to the front surface of the chassis (aligned with the direction of module insertion). Nudge the module gently inward to allow the latches to engage.
- 5 Using your thumbs, press inward firmly on the insertion/extraction handles until the module is seated firmly in the chassis backplane. The module front panel should lie flush with the chassis front panel.
- 6 Push the handles ends towards the edge of the chassis to tuck them away.



- 7 Tighten the retaining screws on either end of the module to ensure the ground connection.

After you have installed the module in the chassis, ensure that you insert a filler panel module in any empty slot(s) of the chassis. Do not operate the chassis with empty slots. This is especially important for the slots on either side of the instrument module. This allows proper air flow and cooling, and provides EMI shielding for the chassis and installed components. Leaving slots empty can increase fan speed, raise ambient noise, overheat components, and can cause the module to shut down.

To remove an instrument/embedded controller module from the chassis

CAUTION

The enclosure surface of the module may become hot during use. If you need to remove the module, first power down the AXIe chassis, allow the module to cool, and then pull the module out of the chassis.

- 1 Loosen the retaining screws on both ends of the module until the module is completely disengaged to prevent damaging your chassis or module..



- 2 Extend the ends of both module insertion/extraction handles, by pulling them inwards towards each other.



- 3 To remove the module: Open the module insertion/extraction handles by pivoting them out towards you. This unseats the module from the chassis backplane.
- 4 Once the module is unseated, use the module insertion/extraction handles by pulling directly outward to remove the module from the chassis.

CAUTION

Do not remove the AXIe ESM, which is integral to the operation of the chassis. An AXIe ESM that needs servicing should be removed by Keysight personnel only.

To create a logic analyzer multi-card set

You can interconnect multiple modules together using cables and then install these interconnected modules into adjoining slots of an AXIe chassis to make a multi-card set. This multi-card set is represented as a single logical instrument module in the Logic and Protocol Analyzer application and can provide an increased number of channels per logical module. All instrument modules may not support configuration as a multi-card set.

NOTE

When multiple modules are connected and installed together in an AXIe chassis to form a multi-card set, pods are indexed from the bottom module up.

You can connect two U4154A, or three U4154B modules, or three U4164A modules to form a multi-card set in an AXIe chassis.

NOTE

For a U4154B or a U4164A multi-card set, the module in the middle of the set is considered the master module in the set.

For setting up a multi-card set of U4164A or U4154A/B modules in an AXIe chassis, use a pair of U4154-61601 flex cables for each additional module to be connected (provided in the accessory pouch shipped with each module).

The following figures display both sides of a flex cable shipped with the U4164A and U4154A/B module.



Figure 17 Flex Cables

NOTE

Turn off the AXIe chassis and host PC power before removing, replacing, or installing modules.

NOTE**For a U4164A multi-card set**

Once you have interconnected the U4164A modules into a multi-card set, you can easily perform the reconfiguration (repartitioning) of this multi-card set using the Logic and Protocol Analyzer software GUI. You need not physically disconnect and reconnect the modules for this repartitioning. This feature is specially useful when you have requirements for different number of interconnected modules for different testing scenarios and memory technologies. To support these different requirements, you can use the same set of interconnected modules and simply adjust the module partitioning boundaries using the software.

Refer to the topic Repartitioning a U4164A Multi-card Set in the Logic and Protocol Analyzer online help to know more.

CAUTION

When removing modules that are connected together as multiple-card modules, be sure to eject the multiple modules simultaneously, otherwise, the flex cables and/or connectors could be damaged.

The enclosure surface of the module may become hot during use. If you need to remove the module, first power down the AXIe chassis, allow the module to cool, and then pull the module out of the chassis.

To install multiple U4164A or U4154A/B modules in an AXIe chassis

- 1 Remove the bolt from its holding position on the top cover of the U4164A or U4154A/B module.

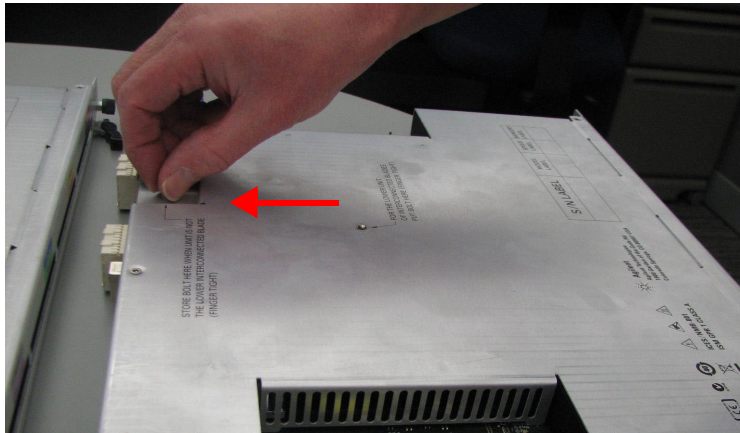

- 2 Place the bolt (removed in step1) in its marked middle location on the top cover of the module. Hand tighten the bolt.

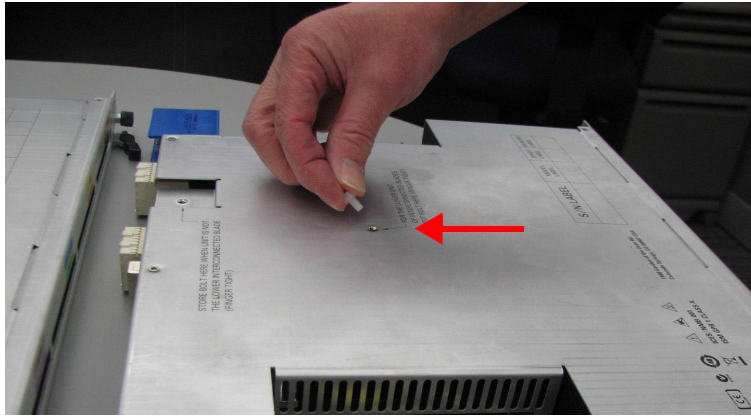

- 3 Perform step1 and 2 for all the U4164A or U4154A/B modules that you want to include in the multi-card set except the module that you want to keep as the *top most* module in the set.
- 4 Turn the U4164A or U4154A/B module that you plan to configure as second from the bottom upside down. The underside of the U4164A or U4154A/B module has two connectors for connecting the flex cables. Attach the flex cable to one of the connector on the under side of the second module.

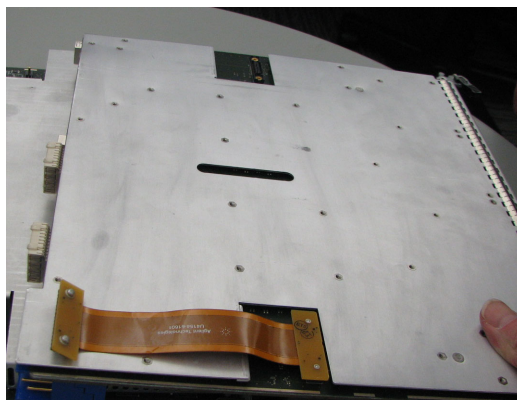
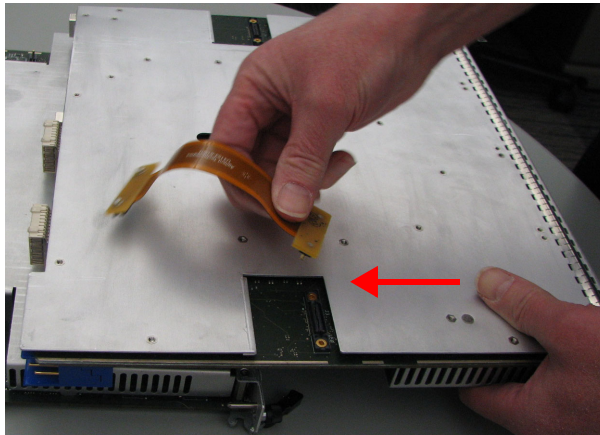

- 5 Attach the other flex cable to the opposite under-side connector of the second module.

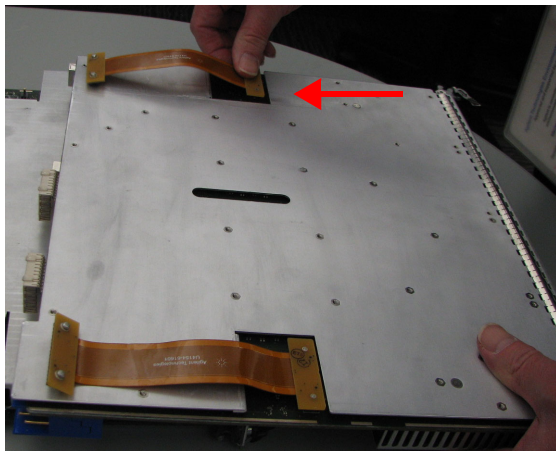

- 6 Turn the second module back over and orient it with the flex cables toward the lower module.

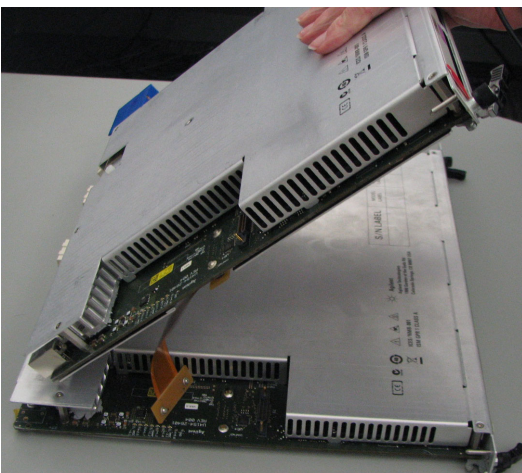

- 7 The top side of the U4164A or U4154A/B module has two connectors to connect to the end of the flex cables. Attach the free end of the two flex cables to these connectors on the lower module. Be careful not to bend or twist the flex ribbons more than is necessary to get these attached.

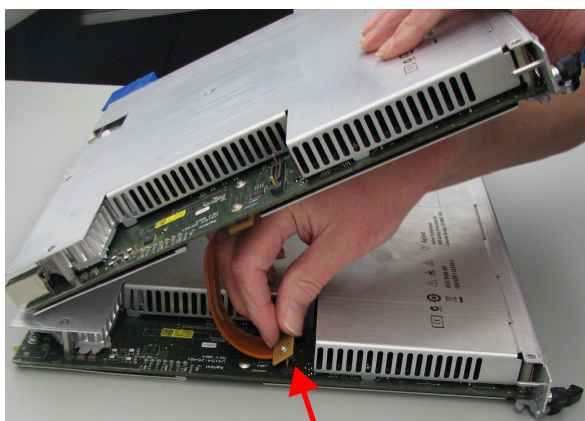

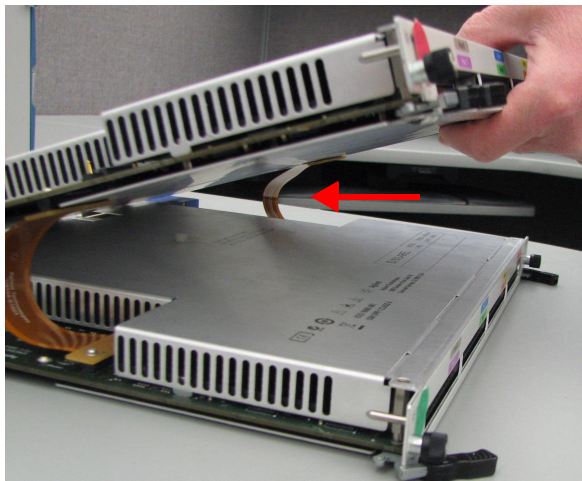

- 8 Repeat steps 4 to 7 for the remaining U4164A or U4154A/B modules that you want to include in the multi-card set, working from bottom to top. Use the plastic alignment bolt of the lower modules to help align the stack. Remember not to use the plastic alignment bolt on the top card.
- 9 Align the set of connected U4164A or U4154A/B modules.



- 10 Insert the aligned set of modules into the AXIe chassis, seat them, lock the module insertion/extraction handles, and tighten the retaining screws.





- 11 To verify that the flex cables are installed correctly, run the self test named *Resource Bus Connection Test* in the Keysight Logic and Protocol Analyzer GUI. Refer to the Keysight Logic and Protocol Analyzer Online Help for assistance with running the self tests. This test checks continuity and makes sure that the flex cables are firmly inserted into the connectors.

If the test results indicate that a flex cable is not seated correctly in the connector, repeat the flex cable attachment steps, and run the test again.

NOTE

You may physically configure as many modules into a multi-card set as the chassis slots allow, but the Keysight Logic and Protocol Analyzer software application will impose a limit on how many modules it will allow to be included in a logical module set.

Set up the Keysight AXIe Chassis

If you want to use the instrument module(s) in a benchtop configuration, then retain the plastic bumpers and carry handle(s) that ship with the chassis for benchtop use.



Figure 18 Module with Carry Handle and Bumpers

If you want to use the module(s) in a rack mounted configuration:

- 1 Remove the bumpers and carry handle(s) from the chassis. The procedure and tools needed to remove these is documented in the *Keysight M9502A/M9505A AXIe Chassis User's Guide* which is available on www.keysight.com.
- 2 Attach the rackmount brackets to the chassis and mount onto a rack. The rackmount brackets are available in the Keysight rackmount kit that you can order for the chassis. Refer to this kit for rackmounting instructions.

Connect the AXIe Chassis to a Host computer

You can connect a Keysight AXIe chassis to a host computer via PCIe or USB connectivity.

- The PCIe connectivity is the standard or default connectivity and is available as a PCIe port on the front panel of the ESM.
- The USB connectivity is available as a licensed option (U20). If you want USB connectivity, you need to order the USB ESM (part number M9505-00230). This ESM has a USB 2.0 port in addition to the standard PCIe port.

At any time, you can use either PCIe or USB connectivity. When you connect a PCIe cable to the ESM's PCIe port, the USB port automatically gets disabled for the time for which the PCIe connectivity is used.

When you want to disconnect either the PCIe or USB cable, you should use the *Safely Remove Hardware and Eject Media* option for that connection, available in the Windows System Tray. When this option is used:

- the Logic and Protocol analyzer application is put in the *Offline* mode.
- Windows does not properly detect a reinserted PCIe cable, but the USB connection is redetected properly and the appropriate driver is reloaded. This is because Hot Plug and Play is not supported for PCIe connectivity, but the USB connection is hot swappable.

You then need to manually move the Logic and Protocol Analyzer application to the Online mode.

NOTE

It is recommended that you turn off standby mode, disable all hibernation and not run from battery power on the host computer connected to the Keysight AXIe chassis. If the host computer enters the standby mode, the PCIe/USB connection will be lost and the host will require a reboot to re-establish the host-chassis connection.

For hosts running Windows 7/higher, it is also recommended that you disable the PCIe Power Management option.

To connect a laptop/desktop host PC via PCIe

In case of PCIe connectivity, the host computer can be a laptop PC with an ExpressCard PCIe slot, a desktop PC with an available x8 or wider PCIe slot or an AXIe embedded host controller module.

To connect a laptop as the host computer

- 1 Install a PCIe x1/x4 ExpressCard Adapter in the laptop PC.
- 2 Connect the x1-x4 ExpressPort adapter in the laptop to the x8 Gen1/Gen2 cabled PCIe port located on the front panel of the AXIe chassis ESM using a PCIe x4-x8 cable

To connect a desktop as the host computer

- 1 Install a PCIe x8 adapter in the desktop PC.
- 2 Connect the desktop to the x8 Gen1/Gen2 cabled PCIe port located on the front panel of the AXIe chassis ESM using the appropriate PCIe x4-x8 or x8-x8 cable.



PCIe Port

Figure 19 PCIe port on the front panel of the AXIe ESM

Refer to www.keysight.com/find/axie-chassis to view the Keysight recommended PCIe adapters for host computers.

NOTE

If you have already installed an instrument module in the chassis, then Windows might display the Network Interface Controller dialog box on power up while trying to connect the host computer to the chassis via PCIe. This dialog box is displayed for the installation of the Intel PROWin32/ PROWin64 network driver. You should cancel any windows driver install dialogs that appear for the NIC at this stage and install the NIC driver manually. The generic driver available on the Intel website for the Intel(R) PRO/1000 PL device does not support this Keysight Logic Analysis instrument. You must use the customized driver available in the Logic Analyzer install directory. You can find the installers of these NIC drivers at the following location:

`-C:\Program Files\Keysight Technologies\Logic Analyzer\CRMNetworkDrivers\PCIe\`

To connect a laptop/desktop host PC via USB

In case of USB connectivity, the host computer can be any laptop or desktop PC with a USB 2.0 port.

You use a USB cable to connect an external host computer to the ESM's USB port.



Figure 20 USB port on the front panel of the AXIe USB ESM

The USB connectivity of chassis to host computer is hot swappable. Plugging/unplugging the USB cable does not require restarting the chassis or host if you use the *Safely Remove Hardware and Eject Media* option for that connection, available in the Windows System Tray. When this option is used:

- the Logic and Protocol analyzer application is put in the *Offline* mode.
- Windows detects a USB cable, the USB connection is detected, and the appropriate driver is loaded.

You then need to manually move the Logic and Protocol Analyzer application to the Online mode.

When you unplug a USB cable, make sure that you plug it back in only after you get a message about the discovery of the removed chassis. By doing so, you can avoid restarting the host after unplugging and plugging the USB cable.

To troubleshoot USB connectivity issues, refer to the topic "[Troubleshooting USB Connectivity Issues](#)" on page 93.

To connect an AXIe Embedded Controller Module to Chassis

If you plan to use the Keysight M9536A or M9537A Embedded Controller Module as the host computer, then:

- 1 Install this module mandatorily in slot 1 of AXIe chassis.
- 2 Connect the keyboard, mouse, and monitor to various ports available on the front panel of the embedded controller module.

- 3 If needed, connect the embedded module to LAN using the Gbe LAN port on the front panel of this module. You need Internet connectivity later to perform firmware upgrades, download instrument module control software or the latest Keysight I/O libraries suite.

NOTE

You do not need to manually establish any external PCIe/USB or LAN connection between the embedded controller module and chassis because this module communicates with the ESM through the chassis backplane.

You do not need to manually install any operating system or drivers for this module. The Windows 7/Higher(32 bit or 64 bit) operating system is pre-installed based on your choice and the module is ready to use as the host computer.

The following figure displays an embedded controller module installed in the slot 1 of AXIe chassis.

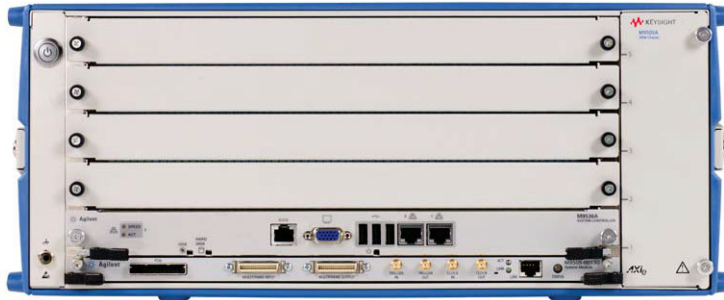

Figure 21 M9536A Embedded Controller Module in AXIe Chassis

Detailed information and user guide for the Embedded Controller Modules are available at:

- www.keysight.com/find/M9536A.
- www.keysight.com/find/M9537A.

NOTE

The host computer that you attached to the chassis can connect to the chassis successfully only when you have installed the instrument module in the required slot of AXIe chassis. Therefore, make sure that you install the instrument module in the chassis before powering up the complete setup.

NOTE

You should not connect the AXIe chassis to multiple operating host computers at the same time. If you plan to use the Keysight AXIe Embedded Controller module as the host computer, then do not connect an external host computer to the chassis.

Connect the Instrument Module to DUT

This section describes how you can connect the supported AXIe based instrument modules to the DUT.

U4154A/B Module

You use the U4201A pod connector cables (available as an orderable accessory) to connect the U4154A/B module to probes.

Tighten the thumb screws on the U4201A cables to connect the cable to the relevant pod input on the front panel of the U4154A/B module. Then connect the other end of the cable to the probe.

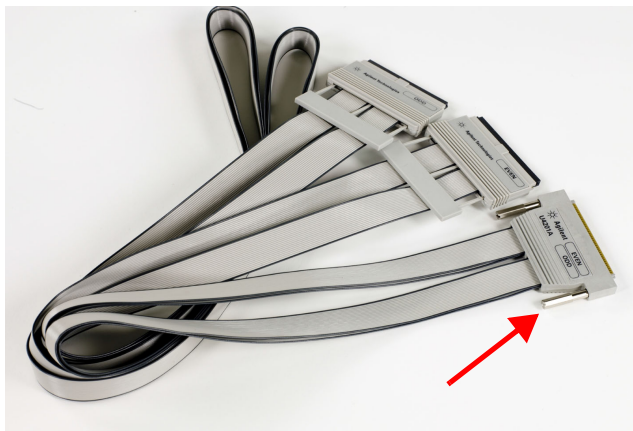

CAUTION

Do not over tighten the thumb screws. Hand tightening is recommended or maximum torque of 3in-lb.

Disengage thumb screws completely from module and pull the pod straight out to remove.

Remember to put the correct pod labels on the pod connector cables matching the color coding of the pods on the front panel of the module.

As per the testing scenario, use the appropriate probe from the probing solutions available with Keysight.

You can use:

- Flying-lead probe sets. This is called general purpose probing. Using this probing solution, connect probe connectors to individual IC pins or test points.
- Elastomeric probe adapter and 1/4 flex adapter products available for several types of QFP packages. This is called QFP package probing. Using this probing solution, connect to all the pins of a specific QFP package.
- Soft Touch Connectorless Logic Analyzer Probes. This is called target connector probing or soft-touch connectorless probing. This probing solution removes the connector that is traditionally attached to the target board and replaces it with an array of probe pads.
- Processor or bus-specific probes. These are called analysis probes and are available for many processors and buses.

To connect and set up a probe, follow the instructions in the User's Guide that accompanies the probe.

U4154A Sample Hardware Setup

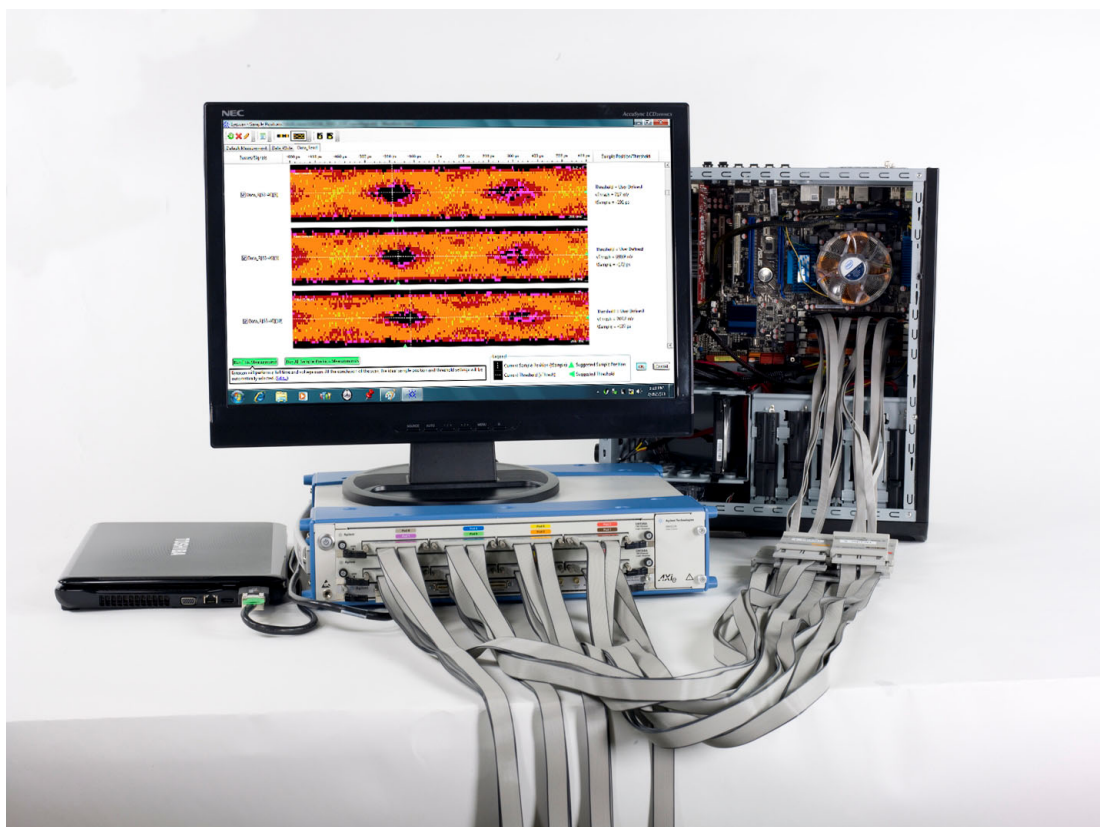

Figure 22 U4154A module in Keysight AXIe chassis

Figure 22 displays a sample setup of the U4154A module. In this setup, two U4154A modules are installed in slot 1 and 2 of the Keysight M9502A portable 2-slot AXIe chassis.

A laptop is used as the host computer and connected to the ESM of the chassis via a PCIe cable. An external LCD monitor is attached to the host laptop.

A DDR3 DIMM interposer probing solution is connected to the DUT.

U4164A Module

Refer to the **U4164A Data Sheet (5992-1057EN)** on www.keysight.com to get a list of supported interposers, probes, and cables for U4164A.

Details of how to set up these interposers, probes, and cables are in their respective user guides available on the probe's/interposer's page on www.keysight.com.

U4164A Sample Hardware Setup

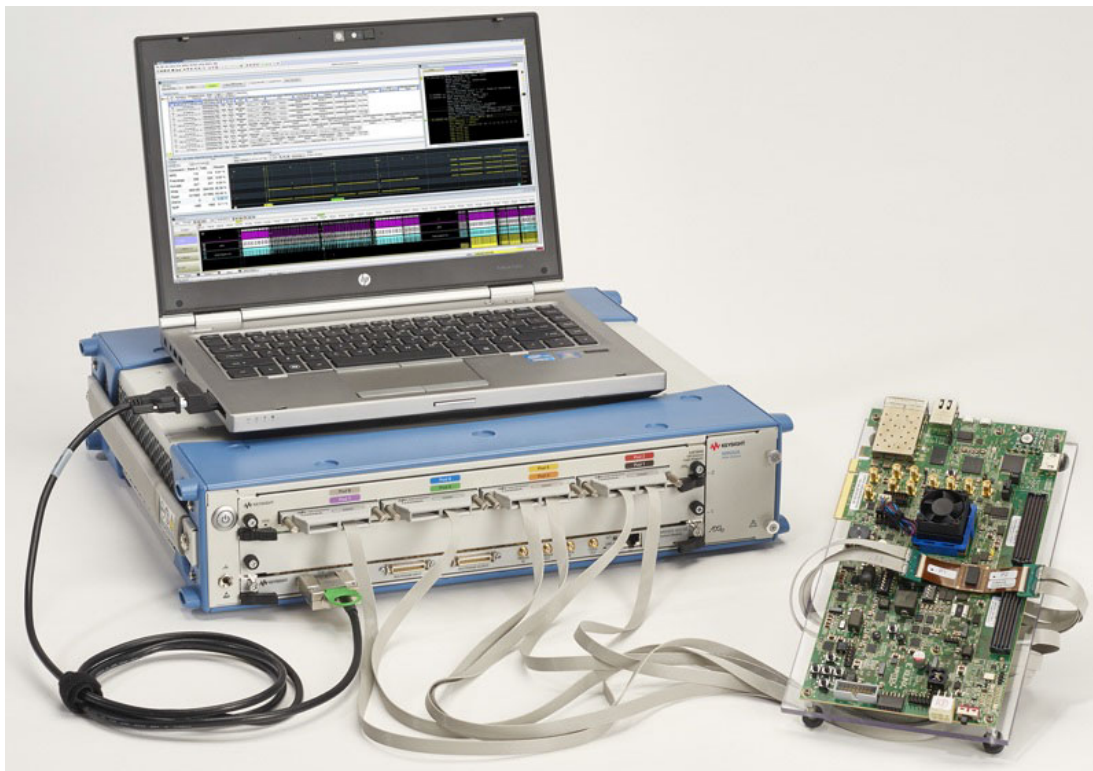

Figure 23 U4164A module in a Keysight AXLe chassis

Figure 23 displays a sample setup of the U4164A module.

A laptop is used as the host computer and connected to the ESM of the chassis via a PCIe cable. The module is connected to a DUT via W4641A BGA interposer and U4208A and U4209A probe cables.

U4301A/B Module

There are currently three DUT probing options for the U4301A/B module. These are:

- U4321A Solid Slot Interposer
- U4322A Soft Touch Midbus 3.0 probe
- U4324A PCIe Gen3 Flying Lead probe

Refer to the *PCI Express Gen3 Hardware and Probing Guide* to learn about these probing options for PCI Express Gen3 devices and how to make probe connections from the device under test (DUT) to the U4301A module. The guide is available on www.keysight.com and is also available in the help system of the Logic and Protocol Analyzer software application.

U4421A Module

For providing stimulus to a D-PHY component

The U4421A module emulates the role of a master D-PHY component when used for providing stimulus to a D-PHY component.

You need to connect the Keysight U4422A SMA stimulus probe to the U4421A module's Exerciser port. The following screen displays this probe.

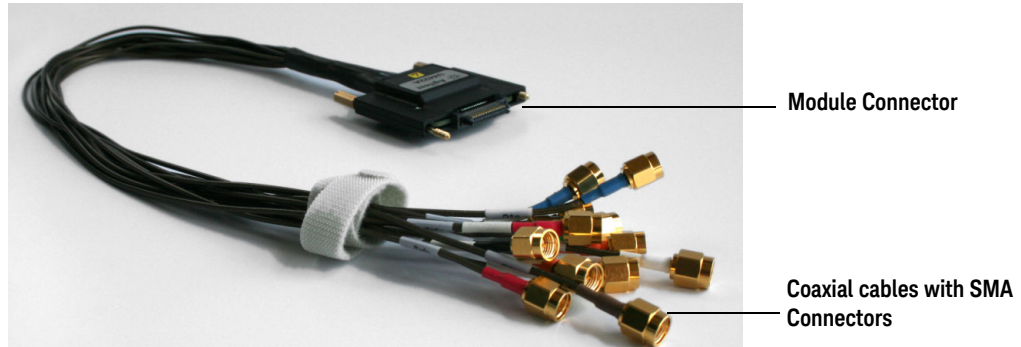

Figure 24 U4422A SMA stimulus probe

You plug the module connector component of the stimulus probe to the Exerciser port on the front panel of the U4421A module. The thirteen coaxial cables (with SMA connectors) of the probe connect the probe to the DUT.

For more details on this probe and how to set up the probe connections with DUT, refer to the *U4421A MIPI D-PHY Protocol Analyzer and Exerciser - Hardware and Probing Guide* available on www.keysight.com/find/dphy_analyzer.

For passive probing and capturing D-PHY data

There are two DUT probing options available when using the U4421A module for capturing D-PHY data. These are:

- E5405A Soft Touch Midbus probe
- E5381A 17-channel Differential Flying Lead probe

Both these probes connect to the Analysis port of the U4421A module via:

- either a U4201A 90-pin two pod cable.
- or a N2815A single pod cable.

The following screens display these acquisition probes and cable.

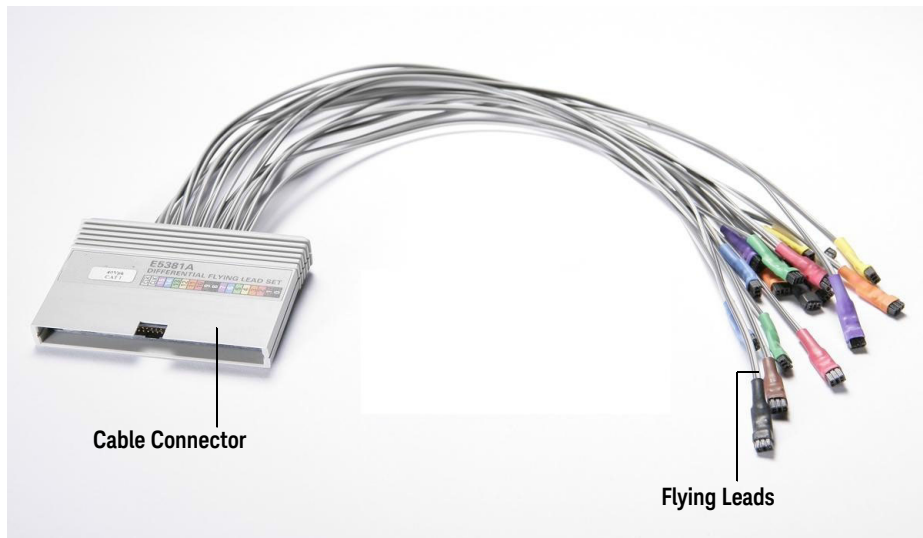

Figure 25 E5381A Differential Flying Lead probe

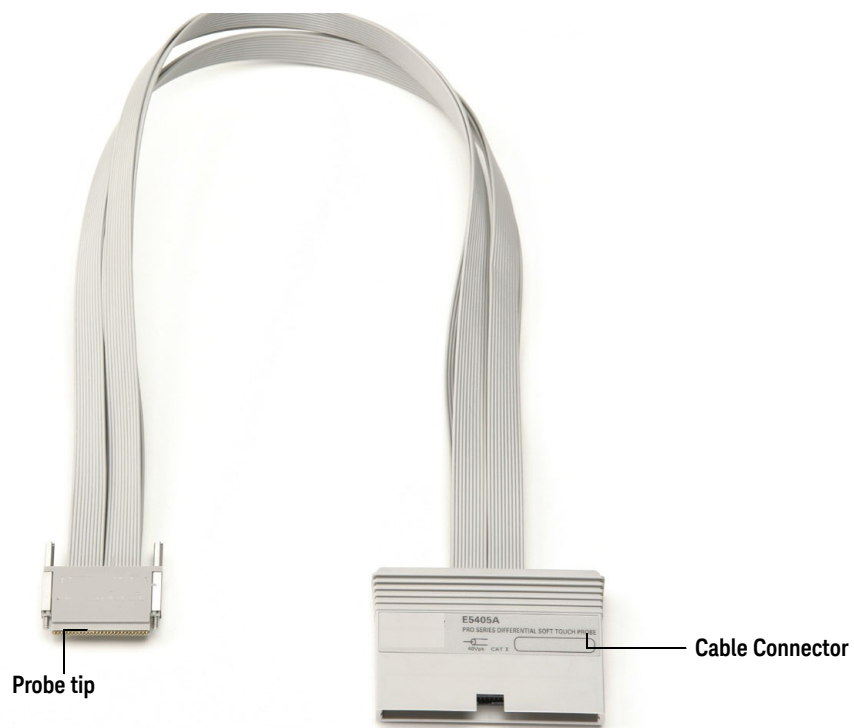

Figure 26 E5405A Soft Touch Midbus probe

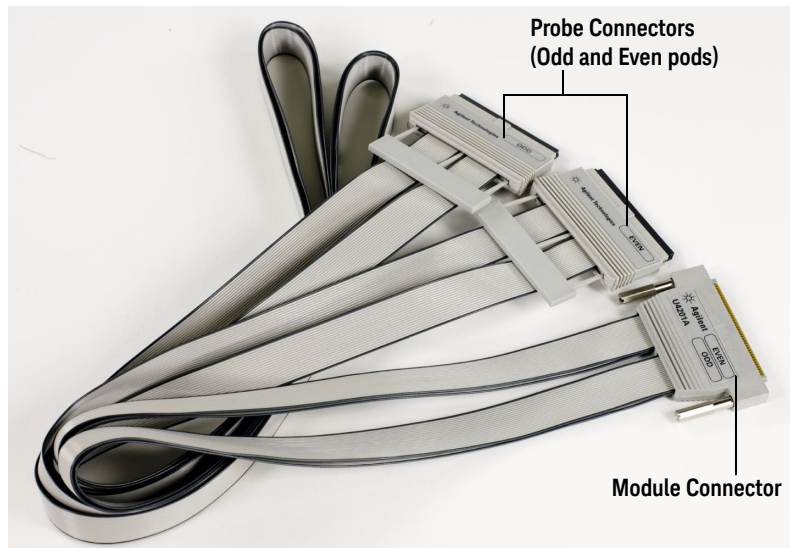

Figure 27 U4201A 90-pin two pod cable

Connecting the E5405A/E5381A acquisition probe to the U4421A module

- 1 Plug the module connector of the U4201A/N2815A cable into the Analysis port on the front panel of the U4421A module.
- 2 The module connector of the cable has two thumb screws. Hand-tighten these screws. Do not over tighten the screws.
- 3 Connect the other end of the U4201A/N2815A cable to the cable connector component of the flying lead/soft touch differential probe.

NOTE

The U4201A cable has two probe connectors - Odd and Even. If you are using this cable, then connect the probe to the connector labeled "Odd" on the cable. The probe connector labeled "Even" on the cable is not used with the U4421A module.

- 4 Finally, connect the probes to the DUT.

Refer to the U4421A MIPI D-PHY Protocol Analyzer and Exerciser - Hardware and Probing Guide to learn about the pinouts details, suggested signal routing, and how to make probe connections to the device under test (DUT). The guide is available on www.keysight.com/find/dphy_analyzer and is also available in the help system of the Logic and Protocol Analyzer software application.

U4421A Sample Hardware Setup



Figure 28 U4421A module in Keysight AXle chassis

Figure 28 displays a sample setup of the U4421A module. In this setup, a U4421A module is installed in slot 2 of the Keysight M9502A portable 2-slot AXle chassis. A filler module is used in slot 1. A laptop is used as the host computer.

For the stimulus function, the module connects to the Keysight U4422A SMA stimulus probe through its Exerciser port.

For the analysis function, the module connects to the Keysight E5405A differential soft touch probe via a U4201A 90-pin cable.

In the sample setup, a demonstration board is being used as the DUT.

U4431A Module

For probing and capturing M-PHY data

The following DUT probing option is available when using the U4431A module for capturing M-PHY data.

- U4433A Differential ZIF Flying Leads probe
- U4432A SMA Differential probe

The following screen displays the U4433A acquisition probe.

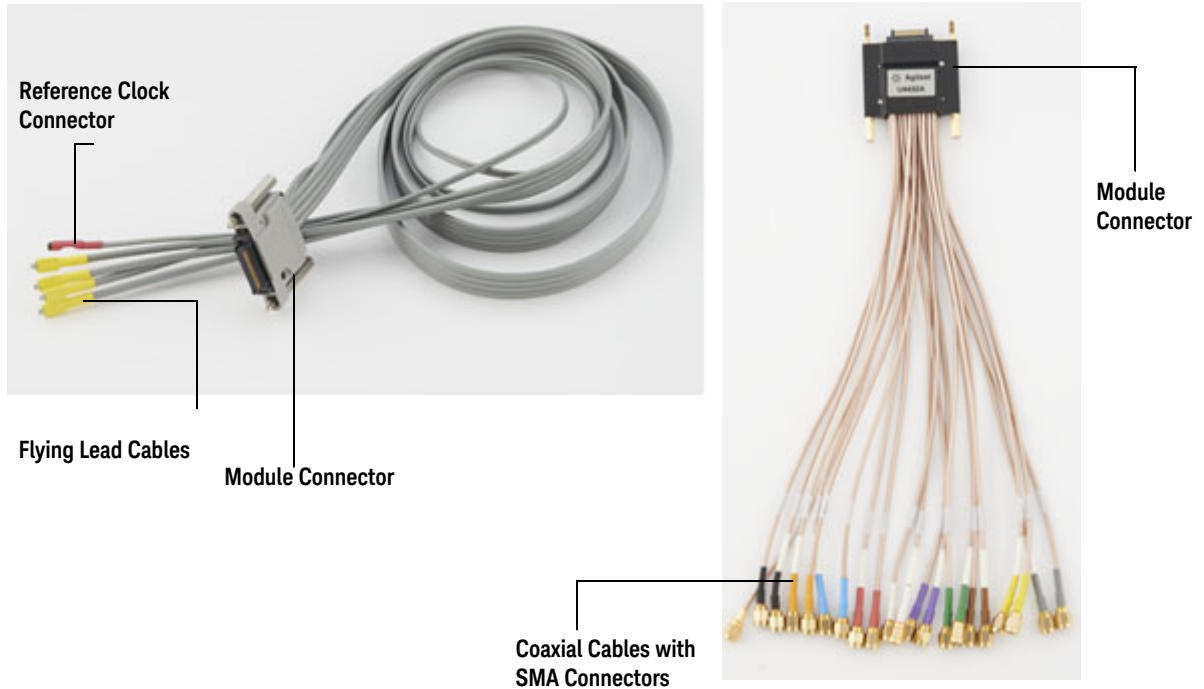

Figure 29 U4433A Differential ZIF Flying Lead probe and U4432A SMA Differential probe

These probes connect to one of the two Analysis pods on the front panel of the U4431A module. For the U4433A probe, flying lead cables of the probe connect to the DUT via N5426A ZIF tips. For the U4432A probe, the 21 coaxial cables with SMA connectors connects the probe to the DUT.

Refer to the U4431A *MIPI M-PHY Protocol Analyzer - Hardware and Probing Guide* to learn about the M-PHY signal to flying lead mapping, probe dimensions, probe accessories, ZIF tips to be used, and how to make probe connections to the DUT. The guide is available on www.keysight.com/find/mphy_analyzer and is also available in the *help* folder of the Logic and Protocol Analyzer software application.

Power up the Connected Hardware Components

NOTE

The host computer that you attached to the chassis can connect to the chassis successfully only when you have installed the instrument module in the required slot of AXIe chassis. Therefore, make sure that you install the instrument module in the chassis before powering up the complete setup.

Power up all the connected hardware components in the AXIe chassis and module setup.

- 1 The instrument module uses the power supplied by the AXIe chassis in which it is installed. The AXIe chassis power cord comes with the chassis shipment. Insert the power cord into the inlet at the rear of the chassis.
- 2 Connect the cord to an appropriate AC power main.
- 3 Push the circuit breaker to the right, which is the ON position.

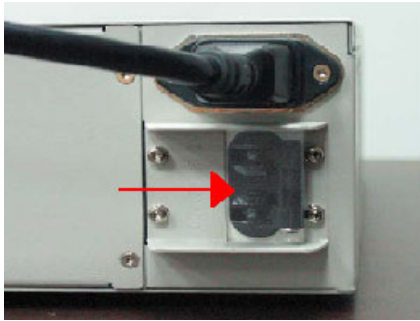

- 4 Press the ON/Standby button on the front panel of the chassis to power on the chassis.



- 5 Wait for 2 minutes after powering up the chassis so that the PCIe channel in the chassis is ready for the successful connectivity of the chassis to the host computer via the PCIe cable.
- 6 After 2 minutes, power up the host computer. By this time, the Status light on the ESM of chassis should also have been steady green indicating a power ready status of the chassis.

The step to power up the host computer is not required if you are using the AXIe Embedded Controller module as the host computer because it gets powered on simultaneously with the chassis through the chassis backplane.

NOTE

To power down a chassis, first turn off the host computer and then power down the chassis using the On/Standby button on its front panel.

If you are using Keysight AXIe Embedded Controller module as the host computer, ensure that you first shut down the controller by executing the Windows shutdown process.

Do not use the circuit breaker for routine chassis turn off.

The module(s) are turned off automatically with the chassis.

Verify the Hardware Setup

After powering ON the connected hardware components, you can verify if you have correctly set up the hardware if:

- a steady green status light is displayed on the ESM of the AXIe chassis indicating that the chassis has powered up successfully.
- the Out of Service (OOS) LED on the front panel of the instrument module turns off indicating that the module is in a power-ready state.
- the Out of Service (OOS) LED on the front panel of the AXIe Embedded Controller module turns off. (Applicable only when you are using AXIe Embedded Controller Module as the host computer)

If the chassis does not power up to a steady green Status light, or powers up to a steady red light, the chassis has detected a failure and requires service.

If the OOS LED on the front panel of the module is steady red and does not turn off, it indicates a power fault condition. In such a situation, the module may require repair/service.

NOTE

Older U4301A modules will display an alternate OOS light functionality; the OOS LED in these modules will be off until power is ready then will remain illuminated as long as there is no module power fault condition present.

Contact your Keysight representative to replace or service the chassis /module.

3 Installing Software Components

Hardware and Software Requirements for the Host Computer /	62
Installing Keysight Logic and Protocol Analyzer Software /	63
Installing Chassis Device Drivers and Keysight I/O Libraries Suite /	64
Networking the Host Computer and AXIe Chassis /	65
Upgrading Chassis Firmware /	72
Upgrading a Module's Backplane Interface FPGA Firmware /	80
Upgrading a Module's BMC (IPMC) Firmware /	84
Installing Additional Software Packages /	87
Setting up Communication between the Host PC and ESM of the AXIe chassis /	88

Once the hardware setup for the instrument module is ready, you need to install the software components of the module on the designated host computer. This chapter describes the installation of these software components.

Hardware and Software Requirements for the Host Computer

The following are the hardware and software requirements that should be met on the host computer before the installation of software components on this computer:

Hardware requirements

- Pentium® processor 1 GHz or equivalent
- 2 GB available RAM
- VGA resolution 1024 x 768
- 1.5 GB or more free hard disc space
- Support for DirectX 9 graphics with 128 MB graphics memory (recommended)

Software requirements

- The following operating systems are supported:
 - Windows 7
 - Windows 8
 - Windows 8.1
 - Windows Server 2008
 - Windows® Server 2008 R2
 - Windows Server 2012
 - Windows® Server 2012 R2
 - Windows Vista (64 bit) SP2
- Microsoft Internet Explorer 7 or greater

Installing Keysight Logic and Protocol Analyzer Software

You will need to install the Logic and Protocol Analyzer application software (version 5.00.0000 or greater is required for all AXIe-supported logic analysis instruments). This software is the primary control software for these modules allowing you to configure, start, stop, and use these modules.

For the U4164A module, the software version the Logic and Protocol Analyzer application software version 6.20.0000 or greater is required

NOTE

If you are using USB connectivity between the AXIe chassis and host computer, then you need to install Keysight Logic and Protocol Analyzer application software version 5.50 or greater to get support for the USB connectivity.

Refer to the *Keysight Logic and Protocol Analyzer online help* for assistance in using the application software.

To install Keysight Logic and Protocol Analyzer

- 1 Download the Keysight Logic and Protocol Analyzer software from www.keysight.com/find/lpa-sw-download.
- 2 Once the application software install package is downloaded to the host PC, double-click the installer.exe file.
The Keysight Logic and Protocol Analyzer Installation Welcome message is displayed.
- 3 Click **OK** to continue.
- 4 Click **Next** if the system controller meets the minimum system configuration requirements displayed by the wizard.
- 5 Accept the license agreement and click **Next**.
- 6 Choose the setup type and click **Next**.
- 7 Click **Install** to start the installation.
- 8 Click **OK** to install the additional components such as Demo center.

The Logic and Protocol Analyzer software contains the required GUI and tools needed to use the modules. It also installs the required drivers, network drivers, and firmware upgrade package (for the chassis) to ensure that chassis and modules are compatible.

Before you can start using the Logic and Protocol Analyzer application, you must perform the configuration tasks that follow to ensure successful communications between the chassis, modules and host computer.

You can verify the successful installation of the Keysight Logic and Protocol Analyzer software by performing the following steps:

- The Keysight Logic Analyzer folder is added to the */Program Files* or */Program Files(x86)* folder
- The Keysight Logic and Protocol Analyzer application GUI can be started by clicking the **Start > Programs > Keysight Logic Analyzer > Keysight Logic and Protocol Analyzer** start menu shortcut on the Windows taskbar.

Installing Chassis Device Drivers and Keysight I/O Libraries Suite

The Keysight Logic and Protocol Analyzer software and AXIe-based instrument modules do not require you to install any chassis device drivers or Keysight I/O libraries tools on the host computer. If the Logic and Protocol Analyzer software needs to interface with any other Keysight instruments that require the I/O libraries, it will prompt you to download and install the libraries.

NOTE

If you are using the AXIe Embedded Controller Module as the host computer, it comes with the Keysight I/O Libraries Suite preinstalled.

Networking the Host Computer and AXIe Chassis

You connect the host computer to the AXIe chassis via the PCIe or USB interface:

- for proper functional operation of the instrument.
- for performing the firmware upgrade process on the chassis. Refer to the topic **“Upgrading Chassis Firmware”** on page 72 for instructions on how to upgrade the chassis firmware.

In some chassis and host configuration scenarios, you also need to connect the host computer and chassis to a common public or private network where as in other configuration scenarios, such a connectivity is not needed and is not recommended.

This topic describes the connectivity requirements for the host PC and chassis for various configuration scenarios.

NOTE

If you are using the Keysight Embedded Controller module as the host computer in a single-frame system, you need not perform this step. This module connects to the Embedded System Module (ESM) of the chassis through the chassis backplane.

In a multi-frame setup using Keysight Embedded Controller modules, the host-chassis instrument package resides in a single chassis. Therefore, no PCIe/USB connection is required, but all instruments must still be connected to a common network to be able to communicate with each other. Except timing information, no instrument application communication occurs across the multi-frame cable.

Network requirements

If your chassis and host configuration scenario requires the chassis and host to connect to a common network, then the network should meet the following requirements:

- The network should provide DHCP services. This will provide an IP address to the chassis and host from a pool of IP addresses. Use of static IPs in any configuration is discouraged.
- The network need not be connected to public Internet access for chassis operation, though the Internet access may be desirable for downloading software applications for use on the host.
- To implement a private (isolated) network, a standalone router should be used to host the required DHCP services and provide IP addresses. A simple hub or a switch does not provide DHCP services.
- If using an Intranet, it is necessary to connect both the host and chassis to the same switch or hub to ensure that these are assigned compatible IP addresses in the same subnet. IP addresses are compatible when the first two octets (the subnet) are the same in the standard dot-decimal notation.

PCIe/USB Connection Requirements

The following are some important points to remember when using the PCIe or USB interface in any configuration scenario.

- When you connect the host PC and chassis via the PCIe/USB interface, the PCIe/USB connection is used to host the network. On the host PC, this is displayed as:
 - Intel(R) PRO/1000 PL device in the Network adapter section of Device Manager in the case where a PCIe connection is used.
 - ASIX AX88178 USB 2.0 to Gigabit Ethernet device in the Network adapter section of Device Manager in the case where a USB connection is used.

- Ensure that the network adapter is operational (that is, it has no driver errors in Windows Device Manager). The network settings corresponding to the network adapter should NOT specify any static IP addresses and should be set to Windows default settings of obtaining IP addresses automatically.
- In case you encounter problems with using the PCIe/USB network connection, refer to the topic [“Troubleshooting ESM Connectivity Issues”](#) on page 94

Chassis LAN Connector

The AXIe chassis has a network adapter (NIC) to connect it to a network. You can connect the AXIe chassis to a network using the RJ45 LAN connector located on the front panel of the ESM of chassis. However, this step of connecting the chassis to a network is not needed and not recommended (except for scenarios in which multiple chassis connect to a single host PC).



Figure 30 RJ45 LAN Connector on the front panel of ESM

Point-to-point LAN

Though it is possible, it is recommended not to use a direct point-to-point LAN connection for networking the host and chassis. When a point-to-point network connection is used in a single chassis scenario, the host PC's LAN port is directly connected to the chassis' LAN port using a standard Ethernet cable. To avoid potential problems during Windows network resolution, it is recommended not to manually configure any network adapters to use static IP addresses.

Single chassis scenario

The following figure illustrates the connectivity of host PC and chassis to the network when you are using a single AXIe chassis with a single host PC.

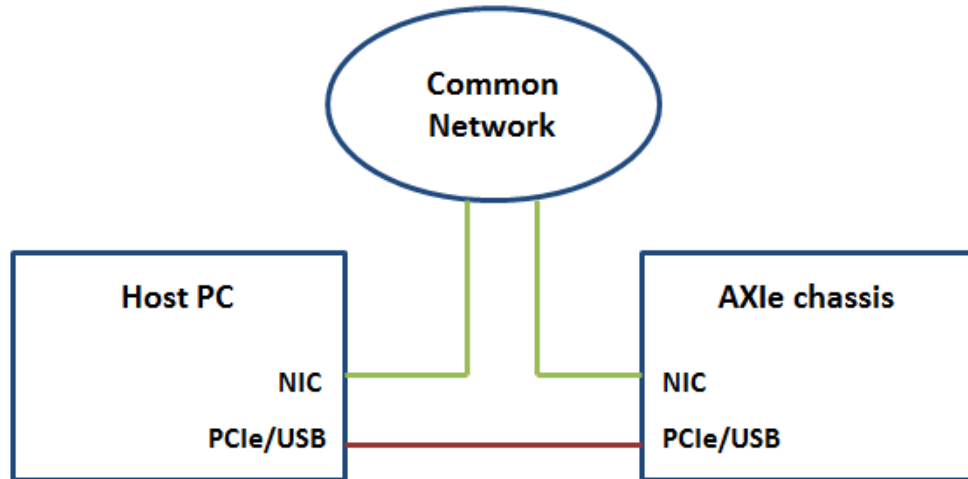
**LEGEND:**

- = optional network connection (not needed and not recommended)
- = either PCIe or USB Cable (not both)

Figure 31 Connecting a single chassis to a host PC

In this scenario, you use the PCIe or USB interface to create a network connection between the host PC and chassis. Optionally, you can connect the host PC and chassis to a common network but such a connectivity is not needed and is discouraged.

If you decide to connect the chassis to a network (which is discouraged), then:

- Connect the host PC to the same network switch as the chassis. (This is mandatory.)
- Leave the primary LAN port configured for DHCP on the host.
- It is not required to configure the PCIe/USB network adapter on the host, though disabling the adapter in Windows Device Manager is preferred to speed up network resolution at Windows startup and eliminate any potential network resolution issues.

Multiple chassis connected to a single host PC in a non multiframe scenario

The following figure illustrates the connectivity of host PC and chassis when you are connecting multiple AXIe chassis to a single host PC.

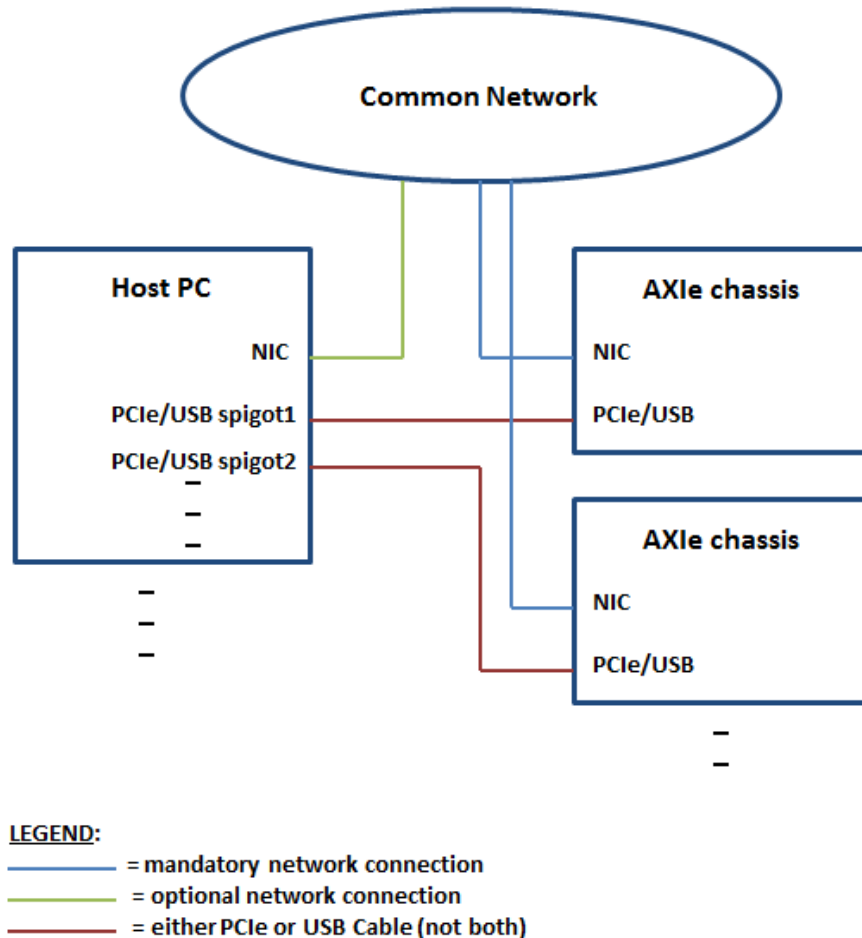

Figure 32 Connecting multiple chassis to a host PC

In this scenario, you use the PCIe or USB interface to create a network connection between the host PC and each chassis. Additionally, you must connect each chassis to a common network (public or private) supplying DHCP services. This allows each chassis to obtain an IP address from DHCP that is non-conflicting with the IP address of all other chassis. The connectivity of the host PC to the common network is optional.

If you decide to connect the chassis as well as host to a common network (which is discouraged), then:

- Connect the host PC to the same network switch as the chassis. (This is mandatory.)
- Leave the primary LAN port configured for DHCP on the host.
- It is not required to configure the PCIe/USB network adapter on the host, though disabling the adapter in Windows Device Manager is preferred to speed up network resolution at Windows startup and eliminate any potential network resolution issues.

Multiframe scenario with one chassis per host PC

The following figure illustrates the connections between a host PC and a chassis when you are using multiple hosted-chassis instruments (multiframe scenario). There is one host PC for each hosted chassis. This scenario can also be used with standalone (non-hosted) instruments as part of the multiframe chain. This is the recommended scenario when using multiple chassis.

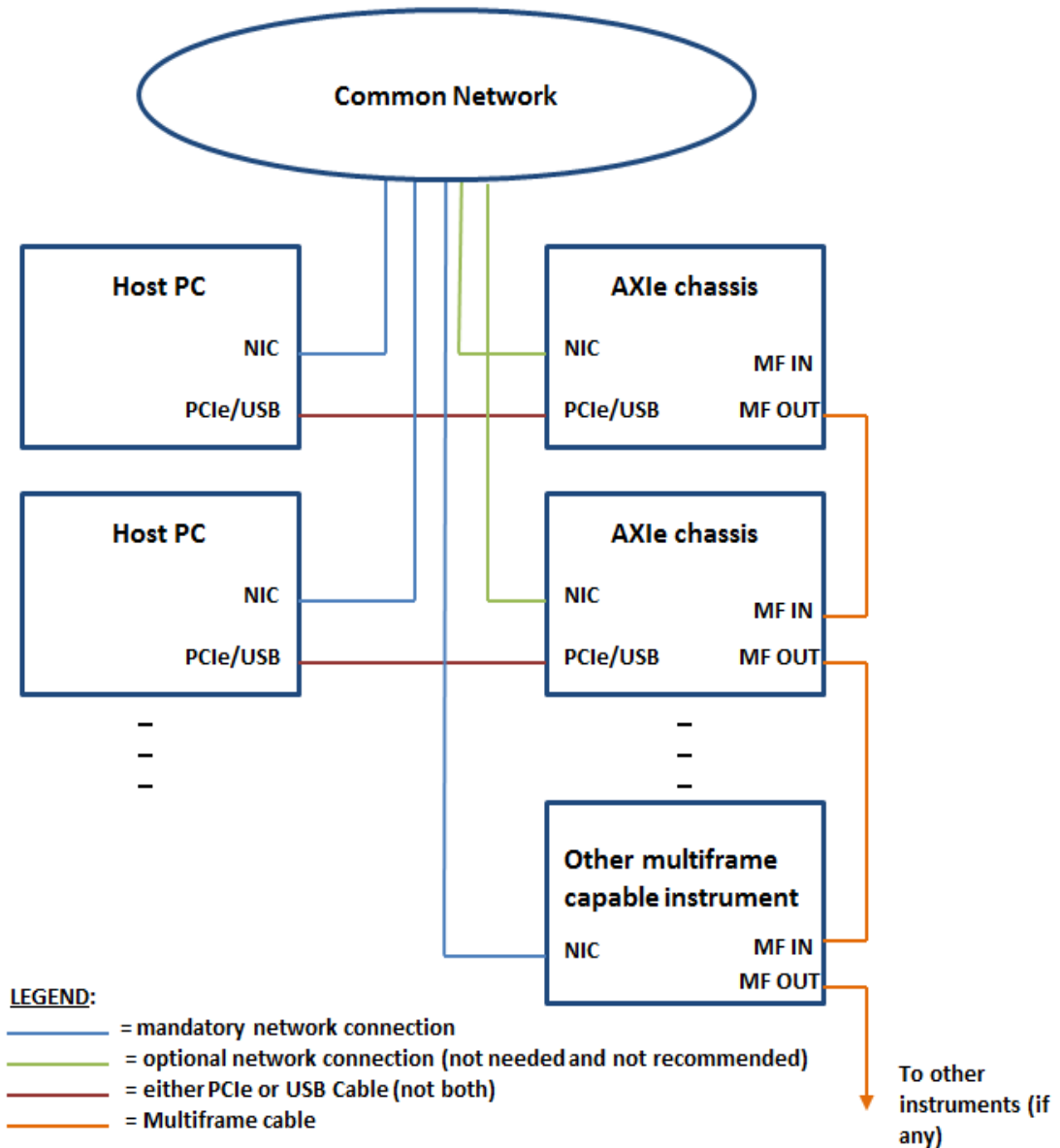

Figure 33 Connecting multiple chassis and host PCs (One chassis per host PC in a multiframe setup)

In this scenario, you:

- Use the PCIe/USB interfaces to create individual network connections between the host PCs and their individual chassis.
- Must connect the host PCs to a common public or private network with DHCP services.
- Optionally, connect the individual chassis to a common network but such a connectivity is discouraged and not needed.

If you decide to connect the chassis as well as hosts to a common network (which is discouraged), then:

- Connect the chassis to the same network switch as the hosts. (This is mandatory.)
- Leave the primary LAN port configured for DHCP on the host.
- It is not required to configure the PCIe/USB network adapter on the hosts, though disabling the adapter in Windows Device Manager is preferred to speed up network resolution at Windows startup and eliminate any potential network resolution issues.

Multiframe scenario with multiple chassis per host PC

The following figure illustrates the connections between a host PC and a chassis when you are using multiple hosted-chassis instruments (multiframe scenario). In this multiframe scenario, there are multiple chassis connected to a host PC via a common network. This scenario can also be used with standalone (non-hosted) instruments as part of the multiframe chain.

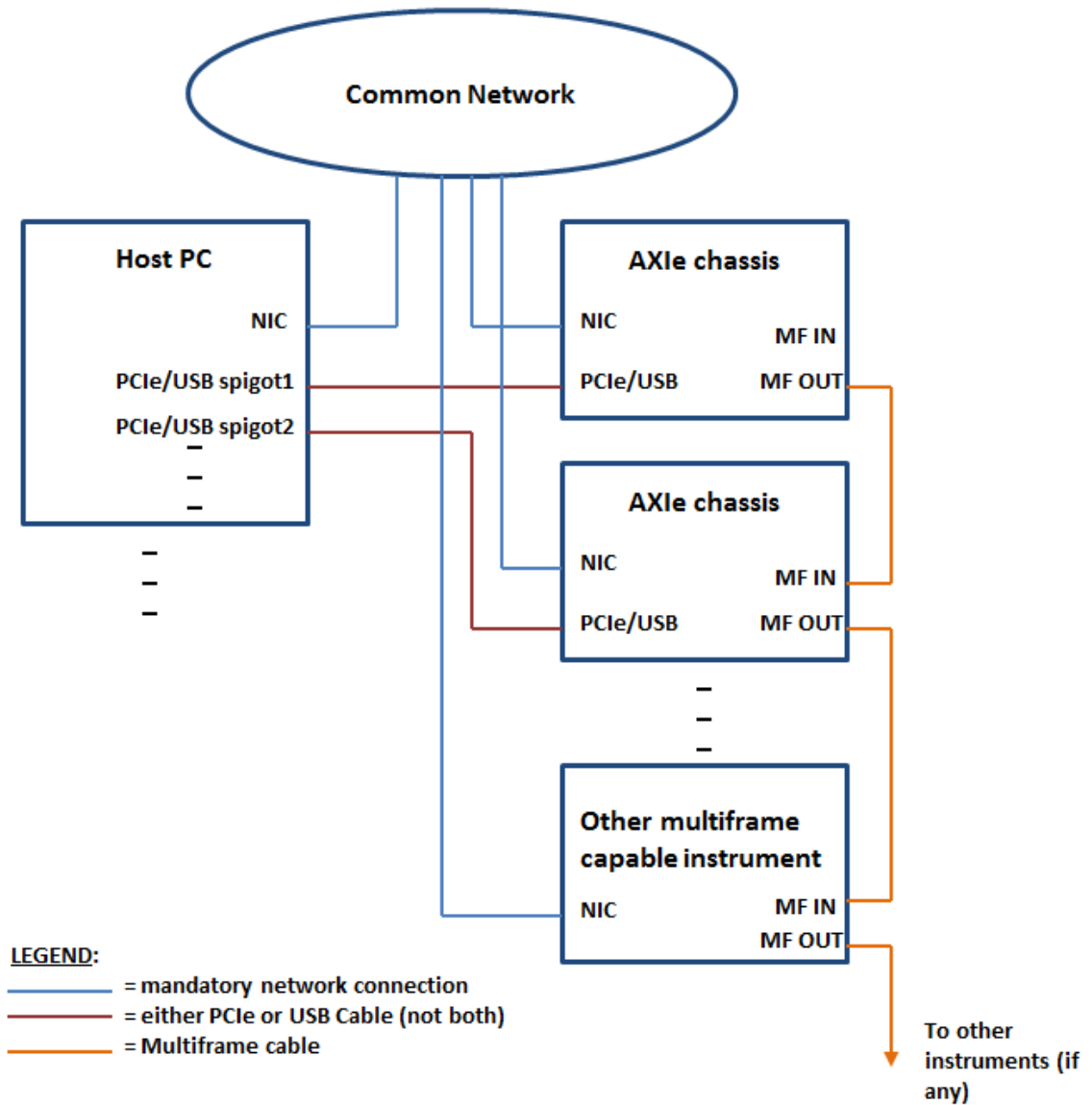

Figure 34 Connecting multiple chassis and host PCs to a network (Multiple chassis per host PC)

In this scenario, it is mandatory to connect all host PCs and all chassis to a common network.

- Connect the host PC and the chassis connected to it to the same network switch. The network must supply DHCP services to allow each chassis to obtain an IP address from DHCP that is non-conflicting with the IP address of all other chassis.
- It is not required to configure the PCIe/USB network adapter on the hosts, though disabling the adapters in Windows Device Manager is preferred to speed up network resolution at Windows startup and eliminate any potential network resolution issues.

NOTE

It is not possible to implement the Multiple Chassis per Host PC scenario when using the Keysight Embedded Controller module as the host PC.

Upgrading Chassis Firmware

You may need to upgrade the firmware of the chassis to ensure that the chassis is compatible with the installed instrument modules. The Keysight Logic and Protocol Analyzer software that you installed on the host computer automatically notifies you if a chassis firmware upgrade is required. You can also manually verify and initiate an upgrade of the chassis firmware.

The following figure displays a firmware upgrade notification message by the Keysight Logic and Protocol Analyzer software service at system startup. This message indicates that you need to update the chassis firmware.

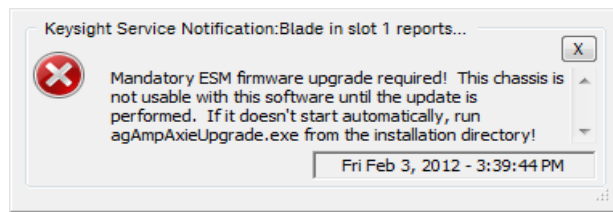

The error message is displayed when the Logic and Protocol Analyzer software detects an outdated chassis firmware during host system startup.

In response to the firmware upgrade message, you must perform the basic steps described in [Figure 35](#). This will upgrade the chassis firmware to the required version from the upgrade package (*ESMFirmware.zip*) that is copied to the Logic and Protocol Analyzer installation directory as part of the Logic and Protocol Analyzer software install process. After a successful firmware upgrade, the chassis will be usable with your current version of the Logic and Protocol Analyzer software.

NOTE

Older versions of the Logic and Protocol Analyzer software application (prior to v5.21.0000) used a more complex upgrade process that required more user intervention and a manual install of a 3rd party FTP software tool. If you are running an older version of the Logic and Protocol Analyzer application, it is strongly recommended to uninstall the older version and upgrade the software to v5.30.000 or newer to fully take advantage of the newer and more automated chassis firmware and module FPGA upgrade process.

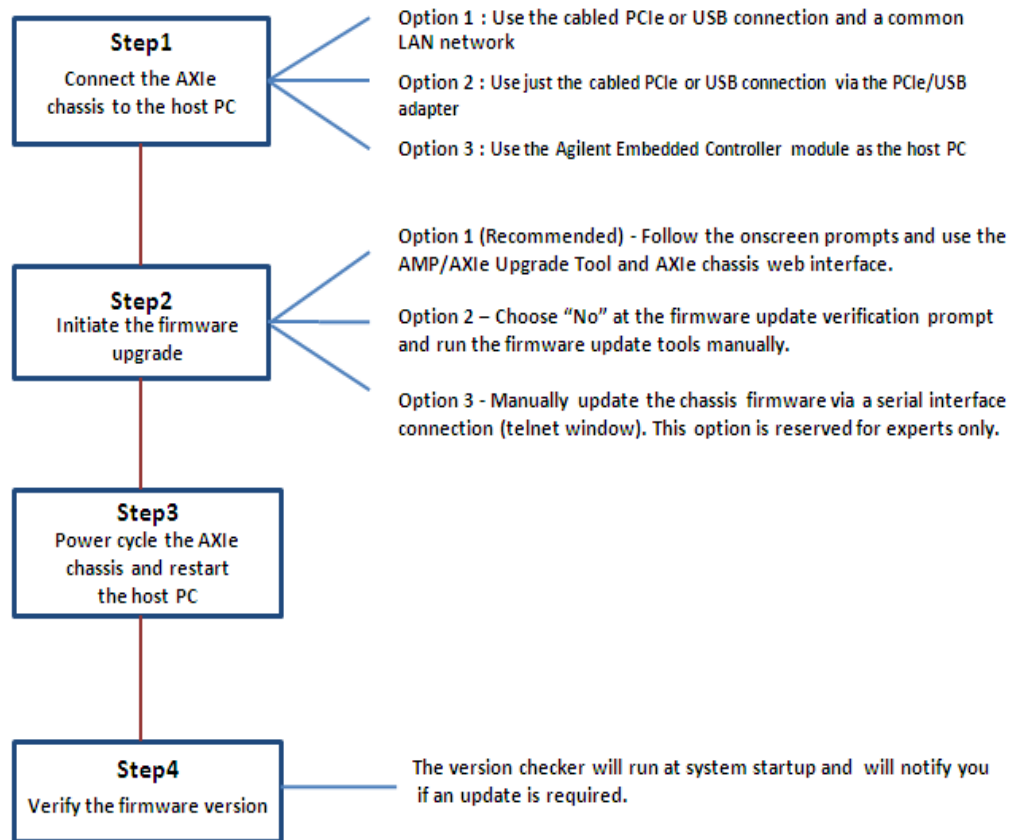

Figure 35 Steps for upgrading firmware on the AXIe chassis

The topics that follow describe these steps in detail.

Step 1 - Connect the AXIe Chassis to the Host PC

For the chassis firmware upgrade process, you must connect the AXIe chassis and host PC using either the standalone cabled PCIe/USB adapter connection or the common-network method. Refer to the topic [“Networking the Host Computer and AXIe Chassis”](#) on page 65 to know more.

NOTE

If you are using the Keysight Embedded Controller module as the host computer, you need not perform this step. This module connects to the Embedded System Module (ESM) through the chassis backplane.

Step 2 - Perform the firmware upgrade

This step describes the primary and recommended option for starting the chassis firmware upgrade. This option should be attempted in all cases. The alternate firmware upgrade options (option 2 and 3 in [Figure 35](#)) should be used only as an alternative for experts in situations where the Windows networking scenario is complex and makes communication between the chassis and host erratic. Before you start the upgrade, ensure that:

- You have successfully established a network connection between the chassis and host.

- You have a valid firewall exception for the tools used to perform the upgrade (agAmpAxleUpgrade.exe and ChassisUpdater.exe). These exceptions should have been set up automatically during the Logic and Protocol Analyzer application software installation; though Windows may prompt the user to approve an exception if one does not exist.

Option 1 - Start the upgrade by following the on-screen prompts for upgrades (recommended)

If you follow the on-screen prompts displayed for the firmware upgrade, the AMP/AXle Upgrade Tool and AXle Chassis Web Interface are automatically launched and used when needed for the firmware upgrade.

To upgrade the firmware using the recommended option

- 1 Choose **Yes** in the following on-screen prompt to initiate the firmware upgrade process.

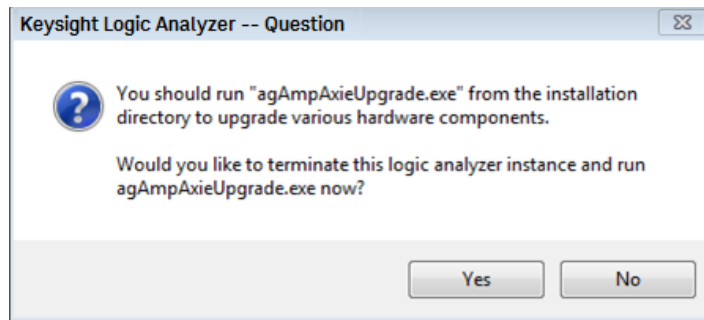
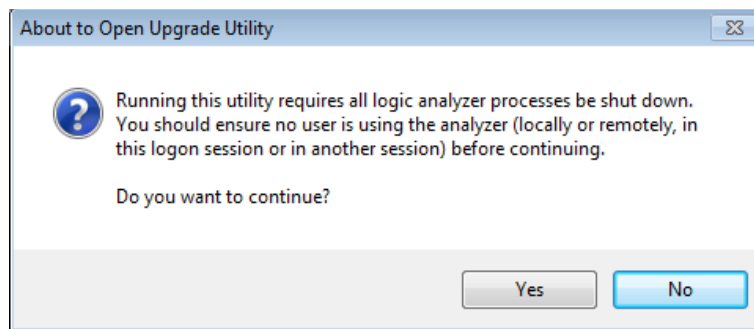

Figure 36 On screen prompt for initiating firmware upgrade

- 2 The following warning message is displayed to give you the opportunity to save data before any running analyzer sessions are closed. Choose **Yes** when you are ready to continue with the upgrade process.



- 3 The AMP/AXle Upgrade tool is launched. Select the **Chassis Firmware** option from the Upgrade Type drop-down listbox

Note the mismatch between the current and expected firmware versions. The expected version is displayed with M95xxA ESM version in the CRM/ESM field and the current firmware version is displayed in the Instance drop-down listbox.

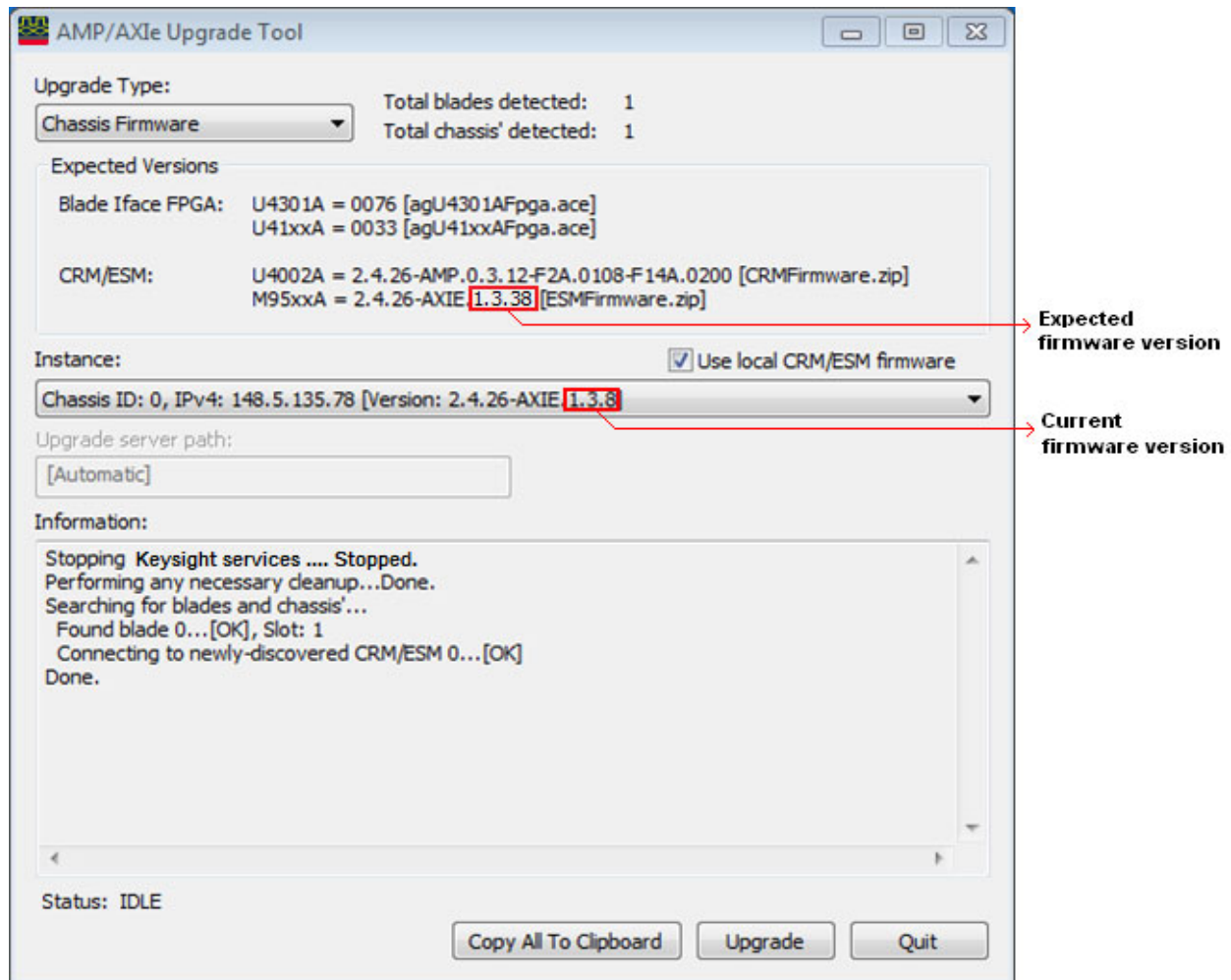
**NOTE**

If multiple chassis' are connected via the multiframe installation using a single host with multiple adapter cards then multiple instances of chassis are available in the **Instance** drop-down listbox. When you start the upgrade in such a scenario, all the chassis would be upgraded at once.

- 4 Click **Upgrade** in the AMP/AXIE Upgrade tool to continue the upgrade process.
- 5 The AXIE Web Page Upgrade Parameters dialog box is displayed. In this dialog box, the FTP site address and the directory to which the firmware update file package has been automatically extracted by the agAmpAxieUpgrade.exe tool are displayed. This IP address and source directory are required in later steps. Therefore, make note of this IP address and source directory before clicking **OK** (which closes this dialogue box). Click **OK** to continue.

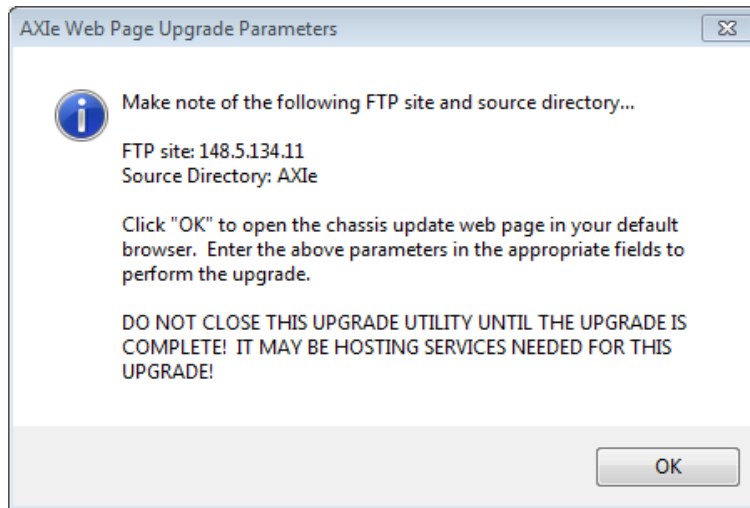

The tool automatically determines the IP address of the chassis and using that IP address, it opens the Web interface of the chassis in your default browser. Using this Web interface, you can continue the firmware upgrade.

Update Chassis Firmware on M9502A AXIe 2 Slot Chassis:

Updating the chassis firmware will require anonymous FTP access to a local FTP server from the chassis and a complete firmware update package. During the update, instruments modules may be deactivated (standby mode) and afterwards the chassis must be power cycled.

Instrument:	M9502A
Serial Number:	TW60510302
Installed Firmware Revision:	F2AX-1.3.8-0103-A002b
Update Package Revision:	<input type="text"/>

IMPORTANT: Temporarily disable the firewall on the FTP server before proceeding. The 'FTP Site' entry box below identifies the IP address of the machine running this window and is expecting an FTP server to be active on this machine. Alternatively a different FTP server may be used. In either case, the firewall --on the host FTP server-- must be disabled for the duration of the upgrade, which may take up to an hour to perform. Pop up windows are also used to present status information and may also require temporary permission to be displayed.

Enter the FTP site and subdirectory containing the update package:

FTP Site: Specify an IP address, such as: x.x.x.x

Source Directory: Specify a directory path, for example: /m9502a_update

Messages:

- 6 In the Web interface of the chassis, the IP address of the FTP site should be pre-filled. Verify that this IP address is the same as the IP address that you noted in Step 5.
- 7 In the Source Directory field, specify the directory containing the update package (this is usually "AXIe"). This directory should be the directory that you noted in Step 5.
- 8 Click **Locate Package** and wait for a result to appear in the Messages box.

If the chassis is able to contact the specified FTP server and locate the firmware update package, a success message is displayed in the Messages box on the web interface of chassis.

Messages:

Server 148.5.134.11 contacted successfully.

- 9 Select the installation option for the firmware upgrade.
 - Select **Typical Install** to ensure that each firmware component is checked against the corresponding component in the upgrade package, and only those components are updated which are earlier versions.
 - Select **Inspect and Review** to first inspect the suggested updates for the firmware components and then update only selected components.
 - Select **Force Complete Update** to replace all firmware components with the corresponding components in the upgrade package.

- 10 Click the **Install Package** button to start the final stage of the upgrade.

The Update Status window displays the internal status messages as the upgrade proceeds. These messages do not signal ultimate success or failure and only reflect the continued progress of the upgrade. It may take from 5 to 60 minutes for the entire chassis firmware update process to complete.

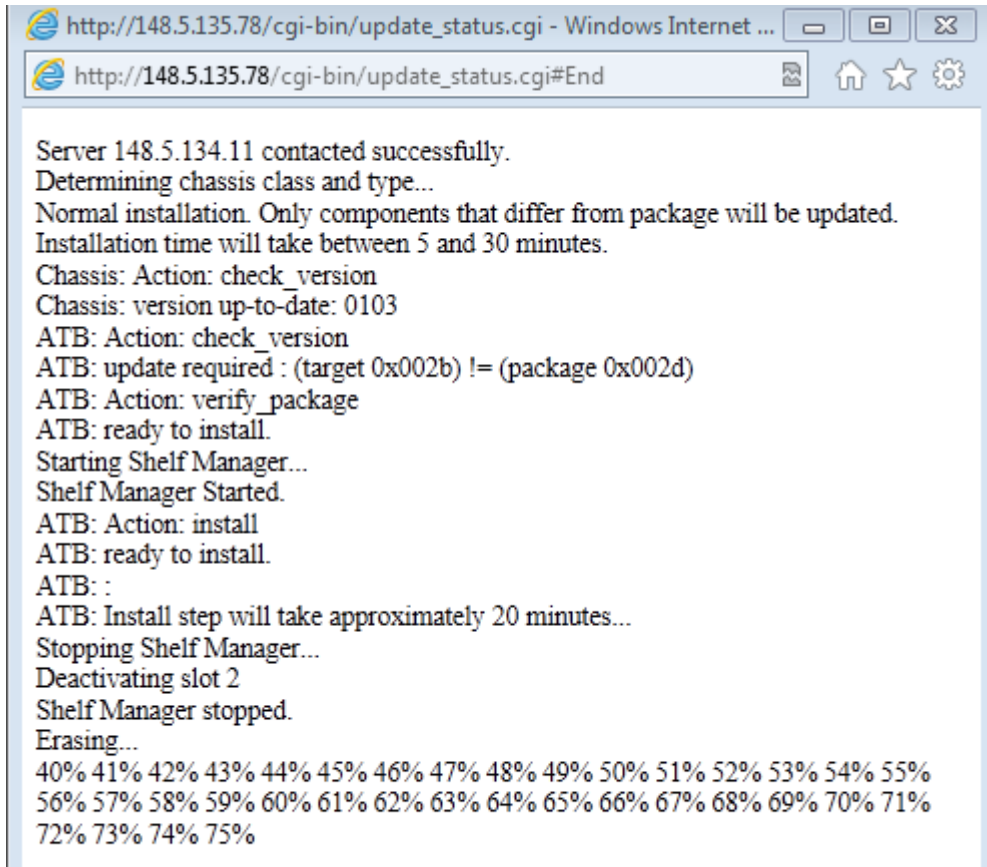

When the upgrade process completes, the Update Status window displays the final result and provides reboot instructions.

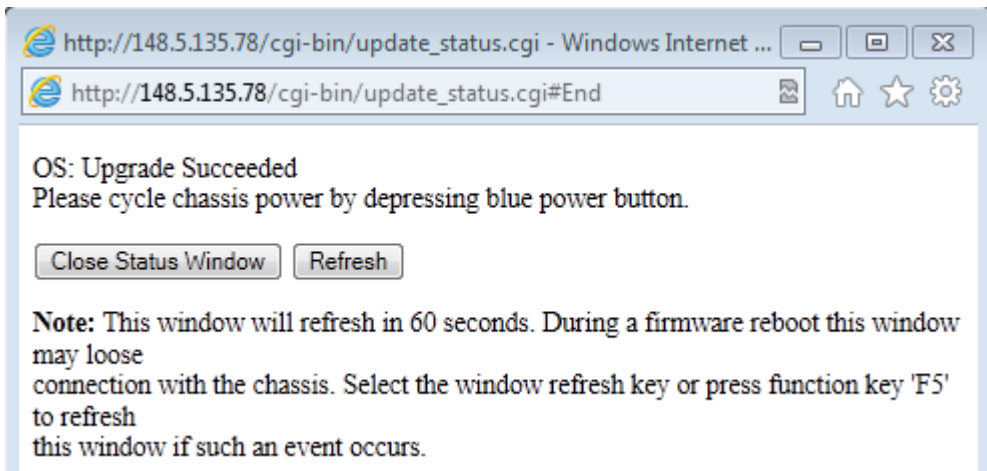

Step 5 - Restart the chassis and host PC

At this point when the firmware upgrade is complete, you should power cycle the chassis and reboot the host system.

The following is the power-up sequence:

- 1 Power up the chassis first. Use the **ON/STANDBY** button on the front panel of the chassis.
- 2 Wait until the chassis ESM Status LED becomes steady green.
- 3 Wait another 60 seconds for the chassis to finish booting up.
- 4 Power up the remote host.

NOTE

The boot sequence for multiframe installations requires you to start the boot sequence on the master multiframe system and then wait for this chassis and host system to reach a fully booted status. The fully booted status is indicated by the green (ready) state of the Keysight Notification Center icon in the system tray. After this, initiate the chassis power up on the next intermediate slave in the multiframe installation.

NOTE

If you are using the AXIe Embedded Controller Module as the host computer, then you need not perform the host PC power up steps because the Embedded Controller startup is managed internally and the controller automatically starts after the chassis power is stable.

Step 6 - Verify the firmware upgrade

You can verify the new firmware version installed on the AXIe chassis by using any of the following methods:

- By monitoring the messaging window in the upper left hand corner of the desktop as the version checker routine runs at system startup. If the firmware is upgraded to the required version on the chassis, there will be no Keysight Service Notification messages regarding chassis firmware upgrades. This is the easiest method.
- Using the AXIe Chassis Web Interface
 - a Access the web interface of the AXIe chassis by typing *http://<IP_address_of_ESM>* in Internet Explorer.
 - b Click the **Advanced information** about this Web- Enabled M9502A drop-down.
 - c Verify the firmware revision displayed with the Firmware Revision field.
- Using the AMP/AXIe Upgrade Tool GUI
 - a Access the AMP/AXIe Upgrade tool by **double-clicking** the *agAmpAxieUpgrade.exe* from the following location:
<Program Files>\Keysight Technologies\Logic Analyzer\agAmpAxieUpgrade.exe
 - b Select the **Chassis Firmware** option from the Upgrade Type drop-down listbox.
 - c Compare the expected firmware version displayed with the M95xxA ESM version in the CRM/ESM field and the current firmware version displayed in the Instance field. The current version should match or be higher than the expected version.
- Using the Keysight Notification Center icon in the system tray
 - a Right-click the green Keysight Notification Center icon in the system tray and select **Show Instrument Details**.
 - b Expand the **Frame Details** heading. You can find the chassis firmware version in the CRM Version field.

Upgrading a Module's Backplane Interface FPGA Firmware

At times, when the Logic and Protocol Analyzer application is started, you may get notifications by the Logic Analyzer service that you need to upgrade one or more module's FPGA firmware. The following screen displays one such notification.

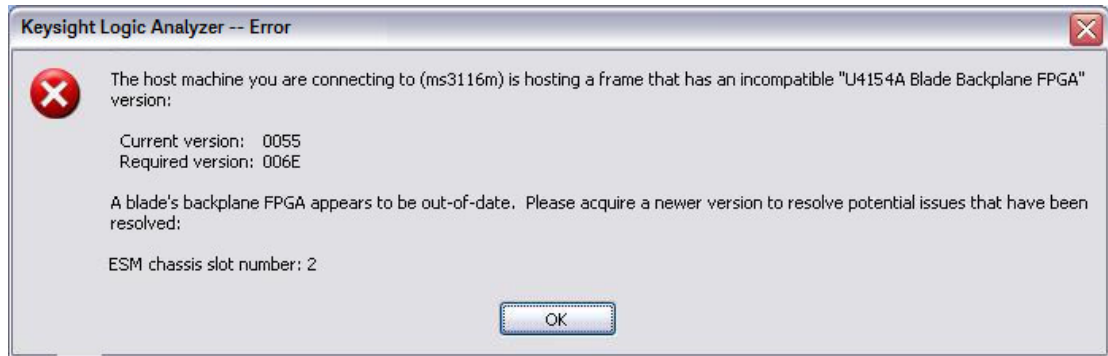

Such messages indicate that the Logic Analyzer has detected a module that has an FPGA version that is too old and requires a backplane interface FPGA upgrade. This module can be any instrument module installed in one of the slots of the AXIe chassis. The error message displays the current FPGA version and the required FPGA version for that module.

- 1 Click **OK** to proceed with the FPGA firmware update.
- 2 On clicking **OK**, the following dialog box is displayed. Click **Yes** to proceed.

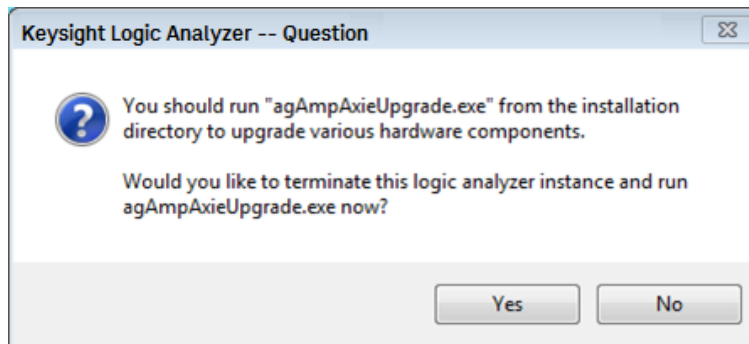

- 3 The following warning message is displayed to give you the opportunity to save data before any running analyzer sessions are closed. Choose **Yes** when you are ready to proceed.

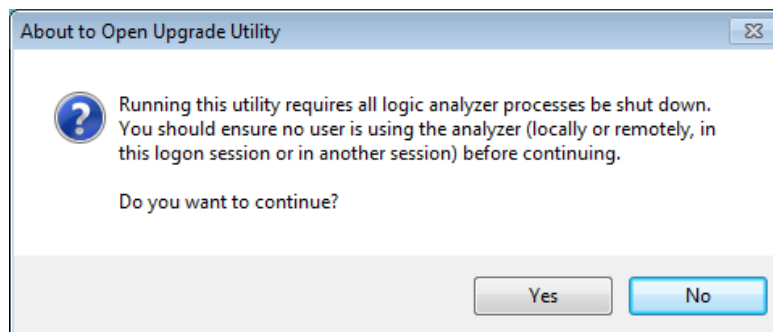

The AMP/AXIe Upgrade tool is launched.

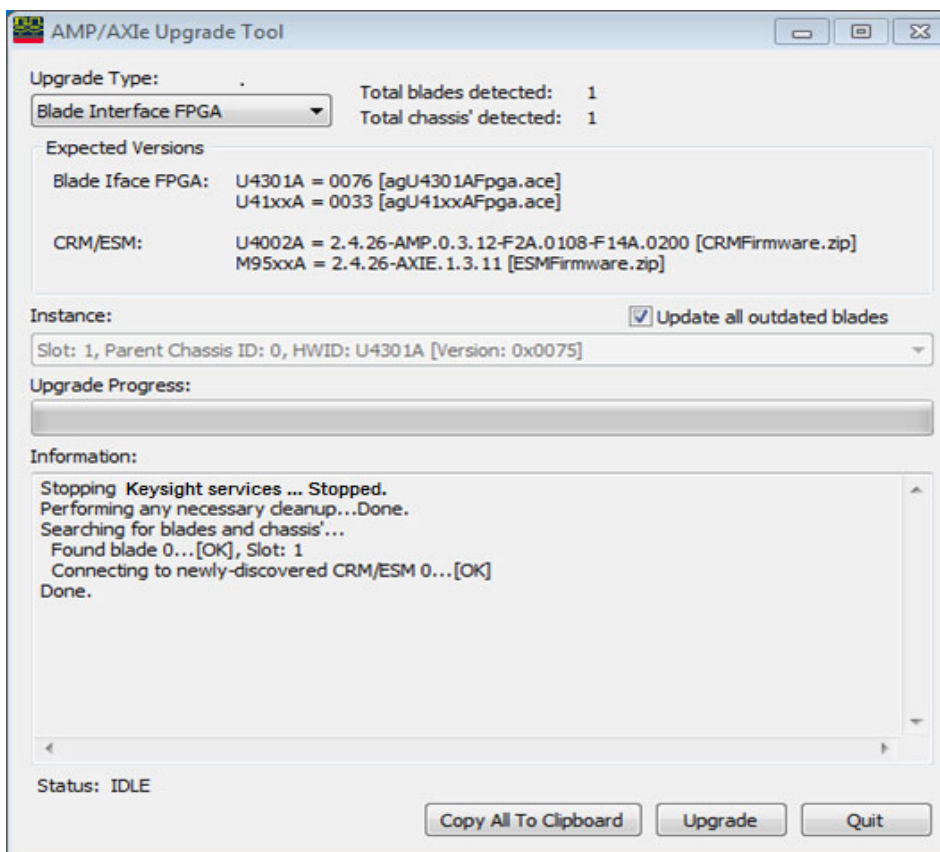

- 4 Select the **Blade Interface FPGA** option from the Upgrade Type drop-down listbox. The expected versions of FPGA are displayed for each of the instrument module types. You can compare these versions against the current FPGA versions listed in the Instance drop-down for each module.
- 5 Leave the **Update all outdated blades** checkbox selected. Doing so ensures that the update process automatically updates the FPGA firmware of all modules in the current chassis as needed.
- 6 Click **Upgrade** to start the update process.
- 7 The following interruption warning is displayed. Click **Yes** to continue.

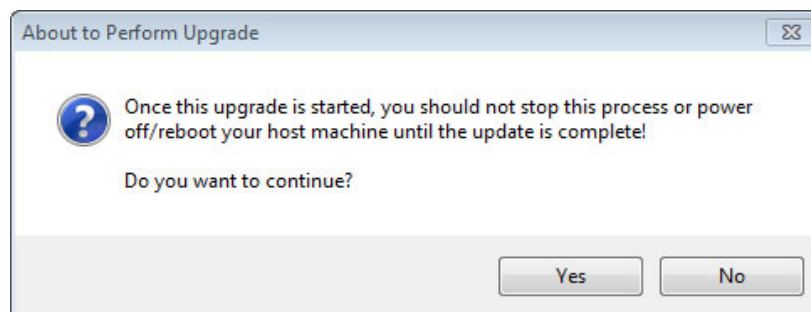

On starting the upgrade, the Status field at the bottom of the Upgrade tool indicates that an upgrade is in progress. After several minutes, the upgrade progress bar also starts displaying the progress of the upgrade. Wait for the progress bar to reach 100% which indicates that the upgrade is about to complete.

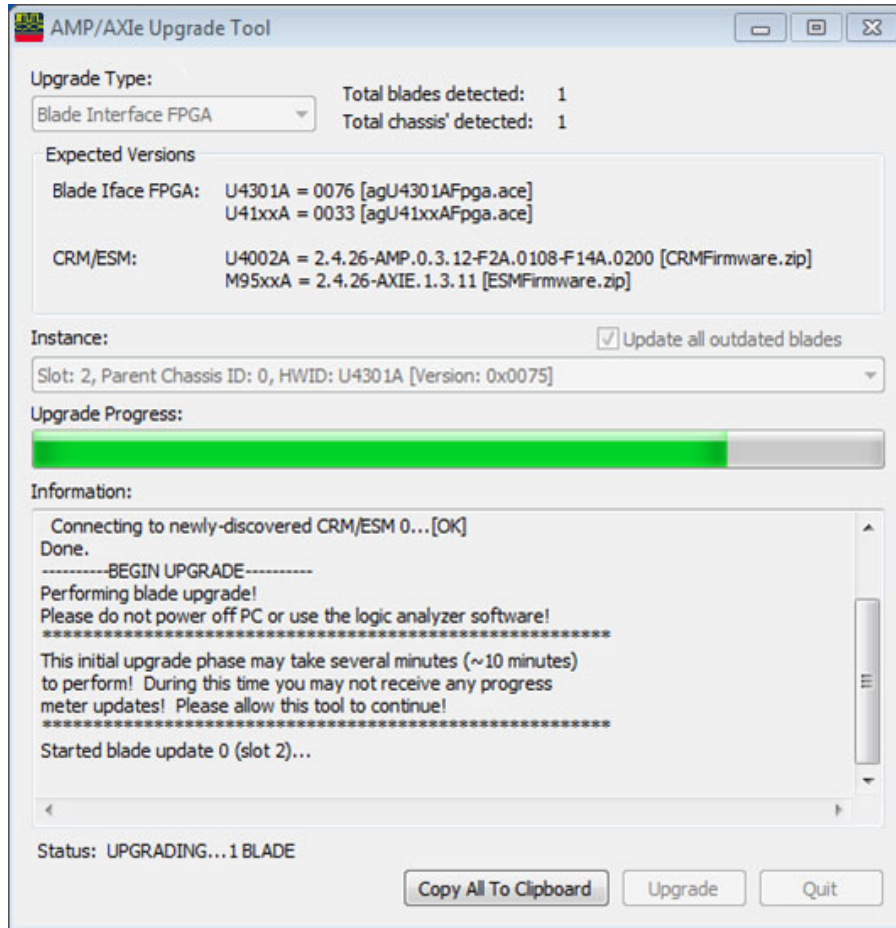
**CAUTION**

The update process will take from 10-30 minutes and all affected modules will be updated simultaneously. Do not interrupt the update process until it is completed. Failure to follow this rule may result in module(s) being left in a non-recoverable state.

Ensure that the host PC is not running on battery power and is not allowed to enter Standby, Hibernate or Sleep mode as this will cause the PCIe hosted network between the host and chassis to be idle and the update will be interrupted.

NOTE

If an interruption occurs and causes an FPGA update failure, the module update may be recovered in some cases. In such situations, do not power off the chassis. Instead, just restart the host PC and re-initiate the FPGA update process by launching the agAmpAxieUpgrade.exe GUI as before.

- 8 When the FPGA upgrade is complete, the Information box in the Upgrade tool displays a completion message similar to the message displayed in the following screen. Click **Quit** to display the power cycle information message.

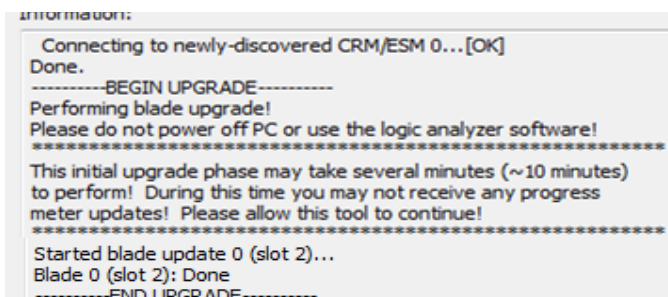

- 9 The following power-up sequence message dialog box is displayed. Read and follow the power-up sequence instructions. Then click **OK** to close the dialog box.

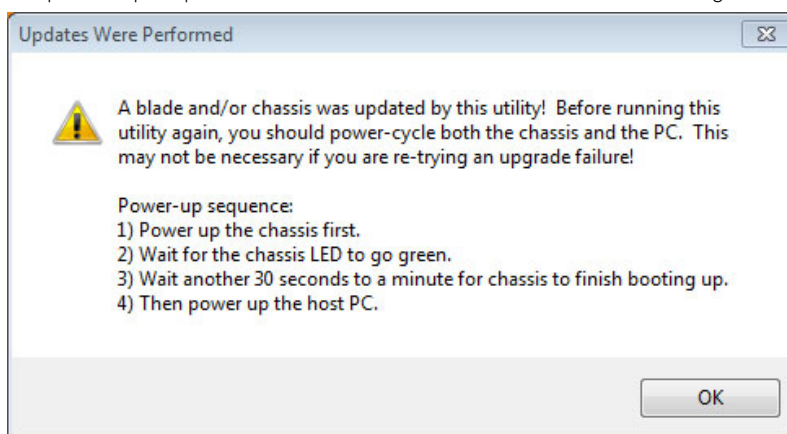

NOTE

The boot sequence for multiframe installations requires you to start the boot sequence on the master multiframe system and then wait for this chassis and host system to reach a fully booted status. The fully booted status is indicated by the green (ready) state of the Keysight Notification Center icon in the system tray. After this, initiate the chassis power up on the next intermediate slave in the multiframe installation.

NOTE

If you are using the AXIe Embedded Controller Module as the host computer, then you need not perform the host PC power up steps because the Embedded Controller startup is managed internally and the controller automatically starts after the chassis power is stable.

Upgrading a Module's BMC (IPMC) Firmware

At times, when you launch the Logic and Protocol Analyzer application after installing the Logic and Protocol Analyzer software, you may get the following notification by the **Logic Analyzer service**.

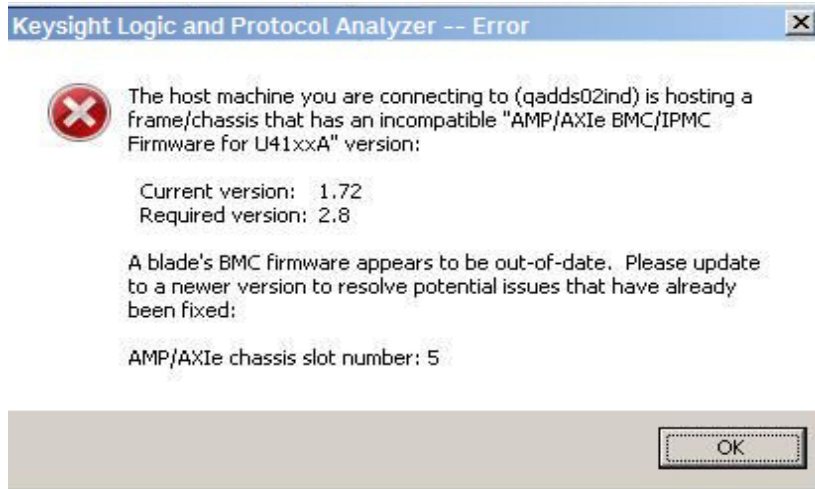

Such a notification indicates that the BMC firmware of one or more modules installed in the chassis is outdated and needs to be upgraded to the latest version provided with the Logic and Protocol Analyzer software. The error message displays the current BMC version detected for a module and the BMC version upgrade required for that module.

Though it is recommended to upgrade the BMC firmware immediately on receiving this notification, you can also choose to perform the upgrade at a later time. The notification will keep appearing on launching the Logic and Protocol Analyzer application until you perform the BMC upgrade.

To upgrade the BMC firmware on receiving the notification

- 1 Click **OK** in the BMC Upgrade notification to proceed with the BMC firmware upgrade.
- 2 The following warning message is displayed to give you the opportunity to save data before any running analyzer sessions are closed. Choose **Yes** when you are ready to proceed.

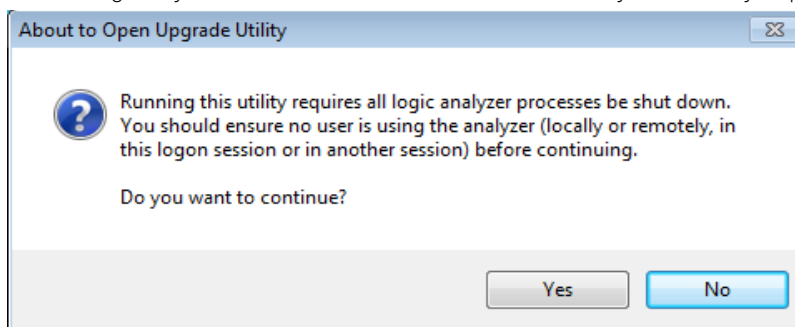

The AMP/AXIe Upgrade Tool is launched.

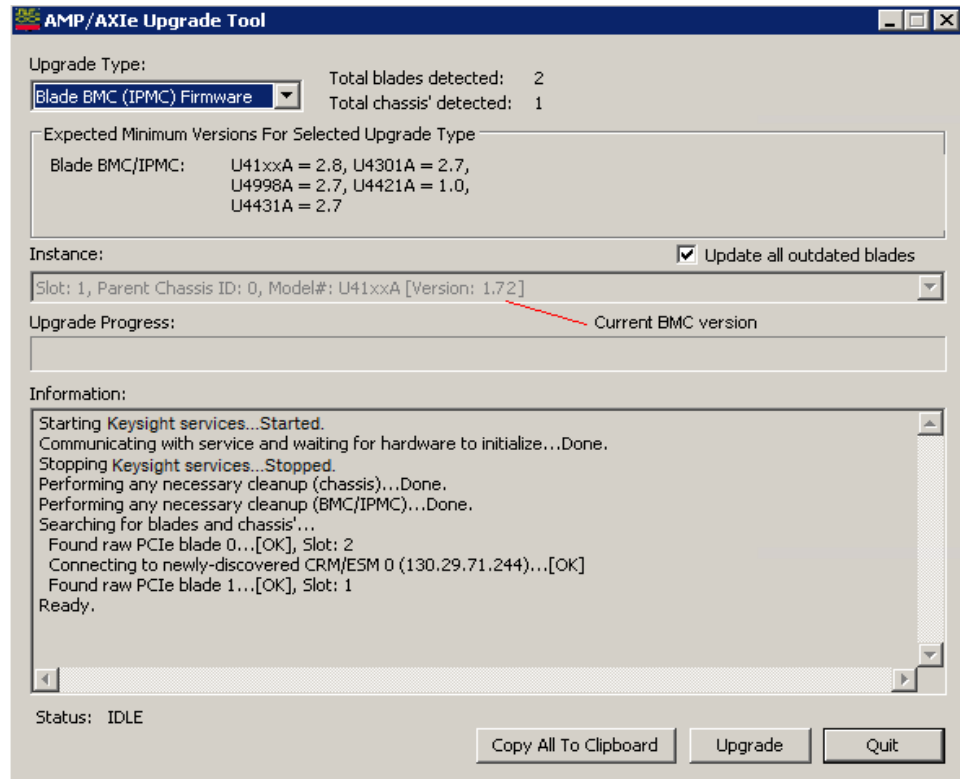

- 3 Select the **Blade BMC (IPMC) Firmware** option from the Upgrade Type drop-down listbox. The expected versions of BMC firmware are displayed for each of the instrument module types. You can compare these versions against the current BMC versions listed for each module in the Instance drop-down listbox.
- 4 Leave the **Update all outdated blades** checkbox selected. Doing so ensures that the update process automatically updates the BMC firmware of all modules in the current chassis as needed.
- 5 Click **Upgrade** to start the BMC upgrade process.

On starting the upgrade, the Status field at the bottom of the Upgrade tool indicates that an upgrade is in progress. The upgrade progress bar also starts displaying the progress of the upgrade. Wait for the progress bar to reach 100% which indicates that the upgrade is about to complete.

CAUTION

The update process will take a few minutes and all affected modules will be updated simultaneously. Do not interrupt the update process until it is completed. Failure to follow this rule may result in module(s) being left in a non-recoverable state.

Ensure that the host PC is not running on battery power and is not allowed to enter Standby, Hibernate or Sleep mode as this will cause the PCIe hosted network between the host and chassis to be idle and the update will be interrupted.

- 6 When the BMC upgrade is complete, the Information box in the Upgrade tool displays a completion message. Click **Quit** to display the power cycle information message.
- 7 A power-up sequence message dialog box is displayed. Read and follow the power-up sequence instructions. Then click **OK** to close the dialog box.

NOTE

The boot sequence for multiframe installations requires you to start the boot sequence on the master multiframe system and then wait for this chassis and host system to reach a fully booted status. The fully booted status is indicated by the green (ready) state of the Keysight Notification Center icon in the system tray. After this, initiate the chassis power up on the next intermediate slave in the multiframe installation.

NOTE

If you are using the AXIe Embedded Controller Module as the host computer, then you need not perform the host PC power up steps because the Embedded Controller startup is managed internally and the controller automatically starts after the chassis power is stable.

Initiating a BMC Firmware Upgrade Manually

You can also initiate the BMC firmware upgrade manually, if needed.

- 1 **Navigate** to C:/Program Files (x86)/Keysight Technologies/Logic Analyzer.
- 2 **Launch** the Keysight Amp/AXIe Upgrade Tool by **double-clicking** agAmpAxieUpgrade.exe.
- 3 Thereafter, perform the same steps as mentioned above in this topic for BMC upgrade.

Installing Additional Software Packages

In addition to the main application software package (Keysight Logic and Protocol Analyzer), you may need to install other software packages as well. This varies with the instrument module which you have installed in the chassis.

This topic describes these additional software packages that are mandatory/optional for an instrument module.

Downloading Additional Software Packages

To download a module's additional software components on the host computer:

- 1 Go to http://www.keysight.com/find/<module_model_number>. For instance, <http://www.keysight.com/find/U4431A>.
Model number is located on the front panel of the module.
- 2 **Click** the Technical support link.
- 3 **Click** the Drivers, Updates, & Examples tab.
- 4 **Click** the software link available in the Drivers, Updates, & Examples tab to start downloading the Setup EXE file.
- 5 Once the download completes, **double-click** the **Setup EXE** file to install the software.
- 6 Follow the on-screen instructions in the Install wizard.

U4154A/B Additional Software Packages

You can install a number of additional software packages for managing and using the U4154A/B Logic Analyzer module. These packages perform a specific function. For instance, the *DDR Setup Assistant* helps you properly set up a logic analyzer module based on the type of the module, DDR bus, and probing solution.

Some of the supported software packages for U4154A/B module are listed:

- DDR Setup Assistant
- DDR Bus Decoder
- Compliance Package

Setting up Communication between the Host PC and ESM of the AXIe chassis

When you have set up the hardware and installed the Logic and Protocol Analyzer software on the host PC, perform the following steps to ensure that the ESM communicates with the host PC and the chassis and the instrument modules are ready to use.

- 1 **Power down** first the host PC and then the AXIe chassis in which the instrument module is installed.
- 2 **Power on** the AXIe chassis.
- 3 Wait for a steady green Status light to appear on the ESM of the chassis. Wait for 2 minutes for all other components and modules to start properly.
- 4 **Power on** the host PC.
- 5 Wait for the Keysight Notification Center green dot icon to appear in the system tray on the host PC. The green dot icon indicates that the chassis and module instrument are ready to use and that communications between the host PC and instrument are functioning properly.

NOTE

If no notification icon becomes visible, check that the host PC operating system is not configured to hide system tray icons.

- 6 If the Keysight Notification Center displays a constant yellow or red icon, or if an icon fails to appear, this indicates a connectivity problem. Refer to any available on-screen warning or error messages for possible causes. You can also refer to "[Troubleshooting ESM Connectivity Issues](#)" on page 94 in this guide for help in troubleshooting the connectivity problems.

4 Accessing Instrument Module Documents

The user documents for an instrument module are installed at the following location when you install the Keysight Logic and Protocol Analyzer software.

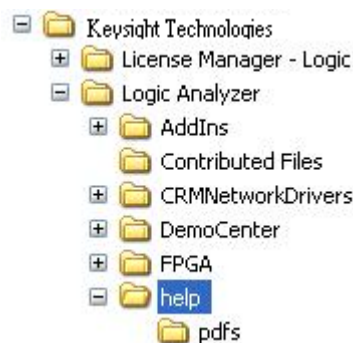

Figure 37 Location of User Documents

Besides this installation guide, the following are some documents which provide information about an instrument module.

- Keysight Logic and Protocol Analyzer User Guide - This user guide describes how to configure, control, and use a module to perform testing in various scenarios.
- Keysight Logic and Protocol Analyzer Online Help - This online help is accessible as a standalone help from the help folder displayed in the [Figure 37](#) or from the Keysight Logic Analyzer GUI (as an integrated help). It describes how to configure, control, and use the module hardware to perform testing in various scenarios.
- Context-sensitive Help - A context-sensitive HTML help page is available with each window and dialog box of the module's GUI components on clicking the Help button displayed within the GUI element.
- Service guide - The service guide for a module is available on www.keysight.com to help you troubleshoot a module or know about its service strategy.

Besides these documents, the printed Quick Start Guide accompanies the module shipment.

5 Troubleshooting and Service

Servicing a Module / 92
Troubleshooting USB Connectivity Issues / 93
Troubleshooting ESM Connectivity Issues / 94
Troubleshooting Host Computer related Problems / 97

This chapter provides information for troubleshooting problems that you might encounter while installing the hardware and software components of an instrument module in AXIe chassis.

Servicing a Module

The service strategy for a module is the replacement of defective module/parts. You can find the service guide for an instrument module on [www.keysight.com/find/ <model_number_of_module>](http://www.keysight.com/find/<model_number_of_module>). The service guide contains information for finding a defective assembly by testing and servicing the module.

When a problem has been detected with a module, carefully remove the module as per the documented procedure. The modules can be returned to Keysight Technologies for all service work, including troubleshooting.

Contact your nearest Keysight Technologies Sales Office for more details.

NOTE

The ESM which controls the chassis is not considered a serviceable module. If an ESM is determined to be bad, the entire chassis and ESM assembly must be returned for repair.

Contacting Keysight Technologies

To locate a sales or service office near you, go to www.keysight.com/find/contactus.

Troubleshooting USB Connectivity Issues

This topic provides information on how you can troubleshoot USB connectivity related problems between the host computer and AXIe chassis.

If you have connected the host computer and AXIe chassis via USB and facing problems in connectivity, then run the USB diagnostic utility named *agDiagnoseAxieUsb.exe*. This utility is installed when you install the Keysight Logic and Protocol Analyzer software version 5.50 or higher and is available in the installation directory of Logic and Protocol Analyzer software.

To run this utility, **double-click** the *agDiagnoseAxieUsb.exe*.

When you run this utility, it checks the USB setup and identifies the cause of USB connectivity issue.

Typically, a USB connectivity issue might be caused due to the following hardware or software related problems:

Cause of USB connectivity issue	Description of the cause	Solution
Missing drivers	The drivers needed for USB connectivity are missing. Specifically, the AX88178 driver is missing or fails to load when connecting to a host computer with Windows 7/Higher, software installation.	<p>If the AX88178 driver fails to load automatically, you should verify that the operating system is configured to automatically check the Windows Update driver database for this WHQL certified driver.</p> <p>On Windows 7/Higher:</p> <ol style="list-style-type: none"> 1 Right-click Computer and then select Properties. 2 Click the Advanced System Settings link on the left. 3 Click the Hardware tab. 4 Click the Device Installation Settings button, 5 Select the No, Let me choose what to do radio button. 6 Select the Install driver software from Windows Update if it is not found on my computer option and click Save changes. <p>After changing these settings, you may need to remove and then re-insert the USB cable.</p>
Outdated USB FPGA	The currently installed version of the AXIe chassis firmware is outdated and requires an upgrade.	Upgrade the chassis firmware. Refer to the topic "Upgrading Chassis Firmware" on page 72 to know more.
Presence of an AXIe based embedded controller module in the AXIe chassis	If you have installed an embedded controller module in slot 1 of the chassis, then this module serves as the host computer. You should not connect the AXIe chassis to multiple operating host computers at the same time. The USB connectivity with any external host computer is disabled due to the presence of an embedded controller module.	<p>Remove the embedded controller module from the chassis slot in which it is installed. Then try connecting the chassis and external host computer via USB.</p> <p>If you plan to use the Keysight AXIe Embedded Controller module as the host computer, then do not connect an external host computer to the chassis.</p>
An external PCIe cable is attached to the PCIe port on the chassis' ESM	If you have connected a PCIe cable to the PCIe port located on the front panel of the ESM in the chassis, then the PCIe connection overrides and disables the USB connection.	Remove the PCIe cable.

If the underlying cause of the USB connectivity issue is not identified or you have additional questions, contact Keysight Technologies sales or support at:

<http://www.keysight.com/find/contactus>

Troubleshooting ESM Connectivity Issues

This topic describes how to troubleshoot communication problems that might be encountered when the operating system on the host PC does not accurately configure all network connections or if the host-side firewall is not configured correctly. You will know that there might be a communication issue between the host and chassis when:

- a "green dot" Keysight Notification Center icon in the system tray is not displayed. This green dot icon indicates that the instrument is ready for use
- a chassis firmware or module FPGA firmware upgrade fails to complete successfully.
If you use just the cabled PCIe connection and encounter connectivity problems (or even if you suspect communication problems when using the recommended network connection scheme), then perform the following steps.

Ensure that there is at least one valid AXIe supported module installed and seated fully in the AXIe chassis

See the ["Supported AXIe Based Logic Analysis and Protocol Test Modules"](#) on page 10 for a list of supported modules.

- Modules that are not seated fully into the chassis backplane can cause the PCIe network to not configure fully on the host due to the absence of a PCIe endpoint in the PCIe channel.
- Modules are not hot-swappable. Power down the chassis before reinstalling any modules, and then follow the standard power-up sequence.
- The host system will not properly detect the entire PCIe channel and will not enumerate the PCIe-hosted network unless the Logic and Protocol Analyzer application software is installed.

Ensure that the network interface is enabled and configured correctly

- 1 Open the Network Sharing Center or the Network Connections manger from the Control Panel, depending on which operating system platform the host PC is running.
- 2 Locate the network hosted via the PCIe cable. It will be the one running on the Intel(R) PRO/1000 PL device.
If the PCIe-hosted network is not present, verify that the network device is present and the driver is loaded properly in Device Manager (skip to the section below on driver troubleshooting).
- 3 Double-click the **PCIe network** and choose **Properties**.
- 4 Choose the **TCP/IPv4** item and click the **Properties** button.
- 5 Ensure that the network is set to Obtain an IP address automatically as static addressing is discouraged.
- 6 Check to see if the Keysight Notification Center icon has appeared and is green (this may take a few minutes).

If communications are not restored, try restarting the Logic Analysis service:

- a Right-click (My)Computer > Manage > Services and Applications > Services
- b Locate the Keysight Logic Analysis service, then right-click it and choose Restart.

If communications are not restored, perform a full system reboot.

- 7 If the instrument still does not show up as ready (Keysight Notification Center icon is not displayed as green), refer sections below on PCIe network driver and firewall exceptions verifications.

Ensure that the PCIe network driver is functional and enabled on the host PC

- 1 Access **Device Manager** on the host PC.
Right-click (My)Computer > Manage > Device Manager > Network Adapters
- 2 Check if the PCIe network connection is displayed under Network Adapters.
When the host PC and chassis are connected via PCIe, the PCIe network adapter is displayed as Intel(R) PRO/1000 PL network connection in Device Manager.
If the PRO/1000 network adapter is not displayed, power cycle the entire system as per the steps described in ["Power up the Connected Hardware Components"](#) on page 57.

- 3 Check if the PCIe network adapter is enabled and working properly.
 - If it is disabled, right-click it and enable it.
 - If it has a driver error indicator (a yellow triangle with an exclamation point), this indicates a driver issue. Re-install the driver manually:
 - It is recommended to perform the driver re-install with the chassis connected to the host via the PCIe cable and adapter and powered on.
 - The driver installer package is available at the following location in the Logic Analyzer install directory.
`<Program Files Dir>\Keysight Technologies\Logic Analyzer\CRMNetworkDrivers\PCIe` where `<Program Files Dir>` is either `C:\Program Files\` or `C:\Program Files (x86)\` depending on whether the host operating system is a 32 or 64 bit installation.
 - Choose the appropriate subfolder within the PCIe folder to get the driver installer as per your OS platform (Vista/Win7/Win8/Win8.1 and 32-bit/64-bit) and run the `Prowinx.exe` driver installer from that subfolder.
 - Retain the default choices when prompted and continue until the driver installation completes.
 - Power cycle the entire system as per the steps described in "[Power up the Connected Hardware Components](#)" on page 57.
 - If these steps fail to resolve a driver issue, a full uninstall and reinstall of the Logic and Protocol Analyzer application might be necessary. The application installer always reinstalls the proprietary Intel(R) PRO/1000 PL network device driver.

Ensure that the Windows Firewall has the proper exceptions.

If all other indications appear normal yet the host still fails to connect to the chassis or if a firmware upgrade fails, the Windows firewall may not be configured to allow an exception for one or more critical components of Logic and Protocol Analyzer software.

Normally, all firewall exceptions are configured properly during the Logic and Protocol Analyzer application installation. Due to individual host system configurations, it is possible that an exception may not have been configured properly for the network profile that needs it. Most 3rd party firewalls follow the standard windows firewall exception list. So configuring this list should allow most security software to run properly with full instrument operation.

- 1 Open the Firewall management utility by clicking **Control Panel** > Windows Firewall.
- 2 Select **Allow** a program or feature through Windows Firewall (for Windows 7 or higher).
- 3 Under the program list, locate the following programs and verify that these are allowed (that is, these are listed and checked).
 - Keysight Technologies AMP/AXIe Upgrade Tool
 - Keysight Technologies Logic Analysis Service
 - Keysight Technologies Logic and Protocol Analyzer Main App
 - chassisUpdater

In Windows 7 or higher, these must have exceptions for all the three network types - Domain, Home/Work (Private) and Public.
- 4 To modify an exception in Win7/Higher:
 - a Click the **Change settings** button.
 - b Select the **desired program exception** and **select all** of the available network types.
 - c Click **OK** when you have modified the exception.
- 5 To Add a missing exception:
 - a In the Allowed Programs utility, click the **Add Program...** or **Allow another program...** button.
 - b Either select the desired program from the list or click the Browse... button and manually locate it in the file system. Here are the relevant paths of the programs:
 - `<Logic Analyzer install directory>\agAmpAxieUpgrade.exe`

- <Logic Analyzer install directory>\agLogicSvc.exe
- <Logic Analyzer install directory>\agLogic.exe
- the chassisUpdater exception is created automatically during the firmware upgrade process and does not have a fixed location.
- c For Windows 7/ higher: **Click** the Network location types button. Then select all the network types and click **OK** in the Network location types dialog box.
- d Click **Add** (Windows 7/higher) to finish adding the exception.
- e Click **OK** for any open dialog boxes and close any remaining windows.

Besides the above-mentioned standard firewall exceptions, the ICMP ping (echo) request must also be allowed through the firewall for the chassis and host to communicate successfully. This is normally configured properly by the Logic and Protocol Analyzer application installer, but to verify or to enable it manually, perform the following steps:

In Windows 7/ higher

- 1 **Open** the Advanced Firewall management tool by clicking Control Panel > Windows Firewall > Advanced settings.
- 2 **Click** Inbound Rules.
- 3 Scroll down to the rule(s) for File and Printer Sharing (Echo Request - ICMPv4-In).
- 4 Ensure that there is a rule and it is enabled for Private, Public and Domain network profiles, or that there is an enabled rule for All profile.
 - To enable a rule, right-click the rule and select **Enable Rule**.
- 5 Close the window when the rule is enabled.

Ensure that the Web browser proxy setting allows a connection to the AXIe chassis

If a chassis firmware upgrade fails because the AXIe chassis status page will not load, check the proxy settings for the Web browser. For the AXIe chassis-hosted web page that runs the chassis firmware upgrade to load properly, the proxy server on the local network must allow connections to it. If the upgrade page hangs at the loading screen:

- 1 **Open** the LAN settings dialog by clicking Control Panel > Internet Options > Connections tab > LAN settings button.
- 2 **Unchecked** Use automatic configuration script and click **OK** for all open dialog boxes.

The browser should now finish loading the AXIe firmware update page.

- Once the upgrade completes, you may revert this setting back to its original state if required by your local IT policy.
- Contact your local IT department for assistance if this setting cannot be configured by the user.

Troubleshooting Host Computer related Problems

The Keysight AXIe Embedded Controller module performs poorly and the operating system seems sluggish

This can happen if there are multiple hosts trying to communicate with the chassis at once. In such a situation, the module's embedded operating system is affected by a low-level driver resource conflict.

To resolve this, ensure that there are no external remote host computers still connected to the chassis and running when the embedded controller module is used as the host computer.

