

---

# Keysight Infiniium Oscilloscopes

# Notices

© Keysight Technologies, Inc. 2007-2024

No part of this manual may be reproduced in any form or by any means (including electronic storage and retrieval or translation into a foreign language) without prior agreement and written consent from Keysight Technologies, Inc. as governed by United States and international copyright laws.

## Revision

Version 06.74.00702

## Edition

January 2024

Available in electronic format only

Published by:

Keysight Technologies, Inc.  
1900 Garden of the Gods Road  
Colorado Springs, CO 80907 USA

## Trademarks

Infinium is a registered trademark of Infinium Technologies AG. The Infinium mark is used with the kind approval of Infinium Technologies, AG.

MIPI® service marks and logo marks are owned by MIPI Alliance, Inc. and any use of such marks by Keysight Technologies is under license. Other service marks and trade names are those of their respective owners.

PCI-SIG®, PCIe®, and the PCI Express® are US registered trademarks and/or service marks of PCI-SIG.

## Warranty

**The material contained in this document is provided "as is," and is subject to being changed, without notice, in future editions. Further, to the maximum extent permitted by applicable law, Keysight disclaims all warranties, either express or implied, with regard to this manual and any information contained herein, including but not limited to the implied warranties of merchantability and fitness for a particular purpose. Keysight shall not be liable for errors or for incidental or consequential damages in connection with the furnishing, use, or performance of this document or of**

**any information contained herein. Should Keysight and the user have a separate written agreement with warranty terms covering the material in this document that conflict with these terms, the warranty terms in the separate agreement shall control.**

## Technology License

The hardware and/or software described in this document are furnished under a license and may be used or copied only in accordance with the terms of such license.

## U.S. Government Rights

The Software is "commercial computer software," as defined by Federal Acquisition Regulation ("FAR") 2.101. Pursuant to FAR 12.212 and 27.405-3 and Department of Defense FAR Supplement ("DFARS") 227.7202, the U.S. government acquires commercial computer software under the same terms by which the software is customarily provided to the public. Accordingly, Keysight provides the Software to U.S. government customers under its standard commercial license, which is embodied in its End User License Agreement (EULA), a copy of which can be found at [www.keysight.com/find/sweula](http://www.keysight.com/find/sweula). The license set forth in the EULA represents the exclusive authority by which the U.S. government may use, modify, distribute, or disclose the Software. The EULA and the license set forth therein, does not require or permit, among other things, that Keysight: (1) Furnish technical information related to commercial computer software or commercial computer software documentation that is not customarily provided to the public; or (2) Relinquish to, or otherwise provide, the government rights in excess of these rights customarily provided to the public to use, modify, reproduce, release, perform, display, or disclose commercial computer software or commercial computer software documentation. No additional government requirements beyond those set forth in the EULA shall apply, except to the extent that those terms, rights, or licenses are explicitly required from all providers of commercial computer software pursuant to the FAR and the DFARS and are set forth specifically in writing elsewhere in the EULA. Keysight

shall be under no obligation to update, revise or otherwise modify the Software. With respect to any technical data as defined by FAR 2.101, pursuant to FAR 12.211 and 27.404.2 and DFARS 227.7102, the U.S. government acquires no greater than Limited Rights as defined in FAR 27.401 or DFAR 227.7103-5 (c), as applicable in any technical data.

## Safety Notices

### CAUTION

A **CAUTION** notice denotes a hazard. It calls attention to an operating procedure, practice, or the like that, if not correctly performed or adhered to, could result in damage to the product or loss of important data. Do not proceed beyond a **CAUTION** notice until the indicated conditions are fully understood and met.

### WARNING

A **WARNING** notice denotes a hazard. It calls attention to an operating procedure, practice, or the like that, if not correctly performed or adhered to, could result in personal injury or death. Do not proceed beyond a **WARNING** notice until the indicated conditions are fully understood and met.

## In This Book

This book is your guide to programming Infiniium oscilloscopes that have the 5.00 or greater, next-generation user interface software. Supported models include:

- 9000 Series and 9000H Series oscilloscopes.
- S-Series oscilloscopes.
- 90000A Series oscilloscopes.
- 90000 X-Series oscilloscopes.
- V-Series oscilloscopes.
- 90000 Q-Series oscilloscopes.
- Z-Series oscilloscopes.
- Infiniium Offline oscilloscope analysis software.

In this book, **Chapter 1**, “What's New,” starting on page 47, describes programming command changes in the latest version of oscilloscope software.

**Chapter 2**, “Setting Up,” starting on page 117, describes the steps you must take before you can control the oscilloscope with remote programs.

The next several chapters give you an introduction to programming the oscilloscopes, along with necessary conceptual information. These chapters describe basic program communications, interface, syntax, data types, and status reporting:

- **Chapter 3**, “Introduction to Programming,” starting on page 125
- **Chapter 4**, “Programming Conventions,” starting on page 161
- **Chapter 5**, “LAN, USB, and GPIB Interfaces,” starting on page 169
- **Chapter 6**, “Message Communication and System Functions,” starting on page 181
- **Chapter 7**, “Status Reporting,” starting on page 185
- **Chapter 8**, “Sequential (Blocking) vs. Overlapped Commands,” starting on page 215
- **Chapter 9**, “Using :PDER? Instead of \*OPC?,” starting on page 217
- **Chapter 10**, “Remote Acquisition Synchronization,” starting on page 219

The next chapters describe the commands used to program the oscilloscopes. Each chapter describes the set of commands that belong to an individual subsystem, and explains the function of each command.

- **Chapter 11**, “Acquire Commands,” starting on page 237
- **Chapter 12**, “Analyze Commands,” starting on page 271
- **Chapter 13**, “Bus Commands,” starting on page 317
- **Chapter 14**, “Calibration Commands,” starting on page 329
- **Chapter 15**, “Channel Commands,” starting on page 341
- **Chapter 16**, “Common Commands,” starting on page 449

- **Chapter 17**, “Digital Commands,” starting on page 481
- **Chapter 18**, “Disk Commands,” starting on page 489
- **Chapter 19**, “Display Commands,” starting on page 513
- **Chapter 20**, “Function Commands,” starting on page 569
- **Chapter 21**, “Hardcopy Commands,” starting on page 645
- **Chapter 22**, “Histogram Commands,” starting on page 651
- **Chapter 23**, “Hosted Commands,” starting on page 667
- **Chapter 24**, “InfiniiScan (ISCan) Commands,” starting on page 693
- **Chapter 25**, “Lane (Equalization) Commands,” starting on page 715
- **Chapter 26**, “Limit Test Commands,” starting on page 767
- **Chapter 27**, “Lister Commands,” starting on page 777
- **Chapter 28**, “:LXI Commands,” starting on page 781
- **Chapter 29**, “Marker Commands,” starting on page 783
- **Chapter 30**, “Mask Test Commands,” starting on page 817
- **Chapter 31**, “Measure Commands,” starting on page 883
- **Chapter 32**, “Pod Commands,” starting on page 1211
- **Chapter 33**, “Root Level Commands,” starting on page 1217
- **Chapter 34**, “Serial Bus Commands,” starting on page 1255
- **Chapter 35**, “Self-Test Commands,” starting on page 1345
- **Chapter 36**, “System Commands,” starting on page 1349
- **Chapter 37**, “Time Base Commands,” starting on page 1369
- **Chapter 38**, “Trigger Commands,” starting on page 1383
- **Chapter 39**, “Waveform Commands,” starting on page 1583
- **Chapter 40**, “Waveform Memory Commands,” starting on page 1649
- **Chapter 41**, “Xtalk (Crosstalk Analysis) Commands,” starting on page 1665

**Chapter 42**, “Obsolete and Discontinued Commands,” starting on page 1703, describes obsolete (deprecated) commands that still work but have been replaced by newer commands, and lists discontinued commands that are no longer supported.

**Chapter 43**, “Error Messages,” starting on page 1799, describes error messages.

**Chapter 44**, “Example Programs,” starting on page 1813, shows example programs in various languages using the VISA COM, VISA, and SICL libraries.

Finally, **Chapter 45**, “Reference,” starting on page 1945, contains file format descriptions.

### See Also

- For more information on using the SICL, VISA, and VISA COM libraries in general, see the documentation that comes with the Keysight IO Libraries Suite.
- For information on controller PC interface configuration, see the documentation for the interface card used (for example, the Keysight 82350A GPIB interface).
- For information on oscilloscope front-panel operation, see the *User's Guide*.
- For detailed connectivity information, refer to the *Keysight Technologies USB/LAN/GPIB Connectivity Guide*. For a printable electronic copy of the *Connectivity Guide*, direct your Web browser to [www.keysight.com](http://www.keysight.com) and search for "Connectivity Guide".
- For the latest versions of this and other manuals, see: <http://www.keysight.com/find/Infiniium-manuals>



# Contents

In This Book / 3

## 1 What's New

What's New in Version 6.74	/ 49
What's New in Version 6.73	/ 50
What's New in Version 6.72	/ 51
What's New in Version 6.71	/ 52
What's New in Version 6.70	/ 54
What's New in Version 6.60	/ 56
What's New in Version 6.55	/ 58
What's New in Version 6.50	/ 59
What's New in Version 6.40	/ 61
What's New in Version 6.30	/ 67
What's New in Version 6.20	/ 71
What's New in Version 6.10	/ 74
What's New in Version 6.00	/ 76
What's New in Version 5.75	/ 80
What's New in Version 5.70	/ 81
What's New in Version 5.60	/ 84
What's New in Version 5.52	/ 87
What's New in Version 5.51	/ 88
What's New in Version 5.50	/ 89
What's New in Version 5.30	/ 95
What's New in Version 5.20	/ 97
What's New in Version 5.10	/ 99
What's New in Version 5.00	/ 100
What's New in Version 4.60	/ 104
What's New in Version 4.50	/ 105

What's New in Version 4.30	/	106
What's New in Version 4.20	/	107
What's New in Version 4.10	/	108
What's New in Version 4.00	/	109
What's New in Version 3.50	/	110
What's New in Version 3.20	/	112
What's New in Version 3.11	/	113
What's New in Version 3.10	/	114

## 2 Setting Up

Step 1. Install Keysight IO Libraries Suite software	/	118
Step 2. Connect and set up the oscilloscope	/	119
Using the USB (Device) Interface	/	119
Using the LAN Interface	/	119
Step 3. Verify the oscilloscope connection	/	120

## 3 Introduction to Programming

Communicating with the Oscilloscope	/	127
Instructions	/	128
Instruction Header	/	129
White Space (Separator)	/	130
Braces	/	131
Ellipsis	/	132
Square Brackets	/	133
Command and Query Sources	/	134
Program Data	/	135
Header Types	/	136
Simple Command Header	/	136
Compound Command Header	/	136
Combining Commands in the Same Subsystem	/	137
Common Command Header	/	137
Duplicate Mnemonics	/	137
Query Headers	/	138
Program Header Options	/	139



Character Program Data /	140
Numeric Program Data /	141
Embedded Strings /	142
Program Message Terminator /	143
Common Commands within a Subsystem /	144
Selecting Multiple Subsystems /	145
Programming Getting Started /	146
Referencing the IO Library /	147
Opening the Oscilloscope Connection via the IO Library /	148
Initializing the Interface and the Oscilloscope /	149
Autoscale /	149
Setting Up the Oscilloscope /	150
Example Program /	151
Using the DIGitize Command /	152
Receiving Information from the Oscilloscope /	154
String Variable Example /	155
Numeric Variable Example /	156
Definite-Length Block Response Data /	157
Multiple Queries /	158
Oscilloscope Status /	159

#### 4 Programming Conventions

Truncation Rule /	162
The Command Tree /	163
Command Types /	163
Tree Traversal Rules /	163
Tree Traversal Examples /	164
Infinity Representation /	166
Response Generation /	167
EOI /	168

#### 5 LAN, USB, and GPIB Interfaces

LAN Interface Connector /	170
GPIB Interface Connector /	171

Default Startup Conditions /	172
Interface Capabilities /	173
GPIB Command and Data Concepts /	174
Communicating Over the GPIB Interface /	175
Interface Select Code /	175
Oscilloscope Address /	175
Communicating Over the LAN Interface /	176
Communicating via Telnet and Sockets /	177
Telnet /	177
Sockets /	177
Bus Commands /	179
Device Clear /	179
Group Execute Trigger /	179
Interface Clear /	179

## 6 Message Communication and System Functions

Protocols /	182
Functional Elements /	182
Protocol Overview /	182
Protocol Operation /	183
Protocol Exceptions /	183
Suffix Multiplier /	183
Suffix Unit /	184

## 7 Status Reporting

Status Reporting Data Structures /	188
Status Byte Register /	190
Service Request Enable Register /	192
Message Event Register /	193
Trigger Event Register /	194
Standard Event Status Register /	195
Standard Event Status Enable Register /	196
Operation Status Register /	197
Operation Status Enable Register /	198
Mask Test Event Register /	199
Mask Test Event Enable Register /	200

- Acquisition Done Event Register / 201
- Process Done Event Register / 202
- Trigger Armed Event Register / 203
- Auto Trigger Event Register / 204
- Error Queue / 205
- Output Queue / 206
- Message Queue / 207
- Clearing Registers and Queues / 208
- Example: Checking for Armed Status / 210

## 8 Sequential (Blocking) vs. Overlapped Commands

## 9 Using :PDER? Instead of \*OPC?

## 10 Remote Acquisition Synchronization

- Programming Flow / 220
- Setting Up the Oscilloscope / 221
- Acquiring a Waveform / 222
- Retrieving Results / 223
- Acquisition Synchronization / 224
  - Blocking Synchronization / 224
  - Polling Synchronization With Timeout / 224
  - Example: Blocking and Polling Synchronization / 225
- Single Shot Device Under Test (DUT) / 234
- Averaging Acquisition Synchronization / 235

## 11 Acquire Commands

- :ACQUIRE:AVERage / 239
- :ACQUIRE[:AVERage]:COUNT / 240
- :ACQUIRE:BANDwidth / 241
- :ACQUIRE:BANDwidth:FRAME? / 243
- :ACQUIRE:BANDwidth:TESTLIMITS? / 244
- :ACQUIRE:COMplete / 245
- :ACQUIRE:COMplete:STATe / 247
- :ACQUIRE:HRESolution / 248
- :ACQUIRE:INTerpolate / 250
- :ACQUIRE:MODE / 251

:ACQUIRE:POINTS[:ANALog] – Memory depth / 253  
 :ACQUIRE:POINTS:AUTO / 255  
 :ACQUIRE:POINTS:DIGital? / 256  
 :ACQUIRE:POINTS:TESTLIMITS? / 257  
 :ACQUIRE:REDge – RealEdge Channel Inputs (90000 Q-Series, Z-Series) / 258  
 :ACQUIRE:RESPonse (90000A Series, 90000 X-Series, V-Series, 90000 Q-Series,  
 Z-Series) / 259  
 :ACQUIRE:SEGmented:AUTOplay / 260  
 :ACQUIRE:SEGmented:COUNt / 261  
 :ACQUIRE:SEGmented:INDex / 262  
 :ACQUIRE:SEGmented:PLAY / 263  
 :ACQUIRE:SEGmented:PRATe / 264  
 :ACQUIRE:SEGmented:TTAGs / 265  
 :ACQUIRE:SRATe[:ANALog] – Analog Sample Rate / 266  
 :ACQUIRE:SRATe[:ANALog]:AUTO / 267  
 :ACQUIRE:SRATe:DIGital – Digital Channels Sample Rate / 268  
 :ACQUIRE:SRATe:DIGital:AUTO / 269  
 :ACQUIRE:SRATe:TESTLIMITS? / 270

## 12 Analyze Commands

:ANALyze:AEDGes / 273  
 :ANALyze:CLOCK / 274  
 :ANALyze:CLOCK:METHod / 275  
 :ANALyze:CLOCK:METHod:ALIGn / 279  
 :ANALyze:CLOCK:METHod:DEEMphasis / 280  
 :ANALyze:CLOCK:METHod:EDGE / 281  
 :ANALyze:CLOCK:METHod:IDLe / 283  
 :ANALyze:CLOCK:METHod:JTF / 284  
 :ANALyze:CLOCK:METHod:OJTF / 286  
 :ANALyze:CLOCK:METHod:PLLadvanced / 288  
 :ANALyze:CLOCK:METHod:PLLTrack / 289  
 :ANALyze:CLOCK:METHod:SKEW / 290  
 :ANALyze:CLOCK:METHod:SKEW:AUTomatic / 291  
 :ANALyze:CLOCK:METHod:SOURce / 292  
 :ANALyze:CLOCK:TIME / 293  
 :ANALyze:CLOCK:VERTical / 295  
 :ANALyze:CLOCK:VERTical:OFFSet / 296  
 :ANALyze:CLOCK:VERTical:RANGe / 297  
 :ANALyze:SIGNal:DATarate / 298  
 :ANALyze:SIGNal:MIXer:CABLEloss / 300  
 :ANALyze:SIGNal:MMWave:CALibrate / 301  
 :ANALyze:SIGNal:MMWave:CFRequency / 302

:ANALyze:SIGNal:MMWave:CONNect / 303  
:ANALyze:SIGNal:MMWave:LOADdress / 304  
:ANALyze:SIGNal:MMWave:MBANdwidth / 305  
:ANALyze:SIGNal:PATTern:CLEar / 306  
:ANALyze:SIGNal:PATTern:LOAD / 307  
:ANALyze:SIGNal:PATTern:PLENght / 308  
:ANALyze:SIGNal:PATTern:SMAP / 309  
:ANALyze:SIGNal:SYMBOLrate / 310  
:ANALyze:SIGNal:TYPE / 312  
:ANALyze:VIEW / 315

### 13 Bus Commands

:BUS:B<N>:TYPE / 318  
:BUS<B>:BIT<M> / 320  
:BUS<B>:BITS / 321  
:BUS<B>:CLEar / 322  
:BUS<B>:CLOCK / 323  
:BUS<B>:CLOCK:SLOPe / 324  
:BUS<B>:DISPlay / 325  
:BUS<B>:LABel / 326  
:BUS<B>:READout / 327

### 14 Calibration Commands

:CALibrate:DATE? / 331  
:CALibrate:OUTPut / 332  
:CALibrate:OUTPut:AUX / 334  
:CALibrate:OUTPut:AUX:RTIME / 335  
:CALibrate:OUTPut:CAL / 336  
:CALibrate:SKEW / 337  
:CALibrate:STATus? / 338  
:CALibrate:TEMP? / 339

### 15 Channel Commands

:CHANnel<N>:BWLimit (9000 Series, 9000H Series, S-Series) / 344  
:CHANnel<N>:COMMonmode / 345  
:CHANnel<N>:DIFFerential / 346  
:CHANnel<N>:DIFFerential:SKEW / 347  
:CHANnel<N>:DISPlay / 348  
:CHANnel<N>:DISPlay:AUTO / 349  
:CHANnel<N>:DISPlay:OFFSet / 351  
:CHANnel<N>:DISPlay:RANGe / 353

:CHANnel<N>:DISPlay:SCALe / 355  
:CHANnel<N>:INPut / 357  
:CHANnel<N>:INVert / 358  
:CHANnel<N>:ISIM:APPLy / 359  
:CHANnel<N>:ISIM:BANDwidth / 360  
:CHANnel<N>:ISIM:BWLimit / 362  
:CHANnel<N>:ISIM:BWLimit:TYPE / 364  
:CHANnel<N>:ISIM:CONVolve / 365  
:CHANnel<N>:ISIM:CORRection / 366  
:CHANnel<N>:ISIM:DEConvolve / 368  
:CHANnel<N>:ISIM:DELay / 369  
:CHANnel<N>:ISIM:NORMAlize / 370  
:CHANnel<N>:ISIM:PEXTraction / 371  
:CHANnel<N>:ISIM:SPAN / 373  
:CHANnel<N>:ISIM:STATe / 374  
:CHANnel<N>:LABel / 375  
:CHANnel<N>:OFFSet / 376  
:CHANnel<N>:PROBe:ACCAL / 377  
:CHANnel<N>:PROBe:ATTenuation / 379  
:CHANnel<N>:PROBe:AUTOzero / 380  
:CHANnel<N>:PROBe:COUPLing / 381  
:CHANnel<N>:PROBe:EADapter / 382  
:CHANnel<N>:PROBe:ECOupling / 385  
:CHANnel<N>:PROBe:EXTernal / 386  
:CHANnel<N>:PROBe:EXTernal:GAIN / 387  
:CHANnel<N>:PROBe:EXTernal:OFFSet / 388  
:CHANnel<N>:PROBe:EXTernal:UNITs / 389  
:CHANnel<N>:PROBe:GAIN / 390  
:CHANnel<N>:PROBe:HEAD:ADD / 391  
:CHANnel<N>:PROBe:HEAD:DELeTe ALL / 392  
:CHANnel<N>:PROBe:HEAD:SELeCt / 393  
:CHANnel<N>:PROBe:HEAD:VTERm / 394  
:CHANnel<N>:PROBe:ID? / 395  
:CHANnel<N>:PROBe:INFO? / 396  
:CHANnel<N>:PROBe:MODE / 397  
:CHANnel<N>:PROBe:PRECprobe:BANDwidth / 398  
:CHANnel<N>:PROBe:PRECprobe:CALibration / 399  
:CHANnel<N>:PROBe:PRECprobe:DELay / 400  
:CHANnel<N>:PROBe:PRECprobe:MODE / 401  
:CHANnel<N>:PROBe:PRECprobe:ZSRC / 402  
:CHANnel<N>:PROBe:PRIMary (9000 Series, 9000H Series, S-Series) / 404  
:CHANnel<N>:PROBe:RESPOnsivity / 405

:CHANnel<N>:PROBe:SKEW / 406  
:CHANnel<N>:PROBe:SKEW:AUTO / 407  
:CHANnel<N>:PROBe:STYPe / 408  
:CHANnel<N>:PROBe:USER / 409  
:CHANnel<N>:PROBe:WAVelength / 411  
:CHANnel<N>:RANGe / 412  
:CHANnel<N>:SCALe / 413  
:CHANnel<N>:SIMulation:AMPLitude / 414  
:CHANnel<N>:SIMulation:DATA:LENGth / 415  
:CHANnel<N>:SIMulation:DATA:ODD / 416  
:CHANnel<N>:SIMulation:DATA:PAM / 417  
:CHANnel<N>:SIMulation:DATA:RESeed / 418  
:CHANnel<N>:SIMulation:DATA:SELectioN / 419  
:CHANnel<N>:SIMulation:DRATe / 420  
:CHANnel<N>:SIMulation:FILTer:ISIM:ADDReSS / 421  
:CHANnel<N>:SIMulation:FILTer:ISIM:PEXTractioN / 422  
:CHANnel<N>:SIMulation:FILTer:SELectioN / 423  
:CHANnel<N>:SIMulation:FLOad:ADDReSS / 424  
:CHANnel<N>:SIMulation:FLOad:LOOP / 425  
:CHANnel<N>:SIMulation:FREQuency / 426  
:CHANnel<N>:SIMulation:FUNCTioN:SELectioN / 427  
:CHANnel<N>:SIMulation:FUNCTioN:SQUare:DCYCLe / 428  
:CHANnel<N>:SIMulation:FUNCTioN:SQUare:FTIME / 429  
:CHANnel<N>:SIMulation:FUNCTioN:SQUare:RTIME / 430  
:CHANnel<N>:SIMulation:JITTer / 431  
:CHANnel<N>:SIMulation:JITTer:ABUJ / 432  
:CHANnel<N>:SIMulation:JITTer:PERiodic<M>:ENABLE / 433  
:CHANnel<N>:SIMulation:JITTer:PERiodic<M>:FREQuency / 434  
:CHANnel<N>:SIMulation:JITTer:PERiodic<M>:MAGNitude / 435  
:CHANnel<N>:SIMulation:JITTer:PERiodic<M>:SHAPE / 436  
:CHANnel<N>:SIMulation:JITTer:RANDom / 437  
:CHANnel<N>:SIMulation:NOISe / 438  
:CHANnel<N>:SIMulation:NOISe:BWLimit / 439  
:CHANnel<N>:SIMulation:NOISe:PERiodic<M>:ENABLE / 440  
:CHANnel<N>:SIMulation:NOISe:PERiodic<M>:FREQuency / 441  
:CHANnel<N>:SIMulation:NOISe:PERiodic<M>:MAGNitude / 442  
:CHANnel<N>:SIMulation:NOISe:PERiodic<M>:SHAPE / 443  
:CHANnel<N>:SIMulation:NOISe:RANDom / 444  
:CHANnel<N>:SIMulation:OFFSet / 445  
:CHANnel<N>:SIMulation:WAVeform / 446  
:CHANnel<N>:UNITs / 447

## 16 Common Commands

- \*CLS – Clear Status / 451
- \*ESE – Event Status Enable / 452
- \*ESR? – Event Status Register / 454
- \*IDN? – Identification Number / 455
- \*LRN? – Learn / 456
- \*OPC – Operation Complete / 458
- \*OPT? – Option / 460
- \*PSC – Power-on Status Clear / 469
- \*RCL – Recall / 470
- \*RST – Reset / 471
- \*SAV – Save / 472
- \*SRE – Service Request Enable / 473
- \*STB? – Status Byte / 475
- \*TRG – Trigger / 477
- \*TST? – Test / 478
- \*WAI – Wait / 479

## 17 Digital Commands

- :DIGital<N>:DISPlay / 482
- :DIGital<N>:LABel / 483
- :DIGital<N>:POSition / 484
- :DIGital<N>:SIZE / 485
- :DIGital<N>:THReshold / 486

## 18 Disk Commands

- :DISK:CDIRectory / 491
- :DISK:COPIY / 492
- :DISK:DELeTe / 493
- :DISK:DIRectory? / 494
- :DISK:GETFILE / 495
- :DISK:LOAD / 496
- :DISK:MDIRectory / 498
- :DISK:PUTFILE / 499
- :DISK:PWD? / 500
- :DISK:SAVE:COMPOSITE / 501
- :DISK:SAVE:IMAGe / 502
- :DISK:SAVE:JITTer / 503
- :DISK:SAVE:LISTing / 504
- :DISK:SAVE:MEASurements / 505
- :DISK:SAVE:MREPort / 506



:DISK:SAVE:NOISe / 507  
:DISK:SAVE:PRECprobe / 508  
:DISK:SAVE:SETup / 509  
:DISK:SAVE:WAVEform / 510  
:DISK:SEGMented / 512

## 19 Display Commands

:DISPlay:BOOKmark:DELeTe:ALL / 515  
:DISPlay:BOOKmark<N>:DELeTe / 516  
:DISPlay:BOOKmark<N>:SET / 517  
:DISPlay:BOOKmark<N>:VERTical? / 519  
:DISPlay:BOOKmark<N>:XPOStion / 520  
:DISPlay:BOOKmark<N>:YPOStion / 521  
:DISPlay:CGRade / 522  
:DISPlay:CGRade:LEGend / 524  
:DISPlay:CGRade:LEVels? / 525  
:DISPlay:CGRade:SCHeme / 527  
:DISPlay:CONNect / 529  
:DISPlay:DATA? / 530  
:DISPlay:GRATicule / 531  
:DISPlay:GRATicule:AREA<N>:HSCale / 532  
:DISPlay:GRATicule:AREA<N>:STATe / 533  
:DISPlay:GRATicule:AREA<N>:VSCale / 534  
:DISPlay:GRATicule:GLAYout / 535  
:DISPlay:GRATicule:INTensity / 536  
:DISPlay:GRATicule:NUMBer / 537  
:DISPlay:GRATicule:SETGrat / 538  
:DISPlay:ISIM:GCOunt / 539  
:DISPlay:ISIM:SElectgraph / 540  
:DISPlay:ISIM:SOURce / 541  
:DISPlay:JITTer:GCOunt / 542  
:DISPlay:JITTer:SElectgraph / 543  
:DISPlay:JITTer:THReshold / 545  
:DISPlay:LABel / 546  
:DISPlay:LAYout / 547  
:DISPlay:MAIN / 548  
:DISPlay:NOISe:LEVel / 550  
:DISPlay:PAM:GRAPh / 551  
:DISPlay:PAM:SOURce / 552  
:DISPlay:PAM:TABLE / 553  
:DISPlay:PERSiStence / 554

:DISPlay:PROPortion / 556  
:DISPlay:PROPortion:RESults / 557  
:DISPlay:PRECprobe:GCOUNT / 558  
:DISPlay:PRECprobe:SElectgraph / 559  
:DISPlay:PRECprobe:SOURce / 560  
:DISPlay:RESults:LAYout / 561  
:DISPlay:SCOLor / 562  
:DISPlay:STATus:COLumn / 564  
:DISPlay:STATus:ROW / 565  
:DISPlay:THEMe / 566  
:DISPlay:WINDow:MAXimize / 567

## 20 Function Commands

:FUNction<F>? / 573  
:FUNction<F>:ABSolute / 574  
:FUNction<F>:ADD / 575  
:FUNction<F>:ADEMod / 576  
:FUNction<F>:AVERage / 577  
:FUNction<F>:COMMonmode / 578  
:FUNction<F>:DELay – Delay / 579  
:FUNction<F>:DIFF – Differentiate / 580  
:FUNction<F>:DISPlay / 581  
:FUNction<F>:DIVide / 582  
:FUNction<F>:FFT:DETECTOR:POINTs / 583  
:FUNction<F>:FFT:DETECTOR:TYPE / 584  
:FUNction<F>:FFT:FREQuency / 585  
:FUNction<F>:FFT:HSCale / 586  
:FUNction<F>:FFT:IMPedance / 587  
:FUNction:FFT:PEAK:SORT / 589  
:FUNction<F>:FFT:PEAK:COUNt / 590  
:FUNction<F>:FFT:PEAK:FREQuency / 591  
:FUNction<F>:FFT:PEAK:LEVel / 592  
:FUNction<F>:FFT:PEAK:MAGNitude / 593  
:FUNction<F>:FFT:PEAK:STATe / 594  
:FUNction<F>:FFT:REFerence / 595  
:FUNction<F>:FFT:RESolution / 596  
:FUNction<F>:FFT:SPAN / 598  
:FUNction<F>:FFT:STARt / 599  
:FUNction<F>:FFT:STOP / 600  
:FUNction<F>:FFT:TDELay / 601  
:FUNction<F>:FFT:VUNits / 602

:FUNCTION<F>:FFT:WINDow / 603  
 :FUNCTION<F>:FFTMagnitude / 605  
 :FUNCTION<F>:FFTPHase / 606  
 :FUNCTION<F>:GATing – Gating / 607  
 :FUNCTION<F>:GATing:GLOBal / 608  
 :FUNCTION<F>:GATing:STARt – Gating window start time / 609  
 :FUNCTION<F>:GATing:STOP – Gating window stop time / 610  
 :FUNCTION<F>:HIGHpass / 611  
 :FUNCTION<F>:HORizontal / 612  
 :FUNCTION<F>:HORizontal:POSition / 613  
 :FUNCTION<F>:HORizontal:RANGe / 615  
 :FUNCTION<F>:INTegrate / 617  
 :FUNCTION<F>:INVert / 618  
 :FUNCTION<F>:LABel / 619  
 :FUNCTION<F>:LOWPass / 620  
 :FUNCTION<F>:MAGNify / 621  
 :FUNCTION<F>:MATLab / 622  
 :FUNCTION<F>:MATLab:CONTRol<N> / 623  
 :FUNCTION<F>:MATLab:OPERator / 625  
 :FUNCTION<F>:MAXimum / 626  
 :FUNCTION<F>:MHISTogram / 627  
 :FUNCTION<F>:MINimum / 629  
 :FUNCTION<F>:MLOG / 630  
 :FUNCTION<F>:MTRend / 631  
 :FUNCTION<F>:MULTiPLY / 632  
 :FUNCTION<F>:OFFSet / 633  
 :FUNCTION<F>:PAverage / 634  
 :FUNCTION<F>:RANGe / 635  
 :FUNCTION<F>:SMOoth / 636  
 :FUNCTION<F>:SQRT / 637  
 :FUNCTION<F>:SQUare / 638  
 :FUNCTION<F>:SUBTract / 639  
 :FUNCTION<F>:VERSus / 640  
 :FUNCTION<F>:VERTical / 641  
 :FUNCTION<F>:VERTical:OFFSet / 642  
 :FUNCTION<F>:VERTical:RANGe / 643  
 :FUNCTION<F>:VERTical:SIZE / 644

## 21 Hardcopy Commands

:HARDcopy:AREA / 646  
 :HARDcopy:DPRinter / 647

:HARDcopy:FACTors / 648  
:HARDcopy:IMAGe / 649  
:HARDcopy:PRINters? / 650

## 22 Histogram Commands

:HISTogram:AXIS / 653  
:HISTogram:HORizontal:BINS / 654  
:HISTogram:MEASurement:BINS / 655  
:HISTogram:MEASurement:MAX / 656  
:HISTogram:MEASurement:MIN / 657  
:HISTogram:MODE / 658  
:HISTogram:SCALE:SIZE / 659  
:HISTogram:VERTical:BINS / 660  
:HISTogram:WINDow:DEFault / 661  
:HISTogram:WINDow:SOURce / 662  
:HISTogram:WINDow:LLIMit / 663  
:HISTogram:WINDow:RLIMit / 664  
:HISTogram:WINDow:BLIMit / 665  
:HISTogram:WINDow:TLIMit / 666

## 23 Hosted Commands

:HOSTed:CALibrate:CALibrate / 669  
:HOSTed:CALibrate:CHANnel / 670  
:HOSTed:CALibrate:DESKew:CHANnels / 671  
:HOSTed:CALibrate:DESKew:FRAMES / 672  
:HOSTed:CALibrate:DESKew:SIGNals / 673  
:HOSTed:CALibrate:DESKew:ZERO / 674  
:HOSTed:CALibrate:LEVel / 675  
:HOSTed:CALibrate:PROMpt / 677  
:HOSTed:CALibrate:STATus:CHANnels? / 678  
:HOSTed:CALibrate:STATus:FRAMES? / 679  
:HOSTed:CALibrate:STATus:LEVel? / 680  
:HOSTed:CALibrate:STATus:SIGNals? / 681  
:HOSTed:CALibrate:TREF:DETECT / 682  
:HOSTed:FOLLOWer<N>:ACHannels? / 683  
:HOSTed:FOLLOWer<N>:CONFigure / 684  
:HOSTed:FOLLOWer<N>:CONNect / 685  
:HOSTed:FOLLOWer<N>:DISConnect / 686  
:HOSTed:LEADer:ACHannels? / 687  
:HOSTed:LEADer:CONFigure / 688  
:HOSTed:LEADer:CONNect / 689

:HOSTed:LEADer:DISConnect / 690  
:HOSTed:NCONnected? / 691  
:HOSTed:PERiodic / 692

## 24 InfiniiScan (IScan) Commands

:IScan:DELay / 694  
:IScan:MEASurement:FAIL / 695  
:IScan:MEASurement:LLIMit / 696  
:IScan:MEASurement / 697  
:IScan:MEASurement:ULIMit / 698  
:IScan:MODE / 699  
:IScan:NONMonotonic:EDGE / 700  
:IScan:NONMonotonic:HYSTeresis / 701  
:IScan:NONMonotonic:SOURce / 702  
:IScan:RUNT:HYSTeresis / 703  
:IScan:RUNT:LLEVel / 704  
:IScan:RUNT:SOURce / 705  
:IScan:RUNT:ULEVel / 706  
:IScan:SERial:PATtern / 707  
:IScan:SERial:SOURce / 708  
:IScan:ZONE:HIDE / 709  
:IScan:ZONE:SOURce / 710  
:IScan:ZONE<Z>:MODE / 711  
:IScan:ZONE<Z>:PLACement / 712  
:IScan:ZONE<Z>:SOURce / 713  
:IScan:ZONE<Z>:STATe / 714

## 25 Lane (Equalization) Commands

:LANE<N>:COPYto / 717  
:LANE<N>:EQUalizer:CTLE:ACGain / 718  
:LANE<N>:EQUalizer:CTLE:DCGain / 719  
:LANE<N>:EQUalizer:CTLE:NUMPoles / 720  
:LANE<N>:EQUalizer:CTLE:P1 / 721  
:LANE<N>:EQUalizer:CTLE:P2 / 722  
:LANE<N>:EQUalizer:CTLE:P3 / 723  
:LANE<N>:EQUalizer:CTLE:P4 / 724  
:LANE<N>:EQUalizer:CTLE:P5 / 725  
:LANE<N>:EQUalizer:CTLE:P6 / 726  
:LANE<N>:EQUalizer:CTLE:RATE / 727  
:LANE<N>:EQUalizer:CTLE:STATe / 728  
:LANE<N>:EQUalizer:CTLE:Z1 / 729

:LANE<N>:EQualizer:CTLE:Z2 / 730  
 :LANE<N>:EQualizer:DFE:NTAPs / 731  
 :LANE<N>:EQualizer:DFE:STATe / 732  
 :LANE<N>:EQualizer:DFE:TAP / 733  
 :LANE<N>:EQualizer:DFE:TAP:AUTomatic / 734  
 :LANE<N>:EQualizer:DFE:TAP:DELay / 735  
 :LANE<N>:EQualizer:DFE:TAP:DELay:AUTomatic / 736  
 :LANE<N>:EQualizer:DFE:TAP:GAIN / 737  
 :LANE<N>:EQualizer:DFE:TAP:LTARget / 738  
 :LANE<N>:EQualizer:DFE:TAP:MAX / 739  
 :LANE<N>:EQualizer:DFE:TAP:MAXV / 740  
 :LANE<N>:EQualizer:DFE:TAP:MIN / 741  
 :LANE<N>:EQualizer:DFE:TAP:MINV / 742  
 :LANE<N>:EQualizer:DFE:TAP:NORMalize / 743  
 :LANE<N>:EQualizer:DFE:TAP:UTARget / 744  
 :LANE<N>:EQualizer:DFE:TAP:WIDTh / 745  
 :LANE<N>:EQualizer:DFE:THReshold:BANDwidth / 746  
 :LANE<N>:EQualizer:DFE:THReshold:BWMode / 747  
 :LANE<N>:EQualizer:DFE:THReshold:DELay / 748  
 :LANE<N>:EQualizer:FFE:BANDwidth / 749  
 :LANE<N>:EQualizer:FFE:BWMode / 750  
 :LANE<N>:EQualizer:FFE:NPRecursor / 751  
 :LANE<N>:EQualizer:FFE:NTAPs / 752  
 :LANE<N>:EQualizer:FFE:RATE / 753  
 :LANE<N>:EQualizer:FFE:STATe / 754  
 :LANE<N>:EQualizer:FFE:TAP / 755  
 :LANE<N>:EQualizer:FFE:TAP:AUTomatic / 756  
 :LANE<N>:EQualizer:FFE:TAP:DELay / 757  
 :LANE<N>:EQualizer:FFE:TAP:WIDTh / 758  
 :LANE<N>:EQualizer:FFE:TDELay / 759  
 :LANE<N>:EQualizer:FFE:TDMode / 760  
 :LANE<N>:EQualizer:LOCation / 761  
 :LANE<N>:SOURce / 762  
 :LANE<N>:STATe / 763  
 :LANE<N>:VERTical / 764  
 :LANE<N>:VERTical:OFFSet / 765  
 :LANE<N>:VERTical:RANGe / 766

## 26 Limit Test Commands

:LTEST:ADDStats / 768  
 :LTEST:FAIL / 769

:LTEST:LLIMit – Lower Limit / 771  
:LTEST:MEASurement / 772  
:LTEST:RESults? / 773  
:LTEST:RUMode:SOfailure / 774  
:LTEST:TEST / 775  
:LTEST:ULIMit – Upper Limit / 776

## 27 Lister Commands

:LISTer:DATA? / 778  
:LISTer:DISPlay / 779

## 28 :LXI Commands

:LXI:IDENtify[:STATe] / 782

## 29 Marker Commands

:MARKer:CURSor? / 785  
:MARKer:DELTA / 786  
:MARKer:MEASurement:MEASurement / 787  
:MARKer:MODE / 789  
:MARKer:TSTArt / 790  
:MARKer:TSTOp / 791  
:MARKer:VSTArt / 792  
:MARKer:VSTOp / 793  
:MARKer:X1Position / 794  
:MARKer:X2Position / 795  
:MARKer:X1Y1source / 796  
:MARKer:X2Y2source / 798  
:MARKer:XDELta? / 800  
:MARKer:Y1Position / 801  
:MARKer:Y2Position / 802  
:MARKer:YDELta? / 803  
:MARKer<K>:CMODE / 804  
:MARKer<K>:COLor / 805  
:MARKer<K>:DELTA / 808  
:MARKer<K>:ENABLE / 809  
:MARKer<K>:NAME / 810  
:MARKer<K>:SOURce / 811  
:MARKer<K>:TYPE / 813  
:MARKer<K>:X:POSition / 815  
:MARKer<K>:Y:POSition / 816

## 30 Mask Test Commands

:MTEST:ALIGn / 819  
:MTEST:AMASK:CREate / 820  
:MTEST:AMASK:SOURce / 821  
:MTEST:AMASK:SAVE / 823  
:MTEST:AMASK:UNITs / 824  
:MTEST:AMASK:XDELta / 825  
:MTEST:AMASK:YDELta / 826  
:MTEST:AUTO / 827  
:MTEST:AVERAge / 828  
:MTEST:AVERAge:COUNT / 829  
:MTEST:COUNT:FAILures? / 830  
:MTEST:COUNT:FUI? / 831  
:MTEST:COUNT:FWAVEforms? / 832  
:MTEST:COUNT:MARGin:FAILures? / 833  
:MTEST:COUNT:SUI? / 834  
:MTEST:COUNT:UI? / 835  
:MTEST:COUNT:WAVEforms? / 836  
:MTEST:DELeTe / 837  
:MTEST:ENABle / 838  
:MTEST:FOLDing (Clock Recovery software only) / 839  
:MTEST:FOLDing:BITS / 841  
:MTEST:FOLDing:COUNT:UI? / 843  
:MTEST:FOLDing:COUNT:WAVEforms? / 845  
:MTEST:FOLDing:FAST / 847  
:MTEST:FOLDing:POSition / 849  
:MTEST:FOLDing:SCALe / 851  
:MTEST:FOLDing:TPOSition / 853  
:MTEST:FOLDing:TSCale / 855  
:MTEST:IMPedance / 857  
:MTEST:INVert / 858  
:MTEST:LOAD / 859  
:MTEST:MARGin:AUTO:HITS / 860  
:MTEST:MARGin:AUTO:HRATIO / 861  
:MTEST:MARGin:AUTO:METHod / 862  
:MTEST:MARGin:METHod / 863  
:MTEST:MARGin:PERCent / 864  
:MTEST:MARGin:STATe / 865  
:MTEST:NREGions? / 866  
:MTEST:PROBe:IMPedance? / 867  
:MTEST:RUMode / 868



:MTESt:RUMode:SOFailure / 869  
:MTESt:SCALe:BINd / 870  
:MTESt:SCALe:DRW / 871  
:MTESt:SCALe:X1 / 872  
:MTESt:SCALe:XDELta / 873  
:MTESt:SCALe:Y1 / 874  
:MTESt:SCALe:Y2 / 875  
:MTESt:SOURce / 876  
:MTESt:STARt / 877  
:MTESt:STOP / 878  
:MTESt:STIMe / 879  
:MTESt:TITLe? / 880  
:MTESt:TRIGger:SOURce / 881

### 31 Measure Commands

:MEASure:AREA / 894  
:MEASure:BER / 896  
:MEASure:BERPeracq / 897  
:MEASure:BINterval / 898  
:MEASure:BPERiod / 899  
:MEASure:BWIDth / 900  
:MEASure:CDRRate / 901  
:MEASure:CGRade:CROSSing / 902  
:MEASure:CGRade:DCDistortion / 903  
:MEASure:CGRade:EHEight / 904  
:MEASure:CGRade:ELOCation / 906  
:MEASure:CGRade:EWIDth / 907  
:MEASure:CGRade:EWIDth:THReshold / 909  
:MEASure:CGRade:EWINDow / 910  
:MEASure:CGRade:JITTer / 912  
:MEASure:CGRade:OLEVel / 914  
:MEASure:CGRade:QFACTOR / 915  
:MEASure:CGRade:ZLEVel / 916  
:MEASure:CHARge (9000 Series, 9000H Series, S-Series) / 917  
:MEASure:CLEar / 918  
:MEASure:CROSSing / 919  
:MEASure:CTCDutycycle / 920  
:MEASure:CTCJitter / 922  
:MEASure:CTCNwidth / 924  
:MEASure:CTCPwidth / 926  
:MEASure:DATarate / 928

:MEASure:DCAI / 930  
:MEASure:DCAQ / 931  
:MEASure:DCIPrime / 932  
:MEASure:DCQPrime / 933  
:MEASure:DEEMphasis / 934  
:MEASure:DELTatime / 936  
:MEASure:DELTatime:DEFine / 938  
:MEASure:DUTYcycle / 940  
:MEASure:EDGE / 941  
:MEASure:ERATio / 942  
:MEASure:ETAEdges / 943  
:MEASure:ETOedge / 944  
:MEASure:FALLtime / 946  
:MEASure:FFT:CPOWer / 948  
:MEASure:FFT:DFRequency / 949  
:MEASure:FFT:DMAGnitude / 951  
:MEASure:FFT:FREQuency / 953  
:MEASure:FFT:MAGNitude / 955  
:MEASure:FFT:OBW / 957  
:MEASure:FFT:PSD / 958  
:MEASure:FREQuency / 959  
:MEASure:HISTogram:FWMH / 961  
:MEASure:HISTogram:HITS / 962  
:MEASure:HISTogram:M1S / 963  
:MEASure:HISTogram:M2S / 964  
:MEASure:HISTogram:M3S / 965  
:MEASure:HISTogram:MAX / 966  
:MEASure:HISTogram:MEAN / 967  
:MEASure:HISTogram:MEDian / 968  
:MEASure:HISTogram:MIN / 969  
:MEASure:HISTogram:MM3S / 970  
:MEASure:HISTogram:MP3S / 971  
:MEASure:HISTogram:MODE / 972  
:MEASure:HISTogram:PEAK / 973  
:MEASure:HISTogram:PP / 974  
:MEASure:HISTogram:RESolution / 975  
:MEASure:HISTogram:STDDev / 976  
:MEASure:HOLDtime / 977  
:MEASure:JITTer:HISTogram / 979  
:MEASure:JITTer:MEASurement / 980  
:MEASure:JITTer:SPECTrum / 981  
:MEASure:JITTer:SPECTrum:HORizontal / 982

:MEASure:JITTer:SPECtrum:HORizontal:POSition / 983  
 :MEASure:JITTer:SPECtrum:HORizontal:RANGe / 984  
 :MEASure:JITTer:SPECtrum:RESolution / 985  
 :MEASure:JITTer:SPECtrum:VERTical / 986  
 :MEASure:JITTer:SPECtrum:VERTical:OFFSet / 987  
 :MEASure:JITTer:SPECtrum:VERTical:RANGe / 988  
 :MEASure:JITTer:SPECtrum:VERTical:TYPE / 989  
 :MEASure:JITTer:SPECtrum:WINDow / 990  
 :MEASure:JITTer:TREnd / 991  
 :MEASure:JITTer:TREnd:SMOoth / 992  
 :MEASure:JITTer:TREnd:SMOoth:POINts / 993  
 :MEASure:JITTer:TREnd:VERTical / 994  
 :MEASure:JITTer:TREnd:VERTical:OFFSet / 995  
 :MEASure:JITTer:TREnd:VERTical:RANGe / 996  
 :MEASure:MARK / 997  
 :MEASure:NAME / 998  
 :MEASure:NCJitter / 999  
 :MEASure:NOISe / 1001  
 :MEASure:NOISe:ALL? / 1003  
 :MEASure:NOISe:BANDwidth / 1005  
 :MEASure:NOISe:LOCation / 1006  
 :MEASure:NOISe:METHod / 1007  
 :MEASure:NOISe:REPort / 1008  
 :MEASure:NOISe:RN / 1009  
 :MEASure:NOISe:SCOPE:RN / 1010  
 :MEASure:NOISe:STATe / 1011  
 :MEASure:NOISe:UNITs / 1012  
 :MEASure:NPERiod / 1013  
 :MEASure:NPULses / 1014  
 :MEASure:NSIGma / 1015  
 :MEASure:NUI / 1016  
 :MEASure:NWIDth / 1017  
 :MEASure:OMAMplitude / 1018  
 :MEASure:OPower / 1019  
 :MEASure:OVERshoot / 1020  
 :MEASure:PAM:ELEVel / 1022  
 :MEASure:PAM:ESKew / 1024  
 :MEASure:PAM:EYE:ELMethod / 1026  
 :MEASure:PAM:EYE:ESTiming / 1027  
 :MEASure:PAM:EYE:PPERcent / 1028  
 :MEASure:PAM:EYE:PROBability / 1029  
 :MEASure:PAM:EYE:TIME:LTDefinition / 1030

:MEASure:PAM:LEVel / 1031  
:MEASure:PAM:LRMS / 1033  
:MEASure:PAM:LTHickness / 1035  
:MEASure:PAM:PRBS13q:COUNT / 1037  
:MEASure:PAM:PRBS13q:EDGE:EOJ / 1038  
:MEASure:PAM:PRBS13q:EDGE:J3U / 1039  
:MEASure:PAM:PRBS13q:EDGE:J4U / 1040  
:MEASure:PAM:PRBS13q:EDGE:J6U / 1041  
:MEASure:PAM:PRBS13q:EDGE:JRMS / 1042  
:MEASure:PAM:PRBS13q:HUNits / 1043  
:MEASure:PAM:PRBS13q:PATTern / 1044  
:MEASure:PAM:PRBS13q:PFILe / 1045  
:MEASure:PAM:PRBS13q:STATe / 1046  
:MEASure:PAM:PRBS13q:UNITs / 1047  
:MEASure:PAMPlitude / 1048  
:MEASure:PBASe / 1049  
:MEASure:PERiod / 1050  
:MEASure:PHASe / 1052  
:MEASure:PJITter / 1054  
:MEASure:PLENght / 1055  
:MEASure:PN:CORRelations / 1056  
:MEASure:PN:DESKew / 1057  
:MEASure:PN:EDGE / 1058  
:MEASure:PN:HORizontal:START / 1059  
:MEASure:PN:HORizontal:STOP / 1060  
:MEASure:PN:RSSC / 1061  
:MEASure:PN:SOURce / 1062  
:MEASure:PN:SPURs / 1064  
:MEASure:PN:SSENSitivity / 1065  
:MEASure:PN:STATe / 1066  
:MEASure:PN:VERTical:REFerence / 1067  
:MEASure:PN:VERTical:SCALe / 1068  
:MEASure:PN:WINDow / 1069  
:MEASure:PPContrast / 1070  
:MEASure:PPULses / 1071  
:MEASure:PREShoot / 1072  
:MEASure:PTOP / 1074  
:MEASure:PWIDth / 1075  
:MEASure:QUALifier<M>:CONDition / 1076  
:MEASure:QUALifier<M>:SOURce / 1077  
:MEASure:QUALifier<M>:STATe / 1078  
:MEASure:RESults? / 1079

:MEASure:RISetime / 1083  
:MEASure:RJDJ:ALL? / 1085  
:MEASure:RJDJ:APLength? / 1087  
:MEASure:RJDJ:BANDwidth / 1088  
:MEASure:RJDJ:BER / 1089  
:MEASure:RJDJ:CLOCK / 1091  
:MEASure:RJDJ:CREference / 1092  
:MEASure:RJDJ:EDGE / 1093  
:MEASure:RJDJ:INTerpolate / 1094  
:MEASure:RJDJ:METHod / 1095  
:MEASure:RJDJ:MODE / 1096  
:MEASure:RJDJ:PAMThreshold / 1097  
:MEASure:RJDJ:PLENght / 1098  
:MEASure:RJDJ:REPort / 1099  
:MEASure:RJDJ:RJ / 1100  
:MEASure:RJDJ:SCOpe:RJ / 1101  
:MEASure:RJDJ:SCOpe:RJ:CALibrate / 1102  
:MEASure:RJDJ:SOURce / 1103  
:MEASure:RJDJ:STATe / 1104  
:MEASure:RJDJ:TJRJDJ? / 1105  
:MEASure:RJDJ:UNITs / 1107  
:MEASure:SCRatch / 1108  
:MEASure:SENDvalid / 1109  
:MEASure:SER / 1110  
:MEASure:SERPeracq / 1111  
:MEASure:SETuptime / 1112  
:MEASure:SLEWrate / 1114  
:MEASure:SOURce / 1116  
:MEASure:STATistics / 1117  
:MEASure:TEDGE / 1118  
:MEASure:THResholds:ABSolute / 1119  
:MEASure:THResholds:DISPlay / 1120  
:MEASure:THResholds:GENAUTO / 1121  
:MEASure:THResholds:GENeral:ABSolute / 1122  
:MEASure:THResholds:GENeral:HYSTEResis / 1124  
:MEASure:THResholds:GENeral:METHod / 1126  
:MEASure:THResholds:GENeral:PAMCustom / 1128  
:MEASure:THResholds:GENeral:PAMAutomatic / 1130  
:MEASure:THResholds:GENeral:PERCent / 1132  
:MEASure:THResholds:GENeral:TOPBase:ABSolute / 1134  
:MEASure:THResholds:GENeral:TOPBase:METHod / 1136  
:MEASure:THResholds:HYSTEResis / 1137

:MEASure:THResholds:METhod / 1139  
:MEASure:THResholds:PERCent / 1140  
:MEASure:THResholds:RFALL:ABSolute / 1141  
:MEASure:THResholds:RFALL:METhod / 1143  
:MEASure:THResholds:RFALL:PAMAutomatic / 1145  
:MEASure:THResholds:RFALL:PERCent / 1147  
:MEASure:THResholds:RFALL:TOPBase:ABSolute / 1149  
:MEASure:THResholds:RFALL:TOPBase:METhod / 1151  
:MEASure:THResholds:SERauto / 1152  
:MEASure:THResholds:SERial:ABSolute / 1153  
:MEASure:THResholds:SERial:HYSteresis / 1155  
:MEASure:THResholds:SERial:METhod / 1157  
:MEASure:THResholds:SERial:PERCent / 1158  
:MEASure:THResholds:SERial:TOPBase:ABSolute / 1160  
:MEASure:THResholds:SERial:TOPBase:METhod / 1162  
:MEASure:THResholds:TOPBase:ABSolute / 1163  
:MEASure:THResholds:TOPBase:METhod / 1164  
:MEASure:TIEClock2 / 1165  
:MEASure:TIEData2 / 1167  
:MEASure:TIEFilter:DAMPing / 1168  
:MEASure:TIEFilter:SHApe / 1169  
:MEASure:TIEFilter:STARt / 1170  
:MEASure:TIEFilter:STATe / 1171  
:MEASure:TIEFilter:STOP / 1172  
:MEASure:TIEFilter:TYPE / 1173  
:MEASure:TMAX / 1174  
:MEASure:TMIN / 1175  
:MEASure:TVOLt / 1176  
:MEASure:UITouijitter / 1178  
:MEASure:UNDerShoot / 1179  
:MEASure:UNITinterval / 1183  
:MEASure:VAMPLitude / 1185  
:MEASure:VAverage / 1186  
:MEASure:VBASe / 1187  
:MEASure:VLOWer / 1188  
:MEASure:VMAX / 1189  
:MEASure:VMIDdle / 1190  
:MEASure:VMIN / 1191  
:MEASure:VOVerShoot / 1192  
:MEASure:VPP / 1193  
:MEASure:VPReshoot / 1194  
:MEASure:VRMS / 1195

:MEASure:VTIMe / 1197  
:MEASure:VTOP / 1198  
:MEASure:VUNDershoot / 1199  
:MEASure:VUPPer / 1200  
:MEASure:WINDow / 1201  
:MEASure:XCORTie / 1202  
:MEASure:ZTMAX / 1203  
:MEASure:ZTMIN / 1204  
:MEASurement<N>:CLEar / 1205  
:MEASurement<N>:NAME / 1206  
:MEASurement<N>:POSition / 1207  
:MEASurement<N>:SOURce / 1208  
:MEASurement<N>:ZTMAX / 1209  
:MEASurement<N>:ZTMIN / 1210

### 32 Pod Commands

:POD<N>:DISPlay / 1212  
:POD<N>:PSKew / 1213  
:POD<N>:THReshold / 1214

### 33 Root Level Commands

:ADER? – Acquisition Done Event Register / 1219  
:AER? – Arm Event Register / 1220  
:ASTate? / 1221  
:ATER? – Auto Trigger Event Register / 1222  
:AUToscale / 1223  
:AUToscale:CHANnels / 1224  
:AUToscale:PLACement / 1225  
:AUToscale:VERTical / 1226  
:BEEP / 1227  
:BLANK / 1228  
:CDISplay / 1229  
:DIGitize / 1230  
:DISable DIGital / 1232  
:ENABle DIGital / 1233  
:MODEl? / 1234  
:MTEEnable – Mask Test Enable Register / 1235  
:MTERegister? – Mask Test Event Register / 1236  
:OPEEnable – Operation Status Enable / 1237  
:OPERegister? – Operation Status Register / 1238  
:OVLRegister? / 1239

- :PDER? – Processing Done Event Register / 1240
- :PRINt / 1241
- :RECall:SETup / 1242
- :RSTate? / 1243
- :RUN / 1244
- :SERial – Serial Number / 1245
- :SINGle / 1246
- :STATus? / 1247
- :STOP / 1249
- :STORe:JITTer / 1250
- :STORe:SETup / 1251
- :STORe:WAVEform / 1252
- :TERegister? – Trigger Event Register / 1253
- :VIEW / 1254

### 34 Serial Bus Commands

- General :SBUS<N> Commands / 1256
  - :SBUS<N>[:DISPlay] / 1257
  - :SBUS<N>:MODE / 1258
  - :SBUS<N>:SEARch:ENABle / 1259
  - :SBUS<N>:SEARch:TRIGger / 1260
- :SBUS<N>:CAN Commands / 1261
  - :SBUS<N>:CAN:FDSPoint / 1262
  - :SBUS<N>:CAN:SAMPlepoint / 1263
  - :SBUS<N>:CAN:SIGNal:BAUDrate / 1264
  - :SBUS<N>:CAN:SIGNal:DEFinition / 1265
  - :SBUS<N>:CAN:SIGNal:FDBaudrate / 1266
  - :SBUS<N>:CAN:SOURce / 1267
  - :SBUS<N>:CAN:TRIGger (9000 Series, 9000H Series, S-Series) / 1268
  - :SBUS<N>:CAN:TRIGger:PATtern:DATA (9000 Series, 9000H Series, S-Series) / 1271
  - :SBUS<N>:CAN:TRIGger:PATtern:DATA:LENGth (9000 Series, 9000H Series, S-Series) / 1272
  - :SBUS<N>:CAN:TRIGger:PATtern:ID (9000 Series, 9000H Series, S-Series) / 1274
  - :SBUS<N>:CAN:TRIGger:PATtern:ID:MODE (9000 Series, 9000H Series, S-Series) / 1275
  - :SBUS<N>:CAN:TYPE / 1276
- :SBUS<N>:FLEXray Commands / 1277
  - :SBUS<N>:FLEXray:BAUDrate / 1278
  - :SBUS<N>:FLEXray:CHANnel / 1279
  - :SBUS<N>:FLEXray:SOURce / 1280
  - :SBUS<N>:FLEXray:TRIGger / 1281



- :SBUS<N>:FLEXray:TRIGger:ERRor:TYPE / 1282
- :SBUS<N>:FLEXray:TRIGger:FRAMe:CCBase / 1283
- :SBUS<N>:FLEXray:TRIGger:FRAMe:CCRepetition / 1284
- :SBUS<N>:FLEXray:TRIGger:FRAMe:ID / 1285
- :SBUS<N>:FLEXray:TRIGger:FRAMe:TYPE / 1286
- :SBUS<N>:GENRaw Commands / 1287
  - :SBUS<N>:GENRaw:SOURce / 1288
  - :SBUS<N>:GENRaw:WSIZE / 1289
- :SBUS<N>:HS Commands / 1290
  - :SBUS<N>:HS:DESCramble / 1291
  - :SBUS<N>:HS:FORMat / 1292
  - :SBUS<N>:HS:IDLE / 1293
  - :SBUS<N>:HS:SOURce<S> / 1294
- :SBUS<N>:IIC Commands / 1295
  - :SBUS<N>:IIC:ASIZe / 1296
  - :SBUS<N>:IIC:SOURce:CLOCK / 1297
  - :SBUS<N>:IIC:SOURce:DATA / 1298
  - :SBUS<N>:IIC:TRIGger:PATtern:ADDRes (9000 Series, 9000H Series, S-Series) / 1299
  - :SBUS<N>:IIC:TRIGger:PATtern:DATA (9000 Series, 9000H Series, S-Series) / 1301
  - :SBUS<N>:IIC:TRIGger:TYPE (9000 Series, 9000H Series, S-Series) / 1302
- :SBUS<N>:LIN Commands / 1304
  - :SBUS<N>:LIN:SAMPlepoint / 1305
  - :SBUS<N>:LIN:SIGNal:BAUDrate / 1306
  - :SBUS<N>:LIN:SOURce / 1307
  - :SBUS<N>:LIN:STANdard / 1308
  - :SBUS<N>:LIN:TRIGger / 1309
  - :SBUS<N>:LIN:TRIGger:ID / 1310
  - :SBUS<N>:LIN:TRIGger:PATtern:DATA / 1311
  - :SBUS<N>:LIN:TRIGger:PATtern:DATA:LENGth / 1312
- :SBUS<N>:SPI Commands / 1313
  - :SBUS<N>:SPI:BITorder / 1314
  - :SBUS<N>:SPI:CLOCK:SLOPe / 1315
  - :SBUS<N>:SPI:CLOCK:TIMeout / 1316
  - :SBUS<N>:SPI:FRAMe:STATe / 1317
  - :SBUS<N>:SPI:SOURce:CLOCK / 1318
  - :SBUS<N>:SPI:SOURce:DATA / 1320
  - :SBUS<N>:SPI:SOURce:FRAMe / 1322
  - :SBUS<N>:SPI:SOURce:MISO / 1323
  - :SBUS<N>:SPI:SOURce:MOSI / 1324
  - :SBUS<N>:SPI:TRIGger:PATtern:DATA (9000 Series, 9000H Series, S-Series) / 1326

:SBUS<N>:SPI:TRIGger:PATtern:WIDTh (9000 Series, 9000H Series, S-Series) / 1328  
 :SBUS<N>:SPI:TRIGger:TYPE (9000 Series, 9000H Series, S-Series) / 1330  
 :SBUS<N>:SPI:TYPE / 1332  
 :SBUS<N>:SPI:WIDTh / 1333  
 :SBUS<N>:UART Commands / 1334  
 :SBUS<N>:UART:BAUDrate / 1335  
 :SBUS<N>:UART:BITOrder / 1336  
 :SBUS<N>:UART:DIRection / 1337  
 :SBUS<N>:UART:EOF:HEX / 1338  
 :SBUS<N>:UART:IDLE / 1339  
 :SBUS<N>:UART:PARity / 1340  
 :SBUS<N>:UART:SOURce:RX / 1341  
 :SBUS<N>:UART:SOURce:TX / 1342  
 :SBUS<N>:UART:WIDTh / 1343

### 35 Self-Test Commands

:SELftest:CANCel / 1346  
 :SELftest:SCOPETEST / 1347

### 36 System Commands

:SYSTem:DATE / 1350  
 :SYSTem:DEBUg / 1351  
 :SYSTem:DIMPedance – (9000 Series, 9000H Series, S-Series) / 1353  
 :SYSTem:DONTtabmeas / 1354  
 :SYSTem:DSP / 1355  
 :SYSTem:ERRor? / 1356  
 :SYSTem:GUI / 1357  
 :SYSTem:HEADer / 1358  
 :SYSTem:HLED (90000 Q-Series, S-Series, V-Series, Z-Series) / 1359  
 :SYSTem:LOCK / 1360  
 :SYSTem:LONGform / 1361  
 :SYSTem:MENU? / 1362  
 :SYSTem:PERSONa / 1363  
 :SYSTem:PRESet / 1364  
 :SYSTem:SETup / 1366  
 :SYSTem:TIME / 1368

### 37 Time Base Commands

:TIMebase:POSition / 1370  
 :TIMebase:RANGe / 1371  
 :TIMebase:REFClock / 1372

:TIMebase:REFerence / 1373  
:TIMebase:REFerence:PERCent / 1374  
:TIMebase:ROLL:ENABLE / 1375  
:TIMebase:SCALe / 1376  
:TIMebase:VIEW / 1377  
:TIMebase:WINDow:DELay / 1378  
:TIMebase:WINDow:POSition / 1379  
:TIMebase:WINDow:RANGe / 1380  
:TIMebase:WINDow:SCALe / 1381

## 38 Trigger Commands

General Trigger Commands / 1385  
:TRIGger:AND:ENABLE / 1386  
:TRIGger:AND:SOURce / 1387  
:TRIGger:FORCe / 1388  
:TRIGger:HOLDoff / 1389  
:TRIGger:HOLDoff:MAX / 1390  
:TRIGger:HOLDoff:MIN / 1391  
:TRIGger:HOLDoff:MODE / 1392  
:TRIGger:HTHReshold / 1393  
:TRIGger:HYSteresis / 1394  
:TRIGger:LEVel / 1395  
:TRIGger:LEVel:FIFTy / 1396  
:TRIGger:LTHReshold / 1397  
:TRIGger:MODE / 1398  
:TRIGger:SWEEP / 1400

Comm Trigger Commands / 1401  
:TRIGger:COMM:BWIDth / 1402  
:TRIGger:COMM:ENCode / 1403  
:TRIGger:COMM:PATtern / 1404  
:TRIGger:COMM:POLarity / 1405  
:TRIGger:COMM:SOURce / 1406

Delay Trigger Commands / 1407  
:TRIGger:DELay:ARM:SOURce / 1408  
:TRIGger:DELay:ARM:SLOPe / 1409  
:TRIGger:DELay:EDELay:COUNt / 1410  
:TRIGger:DELay:EDELay:SOURce / 1411  
:TRIGger:DELay:EDELay:SLOPe / 1412  
:TRIGger:DELay:MODE / 1413  
:TRIGger:DELay:TDELay:TIME / 1414

- :TRIGger:DElay:TRIGger:SOURce / 1415
- :TRIGger:DElay:TRIGger:SLOPe / 1416
- Edge Trigger Commands / 1417
  - :TRIGger:EDGE:COUPling (9000 Series, 9000H Series, S-Series) / 1418
  - :TRIGger:EDGE:SLOPe / 1419
  - :TRIGger:EDGE:SOURce / 1420
- GBSerial Trigger Commands / 1421
  - :TRIGger:GBSerial:CLOCK (V-Series with HWST Option) / 1422
  - :TRIGger:GBSerial:CLOCK:FREQuency (V-Series with HWST Option) / 1423
  - :TRIGger:GBSerial:DRATe (V-Series with HWST Option) / 1425
  - :TRIGger:GBSerial:MODE (V-Series with HWST Option) / 1427
  - :TRIGger:GBSerial:PATtern (V-Series with HWST Option) / 1428
  - :TRIGger:GBSerial:POLarity (V-Series with HWST Option) / 1429
  - :TRIGger:GBSerial:PRBS (V-Series with HWST Option) / 1430
  - :TRIGger:GBSerial:SOURce (V-Series with HWST Option) / 1431
- Glitch Trigger Commands / 1432
  - :TRIGger:GLITch:POLarity / 1433
  - :TRIGger:GLITch:SOURce / 1434
  - :TRIGger:GLITch:WIDTh / 1435
- Pattern Trigger Commands / 1436
  - :TRIGger:PATtern:CONDition / 1437
  - :TRIGger:PATtern:LOGic / 1438
- Pulse Width Trigger Commands / 1439
  - :TRIGger:PWIDth:DIRection / 1440
  - :TRIGger:PWIDth:POLarity / 1441
  - :TRIGger:PWIDth:SOURce / 1442
  - :TRIGger:PWIDth:TPOint / 1443
  - :TRIGger:PWIDth:WIDTh / 1444
- Runt Trigger Commands / 1445
  - :TRIGger:RUNT:POLarity / 1446
  - :TRIGger:RUNT:QUALified / 1447
  - :TRIGger:RUNT:SOURce / 1448
  - :TRIGger:RUNT:TIME / 1449
- Sequence Trigger Commands / 1450
  - :TRIGger:SEQUence:TERM1 (S-Series, 90000A Series, 90000 X-Series, V-Series, 90000 Q-Series, Z-Series) / 1451
  - :TRIGger:SEQUence:TERM2 (S-Series, 90000A Series, 90000 X-Series, V-Series, 90000 Q-Series, Z-Series) / 1452

- :TRIGger:SEQuence:RESet:ENABle (S-Series, 90000A Series, 90000 X-Series, V-Series, 90000 Q-Series, Z-Series) / 1453
- :TRIGger:SEQuence:RESet:TYPE (S-Series, 90000A Series, 90000 X-Series, V-Series, 90000 Q-Series, Z-Series) / 1454
- :TRIGger:SEQuence:RESet:EVENT (S-Series, 90000A Series, 90000 X-Series, V-Series, 90000 Q-Series, Z-Series) / 1455
- :TRIGger:SEQuence:RESet:TIME (S-Series, 90000A Series, 90000 X-Series, V-Series, 90000 Q-Series, Z-Series) / 1456
- :TRIGger:SEQuence:WAIT:ENABle (S-Series, 90000A Series, 90000 X-Series, V-Series, 90000 Q-Series, Z-Series) / 1457
- :TRIGger:SEQuence:WAIT:TIME (S-Series, 90000A Series, 90000 X-Series, V-Series, 90000 Q-Series, Z-Series) / 1458
- Setup and Hold Trigger Commands / 1459
  - :TRIGger:SHOLd:CSourcE / 1460
  - :TRIGger:SHOLd:CSourcE:EDGE / 1461
  - :TRIGger:SHOLd:DSourcE / 1462
  - :TRIGger:SHOLd:HoldTIME (HTIME) / 1463
  - :TRIGger:SHOLd:MODE / 1464
  - :TRIGger:SHOLd:SetupTIME / 1465
- State Trigger Commands / 1466
  - :TRIGger:STATe:CLOCK / 1467
  - :TRIGger:STATe:LOGic / 1468
  - :TRIGger:STATe:LTYPE / 1469
  - :TRIGger:STATe:SLOPe / 1470
- Timeout Trigger Commands / 1471
  - :TRIGger:TIMEout:CONDition / 1472
  - :TRIGger:TIMEout:SOURcE / 1473
  - :TRIGger:TIMEout:TIME / 1474
- Transition Trigger Commands / 1475
  - :TRIGger:TRANSition:DIRection / 1476
  - :TRIGger:TRANSition:SOURcE / 1477
  - :TRIGger:TRANSition:TIME / 1478
  - :TRIGger:TRANSition:TYPE / 1479
- TV Trigger Commands / 1480
  - :TRIGger:TV:LINE / 1481
  - :TRIGger:TV:MODE / 1482
  - :TRIGger:TV:POLarity / 1483
  - :TRIGger:TV:SOURcE / 1484
  - :TRIGger:TV:STANdard / 1485
  - :TRIGger:TV:UDTV:ENUMber / 1486

:TRIGger:TV:UDTV:HSYNc	/	1487
:TRIGger:TV:UDTV:HTIME	/	1488
:TRIGger:TV:UDTV:PGTHan	/	1489
:TRIGger:TV:UDTV:POLarity	/	1490
Window Trigger Commands	/	1491
:TRIGger:WINDow:CONDition	/	1492
:TRIGger:WINDow:SOURce	/	1493
:TRIGger:WINDow:TIME	/	1494
:TRIGger:WINDow:TPOint	/	1495
Advanced Comm Trigger Commands	/	1496
:TRIGger:ADVanced:COMM:BWIDth	/	1497
:TRIGger:ADVanced:COMM:ENCode	/	1498
:TRIGger:ADVanced:COMM:LEVel	/	1499
:TRIGger:ADVanced:COMM:PATtern	/	1500
:TRIGger:ADVanced:COMM:POLarity	/	1501
:TRIGger:ADVanced:COMM:SOURce	/	1502
Advanced Pattern Trigger Commands	/	1503
:TRIGger:ADVanced:PATtern:CONDition	/	1505
:TRIGger:ADVanced:PATtern:LOGic	/	1506
:TRIGger:ADVanced:PATtern:THReshold:LEVel	/	1507
Advanced State Trigger Commands	/	1508
:TRIGger:ADVanced:STATe:CLOCK	/	1509
:TRIGger:ADVanced:STATe:LOGic	/	1510
:TRIGger:ADVanced:STATe:LTYPe	/	1511
:TRIGger:ADVanced:STATe:SLOPe	/	1512
:TRIGger:ADVanced:STATe:THReshold:LEVel	/	1513
Advanced Delay By Event Trigger Commands	/	1514
:TRIGger:ADVanced:DELAy:EDLY:ARM:SOURce	/	1516
:TRIGger:ADVanced:DELAy:EDLY:ARM:SLOPe	/	1517
:TRIGger:ADVanced:DELAy:EDLY:EVENT:DELAy	/	1518
:TRIGger:ADVanced:DELAy:EDLY:EVENT:SOURce	/	1519
:TRIGger:ADVanced:DELAy:EDLY:EVENT:SLOPe	/	1520
:TRIGger:ADVanced:DELAy:EDLY:TRIGger:SOURce	/	1521
:TRIGger:ADVanced:DELAy:EDLY:TRIGger:SLOPe	/	1522
Advanced Delay By Time Trigger Commands	/	1523
:TRIGger:ADVanced:DELAy:TDLY:ARM:SOURce	/	1525
:TRIGger:ADVanced:DELAy:TDLY:ARM:SLOPe	/	1526
:TRIGger:ADVanced:DELAy:TDLY:DELAy	/	1527
:TRIGger:ADVanced:DELAy:TDLY:TRIGger:SOURce	/	1528

- :TRIGger:ADVanced:DElay:TDLY:TRIGger:SLOPe / 1529
- Advanced Standard TV Trigger Commands / 1530
  - :TRIGger:ADVanced:TV:STV:FIELD / 1532
  - :TRIGger:ADVanced:TV:STV:LINE / 1533
  - :TRIGger:ADVanced:TV:STV:SOURce / 1534
  - :TRIGger:ADVanced:TV:STV:SPOLarity / 1535
- Advanced User Defined TV Mode and Commands / 1536
  - :TRIGger:ADVanced:TV:UDTV:ENUMber / 1538
  - :TRIGger:ADVanced:TV:UDTV:PGTHan / 1539
  - :TRIGger:ADVanced:TV:UDTV:POLarity / 1540
  - :TRIGger:ADVanced:TV:UDTV:SOURce / 1541
- Advanced Violation Trigger Modes / 1542
  - :TRIGger:ADVanced:VIOLation:MODE / 1543
- Advanced Pulse Width Violation Trigger Commands / 1544
  - :TRIGger:ADVanced:VIOLation:PWIDth:DIRection / 1546
  - :TRIGger:ADVanced:VIOLation:PWIDth:POLarity / 1547
  - :TRIGger:ADVanced:VIOLation:PWIDth:SOURce / 1548
  - :TRIGger:ADVanced:VIOLation:PWIDth:WIDTh / 1549
- Advanced Setup Violation Trigger Commands / 1550
  - :TRIGger:ADVanced:VIOLation:SETup:MODE / 1553
  - :TRIGger:ADVanced:VIOLation:SETup:SETup:CSOURce / 1554
  - :TRIGger:ADVanced:VIOLation:SETup:SETup:CSOURce:LEVel / 1555
  - :TRIGger:ADVanced:VIOLation:SETup:SETup:CSOURce:EDGE / 1556
  - :TRIGger:ADVanced:VIOLation:SETup:SETup:DSOURce / 1557
  - :TRIGger:ADVanced:VIOLation:SETup:SETup:DSOURce:HTHReshold / 1558
  - :TRIGger:ADVanced:VIOLation:SETup:SETup:DSOURce:LTHReshold / 1559
  - :TRIGger:ADVanced:VIOLation:SETup:SETup:TIME / 1560
  - :TRIGger:ADVanced:VIOLation:SETup:HOLD:CSOURce / 1561
  - :TRIGger:ADVanced:VIOLation:SETup:HOLD:CSOURce:LEVel / 1562
  - :TRIGger:ADVanced:VIOLation:SETup:HOLD:CSOURce:EDGE / 1563
  - :TRIGger:ADVanced:VIOLation:SETup:HOLD:DSOURce / 1564
  - :TRIGger:ADVanced:VIOLation:SETup:HOLD:DSOURce:HTHReshold / 1565
  - :TRIGger:ADVanced:VIOLation:SETup:HOLD:DSOURce:LTHReshold / 1566
  - :TRIGger:ADVanced:VIOLation:SETup:HOLD:TIME / 1567
  - :TRIGger:ADVanced:VIOLation:SETup:SHOLd:CSOURce / 1568
  - :TRIGger:ADVanced:VIOLation:SETup:SHOLd:CSOURce:LEVel / 1569
  - :TRIGger:ADVanced:VIOLation:SETup:SHOLd:CSOURce:EDGE / 1570
  - :TRIGger:ADVanced:VIOLation:SETup:SHOLd:DSOURce / 1571
  - :TRIGger:ADVanced:VIOLation:SETup:SHOLd:DSOURce:HTHReshold / 1572
  - :TRIGger:ADVanced:VIOLation:SETup:SHOLd:DSOURce:LTHReshold / 1573

:TRIGger:ADVanced:VIOLation:SETup:SHOLd:SetupTIme (STIme) / 1574  
 :TRIGger:ADVanced:VIOLation:SETup:SHOLd:HoldTIme (HTIme) / 1575  
 Advanced Transition Violation Trigger Commands / 1576  
 :TRIGger:ADVanced:VIOLation:TRANSition / 1577  
 :TRIGger:ADVanced:VIOLation:TRANSition:SOURce / 1578  
 :TRIGger:ADVanced:VIOLation:TRANSition:SOURce:HTHReshold / 1579  
 :TRIGger:ADVanced:VIOLation:TRANSition:SOURce:LTHReshold / 1580  
 :TRIGger:ADVanced:VIOLation:TRANSition:TYPE / 1581

### 39 Waveform Commands

:WAVeform:BANDpass? / 1586  
 :WAVeform:BYTeorder / 1587  
 :WAVeform:CGRade:HEIGHt? / 1588  
 :WAVeform:CGRade:WIDTh? / 1589  
 :WAVeform:COMPLete? / 1590  
 :WAVeform:COUNT? / 1591  
 :WAVeform:COUPling? / 1592  
 :WAVeform:DATA / 1593  
 :WAVeform:FORMat / 1616  
 :WAVeform:PNOise:FREQuency / 1619  
 :WAVeform:POINts? / 1620  
 :WAVeform:PREamble? / 1621  
 :WAVeform:SEGmented:ALL / 1625  
 :WAVeform:SEGmented:COUNT? / 1627  
 :WAVeform:SEGmented:TTAG? / 1628  
 :WAVeform:SEGmented:XLISt? / 1629  
 :WAVeform:SOURce / 1630  
 :WAVeform:STReaming / 1632  
 :WAVeform:TYPE? / 1633  
 :WAVeform:VIEW / 1634  
 :WAVeform:XDISplay? / 1637  
 :WAVeform:XINCrement? / 1638  
 :WAVeform:XORigin? / 1639  
 :WAVeform:XRANge? / 1640  
 :WAVeform:XREFerence? / 1641  
 :WAVeform:XUNits? / 1642  
 :WAVeform:YDISplay? / 1643  
 :WAVeform:YINCrement? / 1644  
 :WAVeform:YORigin? / 1645  
 :WAVeform:YRANge? / 1646  
 :WAVeform:YREFerence? / 1647



:WAVeform:YUNits? / 1648

#### 40 Waveform Memory Commands

:WMEMory:TIETimebase / 1650  
:WMEMory<R>:CLEar / 1651  
:WMEMory<R>:DISPlay / 1652  
:WMEMory<R>:FFT:HSCale / 1653  
:WMEMory<R>:LABel / 1654  
:WMEMory<R>:LOAD / 1655  
:WMEMory<R>:SAVE / 1656  
:WMEMory<R>:SEGMENTed:COUNT? / 1657  
:WMEMory<R>:SEGMENTed:INDex / 1658  
:WMEMory<R>:SEGMENTed:PLAY / 1659  
:WMEMory<R>:XOFFset / 1660  
:WMEMory<R>:XRANge / 1661  
:WMEMory<R>:YOFFset / 1662  
:WMEMory<R>:YRANge / 1663

#### 41 Xtalk (Crosstalk Analysis) Commands

:XTALk:ENABle / 1667  
:XTALk:PAADeskew / 1669  
:XTALk:PAIFilter / 1670  
:XTALk:PAISi / 1671  
:XTALk:PASLimit / 1672  
:XTALk:PAXFilter / 1673  
:XTALk:PAXSi / 1674  
:XTALk:PJADeskew / 1675  
:XTALk:PJIFilter / 1676  
:XTALk:PJISi / 1677  
:XTALk:PJSLimit / 1678  
:XTALk:PJXFilter / 1679  
:XTALk:PJXSi / 1680  
:XTALk:RESults? / 1681  
:XTALk:SAADeskew / 1683  
:XTALk:SAIFilter / 1684  
:XTALk:SAISi / 1685  
:XTALk:SASLimit / 1686  
:XTALk:SAXFilter / 1687  
:XTALk:SAXSi / 1688  
:XTALk<X>:AENable<X> / 1689  
:XTALk<X>:ENABle / 1690

:XTALK<X>:IAGGressor / 1691  
:XTALK<X>:IVICtim / 1692  
:XTALK<X>:PAUTo / 1693  
:XTALK<X>:PLENght / 1694  
:XTALK<X>:PTYPe / 1695  
:XTALK<X>:RIDeal / 1696  
:XTALK<X>:RISI / 1697  
:XTALK<X>:ROTHer / 1698  
:XTALK<X>:SOURce / 1699  
:XTALK<X>:STYPe / 1701

## 42 Obsolete and Discontinued Commands

:ANALyze:CLOCK:METHOD:PAM:B03 / 1710  
:ANALyze:CLOCK:METHOD:PAM:B12 / 1712  
:ANALyze:CLOCK:METHOD:PAM:NONSymmetric / 1714  
:CHANnel<N>:PROBe / 1716  
:DISPlay:COLumn / 1717  
:DISPlay:LINE / 1718  
:DISPlay:ROW / 1719  
:DISPlay:STRing / 1720  
:DISPlay:TAB / 1721  
:DISPlay:TEXT / 1722  
:HOSTed:CALibrate:ALIGn (MultiScope) / 1723  
:MEASure:CLOCK / 1724  
:MEASure:CLOCK:METHOD / 1725  
:MEASure:CLOCK:METHOD (deprecated) / 1727  
:MEASure:CLOCK:METHOD:ALIGn / 1729  
:MEASure:CLOCK:METHOD:DEEMphasis / 1730  
:MEASure:CLOCK:METHOD:EDGE / 1731  
:MEASure:CLOCK:METHOD:JTF / 1733  
:MEASure:CLOCK:METHOD:OJTF / 1735  
:MEASure:CLOCK:METHOD:PLLTrack / 1737  
:MEASure:CLOCK:METHOD:SOURce / 1738  
:MEASure:CLOCK:VERTical / 1739  
:MEASure:CLOCK:VERTical:OFFSet / 1740  
:MEASure:CLOCK:VERTical:RANGe / 1741  
:MEASure:DDPWS – Data Dependent Pulse Width Shrinkage / 1742  
:MEASure:FFT:PEAK1 / 1744  
:MEASure:FFT:PEAK2 / 1745  
:MEASure:FFT:THReshold / 1746  
:MEASure:JITTer:STATistics / 1747

:MEASure:TIEData / 1748  
 :MTEST:FOLDing:COUNT? / 1750  
 :SPROcessing:CTLequalizer:ACGain / 1752  
 :SPROcessing:CTLequalizer:DCGain / 1753  
 :SPROcessing:CTLequalizer:DISPlay / 1754  
 :SPROcessing:CTLequalizer:NUMPoles / 1755  
 :SPROcessing:CTLequalizer:P1 / 1756  
 :SPROcessing:CTLequalizer:P2 / 1757  
 :SPROcessing:CTLequalizer:P3 / 1758  
 :SPROcessing:CTLequalizer:P4 / 1759  
 :SPROcessing:CTLequalizer:RATE / 1760  
 :SPROcessing:CTLequalizer:SOURce / 1761  
 :SPROcessing:CTLequalizer:VERTical / 1762  
 :SPROcessing:CTLequalizer:VERTical:OFFSet / 1763  
 :SPROcessing:CTLequalizer:VERTical:RANGe / 1764  
 :SPROcessing:CTLequalizer:Z1 / 1765  
 :SPROcessing:CTLequalizer:Z2 / 1766  
 :SPROcessing:CTLequalizer:ZERo / 1767  
 :SPROcessing:DFEQualizer:NTAPs / 1768  
 :SPROcessing:DFEQualizer:SOURce / 1769  
 :SPROcessing:DFEQualizer:STATe / 1770  
 :SPROcessing:DFEQualizer:TAP / 1771  
 :SPROcessing:DFEQualizer:TAP:AUTomatic / 1772  
 :SPROcessing:DFEQualizer:TAP:DELay / 1773  
 :SPROcessing:DFEQualizer:TAP:DELay:AUTomatic / 1774  
 :SPROcessing:DFEQualizer:TAP:GAIN / 1775  
 :SPROcessing:DFEQualizer:TAP:LTARget / 1776  
 :SPROcessing:DFEQualizer:TAP:MAX / 1777  
 :SPROcessing:DFEQualizer:TAP:MIN / 1778  
 :SPROcessing:DFEQualizer:TAP:NORMALize / 1779  
 :SPROcessing:DFEQualizer:TAP:UTARget / 1780  
 :SPROcessing:DFEQualizer:TAP:WIDTh / 1781  
 :SPROcessing:FFEQualizer:BANDwidth / 1782  
 :SPROcessing:FFEQualizer:BWMode / 1783  
 :SPROcessing:FFEQualizer:DISPlay / 1784  
 :SPROcessing:FFEQualizer:NPREcursor / 1785  
 :SPROcessing:FFEQualizer:NTAPs / 1786  
 :SPROcessing:FFEQualizer:RATE / 1787  
 :SPROcessing:FFEQualizer:SOURce / 1788  
 :SPROcessing:FFEQualizer:TAP / 1789  
 :SPROcessing:FFEQualizer:TAP:AUTomatic / 1790  
 :SPROcessing:FFEQualizer:TAP:DELay / 1791

:SPRocessing:FFEQualizer:TAP:WIDTh / 1792  
:SPRocessing:FFEQualizer:TDELaY / 1793  
:SPRocessing:FFEQualizer:TDMoDe / 1794  
:SPRocessing:FFEQualizer:VERTical / 1795  
:SPRocessing:FFEQualizer:VERTical:OFFSet / 1796  
:SPRocessing:FFEQualizer:VERTical:RANGe / 1797

### 43 Error Messages

Error Queue / 1800  
Error Numbers / 1801  
Command Errors / 1802  
Execution Errors / 1803  
Device- or Oscilloscope-Specific Errors / 1804  
Query Errors / 1805  
List of Error Messages / 1806

### 44 Example Programs

VISA COM Examples / 1814  
    VISA COM Example in Visual Basic / 1814  
    VISA COM Example in C# / 1825  
    VISA COM Example in Visual Basic .NET / 1835  
    VISA COM Example in Python 3 / 1844  
VISA Examples / 1853  
    VISA Example in C / 1853  
    VISA Example in Visual Basic / 1862  
    VISA Example in C# / 1872  
    VISA Example in Visual Basic .NET / 1884  
    VISA Example in Python 3 / 1896  
VISA.NET Examples / 1903  
    VISA.NET Example in C# / 1903  
    VISA.NET Example in Visual Basic .NET / 1910  
    VISA.NET Example in Python 3 / 1917  
SICL Examples / 1925  
    SICL Example in C / 1925  
    SICL Example in Visual Basic / 1934  
SCPI.NET Examples / 1944

## 45 Reference

HDF5 Example / 1946

CSV and TSV Header Format / 1947

BIN Header Format / 1949

File Header / 1949

Waveform Header / 1949

Waveform Data Header / 1951

Example Program for Reading Binary Data / 1952

## Index



# 1 What's New

What's New in Version 6.74 /	49
What's New in Version 6.73 /	50
What's New in Version 6.72 /	51
What's New in Version 6.71 /	52
What's New in Version 6.70 /	54
What's New in Version 6.60 /	56
What's New in Version 6.55 /	58
What's New in Version 6.50 /	59
What's New in Version 6.40 /	61
What's New in Version 6.30 /	67
What's New in Version 6.20 /	71
What's New in Version 6.10 /	74
What's New in Version 6.00 /	76
What's New in Version 5.75 /	80
What's New in Version 5.70 /	81
What's New in Version 5.60 /	84
What's New in Version 5.52 /	87
What's New in Version 5.51 /	88
What's New in Version 5.50 /	89
What's New in Version 5.30 /	95
What's New in Version 5.20 /	97
What's New in Version 5.10 /	99
What's New in Version 5.00 /	100
What's New in Version 4.60 /	104
What's New in Version 4.50 /	105
What's New in Version 4.30 /	106
What's New in Version 4.20 /	107
What's New in Version 4.10 /	108
What's New in Version 4.00 /	109
What's New in Version 3.50 /	110
What's New in Version 3.20 /	112
What's New in Version 3.11 /	113

What's New in Version 3.10 / 114



## What's New in Version 6.74

New command descriptions for Version 6.74 of the Infiniium oscilloscope software appear below.

### New Commands

Command	Description
:ANALyze:CLOCK:TIME? (see <a href="#">page 293</a> )	Returns the recovered clock times as a definite-length block of 64-bit double values.

### Changed Commands

Command	Description
:ANALyze:CLOCK:METHOD (see <a href="#">page 275</a> )	Added the "PCIE4,PCIE8" and "PCIE4,PCIE16" PCIe 4 Behavioral SRIS clock recovery methods for 8 Gb/s and 16 Gb/s data rates, respectively.
:DISPlay:GRATICule:GLAYout (see <a href="#">page 535</a> )	The query now returns the short form of the command options.

### Discontinued Commands

Discontinued Command	Current Command Equivalent	Comments
:MTEST:HAMPLitude	None	This command is no longer supported.
:MTEST:LAMPLitude	None	This command is no longer supported.

## What's New in Version 6.73

New command descriptions for Version 6.73 of the Infiniium oscilloscope software appear below.

### New Commands

Command	Description
CHANnel<N>:PROBe:USER (see <a href="#">page 409</a> )	For an undetectable, user-defined probe, this command specifies the probe type and attenuation factor.
:FUNction<F>:FFT:START (see <a href="#">page 599</a> )	This command existed in earlier versions of software but is now documented.
:FUNction<F>:VERTical:SIZE (see <a href="#">page 644</a> )	For the Histogram (Measurement) math function, this command specifies the histogram's vertical size in divisions.

### Changed Commands

Command	Description
:DISPlay:BOOKmark<N>:SET (see <a href="#">page 517</a> )	The <grid> option has been added to specify the grid in which the bookmark appears (when the source is NONE).

### Obsolete Commands

Obsolete Command	Current Command Equivalent	Behavior Differences
CHANnel<N>:PROBe (see <a href="#">page 1716</a> )	CHANnel<N>:PROBe:USER (see <a href="#">page 409</a> )	The current command lets you specify the N7019A Type-C active link fixture in addition to voltage probes.

## What's New in Version 6.72

New command descriptions for Version 6.72 of the Infiniium oscilloscope software appear below.

### New Commands

Command	Description
:DISK:GETFILE (see <a href="#">page 495</a> )	Returns a binary block of bytes that contains the contents of a file on the oscilloscope. This is not a new command but its description is now being included.
:DISK:PUTFILE (see <a href="#">page 499</a> )	Writes bytes to a full-path location on the oscilloscope. This is not a new command but its description is now being included.
:DISPlay:PAM:GRAPh (see <a href="#">page 551</a> )	Selects the PAM-4 12-Edge Jitter graphs to display.
:DISPlay:PAM:SOURce (see <a href="#">page 552</a> )	Selects the PAM-4 12-Edge Jitter sources whose tables and graphs will be displayed.
:DISPlay:PAM:TABLE (see <a href="#">page 553</a> )	Selects the PAM-4 12-Edge Jitter tables to display.
:LXI:IDENTify[:STATe] (see <a href="#">page 782</a> )	Lets you identify an oscilloscope.
:MEASure:UNDershoot (see <a href="#">page 1179</a> )	Installs, or returns the value of, an Undershoot measurement.
:MEASure:VUNDershoot (see <a href="#">page 1199</a> )	Installs, or returns the value of, a V undershoot measurement.

### Changed Commands

Command	Description
:MARKer:MEASurement:MEASurement (see <a href="#">page 787</a> )	Parameters have been added to support multiple measurement tracking markers.

## What's New in Version 6.71

New command descriptions for Version 6.71 of the Infiniium oscilloscope software appear below.

Note also that Secure Instrument Communication is now supported. See [Chapter 2](#), “Setting Up,” starting on page 117.

### New Commands

Command	Description
:MEASure:DCAI (see <a href="#">page 930</a> )	Installs, or returns the value of, a duty cycle adjustment measurement for the I phase of a DDR5 DQS (strobe) signal.
:MEASure:DCAQ (see <a href="#">page 931</a> )	Installs, or returns the value of, a duty cycle adjustment measurement for the Q phase of a DDR5 DQS (strobe) signal.
:MEASure:DCIPrime (see <a href="#">page 932</a> )	Installs, or returns the value of, a duty cycle adjustment measurement for the I' (I prime) phase of a DDR5 DQS (strobe) signal.
:MEASure:DCQPrime (see <a href="#">page 933</a> )	Installs, or returns the value of, a duty cycle adjustment measurement for the Q' (Q prime) phase of a DDR5 DQS (strobe) signal.

### Changed Commands

Command	Description
:LTEST:MEASurement (see <a href="#">page 772</a> )	The maximum number of measurements has increased from 20 to 40, so wherever <N> is used to define a measurement number (for example, in the :MEASurement<N> commands or in MEAS<N> command parameters), it can now be an integer from 1 to 40.
:LTEST:RESults (see <a href="#">page 773</a> )	
:MARKer:MEASurement:MEASurement (see <a href="#">page 787</a> )	
:MEASure:JITTer:MEASurement (see <a href="#">page 980</a> )	
:MEASure:WINDow (see <a href="#">page 1201</a> )	
:MEASure:ZTMAX (see <a href="#">page 1203</a> )	
:MEASure:ZTMIN (see <a href="#">page 1204</a> )	
:MEASurement<N>:CLEar (see <a href="#">page 1205</a> )	
:MEASurement<N>:NAME (see <a href="#">page 1206</a> )	
:MEASurement<N>:POSition (see <a href="#">page 1207</a> )	
:MEASurement<N>:SOURce (see <a href="#">page 1208</a> )	
:MEASurement<N>:ZTMAX (see <a href="#">page 1209</a> )	
:MEASurement<N>:ZTMIN (see <a href="#">page 1210</a> )	

## What's New in Version 6.70

New command descriptions for Version 6.70 of the Infiniium oscilloscope software appear below.

### New Commands

Command	Description
:DIGital<N>:POSition (see <a href="#">page 484</a> )	Sets the vertical position of a digital waveform within its waveform area grid.
:DISPlay:BOOKmark:DELeTe:ALL (see <a href="#">page 515</a> )	Deletes all bookmarks.
:DISPlay:GRATicule:AREA<N>:HSCale (see <a href="#">page 532</a> )	Specifies whether the horizontal scale is displayed.
:DISPlay:GRATicule:AREA<N>:VSCale (see <a href="#">page 534</a> )	Specifies whether the vertical scale is displayed with automatic sizing (AUTO), displayed with handles for manual sizing (MANual), or not displayed (OFF).
:FUNction:FFT:PEAK:SORT (see <a href="#">page 589</a> )	Specifies the peak annotation sort order.
:FUNction<F>:FFT:PEAK:COUNt (see <a href="#">page 590</a> )	Specifies the maximum number of peaks in the FFT to annotate.
:FUNction<F>:FFT:PEAK:FREQUency? (see <a href="#">page 591</a> )	Returns a comma-separated string of annotated peak frequency values.
:FUNction<F>:FFT:PEAK:LEVel (see <a href="#">page 592</a> )	Specifies the level above which peaks are identified.
:FUNction<F>:FFT:PEAK:MAGNitude? (see <a href="#">page 593</a> )	Returns a comma-separated string of annotated peak magnitude values.
:FUNction<F>:FFT:PEAK:STATe (see <a href="#">page 594</a> )	Enables or disables FFT peak annotations.
:FUNction<F>:LABel (see <a href="#">page 619</a> )	Sets the math function waveform label to the quoted string.
:LANE<N>:EQUalizer:CTLE:P5 (see <a href="#">page 725</a> )	Sets the Pole 5 frequency for the CTLE.
:LANE<N>:EQUalizer:CTLE:P6 (see <a href="#">page 726</a> )	Sets the Pole 6 frequency for the CTLE.
:MEASure:NSIGma (see <a href="#">page 1015</a> )	Installs, or returns the value of, a Sigma-n measurement on a PAM-4 waveform.
:MEASure:PAM:PRBS13q:EDGE:J6U? (see <a href="#">page 1041</a> )	When the signal type is PAM-4 and PRBS13Q edge (12-edge) jitter measurements are enabled, this query returns the measured PRBS13Q J6u values.

Command	Description
:MEASure:PAM:PRBS13q:PATTERN (see <a href="#">page 1044</a> )	Specifies the edge definition for the 12-edge jitter measurements' data pattern (either PRBS13Q, PCIE6 (52 symbols), or a custom data pattern).
:MEASure:PAM:PRBS13q:PFILE (see <a href="#">page 1045</a> )	When a custom data pattern is being used, this command specifies the full-path location of the edge definition file for that pattern.
:MEASure:PN:DESKew (see <a href="#">page 1057</a> )	When two channels are used, this command will automatically remove time skew due to different length cables connecting the device under test (DUT) to the oscilloscope.
:WMEMory<R>:LABel (see <a href="#">page 1654</a> )	Sets the waveform memory label to the quoted string.

### Changed Commands

Command	Description
:ANALyze:CLOCK:METHod (see <a href="#">page 275</a> )	Added the "PCIE6,PCIE8", "PCIE6,PCIE16", "PCIE6,PCIE32", and "PCIE6,PCIE64" PCIe 6 CXL Behavioral SRIS CC clock recovery methods for 8 Gb/s, 16 Gb/s, 32 Gb/s, and 64 Gb/s data rates, respectively.
:BUS:B<N>:TYPE (see <a href="#">page 318</a> )	Added support for new E1000BASET1 (Automotive Ethernet 1000BaseT1), DPAUX (DisplayPort Aux), and CPHY2 (MIPI C-PHY 2.0) protocols.
:CHANnel<N>:PROBe:MODE (see <a href="#">page 397</a> )	The SEST (source estimate differential) mode has been added for the MX0020A/21A/22A/24A/25A probe amplifiers.
:CHANnel<N>:PROBe:HEAD:VERTERm (see <a href="#">page 394</a> )	Supports the MX0020A/21A/22A/24A/25A probe amplifiers.
:LISTer:DATA? (see <a href="#">page 778</a> )	Added the BUS parameter for returning Digital Listing data.

## What's New in Version 6.60

New command descriptions for Version 6.60 of the Infiniium oscilloscope software appear below.

### New Commands

Command	Description
:DISK:SAVE:MREPort (see <a href="#">page 506</a> )	Lets you save information about the oscilloscope setup, a waveform screen capture, and measurement results to a PDF or MHTML (*.mht) format file.
:DISK:SAVE:NOISe (see <a href="#">page 507</a> )	Saves the noise measurements, shown in the Noise Results tab at the bottom of the oscilloscope screen, along with the Noise graph data in a comma separated variables (CSV) file format
:DISPlay:CGRade:LEGEnd (see <a href="#">page 524</a> )	Lets you enable or disable the Color Grade legend in the graphical user interface's Results pane.
:DISPlay:GRATICule:GLAYout (see <a href="#">page 535</a> )	Specifies the layout format to be used in organizing the grids in a waveform area.
:DISPlay:THEME (see <a href="#">page 566</a> )	Lets you select the graphical user interface's "Midnight" or "Platinum" theme.
:FUNCTion<F>:FFT:IMPedance (see <a href="#">page 587</a> )	When the FFT vertical units are displayed (and measured) as power (that is, dBm or Watt), this command lets you specify the reference impedance of the waveform source so that power is calculated correctly.
:MEASure:THResholds:SERauto (see <a href="#">page 1152</a> )	For protocol decodes that do not use clock recovery, this command automatically sets the general "Custom: thresholds (low, mid, up)" or "Custom: thresholds +/- hysteresis" when thresholds apply to individual waveforms.
:MEASurement<N>:POSition (see <a href="#">page 1207</a> )	Lets you reorder measurements within the Measurements window in the Results pane
:SBUS<N>:SEARch:ENABle (see <a href="#">page 1259</a> )	Enables or disables protocol search.
:SBUS<N>:SEARch:TRIGger (see <a href="#">page 1260</a> )	Enables or disables protocol search being used as a software trigger.
:SBUS<N>:UART:BAUDrate (see <a href="#">page 1335</a> )	Selects the bit rate (in bps) for the serial decoder and/or trigger when in UART mode.
:SBUS<N>:UART:BITorder (see <a href="#">page 1336</a> )	Selects whether the most significant bit (MSB) or least significant bit (LSB) is presented after the start bit in the signal from your device under test.
:SBUS<N>:UART:DIRection (see <a href="#">page 1337</a> )	Specifies whether you are decoding Rx only (RX), Tx only (TX), or Rx and Tx (RXTX).
:SBUS<N>:UART:EOF:HEX (see <a href="#">page 1338</a> )	Specifies the End-Of-Frame hexadecimal byte value.



Command	Description
:SBUS<N>:UART:IDLE (see <a href="#">page 1339</a> )	Selects LOW or HIGH to match the device under test's state when at idle.
:SBUS<N>:UART:PARity (see <a href="#">page 1340</a> )	Specifies the type of parity being used.
:SBUS<N>:UART:SOURce:RX (see <a href="#">page 1341</a> )	Specifies the receiver signal source.
:SBUS<N>:UART:SOURce:TX (see <a href="#">page 1342</a> )	Specifies the transmitter signal source.
:SBUS<N>:UART:WIDTh (see <a href="#">page 1343</a> )	Sets the number of bits in the RS-232/UART words to match your device under test.

### Changed Commands

Command	Description
:ANALyze:CLOCK:METHod (see <a href="#">page 275</a> )	Added the "PCIE5,PCIE8", "PCIE5,PCIE16", and "PCIE5,PCIE32" PCIe 5 CXL Behavioral SRIS CC clock recovery methods for 8 Gb/s, 16 Gb/s, and 32 Gb/s data rates, respectively.
:BUS:B<N>:TYPE (see <a href="#">page 318</a> )	Added support for new PCI5 (PCI Express Gen 1-5), USB4TUSB32 (USB4 Tunnel USB 3.2), USB4TPCI31 (USB4 Tunnel PCI Express 3.1), and MDIO protocols.
:MEASure:CGRade:EWIDth (see <a href="#">page 907</a> )	Added the ability to select units in UNITInterval or SECond (which was the default before).
:MEASure:CGRade:JITTer (see <a href="#">page 912</a> )	Added the ability to select units in UNITInterval or SECond (which was the default before).
:MEASure:PAM:ESKew (see <a href="#">page 1024</a> )	Added the ability to select units in UNITInterval or SECond. This control has been in the graphical user interface and is now available in the remote SCPI command.
:MEASure:THResholds:RFAL:METHod (see <a href="#">page 1143</a> )	The T1090 (10% and 90% of levels) and T2080 (20% and 80% of levels) settings for rise/fall measurement thresholds now work for NRZ and UNSPecified signal types as well as PAM signal types.
:SBUS<N>:MODE (see <a href="#">page 1258</a> )	Added the UART mode option.
:WAVEform:DATA (see <a href="#">page 1593</a> )	With Infiniium Offline only, this command copies the waveform points in an IEEE data block to the channel source specified by the :WAVEform:SOURce command.

## What's New in Version 6.55

New command descriptions for Version 6.55 of the Infiniium oscilloscope software appear below.

### New Commands

Command	Description
:ANALyze:CLOCK:METHOD:PLLa dvanced (see <a href="#">page 288</a> )	Enables or disables the "Advanced PLL for closed eyes" option.
:MARKer<K>:CMODE (see <a href="#">page 804</a> )	Specifies a particular marker's color mode.
:MARKer<K>:COLor (see <a href="#">page 805</a> )	Gives the marker a custom color when in CUSTom color mode.
:MEASure:HISTogram:MM3S (see <a href="#">page 970</a> )	Installs a histogram measurement, or returns the measurement value, of the mean minus three standard deviations.
:MEASure:HISTogram:MP3S (see <a href="#">page 971</a> )	Installs a histogram measurement, or returns the measurement value, of the mean plus three standard deviations.
:MEASure:TIEFilter:DAMPing (see <a href="#">page 1168</a> )	Specifies the damping factory for a second order low-pass TIE filter.
:SYSTem:DIMPedance (see <a href="#">page 1353</a> )	Sets the <b>Default Impedance to 1M Ohm</b> user preference.
:WAVEform:PNOise:FREQuency ? (see <a href="#">page 1619</a> )	Returns the horizontal frequency axis values for the phase noise analysis results waveform.

### Changed Commands

Command	Description
:ANALyze:CLOCK:METHOD (see <a href="#">page 275</a> )	Added the TOPLL (Third Order PLL), EXPTOPLL (Explicit Third Order PLL), and EQTOPLL (Equalized Third Order PLL) clock recovery methods.
:BUS:B<N>:TYPE (see <a href="#">page 318</a> )	Added support for new USB4 and USB4LS protocols.
:MEASure:TIEFilter:SHAPE (see <a href="#">page 1169</a> )	Added the FIRSt and SECond options for the new First Order and Second Order TIE filter shapes.

## What's New in Version 6.50

New command descriptions for Version 6.50 of the Infiniium oscilloscope software appear below.

### New Commands

Command	Description
:CHANnel<N>:PROBe:RESPonsivity (see <a href="#">page 405</a> )	For the N7004A Optical-to-Electrical Converter probe, when a user-defined wavelength is selected (by using the ":CHANnel<N>:PROBe:WAVelength WUSer" command), this command sets the responsivity value that has been determined using an optical power meter.
:CHANnel<N>:PROBe:WAVelength (see <a href="#">page 411</a> )	For the N7004A Optical-to-Electrical Converter probe, this command lets you specify the wavelength as 850 nm, 1310 nm, 1550 nm, or a user-defined value.
:DISPlay:RESults:LAYout (see <a href="#">page 561</a> )	Sets the Results pane's window layout.
:FUNction<F>:GATing:GLOBal (see <a href="#">page 608</a> )	Enables or disables one of the four global gates for the gating function.
:MEASure:ETAEdges (see <a href="#">page 943</a> )	Measures the time between edges (RISing, FALLing, or BOTH) within a certain number of pulses (N) across all groups of N pulses in the acquired waveform
:MEASure:PAM:PRBS13q:COU Nt (see <a href="#">page 1037</a> )	Lets you change the PRBS13Q edge (12-edge) jitter measurement count.
:MEASure:PAM:PRBS13q:EDGE :EOJ? (see <a href="#">page 1038</a> )	When the signal type is PAM-4 and PRBS13Q edge (12-edge) jitter measurements are enabled, this query returns the measured PRBS13Q even-odd jitter (EOJ) values.
:MEASure:PAM:PRBS13q:EDGE :J3U? (see <a href="#">page 1039</a> )	When the signal type is PAM-4 and PRBS13Q edge (12-edge) jitter measurements are enabled, this query returns the measured PRBS13Q J3u values.
:MEASure:PAM:PRBS13q:EDGE :J4U? (see <a href="#">page 1040</a> )	When the signal type is PAM-4 and PRBS13Q edge (12-edge) jitter measurements are enabled, this query returns the measured PRBS13Q J4u values.
:MEASure:PAM:PRBS13q:EDGE :JRMS? (see <a href="#">page 1042</a> )	When the signal type is PAM-4 and PRBS13Q edge (12-edge) jitter measurements are enabled, this query returns the measured PRBS13Q Jrms values.
:MEASure:PAM:PRBS13q:HUNi ts (see <a href="#">page 1043</a> )	Specifies the PRBS13Q edge (12-edge) jitter measurement graph scale (either Linear or Logarithmic).
:MEASure:PAM:PRBS13q:STAT e (see <a href="#">page 1046</a> )	Enables or disables the PRBS13Q edge (12-edge) jitter measurements on a source waveform.
:MEASure:PAM:PRBS13q:UNIT s (see <a href="#">page 1047</a> )	Specifies the PRBS13Q edge (12-edge) jitter measurement units (either Seconds or Unit Interval).

Command	Description
:MEASure:ZTMAX (see <a href="#">page 1203</a> )	When "Measure All Edges" is enabled and the measurement supports "Zoom To Max", this command adjusts the horizontal scale and position to zoom in on the maximum measured value.
:MEASure:ZTMIN (see <a href="#">page 1204</a> )	When "Measure All Edges" is enabled and the measurement supports "Zoom To Min", this command adjusts the horizontal scale and position to zoom in on the minimum measured value.
:MEASurement<N>:CLEar (see <a href="#">page 1205</a> )	Clears a single measurement.
:MEASurement<N>:ZTMAX (see <a href="#">page 1209</a> )	When "Measure All Edges" is enabled and the measurement supports "Zoom To Max", this command adjusts the horizontal scale and position to zoom in on the maximum measured value.
:MEASurement<N>:ZTMIN (see <a href="#">page 1210</a> )	When "Measure All Edges" is enabled and the measurement supports "Zoom To Min", this command adjusts the horizontal scale and position to zoom in on the minimum measured value.

Changed Commands

Command	Description
:DISPlay:PROPortion (see <a href="#">page 556</a> )	The query portion of this command has been deprecated. The P4Jitter (PAM4 Jitter) pane option has been added.
:DISPlay:PROPortion:RESults (see <a href="#">page 557</a> )	The query portion of this command has been deprecated.
:DISPlay:WINDow:MAXimize (see <a href="#">page 567</a> )	The P4Jitter (PAM4 Jitter) window option has been added.
:MEASure:PJITter (see <a href="#">page 1054</a> )	Added the SRMS or DBC option for specifying the measurement units in s(rms) or dBc, respectively.

Discontinued Commands

Discontinued Command	Current Command Equivalent	Comments
:MEASure:PAM:EOJ	:MEASure:PAM:PRBS13q:EDGE:EOJ? (see <a href="#">page 1038</a> )	The discontinued command installed the measurement in the Results pane and the query returned a composite measurement value. The current query returns a composite measurement value as well as values for individual rising and falling edges (R13, F21, F30, R03, F10, R02, R12, R23, R01, F20, F32, and F31).
:MEASure:PAM:J3U	:MEASure:PAM:PRBS13q:EDGE:J3U? (see <a href="#">page 1039</a> )	
:MEASure:PAM:J4U	:MEASure:PAM:PRBS13q:EDGE:J4U? (see <a href="#">page 1040</a> )	
:MEASure:PAM:JRMS	:MEASure:PAM:PRBS13q:EDGE:JRMS? (see <a href="#">page 1042</a> )	

## What's New in Version 6.40

New command descriptions for Version 6.40 of the Infiniium oscilloscope software appear below.

### New Commands

Command	Description
:LANE<N>:COPYto (see <a href="#">page 717</a> )	Copies all valid settings from lane lane to another.
:LANE<N>:EQUALizer:CTLE:ACGain (see <a href="#">page 718</a> )	Sets the AC Gain parameter for the CTLE when USB31 is selected for the "# of Poles" option
:LANE<N>:EQUALizer:CTLE:DCGain (see <a href="#">page 719</a> )	Sets the DC Gain parameter for the CTLE.
:LANE<N>:EQUALizer:CTLE:NUMPoles (see <a href="#">page 720</a> )	Selects the CTLE number of poles setting.
:LANE<N>:EQUALizer:CTLE:P1 (see <a href="#">page 721</a> )	Sets the Pole 1 frequency for the CTLE.
:LANE<N>:EQUALizer:CTLE:P2 (see <a href="#">page 722</a> )	Sets the Pole 2 frequency for the CTLE.
:LANE<N>:EQUALizer:CTLE:P3 (see <a href="#">page 723</a> )	Sets the Pole 3 frequency for the CTLE.
:LANE<N>:EQUALizer:CTLE:P4 (see <a href="#">page 724</a> )	Sets the Pole 4 frequency for the CTLE.
:LANE<N>:EQUALizer:CTLE:RATE (see <a href="#">page 727</a> )	Sets the data rate for the CTLE.
:LANE<N>:EQUALizer:CTLE:STATE (see <a href="#">page 728</a> )	Turns the CTLE on or off.
:LANE<N>:EQUALizer:CTLE:Z1 (see <a href="#">page 729</a> )	Sets the first zero frequency for the 3-pole CTLE.
:LANE<N>:EQUALizer:CTLE:Z2 (see <a href="#">page 730</a> )	Sets the second zero frequency for the 3-pole CTLE.
:LANE<N>:EQUALizer:DFE:NTAPS (see <a href="#">page 731</a> )	Sets the number of taps to be used in the DFE algorithm.
:LANE<N>:EQUALizer:DFE:STATE (see <a href="#">page 732</a> )	Turns the DFE on or off.
:LANE<N>:EQUALizer:DFE:TAP (see <a href="#">page 733</a> )	Sets the tap value for each DFE tap.
:LANE<N>:EQUALizer:DFE:TAP:AUTOMATIC (see <a href="#">page 734</a> )	Starts the DFE tap optimization.

Command	Description
:LANE<N>:EQUalizer:DFE:TAP:DElAY (see <a href="#">page 735</a> )	Specifies a delay of the DFE equalized waveform relative to an explicit recovered clock in order to center the DFE eye, post equalization.
:LANE<N>:EQUalizer:DFE:TAP:DElAY:AUTomatic (see <a href="#">page 736</a> )	Computes a DFE delay value to center a DFE eye on the screen horizontally.
:LANE<N>:EQUalizer:DFE:TAP:GAIN (see <a href="#">page 737</a> )	Applies a gain factor to compensate for DFE attenuation.
:LANE<N>:EQUalizer:DFE:TAP:L TARGET (see <a href="#">page 738</a> )	Dictates the logical low value used in the DFE algorithm.
:LANE<N>:EQUalizer:DFE:TAP:MAX (see <a href="#">page 739</a> )	Sets the upper limit on taps determined through optimization.
:LANE<N>:EQUalizer:DFE:TAP:MAXV (see <a href="#">page 740</a> )	Sets the maximum tap value for DFE auto tap setup in volts.
:LANE<N>:EQUalizer:DFE:TAP:MIN (see <a href="#">page 741</a> )	Sets the lower limit on taps determined through optimization.
:LANE<N>:EQUalizer:DFE:TAP:MINV (see <a href="#">page 742</a> )	Sets the minimum tap value for DFE auto tap setup in volts.
:LANE<N>:EQUalizer:DFE:TAP:NORMalize (see <a href="#">page 743</a> )	Specifies whether the Normalize DC Gain setting is ON or OFF.
:LANE<N>:EQUalizer:DFE:TAP:UTARGET (see <a href="#">page 744</a> )	Dictates the logical high value used in the DFE algorithm.
:LANE<N>:EQUalizer:DFE:TAP:WIDTH (see <a href="#">page 745</a> )	Sets the Eye Width field for the DFE tap optimization.
:LANE<N>:EQUalizer:DFE:THRe shold:BANDwidth (see <a href="#">page 746</a> )	When the DFE threshold bandwidth mode is CUSTom, this command specifies the threshold bandwidth value.
:LANE<N>:EQUalizer:DFE:THRe shold:BWMode (see <a href="#">page 747</a> )	When lane equalization is being displayed as a function (:LANE<N>:EQUalizer:LOCation FUNCtion), this command sets the threshold bandwidth mode for the DFE.
:LANE<N>:EQUalizer:DFE:THRe shold:DElAY (see <a href="#">page 748</a> )	Sets a delay to move the decision threshold relative to the original waveform when creating the DFE equalized waveform.
:LANE<N>:EQUalizer:FFE:BAND width (see <a href="#">page 749</a> )	When BWMode is CUSTom, this command sets the bandwidth at which the response generated by equalization rolls off.
:LANE<N>:EQUalizer:FFE:BWM ode (see <a href="#">page 750</a> )	Sets the bandwidth at which the response generated by equalization is rolled off.
:LANE<N>:EQUalizer:FFE:NPRe cursor (see <a href="#">page 751</a> )	Sets the number of precursor taps to be used in the FFE algorithm.
:LANE<N>:EQUalizer:FFE:NTAP s (see <a href="#">page 752</a> )	Sets the number of taps to be used in the FFE algorithm.

Command	Description
:LANE<N>:EQUalizer:FFE:RATE (see <a href="#">page 753</a> )	Sets the data rate for the FFE equalizer.
:LANE<N>:EQUalizer:FFE:STATe (see <a href="#">page 754</a> )	Turns the FFE on or off.
:LANE<N>:EQUalizer:FFE:TAP (see <a href="#">page 755</a> )	Sets the tap value for each FFE tap.
:LANE<N>:EQUalizer:FFE:TAP:A UTomatic (see <a href="#">page 756</a> )	Starts the FFE tap optimization.
:LANE<N>:EQUalizer:FFE:TAP:D ELay (see <a href="#">page 757</a> )	Specifies the amount of drift the equalized eye diagram has relative to the unequalized one.
:LANE<N>:EQUalizer:FFE:TAP: WIDTH (see <a href="#">page 758</a> )	Sets the Eye Width field for the FFE tap optimization.
:LANE<N>:EQUalizer:FFE:TDEL ay (see <a href="#">page 759</a> )	When TDMoDe is set to CUSTom, this command sets the tap delay value.
:LANE<N>:EQUalizer:FFE:TDMo de (see <a href="#">page 760</a> )	Sets Tap Delay field to either Track Data Rate or Custom.
:LANE<N>:EQUalizer:LOCation (see <a href="#">page 761</a> )	Tells the equalization lane whether to equalize in-place (modifying the source waveform itself) or display as a function (creating a separate equalized waveform).
:LANE<N>:SOURce (see <a href="#">page 762</a> )	Sets the source for the equalization lane.
:LANE<N>:STATe (see <a href="#">page 763</a> )	Turns the equalization lane on or off.
:LANE<N>:VERTical (see <a href="#">page 764</a> )	Sets the equalization lane's vertical scale mode to automatic or manual.
:LANE<N>:VERTical:OFFSet (see <a href="#">page 765</a> )	When the vertical scale mode is manual, this command sets the equalization lane's vertical offset.
:LANE<N>:VERTical:RANGe (see <a href="#">page 766</a> )	When the vertical scale mode is manual, this command command sets the equalization lane's vertical range.
:MEASure:CGRade:EWIDth:THR eshold (see <a href="#">page 909</a> )	Specifies the threshold voltage level used in measuring the eye width.
:MTEST:SCALE:DRAW (see <a href="#">page 871</a> )	Specifies whether the mask bounding region is displayed.

### Changed Commands

All commands that accepted "EQUalized" or returned "EQU" as a waveform source prior to Version 6.40 now accept "EQUalized1", "EQUalized2", "EQUalized3", or "EQUalized4", or return "EQU1", "EQU2", "EQU3", or "EQU4". "EQUalized" is now equivalent to "EQUalized1".

Command	Description
:FUNction<F>:FFT:DETECTOR:TYPE (see <a href="#">page 584</a> )	The RMS detector type is no longer available.

Obsolete Commands

Obsolete Command	Current Command Equivalent	Behavior Differences
:SPROcessing:CTLequalizer:ACGain (see <a href="#">page 1752</a> )	:LANE1:EQualizer:CTLE:ACGain (see <a href="#">page 718</a> )	All :SPROcessing:CTLequalizer commands apply to Lane 1.
:SPROcessing:CTLequalizer:DCGain (see <a href="#">page 1753</a> )	:LANE1:EQualizer:CTLE:DCGain (see <a href="#">page 719</a> )	
:SPROcessing:CTLequalizer:DISPlay (see <a href="#">page 1754</a> )	:LANE1:EQualizer:CTLE:STATE (see <a href="#">page 728</a> )	The ":SPROcessing:CTLequalizer:DISPlay ON" command now: (1) turns CTLE on in Lane 1, (2) turns FFE off in Lane 1, and (3) turns on Lane 1.
:SPROcessing:CTLequalizer:NUMPoles (see <a href="#">page 1755</a> )	:LANE1:EQualizer:CTLE:NUMPoles (see <a href="#">page 720</a> )	All :SPROcessing:CTLequalizer commands apply to Lane 1.
:SPROcessing:CTLequalizer:P1 (see <a href="#">page 1756</a> )	:LANE1:EQualizer:CTLE:P1 (see <a href="#">page 721</a> )	
:SPROcessing:CTLequalizer:P2 (see <a href="#">page 1757</a> )	:LANE1:EQualizer:CTLE:P2 (see <a href="#">page 722</a> )	
:SPROcessing:CTLequalizer:P3 (see <a href="#">page 1758</a> )	:LANE1:EQualizer:CTLE:P3 (see <a href="#">page 723</a> )	
:SPROcessing:CTLequalizer:RATE (see <a href="#">page 1760</a> )	:LANE1:EQualizer:CTLE:RATE (see <a href="#">page 727</a> )	
:SPROcessing:CTLequalizer:SOURce (see <a href="#">page 1761</a> )	:LANE1:SOURce (see <a href="#">page 762</a> )	Selected source applies to the entire lane.
:SPROcessing:CTLequalizer:VERTical (see <a href="#">page 1762</a> )	:LANE1:VERTical (see <a href="#">page 764</a> )	All :SPROcessing:CTLequalizer commands apply to Lane 1.
:SPROcessing:CTLequalizer:VERTical:OFFSet (see <a href="#">page 1763</a> )	:LANE1:VERTical:OFFSet (see <a href="#">page 765</a> )	
:SPROcessing:CTLequalizer:VERTical:RANGe (see <a href="#">page 1764</a> )	:LANE1:VERTical:RANGe (see <a href="#">page 766</a> )	
:SPROcessing:CTLequalizer:Z1 (see <a href="#">page 1765</a> )	:LANE1:EQualizer:CTLE:Z1 (see <a href="#">page 729</a> )	
:SPROcessing:CTLequalizer:Z2 (see <a href="#">page 1766</a> )	:LANE1:EQualizer:CTLE:Z2 (see <a href="#">page 730</a> )	



Obsolete Command	Current Command Equivalent	Behavior Differences	
:SPRocessing:DFEQualizer:NTAPs (see <a href="#">page 1768</a> )	:LANE2:EQualizer:DFE:NTAPs (see <a href="#">page 731</a> )	All :SPRocessing:DFEQualizer commands apply to Lane 2.	
:SPRocessing:DFEQualizer:SOURce (see <a href="#">page 1769</a> )	:LANE2:SOURce (see <a href="#">page 762</a> )	Selected source applies to the entire lane.	
:SPRocessing:DFEQualizer:STATe (see <a href="#">page 1770</a> )	:LANE2:EQualizer:DFE:STATe (see <a href="#">page 732</a> )	The ":SPRocessing:DFEQualizer:STATe ON" command now: (1) turns on DFE in Lane 2, (2) set Lane 2's location to "in-place", and (3) turns on Lane 2.	
:SPRocessing:DFEQualizer:TAP (see <a href="#">page 1771</a> )	:LANE2:EQualizer:DFE:TAP (see <a href="#">page 733</a> )	All :SPRocessing:DFEQualizer commands apply to Lane 2.	
:SPRocessing:DFEQualizer:TAP:AUTomatic (see <a href="#">page 1772</a> )	:LANE2:EQualizer:DFE:TAP:AUTomatic (see <a href="#">page 734</a> )		
:SPRocessing:DFEQualizer:TAP:DELay (see <a href="#">page 1773</a> )	:LANE2:EQualizer:DFE:TAP:DELay (see <a href="#">page 735</a> )		
:SPRocessing:DFEQualizer:TAP:DELay:AUTomatic (see <a href="#">page 1774</a> )	:LANE2:EQualizer:DFE:TAP:DELay:AUTomatic (see <a href="#">page 736</a> )		
:SPRocessing:DFEQualizer:TAP:GAIN (see <a href="#">page 1775</a> )	:LANE2:EQualizer:DFE:TAP:GAIN (see <a href="#">page 737</a> )		
:SPRocessing:DFEQualizer:TAP:LTA Rget (see <a href="#">page 1776</a> )	:LANE2:EQualizer:DFE:TAP:LTA Rget (see <a href="#">page 738</a> )		
:SPRocessing:DFEQualizer:TAP:MAX (see <a href="#">page 1777</a> )	:LANE2:EQualizer:DFE:TAP:MAX (see <a href="#">page 739</a> )		
:SPRocessing:DFEQualizer:TAP:MIN (see <a href="#">page 1778</a> )	:LANE2:EQualizer:DFE:TAP:MIN (see <a href="#">page 741</a> )		
:SPRocessing:DFEQualizer:TAP:NORMalize (see <a href="#">page 1779</a> )	:LANE2:EQualizer:DFE:TAP:NORMalize (see <a href="#">page 743</a> )		
:SPRocessing:DFEQualizer:TAP:UTARget (see <a href="#">page 1780</a> )	:LANE2:EQualizer:DFE:TAP:UTARget (see <a href="#">page 744</a> )		
:SPRocessing:DFEQualizer:TAP:WIDTh (see <a href="#">page 1781</a> )	:LANE2:EQualizer:DFE:TAP:WIDTh (see <a href="#">page 745</a> )		
:SPRocessing:FFEQualizer:BAN Dwidth (see <a href="#">page 1782</a> )	:LANE1:EQualizer:FFE:BAN Dwidth (see <a href="#">page 749</a> )		All :SPRocessing:FFEQualizer commands apply to Lane 1.
:SPRocessing:FFEQualizer:BW Mode (see <a href="#">page 1783</a> )	:LANE1:EQualizer:FFE:BW Mode (see <a href="#">page 750</a> )		

Obsolete Command	Current Command Equivalent	Behavior Differences
:SPROcessing:FFEQualizer:DIS Play (see <a href="#">page 1784</a> )	:LANE1:EQualizer:FFE:STATe (see <a href="#">page 754</a> )	The ":SPROcessing:FFEQualizer:DIS Play ON" command now: (1) turns FFE on in Lane 1, (2) turns CTLE off in Lane 1, and (3) turns on Lane 1.
:SPROcessing:FFEQualizer:NPR ecursor (see <a href="#">page 1785</a> )	:LANE1:EQualizer:FFE:NPR ecursor (see <a href="#">page 751</a> )	All :SPROcessing:FFEQualizer commands apply to Lane 1.
:SPROcessing:FFEQualizer:NTA Ps (see <a href="#">page 1786</a> )	:LANE1:EQualizer:FFE:NTAPs (see <a href="#">page 752</a> )	
:SPROcessing:FFEQualizer:RAT e (see <a href="#">page 1787</a> )	:LANE1:EQualizer:FFE:RATE (see <a href="#">page 753</a> )	
:SPROcessing:FFEQualizer:SOU Rce (see <a href="#">page 1788</a> )	:LANE1:SOU Rce (see <a href="#">page 762</a> )	
:SPROcessing:FFEQualizer:TAP (see <a href="#">page 1789</a> )	:LANE1:EQualizer:FFE:TAP (see <a href="#">page 755</a> )	All :SPROcessing:FFEQualizer commands apply to Lane 1.
:SPROcessing:FFEQualizer:TAP: AUTomatic (see <a href="#">page 1790</a> )	:LANE1:EQualizer:FFE:TAP:AUT omatic (see <a href="#">page 756</a> )	
:SPROcessing:FFEQualizer:TAP: DELay (see <a href="#">page 1791</a> )	:LANE1:EQualizer:FFE:TAP:DEL ay (see <a href="#">page 757</a> )	
:SPROcessing:FFEQualizer:TAP: WIDTh (see <a href="#">page 1792</a> )	:LANE1:EQualizer:FFE:TAP:WID Th (see <a href="#">page 758</a> )	
:SPROcessing:FFEQualizer:TDE Lay (see <a href="#">page 1793</a> )	:LANE1:EQualizer:FFE:TDE Lay (see <a href="#">page 759</a> )	
:SPROcessing:FFEQualizer:TDM ode (see <a href="#">page 1794</a> )	:LANE1:EQualizer:FFE:TDM ode (see <a href="#">page 760</a> )	
:SPROcessing:FFEQualizer:VER Tical (see <a href="#">page 1795</a> )	:LANE1:VERTical (see <a href="#">page 764</a> )	
:SPROcessing:FFEQualizer:VER Tical:OFFSet (see <a href="#">page 1796</a> )	:LANE1:VERTical:OFFSet (see <a href="#">page 765</a> )	
:SPROcessing:FFEQualizer:VER Tical:RANGe (see <a href="#">page 1797</a> )	:LANE1:VERTical:RANGe (see <a href="#">page 766</a> )	

## What's New in Version 6.30

New command descriptions for Version 6.30 of the Infiniium oscilloscope software appear below.

### New Commands

Command	Description
:ANALyze:CLOCK:METHod:SKEW:AUTomatic (see <a href="#">page 291</a> )	When clock recovery is being performed on a PAM-4 signal type, this command automatically shifts clocks relative to the data to center the eye opening at the clock locations.
:FUNction<F>:FFT:HSCale (see <a href="#">page 586</a> )	For a FFT math function waveform, this command specifies whether the horizontal scale is linear or logarithmic.
:HISTogram:MEASurement:MAX (see <a href="#">page 656</a> )	Specifies the histogram's measurement maximum.
:HISTogram:MEASurement:MIN (see <a href="#">page 657</a> )	Specifies the histogram's measurement minimum.
:MARKer<K>:DELTA (see <a href="#">page 808</a> )	This command sets a particular marker's "delta to" relationship with another marker of the same type. The query returns a particular marker's "delta to" state and delta values if the state is 1 (ON).
:MARKer<K>:ENABle (see <a href="#">page 809</a> )	Turns a particular marker on or off.
:MARKer<K>:NAME (see <a href="#">page 810</a> )	Gives the marker a name.
:MARKer<K>:SOURce (see <a href="#">page 811</a> )	Specifies the waveform source of a particular marker.
:MARKer<K>:TYPE (see <a href="#">page 813</a> )	Specifies a particular marker's type (manual X only, manual Y only, track waveforms, or track RF).
:MARKer<K>:X:POSition (see <a href="#">page 815</a> )	Specifies the horizontal position of a particular marker.
:MARKer<K>:Y:POSition (see <a href="#">page 816</a> )	Specifies the vertical position of a particular marker.
:MEASure:CGRade:ELOCation (see <a href="#">page 906</a> )	Specifies the eye height measurement location.
:MEASure:MARK (see <a href="#">page 997</a> )	This command turns on or off "track measurement" markers for a specified measurement. The query returns the "track measurement" marker results.
:MEASure:PAM:EYE:PROBabilitY (see <a href="#">page 1029</a> )	When making PAM eye height or eye width measurements, the :MEASure:PAM:EYE:PROBability command specifies whether eye boundaries (from the center of each eye) are based on zero hits or at an eye opening BER (Bit Error Ratio) probability.

Command	Description
:MEASure:PJITter (see <a href="#">page 1054</a> )	Measures Phase Jitter on the phase noise single-sideband (SSB) frequency offset FFT plot.
:MEASure:PLENght (see <a href="#">page 1055</a> )	The command installs a Pattern Length measurement into the user interface's measurement Results pane. The query returns the measured pattern length.
:MEASure:PN:CORRelations (see <a href="#">page 1056</a> )	When two clock sources permit the <i>two-channel cross-correlation technique</i> to be used, this command specifies the number of correlations that will be accumulated between phase noise analysis plot averages.
:MEASure:PN:EDGE (see <a href="#">page 1058</a> )	Specifies the clock edge direction to measure.
:MEASure:PN:HORizontal:STARt (see <a href="#">page 1059</a> )	For the phase noise analysis single-sideband (SSB) frequency offset plot, this command specifies the left side of the horizontal log frequency scale.
:MEASure:PN:HORizontal:STOP (see <a href="#">page 1060</a> )	For the phase noise analysis single-sideband (SSB) frequency offset plot, this command specifies the right side of the horizontal log frequency scale.
:MEASure:PN:RSSC (see <a href="#">page 1061</a> )	If your clock source uses spread-spectrum clocking (SSC) and the FLATtop FFT windowing function is selected, you can use this command to enable or disable the removal of the SSC effects from the phase noise analysis results.
:MEASure:PN:SOURce (see <a href="#">page 1062</a> )	Specifies the clock source(s) on which the phase noise analysis is performed.
:MEASure:PN:SPURs (see <a href="#">page 1064</a> )	Specifies how to display spurs in the phase noise analysis single-sideband (SSB) frequency offset plot.
:MEASure:PN:SSENSitivity (see <a href="#">page 1065</a> )	When omitting spurs from the phase noise analysis single-sideband (SSB) frequency offset plot, or when displaying them in power (dBc) instead of the default normalized (dBc/Hz) scale, this command specifies the sensitivity used in identifying spurs.
:MEASure:PN:STATe (see <a href="#">page 1066</a> )	Turns the phase noise analysis feature on or off.
:MEASure:PN:VERTical:REFerence (see <a href="#">page 1067</a> )	Specifies the dBc/Hz value at the top of the phase noise analysis single-sideband (SSB) frequency offset plot.
:MEASure:PN:VERTical:SCALE (see <a href="#">page 1068</a> )	Specifies the height in dBc/Hz of each vertical division in the phase noise analysis single-sideband (SSB) frequency offset plot.
:MEASure:PN:WINDow (see <a href="#">page 1069</a> )	Specifies the FFT windowing function used in the phase noise analysis.
:MEASure:RJDJ:CREference (see <a href="#">page 1092</a> )	Specifies the number of UI away from the data edge at which to measure jitter.

Command	Description
:MEASure:XCORtie (see <a href="#">page 1202</a> )	Measures cross-correlated TIE using the same <i>two-channel cross-correlation technique</i> that is used when measuring phase noise.
:SPROcessing:DFEQualizer:TAP:DELay:AUTomatic (see <a href="#">page 1774</a> )	Computes a DFE delay value to center a DFE eye on the screen horizontally.
:TRIGger:FORCe (see <a href="#">page 1388</a> )	Causes an acquisition to be captured even though the trigger condition has not been met.
:WMEMory<R>:FFT:HSCale (see <a href="#">page 1653</a> )	For a FFT waveform memory, this command specifies whether the horizontal scale is linear or logarithmic.

### Changed Commands

Command	Description
:ANALyze:CLOCK:METhod (see <a href="#">page 275</a> )	Added the BMC (USB PD bi-phase mark coding) and LFPS (USB 3 low frequency periodic signaling) methods.
:ANALyze:SIGNAL:TYPE (see <a href="#">page 312</a> )	PAM3 has been added as a signal type.
:BUS:B<N>:TYPE (see <a href="#">page 318</a> )	Added support for new QSPI (Quad SPI) and USB32 (USB 3.2) protocols.
:CHANnel<N>:ISIM:BWLimit:TYPE (see <a href="#">page 364</a> )	The BANDpass option has been added to support the Phase Noise analysis application.
:DISPlay:LAYout (see <a href="#">page 547</a> )	The obsolete CUSTom option has been replaced with the new TAB option.
:FUNction<F>:MHISTogram (see <a href="#">page 627</a> )	Added <min> and <max> parameters for specifying the histogram's measurement minimum and measurement maximum.
:MEASure:STATistics (see <a href="#">page 1117</a> )	The COUNT option has been added to allow the :MEASure:RESults? query to return the measurement count value.
:MEASure:THResholds:GENeral:PAMCustom (see <a href="#">page 1128</a> )	Modified to work with the PAM-3 signal type.
:MEASurement<N>:NAME (see <a href="#">page 1206</a> )	Now supports up to 20 measurements.
:SPROcessing:CTLequalizer:NUMPoles (see <a href="#">page 1755</a> )	The new option names P2Z1 and P2ACG replace the old option names POLE2 and USB31, respectively (but operations are the same).

Discontinued  
Commands

Discontinued Command	Current Command Equivalent	Comments
:MTEST:AlignFIT	None	This command is no longer supported.
:TRIGger:ADVanced:PATtern:THReshold:POD<N>	:DIGital<N>:THReshold (see <a href="#">page 486</a> )	

## What's New in Version 6.20

New command descriptions for Version 6.20 of the Infiniium oscilloscope software appear below.

### New Commands

Command	Description
:ANALyze:CLOCK:METHOD:IDLE (see <a href="#">page 283</a> )	This command lets you specify the number of additional clocks output by the clock recovery PLL for situations where valid data can occur during electrical idles.
:ANALyze:SIGNAL:PATTERN:CLEAr (see <a href="#">page 306</a> )	Clears a loaded pattern file.
:ANALyze:SIGNAL:PATTERN:LOAD (see <a href="#">page 307</a> )	Loads a pattern file from which pattern lengths and patterns are determined.
:ANALyze:SIGNAL:PATTERN:PLENgth (see <a href="#">page 308</a> )	Specifies a pattern length or that the oscilloscope determine the pattern length automatically.
:ANALyze:SIGNAL:PATTERN:SMAP (see <a href="#">page 309</a> )	For PAM-4 signal types, specifies whether the symbol map is gray-coded or uncoded.
:MEASure:JITTER:SPECTrum:RESolution? (see <a href="#">page 985</a> )	This query returns the resolution bandwidth of the measurement analysis spectrum FFT.
:MEASure:PAM:EOJ	When the signal type is PAM-4, this command installs a PRBS13Q even-odd jitter (EOJ) measurement into the user interface's measurement Results pane. The query returns the measured PRBS13Q even-odd jitter (EOJ) value.
:MEASure:PAM:J4U	When the signal type is PAM-4, this command installs a PRBS13Q J4u measurement into the user interface's measurement Results pane. The query returns the measured PRBS13Q J4u value.
:MEASure:PAM:JRMS	When the signal type is PAM-4, this command installs a PRBS13Q Jrms measurement into the user interface's measurement Results pane. The query returns the measured PRBS13Q Jrms value.
:SBUS<N>:GENRaw:SOURce (see <a href="#">page 1288</a> )	Sets the source for the Generic Raw signal.
:SBUS<N>:GENRaw:WSIZe (see <a href="#">page 1289</a> )	Sets the Generic Raw protocol decode word size.
:SPROcessing:DFEQualizer:TAP:NORMALize (see <a href="#">page 1779</a> )	Specifies whether the Normalize DC Gain setting is ON or OFF.

### Changed Commands

Command	Description
:ACQuire:HRESolution (see <a href="#">page 248</a> )	On S-Series oscilloscopes only, the BITF11, BITF12, BITF13, BITF14, BITF15, and BITF16 options have been added to force the specified number of bits of vertical resolution.
:ANALyze:SIGNal:TYPE (see <a href="#">page 312</a> )	NRZ has been added as a signal type. With this selection, you are able to specify pattern lengths and patterns so that you can make BER measurements on NRZ signals (:MEASure:BER and :MEASure:BERPeracq).
:BUS:B<N>:TYPE (see <a href="#">page 318</a> )	Added support for new PCI4 (PCI Express Gen4) and SENT (Single Edge Nibble Transmission) protocols.
:DISK:LOAD (see <a href="#">page 496</a> )	The <interp> option has been added.
:MARKer:MODE (see <a href="#">page 789</a> )	Now returns ICON when Track RF markers are used.
:MEASure:BER (see <a href="#">page 896</a> )	Now works with the NRZ signal type (as well as the PAM signal type). Pattern length parameters have been removed from this command because pattern lengths and patterns are now specified using the :ANALyze:SIGNal:PATtern:* commands.
:MEASure:BERPeracq (see <a href="#">page 897</a> )	Now works with the NRZ signal type (as well as the PAM signal type). Pattern length parameters have been removed from this command because pattern lengths and patterns are now specified using the :ANALyze:SIGNal:PATtern:* commands.
:MEASure:FFT:DFREquency (see <a href="#">page 949</a> )	The command and query now include peak number and level parameters.
:MEASure:FFT:DMAGnitude (see <a href="#">page 951</a> )	The command and query now include peak number and level parameters.
:MEASure:FFT:FREQuency (see <a href="#">page 953</a> )	The command and query now include peak number and level parameters.
:MEASure:FFT:MAGNitude (see <a href="#">page 955</a> )	The command and query now include peak number and level parameters.
:MEASure:RESults? (see <a href="#">page 1079</a> )	There is now an AORDered option for returning the results according to the order in which measurements were added (ignoring any front panel graphical user interface (GUI) reordering) or a GORDered option for returning the results according to the order they appear on the display (even after front panel GUI reordering). Not specifying any option is the same as using the AORDered option.
:MEASure:SER (see <a href="#">page 1110</a> )	Pattern length parameters have been removed from this command because pattern lengths and patterns are now specified using the :ANALyze:SIGNal:PATtern:* commands.
:MEASure:SERPeracq (see <a href="#">page 1111</a> )	Pattern length parameters have been removed from this command because pattern lengths and patterns are now specified using the :ANALyze:SIGNal:PATtern:* commands.



Command	Description
:SBUS<N>:MODE (see <a href="#">page 1258</a> )	Added the GENRaw mode option.
:SYSTem:GUI (see <a href="#">page 1357</a> )	The LOCK parameter has been added and the query return value is now a string (ON, OFF, or LOCK) instead of the previous 1 or 0 return values.
:TRIGger:ADVanced:PATtern:CONDition (see <a href="#">page 1505</a> )	The OR parameter has been added.
:TRIGger:PATtern:CONDition (see <a href="#">page 1437</a> )	The OR parameter has been added.
:WAVEform:SEGmented:COUNt? (see <a href="#">page 1627</a> )	The signal that is queried for the count is the signal set by the :WAVEform:SOURce command. If you query the COUNt while the segmented acquisition is occurring, it will return the number of segments acquired so far.
:WAVEform:SEGmented:TTAG? (see <a href="#">page 1627</a> )	The signal that is queried for the time tag is the signal set by the :WAVEform:SOURce command.

Obsolete Commands

Obsolete Command	Current Command Equivalent	Behavior Differences
:MEASure:FFT:PEAK1 (see <a href="#">page 1744</a> )	:MEASure:FFT:DFRequency (see <a href="#">page 949</a> )	Peak numbers and threshold levels are now specified in the :MEASure:FFT:DFRequency and :MEASure:FFT:DMAGnitude command/query parameters.
:MEASure:FFT:PEAK2 (see <a href="#">page 1745</a> )	:MEASure:FFT:DMAGnitude (see <a href="#">page 951</a> )	
:MEASure:FFT:THRehold (see <a href="#">page 1746</a> )		

Discontinued Commands

Discontinued Command	Current Command Equivalent	Comments
:SPROcessing:FFEQualizer:TAP:PLENght	:ANALyze:SIGNal:PATtern:*	Pattern lengths and patterns are now specified using the :ANALyze:SIGNal:PATtern:* commands.

## What's New in Version 6.10

New command descriptions for Version 6.10 of the Infiniium oscilloscope software appear below.

### New Commands

Command	Description
:ANALyze:CLOCK:METHOD:SKEW (see <a href="#">page 290</a> )	When clock recovery is being performed on a PAM-4 signal type, this command can be used to center the eye opening at the clock locations by shifting the clocks relative to the data.
:DISPlay:JITTer:THReshold (see <a href="#">page 545</a> )	When the ":MEASure:RJDJ:PAMThreshold ALL" command specifies that all PAM-4 thresholds are measured, this command specifies whether a certain threshold level or ALL threshold levels should be displayed in the jitter graphs.
:DISPlay:NOISe:LEVel (see <a href="#">page 550</a> )	Specifies which of the noise graphs to display.
:FUNCTion<F>:PAverage (see <a href="#">page 634</a> )	Sets up the Pattern Average math function.
:HOSTed:NCONnected? (see <a href="#">page 691</a> )	Returns a number that indicates whether in hosted mode, and if in hosted mode, the number of hosted oscilloscope frames connected.
:MARKer:DELTA (see <a href="#">page 786</a> )	Turns on or off the check box to display deltas on the screen (as opposed to the deltas in the results area and remote queries).
:MEASure:PAM:EYE:ELMethod (see <a href="#">page 1026</a> )	Selects the basis for determining the location of an eye's center on the waveform.
:MEASure:PAM:EYE:ESTiming (see <a href="#">page 1027</a> )	Configures the timing for sampling the data.
:MEASure:PAM:EYE:PPERcent (see <a href="#">page 1028</a> )	Defines the timespan over which an eye's amplitude level is measured.
:MEASure:PAM:EYE:TIME:LTDefinition (see <a href="#">page 1030</a> )	Specifies the method used to locate the time at which to measure an eye's level.
:MEASure:HISTogram:FWMH (see <a href="#">page 961</a> )	The command installs a Full-Width at Half Max histogram measurement into the user interface's measurement Results pane. The query returns the measured histogram Full-Width at Half Max value.
:MEASure:RJDJ:PAMThreshold (see <a href="#">page 1097</a> )	Specifies which PAM thresholds to measure for PAM-4 signals.
:MEASure:THResholds:DISPlay (see <a href="#">page 1120</a> )	When the source is a PAM-4 signal type, this command turns on or off the display of the PAM-4 measurement thresholds.

Changed  
Commands

Command	Description
:ANALyze:SIGNal:TYPE (see <a href="#">page 312</a> )	CPHY has been added as a signal type.
:BUS:B<N>:TYPE (see <a href="#">page 318</a> )	Added support for new CPHY (MIPI C-PHY), BRR (BroadR-Reach), SPW (SpaceWire), and MAN (Manchester) protocols.
:CALibrate:OUTPut (see <a href="#">page 332</a> )	Added the PRBS7, PRBS15, and PRBS31 options for the Infiniium 90000 X-Series, V-Series, 90000 Q-Series, and Z-Series oscilloscopes.
:CHANnel<N>:PROBe:EADapter (see <a href="#">page 382</a> )	Added the CUR0002VA and CUR002VA options for use with the E2697A or N5449A high impedance adapters.
:DISK:SAVE:WAVEform (see <a href="#">page 510</a> )	Added the MATLAB format for saving waveforms to MATLAB (.mat) data format files.
:MEASure:RJDJ:ALL? (see <a href="#">page 1085</a> )	Jitter analysis is supported on PAM-4 signals. When the ":MEASure:RJDJ:PAMThreshold ALL" command setting has been made, the query results include values for multiple threshold levels; otherwise, the query results are for the specific threshold level specified in the :MEASure:RJDJ:PAMThreshold command.
:MEASure:RJDJ:TJRJDJ? (see <a href="#">page 1105</a> )	Jitter analysis is supported on PAM-4 signals. When the ":MEASure:RJDJ:PAMThreshold ALL" command setting has been made, the query results include values for multiple threshold levels; otherwise, the query results are for the specific threshold level specified in the :MEASure:RJDJ:PAMThreshold command.
:MEASure:THResholds:GENeral :PAMCustom (see <a href="#">page 1128</a> )	Added an optional <hysteresis> value at the end of the command parameters.

Obsolete  
Commands

Obsolete Command	Current Command Equivalent	Behavior Differences
:ANALyze:CLOCK:METHod:PAM: B03 (see <a href="#">page 1710</a> )	None	The command works and as before, but changing its default (ON) is not necessary.
:ANALyze:CLOCK:METHod:PAM: B12 (see <a href="#">page 1712</a> )	None	The command works and as before, but changing its default (ON) is not necessary.
:ANALyze:CLOCK:METHod:PAM: NONSymmetric (see <a href="#">page 1714</a> )	None	The command works and as before, but changing its default (OFF) is not necessary.

## What's New in Version 6.00

New command descriptions for Version 6.00 of the Infiniium oscilloscope software appear below.

### New Commands

Command	Description
:ACQUIRE:SEGMENTED:AUTOPLAY (see <a href="#">page 260</a> )	Specifies whether segments are automatically played after a segmented memory acquisition.
:CALIBRATE:OUTPUT:AUX (see <a href="#">page 334</a> )	Enables or disables signal output on the oscilloscope's Aux Out connector.
:CALIBRATE:OUTPUT:AUX:RTIME (see <a href="#">page 335</a> )	Specifies the speed of the Aux Out signal's rise time.
:CALIBRATE:OUTPUT:CAL (see <a href="#">page 336</a> )	Enables or disables signal output on the oscilloscope's Cal Out connector.
:CHANNEL<N>:SIMULATION:AMPLITUDE (see <a href="#">page 414</a> )	Specifies the amplitude of the simulated waveform.
:CHANNEL<N>:SIMULATION:DATA:LENGTH (see <a href="#">page 415</a> )	Specifies the length exponent of the simulated waveform's PRBS sequence (for the DATA simulated waveform type).
:CHANNEL<N>:SIMULATION:DATA:ODD (see <a href="#">page 416</a> )	Sets the PRBS "odd" control (for the DATA simulated waveform type).
:CHANNEL<N>:SIMULATION:DATA:PAM (see <a href="#">page 417</a> )	Specifies the number of symbols (or levels) in the PAM signal (when the DATA simulated waveform type is selected and the PAM signal type is selected).
:CHANNEL<N>:SIMULATION:DATA:RESEED (see <a href="#">page 418</a> )	Specifies whether to reseed the PRBS generator(s) (for the DATA simulated waveform type).
:CHANNEL<N>:SIMULATION:DATA:SELECTION (see <a href="#">page 419</a> )	Specifies whether the simulated PRBS waveform is a Non Return to Zero (NRZ) signal or a Pulse Amplitude Modulation (PAM) signal (for the DATA simulated waveform type).
:CHANNEL<N>:SIMULATION:DATA:RATE (see <a href="#">page 420</a> )	Specifies the data rate of the simulated waveform (for the DATA simulated waveform type).
:CHANNEL<N>:SIMULATION:FILTER:ISIM:ADDRESS (see <a href="#">page 421</a> )	Specifies the path of an InfiniiSim transfer function file (when an InfiniiSim filter is selected).
:CHANNEL<N>:SIMULATION:FILTER:ISIM:PEXTRACTION (see <a href="#">page 422</a> )	Specifies the port extraction method for a 4-port InfiniiSim transfer function file.
:CHANNEL<N>:SIMULATION:FILTER:SELECTION (see <a href="#">page 423</a> )	Sets the filter type.
:CHANNEL<N>:SIMULATION:FILE:ADDRESS (see <a href="#">page 424</a> )	Specifies the full path string of a .wfm file to use as the simulated waveform (for the FILE simulated waveform type).

Command	Description
:CHANnel<N>:SIMulation:FLOa d:LOOP (see <a href="#">page 425</a> )	Specifies whether the simulated waveform should repeat from the beginning of the file when reaching the end of the file (for the FILE simulated waveform type).
:CHANnel<N>:SIMulation:FREQ uency (see <a href="#">page 426</a> )	Specifies the frequency of the simulated waveform (for the CLOCK or FUNCtion simulated waveform types).
:CHANnel<N>:SIMulation:FUN Ction:SElection (see <a href="#">page 427</a> )	Specifies the simulated waveform function type (for the FUNCtion simulated waveform type).
:CHANnel<N>:SIMulation:FUN Ction:SQUare:DCYCLE (see <a href="#">page 428</a> )	Specifies the square wave's duty cycle high time percent value (when the FUNCtion simulated waveform type is selected and the SQUare function is selected).
:CHANnel<N>:SIMulation:FUN Ction:SQUare:FTIME (see <a href="#">page 429</a> )	Specifies the square wave's high-to-low transition time (when the FUNCtion simulated waveform type is selected and the SQUare function is selected).
:CHANnel<N>:SIMulation:FUN Ction:SQUare:RTIME (see <a href="#">page 430</a> )	Specifies the square wave's low-to-high transition time (when the FUNCtion simulated waveform type is selected and the SQUare function is selected).
:CHANnel<N>:SIMulation:JITTe r (see <a href="#">page 431</a> )	Turns all simulated waveform jitter off or on while saving the values.
:CHANnel<N>:SIMulation:JITTe r:ABUJ (see <a href="#">page 432</a> )	Specifies the amount of Aperiodic Bounded Uniform Jitter (ABUJ) to apply to the simulated waveform.
:CHANnel<N>:SIMulation:JITTe r:PERiodic<M>:ENABle (see <a href="#">page 433</a> )	Turns the periodic jitter for the simulated waveform on or off.
:CHANnel<N>:SIMulation:JITTe r:PERiodic<M>:FREQuency (see <a href="#">page 434</a> )	Specifies the frequency of the periodic jitter applied to the simulated waveform.
:CHANnel<N>:SIMulation:JITTe r:PERiodic<M>:MAGNitude (see <a href="#">page 435</a> )	Specifies the magnitude of the periodic jitter applied to the simulated waveform.
:CHANnel<N>:SIMulation:JITTe r:PERiodic<M>:SHAPE (see <a href="#">page 436</a> )	Specifies the shape of the periodic jitter applied to the simulated waveform.
:CHANnel<N>:SIMulation:JITTe r:RANDom (see <a href="#">page 437</a> )	Specifies the standard deviation of random jitter to apply.
:CHANnel<N>:SIMulation:NOIS e (see <a href="#">page 438</a> )	Turns all simulated waveform noise off or on while saving the values.
:CHANnel<N>:SIMulation:NOIS e:BWLimit (see <a href="#">page 439</a> )	Turns the noise filter on or off.

Command	Description
:CHANnel<N>:SIMulation:NOIS e:PERiodic<M>:ENABLE (see page 440)	Turns the periodic noise for the simulated waveform on or off.
:CHANnel<N>:SIMulation:NOIS e:PERiodic<M>:FREQuency (see page 441)	Specifies the frequency of the periodic noise applied to the simulated waveform.
:CHANnel<N>:SIMulation:NOIS e:PERiodic<M>:MAGNitude (see page 442)	Specifies the magnitude of the periodic noise applied to the simulated waveform.
:CHANnel<N>:SIMulation:NOIS e:PERiodic<M>:SHAPE (see page 443)	Specifies the shape of the periodic noise applied to the simulated waveform.
:CHANnel<N>:SIMulation:NOIS e:RANDom (see page 444)	Specifies the standard deviation of random noise to apply.
:CHANnel<N>:SIMulation:OFFS et (see page 445)	Specifies the offset of the simulated waveform.
:CHANnel<N>:SIMulation:WAV eform (see page 446)	Sets the simulated waveform type.
:FUNction<F>:MLOG (see page 630)	Adds a function waveform that is a scrolling record of measurement values over time.
:MEASure:THResholds:GENAU TO (see page 1121)	Automatically sets the general "Custom: thresholds +/- hysteresis" when thresholds apply to individual waveforms.
:MTEST:COUNT:SUI? (see page 834)	Returns the total number of samples that have been mask tested in the UI bit time.
:SYSTem:HLED (see page 1359)	On Infiniium 90000 Q-Series, S-Series, V-Series, and Z-Series oscilloscopes, this command turns the <b>Turn off Front Panel LEDs</b> user preference on or off.
:WAVEform:CGRade:HEIGHt? (see page 1588)	Returns the color grade (pixel) database data height (when the CGRade waveform view is selected).
:WAVEform:CGRade:WIDTh? (see page 1589)	Returns the color grade (pixel) database data width (when the CGRade waveform view is selected).
:WMEMory<R>:SEGmented:CO UNT? (see page 1657)	When segmented memory acquisitions are saved to waveform memory, this query returns the number of segments in the waveform memory.
:WMEMory<R>:SEGmented:IN Dex (see page 1658)	When segmented memory acquisitions are saved to waveform memory, this command command sets the index number for the segment that you want to display on screen.
:WMEMory<R>:SEGmented:PL AY (see page 1659)	When segmented memory acquisitions are saved to waveform memory, this command command plays (or stops) the segments.

### Changed Commands

Command	Description
:BUS:B<N>:TYPE (see <a href="#">page 318</a> )	Added support for new SPMI and GENRaw protocols.
:FUNCTION<F>:FFT:DETECTOR:TYPE (see <a href="#">page 584</a> )	The RMS detector type has been added.
:FUNCTION<F>:HORIZONTAL:POSITION (see <a href="#">page 613</a> )	For functions where the horizontal position cannot be adjusted, this command now gives a -221, "Settings conflict" instead of being accepted without effect.
:FUNCTION<F>:HORIZONTAL:RANGE (see <a href="#">page 615</a> )	For functions where the horizontal position cannot be adjusted, this command now gives a -221, "Settings conflict" instead of being accepted without effect.
:HOSTED:FOLLOWER<N>:CONFIGURE (see <a href="#">page 684</a> )	Added the ability to configure a "Simulated Instrument" to set up simulated waveforms.
:MTEST:SOURCE (see <a href="#">page 876</a> )	Waveform memories can now be used as a source for mask testing.
:WAVEFORM:FORMAT (see <a href="#">page 1616</a> )	There is now a FLOat option for getting color grade (pixel) database data in single-precision floating-point format (when the CGRade waveform view is selected).
:WAVEFORM:VIEW (see <a href="#">page 1634</a> )	There is now a CGRade option for getting color grade (pixel) database data.

### Discontinued Commands

Discontinued Command	Current Command Equivalent	Comments
:MEASURE:THRESHOLDS:RFALL:HYSTeresis	None	Rise/fall thresholds are no longer set using hysteresis and level values.

## What's New in Version 5.75

New command descriptions for Version 5.75 of the Infiniium oscilloscope software appear below.

### New Commands

Command	Description
:SPROcessing:CTLequalizer:Z1 (see <a href="#">page 1765</a> )	Specifies the first zero for 3-pole CTLE.
:SPROcessing:CTLequalizer:Z2 (see <a href="#">page 1766</a> )	Specifies the second zero for 3-pole CTLE.

### Changed Commands

Command	Description
:SPROcessing:CTLequalizer:NUMPoles (see <a href="#">page 1755</a> )	Now that you can specify up to two zeros for a 3-pole CTLE, the previous POLE3 option has been replaced by P3Z1 and P3Z2.
:MEASure:RJDJ:BER (see <a href="#">page 1089</a> )	You can now set J4 and J5 jitter BER levels.



## What's New in Version 5.70

New command descriptions for Version 5.70 of the Infiniium oscilloscope software appear below.

### New Commands

Command	Description
:ACQuire:SEGmented:PRATe (see <a href="#">page 264</a> )	Specifies the segmented memory navigation play rate.
:CHANnel<N>:INVert (see <a href="#">page 358</a> )	Enables or disables the invert setting for a channel.
:CHANnel<N>:ISIM:BWLimit:TY PE (see <a href="#">page 364</a> )	Specifies a channel's bandwidth limit filter response.
:CHANnel<N>:PROBe:INFO? (see <a href="#">page 396</a> )	Returns a comma-separated list of probe information.
:DISPlay:PROPortion:RESults (see <a href="#">page 557</a> )	Specifies the size of the Results pane in the oscilloscope display.
:FUNctioN<F>:FFT:DETEctor:PO INTs (see <a href="#">page 583</a> )	When a detector is used for the FFT magnitude function, this command specifies the maximum number of points (buckets) that detectors should decimate to.
:FUNctioN<F>:FFT:DETEctor:TY PE (see <a href="#">page 584</a> )	Specifies whether a detector is used for the FFT magnitude function.
:FUNctioN<F>:FFT:SPAN (see <a href="#">page 598</a> )	Sets the frequency span for the FFT function.
:FUNctioN<F>:FFT:STOP (see <a href="#">page 600</a> )	Sets the stop frequency for the FFT function.
:FUNctioN<F>:FFT:VUNits (see <a href="#">page 602</a> )	Specifies the vertical units for the FFT magnitude function.
:HOSTed:PERiodic (see <a href="#">page 692</a> )	Turns periodic drift correction on or off.
:LTEST:ADDStats (see <a href="#">page 768</a> )	Enables or disables the limit test "statistics on passing measurements only" option.
:LTEST:RUMode:SOFailure (see <a href="#">page 774</a> )	Enables or disables the limit test "stop on failure" option.
:MEASure:CGRade:OLEVel (see <a href="#">page 914</a> )	The command installs an Eye One Level measurement into the user interface's measurement Results pane. The query returns the measured Eye One Level.
:MEASure:CGRade:ZLEVel (see <a href="#">page 916</a> )	The command installs an Eye Zero Level measurement into the user interface's measurement Results pane. The query returns the measured Eye Zero Level.

Command	Description
:MEASure:ERATio (see <a href="#">page 942</a> )	The command installs an Extinction Ratio measurement into the user interface's measurement Results pane. The query returns the measured Extinction Ratio.
:MEASure:FFT:CPOWer (see <a href="#">page 948</a> )	The command installs a channel power measurement into the user interface's measurement Results pane. The query returns the measured channel power.
:MEASure:FFT:OBW (see <a href="#">page 957</a> )	The command installs an occupied bandwidth measurement into the user interface's measurement Results pane. The query returns the measured occupied bandwidth.
:MEASure:FFT:PSD (see <a href="#">page 958</a> )	The command installs a power spectral density measurement into the user interface's measurement Results pane. The query returns the measured power spectral density.
:MEASure:OMAMplitude (see <a href="#">page 1018</a> )	The command installs an Optical Modulation Amplitude (OMA) measurement into the user interface's measurement Results pane. The query returns the measured Optical Modulation Amplitude (OMA).
:MEASure:OPOWer (see <a href="#">page 1019</a> )	The command installs an Optical Average Power measurement into the user interface's measurement Results pane. The query returns the measured Optical Average Power.
:MTESt:COUnT:MARGIn:FAILure s? (see <a href="#">page 833</a> )	Returns the margin failure count for a specified region.
:MTESt:MARGIn:AUTO:HITS (see <a href="#">page 860</a> )	When the automatic margin method is selected, and the hit ratio method is selected, this command specifies the hit count.
:MTESt:MARGIn:AUTO:HRATio (see <a href="#">page 861</a> )	When the automatic margin method is selected, and the hit ratio method is selected, this command specifies the hit ratio.
:MTESt:MARGIn:AUTO:METHod (see <a href="#">page 862</a> )	When the automatic margin method is selected, this command selects between the hit count and hit ratio and automatic margin methods.
:MTESt:MARGIn:METHod (see <a href="#">page 863</a> )	Selects between the manual and automatic margin types.
:MTESt:MARGIn:PERCent (see <a href="#">page 864</a> )	When the manual margin method is selected, this command specifies the margin percent.
:MTESt:MARGIn:STATe (see <a href="#">page 865</a> )	Enables or disables mask margin testing.
:XTALk Commands (see <a href="#">page 1665</a> )	The commands in the XTALK subsystem are used to control the Crosstalk Analysis application.

### Changed Commands

Command	Description
:BUS:B<N>:TYPE (see <a href="#">page 318</a> )	Added support for new A429, M1553, and I3C protocols.
:DISPlay:SCOLor (see <a href="#">page 562</a> )	Added the ability to set colors for MMPolygons.
:FUNCTion<F>:FFT:RESolution (see <a href="#">page 596</a> )	The command form now lets you set the FFT resolution.
:MARKer:MODE (see <a href="#">page 789</a> )	Added XONLY and YONLY options for for the "Manual (X only)" and "Manual (Y only)" marker modes.
:MEASure:AREA (see <a href="#">page 894</a> )	Added a RISing or FALLing edge parameter when "Measure All Edges" is set and measuring a single cycle of the waveform.

## What's New in Version 5.60

New command descriptions for Version 5.60 of the Infiniium oscilloscope software appear below.

### New Commands

Command	Description
:ACQuire:BA <sup>N</sup> Dwidth:TESTLIMITS? (see <a href="#">page 244</a> )	Returns the oscilloscope's acquisition bandwidth maximum and minimum limits.
:ACQuire:POINts:TESTLIMITS? (see <a href="#">page 257</a> )	Returns the oscilloscope's acquisition points maximum and minimum limits.
:ACQuire:SEGmented:PLAY (see <a href="#">page 263</a> )	Plays (or stops) acquired segments.
:ACQuire:SRATE:TESTLIMITS? (see <a href="#">page 270</a> )	Returns the oscilloscope's acquisition sampling rate maximum and minimum limits.
:ANALyze:SIGNal:MIXer:CABLeLoss (see <a href="#">page 300</a> )	Sets the loss of the cable connecting the mixer to the oscilloscope.
:ANALyze:SIGNal:MMWave:CALibrate (see <a href="#">page 301</a> )	Initiates a mixer/LO (local oscillator) power calibration. The LO is identified by the :ANALyze:SIGNal:MMWave:LOADdress command.
:ANALyze:SIGNal:MMWave:CFRequency (see <a href="#">page 302</a> )	Sets the center frequency for the oscilloscope's FFT math function.
:ANALyze:SIGNal:MMWave:CONNect (see <a href="#">page 303</a> )	Sets the connection status for the mixer and LO (local oscillator) assigned to the specified channel.
:ANALyze:SIGNal:MMWave:LOADdress (see <a href="#">page 304</a> )	Sets the LO's (local oscillator's) VISA address.
:ANALyze:SIGNal:MMWave:MBANdwidth (see <a href="#">page 305</a> )	Sets the measurement bandwidth. This becomes the center frequency for the oscilloscope's FFT math function.
:CHANnel<N>:PROBe:PRIMary (see <a href="#">page 404</a> )	For the N2820A/N2821A high-sensitivity current probes only, this command configures the input channel as a zoomed-in (amplified) or zoomed-out channel.
:MEASure:BER (see <a href="#">page 896</a> )	When the signal type is PAM, this command installs a cumulative BER (bit error rate) measurement of the specified PAM signal into the user interface's measurement Results pane. The query returns the measured cumulative BER value.
:MEASure:BERPeracq (see <a href="#">page 897</a> )	When the signal type is PAM, this command installs a BER (bit error rate) per acquisition measurement of the specified PAM signal into the user interface's measurement Results pane. The query returns the measured BER per acquisition value.
:MEASure:PPContrast (see <a href="#">page 1070</a> )	Measures the peak-to-peak contrast (also known as Michelson contrast or modulation).

Command	Description
:MEASure:SER (see <a href="#">page 1110</a> )	When the signal type is PAM, this command installs a cumulative SER (symbol error rate) measurement of the specified PAM signal into the user interface's measurement Results pane. The query returns the measured cumulative SER value.
:MEASure:SERPeracq (see <a href="#">page 1111</a> )	When the signal type is PAM, this command installs a SER (symbol error rate) per acquisition measurement of the specified PAM signal into the user interface's measurement Results pane. The query returns the measured SER per acquisition value.
:SBUS<N>:CAN:TYPE (see <a href="#">page 1276</a> )	Selects between standard CAN or Flexible Data Rate CAN (CAN FD) decode types.
:SBUS<N>:CAN:FDSPoint (see <a href="#">page 1262</a> )	Sets the point during the bit time where the bit level is sampled to determine whether the bit is dominant or recessive.
:SBUS<N>:CAN:SIGNal:FDBaudrate (see <a href="#">page 1266</a> )	Sets the CAN FD baud rate in the range from 1 Mb/s to 10 Mb/s.
:SYSTem:DONTtabmeas (see <a href="#">page 1354</a> )	Turns the <b>Never tab Measurement Results</b> user preference on or off.

### Changed Commands

Command	Description
:ANALyze:CLOCK:METHod (see <a href="#">page 275</a> )	They CPHY and PWM methods have been added.
:ANALyze:SIGNal:TYPE (see <a href="#">page 312</a> )	MMWave has been added as a signal type.
:DISPlay:SCOLor (see <a href="#">page 562</a> )	Removed the ability to set colors for MEASurements, STExT, TSCale, and WBACKgrnd.
:FUNction<F>:MATLab:CONTRol<N> (see <a href="#">page 623</a> )	Up to 6 user-defined controls supported.
:SBUS<N>:CAN:TRIGger (see <a href="#">page 1268</a> )	Additional trigger condition options for CAN FD have been added.
:SBUS<N>:CAN:TRIGger:PATTe rn:DATA:LENGth (see <a href="#">page 1272</a> )	Length can be from 1 to 15 bytes for CAN FD.

Obsolete  
Commands

Obsolete Command	Current Command Equivalent	Behavior Differences
:DISPlay:TAB (see <a href="#">page 1721</a> )	None	This command is not supported in version 5.00 or higher. The query now returns only NONE.
:HOSTed:CALibrate:ALIGn (see <a href="#">page 1723</a> )	None	Acquired data is now always aligned, and this command has no effect.

## What's New in Version 5.52

New command descriptions for Version 5.52 of the Infiniium oscilloscope software appear below.

### Changed Commands

Command	Description
:MTESt:FOLDing:COUNT:UI? (see <a href="#">page 843</a> )	The <source> parameter is now optional.
:MTESt:FOLDing:COUNT:WAVeforms? (see <a href="#">page 843</a> )	The <source> parameter is now optional.

## What's New in Version 5.51

New command descriptions for Version 5.51 of the Infiniium oscilloscope software appear below.

### Changed Commands

Command	Description
:BUS:B<N>:TYPE (see <a href="#">page 318</a> )	Added support for new ESPI, USB31, and USBPD protocols.



## What's New in Version 5.50

New command descriptions for Version 5.50 of the Infiniium oscilloscope software appear below.

### New Commands

Command	Description
:ANALyze:CLOCK:METHod:PAM:B03 (see <a href="#">page 1710</a> )	When the signal type is PAM-4, this command specifies whether edges from the 0 level to the 3 level and from the 3 level to the 0 level are included in the clock recovery.
:ANALyze:CLOCK:METHod:PAM:B12 (see <a href="#">page 1712</a> )	When the signal type is PAM-4, this command specifies whether edges from the 1 level to the 2 level and from the 2 level to the 1 level are included in the clock recovery.
:ANALyze:CLOCK:METHod:PAM:NONSymmetric (see <a href="#">page 1714</a> )	When the signal type is PAM-4, this command specifies whether edges that are non-symmetric about the middle threshold are included in the clock recovery.
:ANALyze:SIGNAL:DARate (see <a href="#">page 298</a> )	When the signal type is PAM-4, this command specifies the data rate of the signal.
:ANALyze:SIGNAL:SYMBOLrate (see <a href="#">page 310</a> )	When the signal type is PAM-4, this command specifies the edge rate of the signal.
:ANALyze:SIGNAL:TYPE (see <a href="#">page 312</a> )	Lets you specify whether a channel, function, or waveform memory is a special type of signal, like a PAM-4 signal for example.
:DISPlay:ISIM:GCOunt (see <a href="#">page 539</a> )	Sets or returns the number of visible graphs in the InfiniiSim plots window area.
:DISPlay:ISIM:SElectgraph (see <a href="#">page 540</a> )	Inserts the specified graph at the first display graph position.
:DISPlay:ISIM:SOURce (see <a href="#">page 541</a> )	Sets the source for the InfiniiSim plots graph(s).
:DISPlay:JITTer:GCOunt (see <a href="#">page 542</a> )	Sets or returns the number of visible graphs in the Jitter/Noise graphs window area.
:DISPlay:JITTer:SElectgraph (see <a href="#">page 543</a> )	Inserts the specified graph at the first display graph position.
:DISPlay:PRECprobe:GCOunt (see <a href="#">page 558</a> )	Sets or returns the number of visible graphs in the PrecisionProbe correction and analysis charts window area.
:DISPlay:PRECprobe:SElectgraph (see <a href="#">page 559</a> )	Inserts the specified graph at the first display graph position.
:DISPlay:PRECprobe:SOURce (see <a href="#">page 560</a> )	Sets the source for the PrecisionProbe correction and analysis chart(s).
:DISPlay:WINDow:MAXimize (see <a href="#">page 567</a> )	Will maximize the size of the specified window.

Command	Description
:HOSTed:CALibrate:ALIGn (see <a href="#">page 1723</a> )	Lets you align acquired data in the MultiScope system.
:HOSTed:CALibrate:CALibrate (see <a href="#">page 669</a> )	Performs the MultiScope system time-correlation calibration at the level selected by :HOSTed:CALibrate:LEVel.
:HOSTed:CALibrate:CHANnel (see <a href="#">page 670</a> )	Selects the calibration channel or synchronization input where the MultiScope system time-correlation procedures expect to find the calibration signal.
:HOSTed:CALibrate:DESKew:FRAMes (see <a href="#">page 672</a> )	Deskews frames in the MultiScope system by measuring only one input channel from each oscilloscope frame.
:HOSTed:CALibrate:DESKew:CHANnels (see <a href="#">page 671</a> )	Deskews all channels in the MultiScope system.
:HOSTed:CALibrate:DESKew:SIGNals (see <a href="#">page 673</a> )	Aligns the horizontal positions of the closest rising edges of all input signals in the MultiScope system.
:HOSTed:CALibrate:DESKew:ZERO (see <a href="#">page 674</a> )	Resets MultiScope system signal skew values to zero.
:HOSTed:CALibrate:LEVel (see <a href="#">page 675</a> )	Selects the MultiScope system calibration level.
:HOSTed:CALibrate:PROMpt (see <a href="#">page 677</a> )	Specifies whether the user interface software prompts you to make the proper connections while the MultiScope system calibration runs.
:HOSTed:CALibrate:STATUS:CHANNELs? (see <a href="#">page 678</a> )	Returns the MultiScope system calibration status of "Deskew Channels".
:HOSTed:CALibrate:STATUS:FRAMES? (see <a href="#">page 679</a> )	Returns the MultiScope system calibration status of "Deskew Frames".
:HOSTed:CALibrate:STATUS:LEVEL? (see <a href="#">page 680</a> )	Returns the MultiScope system calibration status of the currently selected calibration level.
:HOSTed:CALibrate:STATUS:SIGNals? (see <a href="#">page 681</a> )	Returns the MultiScope system calibration status of "Deskew Signals".
:HOSTed:CALibrate:TREF:DETECT (see <a href="#">page 682</a> )	Automatically detects the reference clock connection between oscilloscopes in a MultiScope system.
:HOSTed:FOLLOWer<N>:ACHannels? (see <a href="#">page 683</a> )	Returns the channel numbers assigned to a Follower oscilloscope in a MultiScope system.
:HOSTed:FOLLOWer<N>:CONFIGure (see <a href="#">page 684</a> )	Identifies the Follower oscilloscope in a MultiScope system by its VISA address.
:HOSTed:FOLLOWer<N>:CONNECT (see <a href="#">page 685</a> )	Opens the connection to a Follower oscilloscope in a MultiScope system.
:HOSTed:FOLLOWer<N>:DISCONNECT (see <a href="#">page 686</a> )	Closes the connection to a Follower oscilloscope in a MultiScope system.

Command	Description
:HOSTed:LEADer:ACHannels? (see <a href="#">page 687</a> )	Returns the channel numbers assigned to the Leader oscilloscope in a MultiScope system.
:HOSTed:LEADer:CONFigure (see <a href="#">page 688</a> )	Identifies the Leader oscilloscope in a MultiScope system by its VISA address.
:HOSTed:LEADer:CONNect (see <a href="#">page 689</a> )	Opens the connection to the Leader oscilloscope in a MultiScope system.
:HOSTed:LEADer:DISConnect (see <a href="#">page 690</a> )	Closes the connection to the Leader oscilloscope in a MultiScope system.
:MEASure:PAM:ELEVel (see <a href="#">page 1022</a> )	When the signal type is PAM-4, this command installs a vertical center measurement of the specified PAM-4 eye into the user interface's measurement Results pane. The query returns the measured vertical center value.
:MEASure:PAM:ESKew (see <a href="#">page 1024</a> )	When the signal type is PAM-4, this command installs a horizontal center skew measurement of the specified PAM-4 eye into the user interface's measurement Results pane. The query returns the measured horizontal center skew value.
:MEASure:PAM:LEVel (see <a href="#">page 1031</a> )	When the signal type is PAM-4, this command installs a mean voltage measurement of the specified PAM-4 level into the user interface's measurement Results pane. The query returns the measured mean voltage value.
:MEASure:PAM:LRMS (see <a href="#">page 1033</a> )	When the signal type is PAM-4, this command installs a RMS voltage measurement of the specified PAM-4 level into the user interface's measurement Results pane. The query returns the measured RMS voltage value.
:MEASure:PAM:LTHickness (see <a href="#">page 1035</a> )	When the signal type is PAM-4, this command installs an eye diagram level thickness measurement of the specified PAM-4 level into the user interface's measurement Results pane. The query returns the measured thickness value.
:MEASure:THResholds:GENeral :PAMCustom (see <a href="#">page 1128</a> )	When the signal type is PAM-4 and :MEASure:THResholds:GENeral:METHod is set to PAMCustom, this command sets the PAM threshold levels for general measurements to the values you specify.
:MEASure:THResholds:GENeral :PAMAutomatic (see <a href="#">page 1130</a> )	When the signal type is PAM-4 and :MEASure:THResholds:GENeral:METHod is set to PAMAutomatic, this command specifies whether the PAM threshold levels for general measurements are determined automatically or using the PAM-4 levels you specify.
:MEASure:THResholds:RFALL:P AMAutomatic (see <a href="#">page 1145</a> )	When the signal type is PAM-4, this command specifies whether the PAM threshold levels for rise/fall measurements are determined automatically or using the PAM-4 levels you specify.
:MEASure:TIEData2 (see <a href="#">page 1167</a> )	Measures data time interval error.

Command	Description
:MTESt:FOLDing:COUNT:UI? (see <a href="#">page 843</a> )	Returns the number of unit intervals in the real time eye.
:MTESt:FOLDing:COUNT:WAVef orms? (see <a href="#">page 843</a> )	Returns the number of waveforms in the real time eye.
:SYSTem:GUI (see <a href="#">page 1357</a> )	Disables or enables the front panel user interface. When disabled, the Remote Operations In Progress dialog box appears on the oscilloscope's screen.  <b>NOTE:</b> The :SYSTem:GUI OFF command lets Infiniium oscilloscopes behave like other Keysight instruments by locking out the GUI (graphical user interface) and the front panel while remote scripts are running. On Infiniium oscilloscopes, the GUI and front panel do not lock automatically during remote operation (as most other instruments do) to preserve the integrity and timing of legacy customer scripts. The recommendation is, however, that all scripts begin with :SYSTem:GUI OFF when convenient and possible to run more like other Keysight instruments and likely improve performance.
:SYSTem:MENU? (see <a href="#">page 1362</a> )	Returns front panel graphical user interface menu strings.
:TRIGger:GBSerial:CLOCK (see <a href="#">page 1422</a> )	Specifies whether an INTERNAL or EXTERNAL reference clock (and internal multipliers) are used to support the selected data rate. External reference clock signals are supplied to a BNC connector on the oscilloscope's hardware serial trigger I/O panel.
:TRIGger:GBSerial:CLOCK:FREQ uency (see <a href="#">page 1423</a> )	When an external reference clock is used, this command specifies its frequency.
:TRIGger:GBSerial:DRATe (see <a href="#">page 1425</a> )	Specifies the data rate of the serial signal. Common data rates are supported.
:TRIGger:GBSerial:MODE (see <a href="#">page 1427</a> )	Selects the hardware serial trigger mode ("generic" sequences, 8b/10b sequences, or PRBS errors).
:TRIGger:GBSerial:PATtern (see <a href="#">page 1428</a> )	When triggering on "generic" sequences or 8b/10b sequences, this command specifies the bit pattern to trigger on.
:TRIGger:GBSerial:POLarity (see <a href="#">page 1429</a> )	When triggering on PRBS errors, this command specifies the polarity of the selected PRBS pattern.
:TRIGger:GBSerial:PRBS (see <a href="#">page 1430</a> )	When triggering on PRBS errors, this command specifies the pattern to check when looking for errors. You can select PRBS 7, 15, 23, or 31 patterns.
:TRIGger:GBSerial:SOURce (see <a href="#">page 1431</a> )	Specifies the oscilloscope input channel on which the hardware serial trigger operates. This is always CHANNEL1.

## Changed Commands

Command	Description
:ANALyze:CLOCK:METHOD (see <a href="#">page 275</a> )	When the signal type is PAM-4, a symbol rate (baud) is specified instead of a data rate (b/s).
:ANALyze:CLOCK:METHOD:JTF (see <a href="#">page 284</a> )	When the signal type is PAM-4, a symbol rate (baud) is specified instead of a data rate (b/s).
:ANALyze:CLOCK:METHOD:OJTF (see <a href="#">page 286</a> )	When the signal type is PAM-4, a symbol rate (baud) is specified instead of a data rate (b/s).
:CHANnel<N>:PROBe:HEAD:VTERm (see <a href="#">page 394</a> )	Supports the N7010A active termination adapter (regardless of the attachment/head) as well as the N5444A probe head.
:DISPlay:CGRade (see <a href="#">page 522</a> )	When the <source> parameter is not provided, enabling color grade will turn off the main waveform view, and disabling color grade will turn on the main waveform view.
:DISK:SAVE:MEASurements (see <a href="#">page 505</a> )	Added the <legacy_save_mode> option to save measurement results in the format used prior to Infiniium version 5.00.
:MEASure:CGRade:EHEight (see <a href="#">page 904</a> )	When the signal type is PAM-4, an additional <threshold> parameter is used to specify which eye, and the <algorithm> parameter is ignored.
:MEASure:CGRade:EWIDth (see <a href="#">page 907</a> )	When the signal type is PAM-4, an additional <threshold> parameter is used to specify which eye, and the <algorithm> parameter is ignored.
:MEASure:FALLtime (see <a href="#">page 946</a> )	With PAM signal types, additional <start_level> and <stop_level> parameters are used to identify the edge to measure.
:MEASure:NOISe:ALL? (see <a href="#">page 1003</a> )	The parameters TWO and THRee are available for PAM-4 signals.
:MEASure:RISetime (see <a href="#">page 1083</a> )	With PAM signal types, additional <start_level> and <stop_level> parameters are used to identify the edge to measure.
:MEASure:THResholds:GENERAL:METHOD (see <a href="#">page 1126</a> )	When the signal type is PAM-4, you can choose between PAMCustom and PAMautomatic methods for setting the general measurement thresholds.
:MEASure:THResholds:RFALL:METHOD (see <a href="#">page 1143</a> )	When the signal type is PAM-4, you can choose between T1090 (10% and 90% of levels) and T2080 (20% and 80% of levels) when setting the rise/fall measurement thresholds.
:MTEST:FOLDing (see <a href="#">page 839</a> )	When the <source> parameter is not provided, enabling the real-time eye will turn off the main waveform view, and disabling the real-time eye will turn on the main waveform view.
:MTEST:FOLDing:BITS (see <a href="#">page 841</a> )	The <pattern> string can contain characters "2" and "3" when specified for PAM-4 signals.
:SPROcessing:CTLequalizer:RATE (see <a href="#">page 1760</a> )	When the signal type is PAM-4, a symbol rate (baud) is specified instead of a data rate (b/s).
:SPROcessing:FFEQualizer:RATE (see <a href="#">page 1787</a> )	When the signal type is PAM-4, a symbol rate (baud) is specified instead of a data rate (b/s).

Obsolete Commands

Obsolete Command	Current Command Equivalent	Behavior Differences
:MEASure:TIEData (see <a href="#">page 1748</a> )	:MEASure:TIEData2 (see <a href="#">page 1167</a> )	<p>Clock recovery options have been removed (clock recovery as specified with the :ANALyze:CLOCK:METHod is used).</p> <p>When the signal type is PAM-4, an additional &lt;threshold&gt; parameter is used to specify the threshold at which to make the TIE measurements.</p>
:MTESt:FOLDing:COUnT? (see <a href="#">page 1750</a> )	:MTESt:FOLDing:COUnT:UI? (see <a href="#">page 843</a> ) :MTESt:FOLDing:COUnT:WAVeforms? (see <a href="#">page 845</a> )	<p>The :MTESt:FOLDing:COUnT? query returns two values for UI count and waveform count. Now, there are separate queries that return those values individually.</p> <p>The UI count returned by :MTESt:FOLDing:COUnT? is now a floating-point value instead of an integer value.</p>

## What's New in Version 5.30

New command descriptions for Version 5.30 of the Infiniium oscilloscope software appear below.

### New Commands

Command	Description
:ANALyze Commands (see <a href="#">page 271</a> )	<p>The commands in the ANALyze subsystem are used to:</p> <ul style="list-style-type: none"> <li>▪ Specify whether to use a single edge or all edges in the acquisition for horizontal measurements (:ANALyze:AEDGes command).</li> <li>▪ Set up clock recovery (:ANALyze:CLOCK commands).</li> <li>▪ Specify whether to use the data on screen or the entire acquisition for measurements, functions, and analysis (:ANALyze:VIEW command).</li> </ul>
:FUNction<F>:GATing:START (see <a href="#">page 609</a> )	Specifies the time, in seconds, where the gating window begins relative to the source waveform.
:FUNction<F>:GATing:STOP (see <a href="#">page 610</a> )	Specifies the time, in seconds, where the gating window ends relative to the source waveform.

Obsolete Commands

Obsolete Command	Current Command Equivalent	Behavior Differences
:MEASure:CLOCK (see <a href="#">page 1724</a> )	:ANALyze:CLOCK (see <a href="#">page 274</a> )	There are no differences in behavior. This is just a remapping of commands into a new subsystem.
:MEASure:CLOCK:METHOD (see <a href="#">page 1725</a> )	:ANALyze:CLOCK:METHOD (see <a href="#">page 275</a> )	
:MEASure:CLOCK:METHOD:ALIGN (see <a href="#">page 1729</a> )	:ANALyze:CLOCK:METHOD:ALIGN (see <a href="#">page 279</a> )	
:MEASure:CLOCK:METHOD:DEEMphasis (see <a href="#">page 1730</a> )	:ANALyze:CLOCK:METHOD:DEEMphasis (see <a href="#">page 280</a> )	
:MEASure:CLOCK:METHOD:EDGE (see <a href="#">page 1731</a> )	:ANALyze:CLOCK:METHOD:EDGE (see <a href="#">page 281</a> )	
:MEASure:CLOCK:METHOD:JTF (see <a href="#">page 1733</a> )	:ANALyze:CLOCK:METHOD:JTF (see <a href="#">page 284</a> )	
:MEASure:CLOCK:METHOD:OJTF (see <a href="#">page 1735</a> )	:ANALyze:CLOCK:METHOD:OJTF (see <a href="#">page 286</a> )	
:MEASure:CLOCK:METHOD:PLLT rack (see <a href="#">page 1737</a> )	:ANALyze:CLOCK:METHOD:PLLT rack (see <a href="#">page 289</a> )	
:MEASure:CLOCK:METHOD:SOURce (see <a href="#">page 1738</a> )	:ANALyze:CLOCK:METHOD:SOURce (see <a href="#">page 292</a> )	
:MEASure:CLOCK:VERTical (see <a href="#">page 1739</a> )	:ANALyze:CLOCK:VERTical (see <a href="#">page 295</a> )	
:MEASure:CLOCK:VERTical:OFFSet (see <a href="#">page 1740</a> )	:ANALyze:CLOCK:VERTical:OFFSet (see <a href="#">page 296</a> )	
:MEASure:CLOCK:VERTical:RANGe (see <a href="#">page 1741</a> )	:ANALyze:CLOCK:VERTical:RANGe (see <a href="#">page 297</a> )	
:MEASure:JITTer:STATistics (see <a href="#">page 1747</a> )	:ANALyze:AEDGes (see <a href="#">page 273</a> )	The :ANALyze:AEDGes command maps to the "Measure All Edges" control in the user interface's Measurement Setup dialog box only. It does not affect jitter modes or statistics.



## What's New in Version 5.20

New command descriptions for Version 5.20 of the Infiniium oscilloscope software appear below.

### New Commands

Command	Description
:ACQuire:BA <sup>N</sup> Dwidth:FRAMe? (see <a href="#">page 243</a> )	Returns the maximum bandwidth associated with oscilloscope model.
:HISTogram:HORizontal:BINs (see <a href="#">page 654</a> )	Sets the maximum number of bins used for a horizontal waveform histogram.
:HISTogram:MEASurement:BINs (see <a href="#">page 655</a> )	Sets the maximum number of bins used for a measurement histogram.
:HISTogram:VERTical:BINs (see <a href="#">page 660</a> )	Sets the maximum number of bins used for a vertical waveform histogram.
:MEASure:CLOCK:METHOD:SOURce (see <a href="#">page 1738</a> )	Clock recovery methods can now be defined for each waveform source (or for all waveform sources, as before). This command selects the waveform source (or all sources) to which other clock recovery method setup commands apply.
:SBUS<N>:FLEXray Commands (see <a href="#">page 1277</a> )	These commands control the FlexRay serial decode bus viewing, mode, and other options.
:SBUS<N>:LIN Commands (see <a href="#">page 1304</a> )	These commands control the LIN serial decode bus viewing, mode, and other options.
:SYSTem:PERSONa (see <a href="#">page 1363</a> )	Sets the manufacturer string and the model number string returned by the *IDN? query.

### Changed Commands

Command	Description
:CHANnel<N>:PROBE:EADapter (see <a href="#">page 382</a> )	Added the DIV1000, CUR001VA, CUR01VA, CUR1VA, CUR10VA, CURN2893, CUR1147, HIVOLTN2790 options for use with the E2697A or N5449A high impedance adapters.
:FUNCTion<F>:MHISTogram (see <a href="#">page 627</a> )	Lets you specify the maximum number of histogram bins along with the measurement source.
:SBUS<N>:MODE (see <a href="#">page 1258</a> )	Added the FLEXray and LIN mode options.

Command	Description
:SBUS<N>:CAN:SOURce (see <a href="#">page 1267</a> )	Added the NONE parameter to make the previously selected channel, waveform memory, or math function available for other decodes (same as selecting "None" for the source in the user interface).
:SBUS<N>:IIC:SOURce:CLOCK (see <a href="#">page 1297</a> )	
:SBUS<N>:IIC:SOURce:DATA (see <a href="#">page 1298</a> )	
:SBUS<N>:SPI:SOURce:CLOCK (see <a href="#">page 1318</a> )	
:SBUS<N>:SPI:SOURce:DATA (see <a href="#">page 1320</a> )	
:SBUS<N>:SPI:SOURce:FRAME (see <a href="#">page 1322</a> )	
:SBUS<N>:SPI:SOURce:MISO (see <a href="#">page 1323</a> )	
:SBUS<N>:SPI:SOURce:MOSI (see <a href="#">page 1324</a> )	

## What's New in Version 5.10

New command descriptions for Version 5.10 of the Infiniium oscilloscope software appear below.

### New Commands

Command	Description
:MTEST:FOLDing:TPOsition (see <a href="#">page 853</a> )	Sets the real-time eye horizontal center position in time.
:MTEST:FOLDing:TSCale (see <a href="#">page 855</a> )	Sets the real-time eye horizontal scale perdivision in time.

### Changed Commands

Command	Description
:MEASure:CLOCK:METhod (see <a href="#">page 1725</a> )	The PCIe clock recovery method has been removed.

## What's New in Version 5.00

Version 5.00 of the Infiniium oscilloscope software introduces the new, next-generation Infiniium user interface.

The next-generation Infiniium user interface software gives you much more flexibility in how you can organize data, measurement results, and analysis views. You can size windows however you like, choose stacked, side by side, or tabbed window layouts, and you can even undock tabbed windows and place them anywhere on your monitor(s).

Plus, the next-generation Infiniium user interface software gives you more features to help you document waveforms and measurements, including visible scale values on the waveform grids, visible markers delta values, bookmarks with user-defined callout labels, and measurement values with callout labels. It is easy to capture screen images with all this information. And, you can save waveform data, measurements, analysis, settings, window layouts, and other settings, all to a single composite file. When you open a composite file later, everything is set up just like it was when you saved the file.

New command descriptions for Version 5.00 of the Infiniium oscilloscope software appear below.

### New Commands

Command	Description
:DISPlay:BOOKmark<N>:DELet (see <a href="#">page 516</a> )	Deletes a bookmark.
:DISPlay:BOOKmark<N>:SET (see <a href="#">page 517</a> )	Sets a bookmark.
:DISPlay:BOOKmark<N>:VERTi cal? (see <a href="#">page 519</a> )	Returns a waveform's vertical value at a bookmark's horizontal position.
:DISPlay:BOOKmark<N>:XPOSi tion (see <a href="#">page 520</a> )	Sets the horizontal grid position of a bookmark's callout box.
:DISPlay:BOOKmark<N>:YPOSi tion (see <a href="#">page 521</a> )	Sets the vertical grid position of a bookmark's callout box.
:DISPlay:GRATicule:AREA<N>:S TATe (see <a href="#">page 533</a> )	Enables or disables waveform areas 2-8. Waveform area 1 is always on.
:DISPlay:LAYout (see <a href="#">page 547</a> )	Sets the window layout.
:DISPlay:MAIN (see <a href="#">page 548</a> )	Turns on or off the main window view for the indicated source.
:DISPlay:PROPortion (see <a href="#">page 556</a> )	Specifies the size of the waveform and plot areas.
:MTESt:FOLDing:COUNT (see <a href="#">page 1750</a> )	Returns the number of waveforms and unit intervals in the real-time eye.

Command	Description
:MTESt:FOLDing:POSition (see <a href="#">page 849</a> )	Sets the real-time eye horizontal center position in unit intervals.
:MTESt:FOLDing:SCALe (see <a href="#">page 851</a> )	Sets the real-time eye horizontal scale, that is, the number of unit intervals (UIs) shown on screen.
:SBUS<N>:HS:DESCramble (see <a href="#">page 1291</a> )	Turns high-speed descrambling on or off if supported by the protocol type.
:SBUS<N>:HS:FORMat (see <a href="#">page 1292</a> )	Specifies the high-speed symbol display format.
:SBUS<N>:HS:IDLE (see <a href="#">page 1293</a> )	Specifies whether electrical idles are present in the signal.
:SBUS<N>:HS:SOURce<S> (see <a href="#">page 1294</a> )	Specifies the signal that is the high-speed data source.
:TIMEbase:REFerence:PERCent (see <a href="#">page 1374</a> )	Sets the timebase reference (trigger) position as a percent of screen value.

### Changed Commands

Command	Description
:BUS:B<N>:TYPE (see <a href="#">page 318</a> )	Added support for new protocols.
:DISK:SAVE:LISTing (see <a href="#">page 504</a> )	Added the <type> parameter for specifying which display window to save.
:DISPlay:CGRade (see <a href="#">page 522</a> )	Added the optional <source> parameter for specifying the waveform on which color grade should be turned on or off.
:DISPlay:CGRade:LEVels (see <a href="#">page 525</a> )	This query is unchanged but results are returned only when a single color grade view is on.
:DISPlay:CONNect (see <a href="#">page 529</a> )	Added the optional <source> parameter for specifying the waveform on which the setting should be made.
:DISPlay:GRATicule:NUMBer (see <a href="#">page 537</a> )	Number of grids can be any number between 1 and 16 (not just 1, 2, 4, 8, or 16). You can also specify which waveform area the number of grids setting is for.
:DISPlay:GRATicule:SETGrat (see <a href="#">page 538</a> )	In addition to assigning a waveform to a grid, you can now optionally specify which waveform area the grid is in. Also, you can specify whether the MAIN or CGRade (color grade) view of the waveform will be placed.
:DISPlay:PERStence (see <a href="#">page 554</a> )	Added the optional <source> parameter for specifying the waveform on which the persistence setting should be made.
:LISTer:DATA (see <a href="#">page 778</a> )	Added the <type> parameter for specifying which display window to save.

Command	Description
:MEASure:CGRade:CROSSsing (see <a href="#">page 902</a> )	Added the optional <source> parameter for specifying the waveform on which the color grade crossing level percent is measured.
:MEASure:CGRade:DCDistortion (see <a href="#">page 903</a> )	Added the optional <source> parameter for specifying the waveform on which the color grade duty cycle distortion is measured.
:MEASure:CGRade:EHEight (see <a href="#">page 904</a> )	Added the optional <source> parameter for specifying the waveform on which the color grade eye height is measured.
:MEASure:CGRade:EWIDth (see <a href="#">page 907</a> )	Added the optional <source> parameter for specifying the waveform on which the color grade eye width is measured.
:MEASure:CGRade:EWINDow (see <a href="#">page 910</a> )	Added the optional <source> parameter for specifying the waveform on which the color grade eye window is applied.
:MEASure:CGRade:JITTer (see <a href="#">page 912</a> )	Added the optional <source> parameter for specifying the waveform on which the color grade jitter is measured.
:MEASure:CGRade:QFACTOR (see <a href="#">page 915</a> )	Added the optional <source> parameter for specifying the waveform on which the color grade Q factor is measured.
:MEASure:WINDow (see <a href="#">page 1201</a> )	Added the CGRade (color grade) view as a measurement window option.
:MTESt:FOLDing (see <a href="#">page 839</a> )	Added the optional <source> parameter for specifying the waveform on which to enable/disable the real-time eye.
:MTESt:FOLDing:BITS (see <a href="#">page 841</a> )	Added the required <source> parameter to specify the waveform on which to set the real-time eye bit qualification.
:MTESt:FOLDing:FAST (see <a href="#">page 847</a> )	Added the optional <source> parameter for specifying the waveform on which to set the fast worst-case option.
:TIMEbase:REFerence (see <a href="#">page 1373</a> )	Query can now return PERC when a reference position percent value is being used.

Obsolete Commands

Obsolete Command	Current Command Equivalent	Behavior Differences
:DISPlay:COLumn (see <a href="#">page 1717</a> )	:DISPlay:BOOKmark<N>:XPOSition (see <a href="#">page 520</a> )	Bookmarks are now the method used to place text strings or annotations on screen.
:DISPlay:LINE (see <a href="#">page 1718</a> )	:DISPlay:BOOKmark<N>:SET (see <a href="#">page 517</a> )	
:DISPlay:ROW (see <a href="#">page 1719</a> )	:DISPlay:BOOKmark<N>:YPOSition (see <a href="#">page 521</a> )	
:DISPlay:STRing (see <a href="#">page 1720</a> )	:DISPlay:BOOKmark<N>:SET (see <a href="#">page 517</a> )	
:DISPlay:TEXT (see <a href="#">page 1722</a> )	:DISPlay:BOOKmark<N>:DELet (see <a href="#">page 516</a> )	

Discontinued  
Commands

Discontinued Command	Current Command Equivalent	Comments
:DISPlay:GRATicule:SIZE	None	Graticule sizing is different in the next-generation Infiniium user interface software.

## What's New in Version 4.60

New command descriptions for Version 4.60 of the Infiniium oscilloscope software appear below.

### New Commands

Command	Description
:AState? (see <a href="#">page 1221</a> )	Returns the acquisition state.
:CHANnel<N>:ISIM:NORMALize (see <a href="#">page 370</a> )	Lets you normalize the gain of an InfiniiSim transfer function.
:RState? (see <a href="#">page 1243</a> )	Returns the run state.
:SBUS<N>:CAN Commands (see <a href="#">page 1261</a> )	These commands control the CAN serial decode bus viewing, mode, and other options.

### Changed Commands

Command	Description
:SBUS<N>:MODE (see <a href="#">page 1258</a> )	Added CAN mode option.



## What's New in Version 4.50

New command descriptions for Version 4.50 of the Infiniium oscilloscope software appear below.

### New Commands

Command	Description
:FUNction<F>:ADEMod (see <a href="#">page 576</a> )	Sets the math function to show the amplitude envelope for an amplitude modulated (AM) input signal.
:MEASurement<N>:NAME (see <a href="#">page 1206</a> )	Lets you give specific names to measurements displayed on the oscilloscope's screen.
:MEASurement<N>:SOURce (see <a href="#">page 1208</a> )	Changes the source of an existing measurement.
:MTEST:FOLDing:FAST (see <a href="#">page 847</a> )	Turns the "Fast, Worst Case Only" real-time eye display option ON or OFF.

### Changed Commands

Command	Description
:DIGital<N>:THReshold (see <a href="#">page 486</a> )	There is now the DIFFerential parameter for specifying the threshold voltage.
:DISK:SAVE:WAVEform (see <a href="#">page 510</a> )	There is now the H5INt format parameter which saves waveform data as integers within the H5 file.
:POD<N>:THReshold (see <a href="#">page 1214</a> )	There is now the DIFFerential parameter for specifying the threshold voltage.

## What's New in Version 4.30

New command descriptions for Version 4.30 of the Infiniium oscilloscope software appear below.

### New Commands

Command	Description
:FUNction<F>:DELay (see <a href="#">page 579</a> )	Defines a function waveform that is the source waveform delayed in time.
:FUNction<F>:GATing (see <a href="#">page 607</a> )	Defines a horizontal gating function of another waveform (similar to horizontal zoom). Measurements on horizontal gating functions are essentially gated measurements.
:MEASure:CLOCK:METHOD:EDG E (see <a href="#">page 1731</a> )	Specifies which edge(s) of the data signal are used to recover a clock.
:MEASure:RJDJ:CLOCK (see <a href="#">page 1091</a> )	When ON, it forces the pattern to be a clock and sets the jitter for edges not examined to zero (0).
:TRIGger:LEVel:FIFTy (see <a href="#">page 1396</a> )	Sets the trigger level to 50%, like pushing the front panel trigger level knob

### Changed Commands

Command	Description
Function Commands (see <a href="#">page 569</a> )	You can now define up to 16 functions.

## What's New in Version 4.20

New command descriptions for Version 4.20 of the Infiniium oscilloscope software appear below.

### New Commands

Command	Description
:DISPlay:CGRade:SCHEME (see <a href="#">page 527</a> )	Lets you set the color grade scheme to CLASsic or TEMP.
:FUNction<F>:FFT:TDElay (see <a href="#">page 601</a> )	Sets the time delay for the FFT phase function.
:MEASure:CHARge (see <a href="#">page 917</a> )	When N2820A/N2821A high-sensitivity current probes are connected, this command/query measures the total current consumption over time with the results listed in ampere-hours (Ah).
:MEASure:CLOCK:METHod:JTF (see <a href="#">page 1733</a> )	Specifies the clock recovery PLL's response in terms of the Jitter Transfer Function's (JTF) 3 dB bandwidth.
:MEASure:CLOCK:METHod:OJTF (see <a href="#">page 1735</a> )	Specifies the clock recovery PLL's response in terms of the Observed Jitter Transfer Function's (OJTF) 3 dB bandwidth.
:MEASure:CLOCK:METHod:PLLT rack (see <a href="#">page 1737</a> )	Turns the Transition Density Dependent setting on or off.

### Changed Commands

Command	Description
:MEASure:CLOCK:METHod (see <a href="#">page 1725</a> )	The command options for specifying clock recovery PLL options have been moved to the new commands :MEASure:CLOCK:METHod:JTF and :MEASure:CLOCK:METHod:OJTF.

### Obsolete Commands

Obsolete Command	Current Command Equivalent	Description
:MEASure:DDPWS	:MEASure:RJDJ:ALL? (see <a href="#">page 1085</a> )	The :MEASure:RJDJ:ALL? query returns all of the RJDJ jitter measurements.

## What's New in Version 4.10

New command descriptions for Version 4.10 of the Infiniium oscilloscope software appear below.

### New Commands

Command	Description
:MEASure:NOISe:MEthod (see <a href="#">page 1007</a> )	Lets you select the method for random noise (RN) analysis, either the SPECTral method or BOTH the spectral and tail fit methods.
:MEASure:NOISe:REPort (see <a href="#">page 1008</a> )	When BOTH is selected for :MEASure:NOISe:MEthod, you can select SPECTral or TAILfit to specify which method is used for the reports.
:MEASure:RJDJ:MEthod (see <a href="#">page 1095</a> )	Lets you select the method for random jitter (RJ) analysis, either the SPECTral method or BOTH the spectral and tail fit methods.
:MEASure:RJDJ:REPort (see <a href="#">page 1099</a> )	When BOTH is selected for :MEASure:RJDJ:MEthod, you can select SPECTral or TAILfit to specify which method is used for the reports.
:MEASure:TIEFilter:SHApe (see <a href="#">page 1169</a> )	Specifies the shape of the TIE filter edge(s).

### Changed Commands

Command	Description
:MEASure:NOISe:ALL (see <a href="#">page 1003</a> )	New results can be returned depending on the :MEASure:NOISe:MEthod and :MEASure:NOISe:REPort settings.
:MEASure:RJDJ:ALL (see <a href="#">page 1085</a> )	New results can be returned depending on the :MEASure:RJDJ:MEthod and :MEASure:RJDJ:REPort settings.

## What's New in Version 4.00

New command descriptions for Version 4.00 of the Infiniium oscilloscope software appear below.

### New Commands

Command	Description
:ACQUIRE:REDGe (see <a href="#">page 258</a> )	For 50 GHz and 63 GHz bandwidth models of the 90000 Q-Series oscilloscopes, this command enables or disables the RealEdge channel inputs.
:DISK:SAVE:PRECprobe (see <a href="#">page 508</a> )	Saves PrecisionProbe/Cable data to a file.
:IScan:ZONE:HIDE (see <a href="#">page 709</a> )	Lets you hide or show all InfiniiScan zones on the display.

### Changed Commands

Command	Description
:ACQUIRE:BANDwidth (see <a href="#">page 241</a> )	There is now a MAX option for selecting the maximum bandwidth.
:MTEST:FOLDing:BITS (see <a href="#">page 841</a> )	There is now a PATtern option for specifying bit pattern qualification for the real-time eye display.

## What's New in Version 3.50

New command descriptions for Version 3.50 of the Infiniium oscilloscope software appear below.

### New Commands

Command	Description
:CHANnel<N>:PROBe:AUTOzero (see <a href="#">page 380</a> )	Initiates the N2893A probe's auto degauss/ offset cal.
:CHANnel<N>:PROBe:HEAD:VTERm (see <a href="#">page 394</a> )	Sets the termination voltage for the N5444A probe head.
:CHANnel<N>:PROBe:MODE (see <a href="#">page 397</a> )	Sets the N2750A probe's InfiniiMode configuration.
:FUNction<F>:MTRend (see <a href="#">page 631</a> )	New Meas Trend math function.
:FUNction<F>:MHISTogram (see <a href="#">page 627</a> )	New Meas Histogram math function.
:LISTer Commands (see <a href="#">page 777</a> )	For displaying and retrieving data from the serial decode listings.
:MEASure:HISTogram:RESolution (see <a href="#">page 975</a> )	The bin width value of one bar in the histogram.
:MEASure:NOISe (see <a href="#">page 1001</a> )	Adds a Noise measurement to the oscilloscope display (like <b>Measure &gt; Data &gt; Noise</b> from the front panel) or gets the measured noise value.
:MEASure:NOISe:ALL (see <a href="#">page 1003</a> )	Returns the NOISe measurement results for the "zeros" or "ones" level.
:MEASure:NOISe:BANDwidth (see <a href="#">page 1005</a> )	Sets the type of filtering used to separate the data dependent noise from the random noise and the periodic noise.
:MEASure:NOISe:LOCation (see <a href="#">page 1006</a> )	Specifies the noise measurement location within the bit where 0% is the beginning of the bit, 50% is the middle of the bit, and 100% is the end of the bit.
:MEASure:NOISe:RN (see <a href="#">page 1009</a> )	Specifies a known amount of random noise.
:MEASure:NOISe:SCOPE:RN (see <a href="#">page 1010</a> )	Specifies the removal of the oscilloscope's calibrated random noise from the reported RN.
:MEASure:NOISe:STATe (see <a href="#">page 1011</a> )	Enables or disables the NOISe measurements.
:MEASure:NOISe:UNITs (see <a href="#">page 1012</a> )	Sets the unit of measure for NOISe measurements to volts or unit amplitude.
:MEASure:RJDJ:RJ (see <a href="#">page 1100</a> )	Specifies a known amount of random jitter.

Command	Description
:MEASure:RJDJ:SCOpe:RJ (see <a href="#">page 1101</a> )	Specifies the removal of the oscilloscope's calibrated random jitter from the reported RJ.
:SBUS<N> Commands (see <a href="#">page 1255</a> )	For setting up IIC and SPI serial decode and triggering.

### Changed Commands

Command	Description
:CHANnel<N>:PROBe:HEAD:SElect (see <a href="#">page 393</a> )	Now lets you select probe heads by the labels given with the :CHANnel<N>:PROBe:HEAD:ADD command.
:MEASure:HISTogram:HITS (see <a href="#">page 962</a> )	Can now use this command with Meas Histogram math functions.
:MEASure:HISTogram:M1S (see <a href="#">page 963</a> )	Can now use this command with Meas Histogram math functions.
:MEASure:HISTogram:M2S (see <a href="#">page 964</a> )	Can now use this command with Meas Histogram math functions.
:MEASure:HISTogram:M3S (see <a href="#">page 965</a> )	Can now use this command with Meas Histogram math functions.
:MEASure:HISTogram:MAX (see <a href="#">page 966</a> )	Can now use this command with Meas Histogram math functions.
:MEASure:HISTogram:MEAN (see <a href="#">page 967</a> )	Can now use this command with Meas Histogram math functions.
:MEASure:HISTogram:MEDian (see <a href="#">page 968</a> )	Can now use this command with Meas Histogram math functions.
:MEASure:HISTogram:MIN (see <a href="#">page 969</a> )	Can now use this command with Meas Histogram math functions.
:MEASure:HISTogram:MODE (see <a href="#">page 972</a> )	Can now use this command with Meas Histogram math functions.
:MEASure:HISTogram:PEAK (see <a href="#">page 973</a> )	Can now use this command with Meas Histogram math functions.
:MEASure:HISTogram:PP (see <a href="#">page 974</a> )	Can now use this command with Meas Histogram math functions.
:MEASure:HISTogram:STDDev (see <a href="#">page 976</a> )	Can now use this command with Meas Histogram math functions.
:MEASure:RJDJ:ALL (see <a href="#">page 1085</a> )	There are two possible additional measurement results, Scope RN(rms) and DDPWS.
:TRIGger:MODE (see <a href="#">page 1398</a> )	Added the SBUS1, SBUS2, SBUS3, and SBUS4 selections for triggering on serial buses.

## What's New in Version 3.20

New command descriptions for Version 3.20 of the Infiniium oscilloscope software appear below.

### New Commands

Command	Description
:MARKer:MEASurement:MEASurement (see <a href="#">page 787</a> )	Specifies which measurement markers track (when the :MARKer:MODE is set to MEASurement).
:MEASure:CLOCK:METHod:ALIGN (see <a href="#">page 1729</a> )	Lets you specify clock edges either center aligned with data or edge aligned with data when using an explicit method of clock recovery.



## What's New in Version 3.11

New command descriptions for Version 3.11 of the Infiniium oscilloscope software appear below.

### New Commands

Command	Description
:CHANnel<N>:ISIM:PEXtraction (see <a href="#">page 371</a> )	Selects a channel's InfiniiSim port extraction.
:MEASure:HISTogram:MODE (see <a href="#">page 972</a> )	Returns the measurement histogram's Mode value.

### Changed Commands

Command	Description
:BUS:B<N>:TYPE (see <a href="#">page 318</a> )	The MPHY protocol type has been added for the MIPI M-PHY serial decode selection.
:FUNction<F>:FFT:WINDow (see <a href="#">page 603</a> )	The HAMMING window mode is now a valid selection.
:MEASure:JITTer:SPECTrum:WINDow (see <a href="#">page 990</a> )	The HAMMING window mode is now a valid selection.

## What's New in Version 3.10

New command descriptions for Version 3.10 of the Infiniium oscilloscope software appear below.

### New Commands

Command	Description
:ACQuire:BA <sup>N</sup> Dwidth (see <a href="#">page 241</a> )	Changes the bandwidth frequency control for the acquisition system.
:CHANnel<N>:PROBe:ACCal (see <a href="#">page 377</a> )	Sets the type of AC response probe calibration to use.
:CHANnel<N>:PROBe:PRECprobe:BA <sup>N</sup> Dwidth (see <a href="#">page 398</a> )	Specifies how the limit of PrecisionProbe or PrecisionCable correction/boosting is determined..
:CHANnel<N>:PROBe:PRECprobe:CALibration (see <a href="#">page 399</a> )	Specifies the name of the PrecisionProbe or PrecisionCable calibration to use for the specified channel and probe.
:CHANnel<N>:PROBe:PRECprobe:MODE (see <a href="#">page 401</a> )	Selects between PrecisionProbe or PrecisionCable AC response probe calibration.
:CHANnel<N>:PROBe:PRECprobe:ZSRC (see <a href="#">page 402</a> )	Specifies how PrecisionProbe characterizes the time domain and frequency domain response.
:DISPlay:STATus:COL (see <a href="#">page 564</a> )	Used to position the real time eye and InfiniiScan Zone Trigger status labels.
:DISPlay:STATus:ROW (see <a href="#">page 565</a> )	Used to position the real time eye and InfiniiScan Zone Trigger status labels.
:MEASure:DDPWS (see <a href="#">page 1742</a> )	For measuring Data Dependent Pulse Width Shrinkage.
:MEASure:EDGE (see <a href="#">page 941</a> )	For measuring the edge time relative to the reference location.
:MEASure:JITTer:SPECTrum:VE <sup>R</sup> Tical:TYPE (see <a href="#">page 989</a> )	Lets you select either a LINear or a LOGarithmic vertical scale for the jitter spectrum plot.
:MEASure:RJDJ:APLength? (see <a href="#">page 1087</a> )	Returns the determined RjDj pattern length.
:MEASure:THResholds:GENeral:ABSolute (see <a href="#">page 1122</a> )	Sets the upper level, middle level, and lower level voltages for everything except rise/fall measurements and protocol decode.
:MEASure:THResholds:GENeral:HYSTeresis (see <a href="#">page 1124</a> )	Sets the hysteresis range and level level voltages for everything except rise/fall measurements and protocol decode.
:MEASure:THResholds:GENeral:METHod (see <a href="#">page 1126</a> )	Specifies the way that the top and base of a waveform are calculated for everything except rise/fall measurements and protocol decode.

Command	Description
:MEASure:THResholds:GENeral:PERCent (see <a href="#">page 1132</a> )	Sets the upper level, middle level, and lower level voltages as a percentage of the top and base voltages for everything except rise/fall measurements and protocol decode.
:MEASure:THResholds:GENeral:TOPBase:ABSolute (see <a href="#">page 1134</a> )	Sets the top level and base level voltages for everything except rise/fall measurements and protocol decode.
:MEASure:THResholds:GENeral:TOPBase:METHod (see <a href="#">page 1134</a> )	Determines the way that the top and base of a waveform are derived for everything except rise/fall measurements and protocol decode.
:MEASure:THResholds:RFALL:ABSolute (see <a href="#">page 1141</a> )	Sets the upper level, middle level, and lower level voltages for rise/fall measurements.
:MEASure:THResholds:RFALL:HYSteresis	Sets the hysteresis range and level level voltages for rise/fall measurements.
:MEASure:THResholds:RFALL:METHod (see <a href="#">page 1143</a> )	Specifies the way that the top and base of a waveform are calculated for rise/fall measurements.
:MEASure:THResholds:RFALL:PERCent (see <a href="#">page 1147</a> )	Sets the upper level, middle level, and lower level voltages as a percentage of the top and base voltages for rise/fall measurements.
:MEASure:THResholds:RFALL:TOPBase:ABSolute (see <a href="#">page 1149</a> )	Sets the top level and base level voltages for rise/fall measurements.
:MEASure:THResholds:RFALL:TOPBase:METHod (see <a href="#">page 1149</a> )	Determines the way that the top and base of a waveform are derived for rise/fall measurements.
:MEASure:THResholds:SERial:ABSolute (see <a href="#">page 1153</a> )	Sets the upper level, middle level, and lower level voltages for protocol decode.
:MEASure:THResholds:SERial:HYSteresis (see <a href="#">page 1155</a> )	Sets the hysteresis range and level level voltages for protocol decode.
:MEASure:THResholds:SERial:METHod (see <a href="#">page 1157</a> )	Specifies the way that the top and base of a waveform are calculated for protocol decode.
:MEASure:THResholds:SERial:PERCent (see <a href="#">page 1158</a> )	Sets the upper level, middle level, and lower level voltages as a percentage of the top and base voltages for protocol decode.
:MEASure:THResholds:SERial:TOPBase:ABSolute (see <a href="#">page 1160</a> )	Sets the top level and base level voltages for protocol decode.
:MEASure:THResholds:SERial:TOPBase:METHod (see <a href="#">page 1160</a> )	Determines the way that the top and base of a waveform are derived for protocol decode.

Command	Description
:SPROcessing:CTLequalizer:NUMPoles (see <a href="#">page 1755</a> )	Selects either a 2 Pole or 3 Pole Continuous Time Linear Equalization.
:SPROcessing:CTLequalizer:P3 (see <a href="#">page 1758</a> )	Sets the Pole 3 frequency for the Continuous Time Linear Equalization.

### Changed Commands

Command	Description
:ACQUIRE:INTERpolate (see <a href="#">page 250</a> )	The INT1, INT2, INT4, INT8, INT16 options have been added for specifying the 1, 2, 4, 8, or 16 point Sin(x)/x interpolation ratios.
:MEASURE:RJDJ:BER (see <a href="#">page 1089</a> )	You can now set J2 and J9 jitter BER levels.
:MEASURE:VRMS (see <a href="#">page 1195</a> )	The VOLT and DBM parameters have been added for specifying the measurement units.
:MEASURE:WINDOW (see <a href="#">page 1201</a> )	The short form of the command was changed from :MEAS:WIN to :MEAS:WIND.

## 2 Setting Up

Step 1. Install Keysight IO Libraries Suite software / 118

Step 2. Connect and set up the oscilloscope / 119

Step 3. Verify the oscilloscope connection / 120

This chapter explains how to install the Keysight IO Libraries Suite software on a controller PC, connect the oscilloscope to the controller PC, set up the oscilloscope, and verify the oscilloscope connection.

Note that Keysight IO Libraries Suite software comes installed on Infiniium oscilloscopes, and it is possible to control the oscilloscope from programs running on the instrument.

### NOTE

Secure Instrument Communication, where participants are authenticated and communication is encrypted, is now supported by the Infiniium oscilloscope software. A recent version of Keysight IO Libraries Suite is required. For more information, see:  
[www.keysight.com/find/secureiousersguide](http://www.keysight.com/find/secureiousersguide)

Also required is the Keysight Secure Instrument Communication (SIC) Expert software running on a central server. You can download the SIC Expert installation file from:  
[www.keysight.com/find/iosuite](http://www.keysight.com/find/iosuite)

For information on setting up the Keysight Secure Instrument Communication (SIC) Expert configuration tool, click the Keysight "IO" Control icon in the taskbar and choose **Documentation > Secure Instrument Communication Expert Setup Guide**.

## Step 1. Install Keysight IO Libraries Suite software

To install the Keysight IO Libraries Suite software on a controller PC:

- 1** Download the Keysight IO Libraries Suite software from the Keysight web site at:
  - <http://www.keysight.com/find/iolib>
- 2** Run the setup file, and follow its installation instructions.

Note that Keysight IO Libraries Suite software comes installed on Infiniium oscilloscopes.

## Step 2. Connect and set up the oscilloscope

Infiniium oscilloscopes can have these interfaces for programming the oscilloscope:

- USB (device port, square connector).
- LAN. To configure the LAN interface, set up the Infiniium oscilloscope on the network as you would any other computer with the Windows operating system.
- GPIB, when the instrument has a GPIB interface connector or when the N4865A GPIB-to-LAN adapter is used.

When installed, these interfaces are always active.

### Using the USB (Device) Interface

- 1** Connect a USB cable from the controller PC's USB port to the "USB DEVICE" port on the back of the oscilloscope.

Some oscilloscopes have a USB 2.0 high-speed port; other more recent models have a USB 3.0 super-speed port.

### Using the LAN Interface

- 1** If the controller PC is not already connected to the local area network (LAN), do that first.
- 2** Contact your network administrator about adding the oscilloscope to the network.

Setting up an Infiniium oscilloscope on a network is the same as setting up any other computer with the Windows 10 operating system.

- 3** Connect the oscilloscope to the local area network (LAN) by inserting LAN cable into the "LAN" port on the oscilloscope.

## Step 3. Verify the oscilloscope connection

### NOTE

Make sure the Keysight Infiniium software is running on the oscilloscope. It must be running before you can make a connection.

- 1 On the controller PC, click on the Keysight IO Control icon in the taskbar and choose **Connection Expert** from the popup menu.

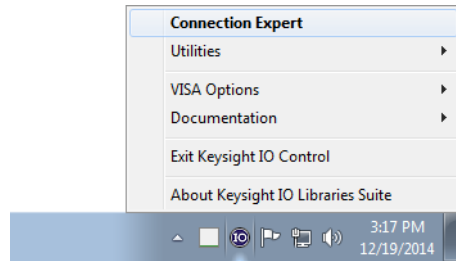

- 2 In the Keysight Connection Expert application, instruments connected to the controller's USB and GPIB interfaces as well as instruments on the same LAN subnet should automatically appear in the Instruments tab.

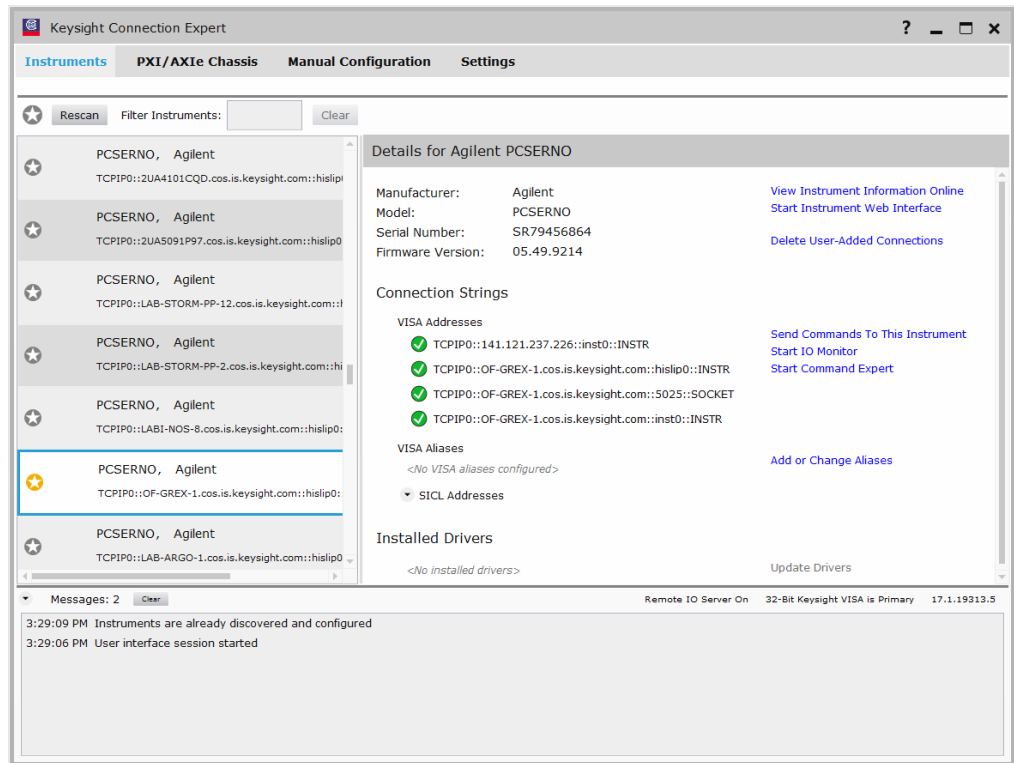



- 3 If your instrument does not appear, you can add it using the Manual Configuration tab.

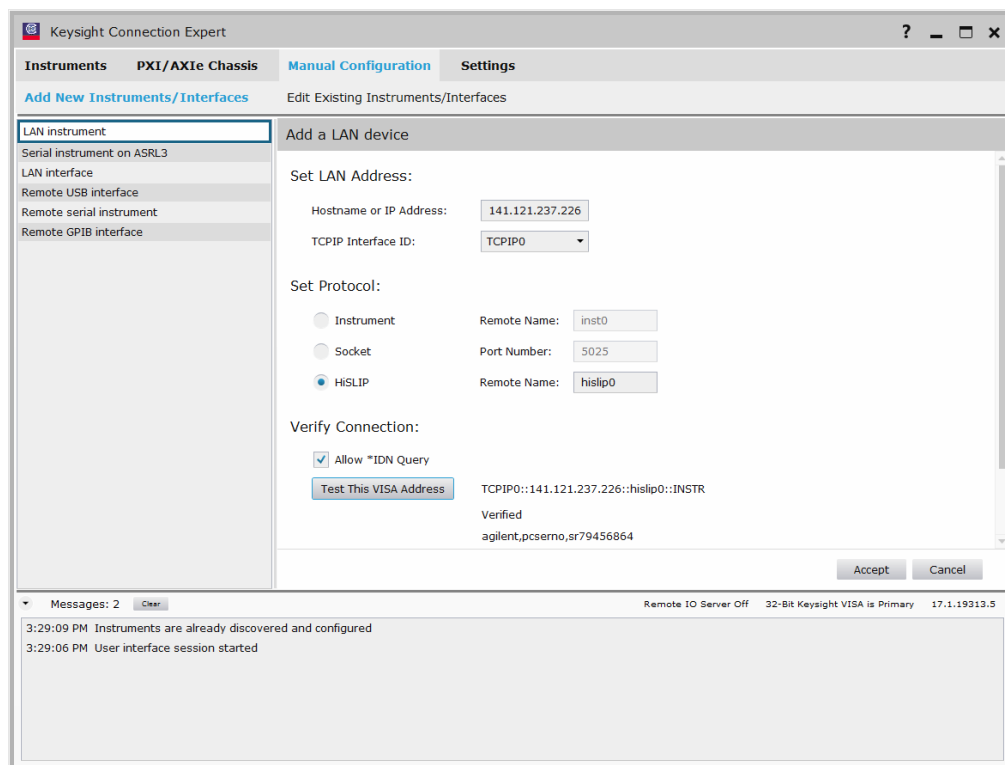

For example, to add a device:

- a Select **LAN instrument** in the list on the left.
- b Enter the oscilloscope's **Hostname** or **IP address**.
- c Select the protocol.
- d Select **HiSLIP** under Set Protocol.

HiSLIP (High-Speed LAN Instrument Protocol) is a protocol for TCP-based instrument control that provides the instrument-like capabilities of conventional test and measurement protocols with minimal impact to performance.

For more information on the HiSLIP protocol, see:

- The Keysight IO Libraries Suite documentation.
- <http://www.lxistandard.org/About/LXI-Device-Support-HiSLIP.aspx>
- <http://www.ivifoundation.org/specifications/>

- e Click **Test This VISA Address** to verify the connection.
- f If the connection test is successful, click **Accept** to add the instrument.

If the connection test is not successful, go back and verify the LAN connections and the oscilloscope setup.

- 4 Test some commands on the instrument:
  - a In the Details for the selected instrument, click **Send Commands To This Instrument**.

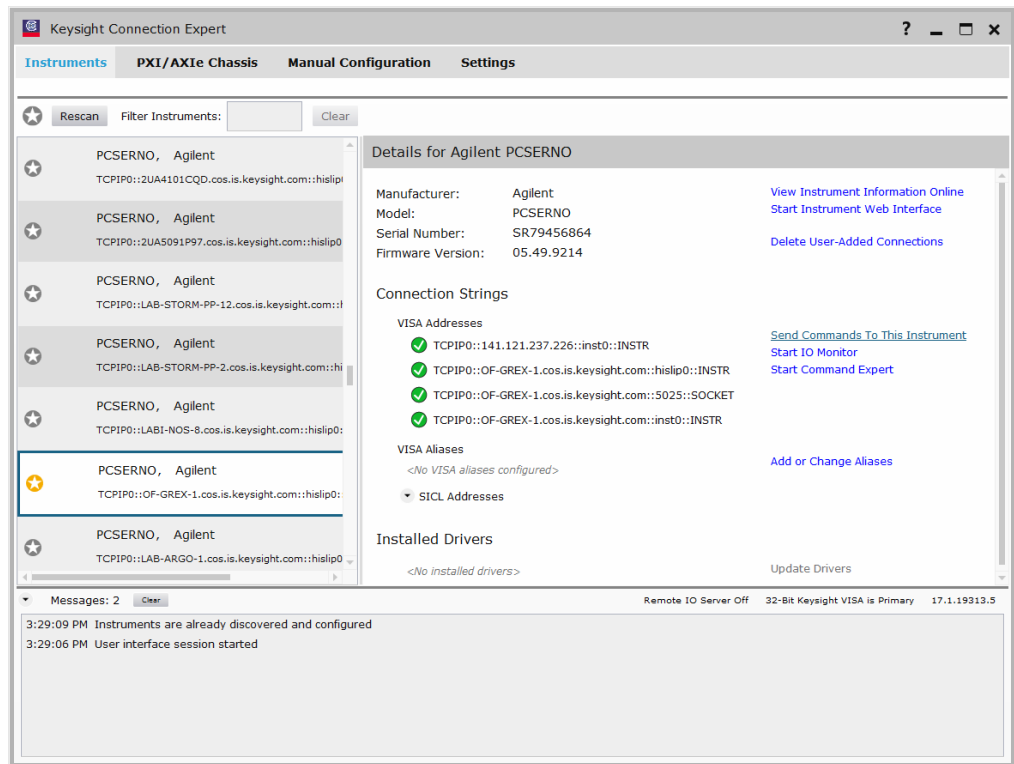

- b In the Keysight Interactive IO application, enter commands in the **Command** field and press **Send Command**, **Read Response**, or **Send & Read**.

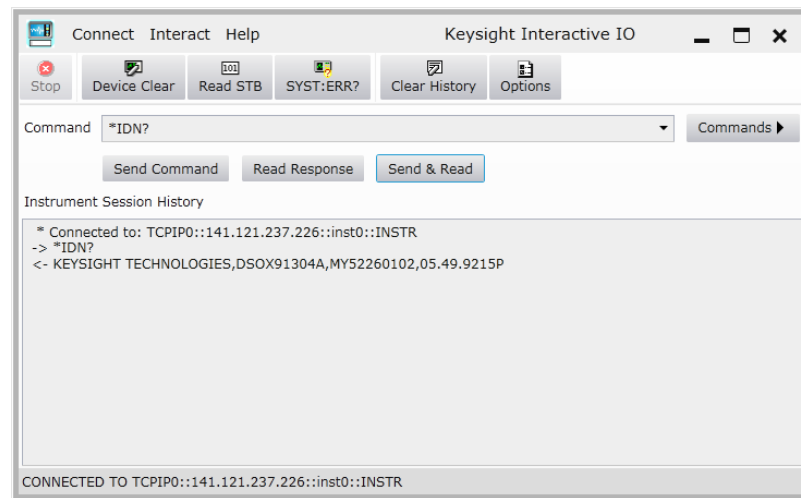

- c Choose **Connect > Exit** from the menu to exit the Keysight Interactive IO application.
- 5 In the Keysight Connection Expert application, choose **File > Exit** from the menu to exit the application.



# 3 Introduction to Programming

Communicating with the Oscilloscope /	127
Instructions /	128
Instruction Header /	129
White Space (Separator) /	130
Braces /	131
Ellipsis /	132
Square Brackets /	133
Command and Query Sources /	134
Program Data /	135
Header Types /	136
Query Headers /	138
Program Header Options /	139
Character Program Data /	140
Numeric Program Data /	141
Embedded Strings /	142
Program Message Terminator /	143
Common Commands within a Subsystem /	144
Selecting Multiple Subsystems /	145
Programming Getting Started /	146
Referencing the IO Library /	147
Opening the Oscilloscope Connection via the IO Library /	148
Initializing the Interface and the Oscilloscope /	149
Example Program /	151
Using the DIGitize Command /	152
Receiving Information from the Oscilloscope /	154
String Variable Example /	155
Numeric Variable Example /	156
Definite-Length Block Response Data /	157
Multiple Queries /	158
Oscilloscope Status /	159

This chapter introduces the basics for remote programming of an oscilloscope. The programming commands in this manual conform to the IEEE 488.2 Standard Digital Interface for Programmable Instrumentation. The programming commands provide the means of remote control.

Basic operations that you can do with a computer and an oscilloscope include:

- Set up the oscilloscope.
- Make measurements.
- Get data (waveform, measurements, and configuration) from the oscilloscope.
- Send information, such as waveforms and configurations, to the oscilloscope.

You can accomplish other tasks by combining these functions.

**NOTE**

**Example Programs are Written in Visual Basic for Applications (VBA) and C**

The programming examples for individual commands in this manual are written in Visual Basic for Applications (VBA) and C.

---

## Communicating with the Oscilloscope

Computers communicate with the oscilloscope by sending and receiving messages over a remote interface, such as a GPIB card (must order the N4865A GPIB-to-LAN adapter) or a Local Area Network (LAN) card. Commands for programming normally appear as ASCII character strings embedded inside the output statements of a "host" language available on your computer. The input commands of the host language are used to read responses from the oscilloscope.

For example, the VISA COM library provides the `WriteString()` method for sending commands and queries. After a query is sent, the response can be read using the `ReadString()` method. The `ReadString()` method passes the value across the bus to the computer and places it in the designated variable.

For the GPIB interface, messages are placed on the bus using an output command and passing the device address, program message, and a terminator. Passing the device address ensures that the program message is sent to the correct GPIB interface and GPIB device.

The following `WriteString()` method sends a command that sets the channel 1 scale value to 500 mV:

```
myScope.WriteString ":CHANnel1:SCALE 500E-3"
```

The VISA COM library setup is explained on the following pages.

### NOTE

#### Use the Suffix Multiplier Instead

Using "mV" or "V" following the numeric voltage value in some commands will cause Error 138 - Suffix not allowed. Instead, use the convention for the suffix multiplier as described in [Chapter 6](#), "Message Communication and System Functions," starting on page 181.

## Instructions

Instructions, both commands and queries, normally appear as strings embedded in a statement of your host language, such as Visual Basic for Applications (VBA), Visual Basic .NET, C#, C, etc.

The only time a parameter is not meant to be expressed as a string is when the instruction's syntax definition specifies <block data>, such as with the :SYSTem:SETup command. There are only a few instructions that use block data.

Instructions are composed of two main parts:

- The header, which specifies the command or query to be sent.
- The program data, which provides additional information to clarify the meaning of the instruction.



## Instruction Header

The instruction header is one or more command mnemonics separated by colons (:). They represent the operation to be performed by the oscilloscope. See **Chapter 4**, “Programming Conventions,” starting on page 161 for more information.

Queries are formed by adding a question mark (?) to the end of the header. Many instructions can be used as either commands or queries, depending on whether or not you include the question mark. The command and query forms of an instruction usually have different program data. Many queries do not use any program data.

## White Space (Separator)

White space is used to separate the instruction header from the program data. If the instruction does not require any program data parameters, you do not need to include any white space. In this manual, white space is defined as one or more spaces. ASCII defines a space to be character 32 in decimal.

## Braces

When several items are enclosed by braces, { }, only one of these elements may be selected. Vertical line ( | ) indicates "or". For example, {ON | OFF} indicates that only ON or OFF may be selected, not both.

## Ellipsis

... An ellipsis (trailing dots) indicates that the preceding element may be repeated one or more times.

## Square Brackets

Items enclosed in square brackets, [], are optional.

## Command and Query Sources

Many commands and queries require that a source be specified. Depending on the command or query and the model number of Infiniium oscilloscope being used, some of the sources are not available. The following is a list of sources:

CHANnel1	FUNction1	WMEMory1	COMMonmode{3 4}
CHANnel2	FUNction2	WMEMory2	DIFFerential{1 2}
CHANnel3	FUNction3	WMEMory3	EQUalized{1 2 3 4}
CHANnel4	FUNction4	WMEMory4	DIGital0 - DIGital15
CLOCK	MTRend	MSPectrum	HISTogram

## Program Data

Program data is used to clarify the meaning of the command or query. It provides necessary information, such as whether a function should be on or off, or which waveform is to be displayed. Each instruction's syntax definition shows the program data and the values they accept.

When there is more than one data parameter, they are separated by commas (.). You can add spaces around the commas to improve readability.

## Header Types

There are three types of headers:

- **"Simple Command Header"** on page 136
- **"Compound Command Header"** on page 136
- **"Common Command Header"** on page 137

- See Also**
- **"Combining Commands in the Same Subsystem"** on page 137
  - **"Duplicate Mnemonics"** on page 137

### Simple Command Header

Simple command headers contain a single mnemonic. AUToscale and DIGitize are examples of simple command headers typically used in this oscilloscope. The syntax is:

```
<program mnemonic><terminator>
```

For example:

```
" :AUToscale"
```

When program data must be included with the simple command header (for example, :DIGitize CHANnel1), white space is added to separate the data from the header. The syntax is:

```
<program mnemonic><separator><program data><terminator>
```

For example:

```
" :DIGitize CHANnel1,FUNCTION2"
```

### Compound Command Header

Compound command headers are a combination of two program mnemonics. The first mnemonic selects the subsystem, and the second mnemonic selects the function within that subsystem. The mnemonics within the compound message are separated by colons. For example:

To execute a single function within a subsystem:

```
:<subsystem>:<function><separator><program data><terminator>
```

For example:

```
" :CHANnel1:BWLimit ON"
```



## Combining Commands in the Same Subsystem

To execute more than one command within the same subsystem, use a semi-colon (;) to separate the commands:

```
:<subsystem>:<command><separator><data>;<command><separator>
<data><terminator>
```

For example:

```
:CHANnel1:INPut DC;BWLimit ON
```

## Common Command Header

Common command headers, such as clear status, control the IEEE 488.2 functions within the oscilloscope. The syntax is:

```
*<command header><terminator>
```

No space or separator is allowed between the asterisk (\*) and the command header. \*CLS is an example of a common command header.

## Duplicate Mnemonics

Identical function mnemonics can be used for more than one subsystem. For example, you can use the function mnemonic RANGE to change both the vertical range and horizontal range:

To set the vertical range of channel 1 to 0.4 volts full scale:

```
:CHANnel1:RANGe .4
```

To set the horizontal time base to 1 second full scale:

```
:TIMebase:RANGe 1
```

In these examples, CHANnel1 and TIMebase are subsystem selectors, and determine the range type being modified.

## Query Headers

A command header immediately followed by a question mark (?) is a query. After receiving a query, the oscilloscope interrogates the requested subsystem and places the answer in its output queue. The answer remains in the output queue until it is read or until another command is issued. When read, the answer is transmitted across the bus to the designated listener (typically a computer).

For example, with VISA COM library and Visual Basic for Applications (VBA) language, the query:

```
myScope.WriteString ":TIMEbase:RANGe?"
```

places the current time base setting in the output queue.

The computer input statement:

```
varRange = myScope.ReadNumber
```

passes the value across the bus to the computer and places it in the variable varRange.

You can use queries to find out how the oscilloscope is currently configured and to get results of measurements made by the oscilloscope. For example, the query:

```
:MEASure:RISetime?
```

tells the oscilloscope to measure the rise time of your waveform and place the result in the output queue.

The output queue must be read before the next program message is sent. For example, when you send the query :MEASure:RISetime?, you must follow it with an input statement.

With the VISA COM library and Visual Basic for Applications (VBA) language, this is usually done with a ReadString() or ReadNumber() method. These methods read the result of the query and place the result in a specified variable.

### NOTE

#### Handle Queries Properly

If you send another command or query before reading the result of a query, the output buffer is cleared and the current response is lost. This also generates a query-interrupted error in the error queue. If you execute an input statement before you send a query, it will cause the computer to wait indefinitely.

## Program Header Options

You can send program headers using any combination of uppercase or lowercase ASCII characters. Oscilloscope responses, however, are always returned in uppercase.

You may send program command and query headers in either long form (complete spelling), short form (abbreviated spelling), or any combination of long form and short form. For example:

":TIMebase:DELay 1E-6" is the long form.

":TIM:DEL 1E-6" is the short form.

The command descriptions in this reference show upper and lowercase characters. For example, ":AUToscale" indicates that the entire command name is ":AUTOSCALE". The short form, ":AUT", is also accepted by the oscilloscope.

### NOTE

#### Using Long Form or Short Form

Programs written in long form are easily read and are almost self-documenting. The short form syntax conserves the amount of computer memory needed for program storage and reduces I/O activity.

---

The rules for the short form syntax are described in [Chapter 4](#), "Programming Conventions," starting on page 161.

## Character Program Data

Character program data is used to convey parameter information as alpha or alphanumeric strings. For example, the `:TIMEbase:REFerence` command can be set to left, center, or right. The character program data in this case may be `LEFT`, `CENTer`, or `RIGHt`. The command `:TIMEbase:REFerence RIGHt` sets the time base reference to right.

The available mnemonics for character program data are always included with the instruction's syntax definition. You may send either the long form of commands, or the short form (if one exists). You may mix uppercase and lowercase letters freely. When receiving responses, uppercase letters are used exclusively.

## Numeric Program Data

Some command headers require program data to be expressed numerically. For example, `:TIMEbase:RANGE` requires the desired full-scale range to be expressed numerically.

For numeric program data, you can use exponential notation or suffix multipliers to indicate the numeric value. The following numbers are all equal:

$$28 = 0.28E2 = 280E-1 = 28000m = 0.028K = 28E-3K$$

When a syntax definition specifies that a number is an integer, it means that the number should be whole. Any fractional part is ignored and truncated. Numeric data parameters that accept fractional values are called real numbers.

All numbers are expected to be strings of ASCII characters.

- When sending the number 9, you would send a byte representing the ASCII code for the character "9" (which is 57).
- A three-digit number like 102 would take up three bytes (ASCII codes 49, 48, and 50). The number of bytes is figured automatically when you include the entire instruction in a string.

## Embedded Strings

Embedded strings contain groups of alphanumeric characters which are treated as a unit of data by the oscilloscope. An example of this is the line of text written to the advisory line of the oscilloscope with the :SYSTem:DSP command:

```
:SYSTem:DSP ""This is a message."""
```

You may delimit embedded strings with either single (') or double (") quotation marks. These strings are case-sensitive, and spaces are also legal characters.

## Program Message Terminator

The program instructions within a data message are executed after the program message terminator is received. The terminator may be either an NL (New Line) character, an EOI (End-Of-Identify) asserted in the GPIB interface, or a combination of the two. Asserting the EOI sets the EOI control line low on the last byte of the data message. The NL character is an ASCII linefeed (decimal 10).

**NOTE****New Line Terminator Functions Like EOS and EOT**

The NL (New Line) terminator has the same function as an EOS (End Of String) and EOT (End Of Text) terminator.

---

## Common Commands within a Subsystem

Common commands can be received and processed by the oscilloscope whether they are sent over the bus as separate program messages or within other program messages. If you have selected a subsystem, and a common command is received by the oscilloscope, the oscilloscope remains in the selected subsystem. For example, if the program message

```
" :ACQUIRE: AVERAGE ON; *CLS; COUNT 1024 "
```

is received by the oscilloscope, the oscilloscope turns averaging on, then clears the status information without leaving the selected subsystem.

If some other type of command is received within a program message, you must re-enter the original subsystem after the command. For example, the program message

```
" :ACQUIRE: AVERAGE ON; :AUTOSCALE; :ACQUIRE: AVERAGE: COUNT 1024 "
```

turns averaging on, completes the autoscale operation, then sets the acquire average count. Here, :ACQUIRE must be sent again after AUTOSCALE to re-enter the ACQUIRE subsystem and set the count.



## Selecting Multiple Subsystems

You can send multiple program commands and program queries for different subsystems on the same line by separating each command with a semicolon. The colon following the semicolon lets you enter a new subsystem. For example:

```
<program mnemonic><data>;:<program mnemonic><data><terminator>  
:CHANnel1:RANGe 0.4;:TIMebase:RANGe 1
```

**NOTE****You can Combine Compound and Simple Commands**

Multiple program commands may be any combination of compound and simple commands.

---

## Programming Getting Started

The remainder of this chapter explains how to set up the oscilloscope, how to retrieve setup information and measurement results, how to digitize a waveform, and how to pass data to the computer. **Chapter 31**, “Measure Commands,” starting on page 883 describes getting measurement data from the oscilloscope.

## Referencing the IO Library

No matter which instrument programming library you use (SICL, VISA, or VISA COM), you must reference the library from your program.

In C/C++, you must tell the compiler where to find the include and library files (see the Keysight IO Libraries Suite documentation for more information).

To reference the Keysight VISA COM library in Visual Basic for Applications (VBA, which comes with Microsoft Office products like Excel):

- 1 Choose **Tools > References...** from the main menu.
- 2 In the References dialog, check the "VISA COM 5.11 Type Library".

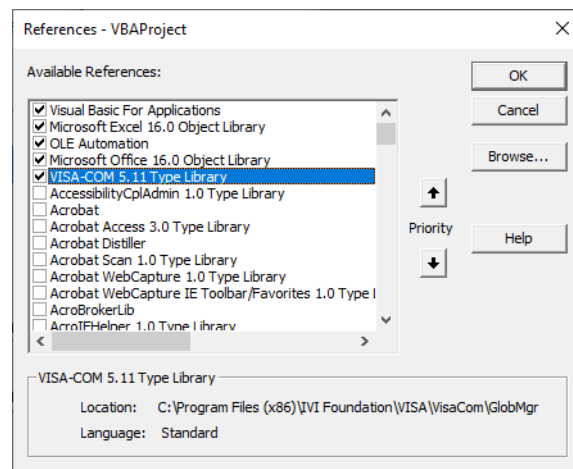

- 3 Click **OK**.

To reference the Keysight VISA COM library in Microsoft Visual Basic 6.0:

- 1 Choose **Project > References...** from the main menu.
- 2 In the References dialog, check the "VISA COM 5.11 Type Library".
- 3 Click **OK**.

## Opening the Oscilloscope Connection via the IO Library

PC controllers communicate with the oscilloscope by sending and receiving messages over a remote interface. Once you have opened a connection to the oscilloscope over the remote interface, programming instructions normally appear as ASCII character strings embedded inside write statements of the programming language. Read statements are used to read query responses from the oscilloscope.

For example, when using the Keysight VISA COM library in Visual Basic (after opening the connection to the instrument using the ResourceManager object's Open method), the FormattedIO488 object's WriteString, WriteNumber, WriteList, or WriteIIEEEBlock methods are used for sending commands and queries. After a query is sent, the response is read using the ReadString, ReadNumber, ReadList, or ReadIIEEEBlock methods.

The following Visual Basic statements open the connection and send a command that turns on the oscilloscope's label display.

```
Dim myMgr As VisaComLib.ResourceManager
Dim myScope As VisaComLib.FormattedIO488

Set myMgr = New VisaComLib.ResourceManager
Set myScope = New VisaComLib.FormattedIO488

' Open the connection to the oscilloscope. Get the VISA Address from the
' Keysight Connection Expert (installed with Keysight IO Libraries Suite
').
Set myScope.IO = myMgr.Open("<VISA Address>")

' Send a command.
myScope.WriteString ":DISPlay:LABel ON"
```

The ":DISPlay:LABEL ON" in the above example is called a *program message*. Program messages are explained in more detail in ["Instructions"](#) on page 128.

## Initializing the Interface and the Oscilloscope

To make sure the bus and all appropriate interfaces are in a known state, begin every program with an initialization statement. When using the Keysight VISA COM library, you can use the resource session object's Clear method to clear the interface buffer:

```
Dim myMgr As VisaComLib.ResourceManager
Dim myScope As VisaComLib.FormattedIO488

Set myMgr = New VisaComLib.ResourceManager
Set myScope = New VisaComLib.FormattedIO488

' Open the connection to the oscilloscope. Get the VISA Address from the
' Keysight Connection Expert (installed with Keysight IO Libraries Suite
').
Set myScope.IO = myMgr.Open("<VISA Address>")

' Clear the interface buffer and set the interface timeout to 10 seconds
.
myScope.IO.Clear
myScope.IO.Timeout = 10000
```

When you are using GPIB, CLEAR also resets the oscilloscope's parser. The parser is the program which reads in the instructions which you send it.

After clearing the interface, initialize the instrument to a preset state:

```
myScope.WriteString "*RST"
```

### NOTE

#### Information for Initializing the Instrument

The actual commands and syntax for initializing the instrument are discussed in [Chapter 16](#), "Common Commands," starting on page 449.

Refer to the Keysight IO Libraries Suite documentation for information on initializing the interface.

- See Also
- ["Autoscale"](#) on page 149
  - ["Setting Up the Oscilloscope"](#) on page 150

## Autoscale

The AUToscale feature of Keysight Technologies digitizing oscilloscopes performs a very useful function on unknown waveforms by automatically setting up the vertical channel, time base, and trigger level of the oscilloscope.

The syntax for the autoscale function is:

```
:AUToscale<terminator>
```

## Setting Up the Oscilloscope

A typical oscilloscope setup configures the vertical range and offset voltage, the horizontal range, delay time, delay reference, trigger mode, trigger level, and slope.

A typical example of the commands sent to the oscilloscope are:

```
:CHANnel1:PROBe 10; RANGE 16;OFFSet 1.00<terminator>  
  
:SYSTem:HEADer OFF<terminator>  
  
:TIMebase:RANGe 1E-3;DELay 100E-6<terminator>
```

This example sets the time base at 1 ms full-scale (100  $\mu$ s/div), with delay of 100  $\mu$ s. Vertical is set to 16 V full-scale (2 V/div), with center of screen at 1 V, and probe attenuation of 10.

## Example Program

This program demonstrates the basic command structure used to program the oscilloscope.

```
' Initialize the instrument interface to a known state.
myScope.IO.Clear
myScope.IO.Timeout = 15000    ' Set interface timeout to 15 seconds.

' Initialize the instrument to a preset state.
myScope.WriteString "*RST"

' Set the time base mode to normal with the horizontal time at
' 50 ms/div with 0 s of delay referenced at the center of the
' graticule.
myScope.WriteString ":TIMEbase:RANGe 5E-4"    ' Time base to 500 us/div.
myScope.WriteString ":TIMEbase:DELay 0"      ' Delay to zero.
myScope.WriteString ":TIMEbase:REFerence CENTER"  ' Display ref. at
                                                ' center.

' Set the vertical range to 1.6 volts full scale with center screen
' at -0.4 volts with 10:1 probe attenuation and DC coupling.
myScope.WriteString ":CHANnel:PROBE 1.0"      ' Probe attenuation
                                                ' to 1:1.
myScope.WriteString ":CHANnel:RANGe 1.6"      ' Vertical range
                                                ' 1.6 V full scale.
myScope.WriteString ":CHANnel:OFFSet -0.4"    ' Offset to -0.4.
myScope.WriteString ":CHANnel:INPut DC"      ' Coupling to DC.

' Configure the instrument to trigger at -0.4 volts with normal
' triggering.
myScope.WriteString ":TRIGger:SWEep NORMal"   ' Normal triggering.
myScope.WriteString ":TRIGger:LEVel CHAN1,-0.4"  ' Trigger level to -0.
4.
myScope.WriteString ":TRIGger:MODE EDGE"      ' Edge triggering
myScope.WriteString ":TRIGger:EDGE:SLOPe POSitive" ' Trigger on pos. slo
pe.

' Configure the instrument for normal acquisition.
myScope.WriteString ":ACQuire:MODE RTIME"     ' Normal acquisition.
myScope.WriteString ":SYSTem:HEADer OFF"     ' Turn system headers off.
myScope.WriteString ":DISPlay:GRATicule FRAMe"  ' Grid off.
```

## Using the DIGitize Command

The DIGitize command is a macro that captures data using the acquisition (ACQUIRE) subsystem. When the digitize process is complete, the acquisition is stopped. You can measure the captured data by using the oscilloscope or by transferring the data to a computer for further analysis. The captured data consists of two parts: the preamble and the waveform data record.

After changing the oscilloscope configuration, the waveform buffers are cleared. Before doing a measurement, you should send the DIGitize command to ensure new data has been collected.

You can send the DIGitize command with no parameters for a higher throughput. Refer to the DIGitize command in [Chapter 33](#), “Root Level Commands,” starting on page 1217 for details.

When the DIGitize command is sent to an oscilloscope, the specified channel's waveform is digitized using the current ACQUIRE parameters. Before sending the :WAVEform:DATA? query to download waveform data to your computer, you should specify the WAVEform parameters.

The number of data points comprising a waveform varies according to the number requested in the ACQUIRE subsystem. The ACQUIRE subsystem determines the number of data points, type of acquisition, and number of averages used by the DIGitize command. This lets you specify exactly what the digitized information contains. The following program example shows a typical setup:

```
myScope.WriteString ":SYSTem:HEADer OFF"
myScope.WriteString ":ACQUIRE:MODE RTIME"
myScope.WriteString ":ACQUIRE:COMPLetE 100"
myScope.WriteString ":WAVEform:SOURce CHANnel1"
myScope.WriteString ":WAVEform:FORMat BYTE"
myScope.WriteString ":ACQUIRE:COUNt 8"
myScope.WriteString ":ACQUIRE:POINts 500"
myScope.WriteString ":DIGitize CHANnel1"
myScope.WriteString ":WAVEform:DATA?"
```

This setup places the oscilloscope into the real time sampling mode using eight averages. This means that when the DIGitize command is received, the command will execute until the waveform has been averaged at least eight times.

After receiving the :WAVEform:DATA? query, the oscilloscope will start downloading the waveform information.

Digitized waveforms are passed from the oscilloscope to the computer by sending a numerical representation of each digitized point. The format of the numerical representation is controlled by using the :WAVEform:FORMat command and may be selected as BYTE, WORD, or ASCII.



The easiest method of receiving a digitized waveform depends on data structures, available formatting, and I/O capabilities. You must convert the data values to determine the voltage value of each point. These data values are passed starting with the left most point on the oscilloscope's display. For more information, refer to the chapter, "Waveform Commands."

When using GPIB, you may abort a digitize operation by sending a Device Clear over the bus.

## Receiving Information from the Oscilloscope

After receiving a query (a command header followed by a question mark), the oscilloscope places the answer in its output queue. The answer remains in the output queue until it is read or until another command is issued. When read, the answer is transmitted across the interface to the computer.

The input statement for receiving a response message from an oscilloscope's output queue typically has two parameters; the device address and a format specification for handling the response message. For example, with the VISA COM library, to read the result of the query command :CHANnel1:INPut? you would use the ReadString() method:

```
Dim strSetting As String
myScope.WriteString ":CHANnel1:INPut?"
strSetting = myScope.ReadString
```

This would enter the current setting for the channel 1 coupling in the string variable strSetting.

All results for queries sent in a program message must be read before another program message is sent. For example, when you send the query :MEASure:RISETIME?, you must follow that query with an input statement.

### NOTE

#### Handle Queries Properly

If you send another command or query before reading the result of a query, the output buffer will be cleared and the current response will be lost. This will also generate a query-interrupted error in the error queue. If you execute an input statement before you send a query, it will cause the computer to wait indefinitely.

---

The format specification for handling response messages depends on both the computer and the programming language.

## String Variable Example

The output of the oscilloscope may be numeric or character data depending on what is queried. Refer to the specific commands for the formats and types of data returned from queries.

**NOTE****Express String Variables Using Exact Syntax**

In Visual Basic, string variables are case sensitive and must be expressed exactly the same each time they are used.

---

This example shows the data being returned to a string variable:

```
Dim strRang As String
myScope.WriteString ":CHANnel:RANGE?"
strRang = myScope.ReadString
Debug.Print strRang
```

After running this program, the computer displays:

```
+8.00000E-01
```

## Numeric Variable Example

This example shows the data being returned to a numeric variable:

```
Dim varRang As Variant
myScope.WriteString ":CHANnel:RANGe?"
varRang = myScope.ReadNumber
Debug.Print "Channel 1 range: " + FormatNumber(varRang, 0)
```

After running this program, the computer displays:

.8

## Definite-Length Block Response Data

Definite-length block response data allows any type of device-dependent data to be transmitted over the system interface as a series of 8-bit binary data bytes. This is particularly useful for sending large quantities of data or 8-bit extended ASCII codes. The syntax is a pound sign ( # ) followed by a non-zero digit representing the number of digits in the decimal integer. After the non-zero digit is the decimal integer that states the number of 8-bit data bytes being sent. This is followed by the actual data.

For example, for transmitting 4000 bytes of data, the syntax would be:

```
#44000 <4000 bytes of data> <terminator>
```

The "4" following the pound sign represents the number of digits in the number of bytes, and "4000" represents the number of bytes to be transmitted.

## Multiple Queries

You can send multiple queries to the instrument within a single command string, but you must also read them back as a single query result. This can be accomplished by reading them back into a single string variable, multiple string variables, or multiple numeric variables.

For example, to read the :TIMEbase:RANGe?;DELay? query result into a single string variable, you could use the commands:

```
myScope.WriteString ":TIMEbase:RANGe?;DELay?"
Dim strQueryResult As String
strQueryResult = myScope.ReadString
MsgBox "Timebase range; delay:" + strQueryResult
```

When you read the result of multiple queries into a single string variable, each response is separated by a semicolon. For example, the output of the previous example would be:

```
Timebase range; delay: <range_value>;<delay_value>
```

To read the :TIMEbase:RANGe?;DELay? query result into multiple string variables, you could use the ReadList method to read the query results into a string array variable using the commands:

```
myScope.WriteString ":TIMEbase:RANGe?;DELay?"
Dim strResults() As String
strResults() = myScope.ReadList(ASCIIType_BSTR)
MsgBox "Timebase range: " + strResults(0) + ", delay: " + strResults(1)
```

To read the :TIMEbase:RANGe?;DELay? query result into multiple numeric variables, you could use the ReadList method to read the query results into a variant array variable using the commands:

```
myScope.WriteString ":TIMEbase:RANGe?;DELay?"
Dim varResults() As Variant
varResults() = myScope.ReadList
MsgBox "Timebase range: " + FormatNumber(varResults(0) * 1000, 4) + " _
      " ms, delay: " + FormatNumber(varResults(1) * 1000000, 4) + " us"
```

## Oscilloscope Status

Status registers track the current status of the oscilloscope. By checking the oscilloscope status, you can find out whether an operation has completed and is receiving triggers. **Chapter 7**, “Status Reporting,” starting on page 185 explains how to check the status of the oscilloscope.





## 4 Programming Conventions

Truncation Rule / 162  
The Command Tree / 163  
Infinity Representation / 166  
Response Generation / 167  
EOI / 168

This chapter describes conventions used to program the Infiniium-Series Oscilloscopes, and conventions used throughout this manual. A description of the command tree and command tree traversal is also included.

## Truncation Rule

The truncation rule is used to produce the short form (abbreviated spelling) for the mnemonics used in the programming headers and parameter arguments.

### NOTE

#### Command Truncation Rule

The mnemonic is the first four characters of the keyword, unless the fourth character is a vowel. Then the mnemonic is the first three characters of the keyword. If the length of the keyword is four characters or less, this rule does not apply, and the short form is the same as the long form.

This document's command descriptions shows how the truncation rule is applied to commands.

**Table 1** Mnemonic Truncation

Long Form	Short Form	How the Rule is Applied
RANGe	RANG	Short form is the first four characters of the keyword.
PATtern	PATT	Short form is the first four characters of the keyword.
DISK	DISK	Short form is the same as the long form.
DElay	DEL	Fourth character is a vowel; short form is the first three characters.

## The Command Tree

The command tree in this document's table of contents shows all of the commands in the Infiniium-Series Oscilloscopes and the relationship of the commands to each other. The IEEE 488.2 common commands are not part of the command tree because they do not affect the position of the parser within the tree.

When a program message terminator (<NL>, linefeed - ASCII decimal 10) or a leading colon (:) is sent to the oscilloscope, the parser is set to the "root" of the command tree.

- **"Command Types"** on page 163
- **"Tree Traversal Rules"** on page 163
- **"Tree Traversal Examples"** on page 164

## Command Types

The commands in this oscilloscope can be viewed as three types: common commands, root level commands, and subsystem commands.

- Common commands are commands defined by IEEE 488.2 and control some functions that are common to all IEEE 488.2 instruments. These commands are independent of the tree and do not affect the position of the parser within the tree. \*RST is an example of a common command.
- Root level commands control many of the basic functions of the oscilloscope. These commands reside at the root of the command tree. They can always be parsed if they occur at the beginning of a program message or are preceded by a colon. Unlike common commands, root level commands place the parser back at the root of the command tree. AUToscale is an example of a root level command.
- Subsystem commands are grouped together under a common node of the command tree, such as the TIMEbase commands. You may select only one subsystem at a given time. When you turn on the oscilloscope initially, the command parser is set to the root of the command tree and no subsystem is selected.

## Tree Traversal Rules

Command headers are created by traversing down the command tree. A legal command header from the command tree would be :TIMEbase:RANGe. This is referred to as a compound header. A compound header is a header made up of two or more mnemonics separated by colons. The compound header contains no spaces. The following rules apply to traversing the tree.

**NOTE****Tree Traversal Rules**

A leading colon or a program message terminator (<NL> or EOI true on the last byte) places the parser at the root of the command tree. A leading colon is a colon that is the first character of a program header. Executing a subsystem command places the oscilloscope in that subsystem until a leading colon or a program message terminator is found.

In the command tree, use the last mnemonic in the compound header as a reference point (for example, RANGE). Then find the last colon above that mnemonic (TIMEbase:). That is the point where the parser resides. You can send any command below this point within the current program message without sending the mnemonics which appear above them (for example, REFERENCE).

## Tree Traversal Examples

The WriteString() methods in the following examples are written using Visual Basic for Application (VBA) with the VISA COM library.

**Example 1** Consider the following command:

```
myScope.WriteString ":CHANnel1:RANGe 0.5;OFFSet 0"
```

The colon between CHANnel1 and RANGe is necessary because :CHANnel1:RANGe is a compound command. The semicolon between the RANGe command and the OFFSet command is required to separate the two commands or operations. The OFFSet command does not need :CHANnel1 preceding it because the :CHANnel1:RANGe command sets the parser to the CHANnel1 node in the tree.

**Example 2** Consider the following commands:

```
myScope.WriteString ":TIMEbase:REFerence CENTer;POSition 0.00001"
```

or

```
myScope.WriteString ":TIMEbase:REFerence CENTer"  
myScope.WriteString ":TIMEbase:POSition 0.00001"
```

In the first line of example 2, the "subsystem selector" is implied for the POSITION command in the compound command.

A second way to send these commands is shown in the second part of the example. Because the program message terminator places the parser back at the root of the command tree, you must reselect TIMEBASE to re-enter the TIMEBASE node before sending the POSITION command.

**Example 3** Consider the following command:

```
myScope.WriteString ":TIMEbase:REFerence CENTer;;CHANnel1:OFFSet 0"
```

In this example, the leading colon before CHANnel1 tells the parser to go back to the root of the command tree. The parser can then recognize the :CHANnel1:OFFSet command and enter the correct node.

## Infinity Representation

The representation for infinity for this oscilloscope is 9.99999E+37. This is also the value returned when a measurement cannot be made.

## Response Generation

As defined by IEEE 488.2, query responses may be buffered for these reasons:

- When the query is parsed by the oscilloscope.
- When the computer addresses the oscilloscope to talk so that it may read the response.

This oscilloscope buffers responses to a query when the query is parsed.

## EOI

The EOI bus control line follows the IEEE 488.2 standard without exception.



## 5 LAN, USB, and GPIB Interfaces

LAN Interface Connector /	170
GPIB Interface Connector /	171
Default Startup Conditions /	172
Interface Capabilities /	173
GPIB Command and Data Concepts /	174
Communicating Over the GPIB Interface /	175
Communicating Over the LAN Interface /	176
Communicating via Telnet and Sockets /	177
Bus Commands /	179

There are several types of interfaces that can be used to remotely program the Infiniium oscilloscope including Local Area Network (LAN) interface and GPIB interface. Telnet and sockets can also be used to connect to the oscilloscope.

## LAN Interface Connector

The oscilloscope is equipped with a LAN interface RJ-45 connector on the rear panel. This allows direct connect to your network. However, before you can use the LAN interface to program the oscilloscope, the network properties must be configured. Unless you are a Network Administrator, you should contact your Network Administrator to add the appropriate client, protocols, and configuration information for your LAN. This information is different for every company.

## GPIB Interface Connector

The oscilloscope is not equipped with a GPIB interface connector. You can, however, order the N4865A GPIB-to-LAN adapter for the 9000A Series oscilloscope.

## Default Startup Conditions

The following default conditions are established during power-up:

- The Request Service (RQS) bit in the status byte register is set to zero.
- All of the event registers are cleared.
- The Standard Event Status Enable Register is set to 0xFF hex.
- Service Request Enable Register is set to 0x80 hex.
- The Operation Status Enable Register is set to 0xFFFF hex.
- The Overload Event Enable Register is set to 0xFF hex.
- The Mask Test Event Enable Register is set to 0xFF hex.

You can change the default conditions using the \*PSC command with a parameter of 1 (one). When set to 1, the Standard Event Status Enable Register is set 0x00 hex and the Service Request Enable Register is set to 0x00 hex. This prevents the Power On (PON) event from setting the SRQ interrupt when the oscilloscope is ready to receive commands.

## Interface Capabilities

The interface capabilities of this oscilloscope, as defined by IEEE 488.1 and IEEE 488.2, are listed in the following table.

**Table 2** Interface Capabilities

Code	Interface Function	Capability
SH1	Source Handshake	Full Capability
AH1	Acceptor Handshake	Full Capability
T5	Talker	Basic Talker/Serial Poll/Talk Only Mode/ Unaddress if Listen Address (MLA)
L4	Listener	Basic Listener/ Unaddresses if Talk Address (MTA)
SR1	Service Request	Full Capability
RL1	Remote Local	Complete Capability
PP0	Parallel Poll	No Capability
DC1	Device Clear	Full Capability
DT1	Device Trigger	Full Capability
C0	Computer	No Capability
E2	Driver Electronics	Tri State (1 MB/SEC MAX)

## GPIB Command and Data Concepts

The GPIB interface has two modes of operation: command mode and data mode. The interface is in the command mode when the Attention (ATN) control line is true. The command mode is used to send talk and listen addresses and various interface commands such as group execute trigger (GET).

The interface is in the data mode when the ATN line is false. The data mode is used to convey device-dependent messages across the bus. The device-dependent messages include all of the oscilloscope-specific commands, queries, and responses found in this manual, including oscilloscope status information.

## Communicating Over the GPIB Interface

Device addresses are sent by the computer in the command mode to specify who talks and who listens. Because GPIB can address multiple devices through the same interface card, the device address passed with the program message must include the correct interface select code and the correct oscilloscope address.

Device Address = (Interface Select Code \* 100) + Oscilloscope Address

- See Also**
- **"Interface Select Code"** on page 175
  - **"Oscilloscope Address"** on page 175

### Interface Select Code

Each interface card has a unique interface select code. This code is used by the computer to direct commands and communications to the proper interface. The default is typically "7" for the GPIB interface cards.

### Oscilloscope Address

Each oscilloscope on the GPIB must have a unique oscilloscope address between decimal 0 and 30. This oscilloscope address is used by the computer to direct commands and communications to the proper oscilloscope on an interface. The default is typically "7" for this oscilloscope. You can change the oscilloscope address in the Utilities, Remote Interface dialog box.

#### NOTE

#### **Do Not Use Address 21 for an Oscilloscope Address**

Address 21 is usually reserved for the Computer interface Talk/Listen address, and should not be used as an oscilloscope address.

---

## Communicating Over the LAN Interface

The device address used to send commands and receive data using the LAN interface is located in the Remote Setup dialog box (**Utilities > Remote Setup**).

The following C example program shows how to communicate with the oscilloscope using the LAN interface and the Keysight Standard Instrument Control Library (SICL).

```
#include <sicl.h>

#define BUFFER_SIZE 1024

main()
{
    INST Bus;
    int reason;
    unsigned long actualcnt;
    char buffer[ BUFFER_SIZE ];

    /* Open the LAN interface */
    Bus = iopen( "lan[130.29.71.143]:hpi7,7" );
    if( Bus != 0 ) {
        /* Bus timeout set to 20 seconds */
        itimeout( Bus, 20000 );

        /* Clear the interface */
        iclear( Bus );
        /* Query and print the oscilloscope's Id */
        iwrite( Bus, "*IDN?", 5, 1, &actualcnt );
        iread( Bus, buffer, BUFFER_SIZE, &reason, &actualcnt );
        buffer[ actualcnt - 1 ] = 0;

        printf( "%s\n", buffer );
        iclose( Bus );
    }
}
```



## Communicating via Telnet and Sockets

- **"Telnet"** on page 177
- **"Sockets"** on page 177

### Telnet

To open a connection to the oscilloscope via a telnet connection, use the following syntax in a command prompt:

```
telnet Oscilloscope_IP_Address 5024
```

5024 is the port number and the name of the oscilloscope can be used in place of the IP address if desired.

After typing the above command line, press enter and a SCPI command line interface will open. You can then use this as you typically would use a command line.

### Sockets

Sockets can be used to connect to your oscilloscope on either a Windows or Unix machine.

The sockets are located on port 5025 on your oscilloscope. Between ports 5024 and 5025, only six socket ports can be opened simultaneously. It is, therefore, important that you use a proper close routine to close the connection to the oscilloscope. If you forget this, the connection will remain open and you may end up exceeding the limit of six socket ports.

Some basic commands used in communicating to your oscilloscope include:

- The receive command is: `recv`
- The send command is: `send`

Below is a programming example (for a Windows-based machine) for opening and closing a connection to your oscilloscope via sockets.

```
#include <winsock2.h>

void main ()
{
    WSADATA wsaData;
    SOCKET mysocket = NULL;
    char* ipAddress = "130.29.70.70";
    const int ipPort = 5025;

    //Initialize Winsock
    int iResult = WSStartup(MAKEWORD(2,2), &wsaData);
    if(iResult != NO_ERROR)
    {
        printf("Error at WSStartup()\n");
    }
}
```

```

        return NULL;
    }

    //Create the socket
    mySocket = socket(AF_INET, SOCK_STREAM, IPPROTO_TCP);
    if(mySocket == INVALID_SOCKET)
    {
        printf("Error at socket(): %ld\n", WSAGetLastError());
        WSACleanup();
        return NULL;
    }

    sockaddr_in clientService;
    clientService.sin_family = AF_INET;
    clientService.sin_addr.s_addr = inet_addr(ipAddress);
    clientService.sin_port = htons(ipPort);

    if(connect(mySocket, (SOCKADDR*) &clientService, sizeof(clientService
)))
    {
        printf("Failed to connect.\n");
        WSACleanup();
        return NULL;
    }

    //Do some work here

    //Close socket when finished
    closesocket(mySocket);
}

```

## Bus Commands

The following commands are IEEE 488.1 bus commands (ATN true). IEEE 488.2 defines many of the actions that are taken when these commands are received by the oscilloscope.

### Device Clear

The device clear (DCL) and selected device clear (SDC) commands clear the input buffer and output queue, reset the parser, and clear any pending commands. If either of these commands is sent during a digitize operation, the digitize operation is aborted.

### Group Execute Trigger

The group execute trigger (GET) command arms the trigger. This is the same action produced by sending the RUN command.

### Interface Clear

The interface clear (IFC) command halts all bus activity. This includes unaddressing all listeners and the talker, disabling serial poll on all devices, and returning control to the system computer.



# 6 Message Communication and System Functions

Protocols / 182

This chapter describes the operation of oscilloscopes that operate in compliance with the IEEE 488.2 (syntax) standard. It is intended to give you enough basic information about the IEEE 488.2 standard to successfully program the oscilloscope. You can find additional detailed information about the IEEE 488.2 standard in ANSI/IEEE Std 488.2-1987, "*IEEE Standard Codes, Formats, Protocols, and Common Commands*."

This oscilloscope series is designed to be compatible with other Keysight Technologies IEEE 488.2 compatible instruments. Oscilloscopes that are compatible with IEEE 488.2 must also be compatible with IEEE 488.1 (GPIB bus standard); however, IEEE 488.1 compatible oscilloscopes may or may not conform to the IEEE 488.2 standard. The IEEE 488.2 standard defines the message exchange protocols by which the oscilloscope and the computer will communicate. It also defines some common capabilities that are found in all IEEE 488.2 oscilloscopes. This chapter also contains some information about the message communication and system functions not specifically defined by IEEE 488.2.

## Protocols

The message exchange protocols of IEEE 488.2 define the overall scheme used by the computer and the oscilloscope to communicate. This includes defining when it is appropriate for devices to talk or listen, and what happens when the protocol is not followed.

- **"Functional Elements"** on page 182
- **"Protocol Overview"** on page 182
- **"Protocol Operation"** on page 183
- **"Protocol Exceptions"** on page 183
- **"Suffix Multiplier"** on page 183
- **"Suffix Unit"** on page 184

### Functional Elements

Before proceeding with the description of the protocol, you should understand a few system components, as described here.

- Input Buffer** The input buffer of the oscilloscope is the memory area where commands and queries are stored prior to being parsed and executed. It allows a computer to send a string of commands, which could take some time to execute, to the oscilloscope, then proceed to talk to another oscilloscope while the first oscilloscope is parsing and executing commands.
- Output Queue** The output queue of the oscilloscope is the memory area where all output data or response messages are stored until read by the computer.
- Parser** The oscilloscope's parser is the component that interprets the commands sent to the oscilloscope and decides what actions should be taken. "Parsing" refers to the action taken by the parser to achieve this goal. Parsing and execution of commands begins when either the oscilloscope recognizes a program message terminator, or the input buffer becomes full. If you want to send a long sequence of commands to be executed, then talk to another oscilloscope while they are executing, you should send all of the commands before sending the program message terminator.

### Protocol Overview

The oscilloscope and computer communicate using program messages and response messages. These messages serve as the containers into which sets of program commands or oscilloscope responses are placed.

A program message is sent by the computer to the oscilloscope, and a response message is sent from the oscilloscope to the computer in response to a query message. A query message is defined as being a program message that contains one or more queries. The oscilloscope will only talk when it has received a valid

query message, and therefore has something to say. The computer should only attempt to read a response after sending a complete query message, but before sending another program message.

**NOTE**

**Remember this Rule of Oscilloscope Communication**

The basic rule to remember is that the oscilloscope will only talk when prompted to, and it then expects to talk before being told to do something else.

### Protocol Operation

When you turn the oscilloscope on, the input buffer and output queue are cleared, and the parser is reset to the root level of the command tree.

The oscilloscope and the computer communicate by exchanging complete program messages and response messages. This means that the computer should always terminate a program message before attempting to read a response. The oscilloscope will terminate response messages except during a hard copy output.

After you send a query message, the next message should be the response message. The computer should always read the complete response message associated with a query message before sending another program message to the same oscilloscope.

The oscilloscope allows the computer to send multiple queries in one query message. This is called sending a "compound query". Multiple queries in a query message are separated by semicolons. The responses to each of the queries in a compound query will also be separated by semicolons.

Commands are executed in the order they are received.

### Protocol Exceptions

If an error occurs during the information exchange, the exchange may not be completed in a normal manner.

### Suffix Multiplier

The suffix multipliers that the oscilloscope will accept are shown in the following table.

**Table 3** <suffix mult>

Value	Mnemonic	Value	Mnemonic
1E18	EX	1E-3	M
1E15	PE	1E-6	U
1E12	T	1E-9	N

**Table 3** <suffix mult> (continued)

Value	Mnemonic	Value	Mnemonic
1E9	G	1E-12	P
1E6	MA	1E-15	F
1E3	K	1E-18	A

## Suffix Unit

The suffix units that the oscilloscope will accept are shown in the following table.

**Table 4** <suffix unit>

Suffix	Referenced Unit
V	Volt
S	Second



# 7 Status Reporting

Status Reporting Data Structures /	188
Status Byte Register /	190
Service Request Enable Register /	192
Message Event Register /	193
Trigger Event Register /	194
Standard Event Status Register /	195
Standard Event Status Enable Register /	196
Operation Status Register /	197
Operation Status Enable Register /	198
Mask Test Event Register /	199
Mask Test Event Enable Register /	200
Acquisition Done Event Register /	201
Process Done Event Register /	202
Trigger Armed Event Register /	203
Auto Trigger Event Register /	204
Error Queue /	1800
Output Queue /	206
Message Queue /	207
Clearing Registers and Queues /	208
Example: Checking for Armed Status /	210

An overview of the oscilloscope's status reporting structure is shown in [Figure 1](#). The status reporting structure shows you how to monitor specific events in the oscilloscope. Monitoring these events lets you determine the status of an operation, the availability and reliability of the measured data, and more.

- To monitor an event, first clear the event, then enable the event. All of the events are cleared when you initialize the oscilloscope.
- To generate a service request (SRQ) interrupt to an external computer, enable at least one bit in the Status Byte Register.

The Status Byte Register, the Standard Event Status Register group, and the Output Queue are defined as the Standard Status Data Structure Model in IEEE 488.2-1987. IEEE 488.2 defines data structures, commands, and common bit definitions for status reporting. There are also oscilloscope-defined structures and bits.

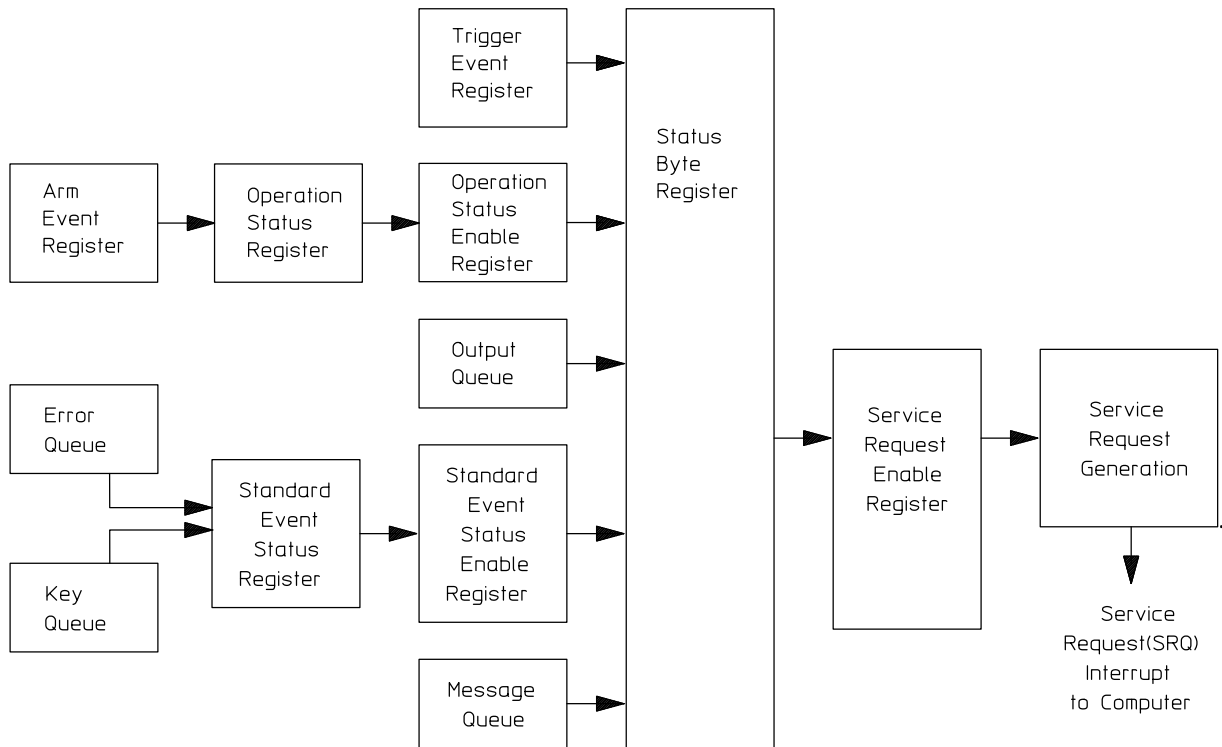

**Figure 1** Status Reporting Overview Block Diagram

The status reporting structure consists of the registers shown here.

The definitions for each bit in the status reporting data structure are listed in the following table.

**Table 5** Status Reporting Bit Definition

Bit	Description	Definition
PON	Power On	Indicates power is turned on.
URQ	User Request	Not Used. Permanently set to zero.
CME	Command Error	Indicates if the parser detected an error.
EXE	Execution Error	Indicates if a parameter was out of range or was inconsistent with the current settings.

**Table 5** Status Reporting Bit Definition (continued)

Bit	Description	Definition
DDE	Device Dependent Error	Indicates if the device was unable to complete an operation for device-dependent reasons.
QYE	Query Error	Indicates if the protocol for queries has been violated.
RQL	Request Control	Indicates if the device is requesting control.
OPC	Operation Complete	Indicates if the device has completed all pending operations.
OPER	Operation Status Register	Indicates if any of the enabled conditions in the Operation Status Register have occurred.
RQS	Request Service	Indicates that the device is requesting service.
MSS	Master Summary Status	Indicates if a device has a reason for requesting service.
ESB	Event Status Bit	Indicates if any of the enabled conditions in the Standard Event Status Register have occurred.
MAV	Message Available	Indicates if there is a response in the output queue.
MSG	Message	Indicates if an advisory has been displayed.
USR	User Event Register	Indicates if any of the enabled conditions have occurred in the User Event Register.
TRG	Trigger	Indicates if a trigger has been received.
WAIT TRIG	Wait for Trigger	Indicates the oscilloscope is armed and ready for trigger.

## Status Reporting Data Structures

The different status reporting data structures, descriptions, and interactions are shown in **Figure 2**. To make it possible for any of the Standard Event Status Register bits to generate a summary bit, you must enable the corresponding bits. These bits are enabled by using the \*ESE common command to set the corresponding bit in the Standard Event Status Enable Register.

To generate a service request (SRQ) interrupt to the computer, you must enable at least one bit in the Status Byte Register. These bits are enabled by using the \*SRE common command to set the corresponding bit in the Service Request Enable Register. These enabled bits can then set RQS and MSS (bit 6) in the Status Byte Register.

For more information about common commands, see the "Common Commands" chapter.

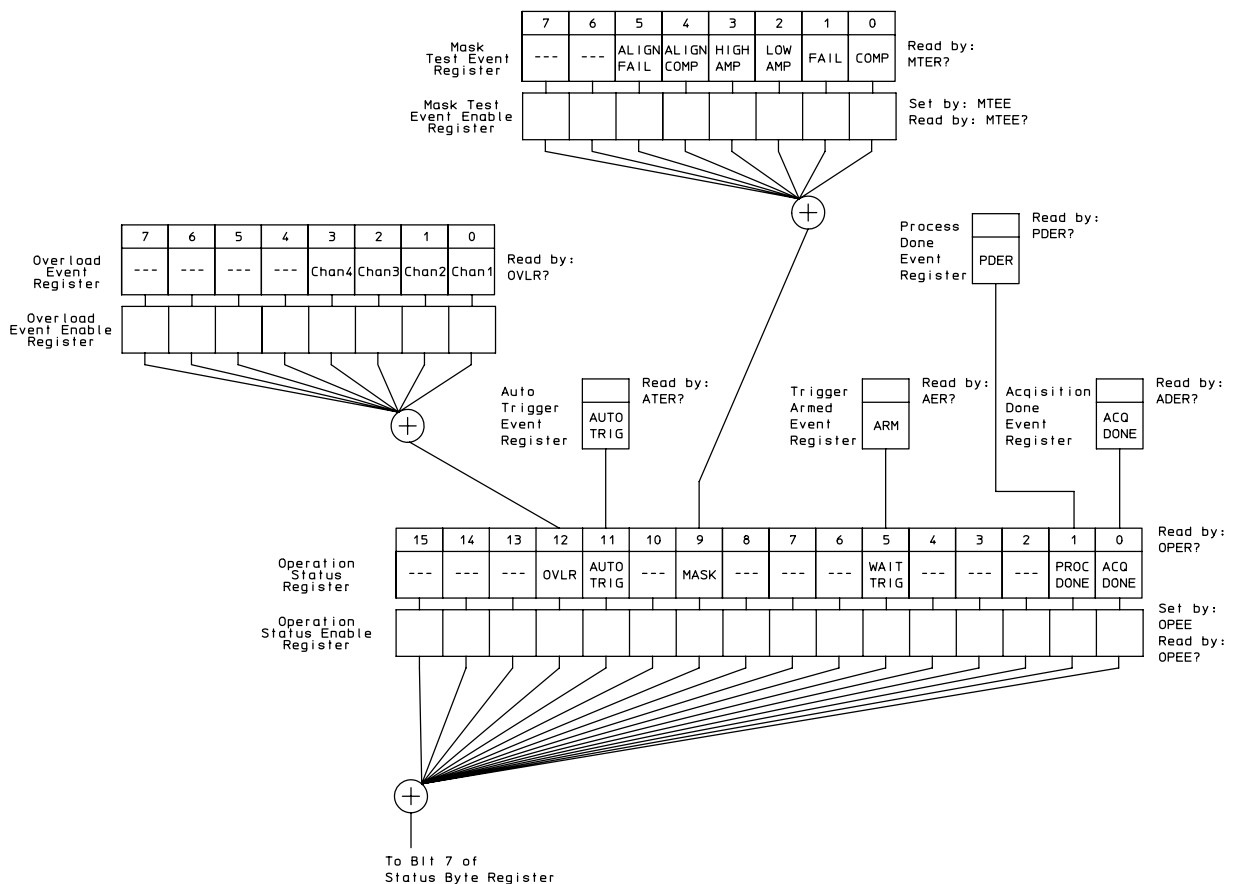

**Figure 2** Status Reporting Data Structures

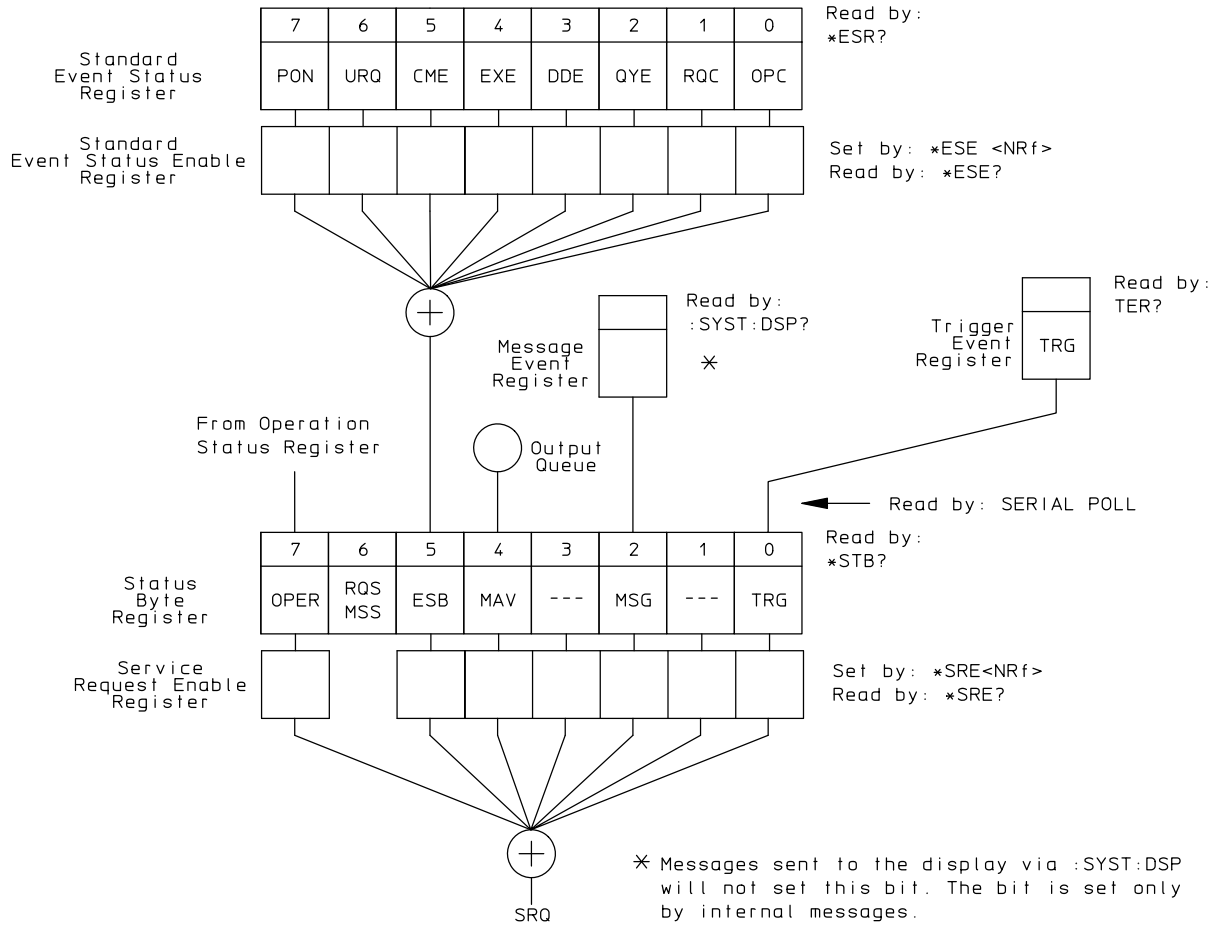

Figure 3 Status Reporting Data Structures (Continued)

## Status Byte Register

The Status Byte Register is the summary-level register in the status reporting structure. It contains summary bits that monitor activity in the other status registers and queues. The Status Byte Register is a live register. That is, its summary bits are set and cleared by the presence and absence of a summary bit from other event registers or queues.

If the Status Byte Register is to be used with the Service Request Enable Register to set bit 6 (RQS/MSS) and to generate an SRQ, at least one of the summary bits must be enabled, then set. Also, event bits in all other status registers must be specifically enabled to generate the summary bit that sets the associated summary bit in the Status Byte Register.

You can read the Status Byte Register using either the \*STB? common command query or the GPIB serial poll command. Both commands return the decimal-weighted sum of all set bits in the register. The difference between the two methods is that the serial poll command reads bit 6 as the Request Service (RQS) bit and clears the bit which clears the SRQ interrupt. The \*STB? query reads bit 6 as the Master Summary Status (MSS) and does not clear the bit or have any effect on the SRQ interrupt. The value returned is the total bit weights of all of the bits that are set at the present time.

The use of bit 6 can be confusing. This bit was defined to cover all possible computer interfaces, including a computer that could not do a serial poll. The important point to remember is that if you are using an SRQ interrupt to an external computer, the serial poll command clears bit 6. Clearing bit 6 allows the oscilloscope to generate another SRQ interrupt when another enabled event occurs.

The only other bit in the Status Byte Register affected by the \*STB? query is the Message Available bit (bit 4). If there are no other messages in the Output Queue, bit 4 (MAV) can be cleared as a result of reading the response to the \*STB? query.

If bit 4 (weight = 16) and bit 5 (weight = 32) are set, a program would print the sum of the two weights. Since these bits were not enabled to generate an SRQ, bit 6 (weight = 64) is not set.

**Example 1** This example uses the \*STB? query to read the contents of the oscilloscope's Status Byte Register when none of the register's summary bits are enabled to generate an SRQ interrupt.

```
Dim varStbValue As Variant
myScope.WriteString ":SYSTEM:HEADer OFF;*STB?" 'Turn headers off
varStbValue = myScope.ReadNumber
Debug.Print "Status Byte Register, Read: 0x" + Hex(varStbValue)
```

The next program prints "0x84" and clears bit 6 (RQS) of the Status Byte Register. The difference in the decimal value between this example and the previous one is the value of bit 6 (weight = 64). Bit 6 is set when the first enabled summary bit is set, and is cleared when the Status Byte Register is read by the serial poll command.

**Example 2** The following example uses the resource session object's ReadSTB method to read the contents of the oscilloscope's Status Byte Register.

```
varStbValue = myScope.IO.ReadSTB
Debug.Print "Status Byte Register, Serial Poll: 0x" + Hex(varStbValue)
```

**NOTE****Use Serial Polling to Read the Status Byte Register**

Serial polling is the preferred method to read the contents of the Status Byte Register because it resets bit 6 and allows the next enabled event that occurs to generate a new SRQ interrupt.

---

See Also · ["Example: Checking for Armed Status"](#) on page 210

## Service Request Enable Register

Setting the Service Request Enable Register bits enables corresponding bits in the Status Byte Register. These enabled bits can then set RQS and MSS (bit 6) in the Status Byte Register.

Bits are set in the Service Request Enable Register using the \*SRE command, and the bits that are set are read with the \*SRE? query. Bit 6 always returns 0. Refer to the Status Reporting Data Structures shown in [Figure 2](#).

**Example** The following example sets bit 4 (MAV) and bit 5 (ESB) in the Service Request Enable Register.

```
myScope.WriteString "*SRE " + CStr(CInt("&H30"))
```

This example uses the decimal parameter value of 48, the string returned by `CStr(CInt("&H30"))`, to enable the oscilloscope to generate an SRQ interrupt under the following conditions:

- When one or more bytes in the Output Queue set bit 4 (MAV).
- When an enabled event in the Standard Event Status Register generates a summary bit that sets bit 5 (ESB).



## Message Event Register

This register sets the MSG bit in the status byte register when an internally generated message is written to the advisory line on the oscilloscope. The message is read using the :SYSTEM:DSP? query. Note that messages written to the advisory line on the oscilloscope using the :SYSTEM:DSP command does not set the MSG status bit.

## Trigger Event Register

This register sets the TRG bit in the status byte register when a trigger event occurs.

The trigger event register stays set until it is cleared by reading the register with the TER? query or by using the \*CLS (clear status) command. If your application needs to detect multiple triggers, the trigger event register must be cleared after each one.

If you are using the Service Request to interrupt a computer operation when the trigger bit is set, you must clear the event register after each time it is set.

## Standard Event Status Register

The Standard Event Status Register (SESR) monitors the following oscilloscope status events:

- PON - Power On
- CME - Command Error
- EXE - Execution Error
- DDE - Device Dependent Error
- QYE - Query Error
- RQC - Request Control
- OPC - Operation Complete

When one of these events occurs, the corresponding bit is set in the register. If the corresponding bit is also enabled in the Standard Event Status Enable Register, a summary bit (ESB) in the Status Byte Register is set.

You can read the contents of the Standard Event Status Register and clear the register by sending the \*ESR? query. The value returned is the total bit weights of all bits set at the present time.

**Example** The following example uses the \*ESR query to read the contents of the Standard Event Status Register.

```
myScope.WriteString ":SYSTem:HEADer OFF"    'Turn headers off
myScope.WriteString "*ESR?"
varQueryResult = myScope.ReadNumber
Debug.print "Standard Event Status Register: 0x" + Hex(varQueryResult)
```

If bit 4 (weight = 16) and bit 5 (weight = 32) are set, the program prints the sum of the two weights.

## Standard Event Status Enable Register

For any of the Standard Event Status Register bits to generate a summary bit, you must first enable the bit. Use the \*ESE (Event Status Enable) common command to set the corresponding bit in the Standard Event Status Enable Register. Set bits are read with the \*ESE? query.

**Example** Suppose your application requires an interrupt whenever any type of error occurs. The error related bits in the (Standard) Event Status Register are bits 2 through 5 (hexadecimal value 0x3C). Therefore, you can enable any of these bits to generate the summary bit by sending:

```
myScope.WriteString "*ESE " + CStr(CInt("&H3C"))
```

Whenever an error occurs, it sets one of these bits in the (Standard) Event Status Register. Because all the error related bits are enabled, a summary bit is generated to set bit 5 (ESB) in the Status Byte Register.

If bit 5 (ESB) in the Status Byte Register is enabled (via the \*SRE command), a service request interrupt (SRQ) is sent to the controller PC.

### NOTE

#### **Disabled Standard Event Status Register Bits Respond, but Do Not Generate a Summary Bit**

Standard Event Status Register bits that are not enabled still respond to their corresponding conditions (that is, they are set if the corresponding event occurs). However, because they are not enabled, they do not generate a summary bit in the Status Byte Register.

## Operation Status Register

This register hosts the following bits:

- ACQ DONE bit 0
- PROC DONE bit 1
- WAIT TRIG bit 5
- MASK bit 9
- AUTO TRIG bit 11
- OVLN bit 12

The ACQ DONE bit is set by the Acquisition Done Event Register.

The PROC DONE bit is set by the Process Done Event Register and indicates that all functions and all math processes are done.

The WAIT TRIG bit is set by the Trigger Armed Event Register and indicates the trigger is armed.

The MASK bit is set whenever at least one of the Mask Test Event Register bits is enabled.

The AUTO TRIG bit is set by the Auto Trigger Event Register.

The OVLN bit is set whenever at least one of the Overload Event Register bits is enabled.

If any of these bits are set, the OPER bit (bit 7) of the Status Byte Register is set. The Operation Status Register is read and cleared with the OPER? query. The register output is enabled or disabled using the mask value supplied with the OPEE command.

**See Also** • ["Example: Checking for Armed Status"](#) on page 210

## Operation Status Enable Register

For any of the Operation Status Register bits to generate a summary bit, you must first enable the bit. Use the OPEE (Operation Event Status Enable) command to set the corresponding bit in the Operation Status Enable Register. Set bits are read with the OPEE? query.

**Example** Suppose your application requires an interrupt whenever any event occurs in the mask test register. The error status bit in the Operation Status Register is bit 9. Therefore, you can enable this bit to generate the summary bit by sending:

```
myScope.WriteString ":OPEE " + CStr(CInt("&H200"))
```

Whenever an error occurs, the oscilloscope sets this bit in the Mask Test Event Register. Because this bit is enabled, a summary bit is generated to set bit 9 (OPER) in the Operation Status Register.

If bit 7 (OPER) in the Status Byte Register is enabled (via the \*SRE command), a service request interrupt (SRQ) is sent to the external computer.

### NOTE

#### **Disabled Operation Status Register Bits Respond, but Do Not Generate a Summary Bit**

Operation Status Register bits that are not enabled still respond to their corresponding conditions (that is, they are set if the corresponding event occurs). However, because they are not enabled, they do not generate a summary bit in the Status Byte Register.

## Mask Test Event Register

This register hosts the following bits:

- Mask Test Complete bit (bit 0)
- Mask Test Fail bit (bit 1)
- Mask Low Amplitude bit (bit 2)
- Mask High Amplitude bit (bit 3)
- Mask Align Complete bit (bit 4)
- Mask Align Fail bit (bit 5)

The Mask Test Complete bit is set whenever the mask test is complete.

The Mask Test Fail bit is set whenever the mask test failed.

The Mask Low Amplitude bit is set whenever the signal is below the mask amplitude.

The Mask High Amplitude bit is set whenever the signal is above the mask amplitude.

The Mask Align Complete bit is set whenever the mask align is complete.

The Mask Align Fail bit is set whenever the mask align failed.

If any of these bits are set, the MASK bit (bit 9) of the Operation Status Register is set. The Mask Test Event Register is read and cleared with the MTER? query. The register output is enabled or disabled using the mask value supplied with the MTEE command.

## Mask Test Event Enable Register

For any of the Mask Test Event Register bits to generate a summary bit, you must first enable the bit. Use the MTEE (Mask Test Event Enable) command to set the corresponding bit in the Mask Test Event Enable Register. Set bits are read with the MTEE? query.

**Example** Suppose your application requires an interrupt whenever a Mask Test Fail occurs in the mask test register. You can enable this bit to generate the summary bit by sending:

```
myScope.WriteString ":MTEE " + CStr(CInt("&H2"))
```

Whenever an error occurs, the oscilloscope sets the MASK bit in the Operation Status Register. Because the bits in the Operation Status Enable Register are all enabled, a summary bit is generated to set bit 7 (OPER) in the Status Byte Register.

If bit 7 (OPER) in the Status Byte Register is enabled (via the \*SRE command), a service request interrupt (SRQ) is sent to the external computer.

### NOTE

#### **Disabled Mask Test Event Register Bits Respond, but Do Not Generate a Summary Bit**

Mask Test Event Register bits that are not enabled still respond to their corresponding conditions (that is, they are set if the corresponding event occurs). However, because they are not enabled, they do not generate a summary bit in the Operation Status Register.



## Acquisition Done Event Register

The Acquisition Done Event Register (ACQ DONE) sets bit 0 (ACQ DONE bit) in the Operation Status Register when the oscilloscope acquisition is completed.

The ACQ DONE event register stays set until it is cleared by reading the register by a ADER? query. If your application needs to detect multiple acquisitions, the ACQ DONE event register must be cleared after each acquisition.

**See Also** · ["Example: Blocking and Polling Synchronization"](#) on page 225

## Process Done Event Register

The Process Done Event Register (PDER) sets bit 1 (PROC DONE) of the Operation Status Register when all functions and all math operations are completed. The PDER bit stays set until cleared by a PDER? query.

**See Also** · ["Example: Blocking and Polling Synchronization"](#) on page 225

## Trigger Armed Event Register

The Trigger Armed Event Register (TDER) sets bit 5 (WAIT TRIG) in the Operation Status Register when the oscilloscope becomes armed.

The ARM event register stays set until it is cleared by reading the register with the AER? query. If your application needs to detect multiple triggers, the ARM event register must be cleared after each one.

**See Also** · ["Example: Checking for Armed Status"](#) on page 210

## Auto Trigger Event Register

The Auto Trigger Event Register (AUTO TRIG) sets bit 11 (AUTO TRIG) in the Operation Status Register when an auto trigger event occurs. The AUTO TRIG register stays set until it is cleared by reading the register with the ATER? query. If the application needs to detect multiple auto trigger events, the AUT TRIG register must be cleared after each one.

## Error Queue

As errors are detected, they are placed in an error queue. This queue is a first-in, first-out queue. If the error queue overflows, the last error in the queue is replaced with error -350, "Queue overflow." Any time the queue overflows, the oldest errors remain in the queue, and the most recent error is discarded. The length of the oscilloscope's error queue is 30 (29 positions for the error messages, and 1 position for the "Queue overflow" message).

The error queue is read with the `:SYSTem:ERRor?` query. Executing this query reads and removes the oldest error from the head of the queue, which opens a position at the tail of the queue for a new error. When all the errors have been read from the queue, subsequent error queries return 0, "No error."

The error queue is cleared when any of these events occur:

- When the oscilloscope is powered up.
- When the oscilloscope receives the `*CLS` common command.
- When the last item is read from the error queue.

For more information on reading the error queue, refer to the `:SYSTem:ERRor?` query in the System Commands chapter. For a complete list of error messages, refer to the chapter, "Error Messages."

## Output Queue

The output queue stores the oscilloscope-to-controller responses that are generated by certain oscilloscope commands and queries. The output queue generates the Message Available summary bit when the output queue contains one or more bytes. This summary bit sets the MAV bit (bit 4) in the Status Byte Register.

When using the Keysight VISA COM library, the output queue may be read with the FormattedIO488 object's ReadString, ReadNumber, ReadList, or ReadIEEEBlock methods.

## Message Queue

The message queue contains the text of the last message written to the advisory line on the screen of the oscilloscope. The queue is read with the `:SYSTEM:DSP?` query. Note that messages sent with the `:SYSTEM:DSP` command do not set the MSG status bit in the Status Byte Register.

## Clearing Registers and Queues

The \*CLS common command clears all event registers and all queues except the output queue. If \*CLS is sent immediately following a program message terminator, the output queue is also cleared.



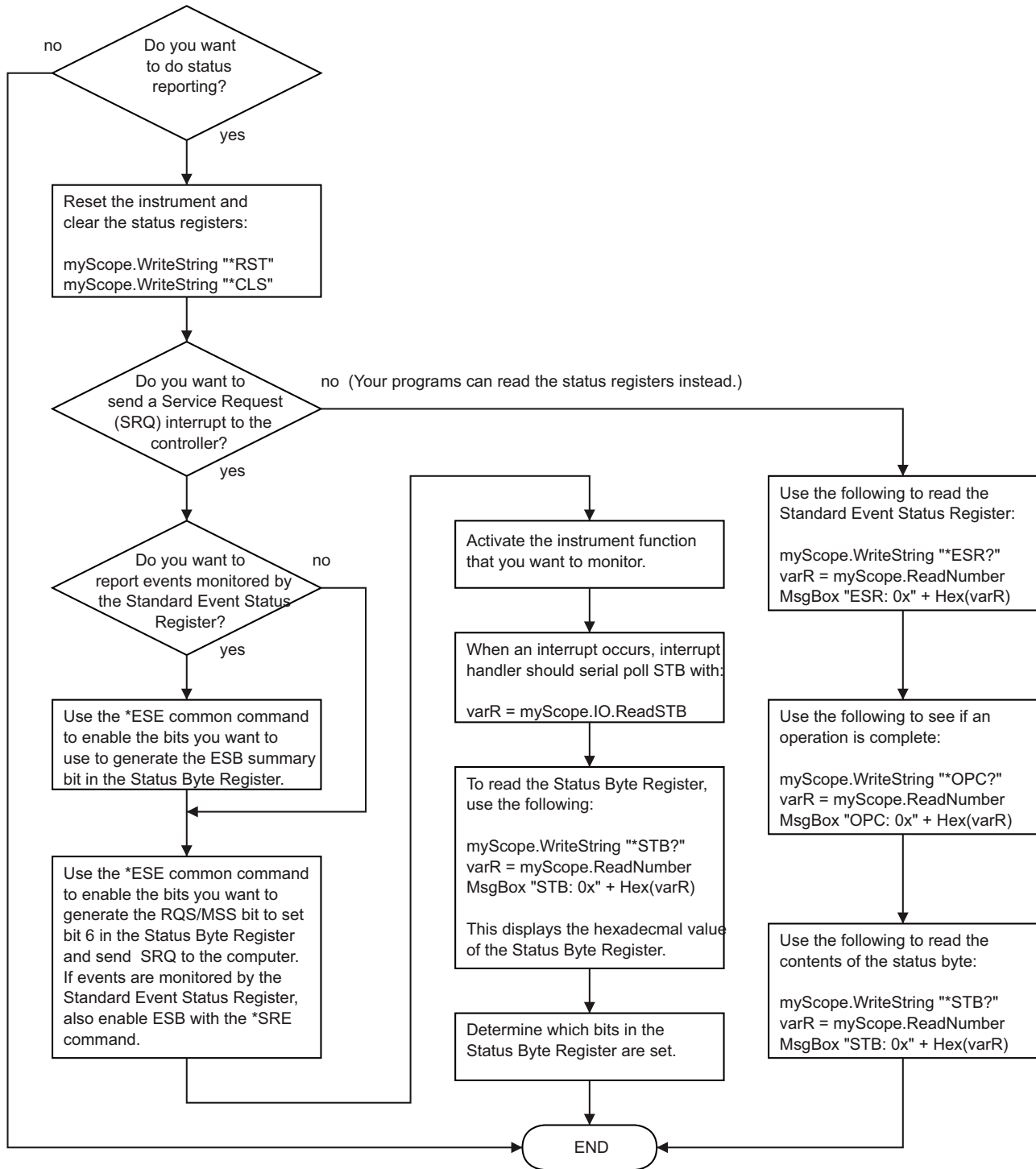

Figure 4 Status Reporting Decision Chart

## Example: Checking for Armed Status

```

#!/python3
# -*- coding: utf-8 -*-

# *****
# This script using the Python language (http://www.python.org/) and
# the PyVISA package (http://pyvisa.readthedocs.org/) shows three
# methods to tell whether a Keysight Infiniium oscilloscope is armed.
# *****

# Import modules
# -----
import sys
import visa
import time

# Initialization constants
# -----
# Get VISA address from Keysight IO Libraries Connection Expert
VISA_ADDRESS = "TCPIP0::141.121.231.13::hislip0::INSTR"
GLOBAL_TOUT = 10000 # IO timeout in milliseconds

# Connect and initialize oscilloscope
# -----
# Define VISA Resource Manager & Install directory
rm = visa.ResourceManager('C:\\Windows\\System32\\visa32.dll')

# Define and open the oscilloscope using the VISA address
KsInfiniiumScope = rm.open_resource(VISA_ADDRESS)

# Set the Global Timeout
KsInfiniiumScope.timeout = GLOBAL_TOUT

# Clear the instrument bus
KsInfiniiumScope.clear()

# Reset the oscilloscope.
KsInfiniiumScope.write("*RST")

# Autoscale to set up vertical scale and trigger level on channel 1.
KsInfiniiumScope.write(":AUToscale:CHANnels DISPLAYed")
KsInfiniiumScope.write(":AUToscale")

# Ensure a "long" time to arm (5 seconds) and not trigger immediately.
# -----
# 10 second total capture, with trigger point in the middle = 5s to arm
KsInfiniiumScope.write(":TIMEbase:RANGE 10")
# Prevent Auto trigger.
KsInfiniiumScope.write(":TRIGger:SWEep TRIGgered")

# =====
# Method 1: Query the Armed Event Register with :AER?
# -----
# This method reads the 1-bit Armed Event Register using the :AER?

```

```

# query.
#
# The Armed Event Register bit goes low (0) when it is read using
# :AER? or when a *CLS command is issued.
# =====

# Stop the oscilloscope.
KsInfiniiumScope.query(":STOP;*OPC?")

# Method 1: Initiate capture using :SINGLE
# -----
print("Acquiring signal (Method 1, using :SINGLE)...\n")
now = time.perf_counter()

# Clear all status registers before checking for new events.
KsInfiniiumScope.write("*CLS")

# Because the :AER? query will not work with :DIGitize (which is
# blocking), use the :SINGLE command to start the acquisition.
KsInfiniiumScope.write(":SINGLE")

# Method 1: Determine if armed using :AER? query.
# -----
# Define armed criteria.
ARMED = 1

# Test for armed.
ARMED_STATUS = int(KsInfiniiumScope.query(":AER?"))

# Wait indefinitely until armed.
while ARMED_STATUS != ARMED:
    # Check the status again after small delay.
    time.sleep(0.1) # 100 ms delay to prevent excessive queries.
    ARMED_STATUS = int(KsInfiniiumScope.query(":AER?"))

print("Oscilloscope is armed (method 1, using :AER? query)!")
print("It took " + str(time.perf_counter() - now) + \
      " seconds to arm.\n")

# =====
# Method 2: Read the Status Byte
# -----
# This method reads the Status Byte register's OPER bit (bit 7) using
# the "read status byte" function in VISA, which works during blocking
# commands and can therefore be used with the :DIGitize command.
#
# The Status Byte bits do NOT go low (0) when the register is read.
#
# The *CLS command will clear the Status Byte bits.
# =====

# Stop the oscilloscope.
KsInfiniiumScope.query(":STOP;*OPC?")

# Method 2: Initiate capture using :DIGitize or :SINGLE
# -----
print("Acquiring signal (Method 2, using :DIGitize)...\n")

```

```

now = time.perf_counter()

# Clear all status registers before checking for new events.
KsInfiniiumScope.write("*CLS")

# Mask out all bits in the Operation Status Register except for
# the ARM bit.
KsInfiniiumScope.write(":OPEE 32") # "Unmask" only the arm bit

# Use the :DIGitize command to start the acquisition.
KsInfiniiumScope.write(":DIGitize")

# Method 2: Determine if armed by reading the Status Byte.
# -----
# Define register bit masks for the Status Byte Register
ARM_BIT = 7
# 1 leftshift 7 = 128 (bit 7 in the Status Byte Register)
ARM_MASK = 1 << ARM_BIT

# Define armed criteria.
ARMED = 1 << ARM_BIT # 1 leftshift 7 = 128

# Test for armed.
STATUS_BYTE = int(KsInfiniiumScope.read_stb())
ARMED_STATUS = STATUS_BYTE & ARM_MASK
# Note that you could also do:
# ARMED_STATUS = int(KsInfiniiumScope.query("*STB?"))
# BUT *STB? does not work with the blocking :DIGitize.

# Wait indefinitely until armed.
while ARMED_STATUS != ARMED:
    # Check the status again after small delay.
    time.sleep(0.1) # 100 ms delay to prevent excessive queries.
    STATUS_BYTE = int(KsInfiniiumScope.read_stb())
    ARMED_STATUS = STATUS_BYTE & ARM_MASK

print("Oscilloscope is armed (method 2, using Read STB function)!")
print("It took " + str(time.perf_counter() - now) + \
      " seconds to arm.\n")

# =====
# Method 3: Query the Operation Status Register with :OPER?
# -----
# This method reads the Operation Status Register's Wait Trig bit
# (bit 5) using the :OPER? query.
#
# The Operation Status Register bits do NOT go low (0) when the
# register is read.
#
# Also, the Wait Trig bit does NOT go low (0) when the oscilloscope
# becomes unarmed by starting or stopping another acquisition (before
# the first one finishes) or by changing the time scale.
#
# The Wait Trig bit is cleared by a *CLS command, or by reading the
# Armed Event Register register with the :AER? query.
# =====

```

```

# Stop the oscilloscope.
KsInfiniiumScope.query(":STOP;*OPC?")

# Method 3: Initiate capture using :SINGLE
# -----
print("Acquiring signal (Method 3, using :SINGLE)...\n")
now = time.perf_counter()

# Clear all status registers before checking for new events.
KsInfiniiumScope.write("*CLS")

# Because the :OPER? query will not work with :DIGitize (which is
# blocking), use the :SINGLE command to start the acquisition.
KsInfiniiumScope.write(":SINGLE")

# Method 3: Determine if armed using :OPER? query.
# -----
# Define register bit masks for the Operation Status Register
ARM_BIT = 5
# 1 leftshift 5 = 32 (bit 5 in the Operation Status Register)
ARM_MASK = 1 << ARM_BIT

# Define armed criteria.
ARMED = 1 << ARM_BIT # 1 leftshift 5 = 32

# Test for armed.
STATUS_REGISTER = int(KsInfiniiumScope.query(":OPER?"))
ARMED_STATUS = STATUS_REGISTER & ARM_MASK

# Wait indefinitely until armed.
while ARMED_STATUS != ARMED:
    # Check the status again after small delay.
    time.sleep(0.1) # 100 ms delay to prevent excessive queries.
    STATUS_REGISTER = int(KsInfiniiumScope.query(":OPER?"))
    ARMED_STATUS = STATUS_REGISTER & ARM_MASK

print("Oscilloscope is armed (method 3, using :OPER? query)!")
print("It took " + str(time.perf_counter() - now) + \
      " seconds to arm.\n")

# End of Script
# -----
KsInfiniiumScope.clear() # Clear communications interface
KsInfiniiumScope.close() # Close communications interface
print("All done.")

```



## 8 Sequential (Blocking) vs. Overlapped Commands

IEEE 488.2 makes the distinction between sequential and overlapped commands (and queries):

- *Sequential commands*, also known as *blocking commands*, must finish their task before the execution of the next command starts.
- *Overlapped commands* run concurrently. Commands following an overlapped command may be started before the overlapped command is completed.

With sequential (blocking) commands and queries, the oscilloscope is expected to stop processing inputs, including additional remote commands and queries as well as front panel knobs, until completed.

In the Infiniium oscilloscopes, commands and queries operate differently:

- All commands are overlapped (non-blocking) except for :DIGitize and :DISK:SAVE.
- All queries are sequential (blocking) except for measurement results queries (for example, :MEASure:RESults?, :MEASure:RJDJ:TJRJDJ?, and others) which can potentially return before tasks complete. Because of this possibility, all measurement results queries should follow a wait for commands to complete.

### Waiting for Overlapped Commands to Complete

With overlapped (or non-blocking) commands, you can use the :PDER? query to prevent any more commands from being executed until the overlapped command is complete. This may be necessary when a command that follows an overlapped command interferes with the overlapped command's processing or analysis. For example:

```
:WMEMory1:SAVE CHAN1
while (PDER == 0)
    pause (to prevent excessive queries)
    read PDER
:WMEMory2:SAVE CHAN2
```

**Using Device Clear to Abort a Sequential (Blocking) Command** When sequential (blocking) commands take too long or fail to complete for some reason, you can send a Device Clear over the bus to clear the input buffer and output queue, reset the parser, and clear any pending commands.

- See Also**
- **Chapter 9**, "Using :PDER? Instead of \*OPC?," starting on page 217
  - **"\*OPC – Operation Complete"** on page 458
  - **"\*ESR? – Event Status Register"** on page 454
  - **Chapter 10**, "Remote Acquisition Synchronization," starting on page 219



## 9 Using :PDER? Instead of \*OPC?

When you programmatically set up an instrument for an operation, you typically send multiple instrument commands. Most instruments are able to accept and process multiple commands. Provided the instrument can complete all these commands before an additional conflicting command or query is sent, the code will work as anticipated.

A better way to send a block of commands is to have the instrument report when the block is complete before sending additional commands.

The SCPI (Standard Commands for Programmable Instruments) standard defines the \*OPC? query as a way to ensure an instrument has completed all operations before your program continues.

In the Infiniium 9000 Series, S-Series, 90000A Series, 90000 X-Series, V-Series, 90000 Q-Series, and Z-Series oscilloscopes, the implementation of the \*OPC? query does not honor the definition in the SCPI standard. Instead it returns from the \*OPC? query after parsing the previous commands, not after the effects of the previous commands are completed. If your program sends :SINGle;\*OPC?, the previous Infiniium oscilloscope software returns with the semantic equivalent of "Okay, I got your request for a single acquisition, and it is coming". This does not guarantee that the single acquisition is complete and that the oscilloscope is ready for the next command. Programs written to this flawed definition obviously have to adapt in order to get valid results. In fact, there are new synchronizing methods to work around this fault.

The :PDER? (Processing Done Event Register) query is one such evolution to work around the faulty \*OPC? query. A coherent program can be written using only the :PDER? query (without using \*OPC? query).

Here is the :PDER? equivalent of :SINGle;\*OPC? that causes your program to wait until the single acquisition has actually completed.

```
*CLS
:SINGle
while (PDER == 0)
    pause (to prevent excessive queries)
    read PDER
```

The :PDER? query provides an alternate way for remote applications to ensure all previous commands are complete before continuing. However, it is not a blocking query like the \*OPC? query, and it does not solve all remote application problems because existing applications need to be re-written to use the new :PDER? query sequence.

- See Also**
- **Chapter 8**, “Sequential (Blocking) vs. Overlapped Commands,” starting on page 215
  - **":PDER? – Processing Done Event Register"** on page 1240
  - **"\*OPC – Operation Complete"** on page 458

# 10 Remote Acquisition Synchronization

- Programming Flow / 220
- Setting Up the Oscilloscope / 221
- Acquiring a Waveform / 222
- Retrieving Results / 223
- Acquisition Synchronization / 224
- Single Shot Device Under Test (DUT) / 234
- Averaging Acquisition Synchronization / 235

When remotely controlling an oscilloscope with SCPI commands, it is often necessary to know when the oscilloscope has finished the previous operation and is ready for the next SCPI command. The most common example is when an acquisition is started using the `:DIG`, `:RUN`, or `:SINGLE` commands. Before a measurement result can be queried, the acquisition must complete. Too often, fixed delays are used to accomplish this wait, but fixed delays often use excessive time or the time may not be long enough. A better solution is to use synchronous commands and status to know when the oscilloscope is ready for the next request.

## Programming Flow

Most remote programming follows these three general steps:

- 1** Setup the oscilloscope and device under test
- 2** Acquire a waveform
- 3** Retrieve results

## Setting Up the Oscilloscope

Before making changes to the oscilloscope setup, it is best to make sure it is stopped using the :STOP command followed by the \*OPC? command.

**NOTE**

It is not necessary to use the \*OPC? command, hard coded waits, or status checking when setting up the oscilloscope.

---

After the oscilloscope is configured, it is ready for an acquisition.

## Acquiring a Waveform

When acquiring a waveform, there are two possible methods used to wait for the acquisition to complete. These methods are blocking and polling. The table below details when each method should be chosen and why.

	Blocking Wait	Polling Wait
Use When	You know the oscilloscope will trigger based on the oscilloscope setup and device under test.	You know the oscilloscope may or may not trigger based on the oscilloscope setup and device under test.
Advantages	<ul style="list-style-type: none"> <li>▪ No need for polling</li> <li>▪ Fast method</li> </ul>	<ul style="list-style-type: none"> <li>▪ Remote interface will not timeout</li> <li>▪ No need for device clear if no trigger</li> </ul>
Disadvantages	<ul style="list-style-type: none"> <li>▪ Remote interface may timeout</li> <li>▪ Device clear only way to get control of oscilloscope if there is no trigger</li> </ul>	<ul style="list-style-type: none"> <li>▪ Slower method</li> <li>▪ Required polling loop</li> <li>▪ Required known maximum wait time</li> </ul>

## Retrieving Results

Once the acquisition is complete, it is safe to retrieve measurements and statistics.

## Acquisition Synchronization

- **"Blocking Synchronization"** on page 224
- **"Polling Synchronization With Timeout"** on page 224
- **"Example: Blocking and Polling Synchronization"** on page 225

### Blocking Synchronization

Use the :DIGitize command to start the acquisition. This blocks subsequent queries until the acquisition and processing is complete.

**Example**

```
// Setup
:TRIGger:MODE EDGE
:TIMEbase:SCALE 5e-9

//Acquire
:DIG

//Get results
:MEASure:RISetime?
```

### Polling Synchronization With Timeout

This example requires a timeout value so the operation can abort if an acquisition does not occur within the timeout period.

**Example**

```
TIMEOUT = 1000ms
currentTime = 0ms

// Setup
:STOP; *OPC? // if not stopped
:ADER? // clear ADER event

// Acquire
:SINGLE

while(currentTime <= TIMEOUT)
{
    if (:ADER? == 1)
    {
        break;
    }
    else
    {
        // Use small wait to prevent excessive
        // queries to the oscilloscope
        wait (100ms)
        currentTime += 100ms
    }
}

//Get results
```



```

if (currentTime < TIMEOUT)
{
    :MEASure:RISetime?
}

```

## Example: Blocking and Polling Synchronization

```

#!/python3
# -*- coding: utf-8 -*-

# *****
# This script using the Python language (http://www.python.org/) and
# the PyVISA package (http://pyvisa.readthedocs.org/) shows the two
# best synchronization methods for Infiniium real-time oscilloscopes.
# Benefits and drawbacks of each method are described. No error
# handling is provided except in the actual synchronization methods.
# *****

# Import modules
# -----
import sys
import visa
import time

# Initialization constants
# -----
# Get VISA address from Keysight IO Libraries Connection Expert
VISA_ADDRESS = "TCPIP0::141.121.231.13::hislip0::INSTR"
GLOBAL_TOUT = 10000 # IO time out in milliseconds

TIME_TO_TRIGGER = 10 # Time in seconds
# -----
# This is the time until the FIRST trigger event.
#
# While the script calculates a general time out for the given setup,
# it cannot know when a trigger event will occur. Thus, you must
# still set this value.
#
# This time is in addition to the calculated minimum timeout... so, if
# an oscilloscope might take say, 1 us to arm and acquire data, the
# signal might take 100 seconds before it occurs... this accounts for
# that.
#
# The SCOPE_ACQUISITION_TIME_OUT calculation pads this by 1.1.
# -----

TIME_BETWEEN_TRIGGERS = 0.025 # Time in seconds - for Average,
# Segmented, and Equivalent Time modes, else set to 0
# -----
# In Average, Segmented, and Equivalent Time modes, the oscilloscope
# makes repeated acquisitions. This is similar to the above
# TIME_TO_TRIGGER, but it is the time BETWEEN triggers. For example,
# it might take 10 seconds for the first trigger event, and then they
# might start occurring regularly at say, 1 ms intervals. In that
# scenario, 15 seconds (a conservative number for 10s) would be good
# for TIME_TO_TRIGGER, and 2 ms (again conservative) would be good for

```

```

# TIME_BETWEEN_TRIGGERS.
#
# The default in this sample script is 0.025 seconds. This is to make
# the sample work for the LINE trigger used in this script when the
# oscilloscope is in Average, Segmented, and Equivalent Time modes to
# force a trigger off of the AC input line (:TRIGger:EDGE:SOURce LINE)
# which runs at 50 or 60 Hz in most of the world (1/50 Hz -> 20 ms, so
# use 25 ms to be conservative).
#
# The SCOPE_ACQUISITION_TIME_OUT calculation pads this by 1.1.
# -----

PROCESSING_TIME = 0 # Time in seconds - this is needed to account
# for additional time after an acquisition to do any processing such
# as FFTs, jitter, etc.
# -----
# When using repetitive modes such as average or segmented mode,
# processing happens only once, at the end, on either the final
# averaged waveform or the last segment, thus this only needs to be
# accounted for once.
#
# This time cannot be known ahead of time. One needs to measure this
# time:
#
# To measure PROCESSING_TIME, a second oscilloscope is ideal.
#
# 1. Connect the trigger output of the oscilloscope to be
#    programmed to an input on a second oscilloscope. It is
#    often best to use peak detect mode, maximize the signal
#    display intensity, and set the trigger sweep to
#    Normal/Triggered, not auto.
#
# 2. Feed the oscilloscope to be programmed a 1 MHz (or faster)
#    sine or square wave or other continuous signal such that the
#    trigger condition is always met and the oscilloscope will
#    trigger as fast as it can.
#
# 3. Set up the oscilloscope to be programmed as it will be used,
#    and put it in the RUNNING state (press the front panel Run
#    key).
#
# 4. Observe and record the delta time (DT) between trigger
#    output pulses. There will be some variation, use the
#    largest observed delta time.
#
# 5. Turn off any processing and again record the smallest delta
#    time of the trigger output pulses.
#
# 6. Calculate PROCESSING_TIME as
#    DT_largest_processing_ON - DT_smallest_processing_OFF
#
#    For example, with an S-Series oscilloscope, at 67 MPts and
#    20 GSa/s (~3.35 ms time capture) with sinx/x interpolation
#    enabled, it takes on the order of ~10-15 ms per capture to
#    capture and display one channel repetitively. Once an FFT
#    is enabled, it takes about ~8.2 seconds to repetitively
#    capture, calculate the FFT, and display it, repetitively.

```

```

#           Thus the PROCESSING_TIME should be 8.2 s - 15 ms = ~8.2
#           seconds. Here, 10 seconds should then be used. (FFTs take a
#           logarithmically long time to compute.)
#
# The SCOPE_ACQUISITION_TIME_OUT calculation pads this by 1.2.
# -----

# =====
# Define a simple and fast function utilizing the blocking :DIGitize
# command in conjunction with *OPC?.
# -----
#
# Benefits of this method:
#
# - Fastest, compact, simple
# - Works for ALL modes including averaging.
# - Don't have to deal with the status registers, which can be
#   confusing.
#
# Drawbacks of this method:
#
# - Requires a well-chosen, hard-set timeout that will cover the
#   time to arm, trigger, finish acquisition AND any processing
#   that is already enabled, for example FFTs, math functions,
#   measurements, jitter separation... The script calculates this
#   timeout.
#
#   Please note that for segmented memory mode, any processing
#   would happen only for the final segment.
#
#   Please note that for average acquisition mode, any processing
#   would happen only for the final averaged waveform.
#
# - Requires Exception handling and a device clear for a possible
#   timeout (no trigger event)
#
# How it works:
#
# - The :DIGitize command is a blocking command, and thus, no
#   other SCPI commands will *execute* until :DIGitize is completely
#   done. This includes any subsequent processing that is already
#   set up, such as math, jitter separation, measurements.
#
# KEY POINT: However, :DIGitize does not prevent additional
# commands from being sent to the queue or cause the remote
# program to wait. For example, if your program does something
# like:
#
#     KsInfiniiumScope.write(":DIGitize")
#     sys.stdout.write("Signal acquired.\n")
#
# The "Signal acquired" message will be written immediately
# after the :DIGitize is sent, not after the acquisition and
# processing is complete.
#
# To pause the program until the :DIGitize is complete, you must

```

```

#       wait for a query result after the :DIGitize.  For example, in
#       this case:
#
#       query_result = KsInfiniiumScope.query(":DIGitize;*OPC?")
#       sys.stdout.write("Signal acquired.\n")
#
#       The "Signal acquired" message will be written after the
#       acquisition and processing is complete.  The *OPC? query is
#       appended to :DIGitize with a semi-colon (;), which
#       essentially ties it to the same thread in the parser.  It is
#       immediately dealt with once :DIGitize finishes and gives a "1"
#       back to the program (whether the program uses it or not),
#       allowing the program to move on.
#
# Other Notes:
#
# - If you DO NOT know when a trigger will occur, you will need to
#   set a very long time out (that is, TIME_TO_TRIGGER should be
#   very long).
#
# - Because it is essentially impossible to know how long
#   additional processing (for example FFT) will take ahead of
#   time, it CAN be beneficial to turn on such things AFTER the
#   signal is acquired.  Further, because much of this processing
#   is done in the Windows OS and memory space, there CAN be a
#   large variation in the post-acquisition processing time.
#   However, read the comments at PROCESSING_TIME for how to
#   actually measure this, and it can be accounted for.
#
# - The timeout will need to be (should be) adjusted before and
#   after the :DIGitize operation, though this is not absolutely
#   required.
#
# - A :DIGitize can be aborted with a device clear:
#   KsInfiniiumScope.clear()
#
#   The device clear itself can timeout.  Can happen if issued
#   after acquisition done, but scope is still processing a long
#   FFT, for example.  A few (10) seconds is usually plenty.
# =====
def blocking_method():

    KsInfiniiumScope.timeout = SCOPE_ACQUISITION_TIME_OUT
    # Time in milliseconds (PyVisa uses ms) to wait for the
    # oscilloscope to arm, trigger, finish acquisition, and finish
    # any processing.
    #
    # Note that this is a property of the device interface,
    # KsInfiniiumScope
    #
# If doing repeated acquisitions, this should be done BEFORE the
# loop, and changed again after the loop if the goal is to
# achieve the best throughput.

sys.stdout.write("Acquiring signal(s)...\n")
# Set up a try/except block to catch a possible timeout and exit.
try:

```

```

KsInfiniiumScope.query(":DIGitize;*OPC?")
# Acquire the signal(s) with :DIGitize (blocking) and wait
# until *OPC? comes back with a one.
sys.stdout.write("Signal acquired.\n")
# Catch a possible timeout and exit.
except Exception:
    print("The acquisition timed out, most likely due to no " \
          "trigger or improper setup causing no trigger. " \
          "Properly closing the oscilloscope connection and " \
          "exiting script.\n")
    KsInfiniiumScope.clear() # Clear communications interface;
                            # A device clear also aborts digitize.
    KsInfiniiumScope.close() # Close communications interface
    sys.exit("Exiting script.")

# Reset timeout back to what it was, GLOBAL_TOUT.
KsInfiniiumScope.timeout = GLOBAL_TOUT

# =====
# Define a function using the non-blocking :SINGLE command and polling
# on the Processing Done Event Register
# -----
#
# Benefits of this method:
#
# - Don't have to worry about interface timeouts.
# - Easy to expand to know when the oscilloscope is armed.
#
# Drawbacks of this method:
#
# - Slow, as you don't want to poll the oscilloscope too fast.
#
# - Still need some maximum timeout (here MAX_TIME_TO_WAIT),
#   ideally, or the script will sit in the while loop forever if
#   there is no trigger event.
#
#   If using :PDER? max time out (here MAX_TIME_TO_WAIT) must also
#   account for any processing done (PROCESSING_TIME).
#
#   Max time out (here MAX_TIME_TO_WAIT) must also account for time
#   to arm the oscilloscope and finish the acquisition.
#
#   The script calculates this MAX_TIME_TO_WAIT as
#   SCOPE_ACQUISITION_TIME_OUT.
#
# - DOES NOT work for Equivalent time mode. MUST use the blocking
#   method.
#
# How it works:
#
# - Basically, clear the status registers with *CLS. Initiate the
#   acquisition with the non-blocking :SINGLE. Poll the
#   oscilloscope until the Processing Done Event Register comes
#   back with a 1, meaning that both the acquisition and any
#   enabled processing (FFTs, Math, jitter...) are done.
#
#

```

```

# Other Notes:
#
# - Instead of using the Processing Done Event Register, you could
#   use the Acquisition Done Event Register (see :ADER?). The
#   benefit here is that one could potentially determine WHEN a
#   trigger occurred, but only within 100 ms (the poll wait time -
#   also need to know how much time acquired after the trigger...)
#   You could also do :ADER? and then, when that comes back with a
#   1, do :PDER? possibly enabling processing in between...
#
#   Please note that for segmented memory mode, any processing would
#   happen only for the final segment.
#
#   Please note that for average acquisition mode, any processing
#   would happen only for the final averaged waveform.
# =====
def polling_method():

    MAX_TIME_TO_WAIT = SCOPE_ACQUISITION_TIME_OUT
    # Time in seconds to wait for the oscilloscope to arm, trigger,
    # finish acquisition, and finish any processing.
    #
    # Note that this is NOT a property of the device interface,
    # KsInfiniiumScope, but rather some constant in the script to be
    # used later with the Python module "time", and will be used with
    # time.perf_counter().
    #
    # If using ADER (below), set PROCESSING_TIME = 0.

    # Define completion criterion:
    ACQ_DONE = 1
    ACQ_NOT_DONE = 0

    sys.stdout.write("Acquiring signal(s)...\n")
    # Clear all status registers (set them to 0). This could be
    # concatenated with the :SINGLE command two lines below to speed
    # things up a little, like this ->
    # KsInfiniiumScope.write("*CLS;:SINGLE")
    KsInfiniiumScope.write("*CLS")

    # Define acquisition start time. This is in seconds.
    StartTime = time.perf_counter()

    # Begin acquisition with non-blocking :SINGLE command.
    KsInfiniiumScope.write(":SINGLE")
    # KsInfiniiumScope.write("*CLS;:SINGLE")
    # Recommended to concatenate these together for repeated
    # acquisition using this method as it goes slightly faster;
    # consider using method 1 instead if max throughput is desired

    # Immediately ask oscilloscope if it is done with the acquisition
    # and processing.
    Status = int(KsInfiniiumScope.query(":PDER?"))
    # NOTE: :ADER? could also be used, but :ADER does not cover any
    # processing. If using ADER, set PROCESSING_TIME = 0.
    #
    # NOTE: :PDER? not supported on older Infiniiums. Use :ADER?

```

```

# instead.

# -----
# For Average mode, MUST use :ADER? (and then PDER if needed) -
# see "Other Notes" at bottom of this section.
#
# This needs to be changed in two places, one above here, and one
# below...
# -----

# Poll the oscilloscope until Status (:PDER?) is a one. (This is
# NOT a "Serial Poll.")
while Status == ACQ_NOT_DONE and \
    (time.perf_counter() - StartTime <= MAX_TIME_TO_WAIT):
    # This loop is never entered if the acquisition completes
    # immediately. Exits if Status == 1 or MAX_TIME_TO_WAIT exceeded
    time.sleep(0.1) # Pause 100 ms to prevent excessive queries
    Status = int(KsInfiniiumScope.query(":PDER?")) # Read status
    # Loop exists when Status != NOT_DONE, that is, it exits the
    # loop when it is DONE

if Status == ACQ_DONE: # Acquisition fully completed
    sys.stdout.write("Signal acquired.\n")
else: # Acquisition failed for some reason
    print("Max wait time exceeded.")
    print("This can happen if there was not enough time to arm the "
\
        "oscilloscope, there was no trigger event, the " \
        "oscilloscope did not finish acquiring, or the " \
        "processing did not finish.")
    print("Visually check the oscilloscope for a trigger, adjust " \
        "settings accordingly.\n")
    print("Properly closing the oscilloscope connection and " \
        "exiting the script.\n")

# Always stop the oscilloscope when making any changes.
KsInfiniiumScope.query(":STOP;*OPC?")
KsInfiniiumScope.clear() # Clear communications interface
KsInfiniiumScope.close() # Close communications interface
sys.exit("Exiting script.")

# =====
# Do Something with data... save, export, additional analysis...
# =====
def do_something_with_data():

    # For example, make a peak-peak voltage measurement on channel 1:
    Vpp_Ch1 = \
        str(KsInfiniiumScope.query("MEASure:VPP? CHANnel1")).strip("\n")
    # The result comes back with a newline, so remove it with .strip("\n")
    print("Vpp Ch1 = " + Vpp_Ch1 + " V\n")

# =====
# Main code
# =====

```

```

# Connect and initialize oscilloscope
# -----
# Define VISA Resource Manager & Install directory
rm = visa.ResourceManager('C:\\Windows\\System32\\visa32.dll')

# Define and open the oscilloscope using the VISA address
KsInfiniiumScope = rm.open_resource(VISA_ADDRESS)

# Set the Global Timeout
KsInfiniiumScope.timeout = GLOBAL_TOUT

# Clear the instrument bus
KsInfiniiumScope.clear()

# Clear all status registers and errors
KsInfiniiumScope.write("*CLS")

# Set up the oscilloscope
# -----
# Note that you would normally perform a reset (default setup) if you
# were to create the setup from scratch... But here we will use the
# oscilloscope "as is" for the most part.
# KsInfiniiumScope.query("*RST;*OPC?") # Resets the oscilloscope

# Always stop the oscilloscope when making any changes.
KsInfiniiumScope.query(":STOP;*OPC?")

# For this example, the oscilloscope will be forced to trigger on the
# (AC input power) LINE voltage so something happens.
# Always use normal trigger sweep, never auto.
KsInfiniiumScope.write(":TRIGger:SWEep TRIGgered")
# This line simply gives the oscilloscope something to trigger on.
KsInfiniiumScope.query(":TRIGger:EDGE:SOURce LINE;*OPC?")

# Clear the display (so you can see the waveform being acquired -
# otherwise, there is no need for this).
KsInfiniiumScope.write(":CDISplay")

# Calculate acquisition timeout/wait time by short, overestimate method
# -----

# Need to get some info
HO = float(KsInfiniiumScope.query(":TRIGger:HOLDoff?"))
SR = float(KsInfiniiumScope.query(":ACQuire:SRATe:ANALog?"))
N_SAMPLES = float(KsInfiniiumScope.query(":ACQuire:POINTs:ANALog?"))
# Note that the :WAVEform:POINTs? command will also return interpolated
# values, so it is not useful.
T_RANGE = N_SAMPLES / SR
# Note that using the :TIMEbase:RANGE? command really only tells us
# what the oscilloscope is on screen, but Infiniium can be set up to
# capture off-screen data.
T_POSITION = float(KsInfiniiumScope.query(":TIMEbase:POSition?"))

# Determine if Average mode is on
AVERAGE_MODE_STATE = \
    str(KsInfiniiumScope.query(":ACQuire:AVERAge?").strip("\n"))

```



```

if AVERAGE_MODE_STATE == "1":
    N_AVERAGES = \
        float(KsInfiniiumScope.query(":ACquire:AVERage:COUNT?"))
else:
    N_AVERAGES = 1

# Determine if Segmented Memory or Equivalent time modes are on.
ACQ_MODE = str(KsInfiniiumScope.query(":ACquire:MODE?").strip("\n"))
ETIME_MULTIPLIER = 1 # For Equivalent Time mode.
# This is a multiplier used as Equivalent time mode builds up over
# numerous acquisitions.
if ACQ_MODE == "SEGM" or ACQ_MODE == "SEGH":
    N_SEGMENTS = \
        float(KsInfiniiumScope.query(":ACquire:SEGmented:COUNT?"))
elif ACQ_MODE != "ETIM":
    N_SEGMENTS = 1
elif ACQ_MODE == "ETIM":
    N_SEGMENTS = 1
    ETIME_MULTIPLIER = 5 # Total guess. Few use this mode.
    sys.stdout.write("Timeout calculation of Equivalent time mode "
                    "not thoroughly tested.")

# Calculate timeout from above info.
# Recall that PyVISA timeouts are in ms, so multiply by 1000.
SCOPE_ACQUISITION_TIME_OUT = (float(TIME_TO_TRIGGER)*1.1 +
    float(PROCESSING_TIME)*1.2 +
    (T_RANGE*2.0 + abs(T_POSITION)*2.0 + HO*1.1 +
    float(TIME_BETWEEN_TRIGGERS)*1.1)*N_SEGMENTS*N_AVERAGES*
    ETIME_MULTIPLIER)*1000.0

# Ensure the timeout is no less than 10 seconds
if SCOPE_ACQUISITION_TIME_OUT < 10000.0:
    SCOPE_ACQUISITION_TIME_OUT = 10000.0

# Acquire Signal
# -----
# Choose blocking_method or polling_method. These were defined as
# functions in case you want to use them repeatedly.
blocking_method()
do_something_with_data()

polling_method()
do_something_with_data()

# End of Script
# -----
KsInfiniiumScope.clear() # Clear communications interface
KsInfiniiumScope.close() # Close communications interface
print("All done.")

```

## Single Shot Device Under Test (DUT)

The examples in the previous section (Acquisition Synchronization) assumed the DUT is continually running and, therefore, the oscilloscope will have more than one opportunity to trigger. With a single shot DUT, there is only one opportunity for the oscilloscope to trigger so it is necessary for the oscilloscope to be armed and ready before the DUT is enabled.

### NOTE

The blocking `:DIGitize` command cannot be used for a single shot DUT because once the `:DIGitize` command is issued, the oscilloscope is blocked from any further commands until the acquisition is complete.

This example is the same as the previous example with the addition of checking for the armed event status.

### Example

```

TIMEOUT = 1000ms
currentTime = 0ms

// Setup
:STOP; *OPC? // if not stopped
:ADER? // clear ADER event

// Acquire
:SINGLE

while(AER? == 0)
{
    wait(100ms)
}

//oscilloscope is armed and ready, enable DUT here

while(currentTime <= TIMEOUT)
{
    if (:ADER? == 1)
    {
        break;
    }
    else
    {
        // Use small wait to prevent excessive
        // queries to the oscilloscope
        wait (100ms)
        currentTime += 100ms
    }
}

//Get results
if (currentTime < TIMEOUT)
{
    :MEASure:RISetime?
}

```

## Averaging Acquisition Synchronization

When averaging, it is necessary to know when the average count has been reached. Since an ADER/PDER event occurs for every acquisition in the average count, these commands cannot be used. The :SINGle command does not average.

If it is known that a trigger will occur, a :DIG will acquire the complete number of averages, but if the number of averages is large, it may cause a timeout on the connection.

The example below acquires the desired number of averages and then stops running.

```

Example  AVERAGE_COUNT = 256

:STOP;*OPC?
:TER?
:ACQ:AVERAge:COUNT AVERAGE_COUNT
:ACQ:AVERAge ON
:RUN

//Assume the oscilloscope will trigger, if not put a check here

while (:WAV:COUNT? < AVERAGE_COUNT)
{
    wait(100ms)
}

:STOP;*OPC?

// Get results

```



# 11 Acquire Commands

:ACquire:AVERage / 239  
:ACquire[:AVERage]:COUNT / 240  
:ACquire:BANDwidth / 241  
:ACquire:BANDwidth:FRAME? / 243  
:ACquire:BANDwidth:TESTLIMITS? / 244  
:ACquire:COMplete / 245  
:ACquire:COMplete:STATe / 247  
:ACquire:HRESolution / 248  
:ACquire:INTerpolate / 250  
:ACquire:MODE / 251  
:ACquire:POINts[:ANALog] – Memory depth / 253  
:ACquire:POINts:AUTO / 255  
:ACquire:POINts:DIGital? / 256  
:ACquire:POINts:TESTLIMITS? / 257  
:ACquire:REDge – RealEdge Channel Inputs (90000 Q-Series, Z-Series) / 258  
:ACquire:RESPonse (90000A Series, 90000 X-Series, V-Series, 90000 Q-Series,  
Z-Series) / 259  
:ACquire:SEGmented:AUTOplay / 260  
:ACquire:SEGmented:COUNT / 261  
:ACquire:SEGmented:INDEX / 262  
:ACquire:SEGmented:PLAY / 263  
:ACquire:SEGmented:PRATE / 264  
:ACquire:SEGmented:TTAGs / 265  
:ACquire:SRATE[:ANALog] – Analog Sample Rate / 266  
:ACquire:SRATE[:ANALog]:AUTO / 267  
:ACquire:SRATE:DIGital – Digital Channels Sample Rate / 268  
:ACquire:SRATE:DIGital:AUTO / 269  
:ACquire:SRATE:TESTLIMITS? / 270

The ACQUIRE subsystem commands set up conditions for executing a :DIGITIZE root level command to acquire waveform data. The commands in this subsystem select the type of data, the number of averages, and the number of data points.

## :ACQUIRE:AVERAge

**Command** :ACQUIRE:AVERAge {{ON|1} | {OFF|0}}

The :ACQUIRE:AVERAge command enables or disables averaging. When ON, the oscilloscope acquires multiple data values for each time bucket, and averages them. When OFF, averaging is disabled. To set the number of averages, use the :ACQUIRE:AVERAge:COUNT command described next.

Averaging is not available in PDETECT mode.

The :MTEST:AVERAge command performs the same function as this command.

**Example** This example turns averaging on.

```
myScope.WriteString ":ACQUIRE:AVERAge ON"
```

**Query** :ACQUIRE:AVERAge?

The :ACQUIRE:AVERAge? query returns the current setting for averaging.

**Returned Format** [:ACQUIRE:AVERAGE] {1|0}<NL>

**Example** This example places the current settings for averaging into the string variable, strSetting, then prints the contents of the variable to the computer's screen.

```
Dim strSetting As String ' Dimension variable.
myScope.WriteString ":ACQUIRE:AVERAge?"
strSetting = myScope.ReadString
Debug.Print strSetting
```

**History** Legacy command (existed before version 3.10).

**:ACQUIRE[:AVERAGE]:COUNT**

**Command**     :ACQUIRE[:AVERAGE]:COUNT <count\_value>

The :ACQUIRE[:AVERAGE]:COUNT command sets the number of averages for the waveforms. In the AVERAGE mode, the :ACQUIRE[:AVERAGE]:COUNT command specifies the number of data values to be averaged for each time bucket before the acquisition is considered complete for that time bucket.

The :MTEST:AVERAGE:COUNT command performs the same function as this command.

<count\_value>   An integer, 2 to 65,534, specifying the number of data values to be averaged.

**Example**     This example specifies that 16 data values must be averaged for each time bucket to be considered complete. The number of time buckets that must be complete for the acquisition to be considered complete is specified by the :ACQUIRE:COMPLETE command.

```
myScope.WriteString ":ACQUIRE:COUNT 16"
```

**Query**       :ACQUIRE[:AVERAGE]:COUNT?

The :ACQUIRE[:AVERAGE]:COUNT? query returns the currently selected count value.

**Returned Format**   [:ACQUIRE[:AVERAGE]:COUNT] <value><NL>

<value>       An integer, 2 to 65,534, specifying the number of data values to be averaged.

**Example**     This example checks the currently selected count value and places that value in the string variable, strResult. The program then prints the contents of the variable to the computer's screen.

```
Dim strResult As String
myScope.WriteString ":SYSTEM:HEADER OFF"
myScope.WriteString ":ACQUIRE:AVERAGE:COUNT?"
strResult = myScope.ReadString
Debug.Print strResult
```

**History**     Legacy command (existed before version 3.10).



## :ACQUIRE:BANDwidth

**Command** :ACQUIRE:BANDwidth {AUTO | MAX | <bandwidth>}

The :ACQUIRE:BANDwidth command changes the bandwidth frequency control for the acquisition system.

- AUTO – The bandwidth is automatically selected based on the sample rate setting in order to make a good a trade-off between bandwidth, noise, and aliasing.
- MAX – Sets the oscilloscope to the hardware bandwidth limit and disables the bandwidth filter.
- <bandwidth> – a real number representing the bandwidth of the bandwidth filter whose range of values depends on the model number of your oscilloscope.

Model	Bandwidth Filter Values
DSOX/DSAX96204Q, DSAZ/DSOZ634A	The maximum bandwidth down to 1 GHz in 1 GHz increments.
DSOX/DSAX95004Q, DSAZ/DSOZ504A	
DSOX/DSAX93304Q, DSAZ/DSOZ334A	
DSOX/DSAX92504Q, DSAZ/DSOZ254A	
DSOX/DSAX92004Q, DSAZ/DSOZ204A	
DSOX/DSAX93204A	The maximum bandwidth down to 1 GHz in 1 GHz increments.
DSOX/DSAX92804A	
DSOX/DSAX92504A	
DSOX/DSAX92004A	
DSOX/DSAX91604A	
DSO/DSA91304A	13E09, 12E09, 10E09, 8E09, 6E09, 4E09, 3E09, 2.5E09, 2E09, 1E09
DSO/DSA91204A	12E09, 10E09, 8E09, 6E09, 4E09, 3E09, 2.5E09, 2E09, 1E09
DSO/DSA90804A	8E09, 6E09, 4E09, 3E09, 2.5E09, 2E09, 1E09
DSO/DSA90604A	6E09, 4E09, 3E09, 2.5E09, 2E09, 1E09
DSO/DSA90404A	4E09, 3E09, 2.5E09, 2E09, 1E09
DSO/DSA90254A	2.5E09, 2E09, 1E09

Model	Bandwidth Filter Values
DSOS/MSOS804A	The maximum bandwidth down to 500 MHz in 500 MHz increments, 250 MHz.
DSOS/MSOS604A	
DSOS/MSOS404A	
DSOS/MSOS254A	
DSOS/MSOS204A	
DSOS/MSOS104A	
DSOS/MSOS054A	
DSO/MSO9404A	4E09, 3.5E09, 3E09, 2.5E09, 2E09, 1.5E09, 1E09, 5E08
DSO/MSO9254A	2.5E09, 2E09, 1.5E09, 1E09, 5E08
DSO/MSO9104A	1E09, 5E08
DSO/MSO9064A	The command is not valid for this model oscilloscope.

**NOTE**

The DSO/MSO 9000 Series oscilloscopes do not have AUTO and MAX modes. Sending the :ACQUIRE:BANDwidth command with these parameters disables the global bandwidth limit. Sending the :ACQUIRE:BANDwidth command with specific bandwidth values enables the global bandwidth limit.

**Query** :ACQUIRE:BANDwidth?

The :ACQUIRE:BANDwidth? query returns the bandwidth setting of the bandwidth control.

**Returned Format** [:ACQUIRE:BANDwidth] <bandwidth><NL>

**History** New in version 3.10.

Version 4.00: Added a MAX option for selecting the maximum bandwidth.

## :ACQuire:BA NDwidth:FRAMe?

**Query** :ACQuire:BA NDwidth:FRAMe?

The :ACQuire:BA NDwidth:FRAMe? query returns the maximum bandwidth associated with oscilloscope model.

**Returned Format** <bandwidth><NL>

<bandwidth> ::= max. BW of oscilloscope model

**History** New in version 5.20.

**:ACQUIRE:BANDWIDTH:TESTLIMITS?**

**Query** :ACQUIRE:BANDWIDTH:TESTLIMITS?

The :ACQUIRE:BANDWIDTH:TESTLIMITS? query returns the oscilloscope's acquisition bandwidth maximum and minimum limits.

**Returned Format** <num\_parms>,<<type>><min>:<max><NL>

<num\_parms> Number of parameters, always 1 for this query.

<type> Type of values returned, always "<numeric>" for this query.

<min> Lower bandwidth limit value.

<max> Upper bandwidth limit value.

- See Also**
- [":ACQUIRE:BANDWIDTH"](#) on page 241
  - [":ACQUIRE:BANDWIDTH:FRAME?"](#) on page 243
  - [":ACQUIRE:POINTS:TESTLIMITS?"](#) on page 257
  - [":ACQUIRE:SRATE:TESTLIMITS?"](#) on page 270

**History** New in version 5.60.

## :ACQUIRE:COMPLETE

**Command** :ACQUIRE:COMPLETE <percent>

In the **Equivalent Time** sampling mode, the :ACQUIRE:COMPLETE command specifies how many of the data point storage bins (time buckets) in the waveform record must contain a waveform sample before a measurement will be made. For example, if the command :ACQUIRE:COMPLETE 60 has been sent, 60% of the storage bins in the waveform record must contain a waveform data sample before a measurement is made.

- If :ACQUIRE:AVERAGE is set to OFF, the oscilloscope only needs one value per time bucket for that time bucket to be considered full.
- If :ACQUIRE:AVERAGE is set to ON, each time bucket must have  $n$  hits for it to be considered full, where  $n$  is the value set by :ACQUIRE:AVERAGE:COUNT.

In the **Real Time** sampling mode, due to the nature of real time acquisition, 100% of the waveform record bins are filled after each trigger event, and all of the previous data in the record is replaced by new data when :ACQUIRE:AVERAGE is off. Hence, the complete mode really *has no effect*, and the behavior of the oscilloscope is the same as when the completion criteria is set to 100% (this is the same as in PDETECT mode). When :ACQUIRE:AVERAGE is on, all of the previous data in the record is replaced by new data.

The range of the :ACQUIRE:COMPLETE command is 0 to 100 and indicates the percentage of time buckets that must be full before the acquisition is considered complete. If the complete value is set to 100%, all time buckets must contain data for the acquisition to be considered complete. If the complete value is set to 0, then one acquisition cycle will take place. Completion is set by default setup or \*RST to 90%. Autoscale changes it to 100%.

<percent> An integer, 0 to 100, representing the percentage of storage bins (time buckets) that must be full before an acquisition is considered complete.

**Example** This example sets the completion criteria for the next acquisition to 90%.

```
myScope.WriteString ":ACQUIRE:COMPLETE 90"
```

**Query** :ACQUIRE:COMPLETE?

The :ACQUIRE:COMPLETE? query returns the completion criteria.

**Returned Format** [:ACQUIRE:COMPLETE] <percent><NL>

<percent> An integer, 0 to 100, representing the percentage of time buckets that must be full before an acquisition is considered complete.

**Example** This example reads the completion criteria and places the result in the variable, varPercent. Then, it prints the content of the variable to the computer's screen.

```
myScope.WriteString ":SYSTEM:HEADER OFF"
myScope.WriteString ":ACQUIRE:COMPLETE?"
varPercent = myScope.ReadNumber
Debug.Print FormatNumber(varPercent, 0)
```

**History** Legacy command (existed before version 3.10).

## :ACQUIRE:COMPLETE:STATE

**Command** :ACQUIRE:COMPLETE:STATE {{ON | 1} | {OFF | 0}}

The :ACQUIRE:COMPLETE:STATE command specifies whether acquisition averaging should complete before measurements are made.

This command maps to the **Wait for channel average to complete for measurements** check box in the front panel user interface's Measurement Setup dialog box, General tab.

**NOTE**

The :ACQUIRE:COMPLETE:STATE command is used only when the oscilloscope is running and a digitize operation is not being performed. The :DIGITIZE command temporarily overrides the setting of this mode and forces it to ON.

**ON** When ON, the oscilloscope waits for an acquisition average to complete before measurements are taken. If you have averaging enabled (using the :ACQUIRE:AVERAGE command), setting :ACQUIRE:COMPLETE:STATE ON forces the measurement calculations to wait until the average is computed. This lets you filter out noise in your waveform before measurements are made.

**OFF** When OFF, the oscilloscope makes measurements without waiting for an acquisition average to complete.

**Query** :ACQUIRE:COMPLETE:STATE?

The :ACQUIRE:COMPLETE:STATE? query returns the :ACQUIRE:COMPLETE:STATE setting.

**History** Legacy command (existed before version 3.10).

## :ACQUIRE:HRESOLUTION

**Command** :ACQUIRE:HRESOLUTION {AUTO | BITS9 | BITS10 | BITS11 | BITS12  
| BITF11 | BITF12 | BITF13 | BITF14 | BITF15 | BITF16}

When :ACQUIRE:MODE is set to HRESOLUTION or SEGHRes, the :ACQUIRE:HRESOLUTION command sets the desired minimum bit resolution.

- AUTO – the number of bits of vertical resolution is determined by the sampling rate, which can be controlled manually by the :ACQUIRE:SRATE:ANALOG command or automatically when adjusting :TIMEBASE:SCALE (or :TIMEBASE:RANGE).
- BITS9, BITS10, BITS11, BITS12 – selects the desired minimum number of bits of vertical resolution (which can affect the sampling rate).
- BITF11, BITF12, BITF13, BITF14, BITF15, BITF16 – on S-Series oscilloscopes only, these options force the specified number of bits of vertical resolution. These options also disable the manual sample rate setting (see :ACQUIRE:SRATE[:ANALOG]:AUTO), and they are not available in roll mode (see :TIMEBASE:ROLL:ENABLE).

**NOTE**

Some of the BITS settings may not be valid in certain 9000H Series models.

**Example** This example sets the bit resolution setting to a minimum of 11 bits.

```
myScope.WriteString ":ACQUIRE:HRESOLUTION BITS11"
```

**Query** :ACQUIRE:HRESOLUTION?

The :ACQUIRE:HRESOLUTION? query returns the bit resolution setting.

**Returned Format** [:ACQUIRE:HRESOLUTION] {AUTO | BITS9 | BITS10 | BITS11 | BITS12  
| BITF11 | BITF12 | BITF13 | BITF14 | BITF15 | BITF16}<NL>

**Example** This example places the current bit resolution setting in the string variable, strBitRes, then prints the contents of the variable to the computer's screen.

```
Dim strBitRes As String ' Dimension variable.
myScope.WriteString ":ACQUIRE:HRESOLUTION?"
strBitRes = myScope.ReadString
Debug.Print strBitRes
```

- See Also**
- [":ACQUIRE:MODE"](#) on page 251
  - [":ACQUIRE:SRATE\[:ANALOG\] – Analog Sample Rate"](#) on page 266
  - [":ACQUIRE:SRATE\[:ANALOG\]:AUTO"](#) on page 267
  - [":TIMEBASE:SCALE"](#) on page 1376
  - [":TIMEBASE:RANGE"](#) on page 1371
  - [":TIMEBASE:ROLL:ENABLE"](#) on page 1375



**History** Legacy command (existed before version 3.10).

Version 6.20: On S-Series oscilloscopes only, the BITF11, BITF12, BITF13, BITF14, BITF15, and BITF16 options have been added to force the specified number of bits of vertical resolution.

**:ACQUIRE:INTERPOLATE**

**Command** :ACQUIRE:INTERPOLATE {{ON | 1} | {OFF | 0} | INT1 | INT2 | INT4 | INT8  
| INT16}

The :ACQUIRE:INTERPOLATE command turns the  $\sin(x)/x$  interpolation filter on or off when the oscilloscope is in one of the real time sampling modes. You can also specify the 1, 2, 4, 8, or 16 point  $\sin(x)/x$  interpolation ratios using INT1, INT2, INT4, INT8, or INT16. When ON, the number of interpolation points is automatically determined.

**Query** :ACQUIRE:INTERPOLATE?

The :ACQUIRE:INTERPOLATE? query returns the current state of the  $\sin(x)/x$  interpolation filter control.

**Returned Format** [:ACQUIRE:INTERPOLATE] {1 | 0 | INT1 | INT2 | INT4 | INT8 | INT16}<NL>

**History** Legacy command (existed before version 3.10).

Version 3.10: Added the INT1, INT2, INT4, INT8, INT16 options for specifying the 1, 2, 4, 8, or 16 point  $\sin(x)/x$  interpolation ratios.

## :ACQUIRE:MODE

**Command** :ACQUIRE:MODE {ETIME | RTIME | PDETECT | HRESOLUTION | SEGMENTED  
| SEGPDETECT | SEGHRES}

The :ACQUIRE:MODE command sets the sampling/acquisition mode of the oscilloscope.

**NOTE**

In the 9000H Series oscilloscopes, HRESOLUTION and SEGHRES are the only valid options.

**ETIME** In Equivalent Time mode, the data record is acquired over multiple trigger events.

**RTIME** In Real Time Normal mode, the complete data record is acquired on a single trigger event.

**PDETECT** In Real Time Peak Detect mode, the oscilloscope acquires all of the waveform data points during one trigger event. The data is acquired at the fastest sample rate of the oscilloscope regardless of the horizontal scale setting. The sampling rate control then shows the storage rate into the channel memory rather than the sampling rate. The storage rate determines the number of data points per data region. From each data region, four sample points are chosen to be displayed for each time column. The four sample points chosen from each data region are:

- the minimum voltage value sample
- the maximum voltage value sample
- a randomly selected sample
- an equally spaced sample

The number of samples per data region is calculated using the equation:

$$\text{Number of Samples} = \frac{\text{Sampling Rate}}{\text{Storage Rate}}$$

The remainder of the samples are not used for display purposes.

**HRESOLUTION** In Real Time High Resolution mode, the oscilloscope acquires all the waveform data points during one trigger event and averages them thus reducing noise and improving voltage resolution. The data is acquired at the fastest sample rate of the oscilloscope regardless of the horizontal scale setting. The sampling rate control then shows the storage rate into the channel memory rather than the sampling rate. The number of samples that are averaged together per data region is calculated using the equation

$$\text{Number of Samples} = \frac{\text{Sampling Rate}}{\text{Storage Rate}}$$

This number determines how many samples are averaged together to form the 16-bit samples that are stored into the channel memories.

To set the desired bits of vertical resolution, see [":ACQUIRE:HRESolution"](#) on page 248.

**SEGmented** In this sampling mode you can view waveform events that are separated by long periods of time without capturing waveform events that are not of interest to you.

**SEGPdetect** Enables Peak Detect Segmented mode.

**SEGHres** Enables High Resolution Segmented mode.

To set the desired bits of vertical resolution, see [":ACQUIRE:HRESolution"](#) on page 248.

**Example** This example sets the acquisition mode to Real Time Normal.

```
myScope.WriteString ":ACQUIRE:MODE RTIME"
```

**Query** :ACQUIRE:MODE?

The :ACQUIRE:MODE? query returns the current acquisition sampling mode.

**Returned Format** [:ACQUIRE:MODE] {ETIM | RTIM | PDET | HRES | SEGM | SEGP | SEGH}<NL>

**Example** This example places the current acquisition mode in the string variable, strMode, then prints the contents of the variable to the computer's screen.

```
Dim strMode As String ' Dimension variable.
myScope.WriteString ":ACQUIRE:MODE?"
strMode = myScope.ReadString
Debug.Print strMode
```

**History** Legacy command (existed before version 3.10).

## :ACQUIRE:POINTS[:ANALOG] – Memory depth

**Command** :ACQUIRE:POINTS[:ANALOG] {AUTO | <points\_value>}

The :ACQUIRE:POINTS[:ANALOG] command sets the requested analog memory depth for an acquisition. Before you download data from the oscilloscope to your computer, always query the points value with the :WAVEFORM:POINTS? query or :WAVEFORM:PREAmble? query to determine the actual number of acquired points.

You can set the points value to AUTO, which allows the oscilloscope to select the optimum memory depth and display update rate.

<points\_value> An integer representing the memory depth.

The range of points available for a channel depends on the oscilloscope settings of sampling mode, sampling rate, and trigger sweep.

**Interaction between :ACQUIRE:SRATE[:ANALOG] and :ACQUIRE:POINTS[:ANALOG]**

If you assign a sample rate value with :ACQUIRE:SRATE[:ANALOG] or a points value using :ACQUIRE:POINTS[:ANALOG] the following interactions will occur. "Manual" means you are setting a non-AUTO value for SRATE or POINTS.

SRATE	POINTS	Result
AUTO	Manual	POINTS value takes precedence (sample rate is limited)
Manual	AUTO	SRATE value takes precedence (memory depth is limited)
Manual	Manual	SRATE value takes precedence (memory depth is limited)

**Example** This example sets the memory depth to 500 points.

```
myScope.WriteString ":ACQUIRE:POINTS:ANALOG 500"
```

**Query** :ACQUIRE:POINTS[:ANALOG]?

The :ACQUIRE:POINTS[:ANALOG]? query returns the value of the analog memory depth control.

**Returned Format** [:ACQUIRE:POINTS:ANALOG] <points\_value><NL>

**Example** This example checks the current setting for memory depth and places the result in the variable, varLength. Then the program prints the contents of the variable to the computer's screen.

```
myScope.WriteString ":SYSTEM:HEADER OFF"
myScope.WriteString ":ACQUIRE:POINTS:ANALOG?"
varLength = myScope.ReadNumber
Debug.Print FormatNumber(varLength, 0)
```

**See Also** • [":WAVEFORM:DATA"](#) on page 1593

**History** Legacy command (existed before version 3.10).

**:ACQUIRE:POINTS:AUTO**

**Command** :ACQUIRE:POINTS:AUTO {{ON | 1} | {OFF | 0}}

The :ACQUIRE:POINTS:AUTO command enables (automatic) or disables (manual) the automatic memory depth selection control. When enabled, the oscilloscope chooses a memory depth that optimizes the amount of waveform data and the display update rate. When disabled, you can select the amount of memory using the :ACQUIRE:POINTS command.

**Example** This example sets the automatic memory depth control to off.

```
myScope.WriteString ":ACQUIRE:POINTS:AUTO OFF"
```

**Query** :ACQUIRE:POINTS:AUTO?

The :ACQUIRE:POINTS:AUTO? query returns the automatic memory depth control state.

**Returned Format** [:ACQUIRE:POINTS:AUTO] {1 | 0}<NL>

**Example** This example checks the current setting for automatic memory depth control and places the result in the variable, varState. Then the program prints the contents of the variable to the computer's screen.

```
myScope.WriteString ":SYSTEM:HEADER OFF"
myScope.WriteString ":ACQUIRE:POINTS:AUTO?"
varState = myScope.ReadNumber
Debug.Print FormatNumber(varState, 0)
```

**See Also** :WAVEFORM:DATA?

**History** Legacy command (existed before version 3.10).

## :ACQUIRE:POINTS:DIGITAL?

**Query** :ACQUIRE:POINTS:DIGITAL?

The :ACQUIRE:POINTS:DIGITAL query returns the current memory depth for the digital channels (MSO models only).

**History** Legacy command (existed before version 3.10).



## :ACQuire:POINts:TESTLIMITS?

**Query** :ACQuire:POINts:TESTLIMITS?

The :ACQuire:POINts:TESTLIMITS? query returns the oscilloscope's acquisition points maximum and minimum limits.

**Returned Format** <num\_parms>,<<type>><min>:<max><NL>

<num\_parms> Number of parameters, always 1 for this query.

<type> Type of values returned, always "<numeric>" for this query.

<min> Lower points limit value.

<max> Upper points limit value.

- See Also**
- [":ACQuire:POINts\[:ANALog\] – Memory depth"](#) on page 253
  - [":ACQuire:POINts:AUTO"](#) on page 255
  - [":ACQuire:BANDwidth:TESTLIMITS?"](#) on page 244
  - [":ACQuire:SRATe:TESTLIMITS?"](#) on page 270

**History** New in version 5.60.

**:ACQUIRE:REDGe** – RealEdge Channel Inputs (90000 Q-Series, Z-Series)**Command****NOTE**

This command is available for the 90000 Q-Series and Z-Series models whose bandwidths are greater than 33 GHz.

```
:ACQUIRE:REDGe {{ON | 1} | {OFF | 0}}
```

The :ACQUIRE:REDGe command enables or disables the RealEdge channel inputs.

When RealEdge channel inputs are enabled, the :CHANNEL1 and :CHANNEL3 commands/queries work for the oscilloscope's 1R and 3R channel inputs, and the :CHANNEL2 and :CHANNEL4 commands give "hardware missing" or "undefined header" messages.

Also when RealEdge channel inputs are enabled:

- The sampling rate is fixed at 160 GSa/s.
- Real Time Normal is the only acquisition mode available.

**Example** This example enables the RealEdge channel inputs.

```
myScope.WriteString ":ACQUIRE:REDGe ON"
```

**Query** :ACQUIRE:REDGe?

The :ACQUIRE:REDGe? query returns the current setting for RealEdge channel inputs.

**Returned Format** [:ACQUIRE:REDGe] {1 | 0}<NL>

**Example** This example places the current setting for RealEdge channel inputs in the string variable, strRealEdge, then prints the contents of the variable to the computer's screen.

```
Dim strRealEdge As String ' Dimension variable.
myScope.WriteString ":ACQUIRE:REDGe?"
strSample = myScope.ReadString
Debug.Print strRealEdge
```

**History** New in version 4.00.

## :ACQUIRE:RESPONSE (90000A Series, 90000 X-Series, V-Series, 90000 Q-Series, Z-Series)

**Command** :ACQUIRE:RESPONSE {FLATmag | GAUSSianmag}

The Flat Magnitude filter is the default one and is the filter typically used on Infiniium oscilloscopes. The Gaussian Magnitude filter eliminates all ringing (preshoot or overshoot) caused by the oscilloscope's response. Therefore, any ringing you see in the displayed signal is actually in your signal and is not caused by the oscilloscope. The main drawback to using the Gaussian Magnitude Filter is the decrease in bandwidth. Please consult the Flat Magnitude / Magnitude Magnitude Filters topic in the help system for specific information regarding the decrease in bandwidth.

**Example** This example turns on the Gaussian Magnitude filter.

```
myScope.WriteString ":ACQUIRE:RESPONSE GAUSSianmag"
```

**Query** :ACQUIRE:RESPONSE?

The :ACQUIRE:RESPONSE? query returns the current filter being used.

**Returned Format** [:ACQ:RESP] {FLAT | GAUS}<NL>

**Example** This example checks the current filter setting and places the result in the variable, state. Then the program prints the contents of the variable to the computer's screen.

```
myScope.WriteString ":SYSTEM:HEADER OFF"
myScope.WriteString ":ACQUIRE:RESPONSE?"
varState = myScope.ReadNumber
Debug.Print FormatNumber(varState, 0)
```

**History** Legacy command (existed before version 3.10).

**:ACQUIRE:SEGMENTED:AUTOPLAY**

**Command** :ACQUIRE:SEGMENTED:AUTOPLAY {{0 | OFF} | {1 | ON}}

The :ACQUIRE:SEGMENTED:AUTOPLAY command specifies whether segments are automatically played after a segmented memory acquisition.

**Query** :ACQUIRE:SEGMENTED:AUTOPLAY?

The :ACQUIRE:SEGMENTED:AUTOPLAY? query returns the segmented memory autoplay setting.

**Returned Format** <setting><NL>

<setting> ::= {0 | 1}

- See Also**
- **" :ACQUIRE:MODE "** on page 251
  - **" :ACQUIRE:SEGMENTED:PLAY "** on page 263
  - **" :ACQUIRE:SEGMENTED:PRATE "** on page 264
  - **" :ACQUIRE:SEGMENTED:COUNT "** on page 261
  - **" :ACQUIRE:SEGMENTED:INDEX "** on page 262
  - **" :ACQUIRE:SEGMENTED:TTAGS "** on page 265

**History** New in version 6.00.

## :ACQUIRE:SEGMENTED:COUNT

**Command** :ACQUIRE:SEGMENTED:COUNT <#segments>

The :ACQUIRE:SEGMENTED:COUNT command sets the number of segments to acquire in the segmented memory mode.

<#segments> An integer representing the number of segments to acquire.

**Example** This example sets the segmented memory count control to 1000.

```
myScope.WriteString ":ACQUIRE:SEGMENTED:COUNT 1000"
```

**Query** :ACQUIRE:SEGMENTED:COUNT?

The :ACQUIRE:SEGMENTED:COUNT? query returns the number of segments control value.

**Returned Format** [:ACQUIRE:SEGMENTED:COUNT] <#segments><NL>

**Example** This example checks the current setting for segmented memory count control and places the result in the variable, varSegments. Then the program prints the contents of the variable to the computer's screen.

```
myScope.WriteString ":SYSTEM:HEADER OFF"
myScope.WriteString ":ACQUIRE:SEGMENTED:COUNT?"
varSegments = myScope.ReadNumber
Debug.Print FormatNumber(varSegments, 0)
```

**See Also**

- [":ACQUIRE:SEGMENTED:INDEX"](#) on page 262
- [":ACQUIRE:SEGMENTED:PLAY"](#) on page 263
- [":ACQUIRE:SEGMENTED:TTAGS"](#) on page 265

**History** Legacy command (existed before version 3.10).

## :ACQUIRE:SEGMENTED:INDEX

**Command** :ACQUIRE:SEGMENTED:INDEX <index#>

The :ACQUIRE:SEGMENTED:INDEX command sets the index number for the segment that you want to display on screen in the segmented memory mode. If an index value larger than the total number of acquired segments is sent, an error occurs indicating that the data is out of range and the segment index is set to the maximum segment number.

<index#> An integer representing the index number of the segment that you want to display.

**Example** This example sets the segmented memory index number control to 1000.

```
myScope.WriteString ":ACQUIRE:SEGMENTED:INDEX 1000"
```

**Query** :ACQUIRE:SEGMENTED:INDEX?

The :ACQUIRE:SEGMENTED:INDEX? query returns the segmented memory index number control value.

**Returned Format** [:ACQUIRE:SEGMENTED:INDEX] <index#><NL>

**Example** This example checks the current setting for segmented memory index number control and places the result in the variable, varIndex. Then the program prints the contents of the variable to the computer's screen.

```
myScope.WriteString ":SYSTEM:HEADER OFF"
myScope.WriteString ":ACQUIRE:SEGMENTED:INDEX?"
varIndex = myScope.ReadNumber
Debug.Print FormatNumber(varIndex, 0)
```

**See Also**

- [":ACQUIRE:SEGMENTED:COUNT"](#) on page 261
- [":ACQUIRE:SEGMENTED:PLAY"](#) on page 263
- [":ACQUIRE:SEGMENTED:TTAGs"](#) on page 265

**History** Legacy command (existed before version 3.10).

## :ACQUIRE:SEGMENTED:PLAY

**Command** :ACQUIRE:SEGMENTED:PLAY {{0 | OFF} | {1 | ON}}

The :ACQUIRE:SEGMENTED:PLAY command plays (or stops) acquired segments.

- ON – is the same as clicking the play button in the graphical user interface.
- OFF – is the same as clicking the stop button in the graphical user interface.

Playing acquired segments can take a while depending on the analysis taking place. You can query to determine when playing is complete.

**Query** :ACQUIRE:SEGMENTED:PLAY?

The :ACQUIRE:SEGMENTED:PLAY? query returns whether segments are currently being played (1) or are stopped (0).

**Returned Format** [:ACQUIRE:SEGMENTED:PLAY] <setting><NL>

<setting> ::= {0 | 1}

- See Also**
- [":ACQUIRE:SEGMENTED:PRATE"](#) on page 264
  - [":ACQUIRE:SEGMENTED:COUNT"](#) on page 261
  - [":ACQUIRE:SEGMENTED:INDEX"](#) on page 262
  - [":ACQUIRE:SEGMENTED:TTAGS"](#) on page 265

**History** New in version 5.60.

**:ACQUIRE:SEGMENTED:PRATE**

**Command** :ACQUIRE:SEGMENTED:PRATE <time\_per\_seg>

<time\_per\_seg> ::= seconds from 0.001 to 1 in NR3 format.

The :ACQUIRE:SEGMENTED:PRATE command specifies the segmented memory navigation play rate.

When playing segments, the current segment through the last segment are displayed at the specified rate. Playing segments lets you collect measurement statistics across all the played-back segments.

**Query** :ACQUIRE:SEGMENTED:PRATE?

The :ACQUIRE:SEGMENTED:PRATE? query returns segmented memory navigation play rate.

**Returned Format** <time\_per\_seg><NL>

**See Also** · **" :ACQUIRE:SEGMENTED:PLAY "** on page 263

**History** New in version 5.70.



## :ACQUIRE:SEGMENTED:TTAGS

**Command** :ACQUIRE:SEGMENTED:TTAGS {{ON | 1} | {OFF | 0}}

The :ACQUIRE:SEGMENTED:TTAGS command turns the time tags feature on or off for the segmented memory sampling mode.

**Example** This example turns the time tags on for segmented memory.

```
myScope.WriteString ":ACQUIRE:SEGMENTED:TTAGS ON"
```

**Query** :ACQUIRE:SEGMENTED:TTAGS?

The :ACQUIRE:SEGMENTED:TTAGS? query returns the segmented memory time tags control value.

**Returned Format** [:ACQUIRE:SEGMENTED:TTAGS] {1 | 0}<NL>

**Example** This example checks the current setting for segmented memory time tags control and places the result in the variable, varTimeTags. Then the program prints the contents of the variable to the computer's screen.

```
myScope.WriteString ":SYSTEM:HEADER OFF"
myScope.WriteString ":ACQUIRE:SEGMENTED:TTAGS?"
varTimeTags = myScope.ReadNumber
Debug.Print FormatNumber(varTimeTags, 0)
```

**See Also**

- [":ACQUIRE:SEGMENTED:COUNT"](#) on page 261
- [":ACQUIRE:SEGMENTED:INDEX"](#) on page 262
- [":ACQUIRE:SEGMENTED:PLAY"](#) on page 263

**History** Legacy command (existed before version 3.10).

## :ACQUIRE:SRATE[:ANALOG] – Analog Sample Rate

**Command** :ACQUIRE:SRATE[:ANALOG] {AUTO | MAX | <rate>}

The :ACQUIRE:SRATE[:ANALOG] command sets the analog acquisition sampling rate.

**AUTO** The AUTO rate allows the oscilloscope to select a sample rate that best accommodates the selected memory depth and horizontal scale.

**MAX** The MAX rate enables the oscilloscope to select maximum available sample rate.

**<rate>** A real number representing the sample rate. You can send any value, but the value is rounded to the next fastest sample rate.

**Interaction between :ACQUIRE:SRATE[:ANALOG] and :ACQUIRE:POINTS[:ANALOG]** If you assign a sample rate value with :ACQUIRE:SRATE[:ANALOG] or a points value using :ACQUIRE:POINTS[:ANALOG] the following interactions will occur. "Manual" means you are setting a non-AUTO value for SRATE or POINTS.

SRATE	POINTS	Result
AUTO	Manual	POINTS value takes precedence (sample rate is limited)
Manual	AUTO	SRATE value takes precedence (memory depth is limited)
Manual	Manual	SRATE value takes precedence (memory depth is limited)

**Example** This example sets the sample rate to 250 MSa/s.

```
myScope.WriteString ":ACQUIRE:SRATE:ANALOG 250E+6"
```

**Query** :ACQUIRE:SRATE[:ANALOG]?

The :ACQUIRE:SRATE[:ANALOG]? query returns the current analog acquisition sample rate.

**Returned Format** [:ACQUIRE:SRATE:ANALOG] {<rate>}<NL>

**Example** This example places the current sample rate in the string variable, strSample, then prints the contents of the variable to the computer's screen.

```
Dim strSample As String ' Dimension variable.
myScope.WriteString ":ACQUIRE:SRATE:ANALOG?"
strSample = myScope.ReadString
Debug.Print strSample
```

**History** Legacy command (existed before version 3.10).

## :ACQUIRE:SRATE[:ANALOG]:AUTO

**Command** :ACQUIRE:SRATE[:ANALOG]:AUTO {{ON | 1} | {OFF | 0}}

The :ACQUIRE:SRATE[:ANALOG]:AUTO command enables (ON) or disables (OFF) the automatic analog sampling rate selection control. On the oscilloscope front-panel interface, ON is equivalent to Automatic and OFF is equivalent to Manual.

**Example** This example changes the sampling rate to manual.

```
myScope.WriteString ":ACQUIRE:SRATE:ANALOG:AUTO OFF"
```

**Query** :ACQUIRE:SRATE[:ANALOG]:AUTO?

The :ACQUIRE:SRATE[:ANALOG]:AUTO? query returns the current acquisition sample rate.

**Returned Format** [:ACQUIRE:SRATE:ANALOG:AUTO] {1 | 0}<NL>

**Example** This example places the current analog sample rate in the variable, varSample, then prints the contents of the variable to the computer's screen.

```
myScope.WriteString ":SYSTEM:HEADER OFF"
myScope.WriteString ":ACQUIRE:SRATE:ANALOG:AUTO?"
varSample = myScope.ReadNumber
Debug.Print FormatNumber(varSample, 0)
```

**History** Legacy command (existed before version 3.10).

## :ACQUIRE:SRATE:DIGITAL – Digital Channels Sample Rate

<b>Command</b>	<code>:ACQUIRE:SRATE:DIGITAL {AUTO   MAX   &lt;rate&gt;}</code>
	The <code>:ACQUIRE:SRATE:DIGITAL</code> command sets the digital acquisition sampling rate.
<b>AUTO</b>	The AUTO rate allows the oscilloscope to select a sample rate that best accommodates the selected memory depth and horizontal scale.
<b>MAX</b>	The MAX rate enables the oscilloscope to select maximum available sample rate.
<b>&lt;rate&gt;</b>	A real number representing the digital sample rate. You can send any value, but the value is rounded to the next fastest sample rate.
<b>Interaction between :ACQUIRE:SRATE:DI Gital and :ACQUIRE:POINTS:DI Gital?</b>	If you assign a sample rate value with <code>:ACQUIRE:SRATE:DIGITAL</code> , the digital memory depth is automatically adjusted and can be seen by using the <code>:ACQUIRE:POINTS:DIGITAL?</code> query.
<b>Query</b>	<code>:ACQUIRE:SRATE:DIGITAL?</code>
	The <code>:ACQUIRE:SRATE:DIGITAL?</code> query returns the current digital acquisition sample rate.
<b>Returned Format</b>	<code>[ :ACQUIRE:SRATE:DIGITAL ] {&lt;rate&gt;}&lt;NL&gt;</code>
<b>Example</b>	This example places the current digital channel sample rate in the string variable, <code>strSample</code> , then prints the contents of the variable to the computer's screen.
	<pre>Dim strSample As String ' Dimension variable. myScope.WriteString ":ACQUIRE:SRATE:DIGITAL?" strSample = myScope.ReadString Debug.Print strSample</pre>
<b>History</b>	Legacy command (existed before version 3.10).

## :ACQUIRE:SRATE:DIGITAL:AUTO

**Command** :ACQUIRE:SRATE:DIGITAL:AUTO {{ON | 1} | {OFF | 0}}

The :ACQUIRE:SRATE:DIGITAL:AUTO command enables (ON) or disables (OFF) the automatic digital channel sampling rate selection control.

**Example** This example changes the digital channel sampling rate to manual.

```
myScope.WriteString ":ACQUIRE:SRATE:DIGITAL:AUTO OFF"
```

**Query** :ACQUIRE:SRATE:DIGITAL:AUTO?

The :ACQUIRE:SRATE:DIGITAL:AUTO? query returns the current digital channel acquisition sample rate.

**Returned Format** [:ACQUIRE:SRATE:DIGITAL:AUTO] {1 | 0}<NL>

**Example** This example places the current digital channel sample rate in the variable, varSample, then prints the contents of the variable to the computer's screen.

```
myScope.WriteString ":SYSTEM:HEADER OFF"
myScope.WriteString ":ACQUIRE:SRATE:DIGITAL:AUTO?"
varSample = myScope.ReadNumber
Debug.Print FormatNumber(varSample, 0)
```

**History** Legacy command (existed before version 3.10).

**:ACQUIRE:SRATE:TESTLIMITS?**

**Query** :ACQUIRE:SRATE:TESTLIMITS?

The :ACQUIRE:SRATE:TESTLIMITS? query returns the oscilloscope's acquisition sampling rate maximum and minimum limits.

**Returned Format** <num\_parms>,<<type>><min>:<max><NL>

<num\_parms> Number of parameters, always 1 for this query.

<type> Type of values returned, always "<numeric>" for this query.

<min> Lower sample rate limit value.

<max> Upper sample rate limit value.

- See Also**
- [":ACQUIRE:SRATE\[:ANALOG\] – Analog Sample Rate"](#) on page 266
  - [":ACQUIRE:SRATE\[:ANALOG\]:AUTO"](#) on page 267
  - [":ACQUIRE:BANDWIDTH:TESTLIMITS?"](#) on page 244
  - [":ACQUIRE:POINTS:TESTLIMITS?"](#) on page 257

**History** New in version 5.60.

# 12 Analyze Commands

:ANALyze:AEDGes / 273  
:ANALyze:CLOCK / 274  
:ANALyze:CLOCK:METHod / 275  
:ANALyze:CLOCK:METHod:ALIGn / 279  
:ANALyze:CLOCK:METHod:DEEMphasis / 280  
:ANALyze:CLOCK:METHod:EDGE / 281  
:ANALyze:CLOCK:METHod:IDLe / 283  
:ANALyze:CLOCK:METHod:JTF / 284  
:ANALyze:CLOCK:METHod:OJTF / 286  
:ANALyze:CLOCK:METHod:PLLadvanced / 288  
:ANALyze:CLOCK:METHod:PLLTrack / 289  
:ANALyze:CLOCK:METHod:SKEW / 290  
:ANALyze:CLOCK:METHod:SKEW:AUTomatic / 291  
:ANALyze:CLOCK:METHod:SOURce / 292  
:ANALyze:CLOCK:TIME / 293  
:ANALyze:CLOCK:VERTical / 295  
:ANALyze:CLOCK:VERTical:OFFSet / 296  
:ANALyze:CLOCK:VERTical:RANGe / 297  
:ANALyze:SIGNal:DATarate / 298  
:ANALyze:SIGNal:MIXer:CABLeLoss / 300  
:ANALyze:SIGNal:MMWave:CALibrate / 301  
:ANALyze:SIGNal:MMWave:CFRequency / 302  
:ANALyze:SIGNal:MMWave:CONNect / 303  
:ANALyze:SIGNal:MMWave:LOADdress / 304  
:ANALyze:SIGNal:MMWave:MBANDwidth / 305  
:ANALyze:SIGNal:PATTern:CLEar / 306  
:ANALyze:SIGNal:PATTern:LOAD / 307  
:ANALyze:SIGNal:PATTern:PLENght / 308  
:ANALyze:SIGNal:PATTern:SMAP / 309  
:ANALyze:SIGNal:SYMBOLrate / 310  
:ANALyze:SIGNal:TYPE / 312  
:ANALyze:VIEW / 315

The commands in the ANALyze subsystem are used to:

- Specify whether to use a single edge or all edges in the acquisition for horizontal measurements (:ANALyze:AEDGes command).
- Set up clock recovery (:ANALyze:CLOCK commands).
- Specify a waveform source's signal type:
  - The PAM4 signal type sets up a new paradigm for serial data signal analysis with multiple data levels and edges for clock recovery (as compared to high and low level NRZ signals).
  - The MMWave signal type supports analysis of millimeter-wave signals that have been down-converted to IF band signals by an external smart mixer and an LO signal from a signal generator.
- Support MMWave millimeter-wave signal analysis.
- Specify whether to use the data on screen or the entire acquisition for measurements, functions, and analysis (:ANALyze:VIEW command).

**Sources for Analyze Commands**

Some :ANALyze commands let you specify the source(s) using a <source> parameter:

```
<source> ::= {CHANnel<N> | DIFF<D> | COMMONmode<C> | WMEMory<R>
             | FUNction<F> | EQUalized<L> | XT<X>}
```

where:

CHANnel<N>	<N> is an integer, 1-4 in a single oscilloscope, 1-40 in a MultiScope system.
DIFF<D>, COMMONmode<C>	<D> is an integer, 1-2. <C> is an integer, 3-4. The DIFF and COMMONmode sources are just aliases that can be used in place of the channel names to apply to differential or common mode signals. These are just aliases - no state change occurs if you refer to a differential channel and you are not in differential mode. DIFF1 refers to the differential signal between channels 1 and 3 (and COMMONmode3 refers to the common mode channel between these same channels). DIFF2 refers to the differential signal between channels 2 and 4 (and COMMONmode4 refers to the common mode channel between these same channels).
WMEMory<R>	<R> is an integer, 1-4.
FUNction<F>	<F> is an integer, 1-16.
EQUalized<L>	<R> is an integer, 1-4. The EQUalized<L> source is available when the Advanced Signal Integrity Software license is installed. This command uses one of the four equalization "lane" function waveforms as the source.
XT<X>	<X> is an integer, 1-4, identifying the crosstalk waveform.



## :ANALyze:AEDGes

**Command** :ANALyze:AEDGes {{0 | OFF} | {1 | ON}}

The :ANALyze:AEDGes command specifies whether a single edge or all edges in the acquisition are used for horizontal measurements.

The :ANALyze:AEDGes command maps to the **Measure All Edges** control in the user interface's Measurement Setup dialog box.

When all edges in an acquisition are used for horizontal measurements, the entire acquisition is also used for measurements, functions, and analysis (see :ANALyze:VIEW ALL).

Some measurements require all edges: [":MEASure:NPULses"](#) on page 1014, [":MEASure:PPULses"](#) on page 1071, [":MEASure:ETOEdege"](#) on page 944, [":MEASure:HOLDtime"](#) on page 977, [":MEASure:NPERiod"](#) on page 1013, [":MEASure:PHASe"](#) on page 1052, [":MEASure:SETuptime"](#) on page 1112, and EZJIT clock and data measurements. When you add one of these measurements, the :ANALyze:AEDGes option is automatically turned ON.

Also, turning on a real-time eye (:MTEST:FOLDing ON) sets :ANALyze:AEDGes to ON, and it cannot be disabled.

**Query** :ANALyze:AEDGes?

The :ANALyze:AEDGes? query returns the value that is currently set.

**Returned Format** [:ANALyze:AEDGes] {0 | 1}<NL>

**See Also** • [":ANALyze:VIEW"](#) on page 315

**History** New in version 5.30. This commands replaces the now deprecated command [":MEASure:JITTer:STATistics"](#) on page 1747.

**:ANALyze:CLOCK**

**Command** :ANALyze:CLOCK {{{ON|1},<source>} | {OFF|0}}

The :ANALyze:CLOCK command turns the recovered clock display on or off and sets the clock recovery channel source.

**<source>** {CHANnel<N> | DIFF<D> | COMMONmode<C> | FUNction<F> | WMEMory<R>}

For more information on <source> parameters, see "[Sources for Analyze Commands](#)" on page 272.

**Example** This example turns the recovered clock display on for channel 1.

```
myScope.WriteString ":ANALyze:CLOCK ON,CHANnel1"
```

**Query** :ANALyze:CLOCK?

The :ANALyze:CLOCK? query returns the state of the recovered clock display.

**Returned Format** [:ANALyze:CLOCK] {1 | 0}<NL>

**Example** This example places the current setting of the recovered clock display in the variable varSetting, then prints the contents of the variable to the computer's screen.

```
myScope.WriteString ":SYSTEM:HEADer OFF"
myScope.WriteString ":ANALyze:CLOCK?"
varSetting = myScope.ReadNumber
Debug.Print FormatNumber(varSetting, 0)
```

- See Also**
- "[:ANALyze:CLOCK:VERTical](#)" on page 295
  - "[:ANALyze:CLOCK:VERTical:OFFSet](#)" on page 296
  - "[:ANALyze:CLOCK:VERTical:RANGe](#)" on page 297
  - "[:ANALyze:CLOCK:TIME](#)" on page 293

**History** New in version 5.30. This command replaces the now deprecated command "[:MEASure:CLOCK](#)" on page 1724.

## :ANALyze:CLOCK:METHOD

```

Command :ANALyze:CLOCK:METHOD
        {FIXed,{AUTO | {SEMI[,<data_rate>]} | <data_rate>}}
        | {TOPLL[,<data_rate>[,<natural_frequency>[,<pole_frequency>[,
          <damping_factor>[,<PLL_settling_time>]]]]]}
        | {EXPLicit,<source>,{RISing | FALLing | BOTH}[,<multiplier>]}
        | {EXPTOPLL,<source>,{RISing | FALLing | BOTH},
          <multiplier>,<clock_frequency>,<natural_frequency>,
          <pole_frequency>,<damping_factor>}
        | {EQTOPLL[,<data_rate>[,<natural_frequency>[,<pole_frequency>[,
          <damping_factor>[,<PLL_settling_time>]]]]]}
        | {FC,{FC1063 | FC2125 | FC425}}
        | {FLEXR,<baud_rate>}
        | {FLEXT,<baud_rate>}
        | {PWM}
        | {CPHY[,<symbol_rate>[,<setup_UI>]]}
        | {BMC}
        | {LFPS}
        | {PCIE4,{PCIE8 | PCIE16}}
        | {PCIE5,{PCIE8 | PCIE16 | PCIE32}}
        | {PCIE6,{PCIE8 | PCIE16 | PCIE32 | PCIE64}}

```

The :ANALyze:CLOCK:METHOD command sets the clock recovery method to:

- FIXed (Constant Frequency)
- TOPLL (Third Order PLL)
- EXPLicit (Explicit Clock)
- EXPTOPLL (Explicit Third Order PLL)
- EQTOPLL (Equalized Third Order PLL)
- FC (Fibre Channel)
- FLEXR (FlexRay Receiver)
- FLEXT (FlexRay Transmitter)
- PWM (MIPI M-PHY PWM)
- CPHY (MIPI C-PHY)
- BMC (USB PD bi-phase mark coding)
- LFPS (USB 3 low frequency periodic signaling)
- PCIE4 (PCIe 4 Behavioral SRIS) and 8 Gb/s or 16 Gb/s data rates
- PCIE5 (PCIe 5 CXL Behavioral SRIS CC) and 8 Gb/s, 16 Gb/s, or 32 Gb/s data rates
- PCIE6 (PCIe 6 CXL Behavioral SRIS CC) and 8 Gb/s, 16 Gb/s, 32 Gb/s, or 64 Gb/s data rates

This command applies to the clock recovery method being set up for the waveform source selected by the :ANALyze:CLOCK:METHOD:SOURce command.

For setting first order and second order phase-locked loop (PLL) clock recovery methods in terms of the Observed Jitter Transfer Function (OJTF), see **":ANALyze:CLOCK:METHod:OJTF"** on page 286.

For setting first order and second order phase-locked loop (PLL) clock recovery methods in terms of the Jitter Transfer Function (JTF), see **":ANALyze:CLOCK:METHod:JTF"** on page 284.

- <source>** {CHANnel<N> | FUNction<F> | WMEMory<R> | EQUalized<L> | XT<X>}
- <N>** An integer, 1-4 in a single oscilloscope, 1-40 in a MultiScope system.
  - <F>** An integer, 1-16.
  - <R>** An integer, 1-4.
  - <L>** An integer, 1-4.
  - <X>** An integer, 1-4, identifying the crosstalk waveform.
- <data\_rate>** A real number for the base data rate in Hertz.
- When the signal type is PAM-4 (see :ANALyze:SIGNal:TYPE), a symbol rate (baud) is specified instead of a data rate (b/s).
- <natural\_frequency>** A real number for the natural frequency of the PLL.
- <pole\_frequency>** A real number for the pole frequency of the PLL.
- <damping\_factor>** A real number for the damping factor of the PLL.
- <PLL\_settling\_time>** A real number for the PLL settling time.
- <multiplier>** An integer used as the multiplication factor.
- <clock\_freq>** A real number used for the clock frequency of the PLL.
- <baud\_rate>** A real number used for the baud rate.
- <symbol\_rate>** When the signal type is CPHY (see :ANALyze:SIGNal:TYPE), CPHY is automatically selected as the clock recovery method, but you can use the :ANALyze:CLOCK:METHod CPHY command to specify the nominal a symbol rate in baud.
- <setup\_UI>** When the signal type is CPHY (see :ANALyze:SIGNal:TYPE), CPHY is automatically selected as the clock recovery method, but you can use the :ANALyze:CLOCK:METHod CPHY command to specify the time (in Unit Intervals) used to cluster edges for clock recovery.

**Example** This example sets the explicit clock recovery method on channel 1, rising edge, with a multiplier of 2.

```
myScope.WriteString ":ANALyze:CLOCK:METHod EXPLICIT,CHANnel1,RISing,2"
```

**Query** :ANALyze:CLOCK:METHOD?

The :ANALyze:CLOCK:METHOD? query returns the state of the clock recovery method.

### NOTE

You can use the :ANALyze:CLOCK:METHOD? query when phase-locked loop (PLL) clock recovery methods are set up. The format returned will be that of the :ANALyze:CLOCK:METHOD:OJTF? query. See [":ANALyze:CLOCK:METHOD:OJTF"](#) on page 286.

### Returned Format

```
[ :ANALyze:CLOCK:METHOD]
  {FIXed, {AUTO | {SEMI, <data_rate>} | <data_rate>}}
  | {TOPLL, <data_rate>, <natural_frequency>, <pole_frequency>,
    <damping_factor>}
  | {EXPLICIT, <source>, {RISing | FALLing | BOTH}, <multiplier>}
  | {EXPTOPLL, <source>, {RISing | FALLing | BOTH},
    <multiplier>, <clock_freq>, <natural_frequency>, <pole_frequency>,
    <damping_factor>}
  | {EQTOPLL, <data_rate>, <natural_frequency>, <pole_frequency>,
    <damping_factor>}
  | {FC, {FC1063 | FC2125 | FC425}}
  | {FLEXR, <baud_rate>}
  | {FLEXT, <baud_rate>}
  | {PWM}
  | {CPHY, <symbol_rate>, <setup_UI>}
  | {BMC}
  | {LFPS}
  | {PCIE4, {PCIE8 | PCIE16}}
  | {PCIE5, {PCIE8 | PCIE16 | PCIE32}}
  | {PCIE6, {PCIE8 | PCIE16 | PCIE32 | PCIE64}}
```

**Example** This example places the current setting of the clock recovery method in the variable strSetting, then prints the contents of the variable to the computer's screen.

```
myScope.WriteString ":SYSTEM:HEADer OFF"
myScope.WriteString ":ANALyze:CLOCK:METHOD?"
strSetting = myScope.ReadString
Debug.Print strSetting
```

- See Also**
- [":ANALyze:CLOCK:METHOD:SOURce"](#) on page 292
  - [":ANALyze:CLOCK:METHOD:OJTF"](#) on page 286
  - [":ANALyze:CLOCK:METHOD:JTF"](#) on page 284
  - [":ANALyze:CLOCK:METHOD:DEEMphasis"](#) on page 280
  - [":ANALyze:CLOCK:METHOD:ALIGn"](#) on page 279
  - [":ANALyze:CLOCK:METHOD:PLLTrack"](#) on page 289
  - [":ANALyze:CLOCK:METHOD:EDGE"](#) on page 281
  - [":ANALyze:SIGNal:TYPE"](#) on page 312

**History** New in version 5.30. This command replaces the now deprecated command **":MEASure:CLOCK:METHod"** on page 1725.

Version 5.50: When the signal type is PAM-4, a symbol rate (baud) is specified instead of a data rate (b/s).

Version 5.60: Added the PWM and CPHY methods.

Version 6.30: Added the BMC (USB PD bi-phase mark coding) and LFPS (USB 3 low frequency periodic signaling) methods.

Version 6.55: Added the TOPLL (Third Order PLL), EXPTOPLL (Explicit Third Order PLL), and EQTOPLL (Equalized Third Order PLL) clock recovery methods.

Version 6.60: Added the "PCIE5,PCIE8", "PCIE5,PCIE16", and "PCIE5,PCIE32" PCIe 5 CXL Behavioral SRIS CC clock recovery methods for 8 Gb/s, 16 Gb/s, and 32 Gb/s data rates, respectively.

Version 6.70: Added the "PCIE6,PCIE8", "PCIE6,PCIE16", "PCIE6,PCIE32", and "PCIE6,PCIE64" PCIe 6 CXL Behavioral SRIS CC clock recovery methods for 8 Gb/s, 16 Gb/s, 32 Gb/s, and 64 Gb/s data rates, respectively.

Version 6.74: Added the "PCIE4,PCIE8" and "PCIE4,PCIE16" PCIe 4 Behavioral SRIS clock recovery methods for 8 Gb/s and 16 Gb/s data rates, respectively.

## :ANALyze:CLOCK:METHod:ALIGn

**Command** :ANALyze:CLOCK:METHod:ALIGn {CENTer | EDGE}

When using an explicit method of clock recovery, the :ANALyze:CLOCK:METHod:ALIGn command specifies how the clock is aligned with data:

- CENTer – Clock edges are aligned with the center of data.
- EDGE – Clock edges are aligned with data edges. In this case, Time Interval Error (TIE) is measured directly from the data edge to the clock edge.

This command applies to the clock recovery method being set up for the waveform source selected by the :ANALyze:CLOCK:METHod:SOURce command.

**Example** When using an explicit method of clock recovery, this example specifies that clock edges are aligned with the center of data.

```
myScope.WriteString ":ANALyze:CLOCK:METHod:ALIGn CENTer"
```

**Query** :ANALyze:CLOCK:METHod:ALIGn?

The :ANALyze:CLOCK:METHod:ALIGn? query returns the clock recovery method's edge alignment setting.

**Returned Format** [:ANALyze:CLOCK:METHod:ALIGn] {CENT | EDGE}

**Example** This example places the current edge alignment setting of the clock recovery method in the variable strSetting, then prints the contents of the variable to the computer's screen.

```
myScope.WriteString ":SYSTem:HEADer OFF"
myScope.WriteString ":ANALyze:CLOCK:METHod:ALIGn?"
strSetting = myScope.ReadString
Debug.Print strSetting
```

- See Also**
- [":ANALyze:CLOCK:METHod:SOURce"](#) on page 292
  - [":ANALyze:CLOCK:METHod"](#) on page 275
  - [":ANALyze:CLOCK:METHod:OJTF"](#) on page 286
  - [":ANALyze:CLOCK:METHod:JTF"](#) on page 284
  - [":ANALyze:CLOCK:METHod:DEEMphasis"](#) on page 280
  - [":ANALyze:CLOCK:METHod:PLLTrack"](#) on page 289
  - [":ANALyze:CLOCK:METHod:EDGE"](#) on page 281

**History** New in version 5.30. This command replaces the now deprecated command [":MEASure:CLOCK:METHod:ALIGn"](#) on page 1729.

**:ANALyze:CLOCK:METHod:DEEMphasis**

**Command** `:ANALyze:CLOCK:METHod:DEEMphasis {OFF | ON}`

The `:ANALyze:CLOCK:METHod:DEEMphasis` command turns de-emphasis on or off.

This command applies to the clock recovery method being set up for the waveform source selected by the `:ANALyze:CLOCK:METHod:SOURce` command.

See the help system for more information on de-emphasis.

**Example** This example enables de-emphasis.

```
myScope.WriteString ":ANALyze:CLOCK:METHod:DEEMphasis ON"
```

**Query** `:ANALyze:CLOCK:METHod:DEEMphasis?`

The `:ANALyze:CLOCK:METHod:DEEMphasis?` query returns whether or not de-emphasis is turned on.

**Returned Format** `[:ANALyze:CLOCK:METHod:DEEMphasis] {OFF | ON}`

**Example** This example places the current setting of the de-emphasis mode in the string variable `strDeemph`, then prints the contents of the variable to the computer's screen.

```
myScope.WriteString ":SYSTem:HEADer OFF"
myScope.WriteString ":ANALyze:CLOCK:METHod:DEEMphasis?"
strDeemph = myScope.ReadString
Debug.Print strDeemph
```

- See Also**
- [":ANALyze:CLOCK:METHod:SOURce"](#) on page 292
  - [":ANALyze:CLOCK:METHod"](#) on page 275
  - [":ANALyze:CLOCK:METHod:OJTF"](#) on page 286
  - [":ANALyze:CLOCK:METHod:JTF"](#) on page 284
  - [":ANALyze:CLOCK:METHod:ALIGn"](#) on page 279
  - [":ANALyze:CLOCK:METHod:PLLTrack"](#) on page 289
  - [":ANALyze:CLOCK:METHod:EDGE"](#) on page 281

**History** New in version 5.30. This command replaces the now deprecated command [":MEASure:CLOCK:METHod:DEEMphasis"](#) on page 1730.



## :ANALyze:CLOCK:METHod:EDGE

**Command** :ANALyze:CLOCK:METHod:EDGE {RISing | FALLing | BOTH}

The :ANALyze:CLOCK:METHod:EDGE command specifies which edge(s) of the data are used to recover a clock. (In the front panel GUI, this control appears in the Advanced Clock Recovery dialog box.) Normally, both edges are used. However, if you are performing clock recovery on a low duty cycle clock signal, for example, you may want to use just the rising or falling edge.

This command applies to the clock recovery method being set up for the waveform source selected by the :ANALyze:CLOCK:METHod:SOURce command.

This command applies to the following clock recovery methods:

- FIXed (Constant Frequency).
- FOPLL (First Order PLL).
- SOPLL (Second Order PLL).
- EXPLicit (Explicit Clock).
- EXPFOPLL (Explicit First Order PLL).
- EXPSOPLL (Explicit Second Order PLL).
- EQFOPLL (Equalized First Order PLL).
- EQSOPLL (Equalized Second Order PLL).

To measure jitter on only rising (or falling) edges of a clock, you must also set :ANALyze:RJDJ:EDGE to the same RISing or FALLing option, and you must set :ANALyze:RJDJ:CLOCK ON to force the pattern to be a clock and set the jitter for edges not examined to zero (0).

**Example** This example specifies that both rising and falling edges of the data are used to recover a clock.

```
myScope.WriteString ":ANALyze:CLOCK:METHod:EDGE BOTH"
```

**Query** :ANALyze:CLOCK:METHod:EDGE?

The :ANALyze:CLOCK:METHod:EDGE? query returns the clock recovery method's edge setting.

**Returned Format** [:ANALyze:CLOCK:METHod:EDGE] {RIS | FALL | BOTH}

**Example** This example places the current edge setting of the clock recovery method in the variable strSetting, then prints the contents of the variable to the computer's screen.

```
myScope.WriteString ":SYSTem:HEADer OFF"
myScope.WriteString ":ANALyze:CLOCK:METHod:EDGE?"
strSetting = myScope.ReadString
Debug.Print strSetting
```

**See Also** • [":ANALyze:CLOCK:METHod:SOURce"](#) on page 292

- **":ANALyze:CLOCK:METHod"** on page 275
- **":ANALyze:CLOCK:METHod:OJTF"** on page 286
- **":ANALyze:CLOCK:METHod:JTF"** on page 284
- **":ANALyze:CLOCK:METHod:DEEMphasis"** on page 280
- **":ANALyze:CLOCK:METHod:ALIGn"** on page 279
- **":ANALyze:CLOCK:METHod:PLLTrack"** on page 289
- **":MEASure:RJDJ:EDGE"** on page 1093
- **":MEASure:RJDJ:CLOCK"** on page 1091

**History** New in version 5.30. This command replaces the now deprecated command **":MEASure:CLOCK:METHod:EDGE"** on page 1731.

## :ANALyze:CLOCK:METHOD:IDLe

**Command** :ANALyze:CLOCK:METHOD:IDLe <#\_idle\_clocks>

The :ANALyze:CLOCK:METHOD:IDLe command lets you specify the number of additional clocks output by the clock recovery PLL for situations where valid data can occur during electrical idles.

<#\_idle\_clocks> Number of PLL idle clocks from 6 to 1000 in NR1 format.

**Query** :ANALyze:CLOCK:METHOD:IDLe?

The :ANALyze:CLOCK:METHOD:IDLe? query returns the number of PLL idle clocks setting.

**Returned Format** <#\_idle\_clocks><NL>

- See Also**
- [":ANALyze:CLOCK:METHOD"](#) on page 275
  - [":ANALyze:CLOCK:METHOD:ALIGN"](#) on page 279
  - [":ANALyze:CLOCK:METHOD:DEEMphasis"](#) on page 280
  - [":ANALyze:CLOCK:METHOD:EDGE"](#) on page 281
  - [":ANALyze:CLOCK:METHOD:JTF"](#) on page 284
  - [":ANALyze:CLOCK:METHOD:OJTF"](#) on page 286
  - [":ANALyze:CLOCK:METHOD:PLLTrack"](#) on page 289
  - [":ANALyze:CLOCK:METHOD:SKEW"](#) on page 290
  - [":ANALyze:CLOCK:METHOD:SOURce"](#) on page 292

**History** New in version 6.20.

## :ANALyze:CLOCK:METHod:JTF

**Command** :ANALyze:CLOCK:METHod:JTF  
 {FOPLL,<data\_rate>,<jtf\_loop\_bandwidth>}  
 | {SOPLL,<data\_rate>,<jtf\_loop\_bandwidth>, <peaking>}  
 | {EXPFOPLL,<source>,{RISing | FALLing | BOTH},  
 <multiplier>,<clock\_freq>,<jtf\_loop\_bandwidth>}  
 | {EXPSOPLL,<source>,{RISing | FALLing | BOTH},  
 <multiplier>,<clock\_freq>,<jtf\_loop\_bandwidth>,<peaking>}  
 | {EQFOPLL,<data\_rate>,<jtf\_loop\_bandwidth>}  
 | {EQSOPLL,<data\_rate>,<jtf\_loop\_bandwidth>, <peaking>}

The :ANALyze:CLOCK:METHod:JTF command specifies the clock recovery PLL's response in terms of the Jitter Transfer Function's (JTF) 3 dB bandwidth.

This command applies to the clock recovery method being set up for the waveform source selected by the :ANALyze:CLOCK:METHod:SOURce command.

You can set these types of PLL clock recovery methods:

- FOPLL (First Order PLL)
- SOPLL (Second Order PLL)
- EQFOPLL (Equalized First Order PLL)
- EQSOPLL (Equalized Second Order PLL)
- EXPFOPLL (Explicit First Order PLL)
- EXPSOPLL (Explicit Second Order PLL)

The equalized clock recovery methods are available when the Advanced Signal Integrity Software license is installed.

For setting phase-locked loop (PLL) clock recovery methods in terms of the Observed Jitter Transfer Function (OJTF), see **":ANALyze:CLOCK:METHod:OJTF"** on page 286.

For setting other clock recovery methods, see **":ANALyze:CLOCK:METHod"** on page 275.

<source> {CHANnel<N> | FUNCtion<F> | WMEMory<R> | EQUalized<L> | XT<X>}

<N> An integer, 1-4 in a single oscilloscope, 1-40 in a MultiScope system.

<F> An integer, 1-16.

<R> An integer, 1-4.

<L> An integer, 1-4.

<X> An integer, 1-4, identifying the crosstalk waveform.

<data\_rate> A real number for the base data rate in bits per second.

When the signal type is PAM-4 (see :ANALyze:SIGNal:TYPE), a symbol rate (baud) is specified instead of a data rate (b/s).

- <jtf\_loop\_bandwidth> A real number for the cutoff frequency for the PLL to track.
- <peaking> The peaking value in dB.
- <multiplier> An integer used as the multiplication factor.
- <clock\_freq> A real number used for the clock frequency of the PLL.

**Example** This example sets the clock recovery method to Second Order PLL, a nominal data rate of 4 Gb/s, and a peaking value of 1.25 dB.

```
myScope.WriteString ":ANALyze:CLOCK:METHOD:JTF SOPLL,4E9,3.822E6,1.25"
```

**Query** :ANALyze:CLOCK:METHOD:JTF?

The :ANALyze:CLOCK:METHOD:JTF? query returns the state of the clock recovery method.

**Returned Format** [:ANALyze:CLOCK:METHOD:JTF]

```
{FOPLL,<data_rate>,<jtf_loop_bandwidth>}
| {SOPLL,<data_rate>,<jtf_loop_bandwidth>,<peaking>}
| {EXPFOPLL <source>,{RISing | FALLing | BOTH},
  <multiplier>,<clock_freq>,<jtf_loop_bandwidth>}
| {EXPSOPLL <source>,{RISing | FALLing | BOTH},
  <multiplier>,<clock_freq>,<jtf_loop_bandwidth>,<peaking>}
| {EQFOPLL,<data_rate>,<jtf_loop_bandwidth>}
| {EQSOPLL,<data_rate>,<jtf_loop_bandwidth>,<peaking>}
```

**Example** This example places the current setting of the clock recovery method in the variable strSetting, then prints the contents of the variable to the computer's screen.

```
myScope.WriteString ":SYSTEM:HEADer OFF"
myScope.WriteString ":ANALyze:CLOCK:METHOD:JTF?"
strSetting = myScope.ReadString
Debug.Print strSetting
```

- See Also**
- [":ANALyze:CLOCK:METHOD:SOURce"](#) on page 292
  - [":ANALyze:CLOCK:METHOD"](#) on page 275
  - [":ANALyze:CLOCK:METHOD:OJTF"](#) on page 286
  - [":ANALyze:CLOCK:METHOD:DEEMphasis"](#) on page 280
  - [":ANALyze:CLOCK:METHOD:ALIGN"](#) on page 279
  - [":ANALyze:CLOCK:METHOD:PLLTrack"](#) on page 289
  - [":ANALyze:CLOCK:METHOD:EDGE"](#) on page 281
  - [":ANALyze:SIGNAL:TYPE"](#) on page 312

**History** New in version 5.30. This command replaces the now deprecated command [":MEASure:CLOCK:METHOD:JTF"](#) on page 1733.

Version 5.50: When the signal type is PAM-4, a symbol rate (baud) is specified instead of a data rate (b/s).

## :ANALyze:CLOCK:METHod:OJTF

**Command** :ANALyze:CLOCK:METHod:OJTF  
 {FOPLL,<data\_rate>,<ojtf\_loop\_bandwidth>}  
 | {SOPLL,<data\_rate>,<ojtf\_loop\_bandwidth>, <damping\_factor>}  
 | {EXPFOPLL,<source>,{RISing | FALLing | BOTH},  
 <multiplier>,<clock\_freq>,<ojtf\_loop\_bandwidth>}  
 | {EXPSOPLL,<source>,{RISing | FALLing | BOTH},  
 <multiplier>,<clock\_freq>,<ojtf\_loop\_bandwidth>,<damping\_factor>}  
 | {EQFOPLL,<data\_rate>,<ojtf\_loop\_bandwidth>}  
 | {EQSOPLL,<data\_rate>,<ojtf\_loop\_bandwidth>, <damping\_factor>}

The :ANALyze:CLOCK:METHod:OJTF command specifies the clock recovery PLL's response in terms of the Observed Jitter Transfer Function's (OJTF) 3 dB bandwidth.

This command applies to the clock recovery method being set up for the waveform source selected by the :ANALyze:CLOCK:METHod:SOURce command.

You can set these types of PLL clock recovery methods:

- FOPLL (First Order PLL)
- SOPLL (Second Order PLL)
- EQFOPLL (Equalized First Order PLL)
- EQSOPLL (Equalized Second Order PLL)
- EXPFOPLL (Explicit First Order PLL)
- EXPSOPLL (Explicit Second Order PLL)

The equalized clock recovery methods are available when the Advanced Signal Integrity Software license is installed.

For setting phase-locked loop (PLL) clock recovery methods in terms of the Jitter Transfer Function (JTF), see **":ANALyze:CLOCK:METHod:JTF"** on page 284.

For setting other clock recovery methods, see **":ANALyze:CLOCK:METHod"** on page 275.

**<source>** {CHANnel<N> | FUNCtion<F> | WMEMory<R> | EQUalized<L> | XT<X>}

**<N>** An integer, 1-4 in a single oscilloscope, 1-40 in a MultiScope system.

**<F>** An integer, 1-16.

**<R>** An integer, 1-4.

**<L>** An integer, 1-4.

**<X>** An integer, 1-4, identifying the crosstalk waveform.

**<data\_rate>** A real number for the base data rate in bits per second.

When the signal type is PAM-4 (see :ANALyze:SIGNal:TYPE), a symbol rate (baud) is specified instead of a data rate (b/s).

- <ojtf\_loop\_bandwidth>** A real number for the cutoff frequency for the PLL to track.
- <damping\_factor>** A real number for the damping factor of the PLL.
- <multiplier>** An integer used as the multiplication factor.
- <clock\_freq>** A real number used for the clock frequency of the PLL.

**Example** This example sets the clock recovery method to Second Order PLL, a nominal data rate of 4 Gb/s, and a damping factor of 1.0.

```
myScope.WriteString ":ANALyze:CLOCK:METHOD:OJTF SOPLL,4E9,2.4E6,1.0"
```

**Query** :ANALyze:CLOCK:METHOD:OJTF?

The :ANALyze:CLOCK:METHOD:OJTF? query returns the state of the clock recovery method.

**Returned Format** [:ANALyze:CLOCK:METHOD:OJTF]

```
{FOPLL,<data_rate>,<ojtf_loop_bandwidth>}
| {SOPLL,<data_rate>,<ojtf_loop_bandwidth>,<damping_factor>}
| {EXPFOPLL <source>,{RISing | FALLing | BOTH},
  <multiplier>,<clock_freq>,<ojtf_loop_bandwidth>}
| {EXPSOPLL <source>,{RISing | FALLing | BOTH},
  <multiplier>,<clock_freq>,<ojtf_loop_bandwidth>,<damping_fact>}
| {EQFOPLL,<data_rate>,<ojtf_loop_bandwidth>}
| {EQSOPLL,<data_rate>,<ojtf_loop_bandwidth>,<damping_factor>}
```

**Example** This example places the current setting of the clock recovery method in the variable strSetting, then prints the contents of the variable to the computer's screen.

```
myScope.WriteString ":SYSTEM:HEADer OFF"
myScope.WriteString ":ANALyze:CLOCK:METHOD:OJTF?"
strSetting = myScope.ReadString
Debug.Print strSetting
```

- See Also**
- [":ANALyze:CLOCK:METHOD:SOURce"](#) on page 292
  - [":ANALyze:CLOCK:METHOD"](#) on page 275
  - [":ANALyze:CLOCK:METHOD:JTF"](#) on page 284
  - [":ANALyze:CLOCK:METHOD:DEEMphasis"](#) on page 280
  - [":ANALyze:CLOCK:METHOD:ALIGN"](#) on page 279
  - [":ANALyze:CLOCK:METHOD:PLLTrack"](#) on page 289
  - [":ANALyze:CLOCK:METHOD:EDGE"](#) on page 281
  - [":ANALyze:SIGNAL:TYPE"](#) on page 312

**History** New in version 5.30. This command replaces the now deprecated command [":MEASure:CLOCK:METHOD:OJTF"](#) on page 1735.

Version 5.50: When the signal type is PAM-4, a symbol rate (baud) is specified instead of a data rate (b/s).

## :ANALyze:CLOCK:METHOD:PLLadvanced

**Command** :ANALyze:CLOCK:METHOD:PLLadvanced {{0 | OFF} | {1 | ON}}

The :ANALyze:CLOCK:METHOD:PLLadvanced command enables or disables the "Advanced PLL for closed eyes" option.

If you are trying to recover a clock on closed eyes due to ISI or other jitter and noise sources, you can enable **Advanced PLL for closed eyes**. Our normal PLL clock recovery algorithms use edge timing of the data waveform to establish the clock edges. If the eye is closed, there may be so much jitter that this approach fails to yield accurate clocks. The Advanced PLL does not use edge information and can recover a clock even for closed eyes. However, if the eye is not closed, we recommend you use the traditional "Golden PLL" approach based upon edge timing.

**Query** :ANALyze:CLOCK:METHOD:PLLadvanced?

The :ANALyze:CLOCK:METHOD:PLLadvanced? query returns whether the setting is enabled or disabled.

**Returned Format** <setting><NL>

<setting> ::= {0 | 1}

**History** New in version 6.55.



## :ANALyze:CLOCK:METHod:PLLTrack

**Command** :ANALyze:CLOCK:METHod:PLLTrack {OFF | ON}

The :ANALyze:CLOCK:METHod:PLLTrack command turns transition density dependence on or off. See the help system for more information on the Transition Density Dependent setting.

This command applies to the clock recovery method being set up for the waveform source selected by the :ANALyze:CLOCK:METHod:SOURce command.

**Example** This example enables the Transition Density Dependent setting.

```
myScope.WriteString ":MEASure:CLOCK:METHod:PLLTrack ON"
```

**Query** :ANALyze:CLOCK:METHod:PLLTrack?

The :ANALyze:CLOCK:METHod:PLLTrack? query returns whether or not the Transition Density Dependent setting is turned on.

**Returned Format** [:ANALyze:CLOCK:METHod:PLLTrack] {OFF | ON}

**Example** This example places the current setting of the Transition Density Dependent setting in the string variable strTDD, then prints the contents of the variable to the computer's screen.

```
myScope.WriteString ":SYSTem:HEADer OFF"
myScope.WriteString ":ANALyze:CLOCK:METHod:PLLTrack?"
strTDD = myScope.ReadString
Debug.Print strTDD
```

**See Also**

- [":ANALyze:CLOCK:METHod:SOURce"](#) on page 292
- [":ANALyze:CLOCK:METHod"](#) on page 275
- [":ANALyze:CLOCK:METHod:OJTF"](#) on page 286
- [":ANALyze:CLOCK:METHod:JTF"](#) on page 284
- [":ANALyze:CLOCK:METHod:DEEMphasis"](#) on page 280
- [":ANALyze:CLOCK:METHod:ALIGN"](#) on page 279
- [":ANALyze:CLOCK:METHod:EDGE"](#) on page 281

**History** New in version 5.30. This command replaces the now deprecated command [":MEASure:CLOCK:METHod:PLLTrack"](#) on page 1737.

**:ANALyze:CLOCK:METHod:SKEW**

**Command** :ANALyze:CLOCK:METHod:SKEW <time>

When clock recovery is being performed on a PAM-4 signal type (see :ANALyze:SIGNal:TYPE), the :ANALyze:CLOCK:METHod:SKEW command can be used to center the eye opening at the clock locations by shifting the clocks relative to the data.

<time> Seconds in NR3 format.

**Query** :ANALyze:CLOCK:METHod:SKEW?

The :ANALyze:CLOCK:METHod:SKEW? query returns the skew setting.

**Returned Format** <time><NL>

- See Also**
- [":ANALyze:SIGNal:TYPE"](#) on page 312
  - [":ANALyze:CLOCK:METHod:SKEW:AUTomatic"](#) on page 291
  - [":MEASure:THResholds:DISPlay"](#) on page 1120
  - [":MEASure:THResholds:GENeral:METHod"](#) on page 1126
  - [":MEASure:THResholds:GENeral:PAMCustom"](#) on page 1128
  - [":MEASure:THResholds:GENeral:PAMAutomatic"](#) on page 1130
  - [":MEASure:THResholds:RFALL:METHod"](#) on page 1143
  - [":MEASure:THResholds:RFALL:PAMAutomatic"](#) on page 1145

**History** New in version 6.10.

## :ANALyze:CLOCK:METhod:SKEW:AUTomatic

**Command** :ANALyze:CLOCK:METhod:SKEW:AUTomatic

When clock recovery is being performed on a PAM-4 signal type (see :ANALyze:SIGNal:TYPE), the :ANALyze:CLOCK:METhod:SKEW:AUTomatic command automatically shifts clocks relative to the data to center the eye opening at the clock locations. The current real-time eye data is used to determine the eye center locations.

**See Also** • [":ANALyze:CLOCK:METhod:SKEW"](#) on page 290

**History** New in version 6.30.

**:ANALyze:CLOCK:METHod:SOURce**

**Command** :ANALyze:CLOCK:METHod:SOURce {ALL | <source>}  
 <source> ::= {CHANnel<N> | FUNction<F> | WMEMory<R> | EQUalized<L>  
 | XT<X>}

The :ANALyze:CLOCK:METHod:SOURce command selects the waveform source (or ALL sources) to which other clock recovery method setup commands apply.

Clock recovery methods can be set up for each waveform source (or for all waveform sources).

**Query** :ANALyze:CLOCK:METHod:SOURce?

The :ANALyze:CLOCK:METHod:SOURce? query returns the waveform source to which other clock recovery method commands currently apply.

**Returned Format** [:ANALyze:CLOCK:METHod:SOURce] <source><NL>  
 <source> ::= {ALL | CHAN<N> | FUNC<F> | WMEM<N> | EQU<L> | XT<X>}

- See Also**
- [":ANALyze:CLOCK:METHod"](#) on page 275
  - [":ANALyze:CLOCK:METHod:OJTF"](#) on page 286
  - [":ANALyze:CLOCK:METHod:JTF"](#) on page 284
  - [":ANALyze:CLOCK:METHod:DEEMphasis"](#) on page 280
  - [":ANALyze:CLOCK:METHod:ALIGn"](#) on page 279
  - [":ANALyze:CLOCK:METHod:PLLTrack"](#) on page 289
  - [":ANALyze:CLOCK:METHod:EDGE"](#) on page 281

**History** New in version 5.30. This command replaces the now deprecated command [":MEASure:CLOCK:METHod:SOURce"](#) on page 1738.

## :ANALyze:CLOCK:TIME

**Query** :ANALyze:CLOCK:TIME? <source>

When clock recovery is enabled for a waveform source, the :ANALyze:CLOCK:TIME? query returns the recovered clock times.

Lots of features enable and use clock recovery. For example:

- Various measurements: TIE, pattern length, BER, and others
- Real-time eye
- Certain protocol decodes
- DFE equalization
- EZJIT jitter/noise analysis
- And more

<source> {CHANnel<N> | DIFF<D> | COMMONmode<C> | WMEMory<R> | FUNCTion<F> | EQUalized<L> | XT<X>}

For more information on <source> parameters, see "[Sources for Analyze Commands](#)" on page 272.

**Returned Format** <time\_values><NL>

<time\_values> ::= Definite-length block of 64-bit double values.

If clock recovery is not enabled, an error is returned.

**Example** This Python code loads the oscilloscope's real-time eye demo composite file and gets the recovered clock times.

```
# Enable clock recovery by loading real-time eye demo.
do_command(":DISK:LOAD \"C:\\ProgramData\\Infiniium\\Demos\\Analysis\\
RTE.osc\"")

# Get recovered clock time data.
clock_time_data_bytes = \
    do_query_ieee_block(":ANALyze:CLOCK:TIME? WMEMory1")
double_clock_time_values = \
    struct.unpack("%dd" % (len(clock_time_data_bytes) / 8), \
                  clock_time_data_bytes)
num_of_double_clock_time_values = len(double_clock_time_values)
print(f"Number of clock times: {num_of_double_clock_time_values}")

# Save clock time data values.
output_file_name = "recovered_clock_time_values.csv"
f = open(f"{output_file_name}", "w")
for i in range(0, num_of_double_clock_time_values - 1):
    f.write(f"{double_clock_time_values[i]:E}\n")
f.close()
print(f"Recovered clock times written to: {output_file_name}")
```

The `do_command()` and `do_query_ieee_block()` functions are described in "[VISA Example in Python 3](#)" on page 1896.

- See Also**
- **":ANALyze:CLOCK"** on page 274
  - **":ANALyze:CLOCK:VERTical"** on page 295
  - **":ANALyze:CLOCK:VERTical:OFFSet"** on page 296
  - **":ANALyze:CLOCK:VERTical:RANGe"** on page 297

**History** New in version 6.74.

## :ANALyze:CLOCK:VERTical

**Command** :ANALyze:CLOCK:VERTical {AUTO | MANual}

The :ANALyze:CLOCK:VERTical command sets the recovered clock vertical scale mode to automatic or manual. In automatic mode, the oscilloscope automatically selects the vertical scaling and offset. In manual mode, you can set your own scaling and offset values.

**Example** This example sets the recovered clock vertical scale mode to automatic.

```
myScope.WriteString ":ANALyze:CLOCK:VERTical AUTO"
```

**Query** :ANALyze:CLOCK:VERTical?

The :ANALyze:CLOCK:VERTical? query returns the current recovered clock vertical scale mode setting.

**Returned Format** [:ANALyze:CLOCK:VERTical] {AUTO | MANual}

**Example** This example places the current setting of the recovered clock vertical scale mode in the string variable strSetting, then prints the contents of the variable to the computer's screen.

```
myScope.WriteString ":SYSTem:HEADer OFF"
myScope.WriteString ":ANALyze:CLOCK:VERTical?"
strSetting = myScope.ReadString
Debug.Print strSetting
```

- See Also**
- [":ANALyze:CLOCK"](#) on page 274
  - [":ANALyze:CLOCK:VERTical:OFFSet"](#) on page 296
  - [":ANALyze:CLOCK:VERTical:RANGe"](#) on page 297
  - [":ANALyze:CLOCK:TIME"](#) on page 293

**History** New in version 5.30. This command replaces the now deprecated command [":MEASure:CLOCK:VERTical"](#) on page 1739.

**:ANALyze:CLOCK:VERTical:OFFSet**

**Command** :ANALyze:CLOCK:VERTical:OFFSet <offset>

The :ANALyze:CLOCK:VERTical:OFFSet command sets the recovered clock vertical offset.

<offset> A real number for the recovered clock vertical offset.

**Example** This example sets the clock recovery vertical offset to 1 volt.

```
myScope.WriteString ":ANALyze:CLOCK:VERTical:OFFSet 1"
```

**Query** :ANALyze:CLOCK:VERTical:OFFSet?

The :ANALyze:CLOCK:VERTical:OFFSet? query returns the clock recovery vertical offset setting.

**Returned Format** [:ANALyze:CLOCK:VERTical:OFFSet] <value><NL>

<value> The clock recovery vertical offset setting.

**Example** This example places the current value of recovered clock vertical offset in the numeric variable, varValue, then prints the contents of the variable to the computer's screen.

```
myScope.WriteString ":SYSTEM:HEADer OFF" ' Response headers off.
myScope.WriteString ":ANALyze:CLOCK:VERTical:OFFSet?"
varValue = myScope.ReadNumber
Debug.Print FormatNumber(varValue, 0)
```

- See Also**
- [":ANALyze:CLOCK"](#) on page 274
  - [":ANALyze:CLOCK:VERTical"](#) on page 295
  - [":ANALyze:CLOCK:VERTical:RANGe"](#) on page 297
  - [":ANALyze:CLOCK:TIME"](#) on page 293

**History** New in version 5.30. This command replaces the now deprecated command [":MEASure:CLOCK:VERTical:OFFSet"](#) on page 1740.



## :ANALyze:CLOCK:VERTical:RANGe

**Command** :ANALyze:CLOCK:VERTical:RANGe <range>

The :ANALyze:CLOCK:VERTical:RANGe command sets the recovered clock vertical range.

<range> A real number for the full-scale recovered clock vertical range.

**Example** This example sets the recovered clock vertical range to 16 volts (2 volts times 8 divisions.)

```
myScope.WriteString ":ANALyze:CLOCK:VERTical:RANGe 16"
```

**Query** :ANALyze:CLOCK:VERTical:RANGe?

The :ANALyze:CLOCK:VERTical:RANGe? query returns the recovered clock vertical range setting.

**Returned Format** [:ANALyze:CLOCK:VERTical:RANGe] <value><NL>

<value> The recovered clock vertical range setting.

**Example** This example places the current value of recovered clock vertical range in the numeric variable, varValue, then prints the contents of the variable to the computer's screen.

```
myScope.WriteString ":SYSTEM:HEADer OFF" ' Response headers off.
myScope.WriteString ":ANALyze:CLOCK:VERTical:RANGe?"
varValue = myScope.ReadNumber
Debug.Print FormatNumber(varValue, 0)
```

- See Also**
- [":ANALyze:CLOCK"](#) on page 274
  - [":ANALyze:CLOCK:VERTical"](#) on page 295
  - [":ANALyze:CLOCK:VERTical:OFFSet"](#) on page 296
  - [":ANALyze:CLOCK:TIME"](#) on page 293

**History** New in version 5.30. This command replaces the now deprecated command [":MEASure:CLOCK:VERTical:RANGe"](#) on page 1741.

## :ANALyze:SIGNal:DATarate

**Command** :ANALyze:SIGNal:DATarate <source>,<data\_rate>

```
<source> ::= {CHANnel<N> | DIFF<D> | COMMONmode<C> | FUNction<F>
             | WMEMory<R> | EQUalized<L> | XT<X>}
```

When the source signal type is PAM-4 (see :ANALyze:SIGNal:TYPE), the :ANALyze:SIGNal:DATarate command specifies the data rate of the signal.

With PAM-4, the data rate is twice the symbol rate because each voltage level represents two bits of data. Changing the data rate also changes the symbol rate (see :ANALyze:SIGNal:SYMBOLrate) and vice-versa.

<N> An integer, 1-4 in a single oscilloscope, 1-40 in a MultiScope system.

<D>, <C> <D> is an integer, 1-2. <C> is an integer, 3-4.

The DIFF and COMMONmode sources are just aliases that can be used in place of the channel names to apply to differential or common mode signals. These are just aliases - no state change occurs if you refer to a differential channel and you are not in differential mode. DIFF1 refers to the differential signal between channels 1 and 3 (and COMMONmode3 refers to the common mode channel between these same channels). DIFF2 refers to the differential signal between channels 2 and 4 (and COMMONmode4 refers to the common mode channel between these same channels).

<F> An integer, 1-16.

<R> An integer, 1-4.

<L> An integer, 1-4.

<X> An integer, 1-4, identifying the crosstalk waveform.

<data\_rate> Bits/second in NR3 format.

**Query** :ANALyze:SIGNal:DATarate? <source>

The :ANALyze:SIGNal:DATarate? query returns the data rate of the source signal.

**Returned Format** [:ANALyze:SIGNal:DATarate] <data\_rate><NL>

```
<data_rate> ::= bits/second in NR3 format.
```

- See Also**
- [":ANALyze:CLOCK:METHod:SKEW"](#) on page 290
  - [":ANALyze:SIGNal:SYMBOLrate"](#) on page 310
  - [":ANALyze:SIGNal:TYPE"](#) on page 312
  - [":MEASure:CGRade:EWIDth"](#) on page 907
  - [":MEASure:CGRade:EHEight"](#) on page 904
  - [":MEASure:FALLtime"](#) on page 946
  - [":MEASure:PAM:ELEVEL"](#) on page 1022

- `":MEASure:PAM:ESKew"` on page 1024
- `":MEASure:PAM:LEVel"` on page 1031
- `":MEASure:PAM:LRMS"` on page 1033
- `":MEASure:PAM:LTHickness"` on page 1035
- `":MEASure:RISetime"` on page 1083
- `":MEASure:THResholds:DISPlay"` on page 1120
- `":MEASure:THResholds:GENeral:METhod"` on page 1126
- `":MEASure:THResholds:GENeral:PAMCustom"` on page 1128
- `":MEASure:THResholds:GENeral:PAMAutomatic"` on page 1130
- `":MEASure:THResholds:RFALL:METhod"` on page 1143
- `":MEASure:THResholds:RFALL:PAMAutomatic"` on page 1145
- `":MEASure:TIEData2"` on page 1167

**History** New in version 5.50.

## :ANALyze:SIGNal:MIXer:CABLeLoss

**Command** :ANALyze:SIGNal:MIXer:CABLeLoss <source>,<loss>

The :ANALyze:SIGNal:MIXer:CABLeLoss command sets the loss of the cable connecting the mixer to the oscilloscope.

<source> {CHANnel<N>}

<loss> The dB cable return loss in NR3 format.

**Query** :ANALyze:SIGNal:MIXer:CABLeLoss? <source>

The :ANALyze:SIGNal:MIXer:CABLeLoss? query returns the specified cable loss.

**Returned Format** <loss><NL>

- See Also**
- [":ANALyze:SIGNal:MMWave:CALibrate"](#) on page 301
  - [":ANALyze:SIGNal:MMWave:CFRequency"](#) on page 302
  - [":ANALyze:SIGNal:MMWave:CONNect"](#) on page 303
  - [":ANALyze:SIGNal:MMWave:LOADdress"](#) on page 304
  - [":ANALyze:SIGNal:MMWave:MBANDwidth"](#) on page 305

**History** New in version 5.60.

## :ANALyze:SIGNal:MMWave:CALibrate

**Command** :ANALyze:SIGNal:MMWave:CALibrate

The :ANALyze:SIGNal:MMWave:CALibrate command initiates a mixer/LO (local oscillator) power calibration.

The LO is identified by the :ANALyze:SIGNal:MMWave:LOADdress command.

The calibration takes about a minute.

You may send additional commands that will not be executed until this command completes. (The command is blocking.)

You may initiate a query (\*IDN?, etc.) to wait until the calibration is complete.

- See Also**
- [":ANALyze:SIGNal:MIXer:CABLEloss"](#) on page 300
  - [":ANALyze:SIGNal:MMWave:CFRequency"](#) on page 302
  - [":ANALyze:SIGNal:MMWave:CONNect"](#) on page 303
  - [":ANALyze:SIGNal:MMWave:LOADdress"](#) on page 304
  - [":ANALyze:SIGNal:MMWave:MBANDwidth"](#) on page 305

**History** New in version 5.60.

## :ANALyze:SIGNal:MMWave:CFRequency

**Command** :ANALyze:SIGNal:MMWave:CFRequency <center\_freq>

The :ANALyze:SIGNal:MMWave:CFRequency command sets the center frequency for the oscilloscope's FFT math function.

Because all channels using mmWave share a LO, there is only one center frequency for the oscilloscope.

<center\_freq> Center frequency in NR3 format.

**Query** :ANALyze:SIGNal:MMWave:CFRequency?

The :ANALyze:SIGNal:MMWave:CFRequency? query returns the specified center frequency.

**Returned Format** <center\_freq><NL>

- See Also**
- [":ANALyze:SIGNal:MIXer:CABLeLoss"](#) on page 300
  - [":ANALyze:SIGNal:MMWave:CALibrate"](#) on page 301
  - [":ANALyze:SIGNal:MMWave:CONNect"](#) on page 303
  - [":ANALyze:SIGNal:MMWave:LOADdress"](#) on page 304
  - [":ANALyze:SIGNal:MMWave:MBANDwidth"](#) on page 305

**History** New in version 5.60.

## :ANALyze:SIGNal:MMWave:CONNect

**Command** :ANALyze:SIGNal:MMWave:CONNect <source>,{0 | OFF} | {1 | ON}}

The :ANALyze:SIGNal:MMWave:CONNect command sets the connection status for the mixer and LO (local oscillator) assigned to the specified channel. Use OFF to disconnect.

<source> {CHANnel<N>}

**Query** :ANALyze:SIGNal:MMWave:CONNect? <source>

The :ANALyze:SIGNal:MMWave:CONNect? query returns the mixer and LO connection status.

**Returned Format** <status><NL>

<status> ::= {0 | 1}

- See Also**
- [":ANALyze:SIGNal:MIXer:CABLeLoss"](#) on page 300
  - [":ANALyze:SIGNal:MMWave:CALibrate"](#) on page 301
  - [":ANALyze:SIGNal:MMWave:CFRequency"](#) on page 302
  - [":ANALyze:SIGNal:MMWave:LOADdress"](#) on page 304
  - [":ANALyze:SIGNal:MMWave:MBANDwidth"](#) on page 305

**History** New in version 5.60.

**:ANALyze:SIGNal:MMWave:LOADdress**

**Command** :ANALyze:SIGNal:MMWave:LOADdress <string>

The :ANALyze:SIGNal:MMWave:LOADdress command sets the LO's (local oscillator's) VISA address.

The VISA address of the LO can be found in the Keysight Connection Expert.

<string> Quoted VISA address of LO.

**Query** :ANALyze:SIGNal:MMWave:LOADdress?

The :ANALyze:SIGNal:MMWave:LOADdress? query returns the specified LO VISA address.

**Returned Format** <string><NL>

- See Also**
- [":ANALyze:SIGNal:MIXer:CABLeLoss"](#) on page 300
  - [":ANALyze:SIGNal:MMWave:CALibrate"](#) on page 301
  - [":ANALyze:SIGNal:MMWave:CFRequency"](#) on page 302
  - [":ANALyze:SIGNal:MMWave:CONNect"](#) on page 303
  - [":ANALyze:SIGNal:MMWave:MBANdwidth"](#) on page 305

**History** New in version 5.60.



## :ANALyze:SIGNal:MMWave:MBANdwidth

**Command** :ANALyze:SIGNal:MMWave:MBANdwidth <meas\_bandwidth>

The :ANALyze:SIGNal:MMWave:MBANdwidth command sets the measurement bandwidth (in Hz).

The specified bandwidth becomes the center frequency for the oscilloscope's FFT math function.

Because all channels using mmWave will share a LO (local oscillator), there is only one measurement bandwidth for the oscilloscope.

<meas\_bandwidth  
>

Bandwidth in NR3 format.

**Query** :ANALyze:SIGNal:MMWave:MBANdwidth?

The :ANALyze:SIGNal:MMWave:MBANdwidth? query returns the specified measurement bandwidth.

**Returned Format** <meas\_bandwidth><NL>

- See Also**
- [":ANALyze:SIGNal:MIXer:CABLeLoss"](#) on page 300
  - [":ANALyze:SIGNal:MMWave:CALibrate"](#) on page 301
  - [":ANALyze:SIGNal:MMWave:CFRequency"](#) on page 302
  - [":ANALyze:SIGNal:MMWave:CONNect"](#) on page 303
  - [":ANALyze:SIGNal:MMWave:LOADdress"](#) on page 304

**History** New in version 5.60.

**:ANALyze:SIGNal:PATtern:CLEar**

**Command** :ANALyze:SIGNal:PATtern:CLEar <source>

For NRZ and PAM4 signal types (see :ANALyze:SIGNal:TYPE), the :ANALyze:SIGNal:PATtern:CLEar command clears a loaded pattern file and goes back to an automatic or manual pattern length setting.

<source> {CHANnel<N> | DIFF<D> | COMMONmode<C> | FUNction<F> | WMEMory<R> | EQUalized<L> | XT<X>}

For more information on <source> parameters, see "[Sources for Analyze Commands](#)" on page 272.

- See Also**
- "[:ANALyze:SIGNal:TYPE](#)" on page 312
  - "[:ANALyze:SIGNal:PATtern:LOAD](#)" on page 307
  - "[:ANALyze:SIGNal:PATtern:PLENght](#)" on page 308
  - "[:ANALyze:SIGNal:PATtern:SMAP](#)" on page 309
  - "[:MEASure:BER](#)" on page 896
  - "[:MEASure:BERPeracq](#)" on page 897
  - "[:MEASure:SER](#)" on page 1110
  - "[:MEASure:SERPeracq](#)" on page 1111

**History** New in version 6.20.

## :ANALyze:SIGNal:PATtern:LOAD

**Command** :ANALyze:SIGNal:PATtern:LOAD <source>,"<pattern\_file\_path>"

For NRZ and PAM4 signal types (see :ANALyze:SIGNal:TYPE), the :ANALyze:SIGNal:PATtern:LOAD command loads a pattern file from which pattern lengths and patterns are determined.

**<source>** {CHANnel<N> | DIFF<D> | COMMONmode<C> | FUNction<F> | WMEMory<R> | EQUalized<L> | XT<X>}

For more information on <source> parameters, see "[Sources for Analyze Commands](#)" on page 272.

**<pattern\_file\_path** Quoted string that is the path of the pattern file.

>

The Infiniium oscilloscope software includes some NRZ PRBS pattern files that are also included with BERTs.

- See Also**
- "[:ANALyze:SIGNal:TYPE](#)" on page 312
  - "[:ANALyze:SIGNal:PATtern:CLEar](#)" on page 306
  - "[:ANALyze:SIGNal:PATtern:PLENght](#)" on page 308
  - "[:ANALyze:SIGNal:PATtern:SMAP](#)" on page 309
  - "[:MEASure:BER](#)" on page 896
  - "[:MEASure:BERPeracq](#)" on page 897
  - "[:MEASure:SER](#)" on page 1110
  - "[:MEASure:SERPeracq](#)" on page 1111

**History** New in version 6.20.

## :ANALyze:SIGNal:PATtern:PLENgtH

**Command** :ANALyze:SIGNal:PATtern:PLENgtH <source>, {AUTO | <pattern\_length>}

For NRZ and PAM4 signal types (see :ANALyze:SIGNal:TYPE), the :ANALyze:SIGNal:PATtern:PLENgtH command specifies a pattern length or that the oscilloscope determine the pattern length automatically.

**<source>** {CHANnel<N> | DIFF<D> | COMMONmode<C> | FUNCTion<F> | WMEMory<R> | EQUalized<L> | XT<X>}

For more information on <source> parameters, see "[Sources for Analyze Commands](#)" on page 272.

**AUTO** The oscilloscope automatically determines the pattern length and pattern by looking for at least two error-free copies of an identical repeating bit pattern in acquisition memory.

**<pattern\_length>** Manually specifies the pattern length as an integer number of symbols from 2 to  $2^{23}$ . In this case, to determine the pattern, the oscilloscope looks in acquisition memory for at least two error-free copies of an identical repeating bit pattern of the specified length.

**Query** :ANALyze:SIGNal:PATtern:PLENgtH? <source>

The :ANALyze:SIGNal:PATtern:PLENgtH? query returns the specified pattern length setting.

**Returned Format** <pattern\_length><NL>

<pattern\_length> ::= 2 to  $2^{23}$

- See Also**
- "[:ANALyze:SIGNal:TYPE](#)" on page 312
  - "[:ANALyze:SIGNal:PATtern:CLEar](#)" on page 306
  - "[:ANALyze:SIGNal:PATtern:LOAD](#)" on page 307
  - "[:ANALyze:SIGNal:PATtern:SMAP](#)" on page 309
  - "[:MEASure:BER](#)" on page 896
  - "[:MEASure:BERPeracq](#)" on page 897
  - "[:MEASure:SER](#)" on page 1110
  - "[:MEASure:SERPeracq](#)" on page 1111

**History** New in version 6.20.

## :ANALyze:SIGNal:PATtern:SMAP

**Command** :ANALyze:SIGNal:PATtern:SMAP <source>, {UNCoded | GRAYcoded}

For PAM4 signal types (see :ANALyze:SIGNal:TYPE), the :ANALyze:SIGNal:PATtern:SMAP command specifies whether the symbol map is gray-coded or uncoded.

**<source>** {CHANnel<N> | DIFF<D> | COMMONmode<C> | FUNction<F> | WMEMory<R> | EQUalized<L> | XT<X>}

For more information on <source> parameters, see "[Sources for Analyze Commands](#)" on page 272.

**Query** :ANALyze:SIGNal:PATtern:SMAP? <source>

The :ANALyze:SIGNal:PATtern:SMAP? query returns the symbol map setting.

**Returned Format** {UNC | GRAY}<NL>

- See Also**
- "[:ANALyze:SIGNal:TYPE](#)" on page 312
  - "[:ANALyze:SIGNal:PATtern:CLEar](#)" on page 306
  - "[:ANALyze:SIGNal:PATtern:LOAD](#)" on page 307
  - "[:ANALyze:SIGNal:PATtern:PLENght](#)" on page 308
  - "[:MEASure:BER](#)" on page 896
  - "[:MEASure:BERPeracq](#)" on page 897
  - "[:MEASure:SER](#)" on page 1110
  - "[:MEASure:SERPeracq](#)" on page 1111

**History** New in version 6.20.

## :ANALyze:SIGNal:SYMBolrate

**Command** :ANALyze:SIGNal:SYMBolrate <source>,<symbol\_rate>

<source> ::= {CHANnel<N> | DIFF<D> | COMMONmode<C> | FUNction<F>  
| WMEMory<R> | XT<X>}

When the source signal type is PAM-4 (see :ANALyze:SIGNal:TYPE), this command specifies the edge rate of the signal. The inverse of this rate is the unit interval (UI).

With PAM-4, the data rate is twice the symbol rate because each voltage level represents two bits of data. Changing the symbol rate also changes the data rate (see :ANALyze:SIGNal:DATarate) and vice-versa.

<N> An integer, 1-4 in a single oscilloscope, 1-40 in a MultiScope system.

<D>, <C> <D> is an integer, 1-2. <C> is an integer, 3-4.

The DIFF and COMMONmode sources are just aliases that can be used in place of the channel names to apply to differential or common mode signals. These are just aliases - no state change occurs if you refer to a differential channel and you are not in differential mode. DIFF1 refers to the differential signal between channels 1 and 3 (and COMMONmode3 refers to the common mode channel between these same channels). DIFF2 refers to the differential signal between channels 2 and 4 (and COMMONmode4 refers to the common mode channel between these same channels).

<F> An integer, 1-16.

<R> An integer, 1-4.

<X> An integer, 1-4, identifying the crosstalk waveform.

<symbol\_rate> Baud in NR3 format.

**Query** :ANALyze:SIGNal:SYMBolrate? <source>

The :ANALyze:SIGNal:SYMBolrate? query returns the symbol rate for the specified source signal.

**Returned Format** [:ANALyze:SIGNal:SYMBolrate] <symbol\_rate><NL>

<symbol\_rate> ::= baud in NR3 format.

- See Also**
- [":ANALyze:CLOCK:METHod:SKEW"](#) on page 290
  - [":ANALyze:SIGNal:DATarate"](#) on page 298
  - [":ANALyze:SIGNal:TYPE"](#) on page 312
  - [":MEASure:CGRade:EWIDth"](#) on page 907
  - [":MEASure:CGRade:EHEight"](#) on page 904
  - [":MEASure:FALLtime"](#) on page 946
  - [":MEASure:PAM:ELEVel"](#) on page 1022
  - [":MEASure:PAM:ESKew"](#) on page 1024

- `":MEASure:PAM:LEVel"` on page 1031
- `":MEASure:PAM:LRMS"` on page 1033
- `":MEASure:PAM:LTHickness"` on page 1035
- `":MEASure:RISetime"` on page 1083
- `":MEASure:THResholds:DISPlay"` on page 1120
- `":MEASure:THResholds:GENeral:METHod"` on page 1126
- `":MEASure:THResholds:GENeral:PAMCustom"` on page 1128
- `":MEASure:THResholds:GENeral:PAMAutomatic"` on page 1130
- `":MEASure:THResholds:RFALL:METHod"` on page 1143
- `":MEASure:THResholds:RFALL:PAMAutomatic"` on page 1145
- `":MEASure:TIEData2"` on page 1167

**History** New in version 5.50.

## :ANALyze:SIGNal:TYPE

**Command** :ANALyze:SIGNal:TYPE <source>, {UNSPecified | NRZ | PAM4 | PAM3  
| MMWave | CPHY, <source\_B-C>, <source\_C-A>}

The :ANALyze:SIGNal:TYPE command lets you specify whether a channel, function, or waveform memory is a special type of signal, like a PAM-4 signal for example.

- UNSPecified – When a signal type is unspecified, the oscilloscope's digital signal analysis and measurement features assume a NRZ signal with two levels (high and low).
- NRZ – With this selection, you are able to specify pattern lengths and patterns so that you can make BER measurements on NRZ signals.
- PAM4 – When a signal is specified as a PAM-4 (4-level Pulse-Amplitude Modulation) signal:
  - It changes how the oscilloscope determines voltage levels. Three thresholds are used to distinguish between the four voltage levels.
  - It changes how the oscilloscope represents the data rate. Two bits of data are represented by each voltage level.
  - The term *symbol rate* is used to describe the clock edge rate of the signal. The inverse of this rate is the unit interval (UI).
  - There are multiple edges to consider in clock recovery.
  - It changes how eye measurements, voltage level measurements, and rise/fall time measurements are presented because of the multiple eyes, levels, and edges.
- PAM3 – When a signal is specified as a PAM-3 (3-level Pulse-Amplitude Modulation) signal:
  - It changes how the oscilloscope determines voltage levels. Two thresholds are used to distinguish between the three voltage levels.
  - It changes how the oscilloscope represents the data rate. Two bits of data are represented by each voltage level (00, 01, or 10).
  - The term *symbol rate* is used to describe the clock edge rate of the signal. The inverse of this rate is the unit interval (UI).
  - There are multiple edges to consider in clock recovery.
  - It changes how eye measurements, voltage level measurements, and rise/fall time measurements are presented because of the multiple eyes, levels, and edges.



- **MMWave** – Supports analysis of millimeter-wave signals that have been down-converted to IF band signals by an external smart mixer and an LO signal from a signal generator. The oscilloscope controls the signal generator and external smart mixer and gets correction factors and detector level information from the mixer. The resulting signals can be analyzed using the oscilloscope's FFT spectral analysis and demodulated using the 89600 VSA vector signal analysis software.
- **CPHY** – Supports decode and analysis of MIPI C-PHY signals.

When CPHY is selected, the first <source> option is the A-B source.

<source>, <source\_B-C>, <source\_C-A> {CHANnel<N> | FUNction<F> | WMEMory<R> | EQUalized<L> | XT<X>}

<N> An integer, 1-4 in a single oscilloscope, 1-40 in a MultiScope system.

<D>, <C> <D> is an integer, 1-2. <C> is an integer, 3-4.

The DIFF and COMMONmode sources are just aliases that can be used in place of the channel names to apply to differential or common mode signals. These are just aliases - no state change occurs if you refer to a differential channel and you are not in differential mode. DIFF1 refers to the differential signal between channels 1 and 3 (and COMMONmode3 refers to the common mode channel between these same channels). DIFF2 refers to the differential signal between channels 2 and 4 (and COMMONmode4 refers to the common mode channel between these same channels).

<F> An integer, 1-16.

<R> An integer, 1-4.

<L> An integer, 1-4.

<X> An integer, 1-4, identifying the crosstalk waveform.

**Query** :ANALyze:SIGNa1:TYPE? <source>

The :ANALyze:SIGNa1:TYPE? query returns a channel, function, or waveform memory's signal type.

**Returned Format** [:ANALyze:SIGNa1:TYPE] <type><NL>

<type> ::= {UNSP | NRZ | PAM4 | PAM3 | MMW | CPHY}

- See Also**
- **":ANALyze:CLOCK:METHod:SKEW"** on page 290
  - **":ANALyze:SIGNa1:PATtern:PLENght"** on page 308
  - **":ANALyze:SIGNa1:PATtern:LOAD"** on page 307
  - **":MEASure:BER"** on page 896
  - **":MEASure:BERPeracq"** on page 897
  - **":ANALyze:SIGNa1:DATarate"** on page 298

- **":ANALyze:SIGNal:SYMBolrate"** on page 310
- **":MEASure:CGRade:EWIDth"** on page 907
- **":MEASure:CGRade:EHEight"** on page 904
- **":MEASure:FALLtime"** on page 946
- **":MEASure:PAM:ELEVel"** on page 1022
- **":MEASure:PAM:ESKew"** on page 1024
- **":MEASure:PAM:LEVel"** on page 1031
- **":MEASure:PAM:LRMS"** on page 1033
- **":MEASure:PAM:LTHickness"** on page 1035
- **":MEASure:RISetime"** on page 1083
- **":MEASure:THResholds:DISPlay"** on page 1120
- **":MEASure:THResholds:GENeral:METHod"** on page 1126
- **":MEASure:THResholds:GENeral:PAMCustom"** on page 1128
- **":MEASure:THResholds:GENeral:PAMAutomatic"** on page 1130
- **":MEASure:THResholds:RFALL:METHod"** on page 1143
- **":MEASure:THResholds:RFALL:PAMAutomatic"** on page 1145
- **":MEASure:TIEData2"** on page 1167

**History** New in version 5.50.

Version 5.60: Added the MMWave signal type.

Version 6.10: Added the CPHY signal type.

Version 6.30: Added the PAM3 signal type.

## :ANALyze:VIEW

**Command** :ANALyze:VIEW <data>

<data> ::= {ALL | MAIN}

The :ANALyze:VIEW command specify whether to use the data on screen or the entire acquisition for measurements, functions, and analysis.

This command maps to the "Window All Data" control in the user interface's Measurement Setup dialog box.

When all edges in an acquisition are used for horizontal measurements (see :ANALyze:AEDGes), this command's setting becomes "ALL" and the entire acquisition is used for measurements, functions, and analysis.

**Query** :ANALyze:VIEW?

The :ANALyze:VIEW? query returns the value that is currently set.

**Returned Format** [:ANALyze:VIEW] <data><NL>

<data> ::= {ALL | MAIN}

**See Also** • [":ANALyze:AEDGes"](#) on page 273

**History** New in version 5.30.



# 13 Bus Commands

:BUS:B<N>:TYPE / 318  
:BUS<B>:BIT<M> / 320  
:BUS<B>:BITS / 321  
:BUS<B>:CLEar / 322  
:BUS<B>:CLOCK / 323  
:BUS<B>:CLOCK:SLOPe / 324  
:BUS<B>:DISPlay / 325  
:BUS<B>:LABel / 326  
:BUS<B>:READout / 327

## NOTE

The :BUS:B<N>:TYPE command applies to oscilloscopes with protocol decode licenses installed. The other :BUS<B> commands apply to mixed-signal oscilloscopes (MSOs).

---

**:BUS:B<N>:TYPE**

**Command** :BUS:B<N>:TYPE {<protocol> | <hs\_protocol>}

**NOTE**

This BUS command only applies to oscilloscopes with protocol decode licenses installed.

The :BUS:B<N>:TYPE command sets the type of protocol being analyzed for a serial bus waveform.

**<protocol>** {A429 | CAN | CPHY | CPHY2 | DDR | E10BASET | E10GBASEKR | E100GBASEKR | E100GBASEKRRCR | EPSI | FLEXray | GENRaw | I3C | IIC | JTAG | LIN | MAN | M1553 | MIPI | RFFE | SENT | SPI | SPMI | SPW | SVID | UART | USB2}

**<hs\_protocol>** {BRR | CSI3 | DIGRf | DPAUX | DVI | E100BASETX | E1000BASET1 | FIBRechannel | GEN8B10B | GENeric} | INFiniband | JESD204B | LLI | MDIO | PCI3 | PCI4 | PCI5 | PCIExpress | QSPI | SAS | SATA | SSIC | UFS | UNIPro | USB3 | USB31 | USB32 | USB4 | USB4LS | USB4TUSB32 | USB4TPCI31 | USBPD | XAUI}

**<N>** An integer, 1-4.

**Example** This example sets the serial bus waveform number one protocol type to FLEXray.

```
myScope.WriteString ":BUS:B1:TYPE FLEXray"
```

**Query** :BUS:B<N>:TYPE?

The :BUS:B<N>:TYPE? query returns the name of the protocol being used for the serial bus.

**Returned Format** [:BUS:B<N>:TYPE] {<protocol> | <hs\_protocol>}<NL>

**<protocol>** {A429 | CAN | CPHY | CPHY2 | DDR | E10BASET | E10GBASEKR | E100GBASEKR | E100GBASEKRRCR | ESPI | FLEX | GENR | I3C | IIC | JTAG | LIN | MAN | M1553 | MIPI | RFFE | SENT | SPI | SPMI | SPW | SVID | UART | USB2}

**<hs\_protocol>** {BRR | CSI3 | DIGR | DPAUX | DVI | E100BASETX | E1000BASET1 | FC | {USER | USER} | INF | JESD204B | LLI | MDIO | PCI3 | PCI4 | PCI5 | PCIE | QSPI | SAS | SATA | SSIC | UFS | UNIP | USB3 | USB31 | USB32 | USB4 | USB4LS | USB4TUSB32 | USB4TPCI31 | USBPD | XAUI}

**See Also** • [":SBUS<N>:HS Commands"](#) on page 1290

**History** Legacy command (existed before version 3.10).

Version 3.11: Added the MPHY protocol type for the MIPI M-PHY serial decode selection.

Version 5.00: Added support for new protocols.

Version 5.51: Added support for new ESPI, USB31, and USBPD protocols.

Version 5.70: Added support for new A429, M1553, and I3C protocols.

Version 6.00: Added support for new GENRaw and SPMI protocols.

Version 6.10: Added support for new CPHY (MIPI C-PHY), BRR (BroadR-Reach), SPW (SpaceWire), and MAN (Manchester) protocols.

Version 6.20: Added support for new PCI4 (PCI Express Gen4) and SENT (Single Edge Nibble Transmission) protocols.

Version 6.30: Added support for new QSPI (Quad SPI) and USB32 (USB 3.2) protocols.

Version 6.55: Added support for new USB4 and USB4LS protocols.

Version 6.60: Added support for new PCI5 (PCI Express Gen 1-5), USB4TUSB32 (USB4 Tunnel USB 3.2), USB4TPCI31 (USB4 Tunnel PCI Express 3.1), and MDIO protocols.

Version 6.70: Added support for new E1000BASET1 (Automotive Ethernet 1000BaseT1), DPAUX (DisplayPort Aux), and CPHY2 (MIPI C-PHY 2.0) protocols.

:BUS<B>:BIT<M>

**Command** :BUS<B>:BIT<M> {ON | OFF | 1 | 0}

**NOTE**

The BUS commands only apply to the MSO oscilloscopes.

The :BUS<B>:BIT<M> command includes or excludes the selected bit as part of the definition for the selected bus. If the parameter is a 1 (ON) then the bit is included in the definition. If the parameter is a 0 (OFF) then the bit is excluded from the definition. The digital subsystem must be enabled for this command will work. See ENABLE command in the root subsystem.

<M> An integer, 0-15.

<N> An integer, 1-4.

**Example** This example includes bit 1 as part of the bus 1 definition.

```
myScope.WriteString ":ENABLE DIGital"
myScope.WriteString ":BUS1:BIT1 ON"
```

**Query** :BUS<B>:BIT<M>?

The :BUS<B>:BIT<M>? query returns the value indicating whether the specified bit is included or excluded from the specified bus definition.

**Returned Format** [:BUS<B>:BIT<M>] {1 | 0}<NL>

**History** Legacy command (existed before version 3.10).



**:BUS<B>:BITS**

**Command** :BUS<B>:BITS <channel\_list>,{ON | OFF| 1 | 0}

**NOTE**

The BUS commands only apply to the MSO oscilloscopes.

The :BUS<B>:BITS command includes or excludes the selected bits in the channel list in the definition of the selected bus. If the parameter is a 1 (ON) then the bits in the channel list are included as part of the selected bus definition. If the parameter is a 0 (OFF) then the bits in the channel list are excluded from the definition of the selected bus. The digital subsystem must be enabled for this command will work. See ENABLE command in the root subsystem.

<N> An integer, 1- 4.

<channel\_list> The channel range is from 0 to 15 in the following format.

@1,5,7,9)	channels 1, 5, 7, and 9 are turned on.
@1:15)	channels 1 through 15 are turned on.
@1:5,8,14)	channels 1 through 5, channel 8, and channel 14 are turned on.

**NOTE**

The parentheses are part of the expression and are necessary.

**Example** This example includes bits 1, 2, 4, 5, 6, 7, 8, and 9 as part of the bus 1 definition.

```
myScope.WriteString ":ENABle DIGital"
myScope.WriteString ":BUS1:BITS (@1,2,4:9),ON"
```

**Query** :BUS<B>:BITS?

The :BUS<B>:BITS? query returns the definition for the specified bus.

**Returned Format** [:BUS<B>:BITS] <channel\_list>,{1 | 0}<NL>

**History** Legacy command (existed before version 3.10).

:BUS<B>:CLEAr

**Command** :BUS<B>:CLEAr

**NOTE**

The BUS commands only apply to the MSO oscilloscopes.

---

The :BUS<B>:CLEAr command excludes all of the digital channels from the selected bus definition.

<N> An integer, 1-4.

**Example** This example excludes all the digital channels from the bus 1 definition.

```
myScope.WriteString ":BUS1:CLEAr"
```

**History** Legacy command (existed before version 3.10).

**:BUS<B>:CLOCK**

**Command** :BUS<B>:CLOCK {CHANnel<N> | DIGital<M> | NONE}

**NOTE**

The BUS commands only apply to the MSO oscilloscopes.

The :BUS<B>:CLOCK command sets the digital or analog channel used as the clock for decoding the bus values.

<M> An integer, 0-15.

<N> An integer, 1-4 in a single oscilloscope, 1-40 in a MultiScope system.

<O> An integer, 1-4.

**Example** This example sets the clock to channel 1 for bus 1.

```
myScope.WriteString ":ENABLE DIGital"
myScope.WriteString ":BUS1:CLOCK CHANnel1"
```

**Query** :BUS<B>:CLOCK?

The :BUS<B>:CLOCK query returns the channel being used for the specified bus.

**Returned Format** [:BUS<B>:CLOCK] {CHANnel<O> | DIGital<M> | NONE}<NL>

**History** Legacy command (existed before version 3.10).

**:BUS<B>:CLOCK:SLOPe**

**Command** :BUS<B>:CLOCK:SLOPe {RISing | FALLing | EITHer}

**NOTE**

The BUS commands only apply to the MSO oscilloscopes.

The :BUS<B>:CLOCK:SLOPe command sets the clock edge used for decoding the bus values.

<O> An integer, 1-4.

**Example** This example sets the clock edge to falling for bus 1.

```
myScope.WriteString ":ENABLE DIGital"
myScope.WriteString ":BUS1:CLOCK:SLOPE FALLING"
```

**Query** :BUS<B>:CLOCK:SLOPe?

The :BUS<B>:CLOCK:SLOPe query returns the clock edge being used for the specified bus.

**Returned Format** [:BUS<B>:CLOCK:SLOPe] {RISing | FALLing | EITHer}<NL>

**History** Legacy command (existed before version 3.10).

**:BUS<B>:DISPlay**

**Command** :BUS<B>[:DISPlay] {ON | OFF | 1 | 0}

**NOTE**

The BUS commands only apply to the MSO oscilloscopes.

The :BUS<B>:DISPlay command enables or disables the view of the selected bus. The digital subsystem must be enabled before this command will work. See the ENABLE command in the root subsystem.

<N> An integer, 1- 4.

**Example** This example enables the viewing of bus 1.

```
myScope.WriteString ":ENABLE DIGital"
myScope.WriteString ":BUS1 ON"
```

**Query** :BUS<B>[:DISPlay]?

The :BUS<B>[:DISPlay]? query returns the display value of the selected bus.

**Returned Format** [:BUS<B>] {1 | 0}<NL>

**History** Legacy command (existed before version 3.10).

:BUS<B>:LABel

**Command** :BUS<B>:LABel <quoted\_string>

**NOTE**

The BUS commands only apply to the MSO oscilloscopes.

---

The :BUS<B>:LABel command sets the bus label to the quoted string. Setting a label for a bus will also result in the name being added to the label list.

**NOTE**

Label strings are 16 characters or less, and may contain any commonly used ASCII characters. Labels with more than 16 characters are truncated to 16 characters.

<N> An integer, 1- 4.

<quoted\_string> A series of 6 or less characters as a quoted ASCII string.

**Example** This example sets the bus 1 label to Data.

```
myScope.WriteString ":BUS1:LABel "Data""
```

**Query** :BUS<B>:LABel?

The :BUS<B>:LABel? query returns the name of the specified bus.

**Returned Format** [:BUS<B>:LABel] <quoted\_string><NL>

**History** Legacy command (existed before version 3.10).

**:BUS<B>:READout**

**Command** :BUS<B>:READout {DECimal | HEX | SIGNed | SYMBOL}

**NOTE**

The BUS commands only apply to the MSO oscilloscopes.

The :BUS<B>:READout command changes the format of the numbers displayed in the bus waveform.

**<N>** An integer, 1-4.

**Example** This example sets the bus read out to decimal.

```
myScope.WriteString ":BUS1:READout DECimal"
```

**Query** :BUS<B>:READout?

The :BUS<B>:READout? query returns the format of the readout control.

**Returned Format** [:BUS<B>:READout] {DECimal | HEX | SIGNed | SYMBOL}<NL>

**History** Legacy command (existed before version 3.10).





# 14 Calibration Commands

:CALibrate:DATE? / 331  
:CALibrate:OUTPut / 332  
:CALibrate:OUTPut:AUX / 334  
:CALibrate:OUTPut:AUX:RTIME / 335  
:CALibrate:OUTPut:CAL / 336  
:CALibrate:SKEW / 337  
:CALibrate:STATus? / 338  
:CALibrate:TEMP? / 339

This chapter briefly explains the calibration of the oscilloscope. It is intended to give you and the calibration lab personnel an understanding of the calibration procedure and how the calibration subsystem is intended to be used.

The commands in the CALibration subsystem allow you to change the output of the front-panel Aux Out connector, adjust the skew of channels, and check the status of calibration.

These CALibration commands and queries are implemented in the Infiniium oscilloscopes:

This chapter briefly explains the calibration of the oscilloscope. It is intended to give you and the calibration lab personnel an understanding of the calibration procedure and how the calibration subsystem is intended to be used.

**Oscilloscope Calibration** Oscilloscope calibration establishes calibration factors for the oscilloscope. These factors are stored on the oscilloscope's hard disk.

- Initiate the calibration from the "Utilities Calibration" menu.

You should calibrate the oscilloscope periodically (at least annually), or if the ambient temperature since the last calibration has changed more than  $\pm 5$  °C. The temperature change since the last calibration is shown on the calibration status screen which is found under the "Utilities Calibration" dialog. It is the line labeled "Calibration  $\Delta$  Temp: \_ °C."

See also the oscilloscope's *Service Guide* has more details about the calibration.

**Probe Calibration** Probe calibration establishes the gain and offset of a probe that is connected to a channel of the oscilloscope, and applies these factors to the calibration of that channel.

- Initiate probe calibration from the "Setup > Channel > Probes > Calibrate Probe" menu.

To achieve the specified accuracy ( $\pm 2\%$ ) with a probe connected to a channel, make sure the oscilloscope is calibrated.

- For probes that the oscilloscope can identify through the probe power connector, like the 1158A, the oscilloscope automatically adjusts the vertical scale factors for that channel even if a probe calibration is not performed.
- For nonidentified probes, the oscilloscope adjusts the vertical scale factors only if a probe calibration is performed.
- If you do not perform a probe calibration but want to use an unidentified probe, enter the attenuation factor in the "Setup > Channel > Probes > Configure Probing System > User Defined Probe" menu.
  - If the probe being calibrated has an attenuation factor that allows the oscilloscope to adjust the gain (in hardware) to produce even steps in the vertical scale factors, the oscilloscope will do so.
  - If the probe being calibrated has an unusual attenuation, like 3.75, the oscilloscope may have to adjust the vertical scale factors to an unusual number, like 3.75 V/div.

Typically, probes have standard attenuation factors such as divide by 10, divide by 20, or divide by 100.

## :CALibrate:DATE?

**Query** :CALibrate:DATE?

The :CALibrate:DATE? query returns two calibration dates and times:

- The date and time of the last regular user calibration.
- The date and time of the last time scale calibration.

**Returned Format** [:CALibrate:DATE] <user\_date\_time>,<ts\_date\_time><NL>

The string returned is formatted like "<day> <month> <year>  
<hours>:<minutes>:<seconds>,<day> <month> <year>  
<hours>:<minutes>:<seconds>", for example "31 MAY 2013 12:52:45,4 DEC 2012  
10:59:52".

**History** Legacy command (existed before version 3.10).

**:CALibrate:OUTPut**

**Command** :CALibrate:OUTPut {AC | TRIGOUT | DC,<dc\_value> | ZERO | ONE | DPULse  
| SOSC | HFOSC | PRBS7 | PRBS15 | PRBS31}

The :CALibrate:OUTPut command sets the coupling frequency, trigger output pulse, and dc level of the calibrator waveform output through the front-panel Aux Out connector.

Options on all oscilloscopes:

- AC – sets the Aux Out to be the probe compensation square wave (approximately 750 Hz).
- TRIGOUT – outputs a pulse when the trigger event occurs. Use this to trigger other instruments.
- DC,<dc\_value> – a DC level value in volts. The <dc\_value> is a real number from -2.4 V to +2.4 V dc.

Options on 90000A Series, 90000 X-Series, V-Series, 90000 Q-Series, and Z-Series oscilloscopes:

- ZERO – a -450 mV DV level.
- ONE – a -150 mV DC level.
- DPULse – A double-pulse signal.
- SOSC – The 100 MHz reference clock output.
- HFOSC – A high-frequency oscillator output.

Options on 90000 X-Series, V-Series, 90000 Q-Series, and Z-Series oscilloscopes:

- PRBS7 – Pseudo-Random Binary Sequence with maximum length  $2^7-1$  bits, and its inverted version.
- PRBS15 – Pseudo-Random Binary Sequence with maximum length  $2^{15}-1$  bits, and its inverted version.
- PRBS31 – Pseudo-Random Binary Sequence with maximum length  $2^{31}-1$  bits, and its inverted version.

**Example** This example puts a DC voltage of 2.0 volts on the oscilloscope front-panel Aux Out connector.

```
myScope.WriteString ":CALibrate:OUTPut DC,2.0"
```

**Query** :CALibrate:OUTPut?

The :CALibrate:OUTPut? query returns the current setup.

**Returned Format** [:CALibrate:OUTPut] {AC | TRIGOUT | DC,<dc\_value> | ZERO | ONE | DPULse  
| SOSC | HFOSC | PRBS7 | PRBS15 | PRBS31}

**Example** This example places the current selection for the DC calibration to be printed in the string variable, strSelection, then prints the contents of the variable to the computer's screen.

```
Dim strSelection As String 'Dimension variable
myScope.WriteString ":CALibrate:OUTPut?"
strSelection = myScope.ReadString
Debug.Print strSelection
```

**History** Legacy command (existed before version 3.10).

Version 6.10: Added the PRBS7, PRBS15, and PRBS31 options for the Infiniium 90000 X-Series, V-Series, 90000 Q-Series, and Z-Series oscilloscopes.

**:CALibrate:OUTPut:AUX**

**Command** :CALibrate:OUTPut:AUX {{0 | OFF} | {1 | ON}}

The :CALibrate:OUTPut:AUX command enables or disables signal output on the oscilloscope's Aux Out connector.

**NOTE**

On the Infiniium S-Series, 9000 Series, or 90000A Series oscilloscopes, the only valid setting for this command is ON or 1.

**Query** :CALibrate:OUTPut:AUX?

The :CALibrate:OUTPut:AUX? query returns the Aux Out enable/disable setting.

**Returned Format** <setting><NL>

<setting> ::= {0 | 1}

- See Also**
- **":CALibrate:OUTPut"** on page 332
  - **":CALibrate:OUTPut:AUX:RTIME"** on page 335
  - **":CALibrate:OUTPut:CAL"** on page 336

**History** New in version 6.00.

**:CALibrate:OUTPut:AUX:RTIME**

**Command** :CALibrate:OUTPut:AUX:RTIME <risetime>

The :CALibrate:OUTPut:AUX:RTIME command specifies the speed of the Aux Out signal's rise time.

<risetime> {FAST | SLOW | RFAST}

**NOTE**

The RFAST option is available with the 9000 Series oscilloscopes only.

**Query** :CALibrate:OUTPut:AUX:RTIME?

The :CALibrate:OUTPut:AUX:RTIME? query returns the Aux Out rise time setting.

**Returned Format** <risetime><NL>

<risetime> ::= {FAST | SLOW | RFAST}

- See Also**
- **":CALibrate:OUTPut"** on page 332
  - **":CALibrate:OUTPut:AUX"** on page 334
  - **":CALibrate:OUTPut:CAL"** on page 336

**History** New in version 6.00.

**:CALibrate:OUTPut:CAL**

**Command** :CALibrate:OUTPut:CAL {{0 | OFF} | {1 | ON}}

The :CALibrate:OUTPut:CAL command enables or disables signal output on the oscilloscope's Cal Out connector.

**NOTE**

On the Infiniium S-Series, 9000 Series, or 90000A Series oscilloscopes, the only valid setting for this command is OFF or 0 because there is no Cal Out connector.

**Query** :CALibrate:OUTPut:CAL?

The :CALibrate:OUTPut:CAL? query returns the Cal Out enable/disable setting.

**Returned Format** <setting><NL>

<setting> ::= {0 | 1}

- See Also**
- **":CALibrate:OUTPut"** on page 332
  - **":CALibrate:OUTPut:AUX"** on page 334
  - **":CALibrate:OUTPut:AUX:RTIME"** on page 335

**History** New in version 6.00.



## :CALibrate:SKEW

**Command** :CALibrate:SKEW <source>,<skew\_value>

<source> ::= {CHANnel<N> | DIFF<D> | COMMONmode<C>}

The :CALibrate:SKEW command sets the channel-to-channel skew factor for a channel. The numeric argument is a real number in seconds, which is added to the current time base position to shift the position of the channel's data in time. Use this command to compensate for differences in the electrical lengths of input paths due to cabling and probes.

<N> An integer, 1-4.

<D>, <C> <D> is an integer, 1-2. <C> is an integer, 3-4.

The DIFF and COMMONmode sources are just aliases that can be used in place of the channel names to apply to differential or common mode signals. These are just aliases - no state change occurs if you refer to a differential channel and you are not in differential mode. DIFF1 refers to the differential signal between channels 1 and 3 (and COMMONmode3 refers to the common mode channel between these same channels). DIFF2 refers to the differential signal between channels 2 and 4 (and COMMONmode4 refers to the common mode channel between these same channels).

<skew\_value> A real number, in seconds.

**Example** This example sets the oscilloscope channel 1 skew to 1  $\mu$ s.

```
myScope.WriteString ":CALibrate:SKEW CHANnel1,1E-6"
```

**Query** :CALibrate:SKEW? <source>

The :CALibrate:SKEW? query returns the current skew value.

**Returned Format** [:CALibrate:SKEW] <skew\_value><NL>

**History** Legacy command (existed before version 3.10).

## :CALibrate:STATus?

**Query** :CALibrate:STATus?

The :CALibrate:STATus? query returns the calibration status of the oscilloscope. These are ten, comma-separated integers, with 1, 0, or -1. A "1" indicates pass, a "0" indicates fail and a "-1" indicates unused. This matches the status in the Calibration dialog box in the Utilities menu.

**Returned Format** [:CALibrate:STATus] <status>

<status> <Oscilloscope Frame Status>, <Channel1 Vertical>, <Channel1 Trigger>, <Channel2 Vertical>, <Channel2 Trigger>, <Channel3 Vertical>, <Channel3 Trigger>, <Channel4 Vertical>, <Channel4 Trigger>, <Aux Trigger>

**History** Legacy command (existed before version 3.10).

## :CALibrate:TEMP?

**Query** :CALibrate:TEMP?

The :CALibrate:TEMP? query returns two delta temperature values in Celsius:

- Between the current temp and the temp of the last time scale calibration.
- Between the current temp and the temp of the last regular user calibration.

**Returned Format** [:CALibrate:TEMP] <ts\_delta\_temp>,<user\_delta\_temp><NL>

For example, the string returned could be "-1,0". A difference in the two delta values of one degree is not uncommon.

**History** Legacy command (existed before version 3.10).



# 15 Channel Commands

:CHANnel<N>:BWLimit (9000 Series, 9000H Series, S-Series) / 344  
:CHANnel<N>:COMMonmode / 345  
:CHANnel<N>:DIFFerential / 346  
:CHANnel<N>:DIFFerential:SKEW / 347  
:CHANnel<N>:DISPlay / 348  
:CHANnel<N>:DISPlay:AUTO / 349  
:CHANnel<N>:DISPlay:OFFSet / 351  
:CHANnel<N>:DISPlay:RANGe / 353  
:CHANnel<N>:DISPlay:SCALe / 355  
:CHANnel<N>:INPut / 357  
:CHANnel<N>:INVert / 358  
:CHANnel<N>:ISIM:APPLy / 359  
:CHANnel<N>:ISIM:BANDwidth / 360  
:CHANnel<N>:ISIM:BWLimit / 362  
:CHANnel<N>:ISIM:BWLimit:TYPE / 364  
:CHANnel<N>:ISIM:CONVolve / 365  
:CHANnel<N>:ISIM:CORRection / 366  
:CHANnel<N>:ISIM:DEConvolve / 368  
:CHANnel<N>:ISIM:DELay / 369  
:CHANnel<N>:ISIM:NORMAlize / 370  
:CHANnel<N>:ISIM:PEXTraction / 371  
:CHANnel<N>:ISIM:SPAN / 373  
:CHANnel<N>:ISIM:STATe / 374  
:CHANnel<N>:LABel / 375  
:CHANnel<N>:OFFSet / 376  
:CHANnel<N>:PROBe:ACCAL / 377  
:CHANnel<N>:PROBe:ATTenuation / 379  
:CHANnel<N>:PROBe:AUTOzero / 380  
:CHANnel<N>:PROBe:COUPLing / 381  
:CHANnel<N>:PROBe:EADapter / 382  
:CHANnel<N>:PROBe:ECOupling / 385  
:CHANnel<N>:PROBe:EXTernal / 386

```

:CHANnel<N>:PROBe:EXtErnal:GAIN / 387
:CHANnel<N>:PROBe:EXtErnal:OFFSet / 388
:CHANnel<N>:PROBe:EXtErnal:UNITs / 389
:CHANnel<N>:PROBe:GAIN / 390
:CHANnel<N>:PROBe:HEAD:ADD / 391
:CHANnel<N>:PROBe:HEAD:DELeTe ALL / 392
:CHANnel<N>:PROBe:HEAD:SELeCt / 393
:CHANnel<N>:PROBe:HEAD:VTErm / 394
:CHANnel<N>:PROBe:ID? / 395
:CHANnel<N>:PROBe:INFO? / 396
:CHANnel<N>:PROBe:MODE / 397
:CHANnel<N>:PROBe:PREcprobe:BANDwidth / 398
:CHANnel<N>:PROBe:PREcprobe:CALibration / 399
:CHANnel<N>:PROBe:PREcprobe:DELay / 400
:CHANnel<N>:PROBe:PREcprobe:MODE / 401
:CHANnel<N>:PROBe:PREcprobe:ZSRC / 402
:CHANnel<N>:PROBe:PRIMary (9000 Series, 9000H Series, S-Series) / 404
:CHANnel<N>:PROBe:RESPonsivity / 405
:CHANnel<N>:PROBe:SKEW / 406
:CHANnel<N>:PROBe:SKEW:AUTO / 407
:CHANnel<N>:PROBe:STYPe / 408
:CHANnel<N>:PROBe:USER / 409
:CHANnel<N>:PROBe:WAVelength / 411
:CHANnel<N>:RANGe / 412
:CHANnel<N>:SCALE / 413
:CHANnel<N>:SIMulation:AMPLitude / 414
:CHANnel<N>:SIMulation:DATA:LENGth / 415
:CHANnel<N>:SIMulation:DATA:ODD / 416
:CHANnel<N>:SIMulation:DATA:PAM / 417
:CHANnel<N>:SIMulation:DATA:RESeed / 418
:CHANnel<N>:SIMulation:DATA:SELeCtion / 419
:CHANnel<N>:SIMulation:DRATe / 420
:CHANnel<N>:SIMulation:FILTer:ISIM:ADDReSS / 421
:CHANnel<N>:SIMulation:FILTer:ISIM:PEXTraction / 422
:CHANnel<N>:SIMulation:FILTer:SELeCtion / 423
:CHANnel<N>:SIMulation:FLOad:ADDReSS / 424
:CHANnel<N>:SIMulation:FLOad:LOOP / 425
:CHANnel<N>:SIMulation:FREQuency / 426
:CHANnel<N>:SIMulation:FUNCTion:SELeCtion / 427

```

```

:CHANnel<N>:SIMulation:FUNction:SQUare:DCYCLE / 428
:CHANnel<N>:SIMulation:FUNction:SQUare:FTIME / 429
:CHANnel<N>:SIMulation:FUNction:SQUare:RTIME / 430
:CHANnel<N>:SIMulation:JITTer / 431
:CHANnel<N>:SIMulation:JITTer:ABUJ / 432
:CHANnel<N>:SIMulation:JITTer:PERiodic<M>:ENABle / 433
:CHANnel<N>:SIMulation:JITTer:PERiodic<M>:FREQuency / 434
:CHANnel<N>:SIMulation:JITTer:PERiodic<M>:MAGNitude / 435
:CHANnel<N>:SIMulation:JITTer:PERiodic<M>:SHAPE / 436
:CHANnel<N>:SIMulation:JITTer:RANDom / 437
:CHANnel<N>:SIMulation:NOISe / 438
:CHANnel<N>:SIMulation:NOISe:BWLimit / 439
:CHANnel<N>:SIMulation:NOISe:PERiodic<M>:ENABle / 440
:CHANnel<N>:SIMulation:NOISe:PERiodic<M>:FREQuency / 441
:CHANnel<N>:SIMulation:NOISe:PERiodic<M>:MAGNitude / 442
:CHANnel<N>:SIMulation:NOISe:PERiodic<M>:SHAPE / 443
:CHANnel<N>:SIMulation:NOISe:RANDom / 444
:CHANnel<N>:SIMulation:OFFSet / 445
:CHANnel<N>:SIMulation:WAVEform / 446
:CHANnel<N>:UNITs / 447

```

The CHANnel subsystem commands control all vertical (Y axis) functions of the oscilloscope. You may toggle the channel displays on and off with the root level commands :VIEW and :BLANK, or with :CHANnel:DISPlay.

## NOTE

In this section, you can specify differential and/or common mode channels using the following convention. If you have differential or common mode channels enabled (using either the :CHANnel<N>:DIFFerential or :CHANnel<N>:COMMonmode commands) then:

- :CHANnel1 would refer to the Channel 1 - Channel 3 differential channel
- :CHANnel2 would refer to the Channel 2 - Channel 4 differential channel
- :CHANnel3 would refer to the Channel 1 + Channel 3 common mode channel
- :CHANnel4 would refer to the Channel 2 + Channel 4 common mode channel

## :CHANnel&lt;N&gt;:BWLimit (9000 Series, 9000H Series, S-Series)

**Command** :CHANnel<N>:BWLimit {{ON | 1} | {OFF | 0}} **for 9000, 9000H Series**  
 :CHANnel<N>:BWLimit {{OFF | 0} | 20e6 | 200e6} **for S-Series**

On Infiniium 9000 Series or S-Series oscilloscopes, the :CHANnel<N>:BWLimit command controls the input channel's low-pass filter. When ON (or set to a value), the bandwidth of the specified channel is limited. The bandwidth filter can be used with either AC or DC coupling.

- On Infiniium 9000 Series oscilloscopes, 1M  $\Omega$  input impedance must be selected before you can turn on the 20 MHz low-pass filter (see **":CHANnel<N>:INPut"** on page 357).
- On Infiniium S-Series oscilloscopes, 20 MHz or 200 MHz low pass filters can be turned on (without a passive probe being connected).

You can enable custom bandwidth limits using the :CHANnel<N>:ISIM:BWLimit command. You can specify the custom bandwidth limit value with the :CHANnel<N>:ISIM:BANDwidth command.

<N> An integer, 1-4.

**Example** This example sets the internal low-pass filter to "ON" for channel 1.

```
myScope.WriteString ":CHANnel1:BWLimit ON"
```

**Query** :CHANnel<N>:BWLimit?

The :CHANnel<N>:BWLimit? query returns the current state of the low-pass filter for the specified channel.

**Returned Format** [:CHANnel<N>:BWLimit] {1 | 0}<NL> **for 9000, 9000H Series**  
 [:CHANnel<N>:BWLimit] {0 | 20e6 | 200e6}<NL> **for S-Series**

**Example** This example places the current setting of the low-pass filter in the variable varLimit, then prints the contents of the variable to the computer's screen.

```
myScope.WriteString ":SYSTem:HEADer OFF"
myScope.WriteString ":CHANnel1:BWLimit?"
varLimit = myScope.ReadNumber
Debug.Print FormatNumber(varLimit, 0)
```

- See Also**
- **":CHANnel<N>:INPut"** on page 357
  - **":CHANnel<N>:ISIM:BWLimit"** on page 362
  - **":CHANnel<N>:ISIM:BANDwidth"** on page 360
  - **":ACQuire:BANDwidth"** on page 241

**History** Legacy command (existed before version 3.10).



## :CHANnel&lt;N&gt;:COMMONmode

**Command** :CHANnel<N>:COMMONmode {{ON | 1} | {OFF | 0}}

The :CHANnel<N>:COMMONmode command turns on/off common mode for the channel. Channels 2 and 4 may form a common mode channel and Channels 1 and 3 may form a common mode channel.

<N> An integer, 1-4 in a single oscilloscope, 1-40 in a MultiScope system.

**Example** This example turns channel 1 common mode channel on (channel 1 + channel 3).

```
myScope.WriteString ":CHANnel1:COMMONmode ON"
```

**Query** :CHANnel<N>:COMMONmode?

The :CHANnel<N>:COMMONmode? query returns whether the channel is in commonmode or not.

**Returned Format** [:CHANnel<N>:COMMONmode] {1 | 0}<NL>

**Example** This example places the current common mode setting of the channel 1 display in the variable varComm, then prints the contents of the variable to the computer's screen.

```
myScope.WriteString ":SYSTEM:HEADer OFF"
myScope.WriteString ":CHANnel1:COMMONmode?"
varComm = myScope.ReadNumber
Debug.Print FormatNumber(varComm, 0)
```

**History** Legacy command (existed before version 3.10).

**:CHANnel<N>:DIFFerential**

**Command** :CHANnel<N>:DIFFerential {{ON | 1} | {OFF | 0}}

The :CHANnel<N>:DIFFerential command turns on/off differential mode for the channel. Channels 1 and 3 may form a differential channel and Channels 2 and 4 may form a differential channel.

When differential channel modes are turned on, you can specify the display vertical scale, range, and offsets for the differential or common mode signals (using the :CHANnel<N>:DISPlay:SCALE, :CHANnel<N>:DISPlay:RANGe, or :CHANnel<N>:DISPlay:OFFSet commands), or you can set the display vertical scale, range, and offsets to track the acquisition vertical scale and offset (using the :CHANnel<N>:DISPlay:AUTO command).

<N> An integer, 1-4 in a single oscilloscope, 1-40 in a MultiScope system.

**Example** This example turns channel 1 differential on (channel 1 - channel 3).

```
myScope.WriteString ":CHANnel1:DIFFerential ON"
```

**Query** :CHANnel<N>:DIFFerential?

The :CHANnel<N>:DIFFerential? query returns whether the channel is in differential mode or not.

**Returned Format** [:CHANnel<N>:DIFFerential] {1 | 0}<NL>

**Example** This example places the current differential setting of the channel 1 display in the variable varDiff, then prints the contents of the variable to the computer's screen.

```
myScope.WriteString ":SYSTem:HEADer OFF"
myScope.WriteString ":CHANnel1:DIFFerential?"
varDiff = myScope.ReadNumber
Debug.Print FormatNumber(varDiff, 0)
```

**See Also**

- [":CHANnel<N>:DISPlay:AUTO"](#) on page 349
- [":CHANnel<N>:DISPlay:OFFSet"](#) on page 351
- [":CHANnel<N>:DISPlay:RANGe"](#) on page 353
- [":CHANnel<N>:DISPlay:SCALE"](#) on page 355

**History** Legacy command (existed before version 3.10).

## :CHANnel&lt;N&gt;:DIFFerential:SKEW

**Command** :CHANnel<N>:DIFFerential:SKEW <skew>

The :CHANnel<N>:DIFFerential:SKEW <skew> command sets the skew that is applied to the differential or common mode pair of channels.

<skew> A real number for the skew value

**Example** This example sets the skew applied to the channel 1 - channel 3 differential channel to 10  $\mu$ s.

```
myScope.WriteString ":CHANnel1:DIFFerential:SKEW 10E-6"
```

**Query** :CHANnel<N>:DIFFerential:SKEW?

The :CHANnel<N>:DIFFerential:SKEW? query returns the skew that is applied to the differential or common mode pair of channels.

**Returned Format** [:CHANnel<N>:DIFFerential:SKEW] <skew\_value><NL>

**Example** This example places the current skew setting of the channel 1 - channel 3 differential channel in the variable varSkew, then prints the contents of the variable to the computer's screen.

```
myScope.WriteString ":SYSTem:HEADer OFF"
myScope.WriteString ":CHANnel1:DIFFerential:SKEW?"
varSkew = myScope.ReadNumber
Debug.Print FormatNumber(varSkew, 0)
```

**History** Legacy command (existed before version 3.10).

**:CHANnel<N>:DISPlay**

**Command** :CHANnel<N>:DISPlay {{ON | 1} | {OFF | 0}}

The :CHANnel<N>:DISPlay command turns the display of the specified channel on or off.

**NOTE**

You can specify differential and/or common mode channels using the following convention. If you have differential or common mode channels enabled (using either the :CHANnel<N>:DIFFerential or :CHANnel<N>:COMMONmode commands) then:

- :CHANnel1 would refer to the Channel 1 - Channel 3 differential channel
- :CHANnel2 would refer to the Channel 2 - Channel 4 differential channel
- :CHANnel3 would refer to the Channel 1 + Channel 3 common mode channel
- :CHANnel4 would refer to the Channel 2 + Channel 4 common mode channel

<N> An integer, 1-4 in a single oscilloscope, 1-40 in a MultiScope system.

**Example** This example sets channel 1 display to on.

```
myScope.WriteString ":CHANnel1:DISPlay ON"
```

**Query** :CHANnel<N>:DISPlay?

The :CHANnel<N>:DISPlay? query returns the current display condition for the specified channel.

**Returned Format** [:CHANnel<N>:DISPlay] {1 | 0}<NL>

**Example** This example places the current setting of the channel 1 display in the variable varDisplay, then prints the contents of the variable to the computer's screen.

```
myScope.WriteString ":SYSTEM:HEADer OFF"
myScope.WriteString ":CHANnel1:DISPlay?"
varDisplay = myScope.ReadNumber
Debug.Print FormatNumber(varDisplay, 0)
```

**History** Legacy command (existed before version 3.10).

## :CHANnel&lt;N&gt;:DISPlay:AUTO

**Command** :CHANnel<N>:DISPlay:AUTO {{ON | 1} | {OFF | 0}}

**NOTE**

This command only works when differential channel modes are turned on (using the :CHANnel<N>:DIFFerential command).

When differential channel modes are turned on:

- ON – sets the differential and common mode display vertical scale and offset to track the acquisition vertical scale and offset.

In this case, the differential and common mode display vertical scale and offsets are set using the normal :CHANnel<N>:SCALE, :CHANnel<N>:RANGE, or :CHANnel<N>:OFFSet commands.

- OFF – the differential and common mode display vertical scale and offset are set using the the :CHANnel<N>:DISPlay:SCALE, :CHANnel<N>:DISPlay:RANGE, or :CHANnel<N>:DISPlay:OFFSet commands.

<N> An integer, 1-4 in a single oscilloscope, 1-40 in a MultiScope system.

**NOTE**

You can specify differential and/or common mode channels using the following convention. If you have differential or common mode channels enabled (using either the :CHANnel<N>:DIFFerential or :CHANnel<N>:COMMonmode commands) then:

- :CHANnel1 would refer to the Channel 1 - Channel 3 differential channel
- :CHANnel2 would refer to the Channel 2 - Channel 4 differential channel
- :CHANnel3 would refer to the Channel 1 + Channel 3 common mode channel
- :CHANnel4 would refer to the Channel 2 + Channel 4 common mode channel

**Example** This example sets the channel 1 - channel 3 differential channel display scale and offset to track the acquisition scale and offset.

```
myScope.WriteString ":CHANnel1:DISPlay:AUTO ON"
```

**Query** :CHANnel<N>:DISPlay:AUTO?

The :CHANnel<N>:DISPlay:AUTO? query returns whether or not the differential or common mode display scale and offset are tracking the acquisition scale and offset.

**Returned Format** [:CHANnel<N>:DISPlay:AUTO] {1 | 0}<NL>

**Example** This example places whether or not the channel 1 - channel 3 differential channel display scale and offset is tracking the acquisition scale and offset in the variable varAuto, then prints the contents of the variable to the computer's screen.

```
myScope.WriteString ":SYSTem:HEADer OFF"
myScope.WriteString ":CHANnel1:DISPlay:AUTO?"
```

```
varAuto = myScope.ReadNumber  
Debug.Print FormatNumber(varAuto, 0)
```

- See Also**
- [":CHANnel<N>:DIFFerential"](#) on page 346
  - [":CHANnel<N>:DISPlay:OFFSet"](#) on page 351
  - [":CHANnel<N>:DISPlay:RANGe"](#) on page 353
  - [":CHANnel<N>:DISPlay:SCALe"](#) on page 355
  - [":CHANnel<N>:OFFSet"](#) on page 376
  - [":CHANnel<N>:RANGe"](#) on page 412
  - [":CHANnel<N>:SCALe"](#) on page 413

**History** Legacy command (existed before version 3.10).

**:CHANnel<N>:DISPlay:OFFSet**

**Command** :CHANnel<N>:DISPlay:OFFSet <value>

**NOTE**

This command only works when differential channel modes are turned on (using the :CHANnel<N>:DIFFerential command).

When differential channel modes are turned on, the :CHANnel<N>:DISPlay:OFFSet command sets the display vertical offset of the selected channel.

If the differential and common mode display vertical scale and offset is set to track the acquisition vertical scale and offset (:CHANnel<N>:DISPlay:AUTO ON), using the :CHANnel<N>:DISPlay:OFFSet command turns OFF auto tracking, and the :CHANnel<N>:DISPlay:SCALe, :CHANnel<N>:DISPlay:RANGe, and :CHANnel<N>:DISPlay:OFFSet commands are used to specify the display vertical scale, range, and offsets for the differential or common mode signals.

<value> A real number for the value variable

**NOTE**

You can specify differential and/or common mode channels using the following convention. If you have differential or common mode channels enabled (using either the :CHANnel<N>:DIFFerential or :CHANnel<N>:COMMonmode commands) then:

- :CHANnel1 would refer to the Channel 1 - Channel 3 differential channel
- :CHANnel2 would refer to the Channel 2 - Channel 4 differential channel
- :CHANnel3 would refer to the Channel 1 + Channel 3 common mode channel
- :CHANnel4 would refer to the Channel 2 + Channel 4 common mode channel

**Example** This example sets the displayed offset of channel 1 to

```
myScope.WriteString ":CHANnel1:DISPlay:RANGe 10e-6"
```

**Query** :CHANnel<N>:DISPlay:OFFSet?

The :CHANnel<N>:DISPlay:OFFSet? query returns the displayed offset for the selected channel.

**Returned Format** [:CHANnel<N>:DISPlay:OFFSet] <value><NL>

**Example** This example places the displayed offset of channel 1 in the variable varOffset, then prints the contents of the variable to the computer's screen.

```
myScope.WriteString ":SYSTem:HEADer OFF"
myScope.WriteString ":CHANnel1:DISPlay:OFFSet?"
varOffset = myScope.ReadNumber
Debug.Print FormatNumber (varOffset, 0)
```

**See Also**

- **":CHANnel<N>:DIFFerential"** on page 346
- **":CHANnel<N>:DISPlay:AUTO"** on page 349

- **":CHANnel<N>:DISPlay:RANGe"** on page 353
- **":CHANnel<N>:DISPlay:SCALe"** on page 355

**History** Legacy command (existed before version 3.10).



## :CHANnel&lt;N&gt;:DISPlay:RANGe

**Command** :CHANnel<N>:DISPlay:RANGe <range>

**NOTE**

This command only works when differential channel modes are turned on (using the :CHANnel<N>:DIFFerential command).

When differential channel modes are turned on, the :CHANnel<N>:DISPlay:RANGe command sets the display full scale vertical range of the selected channel.

If the differential and common mode display vertical scale and offset is set to track the acquisition vertical scale and offset (:CHANnel<N>:DISPlay:AUTO ON), using the :CHANnel<N>:DISPlay:RANGe command turns OFF auto tracking, and the :CHANnel<N>:DISPlay:SCALE, :CHANnel<N>:DISPlay:RANGe, and :CHANnel<N>:DISPlay:OFFSet commands are used to specify the display vertical scale, range, and offsets for the differential or common mode signals.

<range> A real number for the range value

**NOTE**

You can specify differential and/or common mode channels using the following convention. If you have differential or common mode channels enabled (using either the :CHANnel<N>:DIFFerential or :CHANnel<N>:COMMonmode commands) then:

- :CHANnel1 would refer to the Channel 1 - Channel 3 differential channel
- :CHANnel2 would refer to the Channel 2 - Channel 4 differential channel
- :CHANnel3 would refer to the Channel 1 + Channel 3 common mode channel
- :CHANnel4 would refer to the Channel 2 + Channel 4 common mode channel

**Example** This example sets the display range of the display of channel 1 to

```
myScope.WriteString ":CHANnel1:DISPlay:RANGe 10e-6"
```

**Query** :CHANnel<N>:DISPlay:RANGe?

The :CHANnel<N>:DISPlay:RANGe? query returns the full scale vertical range of the display for the selected channel.

**Returned Format** [:CHANnel<N>:DISPlay:RANGe] <range><NL>

**Example** This example places the range of channel 1 in the variable varRange, then prints the contents of the variable to the computer's screen.

```
myScope.WriteString ":SYSTem:HEADer OFF"
myScope.WriteString ":CHANnel1:DISPlay:RANGe?"
varRange = myScope.ReadNumber
Debug.Print FormatNumber (varRange, 0)
```

**See Also**

- [":CHANnel<N>:DIFFerential"](#) on page 346
- [":CHANnel<N>:DISPlay:AUTO"](#) on page 349

- **":CHANnel<N>:DISPlay:OFFSet"** on page 351
- **":CHANnel<N>:DISPlay:SCALe"** on page 355

**History** Legacy command (existed before version 3.10).

## :CHANnel&lt;N&gt;:DISPlay:SCALE

**Command** :CHANnel<N>:DISPlay:SCALE <scale>

**NOTE**

This command only works when differential channel modes are turned on (using the :CHANnel<N>:DIFFerential command).

When differential channel modes are turned on, the :CHANnel<N>:DISPlay:SCALE command sets the display vertical scale (units per division) of the selected channel.

If the differential and common mode display vertical scale and offset is set to track the acquisition vertical scale and offset (:CHANnel<N>:DISPlay:AUTO ON), using the :CHANnel<N>:DISPlay:SCALE command turns OFF auto tracking, and the :CHANnel<N>:DISPlay:SCALE, :CHANnel<N>:DISPlay:RANGE, and :CHANnel<N>:DISPlay:OFFSet commands are used to specify the display vertical scale, range, and offsets for the differential or common mode signals.

<scale> A real number for the scale value

**NOTE**

You can specify differential and/or common mode channels using the following convention. If you have differential or common mode channels enabled (using either the :CHANnel<N>:DIFFerential or :CHANnel<N>:COMMONmode commands) then:

- :CHANnel1 would refer to the Channel 1 - Channel 3 differential channel
- :CHANnel2 would refer to the Channel 2 - Channel 4 differential channel
- :CHANnel3 would refer to the Channel 1 + Channel 3 common mode channel
- :CHANnel4 would refer to the Channel 2 + Channel 4 common mode channel

**Example** This example sets the display scale of channel 1 per division to

```
myScope.WriteString ":CHANnel1:DISPlay:SCALE 10e-6"
```

**Query** :CHANnel<N>:DISPlay:SCALE?

The :CHANnel<N>:DISPlay:SCALE? query returns the displayed scale of the selected channel per division.

**Returned Format** [:CHANnel<N>:DISPlay:SCALE] <scale><NL>

**Example** This example places the display scale of channel 1 in the variable varScale, then prints the contents of the variable to the computer's screen.

```
myScope.WriteString ":SYSTEM:HEADer OFF"
myScope.WriteString ":CHANnel1:DISPlay:SCALE?"
varScale = myScope.ReadNumber
Debug.Print FormatNumber(varScale, 0)
```

**See Also** • [":CHANnel<N>:DIFFerential"](#) on page 346

- **":CHANnel<N>:DISPlay:AUTO"** on page 349
- **":CHANnel<N>:DISPlay:OFFSet"** on page 351
- **":CHANnel<N>:DISPlay:RANGe"** on page 353

**History** Legacy command (existed before version 3.10).

## :CHANnel&lt;N&gt;:INPut

**Command** :CHANnel<N>:INPut <parameter>

The :CHANnel<N>:INPut command selects the input coupling, impedance, and LF/HF reject for the specified channel.

<N> An integer, 1-4 in a single oscilloscope, 1-40 in a MultiScope system.

<parameter> On 9000 Series, 9000H Series, and S-Series oscilloscopes:

- DC – DC coupling, 1 M $\Omega$  impedance.
- DC50 | DCFifty – DC coupling, 50 $\Omega$  impedance.
- AC – AC coupling, 1 M $\Omega$  impedance.
- LFR1 | LFR2 – AC 1 M $\Omega$  input impedance.

When no probe is attached, the coupling for each channel can be AC, DC, DC50, or DCFifty.

If you have an 1153A probe attached, the valid parameters are DC, LFR1, and LFR2 (low-frequency reject).

On 90000A Series, 90000 X-Series, V-Series, 90000 Q-Series, and Z-Series oscilloscopes:

- DC50 | DCFifty – DC coupling, 50 $\Omega$  impedance.

**Example** This example sets the channel 1 input to DC50.

```
myScope.WriteString ":CHANnel1:INPut DC50"
```

**Query** :CHANnel<N>:INPut?

The :CHANnel<N>:INPut? query returns the selected channel input parameter.

**Returned Format** [CHANnel<N>:INPut] <parameter><NL>

**Example** This example puts the current input for channel 1 in the string variable, strInput. The program then prints the contents of the variable to the computer's screen.

```
myScope.WriteString ":SYSTem:HEADer OFF"
myScope.WriteString ":CHANnel1:INPut?"
strInput = myScope.ReadString
Debug.Print strInput
```

**History** Legacy command (existed before version 3.10).

## :CHANnel<N>:INVert

**Command** :CHANnel<N>:INVert {{0 | OFF} | {1 | ON}}

The :CHANnel<N>:INVert command enables or disables the invert setting for a channel.

Inverting a channel causes the waveform to be reflected about the 0 V reference point. Inverting a channel can cause the oscilloscope to stop triggering (depending on the trigger level setting) and it can affect math function waveforms that have the channel as an input source.

**Query** :CHANnel<N>:INVert?

The :CHANnel<N>:INVert? query returns the channel invert setting.

**Returned Format** <setting><NL>

<setting> ::= {0 | 1}

**History** New in version 5.70.

## :CHANnel&lt;N&gt;:ISIM:APPLy

**Command** :CHANnel<N>:ISIM:APPLy "<transfer\_func\_t\_file>"

**NOTE**

This CHANnel command only applies if you have purchased the InfiniiSim software application.

The :CHANnel<N>:ISIM:APPLy command applies a pre-computed transfer function to the waveform. If InfiniiSim is in 2 port mode, the file must be a .tf2 file. If in 4 port mode, the file must be a .tf4 file. Use the ISIM:STATe command to enable InfiniiSim before issuing the APPLy command.

**NOTE**

You can specify differential and/or common mode channels using the following convention. If you have differential or common mode channels enabled (using either the :CHANnel<N>:DIFFerential or :CHANnel<N>:COMMonmode commands) then:

- :CHANnel1 would refer to the Channel 1 - Channel 3 differential channel
- :CHANnel2 would refer to the Channel 2 - Channel 4 differential channel
- :CHANnel3 would refer to the Channel 1 + Channel 3 common mode channel
- :CHANnel4 would refer to the Channel 2 + Channel 4 common mode channel

<N> An integer, 1-4 in a single oscilloscope, 1-40 in a MultiScope system.  
 <transfer\_func\_t\_file> The full path to the .tf2 file name (if in 2 port mode) or the .tf4 file (if in 4 port mode).

**Example** This example applies the example.tf4 file to the waveform on channel 1.

```
myScope.WriteString _
  ":CHANnel1:ISIM:APPLy " + _
  "\"C:\Users\Public\Documents\Infiniium\Filters\example.tf4\""
```

**Query** :CHANnel<N>:ISIM:APPLy?

The :CHANnel<N>:ISIM:APPLy? query returns the currently selected function file name when 2 port or 4 port mode is enabled.

**Returned Format** [CHANnel<N>:ISIM:APPLy] <file\_name><NL>

**Example** This example puts the current transfer function file name in the variable strFile. The program then prints the contents of the variable to the computer's screen.

```
myScope.WriteString ":SYSTem:HEADer OFF"
myScope.WriteString ":CHANnel1:ISIM:APPLy?"
strFile = myScope.ReadString
Debug.Print strFile
```

**History** Legacy command (existed before version 3.10).

## :CHANnel&lt;N&gt;:ISIM:BANDwidth

**Command** :CHANnel<N>:ISIM:BANDwidth <bw\_value>

The :CHANnel<N>:ISIM:BANDwidth command lets you set the custom bandwidth limit (cutoff frequency) value. The :CHANnel<N>:ISIM:BWLlimit command lets you enable or disable the custom bandwidth limit.

**NOTE**

- On Infiniium 9000 Series oscilloscopes, you can use the :CHANnel<N>:BWLlimit command to enable or disable a 20 MHz low-pass filter on the input channel.
- On Infiniium S-Series oscilloscopes, you can use the :CHANnel<N>:BWLlimit command to enable or disable a 20 MHz or 200 MHz low-pass filter on the input channel.

**NOTE**

You can specify differential and/or common mode channels using the following convention. If you have differential or common mode channels enabled (using either the :CHANnel<N>:DIFFerential or :CHANnel<N>:COMMOnmode commands) then:

- :CHANnel1 would refer to the Channel 1 - Channel 3 differential channel
- :CHANnel2 would refer to the Channel 2 - Channel 4 differential channel
- :CHANnel3 would refer to the Channel 1 + Channel 3 common mode channel
- :CHANnel4 would refer to the Channel 2 + Channel 4 common mode channel

<N> An integer, 1-4 in a single oscilloscope, 1-40 in a MultiScope system.

<bw\_value> The maximum value is the sample rate / 2. The minimum value is 1000 Hz.

**Example** This example sets the channel 1 input bandwidth limit cutoff frequency to 2 GHz.

```
myScope.WriteString ":CHANnel1:ISIM:BANDwidth 2e9"
```

**Query** :CHANnel<N>:ISIM:BANDwidth?

The :CHANnel<N>:ISIM:BANDwidth? query returns the selected channel input's bandwidth limit cutoff frequency.

**Returned Format** [CHANnel<N>:ISIM:BANDwidth] <parameter><NL>

**Example** This example puts the current input for channel 1 in the string variable, varBwLimit. The program then prints the contents of the variable to the computer's screen.

```
myScope.WriteString ":SYSTEM:HEADer OFF"
myScope.WriteString ":CHANnel1:ISIM:BANDwidth?"
varBwLimit = myScope.ReadNumber
Debug.Print FormatNumber(varBwLimit, 0)
```

- See Also**
- [":CHANnel<N>:ISIM:BWLlimit"](#) on page 362
  - [":CHANnel<N>:BWLlimit \(9000 Series, 9000H Series, S-Series\)"](#) on page 344
  - [":ACQuire:BANDwidth"](#) on page 241



**History** Legacy command (existed before version 3.10).

**:CHANnel<N>:ISIM:BWLimit**

**Command** :CHANnel<N>:ISIM:BWLimit {{ON | 1} | {OFF | 0}}

The :CHANnel<N>:ISIM:BWLimit command lets you enable or disable the custom bandwidth limit (cutoff frequency). The CHANnel<N>:ISIM:BANDwidth command sets the value to be used when the custom bandwidth limit is enabled.

**NOTE**

- On Infiniium 9000 Series oscilloscopes, you can use the :CHANnel<N>:BWLimit command to enable or disable a 20 MHz low-pass filter on the input channel.
- On Infiniium S-Series oscilloscopes, you can use the :CHANnel<N>:BWLimit command to enable or disable a 20 MHz or 200 MHz low-pass filter on the input channel.

**NOTE**

You can specify differential and/or common mode channels using the following convention. If you have differential or common mode channels enabled (using either the :CHANnel<N>:DIFFerential or :CHANnel<N>:COMMOnmode commands) then:

- :CHANnel1 would refer to the Channel 1 - Channel 3 differential channel
- :CHANnel2 would refer to the Channel 2 - Channel 4 differential channel
- :CHANnel3 would refer to the Channel 1 + Channel 3 common mode channel
- :CHANnel4 would refer to the Channel 2 + Channel 4 common mode channel

<N> An integer, 1-4 in a single oscilloscope, 1-40 in a MultiScope system.

**Example** This example turns on the bandwidth limit feature for channel 1.

```
myScope.WriteString ":CHANnel1:ISIM:BWLimit ON"
```

**Query** :CHANnel<N>:ISIM:BWLimit?

The :CHANnel<N>:ISIM:BWLimit? query returns the current state of the corresponding channel's bandwidth limiting feature.

**Returned Format** [CHANnel<N>:ISIM:BWLimit] {1 | 0}<NL>

**Example** This example puts the current bandwidth limit state for channel 1 in the string variable, varLimit. The program then prints the contents of the variable to the computer's screen.

```
myScope.WriteString ":SYSTem:HEADer OFF"
myScope.WriteString ":CHANnel1:ISIM:BWLimit?"
varLimit = myScope.ReadNumber
Debug.Print FormatNumber(varLimit, 0)
```

- See Also**
- [":CHANnel<N>:ISIM:BWLimit:TYPE"](#) on page 364
  - [":CHANnel<N>:ISIM:BANDwidth"](#) on page 360
  - [":CHANnel<N>:BWLimit \(9000 Series, 9000H Series, S-Series\)"](#) on page 344
  - [":ACQuire:BANDwidth"](#) on page 241

**History** Legacy command (existed before version 3.10).

**:CHANnel<N>:ISIM:BWLimit:TYPE**

**Command** :CHANnel<N>:ISIM:BWLimit:TYPE <filter\_type>  
 <filter\_type> ::= {WALL | BESSEL4 | BANDpass}

The :CHANnel<N>:ISIM:BWLimit:TYPE command specifies a channel's bandwidth limit filter response:

- WALL – Specifies a Brick-Wall response for the bandwidth limit filter. This response has a sharp roll-off.
- BESSEL4 – Specifies a 4th Order Bessel response for the bandwidth limit filter. This response has a more gradual roll-off.

**NOTE**

To achieve the 4th Order Bessel response, the maximum bandwidth you can specify is about 2/3 of the maximum bandwidth you could specify with the Brick-Wall filter. Also with the 4th Order Bessel filter, the brick-wall response takes over at what would be the brick-wall filter's maximum bandwidth. Therefore, you can have a combination of roll-off responses with this selection.

- BANDpass – This option is for use with the Phase Noise analysis application (see **":MEASure:PN:STATe"** on page 1066) and is not intended as a general-purpose bandpass filter.

**Query** :CHANnel<N>:ISIM:BWLimit:TYPE?

The :CHANnel<N>:ISIM:BWLimit:TYPE? query returns the bandwidth limit filter response setting.

**Returned Format** <filter\_type><NL>  
 <filter\_type> ::= {WALL | BESSEL4 | BAND}

**See Also** • **":CHANnel<N>:ISIM:BWLimit"** on page 362

**History** New in version 5.70.

Version 6.30: The BANDpass option has been added to support the Phase Noise analysis application.

## :CHANnel&lt;N&gt;:ISIM:CONVolve

**Command** :CHANnel<N>:ISIM:CONVolve "<s\_parameter\_file>", {OFF | ON}

**NOTE**

This CHANnel command is available when you have purchased the InfiniiSim software application.

The :CHANnel<N>:ISIM:CONVolve command sets the InfiniiSim 2 Port state (:CHANnel<N>:ISIM:STATE PORT2), automates the creation of a transfer function, and applies the transfer function to the channel waveform. The transfer function is created using the **Add insertion loss of a fixture or cable** application preset's simple one-block circuit model. The S-parameter file defines the simulation circuit of the single block and the measurement circuit is a **Thru**. When the generated transfer function is applied, it performs an embed operation.

This command uses the S-parameter file's  $S_{21}$  insertion loss only. If a .s4p file is specified, ports 1 and 2 are used assuming a 1-2, 3-4 port numbering for 4 port files.

Optionally, include ON to flip the port numbering when reading the S-parameter file.

**NOTE**

You can specify differential and/or common mode channels using the following convention. If you have differential or common mode channels enabled (using either the :CHANnel<N>:DIFFerential or :CHANnel<N>:COMMonmode commands) then:

- :CHANnel1 would refer to the Channel 1 - Channel 3 differential channel
- :CHANnel2 would refer to the Channel 2 - Channel 4 differential channel
- :CHANnel3 would refer to the Channel 1 + Channel 3 common mode channel
- :CHANnel4 would refer to the Channel 2 + Channel 4 common mode channel

<N>	An integer, 1-4 in a single oscilloscope, 1-40 in a MultiScope system.
<s_parameter_file>	The quoted name of the S-parameter file.
<b>Example</b>	This example convolves the S-parameter file example.s2p with the waveform on channel 1.  <pre>myScope.WriteString ":CHANnel1:ISIM:CONVolve example.s2p"</pre>
<b>See Also</b>	<ul style="list-style-type: none"> <li>▪ <b>" :CHANnel&lt;N&gt;:ISIM:STATE"</b> on page 374</li> <li>▪ <b>" :CHANnel&lt;N&gt;:ISIM:APPLY"</b> on page 359</li> <li>▪ <b>" :CHANnel&lt;N&gt;:ISIM:DEConvolve"</b> on page 368</li> </ul>
<b>History</b>	Legacy command (existed before version 3.10).

## :CHANnel&lt;N&gt;:ISIM:CORRection

**Command** :CHANnel<N>:ISIM:CORRection <percent>

**NOTE**

This CHANnel command only applies if you have purchased the InfiniiSim software application.

The :CHANnel<N>:ISIM:CORRection command sets the amount of linearly scaled correction applied to the non-DC frequency components of the measured signal. This lets you trade off the amount of correction to apply via the transformation function versus the increase in noise it may create at higher frequencies. In other words, you can fine-tune the amount of high-frequency noise versus the sharpness of the step response edge.

<N> An integer, 1-4 in a single oscilloscope, 1-40 in a MultiScope system.

**NOTE**

You can specify differential and/or common mode channels using the following convention. If you have differential or common mode channels enabled (using either the :CHANnel<N>:DIFFerential or :CHANnel<N>:COMMONmode commands) then:

- :CHANnel1 would refer to the Channel 1 - Channel 3 differential channel
- :CHANnel2 would refer to the Channel 2 - Channel 4 differential channel
- :CHANnel3 would refer to the Channel 1 + Channel 3 common mode channel
- :CHANnel4 would refer to the Channel 2 + Channel 4 common mode channel

<percent> If you are making averaged mode measurements or applying a transfer function that does not magnify the noise, use the full correction by setting this field to 100%.

However, if you are working with eye diagrams or making jitter measurements and the transfer function is magnifying the noise, you may want to limit the correction by selecting a lower percentage.

**Example** This example sets the channel 1 InfiniiSim correction factor to 80%.

```
myScope.WriteString ":CHANnel1:ISIM:CORRection 80"
```

**Query** :CHANnel<N>:ISIM:CORRection?

The :CHANnel<N>:ISIM:CORRection? query returns the selected input channel's percent correction factor.

**Returned Format** [CHANnel<N>:ISIM:CORRection] <percent><NL>

**Example** This example gets the current channel 1 InfiniiSim correction percentage and places it in the numeric variable, varIsimCorrection. The program then prints the contents of the variable to the computer's screen.

```
myScope.WriteString ":SYSTem:HEADer OFF"  
myScope.WriteString ":CHANnel:ISIM:CORRection?"  
varIsimCorrection = myScope.ReadNumber  
Debug.Print FormatNumber(varBwLimit, 0)
```

**History** Legacy command (existed before version 3.10).

## :CHANnel&lt;N&gt;:ISIM:DEConvolve

**Command** :CHANnel<N>:ISIM:DEConvolve "<s\_parameter\_file>", {OFF | ON}

**NOTE**

This CHANnel command is available when you have purchased the InfiniiSim software application.

The :CHANnel<N>:ISIM:DEConvolve command sets the InfiniiSim 2 Port state (:CHANnel<N>:ISIM:STATE PORT2), automates the creation of a transfer function, and applies the transfer function to the channel waveform. The transfer function is created using the **Remove insertion loss of a fixture or cable** application preset's simple one-block circuit model. The S-parameter file defines the measurement circuit of the single block and the simulation circuit is a **Thru**. When the generated transfer function is applied, it performs an de-embed operation.

This command uses the S-parameter file's  $S_{21}$  insertion loss only. If a .s4p file is specified, ports 1 and 2 are used assuming a 1-2, 3-4 port numbering for 4 port files.

Optionally, include ON to flip the port numbering when reading the S-parameter file.

**NOTE**

You can specify differential and/or common mode channels using the following convention. If you have differential or common mode channels enabled (using either the :CHANnel<N>:DIFFerential or :CHANnel<N>:COMMonmode commands) then:

- :CHANnel1 would refer to the Channel 1 - Channel 3 differential channel
- :CHANnel2 would refer to the Channel 2 - Channel 4 differential channel
- :CHANnel3 would refer to the Channel 1 + Channel 3 common mode channel
- :CHANnel4 would refer to the Channel 2 + Channel 4 common mode channel

<N>	An integer, 1-4 in a single oscilloscope, 1-40 in a MultiScope system.
<s_parameter_file>	The quoted name of the S-parameter file.
<b>Example</b>	This example deconvolves the S-parameter file example.s2p with the waveform on channel 1.  <pre>myScope.WriteString ":CHANnel1:ISIM:DEConvolve example.s2p"</pre>
<b>See Also</b>	<ul style="list-style-type: none"> <li>• <b>" :CHANnel&lt;N&gt;:ISIM:STATE"</b> on page 374</li> <li>• <b>" :CHANnel&lt;N&gt;:ISIM:APPLY"</b> on page 359</li> <li>• <b>" :CHANnel&lt;N&gt;:ISIM:CONVolve"</b> on page 365</li> </ul>
<b>History</b>	Legacy command (existed before version 3.10).



## :CHANnel&lt;N&gt;:ISIM:DElay

**Command** :CHANnel<N>:ISIM:DElay {OFF | ON | TRIG}

**NOTE**

This CHANnel command only applies if you have purchased the InfiniiSim software application.

The :CHANnel<N>:ISIM:DElay command specifies the transfer function filter delay option:

- ON – Includes filter delay.
- OFF – Removes filter delay.
- TRIG – Includes trigger-corrected delay.

Consult the InfiniiSim User's Guide in the Manuals section of the GUI help system for more information.

**NOTE**

You can specify differential and/or common mode channels using the following convention. If you have differential or common mode channels enabled (using either the :CHANnel<N>:DIFFerential or :CHANnel<N>:COMMonmode commands) then:

- :CHANnel1 would refer to the Channel 1 - Channel 3 differential channel
- :CHANnel2 would refer to the Channel 2 - Channel 4 differential channel
- :CHANnel3 would refer to the Channel 1 + Channel 3 common mode channel
- :CHANnel4 would refer to the Channel 2 + Channel 4 common mode channel

<N> An integer, 1-4 in a single oscilloscope, 1-40 in a MultiScope system.

**Example** This example applies the transfer function delay in the resultant waveform.

```
myScope.WriteString ":CHANnel1:ISIM:DElay ON"
```

**Query** :CHANnel<N>:ISIM:DElay?

The :CHANnel<N>:ISIM:DElay? query returns the current state of the transfer function delay feature on the corresponding input channel.

**Returned Format** [CHANnel<N>:ISIM:DElay] {OFF | ON | TRIG}<NL>

**Example** This example puts whether or not the transfer function delay is included in the resultant waveform for channel 1 in the string variable, strDelay. The program then prints the contents of the variable to the computer's screen.

```
myScope.WriteString ":SYSTem:HEADer OFF"
myScope.WriteString ":CHANnel1:ISIM:DElay?"
strDelay = myScope.ReadString
Debug.Print strDelay
```

**History** Legacy command (existed before version 3.10).

**:CHANnel<N>:ISIM:NORMalize**

**Command** :CHANnel<N>:ISIM:NORMalize {{ON | 1} | {OFF | 0}}

**NOTE**

This CHANnel command only applies if you have purchased the InfiniiSim software application.

The :CHANnel<N>:ISIM:NORMalize command activates or deactivates the "Normalize Gain" option. The InfiniiSim normalize gain option removes any DC gain of the transfer function and can be used when modeling probes.

**NOTE**

You can specify differential and/or common mode channels using the following convention. If you have differential or common mode channels enabled (using either the :CHANnel<N>:DIFFerential or :CHANnel<N>:COMMONmode commands) then:

- :CHANnel1 would refer to the Channel 1 - Channel 3 differential channel
- :CHANnel2 would refer to the Channel 2 - Channel 4 differential channel
- :CHANnel3 would refer to the Channel 1 + Channel 3 common mode channel
- :CHANnel4 would refer to the Channel 2 + Channel 4 common mode channel

<N> An integer, 1-4 in a single oscilloscope, 1-40 in a MultiScope system.

**Example** This example turns on the InfiniiSim normalize gain option for channel 1.

```
myScope.WriteString ":CHANnel1:ISIM:NORMalize ON"
```

**Query** :CHANnel<N>:ISIM:NORMalize?

The :CHANnel<N>:ISIM:NORMalize? query returns the current state of the corresponding channel's InfiniiSim normalize gain option.

**Returned Format** [CHANnel<N>:ISIM:NORMalize] {1 | 0}<NL>

**Example** This example puts the current InfiniiSim normalize gain state for channel 1 in the string variable, varNormalizeGain. The program then prints the contents of the variable to the computer's screen.

```
myScope.WriteString ":SYSTEM:HEADer OFF"
myScope.WriteString ":CHANnel1:ISIM:NORMalize?"
varNormalizeGain = myScope.ReadNumber
Debug.Print FormatNumber(varLimit, 0)
```

**See Also** • [":CHANnel<N>:ISIM:DELAy"](#) on page 369

**History** New in version 4.60.

## :CHANnel&lt;N&gt;:ISIM:PEXtraction

**Command** :CHANnel<N>:ISIM:PEXtraction {P12 | P32 | P34 | P14 | DIFFerential  
| COMMONmode}

**NOTE**

This CHANnel command only applies if you have purchased the InfiniiSim software application.

The :CHANnel<N>:ISIM:PEXtraction command selects the InfiniiSim port extraction. The selections are:

- P12 – Use ports 1 -> 2.
- P32 – Use ports 3 -> 2.
- P34 – Use ports 3 -> 4.
- P14 – Use ports 1 -> 4.
- DIFFerential – valid for all channels.
- COMMONmode – valid for all channels.

**NOTE**

You can specify differential and/or common mode channels using the following convention. If you have differential or common mode channels enabled (using either the :CHANnel<N>:DIFFerential or :CHANnel<N>:COMMONmode commands) then:

- :CHANnel1 would refer to the Channel 1 - Channel 3 differential channel
- :CHANnel2 would refer to the Channel 2 - Channel 4 differential channel
- :CHANnel3 would refer to the Channel 1 + Channel 3 common mode channel
- :CHANnel4 would refer to the Channel 2 + Channel 4 common mode channel

<N> An integer, 1-4 in a single oscilloscope, 1-40 in a MultiScope system.

**Example** This example selects the channel 1 InfiniiSim differential port extraction.

```
myScope.WriteString ":CHANnel1:ISIM:PEXtraction DIFFerential"
```

**Query** :CHANnel<N>:ISIM:PEXtraction?

The :CHANnel<N>:ISIM:PEXtraction? query returns the current InfiniiSim port extraction selection.

**Returned Format** [CHANnel<N>:ISIM:PEXtraction] {P12 | P32 | P34 | P14 | DIFF | COMM}<NL>

**Example** This example puts the current InfiniiSim port extraction selection for channel 1 in the string variable, strMode. The program then prints the contents of the variable to the computer's screen.

```
myScope.WriteString ":SYSTem:HEADer OFF"
myScope.WriteString ":CHANnel1:ISIM:PEXtraction?"
```

```
strMode = myScope.ReadString  
Debug.Print strMode
```

**History** New in version 3.11.

## :CHANnel&lt;N&gt;:ISIM:SPAN

**Command** :CHANnel<N>:ISIM:SPAN <max\_time\_span>

**NOTE**

This CHANnel command only applies if you have purchased the InfiniiSim software application.

The :CHANnel<N>:ISIM:SPAN command sets the maximum time span control in the InfiniiSim Setup dialog box.

**NOTE**

You can specify differential and/or common mode channels using the following convention. If you have differential or common mode channels enabled (using either the :CHANnel<N>:DIFFerential or :CHANnel<N>:COMMonmode commands) then:

- :CHANnel1 would refer to the Channel 1 - Channel 3 differential channel
- :CHANnel2 would refer to the Channel 2 - Channel 4 differential channel
- :CHANnel3 would refer to the Channel 1 + Channel 3 common mode channel
- :CHANnel4 would refer to the Channel 2 + Channel 4 common mode channel

<N> An integer, 1-4 in a single oscilloscope, 1-40 in a MultiScope system.

<max\_time\_span> A real number.

**Example** This example sets the maximum time span control to 100e-9.

```
myScope.WriteString ":CHANnel1:ISIM:SPAN 100e-9"
```

**Query** :CHANnel<N>:ISIM:SPAN?

The :CHANnel<N>:ISIM:SPAN? query returns the current InfiniiSim filter maximum time span on the corresponding input channel.

**Returned Format** [CHANnel<N>:ISIM:SPAN] <max\_time\_span><NL>

**Example** This example puts the InfiniiSim filter's maximum time span value in the variable varTspan. The program then prints the contents of the variable to the computer's screen.

```
myScope.WriteString ":SYSTem:HEADer OFF"
myScope.WriteString ":CHANnel1:ISIM:SPAN?"
varTspan = myScope.ReadNumber
Debug.Print FormatNumber(varTspan, 0)
```

**History** Legacy command (existed before version 3.10).

## :CHANnel&lt;N&gt;:ISIM:STATe

**Command** :CHANnel<N>:ISIM:STATe {OFF | PORT2 | PORT4 | PORT41}

**NOTE**

This CHANnel command only applies if you have purchased the InfiniiSim software application.

The :CHANnel<N>:ISIM:STATe command turns InfiniiSim on or off and sets whether 2 port, 4 port (Channels 1&3), or 4 port (Channel 1) mode is being used (if it is turned on).

**NOTE**

You can specify differential and/or common mode channels using the following convention. If you have differential or common mode channels enabled (using either the :CHANnel<N>:DIFFerential or :CHANnel<N>:COMMONmode commands) then:

- :CHANnel1 would refer to the Channel 1 - Channel 3 differential channel
- :CHANnel2 would refer to the Channel 2 - Channel 4 differential channel
- :CHANnel3 would refer to the Channel 1 + Channel 3 common mode channel
- :CHANnel4 would refer to the Channel 2 + Channel 4 common mode channel

<N> An integer, 1-4 in a single oscilloscope, 1-40 in a MultiScope system.

**Example** This example turns on InfiniiSim for channel 1 and puts it in 2 port mode.

```
myScope.WriteString ":CHANnel1:ISIM:STATe PORT2"
```

**Query** :CHANnel<N>:ISIM:STATe?

The :CHANnel<N>:ISIM:STATe? query returns the current state of InfiniiSim on the corresponding input channel.

**Returned Format** [CHANnel<N>:ISIM:STATe] {OFF | PORT2 | PORT4 | PORT41}<NL>

**Example** This example puts the current InfiniiSim state for channel 1 in the string variable, strMode. The program then prints the contents of the variable to the computer's screen.

```
myScope.WriteString ":SYSTem:HEADer OFF"
myScope.WriteString ":CHANnel1:ISIM:STATe?"
strMode = myScope.ReadString
Debug.Print strMode
```

**History** Legacy command (existed before version 3.10).

**:CHANnel<N>:LABel**

**Command** :CHANnel<N>:LABel <string>

The :CHANnel<N>:LABel command sets the channel label to the quoted string.

Labels can be enabled with the :DISPlay:LABel command.

**NOTE**

You can specify differential and/or common mode channels using the following convention. If you have differential or common mode channels enabled (using either the :CHANnel<N>:DIFFerential or :CHANnel<N>:COMMonmode commands) then:

- :CHANnel1 would refer to the Channel 1 - Channel 3 differential channel
- :CHANnel2 would refer to the Channel 2 - Channel 4 differential channel
- :CHANnel3 would refer to the Channel 1 + Channel 3 common mode channel
- :CHANnel4 would refer to the Channel 2 + Channel 4 common mode channel

<N> An integer, 1-4 in a single oscilloscope, 1-40 in a MultiScope system.

<string> A series of 16 or less characters as a quoted ASCII string

**Example** This example sets the channel 1 label to Data.

```
myScope.WriteString ":CHANnel1:LABel "Data""
```

**Query** :CHANnel<N>:LABel?

The :CHANnel<N>:LABel? query returns the label of the specified channel.

**Returned Format** [CHANnel<N>:LABel] <string><NL>

- See Also**
- **":DISPlay:LABel"** on page 546
  - **":FUNction<F>:LABel"** on page 619
  - **":WMEMory<R>:LABel"** on page 1654

**History** Legacy command (existed before version 3.10).

**:CHANnel<N>:OFFSet**

**Command** :CHANnel<N>:OFFSet <offset\_value>

The :CHANnel<N>:OFFSet command sets the vertical value that is represented at the center of the display for the selected channel. Offset parameters are probe and vertical scale dependent.

<N> An integer, 1-4 in a single oscilloscope, 1-40 in a MultiScope system.

<offset\_value> A real number for the offset value at center screen. Usually expressed in volts, but it can also be in other measurement units, such as amperes, if you have specified other units using the :CHANnel<N>:UNITs command or the CHANnel<N>:PROBe:EXTeRnal:UNITs command.

**Example** This example sets the offset for channel 1 to 0.125 in the current measurement units:

```
myScope.WriteString ":CHANnel1:OFFSet 125E-3"
```

**Query** :CHANnel<N>:OFFSet?

The :CHANnel<N>:OFFSet? query returns the current offset value for the specified channel.

**Returned Format** [CHANnel<N>:OFFSet] <offset\_value><NL>

**Example** This example places the offset value of the specified channel in the variable, varOffset, then prints the contents of the variable to the computer's screen.

```
myScope.WriteString ":SYSTem:HEADer OFF"
myScope.WriteString ":CHANnel1:OFFSet?"
varOffset = myScope.ReadNumber
Debug.Print FormatNumber(varOffset, "Scientific")
```

**History** Legacy command (existed before version 3.10).



## :CHANnel&lt;N&gt;:PROBe:ACCAL

**Command** :CHANnel<N>:PROBe:ACCAL {AUTO | OFF | PRECprobe}

The :CHANnel<N>:PROBe:ACCAL command sets the type of AC response probe calibration to use:

- OFF – no AC response probe calibration is used.
- AUTO – the AC response probe calibration is based on the type of probe being used and its general characteristics. For example, these probes support automatic probe correction:
  - 1130/1/2/4B
  - 1168/9B
  - N2800/1/2/3A
  - N2830/1/2A
  - N7000/1/2/3A
  - N7010A
  - N7020A
  - N7024A
  - MX0011AA/12A/13A/20A/21A/22A/24A/25A
  - MX0023A
- PRECprobe – PrecisionProbe or PrecisionCable probe calibration is used.

**NOTE**

You are not able to start a PrecisionProbe or PrecisionCable calibration using remote SCPI commands. However, you can enter SCPI commands to use the results of calibrations performed using the front panel wizards.

<N> An integer, 1-4.

**Example** This example chooses the PrecisionProbe or PrecisionCable AC response calibration for the probe on channel 1.

```
myScope.WriteString ":CHANnel1:PROBe:ACCAL PRECprobe"
```

**Query** :CHANnel<N>:PROBe:ACCAL?

The :CHANnel<N>:PROBe:ACCAL? query returns the AC response probe calibration setting for the selected channel.

**Returned Format** [:CHANnel<N>:PROBe:ACCAL] {AUTO | OFF | PREC}<NL>

- See Also**
- [":CHANnel<N>:PROBe:PRECprobe:MODE"](#) on page 401
  - [":CHANnel<N>:PROBe:PRECprobe:CALibration"](#) on page 399
  - [":CHANnel<N>:PROBe:PRECprobe:ZSRC"](#) on page 402
  - [":CHANnel<N>:PROBe:PRECprobe:BANDwidth"](#) on page 398

**History** New in version 3.10.

## :CHANnel&lt;N&gt;:PROBe:ATTenuation

**Command** :CHANnel<N>:PROBe:ATTenuation {DIV1 | DIV10}

**NOTE**

This command is only valid for the 1154A probe.

The :CHANnel<N>:PROBe:ATTenuation command sets the 1154A probe's input amplifier attenuation. If the 1154A probe is not connected to the channel you will get a settings conflict error.

<N> An integer, 1-4.

**Example** This example sets the probe attenuation for channel 1 to divide by 10.

```
myScope.WriteString ":CHANnel1:PROBe:ATTenuation DIV10"
```

**Query** :CHANnel<N>:PROBe:ATTenuation?

The :CHANnel<N>:PROBe:ATTenuation? query returns the current 1154A probe input amplifier attenuation setting for the selected channel.

**Returned Format** [:CHANnel<N>:PROBe:ATTenuation] {DIV1 | DIV10}<NL>

**History** Legacy command (existed before version 3.10).

:CHANnel<N>:PROBe:AUTOzero

**Command** :CHANnel<N>:PROBe:AUTOzero

**NOTE**

This command is currently only valid for the N2893A probe.

---

The :CHANnel<N>:PROBe:AUTOzero command initiates the N2893A probe's auto degauss/ offset cal.

If the N2893A probe is not connected to the channel you will get a settings conflict error.

<N> An integer, 1-4.

**Example** This example performs an auto zero operation for the probe on channel 1.

```
myScope.WriteString ":CHANnel1:PROBe:AUTOzero"
```

**History** New in version 3.50.

## :CHANnel&lt;N&gt;:PROBe:COUPling

**Command** :CHANnel<N>:PROBe:COUPling {DC | AC}

The :CHANnel<N>:PROBe:COUPling command sets the probe coupling to either AC or DC.

**NOTE**

This command is for probes only. To set the input channel coupling, see :CHANnel<N>:INPut.

<N> An integer, 1-4.

**Example** This example sets the probe coupling for channel 1 to AC.

```
myScope.WriteString ":CHANnel1:PROBe:COUPling AC"
```

**Query** :CHANnel<N>:PROBe:COUPling?

The :CHANnel<N>:PROBe:COUPling? query returns the current probe coupling setting for the selected channel.

**Returned Format** [:CHANnel<N>:PROBe:COUPling] {DC | AC}<NL>

**See Also** • [":CHANnel<N>:INPut"](#) on page 357

**History** Legacy command (existed before version 3.10).

## :CHANnel&lt;N&gt;:PROBe:EADapter

**Command** :CHANnel<N>:PROBe:EADapter {NONE | DIV10 | DIV20 | DIV100 | DIV1000  
| CUR0002VA | CUR001VA | CUR002VA | CUR01VA | CUR1VA | CUR10VA  
| CURN2893 | CUR1147 | HIVOLTN2790}

**NOTE**

This command is valid only for the 1153A, 1154A, and 1159A probes and the E2697A and N5449A high impedance adapters.

The :CHANnel<N>:PROBe:EADapter command sets the probe external adapter control. The 1153A, 1154A, and 1159A probes and the E2697A and N5449A high impedance adapters have external adapters that you can attach to the end of your probe. When you attach one of these adapters, you should use the EADapter command to set the external adapter control to match the adapter connected to your probe as follows.

If an 1153A, 1154A, or 1159A probe or E2697A or N5449A high impedance adapter is not connected to the channel you will get a settings conflict error.

With the 1153A,  
1154A, and 1159A  
probes:

Parameter	Description
NONE	Use this setting when there is no adapter connected to the end of your probe.
DIV10	Use this setting when you have a divide by 10 adapter connected to the end of your probe.
DIV20	Use this setting when you have a divide by 20 adapter connected to the end of your probe. (1159A)
DIV100	Use this setting when you have a divide by 100 adapter connected to the end of your probe. (1153A only)

With the E2697A  
and N5449A high  
impedance  
adapters:

When the :CHANnel<N>:PROBe:EADapter command is used with either the E2697A or N5449A high impedance adapter, the behavior is the same as with the 115x probes; however, there are more parameters available to choose from. The following table describes which probes are available with which adapters and what the parameter string is:

Probe	Parameter	Compatibility	
		E2697A adapter	N5449A adapter
1:1 probe	NONE	X	X
10:1 probe	DIV10	X	X
20:1 probe	DIV20	X	X
100:1 probe	DIV100	X	X

Probe	Parameter	Compatibility	
		E2697A adapter	N5449A adapter
100:1 probe	DIV1000		X
0.002 V/A current probe	CUR0002VA	X	X
0.01 V/A current probe	CUR001VA	X	X
0.02 V/A current probe	CUR002VA	X	X
0.1 V/A current probe	CUR01VA	X	X
1 V/A current probe	CUR1VA	X	X
10 V/A current probe	CUR10VA	X	X
N2893A current probe	CURN2893		X
1147A/B current probe	CUR1147		X
N2790A high-voltage differential probe	HIVOLTN2790		X

Lastly, the N5449A adapter has the ability to automatically detect supported probes. If a supported probe (most passive probes) is attached to the N5449A adapter, the `:CHANnel<N>:PROBe:EADapter` command will not have any effect until the attached probe is removed. If, on the other hand, an unsupported probe (BNC cable, etc.) is attached to the N5449A adapter, the `:CHANnel<N>:PROBe:EADapter` command will work as normal. The `:CHANnel<N>:PROBe:EADapter?` query will work in either case.

<N> An integer, 1-4.

**Example** This example sets the external adapter for channel 1 to divide by 10:

```
myScope.WriteString ":CHANnel1:PROBe:EADapter DIV10"
```

**Query** `:CHANnel<N>:PROBe:EADapter?`

The `:CHANnel<N>:PROBe:EADapter?` query returns the current external adapter value for the specified channel.

**Returned Format** `[CHANnel<N>:PROBe:EADapter] {NONE | DIV10 | DIV20 | DIV100 | DIV1000 | CUR0002VA | CUR001VA | CUR002VA | CUR01VA | CUR1VA | CUR10VA | CURN2893 | CUR1147 | HIVOLTN2790}<NL>`

**Example** This example places the external adapter value of the specified channel in the string variable, `strAdapter`, then prints the contents of the variable to the computer's screen.

```
Dim strAdapter As String 'Dimension variable
myScope.WriteString ":CHANnel1:PROBe:EADapter?"
strAdapter = myScope.ReadString
Debug.Print strAdapter
```

**History** Legacy command (existed before version 3.10).

Version 5.20: Added the DIV1000, CUR001VA, CUR01VA, CUR1VA, CUR10VA, CURN2893, CUR1147, HIVOLTN2790 options for use with the E2697A or N5449A high impedance adapters.

Version 6.10: Added the CUR0002VA and CUR002VA options for use with the E2697A or N5449A high impedance adapters.



## :CHANnel&lt;N&gt;:PROBe:ECOupling

**Command** :CHANnel<N>:PROBe:ECOupling {NONE | AC}

**NOTE**

This command is valid only for the 1153A, 1154A, and 1159A probes.

The :CHANnel<N>:PROBe:ECOupling command sets the probe external coupling adapter control. The 1154A and 1159A probes have external coupling adapters that you can attach to the end of your probe. When you attach one of these adapters, you should use the ECOupling command to set the external coupling adapter control to match the adapter connected to your probe as follows.

Parameter	Description
NONE	Use this setting when there is no adapter connected to the end of your probe.
AC	Use this setting when you have an ac coupling adapter connected to the end of your probe.

If an 1153A, 1154A, or 1159A probe is not connected to the channel you will get a settings conflict error.

<N> An integer, 1-4.

**Example** This example sets the external coupling adapter for channel 1 to ac:

```
myScope.WriteString ":CHANnel1:PROBe:ECOupling AC"
```

**Query** :CHANnel<N>:PROBe:ECOupling?

The :CHANnel<N>:PROBe:ECOupling? query returns the current external adapter coupling value for the specified channel.

**Returned Format** [CHANnel<N>:PROBe:ECOupling] {NONE | AC}<NL>

**Example** This example places the external coupling adapter value of the specified channel in the string variable, strAdapter, then prints the contents of the variable to the computer's screen.

```
Dim strAdapter As String ' Dimension variable.
myScope.WriteString ":CHANnel1:PROBe:ECOupling?"
strAdapter = myScope.ReadString
Debug.Print strAdapter
```

**History** Legacy command (existed before version 3.10).

**:CHANnel<N>:PROBe:EXternal**

**Command** :CHANnel<N>:PROBe:EXternal {{ON | 1} | {OFF | 0}}

The :CHANnel<N>:PROBe:EXternal command sets the external probe mode to on or off.

<N> An integer, 1-4.

**Example** This example sets channel 1 external probe mode to on.

```
myScope.WriteString ":CHANnel1:PROBe:EXternal ON"
```

**Query** :CHANnel<N>:PROBe:EXternal?

The :CHANnel<N>:PROBe:EXternal? query returns the current external probe mode for the specified channel.

**Returned Format** [:CHANnel<N>:PROBe:EXternal] {1 | 0}<NL>

**Example** This example places the current setting of the external probe mode on channel 1 in the variable varMode, then prints the contents of the variable to the computer's screen.

```
myScope.WriteString ":SYSTem:HEADer OFF"
myScope.WriteString ":CHANnel1:PROBe:EXternal?"
varMode = myScope.ReadNumber
Debug.Print FormatNumber(varMode, 0)
```

**History** Legacy command (existed before version 3.10).

## :CHANnel&lt;N&gt;:PROBe:EXTeRnal:GAIN

**Command** :CHANnel<N>:PROBe:EXTeRnal:GAIN <gain\_factor>[, {RATio | DECibel}]

**NOTE**

CHANnel<N>:PROBe:EXTeRnal command must be set to ON before issuing this command or query or this command will have no effect.

The :CHANnel<N>:PROBe:EXTeRnal:GAIN command sets the probe external scaling gain factor and, optionally, the units for the probe gain factor. The reference factors that are used for scaling the display are changed with this command, and affect automatic measurements and trigger levels.

The RATio or DECibel also sets the mode for the probe attenuation and also determines the units that may be used for a subsequent command. For example, if you select RATio mode, then the attenuation factor must be given in ratio gain units. In DECibel mode, you can specify the units for the argument as "dB".

<N> An integer, 1-4.

<gain\_factor> A real number from 0.0001 to 1000 for the RATio gain units, or from -80 dB to 60 dB for the DECibel gain units.

**Example** This example sets the probe external scaling gain factor for channel 1 to 10.

```
myScope.WriteString ":CHANnel1:PROBe:EXTeRnal ON"
myScope.WriteString ":CHANnel1:PROBe:EXTeRnal:GAIN 10,RATio"
```

**Query** :CHANnel<N>:PROBe:EXTeRnal:GAIN?

The :CHANnel<N>:PROBe:EXTeRnal:GAIN? query returns the probe external gain setting for the selected channel.

**Returned Format** [:CHANnel<N>:PROBe:EXTeRnal:GAIN] <gain\_factor>,{RAT | DEC}<NL>

**Example** This example places the external gain value of the probe on the specified channel in the variable, varGain, then prints the contents of the variable to the computer's screen.

```
myScope.WriteString ":CHANnel1:PROBe:EXTeRnal ON"
myScope.WriteString ":CHANnel1:PROBe:EXTeRnal:GAIN?"
varGain = myScope.ReadString
Debug.Print varGain
```

**History** Legacy command (existed before version 3.10).

## :CHANnel&lt;N&gt;:PROBe:EXtErnal:OFFSet

**Command** :CHANnel<N>:PROBe:EXtErnal:OFFSet <offset\_value>

**NOTE**

CHANnel<N>:PROBe:EXtErnal command must be set to ON before issuing this command or query or this command will have no effect.

The :CHANnel<N>:PROBe:EXtErnal:OFFSet command sets the external vertical value for the probe that is represented at the center of the display for the selected channel. Offset parameters are probe and vertical scale dependent.

When using the 113xA series probes, the CHANnel<N>:PROBe:STYPe command determines how the offset is applied. When CHANnel<N>:PROBe:STYPe SINGLE is selected, the :CHANnel<N>:PROBe:EXtErnal:OFFSet command changes the offset value of the probe amplifier. When CHANnel<N>:PROBe:STYPe DIFFerential is selected, the :CHANnel<N>:PROBe:EXtErnal:OFFSet command changes the offset value of the channel amplifier.

<N> An integer, 1-4.

<offset\_value> A real number for the offset value at center screen. Usually expressed in volts, but can be in other measurement units, such as amperes, if you have specified other units using the :CHANnel<N>:PROBe:EXtErnal:UNITs command.

**Example** This example sets the external offset for the probe on channel 1 to 0.125 in the current measurement units:

```
myScope.WriteString ":CHANnel1:PROBe:EXtErnal ON"
myScope.WriteString ":CHANnel1:PROBe:EXtErnal:OFFSet 125E-3"
```

**Query** :CHANnel<N>:EXtErnal:PROBe:OFFSet?

The :CHANnel<N>:PROBe:EXtErnal:OFFSet? query returns the current external offset value for the probe on the specified channel.

**Returned Format** [CHANnel<N>:PROBe:EXtErnal:OFFSet] <offset\_value><NL>

**Example** This example places the external offset value of the probe on the specified channel in the variable, Offset, then prints the contents of the variable to the computer's screen.

```
myScope.WriteString ":SYSTem:HEADer OFF"
myScope.WriteString ":CHANnel1:PROBe:EXtErnal ON"
myScope.WriteString ":CHANnel1:PROBe:EXtErnal:OFFSet?"
varOffset = myScope.ReadNumber
Debug.Print FormatNumber(varOffset, 0)
```

**History** Legacy command (existed before version 3.10).

## :CHANnel&lt;N&gt;:PROBe:EXTernal:UNITs

**Command** :CHANnel<N>:PROBe:EXTernal:UNITs {VOLT | AMPere | WATT | UNKNown}

**NOTE**

CHANnel<N>:PROBe:EXTernal command must be set to ON before issuing this command or query or this command will have no effect. UNITs can also be set using the CHANnel<N>:UNITs command.

The :CHANnel<N>:PROBe:EXTernal:UNITs command sets the probe external vertical units on the specified channel. You can specify Y-axis units of VOLTS, AMPS, WATTS, or UNKNown. The units are implied for other pertinent channel probe external commands and channel commands (such as :CHANnel<N>:PROBe:EXTernal:OFFSet and :CHANnel<N>:RANGe). See the Probe Setup dialog box for more information.

<N> An integer, 1-4.

**Example** This example sets the external units for the probe on channel 1 to amperes.

```
myScope.WriteString ":CHANnel1:PROBe:EXTernal ON"
myScope.WriteString ":CHANnel1:PROBe:EXTernal:UNITs AMPERE"
```

**Query** :CHANnel<N>:PROBe:EXTernal:UNITs?

The :CHANnel<N>:PROBe:EXTernal:UNITs? query returns the current external units setting for the probe on the specified channel.

**Returned Format** [:CHANnel<N>:PROBe:EXTernal:UNITs] {VOLT | AMPere | WATT | UNKNown}<NL>

**Example** This example places the external vertical units for the probe on the specified channel in the string variable, strUnits, then prints the contents of the variable to the computer's screen.

```
Dim strUnits As String
myScope.WriteString ":CHANnel1:PROBe:EXTernal ON"
myScope.WriteString ":CHANnel1:PROBe:EXTernal:UNITs?"
strUnits = myScope.ReadString
Debug.Print strUnits
```

**History** Legacy command (existed before version 3.10).

**:CHANnel<N>:PROBe:GAIN****Command** :CHANnel<N>:PROBe:GAIN {X1 | X10}**NOTE**

This command is valid only for the 1154A probe.

The :CHANnel<N>:PROBe:GAIN command sets the 1154A probe input amplifier gain.

If an 1154A probe is not connected to the channel you will get a settings conflict error.

<N> An integer, 1-4.

**Example** This example sets the probe gain for channel 1 to times 10.

```
myScope.WriteString ":CHANnel1:PROBe:GAIN X10"
```

**Query** :CHANnel<N>:PROBe:GAIN?

The :CHANnel<N>:PROBe:GAIN? query returns the current probe gain setting for the selected channel.

**Returned Format** [:CHANnel<N>:PROBe:GAIN] {X1 | X10}<NL>

**History** Legacy command (existed before version 3.10).

## :CHANnel<N>:PROBe:HEAD:ADD

**Command** :CHANnel<N>:PROBe:HEAD:ADD "head", ["label"]

The :CHANnel<N>:PROBe:HEAD:ADD command adds an entry to the list of probe heads.

<N> An integer, 1-4.

"head" A quoted string matching the probe head model such as "N5381A", "E2678A", etc.

"label" An optional quoted string for the head label.

**Example** This example adds the probe head N5381A to the list of probe heads for channel 1.

```
myScope.WriteString ":CHANnel1:PROBe:HEAD:ADD "N5381A""
```

**History** Legacy command (existed before version 3.10).

**:CHANnel<N>:PROBe:HEAD:DELeTe ALL**

**Command** :CHANnel<N>:PROBe:HEAD:DELeTe ALL

The :CHANnel<N>:PROBe:HEAD:DELeTe ALL command deletes all the nodes in the list of probe heads except for one default probe head which remains after this command is executed.

**<N>** An integer, 1-4.

**Example** This example deletes the entire list of probe heads for channel 1 except for the default head.

```
myScope.WriteString ":CHANnel1:PROBe:HEAD:DELeTe ALL"
```

**History** Legacy command (existed before version 3.10).



## :CHANnel&lt;N&gt;:PROBe:HEAD:SElect

**Command** :CHANnel<N>:PROBe:HEAD:SElect {<int> | <quoted\_label\_string>}

The :CHANnel<N>:PROBe:HEAD:SElect command selects the probe head being used from a list of possible probe head choices. You can select by the position number in the list of probe heads, or you can select by the label given when the probe head was added.

<N> An integer, 1-4.

<int> Specifies the number of the head (or position) in the configure list. The entry at the top of the list starts at 1.

<quoted\_label\_string> Specifies the label of the probe head given with the :CHANnel<N>:PROBe:HEAD:ADD command.

**Example** This example add a couple of probe heads to the list then selects the probe head using a number and a label.

```
myScope.WriteString ":CHANnel1:PROBe:HEAD:ADD 'N5445A:B1.5-2.5S'"
myScope.WriteString ":CHANnel1:PROBe:HEAD:ADD 'N5444A:2.92', 'foo'"
myScope.WriteString ":CHANnel1:PROBe:HEAD:SElect 1"
myScope.WriteString ":CHANnel1:PROBe:HEAD:SElect 'foo'"
```

**Query** :CHANnel<N>:PROBe:HEAD:SElect? {MODEl | LABEL}

The :CHANnel<N>:PROBe:HEAD:SElect? query returns a SCPI formatted string of the selected probe head. Optional parameters are:

- MODEl – Returns the model of the probe head.
- LABEL – Returns the label of the probe head. This is the same label given with the :CHANnel<N>:PROBe:HEAD:ADD command and that can also be used with the SElect command.

If no parameter is specified, the MODEl format is returned.

**Example** This example shows a few queries of the channel 1 probe head selection.

```
Dim strProbeHead As String
myScope.WriteString ":CHANnel1:PROBe:HEAD:SElect?"
strProbeHead = myScope.ReadString
Debug.Print strProbeHead ' Prints "N5444A:2.92".
myScope.WriteString ":CHANnel1:PROBe:HEAD:SElect? LABEL"
strProbeHead = myScope.ReadString
Debug.Print strProbeHead ' Prints "foo".
myScope.WriteString ":CHANnel2:PROBe:HEAD:SElect? MODEl"
strProbeHead = myScope.ReadString
Debug.Print strProbeHead ' Prints "N5444A:2.92".
```

**See Also** • [":CHANnel<N>:PROBe:HEAD:ADD"](#) on page 391

**History** Legacy command (existed before version 3.10).

Version 3.50: Added the MPHY protocol type for the MIPI M-PHY serial decode selection.

## :CHANnel&lt;N&gt;:PROBe:HEAD:VTERm

**Command** :CHANnel<N>:PROBe:HEAD:VTERm {FLOating | EXTernal  
| {INTernal,<voltage>}}

The :CHANnel<N>:PROBe:HEAD:VTERm command sets the termination voltage for:

- The N5444A probe head.
- The N7010A active termination adapter, regardless of the attachment/head.
- The MX0020A/21A/22A/24A/25A probe amplifiers.

<N> An integer, 1-4.

<voltage> A real number for the internal termination voltage setting.

**Example** To set an internal termination voltage of -1.0 V:

```
myScope.WriteString ":CHANnel1:PROBe:HEAD:VTERm INTernal,-1.0"
```

**Query** :CHANnel<N>:PROBe:HEAD:VTERm?

The :CHANnel<N>:PROBe:HEAD:VTERm? query returns the termination voltage setting.

**Returned Format** [:CHANnel<N>:PROBe:HEAD:VTERm] {FLO | EXT | {INT,<voltage>}}<NL>

**History** New in version 3.50.

Version 5.50: Supports the N7010A active termination adapter (regardless of the attachment/head) as well as the N5444A probe head.

Version 6.70: Supports the MX0020A/21A/22A/24A/25A probe amplifiers.

## :CHANnel&lt;N&gt;:PROBe:ID?

**Query** :CHANnel<N>:PROBe:ID?

The :CHANnel<N>:PROBe:ID? query returns the type of probe attached to the specified oscilloscope channel.

<N> An integer, 1-4.

**Returned Format** [:CHANnel<N>:PROBe:ID] <probe\_id>

<probe\_id> A string of alphanumeric characters. Some of the possible returned values are:

1131A	1132A	1134A
1152A	1154A	1156A
1157A	1158A	1159A
1163A	1168A	1169A
AutoProbe	E2621A	E2622A
E2695A	E2697A	N5380A
N5381A	N5382A	E2695A
No Probe	Unknown	User Defined Probe

**Example** This example reports the probe type connected to channel 1, if one is connected.

```
myScope.WriteString ":CHANnel1:PROBe:ID?"
```

**History** Legacy command (existed before version 3.10).

**:CHANnel<N>:PROBe:INFO?**

**Query** :CHANnel<N>:PROBe:INFO?

The :CHANnel<N>:PROBe:INFO? query returns a comma-separated list of probe information.

**Returned Format** [:CHANnel<N>:PROBe:INFO] <info\_list><NL>

<info\_list> A comma-delimited list of probe information that includes:

- Model number.
- Serial number.
- Probe head model number or "No Head".
- Attenuation calibration date and time (or "1 JAN 1999 00:00:00" if uncalibrated).
- Skew calibration date and time (or "1 JAN 1999 00:00:00" if uncalibrated).
- Specifies whether default attenuation "Default Atten" or calibrated attenuation "Cal Atten" is being used.
- Specifies whether default skew "Default Skew" or calibrated skew "Cal Skew" is being used.
- The first part of the attenuation ratio (<first>:<second>).
- The second part of the attenuation ratio (<first>:<second>).

**Example** This is an example probe information string.

```
N2751A, US53330101, No Head, 1 JAN 1999 00:00:00, 1 JAN 1999 00:00:00,
Default Atten, Default Skew, 1.9856E+000, 1.0000E+000
```

**See Also** • **":CHANnel<N>:PROBe:ID?"** on page 395

**History** New in version 5.70.

## :CHANnel&lt;N&gt;:PROBe:MODE

**Command** :CHANnel<N>:PROBe:MODE {DIFF | SEA | SEB | CM | SEST}

**NOTE**

This command is valid for InfiniiMode probes, for example:

- N2750/1/2A
- N2830/1/2A
- N7000/1/2/3A
- MX0011AA/12A/13A/20A/21A/22A/24A/25A

The :CHANnel<N>:PROBe:MODE command sets the probe's InfiniiMode configuration.

If the probe is not connected to the channel you will get a settings conflict error.

<N> An integer, 1-4.

**Example** This example sets the probe InfiniiMode for channel 1 to common mode.

```
myScope.WriteString ":CHANnel1:PROBe:MODE CM"
```

**Query** :CHANnel<N>:PROBe:MODE?

The :CHANnel<N>:PROBe:MODE? query returns the probe's InfiniiMode setting for the selected channel.

**Returned Format** [:CHANnel<N>:PROBe:MODE] {DIFF | SEA | SEB | CM | SEST | NONE}<NL>

NONE will be returned for unsupported probes.

**History** New in version 3.50.

Version 6.70: The SEST (source estimate differential) mode has been added for the MX0020A/21A/22A/24A/25A probe amplifiers.

## :CHANnel&lt;N&gt;:PROBe:PRECprobe:BANDwidth

**Command** :CHANnel<N>:PROBe:PRECprobe:BANDwidth {AUTO | {MANual, <bandwidth>}  
| {BOOSt, <boost\_dB>}}

The :CHANnel<N>:PROBe:PRECprobe:BANDwidth command specifies how the limit of PrecisionProbe or PrecisionCable correction/boosting is determined.

<N> An integer, 1-4.

**AUTO** PrecisionProbe or PrecisionCable normally sets the bandwidth to a value that has a small amount of boosting in the frequency response.

**MANual, <bandwidth>** Let you manually specify a bandwidth limit at which to stop applying correction.

**BOOSt, <boost\_dB>** Lets you specify a dB limit at which to stop applying correction.

**Example** This example specifies that, for PrecisionProbe or PrecisionCable on channel 1, correction/boosting should stop being applied at a 3 dB limit.

```
myScope.WriteString ":CHANnel1:PROBe:PRECprobe:BANDwidth BOOSt, 3"
```

**Query** :CHANnel<N>:PROBe:PRECprobe:BANDwidth?

The :CHANnel<N>:PROBe:PRECprobe:BANDwidth? query returns the current PrecisionProbe or PrecisionCable corrected bandwidth setting for the selected channel.

**Returned Format** [:CHANnel<N>:PROBe:PRECprobe:BANDwidth] {AUTO | {MANual, <bandwidth>}  
| {BOOSt, <boost\_dB>}}<NL>

- See Also**
- [":CHANnel<N>:PROBe:ACCAL"](#) on page 377
  - [":CHANnel<N>:PROBe:PRECprobe:MODE"](#) on page 401
  - [":CHANnel<N>:PROBe:PRECprobe:CALibration"](#) on page 399
  - [":CHANnel<N>:PROBe:PRECprobe:ZSRC"](#) on page 402
  - [":CHANnel<N>:PROBe:PRECprobe:DELay"](#) on page 400

**History** New in version 3.10.

## :CHANnel&lt;N&gt;:PROBe:PRECprobe:CALibration

**Command** :CHANnel<N>:PROBe:PRECprobe:CALibration <cal\_string>[,<cal\_string2>]

The :CHANnel<N>:PROBe:PRECprobe:CALibration command specifies the name of the PrecisionProbe or PrecisionCable calibration to use for the specified channel and probe.

<N> An integer, 1-4.

<cal\_string>[,<cal\_string2>] A quoted string that is the name of the PrecisionProbe or Precision Cable calibration. The SMA probe heads can use two independent calibration files.

**Example** This example says to use the PrecisionProbe or PrecisionCable calibration named "2-8-2" for channel 1.

```
myScope.WriteString ":CHANnel1:PROBe:PRECprobe:CALibration "2-8-2"
```

**Query** :CHANnel<N>:PROBe:PRECprobe:CALibration?

The :CHANnel<N>:PROBe:PRECprobe:CALibration? query returns the currently specified name for the selected channel's PrecisionProbe or PrecisionCable calibration.

**Returned Format** [:CHANnel<N>:PROBe:PRECprobe:CALibration] <cal\_string>[,<cal\_string2>]<NL>

- See Also**
- [":CHANnel<N>:PROBe:ACCAL"](#) on page 377
  - [":CHANnel<N>:PROBe:PRECprobe:MODE"](#) on page 401
  - [":CHANnel<N>:PROBe:PRECprobe:ZSRC"](#) on page 402
  - [":CHANnel<N>:PROBe:PRECprobe:BANDwidth"](#) on page 398
  - [":CHANnel<N>:PROBe:PRECprobe:DELay"](#) on page 400

**History** New in version 3.10.

## :CHANnel&lt;N&gt;:PROBe:PRECprobe:DELAy

**Command** :CHANnel<N>:PROBe:PRECprobe:DELAy {{ON | 1} | {OFF | 0}}

The :CHANnel<N>:PROBe:PRECprobe:DELAy command specifies whether to include cable delay in a PrecisionCable AC response probe calibration.

<N> An integer, 1-4.

**Example** This example specifies to include cable delay in the calibration.

```
myScope.WriteString ":CHANnel1:PROBe:PRECprobe:DELAy ON"
```

**Query** :CHANnel<N>:PROBe:PRECprobe:DELAy?

The :CHANnel<N>:PROBe:PRECprobe:DELAy? query returns the current "include cable delay" selection.

**Returned Format** [:CHANnel<N>:PROBe:PRECprobe:DELAy] {1 | 0}<NL>

- See Also**
- [":CHANnel<N>:PROBe:ACCAL"](#) on page 377
  - [":CHANnel<N>:PROBe:PRECprobe:MODE"](#) on page 401
  - [":CHANnel<N>:PROBe:PRECprobe:CALibration"](#) on page 399
  - [":CHANnel<N>:PROBe:PRECprobe:ZSRC"](#) on page 402
  - [":CHANnel<N>:PROBe:PRECprobe:BANDwidth"](#) on page 398

**History** New in version 4.20.



## :CHANnel&lt;N&gt;:PROBe:PRECprobe:MODE

**Command** :CHANnel<N>:PROBe:PRECprobe:MODE {PROBe | CABLE}

The :CHANnel<N>:PROBe:PRECprobe:MODE command chooses between PrecisionProbe or PrecisionCable AC response probe calibration.

<N> An integer, 1-4.

**Example** This example chooses PrecisionProbe calibration for the probe on channel 1.

```
myScope.WriteString ":CHANnel1:PROBe:PRECprobe:MODE PROBe"
```

**Query** :CHANnel<N>:PROBe:PRECprobe:MODE?

The :CHANnel<N>:PROBe:PRECprobe:MODE? query returns the current PrecisionProbe/PrecisionCable selection for the selected channel.

**Returned Format** [:CHANnel<N>:PROBe:PRECprobe:MODE] {PROBe | CABLE}<NL>

- See Also**
- [":CHANnel<N>:PROBe:ACCAL"](#) on page 377
  - [":CHANnel<N>:PROBe:PRECprobe:CALibration"](#) on page 399
  - [":CHANnel<N>:PROBe:PRECprobe:ZSRC"](#) on page 402
  - [":CHANnel<N>:PROBe:PRECprobe:BANDwidth"](#) on page 398
  - [":CHANnel<N>:PROBe:PRECprobe:DELay"](#) on page 400

**History** New in version 3.10.

## :CHANnel&lt;N&gt;:PROBe:PRECprobe:ZSRC

**Command** :CHANnel<N>:PROBe:PRECprobe:ZSRC {VIN | {VSRC, <impedance>}  
| {VSRC, <file\_string>}}

The :CHANnel<N>:PROBe:PRECprobe:ZSRC command specifies how PrecisionProbe characterizes the time domain and frequency domain response.

<N> An integer, 1-4.

**VIN** Selects the VOut/Vin probe transfer function (which characterizes the output of the probe as a function of the input at the probe tips).

Defining the response this way lets you evaluate the probe's accuracy in reproducing the actual signal present in your system with the probe attached. This correction is what you would see with a real band limited probe that has finite input impedance. PrecisionProbe corrects the "VOut/Vin" response to be flat with frequency and phase to your defined bandwidth limit. It does not de-embed the loading effects of the probe. (Keysight's probe corrections are typically defined using Vout/Vin.)

**VSRC, <impedance>** Selects the VOut/VSrc estimate of probed system response (which corrects the probe as "what would be there if the probe were not present"), and specifies a constant ( $Z_0/2$ ) value (in ohms) as the system source impedance.

One drawback of defining the probe's response in this manner is that if the probe's loading causes your circuit to lose some timing or amplitude margin, you probably want to know that when you make a measurement. VOut/VSource compensation will hide these effects from you. However, this method can be effective if probing at the transmitter.

**VSRC, <file\_string>** Selects the VOut/VSrc estimate of probed system response (which corrects the probe as "what would be there if the probe were not present"), and names an S-parameter file whose S11 is used to specify the system source impedance.

**Example** This example, for channel 1, tells PrecisionProbe to use the VOut/VSrc characterization and to get the system source impedance from S11 in the "foo.s2p" S-parameter file.

```
myScope.WriteString ":CHANnel1:PROBe:PRECprobe:ZSRC VSRC, "foo.s2p"
```

**Query** :CHANnel<N>:PROBe:PRECprobe:ZSRC?

The :CHANnel<N>:PROBe:PRECprobe:ZSRC? query returns the current settings for PrecisionProbe time domain and frequency domain response characterization.

**Returned Format** [:CHANnel<N>:PROBe:PRECprobe:ZSRC] {VIN | {VSRC, <impedance>}  
| {VSRC, <file\_string>}}<NL>

- See Also**
- **":CHANnel<N>:PROBe:ACCAL"** on page 377
  - **":CHANnel<N>:PROBe:PRECprobe:MODE"** on page 401
  - **":CHANnel<N>:PROBe:PRECprobe:CALibration"** on page 399

- `":CHANnel<N>:PROBe:PRECprobe:BANDwidth"` on page 398
- `":CHANnel<N>:PROBe:PRECprobe:DELay"` on page 400

**History** New in version 3.10.

## :CHANnel&lt;N&gt;:PROBe:PRIMary (9000 Series, 9000H Series, S-Series)

**Command** :CHANnel<N>:PROBe:PRIMary {ZIN | ZOUT}

<N> is an integer, 1-4.

For the N2820A/N2821A high-sensitivity current probes only, the :CHANnel<N>:PROBe:PRIMary command configures the input channel as a zoomed-in amplified channel (ZIN) or zoomed-out channel (ZOUT). With N2820A probes, the secondary channel will have the other waveform.

**Query** :CHANnel<N>:PROBe:PRIMary?

The :CHANnel<N>:PROBe:PRIMary? query returns the primary channel output setting.

**Returned Format** [:CHANnel<N>:PROBe:PRIMary] {ZIN | ZOUT}<NL>

**See Also** • [":MEASure:CHARge \(9000 Series, 9000H Series, S-Series\)"](#) on page 917

**History** New in version 5.60.

**:CHANnel<N>:PROBe:RESPonsivity**

**Command** :CHANnel<N>:PROBe:RESPonsivity <value>

**NOTE**

This command is valid only for the N7004A Optical-to-Electrical Converter probe.

When a user-defined wavelength is selected (by using the ":CHANnel<N>:PROBe:WAVelength WUSer" command), the :CHANnel<N>:PROBe:RESPonsivity command sets the responsivity value that has been determined using an optical power meter.

You can set the responsivity only when the wavelength is set to WUSer.

<N> An integer, 1-4.

<value> Responsivity value in Volts/Watt.

**Query** :CHANnel<N>:PROBe:RESPonsivity?

The :CHANnel<N>:PROBe:RESPonsivity? query returns responsivity value setting.

**Returned Format** <value><NL>

<value> ::= V/W responsivity value in NR3 format

**See Also** · **":CHANnel<N>:PROBe:WAVelength"** on page 411

**History** New in version 6.50.

**:CHANnel<N>:PROBe:SKEW**

**Command** :CHANnel<N>:PROBe:SKEW <skew\_value>

The :CHANnel<N>:PROBe:SKEW command sets the channel-to-channel skew factor for the specified channel. You can use the oscilloscope's probe skew control to remove timing differences between probes or cables on different channels.

<N> An integer, 1-4.

<skew\_value> A real number for the skew value, in the range -1 ms to +1 ms.

**Example** This example sets the probe skew for channel 1 to 10  $\mu$ s.

```
myScope.WriteString ":CHANnel1:PROBe:SKEW 10E-6"
```

**Query** :CHANnel<N>:PROBe:SKEW?

The :CHANnel<N>:PROBe:SKEW? query returns the current probe skew setting for the selected channel.

**Returned Format** [:CHANnel<N>:PROBe:SKEW] <skew\_value><NL>

**See Also** • **":CHANnel<N>:PROBe:SKEW:AUTO"** on page 407

**History** Legacy command (existed before version 3.10).

## :CHANnel<N>:PROBe:SKEW:AUTO

**Command** :CHANnel<N>:PROBe:SKEW:AUTO

The :CHANnel<N>:PROBe:SKEW:AUTO command measures and sets the skew for a differential channel:

- 1 First, set up the differential channel and apply your signal.
- 2 Then, use this command to automatically set the skew.

<N> An integer, 1-4.

**See Also** · [":CHANnel<N>:PROBe:SKEW"](#) on page 406

**History** Legacy command (existed before version 3.10).

**:CHANnel<N>:PROBe:STYPe****Command** :CHANnel<N>:PROBe:STYPe {DIFFerential | SINGle}**NOTE**

This command is valid only for the 113xA series probes, 1168A probe, and 1169A probe.

The :CHANnel<N>:PROBe:STYPe command sets the channel probe signal type (STYPe) to differential or single-ended when using the 113xA series probes, 1168A probe, and 1169A probe. This setting determines how offset is applied.

When single-ended is selected, the :CHANnel<N>:PROBe:EXtErnal:OFFset command changes the offset value of the probe amplifier. When differential is selected, the :CHANnel<N>:PROBe:EXtErnal:OFFset command changes the offset value of the channel amplifier.

**<N>** An integer, 1-4.**Example** This example sets the probe mode to single-ended.

```
myScope.WriteString ":CHANnel1:PROBe:STYPe SINGle"
```

**Query** :CHANnel<N>:PROBe:STYPe?

The :CHANnel<N>:PROBe:STYPe? query returns the current probe mode setting for the selected channel.

**Returned Format** [:CHANnel<N>:PROBe:STYPe] {DIFFerential | SINGle}<NL>**History** Legacy command (existed before version 3.10).



## :CHANnel&lt;N&gt;:PROBe:USER

**Command** :CHANnel<N>:PROBe:USER {NONE | N7019A  
 | VOLTage, {RATio | DECibel}, <attenuation>  
 | CURRent, {VA2M | VA10M | VA20M | VA100M | VA1 | VA10}}

For an undetectable, user-defined probe, the :CHANnel<N>:PROBe:USER command specifies the probe type and attenuation factor.

The probe type selections are:

- NONE – No probe attached.
- N7019A – N7019A Type-C active link fixture.
- VOLTage – Voltage probe.

With the voltage probe type, the <attenuation\_factor> is a real number from 0.0001 to 1000 for the RATio attenuation units or from -80 dB to 60 dB for the DECibel attenuation units.

- CURRent – Current probe.

The current probe type is supported on S-Series and 9000 Series oscilloscopes when 1 M $\Omega$  input impedance is selected.

With the current probe type, the attenuation settings can be:

- VA2M – 2 mV/A.
- VA10M – 10 mV/A.
- VA20M – 20 mV/A.
- VA100M – 100 mV/A.
- VA1 – 1 V/A.
- VA10 – 10 V/A.

These parameters determine the scaling of the display and affect automatic measurements and trigger levels.

<N> An integer, 1 to the number of analog input channels.

**Example** This example sets a voltage probe attenuation factor for a 10:1 probe on channel 1 in ratio units.

```
myScope.WriteString ":CHANnel1:PROBe:USER VOLTage,RATio,10"
```

**Query** :CHANnel<N>:PROBe:USER?

The :CHANnel<N>:PROBe:USER? query returns the currently specified probe type and attenuation factor for the selected channel.

**Returned Format** [:CHANnel<N>:PROBe:USER] {NONE | N7019A  
 | VOLT, {RAT | DEC}, <attenuation>  
 | CURR, {VA2M | VA10M | VA20M | VA100M | VA1 | VA10}}<NL>

**Example** This example places the currently specified probe type and attenuation setting for channel 1 in the string variable, strAtten, then the program prints the contents.

```
Dim strAtten As String ' Dimension variable.  
myScope.WriteString ":CHANnel1:PROBe:USER?"  
strAtten = myScope.ReadString  
Debug.Print strAtten
```

**History** New in version 6.73. Replaces the now-deprecated command **":CHANnel<N>:PROBe"** on page 1716.

## :CHANnel&lt;N&gt;:PROBe:WAVelength

**Command** :CHANnel<N>:PROBe:WAVelength <wavelength>

**NOTE**

This command is valid only for the N7004A Optical-to-Electrical Converter probe.

The :CHANnel<N>:PROBe:WAVelength command lets you specify the wavelength as 850 nm, 1310 nm, 1550 nm, or a user-defined value.

When WUSer is selected, use the :CHANnel<N>:PROBe:RESPonsivity command to enter the responsivity value determined by using an optical power meter.

<N> An integer, 1-4.

<wavelength> {W850 | W1310 | W1550 | WUSer}

**Query** :CHANnel<N>:PROBe:WAVelength?

The :CHANnel<N>:PROBe:WAVelength? query returns the wavelength setting.

**Returned Format** <wavelength><NL>

<wavelength> ::= {W850 | W1310 | W1550 | WUS}

**See Also** • [":CHANnel<N>:PROBe:RESPonsivity"](#) on page 405

**History** New in version 6.50.

**:CHANnel<N>:RANGe**

**Command** :CHANnel<N>:RANGe <range\_value>

The :CHANnel<N>:RANGe command defines the full-scale vertical axis of the selected channel. It sets up acquisition and display hardware to display the waveform at a given range scale. The values represent the full-scale deflection factor of the vertical axis in volts. These values change as the probe attenuation factor is changed.

<N> An integer, 1-4 in a single oscilloscope, 1-40 in a MultiScope system.

<range\_value> A real number for the full-scale voltage of the specified channel number.

**Example** This example sets the full-scale range for channel 1 to 500 mV.

```
myScope.WriteString ":CHANnel1:RANGe 500E-3"
```

**Query** :CHANnel<N>:RANGe?

The :CHANnel<N>:RANGe? query returns the current full-scale vertical axis setting for the selected channel.

**Returned Format** [:CHANnel<N>:RANGe] <range\_value><NL>

**Example** This example places the current range value in the number variable, varSetting, then prints the contents of the variable to the computer's screen.

```
myScope.WriteString ":SYSTem:HEADer OFF"      ' Response headers off.
myScope.WriteString ":CHANnel1:RANGe?"
varSetting = myScope.ReadNumber
Debug.Print FormatNumber(varSetting, 0)
```

**History** Legacy command (existed before version 3.10).

**:CHANnel<N>:SCALE**

**Command** :CHANnel<N>:SCALE <scale\_value>

The :CHANnel<N>:SCALE command sets the vertical scale, or units per division, of the selected channel. This command is the same as the front-panel channel scale.

<N> An integer, 1-4 in a single oscilloscope, 1-40 in a MultiScope system.

<scale\_value> A real number for the vertical scale of the channel in units per division.

**Example** This example sets the scale value for channel 1 to 500 mV/div.

```
myScope.WriteString ":CHANnel1:SCALE 500E-3"
```

**Query** :CHANnel<N>:SCALE?

The :CHANnel<N>:SCALE? query returns the current scale setting for the specified channel.

**Returned Format** [:CHANnel<N>:SCALE] <scale\_value><NL>

**Example** This example places the current scale value in the number variable, varSetting, then prints the contents of the variable to the computer's screen.

```
myScope.WriteString ":SYSTEM:HEADer OFF"      ' Response headers off.
myScope.WriteString ":CHANnel1:SCALE?"
varSetting = myScope.ReadNumber
Debug.Print FormatNumber(varSetting, 0)
```

**History** Legacy command (existed before version 3.10).

## :CHANnel&lt;N&gt;:SIMulation:AMPLitude

**Command** :CHANnel<N>:SIMulation:AMPLitude <value>

The :CHANnel<N>:SIMulation:AMPLitude command specifies the amplitude of the simulated waveform.

<N> An integer, 1-4 in a single oscilloscope, 1-40 in a MultiScope system.

<value> Simulated waveform vertical value in NR3 format.

**Query** :CHANnel<N>:SIMulation:AMPLitude?

The :CHANnel<N>:SIMulation:AMPLitude? query returns the simulated waveform's amplitude value.

**Returned Format** <value><NL>

<value> ::= waveform vertical value in NR3 format

**See Also** · [":CHANnel<N>:SIMulation:WAVEform"](#) on page 446

**History** New in version 6.00.

## :CHANnel&lt;N&gt;:SIMulation:DATA:LENGth

**Command** :CHANnel<N>:SIMulation:DATA:LENGth <length\_exp>

For the DATA simulated waveform type (see :CHANnel<N>:SIMulation:WAVEform), the :CHANnel<N>:SIMulation:DATA:LENGth command specifies the length exponent of the simulated waveform's PRBS sequence ( $2^{\langle\text{length\_exp}\rangle}$ ).

<N> An integer, 1-4 in a single oscilloscope, 1-40 in a MultiScope system.

<length\_exp> PRBS length exponent from 1 to 15 in NR1 format.

**Query** :CHANnel<N>:SIMulation:DATA:LENGth?

The :CHANnel<N>:SIMulation:DATA:LENGth? query returns the specified length exponent.

**Returned Format** <length\_exp><NL>

<length\_exp> ::= PRBS length exponent from 1 to 15 in NR1 format

- See Also**
- [":CHANnel<N>:SIMulation:WAVEform"](#) on page 446
  - [":CHANnel<N>:SIMulation:DRATE"](#) on page 420
  - [":CHANnel<N>:SIMulation:DATA:SELECTION"](#) on page 419
  - [":CHANnel<N>:SIMulation:DATA:ODD"](#) on page 416
  - [":CHANnel<N>:SIMulation:DATA:RESeed"](#) on page 418

**History** New in version 6.00.

**:CHANnel<N>:SIMulation:DATA:ODD**

**Command** :CHANnel<N>:SIMulation:DATA:ODD {{0 | OFF} | {1 | ON}}

For the DATA simulated waveform type (see :CHANnel<N>:SIMulation:WAVEform), the :CHANnel<N>:SIMulation:DATA:ODD command sets the PRBS "odd" control. When ON, one is subtracted from the length of the PRBS sequence.

<N> An integer, 1-4 in a single oscilloscope, 1-40 in a MultiScope system.

**Query** :CHANnel<N>:SIMulation:DATA:ODD?

The :CHANnel<N>:SIMulation:DATA:ODD? query returns the PRBS "odd" control setting.

**Returned Format** <setting><NL>

<setting> ::= {0 | 1}

- See Also**
- [":CHANnel<N>:SIMulation:WAVEform"](#) on page 446
  - [":CHANnel<N>:SIMulation:DRATE"](#) on page 420
  - [":CHANnel<N>:SIMulation:DATA:SELECTION"](#) on page 419
  - [":CHANnel<N>:SIMulation:DATA:LENGTH"](#) on page 415
  - [":CHANnel<N>:SIMulation:DATA:RESeed"](#) on page 418

**History** New in version 6.00.



## :CHANnel&lt;N&gt;:SIMulation:DATA:PAM

**Command** :CHANnel<N>:SIMulation:DATA:PAM <num\_of\_symbols>

When the DATA simulated waveform type is selected (:CHANnel<N>:SIMulation:WAVEform DATA) and PAM is selected as the PRBS signal type (:CHANnel<N>:SIMulation:DATA:SElection PAM), the :CHANnel<N>:SIMulation:DATA:PAM command specifies the number of symbols (or levels) in the PAM signal. For example, for a PAM-4 signal, you specify 4.

<N> An integer, 1-4 in a single oscilloscope, 1-40 in a MultiScope system.

<num\_of\_symbols> A value from 2 to 255 in NR1 format.

>

**Query** :CHANnel<N>:SIMulation:DATA:PAM?

The :CHANnel<N>:SIMulation:DATA:PAM? query returns the specified number of symbols in the PAM signal.

**Returned Format** <num\_of\_symbols><NL>

<num\_of\_symbols> ::= 2 to 255 in NR1 format, e.g., 4 = PAM-4

- See Also**
- [":CHANnel<N>:SIMulation:WAVEform"](#) on page 446
  - [":CHANnel<N>:SIMulation:DATA:SElection"](#) on page 419

**History** New in version 6.00.

## :CHANnel&lt;N&gt;:SIMulation:DATA:RESeed

**Command** :CHANnel<N>:SIMulation:DATA:RESeed {{0 | OFF} | {1 | ON}}

For the DATA simulated waveform type (see :CHANnel<N>:SIMulation:WAVEform), the :CHANnel<N>:SIMulation:DATA:RESeed command specifies whether to reseed the PRBS generator(s). When ON, a new sequence is given on each acquire.

<N> An integer, 1-4 in a single oscilloscope, 1-40 in a MultiScope system.

**Query** :CHANnel<N>:SIMulation:DATA:RESeed?

The :CHANnel<N>:SIMulation:DATA:RESeed? query returns the PRBS generator(s) reseed setting.

**Returned Format** <setting><NL>

<setting> ::= {0 | 1}

- See Also**
- [":CHANnel<N>:SIMulation:WAVEform"](#) on page 446
  - [":CHANnel<N>:SIMulation:DRATE"](#) on page 420
  - [":CHANnel<N>:SIMulation:DATA:SELECTION"](#) on page 419
  - [":CHANnel<N>:SIMulation:DATA:LENGTH"](#) on page 415
  - [":CHANnel<N>:SIMulation:DATA:ODD"](#) on page 416

**History** New in version 6.00.

## :CHANnel&lt;N&gt;:SIMulation:DATA:SElection

**Command** :CHANnel<N>:SIMulation:DATA:SElection <type>

For the DATA simulated waveform type (see :CHANnel<N>:SIMulation:WAVEform), the :CHANnel<N>:SIMulation:DATA:SElection command specifies whether the simulated PRBS waveform is a Non Return to Zero (NRZ) signal or a Pulse Amplitude Modulation (PAM) signal.

<N> An integer, 1-4 in a single oscilloscope, 1-40 in a MultiScope system.

<type> {NRZ | PAM}

**Query** :CHANnel<N>:SIMulation:DATA:SElection?

The :CHANnel<N>:SIMulation:DATA:SElection? query returns the simulated PRBS waveform signal type selection.

**Returned Format** <type><NL>

<type> ::= {NRZ | PAM}

- See Also**
- [":CHANnel<N>:SIMulation:WAVEform"](#) on page 446
  - [":CHANnel<N>:SIMulation:DRATE"](#) on page 420
  - [":CHANnel<N>:SIMulation:DATA:LENGth"](#) on page 415
  - [":CHANnel<N>:SIMulation:DATA:ODD"](#) on page 416
  - [":CHANnel<N>:SIMulation:DATA:PAM"](#) on page 417
  - [":CHANnel<N>:SIMulation:DATA:RESeed"](#) on page 418

**History** New in version 6.00.

## :CHANnel&lt;N&gt;:SIMulation:DRATe

**Command** :CHANnel<N>:SIMulation:DRATe <data\_rate>

For the DATA simulated waveform type (see :CHANnel<N>:SIMulation:WAVEform), the :CHANnel<N>:SIMulation:DRATe command specifies the data rate of the simulated waveform.

<N> An integer, 1-4 in a single oscilloscope, 1-40 in a MultiScope system.

<data\_rate> Value in NR3 format.

**Query** :CHANnel<N>:SIMulation:DRATe?

The :CHANnel<N>:SIMulation:DRATe? query returns the specified data rate of the simulated waveform.

**Returned Format** <data\_rate><NL>

<data\_rate> ::= value in NR3 format

- See Also**
- [":CHANnel<N>:SIMulation:WAVEform"](#) on page 446
  - [":CHANnel<N>:SIMulation:DATA:SELECTION"](#) on page 419
  - [":CHANnel<N>:SIMulation:DATA:LENGTH"](#) on page 415
  - [":CHANnel<N>:SIMulation:DATA:ODD"](#) on page 416
  - [":CHANnel<N>:SIMulation:DATA:RESEED"](#) on page 418

**History** New in version 6.00.

## :CHANnel&lt;N&gt;:SIMulation:FILTer:ISIM:ADDRESS

**Command** :CHANnel<N>:SIMulation:FILTer:ISIM:ADDRESS <file\_path>

When the InfiniiSim filter is selected (with the ":CHANnel<N>:SIMulation:FILTer:SElection ISIM" command), the :CHANnel<N>:SIMulation:FILTer:ISIM:ADDRESS command specifies the path of an InfiniiSim transfer function file.

<N> An integer, 1-4 in a single oscilloscope, 1-40 in a MultiScope system.

<file\_path> Quoted path string of a valid .tf2 or .tf4 file.

**Query** :CHANnel<N>:SIMulation:FILTer:ISIM:ADDRESS?

The :CHANnel<N>:SIMulation:FILTer:ISIM:ADDRESS? query returns the path of the selected InfiniiSim transfer function file.

**Returned Format** <file\_path><NL>

<file\_path> ::= quoted path string of a valid .tf2 or .tf4 file

- See Also**
- [":CHANnel<N>:SIMulation:FILTer:ISIM:PEXTraction"](#) on page 422
  - [":CHANnel<N>:SIMulation:FILTer:SElection"](#) on page 423

**History** New in version 6.00.

## :CHANnel&lt;N&gt;:SIMulation:FILTer:ISIM:PEXTraction

**Command** :CHANnel<N>:SIMulation:FILTer:ISIM:PEXTraction <port\_extraction>

When a .tf4 4-port InfiniiSim transfer function file is used (see :CHANnel<N>:SIMulation:FILTer:ISIM:ADDRes), the :CHANnel<N>:SIMulation:FILTer:ISIM:PEXTraction command specifies the port extraction method.

<N> An integer, 1-4 in a single oscilloscope, 1-40 in a MultiScope system.

<port\_extraction> {P12 | P32 | P34 | P14 | DIFFerential | COMMONmode}

**Query** :CHANnel<N>:SIMulation:FILTer:ISIM:PEXTraction?

The :CHANnel<N>:SIMulation:FILTer:ISIM:PEXTraction? query returns the selected port extraction method.

**Returned Format** <port\_extraction><NL>

<port\_extraction> ::= {P12 | P32 | P34 | P14 | DIFF | COMM}

- See Also**
- [":CHANnel<N>:SIMulation:FILTer:ISIM:ADDRes"](#) on page 421
  - [":CHANnel<N>:SIMulation:FILTer:SELECTION"](#) on page 423

**History** New in version 6.00.

## :CHANnel&lt;N&gt;:SIMulation:FILTer:SELection

**Command** :CHANnel<N>:SIMulation:FILTer:SELection <filter\_type>

The :CHANnel<N>:SIMulation:FILTer:SELection command sets the filter type.

<N> An integer, 1-4 in a single oscilloscope, 1-40 in a MultiScope system.

<filter\_type> {BWALI | GAUSSian | ISIM | NONE}

**NOTE**

The InfiniiSim feature must be licensed to make the ISIM selection.

**Query** :CHANnel<N>:SIMulation:FILTer:SELection?

The :CHANnel<N>:SIMulation:FILTer:SELection? query returns the filter type setting

**Returned Format** <filter\_type><NL>

<filter\_type> ::= {BWAL | GAUS | ISIM | NONE}

**See Also**

- [":CHANnel<N>:SIMulation:FILTer:ISIM:ADDRESS"](#) on page 421
- [":CHANnel<N>:SIMulation:FILTer:ISIM:PEXTraction"](#) on page 422

**History** New in version 6.00.

**:CHANnel<N>:SIMulation:FLOad:ADDRess**

**Command** :CHANnel<N>:SIMulation:FLOad:ADDRess <load\_file\_path>

For the FILE simulated waveform type (see :CHANnel<N>:SIMulation:WAVEform), the :CHANnel<N>:SIMulation:FLOad:ADDRess command specifies the full path string of a .wfm file to use as the simulated waveform.

The string must include the full path and file extension. Only Infiniium waveform data files are supported.

<N> An integer, 1-4 in a single oscilloscope, 1-40 in a MultiScope system.

<load\_file\_path> Quoted full path string of a .wfm file.

**Query** :CHANnel<N>:SIMulation:FLOad:ADDRess?

The :CHANnel<N>:SIMulation:FLOad:ADDRess? query returns ...

**Returned Format** <load\_file\_path><NL>

<load\_file\_path> ::= quoted full path string of a .wfm file

- See Also**
- [":CHANnel<N>:SIMulation:WAVEform"](#) on page 446
  - [":CHANnel<N>:SIMulation:FLOad:LOOP"](#) on page 425

**History** New in version 6.00.



## :CHANnel&lt;N&gt;:SIMulation:FLOad:LOOP

**Command** :CHANnel<N>:SIMulation:FLOad:LOOP {{0 | OFF} | {1 | ON}}

For the FILE simulated waveform type (see :CHANnel<N>:SIMulation:WAVEform), the :CHANnel<N>:SIMulation:FLOad:LOOP command specifies whether the simulated waveform should repeat from the beginning of the file when reaching the end of the file.

<N> An integer, 1-4 in a single oscilloscope, 1-40 in a MultiScope system.

**Query** :CHANnel<N>:SIMulation:FLOad:LOOP?

The :CHANnel<N>:SIMulation:FLOad:LOOP? query returns the loop control setting.

**Returned Format** <setting><NL>

<setting> ::= {0 | 1}

- See Also**
- [":CHANnel<N>:SIMulation:WAVEform"](#) on page 446
  - [":CHANnel<N>:SIMulation:FLOad:ADDRESS"](#) on page 424

**History** New in version 6.00.

## :CHANnel&lt;N&gt;:SIMulation:FREQuency

**Command** :CHANnel<N>:SIMulation:FREQuency <freq>

For the CLOCK or FUNCTION simulated waveform types (see :CHANnel<N>:SIMulation:WAVEform), the :CHANnel<N>:SIMulation:FREQuency command specifies the frequency of the simulated waveform.

<N> An integer, 1-4 in a single oscilloscope, 1-40 in a MultiScope system.

<freq> Value in NR3 format.

**Query** :CHANnel<N>:SIMulation:FREQuency?

The :CHANnel<N>:SIMulation:FREQuency? query returns the specified frequency of the simulated waveform.

**Returned Format** <freq><NL>

<freq> ::= value in NR3 format

**See Also** • [":CHANnel<N>:SIMulation:WAVEform"](#) on page 446

**History** New in version 6.00.

## :CHANnel&lt;N&gt;:SIMulation:FUNCTion:SELection

**Command** :CHANnel<N>:SIMulation:FUNCTion:SELection <type>

For the FUNCTion simulated waveform type (see :CHANnel<N>:SIMulation:WAVEform), the :CHANnel<N>:SIMulation:FUNCTion:SELection command specifies the simulated waveform function type.

<N> An integer, 1-4 in a single oscilloscope, 1-40 in a MultiScope system.

<type> {IMPulse | SAWTooth | SIN | SQUare | TRIangle}

**Query** :CHANnel<N>:SIMulation:FUNCTion:SELection?

The :CHANnel<N>:SIMulation:FUNCTion:SELection? query returns the selected simulated waveform function type.

**Returned Format** <type><NL>

<type> ::= {IMP | SAWT | SIN | SQU | TRI}

- See Also**
- [":CHANnel<N>:SIMulation:WAVEform"](#) on page 446
  - [":CHANnel<N>:SIMulation:FREQuency"](#) on page 426
  - [":CHANnel<N>:SIMulation:FUNCTion:SQUare:DCYCLE"](#) on page 428
  - [":CHANnel<N>:SIMulation:FUNCTion:SQUare:RTIME"](#) on page 430
  - [":CHANnel<N>:SIMulation:FUNCTion:SQUare:FTIME"](#) on page 429

**History** New in version 6.00.

## :CHANnel&lt;N&gt;:SIMulation:FUNCTion:SQUare:DCYClE

**Command** :CHANnel<N>:SIMulation:FUNCTion:SQUare:DCYClE <duty\_cycle>

When the FUNCTion simulated waveform type is selected (:CHANnel<N>:SIMulation:WAVEform FUNCTion) and the SQUare function is selected (:CHANnel<N>:SIMulation:FUNCTion:SELECTION SQUare), the :CHANnel<N>:SIMulation:FUNCTion:SQUare:DCYClE command specifies the square wave's duty cycle high time percent value.

<N> An integer, 1-4 in a single oscilloscope, 1-40 in a MultiScope system.

<duty\_cycle> The percent high time value in NR1 format.

**Query** :CHANnel<N>:SIMulation:FUNCTion:SQUare:DCYClE?

The :CHANnel<N>:SIMulation:FUNCTion:SQUare:DCYClE? query returns the specified duty cycle high time percent value.

**Returned Format** <duty\_cycle><NL>

<duty\_cycle> ::= percent high time value in NR1 format

- See Also**
- [":CHANnel<N>:SIMulation:WAVEform"](#) on page 446
  - [":CHANnel<N>:SIMulation:FUNCTion:SELECTION"](#) on page 427

**History** New in version 6.00.

## :CHANnel&lt;N&gt;:SIMulation:FUNCTion:SQUare:FTIME

**Command** :CHANnel<N>:SIMulation:FUNCTion:SQUare:FTIME <fall\_time>

When the FUNCTion simulated waveform type is selected (:CHANnel<N>:SIMulation:WAVEform FUNCTion) and the SQUare function is selected (:CHANnel<N>:SIMulation:FUNCTion:SELECTION SQUare), the :CHANnel<N>:SIMulation:FUNCTion:SQUare:FTIME command specifies the square wave's high-to-low transition time.

<N> An integer, 1-4 in a single oscilloscope, 1-40 in a MultiScope system.

<fall\_time> The high-to-low transition time value in NR3 format.

**Query** :CHANnel<N>:SIMulation:FUNCTion:SQUare:FTIME?

The :CHANnel<N>:SIMulation:FUNCTion:SQUare:FTIME? query returns the specified high-to-low transition time.

**Returned Format** <fall\_time><NL>

<fall\_time> ::= high-to-low transition time value in NR3 format

- See Also**
- [":CHANnel<N>:SIMulation:WAVEform"](#) on page 446
  - [":CHANnel<N>:SIMulation:FUNCTion:SELECTION"](#) on page 427

**History** New in version 6.00.

## :CHANnel&lt;N&gt;:SIMulation:FUNCTion:SQUare:RTIME

**Command** :CHANnel<N>:SIMulation:FUNCTion:SQUare:RTIME <rise\_time>

When the FUNCTion simulated waveform type is selected (:CHANnel<N>:SIMulation:WAVEform FUNCTion) and the SQUare function is selected (:CHANnel<N>:SIMulation:FUNCTion:SELECTION SQUare), the :CHANnel<N>:SIMulation:FUNCTion:SQUare:RTIME command specifies the square wave's low-to-high transition time.

<N> An integer, 1-4 in a single oscilloscope, 1-40 in a MultiScope system.

<rise\_time> The low-to-high transition time value in NR3 format.

**Query** :CHANnel<N>:SIMulation:FUNCTion:SQUare:RTIME?

The :CHANnel<N>:SIMulation:FUNCTion:SQUare:RTIME? query returns the specified low-to-high transition time.

**Returned Format** <rise\_time><NL>

<rise\_time> ::= low-to-high transition time value in NR3 format

- See Also**
- [":CHANnel<N>:SIMulation:WAVEform"](#) on page 446
  - [":CHANnel<N>:SIMulation:FUNCTion:SELECTION"](#) on page 427

**History** New in version 6.00.

## :CHANnel&lt;N&gt;:SIMulation:JITTer

**Command** :CHANnel<N>:SIMulation:JITTer {{0 | OFF} | {1 | ON}}

The :CHANnel<N>:SIMulation:JITTer command turns all simulated waveform jitter off or on while saving the values.

<N> An integer, 1-4 in a single oscilloscope, 1-40 in a MultiScope system.

**Query** :CHANnel<N>:SIMulation:JITTer?

The :CHANnel<N>:SIMulation:JITTer? query returns the simulated waveform jitter off/on setting.

**Returned Format** <setting><NL>

<setting> ::= {0 | 1}

- See Also**
- [":CHANnel<N>:SIMulation:JITTer:ABUJ"](#) on page 432
  - [":CHANnel<N>:SIMulation:JITTer:PERiodic<M>:ENABle"](#) on page 433
  - [":CHANnel<N>:SIMulation:JITTer:PERiodic<M>:FREQuency"](#) on page 434
  - [":CHANnel<N>:SIMulation:JITTer:PERiodic<M>:MAGNitude"](#) on page 435
  - [":CHANnel<N>:SIMulation:JITTer:PERiodic<M>:SHAPE"](#) on page 436
  - [":CHANnel<N>:SIMulation:JITTer:RANDom"](#) on page 437

**History** New in version 6.00.

## :CHANnel&lt;N&gt;:SIMulation:JITTer:ABUJ

**Command** :CHANnel<N>:SIMulation:JITTer:ABUJ <magnitude>

The :CHANnel<N>:SIMulation:JITTer:ABUJ command specifies the amount of Aperiodic Bounded Uniform Jitter (ABUJ) to apply to the simulated waveform. The ABUJ follows a uniform distribution between  $[-\text{Magnitude}/2, \text{Magnitude}/2]$ .

<N> An integer, 1–4 in a single oscilloscope, 1–40 in a MultiScope system.

<magnitude> Value in NR3 format.

**Query** :CHANnel<N>:SIMulation:JITTer:ABUJ?

The :CHANnel<N>:SIMulation:JITTer:ABUJ? query returns the Aperiodic Bounded Uniform Jitter (ABUJ) value.

**Returned Format** <magnitude><NL>

<magnitude> ::= value in NR3 format

- See Also**
- [":CHANnel<N>:SIMulation:JITTer"](#) on page 431
  - [":CHANnel<N>:SIMulation:JITTer:PERiodic<M>:ENABle"](#) on page 433
  - [":CHANnel<N>:SIMulation:JITTer:PERiodic<M>:FREQuency"](#) on page 434
  - [":CHANnel<N>:SIMulation:JITTer:PERiodic<M>:MAGNitude"](#) on page 435
  - [":CHANnel<N>:SIMulation:JITTer:PERiodic<M>:SHAPE"](#) on page 436
  - [":CHANnel<N>:SIMulation:JITTer:RANDom"](#) on page 437

**History** New in version 6.00.



## :CHANnel&lt;N&gt;:SIMulation:JITTer:PERiodic&lt;M&gt;:ENABle

**Command** :CHANnel<N>:SIMulation:JITTer:PERiodic<M>:ENABle {{0 | OFF} | {1 | ON}}

The :CHANnel<N>:SIMulation:JITTer:PERiodic<M>:ENABle command turns the periodic jitter on or off.

<N> An integer, 1-4 in a single oscilloscope, 1-40 in a MultiScope system.

<M> Periodic jitter slot, 1-10.

**Query** :CHANnel<N>:SIMulation:JITTer:PERiodic<M>:ENABle?

The :CHANnel<N>:SIMulation:JITTer:PERiodic<M>:ENABle? query returns the periodic jitter enable setting.

**Returned Format** <setting><NL>

<setting> ::= {0 | 1}

- See Also**
- [":CHANnel<N>:SIMulation:JITTer"](#) on page 431
  - [":CHANnel<N>:SIMulation:JITTer:ABUJ"](#) on page 432
  - [":CHANnel<N>:SIMulation:JITTer:PERiodic<M>:FREQuency"](#) on page 434
  - [":CHANnel<N>:SIMulation:JITTer:PERiodic<M>:MAGNitude"](#) on page 435
  - [":CHANnel<N>:SIMulation:JITTer:PERiodic<M>:SHAPE"](#) on page 436
  - [":CHANnel<N>:SIMulation:JITTer:RANDom"](#) on page 437

**History** New in version 6.00.

## :CHANnel&lt;N&gt;:SIMulation:JITTer:PERiodic&lt;M&gt;:FREQUency

**Command** :CHANnel<N>:SIMulation:JITTer:PERiodic<M>:FREQUency <freq>

The :CHANnel<N>:SIMulation:JITTer:PERiodic<M>:FREQUency command specifies the frequency of the periodic jitter applied to the simulated waveform.

<N> An integer, 1-4 in a single oscilloscope, 1-40 in a MultiScope system.

<M> Periodic jitter slot, 1-10.

<freq> Value in NR3 format.

**Query** :CHANnel<N>:SIMulation:JITTer:PERiodic<M>:FREQUency?

The :CHANnel<N>:SIMulation:JITTer:PERiodic<M>:FREQUency? query returns the specified frequency of the periodic jitter.

**Returned Format** <freq><NL>

<freq> ::= value in NR3 format

- See Also**
- [":CHANnel<N>:SIMulation:JITTer"](#) on page 431
  - [":CHANnel<N>:SIMulation:JITTer:ABUJ"](#) on page 432
  - [":CHANnel<N>:SIMulation:JITTer:PERiodic<M>:ENABle"](#) on page 433
  - [":CHANnel<N>:SIMulation:JITTer:PERiodic<M>:MAGNitude"](#) on page 435
  - [":CHANnel<N>:SIMulation:JITTer:PERiodic<M>:SHAPE"](#) on page 436
  - [":CHANnel<N>:SIMulation:JITTer:RANDom"](#) on page 437

**History** New in version 6.00.

## :CHANnel&lt;N&gt;:SIMulation:JITTer:PERiodic&lt;M&gt;:MAGNitude

**Command** :CHANnel<N>:SIMulation:JITTer:PERiodic<M>:MAGNitude <magnitude>

The :CHANnel<N>:SIMulation:JITTer:PERiodic<M>:MAGNitude command specifies the magnitude of the periodic jitter applied to the simulated waveform.

This magnitude is a peak-to-peak value similar to amplitude.

<N> An integer, 1-4 in a single oscilloscope, 1-40 in a MultiScope system.

<M> Periodic jitter slot, 1-10.

<magnitude> Value in NR3 format.

**Query** :CHANnel<N>:SIMulation:JITTer:PERiodic<M>:MAGNitude?

The :CHANnel<N>:SIMulation:JITTer:PERiodic<M>:MAGNitude? query returns the specified magnitude of the periodic jitter.

**Returned Format** <magnitude><NL>

<magnitude> ::= value in NR3 format

- See Also**
- [":CHANnel<N>:SIMulation:JITTer"](#) on page 431
  - [":CHANnel<N>:SIMulation:JITTer:ABUJ"](#) on page 432
  - [":CHANnel<N>:SIMulation:JITTer:PERiodic<M>:ENABLE"](#) on page 433
  - [":CHANnel<N>:SIMulation:JITTer:PERiodic<M>:FREQuency"](#) on page 434
  - [":CHANnel<N>:SIMulation:JITTer:PERiodic<M>:SHAPE"](#) on page 436
  - [":CHANnel<N>:SIMulation:JITTer:RANDom"](#) on page 437

**History** New in version 6.00.

**:CHANnel<N>:SIMulation:JITTer:PERiodic<M>:SHAPE**

**Command** :CHANnel<N>:SIMulation:JITTer:PERiodic<M>:SHAPE <shape>

The :CHANnel<N>:SIMulation:JITTer:PERiodic<M>:SHAPE command specifies the shape of the periodic jitter applied to the simulated waveform.

<N> An integer, 1-4 in a single oscilloscope, 1-40 in a MultiScope system.

<M> Periodic jitter slot, 1-10.

<shape> {SAWtooth | SIN | SQUARE | TRIangle}

**Query** :CHANnel<N>:SIMulation:JITTer:PERiodic<M>:SHAPE?

The :CHANnel<N>:SIMulation:JITTer:PERiodic<M>:SHAPE? query returns the specified shape of the periodic jitter.

**Returned Format** <shape><NL>

<shape> ::= {SAWT | SIN | SQU | TRI}

- See Also**
- [":CHANnel<N>:SIMulation:JITTer"](#) on page 431
  - [":CHANnel<N>:SIMulation:JITTer:ABUJ"](#) on page 432
  - [":CHANnel<N>:SIMulation:JITTer:PERiodic<M>:ENABLE"](#) on page 433
  - [":CHANnel<N>:SIMulation:JITTer:PERiodic<M>:FREQuency"](#) on page 434
  - [":CHANnel<N>:SIMulation:JITTer:PERiodic<M>:MAGNitude"](#) on page 435
  - [":CHANnel<N>:SIMulation:JITTer:RANDom"](#) on page 437

**History** New in version 6.00.

## :CHANnel&lt;N&gt;:SIMulation:JITTer:RANDom

**Command** :CHANnel<N>:SIMulation:JITTer:RANDom <standard\_deviation>

The :CHANnel<N>:SIMulation:JITTer:RANDom command specifies the standard deviation of random jitter to apply. This random jitter follows a normal distribution.

<N> An integer, 1-4 in a single oscilloscope, 1-40 in a MultiScope system.

<standard\_deviation>  
Value in NR3 format.

**Query** :CHANnel<N>:SIMulation:JITTer:RANDom?

The :CHANnel<N>:SIMulation:JITTer:RANDom? query returns the random jitter standard deviation value.

**Returned Format** <standard\_deviation><NL>

<standard\_deviation> ::= value in NR3 format

- See Also**
- [":CHANnel<N>:SIMulation:JITTer"](#) on page 431
  - [":CHANnel<N>:SIMulation:JITTer:ABUJ"](#) on page 432
  - [":CHANnel<N>:SIMulation:JITTer:PERiodic<M>:ENABLE"](#) on page 433
  - [":CHANnel<N>:SIMulation:JITTer:PERiodic<M>:FREQuency"](#) on page 434
  - [":CHANnel<N>:SIMulation:JITTer:PERiodic<M>:MAGNitude"](#) on page 435
  - [":CHANnel<N>:SIMulation:JITTer:PERiodic<M>:SHAPE"](#) on page 436

**History** New in version 6.00.

**:CHANnel<N>:SIMulation:NOISe**

**Command** :CHANnel<N>:SIMulation:NOISe {{0 | OFF} | {1 | ON}}

The :CHANnel<N>:SIMulation:NOISe command turns all simulated waveform noise off or on while saving the values.

<N> An integer, 1-4 in a single oscilloscope, 1-40 in a MultiScope system.

**Query** :CHANnel<N>:SIMulation:NOISe?

The :CHANnel<N>:SIMulation:NOISe? query returns the simulated waveform noise off/on setting.

**Returned Format** <setting><NL>

<setting ::= {0 | 1}

- See Also**
- [":CHANnel<N>:SIMulation:NOISe:BWLimit"](#) on page 439
  - [":CHANnel<N>:SIMulation:NOISe:PERiodic<M>:ENABLE"](#) on page 440
  - [":CHANnel<N>:SIMulation:NOISe:PERiodic<M>:FREQuency"](#) on page 441
  - [":CHANnel<N>:SIMulation:NOISe:PERiodic<M>:MAGNitude"](#) on page 442
  - [":CHANnel<N>:SIMulation:NOISe:PERiodic<M>:SHAPE"](#) on page 443
  - [":CHANnel<N>:SIMulation:NOISe:RANDom"](#) on page 444

**History** New in version 6.00.

## :CHANnel&lt;N&gt;:SIMulation:NOISe:BWLimit

**Command** :CHANnel<N>:SIMulation:NOISe:BWLimit {{0 | OFF} | {1 | ON}}

The :CHANnel<N>:SIMulation:NOISe:BWLimit command turns the noise filter on or off. This filter is a brick wall filter with a cut-off frequency of 0.4 times the sample rate.

<N> An integer, 1-4 in a single oscilloscope, 1-40 in a MultiScope system.

**Query** :CHANnel<N>:SIMulation:NOISe:BWLimit?

The :CHANnel<N>:SIMulation:NOISe:BWLimit? query returns the noise filter on/off setting.

**Returned Format** <setting><NL>

<setting> ::= {0 | 1}

- See Also**
- [":CHANnel<N>:SIMulation:NOISe"](#) on page 438
  - [":CHANnel<N>:SIMulation:NOISe:PERiodic<M>:ENABLE"](#) on page 440
  - [":CHANnel<N>:SIMulation:NOISe:PERiodic<M>:FREQuency"](#) on page 441
  - [":CHANnel<N>:SIMulation:NOISe:PERiodic<M>:MAGNitude"](#) on page 442
  - [":CHANnel<N>:SIMulation:NOISe:PERiodic<M>:SHAPE"](#) on page 443
  - [":CHANnel<N>:SIMulation:NOISe:RANDom"](#) on page 444

**History** New in version 6.00.

## :CHANnel&lt;N&gt;:SIMulation:NOISe:PERiodic&lt;M&gt;:ENABLE

**Command** :CHANnel<N>:SIMulation:NOISe:PERiodic<M>:ENABLE {{0 | OFF} | {1 | ON}}

The :CHANnel<N>:SIMulation:NOISe:PERiodic<M>:ENABLE command turns the periodic noise on or off.

<N> An integer, 1-4 in a single oscilloscope, 1-40 in a MultiScope system.

<M> Periodic noise slot, 1-10.

**Query** :CHANnel<N>:SIMulation:NOISe:PERiodic<M>:ENABLE?

The :CHANnel<N>:SIMulation:NOISe:PERiodic<M>:ENABLE? query returns the periodic noise enable setting.

**Returned Format** <setting><NL>

<setting> ::= {0 | 1}

- See Also**
- [":CHANnel<N>:SIMulation:NOISe"](#) on page 438
  - [":CHANnel<N>:SIMulation:NOISe:BWLimit"](#) on page 439
  - [":CHANnel<N>:SIMulation:NOISe:PERiodic<M>:FREQuency"](#) on page 441
  - [":CHANnel<N>:SIMulation:NOISe:PERiodic<M>:MAGNitude"](#) on page 442
  - [":CHANnel<N>:SIMulation:NOISe:PERiodic<M>:SHAPE"](#) on page 443
  - [":CHANnel<N>:SIMulation:NOISe:RANDom"](#) on page 444

**History** New in version 6.00.



## :CHANnel<N>:SIMulation:NOISe:PERiodic<M>:FREQuency

**Command** :CHANnel<N>:SIMulation:NOISe:PERiodic<M>:FREQuency <freq>

The :CHANnel<N>:SIMulation:NOISe:PERiodic<M>:FREQuency command specifies the frequency of the periodic noise applied to the simulated waveform.

<N> An integer, 1-4 in a single oscilloscope, 1-40 in a MultiScope system.

<M> Periodic noise slot, 1-10.

<freq> Value in NR3 format.

**Query** :CHANnel<N>:SIMulation:NOISe:PERiodic<M>:FREQuency?

The :CHANnel<N>:SIMulation:NOISe:PERiodic<M>:FREQuency? query returns the specified frequency of the periodic noise.

**Returned Format** <freq><NL>

<freq> ::= value in NR3 format

- See Also**
- [":CHANnel<N>:SIMulation:NOISe"](#) on page 438
  - [":CHANnel<N>:SIMulation:NOISe:BWLimit"](#) on page 439
  - [":CHANnel<N>:SIMulation:NOISe:PERiodic<M>:ENABLE"](#) on page 440
  - [":CHANnel<N>:SIMulation:NOISe:PERiodic<M>:MAGNitude"](#) on page 442
  - [":CHANnel<N>:SIMulation:NOISe:PERiodic<M>:SHAPE"](#) on page 443
  - [":CHANnel<N>:SIMulation:NOISe:RANDOM"](#) on page 444

**History** New in version 6.00.

## :CHANnel&lt;N&gt;:SIMulation:NOISe:PERiodic&lt;M&gt;:MAGNitude

**Command** :CHANnel<N>:SIMulation:NOISe:PERiodic<M>:MAGNitude <magnitude>

The :CHANnel<N>:SIMulation:NOISe:PERiodic<M>:MAGNitude command specifies the magnitude of the periodic noise applied to the simulated waveform.

This magnitude is a peak-to-peak value similar to amplitude.

<N> An integer, 1-4 in a single oscilloscope, 1-40 in a MultiScope system.

<M> Periodic noise slot, 1-10.

<magnitude> Value in NR3 format.

**Query** :CHANnel<N>:SIMulation:NOISe:PERiodic<M>:MAGNitude?

The :CHANnel<N>:SIMulation:NOISe:PERiodic<M>:MAGNitude? query returns the specified magnitude of the periodic noise.

**Returned Format** <magnitude><NL>

<magnitude> ::= value in NR3 format

- See Also**
- [":CHANnel<N>:SIMulation:NOISe"](#) on page 438
  - [":CHANnel<N>:SIMulation:NOISe:BWLimit"](#) on page 439
  - [":CHANnel<N>:SIMulation:NOISe:PERiodic<M>:ENABLE"](#) on page 440
  - [":CHANnel<N>:SIMulation:NOISe:PERiodic<M>:FREQuency"](#) on page 441
  - [":CHANnel<N>:SIMulation:NOISe:PERiodic<M>:SHAPE"](#) on page 443
  - [":CHANnel<N>:SIMulation:NOISe:RANDom"](#) on page 444

**History** New in version 6.00.

## :CHANnel&lt;N&gt;:SIMulation:NOISe:PERiodic&lt;M&gt;:SHAPE

**Command** :CHANnel<N>:SIMulation:NOISe:PERiodic<M>:SHAPE <shape>

The :CHANnel<N>:SIMulation:NOISe:PERiodic<M>:SHAPE command specifies the shape of the periodic noise applied to the simulated waveform.

<N> An integer, 1-4 in a single oscilloscope, 1-40 in a MultiScope system.

<M> Periodic noise slot, 1-10.

<shape> {SAWtooth | SIN | SQUARE | TRIangle}

**Query** :CHANnel<N>:SIMulation:NOISe:PERiodic<M>:SHAPE?

The :CHANnel<N>:SIMulation:NOISe:PERiodic<M>:SHAPE? query returns the specified shape of the periodic noise.

**Returned Format** <shape><NL>

<shape> ::= {SAWT | SIN | SQU | TRI}

- See Also**
- [":CHANnel<N>:SIMulation:NOISe"](#) on page 438
  - [":CHANnel<N>:SIMulation:NOISe:BWLimit"](#) on page 439
  - [":CHANnel<N>:SIMulation:NOISe:PERiodic<M>:ENABLE"](#) on page 440
  - [":CHANnel<N>:SIMulation:NOISe:PERiodic<M>:FREQUENCY"](#) on page 441
  - [":CHANnel<N>:SIMulation:NOISe:PERiodic<M>:MAGNitude"](#) on page 442
  - [":CHANnel<N>:SIMulation:NOISe:RANDOM"](#) on page 444

**History** New in version 6.00.

## :CHANnel&lt;N&gt;:SIMulation:NOISe:RANDom

**Command** :CHANnel<N>:SIMulation:NOISe:RANDom <standard\_deviation>

The :CHANnel<N>:SIMulation:NOISe:RANDom command specifies the standard deviation of random noise to apply. This random noise follows a normal distribution.

<N> An integer, 1-4 in a single oscilloscope, 1-40 in a MultiScope system.

<standard\_deviation>  
Value in NR3 format.

**Query** :CHANnel<N>:SIMulation:NOISe:RANDom?

The :CHANnel<N>:SIMulation:NOISe:RANDom? query returns the random noise standard deviation value.

**Returned Format** <standard\_deviation><NL>

<standard\_deviation> ::= value in NR3 format

- See Also**
- [":CHANnel<N>:SIMulation:NOISe"](#) on page 438
  - [":CHANnel<N>:SIMulation:NOISe:BWLimit"](#) on page 439
  - [":CHANnel<N>:SIMulation:NOISe:PERiodic<M>:ENABLE"](#) on page 440
  - [":CHANnel<N>:SIMulation:NOISe:PERiodic<M>:FREQuency"](#) on page 441
  - [":CHANnel<N>:SIMulation:NOISe:PERiodic<M>:MAGNitude"](#) on page 442
  - [":CHANnel<N>:SIMulation:NOISe:PERiodic<M>:SHAPE"](#) on page 443

**History** New in version 6.00.

## :CHANnel&lt;N&gt;:SIMulation:OFFSet

**Command** :CHANnel<N>:SIMulation:OFFSet <offset\_value>

The :CHANnel<N>:SIMulation:OFFSet command specifies the offset of the simulated waveform.

This offset is applied to the simulated waveform and is not to be confused with the channel offset. For example, to specify a simulated waveform that goes from 0 V to 5 V, specify an amplitude of 5 V and an offset of 2.5 V.

<N> An integer, 1-4 in a single oscilloscope, 1-40 in a MultiScope system.

<offset\_value> Simulated waveform vertical value in NR3 format.

**Query** :CHANnel<N>:SIMulation:OFFSet?

The :CHANnel<N>:SIMulation:OFFSet? query returns the simulated waveform's offset value.

**Returned Format** <offset\_value><NL>

<offset\_value> ::= waveform vertical value in NR3 format

**See Also** • [":CHANnel<N>:SIMulation:WAVEform"](#) on page 446

**History** New in version 6.00.

**:CHANnel<N>:SIMulation:WAVEform**

**Command** :CHANnel<N>:SIMulation:WAVEform <type>

The :CHANnel<N>:SIMulation:WAVEform command sets the simulated waveform type.

**NOTE**

Simulated waveforms become available when the "Simulated Instrument" is added as a follower using the :HOSTed:FOLLOWer<N>:CONFigure and :HOSTed:FOLLOWer<N>:CONNect commands. The channel numbers of the simulated waveforms depend on the follower used (for example, using follower 1 enables simulated waveforms on channels 5 through 8).

<N> An integer, 1–4 in a single oscilloscope, 1–40 in a MultiScope system.

<type> {CLOCK | DATA | FILE | FUNCtion}

- CLOCK – The simulated waveform is a square-wave clock signal.
- DATA – The simulated waveform is a Pseudo-Random Binary Sequence (PRBS) Non Return to Zero (NRZ) or Pulse Amplitude Modulation (PAM) signal.
- FILE – The simulated waveform comes from a saved waveform data file (similar to an arbitrary waveform in a function generator).
- FUNCtion – The simulated waveform is an impulse, sawtooth, sine, square, or triangle function.

**Query** :CHANnel<N>:SIMulation:WAVEform?

The :CHANnel<N>:SIMulation:WAVEform? query returns the selected simulated waveform type.

**Returned Format** <type><NL>

<type> ::= {CLOC | DATA | FILE | FUNC}

- See Also**
- [":HOSTed:FOLLOWer<N>:CONFigure"](#) on page 684
  - [":HOSTed:FOLLOWer<N>:CONNect"](#) on page 685
  - [":CHANnel<N>:SIMulation:AMPLitude"](#) on page 414
  - [":CHANnel<N>:SIMulation:OFFSet"](#) on page 445
  - [":CHANnel<N>:SIMulation:FREQuency"](#) on page 426
  - [":CHANnel<N>:SIMulation:DATA:SELECTION"](#) on page 419
  - [":CHANnel<N>:SIMulation:DRATE"](#) on page 420
  - [":CHANnel<N>:SIMulation:FLOad:ADDRESS"](#) on page 424
  - [":CHANnel<N>:SIMulation:FUNCtion:SELECTION"](#) on page 427

**History** New in version 6.00.

## :CHANnel&lt;N&gt;:UNITs

**Command** :CHANnel<N>:UNITs {VOLT | AMPere | WATT | UNKNown}

**NOTE**

UNITs can also be set using the CHANnel<N>:PROBe:EXTeRnal:UNITs command when CHANnel<N>:PROBe:EXTeRnal command has been set to ON.

The :CHANnel<N>:UNITs command sets the vertical units. You can specify Y-axis units of VOLTS, AMPs, WATTs, or UNKNown. The units are implied for other pertinent channel commands (such as :CHANnel<N>:RANGe and :CHANnel<N>:OFFSet). See the Probe Setup dialog box for more information.

<N> An integer, 1-4 in a single oscilloscope, 1-40 in a MultiScope system.

**Example** This example sets the units for channel 1 to amperes.

```
myScope.WriteString ":CHANnel1:UNITs AMPere"
```

**Query** :CHANnel<N>:UNITs?

The :CHANnel<N>:UNITs? query returns the current units setting for the specified channel.

**Returned Format** [:CHANnel<N>:UNITs] {VOLT | AMPere | WATT | UNKNown}<NL>

**Example** This example places the vertical units for the specified channel in the string variable, strUnits, then prints the contents of the variable to the computer's screen.

```
Dim strUnits As String
myScope.WriteString ":CHANnel1:UNITs?"
strUnits = myScope.ReadString
Debug.Print strUnits
```

**History** Legacy command (existed before version 3.10).





# 16 Common Commands

- \*CLS – Clear Status / 451
- \*ESE – Event Status Enable / 452
- \*ESR? – Event Status Register / 454
- \*IDN? – Identification Number / 455
- \*LRN? – Learn / 456
- \*OPC – Operation Complete / 458
- \*OPT? – Option / 460
- \*PSC – Power-on Status Clear / 469
- \*RCL – Recall / 470
- \*RST – Reset / 471
- \*SAV – Save / 472
- \*SRE – Service Request Enable / 473
- \*STB? – Status Byte / 475
- \*TRG – Trigger / 477
- \*TST? – Test / 478
- \*WAI – Wait / 479

Common commands are defined by the IEEE 488.2 standard. They control generic device functions that are common to many different types of instruments. Common commands can be received and processed by the oscilloscope, whether they are sent over the remote interface as separate program messages or within other program messages.

## Receiving Common Commands

Common commands can be received and processed by the oscilloscope, whether they are sent over the remote interface as separate program messages or within other program messages. If a subsystem is currently selected and a common command is received by the oscilloscope, the oscilloscope remains in the selected subsystem. For example, if the program message

```
"ACQUIRE:AVERAGE ON;*CLS;COUNT 1024"
```

is received by the oscilloscope, the oscilloscope sets the acquire type, clears the status information, then sets the number of averages without leaving the selected subsystem.

**NOTE****Headers and Common Commands.**

Headers are not prepended to common commands.

---

**Status Registers** The following two status registers used by common commands have an enable (mask) register. By setting bits in the enable register, you can select the status information for use. Refer to the chapter, "Status Reporting," for a complete discussion of status.

**Table 6** Status and Enable Registers

Status Register	Enable Register
Event Status Register	Event Status Enable Register
Status Byte Register	Service Request Enable Register

## \*CLS – Clear Status

**Command** \*CLS

The \*CLS command clears all status and error registers.

**Example** This example clears the status data structures of the oscilloscope.

```
myScope.WriteString "*CLS"
```

**See Also**

- [Chapter 7](#), “Status Reporting,” starting on page 185 for a complete discussion of status.
- ["Example: Blocking and Polling Synchronization"](#) on page 225
- ["Example: Checking for Armed Status"](#) on page 210

**History** Legacy command (existed before version 3.10).

## \*ESE – Event Status Enable

**Command** \*ESE <mask>

The \*ESE command sets the Standard Event Status Enable Register bits.

<mask> An integer, 0 to 255, representing a mask value for the bits to be enabled in the Standard Event Status Register as shown in [Table 7](#).

**Example** This example enables the User Request (URQ) bit of the Standard Event Status Enable Register. When this bit is enabled and a front-panel key is pressed, the Event Summary bit (ESB) in the Status Byte Register is also set.

```
myScope.WriteString "*ESE 64"
```

**Query** \*ESE?

The \*ESE? query returns the current contents of the Standard Event Status Enable Register.

**Returned Format** <mask><NL>

<mask> An integer, +0 to +255 (the plus sign is also returned), representing a mask value for the bits enabled in the Standard Event Status Register as shown in [Table 7](#).

**Example** This example places the current contents of the Standard Event Status Enable Register in the numeric variable, varEvent. The value of the variable is printed on the computer's screen.

```
myScope.WriteString "*ESE?"
varEvent = myScope.ReadNumber
Debug.Print FormatNumber(varEvent, 0)
```

The Standard Event Status Enable Register contains a mask value for the bits to be enabled in the Standard Event Status Register. A "1" in the Standard Event Status Enable Register enables the corresponding bit in the Standard Event Status Register. A "0" in the enable register disables the corresponding bit.

**Table 7** Standard Event Status Enable Register Bits

Bit	Weight	Enables	Definition
7	128	PON - Power On	Indicates power is turned on.
6	64		Not Used. Permanently set to zero.
5	32	CME - Command Error	Indicates whether the parser detected an error.
4	16	EXE - Execution Error	Indicates whether a parameter was out of range, or was inconsistent with the current settings.
3	8	DDE - Device Dependent Error	Indicates whether the device was unable to complete an operation for device-dependent reasons.

**Table 7** Standard Event Status Enable Register Bits (continued)

Bit	Weight	Enables	Definition
2	4	QYE - Query Error	Indicates if the protocol for queries has been violated.
1	2	RQC - Request Control	Indicates whether the device is requesting control.
0	1	OPC - Operation Complete	Indicates whether the device has completed all pending operations.

**See Also** Refer to **Chapter 7**, “Status Reporting,” starting on page 185 for a complete discussion of status.

**History** Legacy command (existed before version 3.10).

## \*ESR? – Event Status Register

**Query** \*ESR?

The \*ESR? query returns the contents of the Standard Event Status Register. Reading this register clears the Standard Event Status Register, as does a \*CLS.

**Returned Format** <status><NL>

<status> An integer, 0 to 255, representing the total bit weights of all bits that are high at the time you read the register.

**Example** This example places the current contents of the Standard Event Status Register in the numeric variable, varEvent, then prints the value of the variable to the computer's screen.

```
myScope.WriteString "*ESR?"
varEvent = myScope.ReadNumber
Debug.Print FormatNumber(varEvent, 0)
```

**Table 8** lists each bit in the Event Status Register and the corresponding bit weights.

**Table 8** Standard Event Status Register Bits

Bit	Bit Weight	Bit Name	Condition (0 = False = Low, 1 = True = High)
7	128	PON	1 = OFF to ON transition has occurred.
6	64		Not Used. Permanently set to zero.
5	32	CME	0 = no command errors. 1 = a command error has been detected.
4	16	EXE	0 = no execution error. 1 = an execution error has been detected.
3	8	DDE	0 = no device-dependent errors. 1 = a device-dependent error has been detected.
2	4	QYE	0 = no query errors. 1 = a query error has been detected.
1	2	RQC	0 = request control - NOT used - always 0.
0	1	OPC	0 = operation is not complete. 1 = operation is complete.

**History** Legacy command (existed before version 3.10).

**\*IDN? – Identification Number****Query** \*IDN?

The \*IDN? query returns the company name, oscilloscope model number, serial number, and software version by returning this string:

```
Keysight Technologies,<Model #>,<USXXXXXXXX>,<Rev #>[,<Options>]
```

**<Model #>** Specifies the model number of the oscilloscope.

**<USXXXXXXXX>** Specifies the serial number of the oscilloscope. The first four digits and letter are the serial prefix, which is the same for all identical oscilloscopes. The last five digits are the serial suffix, which is assigned sequentially, and is different for each oscilloscope.

**<Rev #>** Specifies the software version of the oscilloscope, and is the revision number.

**<Options>** Comma separated list of the installed options.

**Returned Format** `Keysight Technologies,DS09404A,USXXXXXXXX,XX.XX.XXXX`

**Example** This example places the oscilloscope's identification information in the string variable, `strIdentify`, then prints the identification information to the computer's screen.

```
Dim strIdentify As String ' Dimension variable.
myScope.WriteString "*IDN?"
strIdentify = myScope.ReadString
Debug.Print strIdentify
```

**History** Legacy command (existed before version 3.10).

## \*LRN? – Learn

**Query** \*LRN?

The \*LRN? query returns a block of data that contains the oscilloscope's current setup. You can store the oscilloscope's setup and send it back to the oscilloscope at a later time. This block of setup data should be sent to the oscilloscope just as it is. It works because of its embedded ":SYST:SET" header.

**Returned Format** :SYST:SET <setup><NL>

### NOTE

#### \*LRN? Returns Prefix to Setup Block

The \*LRN? query always returns ":SYST:SET " as a prefix to the setup block. The :SYSTEM:HEAdER command has no effect on this response.

<setup> This is a definite-length, arbitrary block response specifying the current oscilloscope setup. The block size is subject to change with different firmware revisions.

**Example** This Python and PyVISA example saves the \*LRN? string to a file and then restores the oscilloscope setup from the file.

```

#!python3
# *****
# Using the *LRN? string to save and restore the oscilloscope setup.
# *****

# Import modules.
# -----
import visa
import sys
import time

# =====
# Check for instrument errors:
# =====
def check_instrument_errors():

    while True:
        error_string = Infiniium.query(":SYSTem:ERRor? STRing")
        if error_string: # If there is an error string value.

            if error_string.find("0,", 0, 2) == -1: # Not "No error".
                print("ERROR: %s." % error_string)
                print("Exited because of error.")
                sys.exit(1)

            else: # "No error"
                break

    else: # :SYSTem:ERRor? STRing should always return string.
        print("ERROR: :SYSTem:ERRor? STRing returned nothing.")
        print("Exited because of error.")

```



```

    sys.exit(1)

# =====
# Main program:
# =====

rm = visa.ResourceManager()
Infiniium = rm.open_resource("TCPIP0::141.121.231.13::hislip0::INSTR")

Infiniium.timeout = 20000
Infiniium.clear()

# Get oscilloscope setup from *LRN? string.
values_list = Infiniium.query_binary_values("*LRN?", datatype='s')
check_instrument_errors()
learn_bytes = values_list[0]

# Save *LRN? string.
f = open("setup_lrn.set", "wb")
f.write(learn_bytes)
f.close()
print("*LRN? string bytes saved: %d" % len(learn_bytes))

# Restore the default setup.
Infiniium.write("*RST")
time.sleep(5)

# Set up oscilloscope by loading previously saved setup.
f = open("setup_lrn.set", "rb")
lrn_bytes = f.read()
f.close()

Infiniium.write_binary_values(":SYSTem:SETup ", lrn_bytes, datatype='B')
check_instrument_errors()

print("*LRN? string bytes restored: %d" % len(lrn_bytes))

Infiniium.close()

```

**See Also** • [":SYSTem:SETup"](#) on page 1366

When HEADers is ON and LONGform is OFF, the :SYSTem:SETup command performs the same function as the \*LRN? query. However, \*LRN and SETup block setup data are not interchangeable.

• ["Definite-Length Block Response Data"](#) on page 157

**History** Legacy command (existed before version 3.10).

## \*OPC – Operation Complete

### Command \*OPC

The \*OPC command sets the operation complete bit in the Standard Event Status Register when all pending device operations have finished.

You can use the \*ESR? query to look at the OPC bit (bit 0) in the Standard Event Status Register to determine when an operation is complete.

### NOTE

In the Infiniium 9000 Series, S-Series, 90000A Series, 90000 X-Series, V-Series, 90000 Q-Series, and Z-Series oscilloscopes, the implementation of the \*OPC? query does not honor the definition in the SCPI standard. Instead it returns from the \*OPC? query after parsing the previous commands, not after the effects of the previous commands are completed. See [Chapter 9](#), “Using :PDER? Instead of \*OPC?,” starting on page 217.

**Example** This example sets the operation complete bit in the Standard Event Status Register when the :SINGle operation is complete.

```
myScope.WriteString "*CLS"
myScope.WriteString ":SINGle;*OPC"
Do
    Sleep 100 ' To prevent excessive queries.
    myScope.WriteString "*ESR?"
    varQueryResult = myScope.ReadNumber
    Debug.Print "Event Status Register: 0x" + Hex(varQueryResult)
    If varQueryResult And (2 ^ 0) Then
        Debug.Print "Bit 0 is True"
    End If
Loop While Not varQueryResult And (2 ^ 0)
Debug.Print "Operation complete."
```

### Query \*OPC?

The \*OPC? query places an ASCII character "1" in the oscilloscope's output queue when all pending selected device operations have finished.

**Returned Format** 1<NL>

**Example** This example places an ASCII character "1" in the oscilloscope's output queue when the AUToscale operation is complete. Then the value in the output queue is placed in the numeric variable "varComplete".

```
myScope.WriteString ":AUToscale;*OPC?"
varComplete = myScope.ReadNumber
Debug.Print FormatNumber(varComplete, 0)
```

The \*OPC? query allows synchronization between the computer and the oscilloscope by using the message available (MAV) bit in the Status Byte or by reading the output queue.

Unlike the \*OPC command, the \*OPC? query does not affect the OPC Event bit in the Standard Event Status Register.

**See Also** · [Chapter 9](#), “Using :PDER? Instead of \*OPC?,” starting on page 217

**History** Legacy command (existed before version 3.10).

**\*OPT? – Option****Query** \*OPT?

The \*OPT? query returns a string with a list of installed options. If no options are installed, the string will have a 0 as the first character.

The length of the returned string may increase as options become available in the future. Once implemented, an option name will be appended to the end of the returned string, delimited by a comma.

**Returned Format** [002, EZP, EZJ, SDA, LSS, ABD, ABC, ABB, NRD, ERC, AIP, PCI1, ETH, DVI, HDM, B30, CAN, SA1, DDR] <NL>

**Table 9** Possible Installed Options and Descriptions

Installed Option	Description
01G	1 GPs
020	20 MPts
02G	2 GPs
13S	Display Port 1.4 Switch
200	200 MPts
3PC	MIPI 3-Phase Compliance
400	400 MPts
500	500 MPts
AER	MIL-STD 1553/ARINC 429 Protocols
ALT	Altera Probe
AP2	DDR1 Compliance
ASV	Spectrum Visualizer
B30	USB Compliance
BRP	BroadR-Reach Protocol
BRR	BroadR Compliance
BRS	BroadR Switch
BT1	1000BaseT1 Compliance
C3P	CSI3 Protocol
C4C	CAUI-4 Compliance
C4S	CAUI-4 Switch
CAN	CAN/LIN/FlexRay Protocols
CFD	CAN/CAN FD/CAN XL/LIN/FlexRay Protocols

**Table 9** Possible Installed Options and Descriptions (continued)

Installed Option	Description
CFL	CAN/LIN/FlexRay Protocols
CFU	CAN/CAN FD/CAN XL/LIN/FlexRay Protocols Upgrade
CRI	App Remote
D12	Display Port 1.2 Compliance
D13	Display Port 1.4 Compliance
D1S	DDR1 Switch
D2D	DDR2 Debug
D2S	DDR2 Switch
D3D	DDR3 Debug
D3S	DDR3 Switch
D4D	DDR4 Debug
D4S	DDR4 Switch
D9010ASIO	Infiniium Offline - Adv Signal Integrity Software (InfiniSim Adv/EQ/Crosstalk)
D9010AUTP	Automotive Protocol Decode/Trigger Software (CAN, LIN, CAN-FD, FlexRay ...)
D9010BDLP	Protocol Decode/Trigger Software Bundle (Low Speed, Auto, MIPI, Military ...)
D9010BSEO	Infiniium Offline - Base Software
D9010DMBA	De-embedding Software (Precision Probe, InfiniSim Basic)
D9010EKRP	10G/100GBASE-KR 64b/66b and Link Training Decode/Trigger Software
D9010EMBP	Embedded Protocol Decode/Trigger Software (USB2.0, 10/100 ETH, PCIe 2/1 ...)
D9010EXMA	External Mixer Assistant Software
D9010HSPO	Infiniium Offline - High Speed Protocol Software Bundle
D9010JITA	EZJIT Complete - Jitter and Vertical Noise Analysis Software for 9000/S-Series
D9010JITO	Infiniium Offline - EZJIT Complete Software
D9010LSPO	Infiniium Offline - Low Speed Protocol Software Bundle
D9010LSSP	Low Speed Protocol Decode/Trigger Software (I2C, SPI, RS232, I2S, JTAG ...)
D9010MCDP	MIPI CSI and DSI Protocol Decode/Trigger Software (C-PHY and D-PHY)
D9010MILP	Military Protocol Decode/Trigger Software (ARINC 429, MIL-STD 1553, SpaceWire)
D9010MPLP	Low Speed MIPI Protocol Decode/Trigger Software (RFFE, I3C, SPMI)
D9010MPMP	MIPI M-PHY Protocol Decode/Trigger Software (DigRF, LLI, CSI-3, UniPro, UFS, SSIC)

**Table 9** Possible Installed Options and Descriptions (continued)

Installed Option	Description
D9010PAMA	Pulse Amplitude Modulation PAM-N Analysis Software
D9010PCIP	Advanced PCIe Protocol Decode/Trigger Software (PCIe 5/4/3/2/1, SATA/SAS)
D9010POWA	Power Integrity Analysis Software
D9010SCNA	InfiniiScan Event Identification Software for 9000/S-Series
D9010UDAA	User Defined Application Software
D9010USBP	USB4, USB 3.x, USB2.0, eUSB2, and DP AUX Protocol Decode/Trigger Software
D9020ASIA	Advanced Signal Integrity Software (EQ, InfiniSimAdv, Crosstalk)
D9020AUTP	High Speed Automotive Protocol Decode/Trigger Software (100BASE-T1 and 1000BASE-T1)
D9020JITA	EZJIT Complete - Jitter and Vertical Noise Analysis Software for V/Z/UXR-Series
D9020SCNA	InfiniiScan Event Identification Software for V/Z/UXR-Series
D9110AUTP	Automotive Protocol Decode/Trigger Software (CAN, LIN, CAN-FD, FlexRay ...)
D9110DMBA	De-embedding Software (Precision Probe, InfiniSim Basic)
D9110EKRP	10G/100GBASE-KR 64b/66b and Link Training Decode/Trigger Software
D9110EMBP	Embedded Protocol Decode/Trigger Software (USB2.0, 10/100 ETH, PCIe 2/1 ...)
D9110LSSP	Low Speed Protocol Decode/Trigger Software (I2C, SPI, RS232, I2S, JTAG ...)
D9110MCDP	MIPI CSI and DSI Protocol Decode/Trigger Software (C-PHY and D-PHY)
D9110MILP	Military Protocol Decode/Trigger Software (ARINC 429, MIL-STD 1553, SpaceWire)
D9110MPLP	Low Speed MIPI Protocol Decode/Trigger Software (RFFE, I3C, SPMI)
D9110MPMP	MIPI M-PHY Protocol Decode/Trigger Software (DigRF, LLI, CSI-3, UniPro, UFS, SSIC)
D9110PCIP	Advanced PCIe Protocol Decode/Trigger Software (PCIe 5/4/3/2/1, SATA/SAS)
D9110POWA	Power Integrity Analysis Software
D9110UDAA	User Defined Application Software
D9110USBP	USB4, USB 3.x, USB2.0, eUSB2, and DP AUX Protocol Decode/Trigger Software
D9120ASIA	Advanced Signal Integrity Software (EQ, InfiniSimAdv, Crosstalk)
D9120AUTP	High Speed Automotive Protocol Decode/Trigger Software (100BASE-T1 and 1000BASE-T1)
D9120JITA	EZJIT Complete - Jitter and Vertical Noise Analysis Software for V/Z/UXR-Series

**Table 9** Possible Installed Options and Descriptions (continued)

Installed Option	Description
D9120PAMA	Pulse Amplitude Modulation PAM-N Analysis Software
D9120SCNA	InfiniiScan Event Identification Software for V/Z/UXR-Series
DD3	DDR3 Compliance
DD4	DDR4 Compliance
DD5	DDR5 Compliance
DDB	DDR Bundle
DDR	DDR2 Compliance
DEA	InfiniiSim Advanced
DEB	InfiniiSim Basic
DEQ	Equalization
DPC	Display Port Compliance
DPP	Display Port Aux Protocol
DPS	Display Port Switch
DPT	Display Port Compliance
DRF	DigRF4 Protocol
DRP	DDR Protocol
DTS	Digital Test Apps Switch
DVI	DVI Compliance
E1C	100GBASE-CR4 Ethernet Compliance
E1K	100GBASE-KR4 Ethernet Compliance
E1S	100G-KR4 Ethernet Switch
E2M	2.5G MGBase-T Compliance
E2S	100G-CR4 Ethernet Switch
E4C	40GBASE Ethernet Compliance
E4S	40G Ethernet Switch
E5M	5G MGBase-T Compliance
ECU	ECU PHY Compliance
EDP	eDP 1.4 Compliance
EDS	eDP 1.4 Switch
EEE	Energy Efficient Ethernet
EEU	EE Ethernet Upgrade

**Table 9** Possible Installed Options and Descriptions (continued)

Installed Option	Description
EGR	100GBASE-KR/CR Ethernet Protocol
EGT	1000BASE-T1 Ethernet Protocol
EKC	10GBASE-KR Ethernet Compliance
EKR	10GBASE-KR Ethernet Protocol
EKS	10GBASE-KR Ethernet Switch
EMC	eMMC Compliance
ESP	eSPI Protocol
ETH	Gigabit Ethernet Compliance
ETN	10G Ethernet Compliance
ETP	Ethernet Protocol
EUS	eUSB 2.0 Protocol
EZC	EZJIT Complete
EZJ	EZJIT
EZP	EZJIT Plus
FBD	FB DIMM Compliance
FBR	Fibre Channel Compliance
GD3	GDDR3 Compliance
GD4	GDDR4 Compliance
GD5	GDDR5 Compliance
GDR	GDDR Compliance
GMP	Manchester Protocol
H14	HDMI 14 Compliance
H1T	HDMI 1.4 TMDS Compliance
H21	HDMI FRL/TMDS Compliance
H2C	HDMI 2.0 Compliance
H2T	HDMI TMDS Compliance
HCS	Hybrid Memory Cube Switch
HDF	Hosted Digitizer Frame
HDM	HDMI Compliance
HDS	HDMI Switch
HMC	Hybrid Memory Cube Compliance



**Table 9** Possible Installed Options and Descriptions (continued)

Installed Option	Description
HSI	HSIC USB Compliance
HTE	HDMI 1.4 TMDS Compliance
I3C	MIPI I3C Protocol
ISP	I2S Protocol
JTP	JTAG Protocol
L4D	LPDDR4 Debug
LLI	LLI Protocol
LP2	LPDDR2 Compliance
LP3	LPDDR3 Compliance
LP4	LPDDR4 Compliance
LSS	SPI/I2C Protocols
M3C	MHL 3.0 Compliance
MCC	MIPI C-PHY Compliance
MCP	MIPI C-PHY
MDC	MIPI D-PHY 2.0 Compliance
MDS	MIPI DPHY Switch
MDU	MIPI D-PHY 2.0 Upgrade
MHL	Mobile HD Link Compliance
MHS	MHL Switch
MMS	MIPI MPHY Switch
MP4	MIPI M-PHY 4.1 Compliance
MPH	MIPI M-PHY Compliance
MPI	MIPI D-PHY Compliance
MPP	MIPI D-PHY Protocol
MSO	MSO Upgrade
MSS	MOST Switch
MST	MOST Compliance
MYC	User Defined App
NB2	2.5G NBase-T Compliance
NB5	5G NBase-T Compliance
NRD	Noise Reduction

**Table 9** Possible Installed Options and Descriptions (continued)

Installed Option	Description
OD2	ONFI-NVDDR2 Compliance
OSA	Oscilloscope Signal Analyzer
P3D	PCI Express 3.0 Protocol
P4D	PCI Express 4.0 Protocol
P5D	PCI Express 5.0 Protocol
PC2	PCI Express 2.0 Compliance
PC3	PCI 3.0 Compliance
PC4	PCI Express 4.0 Compliance
PCE	PAM-4 CEI Application
PCI	PCI Express 1.0a Compliance
PEI	PAM-4 CEI 4.0 Application
PEP	PCI Express Protocol
PES	PCI Express Switch
PEU	PAM-4 CEI 4.0 Application Upgrade
PFC	PAM-4 Fibre Channel Application
PHN	Phase Noise
PI2	PAM-4 IEEE 802.3bs/cd Application
PIE	PAM-4 IEEE Application
PIU	PAM-4 IEEE 802.3bs/cd App Upgrade
PM3	PAM-3 Measurement
PM4	PAM-4 Measurement
PRN	PrecisionProbe
PSW	PAM-4 Switch
PWI	PowerIntegrity
QPI	QPI Compliance
QSS	SFP+ Switch
RFE	RFFE Protocol
RSP	RS232/UART Protocol
RXP	PCI-E Rx Compliance
RXT	Rx Compliance
RXU	USB Rx Compliance

**Table 9** Possible Installed Options and Descriptions (continued)

Installed Option	Description
S12	SAS 12G Compliance
S6G	SAS 6G Compliance
SA1	SATA 1 Compliance
SA2	SATA 2 Compliance
SA4	SAS 4 Compliance
SA6	SATA 3 Compliance
SAS	SAS Compliance
SDA	Serial Data Analysis
SDC	SD Card Compliance
SFP	SFP+ Compliance
SNT	SENT
SPP	SPMI Protocol
SPW	Spacewire
SSC	SSIC Protocol
SSS	SAS Switch
STP	SATA/SAS Protocol
STS	SATA Switch
SVD	SVID Protocol
SWT	InfiniiScan
T2C	Thunderbolt 2.0 Compliance
T3C	Thunderbolt 3.0 Compliance
TBL	Thunderbolt Compliance
TBS	Thunderbolt Switch
TCC	Thunderbolt 3.0 Compliance
TGS	10G Ethernet Switch
U31	USB 3.1 Protocol
U3P	USB 3.0 Protocol
U3S	USB 3.0 Switch
U4	USB 4 Protocol
U4L	USB 4 Low-Speed Protocol
UDF	User Def Fn

**Table 9** Possible Installed Options and Descriptions (continued)

Installed Option	Description
UDP	User Defined Protocol
UDS	User Defined App Switch
UFP	UFS Protocol
UFS	Universal Flash Storage Compliance
UH2	Ultra HS2 SD Compliance
UHS	Ultra HS SD Compliance
UNI	UniPro Protocol
UPD	USB Power Delivery Protocol
US3	USB 3.1/3.0 Transmitter Compliance
USC	USB 3.1 Compliance
USP	USB 2.0 Protocol
USS	USB3 SuperSpeed Plus Compliance
VX1	Vx1 Compliance
WUB	Wireless USB Compliance
XAI	XAUI Compliance
XTK	Crosstalk
XTU	CrosstalkUpgrade

**Example** This example places all options into the string variable, strOptions, then prints the option name to the computer's screen.

```
Dim strOptions As String
myScope.WriteString "*OPT?"
strOptions = myScope.ReadString
Debug.Print strOptions
```

**History** Legacy command (existed before version 3.10).

## \*PSC – Power-on Status Clear

**Command** \*PSC {{ON|1} | {OFF|0}}

The \*PSC command determines whether or not the SRQ line is set upon the completion of the oscilloscope's boot process. When the \*PSC flag is set to 1, the Power On (PON) bit of the Standard Event Status Register is 0 during the boot process. When the \*PSC flag is set to 0, the PON bit is set to a 1 during the boot process.

When the \*PSC flag is set to 0, the Standard Event Status Enable Register must be set to 128 decimal and the Service Request Enable Register must be set to 32 decimal. This allows the Power On (PON) bit to set the SRQ line when the oscilloscope is ready to receive commands.

### NOTE

If you are using a LAN interface rather than a GPIB interface, it is not possible to receive the SRQ during the boot process.

**Example** This example sets the \*PSC flag to 0 which sets the SRQ line during the boot process.

```
myScope.WriteString "*PSC 0;*SRE 32;*ESE 128"
```

**Query** The \*PSC? query returns the value of the \*PSC flag.

**Returned Format** 1<NL>

**Example** This example places the \*PSC flag into the integer variable varPscflag.

```
myScope.WriteString "*PSC?"
varPscflag = myScope.ReadNumber
Debug.Print FormatNumber(varPscflag, 0)
```

**History** Legacy command (existed before version 3.10).

## \*RCL – Recall

**Command** \*RCL <register>

The \*RCL command restores the state of the oscilloscope to a setup previously stored in the specified save/recall register. An oscilloscope setup must have been stored previously in the specified register. Registers 0 through 9 are general-purpose registers and can be used by the \*RCL command.

**<register>** An integer, 0 through 9, specifying the save/recall register that contains the oscilloscope setup you want to recall.

**Example** This example restores the oscilloscope to the oscilloscope setup stored in register 3.

```
myScope.WriteString "*RCL 3"
```

**See Also** \*SAV (Save). An error message appears on the oscilloscope's display if nothing has been previously saved in the specified register.

**History** Legacy command (existed before version 3.10).

## \*RST – Reset

**Command** \*RST

The \*RST command performs a default setup which is the same as pressing the oscilloscope front panel **[Default Setup]** key.

**Example** This example resets the oscilloscope to a known state.

```
myScope.WriteString "*RST"
```

**See Also** · **":SYSTem:PRESet"** on page 1364 (where the default values for Infiniium oscilloscope controls are described)

**History** Legacy command (existed before version 3.10).

## \*SAV – Save

**Command** \*SAV <register>

The \*SAV command stores the current state of the oscilloscope in a save register.

**<register>** An integer, 0 through 9, specifying the register used to save the current oscilloscope setup.

**Example** This example stores the current oscilloscope setup to register 3.

```
myScope.WriteString "**SAV 3"
```

**See Also** \*RCL (Recall).

**History** Legacy command (existed before version 3.10).



## \*SRE – Service Request Enable

**Command** \*SRE <mask>

The \*SRE command sets the Service Request Enable Register bits. By setting the \*SRE, when the event happens, you have enabled the oscilloscope's interrupt capability. The oscilloscope will then do an SRQ (service request), which is an interrupt.

<mask> An integer, 0 to 255, representing a mask value for the bits to be enabled in the Service Request Enable Register as shown in [Table 10](#).

**Example** This example enables a service request to be generated when a message is available in the output queue. When a message is available, the MAV bit is high.

```
myScope.WriteString "*SRE 16"
```

**Query** \*SRE?

The \*SRE? query returns the current contents of the Service Request Enable Register.

**Returned Format** <mask><NL>

<mask> An integer, 0 to 255, representing a mask value for the bits enabled in the Service Request Enable Register.

**Example** This example places the current contents of the Service Request Enable Register in the numeric variable, varValue, then prints the value of the variable to the computer's screen.

```
myScope.WriteString "*SRE?"
varValue = myScope.ReadNumber
Debug.Print FormatNumber(varValue, 0)
```

The Service Request Enable Register contains a mask value for the bits to be enabled in the Status Byte Register. A "1" in the Service Request Enable Register enables the corresponding bit in the Status Byte Register. A "0" disables the bit.

**Table 10** Service Request Enable Register Bits

Bit	Weight	Enables
7	128	OPER - Operation Status Register
6	64	Not Used
5	32	ESB - Event Status Bit
4	16	MAV - Message Available
3	8	Not Used
2	4	MSG - Message

**Table 10** Service Request Enable Register Bits (continued)

Bit	Weight	Enables
1	2	USR - User Event Register
0	1	TRG - Trigger

**History** Legacy command (existed before version 3.10).

## \*STB? – Status Byte

**Query** \*STB?

The \*STB? query returns the current contents of the Status Byte, including the Master Summary Status (MSS) bit. See [Table 11](#) for Status Byte Register bit definitions.

**Returned Format** <value><NL>

<value> An integer, 0 to 255, representing a mask value for the bits enabled in the Status Byte.

**Example** This example reads the contents of the Status Byte into the numeric variable, varValue, then prints the value of the variable to the computer's screen.

```
myScope.WriteString "*STB?"
varValue = myScope.ReadNumber
Debug.Print FormatNumber(varValue, 0)
```

In response to a serial poll (SPOLL), Request Service (RQS) is reported on bit 6 of the status byte. Otherwise, the Master Summary Status bit (MSS) is reported on bit 6. MSS is the inclusive OR of the bitwise combination, excluding bit 6, of the Status Byte Register and the Service Request Enable Register. The MSS message indicates that the oscilloscope is requesting service (SRQ).

**Table 11** Status Byte Register Bits

Bit	Bit Weight	Bit Name	Condition (0 = False = Low, 1 = True = High)
7	128	OPER	0 = no enabled operation status conditions have occurred 1 = an enabled operation status condition has occurred
6	64	RQS/MSS	0 = oscilloscope has no reason for service 1 = oscilloscope is requesting service
5	32	ESB	0 = no event status conditions have occurred 1 = an enabled event status condition has occurred
4	16	MAV	0 = no output messages are ready 1 = an output message is ready
3	8	---	0 = not used
2	4	MSG	0 = no message has been displayed 1 = message has been displayed

**Table 11** Status Byte Register Bits (continued)

Bit	Bit Weight	Bit Name	Condition (0 = False = Low, 1 = True = High)
1	2	USR	0 = no enabled user event conditions have occurred 1 = an enabled user event condition has occurred
0	1	TRG	0 = no trigger has occurred 1 = a trigger occurred

**History** Legacy command (existed before version 3.10).

## \*TRG – Trigger

**Command** \*TRG

The \*TRG command has the same effect as the Group Execute Trigger message (GET) or RUN command. It acquires data for the active waveform display, if the trigger conditions are met, according to the current settings.

**Example** This example starts the data acquisition for the active waveform display according to the current settings.

```
myScope.WriteString "*TRG"
```

### NOTE

#### **Trigger Conditions Must Be Met**

When you send the \*TRG command in Single trigger mode, the trigger conditions must be met before the oscilloscope will acquire data.

---

**History** Legacy command (existed before version 3.10).

## \*TST? – Test

**Query** \*TST?

The \*TST? query causes the oscilloscope to perform a self-test, and places a response in the output queue indicating whether or not the self-test completed without any detected errors. Use the :SYSTem:ERRor command to check for errors. A zero indicates that the test passed and a non-zero indicates the self-test failed.

### NOTE

#### Disconnect Inputs First

You must disconnect all front-panel inputs before sending the \*TST? command.

---

**Returned Format** <result><NL>

<result> 0 for pass; non-zero for fail.

**Example** This example performs a self-test on the oscilloscope and places the results in the numeric variable, varResults. The program then prints the results to the computer's screen.

```
myScope.WriteString "*TST?"
varResults = myScope.ReadNumber
Debug.Print FormatNumber(varResults, 0)
```

If a test fails, refer to the troubleshooting section of the service guide.

### NOTE

#### Expanded Error Reporting

The :SELfTest:SCOPEtEST command has expanded error reporting. Instead of using \*TST?, Keysight recommends that you use the :SELfTest:SCOPEtEST command. In either case, be sure you disconnect all front-panel inputs before sending the \*TST? command.

---

**History** Legacy command (existed before version 3.10).

## \*WAI – Wait

**Command**    \*WAI

The \*WAI command has no function in the oscilloscope, but is parsed for compatibility with other instruments.

**Example**    `myScope.WriteString "*WAI"`

**History**    Legacy command (existed before version 3.10).





# 17 Digital Commands

:DIGital<N>:DISPlay / 482

:DIGital<N>:LABel / 483

:DIGital<N>:POSition / 484

:DIGital<N>:SIZE / 485

:DIGital<N>:THReshold / 486

**NOTE**

The DIGital commands only apply to the MSO oscilloscopes.

---

## :DIGital&lt;N&gt;:DISPlay

## Command

## NOTE

The DIGital commands only apply to the MSO oscilloscopes.

```
:DIGital<N>[:DISPlay] {ON | OFF | 1 | 0}
```

The :DIGital<N>:DISPlay command enables or disables the view for the selected digital channel.

<N> An integer, 0-15.

**Example** This example turns on the display of bit 5 for the digital channels.

```
myScope.WriteString ":DIGital5:DISPlay ON"
```

**Query** :DIGital<N>[:DISPlay]?

The :DIGital<N>:DISPlay? query returns the value of the display setting for the selected digital channel.

**Returned Format** [:DIGital<N>:DISPlay] {1 | 0}<NL>

- See Also**
- [":DIGital<N>:LABel"](#) on page 483
  - [":DIGital<N>:POSition"](#) on page 484
  - [":DIGital<N>:SIZE"](#) on page 485
  - [":DIGital<N>:THReshold"](#) on page 486

**History** Legacy command (existed before version 3.10).

:DIGital<N>:LABel

Command

NOTE

The DIGital commands only apply to the MSO oscilloscopes.

```
:DIGital<N>:LABel <quoted_string>
```

The :DIGital<N>:LABel command sets the digital channel label to the quoted string. Setting a label for a digital channel will also result in the name being added to the label list.

NOTE

Label strings are 16 characters or less, and may contain any commonly used ASCII characters. Labels with more than 16 characters are truncated to 16 characters.

<N> An integer, 1-2.

<quoted\_string> A series of 16 or less characters as a quoted ASCII string.

**Example** This example sets the label for bit 7 to Clock.

```
myScope.WriteString ":DIGital7:LABel "Clock""
```

**Query** :DIGital<N>:LABel?

The :DIGital<N>:LABel? query returns the name of the specified digital channel.

**Returned Format** [:DIGital<N>:LABel] <quoted\_string><NL>

- See Also**
- [":DIGital<N>:DISPlay"](#) on page 482
  - [":DIGital<N>:POSition"](#) on page 484
  - [":DIGital<N>:SIZE"](#) on page 485
  - [":DIGital<N>:THReshold"](#) on page 486

**History** Legacy command (existed before version 3.10).

**:DIGital<N>:POSition**

**Command**    :DIGital<N>:POSition <position>

The :DIGital<N>:POSition command sets the vertical position of a digital waveform within its waveform area grid.

<integer>    Integer value from 0 to 24 in NR1 format.

**Query**        :DIGital<N>:POSition?

The :DIGital<N>:POSition? query returns the digital waveform's vertical position.

**Returned Format**    [:DIGital<N>:DISPlay] <integer><NL>

- See Also**
- **":DIGital<N>:DISPlay"** on page 482
  - **":DIGital<N>:LABel"** on page 483
  - **":DIGital<N>:SIZE"** on page 485
  - **":DIGital<N>:THReshold"** on page 486

**History**        New in version 6.70.

## :DIGital&lt;N&gt;:SIZE

## Command

## NOTE

The DIGital commands only apply to the MSO oscilloscopes.

```
DIGital<N>:SIZE {SMALL | MEDIUM | LARGE}
```

The :DIGital<N>:SIZE command changes the vertical size of all the displayed digital channels. The digital subsystem must be enabled before this command will work. See ENABLE command in the root subsystem.

<N> An integer, 0-15.

**Example** This example changes the size to medium for all displayed digital channels or buses.

```
myScope.WriteString ":ENABLE DIGital"
myScope.WriteString ":DIGital5:SIZE MEDIUM"
```

**Query** :DIGital<N>:SIZE?

The :DIGital:CHANnel:SIZE? query returns the size of the displayed digital channels.

**Returned Format** [:DIGital<N>:SIZE] {SMALL | MEDIUM | LARGE}<NL>

- See Also**
- [":DIGital<N>:DISPlay"](#) on page 482
  - [":DIGital<N>:LABel"](#) on page 483
  - [":DIGital<N>:POSition"](#) on page 484
  - [":DIGital<N>:THReshold"](#) on page 486

**History** Legacy command (existed before version 3.10).

## :DIGital&lt;N&gt;:THReshold

## Command

## NOTE

The DIGital commands only apply to the MSO oscilloscopes.

```
:DIGital<N>:THReshold {CMOS50 | CMOS33 | CMOS25 | ECL | PECL | TTL
| DIFFerential | <value>}
```

The :DIGital<N>:THReshold command sets the logic threshold value for a pod. Setting the threshold for digital channels 0 through 7 sets the threshold for pod 1 while setting the threshold for digital channels 8 through 15 sets the threshold for pod 2. This command is equivalent to the POD<N>:THReshold command.

The threshold is used for triggering purposes and for displaying the digital data as high (above the threshold) or low (below the threshold). The voltage values for the predefined thresholds are:

- CMOS50 = 2.5 V
- CMOS33 = 1.65 V
- CMOS25 = 1.25 V
- ECL = -1.3 V
- PECL = 3.7 V
- TTL = 1.4 V
- DIFFerential = 0 V

<N> An integer, 0-15.

<value> A real number representing the voltage value which distinguishes a 1 logic level from a 0 logic level. Waveform voltages greater than the threshold are 1 logic levels while waveform voltages less than the threshold are 0 logic levels.

On 9000 Series, 9000H Series, and S-Series mixed-signal oscilloscopes, the range of the threshold voltage is from -8 volts to 8 volts.

On 90000 X-Series and V-Series mixed-signal oscilloscopes, the range of the threshold voltage is from -3.75 volts to 3.75 volts.

**Example** This example sets the threshold to 1.8 volts for bits D15 through D8.

```
myScope.WriteString ":DIGital8:THReshold 1.8"
```

**Query** :DIGital<N>:THReshold?

The :DIGital<N>:THReshold? query returns the threshold value for the specified pod.

**Returned Format** [:DIGital<N>:THReshold] {CMOS50 | CMOS33 | CMOS25 | ECL | PECL | TTL  
| DIFF | <value>}<NL>

- See Also**
- **":DIGital<N>:DISPlay"** on page 482
  - **":DIGital<N>:LABel"** on page 483
  - **":DIGital<N>:POSition"** on page 484
  - **":DIGital<N>:SIZE"** on page 485

**History** Legacy command (existed before version 3.10).

Version 4.50: Added the DIFFerential parameter for specifying the threshold voltage.





# 18 Disk Commands

:DISK:CDIRectory / 491  
:DISK:COPIY / 492  
:DISK:DELeTe / 493  
:DISK:DIRectory? / 494  
:DISK:GETFILE / 495  
:DISK:LOAD / 496  
:DISK:MDIRectory / 498  
:DISK:PUTFILE / 499  
:DISK:PWD? / 500  
:DISK:SAVE:COMPOSITE / 501  
:DISK:SAVE:IMAGe / 502  
:DISK:SAVE:JITTer / 503  
:DISK:SAVE:LISTing / 504  
:DISK:SAVE:MEASurements / 505  
:DISK:SAVE:MREPort / 506  
:DISK:SAVE:NOISe / 507  
:DISK:SAVE:PRECprobe / 508  
:DISK:SAVE:SETup / 509  
:DISK:SAVE:WAVEform / 510  
:DISK:SEGMENTed / 512

The DISK subsystem commands perform the disk operations as defined in the File menu. This allows saving and loading of waveforms and setups, as well as saving screen images to bitmap files.

## NOTE

### Enclose File Name in Quotation Marks

When specifying a file name, you must enclose it in quotation marks.

**NOTE**

**Filenames are Not Case Sensitive.**

The filename that you use is not case sensitive.

---

## :DISK:CDIRectory

**Command** :DISK:CDIRectory "<directory>"

The :DISK:CDIRectory command changes the present working directory to the designated directory name. An error occurs when the requested directory does not exist. You can then view the error with the :SYSTem:ERRor? [{NUMBER | STRing}] query.

**<directory>** A character-quoted ASCII string, which can include the subdirectory designation. You must separate the directory name and any subdirectories with a backslash (\).

**Example** This example sets the present working directory to C:\Users\Public\Documents\Infiniium.

```
myScope.WriteString ":DISK:CDIRectory "C:\Users\Public\Documents\
Infiniium" "
```

**History** Legacy command (existed before version 3.10).

**:DISK:COPY**

**Command**    :DISK:COPY "<source\_file>","<dest\_file>"

The :DISK:COPY command copies a source file from the disk to a destination file on the disk. An error is displayed on the oscilloscope screen if the requested file does not exist. Use full directory paths for the source and destination files.

<source\_file> A character-quoted ASCII string which can include subdirectories with the name of the file.  
 <dest\_file>

**Example**    This example copies C:\Users\Public\Documents\Infiniium\File1.wfm to C:\Temp\File1b.wfm on the disk.

```
myScope.WriteString ":DISK:COPY "C:\Users\Public\Documents\Infiniium\
File1.wfm" ,"C:\Temp\File1b.wfm"
```

**History**    Legacy command (existed before version 3.10).

## :DISK:DELeTe

**Command** :DISK:DELeTe "<file\_name>"

The :DISK:DELeTe command deletes a file from the disk. An error is displayed on the oscilloscope screen if the requested file does not exist. The default path is C:\Users\Public\Documents\Infiniium.

**<file\_name>** A character-quoted ASCII string which can include subdirectories with the name of the file.

**Example** This example deletes FILE1.SET from the disk.

```
myScope.WriteString ":DISK:DELeTe ""FILE1.SET"""
```

**History** Legacy command (existed before version 3.10).

**:DISK:DIRectory?**

**Query** :DISK:DIRectory? ["<directory>"]

The :DISK:DIRectory? query returns the requested directory listing. Each entry is 63 bytes long, including a carriage return and line feed. The default path is C:\Users\Public\Documents\Infiniium.

**<directory>** The list of filenames and directories.

**Returned Format** [:DISK:DIRectory] <n><NL><directory>

**<n>** The specifier that is returned before the directory listing, indicating the number of lines in the listing.

**<directory>** The list of filenames and directories. Each line is separated by a <NL>.

**Example** This example displays a number, then displays a list of files and directories in the current directory. The number indicates the number of lines in the listing.

```
Dim varResults As Variant
Dim lngI As Long

myScope.WriteString ":DISK:DIR?"
varResults = myScope.ReadList(ASCIIType_BSTR, vbLf)
Debug.Print FormatNumber(varResults(0), 0)

For lngI = 1 To (varResults(0) - 2)
    Debug.Print CStr(varResults(lngI))
Next lngI
```

**History** Legacy command (existed before version 3.10).

## :DISK:GETFILE

**Query** :DISK:GETFILE? "<file\_name>"

The :DISK:GETFILE? query returns a binary block of bytes that contains the contents of a file on the oscilloscope.

<file\_name> A quoted ASCII full path name of the file to be read.

**Returned Format** <binary\_block><NL>

<binary\_block> A binary block of data, consisting of the bytes of the file that were read.

This is the same binary block format used when reading display data from the oscilloscope. For examples of reading binary blocks from the oscilloscope, see the :DISPlay:DATA? query examples.

- See Also**
- [":DISK:CDIRectory"](#) on page 491
  - [":DISK:PUTFILE"](#) on page 499
  - [":DISPlay:DATA?"](#) on page 530
  - ["Definite-Length Block Response Data"](#) on page 157

**History** Version 6.72: This is not a new command but its description is now being included.

## :DISK:LOAD

**Command** :DISK:LOAD "<file\_name>" [,<destination>,<interp>]

The :DISK:LOAD command restores from the disk a setup file, composite file, or a waveform file into a waveform memory destination. The type of file is determined by the filename suffix if one is present, or by the destination field if one is not present. You can load .WFM, .CSV, .TSV, .TXT, .BIN, .H5, .SET, and .OSC file types. The destination is only used when loading a waveform memory.

**CAUTION**

Setups saved from Infiniium software versions prior to 2.00 may not load correctly in software versions 4.30 and greater.

You can remedy this by re-saving any pre-2.00 setups using any version of software from version 2.00 to version 4.20.

Setups saved from software versions between 2.00 and 4.20 should load correctly into version 4.30 and greater.

**<file\_name>** A quoted ASCII string with a maximum of 254 characters including the entire path name, if used. You can use either .WFM, .CSV, .TSV, .TXT, .BIN, .H5, .SET, or .OSC as a suffix after the filename. If no file suffix is specified, the default is .wfm.

The present working directory is assumed, or you can specify the entire path. For example, you can load the standard setup file "SETUP0.SET" using the command:

```
:DISK:LOAD "C:\Users\Public\Documents\Infiniium\Setups\SETUP0.SET"
```

Or, you can use :DISK:CDIRectory to change the present working directory to C:\Users\Public\Documents\Infiniium\Setups, then just use the file name ("SETUP0.SET", for example). The default path is C:\Users\Public\Documents\Infiniium\Setups.

When setup files are loaded, touch screen settings are ignored.

**<destination>** WMEMory<R>.

Where <R> is an integer from 1-4.

If a destination is not specified, waveform memory 1 is used.

**<interp>** {OFF | INT1 | INT2 | INT4 | INT8 | INT16}

When loading waveform data into a waveform memory, you can specify the Sin(x)/x interpolation ratio that is used. OFF means no interpolation. You can also specify the 1, 2, 4, 8, or 16 point Sin(x)/x interpolation ratios using INT1, INT2, INT4, INT8, or INT16.

**Example** This example restores the waveform in FILE1.WFM to waveform memory 1 with no Sin(x)/x interpolation.

```
myScope.WriteString ":DISK:LOAD ""FILE1.WFM"",WMEM1,OFF"
```



**History** Legacy command (existed before version 3.10).  
Version 6.20: The <interp> option has been added.

## :DISK:MDIRectory

**Command** :DISK:MDIRectory "<directory>"

The :DISK:MDIRectory command creates a directory in the present working directory which has been set by the :DISK:CDIRectory command. If the present working directory has not been set by the :DISK:CDIRectory command, you must specify the full path in the <directory> parameter as shown in Example 1 below.

An error is displayed if the requested subdirectory does not exist.

**<directory>** A quoted ASCII string which can include subdirectories. You must separate the directory name and any subdirectories with a backslash (\).

**Example 1** This example creates the directory CPROGRAMS in the C:\Users\Public\Documents\Infiniium directory.

```
myScope.WriteString _
  ":DISK:MDIRectory ""C:\Users\Public\Documents\Infiniium\CPROGRAMS"" "
```

**Example 2** This example creates the directory CPROGRAMS in the present working directory set by the :DISK:CDIRectory command.

```
myScope.WriteString ":DISK:MDIRectory ""CPROGRAMS"" "
```

You can check your path with the :DISK:DIRectory? query.

**History** Legacy command (existed before version 3.10).

**:DISK:PUTFILE**

**Command** :DISK:PUTFILE "<file\_name>",<binary\_block>

The :DISK:PUTFILE command writes bytes to a full-path location on the oscilloscope.

<file\_name> A quoted ASCII full path name of the file to be written.

<binary\_block> A binary block of data, consisting of the bytes of the file to be written.

This is the same binary block format used when writing setup files to the oscilloscope. For examples of sending binary blocks to the oscilloscope, see the :SYSTEM:SETup command examples.

**Example** This example shows how to write a transfer function file to the oscilloscope.

```
// Make a directory on the oscilloscope.
INF_USER_DATA_DIR = "C:\Users\Public\Documents\Infiniium\"
:DISK:MDIRECTory INF_USER_DATA_DIR + "Apps\InfiniiSim\"

// Check to see if the above step was successful.
:DISK:CDIRECTory INF_USER_DATA_DIR + "Apps\InfiniiSim\"

// Tell Infiniium to receive the <binary_block> bytes stream and
// write it to the "My.tf2" file.
:DISK:PUTFILE INF_USER_DATA_DIR + "Apps\InfiniiSim\
My.tf2",<binary_block>

// Tell Infiniium to load the transfer function from the newly
// written file.
:CHANnel1:ISIM:APPLY CHANnel1,INF_USER_DATA_DIR + "Apps\InfiniiSim\
My.tf2"
```

- See Also**
- **":DISK:MDIRECTory"** on page 498
  - **":DISK:CDIRECTory"** on page 491
  - **":SYSTEM:SETup"** on page 1366
  - **"Definite-Length Block Response Data"** on page 157

**History** Version 6.72: This is not a new command but its description is now being included.

## :DISK:PWD?

**Query** :DISK:PWD?

The :DISK:PWD? query returns the name of the present working directory (including the full path). If the default path (C:\Users\Public\Documents\Infiniium) has not been changed by the :DISK:CDIRectory command, the :DISK:PWD? query will return an empty string.

**Returned Format** :DISK:PWD? <present\_working\_directory><NL>

**Example** This example places the present working directory in the string variable strWdir, then prints the contents of the variable to the computer's screen.

```
Dim strWdir As String
myScope.WriteString ":DISK:PWD?"
str Wdir = myScope.ReadString
Debug.Print strWdir
```

**History** Legacy command (existed before version 3.10).

## :DISK:SAVE:COMPOSITE

**Command** :DISK:SAVE:COMPOSITE "<file\_name>"

The :DISK:SAVE:COMPOSITE command lets you save oscilloscope composite files to Infiniium's hard disk or to a network drive. Composite files contain setups and waveform data.

The file will have an .osc extension.

**<file\_name>** A quoted ASCII string with a maximum of 254 characters including the entire path name, if used.

The filename assumes the present working directory if a path does not precede the file name.

**Example** This example saves the oscilloscope's setup and waveform data to a composite file named "C:\Scope\Setup\Comp001.osc".

```
myScope.WriteString ":DISK:SAVE:COMPOSITE " "C:\Scope\Setup\Comp001" ""
```

**History** New in version 3.50.

## :DISK:SAVE:IMAGe

**Command** :DISK:SAVE:IMAGe "<file\_name>" [, <format>  
 [, {SCReen | GRATicule}  
 [, {ON | 1} | {OFF | 0}  
 [, {NORMal | INVert}  
 [, {ON | 1} | {OFF | 0}]]]]]

The DISK:SAVE:IMAGe command saves a screen image. The default path is C:\Users\Public\Documents\Infiniium.

**<format>** The image format can be: BMP, GIF, TIF, PNG, or JPEG. The extension is supplied by the oscilloscope depending on the selected file format.

If you do not include the format in the command, the file is saved in the format shown in the Save Screen dialog box.

**<file\_name>** A quoted ASCII string with a maximum of 254 characters including the entire path name, if used.

**(First) ON | OFF** ON means that compression is on for the bitmap format (BMP). OFF means compression is off.

**(Second) ON | OFF** The second ON/OFF selection indicates to save the setup information in the image or not.

**<format>** {BMP | GIF | TIF | JPEG | PNG}

**NOTE**

Error 273 can occur after this command to warn you about a known issue when Remote Desktop is being used to control the oscilloscope. See "[List of Error Messages](#)" on page 1806.

**Examples** myScope.WriteString ":DISK:SAVE:IMAGe "FILE1",BMP,SCR,ON,INVERT"

or:

myScope.WriteString ":DISK:SAVE:IMAGe "FILE1",TIF,GRAT,ON"

or:

myScope.WriteString ":DISK:SAVE:IMAGe "FILE1""

**History** Legacy command (existed before version 3.10).

## :DISK:SAVE:JITTer

**Command** :DISK:SAVE:JITTer "<file\_name>"

The DISK:SAVE:JITTer command saves the jitter measurements shown in the RJDJ tab at the bottom of the oscilloscope screen along with the RJDJ graph data in a comma separated variables (CSV) file format. The csv extension is supplied by the oscilloscope. The default path is C:\Users\Public\Documents\Infiniium.

**<file\_name>** A quoted ASCII string with a maximum of 254 characters including the entire path name, if used.

**Example** `myScope.WriteString ":DISK:SAVE:JITTer " "FILE1" ""`

**History** Legacy command (existed before version 3.10).

**:DISK:SAVE:LISTing**

**Command** `:DISK:SAVE:LISTing [<source>] "<file_name>" [,<format>[,<type>]]`

The DISK:SAVE:LISTing command saves the contents of the bus listing window to a file in either a .csv or .txt format. The default path is C:\Users\Public\Documents\Infiniium.

**<source>** {SERial<N>} – The default serial bus is the one currently displayed in the listing window.

**<N>** An integer 1 - 4.

**<file\_name>** A quoted ASCII string with a maximum of 254 characters including the entire path name, if used.

**<format>** {CSV | TXT}

**<type>** {PACKets | SYMBols}

Specifies which display window to save.

**Example** `myScope.WriteString ":DISK:SAVE:LISTing SERIAL3, "FILE1", CSV"`

**History** Legacy command (existed before version 3.10).

Version 5.00: Added the <type> parameter for specifying which display window to save.



## :DISK:SAVE:MEASurements

**Command** :DISK:SAVE:MEASurements "<file\_name>" [,<legacy\_save\_mode>]

The DISK:SAVE:MEASurements command saves the measurements shown in the measurements tab at the bottom of the oscilloscope screen in a comma separated variables (CSV) file format. The csv extension is supplied by the oscilloscope. The default path is C:\Users\Public\Documents\Infiniium.

**<file\_name>** A quoted ASCII string with a maximum of 254 characters including the entire path name, if used.

**<legacy\_save\_mode>** {{ON | 1} | {OFF | 0}}

**e>**

The <legacy\_save\_mode> option specifies whether to save measurement results in the format used prior to Infiniium version 5.00. If this option is not used, it is OFF.

**Example** myScope.WriteString ":DISK:SAVE:MEASurements "FILE1""

**History** Legacy command (existed before version 3.10).

Version 5.50: Added the <legacy\_save\_mode> option to save measurement results in the format used prior to Infiniium version 5.00.

## :DISK:SAVE:MREPort

**Command** :DISK:SAVE:MREPort "<filename>"

The :DISK:SAVE:MREPort command lets you save information about the oscilloscope setup, a waveform screen capture, and measurement results to a PDF or MHTML (\*.mht) format file.

MHTML is a web page archive format that includes, in one file, the HTML, images, and other resources used to display the page.

**<filename>** A quoted ASCII string file name with either a ".pdf" or ".mht" extension to specify the format.

The file name can be a full path name or just the file name, in which case the report is saved to the default Infiniium data directory.

If the ".pdf" or ".mht" extension is not specified, the command will return a SCPI file path error.

**History** New in version 6.60.

## :DISK:SAVE:NOISe

**Command** :DISK:SAVE:NOISe "<filename>"

The :DISK:SAVE:NOISe command saves the noise measurements shown in the Noise Results tab at the bottom of the oscilloscope screen along with the Noise graph data in a comma separated variables (CSV) file format. The csv extension is supplied by the oscilloscope. The default path is C:\Users\Public\Documents\Infiniium.

**<file\_name>** A quoted ASCII string with a maximum of 254 characters including the entire path name, if used.

**See Also** · [":DISK:SAVE:JITTer"](#) on page 503

**History** New in version 6.60.

## :DISK:SAVE:PRECprobe

**Command** :DISK:SAVE:PRECprobe "<file\_name>.csv", {CHAN1 | CHAN2 | CHAN3 | CHAN4}

The DISK:SAVE:PRECprobe command saves PrecisionProbe/Cable data in a comma separated variables (CSV) file format. The default path is C:\Users\Public\Documents\Infiniium.

**<file\_name>** A quoted ASCII string with a maximum of 254 characters including the entire path name, if used.

**Example** myScope.WriteString ":DISK:SAVE:PRECprobe ""PPch1data.csv""", CHAN1

**History** New in version 4.00.

## :DISK:SAVE:SETup

**Command** :DISK:SAVE:SETup "<file\_name>"

The :DISK:SAVE:SETup command saves the current oscilloscope setup to a disk. The file will have a .set extension.

**<file\_name>** A quoted ASCII string with a maximum of 254 characters including the entire path name, if used. The filename assumes the present working directory if a path does not precede the file name. The default path is C:\Users\Public\Documents\Infiniium\setups.

**Example** This example saves the channel 1 waveform to SETUP1 on the disk.

```
myScope.WriteString ":DISK:SAVE:SETup " "SETUP1" ""
```

**History** Legacy command (existed before version 3.10).

## :DISK:SAVE:WAVEform

**Command** :DISK:SAVE:WAVEform <source>,"<file\_name>" [,<format>[,<header>]]

The :DISK:SAVE:WAVEform command saves a waveform to a disk. If the source is ALL, all of the currently displayed waveforms are saved to the file. If you use a file extension as shown below in the <format> variable, then the type of file saved defaults to the extension type. If no format is specified and no extension is used, the file is saved in the INTernal format.

**NOTE**

See the **":WAVEform:VIEW"** on page 1634 command to determine how much data is saved.

**NOTE**

When an acquisition is made on multiple channels, the data for each channel has the same X origin and the same number of points.

<source> {ALL | CHANnel<N> | CLOCK | FUNCtion<F> | HISTogram | MTRend | MSPectrum | EQUalized<L> | WMEMory<R> | XT<X> | PNOise | BUS<B> | PODALL | POD1 | POD2}

The MTRend and MSPectrum sources are available when the Jitter Analysis Software license is installed and the features are enabled.

The CLOCK source is available when the recovered clock is displayed.

The EQUalized<L> source is available when the Advanced Signal Integrity Software license is installed and the equalized waveform is displayed as a function.

The PNOise source is available when the Jitter and Vertical Noise Analysis Software license is installed and the Phase Noise analysis feature is enabled.

The BUS<B> sources are can be used with the BIN, CSV, TSV, and TXT formats.

The PODALL source is all digital channels, POD1 is d0-d7, and POD2 is d8-d15.

<N> An integer, 1-4 in a single oscilloscope, 1-40 in a MultiScope system.

<F> An integer, 1-16.

<L> An integer, 1-4.

<R> An integer, 1-4.

<X> An integer, 1-4, identifying the crosstalk waveform.

<file\_name> A quoted ASCII string with a maximum of 254 characters including the entire path name, if used. The filename assumes the present working directory if a path does not precede the file name. The default path is C:\Users\Public\Documents\Infiniium.

**<format>** {BIN | CSV | INTernal | TSV | TXT | H5 | H5INt | MATlab}

The following file name extensions are used for the different formats:

- BIN = file\_name.bin
- CSV (comma separated values) = file\_name.csv
- INTernal = file\_name.wfm
- TSV (tab separated values) = file\_name.tsv
- TXT = file\_name.txt
- H5 (HDF5) = file\_name.h5

In the H5 format, data is saved as floats. In this case, the data values are actual vertical values and do not need to be multiplied by the Y increment value.

- H5INt (HDF5) = file\_name.h5

In the H5INt format, data is saved as integers. In this case, data values are quantization values and need to be multiplied by the Y increment value and added to the Y origin value to get the actual vertical values.

- MATlab (MATLAB data format) = file\_name.mat

**<header>** {{ON | 1} | {OFF | 0}}

**Example** This example saves the channel 1 waveform to FILE1 on the disk in the CSV format with header on.

```
myScope.WriteString ":DISK:SAVE:WAVEform CHANnel1, "FILE1", CSV, ON"
```

**History** Legacy command (existed before version 3.10).

Version 4.50: Added the H5INt format parameter which saves waveform data as integers within the H5 file.

Version 6.10: Added the MATlab format for saving waveforms to MATLAB (.mat) data format files.

**:DISK:SEGMented**

**Command** `:DISK:SEGMented {ALL | CURRent}`

The :DISK:SEGMented command sets whether all segments or just the current segment are saved to a file when the :DISK:SAVE:WAVEform command is issued and the source is a channel but not a waveform memory or function. Before segments can be saved, the :ACQUIRE:MODE must be set to the SEGMented mode and segments must be acquired.

**Example** This example sets the disk segmented memory store method to CURRent.

```
myScope.WriteString ":DISK:SEGMented CURRent"
```

**Query** `:DISK:SEGMented?`

The :DISK:SEGMented? query returns disk segmented memory store method value.

**Returned Format** `[:DISK:SEGMented] {ALL | CURRent}<NL>`

**Example** This example places the disk store method in the string variable strMethod, then prints the contents of the variable to the computer's screen.

```
Dim strMethod As String
myScope.WriteString ":DISK:SEGMented?"
strMethod = myScope.ReadString
Debug.Print strMethod
```

**History** Legacy command (existed before version 3.10).



# 19 Display Commands

:DISPlay:BOOKmark:DELeTe:ALL / 515  
:DISPlay:BOOKmark<N>:DELeTe / 516  
:DISPlay:BOOKmark<N>:SEt / 517  
:DISPlay:BOOKmark<N>:VERTical? / 519  
:DISPlay:BOOKmark<N>:XPOsition / 520  
:DISPlay:BOOKmark<N>:YPOsition / 521  
:DISPlay:CGRade / 522  
:DISPlay:CGRade:LEGenD / 524  
:DISPlay:CGRade:LEVels? / 525  
:DISPlay:CGRade:SCHeMeme / 527  
:DISPlay:CONNect / 529  
:DISPlay:DATA? / 530  
:DISPlay:GRATicule / 531  
:DISPlay:GRATicule:AREA<N>:HSCale / 532  
:DISPlay:GRATicule:AREA<N>:STATe / 533  
:DISPlay:GRATicule:AREA<N>:VSCale / 534  
:DISPlay:GRATicule:GLAYout / 535  
:DISPlay:GRATicule:INTensity / 536  
:DISPlay:GRATicule:NUMBer / 537  
:DISPlay:GRATicule:SEtGrat / 538  
:DISPlay:ISIM:GCOunt / 539  
:DISPlay:ISIM:SElectgraph / 540  
:DISPlay:ISIM:SOURce / 541  
:DISPlay:JITTer:GCOunt / 542  
:DISPlay:JITTer:SElectgraph / 543  
:DISPlay:JITTer:THReshold / 545  
:DISPlay:LABel / 546  
:DISPlay:LAYout / 547  
:DISPlay:MAIN / 548  
:DISPlay:NOISe:LEVel / 550  
:DISPlay:PAM:GRAPh / 551  
:DISPlay:PAM:SOURce / 552

:DISPlay:PAM:TABLE / 553  
:DISPlay:PERsistence / 554  
:DISPlay:PRECprobe:GCOunt / 558  
:DISPlay:PRECprobe:SElectgraph / 559  
:DISPlay:PRECprobe:SOURce / 560  
:DISPlay:PROPortion / 556  
:DISPlay:PROPortion:RESults / 557  
:DISPlay:RESults:LAYout / 561  
:DISPlay:SCOLor / 562  
:DISPlay:STATus:COLumn / 564  
:DISPlay:STATus:ROW / 565  
:DISPlay:THEMe / 566  
:DISPlay:WINDow:MAXimize / 567

The DISPlay subsystem controls the display of data, text, and graticules, and the use of color.

## :DISPlay:BOOKmark:DELeTe:ALL

**Command** :DISPlay:BOOKmark:DELeTe:ALL

The :DISPlay:BOOKmark:DELeTe:ALL command deletes all bookmarks.

- See Also**
- [":DISPlay:BOOKmark<N>:DELeTe"](#) on page 516
  - [":DISPlay:BOOKmark<N>:SET"](#) on page 517
  - [":DISPlay:BOOKmark<N>:VERTical?"](#) on page 519
  - [":DISPlay:BOOKmark<N>:XPOStion"](#) on page 520
  - [":DISPlay:BOOKmark<N>:YPOStion"](#) on page 521

**History** New in version 6.70.

## :DISPlay:BOOKmark<N>:DELeTe

**Command** :DISPlay:BOOKmark<N>:DELeTe

The :DISPlay:BOOKmark<N>:DELeTe command deletes a bookmark.

<N> An integer, 1-100.

- See Also**
- [":DISPlay:BOOKmark:DELeTe:ALL"](#) on page 515
  - [":DISPlay:BOOKmark<N>:SET"](#) on page 517
  - [":DISPlay:BOOKmark<N>:VERTical?"](#) on page 519
  - [":DISPlay:BOOKmark<N>:XPOSition"](#) on page 520
  - [":DISPlay:BOOKmark<N>:YPOSition"](#) on page 521

**History** New in version 5.00.

## :DISPlay:BOOKmark&lt;N&gt;:SET

**Command** :DISPlay:BOOKmark<N>:SET NONE,"label" [,<color>[, "content" [,<grid>]]]  
 :DISPlay:BOOKmark<N>:SET <source>,"label" [,<color>[, "content" [,<time>]]]

The :DISPlay:BOOKmark<N>:SET command sets a bookmark.

- <N>** An integer, 1-100.
  - "label"** A quoted ASCII string. This is the text that appears in the bookmark callout box.
  - <color>** Display element color name (see the color names in **":DISPlay:SCOLor"** on page 562).
  - "content"** A quoted ASCII string. This is the text that pops up when you mouse over a bookmark callout box.
  - <grid>** A value from 1 to the number of grids displayed. Bookmarks are placed in waveform area 1.
  - <source>** {CHANnel<N> | DIFF<D> | COMMONmode<C> | FUNCTION<F> | WMEMory<R> | CLOCK | MTRend | MSPectrum | EQUalized<L> | XT<X> | PNOise | DIGital<M>}
- The MTRend and MSPectrum sources are available when the Jitter Analysis Software license is installed and the features are enabled.
- The CLOCK source is available when the recovered clock is displayed.
- The EQUalized<L> source is available when the Advanced Signal Integrity Software license is installed and the equalized waveform is displayed as a function.
- The PNOise source is available when the Jitter and Vertical Noise Analysis Software license is installed and the Phase Noise analysis feature is enabled.
- <N>** An integer, 1-4 in a single oscilloscope, 1-40 in a MultiScope system.
  - <D>, <C>** <D> is an integer, 1-2. <C> is an integer, 3-4.
- The DIFF and COMMONmode sources are just aliases that can be used in place of the channel names to apply to differential or common mode signals. These are just aliases - no state change occurs if you refer to a differential channel and you are not in differential mode. DIFF1 refers to the differential signal between channels 1 and 3 (and COMMONmode3 refers to the common mode channel between these same channels). DIFF2 refers to the differential signal between channels 2 and 4 (and COMMONmode4 refers to the common mode channel between these same channels).
- <F>** An integer, 1-16.
  - <R>** An integer, 1-4.
  - <L>** An integer, 1-4.

<X> An integer, 1-4, identifying the crosstalk waveform.

<time> A real number time position. Time values are appropriate only for bookmarks associated with waveforms.

- See Also**
- **":DISPlay:BOOKmark:DELeTe:ALL"** on page 515
  - **":DISPlay:BOOKmark<N>:DELeTe"** on page 516
  - **":DISPlay:BOOKmark<N>:VERTical?"** on page 519
  - **":DISPlay:BOOKmark<N>:XPOSition"** on page 520
  - **":DISPlay:BOOKmark<N>:YPOSition"** on page 521

**History** New in version 5.00.

Version 6.73: The <grid> option has been added to specify the grid in which the bookmark appears (when the source is NONE).

## :DISPlay:BOOKmark<N>:VERTical?

**Query** :DISPlay:BOOKmark<N>:VERTical?

The :DISPlay:BOOKmark<N>:VERTical? query returns a waveform's vertical value at a bookmark's horizontal position.

<N> An integer, 1-100.

**Returned Format** <vertical\_value><NL>

<vertical\_value> A real number value.

- See Also**
- [":DISPlay:BOOKmark:DELeTe:ALL"](#) on page 515
  - [":DISPlay:BOOKmark<N>:DELeTe"](#) on page 516
  - [":DISPlay:BOOKmark<N>:SET"](#) on page 517
  - [":DISPlay:BOOKmark<N>:XPOStion"](#) on page 520
  - [":DISPlay:BOOKmark<N>:YPOStion"](#) on page 521

**History** New in version 5.00.

**:DISPlay:BOOKmark<N>:XPOSition**

**Command**    `:DISPlay:BOOKmark<N>:XPOSition <x_pos>`

The `:DISPlay:BOOKmark<N>:XPOSition` command sets the horizontal grid position of a bookmark's callout box.

**<N>**    An integer, 1-100.

**<x\_pos>**    A real number between 0.0 and 1.0 that represents a percentage of the grid width.

**Query**    `:DISPlay:BOOKmark<N>:XPOSition?`

The `:DISPlay:BOOKmark<N>:XPOSition?` query returns the horizontal grid position of a bookmark's callout box.

**Returned Format**    `[:DISPlay:BOOKmark<N>:XPOSition] <x_pos><NL>`

- See Also**
- [":DISPlay:BOOKmark:DELeTe:ALL"](#) on page 515
  - [":DISPlay:BOOKmark<N>:DELeTe"](#) on page 516
  - [":DISPlay:BOOKmark<N>:SET"](#) on page 517
  - [":DISPlay:BOOKmark<N>:VERTical?"](#) on page 519
  - [":DISPlay:BOOKmark<N>:YPOSition"](#) on page 521

**History**    New in version 5.00.



## :DISPlay:BOOKmark<N>:YPOSition

**Command** :DISPlay:BOOKmark<N>:YPOSition <y\_pos>

The :DISPlay:BOOKmark<N>:YPOSition command sets the vertical grid position of a bookmark's callout box.

<N> An integer, 1-100.

<y\_pos> A real number between 0.0 and 1.0 that represents a percentage of the grid height.

**Query** :DISPlay:BOOKmark<N>:YPOSition?

The :DISPlay:BOOKmark<N>:YPOSition? query returns the vertical grid position of a bookmark's callout box.

**Returned Format** [:DISPlay:BOOKmark<N>:YPOSition] <y\_pos><NL>

- See Also**
- [":DISPlay:BOOKmark:DELeTe:ALL"](#) on page 515
  - [":DISPlay:BOOKmark<N>:DELeTe"](#) on page 516
  - [":DISPlay:BOOKmark<N>:SET"](#) on page 517
  - [":DISPlay:BOOKmark<N>:VERTical?"](#) on page 519
  - [":DISPlay:BOOKmark<N>:XPOSition"](#) on page 520

**History** New in version 5.00.

## :DISPlay:CGRade

**Command** :DISPlay:CGRade {{ON | 1} | {OFF | 0}} [, <source>]

The :DISPlay:CGRade command sets the color grade persistence on or off.

When in the color grade persistence mode, all waveforms are mapped into a database and shown with different colors representing varying number of hits in a pixel. "Connected dots" display mode (:DISPlay:CONNect) is disabled when the color grade persistence is on.

The oscilloscope has three features that use a specific database. This database uses a different memory area than the waveform record for each channel. The three features that use the database are:

- Histograms.
- Mask testing.
- Color grade persistence.

When any one of these three features is turned on, the oscilloscope starts building the database. The database is the size of the graticule area and varies in size. Behind each pixel is a 53-bit counter. Each counter is incremented each time a pixel is hit by data from a channel or function. The maximum count (saturation) for each counter is 9,007,199,254,740,991. You can check for counter saturation by using the DISPlay:CGRade:LEVels? query.

The color grade persistence uses colors to represent the number of hits on various areas of the display. The default color-grade state is off.

**<source>** {CHANnel<N> | DIFF<D> | COMMONmode<C> | FUNCTION<F> | WMEMory<R> | EQUalized<L> | MTRend | MSPectrum | XT<X>}

If <source> is omitted:

- Color grade is enabled/disabled for all sources which are currently on.
- When enabling color grade, the main waveform view is turned off.
- When disabling color grade, the main waveform view is turned on.

**<N>** An integer, 1-4 in a single oscilloscope, 1-40 in a MultiScope system.

**<D>, <C>** <D> is an integer, 1-2. <C> is an integer, 3-4.

The DIFF and COMMONmode sources are just aliases that can be used in place of the channel names to apply to differential or common mode signals. These are just aliases - no state change occurs if you refer to a differential channel and you are not in differential mode. DIFF1 refers to the differential signal between channels 1 and 3 (and COMMONmode3 refers to the common mode channel between these same channels). DIFF2 refers to the differential signal between channels 2 and 4 (and COMMONmode4 refers to the common mode channel between these same channels).

**<F>** An integer, 1-16.

- <R> An integer, 1-4.
- <L> An integer, 1-4.
- <X> An integer, 1-4, identifying the crosstalk waveform.

**Example** This example sets the color grade persistence on.

```
myScope.WriteString ":DISPlay:CGRade ON"
```

**Query** :DISPlay:CGRade? [<source>]

The DISPlay:CGRade query returns the current color-grade state.

If <source> is omitted, the query returns ON (1) if any color grade is enabled.

**Returned Format** [:DISPlay:CGRade] {1 | 0}<NL>

**Example** This example returns the current color grade state.

```
Dim strCgrade As String ' Dimension variable.
myScope.WriteString ":DISPlay:CGRade?"
strCgrade = myScope.ReadString
Debug.Print strCgrade
```

- See Also**
- [":DISPlay:CGRade:LEVels?"](#) on page 525
  - [":DISPlay:CGRade:SCHEME"](#) on page 527

**History** Legacy command (existed before version 3.10).

Version 5.00: Added the optional <source> parameter for specifying the waveform on which color grade should be turned on or off.

Version 5.50: When the <source> parameter is not provided, enabling color grade will turn off the main waveform view, and disabling color grade will turn on the main waveform view.

## :DISPlay:CGRade:LEGend

**Command** :DISPlay:CGRade:LEGend {{0 | OFF} | {1 | ON}}

The :DISPlay:CGRade:LEGend command lets you enable or disable the Color Grade legend in the graphical user interface's Results pane.

**Query** :DISPlay:CGRade:LEGend?

The :DISPlay:CGRade:LEGend? query returns the Color Grade legend setting.

**Returned Format** <setting><NL>

<setting> ::= {0 | 1}

**See Also** • [":DISPlay:CGRade"](#) on page 522

**History** New in version 6.60.

## :DISPlay:CGRade:LEVels?

**Query** :DISPlay:CGRade:LEVels?

The :DISPlay:CGRade:LEVels? query returns the range of hits represented by each color. Fourteen values are returned, representing the minimum and maximum count for each of seven colors. In the CLASsic color grade scheme, the values are returned in the following order:

- Green minimum value
- Green maximum value
- Blue minimum value
- Blue maximum value
- Pink minimum value
- Pink maximum value
- Red minimum value
- Red maximum value
- Orange minimum value
- Orange maximum value
- Yellow minimum value
- Yellow maximum value
- White minimum value
- White maximum value

**Returned Format** [DISPlay:CGRade:LEVels] <color format><NL>

<color format> <intensity color min/max> is an integer value from 0 to 9,007,199,254,740,991

**Example** This example gets the range of hits represented by each color and prints it on the computer screen:

```
Dim strSetting As String    ' Dimension variable.
myScope.WriteString ":DISPlay:CGRade:LEVels?"
strCgrade = myScope.ReadString
Debug.Print strCgrade
```

In the CLASsic color grade scheme, colors start at green minimum, maximum, then blue, pink, red, orange, yellow, white. The format is a string where commas separate minimum and maximum values. The largest number in the string can be 9,007,199,254,740,991

An example of a possible returned string is as follows:

```
1,414,415,829,830,1658,1659,3316,3317,6633,6634,13267,13268,26535
```

- See Also**
- **":DISPlay:CGRade"** on page 522
  - **":DISPlay:CGRade:SCHeme"** on page 527

**History** Legacy command (existed before version 3.10).

Version 5.00: This query is unchanged but results are returned only when a single color grade view is on.















## :DISPlay:CGRade:SCHEME

**Command** :DISPlay:CGRade:SCHEME {CLASSic | TEMP}

The :DISPlay:CGRade:SCHEME command sets the color grade scheme to CLASSic or TEMP.

Color grade persistence is displayed in 255 colors grouped into seven color range blocks. The blocks represent the database counts for each color range. In the CLASSic color grade scheme, the counters with the largest counts are displayed using a white pixel while the counters with the smallest counts are displayed using green pixels.

The following table shows the counter range blocks for each color for both the CLASSic and TEMP color grade schemes.

Color Grade Scheme		Range
Classic	Temperature	
		50% to 100% of Max counter
		25% to 50% of Max counter
		12.5% to 25% of Max counter
		6.25% to 12.5% of Max counter
		3.125% to 6.25% of Max counter
		1.5625% to 3.125% of Max counter
		1 hit to 1.5625% of Max counter

**Example** This example sets the color grade scheme to "classic".

```
myScope.WriteString ":DISPlay:CGRade:SCHEME CLASSic"
```

**Query** :DISPlay:CGRade:SCHEME?

The :DISPlay:CGRade:SCHEME? query returns the specified color scheme.

**Returned Format** [DISPlay:CGRade:SCHEME] {CLASSic | TEMP}<NL>

**Example** This example gets the specified color scheme and prints it on the computer screen:

```
Dim strCgradeScheme As String ' Dimension variable.  
myScope.WriteString ":DISPlay:CGRade:SCHEME?"  
strCgradeScheme = myScope.ReadString  
Debug.Print strCgradeScheme
```

**See Also**

- [":DISPlay:CGRade"](#) on page 522
- [":DISPlay:CGRade:LEVELS?"](#) on page 525

**History** New in version 4.20.



## :DISPlay:CONNect

**Command** :DISPlay:CONNect {{ON | 1} | {OFF | 0}} [,<source>]

When enabled, :DISPlay:CONNect draws a line between consecutive waveform data points. This is also known as linear interpolation.

**<source>** {CHANnel<N> | DIFF<D> | COMMONmode<C> | FUNCTION<F> | WMEMory<R> | EQUalized<L> | MTRend | MSPectrum | XT<X> | PNOise}

If <source> is omitted, connected dots is enabled for all sources.

The PNOise source is available when the Jitter and Vertical Noise Analysis Software license is installed and the Phase Noise analysis feature is enabled.

**<N>** An integer, 1-4 in a single oscilloscope, 1-40 in a MultiScope system.

**<D>, <C>** <D> is an integer, 1-2. <C> is an integer, 3-4.

The DIFF and COMMONmode sources are just aliases that can be used in place of the channel names to apply to differential or common mode signals. These are just aliases - no state change occurs if you refer to a differential channel and you are not in differential mode. DIFF1 refers to the differential signal between channels 1 and 3 (and COMMONmode3 refers to the common mode channel between these same channels). DIFF2 refers to the differential signal between channels 2 and 4 (and COMMONmode4 refers to the common mode channel between these same channels).

**<F>** An integer, 1-16.

**<R>** An integer, 1-4.

**<L>** An integer, 1-4.

**<X>** An integer, 1-4, identifying the crosstalk waveform.

**Example** This example turns on the connect-the-dots feature.

```
myScope.WriteString ":DISPlay:CONNect ON"
```

**Query** :DISPlay:CONNect? [<source>]

The :DISPlay:CONNect? query returns the status of the connect-the-dots feature.

If <source> is omitted, the query returns ON (1) if connect the dots is enabled on channel 1.

**Returned Format** [:DISPlay:CONNect] {1 | 0}<NL>

**History** Legacy command (existed before version 3.10).

Version 5.00: Added the optional <source> parameter for specifying the waveform on which the setting should be made.

**:DISPlay:DATA?**

**Query** :DISPlay:DATA? [<type>[,<screen\_mode>[,<compression> [,<inversion>]]]]

The :DISPlay:DATA? query returns information about the captured data. If no options to the query are specified, the default selections are BMP file type, SCReen mode, compression turned ON, and inversion set to NORMAl.

<type> The bitmap type: BMP | JPG | GIF | TIF | PNG.

<screen\_mode> The display setting: SCReen | GRATicule. Selecting GRATicule displays a 10-by-8 (unit) display graticule on the screen. See also :DISPlay:GRATicule.

<compression> The file compression feature: ON | OFF.

<inversion> The inversion of the displayed file: NORMAl | INVert.

**NOTE**

Error 273 can occur after this query to warn you about a known issue when Remote Desktop is being used to control the oscilloscope. See "[List of Error Messages](#)" on page 1806.

**Returned Format** [:DISPlay:DATA] <binary\_block\_data><NL>

<binary\_block\_data> Data in the IEEE 488.2 definite block format.

**See Also** • "[Definite-Length Block Response Data](#)" on page 157

**History** Legacy command (existed before version 3.10).

## :DISPlay:GRATicule

**Command** :DISPlay:GRATicule {GRID | FRAMe}

The :DISPlay:GRATicule command selects the type of graticule that is displayed. Infiniium oscilloscopes have a 10-by-8 (unit) display graticule grid (GRID), a grid line is place on each vertical and horizontal division. When it is off (FRAMe), a frame with tic marks surrounds the graticule edges.

**Example** This example sets up the oscilloscope's display background with a frame that is separated into major and minor divisions.

```
myScope.WriteString ":DISPlay:GRATicule FRAMe"
```

**Query** :DISPlay:GRATicule?

The :DISPlay:GRATicule? query returns the type of graticule currently displayed.

**Returned Format** [:DISPlay:GRATicule] {GRID | FRAMe}<NL>

**Example** This example places the current display graticule setting in the string variable, strSetting, then prints the contents of the variable to the computer's screen.

```
Dim strSetting As String ' Dimension variable.
myScope.WriteString ":DISPlay:GRATicule?"
strSetting = myScope.ReadString
Debug.Print strSetting
```

**See Also**

- [":DISPlay:GRATicule:INTensity"](#) on page 536
- [":DISPlay:GRATicule:NUMBer"](#) on page 537
- [":DISPlay:GRATicule:SETGrat"](#) on page 538

**History** Legacy command (existed before version 3.10).

## :DISPlay:GRATicule:AREA&lt;N&gt;:HSCale

**Command** :DISPlay:GRATicule:AREA<N>:HSCale {{0 | OFF} | {1 | ON}}

The :DISPlay:GRATicule:AREA<N>:HSCale command specifies whether the horizontal scale is displayed.

<N> Integer waveform window number, 1-8.

**Query** :DISPlay:GRATicule:AREA<N>:HSCale?

The :DISPlay:GRATicule:AREA<N>:HSCale? query returns whether the horizontal scale is displayed.

**Returned Format** <setting><NL>

<setting> ::= {0 | 1}

**See Also**

- [":DISPlay:GRATicule:AREA<N>:VSCale"](#) on page 534
- [":DISPlay:GRATicule:AREA<N>:STATe"](#) on page 533

**History** New in version 6.70.

## :DISPlay:GRATicule:AREA&lt;N&gt;:STATe

**Command** :DISPlay:GRATicule:AREA<N>:STATe {{ON | 1} | {OFF | 0}}

The :DISPlay:GRATicule:AREA<N>:STATe command turn a waveform area on or off.

<N> Can be an integer from 1–8. Waveform area 1 is always on and cannot be set to off.

**Example** This example turns on waveform area 2.

```
myScope.WriteString ":DISPlay:GRATicule:AREA2:STATe ON"
```

**Query** :DISPlay:GRATicule:AREA<N>:STATe?

The :DISPlay:GRATicule:AREA<N>:STATe? query returns whether the waveform area is on or off.

**Returned Format** [:DISPlay:GRATicule:AREA<N>:STATe] {1 | 0}<NL>

**Example** This example places the status of waveform area 2 in the string variable, strSetting, then prints the contents of the variable to the computer's screen.

```
Dim strSetting As String ' Dimension variable.
myScope.WriteString ":DISPlay:GRATicule:AREA2:STATe?"
strSetting = myScope.ReadString
Debug.Print strSetting
```

**See Also**

- [":DISPlay:GRATicule"](#) on page 531
- [":DISPlay:GRATicule:INTensity"](#) on page 536
- [":DISPlay:GRATicule:NUMBer"](#) on page 537
- [":DISPlay:GRATicule:SETGrat"](#) on page 538
- [":DISPlay:GRATicule:AREA<N>:HSCale"](#) on page 532
- [":DISPlay:GRATicule:AREA<N>:VSCale"](#) on page 534

**History** New in version 5.00.

## :DISPlay:GRATicule:AREA&lt;N&gt;:VSCale

**Command** :DISPlay:GRATicule:AREA<N>:VSCale {OFF | AUTO | MANual}

The :DISPlay:GRATicule:AREA<N>:VSCale command specifies whether the vertical scale is displayed with automatic sizing (AUTO), displayed with handles for manual sizing (MANual), or not displayed (OFF).

<N> Integer waveform window number, 1-8.

**Query** :DISPlay:GRATicule:AREA<N>:VSCale?

The :DISPlay:GRATicule:AREA<N>:VSCale? query returns whether the vertical scale is displayed with automatic sizing (AUTO), displayed with handles for manual sizing (MAN), or not displayed (OFF).

**Returned Format** <setting> ::= Integer waveform window number, 1-8.  
<setting> ::= {OFF | AUTO | MAN}

**See Also** • [":DISPlay:GRATicule:AREA<N>:HSCale"](#) on page 532  
• [":DISPlay:GRATicule:AREA<N>:STATe"](#) on page 533

**History** New in version 6.70.

## :DISPlay:GRATicule:GLAYout

**Command** :DISPlay:GRATicule:GLAYout <layout>[,<area>]

<layout> ::= {SVERTical | SHORizontal | TVERTical | THORizontal}

The :DISPlay:GRATicule:GLAYout command specifies the layout format to be used in organizing the grids in a waveform area:

- SVERTical – Stacked vertical layout.
- SHORizontal – Stacked horizontal layout.
- TVERTical – Tiled vertical layout.
- THORizontal – Tiled horizontal layout.

When a waveform area is using horizontal Zoom, the :DISPlay:GRATicule:GLAYout command is not applicable and will result in the error -224,"Illegal parameter value".

<area> An integer from 1-8.

If the <area> is omitted, the number of grids will be applied to waveform area 1.

**Example** This example sets up stacked vertical layout for window 2.

```
myScope.WriteString ":DISPlay:GRATicule:GLAYout SVERTical, 2"
```

**Query** :DISPlay:GRATicule:GLAYout? [<area>]

The :DISPlay:GRATicule:GLAYout? query returns the layout format for the specified area or area 1 if the area is not specified.

**Returned Format** <layout><NL>

<layout> ::= {SVER | SHOR | TVER | THOR | ZOOM}

- SVER – Stacked vertical layout.
- SHOR – Stacked horizontal layout.
- TVER – Tiled vertical layout.
- THOR – Tiled horizontal layout.
- ZOOM – This is returned If you query while a waveform area is using horizontal Zoom.

**See Also** • [":DISPlay:LAYout"](#) on page 547  
• [":DISPlay:RESults:LAYout"](#) on page 561

**History** New in version 6.60.

Version 6.74: The query now returns the short form of the command options.

**:DISPlay:GRATicule:INTensity**

**Command**     :DISPlay:GRATicule:INTensity <intensity\_value>

You can dim the grid's intensity or turn the grid off to better view waveforms that might be obscured by the graticule lines using the :DISPlay:GRATicule:INTensity command. Otherwise, you can use the grid to estimate waveform measurements such as amplitude and period.

When printing, the grid intensity control does not affect the hard copy. To remove the grid from a printed hard copy, you must turn off the grid before printing.

<intensity\_value>   A integer from 0 to 100, indicating the percentage of grid intensity.

**Example**       This example sets the graticule intensity to 50%.

```
myScope.WriteString ":DISPlay:GRATicule:INTensity 50"
```

**Query**         :DISPlay:GRATicule:INTensity?

The :DISPlay:GRATicule:INTensity? query returns the intensity.

**Returned Format**   [:DISPlay:GRATicule:INTensity] <value><NL>

**Example**       This example places the current graticule intensity setting in the string variable, strSetting, then prints the contents of the variable to the computer's screen.

```
Dim strSetting As String   ' Dimension variable.
myScope.WriteString ":DISPlay:GRATicule:INTensity?"
strSetting = myScope.ReadString
Debug.Print strSetting
```

- See Also**
- **"[:DISPlay:GRATicule](#)"** on page 531
  - **"[:DISPlay:GRATicule:NUMBer](#)"** on page 537
  - **"[:DISPlay:GRATicule:SETGrat](#)"** on page 538

**History**       Legacy command (existed before version 3.10).



## :DISPlay:GRATicule:NUMBER

**Command** :DISPlay:GRATicule:NUMBER <grids>[,<area>]

The :DISPlay:GRATicule:NUMBER command specifies the number of grids in a waveform area. Multiple grids let you more easily view multiple waveforms that use the full vertical scale.

<grids> Can be an integer from 1–16.

<area> Can be an integer from 1–8.

If the <area> is omitted, the number of grids will be applied to waveform area 1.

**Example** This example sets up two viewing areas.

```
myScope.WriteString ":DISPlay:GRATicule:NUMBER 2"
```

**Query** :DISPlay:GRATicule:NUMBER? [<area>]

The :DISPlay:GRATicule:NUMBER? query returns the the number of grids in a waveform area.

**Returned Format** [:DISPlay:GRATicule:NUMBER] {1-16}<NL>

**Example** This example places the current number of grids in the string variable, strSetting, then prints the contents of the variable to the computer's screen.

```
Dim strSetting As String ' Dimension variable.
myScope.WriteString ":DISPlay:GRATicule:NUMBER?"
strSetting = myScope.ReadString
Debug.Print strSetting
```

**See Also**

- [":DISPlay:GRATicule"](#) on page 531
- [":DISPlay:GRATicule:INTensity"](#) on page 536
- [":DISPlay:GRATicule:SETGrat"](#) on page 538
- [":DISPlay:GRATicule:AREA<N>:STATe"](#) on page 533

**History** Legacy command (existed before version 3.10).

Version 5.0: Number of grids can be any number between 1 and 16 (not just 1, 2, 4, 8, or 16). You can also specify which waveform area the number of grids setting is for.

## :DISPlay:GRATicule:SETGrat

**Command** :DISPlay:GRATicule:SETGrat  
 <DispGratChan>,<grid>[,<area>][,{MAIN | CGRade}]

The :DISPlay:GRATicule:SETGrat command assigns the corresponding waveform to a specific grid and waveform area.

If {MAIN | CGRade} is omitted, the MAIN view will be placed.

<DispGratChan> Can be:

- CHN<N>
- DIFF1, DIFF2
- COMM3, COMM4
- MEM<N> where N is between 1 and 4
- EQU<N> EQUALized<N> where N is between 1 and 4
- FN<N> where N is between 1 and 16 (function)
- HIST
- D<M> where M is between 0 and 15 (on MSO models with 16 digital channels)
- BUS<Y> where Y is between 1 and 4 (on MSO models)

<grid> Can be an integer from 1-16; this is the number of the grid you want to assign the waveform to.

<area> Can be an integer from 1-8.

If <area> is omitted, the waveform will be placed in waveform area 1.

**Example** This example assigns the histogram to grid 2 (in waveform area 1).

```
myScope.WriteString ":DISPlay:GRATicule:SETGrat HIST,2"
```

**See Also**

- [":DISPlay:GRATicule"](#) on page 531
- [":DISPlay:GRATicule:INTensity"](#) on page 536
- [":DISPlay:GRATicule:NUMBer"](#) on page 537
- [":DISPlay:GRATicule:AREA<N>:STATe"](#) on page 533

**History** Legacy command (existed before version 3.10).

Version 5.00: In addition to assigning a waveform to a grid, you can now optionally specify which waveform area the grid is in. Also, you can specify whether the MAIN or CGRade (color grade) view of the waveform will be placed.

## :DISPlay:ISIM:GCOunt

**Command** :DISPlay:ISIM:GCOunt <count>

The :DISPlay:ISIM:GCOunt command sets the number of visible graphs in the InfiniiSim plots window area.

<count> An integer in NR1 format.

Up to three plots can be displayed for each channel source (12 total for all sources).

**Query** :DISPlay:ISIM:GCOunt?

The :DISPlay:ISIM:GCOunt? query returns the number of visible graphs in the InfiniiSim plots window area.

**Returned Format** [:DISPlay:ISIM:GCOunt] <count><NL>

- See Also**
- [":DISPlay:ISIM:SElectgraph"](#) on page 540
  - [":DISPlay:ISIM:SOURce"](#) on page 541

**History** New in version 5.50.

## :DISPlay:ISIM:SElectgraph

**Command**    :DISPlay:ISIM:SElectgraph <graph>  
                 <graph> ::= {SPECTrum | IMPulse | STEP | ALL}

The :DISPlay:ISIM:SElectgraph command inserts the specified graph at the first display graph position.

### NOTE

Selecting ALL graphs results in all allowed graphs being displayed for the source (see :DISPlay:ISIM:SOURce). If the source is ALL, all graphs will be displayed for all sources. The graph count may change.

---

**See Also**    · [":DISPlay:ISIM:GCOunt"](#) on page 539  
                 · [":DISPlay:ISIM:SOURce"](#) on page 541

**History**    New in version 5.50.

## :DISPlay:ISIM:SOURce

**Command** :DISPlay:ISIM:SOURce <source>  
 <source> ::= {CHANnel<N> | ALL}

The :DISPlay:ISIM:SOURce command sets the source for the InfiniiSim plots graph(s).

**NOTE**

Selecting ALL sources causes the selected graph to be applied to all graph sources. If ALL is the selected graph type, all sources are applied to all graphs. The graph count may change.

<N> An integer, 1-4 in a single oscilloscope, 1-40 in a MultiScope system.

- See Also**
- [":DISPlay:ISIM:GCOunt"](#) on page 539
  - [":DISPlay:ISIM:SElectgraph"](#) on page 540

**History** New in version 5.50.

## :DISPlay:JITTer:GCOunt

**Command** :DISPlay:JITTer:GCOunt <count>

The :DISPlay:JITTer:GCOunt command sets the number of visible graphs in the Jitter/Noise graphs window area.

<count> An integer in NR1 format.

**Query** :DISPlay:JITTer:GCOunt?

The :DISPlay:JITTer:GCOunt? query returns the number of visible graphs in the Jitter/Noise graphs window area.

**Returned Format** [:DISPlay:JITTer:GCOunt] <count><NL>

**See Also** · [":DISPlay:JITTer:SElectgraph"](#) on page 543

**History** New in version 5.50.

## :DISPlay:JITTer:SElectgraph

**Command** :DISPlay:JITTer:SElectgraph <graph>

```
<graph> ::= {RPHistogram | TJHistogram | DDJHistogram | JBERbathtub
| DDJVsbIt | JSpectrum | TJComposite | DDJComposite | ISIFilter
| RJPJsep | JTAilbathtub | NBERbathtub | NSpectrum | RNPHistogram
| DDIHistogram | TIHistogram | TIComposite | ISIVsbIt | NSEparation
| NISifilter | RNTailhist | NTAilbathtub | ALL}
```

The :DISPlay:JITTer:SElectgraph command inserts the specified graph at the first display graph position.

**NOTE**

Selecting ALL graphs results in all allowed graphs being displayed. The graph count may change.

Graph Option	Description
RPHistogram	RjPj Histogram
TJHistogram	TJ Histogram
DDJHistogram	DDJ Histogram
JBERbathtub	Jitter BER Bathtub
DDJVsbIt	DDJ vs. Bit
JSpectrum	Jitter Spectrum
TJComposite	Composite TJ Histogram
DDJComposite	Composite DDJ Histogram
ISIFilter	Jitter ISI Filter
RJPJsep	RJ PJ Separation
JTAilbathtub	Jitter Tail Fit Bathtub
NBERbathtub	Noise BER Bathtub
NSpectrum	Noise Spectrum
RNPHistogram	RN PI Histogram
DDIHistogram	DDI Histogram
TIHistogram	TI Histogram
TIComposite	Composite TI Histogram
ISIVsbIt	ISI vs. Bit
NSEparation	RN PI Threshold
NISifilter	Noise ISI Filter

Graph Option	Description
RNTailhist	RN PI Tailfit Histogram
NTAILbathtub	Noise Tailfit Bathtub

**See Also** · [":DISPlay:JITTer:GCOut"](#) on page 542

**History** New in version 5.50.



## :DISPlay:JITTer:THReshold

**Command**    :DISPlay:JITTer:THReshold <level>  
                 <level> ::= {T01 | T12 | T23 | ALL}

When the ":MEASure:RJDJ:PAMThreshold ALL" command specifies that all PAM-4 thresholds are measured, the :DISPlay:JITTer:THReshold command specifies whether a certain threshold level or ALL threshold levels should be displayed in the jitter graphs.

When the ":MEASure:RJDJ:PAMThreshold" command specifies the 0/1, 1/2, or 2/3 PAM-4 thresholds are measured, that level is the one used when displaying jitter graphs.

**See Also**    • [":MEASure:RJDJ:PAMThreshold"](#) on page 1097

**History**    New in version 6.10.

**:DISPlay:LABel**

**Command** `:DISPlay:LABel {{ON | 1} | {OFF | 0}}`

The `:DISPlay:LABel` command turns on or off the display of analog channel labels. Label names can be up to 6 characters long. The label name is assigned by using the `CHANnel<n>:LABel` command:

**Example** This example turns on the display of all labels.

```
myScope.WriteString ":DISPlay:LABel ON"
```

**Query** `:DISPlay:LABel?`

The `:DISPlay:LABel?` query returns the current state of the labels.

**Returned Format** `[:DISPlay:LABel] {1 | 0}<NL>`

**Example** This example places the current label state into the string variable, `strSetting`, then prints the contents of the variable to the computer's screen.

```
Dim strSetting As String ' Dimension variable.
myScope.WriteString ":DISPlay:LABel?"
strSetting = myScope.ReadString
Debug.Print strSetting
```

**History** Legacy command (existed before version 3.10).

## :DISPlay:LAYout

**Command** :DISPlay:LAYout <layout>

The :DISPlay:LAYout command sets the window layout.

<layout> {{TAB | CUSTom} | SVERTical | SHORizontal}

- TAB (or CUSTom) – Tabbed window layout.
- SVERTical – Stack windows vertically.
- SHORizontal – Stack windows horizontally.

**Query** :DISPlay:LAYout?

The :DISPlay:LAYout? query returns the window layout setting.

**Returned Format** [DISPlay:LAYout] <layout><NL>

<layout> ::= {TAB | SVER | SHOR}

**See Also** • [":DISPlay:PROPortion"](#) on page 556

**History** New in version 5.00.

Version 6.30: The obsolete CUSTom option has been replaced with the new TAB option.

**:DISPlay:MAIN**

**Command** `:DISPlay:MAIN {{ON | 1} | {OFF | 0}} [, <source>]`

The `:DISPlay:MAIN` command turns on or off the main window view for the indicated source.

**<source>** {CHANnel<N> | DIFF<D> | COMMONmode<C> | FUNction<F> | WMEMory<R> | EQUalized<L> | MTRend | MSPectrum | XT<X>}

If `<source>` is omitted, the main window view is enabled/disabled for all sources that are currently on, except for digital channel sources.

**<N>** An integer, 1-4 in a single oscilloscope, 1-40 in a MultiScope system.

**<D>, <C>** `<D>` is an integer, 1-2. `<C>` is an integer, 3-4.

The DIFF and COMMONmode sources are just aliases that can be used in place of the channel names to apply to differential or common mode signals. These are just aliases - no state change occurs if you refer to a differential channel and you are not in differential mode. DIFF1 refers to the differential signal between channels 1 and 3 (and COMMONmode3 refers to the common mode channel between these same channels). DIFF2 refers to the differential signal between channels 2 and 4 (and COMMONmode4 refers to the common mode channel between these same channels).

**<F>** An integer, 1-16.

**<R>** An integer, 1-4.

**<L>** An integer, 1-4.

**<X>** An integer, 1-4, identifying the crosstalk waveform.

**Example** This example sets the main view on.

```
myScope.WriteString ":DISPlay:MAIN ON"
```

**Query** `:DISPlay:MAIN? [<source>]`

The `DISPlay:MAIN?` returns whether the main window view for the indicated source is on or off.

If `<source>` is omitted, the query returns ON (1) if any main window view is enabled.

**Returned Format** `[:DISPlay:MAIN] {1 | 0}<NL>`

**Example** This example returns the main window view state.

```
Dim strMain As String ' Dimension variable.
myScope.WriteString ":DISPlay:MAIN?"
strCgrade = myScope.ReadString
Debug.Print strMain
```

**See Also** • [":DISPlay:CGRade"](#) on page 522

**History** New in version 5.00.

## :DISPlay:NOISe:LEVel

**Command** :DISPlay:NOISe:LEVel <level>

The :DISPlay:NOISe:LEVel command specifies which of the noise graphs to display.

<level> {0 | 1 | 2 | 3}

For a Non Return to Zero (NRZ) signal, you can display the noise graphs for levels 0 or 1. For a PAM-4 signal, you can display the noise graphs for levels 2 or 3 as well.

- See Also**
- [":MEASure:NOISe"](#) on page 1001
  - [":MEASure:NOISe:ALL?"](#) on page 1003
  - [":MEASure:NOISe:BANDwidth"](#) on page 1005
  - [":MEASure:NOISe:LOCation"](#) on page 1006
  - [":MEASure:NOISe:METHod"](#) on page 1007
  - [":MEASure:NOISe:REPort"](#) on page 1008
  - [":MEASure:NOISe:RN"](#) on page 1009
  - [":MEASure:NOISe:SCOPE:RN"](#) on page 1010
  - [":MEASure:NOISe:STATe"](#) on page 1011
  - [":MEASure:NOISe:UNITs"](#) on page 1012

**History** New in version 6.10.

## :DISPlay:PAM:GRAPh

**Command** :DISPlay:PAM:GRAPh <string\_of\_choices>

The :DISPlay:PAM:GRAPh command selects the PAM-4 12-Edge Jitter graphs to display.

**<string\_of\_choices>** A comma-separated list of graphical user interface graph names.

> When a misspelled or unrecognized string is encountered, the command will ignore that selection and move on to the next in the list.

**Examples** Here are some examples of how to specify the PAM-4 12-Edge Jitter graphs to display.

```
myScope.WriteString ':DISPlay:PAM:GRAPh "Composite Histogram"'
myScope.WriteString ':DISPlay:PAM:GRAPh "L0 to L1,L1 to L0"'
myScope.WriteString ':DISPlay:PAM:GRAPh "AllItemsChecked"'
myScope.WriteString ':DISPlay:PAM:GRAPh ""'
```

Specifying "AllItemsChecked" for the string of choices will select all graphs.

Specifying an empty string ("") will select none of the graphs.

- See Also**
- [":MEASure:PAM:PRBS13q:STATe"](#) on page 1046
  - [":DISPlay:PAM:SOURce"](#) on page 552
  - [":DISPlay:PAM:TABLE"](#) on page 553

**History** New in version 6.72.

**:DISPlay:PAM:SOURce**

**Command** `:DISPlay:PAM:SOURce <source_string>`

The `:DISPlay:PAM:SOURce` command selects the PAM-4 12-Edge Jitter sources whose tables and graphs will be displayed.

**<source\_string>** A comma-separated list of graphical user interface source names.

When a misspelled or unrecognized string is encountered, the command will ignore that selection and move on to the next in the list.

**Examples** Here are some examples of how to specify the PAM-4 12-Edge Jitter sources.

```
myScope.WriteString ':DISPlay:PAM:SOURce "Memory 1"'
myScope.WriteString ':DISPlay:PAM:SOURce "Channel 1"'
myScope.WriteString ':DISPlay:PAM:SOURce "Memory 1, Memory 2"'
myScope.WriteString ':DISPlay:PAM:SOURce "AllItemsChecked"'
myScope.WriteString ':DISPlay:PAM:SOURce ""'
```

Specifying "AllItemsChecked" for the string of choices will select all available sources (that have PAM-4 12-Edge Jitter enabled).

Specifying an empty string ("") will select the lowest available source (one must remain selected).

- See Also**
- [":MEASure:PAM:PRBS13q:STATe"](#) on page 1046
  - [":DISPlay:PAM:GRAPh"](#) on page 551
  - [":DISPlay:PAM:TABLE"](#) on page 553

**History** New in version 6.72.



## :DISPlay:PAM:TABLE

**Command** :DISPlay:PAM:TABLE <string\_of\_choices>

The :DISPlay:PAM:TABLE command selects the PAM-4 12-Edge Jitter tables to display.

**<string\_of\_choices** A comma-separated list of graphical user interface table names.

>

When a misspelled or unrecognized string is encountered, the command will ignore that selection and move on to the next in the list.

**Examples** Here are some examples of how to specify the PAM-4 12-Edge Jitter tables to display.

```
myScope.WriteString ':DISPlay:PAM:TABLE "J3u Table"'
myScope.WriteString ':DISPlay:PAM:TABLE "J3u Table,J4u Table,
    Jrms Table,EOJ Table"'
myScope.WriteString ':DISPlay:PAM:TABLE "AllItemsChecked"'
myScope.WriteString ':DISPlay:PAM:TABLE ""'
```

Specifying "AllItemsChecked" for the string of choices will select all tables.

Specifying an empty string ("") will select none of the tables.

- See Also**
- [":MEASure:PAM:PRBS13q:STATE"](#) on page 1046
  - [":DISPlay:PAM:GRAPh"](#) on page 551
  - [":DISPlay:PAM:SOURce"](#) on page 552

**History** New in version 6.72.

## :DISPlay:PERSistence

**Command** :DISPlay:PERSistence {MINimum | INFinite | <time>} [,<source>]

<time> ::= seconds in in NR3 format from 100E-3 to 200E0

The :DISPlay:PERSistence command sets the display persistence. The parameter for this command can be:

- MINimum – indicates zero persistence.
- INFinite – indicates infinite persistence.
- <time> – for variable persistence, that is, you can specify how long acquisitions remain on the screen.

**<source>** {CHANnel<N> | DIFF<D> | COMMONmode<C> | FUNction<F> | WMEMory<R> | EQUalized<L> | MTRend | MSPectrum | XT<X> | PNOise}

The <source> option is allowed to support earlier syntax, and there are no errors when you use it; however, persistence is always applied to all waveforms whether the <source> option is included or not.

The Color Grade View, a variation of infinite persistence, can be applied to individual waveforms (using the :DISPlay:CGRade command).

**<N>** An integer, 1-4 in a single oscilloscope, 1-40 in a MultiScope system.

**<D>, <C>** <D> is an integer, 1-2. <C> is an integer, 3-4.

The DIFF and COMMONmode sources are just aliases that can be used in place of the channel names to apply to differential or common mode signals. These are just aliases - no state change occurs if you refer to a differential channel and you are not in differential mode. DIFF1 refers to the differential signal between channels 1 and 3 (and COMMONmode3 refers to the common mode channel between these same channels). DIFF2 refers to the differential signal between channels 2 and 4 (and COMMONmode4 refers to the common mode channel between these same channels).

**<F>** An integer, 1-16.

**<R>** An integer, 1-4.

**<L>** An integer, 1-4.

**<X>** An integer, 1-4, identifying the crosstalk waveform.

**Example** This example sets the persistence to infinite.

```
myScope.WriteString ":DISPlay:PERSistence INFinite"
```

**Query** :DISPlay:PERSistence? [<source>]

The :DISPlay:PERSistence? query returns the current persistence value.

When <source> is omitted, the query returns the persistence mode for channel 1.

**Returned Format** [:DISPlay:PERSistence] {MINimum | INFinite | <time>}<NL>

**Example** This example places the current persistence setting in the string variable, strSetting, then prints the contents of the variable to the computer's screen.

```
Dim strSetting As String ' Dimension variable.
myScope.WriteString ":DISPlay:PERSistence?"
strSetting = myScope.ReadString
Debug.Print strSetting
```

**See Also** · [":DISPlay:CGRade"](#) on page 522

**History** Legacy command (existed before version 3.10).

Version 5.00: Added the optional <source> parameter for specifying the waveform on which the persistence setting should be made.

**:DISPlay:PROPortion**

**Command** :DISPlay:PROPortion <pane>, <float>

The :DISPlay:PROPortion command specifies the size of the waveform and plot areas.

If the :DISPlay:LAYout is VERTical, this command sets an area's height.

If the :DISPlay:LAYout is HORizontal, this command sets an area's width.

If the :DISPlay:LAYout is CUSTom, this command is not supported.

<pane> {AREA<N> | SERIAL<M> | {JITTer | NOISe} | ISIM | PRECprobe | BUS | P4Jitter}

<N> An integer, 1-8.

<M> An integer, 1-4.

<float> A value from 0.0 to 100.0.

**Example** You should set the proportion of all areas that are displayed such that the sum of the proportions is 100. For example, if you have three areas on: Waveform Area1, Waveform Area 2, and Jitter graphs, you may want to size them as follows:

```
:DISPlay:PROPortion AREA1, 20.0
:DISPlay:PROPortion AREA2, 20.0
:DISPlay:PROPortion JITTer, 60.0
```

If you set the size of one area only, it may not have the intended effect.

**See Also**

- **":DISPlay:PROPortion:RESults"** on page 557
- **":DISPlay:LAYout"** on page 547

**History** New in version 5.00.

Version 6.50: The query portion of this command has been deprecated. The P4Jitter (PAM4 Jitter) pane option has been added.

## :DISPlay:PROPortion:RESults

**Command** :DISPlay:PROPortion:RESults <float>

The :DISPlay:PROPortion:RESults command specifies the size of the Results pane in the oscilloscope display.

<float> A value from 0.0 to 100.0.

**See Also** • [":DISPlay:PROPortion"](#) on page 556

**History** New in version 5.70.

Version 6.50: The query portion of this command has been deprecated.

## :DISPlay:PRECprobe:GCOunt

**Command** :DISPlay:PRECprobe:GCOunt <count>

The :DISPlay:PRECprobe:GCOunt command sets the number of visible graphs in the PrecisionProbe correction and analysis charts window area.

<count> An integer in NR1 format.

Up to six charts can be displayed for each channel source (24 total for all sources).

**Query** :DISPlay:PRECprobe:GCOunt?

The :DISPlay:PRECprobe:GCOunt? query returns the number of visible graphs in the PrecisionProbe correction and analysis charts window area.

**Returned Format** [:DISPlay:PRECprobe:GCOunt] <count><NL>

**See Also**

- [":DISPlay:PRECprobe:SElectgraph"](#) on page 559
- [":DISPlay:PRECprobe:SOURce"](#) on page 560

**History** New in version 5.50.

## :DISPlay:PRECprobe:SElectgraph

**Command** :DISPlay:PRECprobe:SElectgraph <graph>  
<graph> ::= {FRPHase | IMAG | IPHase | FFRMag | FFRPhase | MFRMag | ALL}

The :DISPlay:PRECprobe:SElectgraph command inserts the specified graph at the first display graph position.

### NOTE

Selecting ALL graphs results in all allowed graphs being displayed for the source (see :DISPlay:PRECprobe:SOURce). If the source is ALL, all graphs will be displayed for all sources. The graph count may change.

- See Also**
- [":DISPlay:PRECprobe:GCOunt"](#) on page 558
  - [":DISPlay:PRECprobe:SOURce"](#) on page 560

**History** New in version 5.50.

## :DISPlay:PRECprobe:SOURce

**Command** :DISPlay:PRECprobe:SOURce <source>

<source> ::= {CHANnel<N> | ALL}

The :DISPlay:PRECprobe:SOURce command sets the source for the PrecisionProbe correction and analysis chart(s).

### NOTE

Selecting ALL sources causes the selected graph to be applied to all graph sources. If ALL is the selected graph type, all sources are applied to all graphs. The graph count may change.

<N> An integer, 1-4.

- See Also**
- [":DISPlay:PRECprobe:GCOunt"](#) on page 558
  - [":DISPlay:PRECprobe:SElectgraph"](#) on page 559

**History** New in version 5.50.



## :DISPlay:RESults:LAYout

**Command** :DISPlay:RESults:LAYout <layout>

The :DISPlay:RESults:LAYout command sets the Results pane's window layout.

<layout> {{TAB | CUSTom} | SHORizontal}

- TAB (or CUSTom) – Tabbed window layout.
- SHORizontal – Stack windows horizontally.

**Query** :DISPlay:RESults:LAYout?

The :DISPlay:RESults:LAYout? query returns the Results pane window layout setting.

**Returned Format** [:DISPlay:RESults:LAYout] <layout><NL>

<layout> ::= {TAB | SHOR}

**See Also** • [":DISPlay:LAYout"](#) on page 547

**History** New in version 6.50.

**:DISPlay:SCOLor**

**Command** :DISPlay:SCOLor <color\_name>, <hue>, <saturation>, <luminosity>

The :DISPlay:SCOLor command sets the color of the specified display element. The display elements are described in [Table 12](#).

<color\_name> {BUS | CGLevel1 - CGLevel7 | CHANnel1 - CHANnel4 | DCHannel | DMEMemory  
| FUNction1 - FUNction16 | GRID | HISTogram | MARKers | MTPolygons  
| MMPolygons | TINputs | WMEMories | WMEMory1 - WMEMory4}

**Table 12** Color Names

Color Name	Definition
BUS	Buses.
CGLevel1 - CGLevel7	Color Grade Level 1 through Level 7 waveform display elements.
CHANnel1 - CHANnel4	Channel 1 through Channel 4 waveform display elements.
DCHannel	Digital channels.
DMEMemory	Digital waveform memory.
FUNction1 - FUNction16	Function 1 through Function 16 waveform display elements.
GRID	Display element for the grid inside the waveform viewing area.
HISTogram	Histogram bars.
MARKers	Display element for the markers.
MTPolygons	Mask test regions.
MMPolygons	Mask test margin regions.
TINputs	Display element for line and aux trigger colors.
WMEMories	Display element for waveform memories (same as WMEMory1).
WMEMory1 - WMEMory4	Waveform Memory 1 through Waveform Memory 4 display elements.

<hue> An integer from 0 to 100. The hue control sets the color of the chosen display element. As hue is increased from 0%, the color changes from red, to yellow, to green, to blue, to purple, then back to red again at 100% hue. For color examples, see the sample color settings table in the Infiniium Oscilloscope online help file. Pure red is 100%, pure blue is 67%, and pure green is 33%.

<saturation> An integer from 0 to 100. The saturation control sets the color purity of the chosen display element. The saturation of a color is the purity of a color, or the absence of white. A 100% saturated color has no white component. A 0% saturated color is pure white.

**<luminosity>** An integer from 0 to 100. The luminosity control sets the color brightness of the chosen display element. A 100% luminosity is the maximum color brightness. A 0% luminosity is pure black.

**Example** This example sets the hue to 50, the saturation to 70, and the luminosity to 90 for the markers.

```
myScope.WriteString ":DISPlay:SCOLor MARKers,50,70,90"
```

**Query** :DISPlay:SCOLor? <color\_name>

The :DISPlay:SCOLor? query returns the hue, saturation, and luminosity for the specified color.

**Returned Format** [:DISPlay:SCOLor] <color\_name>, <hue>, <saturation>, <luminosity><NL>

**Example** This example places the current settings for the graticule color in the string variable, strSetting, then prints the contents of the variable to the computer's screen.

```
Dim strSetting As String ' Dimension variable.
myScope.WriteString ":DISPlay:SCOLor? GRID"
strSetting = myScope.ReadString
Debug.Print strSetting
```

**History** Legacy command (existed before version 3.10).

Version 5.60: Removed the ability to set colors for MEASurements, STExT, TSCale, and WBACKgrnd.

Version 5.70: Added the ability to set colors for MMPolygons.

**:DISPlay:STATus:COLumn**

**Command**    `:DISPlay:STATus:COLumn <column>`

The `:DISPlay:STATus:COLumn` command is used to position the real time eye and InfiniiScan Zone Trigger status labels.

This and the `:DISPlay:STATus:ROW` commands specify the upper left corner of the box relative to the screen.

**<column>**    A value of 0 to 1 may be given for the column where 0 is the far left and 1 the far right.

**Example**    For example, a column of 0.5 will place the upper left of the status label at the center screen.

```
myScope.WriteString ":DISPlay:STATus:COLumn 0.5"
```

**Query**        `:DISPlay:STATus:COLumn?`

The `:DISPlay:STATus:COLumn?` query returns the current value of the status label column location.

**Returned Format**    `[ :DISPlay:STATus:COLumn ] <column><NL>`

**Example**    This example places the current value for the status label column location in the string variable, `strSetting`, then prints the contents of the variable to the computer's screen.

```
Dim strSetting As String    ' Dimension variable.
myScope.WriteString ":DISPlay:STATus:COLumn?"
strSetting = myScope.ReadString
Debug.Print strSetting
```

**History**    New in version 3.10.

## :DISPlay:STATus:ROW

**Command** :DISPlay:STATus:ROW <row>

The :DISPlay:STATus:ROW command is used to position the real time eye and InfiniiScan Zone Trigger status labels.

This and the :DISPlay:STATus:COL commands specify the upper left corner of the box relative to the screen.

<row> A value of 0 to 1 may be given for the row where 0 is the far top and 1 the far bottom.

**Example** For example, a row and column of 0.5 will place the upper left of the status label at the center screen.

```
myScope.WriteString ":DISPlay:STATus:ROW 0.5"
```

**Query** :DISPlay:STATus:ROW?

The :DISPlay:STATus:ROW? query returns the current value of the status label row location.

**Returned Format** [:DISPlay:STATus:ROW] <row><NL>

**Example** This example places the current value for the status label row location in the string variable, strSetting, then prints the contents of the variable to the computer's screen.

```
Dim strSetting As String ' Dimension variable.
myScope.WriteString ":DISPlay:STATus:ROW?"
strSetting = myScope.ReadString
Debug.Print strSetting
```

**History** New in version 3.10.

## :DISPlay:THEMe

**Command** :DISPlay:THEMe {"Midnight" | "Platinum"}

The :DISPlay:THEMe command lets you select the graphical user interface's "Midnight" or "Platinum" theme.

**Query** :DISPlay:THEMe?

The :DISPlay:THEMe? query returns the selected user interface theme.

**Returned Format** <string><NL>

<string> ::= {"Midnight" | "Platinum"}

**History** New in version 6.60.

## :DISPlay:WINDow:MAXimize

**Command** :DISPlay:WINDow:MAXimize <window>

```
<window> ::= {AREA<N> | SERIAL<M> | {JITTER | NOISE} | ISIM  
            | PRECprobe | BUS | P4Jitter}
```

The :DISPlay:WINDow:MAXimize command will maximize the size of the specified window.

<N> An integer, 1-8.

<M> An integer, 1-4.

**History** New in version 5.50.

Version 6.50: The P4Jitter (PAM4 Jitter) window option has been added.





## 20 Function Commands

:FUNction<F>? / 573  
:FUNction<F>:ABSolute / 574  
:FUNction<F>:ADD / 575  
:FUNction<F>:ADEMod / 576  
:FUNction<F>:AVERage / 577  
:FUNction<F>:COMMonmode / 578  
:FUNction<F>:DELAy – Delay / 579  
:FUNction<F>:DIFF – Differentiate / 580  
:FUNction<F>:DISPlay / 581  
:FUNction<F>:DIVide / 582  
:FUNction<F>:FFT:DETEctor:POINts / 583  
:FUNction<F>:FFT:DETEctor:TYPE / 584  
:FUNction<F>:FFT:FREQuency / 585  
:FUNction<F>:FFT:HSCale / 586  
:FUNction<F>:FFT:IMPedance / 587  
:FUNction:FFT:PEAK:SORT / 589  
:FUNction<F>:FFT:PEAK:COUNt / 590  
:FUNction<F>:FFT:PEAK:FREQuency / 591  
:FUNction<F>:FFT:PEAK:LEVel / 592  
:FUNction<F>:FFT:PEAK:MAGNitude / 593  
:FUNction<F>:FFT:PEAK:STATe / 594  
:FUNction<F>:FFT:REFerence / 595  
:FUNction<F>:FFT:RESolution / 596  
:FUNction<F>:FFT:SPAN / 598  
:FUNction<F>:FFT:STARt / 599  
:FUNction<F>:FFT:STOP / 600  
:FUNction<F>:FFT:TDELAy / 601  
:FUNction<F>:FFT:VUNits / 602  
:FUNction<F>:FFT:WINDow / 603  
:FUNction<F>:FFTMagnitude / 605  
:FUNction<F>:FFTPhase / 606  
:FUNction<F>:GATING – Gating / 607

```

:FUNCTION<F>:GATING:GLOBal / 608
:FUNCTION<F>:GATING:START – Gating window start time / 609
:FUNCTION<F>:GATING:STOP – Gating window stop time / 610
:FUNCTION<F>:HIGHpass / 611
:FUNCTION<F>:HORizontal / 612
:FUNCTION<F>:HORizontal:POSition / 613
:FUNCTION<F>:HORizontal:RANGe / 615
:FUNCTION<F>:INTegrate / 617
:FUNCTION<F>:INVert / 618
:FUNCTION<F>:LABel / 619
:FUNCTION<F>:LOWPass / 620
:FUNCTION<F>:MAGNify / 621
:FUNCTION<F>:MATLab / 622
:FUNCTION<F>:MATLab:CONTRol<N> / 623
:FUNCTION<F>:MATLab:OPERator / 625
:FUNCTION<F>:MAXimum / 626
:FUNCTION<F>:MHISTogram / 627
:FUNCTION<F>:MINimum / 629
:FUNCTION<F>:MLOG / 630
:FUNCTION<F>:MTRend / 631
:FUNCTION<F>:MULTiply / 632
:FUNCTION<F>:OFFSet / 633
:FUNCTION<F>:PAverage / 634
:FUNCTION<F>:RANGe / 635
:FUNCTION<F>:SMOoth / 636
:FUNCTION<F>:SQRT / 637
:FUNCTION<F>:SQUare / 638
:FUNCTION<F>:SUBTract / 639
:FUNCTION<F>:VERSus / 640
:FUNCTION<F>:VERTical / 641
:FUNCTION<F>:VERTical:OFFSet / 642
:FUNCTION<F>:VERTical:RANGe / 643
:FUNCTION<F>:VERTical:SIZE / 644

```

The FUNCTION subsystem defines functions 1–16. The operands of these functions can be:

- Any of the installed channels in the oscilloscope (see [page 571](#))

- Differential channels or common mode channels (see [page 571](#))
- Waveform memories (see [page 571](#))
- Crosstalk waveforms (see [page 572](#))
- Functions (see [page 572](#))
- A constant (see [page 572](#))
- Jitter measurement trend or jitter spectrum (see [page 572](#))
- Phase noise frequency domain waveform (see [page 572](#))

You can control the vertical scaling and offset functions remotely using the RANGE and OFFSet commands in this subsystem. You can obtain the horizontal scaling and position values of the functions using the :HORizontal:RANge? and :HORizontal:POSition? queries in this subsystem.

If a channel is not on but is used as an operand, that channel will acquire waveform data.

If the operand waveforms have different memory depths, the function uses the shorter of the two.

If the two operands have the same time scales, the resulting function has the same time scale. If the operands have different time scales, the resulting function has no valid time scale. This is because operations are performed based on the displayed waveform data position, and the time relationship of the data records cannot be considered. When the time scale is not valid, delta time pulse parameter measurements have no meaning, and the unknown result indicator is displayed on the screen.

Constant operands take on the same time scale as the associated waveform operand.

**Channel Operands** CHANnel<N>, where N is an integer, 1-4 in a single oscilloscope, 1-40 in a MultiScope system.

**Differential and Common Mode Channel Operands** DIFF<D>, where D is an integer, 1-2.

COMMONmode<C>, where C is an integer, 3-4.

The COMMONmode and DIFF sources are just aliases that can be used in place of the channel names to apply to differential or common mode signals. These are just aliases - no state change occurs if you refer to a differential channel and you are not in differential mode. DIFF1 refers to the differential signal between channels 1 and 3 (and COMMONmode3 refers to the common mode channel between these same channels). DIFF2 refers to the differential signal between channels 2 and 4 (and COMMONmode4 refers to the common mode channel between these same channels).

**Waveform Memory Operands** WMEMory<R>, where R is an integer, 1-4.

<b>Crosstalk Waveform Operands</b>	XT<X>, where X is an integer, 1-4, identifying the crosstalk waveform.
<b>Function Operands</b>	<p>FUNcTion&lt;F&gt;, where F is an integer, 1-16.</p> <p>Another function can be a function's source as long as the other function doesn't use the function being defined. In other words, circular expressions are not allowed.</p>
<b>Equalization Lane Operands</b>	EQUalized<L>, where L is an integer, 1-4.
<b>Constant Operands</b>	Constant operands can be a real number from -1E6 to 1E12.
<b>Jitter Measurement Trend and Jitter Spectrum Operands</b>	The jitter measurement trend, MTRend, and jitter spectrum, MSPpectrum, operands are available when the Jitter Analysis Software license is installed and the features are enabled.
<b>Phase Noise Operands</b>	The PNOise source is available when the Jitter and Vertical Noise Analysis Software license is installed and the Phase Noise analysis feature is enabled.

## :FUNction&lt;F&gt;?

**Query** :FUNction<F>?

The :FUNction<F>? query returns the currently defined source(s) for the function.

**Returned Format** [:FUNction<F>:<operator>] {<operand>[, <operand>]}<NL>

<F> An integer, 1-16, representing the selected function.

<operator> Active math operation for the selected function. For example, ADD, AVERage, COMMONmode, DIFF, DIVide, FFTMagnitude, FFTPhase, HIGHpass, INTegrate, INVert, LOWPass, MAGNify, MAXimum, MINimum, MULTiply, SMOoth, SUBTract, or VERSus.

<operand> Any allowable source for the selected FUNction, including channels, differential channels, common mode channels. waveform memories 1-4, functions 1-4, a constant, jitter measurement trend, and jitter spectrum. If the function is applied to a constant, the source returns the constant.

See the discussion of possible operands in the introduction to [Chapter 20](#), "Function Commands," starting on page 569.

**Example** This example returns the currently defined source for function 1.

```
myScope.WriteString ":FUNction1?"
```

If the headers are off (see :SYSTem:HEADer), the query returns only the operands, not the operator.

```
myScope.WriteString ":SYST:HEAD ON"
myScope.WriteString ":FUNC1:ADD CHAN1, CHAN2"
myScope.WriteString ":FUNC1?"
strSettings = myScope.ReadString ' Returns ":FUNC1:ADD CHAN1, CHAN2" .
myScope.WriteString ":SYST:HEAD OFF"
myScope.WriteString ":FUNC1?"
strSettings = myScope.ReadString ' Returns "CHAN1, CHAN2" .
```

**History** Legacy command (existed before version 3.10).

Version 4.30: Up to 16 functions supported.

**:FUNction<F>:ABSolute**

**Command** `:FUNction<F>:ABSolute <operand>`

The `:FUNction<F>:ABSolute` command takes the absolute value an operand.

**<operand>** {CHANnel<N> | DIFF<D> | COMMONmode<C> | FUNction<F> | EQUalized<L> | WMEMory<R> | MTRend | MSPectrum | XT<X> | PNOise}

See the discussion of possible operands in the introduction to [Chapter 20](#), “Function Commands,” starting on page 569.

**Example** This example turns on the absolute value command using channel 3.

```
myScope.WriteString ":FUNction1:ABSolute CHANnel3"
```

**History** Legacy command (existed before version 3.10).

Version 4.30: Up to 16 functions supported.

## :FUNCTION&lt;F&gt;:ADD

**Command** :FUNCTION<F>:ADD <operand>, <operand>

The :FUNCTION<F>:ADD command defines a function that takes the algebraic sum of the two operands.

<F> An integer, 1-16, representing the selected function.

<operand> {CHANnel<n> | DIFF<D> | COMMONmode<C> | FUNCTION<F> | EQUALized<L> | WMEMORY<n> | <float\_value> | MTRend | MSPectrum | XT<X> | PNOise}

See the discussion of possible operands in the introduction to [Chapter 20](#), "Function Commands," starting on page 569.

**Example** This example sets up function 1 to add channel 1 to channel 2.

```
myScope.WriteString ":FUNCTION1:ADD CHANNEL1,CHANNEL2"
```

**History** Legacy command (existed before version 3.10).

Version 4.30: Up to 16 functions supported.

## :FUNCTION&lt;F&gt;:ADEMod

**Command** :FUNCTION<F>:ADEMod <source>

The :FUNCTION<F>:ADEMod command sets the math function to show the amplitude envelope for an amplitude modulated (AM) input signal.

This function uses a Hilbert transform to get the real (in-phase, I) and imaginary (quadrature, Q) parts of the input signal and then performs a square root of the sum of the real and imaginary parts to get the demodulated amplitude envelope waveform.

<F> An integer, 1-16, representing the selected function.

<source> {CHANnel<n> | DIFF<D> | COMMONmode<C> | FUNCTION<F> | EQUALized<L> | WMEMORY<n> | MTRend | MSPectrum | XT<X> | PNOise}

See the discussion of possible operands in the introduction to [Chapter 20](#), "Function Commands," starting on page 569.

**Example** This example sets up function 1 to perform the amplitude demodulation function on channel 1.

```
myScope.WriteString ":FUNCTION1:ADEMod CHANnel1"
```

**History** New in version 4.50.



## :FUNCTION&lt;F&gt;:AVERAge

**Command** :FUNCTION<F>:AVERAge <operand> [, <averages>]

The :FUNCTION<F>:AVERAge command defines a function that averages the operand based on the number of specified averages.

<F> An integer, 1-16, representing the selected function.

<operand> {CHANnel<n> | DIFF<D> | COMMONmode<C> | FUNCTION<F> | EQUalized<L> | WMEMory<n> | <float\_value> | MTRend | MSPectrum | XT<X> | PNOise}

See the discussion of possible operands in the introduction to [Chapter 20](#), "Function Commands," starting on page 569.

<averages> An integer, 2 to 65534 specifying the number of waveforms to be averaged

**Example** This example sets up function 1 to average channel 1 using 16 averages.

```
myScope.WriteString ":FUNCTION1:AVERAge CHANnel1,16"
```

**History** Legacy command (existed before version 3.10).

Version 4.30: Up to 16 functions supported.

## :FUNCTION&lt;F&gt;:COMMONmode

**Command** :FUNCTION<F>:COMMONmode <operand>,<operand>

The :FUNCTION<F>:COMMONmode command defines a function that adds the voltage values of the two operands and divides by 2, point by point.

<F> An integer, 1-16, representing the selected function.

<operand> {CHANnel<n> | DIFF<D> | COMMONmode<C> | FUNCTION<F> | EQUALized<L> | WMEMORY<n> | <float\_value> | MTRend | MSPectrum | XT<X> | PNOise}

See the discussion of possible operands in the introduction to [Chapter 20](#), "Function Commands," starting on page 569.

**Example** This example sets up function 1 to view the common mode voltage value of channel 1 and channel 2.

```
myScope.WriteString ":FUNCTION1:COMMONmode CHANnel1,CHANnel2"
```

**History** Legacy command (existed before version 3.10).

Version 4.30: Up to 16 functions supported.

## :FUNCTION&lt;F&gt;:DElay – Delay

**Command** :FUNCTION<F>:DElay <operand>, <delay\_time>

The :FUNCTION<F>:DElay command adds the provided time to the X origin of the source waveform, effectively shifting the function waveform in time.

<F> An integer, 1-16, representing the selected function.

<operand> {CHANnel<n> | DIFF<D> | COMMONmode<C> | FUNCTION<F> | EQUalized<L> | WMEMory<n> | MTRend | MSPectrum | XT<X> | PNOise}

See the discussion of possible operands in the introduction to [Chapter 20](#), “Function Commands,” starting on page 569.

<delay\_time> Time, in seconds, set for the delay.

**Example** This example sets function 2 to be the waveform from channel1, delayed by 100 ps.

```
myScope.WriteString ":FUNCTION2:DElay CHANnel1,100E-12"
```

**History** New in version 4.30.

Version 4.30: Up to 16 functions supported.

## :FUNCTION&lt;F&gt;:DIFF – Differentiate

**Command** :FUNCTION<F>:DIFF <operand>[,<low\_pass\_phase\_align>]

The :FUNCTION<F>:DIFF command defines a function that computes the discrete derivative of the operand.

<F> An integer, 1-16, representing the selected function.

<operand> {CHANnel<n> | DIFF<D> | COMMONmode<C> | FUNCTION<F> | EQUALized<L> | WMEMORY<n> | <float\_value> | MTRend | MSPectrum | XT<X> | PNOise}

See the discussion of possible operands in the introduction to [Chapter 20](#), “Function Commands,” starting on page 569.

<low\_pass\_phase\_align> {{ON | 1} | {OFF | 0}}

This parameter turns on or off the low pass and phase align filter.

**Example** This example sets up function 2 to take the discrete derivative of the waveform on channel 2.

```
myScope.WriteString ":FUNCTION2:DIFF CHANNEL2"
```

**History** Legacy command (existed before version 3.10).

Version 4.30: Up to 16 functions supported.

## :FUNCTION&lt;F&gt;:DISPLAY

**Command** :FUNCTION<F>:DISPLAY {{ON|1} | {OFF|0}}

The :FUNCTION<F>:DISPLAY command either displays the selected function or removes it from the display.

<F> An integer, 1-16, representing the selected function.

**Example** This example turns function 1 on.

```
myScope.WriteString ":FUNCTION1:DISPLAY ON"
```

**Query** :FUNCTION<F>:DISPLAY?

The :FUNCTION<F>:DISPLAY? query returns the displayed status of the specified function.

**Returned Format** [:FUNCTION<F>:DISPLAY] {1|0}<NL>

**Example** This example places the current state of function 1 in the variable, strSetting, then prints the contents of the variable to the computer's screen.

```
myScope.WriteString ":SYSTEM:HEADER OFF"
myScope.WriteString ":FUNCTION1:DISPLAY?"
strSetting = myScope.ReadString
Debug.Print strSetting
```

**History** Legacy command (existed before version 3.10).

Version 4.30: Up to 16 functions supported.

## :FUNCTION&lt;F&gt;:DIVide

**Command** :FUNCTION<F>:DIVide <operand>, <operand>

The :FUNCTION<F>:DIVide command defines a function that divides the first operand by the second operand.

<F> An integer, 1-16, representing the selected function.

<operand> {CHANnel<n> | DIFF<D> | COMMONmode<C> | FUNCTION<F> | EQUALized<L> | WMEMORY<n> | <float\_value> | MTRend | MSPectrum | XT<X> | PNOise}

See the discussion of possible operands in the introduction to [Chapter 20](#), "Function Commands," starting on page 569.

**Example** This example sets up function 2 to divide the waveform on channel 1 by the waveform in waveform memory 4.

```
myScope.WriteString ":FUNCTION2:DIVide CHANnel1,WMEMory4"
```

**History** Legacy command (existed before version 3.10).

Version 4.30: Up to 16 functions supported.

## :FUNCTION&lt;F&gt;:FFT:DETECTOR:POINTS

**Command** :FUNCTION<F>:FFT:DETECTOR:POINTS <number\_of\_buckets>  
 <number\_of\_buckets> ::= an integer.

When a detector is used for the FFT magnitude function (see :FUNCTION<F>:FFT:DETECTOR:TYPE), the :FUNCTION<F>:FFT:DETECTOR:POINTS command specifies the maximum number of points (buckets) that detectors should decimate to.

**Query** :FUNCTION<F>:FFT:DETECTOR:POINTS?

The :FUNCTION<F>:FFT:DETECTOR:POINTS? query returns the specified number of detector points.

**Returned Format** <number\_of\_buckets><NL>

- See Also**
- [":FUNCTION<F>:FFT:DETECTOR:TYPE"](#) on page 584
  - [":FUNCTION<F>:FTTMagnitude"](#) on page 605
  - [":FUNCTION<F>:FFT:VUNits"](#) on page 602

**History** New in version 5.70.

## :FUNCTION&lt;F&gt;:FFT:DETECTOR:TYPE

**Command** :FUNCTION<F>:FFT:DETECTOR:TYPE <type>

<type> ::= {OFF | SAMPLE | PPOSITIVE | PNEGATIVE | NORMAL | AVERAGE}

The :FUNCTION<F>:FFT:DETECTOR:TYPE command specifies whether a detector is used for the FFT magnitude function.

Detectors decimate the number of points on screen to at most the number of detector points (buckets, see :FUNCTION<F>:FFT:DETECTOR:POINTS). Detectors give you a way of manipulating the acquired data to emphasize different features of the data. The detector types are:

- OFF – No detector is used.
- SAMPLE – Takes the point nearest to the center of every bucket.
- PPOSITIVE – Takes the most positive point in every bucket.
- PNEGATIVE – Takes the most negative point in every bucket.
- NORMAL – Implements a rosenfell algorithm. For details, see the [🌐 Spectrum Analysis Basics](#) application note.
- AVERAGE – Takes the average of all points in every bucket.

**Query** :FUNCTION<F>:FFT:DETECTOR:TYPE?

The :FUNCTION<F>:FFT:DETECTOR:TYPE? query returns the selected detector.

**Returned Format** <type><NL>

<type> ::= {OFF | SAMP | PPOS | PNEG | NORM | AVER}

- See Also**
- [":FUNCTION<F>:FFT:DETECTOR:POINTS"](#) on page 583
  - [":FUNCTION<F>:FFTMagnitude"](#) on page 605
  - [":FUNCTION<F>:FFT:VUNITS"](#) on page 602

**History** New in version 5.70.

Version 6.40: The RMS detector type is no longer available.



## :FUNCTION&lt;F&gt;:FFT:FREQUENCY

**Command** :FUNCTION<F>:FFT:FREQUENCY <center\_frequency\_value>

The :FUNCTION<F>:FFT:FREQUENCY command sets the center frequency for the FFT when :FUNCTION<F>:FTTMagnitude is defined for the selected function.

<F> An integer, 1-16, representing the selected function.

<center\_frequency\_value> A real number for the value in Hertz, from -1E12 to 1E12.

**Query** :FUNCTION<F>:FFT:FREQUENCY?

The :FUNCTION<F>:FFT:FREQUENCY? query returns the center frequency value.

**Returned Format** [FUNCTION<F>:FFT:FREQUENCY] <center\_frequency\_value><NL>

- See Also**
- **":FUNCTION<F>:FFT:START"** on page 599
  - **":FUNCTION<F>:FFT:STOP"** on page 600
  - **":FUNCTION<F>:FFT:SPAN"** on page 598
  - **":FUNCTION<F>:FFT:RESolution"** on page 596

**History** Legacy command (existed before version 3.10).

Version 4.30: Up to 16 functions supported.

## :FUNction<F>:FFT:HSCale

**Command** :FUNction<F>:FFT:HSCale {LINear | LOG}

For a FFT math function waveform, the :FUNction<F>:FFT:HSCale command specifies whether the horizontal scale is linear or logarithmic.

**Query** :FUNction<F>:FFT:HSCale?

The :FUNction<F>:FFT:HSCale? query returns the horizontal scale setting.

**Returned Format** <type><NL>

<type> ::= {LIN | LOG}

**See Also** • [":WMEMory<R>:FFT:HSCale"](#) on page 1653

**History** New in version 6.30.

## :FUNCTION&lt;F&gt;:FFT:IMPedance

**Command** :FUNCTION<F>:FFT:IMPedance {AUTO | <impedance>}

When the FFT vertical units are displayed (and measured) as power (that is, dBm or Watt – see :FUNCTION<F>:FFT:VUNits), the :FUNCTION<F>:FFT:IMPedance command lets you specify the reference impedance of the waveform source so that power is calculated correctly. You can select automatically determined or manually entered values.

**AUTO** When AUTO is selected, analog input channel reference impedances can be automatically determined by the type of probe detected (differential, common mode, single-ended) or by whether two channels are set up as Differential Channels or Common Mode Channels using the :CHANNEL<N>:DIFFerential command.

For:	The automatically determined Reference Impedance is:
Single-ended input channels and almost all high-impedance probes	50 $\Omega$
Differential input channels <sup>1</sup> and differential probes	100 $\Omega$
Common Mode input channels <sup>1</sup> and common mode probes <sup>2</sup>	25 $\Omega$
<b>NOTES:</b> <sup>1</sup> The Differential Channels or Common Mode Channels selections (see :CHANNEL<N>:DIFFerential) take precedence over the detected probe type. <sup>2</sup> Common mode is not available on high-impedance probes.	

All other sources (math functions, waveform memories, etc.) are assumed to be 50  $\Omega$ . If this is not correct, for example, when a waveform memory or math function source comes from a differential or common mode signal, you must manually enter the appropriate reference impedance.

<impedance> Reference impedance from 20  $\Omega$  to 200  $\Omega$ . in NR3 format.

**Query** :FUNCTION<F>:FFT:IMPedance?

The :FUNCTION<F>:FFT:IMPedance? query returns AUTO or the reference impedance setting.

**Returned Format** <setting><NL>

<setting> :: = {AUTO | <impedance>}

- See Also**
- [":FUNCTION<F>:FFTMagnitude"](#) on page 605
  - [":FUNCTION<F>:FFT:VUNits"](#) on page 602

- **":CHANnel<N>:DIFFerential"** on page 346

**History** New in version 6.60.

## :FUNCTION:FFT:PEAK:SORT

**Command** :FUNCTION:FFT:PEAK:SORT {DMAGnitude | DFRequency | IMAGnitude  
| IFRequency}

The :FUNCTION:FFT:PEAK:SORT command specifies whether peaks are annotated by Decreasing Magnitude (DMAGnitude), Increasing Frequency (IFRequency), Decreasing Frequency (DFRequency), or Increasing Magnitude (IMAGnitude) order. Peak annotations are numbered according to the chosen sort.

<F> An integer, 1-16, representing the selected function.

**Query** :FUNCTION:FFT:PEAK:SORT?

The :FUNCTION:FFT:PEAK:SORT? query returns the selected peak annotation sort order.

**Returned Format** <order><NL>

<order> ::= {DMAG | DFR | IMAG | IFR}

- See Also**
- [":FUNCTION<F>:FFT:PEAK:COUNt"](#) on page 590
  - [":FUNCTION<F>:FFT:PEAK:FREQuency"](#) on page 591
  - [":FUNCTION<F>:FFT:PEAK:LEVel"](#) on page 592
  - [":FUNCTION<F>:FFT:PEAK:MAGNitude"](#) on page 593
  - [":FUNCTION<F>:FFT:PEAK:STATe"](#) on page 594

**History** New in version 6.70.

## :FUNCTION&lt;F&gt;:FFT:PEAK:COUNT

**Command** :FUNCTION<F>:FFT:PEAK:COUNT <max\_peaks\_to\_find>

The :FUNCTION<F>:FFT:PEAK:COUNT command specifies the maximum number of peaks in the FFT to annotate.

<F> An integer, 1-16, representing the selected function.

<max\_peaks\_to\_find> Integer value in NR1 format.

**Query** :FUNCTION<F>:FFT:PEAK:COUNT?

The :FUNCTION<F>:FFT:PEAK:COUNT? query returns the specified maximum number of peaks in the FFT to annotate.

**Returned Format** <max\_peaks\_to\_find><NL>

<max\_peaks\_to\_find> ::= integer value in NR1 format

- See Also**
- [":FUNCTION:FFT:PEAK:SORT"](#) on page 589
  - [":FUNCTION<F>:FFT:PEAK:FREQUENCY"](#) on page 591
  - [":FUNCTION<F>:FFT:PEAK:LEVEL"](#) on page 592
  - [":FUNCTION<F>:FFT:PEAK:MAGNITUDE"](#) on page 593
  - [":FUNCTION<F>:FFT:PEAK:STATE"](#) on page 594

**History** New in version 6.70.

## :FUNction&lt;F&gt;:FFT:PEAK:FREQuency

**Query** :FUNction<F>:FFT:PEAK:FREQuency?

The :FUNction<F>:FFT:PEAK:FREQuency? query returns a comma-separated string of annotated peak frequency values.

Values are returned according to the order specified by the :FUNction:FFT:PEAK:SORT command.

If no peaks are found, 9.99e37 is returned.

<F> An integer, 1–16, representing the selected function.

**Returned Format** <string><NL>

<string> ::= string of comma-separated frequency values

- See Also**
- [":FUNction:FFT:PEAK:SORT"](#) on page 589
  - [":FUNction<F>:FFT:PEAK:COUNT"](#) on page 590
  - [":FUNction<F>:FFT:PEAK:LEVel"](#) on page 592
  - [":FUNction<F>:FFT:PEAK:MAGNitude"](#) on page 593
  - [":FUNction<F>:FFT:PEAK:STATe"](#) on page 594

**History** New in version 6.70.

## :FUNCTION&lt;F&gt;:FFT:PEAK:LEVel

**Command** :FUNCTION<F>:FFT:PEAK:LEVel <peak\_search\_level>

The :FUNCTION<F>:FFT:PEAK:LEVel command specifies the level above which peaks are identified.

<F> An integer, 1-16, representing the selected function.

<peak\_search\_level> Floating-point value in NR3 format.

**Query** :FUNCTION<F>:FFT:PEAK:LEVel?

The :FUNCTION<F>:FFT:PEAK:LEVel? query returns the specified level above which peaks are identified.

**Returned Format** <peak\_search\_level><NL>

<peak\_search\_level> ::= float value in NR3 format

- See Also**
- **":FUNCTION:FFT:PEAK:SORT"** on page 589
  - **":FUNCTION<F>:FFT:PEAK:COUNT"** on page 590
  - **":FUNCTION<F>:FFT:PEAK:FREQuency"** on page 591
  - **":FUNCTION<F>:FFT:PEAK:MAGNitude"** on page 593
  - **":FUNCTION<F>:FFT:PEAK:STATe"** on page 594

**History** New in version 6.70.



## :FUNction&lt;F&gt;:FFT:PEAK:MAGNitude

**Query** :FUNction<F>:FFT:PEAK:MAGNitude?

The :FUNction<F>:FFT:PEAK:MAGNitude? query returns a comma-separated string of annotated peak magnitude values.

Values are returned according to the order specified by the :FUNction:FFT:PEAK:SORT command.

If no peaks are found, 9.99e37 is returned.

<F> An integer, 1-16, representing the selected function.

**Returned Format** <string><NL>

<string> ::= string of comma-separated magnitude values

- See Also**
- [":FUNction:FFT:PEAK:SORT"](#) on page 589
  - [":FUNction<F>:FFT:PEAK:COUNT"](#) on page 590
  - [":FUNction<F>:FFT:PEAK:FREQuency"](#) on page 591
  - [":FUNction<F>:FFT:PEAK:LEVel"](#) on page 592
  - [":FUNction<F>:FFT:PEAK:STATe"](#) on page 594

**History** New in version 6.70.

**:FUNction<F>:FFT:PEAK:STATe**

**Command** :FUNction<F>:FFT:PEAK:STATe {{0 | OFF} | {1 | ON}}

The :FUNction<F>:FFT:PEAK:STATe command enables or disables FFT peak annotations.

When enabled, the first N peaks in the FFT above the specified Peak Level are annotated. N is specified by the :FUNction<F>:FFT:PEAK:COUNt command. The Peak level is specified by the :FUNction<F>:FFT:PEAK:LEVel command.

The annotated peak values are displayed in the graphical user interface's FFT Peaks results window at the bottom of the display.

You can get the frequency values of the annotated peaks using the :FUNction<F>:FFT:PEAK:FREQuency? query. You can get the magnitude values of the annotated peaks using the :FUNction<F>:FFT:PEAK:MAGNitude? query.

<F> An integer, 1-16, representing the selected function.

**Query** :FUNction<F>:FFT:PEAK:STATe?

The :FUNction<F>:FFT:PEAK:STATe? query returns whether the FFT annotated peaks feature is enabled or disabled.

**Returned Format** <setting><NL>

<setting> ::= {0 | 1}

- See Also**
- **":FUNction:FFT:PEAK:SORT"** on page 589
  - **":FUNction<F>:FFT:PEAK:COUNt"** on page 590
  - **":FUNction<F>:FFT:PEAK:FREQuency"** on page 591
  - **":FUNction<F>:FFT:PEAK:LEVel"** on page 592
  - **":FUNction<F>:FFT:PEAK:MAGNitude"** on page 593

**History** New in version 6.70.

## :FUNction&lt;F&gt;:FFT:REFerence

**Command** :FUNction<F>:FFT:REFerence {DISPlay | TRIGger}

The :FUNction<F>:FFT:REFerence command sets the reference point for calculating the FFT phase function.

<F> An integer, 1-16, representing the selected function.

**Example** This example sets the reference point to DISPlay.

```
myScope.WriteString ":FUNction1:FFT:REFerence DISPlay"
```

**Query** :FUNction<F>:FFT:REFerence?

The :FUNction<F>:FFT:REFerence? query returns the currently selected reference point for the FFT phase function.

**Returned Format** [:FUNction<F>:FFT:REFerence] {DISPlay | TRIGger}<NL>

**Example** This example places the current state of the function 1 FFT reference point in the string variable, strREF, then prints the contents of the variable to the computer's screen.

```
Dim strREF As String
myScope.WriteString ":FUNction1:FFT:REFerence?"
strREF = myScope.ReadString
Debug.Print strREF
```

**History** Legacy command (existed before version 3.10).

Version 4.30: Up to 16 functions supported.

## :FUNCTION&lt;F&gt;:FFT:RESolution

**Command** :FUNCTION<F>:FFT:RESolution <resolution\_value>

The :FUNCTION<F>:FFT:RESolution command sets the resolution bandwidth of the FFT function.

If either the memory depth or sampling rate is set to AUTO (see :ACQUIRE:POINTS or :ACQUIRE:SRATE), you can adjust this control. However, if both the memory depth and sampling rate are in manual mode, you cannot set the resolution and can only query it.

The change in resolution bandwidth is achieved by changing the horizontal scale (as with the :TIMEbase:SCALE command). Changes to the horizontal scale will also change the resolution bandwidth.

<F> An integer, 1-16, representing the selected function.

<resolution\_value> Resolution bandwidth frequency.

The FFT resolution is defined as sampling rate / memory depth when using the Rectangular window (other windows have a Normalized Equivalent Noise Bandwidth factor applied).

$$\text{FFT Resolution} = \frac{\text{Sample Rate}}{\text{Effective Memory Depth}}$$

The effective memory depth is the highest power of 2 less than or equal to the number of sample points across the display. The memory bar in the status area at the top of the display indicates how much of the actual memory depth is across the display.

**Query** :FUNCTION<F>:FFT:RESolution?

The :FUNCTION<F>:FFT:RESolution? query returns the current resolution of the FFT function.

**Returned Format** [FUNCTION<F>:FFT:RESolution] <resolution\_value><NL>

- See Also**
- [":ACQUIRE:POINTS\[:ANALog\] – Memory depth"](#) on page 253
  - [":ACQUIRE:SRATE\[:ANALog\] – Analog Sample Rate"](#) on page 266
  - [":FUNCTION<F>:FFT:START"](#) on page 599
  - [":FUNCTION<F>:FFT:STOP"](#) on page 600
  - [":FUNCTION<F>:FFT:FREQuency"](#) on page 585
  - [":FUNCTION<F>:FFT:SPAN"](#) on page 598
  - [":TIMEbase:SCALE"](#) on page 1376

**History** Legacy command (existed before version 3.10).

Version 4.30: Up to 16 functions supported.

Version 5.70: The command form now lets you set the FFT resolution bandwidth.

## :FUNCTION&lt;F&gt;:FFT:SPAN

**Command** :FUNCTION<F>:FFT:SPAN <frequency\_span>

The :FUNCTION<F>:FFT:SPAN command sets the frequency span for the FFT function.

<F> An integer, 1-16, representing the selected function.

<frequency\_span> Frequency value in NR3 format.

**Query** :FUNCTION<F>:FFT:SPAN?

The :FUNCTION<F>:FFT:SPAN? query returns the frequency span setting.

**Returned Format** [FUNCTION<F>:FFT:SPAN] <frequency\_span><NL>

- See Also**
- **":FUNCTION<F>:FFT:START"** on page 599
  - **":FUNCTION<F>:FFT:STOP"** on page 600
  - **":FUNCTION<F>:FFT:FREQUENCY"** on page 585
  - **":FUNCTION<F>:FFT:RESOLUTION"** on page 596

**History** New in version 5.70.

## :FUNCTION&lt;F&gt;:FFT:START

**Command** :FUNCTION<F>:FFT:START <start\_frequency>

The :FUNCTION<F>:FFT:START command sets the start frequency for the FFT function.

<F> An integer, 1-16, representing the selected function.

<start\_frequency> Frequency value in NR3 format.

**Query** :FUNCTION<F>:FFT:START?

The :FUNCTION<F>:FFT:START? query returns the start frequency setting.

**Returned Format** [FUNCTION<F>:FFT:START] <start\_frequency><NL>

- See Also**
- **":FUNCTION<F>:FFT:STOP"** on page 600
  - **":FUNCTION<F>:FFT:FREQUENCY"** on page 585
  - **":FUNCTION<F>:FFT:SPAN"** on page 598
  - **":FUNCTION<F>:FFT:RESOLUTION"** on page 596

**History** Version 6.73: This command existed in earlier versions of software but is now documented.

**:FUNction<F>:FFT:STOP**

**Command** :FUNction<F>:FFT:STOP <stop\_frequency>

The :FUNction<F>:FFT:STOP command sets the stop frequency for the FFT function.

<F> An integer, 1-16, representing the selected function.

<stop\_frequency> Frequency value in NR3 format.

**Query** :FUNction<F>:FFT:STOP?

The :FUNction<F>:FFT:STOP? query returns the stop frequency setting.

**Returned Format** [FUNction<F>:FFT:STOP] <stop\_frequency><NL>

- See Also**
- **":FUNction<F>:FFT:START"** on page 599
  - **":FUNction<F>:FFT:FREQuency"** on page 585
  - **":FUNction<F>:FFT:SPAN"** on page 598
  - **":FUNction<F>:FFT:RESolution"** on page 596

**History** New in version 5.70.



## :FUNCTION&lt;F&gt;:FFT:TDELAY

**Command** :FUNCTION<F>:FFT:TDELAY <time\_delay>

The :FUNCTION<F>:FFT:TDELAY command sets the time delay for the FFT phase function.

<time\_delay> Time, in seconds, set for the time delay.

**Example** This example sets the time delay to one millisecond.

```
myScope.WriteString ":FUNCTION1:FFT:TDELAY 1E-3"
```

**Query** :FUNCTION<F>:FFT:TDELAY?

The :FUNCTION<F>:FFT:TDELAY? query returns the time delay for the FFT phase function.

**Returned Format** [:FUNCTION<F>:FFT:TDELAY] <time\_delay><NL>

**Example** This example places the FFT phase function's time delay value in the variable, varFftPhaseTimeDelay, then prints the contents of the variable to the computer's screen.

```
Dim varFftPhaseTimeDelay As Variant
myScope.WriteString ":FUNCTION1:FFT:TDELAY?"
varFftPhaseTimeDelay = myScope.ReadNumber
Debug.Print FormatNumber(varFftPhaseTimeDelay, 0)
```

**See Also** • [":FUNCTION<F>:FFTPhase"](#) on page 606

**History** New in version 4.20.

Version 4.30: Up to 16 functions supported.

## :FUNCTION&lt;F&gt;:FFT:VUNits

**Command** :FUNCTION<F>:FFT:VUNits <units>

<units> ::= {DB | DBMV | DBUV | WATT | VRMS}

The :FUNCTION<F>:FFT:VUNits command specifies the vertical units for the FFT magnitude function.

**Query** :FUNCTION<F>:FFT:VUNits?

The :FUNCTION<F>:FFT:VUNits? query returns the FFT magnitude function vertical units setting.

**Returned Format** <units><NL>

- See Also**
- [":FUNCTION<F>:FFTMagnitude"](#) on page 605
  - [":FUNCTION<F>:FFT:DETECTOR:POINTS"](#) on page 583
  - [":FUNCTION<F>:FFT:DETECTOR:TYPE"](#) on page 584

**History** New in version 5.70.

## :FUNction&lt;F&gt;:FFT:WINDow

**Command** :FUNction<F>:FFT:WINDow {RECTangular | HANNing | FLATtop  
| BHARris | HAMMING}

The :FUNction<F>:FFT:WINDow command sets the window type for the FFT function.

The FFT function assumes that the time record repeats. Unless there is an integral number of cycles of the sampled waveform in the record, a discontinuity is created at the beginning of the record. This introduces additional frequency components into the spectrum about the actual peaks, which is referred to as spectral leakage. To minimize spectral leakage, windows that approach zero smoothly at the beginning and end of the record are employed as filters to the FFTs. Each window is useful for certain classes of input waveforms.

- **RECTangular** – is essentially no window, and all points are multiplied by 1. This window is useful for transient waveforms and waveforms where there are an integral number of cycles in the time record.
- **HANNing** – is useful for frequency resolution and general purpose use. It is good for resolving two frequencies that are close together, or for making frequency measurements.
- **FLATtop** – is best for making accurate amplitude measurements of frequency peaks.
- **BHARris** – (Blackman-Harris) is best used when you want to look at signals with a strong interference component that is fairly distant from the frequency you want to see. It can be used as a general purpose window as its main lobe is not too wide (decent frequency discrimination) and the side lobes drop off by 90 dB.
- **HAMMING** – is a "raised cosine" function like the HANNing window but with different coefficients. It has slightly better frequency resolution than the HANNing window.

<F> An integer, 1-16, representing the selected function. This command presently selects all functions, regardless of which integer (1-16) is passed.

**Example** This example sets the window type for the FFT function to RECTangular.

```
myScope.WriteString ":FUNction1:FFT:WINDow RECTangular"
```

**Query** :FUNction<F>:FFT:WINDow?

The :FUNction<F>:FFT:WINDow? query returns the current selected window for the FFT function.

**Returned Format** [:FUNction<F>:FFT:WINDow] {RECTangular | HANNing | FLATtop  
| BHARris | HAMMING}<NL>

**Example** This example places the current state of the function 1 FFT window in the string variable, strWND, then prints the contents of the variable to the computer's screen.

```
Dim strWND As String  
myScope.WriteString ":FUNCTION1:FFT:WINDOW?"  
strWND = myScope.ReadString  
Debug.Print strWND
```

**History** Legacy command (existed before version 3.10).

Version 3.11: Added the HAMMING window mode selection.

Version 4.30: Up to 16 functions supported.

## :FUNction&lt;F&gt;:FFTMagnitude

**Command** :FUNction<F>:FFTMagnitude <operand>

The :FUNction<F>:FFTMagnitude command computes the Fast Fourier Transform (FFT) of the specified channel, function, or memory. The FFT takes the digitized time record and transforms it to magnitude and phase components as a function of frequency.

<F> An integer, 1-16, representing the selected function.

<operand> {CHANnel<n> | DIFF<D> | COMMONmode<C> | FUNction<F> | EQUalized<L> | WMEMory<n> | <float\_value> | MTRend | MSPectrum | XT<X> | PNOise}

See the discussion of possible operands in the introduction to [Chapter 20](#), "Function Commands," starting on page 569.

**Example** This example sets up function 1 to compute the FFT of waveform memory 3.

```
myScope.WriteString ":FUNction1:FFTMagnitude WMEMory3"
```

**See Also**

- [":FUNction<F>:FFT:VUNits"](#) on page 602
- [":FUNction<F>:FFT:DETEctor:TYPE"](#) on page 584
- [":FUNction<F>:FFT:DETEctor:POINts"](#) on page 583
- [":FUNction<F>:FFT:IMPedance"](#) on page 587

**History** Legacy command (existed before version 3.10).

Version 4.30: Up to 16 functions supported.

## :FUNCTION&lt;F&gt;:FFTPHASE

**Command** :FUNCTION<F>:FFTPHASE <source>

The :FUNCTION<F>:FFTPHASE command computes the Fast Fourier Transform (FFT) of the specified channel, function, or waveform memory. The FFT takes the digitized time record and transforms it into magnitude and phase components as a function of frequency.

<F> An integer, 1-16, representing the selected function.

<source> {CHANnel<n> | DIFF<D> | COMMONmode<C> | FUNCTION<F> | EQUALized<L> | WMEMory<n> | <float\_value> | MTRend | MSPectrum | XT<X> | PNOise}

See the discussion of possible operands in the introduction to [Chapter 20](#), "Function Commands," starting on page 569.

**Example** This example sets up function 1 to compute the FFT of waveform memory 3.

```
myScope.WriteString ":FUNCTION1:FFTPHASE WMEMory3"
```

**See Also** • [":FUNCTION<F>:FFT:TDELay"](#) on page 601

**History** Legacy command (existed before version 3.10).

Version 4.30: Up to 16 functions supported.

## :FUNCTION&lt;F&gt;:GATING – Gating

**Command** :FUNCTION<F>:GATING <operand> [, <gating\_start>, <gating\_stop>]

The :FUNCTION<F>:GATING command defines a horizontal gating function of another waveform (similar to horizontal zoom). Measurements on horizontal gating functions are essentially gated measurements.

<F> An integer, 1-16, representing the selected function.

<operand> {CHANnel<n> | DIFF<D> | COMMONmode<C> | FUNCTION<F> | EQUALized<L> | WMemory<n> | MTRend | MSPectrum | XT<X> | PNOise}

See the discussion of possible operands in the introduction to [Chapter 20](#), “Function Commands,” starting on page 569.

<gating\_start> Time, in seconds, relative to the source waveform that specifies where the gating window begins.

<gating\_stop> Time, in seconds, relative to the source waveform that specifies where the gating window ends.

**Example** This example sets function 4 to be a horizontal gating of the channel1 waveform beginning at -8 ns and ending at -5 ns.

```
myScope.WriteString ":FUNCTION4:GATING CHANnel1, -8E-9, -5E-9"
```

**See Also**

- [":FUNCTION<F>:GATING:START – Gating window start time"](#) on page 609
- [":FUNCTION<F>:GATING:STOP – Gating window stop time"](#) on page 610

**History** New in version 4.30.

Version 4.30: Up to 16 functions supported.

## :FUNCTION<F>:GATING:GLOBAL

**Command** :FUNCTION<F>:GATING:GLOBAL <state>[, {GG1 | GG2 | GG3 | GG4}]

The :FUNCTION<F>:GATING:GLOBAL command enables or disables one of the four global gates for the gating function.

<state> {{OFF | 0} | {ON | 1}}

- See Also**
- [":FUNCTION<F>:GATING – Gating"](#) on page 607
  - [":FUNCTION<F>:GATING:START – Gating window start time"](#) on page 609
  - [":FUNCTION<F>:GATING:STOP – Gating window stop time"](#) on page 610

**History** New in version 6.50.



## :FUNCTION<F>:GATING:START – Gating window start time

**Command** :FUNCTION<F>:GATING:START <gating\_start>

The :FUNCTION<F>:GATING:START command specifies the time, in seconds, where the gating window begins relative to the source waveform (see :FUNCTION<F>:GATING).

<F> An integer, 1-16, representing the selected function.

**Example** This example sets a -8 ns gating window begin time for function 4.

```
myScope.WriteString ":FUNCTION4:GATING:START -8E-9"
```

The gating window is applied to the source operand specified in the :FUNCTION4:GATING command.

**Query** :FUNCTION<F>:GATING:START?

The ::FUNCTION<F>:GATING:START? query returns the gating window start time.

**Returned Format** [:FUNCTION<F>:GATING:START] <gating\_start><NL>

- See Also**
- [":FUNCTION<F>:GATING – Gating"](#) on page 607
  - [":FUNCTION<F>:GATING:STOP – Gating window stop time"](#) on page 610

**History** New in version 5.30.

**:FUNCTION<F>:GATING:STOP** – Gating window stop time

**Command**     :FUNCTION<F>:GATING:STOP <gating\_stop>

The :FUNCTION<F>:GATING:STOP command specifies the time, in seconds, where the gating window ends relative to the source waveform (see :FUNCTION<F>:GATING).

<F>     An integer, 1-16, representing the selected function.

**Example**     This example sets a -5 ns gating window end time for function 4.

```
myScope.WriteString ":FUNCTION4:GATING:STOP -5E-9"
```

The gating window is applied to the source operand specified in the :FUNCTION4:GATING command.

**Query**       :FUNCTION<F>:GATING:STOP?

The ::FUNCTION<F>:GATING:STOP? query returns the gating window stop time.

**Returned Format**   [:FUNCTION<F>:GATING:STOP] <gating\_stop><NL>

- See Also**
- [":FUNCTION<F>:GATING – Gating"](#) on page 607
  - [":FUNCTION<F>:GATING:START – Gating window start time"](#) on page 609

**History**     New in version 5.30.

## :FUNCTION&lt;F&gt;:HIGHpass

**Command** :FUNCTION<F>:HIGHpass <source>,<bandwidth>

The :FUNCTION<F>:HIGHpass command applies a single-pole high pass filter to the source waveform. The bandwidth that you set is the 3 dB bandwidth of the filter.

<F> An integer, 1-16, representing the selected function.

<source> {CHANnel<n> | DIFF<D> | COMMONmode<C> | FUNCTION<F> | EQUALized<L> | WMEMory<n> | MTRend | MSPectrum | XT<X> | PNOise}

See the discussion of possible operands in the introduction to [Chapter 20](#), "Function Commands," starting on page 569.

<bandwidth> A real number in the range of 50 to 50E9.

**Example** This example sets up function 2 to compute a high pass filter with a bandwidth of 1 MHz.

```
myScope.WriteString ":FUNCTION2:HIGHpass CHANnel14,1E6"
```

**History** Legacy command (existed before version 3.10).

Version 4.30: Up to 16 functions supported.

**:FUNCTION<F>:HORIZONTAL**

**Command**    `:FUNCTION<F>:HORIZONTAL {AUTO | MANUAL}`

The `:FUNCTION<F>:HORIZONTAL` command sets the horizontal tracking to either `AUTO` or `MANUAL`.

**NOTE**

Using the `:FUNCTION<F>:HORIZONTAL:RANGE` or `:FUNCTION<F>:HORIZONTAL:POSITION` commands automatically changes the `:FUNCTION<F>:HORIZONTAL` setting to `MANUAL`.

**<F>**    An integer, 1-16, representing the selected function.

**Query**    `:FUNCTION<F>:HORIZONTAL?`

The `:FUNCTION<F>:HORIZONTAL?` query returns the current horizontal scaling mode of the specified function.

**Returned Format**    `[ :FUNCTION<F>:HORIZONTAL ] {AUTO | MANUAL}<NL>`

**Example**    This example places the current state of the function 1 horizontal tracking in the string variable, `strSetting`, then prints the contents of the variable to the computer's screen.

```
Dim strSetting As String    ' Dimension variable.
myScope.WriteString ":FUNCTION1:HORIZONTAL?"
strSetting = myScope.ReadString
Debug.Print strSetting
```

**See Also**    • [":FUNCTION<F>:HORIZONTAL:POSITION"](#) on page 613  
               • [":FUNCTION<F>:HORIZONTAL:RANGE"](#) on page 615

**History**    Legacy command (existed before version 3.10).

Version 4.30: Up to 16 functions supported.

## :FUNction&lt;F&gt;:HORizontal:POSition

**Command** :FUNction<F>:HORizontal:POSition <position\_value>

The :FUNction<F>:HORizontal:POSition command sets the time value at center screen for the selected function.

Using the :FUNction<F>:HORizontal:POSition command automatically changes the :FUNction<F>:HORizontal setting to MANUAL.

When you select :FUNction<F>:FFTMagnitude, the horizontal position is equivalent to the center frequency. This also automatically selects manual mode.

**NOTE**

For some math functions (:FUNction<F>:ABSolute, :FUNction<F>:ADD, :FUNction<F>:ADEMod, :FUNction<F>:COMMONmode, :FUNction<F>:DIFF, :FUNction<F>:DIVide, :FUNction<F>:HIGHpass, :FUNction<F>:INTEgrate, :FUNction<F>:INVert, :FUNction<F>:LOWPass, :FUNction<F>:MAXimum, :FUNction<F>:MTRend, :FUNction<F>:MINimum, :FUNction<F>:MULTiply, :FUNction<F>:SQUare, :FUNction<F>:SQRT, :FUNction<F>:SUBTract), the waveform's horizontal scaling is tied to the timebase of the source channel waveform(s).

The :FUNction<F>:HORizontal:RANGe and :FUNction<F>:HORizontal:POSition commands for these functions give a -221, "Settings conflict" error. Instead, you must use the :TIMEbase:RANGe and :TIMEbase:POSition commands to make horizontal scale and position changes.

<F> An integer, 1-16, representing the selected function.

<position\_value> A real number for the position value in time, in seconds.

**Query** :FUNction<F>:HORizontal:POSition?

The :FUNction<F>:HORizontal:POSition? query returns the current time value at center screen of the selected function.

**Returned Format** [:FUNction<F>:HORizontal:POSition] <position><NL>

**Example** This example places the current horizontal position setting for function 2 in the numeric variable, varValue, then prints the contents to the computer's screen.

```
myScope.WriteString ":SYSTEM:HEADer OFF" ' Response headers off.
myScope.WriteString ":FUNction2:HORizontal:POSition?"
varValue = myScope.ReadNumber
Debug.Print FormatNumber(varValue, 0)
```

**See Also**

- [":FUNction<F>:HORizontal:RANGe"](#) on page 615
- [":FUNction<F>:HORizontal"](#) on page 612
- [":TIMEbase:POSition"](#) on page 1370

**History** Legacy command (existed before version 3.10).

Version 4.30: Up to 16 functions supported.

Version 6.00: For functions where the horizontal position cannot be adjusted, this command now gives a -221, "Settings conflict" instead of being accepted without effect.

## :FUNCTION&lt;F&gt;:HORIZONTAL:RANGE

**Command** :FUNCTION<F>:HORIZONTAL:RANGE <range\_value>

The :FUNCTION<F>:HORIZONTAL:RANGE command sets the current time range for the specified function.

Using the :FUNCTION<F>:HORIZONTAL:RANGE command automatically changes the :FUNCTION<F>:HORIZONTAL setting to MANUAL.

**NOTE**

For some math functions (:FUNCTION<F>:ABSOLUTE, :FUNCTION<F>:ADD, :FUNCTION<F>:ADEMOD, :FUNCTION<F>:COMMONMODE, :FUNCTION<F>:DIFF, :FUNCTION<F>:DIVIDE, :FUNCTION<F>:HIGHPASS, :FUNCTION<F>:INTEGRATE, :FUNCTION<F>:INVERT, :FUNCTION<F>:LOWPASS, :FUNCTION<F>:MAXIMUM, :FUNCTION<F>:MTRND, :FUNCTION<F>:MINIMUM, :FUNCTION<F>:MULTIPLY, :FUNCTION<F>:SQUARE, :FUNCTION<F>:SQRT, :FUNCTION<F>:SUBTRACT), the waveform's horizontal scaling is tied to the timebase of the source channel waveform(s).

The :FUNCTION<F>:HORIZONTAL:RANGE and :FUNCTION<F>:HORIZONTAL:POSITION commands for these functions give a -221, "Settings conflict" error. Instead, you must use the :TIMEBASE:RANGE and :TIMEBASE:POSITION commands to make horizontal scale and position changes.

<F> An integer, 1-16, representing the selected function.

<range\_value> A real number for the width of screen in current X-axis units (usually seconds).

**Query** :FUNCTION<F>:HORIZONTAL:RANGE?

The :FUNCTION<F>:HORIZONTAL:RANGE? query returns the current time range setting of the specified function.

**Returned Format** [:FUNCTION<F>:HORIZONTAL:RANGE] <range><NL>

**Example** This example places the current horizontal range setting of function 2 in the numeric variable, varValue, then prints the contents to the computer's screen.

```
myScope.WriteString ":SYSTEM:HEADER OFF" ' Response headers off.
myScope.WriteString ":FUNCTION2:HORIZONTAL:RANGE?"
varValue = myScope.ReadNumber
Debug.Print FormatNumber(varValue, 0)
```

- See Also**
- [":FUNCTION<F>:HORIZONTAL:POSITION"](#) on page 613
  - [":FUNCTION<F>:HORIZONTAL"](#) on page 612
  - [":TIMEBASE:RANGE"](#) on page 1371

**History** Legacy command (existed before version 3.10).

Version 4.30: Up to 16 functions supported.

Version 6.00: For functions where the horizontal position cannot be adjusted, this command now gives a -221, "Settings conflict" instead of being accepted without effect.



## :FUNCTION&lt;F&gt;:INTEGRATE

**Command** :FUNCTION<F>:INTEGRATE <operand>

The :FUNCTION<F>:INTEGRATE command defines a function that computes the integral of the specified operand's waveform.

<F> An integer, 1-16, representing the selected function.

<operand> {CHANnel<n> | DIFF<D> | COMMONmode<C> | FUNCTION<F> | EQUALized<L> | WMEMORY<n> | <float\_value> | MTRend | MSPectrum | XT<X> | PNOise}

See the discussion of possible operands in the introduction to [Chapter 20](#), "Function Commands," starting on page 569.

**Example** This example sets up function 1 to compute the integral of waveform memory 3.

```
myScope.WriteString ":FUNCTION1:INTEGRATE WMEMORY3"
```

**History** Legacy command (existed before version 3.10).

Version 4.30: Up to 16 functions supported.

**:FUNCTION<F>:INVert**

**Command** :FUNCTION<F>:INVert <operand>

The :FUNCTION<F>:INVert command defines a function that inverts the defined operand's waveform by multiplying by -1.

<F> An integer, 1-16, representing the selected function.

<operand> {CHANnel<n> | DIFF<D> | COMMONmode<C> | FUNCTION<F> | EQUalized<L> | WMEMory<n> | <float\_value> | MTRend | MSPectrum | XT<X> | PNOise}

See the discussion of possible operands in the introduction to [Chapter 20](#), "Function Commands," starting on page 569.

**Example** This example sets up function 2 to invert the waveform on channel 1.

```
myScope.WriteString ":FUNCTION2:INVert CHANnel1"
```

**History** Legacy command (existed before version 3.10).

Version 4.30: Up to 16 functions supported.

## :FUNCTION&lt;F&gt;:LABEL

**Command** :FUNCTION<F>:LABEL <quoted\_string>

The :FUNCTION<F>:LABEL command sets the math function waveform label to the quoted string.

Labels can be enabled with the :DISPLAY:LABEL command.

<F> An integer, 1-16, representing the selected function.

<quoted\_string> A series of 16 or fewer characters as a quoted ASCII string.

**Query** :FUNCTION<F>:LABEL?

The :FUNCTION<F>:LABEL? query returns the label of the specified math function waveform.

**Returned Format** [:FUNCTION<F>:LABEL] <quoted\_string><NL>

- See Also**
- **":DISPLAY:LABEL"** on page 546
  - **":CHANNEL<N>:LABEL"** on page 375
  - **":WMEMORY<R>:LABEL"** on page 1654

**History** New in version 6.70.

## :FUNCTION&lt;F&gt;:LOWPass

**Command** :FUNCTION<F>:LOWPass <source>, <bandwidth>

The :FUNCTION<F>:LOWPass command applies a 4th order Bessel-Thompson low pass filter to the source waveform. The bandwidth that you set is the 3 dB bandwidth of the filter.

<F> An integer, 1-16, representing the selected function.

<source> {CHANnel<n> | DIFF<D> | COMMONmode<C> | FUNCTION<F> | EQUALized<L> | WMEMory<n> | MTRend | MSPectrum | XT<X> | PNOise}

See the discussion of possible operands in the introduction to [Chapter 20](#), "Function Commands," starting on page 569.

<bandwidth> A real number in the range of 50 to 50E9.

**Example** This example sets up function 2 to compute a low pass filter with a bandwidth of 1 MHz.

```
myScope.WriteString ":FUNCTION2:LOWPass CHANnel4,1E6"
```

**History** Legacy command (existed before version 3.10).

Version 4.30: Up to 16 functions supported.

## :FUNCTION&lt;F&gt;:MAGNify

**Command** :FUNCTION<F>:MAGNify <operand>

The :FUNCTION<F>:MAGNify command defines a function that is a copy of the operand. The magnify function is a software magnify. No hardware settings are altered as a result of using this function. It is useful for scaling channels, another function, or memories with the RANGE and OFFSET commands in this subsystem.

<F> An integer, 1-16, representing the selected function.

<operand> {CHANnel<n> | DIFF<D> | COMMONmode<C> | FUNCTION<F> | EQUALized<L> | WMemory<n> | <float\_value> | MTRend | MSPpectrum | XT<X> | PNOise}

See the discussion of possible operands in the introduction to [Chapter 20](#), "Function Commands," starting on page 569.

**Example** This example creates a function (function 1) that is a magnified version of channel 1.

```
myScope.WriteString ":FUNCTION1:MAGNify CHANnel1"
```

**History** Legacy command (existed before version 3.10).

Version 4.30: Up to 16 functions supported.

## :FUNction&lt;F&gt;:MATLab

**Command** :FUNction<F>:MATLab <operand> [, <operand>]

The :FUNction<F>:MATLab command sets the operand(s) for these user-defined functions:

- Butterworth
- FIR
- LFE
- RTEye
- SqrtSumOfSquare

And these InfiniiSim functions:

- InfiniiSim 2 Port
- InfiniiSim 4 Port 1 Src
- InfiniiSim 4 Port CM
- InfiniiSim 4 Port Diff
- InfiniiSim 4 Port Src1
- InfiniiSim 4 Port Src2

<F> An integer, 1-16, representing the selected function.

<operand> {CHANnel<N> | DIFF<D> | COMMONmode<C> | FUNction<F> | EQUalized<L> | WMemory<R> | MTRend | MSPectrum | XT<X> | PNOise}

See the discussion of possible operands in the introduction to [Chapter 20](#), "Function Commands," starting on page 569.

**Example** This example sets the "InfiniiSim 2 Port" math function, operands, and controls.

```
myScope.WriteString ":FUNction1:MATLab:OPERator 'InfiniiSim 2 Port'"
myScope.WriteString ":FUNction1:MATLab CHANnel1"
myScope.WriteString ":FUNction1:MATLab:CONTRol1 'c:\users\public\
documents\infiniium\filters\cable only.tf2'"
myScope.WriteString ":FUNction1:MATLab:CONTRol2 5e-9"
myScope.WriteString ":FUNction1:MATLab:CONTRol3 10e9"
myScope.WriteString ":FUNction1:MATLab:CONTRol4 2"
```

**See Also**

- [":FUNction<F>:MATLab:OPERator"](#) on page 625
- [":FUNction<F>:MATLab:CONTRol<N>"](#) on page 623

**History** Legacy command (existed before version 3.10).

Version 4.30: Up to 16 functions supported.

## :FUNCTION&lt;F&gt;:MATLAB:CONTROL&lt;N&gt;

**Command** :FUNCTION<F>:MATLAB:CONTROL<N> {<value> | <string>}

The :FUNCTION<F>:MATLAB:CONTROL<N> command sets control values for these user-defined functions:

- Butterworth
- FIR
- LFE
- RTEye
- SqrtSumOfSquare

And these InfiniiSim functions:

- InfiniiSim 2 Port
- InfiniiSim 4 Port 1 Src
- InfiniiSim 4 Port CM
- InfiniiSim 4 Port Diff
- InfiniiSim 4 Port Src1
- InfiniiSim 4 Port Src2

<F> An integer, 1-16, representing the selected function.

<N> An integer, 1-6, representing the user-defined or InfiniiSim function control.

<value> A double, integer, or enumerated type value. For an enumerated type, the 1 based index is passed to select the enumeration.

<string> A character array.

**Example** This example sets the "InfiniiSim 2 Port" math function, operands, and controls.

```
myScope.WriteString ":FUNCTION1:MATLAB:OPERATOR 'InfiniiSim 2 Port'"
myScope.WriteString ":FUNCTION1:MATLAB:CHANNEL1"
myScope.WriteString ":FUNCTION1:MATLAB:CONTROL1 'c:\users\public\
documents\infiniium\filters\cable only.tf2'"
myScope.WriteString ":FUNCTION1:MATLAB:CONTROL2 5e-9"
myScope.WriteString ":FUNCTION1:MATLAB:CONTROL3 10e9"
myScope.WriteString ":FUNCTION1:MATLAB:CONTROL4 2"
```

**Query** :FUNCTION<F>:MATLAB:CONTROL<N>?

The :FUNCTION<F>:MATLAB:CONTROL<N>? query returns the value or string of the user-defined control.

**Returned Format** [:FUNCTION<F>:MATLAB:CONTROL<N>] {<value> | <string>}<NL>

**Example** This example places the current returned value for function 1 control 1 in the string variable, strSelection, then prints the contents of the variable to the computer's screen.

```
Dim strSelection As String ' Dimension variable.  
myScope.WriteString ":FUNCTION1:MATLAB:CONTROL1?"  
strSelection = myScope.ReadString  
Debug.Print strSelection
```

- See Also**
- [":FUNCTION<F>:MATLAB:OPERATOR"](#) on page 625
  - [":FUNCTION<F>:MATLAB"](#) on page 622

**History** Legacy command (existed before version 3.10).

Version 4.30: Up to 16 functions supported.

Version 5.60: Up to 6 user-defined controls supported.



## :FUNCTION&lt;F&gt;:MATLAB:OPERATOR

**Command** :FUNCTION<F>:MATLAB:OPERATOR <string>

The :FUNCTION<F>:MATLAB:OPERATOR command sets the Function dialog box operator. Any math function operator name can be specified, not just user-defined or InfiniiSim math functions.

<F> An integer, 1-16, representing the selected function.

<string> A character array that is the name of the math function as it appears in the Function dialog box.

**Example** This example sets the "InfiniiSim 2 Port" math function, operands, and controls.

```
myScope.WriteString ":FUNCTION1:MATLAB:OPERATOR 'InfiniiSim 2 Port'"
myScope.WriteString ":FUNCTION1:MATLAB:CHANNEL1"
myScope.WriteString ":FUNCTION1:MATLAB:CONTROL1 'c:\users\public\
documents\infiniium\filters\cable only.tf2'"
myScope.WriteString ":FUNCTION1:MATLAB:CONTROL2 5e-9"
myScope.WriteString ":FUNCTION1:MATLAB:CONTROL3 10e9"
myScope.WriteString ":FUNCTION1:MATLAB:CONTROL4 2"
```

**Query** :FUNCTION<F>:MATLAB:OPERATOR?

The :FUNCTION<F>:MATLAB:OPERATOR? query returns the string of the math function operator.

**Returned Format** [:FUNCTION<F>:MATLAB:OPERATOR] <string><NL>

**Example** This example places the current operator string for function 1 in the string variable, strSelection, then prints the contents of the variable to the computer's screen.

```
Dim strSelection As String ' Dimension variable.
myScope.WriteString ":FUNCTION1:MATLAB:OPERATOR?"
strSelection = myScope.ReadString
Debug.Print strSelection
```

**See Also**

- [":FUNCTION<F>:MATLAB"](#) on page 622
- [":FUNCTION<F>:MATLAB:CONTROL<N>"](#) on page 623

**History** Legacy command (existed before version 3.10).

Version 4.30: Up to 16 functions supported.

## :FUNCTION&lt;F&gt;:MAXimum

**Command** :FUNCTION<F>:MAXimum <operand>

The :FUNCTION<F>:MAXimum command defines a function that computes the maximum of each time bucket for the defined operand's waveform.

<F> An integer, 1-16, representing the selected function.

<operand> {CHANnel<n> | DIFF<D> | COMMONmode<C> | FUNCTION<F> | EQUALized<L> | WMEMORY<n> | <float\_value> | MTRend | MSPectrum | XT<X> | PNOise}

See the discussion of possible operands in the introduction to [Chapter 20](#), "Function Commands," starting on page 569.

**Example** This example sets up function 2 to compute the maximum of each time bucket for channel 4.

```
myScope.WriteString ":FUNCTION2:MAXimum CHANnel4"
```

**History** Legacy command (existed before version 3.10).

Version 4.30: Up to 16 functions supported.

## :FUNCTION&lt;F&gt;:MHISTogram

**Command** :FUNCTION<F>:MHISTogram {MEAS1 | MEAS2 | MEAS3 | ...  
| MEAS20}[, <max\_bins>[, {MIN | <min>}[, {MAX | <max>}]]]

The :FUNCTION<F>:MHISTogram command adds a Meas Histogram function that shows a histogram of measurement values. Measurement values are captured and the histogram is updated as new acquisitions are made.

You can display statistics for the histogram in the Measurements tab using the :MEASure:HISTogram commands and you can get histogram statistics using the :MEASure:HISTogram queries.

<F> An integer, 1-16, representing the selected function.

<max\_bins> An integer from 10-1280.

{MIN | <min>},  
{MAX | <max>} You can specify the histogram's measurement minimum and measurement maximum bounds with <min> and <max> floating-point values, or if you want the histogram bounds to be automatically determined, use MIN and MAX.

**Example** This example sets up a histogram function of the first measurement.

```
myScope.WriteString ":FUNCTION1:MHISTogram MEAS6,1280,-20E-12,20E-12"
```

**See Also**

- [":FUNCTION<F>:VERTical:SIZE"](#) on page 644
- [":MEASure:HISTogram:HITS"](#) on page 962
- [":MEASure:HISTogram:M1S"](#) on page 963
- [":MEASure:HISTogram:M2S"](#) on page 964
- [":MEASure:HISTogram:M3S"](#) on page 965
- [":MEASure:HISTogram:MAX"](#) on page 966
- [":MEASure:HISTogram:MEAN"](#) on page 967
- [":MEASure:HISTogram:MEDian"](#) on page 968
- [":MEASure:HISTogram:MIN"](#) on page 969
- [":MEASure:HISTogram:MODE"](#) on page 972
- [":MEASure:HISTogram:PEAK"](#) on page 973
- [":MEASure:HISTogram:PP"](#) on page 974
- [":MEASure:HISTogram:RESolution"](#) on page 975
- [":MEASure:HISTogram:STDDev"](#) on page 976

**History** New in version 3.50.

Version 4.30: Up to 16 functions supported.

Version 5.00: Now 20 measurements to choose from.

Version 5.20: Lets you specify the maximum number of histogram bins along with the measurement source.

Version 6.30: Added <min> and <max> parameters for specifying the histogram's measurement minimum and measurement maximum.

## :FUNCTION&lt;F&gt;:MINimum

**Command** :FUNCTION<F>:MINimum <operand>

The :FUNCTION<F>:MINimum command defines a function that computes the minimum of each time bucket for the defined operand's waveform.

<F> An integer, 1-16, representing the selected function.

<operand> {CHANnel<n> | DIFF<D> | COMMONmode<C> | FUNCTION<F> | EQUALized<L> | WMEMORY<n> | <float\_value> | MTRend | MSPectrum | XT<X> | PNOise}

See the discussion of possible operands in the introduction to [Chapter 20](#), "Function Commands," starting on page 569.

**Example** This example sets up function 2 to compute the minimum of each time bucket for channel 4.

```
myScope.WriteString ":FUNCTION2:MINimum CHANnel4"
```

**History** Legacy command (existed before version 3.10).

Version 4.30: Up to 16 functions supported.

## :FUNction<F>:MLOG

**Command** :FUNction<F>:MLOG {MEAS1 | MEAS2 | MEAS3 | ... | MEAS20}

The :FUNction<F>:MLOG command adds a function waveform that is a scrolling record of measurement values over time.

<F> An integer, 1-16, representing the selected function.

**See Also** • [":FUNction<F>:MTRend"](#) on page 631

**History** New in version 6.00.

## :FUNCTION&lt;F&gt;:MTRend

**Command** :FUNCTION<F>:MTRend {MEAS1 | MEAS2 | MEAS3 | ... | MEAS20}

The :FUNCTION<F>:MTRend command adds a Meas Trend function that shows measurement values for a waveform (based on measurement threshold settings) as the waveform progresses across the screen. For every cycle, a measurement is made, and the value is displayed on the screen for the cycle.

If a measurement cannot be made for part of a waveform, the trend function output is a hole (that is, no value) until a measurement can be made.

<F> An integer, 1-16, representing the selected function.

**Example** This example sets up a trend function of the first measurement.

```
myScope.WriteString ":FUNCTION2:MTRend MEAS1"
```

**History** New in version 3.50.

Version 4.30: Up to 16 functions supported.

Version 5.00: Now 20 measurements to choose from.

**:FUNction<F>:MULTiPLY**

**Command** `:FUNction<F>:MULTiPLY <operand>,<operand>`

The `:FUNction<F>:MULTiPLY` command defines a function that algebraically multiplies the first operand by the second operand.

**<F>** An integer, 1-16, representing the selected function.

**<operand>** {CHANnel<n> | DIFF<D> | COMMONmode<C> | FUNction<F> | EQUalized<L> | WMEMory<n> | <float\_value> | MTRend | MSPectrum | XT<X> | PNOise}

See the discussion of possible operands in the introduction to [Chapter 20](#), “Function Commands,” starting on page 569.

**Example** This example defines a function that multiplies channel 1 by waveform memory 1.

```
myScope.WriteString ":FUNction1:MULTiPLY CHANnel1,WMEMory1"
```

**History** Legacy command (existed before version 3.10).

Version 4.30: Up to 16 functions supported.



## :FUNCTION&lt;F&gt;:OFFSet

**Command** :FUNCTION<F>:OFFSet <offset\_value>

The :FUNCTION<F>:OFFSet command sets the voltage represented at the center of the screen for the selected function. This automatically changes the mode from auto to manual.

<F> An integer, 1-16, representing the selected function.

<offset\_value> A real number for the vertical offset in the currently selected Y-axis units (normally volts). The offset value is limited to being within the vertical range that can be represented by the function data.

**Example** This example sets the offset voltage for function 1 to 2 mV.

```
myScope.WriteString ":FUNCTION1:OFFSet 2E-3"
```

**Query** :FUNCTION<F>:OFFSet?

The :FUNCTION<F>:OFFSet? query returns the current offset value for the selected function.

**Returned Format** [:FUNCTION<F>:OFFSet] <offset\_value><NL>

**Example** This example places the current setting for offset on function 2 in the numeric variable, varValue, then prints the result to the computer's screen.

```
myScope.WriteString ":SYSTEM:HEADer OFF" ' Response headers off.
myScope.WriteString ":FUNCTION2:OFFSet?"
varValue = myScope.ReadNumber
Debug.Print FormatNumber(varValue, 0)
```

**History** Legacy command (existed before version 3.10).

Version 4.30: Up to 16 functions supported.

## :FUNCTION&lt;F&gt;:PAverage

**Command** :FUNCTION<F>:PAverage <source>[, <num\_averages>[, <pts\_per\_UI>]]

The :FUNCTION<F>:PAverage command sets up the Pattern Average math function.

From a detected bit pattern, the Pattern Average math function removes random jitter and noise and preserves inter-symbol interference and data dependent jitter and noise.

The Pattern Average math function requires clock recovery and at least two error-free copies of an identical repeating bit pattern in acquisition memory.

**<source>** {CHANnel<N> | FUNCTION<F> | EQUalized<L> | WMEMory<R> | EQUalized<L> | MTRend | MSPectrum | XT<X> | PNOise}

See the discussion of possible operands in the introduction to [Chapter 20](#), "Function Commands," starting on page 569.

**<num\_averages>** This option specifies the number of averages of the detected bit pattern output. You can specify an integer from 2 to 65534.

**<pts\_per\_UI>** This option specifies the points per unit interval to use from the input waveform source data. You can specify an integer from 8 to 1024.

**See Also**

- [":ANALyze:SIGNal:PATtern:PLENght"](#) on page 308
- [":FUNCTION<F>:DISPlay"](#) on page 581

**History** New in version 6.10.

## :FUNction&lt;F&gt;:RANGe

**Command** :FUNction<F>:RANGe <full\_scale\_range>

The :FUNction<F>:RANGe command defines the full-scale vertical axis of the selected function. This automatically changes the mode from auto to manual.

<F> An integer, 1-16, representing the selected function.

<full\_scale\_range> A real number for the full-scale vertical range, from -100E15 to 100E15.

**Example** This example sets the full-scale range for function 1 to 400 mV.

```
myScope.WriteString ":FUNction1:RANGe 400E-3"
```

**Query** :FUNction<F>:RANGe?

The :FUNction<F>:RANGe? query returns the current full-scale range setting for the specified function.

**Returned Format** [:FUNction<F>:RANGe] <full\_scale\_range><NL>

**Example** This example places the current range setting for function 2 in the numeric variable "varValue", then prints the contents to the computer's screen.

```
myScope.WriteString ":SYSTem:HEADer OFF" ' Response headers off.
myScope.WriteString ":FUNction2:RANGe?"
varValue = myScope.ReadNumber
Debug.Print FormatNumber(varValue, 0)
```

**History** Legacy command (existed before version 3.10).

Version 4.30: Up to 16 functions supported.

## :FUNCTION&lt;F&gt;:SMOoth

**Command** :FUNCTION<F>:SMOoth <operand> [, <points>]

The :FUNCTION<F>:SMOoth command defines a function that assigns the smoothing operator to the operand with the number of specified smoothing points.

<F> An integer, 1-16, representing the selected function.

<operand> {CHANnel<n> | DIFF<D> | COMMONmode<C> | FUNCTION<F> | EQUALized<L> | WMEMORY<n> | <float\_value> | MTRend | MSPectrum | XT<X> | PNOise}

See the discussion of possible operands in the introduction to [Chapter 20](#), "Function Commands," starting on page 569.

<points> An integer, odd numbers from 3 to 4001 specifying the number of smoothing points.

**Example** This example sets up function 1 using assigning smoothing operator to channel 1 using 5 smoothing points.

```
myScope.WriteString ":FUNCTION1:SMOoth CHANnel1,5"
```

**History** Legacy command (existed before version 3.10).

Version 4.30: Up to 16 functions supported.

## :FUNction&lt;F&gt;:SQRT

**Command** :FUNction<F>:SQRT <operand>

The :FUNction<F>:SQRT command takes the square root of the operand.

**<operand>** {CHANnel<N> | DIFF<D> | COMMONmode<C> | FUNction<F> | EQUalized<L> | WMEMory<R> | MTRend | MSPectrum | XT<X> | PNOise}

See the discussion of possible operands in the introduction to [Chapter 20](#), “Function Commands,” starting on page 569.

**Example** This example turns on the square root function using channel 3.

```
myScope.WriteString ":FUNCTION1:SQRT CHANNEL3"
```

**History** Legacy command (existed before version 3.10).

Version 4.30: Up to 16 functions supported.

**:FUNction<F>:SQUare**

**Command** :FUNction<F>:SQUare <operand>

The :FUNction<F>:SQUare command takes the square value of the operand.

**<operand>** {CHANnel<N> | DIFF<D> | COMMONmode<C> | FUNction<F> | EQUalized<L> | WMEMory<R> | MTRend | MSPectrum | XT<X> | PNOise}

See the discussion of possible operands in the introduction to [Chapter 20](#), “Function Commands,” starting on page 569.

**Example** This example turns on the square value command using channel 3.

```
myScope.WriteString ":FUNction1:SQUare CHANnel3"
```

**History** Legacy command (existed before version 3.10).

Version 4.30: Up to 16 functions supported.

## :FUNCTION&lt;F&gt;:SUBTRACT

**Command** :FUNCTION<F>:SUBTRACT <operand>,<operand>

The :FUNCTION<F>:SUBTRACT command defines a function that algebraically subtracts the second operand from the first operand.

<F> An integer, 1-16, representing the selected function.

<operand> {CHANnel<n> | DIFF<D> | COMMONmode<C> | FUNCTION<F> | EQUALized<L> | WMEMORY<n> | <float\_value> | MTRend | MSPectrum | XT<X> | PNOise}

See the discussion of possible operands in the introduction to [Chapter 20](#), "Function Commands," starting on page 569.

**Example** This example defines a function that subtracts waveform memory 1 from channel 1.

```
myScope.WriteString ":FUNCTION1:SUBTRACT CHANnel1,WMEMory1"
```

**History** Legacy command (existed before version 3.10).

Version 4.30: Up to 16 functions supported.

## :FUNCTION&lt;F&gt;:VERSUS

**Command** :FUNCTION<F>:VERSUS <operand>, <operand>

The :FUNCTION<F>:VERSUS command defines a function for an X-versus-Y display. The first operand defines the Y axis and the second defines the X axis. The Y-axis range and offset are initially equal to that of the first operand, and you can adjust them with the RANGE and OFFSET commands in this subsystem.

<F> An integer, 1-16, representing the selected function.

<operand> {CHANNEL<n> | DIFF<D> | COMMONMODE<C> | FUNCTION<F> | EQUALIZED<L> | WMEMORY<n> | <float\_value> | MTRend | MSPpectrum | XT<X> | PNOise}

See the discussion of possible operands in the introduction to [Chapter 20](#), "Function Commands," starting on page 569.

**Example** This example defines function 1 as an X-versus-Y display. Channel 1 is the X axis and waveform memory 2 is the Y axis.

```
myScope.WriteString ":FUNCTION1:VERSUS WMEMORY2, CHANNEL1"
```

**History** Legacy command (existed before version 3.10).

Version 4.30: Up to 16 functions supported.



## :FUNction&lt;F&gt;:VERTical

**Command** :FUNction<F>:VERTical {AUTO | MANual}

The :FUNction<F>:VERTical command sets the vertical scaling mode of the specified function to either AUTO or MANual.

This command also contains the following commands and queries:

- OFFset
- RANge

<F> An integer, 1-16, representing the selected function.

**Query** :FUNction<F>:VERTical?

The :FUNction<F>:VERTical? query returns the current vertical scaling mode of the specified function.

**Returned Format** [:FUNction<F>:VERTical] {AUTO | MANual}<NL>

**Example** This example places the current state of the vertical tracking of function 1 in the string variable, strSetting, then prints the contents of the variable to the computer's screen.

```
Dim strSetting As String ' Dimension variable.
myScope.WriteString ":FUNction1:VERTical?"
strSetting = myScope.ReadString
Debug.Print strSetting
```

**History** Legacy command (existed before version 3.10).

Version 4.30: Up to 16 functions supported.

## :FUNCTION&lt;F&gt;:VERTICAL:OFFSET

**Command** :FUNCTION<F>:VERTICAL:OFFSET <offset\_value>

The :FUNCTION<F>:VERTICAL:OFFSET command sets the voltage represented at center screen for the selected function. This automatically changes the mode from auto to manual.

<F> An integer, 1-16, representing the selected function.

<offset\_value> A real number for the vertical offset in the currently selected Y-axis units (normally volts). The offset value is limited only to being within the vertical range that can be represented by the function data.

**Query** :FUNCTION<F>:VERTICAL:OFFSET?

The :FUNCTION<F>:VERTICAL:OFFSET? query returns the current offset value of the selected function.

**Returned Format** [:FUNCTION<F>:VERTICAL:OFFSET] <offset\_value><NL>

**Example** This example places the current offset setting for function 2 in the numeric variable, varValue, then prints the contents to the computer's screen.

```
myScope.WriteString ":SYSTEM:HEADER OFF" ' Response headers off.
myScope.WriteString ":FUNCTION2:VERTICAL:OFFSET?"
varValue = myScope.ReadNumber
Debug.Print FormatNumber(varValue, 0)
```

**History** Legacy command (existed before version 3.10).

Version 4.30: Up to 16 functions supported.

## :FUNction&lt;F&gt;:VERTical:RANGe

**Command** :FUNction<F>:VERTical:RANGe <full\_scale\_range>

The :FUNction<F>:VERTical:RANGe command defines the full-scale vertical axis of the selected function. This automatically changes the mode from auto to manual, if the oscilloscope is not already in manual mode.

<F> An integer, 1-16, representing the selected function.

<full\_scale\_range> A real number for the full-scale vertical range, from -100E15 to 100E15.

**Query** :FUNction<F>:VERTical:RANGe?

The :FUNction<F>:VERTical:RANGe? query returns the current range setting of the specified function.

**Returned Format** [:FUNction<F>:VERTical:RANGe] <range><NL>

**Example** This example places the current vertical range setting of function 2 in the numeric variable, varValue, then prints the contents to the computer's screen.

```
myScope.WriteString ":SYSTEM:HEADer OFF" ' Response headers off.
myScope.WriteString ":FUNction2:VERTical:RANGe?"
varValue = myScope.ReadNumber
Debug.Print FormatNumber(varValue, 0)
```

**History** Legacy command (existed before version 3.10).

Version 4.30: Up to 16 functions supported.

**:FUNction<F>:VERTical:SIZE**

**Command** :FUNction<F>:VERTical:SIZE <size>

For the Histogram (Measurement) math function (see :FUNction<F>:MHIStogram), the :FUNction<F>:VERTical:SIZE command specifies the histogram's vertical size in divisions.

<size> The size is from 0.5 to 8.0 divisions.

**Query** :FUNction<F>:VERTical:SIZE?

The :FUNction<F>:VERTical:SIZE? query returns the measurement histogram vertical size setting.

**Returned Format** <size><NL>

**See Also** • [":FUNction<F>:MHIStogram"](#) on page 627

**History** New in version 6.73.

# 21 Hardcopy Commands

:HARDcopy:AREA / 646  
:HARDcopy:DPRinter / 647  
:HARDcopy:FACTors / 648  
:HARDcopy:IMAGe / 649  
:HARDcopy:PRINters? / 650

The HARDcopy subsystem commands set various parameters for printing the screen. The print sequence is activated when the root level command :PRINT is sent.

## :HARDcopy:AREA

**Command** :HARDcopy:AREA {GRATicule | SCReen}

The :HARDcopy:AREA command selects which data from the screen is to be printed. When you select GRATicule, only the graticule area of the screen is printed (this is the same as choosing Waveforms Only in the Configure Printer dialog box). When you select SCReen, the entire screen is printed.

**Example** This example selects the graticule for printing.

```
myScope.WriteString ":HARDcopy:AREA GRATicule"
```

**Query** :HARDcopy:AREA?

The :HARDcopy:AREA? query returns the current setting for the area of the screen to be printed.

**Returned Format** [:HARDcopy:AREA] {GRATicule | SCReen}<NL>

**Example** This example places the current selection for the area to be printed in the string variable, strSelection, then prints the contents of the variable to the computer's screen.

```
Dim strSelection As String ' Dimension variable.
myScope.WriteString ":HARDcopy:AREA?"
strSelection = myScope.ReadString
Debug.Print strSelection
```

**History** Legacy command (existed before version 3.10).

## :HARDcopy:DPRinter

**Command** :HARDcopy:DPRinter {<printer\_number> | <printer\_string>}

The :HARDcopy:DPRinter command selects the default printer to be used.

**<printer\_number>** An integer representing the attached printer. This number corresponds to the number returned with each printer name by the :HARDcopy:PRINTers? query.

**<printer\_string>** A string of alphanumeric characters representing the attached printer.

The :HARDcopy:DPRinter command specifies a number or string for the printer attached to the oscilloscope. The printer string must exactly match the character strings in the File->Print Setup dialog boxes, or the strings returned by the :HARDcopy:PRINTers? query.

**Examples** This example sets the default printer to the second installed printer returned by the :HARDcopy:PRINTers? query.

```
myScope.WriteString ":HARDcopy:DPRinter 2"
```

This example sets the default printer to the installed printer with the name "HP Laser".

```
myScope.WriteString ":HARDcopy:DPRinter \"HP Laser\""
```

**Query** :HARDcopy:DPRinter?

The :HARDcopy:DPRinter? query returns the current printer number and string.

**Returned Format** [:HARDcopy:DPRinter?] {<printer\_number>,<printer\_string>,DEFAULT}<NL>

Or, if there is no default printer (no printers are installed), only a <NL> is returned.

**Example** This example places the current setting for the hard copy printer in the string variable, strSetting, then prints the contents of the variable to the computer's screen.

```
Dim strSetting As String ' Dimension variable.
myScope.WriteString ":HARDcopy:DPRinter?"
strSetting = myScope.ReadString
Debug.Print strSetting
```

### NOTE

It takes several seconds to change the default printer. Any programs that try to set the default printer must wait (10 seconds is a safe amount of time) for the change to complete before sending other commands. Otherwise, the oscilloscope will become unresponsive.

**History** Legacy command (existed before version 3.10).

## :HARDcopy:FACTors

**Command** :HARDcopy:FACTors {{ON | 1} | {OFF | 0}}

The :HARDcopy:FACTors command determines whether the oscilloscope setup factors will be appended to screen or graticule images. FACTors ON is the same as choosing Include Setup Information in the Configure Printer dialog box.

**Example** This example turns on the setup factors.

```
myScope.WriteString ":HARDcopy:FACTors ON"
```

**Query** :HARDcopy:FACTors?

The :HARDcopy:FACTors? query returns the current setup factors setting.

**Returned Format** [:HARDcopy:FACTors] {1 | 0}<NL>

**Example** This example places the current setting for the setup factors in the string variable, strSetting, then prints the contents of the variable to the computer's screen.

```
Dim strSetting As String ' Dimension variable.
myScope.WriteString ":HARDcopy:FACTors?"
strSetting = myScope.ReadString
Debug.Print strSetting
```

**History** Legacy command (existed before version 3.10).



## :HARDcopy:IMAGe

**Command** :HARDcopy:IMAGe {NORMal | INVert}

The :HARDcopy:IMAGe command prints the image normally, inverted, or in monochrome. IMAGe INVert is the same as choosing Invert Waveform Colors in the Configure Printer dialog box.

**Example** This example sets the hard copy image output to normal.

```
myScope.WriteString ":HARDcopy:IMAGe NORMal"
```

**Query** :HARDcopy:IMAGe?

The :HARDcopy:IMAGe? query returns the current image setting.

**Returned Format** [:HARDcopy:IMAGe] {NORMal | INVert}<NL>

**Example** This example places the current setting for the hard copy image in the string variable, strSetting, then prints the contents of the variable to the computer's screen.

```
Dim strSetting As String ' Dimension variable.
myScope.WriteString ":HARDcopy:IMAGe?"
strSetting = myScope.ReadString
Debug.Print strSetting
```

**History** Legacy command (existed before version 3.10).

## :HARDcopy:PRINTers?

**Query** :HARDcopy:PRINTers?

The :HARDcopy:PRINTers? query returns the currently available printers.

**Returned Format** [:HARDcopy:PRINTers?]  
<printer\_count><NL><printer\_data><NL>[,<printer\_data><NL>]

<printer\_count> The number of printers currently installed.

<printer\_data> The printer number and the name of an installed printer. The word DEFAULT appears next to the printer that is the currently selected default printer.

The <printer\_data> return string has the following format:  
<printer\_number>,<printer\_string>{,DEFAULT}

**Example** This example places the number of installed printers into the variable varCount, loops through it that number of times, and prints the installed printer names to the computer's screen.

```
Dim varResults As Variant
Dim lngI As Long

myScope.WriteString ":HARDcopy:PRINTers?"
varResults = myScope.ReadList(ASCIIType_BSTR, vbLf)
Debug.Print FormatNumber(varResults(0), 0)

For lngI = 1 To varResults(0)
    Debug.Print CStr(varResults(lngI))
Next lngI
```

**History** Legacy command (existed before version 3.10).

## 22 Histogram Commands

:HISTogram:AXIS / 653  
:HISTogram:HORizontal:BINS / 654  
:HISTogram:MEASurement:BINS / 655  
:HISTogram:MEASurement:MAX / 656  
:HISTogram:MEASurement:MIN / 657  
:HISTogram:MODE / 658  
:HISTogram:SCALE:SIZE / 659  
:HISTogram:VERTical:BINS / 660  
:HISTogram:WINDow:DEFault / 661  
:HISTogram:WINDow:SOURce / 662  
:HISTogram:WINDow:LLIMit / 663  
:HISTogram:WINDow:RLIMit / 664  
:HISTogram:WINDow:BLIMit / 665  
:HISTogram:WINDow:TLIMit / 666

The HISTogram commands and queries control the histogram features. A histogram is a probability distribution that shows the distribution of acquired data within a user-definable histogram window.

You can display the histogram either vertically, for voltage measurements, or horizontally, for timing measurements.

The most common use for histograms is measuring and characterizing noise or jitter on displayed waveforms. Noise is measured by sizing the histogram window to a narrow portion of time and observing a vertical histogram that measures the noise on a waveform. Jitter is measured by sizing the histogram window to a narrow portion of voltage and observing a horizontal histogram that measures the jitter on an edge.

### Histograms and the database

The histograms, mask testing, and color grade persistence use a specific database that uses a different memory area from the waveform record for each channel. When any of these features are turned on, the oscilloscope starts building the database. The database is the size of the graticule area. Behind each pixel is a 21-bit counter that is incremented each time data from a channel or function hits a

pixel. The maximum count (saturation) for each counter is 2,097,151. You can use the `DISPlay:CGRade:LEVels` command to see if any of the counters are close to saturation.

The database continues to build until the oscilloscope stops acquiring data or all both features (color grade persistence and histograms) are turned off. You can clear the database by turning off all three features that use the database.

The database does not differentiate waveforms from different channels or functions. If three channels are on and the waveform from each channel happens to light the same pixel at the same time, the counter is incremented by three. However, it is not possible to tell how many hits came from each waveform. To separate waveforms, you can position the waveforms vertically with the channel offset. By separating the waveforms, you can avoid overlapping data in the database caused by multiple waveforms. Even if the display is set to show only the most recent acquisition, the database keeps track of all pixel hits while the database is building.

Remember that color grade persistence, mask testing, and histograms all use the same database. Suppose that the database is building because color grade persistence is ON; when mask testing or histograms are turned on, they can use the information already established in the database as though they had been turned on the entire time.

To avoid erroneous data, clear the display after you change oscilloscope setup conditions or DUT conditions and acquire new data before extracting measurement results.

## :HISTogram:AXIS

**Command** :HISTogram:AXIS {VERTical | HORizontal}

The :HISTogram:AXIS command selects the type of histogram. A horizontal histogram can be used to measure time related information like jitter. A vertical histogram can be used to measure voltage related information like noise.

**Example** This example defines a vertical histogram.

```
myScope.WriteString ":HISTogram:AXIS VERTical"
```

**Query** :HISTogram:AXIS?

The :HISTogram:AXIS? query returns the currently selected histogram type.

**Returned Format** [:HISTogram:AXIS] {VERTical | HORizontal}<NL>

**Example** This example returns the histogram type and prints it to the computer's screen.

```
Dim strAxis As String
myScope.WriteString ":HISTogram:AXIS?"
strAxis = myScope.ReadString
Debug.Print strAxis
```

**History** Legacy command (existed before version 3.10).

**:HISTogram:HORizontal:BINs**

**Command** :HISTogram:HORizontal:BINs <max\_bins>

<max\_bins> ::= integer from 10-1280

The :HISTogram:HORizontal:BINs command sets the maximum number of bins used for a horizontal waveform histogram.

**Query** :HISTogram:HORizontal:BINs?

The :HISTogram:HORizontal:BINs? query returns the maximum number of bins setting.

**Returned Format** <max\_bins><NL>

<max\_bins> ::= integer from 10-1280

- See Also**
- **":HISTogram:MODE"** on page 658
  - **":HISTogram:AXIS"** on page 653
  - **":HISTogram:MEASurement:BINs"** on page 655
  - **":HISTogram:VERTical:BINs"** on page 660

**History** New in version 5.20.

## :HISTogram:MEASurement:BINs

**Command** :HISTogram:MEASurement:BINs <max\_bins>

<max\_bins> ::= integer from 10-8000

The :HISTogram:MEASurement:BINs command sets the maximum number of bins used for a measurement histogram.

**Query** :HISTogram:MEASurement:BINs?

The :HISTogram:MEASurement:BINs? query returns the maximum number of bins setting.

**Returned Format** <max\_bins><NL>

<max\_bins> ::= integer from 10-8000

- See Also**
- **" :HISTogram:MODE "** on page 658
  - **" :HISTogram:AXIS "** on page 653
  - **" :HISTogram:HORizontal:BINs "** on page 654
  - **" :HISTogram:VERTical:BINs "** on page 660

**History** New in version 5.20.

## :HISTogram:MEASurement:MAX

**Command** :HISTogram:MEASurement:MAX {MAX | <max>}

<max> ::= measurement maximum floating-point value

The :HISTogram:MEASurement:MAX command specifies the histogram's measurement maximum. This is the upper bound of the histogram.

You can specify a <max> floating-point value, or if you want the measurement maximum to be automatically determined, use MAX.

**Query** :HISTogram:MEASurement:MAX?

The :HISTogram:MEASurement:MAX? query returns the specified measurement maximum value.

If MAX was specified, the value returned is 1.79769313486232E+308 (the highest 64-bit floating-point value).

**Returned Format** <max><NL>

**See Also** · [":HISTogram:MEASurement:MIN"](#) on page 657

**History** New in version 6.30.



## :HISTogram:MEASurement:MIN

**Command** :HISTogram:MEASurement:MIN {MIN | <min>}

<min> ::= measurement minimum floating-point value

The :HISTogram:MEASurement:MIN command specifies the histogram's measurement minimum. This is the lower bound of the histogram.

You can specify a <min> floating-point value, or if you want the measurement minimum to be automatically determined, use MIN.

**Query** :HISTogram:MEASurement:MIN?

The :HISTogram:MEASurement:MIN? query returns the specified measurement minimum value.

If MIN was specified, the value returned is -1.79769313486232E+308 (the lowest 64-bit floating-point value).

**Returned Format** <min><NL>

**See Also** · [":HISTogram:MEASurement:MAX"](#) on page 656

**History** New in version 6.30.

**:HISTogram:MODE**

**Command** :HISTogram:MODE {OFF | MEASurement | WAVeforms}

**NOTE**

The MEASurement parameter is available only when the Jitter Analysis Software license is installed.

The :HISTogram:MODE command selects the histogram mode. The histogram may be off, set to track the waveforms, or set to track the measurement when the Jitter Analysis Software license is installed. When the Jitter Analysis Software license is installed, sending the :MEASure:JITTer:HISTogram ON command will automatically set :HISTogram:MODE to MEASurement.

**Example** This example sets the histogram mode to track the waveform.

```
myScope.WriteString ":HISTogram:MODE WAVeform"
```

**Query** :HISTogram:MODE?

The :HISTogram:MODE? query returns the currently selected histogram mode.

**Returned Format** [:HISTogram:MODE] {OFF | MEASurement | WAVeform}<NL>

**Example** This example returns the result of the mode query and prints it to the computer's screen.

```
Dim strMode As String
myScope.WriteString ":HISTogram:MODE?"
strMode = myScope.ReadString
Debug.Print strMode
```

**History** Legacy command (existed before version 3.10).

## :HISTogram:SCALE:SIZE

**Command** :HISTogram:SCALE:SIZE <size>

The :HISTogram:SCALE:SIZE command sets histogram size for vertical and horizontal mode.

<size> The size is from 1.0 to 8.0 for the horizontal mode and from 1.0 to 10.0 for the vertical mode.

**Example** This example sets the histogram size to 3.5.

```
myScope.WriteString ":HISTogram:SCALE:SIZE 3.5"
```

**Query** :HISTogram:SCALE:SIZE?

The :HISTogram:SCALE:SIZE? query returns the correct size of the histogram.

**Returned Format** [:HISTogram:SCALE:SIZE] <size><NL>

**Example** This example returns the result of the size query and prints it to the computer's screen.

```
Dim strSize As String
myScope.WriteString ":HISTogram:SCALE:SIZE?"
strSize = myScope.ReadString
Debug.Print strSize
```

**History** Legacy command (existed before version 3.10).

## :HISTogram:VERTical:BINS

**Command** :HISTogram:VERTical:BINS <max\_bins>

<max\_bins> ::= integer from 10-1024

The :HISTogram:VERTical:BINS command sets the maximum number of bins used for a vertical waveform histogram.

**Query** :HISTogram:VERTical:BINS?

The :HISTogram:VERTical:BINS? query returns the maximum number of bins.

**Returned Format** <max\_bins><NL>

<max\_bins> ::= integer from 10-1024

- See Also**
- **"[:HISTogram:MODE](#)"** on page 658
  - **"[:HISTogram:AXIS](#)"** on page 653
  - **"[:HISTogram:HORizontal:BINS](#)"** on page 654
  - **"[:HISTogram:MEASurement:BINS](#)"** on page 655

**History** New in version 5.20.

## :HISTogram:WINDow:DEFault

**Command** :HISTogram:WINDow:DEFault

The :HISTogram:WINDow:DEFault command positions the histogram markers to a default location on the display. Each marker will be positioned one division off the left, right, top, and bottom of the display.

**Example** This example sets the histogram window to the default position.

```
myScope.WriteString ":HISTogram:WINDow:DEFault"
```

**History** Legacy command (existed before version 3.10).

**:HISTogram:WINDow:SOURce**

**Command** :HISTogram:WINDow:SOURce {CHANnel<N> | DIFF<D> | COMMONmode<C>  
 | FUNction<F> | WMEMory<R> | CLOCk | EQUalized<L> | MTRend  
 | MSPectrum | XT<X>}

The :HISTogram:WINDow:SOURce command selects the source of the histogram window. The histogram window will track the source's vertical and horizontal scale.

<N> An integer, 1-4 in a single oscilloscope, 1-40 in a MultiScope system.

<D>, <C> <D> is an integer, 1-2. <C> is an integer, 3-4.

The DIFF and COMMONmode sources are just aliases that can be used in place of the channel names to apply to differential or common mode signals. These are just aliases - no state change occurs if you refer to a differential channel and you are not in differential mode. DIFF1 refers to the differential signal between channels 1 and 3 (and COMMONmode3 refers to the common mode channel between these same channels). DIFF2 refers to the differential signal between channels 2 and 4 (and COMMONmode4 refers to the common mode channel between these same channels).

<F> An integer, 1-16.

<R> An integer, 1-4.

<L> An integer, 1-4.

<X> An integer, 1-4, identifying the crosstalk waveform.

**Example** This example sets the histogram window's source to Channel 1.

```
myScope.WriteString ":HISTogram:WINDow:SOURce CHANnel1"
```

**Query** :HISTogram:WINDow:SOURce?

The :HISTogram:WINDow:SOURce? query returns the currently selected histogram window source.

**Returned Format** [:HISTogram:WINDow:SOURce] {CHAN<N> | DIFF<D> | COMM<C> | FUNC<F>  
 | WMEM<N> | CLOC | EQU<L> | MTR | MSP | XT<X>}<NL>

**Example** This example returns the result of the window source query and prints it to the computer's screen.

```
Dim strWinsour As String
myScope.WriteString ":HISTogram:WINDow:SOURce?"
strWinsour = myScope.ReadString
Debug.Print strWinsour
```

**History** Legacy command (existed before version 3.10).

## :HISTogram:WINDow:LLIMit

**Command** :HISTogram:WINDow:LLIMit <left\_limit>

The :HISTogram:WINDow:LLIMit command moves the Ax marker (left limit) of the histogram window. The histogram window determines the portion of the display used to build the database for the histogram. The histogram window markers will track the scale of the histogram window source.

**<left\_limit>** A real number that represents the left boundary of the histogram window.

**Example** This example sets the left limit position to -200 microseconds.

```
myScope.WriteString ":HISTogram:WINDow:LLIMit -200E-6"
```

**Query** :HISTogram:WINDow:LLIMit?

The :HISTogram:WINDow:LLIMit? query returns the value of the left limit histogram window marker.

**Returned Format** [:HISTogram:WINDow:LLIMit] <left\_limit><NL>

**Example** This example returns the result of the left limit position query and prints it to the computer's screen.

```
Dim strLL As String
myScope.WriteString ":HISTogram:WINDow:LLIMit?"
strLL = myScope.ReadString
Debug.Print strLL
```

**History** Legacy command (existed before version 3.10).

**:HISTogram:WINDow:RLIMit**

**Command**     : HISTogram:WINDow:RLIMit <right\_limit>

The :HISTogram:WINDow:RLIMit command moves the Bx marker (right limit) of the histogram window. The histogram window determines the portion of the display used to build the database used for the histogram. The histogram window markers will track the scale of the histogram window source.

**<right\_limit>**   A real number that represents the right boundary of the histogram window.

**Example**       This example sets the Bx marker to 200 microseconds.

```
myScope.WriteString ":HISTogram:WINDow:RLIMit 200E-6"
```

**Query**         : HISTogram:WINDow:RLIMit?

The :HISTogram:WINDow:RLIMit? query returns the value of the right histogram window marker.

**Returned Format**   [:HISTogram:WINDow:RLIMit] <right\_limit><NL>

**Example**       This example returns the result of the Bx position query and prints it to the computer's screen.

```
Dim strRL As String
myScope.WriteString ":HISTogram:WINDow:RLIMit?"
strRL = myScope.ReadString
Debug.Print strRL
```

**History**       Legacy command (existed before version 3.10).



## :HISTogram:WINDow:BLIMit

**Command** :HISTogram:WINDow:BLIMit <bottom\_limit>

The :HISTogram:WINDow:BLIMit command moves the Ay marker (bottom limit) of the histogram window. The histogram window determines the portion of the display used to build the database used for the histogram. The histogram window markers will track the scale of the histogram window source.

<bottom\_limit> A real number that represents the bottom boundary of the histogram window.

**Example** This example sets the position of the Ay marker to -250 mV.

```
myScope.WriteString ":HISTogram:WINDow:BLIMit -250E-3"
```

**Query** :HISTogram:WINDow:BLIMit?

The :HISTogram:WINDow:BLIMit? query returns the value of the Ay histogram window marker.

**Returned Format** [:HISTogram:WINDow:BLIMit] <bottom\_limit><NL>

**Example** This example returns the result of the Ay position query and prints it to the computer's screen.

```
Dim strBL As String
myScope.WriteString ":HISTogram:WINDow:BLIMit?"
strBL = myScope.ReadString
Debug.Print strBL
```

**History** Legacy command (existed before version 3.10).

**:HISTogram:WINDow:TLIMit**

**Command**     : HISTogram:WINDow:TLIMit <top\_limit>

The :HISTogram:WINDow:TLIMit command moves the By marker (top limit) of the histogram window. The histogram window determines the portion of the display used to build the database used for the histogram. The histogram window markers will track the scale of the histogram window source.

<top\_limit>    A real number that represents the top boundary of the histogram window.

**Example**     This example sets the position of the By marker to 250 mV.

```
myScope.WriteString ":HISTogram:WINDow:TLIMit 250E-3"
```

**Query**       : HISTogram:WINDow:TLIMit?

The :HISTogram:WINDow:TLIMit? query returns the value of the By histogram window marker.

**Returned Format**   [:HISTogram:WINDow:TLIMit] <top\_limit><NL>

**Example**     This example returns the result of the By position query and prints it to the computer's screen.

```
Dim strTL As String
myScope.WriteString ":HISTogram:WINDow:TLIMit?"
strTL = myScope.ReadString
Debug.Print strTL
```

**History**     Legacy command (existed before version 3.10).

## 23 Hosted Commands

:HOSTed:CALibrate:CALibrate / 669  
:HOSTed:CALibrate:CHANnel / 670  
:HOSTed:CALibrate:DESKew:CHANnels / 671  
:HOSTed:CALibrate:DESKew:FRAMes / 672  
:HOSTed:CALibrate:DESKew:SIGNals / 673  
:HOSTed:CALibrate:DESKew:ZERO / 674  
:HOSTed:CALibrate:LEVel / 675  
:HOSTed:CALibrate:PROMpt / 677  
:HOSTed:CALibrate:STATus:CHANnels? / 678  
:HOSTed:CALibrate:STATus:FRAMes? / 679  
:HOSTed:CALibrate:STATus:LEVel? / 680  
:HOSTed:CALibrate:STATus:SIGNals? / 681  
:HOSTed:CALibrate:TREF:DETECT / 682  
:HOSTed:FOLLower<N>:ACHannels? / 683  
:HOSTed:FOLLower<N>:CONFigure / 684  
:HOSTed:FOLLower<N>:CONNect / 685  
:HOSTed:FOLLower<N>:DISConnect / 686  
:HOSTed:LEADer:ACHannels? / 687  
:HOSTed:LEADer:CONFigure / 688  
:HOSTed:LEADer:CONNect / 689  
:HOSTed:LEADer:DISConnect / 690  
:HOSTed:NCONnected? / 691  
:HOSTed:PERiodic / 692

The commands in the HOSTed subsystem are used to configure and manage the list of oscilloscopes in a MultiScope system.

MultiScope systems can combine up to 10 Infiniium oscilloscopes to create an oscilloscope system with up to 40 time-synchronized channels.

In a MultiScope system, oscilloscopes are connected in daisy-chain configuration where the reference clock output of the Leader oscilloscope is connected to the reference clock input of the Follower 1 oscilloscope and the trigger output of the Leader oscilloscope is connected to the auxiliary trigger input of the Follower 1 oscilloscope, and so on. A calibration signal from one of the Follower 1 oscilloscopes is split and fed into a channel input on all the oscilloscopes to set up time-correlation.

For more information on MultiScope systems, see:

- The *Keysight MultiScope Hardware Configuration Guide*.
- The online help in the Infiniium Offline software.

## :HOSTed:CALibrate:CALibrate

**Command** :HOSTed:CALibrate:CALibrate

The :HOSTed:CALibrate:CALibrate command performs the MultiScope system time-correlation calibration at the level selected by :HOSTed:CALibrate:LEVel.

This command does nothing when the MANual level is selected.

To get the status of the calibration, use the :HOSTed:CALibrate:STATus:LEVel? query.

- See Also**
- [":HOSTed:CALibrate:CHANnel"](#) on page 670
  - [":HOSTed:CALibrate:DESKew:FRAMes"](#) on page 672
  - [":HOSTed:CALibrate:DESKew:CHANnels"](#) on page 671
  - [":HOSTed:CALibrate:DESKew:SIGNals"](#) on page 673
  - [":HOSTed:CALibrate:DESKew:ZERO"](#) on page 674
  - [":HOSTed:CALibrate:LEVel"](#) on page 675
  - [":HOSTed:CALibrate:PROMpt"](#) on page 677
  - [":HOSTed:CALibrate:STATus:CHANnels?"](#) on page 678
  - [":HOSTed:CALibrate:STATus:FRAMes?"](#) on page 679
  - [":HOSTed:CALibrate:STATus:LEVel?"](#) on page 680
  - [":HOSTed:CALibrate:STATus:SIGNals?"](#) on page 681
  - [":HOSTed:CALibrate:TREF:DETECT"](#) on page 682

**History** New in version 5.50.

## :HOSTed:CALibrate:CHANnel

**Command** :HOSTed:CALibrate:CHANnel <source>

<source> ::= CHANnel<N>

The :HOSTed:CALibrate:CHANnel command selects the calibration channel or synchronization input where the MultiScope system time-correlation procedures expect to find the calibration signal.

This signal comes from the Follower 1 oscilloscope's calibrator output and is split and fed into the calibration channel on each oscilloscope in the MultiScope system.

<N> An integer, 1–4.

**Query** :HOSTed:CALibrate:CHANnel?

The :HOSTed:CALibrate:CHANnel? query returns the selected the calibration channel or synchronization input.

**Returned Format** [:HOSTed:CALibrate:CHANnel] <source><NL>

<source> ::= CHAN<N>

- See Also**
- [":HOSTed:CALibrate:CALibrate"](#) on page 669
  - [":HOSTed:CALibrate:DESKew:FRAMES"](#) on page 672
  - [":HOSTed:CALibrate:DESKew:CHANnels"](#) on page 671
  - [":HOSTed:CALibrate:DESKew:SIGNals"](#) on page 673
  - [":HOSTed:CALibrate:DESKew:ZERO"](#) on page 674
  - [":HOSTed:CALibrate:LEVel"](#) on page 675
  - [":HOSTed:CALibrate:PROMpt"](#) on page 677
  - [":HOSTed:CALibrate:STATus:CHANnels?"](#) on page 678
  - [":HOSTed:CALibrate:STATus:FRAMES?"](#) on page 679
  - [":HOSTed:CALibrate:STATus:LEVel?"](#) on page 680
  - [":HOSTed:CALibrate:STATus:SIGNals?"](#) on page 681
  - [":HOSTed:CALibrate:TREF:DETECT"](#) on page 682

**History** New in version 5.50.

## :HOSTed:CALibrate:DESKew:CHANnels

**Command** :HOSTed:CALibrate:DESKew:CHANnels

The :HOSTed:CALibrate:DESKew:CHANnels command deskews all channels in the MultiScope system. The calibration process prompts you to connect the Leader oscilloscope's Cal Out signal to each of the system's input channels in turn.

To get the status of the calibration, use the :HOSTed:CALibrate:STATus:CHANnels? query.

- See Also**
- [":HOSTed:CALibrate:CALibrate"](#) on page 669
  - [":HOSTed:CALibrate:CHANnel"](#) on page 670
  - [":HOSTed:CALibrate:DESKew:FRAMes"](#) on page 672
  - [":HOSTed:CALibrate:DESKew:SIGNals"](#) on page 673
  - [":HOSTed:CALibrate:DESKew:ZERO"](#) on page 674
  - [":HOSTed:CALibrate:LEVel"](#) on page 675
  - [":HOSTed:CALibrate:PROMpt"](#) on page 677
  - [":HOSTed:CALibrate:STATus:CHANnels?"](#) on page 678
  - [":HOSTed:CALibrate:STATus:FRAMes?"](#) on page 679
  - [":HOSTed:CALibrate:STATus:LEVel?"](#) on page 680
  - [":HOSTed:CALibrate:STATus:SIGNals?"](#) on page 681
  - [":HOSTed:CALibrate:TREF:DETECT"](#) on page 682

**History** New in version 5.50.

## :HOSTed:CALibrate:DESKew:FRAMes

**Command** :HOSTed:CALibrate:DESKew:FRAMes

The :HOSTed:CALibrate:DESKew:FRAMes command deskews frames in the MultiScope system by measuring only one input channel from each oscilloscope frame. It assumes that the skew of all channels within a single oscilloscope frame is the same since they were deskewed in production.

To get the status of the calibration, use the :HOSTed:CALibrate:STATus:FRAMes? query.

- See Also**
- [":HOSTed:CALibrate:CALibrate"](#) on page 669
  - [":HOSTed:CALibrate:CHANnel"](#) on page 670
  - [":HOSTed:CALibrate:DESKew:CHANnels"](#) on page 671
  - [":HOSTed:CALibrate:DESKew:SIGNals"](#) on page 673
  - [":HOSTed:CALibrate:DESKew:ZERO"](#) on page 674
  - [":HOSTed:CALibrate:LEVel"](#) on page 675
  - [":HOSTed:CALibrate:PROMpt"](#) on page 677
  - [":HOSTed:CALibrate:STATus:CHANnels?"](#) on page 678
  - [":HOSTed:CALibrate:STATus:FRAMes?"](#) on page 679
  - [":HOSTed:CALibrate:STATus:LEVel?"](#) on page 680
  - [":HOSTed:CALibrate:STATus:SIGNals?"](#) on page 681
  - [":HOSTed:CALibrate:TREF:DETECT"](#) on page 682

**History** New in version 5.50.



## :HOSTed:CALibrate:DESKew:SIGNals

**Command** :HOSTed:CALibrate:DESKew:SIGNals

Given a common edge on configured channels in the MultiScope system, send the :HOSTed:CALibrate:DESKew:SIGNals command to align the horizontal positions of the closest rising edges of all input signals.

This is typically used for demonstration or quick verification purposes, but can also be a quick alternative to the system deskew process if your SUT (signals under test) are already connected and have the necessary rising edges.

To get the status of the calibration, use the :HOSTed:CALibrate:STATus:SIGNals? query.

- See Also**
- [":HOSTed:CALibrate:CALibrate"](#) on page 669
  - [":HOSTed:CALibrate:CHANnel"](#) on page 670
  - [":HOSTed:CALibrate:DESKew:FRAMES"](#) on page 672
  - [":HOSTed:CALibrate:DESKew:CHANnels"](#) on page 671
  - [":HOSTed:CALibrate:DESKew:ZERO"](#) on page 674
  - [":HOSTed:CALibrate:LEVel"](#) on page 675
  - [":HOSTed:CALibrate:PROMpt"](#) on page 677
  - [":HOSTed:CALibrate:STATus:CHANnels?"](#) on page 678
  - [":HOSTed:CALibrate:STATus:FRAMES?"](#) on page 679
  - [":HOSTed:CALibrate:STATus:LEVel?"](#) on page 680
  - [":HOSTed:CALibrate:STATus:SIGNals?"](#) on page 681
  - [":HOSTed:CALibrate:TREF:DETECT"](#) on page 682

**History** New in version 5.50.

## :HOSTed:CALibrate:DESKew:ZERO

**Command** :HOSTed:CALibrate:DESKew:ZERO

The :HOSTed:CALibrate:DESKew:ZERO command resets MultiScope system signal skew values to zero.

This is provided as a convenience because the skew values are distributed across all channels of all oscilloscope frames and are not changed by setup recall or default setup. Factory default setup does set all skew values to zero, but it must be performed on all oscilloscope frames.

- See Also**
- [":HOSTed:CALibrate:CALibrate"](#) on page 669
  - [":HOSTed:CALibrate:CHANnel"](#) on page 670
  - [":HOSTed:CALibrate:DESKew:FRAMES"](#) on page 672
  - [":HOSTed:CALibrate:DESKew:CHANnels"](#) on page 671
  - [":HOSTed:CALibrate:DESKew:SIGNals"](#) on page 673
  - [":HOSTed:CALibrate:LEVel"](#) on page 675
  - [":HOSTed:CALibrate:PROMpt"](#) on page 677
  - [":HOSTed:CALibrate:STATus:CHANnels?"](#) on page 678
  - [":HOSTed:CALibrate:STATus:FRAMES?"](#) on page 679
  - [":HOSTed:CALibrate:STATus:LEVel?"](#) on page 680
  - [":HOSTed:CALibrate:STATus:SIGNals?"](#) on page 681
  - [":HOSTed:CALibrate:TREF:DETECT"](#) on page 682

**History** New in version 5.50.

## :HOSTed:CALibrate:LEVel

**Command** :HOSTed:CALibrate:LEVel <level>

<level> ::= {MANual | BASic | PRECision}

The :HOSTed:CALibrate:LEVel command selects the MultiScope system calibration level:

- **MANual** – No time-correlation calibration is performed. However, you can still:
  - Capture and view signals in the MultiScope system.
  - Phase-lock the timebase reference clocks of the oscilloscopes in the MultiScope system.
  - Input a calibration signal to the oscilloscopes and manually measure the time skew between oscilloscope frames.
  - Manually enter skew values for waveforms to align them in time.
- **BASic** – The time-correlation calibration procedure automates all the time calibration steps you could perform manually.

The calibration output from the Follower 1 oscilloscope is split and fed into the calibration channel on each oscilloscope in the MultiScope system.

After the basic calibration is performed, you can disconnect the calibration channel on each oscilloscope and use it as a normal input channel.

- **PRECision** – Select this calibration level if you want to perform jitter and drift time correction between the oscilloscopes in the MultiScope system. This calibration level gives you the highest time accuracy because jitter and drift calibrations continue to be made as the oscilloscopes acquire data.

For this calibration level, the calibration channel must remain connected during normal operation.

To perform the MultiScope system time-correlation calibration at the BASic or PRECision levels, send the :HOSTed:CALibrate:CALibrate command.

**Query** :HOSTed:CALibrate:LEVel?

The :HOSTed:CALibrate:LEVel? query returns the selected calibration level.

**Returned Format** [:HOSTed:CALibrate:LEVel] <level><NL>

<level> ::= {MAN | BAS | PREC}

- See Also**
- [":HOSTed:CALibrate:CALibrate"](#) on page 669
  - [":HOSTed:CALibrate:CHANnel"](#) on page 670
  - [":HOSTed:CALibrate:DESKew:FRAMES"](#) on page 672
  - [":HOSTed:CALibrate:DESKew:CHANnels"](#) on page 671
  - [":HOSTed:CALibrate:DESKew:SIGNals"](#) on page 673
  - [":HOSTed:CALibrate:DESKew:ZERO"](#) on page 674

- `":HOSTed:CALibrate:PROMpt"` on page 677
- `":HOSTed:CALibrate:STATus:CHANnels?"` on page 678
- `":HOSTed:CALibrate:STATus:FRAMes?"` on page 679
- `":HOSTed:CALibrate:STATus:LEVel?"` on page 680
- `":HOSTed:CALibrate:STATus:SIGNals?"` on page 681
- `":HOSTed:CALibrate:TREF:DETect"` on page 682

**History** New in version 5.50.

## :HOSTed:CALibrate:PROMpt

**Command** :HOSTed:CALibrate:PROMpt {{0 | OFF} | {1 | ON}}

The :HOSTed:CALibrate:PROMpt command specifies whether the user interface software prompts you to make the proper connections while the MultiScope system calibration runs.

You can select OFF when you know required connections have already been made and you do not want to be prompted to make them.

**Query** :HOSTed:CALibrate:PROMpt?

The :HOSTed:CALibrate:PROMpt? query returns the setting.

**Returned Format** [:HOSTed:CALibrate:PROMpt] <setting><NL>  
<setting> ::= {0 | 1}

- See Also**
- [":HOSTed:CALibrate:CALibrate"](#) on page 669
  - [":HOSTed:CALibrate:CHANnel"](#) on page 670
  - [":HOSTed:CALibrate:DESKew:FRAMES"](#) on page 672
  - [":HOSTed:CALibrate:DESKew:CHANnels"](#) on page 671
  - [":HOSTed:CALibrate:DESKew:SIGNals"](#) on page 673
  - [":HOSTed:CALibrate:DESKew:ZERO"](#) on page 674
  - [":HOSTed:CALibrate:LEVel"](#) on page 675
  - [":HOSTed:CALibrate:STATus:CHANnels?"](#) on page 678
  - [":HOSTed:CALibrate:STATus:FRAMES?"](#) on page 679
  - [":HOSTed:CALibrate:STATus:LEVel?"](#) on page 680
  - [":HOSTed:CALibrate:STATus:SIGNals?"](#) on page 681
  - [":HOSTed:CALibrate:TREF:DETECT"](#) on page 682

**History** New in version 5.50.

## :HOSTed:CALibrate:STATus:CHANnels?

**Query** :HOSTed:CALibrate:STATus:CHANnels?

The :HOSTed:CALibrate:STATus:CHANnels? query returns the MultiScope system calibration status of "Deskew Channels" (see :HOSTed:CALibrate:DESKew:CHANnels).

**Returned Format** <status><NL>

<status>	Status Description
UNAVAILABLE	Configuration is incompatible. This could be because: <ul style="list-style-type: none"> <li>▪ There are insufficient connections</li> <li>▪ Manual Calibration is selected</li> </ul>
NOTAPPLIED	The deskew is available, but not currently done.
PASSED	Calibration completed and passed.
INPROGRESS	Calibration is in progress.

Nothing is applied for a status result other than PASSED.

- See Also**
- [":HOSTed:CALibrate:CALibrate"](#) on page 669
  - [":HOSTed:CALibrate:CHANnel"](#) on page 670
  - [":HOSTed:CALibrate:DESKew:FRAMES"](#) on page 672
  - [":HOSTed:CALibrate:DESKew:CHANnels"](#) on page 671
  - [":HOSTed:CALibrate:DESKew:SIGNals"](#) on page 673
  - [":HOSTed:CALibrate:DESKew:ZERO"](#) on page 674
  - [":HOSTed:CALibrate:LEVel"](#) on page 675
  - [":HOSTed:CALibrate:PROMpt"](#) on page 677
  - [":HOSTed:CALibrate:STATus:FRAMES?"](#) on page 679
  - [":HOSTed:CALibrate:STATus:LEVel?"](#) on page 680
  - [":HOSTed:CALibrate:STATus:SIGNals?"](#) on page 681
  - [":HOSTed:CALibrate:TREF:DETECT"](#) on page 682

**History** New in version 5.50.

## :HOSTed:CALibrate:STATus:FRAMes?

**Query** :HOSTed:CALibrate:STATus:FRAMes?

The :HOSTed:CALibrate:STATus:FRAMes? query returns the MultiScope system calibration status of "Deskew Frames" (see :HOSTed:CALibrate:DESKew:FRAMes).

**Returned Format** <status><NL>

<status>	Status Description
UNAVAILABLE	Configuration is incompatible. This could be because: <ul style="list-style-type: none"> <li>▪ There are insufficient connections</li> <li>▪ Manual Calibration is selected</li> </ul>
NOTAPPLIED	The deskew is available, but not currently done.
PASSED	Calibration completed and passed.
INPROGRESS	Calibration is in progress.

Nothing is applied for a status result other than PASSED.

- See Also**
- [":HOSTed:CALibrate:CALibrate"](#) on page 669
  - [":HOSTed:CALibrate:CHANnel"](#) on page 670
  - [":HOSTed:CALibrate:DESKew:FRAMes"](#) on page 672
  - [":HOSTed:CALibrate:DESKew:CHANnels"](#) on page 671
  - [":HOSTed:CALibrate:DESKew:SIGNals"](#) on page 673
  - [":HOSTed:CALibrate:DESKew:ZERO"](#) on page 674
  - [":HOSTed:CALibrate:LEVel"](#) on page 675
  - [":HOSTed:CALibrate:PROMpt"](#) on page 677
  - [":HOSTed:CALibrate:STATus:CHANnels?"](#) on page 678
  - [":HOSTed:CALibrate:STATus:LEVel?"](#) on page 680
  - [":HOSTed:CALibrate:STATus:SIGNals?"](#) on page 681
  - [":HOSTed:CALibrate:TREF:DETECT"](#) on page 682

**History** New in version 5.50.

## :HOSTed:CALibrate:STATus:LEVel?

**Query** :HOSTed:CALibrate:STATus:LEVel?

The :HOSTed:CALibrate:STATus:LEVel? query returns the MultiScope system calibration status of the currently selected calibration level (see :HOSTed:CALibrate:LEVel and :HOSTed:CALibrate:CALibrate).

**Returned Format** <status><NL>

<status>	Status Description
FAILED	Calibration completed and failed.
PASSED	Calibration completed and passed.
INPROGRESS	Calibration is in progress.

- See Also**
- [":HOSTed:CALibrate:CALibrate"](#) on page 669
  - [":HOSTed:CALibrate:CHANnel"](#) on page 670
  - [":HOSTed:CALibrate:DESKew:FRAMes"](#) on page 672
  - [":HOSTed:CALibrate:DESKew:CHANnels"](#) on page 671
  - [":HOSTed:CALibrate:DESKew:SIGNals"](#) on page 673
  - [":HOSTed:CALibrate:DESKew:ZERO"](#) on page 674
  - [":HOSTed:CALibrate:LEVel"](#) on page 675
  - [":HOSTed:CALibrate:PROMpt"](#) on page 677
  - [":HOSTed:CALibrate:STATus:CHANnels?"](#) on page 678
  - [":HOSTed:CALibrate:STATus:FRAMes?"](#) on page 679
  - [":HOSTed:CALibrate:STATus:SIGNals?"](#) on page 681
  - [":HOSTed:CALibrate:TREF:DETECT"](#) on page 682

**History** New in version 5.50.



## :HOSTed:CALibrate:STATus:SIGNals?

**Query** :HOSTed:CALibrate:STATus:SIGNals?

The :HOSTed:CALibrate:STATus:SIGNals? query returns the MultiScope system calibration status of "Deskew Signals" (see :HOSTed:CALibrate:DESKew:SIGNals).

**Returned Format** <status><NL>

<status>	Status Description
UNAVAILABLE	Configuration is incompatible. This could be because: <ul style="list-style-type: none"> <li>▪ There are insufficient connections</li> <li>▪ Manual Calibration is selected</li> </ul>
NOTAPPLIED	The deskew is available, but not currently done.
PASSED	Calibration completed and passed.
INPROGRESS	Calibration is in progress.

Nothing is applied for a status result other than PASSED.

- See Also**
- [":HOSTed:CALibrate:CALibrate"](#) on page 669
  - [":HOSTed:CALibrate:CHANnel"](#) on page 670
  - [":HOSTed:CALibrate:DESKew:FRAMes"](#) on page 672
  - [":HOSTed:CALibrate:DESKew:CHANnels"](#) on page 671
  - [":HOSTed:CALibrate:DESKew:SIGNals"](#) on page 673
  - [":HOSTed:CALibrate:DESKew:ZERO"](#) on page 674
  - [":HOSTed:CALibrate:LEVel"](#) on page 675
  - [":HOSTed:CALibrate:PROMpt"](#) on page 677
  - [":HOSTed:CALibrate:STATus:CHANnels?"](#) on page 678
  - [":HOSTed:CALibrate:STATus:FRAMes?"](#) on page 679
  - [":HOSTed:CALibrate:STATus:LEVel?"](#) on page 680
  - [":HOSTed:CALibrate:TREF:DETECT"](#) on page 682

**History** New in version 5.50.

## :HOSTed:CALibrate:TREF:DETECT

**Command** :HOSTed:CALibrate:TREF:DETECT

When the MultiScope system's timebase reference clock status is unlocked, or after you have changed reference clock connections between oscilloscopes, send the :HOSTed:CALibrate:TREF:DETECT command to automatically detect the reference clock connection between oscilloscopes.

Running the BASic or PRECision calibrations (see :HOSTed:CALibrate:LEVel) will automatically detect the timebase reference clock. In the MANual calibration level, you can send the :HOSTed:CALibrate:TREF:DETECT command.

- See Also**
- [":HOSTed:CALibrate:CALibrate"](#) on page 669
  - [":HOSTed:CALibrate:CHANnel"](#) on page 670
  - [":HOSTed:CALibrate:DESKew:FRAMES"](#) on page 672
  - [":HOSTed:CALibrate:DESKew:CHANnels"](#) on page 671
  - [":HOSTed:CALibrate:DESKew:SIGNals"](#) on page 673
  - [":HOSTed:CALibrate:DESKew:ZERO"](#) on page 674
  - [":HOSTed:CALibrate:LEVel"](#) on page 675
  - [":HOSTed:CALibrate:PROMpt"](#) on page 677
  - [":HOSTed:CALibrate:STATus:CHANnels?"](#) on page 678
  - [":HOSTed:CALibrate:STATus:FRAMES?"](#) on page 679
  - [":HOSTed:CALibrate:STATus:LEVel?"](#) on page 680
  - [":HOSTed:CALibrate:STATus:SIGNals?"](#) on page 681

**History** New in version 5.50.

## :HOSTed:FOLLower&lt;N&gt;:ACHannels?

**Query** :HOSTed:FOLLower<N>:ACHannels?

The :HOSTed:FOLLower<N>:ACHannels? query returns the channel numbers assigned to a Follower oscilloscope in a MultiScope system. There can be up to 9 Follower oscilloscopes in a MultiScope system.

<N> An integer, 1-9.

**Returned Format** <channel\_range><NL>

<channel\_range> ::= range of channel numbers, for example, 5-8

- See Also**
- [":HOSTed:NCONnected?"](#) on page 691
  - [":HOSTed:FOLLower<N>:CONFigure"](#) on page 684
  - [":HOSTed:FOLLower<N>:CONNect"](#) on page 685
  - [":HOSTed:FOLLower<N>:DISConnect"](#) on page 686
  - [":HOSTed:LEADer:ACHannels?"](#) on page 687
  - [":HOSTed:LEADer:CONFigure"](#) on page 688
  - [":HOSTed:LEADer:CONNect"](#) on page 689
  - [":HOSTed:LEADer:DISConnect"](#) on page 690

**History** New in version 5.50.

## :HOSTed:FOLLower&lt;N&gt;:CONFigure

**Command** :HOSTed:FOLLower<N>:CONFigure {"<instrument\_VISA\_string>"  
| "Simulated Instrument"}

The :HOSTed:FOLLower<N>:CONFigure command identifies a Follower oscilloscope in a MultiScope system by its VISA address. There can be up to 9 Follower oscilloscopes in a MultiScope system.

You can also configure a "Simulated Instrument" to set up simulated waveforms. For more information, see **":CHANnel<N>:SIMulation:WAVEform"** on page 446.

<N> An integer, 1-9.

**Example** This example identifies the oscilloscope whose VISA address is "TCPIP0::141.121.237.226::inst0::INSTR" as the Follower 1 oscilloscope.

```
myScope.WriteString ":HOSTed:FOLLower1:CONFigure 'TCPIP0::141.121.237.226::inst0::INSTR' "
```

**See Also**

- **":HOSTed:FOLLower<N>:ACHannels?"** on page 683
- **":HOSTed:FOLLower<N>:CONNect"** on page 685
- **":HOSTed:FOLLower<N>:DISConnect"** on page 686
- **":HOSTed:LEADer:ACHannels?"** on page 687
- **":HOSTed:LEADer:CONFigure"** on page 688
- **":HOSTed:LEADer:CONNect"** on page 689
- **":HOSTed:LEADer:DISConnect"** on page 690
- **":CHANnel<N>:SIMulation:WAVEform"** on page 446

**History** New in version 5.50.

Version 6.00: Added the ability to configure a "Simulated Instrument" to set up simulated waveforms.

## :HOSTed:FOLLower<N>:CONNect

**Command** :HOSTed:FOLLower<N>:CONNect

The :HOSTed:FOLLower<N>:CONNect command opens the connection to a Follower oscilloscope in a MultiScope system. There can be up to 9 Follower oscilloscopes in a MultiScope system.

<N> An integer, 1–9.

- See Also**
- [":HOSTed:FOLLower<N>:ACHannels?"](#) on page 683
  - [":HOSTed:FOLLower<N>:CONFigure"](#) on page 684
  - [":HOSTed:FOLLower<N>:DISConnect"](#) on page 686
  - [":HOSTed:LEADer:ACHannels?"](#) on page 687
  - [":HOSTed:LEADer:CONFigure"](#) on page 688
  - [":HOSTed:LEADer:CONNect"](#) on page 689
  - [":HOSTed:LEADer:DISConnect"](#) on page 690

**History** New in version 5.50.

## :HOSTed:FOLLower<N>:DISConnect

**Command** :HOSTed:FOLLower<N>:DISConnect

The :HOSTed:FOLLower<N>:DISConnect command closes the connection to a Follower oscilloscope in a MultiScope system. There can be up to 9 Follower oscilloscopes in a MultiScope system.

<N> An integer, 1–9.

- See Also**
- [":HOSTed:FOLLower<N>:ACHannels?"](#) on page 683
  - [":HOSTed:FOLLower<N>:CONFigure"](#) on page 684
  - [":HOSTed:FOLLower<N>:CONNect"](#) on page 685
  - [":HOSTed:LEADer:ACHannels?"](#) on page 687
  - [":HOSTed:LEADer:CONFigure"](#) on page 688
  - [":HOSTed:LEADer:CONNect"](#) on page 689
  - [":HOSTed:LEADer:DISConnect"](#) on page 690

**History** New in version 5.50.

## :HOSTed:LEADer:ACHannels?

**Query** :HOSTed:LEADer:ACHannels?

The :HOSTed:LEADer:ACHannels? query returns the channel numbers assigned to the Leader oscilloscope in a MultiScope system.

**Returned Format** <channel\_range><NL>

<channel\_range> ::= range of channel numbers, for example, 1-4

- See Also**
- [":HOSTed:NCONnected?"](#) on page 691
  - [":HOSTed:LEADer:CONFigure"](#) on page 688
  - [":HOSTed:LEADer:CONNect"](#) on page 689
  - [":HOSTed:LEADer:DISConnect"](#) on page 690
  - [":HOSTed:FOLLower<N>:ACHannels?"](#) on page 683
  - [":HOSTed:FOLLower<N>:CONFigure"](#) on page 684
  - [":HOSTed:FOLLower<N>:CONNect"](#) on page 685
  - [":HOSTed:FOLLower<N>:DISConnect"](#) on page 686

**History** New in version 5.50.

## :HOSTed:LEADer:CONFigure

**Command** :HOSTed:LEADer:CONFigure "<instrument\_VISA\_string>"

The :HOSTed:LEADer:CONFigure command identifies the Leader oscilloscope in a MultiScope system by its VISA address.

**Example** This example identifies the oscilloscope whose VISA address is "TCPIP0::141.121.238.47::inst0::INSTR" as the Leader oscilloscope.

```
myScope.WriteString ":HOSTed:LEADer:CONFigure 'TCPIP0::141.121.238.47::inst0::INSTR' "
```

- See Also**
- [":HOSTed:LEADer:ACHannels?"](#) on page 687
  - [":HOSTed:LEADer:CONNect"](#) on page 689
  - [":HOSTed:LEADer:DISConnect"](#) on page 690
  - [":HOSTed:FOLLower<N>:ACHannels?"](#) on page 683
  - [":HOSTed:FOLLower<N>:CONFigure"](#) on page 684
  - [":HOSTed:FOLLower<N>:CONNect"](#) on page 685
  - [":HOSTed:FOLLower<N>:DISConnect"](#) on page 686

**History** New in version 5.50.



## :HOSTed:LEADer:CONNect

**Command** :HOSTed:LEADer:CONNect

The :HOSTed:LEADer:CONNect command opens the connection to the Leader oscilloscope in a MultiScope system.

- See Also**
- [":HOSTed:LEADer:ACHannels?"](#) on page 687
  - [":HOSTed:LEADer:CONFigure"](#) on page 688
  - [":HOSTed:LEADer:DISConnect"](#) on page 690
  - [":HOSTed:FOLLower<N>:ACHannels?"](#) on page 683
  - [":HOSTed:FOLLower<N>:CONFigure"](#) on page 684
  - [":HOSTed:FOLLower<N>:CONNect"](#) on page 685
  - [":HOSTed:FOLLower<N>:DISConnect"](#) on page 686

**History** New in version 5.50.

## :HOSTed:LEADer:DISConnect

**Command** :HOSTed:LEADer:DISConnect

The :HOSTed:LEADer:DISConnect command closes the connection to the Leader oscilloscope in a MultiScope system.

- See Also**
- [":HOSTed:LEADer:ACHannels?"](#) on page 687
  - [":HOSTed:LEADer:CONFigure"](#) on page 688
  - [":HOSTed:LEADer:CONNect"](#) on page 689
  - [":HOSTed:FOLLower<N>:ACHannels?"](#) on page 683
  - [":HOSTed:FOLLower<N>:CONFigure"](#) on page 684
  - [":HOSTed:FOLLower<N>:CONNect"](#) on page 685
  - [":HOSTed:FOLLower<N>:DISConnect"](#) on page 686

**History** New in version 5.50.

## :HOSTed:NCONnected?

**Query** :HOSTed:NCONnected?

The :HOSTed:NCONnected? query returns a number that indicates whether in hosted mode, and if in hosted mode, the number of hosted oscilloscope frames connected. This query can return:

- 0 – Not in hosted mode. There are no hosted oscilloscope frames connected.
- 1 – One hosted oscilloscope frame is connected, either itself or a remote frame when using Infiniium Offline.
- 2 through 10 – The number of hosted oscilloscope frames connected.

With four analog input channels in each frame, the number returned tells you the potential number of channels in the MultiScope system. If the query returns a 0 or 1, you know there can be up to four channels, if the query returns 2 or more, multiply the returned number by four to get the number of possible channels.

**Returned Format** <#\_of\_frames><NL>

<#\_of\_frames> ::= number of hosted oscilloscope frames connected,  
from 0 to 10 in NR1 format

- See Also**
- [":HOSTed:LEADer:ACHannels?"](#) on page 687
  - [":HOSTed:FOLLower<N>:ACHannels?"](#) on page 683

**History** New in version 6.10.

## :HOSTed:PERiodic

**Command** :HOSTed:PERiodic <drift\_corr>  
<drift\_corr> ::= {OFF | TIME}

The :HOSTed:PERiodic command turns periodic drift correction on (TIME) or off.

**Query** :HOSTed:PERiodic?

The :HOSTed:PERiodic? query returns the periodic drift correction setting.

**Returned Format** <drift\_corr><NL>  
<drift\_corr> ::= {OFF | TIME}

**See Also** • [":HOSTed:PERiodic"](#) on page 692

**History** New in version 5.70.

## 24 InfiniiScan (ISCan) Commands

:IScan:DElay / 694  
:IScan:MEASurement:FAIL / 695  
:IScan:MEASurement:LLIMit / 696  
:IScan:MEASurement / 697  
:IScan:MEASurement:ULIMit / 698  
:IScan:MODE / 699  
:IScan:NONMonotonic:EDGE / 700  
:IScan:NONMonotonic:HYSteresis / 701  
:IScan:NONMonotonic:SOURce / 702  
:IScan:RUNT:HYSteresis / 703  
:IScan:RUNT:LLEVel / 704  
:IScan:RUNT:SOURce / 705  
:IScan:RUNT:ULEVel / 706  
:IScan:SERial:PATtern / 707  
:IScan:SERial:SOURce / 708  
:IScan:ZONE:HIDE / 709  
:IScan:ZONE:SOURce / 710  
:IScan:ZONE<Z>:MODE / 711  
:IScan:ZONE<Z>:PLACement / 712  
:IScan:ZONE<Z>:SOURce / 713  
:IScan:ZONE<Z>:STATe / 714

The ISCan commands and queries control the InfiniiScan feature of the oscilloscope. InfiniiScan provides several ways of searching through the waveform data to find unique events.

## :ISCan:DElAy

**Command** :ISCan:DElAy {OFF | <delay\_time>}

The :ISCan:DElAy command sets the delay time from when the hardware trigger occurs and when InfiniiScan tries to find the waveform event that has been defined.

**OFF** Turns off the delay from the hardware trigger.

**<delay\_time>** Sets the amount of time that the InfiniiScan trigger is delayed from the hardware trigger.

**Example** The following example causes the oscilloscope to delay by 1 ms.

```
myScope.WriteString ":ISCan:DElAy 1E-06"
```

**Query** :ISCan:DElAy?

The query returns the current set delay value.

**Returned Format** [:ISCan:DElAy] {OFF | <delay\_time>}<NL>

**Example** The following example returns the current delay value and prints the result to the controller's screen.

```
myScope.WriteString ":SYSTem:HEADer OFF"      ' Response headers off.
myScope.WriteString ":ISCan:DElAy?"
varValue = myScope.ReadNumber
Debug.Print FormatNumber(varValue, 0)
```

**History** Legacy command (existed before version 3.10).

## :IScan:MEASurement:FAIL

**Command** :IScan:MEASurement:FAIL {INSide | OUTSide}

The :IScan:MEASurement:FAIL command sets the fail condition for an individual measurement. The conditions for a test failure are set on the measurement selected by the :IScan:MEASurement command.

When a measurement failure is detected by the limit test the oscilloscope triggers and the trigger action is executed.

**INSide** INSide causes the oscilloscope to fail a test when the measurement results are within the parameters set by the :IScan:MEASurement:LIMit and :IScan:MEASurement:ULIMit commands.

**OUTSide** OUTSide causes the oscilloscope to fail a test when the measurement results exceed the parameters set by the :IScan:MEASurement:LLIMit and the :IScan:MEASurement:ULIMit commands.

**Example** The following example causes the oscilloscope to trigger when the measurements are outside the lower or upper limits.

```
myScope.WriteString ":IScan:MEASurement:FAIL OUTSide"
```

**Query** :IScan:MEASurement:FAIL?

The query returns the current set fail condition.

**Returned Format** [:IScan:MEASurement:FAIL] {INSide | OUTSide}<NL>

**Example** The following example returns the current fail condition and prints the result to the controller's screen.

```
Dim strFAIL As String
myScope.WriteString ":IScan:MEASurement:FAIL?"
strFAIL = myScope.ReadString
Debug.Print strFAIL
```

**History** Legacy command (existed before version 3.10).

**:ISCan:MEASurement:LLIMit**

**Command**    `:ISCan:MEASurement:LLIMit <lower_value>`

The `:ISCan:MEASurement:LLIMit` (lower limit) command sets the lower test limit for the currently selected measurement. The `:ISCan:MEASurement` command selects the measurement used.

**<lower\_value>**    A real number.

**Example**    The following example sets the lower test limit to 1.0.

```
myScope.WriteString ":ISCan:MEASurement:LLIMit 1.0"
```

If, for example, you chose to measure volts peak-peak and want the smallest acceptable signal swing to be one volt, you could use the above command, then set the measurement limit to trigger when the signal is outside the specified limit.

**Query**    `:ISCan:MEASurement:LLIMit?`

The query returns the current value set by the command.

**Returned Format**    `[:ISCan:MEASurement:LLIMit]<lower_value><NL>`

**Example**    The following example returns the current lower test limit and prints the result to the controller's screen.

```
myScope.WriteString ":SYSTEM:HEADer OFF"    ' Response headers off.
myScope.WriteString ":ISCan:MEASurement:LLIMit?"
varValue = myScope.ReadNumber
Debug.Print FormatNumber(varValue, 0)
```

**History**    Legacy command (existed before version 3.10).



## :ISCan:MEASurement

**Command** :ISCan:MEASurement {MEAS1 | MEAS2 | MEAS3 | ... | MEAS20}

The :ISCan:MEASurement command selects the current source for Measurement Limit Test Trigger. It selects one of the active measurements as referred to by their position in the Measurement tab area at the bottom of the screen. Measurements are numbered from left to right in the Measurements tab area of the screen.

**Example** The following example selects the first measurement as the source for the limit testing commands.

```
myScope.WriteString ":ISCan:MEASurement MEAS1"
```

**Query** :ISCan:MEASurement?

The query returns the currently selected measurement source.

**Returned Format** [:ISCan:MEASurement] {MEAS1 | MEAS2 | MEAS3 | ... | MEAS20}<NL>

**Example** The following example returns the currently selected measurement source for the limit testing commands.

```
Dim strSOURCE As String
myScope.WriteString ":ISCan:MEASurement?"
strSOURCE = myScope.ReadString
Debug.Print strSOURCE
```

**See Also** Measurements are started by the commands in the Measurement Subsystem.

**History** Legacy command (existed before version 3.10).

Version 5.00: Now 20 measurements to choose from.

**:ISCan:MEASurement:ULIMit**

**Command** :ISCan:MEASurement:ULIMit <upper\_value>

The :ISCan:MEASurement:ULIMit (upper limit) command sets the upper test limit for the active measurement currently selected by the :ISCan:MEASurement command.

<upper\_value> A real number.

**Example** The following example sets the upper limit of the currently selected measurement to 500 mV.

```
myScope.WriteString ":ISCan:MEASurement:ULIMit 500E-3"
```

Suppose you are measuring the maximum voltage of a signal with Vmax, and that voltage should not exceed 500 mV. You can use the above program and set the :ISCan:MEASurement:FAIL OUTside command to specify that the oscilloscope will trigger when the voltage exceeds 500 mV.

**Query** :ISCan:MEASurement:ULIMit?

The query returns the current upper limit of the limit test.

**Returned Format** [:ISCan:MEASurement:ULIMit] <upper\_value><NL>

**Example** The following example returns the current upper limit of the limit test and prints the result to the controller's screen.

```
myScope.WriteString ":SYSTEM:HEADer OFF" ' Response headers off.
myScope.WriteString ":ISCan:MEASurement:ULIMit?"
varValue = myScope.ReadNumber
Debug.Print FormatNumber(varValue, 0)
```

**History** Legacy command (existed before version 3.10).

**:IScan:MODE**

**Command** :IScan:MODE {OFF | MEASurement | NONMonotonic | RUNT | SERial | ZONE}

The :IScan:MODE command selects the type of InfiniiScan trigger mode:

- OFF – Turns off the InfiniiScan trigger mode.
- MEASurement – Sets the Measurement limit trigger mode.
- NONMonotonic – Sets the Non-monotonic Edge trigger mode.
- RUNT – Sets the Runt trigger mode.
- SERial – Sets the General Serial trigger mode.
- ZONE – Sets the Zone Qualify trigger mode.

**Example** The following example selects the runt trigger.

```
myScope.WriteString ":IScan:MODE RUNT"
```

**Query** :IScan:MODE?

The query returns the currently selected InfiniiScan trigger mode.

**Returned Format** [:IScan:MEASurement] {OFF | MEAS | NONM | RUNT | SER | ZONE}<NL>

**Example** The following example returns the currently selected InfiniiScan trigger mode.

```
Dim strMODE As String
myScope.WriteString ":IScan:MODE?"
strMODE = myScope.ReadString
Debug.Print strMODE
```

**History** Legacy command (existed before version 3.10).

## :IScan:NONMonotonic:EDGE

**Command** `:IScan:NONMonotonic:EDGE {EITHer | FALLing | RISing}`

The :IScan:NONMonotonic:EDGE command selects the rising edge, the falling edge, or either edge for the Non-monotonic edge trigger mode.

**EITHer** Sets the edge used by the Non-monotonic edge trigger to both rising and falling edges.

**FALLing** Sets the edge used by the Non-monotonic edge trigger to falling edges.

**RISing** Sets the edge used by the Non-monotonic edge trigger to rising edges.

**Example** The following example selects the falling edge non-monotonic trigger.

```
myScope.WriteString ":IScan:NONMonotonic:EDGE FALLing"
```

**Query** `:IScan:NONMonotonic:EDGE?`

The query returns the currently selected edge type for the Non-Monotonic Edge trigger.

**Returned Format** `[:IScan:NONMonotonic:EDGE]{EITHer | FALLing | RISing}<NL>`

**Example** The following example returns the currently selected edge type used for the Non-monotonic Edge trigger mode.

```
Dim strSOURCE As String
myScope.WriteString ":IScan:NONMonotonic:EDGE?"
strSOURCE = myScope.ReadString
Debug.Print strSOURCE
```

**History** Legacy command (existed before version 3.10).

## :IScan:NONMonotonic:HYSteresis

**Command** :IScan:NONMonotonic:HYSteresis <value>

The :IScan:NONMonotonic:HYSteresis command sets the hysteresis value used for the Non-monotonic Edge trigger.

<value> is a real number for the hysteresis.

**Example** The following example sets the hysteresis value used by the Non-monotonic trigger mode to 10 mV.

```
myScope.WriteString ":IScan:NONMonotonic:HYSteresis 1E-2"
```

**Query** :IScan:NONMonotonic:HYSteresis?

The query returns the hysteresis value used by the Non-monotonic Edge trigger mode.

**Returned Format** [:IScan:NONMonotonic:HYSteresis]<value><NL>

**Example** The following example returns and prints the value of the hysteresis.

```
myScope.WriteString ":SYSTem:HEADer OFF" ' Response headers off.
myScope.WriteString ":IScan:NONMonotonic:HYSteresis?"
varValue = myScope.ReadNumber
Debug.Print FormatNumber(varValue, 0)
```

**History** Legacy command (existed before version 3.10).

**:IScan:NONMonotonic:SOURce**

**Command** `:IScan:NONMonotonic:SOURce CHANnel<N>`

The `:IScan:NONMonotonic:SOURce` command sets the source used for the Non-monotonic Edge trigger.

`<N>` is an integer from 1-4.

**Example** The following example sets the source used by the Non-monotonic trigger mode to channel 1.

```
myScope.WriteString ":IScan:NONMonotonic:SOURce CHANnel1"
```

**Query** `:IScan:NONMonotonic:SOURce?`

The query returns the source used by the Non-monotonic Edge trigger mode.

**Returned Format** `[:IScan:NONMonotonic:SOURce] CHANnel<N><NL>`

**Example** The following example returns the currently selected source for the Non-monotonic Edge trigger mode.

```
Dim strSOURCE As String
myScope.WriteString ":IScan:NONMonotonic:SOURce?"
strSOURCE = myScope.ReadString
Debug.Print strSOURCE
```

**History** Legacy command (existed before version 3.10).

## :IScan:RUNT:HYSTeresis

**Command** :IScan:RUNT:HYSTeresis <value>

The :IScan:RUNT:HYSTeresis command sets the hysteresis value used for the Runt trigger.

<value> is a real number for the hysteresis.

**Example** The following example sets the hysteresis value used by the Runt trigger mode to 10 mV.

```
myScope.WriteString ":IScan:RUNT:HYSTeresis 1E-2"
```

**Query** :IScan:RUNT:HYSTeresis?

The query returns the hysteresis value used by the Runt trigger mode.

**Returned Format** [:IScan:RUNT:HYSTeresis] <value><NL>

**Example** The following example returns and prints the value of the hysteresis.

```
myScope.WriteString ":SYSTEM:HEADer OFF" ' Response headers off.
myScope.WriteString ":IScan:RUNT:HYSTeresis?"
varValue = myScope.ReadNumber
Debug.Print FormatNumber(varValue, 0)
```

**History** Legacy command (existed before version 3.10).

**:ISCan:RUNT:LLEVel**

**Command** `ISCan:RUNT:LLEVel <lower_level>`

The `:ISCan:RUNT:LLEVel` (lower level) command sets the lower level limit for the Runt trigger mode.

**<lower\_level>** A real number.

**Example** The following example sets the lower level limit to 1.0 V.

```
myScope.WriteString ":ISCan:RUNT:LLEVel 1.0"
```

**Query** `:ISCan:RUNT:LLEVel?`

The query returns the lower level limit set by the command.

**Returned Format** `[:ISCan:RUNT:LLEVel] <lower_level><NL>`

**Example** The following example returns the current lower level used by the Runt trigger and prints the result to the controller's screen.

```
myScope.WriteString ":SYSTEM:HEADer OFF" ' Response headers off.
myScope.WriteString ":ISCan:RUNT:LLEVel?"
varValue = myScope.ReadNumber
Debug.Print FormatNumber(varValue, 0)
```

**History** Legacy command (existed before version 3.10).



## :IScan:RUNT:SOURce

**Command** :IScan:RUNT:SOURce CHANnel<N>

The :IScan:RUNT:SOURce command sets the source used for the Runt trigger.

<N> is an integer from 1-4.

**Example** The following example sets the source used by the Runt trigger mode to channel 1.

```
myScope.WriteString ":IScan:RUNT:SOURce CHANnel1"
```

**Query** :IScan:RUNT:SOURce?

The query returns the source used by the Runt trigger mode.

**Returned Format** [:IScan:RUNT:SOURce] CHANnel<N><NL>

**Example** The following example returns the currently selected source for the Runt trigger mode.

```
Dim strSOURCE As String
myScope.WriteString ":IScan:RUNT:SOURce?"
strSOURCE = myScope.ReadString
Debug.Print strSOURCE
```

**History** Legacy command (existed before version 3.10).

**:ISCan:RUNT:ULEVel**

**Command** :ISCan:RUNT:ULEVel <upper\_level>

The :ISCan:RUNT:ULEVel (upper level) command sets the upper level limit for the Runt trigger mode.

<upper\_level> A real number.

**Example** The following example sets the upper level value used by the Runt trigger mode to 500 mV.

```
myScope.WriteString ":ISCan:RUNT:ULEVel 500E-3"
```

**Query** :ISCan:RUNT:ULEVel?

The query returns the current upper level value used by the Runt trigger.

**Returned Format** [:ISCan:RUNT:ULEVel] <upper\_level><NL>

**Example** The following example returns the current upper level used by the Runt trigger and prints the result to the controller's screen.

```
myScope.WriteString ":SYSTem:HEADer OFF" ' Response headers off.
myScope.WriteString ":ISCan:RUNT:ULEVel?"
varValue = myScope.ReadNumber
Debug.Print FormatNumber(varValue, 0)
```

**History** Legacy command (existed before version 3.10).

## :IScan:SERial:PATtern

**Command** :IScan:SERial:PATtern "<pattern>"

The :IScan:SERial:PATtern command sets the pattern used for the Serial trigger.

**<pattern>** is a 1, 0, or X binary character string of up to 80 characters. The pattern can only be expressed in the binary format.

**Example** The following example sets the pattern used by the Serial trigger to 101100.

```
myScope.WriteString ":IScan:SERial:PATtern "101100""
```

**Query** :IScan:SERial:PATtern?

The query returns the pattern used by the Serial trigger mode.

**Returned Format** [:IScan:SERial:PATtern] <pattern><NL>

**Example** The following example returns the currently selected pattern for the Serial trigger mode.

```
Dim strPATTERN As String
myScope.WriteString ":IScan:SERial:PATtern?"
strPATTERN = myScope.ReadString
Debug.Print strPATTERN
```

**History** Legacy command (existed before version 3.10).

**:IScan:SERial:SOURce**

**Command** :IScan:SERial:SOURce CHANnel<N>

The :IScan:SERial:SOURce command sets the source used for the Serial trigger.

<N> is an integer from 1-4.

**Example** The following example sets the source used by the Serial trigger mode to channel 1.

```
myScope.WriteString ":IScan:SERial:SOURce CHANnel1"
```

**Query** :IScan:SERial:SOURce?

The query returns the source used by the Serial trigger mode.

**Returned Format** [:IScan:SERial:SOURce] CHANnel<N><NL>

**Example** The following example returns the currently selected source for the Serial trigger mode.

```
Dim strSOURCE As String
myScope.WriteString ":IScan:SERial:SOURce?"
strSOURCE = myScope.ReadString
Debug.Print strSOURCE
```

**History** Legacy command (existed before version 3.10).

## :IScan:ZONE:HIDE

**Command** :IScan:ZONE:HIDE {{ON | 1} | {OFF | 0}}

The :IScan:ZONE:HIDE command lets you hide or show all InfiniiScan zones on the display.

**Example** The following example hides all InfiniiScan zones on the display.

```
myScope.WriteString ":IScan:ZONE:HIDE ON"
```

**Query** :IScan:ZONE:HIDE?

The query returns the current zone hide setting.

**Returned Format** [:IScan:ZONE:HIDE] {1 | 0}<NL>

**Example** The following example returns the current zone hide setting.

```
Dim strHide As String
myScope.WriteString ":IScan:ZONE:HIDE?"
strHide = myScope.ReadString
Debug.Print strHide
```

**See Also**

- [":IScan:ZONE:SOURce"](#) on page 710
- [":IScan:ZONE<Z>:MODE"](#) on page 711
- [":IScan:ZONE<Z>:PLACement"](#) on page 712
- [":IScan:ZONE<Z>:SOURce"](#) on page 713
- [":IScan:ZONE<Z>:STATe"](#) on page 714

**History** New in version 4.00.

**:IScan:ZONE:SOURce**

**Command** `:IScan:ZONE:SOURce CHANnel<N>`

The `:IScan:ZONE:SOURce` command sets the source for all zones used in the zone qualify trigger.

**<N>** An integer from 1–4.

**Example** The following example sets the source used by all zones in the zone qualify trigger to channel 1.

```
myScope.WriteString ":IScan:ZONE:SOURce CHANnel1"
```

**Query** `:IScan:ZONE:SOURce?`

The query returns the source used for all zones in the zone qualify trigger.

**Returned Format** `[ :IScan:ZONE:SOURce] CHANnel<N><NL>`

**Example** The following example returns the currently selected source for all zones in the zone qualify trigger.

```
Dim strSOURCE As String
myScope.WriteString ":IScan:ZONE:SOURce?"
strSOURCE = myScope.ReadString
Debug.Print strSOURCE
```

- See Also**
- [":IScan:ZONE:HIDE"](#) on page 709
  - [":IScan:ZONE<Z>:MODE"](#) on page 711
  - [":IScan:ZONE<Z>:PLACement"](#) on page 712
  - [":IScan:ZONE<Z>:SOURce"](#) on page 713
  - [":IScan:ZONE<Z>:STATe"](#) on page 714

**History** Legacy command (existed before version 3.10).

## :IScan:ZONE&lt;Z&gt;:MODE

**Command** :IScan:ZONE<Z>:MODE {INTERsect | NOTintersect | OINTERsect | ONOT}

The :IScan:ZONE<Z>:MODE command sets the Zone Qualify trigger mode. For the INTERsect mode, the waveform must enter the zone region to qualify as a valid waveform. For NOTintersect mode, the waveform cannot enter a zone region to qualify as a valid waveform.

<Z> An integer from 1-8.

**Example** The following example sets the mode to intersect for zone 1.

```
myScope.WriteString ":IScan:ZONE1:MODE INTERsect"
```

**Query** :IScan:ZONE<Z>:MODE?

The query returns the mode used by zone 1.

**Returned Format** [:IScan:ZONE<Z>:MODE] {INT | NOT | OINT | ONOT}<NL>

**Example** The following example returns the currently selected mode for zone 1.

```
Dim strMODE As String
myScope.WriteString ":IScan:ZONE1:MODE?"
strMODE = myScope.ReadString
Debug.Print strMODE
```

- See Also**
- [":IScan:ZONE:HIDE"](#) on page 709
  - [":IScan:ZONE:SOURce"](#) on page 710
  - [":IScan:ZONE<Z>:PLACement"](#) on page 712
  - [":IScan:ZONE<Z>:SOURce"](#) on page 713
  - [":IScan:ZONE<Z>:STATe"](#) on page 714

**History** Legacy command (existed before version 3.10).

**:IScan:ZONE<Z>:PLACement**

**Command** :IScan:ZONE<Z>:PLACement <width>,<height>,<x\_center>,<y\_center>

The :IScan:ZONE<Z>:PLACement command sets the location and size of a zone for the zone qualify trigger mode.

<Z> An integer from 1-8.

<width> A real number defining the width of a zone in seconds.

<height> A real number defining the height of a zone in volts.

<x\_center> A real number defining the x coordinate of the center of the zone in seconds.

<y\_center> A real number defining the y coordinate of the center of the zone in volts.

**Example** The following example sets the size of zone 1 to be 500 ps wide and 0.5 volts high and centered about the xy coordinate of 1.5 ns and 1 volt.

```
myScope.WriteString ":IScan:ZONE1:PLACement 500e-12,0.5,1.5e-9,1"
```

**Query** :IScan:ZONE<Z>:PLACement?

The query returns the placement values used by zone 1.

**Returned Format** [:IScan:ZONE<Z>:PLACement] <width>,<height>,<x\_center>,<y\_center><NL>

**Example** The following example returns the current placement values for zone 1.

```
Dim strPLACEMENT As String
myScope.WriteString ":IScan:ZONE1:PLACement?"
strPLACEMENT = myScope.ReadString
Debug.Print strPLACEMENT
```

- See Also**
- [":IScan:ZONE:HIDE"](#) on page 709
  - [":IScan:ZONE:SOURce"](#) on page 710
  - [":IScan:ZONE<Z>:MODE"](#) on page 711
  - [":IScan:ZONE<Z>:SOURce"](#) on page 713
  - [":IScan:ZONE<Z>:STATe"](#) on page 714

**History** Legacy command (existed before version 3.10).



## :ISCan:ZONE&lt;Z&gt;:SOURce

**Command** :ISCan:ZONE<Z>:SOURce CHANnel<N>

The :ISCan:ZONE<Z>:SOURce command sets the source used for a particular zone in the zone qualify trigger.

<Z> An integer from 1-8.

<N> An integer from 1-4.

**Example** The following example sets the source used by zone 1 to channel 1.

```
myScope.WriteString ":ISCan:ZONE1:SOURce CHANnel1"
```

**Query** :ISCan:ZONE<Z>:SOURce?

The query returns the source used by the particular zone.

**Returned Format** [:ISCan:ZONE<Z>:SOURce] CHANnel<N><NL>

**Example** The following example returns the currently selected source for zone 1.

```
Dim strSOURCE As String
myScope.WriteString ":ISCan:ZONE1:SOURce?"
strSOURCE = myScope.ReadString
Debug.Print strSOURCE
```

- See Also**
- [":ISCan:ZONE:HIDE"](#) on page 709
  - [":ISCan:ZONE:SOURce"](#) on page 710
  - [":ISCan:ZONE<Z>:MODE"](#) on page 711
  - [":ISCan:ZONE<Z>:PLACement"](#) on page 712
  - [":ISCan:ZONE<Z>:STATe"](#) on page 714

**History** Legacy command (existed before version 3.10).

**:ISCan:ZONE<Z>:STATE**

**Command** :ISCan:ZONE<Z>:STATE {{ON | 1} | {OFF | 0}}

The :ISCan:ZONE<Z>:STATE command turns a zone off or on for the zone qualify trigger.

<Z> An integer from 1-8.

**Example** The following example turns on zone 2.

```
myScope.WriteString ":ISCan:ZONE2:STATE ON"
```

**Query** :ISCan:ZONE<Z>:STATE?

The query returns the state value for a zone.

**Returned Format** [:ISCan:ZONE<Z>:STATE] {1 | 0}<NL>

**Example** The following example returns the current state value for zone 2.

```
Dim strSTATE As String
myScope.WriteString ":ISCan:ZONE2:STATE?"
strSTATE = myScope.ReadString
Debug.Print strSTATE
```

- See Also**
- **"ISCan:ZONE:HIDE"** on page 709
  - **"ISCan:ZONE:SOURce"** on page 710
  - **"ISCan:ZONE<Z>:MODE"** on page 711
  - **"ISCan:ZONE<Z>:PLACement"** on page 712
  - **"ISCan:ZONE<Z>:SOURce"** on page 713

**History** Legacy command (existed before version 3.10).

## 25 Lane (Equalization) Commands

:LANE<N>:COPYto / 717  
:LANE<N>:EQUalizer:CTLE:ACGain / 718  
:LANE<N>:EQUalizer:CTLE:DCGain / 719  
:LANE<N>:EQUalizer:CTLE:NUMPoles / 720  
:LANE<N>:EQUalizer:CTLE:P1 / 721  
:LANE<N>:EQUalizer:CTLE:P2 / 722  
:LANE<N>:EQUalizer:CTLE:P3 / 723  
:LANE<N>:EQUalizer:CTLE:P4 / 724  
:LANE<N>:EQUalizer:CTLE:P5 / 725  
:LANE<N>:EQUalizer:CTLE:P6 / 726  
:LANE<N>:EQUalizer:CTLE:RATE / 727  
:LANE<N>:EQUalizer:CTLE:STATe / 728  
:LANE<N>:EQUalizer:CTLE:Z1 / 729  
:LANE<N>:EQUalizer:CTLE:Z2 / 730  
:LANE<N>:EQUalizer:DFE:NTAPs / 731  
:LANE<N>:EQUalizer:DFE:STATe / 732  
:LANE<N>:EQUalizer:DFE:TAP / 733  
:LANE<N>:EQUalizer:DFE:TAP:AUTomatic / 734  
:LANE<N>:EQUalizer:DFE:TAP:DELay / 735  
:LANE<N>:EQUalizer:DFE:TAP:DELay:AUTomatic / 736  
:LANE<N>:EQUalizer:DFE:TAP:GAIN / 737  
:LANE<N>:EQUalizer:DFE:TAP:LTARget / 738  
:LANE<N>:EQUalizer:DFE:TAP:MAX / 739  
:LANE<N>:EQUalizer:DFE:TAP:MAXV / 740  
:LANE<N>:EQUalizer:DFE:TAP:MIN / 741  
:LANE<N>:EQUalizer:DFE:TAP:MINV / 742  
:LANE<N>:EQUalizer:DFE:TAP:NORMalize / 743  
:LANE<N>:EQUalizer:DFE:TAP:UTARget / 744  
:LANE<N>:EQUalizer:DFE:TAP:WIDTH / 745  
:LANE<N>:EQUalizer:DFE:THReshold:BANDwidth / 746

```

:LANE<N>:EQUalizer:DFE:THReshold:BWMode / 747
:LANE<N>:EQUalizer:DFE:THReshold:DELay / 748
:LANE<N>:EQUalizer:FFE:BANDwidth / 749
:LANE<N>:EQUalizer:FFE:BWMode / 750
:LANE<N>:EQUalizer:FFE:NPRecursor / 751
:LANE<N>:EQUalizer:FFE:NTAPs / 752
:LANE<N>:EQUalizer:FFE:RATE / 753
:LANE<N>:EQUalizer:FFE:STATe / 754
:LANE<N>:EQUalizer:FFE:TAP / 755
:LANE<N>:EQUalizer:FFE:TAP:AUTomatic / 756
:LANE<N>:EQUalizer:FFE:TAP:DELay / 757
:LANE<N>:EQUalizer:FFE:TAP:WIDTh / 758
:LANE<N>:EQUalizer:FFE:TDELay / 759
:LANE<N>:EQUalizer:FFE:TDMode / 760
:LANE<N>:EQUalizer:LOCation / 761
:LANE<N>:SOURce / 762
:LANE<N>:STATe / 763
:LANE<N>:VERTical / 764
:LANE<N>:VERTical:OFFSet / 765
:LANE<N>:VERTical:RANGe / 766

```

The Equalization application is used to re-open partially or completely closed real-time eye diagrams. For additional information on equalization, consult the *Infiniium Serial Data Equalization User's Guide*.

Before the 6.40 version of Infiniium oscilloscope software, you could perform equalization on a single input source. Now, you can perform equalization on up to four sources at once. Each of the four "lanes" of equalization has its own settings, distinct from the other lanes, allowing for independent equalization on different signals, concurrent equalization on the same signal, or any combination thereof.

## :LANE<N>:COPYto

**Command**    :LANE<N>:COPYto LANE<L>

The :LANE<N>:COPYto command copies all valid settings from LANE<N> to LANE<L> (both <N> and <L> are integers between 1 and 4, inclusive).

This command includes all CTLE, FFE, and DFE settings, with one special case exception: If LANE<X> is using EQUalized<X-1> as its source, and LANE<X>'s settings are copied to LANE<Y>, LANE<Y> will attempt to use EQUalized<Y-1> as its source. The only case in which this does not work is if Y is 1, in which case LANE<Y>'s source is unchanged from LANE<X>.

**See Also**    • [":LANE<N>:SOURce"](#) on page 762

**History**    New in version 6.40.

**:LANE<N>:EQUalizer:CTLE:ACGain**

**Command** :LANE<N>:EQUalizer:CTLE:ACGain <ac\_gain>

The :LANE<N>:EQUalizer:CTLE:ACGain command sets the AC Gain parameter for the Continuous Time Linear Equalization when USB31 is selected for the "# of Poles" option.

<ac\_gain> A real number

**Example** This example sets the CTLE AC Gain parameter to 1.

```
myScope.WriteString ":LANE1:EQUalizer:CTLE:ACGain 1"
```

**Query** :LANE<N>:EQUalizer:CTLE:ACGain?

The :LANE<N>:EQUalizer:CTLE:ACGain? query returns the CTLE's AC Gain parameter setting.

**See Also** • [":LANE<N>:EQUalizer:CTLE:NUMPoles"](#) on page 720

**History** New in version 6.40.

## :LANE<N>:EQUalizer:CTLE:DCGain

**Command** :LANE<N>:EQUalizer:CTLE:DCGain <dc\_gain>

The :LANE<N>:EQUalizer:CTLE:DCGain command sets the DC Gain parameter for the Continuous Time Linear Equalization.

<dc\_gain> A real number

**Example** This example sets the CTLE DC Gain parameter to 1.

```
myScope.WriteString ":LANE1:EQUalizer:CTLE:DCGain 1"
```

**Query** :LANE<N>:EQUalizer:CTLE:DCGain?

The :LANE<N>:EQUalizer:CTLE:DCGain? query returns the CTLE's DC Gain parameter.

**History** New in version 6.40.

## :LANE&lt;N&gt;:EQUalizer:CTLE:NUMPoles

**Command** :LANE<N>:EQUalizer:CTLE:NUMPoles {{P2Z1 | POLE2} | {P3Z1 | POLE3}  
| P3Z2 | P4Z1 | {P2ACG | USB31}}

The :LANE<N>:EQUalizer:CTLE:NUMPoles command selects from these Continuous Time Linear Equalizer (CTLE) options:

- {P2Z1 | POLE2} – 2 Pole 1 Zero.
- {P3Z1 | POLE3} – 3 Pole 1 Zero.
- P3Z2 – 3 Pole 2 Zeros.
- P4Z1 – 4 Pole 1 Zero.
- {P2ACG | USB31} – 2 Pole AC Gain.

**Example** This example selects a 2 Pole, 1 Zero CTLE.

```
myScope.WriteString ":LANE1:EQUalizer:CTLE:NUMPoles P2Z1"
```

**Query** :LANE<N>:EQUalizer:CTLE:NUMPoles?

The :LANE<N>:EQUalizer:CTLE:NUMPoles? query returns the current "number of poles" selection.

**Returned Format** [:LANE<N>:EQUalizer:CTLE:NUMPoles] {P2Z1 | P3Z1 | P3Z2 | P4Z1 | P2ACG}

- See Also**
- [":LANE<N>:EQUalizer:CTLE:Z1"](#) on page 729
  - [":LANE<N>:EQUalizer:CTLE:Z2"](#) on page 730
  - [":LANE<N>:EQUalizer:CTLE:ACGain"](#) on page 718

**History** New in version 6.40.



**:LANE<N>:EQUalizer:CTLE:P1**

**Command** :LANE<N>:EQUalizer:CTLE:P1 <pole1\_freq>

The :LANE<N>:EQUalizer:CTLE:P1 command sets the Pole 1 frequency for the Continuous Time Linear Equalization.

<pole1\_freq> A real number

**Example** This example sets the CTLE Pole 1 frequency to 1GHz.

```
myScope.WriteString ":LANE1:EQUalizer:CTLE:P1 1e9"
```

**Query** :LANE<N>:EQUalizer:CTLE:P1?

The :LANE<N>:EQUalizer:CTLE:P1? query returns the CTLE's Pole 1 frequency.

**History** New in version 6.40.

## :LANE<N>:EQUalizer:CTLE:P2

**Command** :LANE<N>:EQUalizer:CTLE:P2 <pole2\_freq>

The :LANE<N>:EQUalizer:CTLE:P2 command sets the Pole 2 frequency for the Continuous Time Linear Equalization.

<pole2\_freq> A real number

**Example** This example sets the CTLE Pole 2 frequency to 4 GHz.

```
myScope.WriteString ":LANE1:EQUalizer:CTLE:P2 4e9"
```

**Query** :LANE<N>:EQUalizer:CTLE:P2?

The :LANE<N>:EQUalizer:CTLE:P2? query returns the CTLE's Pole 2 frequency.

**History** New in version 6.40.

**:LANE<N>:EQUalizer:CTLE:P3**

**Command** :LANE<N>:EQUalizer:CTLE:P3 <pole3\_freq>

The :LANE<N>:EQUalizer:CTLE:P3 command sets the Pole 3 frequency for the Continuous Time Linear Equalization.

<pole3\_freq> A real number

**Example** This example sets the CTLE Pole 3 frequency to 4 GHz.

```
myScope.WriteString ":LANE1:EQUalizer:CTLE:P3 4e9"
```

**Query** :LANE<N>:EQUalizer:CTLE:P3?

The :LANE<N>:EQUalizer:CTLE:P3? query returns the CTLE's Pole 3 frequency.

**History** New in version 6.40.

## :LANE<N>:EQualizer:CTLE:P4

**Command** :LANE<N>:EQualizer:CTLE:P4 <pole4\_freq>

The :LANE<N>:EQualizer:CTLE:P4 command sets the Pole 4 frequency for the Continuous Time Linear Equalization.

<pole4\_freq> A real number

**Example** This example sets the CTLE Pole 4 frequency to 4 GHz.

```
myScope.WriteString ":LANE1:EQualizer:CTLE:P4 4e9"
```

**Query** :LANE<N>:EQualizer:CTLE:P4?

The :LANE<N>:EQualizer:CTLE:P4? query returns the CTLE's Pole 4 frequency.

**History** New in version 6.40.

**:LANE<N>:EQUalizer:CTLE:P5**

**Command** :LANE<N>:EQUalizer:CTLE:P5 <pole5\_freq>

The :LANE<N>:EQUalizer:CTLE:P5 command sets the Pole 5 frequency for the Continuous Time Linear Equalization.

<pole5\_freq> A real number

**Example** This example sets the CTLE Pole 5 frequency to 4 GHz.

```
myScope.WriteString ":LANE1:EQUalizer:CTLE:P5 4e9"
```

**Query** :LANE<N>:EQUalizer:CTLE:P5?

The :LANE<N>:EQUalizer:CTLE:P5? query returns the CTLE's Pole 5 frequency.

**History** New in version 6.70.

## :LANE<N>:EQUalizer:CTLE:P6

**Command** :LANE<N>:EQUalizer:CTLE:P6 <pole6\_freq>

The :LANE<N>:EQUalizer:CTLE:P6 command sets the Pole 6 frequency for the Continuous Time Linear Equalization.

<pole6\_freq> A real number

**Example** This example sets the CTLE Pole 6 frequency to 4 GHz.

```
myScope.WriteString ":LANE1:EQUalizer:CTLE:P6 4e9"
```

**Query** :LANE<N>:EQUalizer:CTLE:P6?

The :LANE<N>:EQUalizer:CTLE:P6? query returns the CTLE's Pole 6 frequency.

**History** New in version 6.70.

**:LANE<N>:EQUalizer:CTLE:RATE**

**Command** :LANE<N>:EQUalizer:CTLE:RATE <data\_rate>

The :LANE<N>:EQUalizer:CTLE:RATE command sets the data rate for the CTLE equalizer.

<data\_rate> A real number.

When the signal type is PAM-4 (see :ANALyze:SIGNaL:TYPE), a symbol rate (baud) is specified instead of a data rate (b/s).

**Example** This example sets the CTLE data rate to 3e9.

```
myScope.WriteString ":LANE1:EQUalizer:CTLE:RATE 3e9"
```

**Query** :LANE<N>:EQUalizer:CTLE:RATE?

The :LANE<N>:EQUalizer:CTLE:RATE? query returns the CTLE's data rate.

**See Also** • [":ANALyze:SIGNaL:TYPE"](#) on page 312

**History** New in version 6.40.

## :LANE<N>:EQUalizer:CTLE:STATe

**Command** :LANE<N>:EQUalizer:CTLE:STATe {(OFF | 0) | (ON | 1)}

The :LANE<N>:EQUalizer:CTLE:STATe command turns the Continuous Time Linear Equalizer (CTLE) on or off.

**Example** This example turns on CTLE.

```
myScope.WriteString ":LANE1:EQUalizer:CTLE:STATe ON"
```

**Query** :LANE<N>:EQUalizer:CTLE:STATe?

The :LANE<N>:EQUalizer:CTLE:STATe? query returns whether or not CTLE is turned on.

**History** New in version 6.40.



**:LANE<N>:EQUalizer:CTLE:Z1**

**Command** :LANE<N>:EQUalizer:CTLE:Z1 <zero\_freq\_1>

The :LANE<N>:EQUalizer:CTLE:Z1 command sets the first zero frequency for the 3-pole Continuous Time Linear Equalization.

<zero\_freq\_1> A real number in NR3 format.

**Example** This example sets the 3-pole CTLE's first zero frequency to 900 MHz.

```
myScope.WriteString ":LANE1:EQUalizer:CTLE:Z1 650e6"
```

**Query** :LANE<N>:EQUalizer:CTLE:Z1?

The :LANE<N>:EQUalizer:CTLE:Z1? query returns the 3-pole CTLE's first zero frequency.

**Returned Format** <zero\_freq\_1><NL>

- See Also**
- [":LANE<N>:EQUalizer:CTLE:Z2"](#) on page 730
  - [":LANE<N>:EQUalizer:CTLE:NUMPoles"](#) on page 720

**History** New in version 6.40.

**:LANE<N>:EQUalizer:CTLE:Z2**

**Command**     :LANE<N>:EQUalizer:CTLE:Z2 <zero\_freq\_2>

The :LANE<N>:EQUalizer:CTLE:Z2 command sets the second zero frequency for the 3-pole Continuous Time Linear Equalization.

<zero\_freq\_2>   A real number in NR3 format.

**Example**     This example sets the 3-pole CTLE's second zero frequency to 4 GHz.

```
myScope.WriteString ":LANE1:EQUalizer:CTLE:Z2 4e9"
```

**Query**       :LANE<N>:EQUalizer:CTLE:Z2?

The :LANE<N>:EQUalizer:CTLE:Z2? query returns the 3-pole CTLE's second zero frequency.

**Returned Format**   <zero\_freq\_2><NL>

- See Also**
- [":LANE<N>:EQUalizer:CTLE:Z1"](#) on page 729
  - [":LANE<N>:EQUalizer:CTLE:NUMPoles"](#) on page 720

**History**     New in version 6.40.

## :LANE<N>:EQUalizer:DFE:NTAPs

**Command** :LANE<N>:EQUalizer:DFE:NTAPs <number>

The :LANE<N>:EQUalizer:DFE:NTAPs command sets the number of taps to be used in the DFE algorithm.

DFE tap indices always begin with 1 and extend to the number of taps.

<number> An integer between 1 and 40

**Example** This example sets the number of DFE taps to 3.

```
myScope.WriteString ":LANE1:EQUalizer:DFE:NTAPs 3"
```

**Query** :LANE<N>:EQUalizer:DFE:NTAPs?

The :LANE<N>:EQUalizer:DFE:NTAPs? query returns the number of DFE taps.

**History** New in version 6.40.

## :LANE<N>:EQUalizer:DFE:STATe

**Command** :LANE<N>:EQUalizer:DFE:STATe {(OFF | 0) | (ON | 1)}

The :LANE<N>:EQUalizer:DFE:STATe command turns the Decision Feedback Equalization on or off.

**Example** This example turns on DFE.

```
myScope.WriteString ":LANE1:EQUalizer:DFE:STATe ON"
```

**Query** :LANE<N>:EQUalizer:DFE:STATe?

The :LANE<N>:EQUalizer:DFE:STATe? query returns whether or not DFE is turned on.

**History** New in version 6.40.

**:LANE<N>:EQUalizer:DFE:TAP**

**Command** :LANE<N>:EQUalizer:DFE:TAP <tap>, <value>

The :LANE<N>:EQUalizer:DFE:TAP command sets the tap value for each DFE tap. For example, when <tap> is equal to 1 then the 1st tap is set to <value>.

DFE tap indices always start at 1 and extend to the number of taps.

<tap> The tap number.

<value> The tap value

**Example** This example sets the DFE Tap 1 to 0.432.

```
myScope.WriteString ":LANE1:EQUalizer:DFE:TAP 1,0.432"
```

**Query** :LANE<N>:EQUalizer:DFE:TAP? <tap>

The :LANE<N>:EQUalizer:DFE:TAP? query returns the DFE tap values.

**See Also** · [":LANE<N>:EQUalizer:DFE:NTAPs"](#) on page 731

**History** New in version 6.40.

## :LANE<N>:EQUalizer:DFE:TAP:AUTomatic

**Command** :LANE<N>:EQUalizer:DFE:TAP:AUTomatic

The :LANE<N>:EQUalizer:DFE:TAP:AUTomatic command starts the DFE tap optimization. Be sure to first specify the number of taps, the max/min tap values, and the Normalize DC Gain setting.

**Example** This example starts the DFE tap optimization.

```
myScope.WriteString ":LANE1:EQUalizer:DFE:TAP:AUTomatic"
```

- See Also**
- [":LANE<N>:EQUalizer:DFE:NTAPs"](#) on page 731
  - [":LANE<N>:EQUalizer:DFE:TAP:MIN"](#) on page 741
  - [":LANE<N>:EQUalizer:DFE:TAP:MAX"](#) on page 739
  - [":LANE<N>:EQUalizer:DFE:TAP:NORMalize"](#) on page 743

**History** New in version 6.40.

**:LANE<N>:EQUalizer:DFE:TAP:DELay**

**Command** :LANE<N>:EQUalizer:DFE:TAP:DELay <delay>

The :LANE<N>:EQUalizer:DFE:TAP:DELay command specifies a delay of the DFE equalized waveform relative to an explicit recovered clock in order to center the DFE eye, post equalization.

You can automatically set the tap delay to center the DFE eye by using the :LANE<N>:EQUalizer:DFE:TAP:DELay:AUTomatic command.

You can also affect the DFE eye location when creating the DFE equalized waveform by using the :LANE<N>:EQUalizer:DFE:THReshold:DELay command to delay the DFE decision threshold.

<delay> The delay value in NR3 (real number) format.

**Query** :LANE<N>:EQUalizer:DFE:TAP:DELay?

The :LANE<N>:EQUalizer:DFE:TAP:DELay? query returns the value of the specified DFE tap delay.

**Returned Format** <delay><NL>

<delay> ::= value in NR3 format

- See Also**
- **":LANE<N>:EQUalizer:DFE:TAP:DELay:AUTomatic"** on page 736
  - **":LANE<N>:EQUalizer:DFE:THReshold:DELay"** on page 748

**History** New in version 6.40.

## :LANE<N>:EQUalizer:DFE:TAP:DELay:AUTomatic

**Command** :LANE<N>:EQUalizer:DFE:TAP:DELay:AUTomatic

The :LANE<N>:EQUalizer:DFE:TAP:DELay:AUTomatic command computes a DFE delay value to center a DFE eye on the screen horizontally. The current real-time eye data is used to center the DFE eye.

**See Also** · [":LANE<N>:EQUalizer:DFE:TAP:DELay"](#) on page 735

**History** New in version 6.40.



## :LANE<N>:EQUalizer:DFE:TAP:GAIN

**Command** :LANE<N>:EQUalizer:DFE:TAP:GAIN <gain>

The eye diagram drawn after DFE is applied is attenuated. To amplify the eye back to its original size (so you can directly compare the eye at the receiver to the eye at the transmitter), a gain factor needs to be applied. The :LANE<N>:EQUalizer:DFE:TAP:GAIN command allows you to set this gain. For more information on this parameter, refer to the Infiniium Serial Data Equalization User's Guide.

<gain> A real number

**Example** This example sets the gain to 3.23.

```
myScope.WriteString ":LANE1:EQUalizer:DFE:TAP:GAIN 3.23"
```

**Query** :LANE<N>:EQUalizer:DFE:TAP:GAIN?

The :LANE<N>:EQUalizer:DFE:TAP:GAIN? query returns the current gain value.

**History** New in version 6.40.

**:LANE<N>:EQUalizer:DFE:TAP:LTARget**

**Command** :LANE<N>:EQUalizer:DFE:TAP:LTARget <lower\_target>

The Lower Target field dictates the logical low value used in the DFE algorithm. For example, in DFE, when a bit is determined to be a logical low, its value will be equal to Lower Target. The :LANE<N>:EQUalizer:DFE:TAP:LTARget command allows you to set this value.

<lower\_target> A real number

**Example** This example sets the Lower Target to 1.0.

```
myScope.WriteString ":LANE1:EQUalizer:DFE:TAP:LTARget 1.0"
```

**Query** :LANE<N>:EQUalizer:DFE:TAP:LTARget?

The :LANE<N>:EQUalizer:DFE:TAP:LTARget? query returns the current value for the Lower Target field.

**History** New in version 6.40.

## :LANE&lt;N&gt;:EQUalizer:DFE:TAP:MAX

**Command** :LANE<N>:EQUalizer:DFE:TAP:MAX <max\_tap\_value>

Some standards have upper and lower limits on the tap values. The :LANE<N>:EQUalizer:DFE:TAP:MAX command sets the upper limit on taps determined through optimization.

<max\_tap\_value> A real number

**Example** This example sets the Upper Limit field to 3.23.

```
myScope.WriteString ":LANE1:EQUalizer:DFE:TAP:MAX 3.23"
```

**Query** :LANE<N>:EQUalizer:DFE:TAP:MAX?

The :LANE<N>:EQUalizer:DFE:TAP:MAX? query returns the Upper Limit used in the DFE tap optimization.

**History** New in version 6.40.

## :LANE&lt;N&gt;:EQUalizer:DFE:TAP:MAXV

**Command** :LANE<N>:EQUalizer:DFE:TAP:MAXV <max\_tap\_value\_in\_volts>

The :LANE<N>:EQUalizer:DFE:TAP:MAXV command sets the maximum tap value for DFE auto tap setup in volts as opposed to the :LANE<N>:EQUalizer:DFE:TAP:MAX command that sets the max in unitless values.

If the unitless values are changed by the :LANE<N>:EQUalizer:DFE:TAP:MAX command, they supersede the voltage values.

<max\_tap\_value\_in  
\_volts> A real number.

**Query** :LANE<N>:EQUalizer:DFE:TAP:MAXV?

The :LANE<N>:EQUalizer:DFE:TAP:MAXV? query returns the maximum tap value in volts used in the DFE auto tap setup.

**See Also** · [":LANE<N>:EQUalizer:DFE:TAP:MINV"](#) on page 742

**History** New in version 6.40.

## :LANE&lt;N&gt;:EQUalizer:DFE:TAP:MIN

**Command** :LANE<N>:EQUalizer:DFE:TAP:MIN <min\_tap\_value>

Some standards have upper and lower limits on the tap values. The :LANE<N>:EQUalizer:DFE:TAP:MIN command sets the lower limit on taps determined through optimization.

<min\_tap\_value> A real number

**Example** This example sets the Lower Limit field to 3.23.

```
myScope.WriteString ":LANE1:EQUalizer:DFE:TAP:MIN 3.23"
```

**Query** :LANE<N>:EQUalizer:DFE:TAP:MIN?

The :LANE<N>:EQUalizer:DFE:TAP:MIN? query returns the Lower Limit used in the DFE tap optimization.

**History** New in version 6.40.

## :LANE&lt;N&gt;:EQUalizer:DFE:TAP:MINV

**Command** :LANE<N>:EQUalizer:DFE:TAP:MINV <min\_tap\_value\_in\_volts>

The :LANE<N>:EQUalizer:DFE:TAP:MINV command sets the minimum tap value for DFE auto tap setup in volts as opposed to the :LANE<N>:EQUalizer:DFE:TAP:MIN command that sets the min in unitless values.

If the unitless values are changed by the :LANE<N>:EQUalizer:DFE:TAP:MIN command, they supersede the voltage values.

<min\_tap\_value\_in  
\_volts> A real number.

**Query** :LANE<N>:EQUalizer:DFE:TAP:MINV?

The :LANE<N>:EQUalizer:DFE:TAP:MINV? query returns the minimum tap value in volts used in the DFE auto tap setup.

**See Also** · [":LANE<N>:EQUalizer:DFE:TAP:MAXV"](#) on page 740

**History** New in version 6.40.

## :LANE&lt;N&gt;:EQUalizer:DFE:TAP:NORMalize

**Command** :LANE<N>:EQUalizer:DFE:TAP:NORMalize {{0 | OFF} | {1 | ON}}

The :LANE<N>:EQUalizer:DFE:TAP:NORMalize command specifies whether the Normalize DC Gain setting is ON or OFF. When ON, the eye diagram is automatically scaled so that it is the same size as the transmitted eye.

the Normalize DC Gain setting should be set (if desired) prior to calling the :LANE<N>:EQUalizer:DFE:TAP:AUTOMATIC command.

This command maps to the **Normalize DC Gain** setting in the Equalization Auto Tap Setup dialog box in the front panel graphical user interface.

**Query** :LANE<N>:EQUalizer:DFE:TAP:NORMalize?

The :LANE<N>:EQUalizer:DFE:TAP:NORMalize? query returns the Normalize DC Gain setting.

**Returned Format** <setting><NL>

<setting> ::= {0 | 1}

**See Also** • [":LANE<N>:EQUalizer:DFE:TAP:AUTOMATIC"](#) on page 734

**History** New in version 6.40.

## :LANE&lt;N&gt;:EQUalizer:DFE:TAP:UTARget

**Command** :LANE<N>:EQUalizer:DFE:TAP:UTARget <upper\_target>

The Upper Target field dictates the logical high value used in the DFE algorithm. For example, in DFE, when a bit is determined to be a logical high, its value will be equal to Upper Target. The :LANE<N>:EQUalizer:DFE:TAP:UTARget command allows you to set this value.

<upper\_target> A real number

**Example** This example sets the Upper Target to 1.0.

```
myScope.WriteString ":LANE1:EQUalizer:DFE:TAP:UTARget 1.0"
```

**Query** :LANE<N>:EQUalizer:DFE:TAP:UTARget?

The :LANE<N>:EQUalizer:DFE:TAP:UTARget? query returns the current value for the Upper Target field.

**History** New in version 6.40.



## :LANE<N>:EQUalizer:DFE:TAP:WIDTH

**Command** :LANE<N>:EQUalizer:DFE:TAP:WIDTH <width>

The :LANE<N>:EQUalizer:DFE:TAP:WIDTH command sets the Eye Width field for the DFE tap optimization. Setting the width to 0.0 means the optimization is only performed at the location of the clock. Setting the width to 1.0 means the entire acquisition is used in the optimization. The default value for DFE is 0.0. For more information on this parameter, refer to the Infiniium Serial Data Equalization User's Guide.

<width> A real number between 0.0 and 1.0.

**Example** This example sets the eye width to 0.0.

```
myScope.WriteString ":LANE1:EQUalizer:DFE:TAP:WIDTH 0.0"
```

**Query** :LANE<N>:EQUalizer:DFE:TAP:WIDTH?

The :LANE<N>:EQUalizer:DFE:TAP? query returns the eye width used in the DFE tap optimization.

**History** New in version 6.40.

## :LANE<N>:EQUalizer:DFE:THReshold:BANDwidth

**Command** :LANE<N>:EQUalizer:DFE:THReshold:BANDwidth <bw\_value>

When the DFE threshold bandwidth mode is set to CUSTom (by the :LANE<N>:EQUalizer:DFE:THReshold:BWMode command), the :LANE<N>:EQUalizer:DFE:THReshold:BANDwidth command specifies the threshold bandwidth value.

<bw\_value> A real number.

**Query** :LANE<N>:EQUalizer:DFE:THReshold:BANDwidth?

The :LANE<N>:EQUalizer:DFE:THReshold:BANDwidth? query returns the custom threshold bandwidth value.

**See Also** • [":LANE<N>:EQUalizer:DFE:THReshold:BWMode"](#) on page 747

**History** New in version 6.40.

## :LANE&lt;N&gt;:EQUalizer:DFE:THReshold:BWMode

**Command** :LANE<N>:EQUalizer:DFE:THReshold:BWMode {OFF | CUSTom | TSBandwidth}

When lane equalization is being displayed as a function (:LANE<N>:EQUalizer:LOCation FUNCTION), the :LANE<N>:EQUalizer:DFE:THReshold:BWMode command sets the threshold bandwidth mode for the DFE:

- TSBandwidth – Tracks the bandwidth limit of the source waveform.
- CUSTom – Use the :LANE<N>:EQUalizer:DFE:THReshold:BANDwidth command to specify the custom bandwidth value.
- OFF

**Query** :LANE<N>:EQUalizer:DFE:THReshold:BWMode?

The :LANE<N>:EQUalizer:DFE:THReshold:BWMode? query returns the current setting of the threshold bandwidth mode.

**Returned Format** <thr\_bw\_mode><NL>

<thr\_bw\_mode> ::= {OFF | CUST | TSB}

- See Also**
- [":LANE<N>:EQUalizer:LOCation"](#) on page 761
  - [":LANE<N>:EQUalizer:DFE:THReshold:BANDwidth"](#) on page 746

**History** New in version 6.40.

## :LANE&lt;N&gt;:EQUalizer:DFE:THReshold:DELay

**Command** :LANE<N>:EQUalizer:DFE:THReshold:DELay <threshold\_delay>

The :LANE<N>:EQUalizer:DFE:THReshold:DELay command sets a delay to move the decision threshold relative to the original waveform when creating the DFE equalized waveform.

This command is in contrast to the :LANE<N>:EQU:DFE:TAP:DELay command that moves the DFE equalized waveform relative to an explicit recovered clock in order to center the DFE eye post equalization.

<threshold\_delay> The delay value in NR3 (real number) format.

**Query** :LANE<N>:EQUalizer:DFE:THReshold:DELay?

The :LANE<N>:EQUalizer:DFE:THReshold:DELay? query returns the decision threshold delay value.

**Returned Format** <threshold\_delay><NL>

<threshold\_delay> ::= value in NR3 format

**See Also** • [":LANE<N>:EQUalizer:DFE:TAP:DELay"](#) on page 735

**History** New in version 6.40.

## :LANE<N>:EQUalizer:FFE:BANDwidth

**Command** :LANE<N>:EQUalizer:FFE:BANDwidth <bandwidth>

The :LANE<N>:EQUalizer:FFE:BANDwidth command is only needed if the :LANE<N>:EQUalizer:FFE:BWMode command is set to CUSTom and in this case it sets the bandwidth at which the response generated by equalization rolls off. To understand more about this parameter, consult the Infiniium Serial Data Equalization User's Guide.

<bandwidth> The bandwidth at which the response generated by equalization rolls off.

**Query** :LANE<N>:EQUalizer:FFE:BANDwidth?

The :LANE<N>:EQUalizer:FFE:BANDwidth? query returns the current value for the BANDwidth parameter.

**History** New in version 6.40.

## :LANE<N>:EQUalizer:FFE:BWMode

**Command** :LANE<N>:EQUalizer:FFE:BWMode {TSBandwidth | TTDelay | CUSTom}

The :LANE<N>:EQUalizer:FFE:BWMode command sets the bandwidth at which the response generated by equalization is rolled off. To understand more about this parameter, consult the Infiniium Serial Data Equalization User's Guide.

**Example** This example sets the FFE Bandwidth Mode to TTDelay.

```
myScope.WriteString ":LANE1:EQUalizer:FFE:BWMode TTDelay"
```

**Query** :LANE<N>:EQUalizer:FFE:BWMode?

The :LANE<N>:EQUalizer:FFE:BWMode? query returns the FFE Bandwidth Mode.

**History** New in version 6.40.

## :LANE<N>:EQUalizer:FFE:NPreursor

**Command** :LANE<N>:EQUalizer:FFE:NPreursor <number>

The :LANE<N>:EQUalizer:FFE:NPreursor command sets the number of precursor taps to be used in the FFE algorithm.

<number> An integer between 1 and (NTAPs - 1)

**Example** This example sets the number of FFE precursor taps to 3.

```
myScope.WriteString ":LANE1:EQUalizer:FFE:NPreursor 3"
```

**Query** :LANE<N>:EQUalizer:FFE:NPreursor?

The :LANE<N>:EQUalizer:FFE:NPreursor? query returns the number of FFE precursor taps.

**History** New in version 6.40.

**:LANE<N>:EQUalizer:FFE:NTAPs**

**Command** `:LANE<N>:EQUalizer:FFE:NTAPs <number>`

The `:LANE<N>:EQUalizer:FFE:NTAPs` command sets the number of taps to be used in the FFE algorithm.

The indices of your FFE taps depend on the number of precursor taps being used. For example, if you are using zero precursor taps then your FFE tap indices would range from 0 to (NTAPs - 1). If you are using two precursor taps then your FFE tap indices would range from -2 to (NTAPs - 1 - 2).

**<number>** an integer between 2 and 40

**Example** This example sets the number of FFE taps to 3.

```
myScope.WriteString ":LANE1:EQUalizer:FFE:NTAPs 3"
```

**Query** `:LANE<N>:EQUalizer:FFE:NTAPs?`

The `:LANE<N>:EQUalizer:FFE:NTAPs?` query returns the number of FFE taps.

**History** New in version 6.40.



**:LANE<N>:EQUalizer:FFE:RATE**

**Command** :LANE<N>:EQUalizer:FFE:RATE <data\_rate>

The :LANE<N>:EQUalizer:FFE:RATE command sets the data rate for the FFE equalizer.

<data\_rate> A real number.

When the signal type is PAM-4 (see :ANALyze:SIGNal:TYPE), a symbol rate (baud) is specified instead of a data rate (b/s).

**Example** This example sets the FFE data rate to 3e9.

```
myScope.WriteString ":LANE1:EQUalizer:FFE:RATE 3e9"
```

**Query** :LANE<N>:EQUalizer:FFE:RATE?

The :LANE<N>:EQUalizer:FFE:RATE? query returns the FFE's data rate.

**See Also** • [":ANALyze:SIGNal:TYPE"](#) on page 312

**History** New in version 6.40.

## :LANE<N>:EQUalizer:FFE:STATe

**Command** :LANE<N>:EQUalizer:FFE:STATe {(OFF | 0) | (ON | 1)}

The :LANE<N>:EQUalizer:FFE:STATe command turns the Feed-Forward Equalized (FFE) on or off.

**Example** This example turns on FFE.

```
myScope.WriteString ":LANE1:EQUalizer:FFE:STATe ON"
```

**Query** :LANE<N>:EQUalizer:FFE:STATe?

The :LANE<N>:EQUalizer:FFE:STATe? query returns whether or not FFE is turned on.

**History** New in version 6.40.

**:LANE<N>:EQUalizer:FFE:TAP**

**Command** :LANE<N>:EQUalizer:FFE:TAP <tap>, <value>

The :LANE<N>:EQUalizer:FFE:TAP command sets the tap value for each FFE tap. For example, when <tap> is equal to 0 then the 0th tap is set to <value>.

The indices of your FFE taps depend on the number of precursor taps being used. For example, if you are using zero precursor taps then your FFE tap indices would range from 0 to (NTAPs - 1). If you are using two precursor taps then your FFE tap indices would range from -2 to (NTAPs - 1 - 2).

<tap> The tap number; when <tap> == 0, Tap 0 is set

<value> The tap value

**Example** This example sets the second FFE tap to -1.432.

```
myScope.WriteString ":LANE1:EQUalizer:FFE:TAP 2,-1.432"
```

**Query** :LANE<N>:EQUalizer:FFE:TAP? <tap>

The :LANE<N>:EQUalizer:FFE:TAP? query returns the FFE tap values.

**See Also** • [":LANE<N>:EQUalizer:FFE:NTAPs"](#) on page 752

**History** New in version 6.40.

## :LANE<N>:EQUalizer:FFE:TAP:AUTomatic

**Command** :LANE<N>:EQUalizer:FFE:TAP:AUTomatic

The :LANE<N>:EQUalizer:FFE:TAP:AUTomatic command starts the FFE tap optimization. Be sure to first specify the number of taps and specify the Pattern and Eye Width parameters.

**Example** This example starts the FFE tap optimization.

```
myScope.WriteString ":LANE1:EQUalizer:FFE:TAP:AUTomatic"
```

**History** New in version 6.40.

## :LANE<N>:EQUalizer:FFE:TAP:DELay

**Command** :LANE<N>:EQUalizer:FFE:TAP:DELay <delay>

The :LANE<N>:EQUalizer:FFE:TAP:DELay command specifies the amount of drift the equalized eye diagram has relative to the unequalized one. This drift is then accounted for so the two eyes overlap. For more information on this parameter, refer to the Infiniium Serial Data Equalization User's Guide.

<delay> A real number

**Query** :LANE<N>:EQUalizer:FFE:TAP:DELay?

The :LANE<N>:EQUalizer:FFE:TAP:DELay? query returns the value for the FFE Delay field.

**History** New in version 6.40.

## :LANE&lt;N&gt;:EQUalizer:FFE:TAP:WIDTh

**Command** :LANE<N>:EQUalizer:FFE:TAP:WIDTh <width>

The :LANE<N>:EQUalizer:FFE:TAP:WIDTh command sets the Eye Width field for the FFE tap optimization. Setting the width to 0.0 means the optimization is only performed at the location of the clock. Setting the width to 1.0 means the entire acquisition is used in the optimization. The default value for FFE is 0.33. For more information on this parameter, refer to the Infiniium Serial Data Equalization User's Guide.

<width> A real number between 0.0 and 1.0.

**Example** This example sets the eye width to 0.0.

```
myScope.WriteString ":LANE1:EQUalizer:FFE:TAP:WIDTh 0.0"
```

**Query** :LANE<N>:EQUalizer:FFE:TAP:WIDTh?

The :LANE<N>:EQUalizer:FFE:TAP:WIDTh? query returns the eye width used in the FFE tap optimization.

**History** New in version 6.40.

## :LANE<N>:EQUalizer:FFE:TDElay

**Command** :LANE<N>:EQUalizer:FFE:TDElay <delay\_value>

The :LANE<N>:EQUalizer:FFE:TDElay command is only needed if the :LANE<N>:EQUalizer:FFE:TDMODE is set to CUSTOM. To determine what this value should be, use the equation: tap delay = 1/[(data rate)x(# of taps per bit)]. To understand more about this parameter, consult the Infiniium Serial Data Equalization User's Guide.

<delay\_value> A real number

**Query** :LANE<N>:EQUalizer:FFE:TDElay?

The :LANE<N>:EQUalizer:FFE:TDElay? query returns the current value for the tap delay.

**History** New in version 6.40.

## :LANE<N>:EQUalizer:FFE:TDMode

**Command** :LANE<N>:EQUalizer:FFE:TDMode {TBITrate | CUSTom}

The :LANE<N>:EQUalizer:FFE:TDMode command sets Tap Delay field to either Track Data Rate or Custom. If you are using one tap per bit, use the TBITrate selection. If you are using multiple taps per bit, use CUSTom and then use the :LANE<N>:EQUalizer:FFE:TDElay command to set the value. To understand more about this parameter, consult the Infiniium Serial Data Equalization User's Guide.

**Example** This example sets the FFE Tap Delay mode to TBITrate.

```
myScope.WriteString ":LANE1:EQUalizer:FFE:TDMode TBITrate"
```

**Query** :LANE<N>:EQUalizer:FFE:TDMode?

The :LANE<N>:EQUalizer:FFE:TDMode? query returns the current Tap Delay mode.

**History** New in version 6.40.



**:LANE<N>:EQUalizer:LOCation**

**Command** :LANE<N>:EQUalizer:LOCation {INPLace | FUNction}

The :LANE<N>:EQUalizer:LOCation command tells the equalization lane whether to equalize in-place (modifying the source waveform itself) or display as a function (creating a separate equalized waveform, which is what was done in the Infiniium oscilloscope software versions before 6.40).

For linear equalization (CTLE and FFE), "in-place" means the equalization runs completely in hardware, greatly improving speed. For DFE, "in-place" means the pre-6.40 version of DFE is performed (that is, the DFE that modifies the display of the real-time eye only).

**Rules for In-Place Equalization**

The following rules determine whether in-place equalization is legal, and can be used to explain interactions involving the "in-place" vs. "as-a-function" selection:

- 1 Of all running lanes using source <S>, only the lowest-numbered lane can equalize <S> in place.
- 2 In-place CTLE and FFE can be applied to analog channels only.
- 3 In-place DFE can be applied to all sources with a real-time eye displayed.

**Query** :LANE<N>:EQUalizer:LOCation?

The :LANE<N>:EQUalizer:LOCation? query returns the localtion setting for the equalization lane.

**Returned Format** [:LANE<N>:EQUalizer:LOCation] {INPL | FUNC}<NL>

**See Also** · [":LANE<N>:SOURce"](#) on page 762

**History** New in version 6.40.

**:LANE<N>:SOURce**

**Command** :LANE<N>:SOURce {CHANnel<N> | DIFF<D> | COMMONmode<C> | FUNction<F>  
| WMEMory<R> | XT<X> | EQUalized<L>}

The :LANE<N>:SOURce command sets the source for the equalization lane.

**<N>** In LANE<N>, N is an integer 1-4. In CHANnel<N>, N is an integer, 1-4 in a single oscilloscope, 1-40 in a MultiScope system.

**<D>, <C>** <D> is an integer, 1-2. <C> is an integer, 3-4.

The DIFF and COMMONmode sources are just aliases that can be used in place of the channel names to apply to differential or common mode signals. These are just aliases - no state change occurs if you refer to a differential channel and you are not in differential mode. DIFF1 refers to the differential signal between channels 1 and 3 (and COMMONmode3 refers to the common mode channel between these same channels). DIFF2 refers to the differential signal between channels 2 and 4 (and COMMONmode4 refers to the common mode channel between these same channels).

**<F>** An integer, 1-16.

**<R>** An integer, 1-4.

**<X>** An integer, 1-4, identifying the crosstalk waveform.

**<L>, Chaining Equalization Lanes** An integer, 1-3. LANE<N> can use as its source the equalization of the previous lane, EQUalized<N-1>, provided that the result of that equalization is displayed as a function. This lets you chain equalization lanes from one to the next. In other words, LANE<N> can be the source for LANE<N+1>.

If the LANE<N> equalization is "in-place", its source (for example, CHANnel1) can also be the source for LANE<N+1> but no other lanes, and LANE<N+1> cannot be done "in-place".

**Example** This example sets the first equalization lane source to Channel 1.

```
myScope.WriteString ":LANE1:SOURce CHANnel1"
```

**Query** :LANE<N>:SOURce?

The :LANE<N>:SOURce? query returns the equalization lane's source.

**See Also** • [":LANE<N>:EQUalizer:LOCation"](#) on page 761

**History** New in version 6.40.

## :LANE<N>:STATE

**Command** :LANE<N>:STATE { (OFF | 0) | (ON | 1) }

The :LANE<N>:STATE command turns the equalization lane on or off. This command has no effect on the states of the three types of equalization available within the lane (CTLE, FFE, or DFE).

**Example** This example turns on equalization lane number one.

```
myScope.WriteString ":LANE1:STATE ON"
```

**Query** :LANE<N>:STATE?

The :LANE<N>:STATE? query returns whether or not the equalization lane is turned on.

**History** New in version 6.40.

**:LANE<N>:VERTical**

**Command** :LANE<N>:VERTical {AUTO | MANual}

The :LANE<N>:VERTical command sets the equalization lane's vertical scale mode to automatic or manual. In automatic mode, the oscilloscope automatically selects the vertical scaling and offset. In manual mode, you can set your own scaling and offset values.

**Example** This example sets the first equalization lane's vertical scale mode to automatic.

```
myScope.WriteString ":LANE1:VERTical AUTO"
```

**Query** :LANE<N>:VERTical?

The :LANE<N>:VERTical? query returns the current equalization lane's vertical scale mode setting.

**Returned Format** [:LANE<N>:VERTical] {AUTO | MAN}

**History** New in version 6.40.

## :LANE&lt;N&gt;:VERTical:OFFSet

**Command** :LANE<N>:VERTical:OFFSet <offset>

The :LANE<N>:VERTical:OFFSet command sets the equalization lane's vertical offset.

<offset> A real number for the equalization lane's vertical offset.

**Example** This example sets the first equalization lane's vertical offset to 1 volt.

```
myScope.WriteString ":LANE1:VERTical:OFFSet 1"
```

**Query** :LANE<N>:VERTical:OFFSet?

The :LANE<N>:VERTical:OFFSet? query returns the equalization lane's vertical offset setting.

**Returned Format** [:LANE<N>:VERTical:OFFSet] <value><NL>

<value> The equalization lane's vertical offset setting.

**History** New in version 6.40.

**:LANE<N>:VERTical:RANGe**

**Command** :LANE<N>:VERTical:RANGe <range>

The :LANE<N>:VERTical:RANGe command sets the equalization lane's vertical range.

<range> A real number for the full-scale equalization lane's vertical range.

**Example** This example sets the first equalization lane's vertical range to 8 volts (1 volts times 8 divisions.)

```
myScope.WriteString ":LANE1:VERTical:RANGe 8"
```

**Query** :LANE<N>:VERTical:RANGe?

The :LANE<N>:VERTical:RANGe? query returns the equalization lane's vertical range setting.

**Returned Format** [:LANE<N>:VERTical:RANGe] <value><NL>

<value> The equalization lane's vertical range setting.

**History** New in version 6.40.

## 26 Limit Test Commands

:LTEST:ADDStats / 768  
:LTEST:FAIL / 769  
:LTEST:LLIMit – Lower Limit / 771  
:LTEST:MEASurement / 772  
:LTEST:RESults? / 773  
:LTEST:RUMode:SOFailure / 774  
:LTEST:TEST / 775  
:LTEST:ULIMit – Upper Limit / 776

The Limit Test commands and queries control the limit test features of the oscilloscope. Limit testing automatically compares measurement results with pass or fail limits. The limit test tracks up to 20 measurements. The action taken when the test fails is also controlled with commands in this subsystem.

## :LTEST:ADDStats

**Command** :LTEST:ADDStats {{0 | OFF} | {1 | ON}}

The :LTEST:ADDStats command enables or disables the limit test "statistics on passing measurements only" option.

When ON, statistics are compiled on passing measurements only.

**Query** :LTEST:ADDStats?

The :LTEST:ADDStats? query returns the "statistics on passing measurements only" setting.

**Returned Format** <setting><NL>

<setting> ::= {0 | 1}

**See Also** · [":LTEST:RUMode:SOFailure"](#) on page 774

**History** New in version 5.70.



**:LTEST:FAIL**

**Command** :LTEST:FAIL {{INSide | OUTSide} | {COUNT | RANGE}}

For the active measurement currently selected by the :LTEST:MEASUREMENT command, the :LTEST:FAIL command sets the fail condition for the measurement.

When a measurement failure is detected by the limit test, the fail action conditions are executed, and there is the potential to generate an SRQ.

**INSide, OUTSide** These are the fail condition options for most measurements.

- **INSide** – causes the oscilloscope to fail a test when the measurement results are within the parameters set by the :LTEST:LLIMIT and :LTEST:ULIMIT commands.
- **OUTSide** – causes the oscilloscope to fail a test when the measurement results exceed the parameters set by :LTEST:LLIMIT and :LTEST:ULIMIT commands.

**COUNT, RANGE** When performing limit test on the BER (Per Acq) measurement (:MEASURE:BERPERACQ), the fail condition options are COUNT and RANGE instead of INSIDE and OUTSIDE.

- **COUNT** – causes the oscilloscope to fail a test when the BER (Bit Error Ratio) fail count occurs. In this case, the count is specified by the :LTEST:LLIMIT command (and the :LTEST:ULIMIT command does not apply).
- **RANGE** – causes the oscilloscope to fail a test when the BER (Bit Error Ratio) fail count occurs within a certain number of bits. In this case, the count is specified by the :LTEST:LLIMIT command and the range of bits is specified by the :LTEST:ULIMIT command. This option is useful for finding burst errors.

**Example** The following example causes the oscilloscope to fail a test when the measurements are outside the lower and upper limits.

```
myScope.WriteString ":LTEST:FAIL OUTSide"
```

**Query** :LTEST:FAIL?

The query returns the currently set fail condition.

**Returned Format** [:LTEST:FAIL] {INSide | OUTSide}<NL>

**Example** The following example returns the current fail condition and prints the result to the controller's screen.

```
Dim strFAIL As String
myScope.WriteString ":LTEST:FAIL?"
strFAIL = myScope.ReadString
Debug.Print strFAIL
```

- See Also**
- **" :LTEST:LLIMIT – Lower Limit "** on page 771
  - **" :LTEST:MEASUREMENT "** on page 772
  - **" :LTEST:RESULTS? "** on page 773
  - **" :LTEST:TEST "** on page 775

- **":LTEST:ULIMit – Upper Limit"** on page 776
- **":MEASure:BERPeracq"** on page 897

**History** Legacy command (existed before version 3.10).

## :LTEST:LLIMit – Lower Limit

**Command** :LTEST:LLIMit <lower\_value>

For the active measurement currently selected by the :LTEST:MEASurement command, the :LTEST:LLIMit (Lower LIMit) command sets the lower test limit.

<lower\_value> A real number.

**Example** The following example sets the lower test limit to 1.0.

```
myScope.WriteString ":LTEST:LLIMit 1.0"
```

If, for example, you chose to measure volts peak-peak and want the smallest acceptable signal swing to be one volt, you could use the above command, then set the limit test to fail when the signal is outside the specified limit.

**Query** :LTEST:LLIMit?

The query returns the current value set by the command.

**Returned Format** [:LTEST:LLIMit]<lower\_value><NL>

**Example** The following example returns the current lower test limit and prints the result to the controller's screen.

```
Dim strLLIM As String
myScope.WriteString ":LTEST:LLIMit?"
strLLIM = myScope.ReadString
Debug.Print strLLIM
```

- See Also**
- **" :LTEST:FAIL "** on page 769
  - **" :LTEST:MEASurement "** on page 772
  - **" :LTEST:RESults? "** on page 773
  - **" :LTEST:TEST "** on page 775
  - **" :LTEST:ULIMit – Upper Limit "** on page 776

**History** Legacy command (existed before version 3.10).

## :LTEST:MEASurement

**Command** :LTEST:MEASurement {MEAS<N>}

The :LTEST:MEASurement command selects the measurement source for the FAIL, LLIMit, ULIMit, and TEST commands. It selects one of the active measurements by its number, where MEAS1 is the most recently added measurement.

<N> An integer, 1–40.

**Example** The following example selects the first measurement as the source for the limit testing commands.

```
myScope.WriteString ":LTEST:MEASurement MEAS1"
```

**Query** :LTEST:MEASurement?

The query returns the currently selected measurement source.

**Returned Format** [:LTEST:MEASurement] {MEAS<N>} <NL>

**Example** The following example returns the currently selected measurement source for the limit testing commands.

```
Dim strSOURCE As String
myScope.WriteString ":LTEST:MEASurement?"
strSOURCE = myScope.ReadString
Debug.Print strSOURCE
```

**See Also** Measurements are started in the :MEASure subsystem.

- See Also**
- **" :LTEST:FAIL "** on page 769
  - **" :LTEST:LLIMit – Lower Limit "** on page 771
  - **" :LTEST:RESults? "** on page 773
  - **" :LTEST:TEST "** on page 775
  - **" :LTEST:ULIMit – Upper Limit "** on page 776

**History** Legacy command (existed before version 3.10).

Version 6.71: The maximum number of measurements has increased from 20 to 40.

## :LTEST:RESults?

**Query** :LTEST:RESults? {MEAS<N>}

The query returns the measurement results for selected measurement.

When :LTEST:TEST is ON, the :LTEST:RESults? query returns the failed minimum value (Fail Min), the failed maximum value (Fail Max), and the total number of measurements made (# of Meas).

When :LTEST:TEST is OFF, the :LTEST:RESults? query returns nothing.

<N> An integer, 1–40.

**Returned Format** [:LTEST:RESults] <fail\_min>,<fail\_max>,<num\_meas><NL>

<fail\_min> A real number representing the total number of measurements that have failed the minimum limit.

<fail\_max> A real number representing the total number of measurements that have failed the maximum limit.

<num\_meas> A real number representing the total number of measurements that have been made.

**Example** The following example returns the values for the limit test of measurement 1.

```
Dim strRESULTS As String
myScope.WriteString ":LTEST:RESults? MEAS1"
strRESULTS = myScope.ReadString
Debug.Print strRESULTS
```

**See Also** Measurements are started in the Measurement Subsystem.

- See Also**
- **" :LTEST:FAIL "** on page 769
  - **" :LTEST:LLIMit – Lower Limit "** on page 771
  - **" :LTEST:MEASurement "** on page 772
  - **" :LTEST:TEST "** on page 775
  - **" :LTEST:ULIMit – Upper Limit "** on page 776

**History** Legacy command (existed before version 3.10).

Version 6.71: The maximum number of measurements has increased from 20 to 40.

## :LTEST:RUMode:SOFailure

**Command** :LTEST:RUMode:SOFailure {{0 | OFF} | {1 | ON}}

The :LTEST:RUMode:SOFailure command enables or disables the limit test "stop on failure" option.

When ON, the oscilloscope acquisition system stops once a limit failure is detected. If more than one measurement limit test is enabled, a failure of any of the measurements stops the oscilloscope from acquiring new waveforms.

**Query** :LTEST:RUMode:SOFailure?

The :LTEST:RUMode:SOFailure? query returns the "stop on failure" setting.

**Returned Format** <setting><NL>

<setting> ::= {0 | 1}

**See Also** • [":LTEST:ADDStats"](#) on page 768

**History** New in version 5.70.

## :LTEST:TEST

**Command** :LTEST:TEST {{ON | 1} {OFF | 0}}

For the active measurement currently selected by the :LTEST:MEASUREMENT command, the LTEST:TEST command enables or disables the limit test function on that measurement.

When any measurement has its limit test function enabled, the overall Limit Test feature is enabled.

The :LTEST:RESULTS? query returns nothing when :LTEST:TEST is OFF.

**Example** The following example turns off the limit test function for the active measurement currently selected by the :LTEST:MEASUREMENT command.

```
myScope.WriteString ":LTEST:TEST OFF"
```

**Query** :LTEST:TEST?

The query returns the state of the TEST control for the active measurement currently selected by the :LTEST:MEASUREMENT command.

**Returned Format** [:LTEST:TEST] {1 | 0} <NL>

**Example** The following example returns the current state of the limit test and prints the result to the controller's screen.

```
Dim strTEST As String
myScope.WriteString ":LTEST:TEST?"
strTEST = myScope.ReadString
Debug.Print strTEST
```

**See Also**

- **" :LTEST:FAIL "** on page 769
- **" :LTEST:LLIMIT – Lower Limit "** on page 771
- **" :LTEST:MEASUREMENT "** on page 772
- **" :LTEST:RESULTS? "** on page 773
- **" :LTEST:ULIMIT – Upper Limit "** on page 776

**History** Legacy command (existed before version 3.10).

## :LTEST:ULIMit – Upper Limit

**Command** :LTEST:ULIMit <upper\_value>

For the active measurement currently selected by the :LTEST:MEASurement command, the :LTEST:ULIMit (Upper LIMit) command sets the upper test limit.

<upper\_value> A real number.

**Example** The following example sets the upper limit of the currently selected measurement to 500 mV.

```
myScope.WriteString ":LTEST:ULIMit 500E-3"
```

Suppose you are measuring the maximum voltage of a signal with Vmax, and that voltage should not exceed 500 mV. You can use the above program and set the LTEST:FAIL OUTside command to specify that the limit subsystem will fail a measurement when the voltage exceeds 500 mV.

**Query** :LTEST:ULIMit?

The query returns the current upper limit of the limit test.

**Returned Format** [:LTEST:ULIMit] <upper\_value><NL>

**Example** The following example returns the current upper limit of the limit test and prints the result to the controller's screen.

```
Dim strULIM As String
myScope.WriteString ":LTEST:ULIMit?"
strULIM = myScope.ReadString
Debug.Print strULIM
```

- See Also**
- **" :LTEST:FAIL "** on page 769
  - **" :LTEST:LLIMit – Lower Limit "** on page 771
  - **" :LTEST:MEASurement "** on page 772
  - **" :LTEST:RESults? "** on page 773
  - **" :LTEST:TEST "** on page 775

**History** Legacy command (existed before version 3.10).



## 27 Lister Commands

:LISTer:DATA? / 778

:LISTer:DISPlay / 779

The LISTer subsystem is used to turn on/off the serial decode Lister display and return data from the Lister display.

**:LISTer:DATA?**

**Query** :LISTer:DATA? [{SBUS1 | SBUS2 | SBUS3 | SBUS4} [, <type>] | BUS]

The :LISTer:DATA? query returns the lister data (SBUS1, SBUS2, SBUS3, or SBUS4) or the Digital Listing data (BUS).

To turn on the Digital Listing, you need to enable one or more of the digital buses (see :BUS<B>:DISPlay).

<type> {PACKets | SYMBols | PAYLoad}

Specifies which display window to save.

**Returned Format** <binary\_block><NL>

<binary\_block> ::= comma-separated data with newlines at the end of each row

- See Also**
- **" :LISTer:DISPlay "** on page 779
  - **" :BUS<B>:DISPlay "** on page 325
  - **" Definite-Length Block Response Data "** on page 157

**History** New in version 3.50.

Version 5.00: Added the <type> parameter for specifying which display window to save.

Version 6.70: Added the BUS parameter for returning Digital Listing data.

## :LISTer:DISPlay

**Command** :LISTer:DISPlay <value>

<value> ::= {OFF | ON | SBUS1 | SBUS2 | SBUS3 | SBUS4}

The :LISTer:DISPlay command configures which of the serial buses to display in the Lister, or whether the Lister is off. "ON" or "1" is the same as "SBUS1".

Serial bus decode must be on before it can be displayed in the Lister.

**Query** :LISTer:DISPlay?

The :LISTer:DISPlay? query returns the Lister display setting.

**Returned Format** <value><NL>

<value> ::= {OFF | ON | SBUS1 | SBUS2 | SBUS3 | SBUS4}

- See Also**
- **":SBUS<N>[:DISPlay]"** on page 1257
  - **":LISTer:DATA?"** on page 778

**History** New in version 3.50.



## 28 :LXI Commands

:LXI:IDENtify[:STATe] / 782

The :LXI commands and queries are common for instruments that support the LAN eXtensions for Instrumentation (LXI) standard.

**:LXI:IDENTify[:STATe]**

**Command** :LXI:IDENTify[:STATe] {{0 | OFF} | {1 | ON}}

The :LXI:IDENTify[:STATe] command lets you identify an oscilloscope.

- ON – Opens the oscilloscope graphical user interface LXI LAN dialog box and flashes the green LXI logo.
- OFF – Turns off the flashing logo and closes the LXI LAN dialog box.

**Query** :LXI:IDENTify[:STATe]?

The :LXI:IDENTify[:STATe]? query returns whether the oscilloscope is being identified in the graphical user interface LXI LAN dialog box.

**Returned Format** <setting><NL>

<setting> ::= {0 | 1}

**See Also** • **":SYSTem:DSP"** on page 1355

**History** New in version 6.72.

## 29 Marker Commands

:MARKer:CURSor? / 785  
:MARKer:DELTA / 786  
:MARKer:MEASurement:MEASurement / 787  
:MARKer:MODE / 789  
:MARKer:TSTArt / 790  
:MARKer:TSTOp / 791  
:MARKer:VSTArt / 792  
:MARKer:VSTOp / 793  
:MARKer:X1Position / 794  
:MARKer:X2Position / 795  
:MARKer:X1Y1source / 796  
:MARKer:X2Y2source / 798  
:MARKer:XDELta? / 800  
:MARKer:Y1Position / 801  
:MARKer:Y2Position / 802  
:MARKer:YDELta? / 803  
:MARKer<K>:CMODE / 804  
:MARKer<K>:COLor / 805  
:MARKer<K>:DELTA / 808  
:MARKer<K>:ENABle / 809  
:MARKer<K>:NAME / 810  
:MARKer<K>:SOURce / 811  
:MARKer<K>:TYPE / 813  
:MARKer<K>:X:POSition / 815  
:MARKer<K>:Y:POSition / 816

The commands in the MARKer subsystem specify and query the settings of the time markers (X axis) and current measurement unit markers (volts, amps, and watts for the Y axis). You typically set the Y-axis measurement units using the :CHANnel:UNITs command.

**NOTE****Guidelines for Using Queries in Marker Modes**

In Track Waveforms mode, use :MARKer:CURSor? to track the position of the waveform. In Manual Markers and Track Measurements Markers modes, use other queries, such as the X1Position? and X2Position?, and VStart? and VStop? queries. If you use :MARKer:CURSor? when the oscilloscope is in either Manual Markers or Track Measurements Markers modes, it will put the oscilloscope in Track Waveforms mode, regardless of the mode previously selected. In addition, measurement results may not be what you expected.

---



## :MARKer:CURSor?

**Query** :MARKer:CURSor? {DELTA | START | STOP}

The :MARKer:CURSor? query returns the time and current measurement unit values of the specified marker (if markers are in Track Waveforms mode) as an ordered pair of time and measurement unit values.

- If DELTA is specified, the value of delta Y and delta X are returned.
- If START is specified, marker A's x-to-y positions are returned.
- If STOP is specified, marker B's x-to-y positions are returned.

**CAUTION**

**The :MARKer:CURSor? query may change marker mode and results.**

In Track Waveforms mode, use :MARKer:CURSor? to track the position of the waveform. In Manual Markers and Track Measurements Markers modes, use other marker queries, such as the X1Position? and X2Position?, and VStart? and VStop? queries.

If you use :MARKer:CURSor? when the oscilloscope is in either Manual Markers or Track Measurements Markers modes, it will put the oscilloscope in Track Waveforms mode, regardless of the mode previously selected. In addition, measurement results may not be what you expected. In addition, measurement results may not be what you expected.

**Returned Format** [:MARKer:CURSor] {DELTA | START | STOP}  
{<Ax, Ay> | <Bx, By> | <deltaX, deltaY>}<NL>

**Example** This example returns the current position of the X cursor and measurement unit marker 1 to the string variable, strPosition. The program then prints the contents of the variable to the computer's screen.

```
Dim strPosition As String    ' Dimension variable.
myScope.WriteString ":MARKer:CURSor? START"
strPosition = myScope.ReadString
Debug.Print strPosition
```

**History** Legacy command (existed before version 3.10).

## :MARKer:DELTA

**Command** :MARKer:DELTA {{0 | OFF} | {1 | ON}}

The :MARKer:DELTA command turns on or off the graphical user interface's **Delta Markers** check box setting to display deltas on the screen (as opposed to the deltas in the results area and remote queries).

**Query** :MARKer:DELTA?

The :MARKer:DELTA? query returns the graphical user interface's **Delta Markers** check box setting (in the Markers dialog box).

**Returned Format** <setting><NL>

<setting> ::= {0 | 1}

- See Also**
- [":MARKer:XDELTA?"](#) on page 800
  - [":MARKer:YDELTA?"](#) on page 803

**History** New in version 6.10.

## :MARKer:MEASurement:MEASurement

**Command** :MARKer:MEASurement:MEASurement {MEASurement<N>}[, {{1 | ON}  
| {0 | OFF}}]

The :MARKer:MEASurement:MEASurement command adds or deletes measurement tracking markers. This setting is only used when the :MARKer:MODE is set to MEASurement.

When not specifically turning a particular measurement tracking marker on or off (for example, ":MARK:MEAS:MEAS MEAS1"), all markers are deleted, and measurement tracking markers for the specified measurement are added.

When specifically turning a particular measurement tracking marker on or off (for example, ":MARK:MEAS:MEAS MEAS2,ON" or ":MARK:MEAS:MEAS MEAS3,OFF"), only the measurement tracking markers for the specified measurement are affected. No other markers are deleted before turning the specified measurement tracking marker on or off.

<N> An integer, 1-40.

**NOTE**

When <N> is 10-40, the long form of the mnemonic, MEASurement<N>, is too long. In this case, you must use the short form, MEAS<N>.

**Example** This example deletes all markers and adds measurement tracking markers for the fourth measurement.

```
myScope.WriteString ":MARKer:MEASurement:MEASurement MEASurement4"
```

**Query** :MARKer:MEASurement:MEASurement? [MEASurement<N>]

The :MARKer:MEASurement:MEASurement? query returns the status of the measurement tracking marker.

Without any parameters (for example, ":MARK:MEAS:MEAS?"), the query looks at the tracking markers most recently added without using the "ON | OFF" syntax. If those tracking markers are still on, the measurement number is returned (for example, "MEAS1"). If those tracking markers have since been deleted, an empty string is returned.

When using the MEASurement<N> query parameter, a 1 or 0 is returned if measurement tracking markers for the specified measurement are ON or OFF.

**NOTE**

For `:MARKer:MEASurement:MEASurement`, command and query syntax using the optional `[]` square bracket parameters is called new-style syntax. Syntax not using the optional `[]` square bracket parameters is called old-style syntax. Keysight recommends when using new-style commands to also use new-style queries. Likewise, when using old-style commands, use old-style queries.

Adding and deleting measurement tracking markers from the graphical user interface (GUI) is the same as using new-style command syntax.

**Returned Format** `[ :MARKer:MEASurement:MEASurement ] {MEAS<N> | {1 | 0}}<NL>`

**Example** This example places the status of the measurement tracking marker in the string variable, `strTrackMeasStatus`, then prints the contents of the variable to the computer's screen.

```
Dim strTrackMeas As String    ' Dimension variable.
myScope.WriteString ":MARKer:MEASurement:MEASurement?"
strTrackMeasStatus = myScope.ReadString
Debug.Print strTrackMeasStatus
```

**See Also** • [":MARKer:MODE"](#) on page 789

**History** New in version 3.20.

Version 5.00: Up to 20 measurements are supported.

Version 6.71: The maximum number of measurements has increased from 20 to 40.

Version 6.72: Parameters have been added to support multiple measurement tracking markers.

## :MARKer:MODE

**Command** :MARKer:MODE {OFF | MANual | WAVeform | MEASurement | XONLy | YONLy}

The :MARKer:MODE command sets the marker mode:

- OFF – Removes the marker information from the display.
- MANual – Enables manual placement of both X (horizontal) and Y (vertical) markers.
- XONLy – Enables manual placement of X (horizontal) markers.
- YONLy – Enables manual placement of Y (vertical) markers.
- WAVeform – Tracks the current waveform.
- MEASurement – Tracks the most recent measurement.

**Example** This example sets the marker mode to waveform.

```
myScope.WriteString ":MARKer:MODE WAVeform"
```

**Query** :MARKer:MODE?

The :MARKer:MODE? query returns the current marker mode.

**Returned Format** [:MARKer:MODE] {OFF | MAN | WAV | MEAS | XONL | YONL}<NL>

**Example** This example places the current marker mode in the string variable, strSelection, then prints the contents of the variable to the computer's screen.

```
Dim strSelection As String ' Dimension variable.
myScope.WriteString ":MARKer:MODE?"
strSelection = myScope.ReadString
Debug.Print strSelection
```

**History** Legacy command (existed before version 3.10).

Version 5.00: The FFTPeak mode was removed.

Version 5.70: Added XONLy and YONLy options for for the "Manual (X only)" and "Manual (Y only)" marker modes.

## :MARKer:TSTArt

**Command** :MARKer:TSTArt <Ax\_position>

The :MARKer:TSTArt command sets the Ax marker position. The :MARKer:X1Position command described in this chapter also sets the Ax marker position.

### NOTE

#### Use :MARKer:X1Position Instead of :MARKer:TSTArt

The :MARKer:TSTArt command and query perform the same function as the :MARKer:X1Position command and query. The :MARKer:TSTArt command is provided for compatibility with programs written for previous oscilloscopes. You should use :MARKer:X1Position for new programs.

<Ax\_position> A real number for the time at the Ax marker, in seconds.

**Example** This example sets the Ax marker at 90 ns. Notice that this example uses the X1Position command instead of TSTArt.

```
myScope.WriteString ":MARKer:X1Position 90E-9"
```

**Query** :MARKer:TSTArt?

The :MARKer:TSTArt? query returns the time at the Ax marker.

**Returned Format** [:MARKer:TSTArt] <Ax\_position><NL>

**Example** This example places the current setting of the Ax marker in the numeric variable, varSetting, then prints the contents of the variable to the computer's screen. Notice that this example uses the :MARKer:X1Position? query instead of the :MARKer:TSTArt? query.

```
myScope.WriteString ":SYSTem:HEADer OFF" ' Response headers off.
myScope.WriteString ":MARKer:X1Position?"
varSetting = myScope.ReadNumber
Debug.Print FormatNumber(varSetting, 0)
```

### NOTE

#### Do Not Use TST as the Short Form of TSTArt and TSTOp

The short form of the TSTArt command and query does not follow the defined convention for short form commands. Because the short form, TST, is the same for TSTArt and TSTOp, sending TST produces an error. Use TSTA for TSTArt.

**History** Legacy command (existed before version 3.10).

## :MARKer:TSTOp

**Command** :MARKer:TSTOp <Bx\_position>

The :MARKer:TSTOp command sets the Bx marker position. The :MARKer:X2Position command described in this chapter also sets the Bx marker position.

**NOTE****Use :MARKer:X2Position Instead of :MARKer:TSTOp**

The :MARKer:TSTOp command and query perform the same function as the :MARKer:X2Position command and query. The :MARKer:TSTOp command is provided for compatibility with programs written for previous oscilloscopes. You should use :MARKer:X2Position for new programs.

<Bx\_position> A real number for the time at the Bx marker, in seconds.

**Example** This example sets the Bx marker at 190 ns. Notice that this example uses the X2Position command instead of TSTOp.

```
myScope.WriteString ":MARKer:X2Position 190E-9"
```

**Query** :MARKer:TSTOp?

The :MARKer:TSTOp? query returns the time at the Bx marker position.

**Returned Format** [:MARKer:TSTOp] <Bx\_position><NL>

**Example** This example places the current setting of the Bx marker in the numeric variable, varSetting, then prints the contents of the variable to the computer's screen. Notice that this example uses the :MARKer:X2Position? query instead of the :MARKer:TSTOp? query.

```
myScope.WriteString ":SYSTem:HEADer OFF" ' Response headers off.
myScope.WriteString ":MARKer:X2Position?"
varSetting = myScope.ReadNumber
Debug.Print FormatNumber(varSetting, 0)
```

**NOTE****Do Not Use TST as the Short Form of TSTArt and TSTOp**

The short form of the TSTOp command and query does not follow the defined convention for short form commands. Because the short form, TST, is the same for TSTArt and TSTOp, sending TST produces an error. Use TSTO for TSTOp.

**History** Legacy command (existed before version 3.10).

**:MARKer:VSTArt**

**Command** :MARKer:VSTArt <Ay\_position>

The :MARKer:VSTArt command sets the Ay marker position and moves the Ay marker to the specified measurement unit value on the specified source. The :MARKer:Y1Position command described in this chapter does also.

**NOTE****Use :MARKer:Y1Position Instead of :MARKer:VSTArt**

The :MARKer:VSTArt command and query perform the same function as the :MARKer:Y1Position command and query. The :MARKer:VSTArt command is provided for compatibility with programs written for previous oscilloscopes. You should use :MARKer:Y1Position for new programs.

<Ay\_position> A real number for the current measurement unit value at Ay (volts, amps, or watts).

**Example** This example sets Ay to -10 mV. Notice that this example uses the Y1Position command instead of VSTArt.

```
myScope.WriteString ":MARKer:Y1Position -10E-3"
```

**Query** :MARKer:VSTArt?

The :MARKer:VSTArt? query returns the current measurement unit level of Ay.

**Returned Format** [:MARKer:VSTArt] <Ay\_position><NL>

**History** Legacy command (existed before version 3.10).



## :MARKer:VSTOp

**Command** :MARKer:VSTOp <By\_position>

The :MARKer:VSTOp command sets the By marker position. The :MARKer:Y2Position command described in this chapter also sets the By marker position.

**NOTE****Use :MARKer:Y2Position Instead of :MARKer:VSTOp**

The :MARKer:VSTOp command and query perform the same function as the :MARKer:Y2Position command and query. The :MARKer:VSTOp command is provided for compatibility with programs written for previous oscilloscopes. You should use :MARKer:Y2Position for new programs.

<By\_position> A real number for the time at the By marker, in seconds.

**Example** This example sets the By marker at 10 mV. Notice that this example uses the Y2Position command instead of VSTOp.

```
myScope.WriteString ":MARKer:Y2Position 10E-3"
```

**Query** :MARKer:VSTOp?

The :MARKer:VSTOp? query returns the time at the By marker position.

**Returned Format** [:MARKer:VSTOp] <By\_position><NL>

**Example** This example places the current setting of the By marker in the numeric variable, varSetting, then prints the contents of the variable to the computer's screen. Notice that this example uses the :MARKer:Y2? query instead of the :MARKer:VSTOp? query.

```
myScope.WriteString ":SYSTem:HEADer OFF" ' Response headers off.
myScope.WriteString ":MARKer:Y2Position?"
varSetting = myScope.ReadNumber
Debug.Print FormatNumber(varSetting, 0)
```

**History** Legacy command (existed before version 3.10).

## :MARKer:X1Position

**Command** :MARKer:X1Position <Ax\_position>

The :MARKer:X1Position command sets the Ax marker position, and moves the Ax marker to the specified time with respect to the trigger time.

<Ax\_position> A real number for the time at the Ax marker in seconds.

**Example** This example sets the Ax marker to 90 ns.

```
myScope.WriteString ":MARKer:X1Position 90E-9"
```

**Query** :MARKer:X1Position?

The :MARKer:X1Position? query returns the time at the Ax marker position.

**Returned Format** [:MARKer:X1Position] <Ax\_position><NL>

**Example** This example returns the current setting of the Ax marker to the numeric variable, varValue, then prints the contents of the variable to the computer's screen.

```
myScope.WriteString ":SYSTem:HEADer OFF" ' Response headers off.
myScope.WriteString ":MARKer:X1Position?"
varValue = myScope.ReadNumber
Debug.Print FormatNumber(varValue, 0)
```

**See Also** :MARKer:TStart

**History** Legacy command (existed before version 3.10).

## :MARKer:X2Position

**Command** :MARKer:X2Position <Bx\_position>

The :MARKer:X2Position command sets the Bx marker position and moves the Bx marker to the specified time with respect to the trigger time.

<Bx\_position> A real number for the time at the Bx marker in seconds.

**Example** This example sets the Bx marker to 90 ns.

```
myScope.WriteString ":MARKer:X2Position 90E-9"
```

**Query** :MARKer:X2Position?

The :MARKer:X2Position? query returns the time at Bx marker in seconds.

**Returned Format** [:MARKer:X2Position] <Bx\_position><NL>

**Example** This example returns the current position of the Bx marker to the numeric variable, varValue, then prints the contents of the variable to the computer's screen.

```
myScope.WriteString ":SYSTem:HEADer OFF" ' Response headers off.
myScope.WriteString ":MARKer:X2Position?"
varValue = myScope.ReadNumber
Debug.Print FormatNumber(varValue, 0)
```

**History** Legacy command (existed before version 3.10).

## :MARKer:X1Y1source

**Command** :MARKer:X1Y1source {CHANnel<N> | DIFF<D> | COMMONmode<C>  
 | FUNction<F> | WMEMory<R> | CLOCk | MTRend | MSPectrum  
 | EQUalized<L> | XT<X> | HISTogram | PNOise | DIGital<M> | BUS<B>}

The :MARKer:X1Y1source command sets the source for the Ax and Ay markers. The channel you specify must be enabled for markers to be displayed. If the channel, function, or waveform memory that you specify is not on, an error message is issued and the query will return channel 1.

The MTRend and MSPectrum sources are available when the Jitter Analysis Software license is installed and the features are enabled.

The CLOCk source is available when the recovered clock is displayed.

The EQUalized<L> source is available when the Advanced Signal Integrity Software license is installed and the equalized waveform is displayed as a function.

The PNOise source is available when the Jitter and Vertical Noise Analysis Software license is installed and the Phase Noise analysis feature is enabled.

<N> An integer, 1-4 in a single oscilloscope, 1-40 in a MultiScope system.

<F> An integer, 1-16.

<R> An integer, 1-4.

<L> An integer, 1-4.

<X> An integer, 1-4, identifying the crosstalk waveform.

<D>, <C> <D> is an integer, 1-2. <C> is an integer, 3-4.

The DIFF and COMMONmode sources are just aliases that can be used in place of the channel names to apply to differential or common mode signals. These are just aliases - no state change occurs if you refer to a differential channel and you are not in differential mode. DIFF1 refers to the differential signal between channels 1 and 3 (and COMMONmode3 refers to the common mode channel between these same channels). DIFF2 refers to the differential signal between channels 2 and 4 (and COMMONmode4 refers to the common mode channel between these same channels).

<M> An integer, 0-15. Digital channels are available on mixed-signal oscilloscopes.

<B> An integer, 1-4. Buses are available on mixed-signal oscilloscopes.

**Example** This example selects channel 1 as the source for markers Ax and Ay.

```
myScope.WriteString ":MARKer:X1Y1source CHANnel1"
```

**Query** :MARKer:X1Y1source?

The :MARKer:X1Y1source? query returns the current source for markers Ax and Ay.

**Returned Format** [:MARKer:X1Y1source] {CHAN<N> | DIFF<D> | COMM<C> | FUNC<F> | WMEM<R>  
| CLOC | MTR | MSP | EQU<L> | XT<X> | HIST | DIG<M> | BUS<B>}<NL>

**Example** This example returns the current source selection for the Ax and Ay markers to the string variable, strSelection, then prints the contents of the variable to the computer's screen.

```
Dim strSelection As String ' Dimension variable.
myScope.WriteString ":MARKer:X1Y1source?"
strSelection = myScope.ReadString
Debug.Print strSelection
```

**History** Legacy command (existed before version 3.10).

## :MARKer:X2Y2source

**Command** :MARKer:X2Y2source {CHANnel<N> | DIFF<D> | COMMONmode<C>  
 | FUNction<F> | WMEMory<R> | CLOCk | MTRend | MSPectrum  
 | EQUalized<L> | XT<X> | HISTogram | PNOise | DIGital<M> | BUS<B>}

The :MARKer:X2Y2source command sets the source for the Bx and By markers. The channel you specify must be enabled for markers to be displayed. If the channel, function, or waveform memory that you specify is not on, an error message is issued and the query will return channel 1.

The MTRend and MSPectrum sources are available when the Jitter Analysis Software license is installed and the features are enabled.

The CLOCk source is available when the recovered clock is displayed.

The EQUalized<L> source is available when the Advanced Signal Integrity Software license is installed and the equalized waveform is displayed as a function.

The PNOise source is available when the Jitter and Vertical Noise Analysis Software license is installed and the Phase Noise analysis feature is enabled.

<N> An integer, 1-4 in a single oscilloscope, 1-40 in a MultiScope system.

<D>, <C> <D> is an integer, 1-2. <C> is an integer, 3-4.

The DIFF and COMMONmode sources are just aliases that can be used in place of the channel names to apply to differential or common mode signals. These are just aliases - no state change occurs if you refer to a differential channel and you are not in differential mode. DIFF1 refers to the differential signal between channels 1 and 3 (and COMMONmode3 refers to the common mode channel between these same channels). DIFF2 refers to the differential signal between channels 2 and 4 (and COMMONmode4 refers to the common mode channel between these same channels).

<F> An integer, 1-16.

<R> An integer, 1-4.

<L> An integer, 1-4.

<X> An integer, 1-4, identifying the crosstalk waveform.

<M> An integer, 0-15. Digital channels are available on mixed-signal oscilloscopes.

<B> An integer, 1-4. Buses are available on mixed-signal oscilloscopes.

**Example** This example selects channel 1 as the source for markers Bx and By.

```
myScope.WriteString ":MARKer:X2Y2source CHANnel1"
```

**Query** :MARKer:X2Y2source?

The :MARKer:X2Y2source? query returns the current source for markers Bx and By.

**Returned Format** [:MARKer:X2Y2source] {CHAN<N> | DIFF<D> | COMM<C> | FUNC<F> | WMEM<R>  
| CLOC | MTR | MSP | EQU<L> | XT<X> | HIST | DIG<M> | BUS<B>}<NL>

**Example** This example returns the current source selection for the Bx and By markers to the string variable, strSelection, then prints the contents of the variable to the computer's screen.

```
Dim strSelection As String    ' Dimension variable.
myScope.WriteString ":MARKer:X2Y2source?"
strSelection = myScope.ReadString
Debug.Print strSelection
```

**History** Legacy command (existed before version 3.10).

**:MARKer:XDELta?****Query** :MARKer:XDELta?

The :MARKer:XDELta? query returns the time difference between Ax and Bx time markers.

Xdelta = time at Bx - time at Ax

**Returned Format** [:MARKer:XDELta] <time><NL>

<time> Time difference between Ax and Bx time markers in seconds.

**Example** This example returns the current time between the Ax and Bx time markers to the numeric variable, varTime, then prints the contents of the variable to the computer's screen.

```
myScope.WriteString ":SYSTEM:HEADer OFF" ' Response headers off.
myScope.WriteString ":MARKer:XDELta?"
varTime = myScope.ReadNumber
Debug.Print FormatNumber(varTime, 0)
```

**History** Legacy command (existed before version 3.10).



## :MARKer:Y1Position

**Command** :MARKer:Y1Position <Ay\_position>

The :MARKer:Y1Position command sets the Ay marker position on the specified source.

<Ay\_position> A real number for the current measurement unit value at Ay (volts, amps, or watts).

**Example** This example sets the Ay marker to 10 mV.

```
myScope.WriteString ":MARKer:Y1Position 10E-3"
```

**Query** :MARKer:Y1Position?

The :MARKer:Y1Position? query returns the current measurement unit level at the Ay marker position.

**Returned Format** [:MARKer:Y1Position] <Ay\_position><NL>

**Example** This example returns the current setting of the Ay marker to the numeric variable, varValue, then prints the contents of the variable to the computer's screen.

```
myScope.WriteString ":SYSTem:HEADer OFF" ' Response headers off.
myScope.WriteString ":MARKer:Y1Position?"
varValue = myScope.ReadNumber
Debug.Print FormatNumber(varValue, 0)
```

**History** Legacy command (existed before version 3.10).

## :MARKer:Y2Position

**Command** :MARKer:Y2Position <By\_position>

The :MARKer:Y2Position command sets the By marker position on the specified source.

<By\_position> A real number for the current measurement unit value at By (volts, amps, or watts).

**Example** This example sets the By marker to -100 mV.

```
myScope.WriteString ":MARKer:Y2Position -100E-3"
```

**Query** :MARKer:Y2Position?

The :MARKer:Y2Position? query returns the current measurement unit level at the By marker position.

**Returned Format** [:MARKer:Y2Position] <By\_position><NL>

**Example** This example returns the current setting of the By marker to the numeric variable, varValue, then prints the contents of the variable to the computer's screen.

```
myScope.WriteString ":SYSTem:HEADer OFF" ' Response headers off.
myScope.WriteString ":MARKer:Y2Position?"
varValue = myScope.ReadNumber
Debug.Print FormatNumber(varValue, 0)
```

**History** Legacy command (existed before version 3.10).

**:MARKer:YDELta?**

**Query** :MARKer:YDELta?

The :MARKer:YDELta? query returns the current measurement unit difference between Ay and By.

Ydelta = value at By - value at Ay

**Returned Format** [:MARKer:YDELta] <value><NL>

<value> Measurement unit difference between Ay and By.

**Example** This example returns the voltage difference between Ay and By to the numeric variable, varVolts, then prints the contents of the variable to the computer's screen.

```
myScope.WriteString ":SYSTEM:HEADer OFF" ' Response headers off.
myScope.WriteString ":MARKer:YDELta?"
varVolts = myScope.ReadNumber
Debug.Print FormatNumber(varVolts, 0)
```

**History** Legacy command (existed before version 3.10).

**:MARKer<K>:CMODE**

**Command** :MARKer<K>:CMODE {CUSTom | SOURce}

The :MARKer<K>:CMODE command specifies a particular marker's color mode:

- CUSTom – A custom color can be specified for the marker using the :MARKer<K>:COLor command.
- SOURce – The marker is set to the color of the associated channel, waveform memory, or math function source.

<K> An integer, 1-60.

**Query** :MARKer<K>:CMODE?

The :MARKer<K>:CMODE? query returns a particular marker's color mode.

**Returned Format** <color\_mode><NL>

<color\_mode> ::= {CUST | SOUR}

**See Also** • **":MARKer<K>:COLor"** on page 805

**History** New in version 6.55.

## :MARKer&lt;K&gt;:COLor





















































**Command** :MARKer<K>:COLor <color>

The :MARKer<K>:COLor command gives the marker a custom color when the color mode is set to CUSTom (see :MARKer<K>:CMODE).





































































<K> An integer, 1-60.

<color> A quoted string where the color is specified as "#HHHHHHHH" where Eight-digit hex notation consists of a hash symbol (#), followed by eight characters. The first two represent the alpha channel of the color. The remaining six characters represent the RGB (red, green, blue) value of the color. Additionally, a named color from the following list can be specified (strings are not case-sensitive):













**Table 13** Named Marker Colors

	AliceBlue (#FFF0F8FF)		DarkSlateGray (#FF2F4F4F)		LightSalmon (#FFFA07A)		PaleVioletRed (#FFDB7093)
	AntiqueWhite (#FFFAEBD7)		DarkTurquoise (#FF00CED1)		LightSeaGreen (#FF20B2AA)		PapayaWhip (#FFFFEFD5)
	Aqua (#FF00FFFF)		DarkViolet (#FF9400D3)		LightSkyBlue (#FF87CEFA)		PeachPuff (#FFFFDAB9)
	Aquamarine (#FF7FFFD4)		DeepPink (#FFFF1493)		LightSlateGray (#FF778899)		Peru (#FFCD853F)
	Azure (#FFF0FFFF)		DeepSkyBlue (#FF00BFFF)		LightSteelBlue (#FFB0C4DE)		Pink (#FFFC0CB)
	Beige (#FFF5F5DC)		DimGray (#FF696969)		LightYellow (#FFFFFFE0)		Plum (#FFDDA0DD)
	Bisque (#FFFFE4C4)		DodgerBlue (#FF1E90FF)		Lime (#FF00FF00)		PowderBlue (#FFB0E0E6)
	Black (#FF000000)		FireBrick (#FFB22222)		LimeGreen (#FF32CD32)		Purple (#FF800080)
	BlanchedAlmond (#FFFFEBCD)		FloralWhite (#FFFFFFAF0)		Linen (#FFFAF0E6)		Red (#FFFF0000)
	Blue (#FF0000FF)		ForestGreen (#FF228B22)		Magenta (#FFFF00FF)		RosyBrown (#FFBC8F8F)
	BlueViolet (#FF8A2BE2)		Fuchsia (#FFFF00FF)		Maroon (#FF800000)		RoyalBlue (#FF4169E1)
	Brown (#FFA52A2A)		Gainsboro (#FFDCDCDC)		MediumAquamarine (#FF66CDAA)		SaddleBrown (#FF8B4513)
	BurlyWood (#FFDEB887)		GhostWhite (#FFF8F8FF)		MediumBlue (#FF0000CD)		Salmon (#FFFA8072)

**Table 13** Named Marker Colors (continued)

	CadetBlue (#FF5F9EA0)		Gold (#FFFFD700)		MediumOrchid (#FFBA55D3)		SandyBrown (#FFF4A460)
	Chartreuse (#FF7FFF00)		Goldenrod (#FFDAA520)		MediumPurple (#FF9370DB)		SeaGreen (#FF2E8B57)
	Chocolate (#FFD2691E)		Gray (#FF808080)		MediumSeaGreen (#FF3CB371)		Seashell (#FFFFFF5EE)
	Coral (#FFFF7F50)		Green (#FF00FF00)		MediumSlateBlue (#FF7B68EE)		Sienna (#FFA0522D)
	CornflowerBlue (#FF6495ED)		GreenYellow (#FFADFF2F)		MediumSpringGreen (#FF00FA9A)		Silver (#FFC0C0C0)
	CornSilk (#FFFFFF8DC)		Honeydew (#FFF0FFF0)		MediumTurquoise (#FF48D1CC)		SkyBlue (#FF87CEEB)
	Crimson (#FFDC143C)		HotPink (#FFFF69B4)		MediumVioletRed (#FFC71585)		SlateBlue (#FF6A5ACD)
	Cyan (#FF00FFFF)		IndianRed (#FFCD5C5C)		MidnightBlue (#FF191970)		SlateGray (#FF708090)
	DarkBlue (#FF00008B)		Indigo (#FF4B0082)		MintCream (#FFF5FFFA)		Snow (#FFFFFFAFA)
	DarkCyan (#FF008B8B)		Ivory (#FFFFFFF0)		MistyRose (#FFFFE4E1)		SpringGreen (#FF00FF7F)
	DarkGoldenrod (#FFB8860B)		Khaki (#FFF0E68C)		Moccasin (#FFFFE4B5)		SteelBlue (#FF4682B4)
	DarkGray (#FFA9A9A9)		Lavender (#FFE6E6FA)		NavajoWhite (#FFFDEAD)		Tan (#FFD2B48C)
	DarkGreen (#FF006400)		LavenderBlush (#FFFFFF0F5)		Navy (#FF000080)		Teal (#FF008080)
	DarkKhaki (#FFBDB76B)		LawnGreen (#FF7CFC00)		OldLace (#FFFD5E6)		Thistle (#FFD8BFD8)
	DarkMagenta (#FF8B008B)		LemonChiffon (#FFFFACD)		Olive (#FF808000)		Tomato (#FFFF6347)
	DarkOliveGreen (#FF556B2F)		LightBlue (#FFADD8E6)		OliveDrab (#FF6B8E23)		Turquoise (#FF40E0D0)
	DarkOrange (#FFF8C00)		LightCoral (#FFF08080)		Orange (#FFFA500)		Violet (#FEE82EE)
	DarkOrchid (#FF9932CC)		LightCyan (#FFE0FFFF)		OrangeRed (#FFF4500)		Wheat (#FFF5DEB3)
	DarkRed (#FF8B0000)		LightGoldenrodYellow (#FFAFAD2)		Orchid (#FFDA70D6)		White (#FFFFFFF)

**Table 13** Named Marker Colors (continued)

	DarkSalmon (#FFE9967A)		LightGray (#FFD3D3D3)		PaleGoldenrod (#FFEEE8AA)		WhiteSmoke (#FFF5F5F5)
	DarkSeaGreen (#FF8FBC8F)		LightGreen (#FF90EE90)		PaleGreen (#FF98FB98)		Yellow (#FFFFFFF0)
	DarkSlateBlue (#FF483D8B)		LightPink (#FFFFB6C1)		PaleTurquoise (#FFAFEEEE)		YellowGreen (#FF9ACD32)

**Query** :MARKer<K>:COLor?

The :MARKer<K>:COLor? query returns the marker custom color.

**Returned Format** <color><NL>

<color> ::= quoted string

**See Also** • [":MARKer<K>:CMODE"](#) on page 804

**History** New in version 6.55.

**:MARKer<K>:DELTA**

**Command** :MARKer<K>:DELTA MARKer<L>,{{0 | OFF} | {1 | ON}}

The :MARKer<K>:DELTA command sets a particular marker's "delta to" relationship with another marker of the same type.

<K>, <L> An integer, 1-60.

**Query** :MARKer<K>:DELTA? MARKer<L>

The :MARKer<K>:DELTA? query returns a particular marker's "delta to" state and delta values if the state is 1 (ON).

**Returned Format** <marker\_delta\_results><NL>

```
<marker_delta_results> ::= <delta-to_state>,<delta_X>,<delta_X_inv>,<delta_Y>,<delta_Y_over_delta_X>
```

```
<delta-to_state> ::= {0 | 1}
```

```
<delta_X> ::= ΔX value in NR3 format
```

```
<delta_X_inv> ::= 1/ΔX value in NR3 format
```

```
<delta_Y> ::= ΔY value in NR3 format
```

```
<delta_Y_over_delta_X> ::= ΔY/ΔX value in NR3 format
```

If the delta measurement does not apply or cannot be made or if the "delta to" relationship is 0 (OFF), the infinity representation value (9.99999E+37) is returned.

- See Also**
- **":MARKer<K>:ENABle"** on page 809
  - **":MARKer<K>:NAME"** on page 810
  - **":MARKer<K>:SOURce"** on page 811
  - **":MARKer<K>:TYPE"** on page 813
  - **":MARKer<K>:X:POSition"** on page 815
  - **":MARKer<K>:Y:POSition"** on page 816

**History** New in version 6.30.



## :MARKer&lt;K&gt;:ENABLE

**Command** :MARKer<K>:ENABLE {{0 | OFF} | {1 | ON}}

The :MARKer<K>:ENABLE command turns a particular marker on or off.

<K> An integer, 1-60.

**Query** :MARKer<K>:ENABLE?

The :MARKer<K>:ENABLE? query returns whether a particular marker is on or off.

**Returned Format** [:MARKer<K>:ENABLE] <setting><NL>

<setting> ::= {0 | 1}

- See Also**
- [":MARKer<K>:DELTA"](#) on page 808
  - [":MARKer<K>:NAME"](#) on page 810
  - [":MARKer<K>:SOURCE"](#) on page 811
  - [":MARKer<K>:TYPE"](#) on page 813
  - [":MARKer<K>:X:POSITION"](#) on page 815
  - [":MARKer<K>:Y:POSITION"](#) on page 816

**History** New in version 6.30.

**:MARKer<K>:NAME**

**Command** :MARKer<K>:NAME <name>

The :MARKer<K>:NAME command gives the marker a name.

<K> An integer, 1-60.

<name> A quoted string.

**Query** :MARKer<K>:NAME?

The :MARKer<K>:NAME? query returns the marker name.

**Returned Format** <name><NL>

<name> ::= quoted string

- See Also**
- [":MARKer<K>:DELTA"](#) on page 808
  - [":MARKer<K>:ENABLE"](#) on page 809
  - [":MARKer<K>:SOURce"](#) on page 811
  - [":MARKer<K>:TYPE"](#) on page 813
  - [":MARKer<K>:X:POSition"](#) on page 815
  - [":MARKer<K>:Y:POSition"](#) on page 816

**History** New in version 6.30.

## :MARKer&lt;K&gt;:SOURce

**Command** :MARKer<K>:SOURce {CHANnel<N> | DIFF<D> | COMMONmode<C> | FUNCTION<F>  
 | WMEMory<R> | CLOCK | MTRend | MSPectrum | EQUalized<L>  
 | HISTogram | DIGital<M> | BUS<B> | XT<X> | PNOise}

The :MARKer<K>:SOURce command specifies the waveform source of a particular marker.

This command is similar to :MARKer:X1Y1source or :MARKer:X2Y2source commands for marker 1 and marker 2, respectively.

The waveform you specify must be enabled for markers to be displayed. If the channel, function, or waveform memory that you specify is not on, an error message is issued and the query will return channel 1.

MTRend and MSPectrum sources are available only if the oscilloscope has the Jitter and Vertical Noise Analysis Software license installed and the feature is enabled.

The CLOCK source is the recovered clock from the clock recovery feature.

The EQUalized<L> source is available only if the Advanced Signal Integrity Bundle license is installed and the Equalization feature is enabled. This command uses the Feed-Forward Equalized (FFE) signal as the source.

The PNOise source is available when the Jitter and Vertical Noise Analysis Software license is installed and the Phase Noise analysis feature is enabled.

- <K> An integer, 1-60.
- <N> An integer, 1-4 in a single oscilloscope, 1-40 in a MultiScope system.
- <F> An integer, 1-16.
- <R> An integer, 1-4.
- <L> An integer, 1-4.
- <D>, <C> <D> is an integer, 1-2. <C> is an integer, 3-4.

The DIFF and COMMONmode sources are just aliases that can be used in place of the channel names to apply to differential or common mode signals. These are just aliases - no state change occurs if you refer to a differential channel and you are not in differential mode. DIFF1 refers to the differential signal between channels 1 and 3 (and COMMONmode3 refers to the common mode channel between these same channels). DIFF2 refers to the differential signal between channels 2 and 4 (and COMMONmode4 refers to the common mode channel between these same channels).

- <M> An integer, 0-15. Digital channels are available on mixed-signal oscilloscopes.
- <B> An integer, 1-4. Buses are available on mixed-signal oscilloscopes.
- <X> An integer, 1-4, identifying the crosstalk waveform.

**Example** This example selects channel 1 as the source for markers 3.

```
myScope.WriteString ":MARKer3:SOURce CHANnel1"
```

**Query** :MARKer<K>:SOURce?

The :MARKer<K>:SOURce? query returns the specified source for a particular marker.

**Returned Format** [:MARKer<K>:SOURce] <source><NL>

```
<source> ::= {CHAN<N> | DIFF<D> | COMM<C> | FUNC<F> | WMEM<R> | CLOC
  | MTR | MSP | EQU<L> | HIST | DIG<M> | BUS<B> | XT<X> | PNO}
```

- See Also**
- [":MARKer:X1Y1source"](#) on page 796
  - [":MARKer:X2Y2source"](#) on page 798
  - [":MARKer<K>:DELTA"](#) on page 808
  - [":MARKer<K>:ENABLE"](#) on page 809
  - [":MARKer<K>:NAME"](#) on page 810
  - [":MARKer<K>:TYPE"](#) on page 813
  - [":MARKer<K>:X:POSition"](#) on page 815
  - [":MARKer<K>:Y:POSition"](#) on page 816

**History** New in version 6.30.

## :MARKer&lt;K&gt;:TYPE

**Command** :MARKer<K>:TYPE {XMANual | YMANual | TRACK | RF}

The :MARKer<K>:TYPE command specifies a particular marker's type:

- XMANual – manual X only horizontal marker that can be moved freely.
- YMANual – manual Y only vertical marker that can be moved freely.

Vertical markers are not allowed if the marker source is a digital input channel.

- TRACK – track waveform marker.

A track waveform marker is a horizontal marker that can be moved freely. The waveform's vertical value at that horizontal time point is also marked (but cannot be moved).

- RF – track RF marker.

Track RF markers are allowed only on frequency domain (FFT) waveform sources. Track RF markers show the frequency and vertical value associated with the marker's horizontal position.

There is an additional marker type, MEASurement, that cannot be specified with the :MARKer<K>:TYPE command. Measurement markers are turned on or off using the :MEASure:MARK command.

**NOTE**

You cannot change a marker's type when it is enabled. Use the ":MARKer<K>:ENABLE OFF" to disable a marker before changing its type.

<K> An integer, 1-60.

**Query** :MARKer<K>:TYPE?

The :MARKer<K>:TYPE? query returns a particular marker's type.

If the marker was added as a measurement marker (using the :MEASure:MARK command), the query will return MEAS.

**Returned Format** [:MARKer<K>:TYPE] <marker\_type><NL>

<marker\_type> ::= {XMAN | YMAN | TRAC | RF | MEAS}

- See Also**
- [":MEASure:MARK"](#) on page 997
  - [":MARKer<K>:DELTA"](#) on page 808
  - [":MARKer<K>:ENABLE"](#) on page 809
  - [":MARKer<K>:NAME"](#) on page 810
  - [":MARKer<K>:SOURce"](#) on page 811
  - [":MARKer<K>:X:POSition"](#) on page 815
  - [":MARKer<K>:Y:POSition"](#) on page 816

**History** New in version 6.30.

## :MARKer&lt;K&gt;:X:POSition

**Command** :MARKer<K>:X:POSition <X\_position>

The :MARKer<K>:X:POSition command specifies the horizontal position of a particular marker.

Whether this command is valid depends on the type of marker (see :MARKer<K>:TYPE). For example, you cannot set the X position of a manual Y only vertical marker.

<K> An integer, 1-60.

<X\_position> Horizontal position of marker in NR3 format.

The horizontal position units are determined by the marker's source; they are typically seconds or Hertz.

**Query** :MARKer<K>:X:POSition?

The :MARKer<K>:X:POSition? query returns a particular marker's horizontal position.

**Returned Format** [:MARKer<K>:X:POSition] <X\_position><NL>

If a horizontal position value is not appropriate for the type of marker (see :MARKer<K>:TYPE), for example querying the X position of a manual Y only vertical marker, the infinity representation value (9.99999E+37) is returned.

- See Also**
- **":MARKer<K>:DELTA"** on page 808
  - **":MARKer<K>:ENABLE"** on page 809
  - **":MARKer<K>:NAME"** on page 810
  - **":MARKer<K>:SOURCE"** on page 811
  - **":MARKer<K>:TYPE"** on page 813
  - **":MARKer<K>:Y:POSition"** on page 816

**History** New in version 6.30.

**:MARKer<K>:Y:POSition**

**Command** :MARKer<K>:Y:POSition <Y\_position>

The :MARKer<K>:Y:POSition command specifies the vertical position of a particular marker.

Whether this command is valid depends on the type of marker (see :MARKer<K>:TYPE). For example, you cannot set the Y position of a manual X only vertical marker.

<K> An integer, 1-60.

<Y\_position> The vertical position of marker in NR3 format.

The vertical position units are determined by the marker's source; they are typically Volts or dBm, but other options are available with frequency domain waveforms.

**Query** :MARKer<K>:Y:POSition?

The :MARKer<K>:Y:POSition? query returns a particular marker's vertical position.

**Returned Format** [:MARKer<K>:Y:POSition] <Y\_position><NL>

If a vertical position value is not appropriate for the type of marker (see :MARKer<K>:TYPE), for example querying the Y position of a manual X only horizontal marker, the infinity representation value (9.99999E+37) is returned.

- See Also**
- **" :MARKer<K>:DELTA "** on page 808
  - **" :MARKer<K>:ENABLE "** on page 809
  - **" :MARKer<K>:NAME "** on page 810
  - **" :MARKer<K>:SOURce "** on page 811
  - **" :MARKer<K>:TYPE "** on page 813
  - **" :MARKer<K>:X:POSition "** on page 815

**History** New in version 6.30.



## 30 Mask Test Commands

:MTESt:ALIGn / 819  
:MTESt:AMASk:CREate / 820  
:MTESt:AMASk:SOURce / 821  
:MTESt:AMASk:SAVE / 823  
:MTESt:AMASk:UNITs / 824  
:MTESt:AMASk:XDELta / 825  
:MTESt:AMASk:YDELta / 826  
:MTESt:AUTO / 827  
:MTESt:AVERAge / 828  
:MTESt:AVERAge:COUNT / 829  
:MTESt:COUNt:FAILures? / 830  
:MTESt:COUNt:FUI? / 831  
:MTESt:COUNt:FWAVEforms? / 832  
:MTESt:COUNt:MARGin:FAILures? / 833  
:MTESt:COUNt:SUI? / 834  
:MTESt:COUNt:UI? / 835  
:MTESt:COUNt:WAVEforms? / 836  
:MTESt:DELeTe / 837  
:MTESt:ENABLE / 838  
:MTESt:FOLDing (Clock Recovery software only) / 839  
:MTESt:FOLDing:BITS / 841  
:MTESt:FOLDing:COUNt:UI? / 843  
:MTESt:FOLDing:COUNt:WAVEforms? / 845  
:MTESt:FOLDing:FAST / 847  
:MTESt:FOLDing:POSition / 849  
:MTESt:FOLDing:SCALe / 851  
:MTESt:FOLDing:TPOSition / 853  
:MTESt:FOLDing:TSCale / 855  
:MTESt:IMPedance / 857  
:MTESt:INVert / 858  
:MTESt:LOAD / 859  
:MTESt:MARGin:AUTO:HITS / 860

:MTESt:MARGIn:AUTO:HRATio / 861  
:MTESt:MARGIn:AUTO:MEtHod / 862  
:MTESt:MARGIn:MEtHod / 863  
:MTESt:MARGIn:PERCent / 864  
:MTESt:MARGIn:STATe / 865  
:MTESt:NREGions? / 866  
:MTESt:PROBe:IMPedance? / 867  
:MTESt:RUMode / 868  
:MTESt:RUMode:SOFailure / 869  
:MTESt:SCALe:BIND / 870  
:MTESt:SCALe:DRAW / 871  
:MTESt:SCALe:X1 / 872  
:MTESt:SCALe:XDELta / 873  
:MTESt:SCALe:Y1 / 874  
:MTESt:SCALe:Y2 / 875  
:MTESt:SOURce / 876  
:MTESt:STARt / 877  
:MTESt:STOP / 878  
:MTESt:STIMe / 879  
:MTESt:TITLe? / 880  
:MTESt:TRIGger:SOURce / 881

The MTESt subsystem commands and queries control the mask test features. Mask Testing automatically compares measurement results with the boundaries of a set of polygons that you define. Any waveform or sample that falls within the boundaries of one or more polygons is recorded as a failure.

## :MTEST:ALIGN

**Command** :MTEST:ALIGN

The :MTEST:ALIGN command automatically aligns and scales the mask to the current waveform on the display. The type of mask alignment performed depends on the current setting of the Use File Setup When Aligning control. See the :MTEST:AUTO command for more information.

**Example** This example aligns the current mask to the current waveform.

```
myScope.WriteString ":MTEST:ALIGN"
```

**History** Legacy command (existed before version 3.10).

## :MTEST:AMASK:CREate

**Command** :MTEST:AMASK:CREate

The :MTEST:AMASK:CREate command automatically constructs a mask around the current selected channel, using the tolerance parameters defined by the AMASK:XDELta, AMASK:YDELta, and AMASK:UNITs commands. The mask only encompasses the portion of the waveform visible on the display, so you must ensure that the waveform is acquired and displayed consistently to obtain repeatable results.

The :MTEST:SOURce command selects the channel and should be set before using this command.

**Example** This example creates an automask using the current XDELta and YDELta units settings.

```
myScope.WriteString ":MTEST:AMASK:CREate"
```

**History** Legacy command (existed before version 3.10).

## :MTEST:AMASK:SOURce

**Command** :MTEST:AMASK:SOURce {CHANnel<N> | DIFF<D> | COMMONmode<C>  
 | FUNction<F> | WMEMory<R> | CLOCk | EQUalized<L> | MTRend  
 | MSPectrum | XT<X>}

The :MTEST:AMASK:SOURce command selects the source for the interpretation of the AMASK:XDELta and AMASK:YDELta parameters when AMASK:UNITs is set to CURRent. When UNITs are CURRent, the XDELta and YDELta parameters are defined in terms of the channel units, as set by the :CHANnel:UNITs command, of the selected source. Suppose that UNITs are CURRent and that you set SOURce to CHANnel1, which is using units of volts. Then you can define AMASK:XDELta in terms of volts and AMASK:YDELta in terms of seconds.

The EQUalized<L> source is available when the Advanced Signal Integrity Software license is installed and the equalized waveform is displayed as a function.

<N> An integer, 1-4 in a single oscilloscope, 1-40 in a MultiScope system.

<D>, <C> <D> is an integer, 1-2. <C> is an integer, 3-4.

The DIFF and COMMONmode sources are just aliases that can be used in place of the channel names to apply to differential or common mode signals. These are just aliases - no state change occurs if you refer to a differential channel and you are not in differential mode. DIFF1 refers to the differential signal between channels 1 and 3 (and COMMONmode3 refers to the common mode channel between these same channels). DIFF2 refers to the differential signal between channels 2 and 4 (and COMMONmode4 refers to the common mode channel between these same channels).

<F> An integer, 1-16.

<R> An integer, 1-4.

<L> An integer, 1-4.

<X> An integer, 1-4, identifying the crosstalk waveform.

**Example** This example sets the automask source to Channel 1.

```
myScope.WriteString ":MTEST:AMASK:SOURce CHANnel1"
```

**Query** :MTEST:AMASK:SOURce?

The :MTEST:AMASK:SOURce? query returns the currently set source.

**Returned Format** [:MTEST:AMASK:SOURce] {CHAN<N> | DIFF<D> | COMM<C> | WMEM<R>  
 | FUNC<F> | CLOC | EQU<L> | MTR | MSP | XT<X>}<NL>

**Example** This example gets the source setting for automask and prints the result on the computer display.

```
Dim strAmask_source As String
myScope.WriteString ":MTEST:AMASK:SOURce?"
```

```
strAmask_source = myScope.ReadString  
Debug.Print strAmask_source
```

**History** Legacy command (existed before version 3.10).

## :MTEST:AMASK:SAVE

**Command** :MTEST:AMASK:{SAVE | STORE} "<filename>"

**NOTE**

The :MTEST:AMASK:STORE command is equivalent to the :MTEST:AMASK:SAVE command.

The :MTEST:AMASK:SAVE command saves the automask generated mask to a file. If an automask has not been generated, an error occurs.

**<filename>** An MS-DOS compatible name of the file, a maximum of 254 characters long (including the path name, if used). The filename assumes the present working directory if a path does not precede the file name. The default save path is C:\Users\Public\Documents\Infiniium\masks. The filename must have a .msk or .MSK extension or the command will fail.

**Example** This example saves the automask generated mask to a file named "FILE1.MSK".

```
myScope.WriteString ":MTEST:AMASK:SAVE" "FILE1.MSK" ""
```

**History** Legacy command (existed before version 3.10).

## :MTEST:AMASK:UNITs

**Command** :MTEST:AMASK:UNITs {CURRENT | DIVisions}

The :MTEST:AMASK:UNITs command alters the way the mask test subsystem interprets the tolerance parameters for automasking as defined by AMASK:XDELta and AMASK:YDELta commands.

**CURRent** When set to CURRent, the mask test subsystem uses the units as set by the :CHANnel:UNITs command, usually time for  $\Delta X$  and voltage for  $\Delta Y$ .

**DIVisions** When set to DIVisions, the mask test subsystem uses the graticule as the measurement system, so tolerance settings are specified as parts of a screen division. The mask test subsystem maintains separate XDELta and YDELta settings for CURRent and DIVisions. Thus, XDELta and YDELta are not converted to new values when the UNITs setting is changed.

**Example** This example sets the measurement units for automasking to the current :CHANnel:UNITs setting.

```
myScope.WriteString ":MTEST:AMASK:UNITs CURRent"
```

**Query** :MTEST:AMASK:UNITs?

The AMASK:UNITs query returns the current measurement units setting for the mask test automask feature.

**Returned Format** [:MTEST:AMASK:UNITs] {CURRENT | DIVision}<NL>

**Example** This example gets the automask units setting, then prints the setting on the screen of the computer.

```
Dim strAutomask_units As String
myScope.WriteString ":MTEST:AMASK:UNITs?"
strAutomask_units = myScope.ReadString
Debug.Print strAutomask_units
```

**History** Legacy command (existed before version 3.10).



## :MTEST:AMASK:XDELta

**Command** :MTEST:AMASK:XDELta <xdelta\_value>

The :MTEST:AMASK:XDELta command sets the tolerance in the X direction around the waveform for the automasking feature. The absolute value of the tolerance will be added and subtracted to horizontal values of the waveform to determine the boundaries of the mask.

**<xdelta\_value>** A value for the horizontal tolerance. This value is interpreted based on the setting specified by the AMASK:UNITs command; thus, if you specify 250-E3, the setting for AMASK:UNITs is CURRent, and the current setting specifies time in the horizontal direction, the tolerance will be  $\pm 250$  ms. If the setting for AMASK:UNITs is DIVISIONs, the same xdelta\_value will set the tolerance to  $\pm 250$  millidivisions, or 1/4 of a division.

**Example** This example sets the units to divisions and sets the  $\Delta X$  tolerance to one-eighth of a division.

```
myScope.WriteString ":MTEST:AMASK:UNITs DIVISIONs"
myScope.WriteString ":MTEST:AMASK:XDELta 125E-3"
```

**Query** :MTEST:AMASK:XDELta?

The AMASK:XDELta? query returns the current setting of the  $\Delta X$  tolerance for automasking. If your computer program will interpret this value, it should also request the current measurement system using the AMASK:UNITs query.

**Returned Format** [:MTEST:AMASK:XDELta] <xdelta\_value><NL>

**Example** This example gets the measurement system units and  $\Delta X$  settings for automasking from the oscilloscope and prints the results on the computer screen.

```
Dim strAutomask_units As String
Dim strAutomask_xdelta As String
myScope.WriteString ":MTEST:AMASK:UNITs?"
strAutomask_units = myScope.ReadString
myScope.WriteString ":MTEST:AMASK:XDELta?"
strAutomask_xdelta = myScope.ReadString
Debug.Print strAutomask_units
Debug.Print strAutomask_xdelta
```

**History** Legacy command (existed before version 3.10).

**:MTEST:AMASK:YDELta**

**Command** :MTEST:AMASK:YDELta <ydelta\_value>

The :MTEST:AMASK:YDELta command sets the vertical tolerance around the waveform for the automasking feature. The absolute value of the tolerance will be added and subtracted to vertical values of the waveform to determine the boundaries of the mask.

This command requires that mask testing be enabled, otherwise a settings conflict error message is displayed. See :MTEST:ENABLE for information on enabling mask testing.

**<ydelta\_value>** A value for the vertical tolerance. This value is interpreted based on the setting specified by the AMASK:UNITs command; thus, if you specify 250-E3, the setting for AMASK:UNITs is CURRent, and the current setting specifies voltage in the vertical direction, the tolerance will be  $\pm 250$  mV. If the setting for AMASK:UNITs is DIVisions, the same ydelta\_value will set the tolerance to  $\pm 250$  millidivisions, or 1/4 of a division.

**Example** This example sets the units to current and sets the  $\Delta Y$  tolerance to 30 mV, assuming that the current setting specifies volts in the vertical direction.

```
myScope.WriteString ":MTEST:AMASK:UNITs CURRent"
myScope.WriteString ":MTEST:AMASK:YDELta 30E-3"
```

**Query** :MTEST:AMASK:YDELta?

The AMASK:YDELta? query returns the current setting of the  $\Delta Y$  tolerance for automasking. If your computer program will interpret this value, it should also request the current measurement system using the AMASK:UNITs query.

**Returned Format** [:MTEST:AMASK:YDELta] <ydelta\_value><NL>

**Example** This example gets the measurement system units and  $\Delta Y$  settings for automasking from the oscilloscope and prints the results on the computer screen.

```
Dim strAutomask_units As String
Dim strAutomask_ydelta As String
myScope.WriteString ":MTEST:AMASK:UNITs?"
strAutomask_units = myScope.ReadString
myScope.WriteString ":MTEST:AMASK:YDELta?"
strAutomask_ydelta = myScope.ReadString
Debug.Print strAutomask_units
Debug.Print strAutomask_ydelta
```

**History** Legacy command (existed before version 3.10).

## :MTEST:AUTO

**Command** :MTEST:AUTO {{ON | 1} | {OFF | 0}}

The :MTEST:AUTO command enables (ON) or disables (OFF) the Use File Setup When Aligning control. This determines which type of mask alignment is performed when the :MTEST:ALIGN command is sent. When enabled, the oscilloscope controls are changed to the values which are determined by the loaded mask file. This alignment guarantees that the aligned mask and any subsequent mask tests meet the requirements of the standard.

When disabled, the alignment is performed using the current oscilloscope settings. This may be useful when troubleshooting problems during the design phase of a project.

**Example** This example enables the Use File Settings When Aligning control.

```
myScope.WriteString ":MTEST:AUTO ON"
```

**Query** :MTEST:AUTO?

The :MTEST:AUTO? query returns the current value of the Use File Setup When Aligning control.

**Returned Format** [:MTEST:AUTO] {1 | 0} <NL>

**Example**

```
myScope.WriteString ":MTEST:AUTO?"
varValue = myScope.ReadNumber
Debug.Print FormatNumber(varValue, 0)
```

**History** Legacy command (existed before version 3.10).

## :MTESt:AVERAge

**Command** :MTESt:AVERAge {{ON | 1} | {OFF | 0}}

The :MTESt:AVERAge command enables or disables averaging. When ON, the oscilloscope acquires multiple data values for each time bucket, and averages them. When OFF, averaging is disabled. To set the number of averages, use the :MTESt:AVERAge:COUNT command described next.

The :ACQuire:AVERAge command performs the same function as this command.

Averaging is not available in PDETECT mode.

**Example** This example turns averaging on.

```
myScope.WriteString ":MTESt:AVERAge ON"
```

**Query** :MTESt:AVERAge?

The :MTESt:AVERAge? query returns the current setting for averaging.

**Returned Format** [:MTESt:AVERAge] {1 | 0} <NL>

**Example** This example places the current settings for averaging into the string variable, strSetting, then prints the contents of the variable to the computer's screen.

```
Dim strSetting As String ' Dimension variable.
myScope.WriteString ":MTESt:AVERAge?"
strSetting = myScope.ReadString
Debug.Print strSetting
```

**History** Legacy command (existed before version 3.10).

## :MTEST:AVERAge:COUNT

**Command** :MTEST:AVERAge:COUNT <count\_value>

The :MTEST:AVERAge:COUNT command sets the number of averages for the waveforms. In the AVERAge mode, the :MTEST:AVERAge:COUNT command specifies the number of data values to be averaged for each time bucket before the acquisition is considered complete for that time bucket.

The :ACQUIRE:AVERAge:COUNT command performs the same function as this command.

<count\_value> An integer, 2 to 65534, specifying the number of data values to be averaged.

**Example** This example specifies that 16 data values must be averaged for each time bucket to be considered complete. The number of time buckets that must be complete for the acquisition to be considered complete is specified by the :MTEST:COMplete command.

```
myScope.WriteString ":MTEST:AVERAge:COUNT 16"
```

**Query** :MTEST:AVERAge:COUNT?

The :MTEST:AVERAge:COUNT? query returns the currently selected count value.

**Returned Format** [:MTEST:AVERAge:COUNT] <value><NL>

<value> An integer, 2 to 65534, specifying the number of data values to be averaged.

**Example** This example checks the currently selected count value and places that value in the string variable, varResult. The program then prints the contents of the variable to the computer's screen.

```
myScope.WriteString ":SYSTem:HEADer OFF"
myScope.WriteString ":MTEST:AVERAge:COUNT?"
varResult = myScope.ReadNumber
Debug.Print FormatNumber(varResult, 0)
```

**History** Legacy command (existed before version 3.10).

## :MTEST:COUNT:FAILures?

**Query** :MTEST:COUNT:FAILures? REGION<number>

The MTEST:COUNT:FAILures? query returns the number of failures that occurred within a particular mask region.

The value 9.999E37 is returned if mask testing is not enabled or if you specify a region number that is unused.

<number> An integer, 1 through 8, designating the region for which you want to determine the failure count.

**Returned Format** [:MTEST:COUNT:FAILures] REGION<number><number\_of\_failures> <NL>

<number\_of\_failures> The number of failures that have occurred for the designated region.

**Example** This example determines the current failure count for region 3 and prints it on the computer screen.

```
Dim strMask_failures As String
myScope.WriteString ":MTEST:COUNT:FAILures? REGION3"
strMask_failures = myScope.ReadString
Debug.Print strMask_failures
```

**History** Legacy command (existed before version 3.10).

## :MTEST:COUNT:FUI?

- Query** :MTEST:COUNT:FUI?
- The MTEST:COUNT:FUI? query returns the number of unit interval failures that have occurred.
- Returned Format** [:MTEST:COUNT:FUI?] <unit\_interval\_failures> <NL>
- <unit\_interval\_failures> The number of unit interval failures.
- Example** This example determines the current number of unit interval failures and prints it to the computer screen.
- ```
Dim strFailures As String
myScope.WriteString ":MTEST:COUNT:FUI?"
strFailures = myScope.ReadString
Debug.Print strFailures
```
- See Also**
- [":MTEST:COUNT:UI?"](#) on page 835
  - [":MTEST:COUNT:SUI?"](#) on page 834
  - [":MTEST:COUNT:WAVEforms?"](#) on page 836
  - [":MTEST:COUNT:FWAVEforms?"](#) on page 832
- History** Legacy command (existed before version 3.10).

## :MTEST:COUNT:FWAVEforms?

**Query** :MTEST:COUNT:FWAVEforms?

The :MTEST:COUNT:FWAVEforms? query returns the total number of failed waveforms in the current mask test run. This count is for all regions and all waveforms, so if you wish to determine failures by region number, use the COUNT:FAILures? query.

This count may not always be available. It is available only when the following conditions are true:

- Mask testing was turned on before the histogram or color grade persistence, and
- No mask changes have occurred, including scaling changes, editing, or new masks.

The value 9.999E37 is returned if mask testing is not enabled, or if you have modified the mask.

**Returned Format** [:MTEST:COUNT:FWAVEforms] <number\_of\_failed\_waveforms><NL>

<number\_of\_failed\_waveforms> The total number of failed waveforms for the current test run.

**Example** This example determines the number of failed waveforms and prints the result on the computer screen.

```
myScope.WriteString ":SYSTEM:HEADER OFF"
myScope.WriteString ":MTEST:COUNT:FWAVEforms?"
strMask_fwaveforms = myScope.ReadString
Debug.Print strMask_fwaveforms
```

- See Also**
- [":MTEST:COUNT:UI?"](#) on page 835
  - [":MTEST:COUNT:FUI?"](#) on page 831
  - [":MTEST:COUNT:SUI?"](#) on page 834
  - [":MTEST:COUNT:WAVEforms?"](#) on page 836

**History** Legacy command (existed before version 3.10).



## :MTEST:COUNT:MARGIN:FAILures?

**Query** :MTEST:COUNT:MARGIN:FAILures? REGION<number>

<number> ::= an integer, 1-8.

The :MTEST:COUNT:MARGIN:FAILures? query returns the margin failure count for a specified region.

**Returned Format** <failures><NL>

<failures> ::= number of failures in NR3 format.

- See Also**
- [":MTEST:MARGIN:STATE"](#) on page 865
  - [":MTEST:MARGIN:METHod"](#) on page 863
  - [":MTEST:MARGIN:PERCent"](#) on page 864
  - [":MTEST:MARGIN:AUTO:METHod"](#) on page 862
  - [":MTEST:MARGIN:AUTO:HITS"](#) on page 860
  - [":MTEST:MARGIN:AUTO:HRATio"](#) on page 861

**History** New in version 5.70.

## :MTEST:COUNT:SUI?

**Query** :MTEST:COUNT:SUI?

The :MTEST:COUNT:SUI? query returns the total number of samples that have been mask tested in the UI bit time.

This count is valid only when mask testing a real-time eye.

**Returned Format** [:MTEST:COUNT:SUI?] <samples\_tested><NL>

<samples\_tested> The total number of samples that have been mask tested in the UI bit time.

- See Also**
- [":MTEST:COUNT:UI?"](#) on page 835
  - [":MTEST:COUNT:FUI?"](#) on page 831
  - [":MTEST:COUNT:WAVEforms?"](#) on page 836
  - [":MTEST:COUNT:FWAVEforms?"](#) on page 832

**History** New in version 6.00.

## :MTEST:COUNT:UI?

- Query** :MTEST:COUNT:UI?
- The MTEST:COUNT:UI? query returns the number of unit intervals that have been mask tested.
- Returned Format** [:MTEST:COUNT:UI?] <unit\_intervals\_tested> <NL>
- <unit\_intervals\_tested> The number of unit intervals tested.
- Example** This example determines the current number of unit intervals tested and prints it to the computer screen.
- ```
Dim strUnit_intervals As String
myScope.WriteString ":MTEST:COUNT:UI?"
strUnit_intervals = myScope.ReadString
Debug.Print strUnit_intervals
```
- See Also**
- [":MTEST:COUNT:FUI?"](#) on page 831
  - [":MTEST:COUNT:SUI?"](#) on page 834
  - [":MTEST:COUNT:WAVEforms?"](#) on page 836
  - [":MTEST:COUNT:FWAVEforms?"](#) on page 832
- History** Legacy command (existed before version 3.10).

## :MTEST:COUNT:WAVEforms?

**Query** :MTEST:COUNT:WAVEforms?

The :MTEST:COUNT:WAVEforms? query returns the total number of waveforms acquired in the current mask test run. The value 9.999E37 is returned if mask testing is not enabled.

**Returned Format** [:MTEST:COUNT:WAVEforms] <number\_of\_waveforms><NL>

<number\_of\_waveforms> The total number of waveforms for the current test run.

**Example** This example determines the number of waveforms acquired in the current test run and prints the result on the computer screen.

```
myScope.WriteString ":SYSTEM:HEADER OFF"
myScope.WriteString ":MTEST:COUNT:WAVEforms?"
varMask_waveforms = myScope.ReadNumber
Debug.Print FormatNumber(varMask_waveforms, 0)
```

- See Also**
- [":MTEST:COUNT:UI?"](#) on page 835
  - [":MTEST:COUNT:FUI?"](#) on page 831
  - [":MTEST:COUNT:SUI?"](#) on page 834
  - [":MTEST:COUNT:FWAVEforms?"](#) on page 832

**History** Legacy command (existed before version 3.10).

## :MTESt:DELeTe

**Command** :MTESt:DELeTe

The :MTESt:DELeTe command clears the currently loaded mask.

**Example** This example clears the currently loaded mask.

```
myScope.WriteString ":MTESt:DELeTe"
```

**History** Legacy command (existed before version 3.10).

**:MTEST:ENABle**

**Command** `:MTEST:ENABle {{ON | 1} | {OFF | 0}}`

The `:MTEST:ENABle` command enables or disables the mask test features.

**ON** Enables the mask test features.

**OFF** Disables the mask test features.

**Example** This example enables the mask test features.

```
myScope.WriteString ":MTEST:ENABle ON"
```

**Query** `:MTEST:ENABle?`

The `:MTEST:ENABle?` query returns the current state of mask test features.

**Returned Format** `[MTEST:ENABle] {1 | 0}<NL>`

**Example** This example places the current value of the mask test state in the numeric variable `varValue`, then prints the contents to the computer's screen.

```
myScope.WriteString ":SYSTEM:HEADer OFF"
myScope.WriteString ":MTEST:ENABle?"
varValue = myScope.ReadNumber
Debug.Print FormatNumber(varValue, 0)
```

**History** Legacy command (existed before version 3.10).

## :MTEST:FOLDing (Clock Recovery software only)

**Command** :MTEST:FOLDing {{ON | 1} | {OFF | 0}} [,<source>]

The :MTEST:FOLDing command enables (ON) or disables (OFF) the display of the real-time eye.

Color grade must be enabled before enabling the real-time eye.

Refer to the :MEASure:CLOCK commands for clock recovery.

**<source>** {CHANnel<N> | DIFF<D> | COMMONmode<C> | FUNCTION<F> | WMEMory<R> | EQUalized<L> | XT<X>}

If <source> is omitted:

- The real-time eye is enabled for all sources which currently have a color grade view on.
- When enabling real-time eye, the main waveform view is turned off.
- When disabling real-time eye, the main waveform view is turned on.

**<N>** An integer, 1-4 in a single oscilloscope, 1-40 in a MultiScope system.

**<D>, <C>** <D> is an integer, 1-2. <C> is an integer, 3-4.

The DIFF and COMMONmode sources are just aliases that can be used in place of the channel names to apply to differential or common mode signals. These are just aliases - no state change occurs if you refer to a differential channel and you are not in differential mode. DIFF1 refers to the differential signal between channels 1 and 3 (and COMMONmode3 refers to the common mode channel between these same channels). DIFF2 refers to the differential signal between channels 2 and 4 (and COMMONmode4 refers to the common mode channel between these same channels).

**<F>** An integer, 1-16.

**<R>** An integer, 1-4.

**<L>** An integer, 1-4.

**<X>** An integer, 1-4, identifying the crosstalk waveform.

**Example** This example enables the display of the real-time eye.

```
myScope.WriteString ":MTEST:FOLDing ON"
```

**Query** :MTEST:FOLDing? [<source>]

The :MTEST:FOLDing? query returns the current state of clock recovery folding.

If <source> is omitted, the query returns ON (1) if any source has real-time eye enabled.

**Returned Format** [:MTEST:FOLDing] {1 | 0} <NL>

**Example** `myScope.WriteString ":MTEST:FOLDing?"`  
`varValue = myScope.ReadNumber`  
`Debug.Print FormatNumber(varValue, 0)`

- See Also**
- [":MTEST:FOLDing:BITS"](#) on page 841
  - [":MTEST:FOLDing:FAST"](#) on page 847
  - [":MTEST:FOLDing:COUNT:UI?"](#) on page 843
  - [":MTEST:FOLDing:COUNT:WAVEforms?"](#) on page 845
  - [":MTEST:FOLDing:POSition"](#) on page 849
  - [":MTEST:FOLDing:TPOSition"](#) on page 853
  - [":MTEST:FOLDing:SCALe"](#) on page 851
  - [":MTEST:FOLDing:TSCale"](#) on page 855
  - [":ANALyze:CLOCK"](#) on page 274
  - [":ANALyze:CLOCK:METHod"](#) on page 275
  - [":ANALyze:CLOCK:METHod:ALIGN"](#) on page 279
  - [":ANALyze:CLOCK:METHod:DEEMphasis"](#) on page 280
  - [":ANALyze:CLOCK:METHod:EDGE"](#) on page 281
  - [":ANALyze:CLOCK:METHod:JTF"](#) on page 284
  - [":ANALyze:CLOCK:METHod:OJTF"](#) on page 286

**History** Legacy command (existed before version 3.10).

Version 5.00: Added the optional <source> parameter for specifying the waveform on which to enable/disable the real-time eye.

Version 5.50: When the <source> parameter is not provided, enabling the real-time eye will turn off the main waveform view, and disabling the real-time eye will turn on the main waveform view.



## :MTEST:FOLDing:BITS

**Command** :MTEST:FOLDing:BITS <source>,{BOTH | DEEMphasis | TRANSition  
| PATtern, "<pattern>", <cursor>}

The :MTEST:FOLDing:BITS command determines the type of data bits used to create the eye pattern. The transition bits are greater in amplitude than the deemphasis bits. The PCI Express standard requires that compliance mask testing be done for both bit types.

**<source>** {CHANnel<N> | DIFF<D> | COMMONmode<C> | FUNction<F> | WMEMory<R> | EQUalized<L> | XT<X>}

**<N>** An integer, 1-4 in a single oscilloscope, 1-40 in a MultiScope system.

**<D>, <C>** <D> is an integer, 1-2. <C> is an integer, 3-4.

The DIFF and COMMONmode sources are just aliases that can be used in place of the channel names to apply to differential or common mode signals. These are just aliases - no state change occurs if you refer to a differential channel and you are not in differential mode. DIFF1 refers to the differential signal between channels 1 and 3 (and COMMONmode3 refers to the common mode channel between these same channels). DIFF2 refers to the differential signal between channels 2 and 4 (and COMMONmode4 refers to the common mode channel between these same channels).

**<F>** An integer, 1-16.

**<R>** An integer, 1-4.

**<L>** An integer, 1-4.

**<X>** An integer, 1-4, identifying the crosstalk waveform.

**<pattern>** An eight character string of level values. For typical NRZ (non-return-to-zero) signals, the levels are "1", "0", or "X" (for example, "101XX010"). For PAM-4 (four-level) signals, the levels are "3", "2", "1", "0", or "X" (for example, "01230X03").

**<cursor>** A value from 0 to 7 representing which bit is bit 0 from the LSB.

**Example** This example sets bit type to transition bits on the CHANnel1 real-time eye.

```
myScope.WriteString ":MTEST:FOLDing:BITS CHANnel1,TRANSition"
```

**Query** :MTEST:FOLDing:BITS? <source>

The :MTEST:FOLDing:BITS? query returns the current setting of the real time eye bits.

**Returned Format** [:MTEST:FOLDing:BITS] {BOTH | DEEMphasis | TRANSition  
| PATT,<pattern>,<cursor>} <NL>

**Example**

```
myScope.WriteString ":MTEST:FOLDing:BITS? CHANnel1"  
strSetting = myScope.ReadString  
Debug.Print strSetting
```

- See Also**
- [":MTEST:FOLDing \(Clock Recovery software only\)"](#) on page 839
  - [":MTEST:FOLDing:FAST"](#) on page 847
  - [":MTEST:FOLDing:COUNT:UI?"](#) on page 843
  - [":MTEST:FOLDing:COUNT:WAVEforms?"](#) on page 845
  - [":MTEST:FOLDing:POSition"](#) on page 849
  - [":MTEST:FOLDing:TPOSition"](#) on page 853
  - [":MTEST:FOLDing:SCALe"](#) on page 851
  - [":MTEST:FOLDing:TSCale"](#) on page 855

**History** Legacy command (existed before version 3.10).

Version 4.00: Added a PATtern option for specifying bit pattern qualification for the real-time eye display.

Version 5.00: Added the required <source> parameter to specify the waveform on which to set the real-time eye bit qualification.

Version 5.50: The <pattern> string can contain characters "2" and "3" when specified for PAM-4 signals.

## :MTEST:FOLDing:COUNT:UI?

**Query** :MTEST:FOLDing:COUNT:UI? [<source>]

The :MTEST:FOLDing:COUNT:UI? query returns the number of unit intervals in the real time eye.

**<source>** {CHANnel<N> | DIFF<D> | COMMONmode<C> | FUNCTION<F> | WMEMory<R> | EQUalized<L> | XT<X>}

**<N>** An integer, 1-4 in a single oscilloscope, 1-40 in a MultiScope system.

**<D>, <C>** <D> is an integer, 1-2. <C> is an integer, 3-4.

The DIFF and COMMONmode sources are just aliases that can be used in place of the channel names to apply to differential or common mode signals. These are just aliases - no state change occurs if you refer to a differential channel and you are not in differential mode. DIFF1 refers to the differential signal between channels 1 and 3 (and COMMONmode3 refers to the common mode channel between these same channels). DIFF2 refers to the differential signal between channels 2 and 4 (and COMMONmode4 refers to the common mode channel between these same channels).

If the <source> is not specified, the :MTEST:FOLDing:COUNT? query returns the results of the first real-time eye that is on. Sources are ordered by channels, memories, and then functions.

**<F>** An integer, 1-16.

**<R>** An integer, 1-4.

**<L>** An integer, 1-4.

**<X>** An integer, 1-4, identifying the crosstalk waveform.

**Returned Format** [:MTEST:FOLDing:COUNT:UI] <UI\_count><NL>

The UI count returned is a floating-point value.

**Example**

```
myScope.WriteString ":MTEST:FOLDing:COUNT:UI? CHANNEL1"
varUiCount = myScope.ReadNumber
Debug.Print FormatNumber(varUiCount, 0)
```

- See Also**
- [":MTEST:FOLDing \(Clock Recovery software only\)"](#) on page 839
  - [":MTEST:FOLDing:BITS"](#) on page 841
  - [":MTEST:FOLDing:FAST"](#) on page 847
  - [":MTEST:FOLDing:COUNT:WAVEforms?"](#) on page 845
  - [":MTEST:FOLDing:POSITION"](#) on page 849
  - [":MTEST:FOLDing:TPOSITION"](#) on page 853
  - [":MTEST:FOLDing:SCALE"](#) on page 851
  - [":MTEST:FOLDing:TSCALE"](#) on page 855

**History** New in version 5.50. This query replaces part of the now deprecated query **":MTESt:FOLDing:COUNt?"** on page 1750.

Version 5.52: The <source> parameter is now optional.

## :MTEST:FOLDing:COUNT:WAVEforms?

**Query** :MTEST:FOLDing:COUNT:WAVEforms? [<source>]

The :MTEST:FOLDing:COUNT:WAVEforms? query returns the number of waveforms in the real time eye.

**<source>** {CHANnel<N> | DIFF<D> | COMMONmode<C> | FUNCTION<F> | WMEMory<R> | EQUalized<L> | XT<X>}

**<N>** An integer, 1-4 in a single oscilloscope, 1-40 in a MultiScope system.

**<D>, <C>** <D> is an integer, 1-2. <C> is an integer, 3-4.

The DIFF and COMMONmode sources are just aliases that can be used in place of the channel names to apply to differential or common mode signals. These are just aliases - no state change occurs if you refer to a differential channel and you are not in differential mode. DIFF1 refers to the differential signal between channels 1 and 3 (and COMMONmode3 refers to the common mode channel between these same channels). DIFF2 refers to the differential signal between channels 2 and 4 (and COMMONmode4 refers to the common mode channel between these same channels).

If the <source> is not specified, the :MTEST:FOLDing:COUNT? query returns the results of the first real-time eye that is on. Sources are ordered by channels, memories, and then functions.

**<F>** An integer, 1-16.

**<R>** An integer, 1-4.

**<L>** An integer, 1-4.

**<X>** An integer, 1-4, identifying the crosstalk waveform.

**Returned Format** [:MTEST:FOLDing:COUNT:WAVEforms] <Wfm\_count><NL>

The Wfm count returned is an integer.

**Example**

```
myScope.WriteString ":MTEST:FOLDing:COUNT:WAVEforms? CHANnel1"
strWfmCount = myScope.ReadString
Debug.Print strWfmCount
```

- See Also**
- [":MTEST:FOLDing \(Clock Recovery software only\)"](#) on page 839
  - [":MTEST:FOLDing:BITS"](#) on page 841
  - [":MTEST:FOLDing:FAST"](#) on page 847
  - [":MTEST:FOLDing:COUNT:UI?"](#) on page 843
  - [":MTEST:FOLDing:POSition"](#) on page 849
  - [":MTEST:FOLDing:TPOSition"](#) on page 853
  - [":MTEST:FOLDing:SCALE"](#) on page 851
  - [":MTEST:FOLDing:TSCale"](#) on page 855

**History** New in version 5.50. This query replaces part of the now deprecated query **":MTESt:FOLDing:COUNt?"** on page 1750.

Version 5.52: The <source> parameter is now optional.

## :MTEST:FOLDing:FAST

**Command** :MTEST:FOLDing:FAST {{ON | 1} | {OFF | 0}} [, <source>]

The :MTEST:FOLDing:FAST command turns the "Fast, Worst Case Only" real-time eye display option ON or OFF.

When ON, the oscilloscope performs a fast real-time eye display by showing only the worst case bits and other bits that surround them.

This option can be used to speed up the real-time eye display when the oscilloscope is using deep memory.

Worst case bits are evaluated using these 8 points inside the eye:

- Left and right of the eye at the threshold level.
- Left and right of the eye at the threshold + hysteresis level.
- Left and right of the eye at the threshold - hysteresis level.
- Top and bottom of the eye at the center.

For each bit that represents the worst case at one of the evaluated points, the 1,000 bits that surround that bit are also displayed. So, up to 8,000 bits per acquisition can contribute to the real-time eye display. Keep in mind that one bit can represent the worst case at multiple points or that the 1,000 bits surrounding the worst case bits can overlap, so there can be fewer than 8,000 bits displayed per acquisition.

**<source>** {CHANnel<N> | DIFF<D> | COMMONmode<C> | FUNCTION<F> | WMEMORY<R> | EQUALized<L> | XT<X>}

If <source> is omitted, fast worst-case real-time eye is enabled for all sources which currently have a color grade view on.

**<N>** An integer, 1-4 in a single oscilloscope, 1-40 in a MultiScope system.

**<D>, <C>** <D> is an integer, 1-2. <C> is an integer, 3-4.

The DIFF and COMMONmode sources are just aliases that can be used in place of the channel names to apply to differential or common mode signals. These are just aliases - no state change occurs if you refer to a differential channel and you are not in differential mode. DIFF1 refers to the differential signal between channels 1 and 3 (and COMMONmode3 refers to the common mode channel between these same channels). DIFF2 refers to the differential signal between channels 2 and 4 (and COMMONmode4 refers to the common mode channel between these same channels).

**<F>** An integer, 1-16.

**<R>** An integer, 1-4.

**<L>** An integer, 1-4.

**<X>** An integer, 1-4, identifying the crosstalk waveform.

**Example** This example turns on the "Fast, Worst Case Only" real-time eye display option.

```
myScope.WriteString ":MTEST:FOLDing:FAST ON"
```

**Query** `:MTEST:FOLDing:FAST? [<source>]`

The `:MTEST:FOLDing:FAST?` query returns the current setting.

If `<source>` is omitted, the query returns ON (1) if any source has fast real time eye enabled.

**Returned Format** `[:MTEST:FOLDing:FAST] {1 | 0} <NL>`

**Example**

```
myScope.WriteString ":MTEST:FOLDing:FAST?"
strSetting = myScope.ReadString
Debug.Print strSetting
```

- See Also**
- [":MTEST:FOLDing \(Clock Recovery software only\)"](#) on page 839
  - [":MTEST:FOLDing:BITS"](#) on page 841
  - [":MTEST:FOLDing:COUNT:UI?"](#) on page 843
  - [":MTEST:FOLDing:COUNT:WAVEforms?"](#) on page 845
  - [":MTEST:FOLDing:POSition"](#) on page 849
  - [":MTEST:FOLDing:TPOSition"](#) on page 853
  - [":MTEST:FOLDing:SCALe"](#) on page 851
  - [":MTEST:FOLDing:TSCale"](#) on page 855

**History** New in version 4.50.

Version 5.00: Added the optional `<source>` parameter for specifying the waveform on which to set the fast worst-case option.



## :MTEST:FOLDing:POStion

**Command** :MTEST:FOLDing:POStion <UI\_position> [,<source>]

The :MTEST:FOLDing:POStion command sets the real-time eye horizontal center position in unit intervals.

**<source>** {CHANnel<N> | DIFF<D> | COMMONmode<C> | FUNction<F> | WMEMory<R> | EQUalized<L> | XT<X>}

If <source> is omitted, this command sets the position for all sources.

**<N>** An integer, 1-4 in a single oscilloscope, 1-40 in a MultiScope system.

**<D>, <C>** <D> is an integer, 1-2. <C> is an integer, 3-4.

The DIFF and COMMONmode sources are just aliases that can be used in place of the channel names to apply to differential or common mode signals. These are just aliases - no state change occurs if you refer to a differential channel and you are not in differential mode. DIFF1 refers to the differential signal between channels 1 and 3 (and COMMONmode3 refers to the common mode channel between these same channels). DIFF2 refers to the differential signal between channels 2 and 4 (and COMMONmode4 refers to the common mode channel between these same channels).

**<F>** An integer, 1-16.

**<R>** An integer, 1-4.

**<L>** An integer, 1-4.

**<X>** An integer, 1-4, identifying the crosstalk waveform.

**Example** This example sets the real-time eye horizontal center position to -0.300 UI.

```
myScope.WriteString ":MTEST:FOLDing:POStion -0.300"
```

**Query** :MTEST:FOLDing:POStion? [<source>]

The :MTEST:FOLDing:POStion? query returns the real-time eye horizontal center position.

If <source> is omitted, the query returns the position for the first real-time eye.

**Returned Format** [:MTEST:FOLDing:POStion] <UI\_position> <NL>

**Example**

```
myScope.WriteString ":MTEST:FOLDing:POStion?"
strUiPosition = myScope.ReadString
Debug.Print strUiPosition
```

- See Also**
- **" :MTEST:FOLDing:TPOStion "** on page 853
  - **" :MTEST:FOLDing (Clock Recovery software only) "** on page 839
  - **" :MTEST:FOLDing:BITS "** on page 841
  - **" :MTEST:FOLDing:FAST "** on page 847

- `":MTESt:FOLDing:COUNT:UI?"` on page 843
- `":MTESt:FOLDing:COUNT:WAVEforms?"` on page 845
- `":MTESt:FOLDing:SCALe"` on page 851
- `":MTESt:FOLDing:TSCale"` on page 855

**History** New in version 5.00.

## :MTEST:FOLDing:SCALE

**Command** :MTEST:FOLDing:SCALE <UI\_scale> [, <source>]

The :MTEST:FOLDing:SCALE command sets the real-time eye horizontal scale, that is, the number of unit intervals (UIs) shown on screen.

**<source>** {CHANnel<N> | DIFF<D> | COMMONmode<C> | FUNCTION<F> | WMEMory<R> | EQUalized<L> | XT<X>}

If <source> is omitted, this command sets the number of unit intervals for all sources.

**<N>** An integer, 1-4 in a single oscilloscope, 1-40 in a MultiScope system.

**<D>, <C>** <D> is an integer, 1-2. <C> is an integer, 3-4.

The DIFF and COMMONmode sources are just aliases that can be used in place of the channel names to apply to differential or common mode signals. These are just aliases - no state change occurs if you refer to a differential channel and you are not in differential mode. DIFF1 refers to the differential signal between channels 1 and 3 (and COMMONmode3 refers to the common mode channel between these same channels). DIFF2 refers to the differential signal between channels 2 and 4 (and COMMONmode4 refers to the common mode channel between these same channels).

**<F>** An integer, 1-16.

**<R>** An integer, 1-4.

**<L>** An integer, 1-4.

**<X>** An integer, 1-4, identifying the crosstalk waveform.

**Example** This example sets the real-time eye horizontal scale to 2.0 UI.

```
myScope.WriteString ":MTEST:FOLDing:SCALE 2.0"
```

**Query** :MTEST:FOLDing:SCALE? [<source>]

The :MTEST:FOLDing:SCALE? query returns the current real-time eye horizontal scale.

If <source> is omitted, the query returns the number of unit intervals for the first real-time eye.

**Returned Format** [:MTEST:FOLDing:SCALE] <UI\_scale><NL>

**Example**

```
myScope.WriteString ":MTEST:FOLDing:SCALE?"
strUiScale = myScope.ReadString
Debug.Print strUiScale
```

**See Also**

- **":MTEST:FOLDing:TSCale"** on page 855
- **":MTEST:FOLDing (Clock Recovery software only)"** on page 839
- **":MTEST:FOLDing:BITS"** on page 841

- **":MTESt:FOLDing:FAST"** on page 847
- **":MTESt:FOLDing:COUNT:UI?"** on page 843
- **":MTESt:FOLDing:COUNT:WAVeforms?"** on page 845
- **":MTESt:FOLDing:POSition"** on page 849
- **":MTESt:FOLDing:TPOSition"** on page 853

**History** New in version 5.00.

## :MTEST:FOLDing:TPOsition

**Command** :MTEST:FOLDing:TPOsition <position> [,<source>]

The :MTEST:FOLDing:TPOsition command sets the real-time eye horizontal center position in time.

**<source>** {CHANnel<N> | DIFF<D> | COMMONmode<C> | FUNction<F> | WMEMory<R> | EQUalized<L> | XT<X>}

If <source> is omitted, this command sets the position for all sources.

**<N>** An integer, 1-4 in a single oscilloscope, 1-40 in a MultiScope system.

**<D>, <C>** <D> is an integer, 1-2. <C> is an integer, 3-4.

The DIFF and COMMONmode sources are just aliases that can be used in place of the channel names to apply to differential or common mode signals. These are just aliases - no state change occurs if you refer to a differential channel and you are not in differential mode. DIFF1 refers to the differential signal between channels 1 and 3 (and COMMONmode3 refers to the common mode channel between these same channels). DIFF2 refers to the differential signal between channels 2 and 4 (and COMMONmode4 refers to the common mode channel between these same channels).

**<F>** An integer, 1-16.

**<R>** An integer, 1-4.

**<L>** An integer, 1-4.

**<X>** An integer, 1-4, identifying the crosstalk waveform.

**Example** This example sets the real-time eye horizontal center position to -0.300 ns.

```
myScope.WriteString ":MTEST:FOLDing:TPOsition -0.300E-09"
```

**Query** :MTEST:FOLDing:TPOsition? [<source>]

The :MTEST:FOLDing:TPOsition? query returns the real-time eye horizontal center position.

If <source> is omitted, the query returns the position for the first real-time eye.

**Returned Format** [:MTEST:FOLDing:TPOsition] <position> <NL>

**Example**

```
myScope.WriteString ":MTEST:FOLDing:TPOsition?"
strTimePosition = myScope.ReadString
Debug.Print strTimePosition
```

- See Also**
- **" :MTEST:FOLDing:POsition "** on page 849
  - **" :MTEST:FOLDing (Clock Recovery software only) "** on page 839
  - **" :MTEST:FOLDing:BITs "** on page 841
  - **" :MTEST:FOLDing:FASt "** on page 847

- `":MTESt:FOLDing:COUNT:UI?"` on page 843
- `":MTESt:FOLDing:COUNT:WAVEforms?"` on page 845
- `":MTESt:FOLDing:TSCale"` on page 855
- `":MTESt:FOLDing:SCALe"` on page 851

**History** New in version 5.10.

## :MTEST:FOLDing:TSCale

**Command** :MTEST:FOLDing:TSCale <scale> [,<source>]

The :MTEST:FOLDing:TSCale command sets the real-time eye horizontal scale per division in time.

**<source>** {CHANnel<N> | DIFF<D> | COMMONmode<C> | FUNCTion<F> | WMEMory<R> | EQUalized<L> | XT<X>}

If <source> is omitted, this command sets the number of unit intervals for all sources.

**<N>** An integer, 1-4 in a single oscilloscope, 1-40 in a MultiScope system.

**<D>, <C>** <D> is an integer, 1-2. <C> is an integer, 3-4.

The DIFF and COMMONmode sources are just aliases that can be used in place of the channel names to apply to differential or common mode signals. These are just aliases - no state change occurs if you refer to a differential channel and you are not in differential mode. DIFF1 refers to the differential signal between channels 1 and 3 (and COMMONmode3 refers to the common mode channel between these same channels). DIFF2 refers to the differential signal between channels 2 and 4 (and COMMONmode4 refers to the common mode channel between these same channels).

**<F>** An integer, 1-16.

**<R>** An integer, 1-4.

**<L>** An integer, 1-4.

**<X>** An integer, 1-4, identifying the crosstalk waveform.

**Example** This example sets the real-time eye horizontal scale to 2.0 microseconds.

```
myScope.WriteString ":MTEST:FOLDing:TSCale 2.0E-06"
```

**Query** :MTEST:FOLDing:TSCale? [<source>]

The :MTEST:FOLDing:TSCale? query returns the current real-time eye horizontal scale.

If <source> is omitted, the query returns the number of unit intervals for the first real-time eye.

**Returned Format** [:MTEST:FOLDing:TSCale] <scale><NL>

**Example**

```
myScope.WriteString ":MTEST:FOLDing:TSCale?"
strTimeScale = myScope.ReadString
Debug.Print strTimeScale
```

- See Also**
- **":MTEST:FOLDing:SCALe"** on page 851
  - **":MTEST:FOLDing (Clock Recovery software only)"** on page 839
  - **":MTEST:FOLDing:BITS"** on page 841

- **":MTEST:FOLDing:FAST"** on page 847
- **":MTEST:FOLDing:COUNT:UI?"** on page 843
- **":MTEST:FOLDing:COUNT:WAVEforms?"** on page 845
- **":MTEST:FOLDing:TPOStion"** on page 853
- **":MTEST:FOLDing:POStion"** on page 849

**History** New in version 5.10.



## :MTESt:IMPedance

**Command** :MTESt:IMPedance {NONE | IMP75 | IMP100 | IMP110 | IMP120}

The :MTESt:IMPedance command sets the desired probe impedance of the channel being used for mask testing. This impedance value is used when starting a mask test to determine whether or not the correct Infiniium probe is connected and in the case of the E2621A if the switch is set to the correct impedance value.

Infiniium has an AutoProbe interface that detects probes that have Probe ID resistors. If one of these probes is connected to the channel being mask tested and is not the correct probe for the selected impedance, a warning dialog box appears when the mask test is started from the human interface.

This command is meant to be used in the setup section of a mask file.

**NONE** Disables the probe impedance check.

**IMP75** Enables the probe impedance check for the E2622A probe.

**IMP100** Enables the probe impedance check for the E2621A probe with the switch set to the 100 ohm position.

**IMP110** Enables the probe impedance check for the E2621A probe with the switch set to the 110 ohm position.

**IMP120** Enables the probe impedance check for the E2621A probe with the switch set to the 120 ohm position.

**Example** This example sets the probe impedance of the channel being used for mask testing to 100 ohms.

```
myScope.WriteString ":MTESt:IMPedance IMP100"
```

**Query** :MTESt:IMPedance?

The :MTESt:IMPedance? query returns the current value of the mask test impedance.

**Returned Format** [:MTESt:IMPedance] {NONE | IMP75 | IMP100 | IMP110 | IMP120}<NL>

**Example** This example returns the current value of the mask test impedance and prints the result to the computer screen.

```
myScope.WriteString ":SYSTEM:HEADer OFF" ' Response headers off.
myScope.WriteString ":MTESt:IMPedance?"
strImpedance = myScope.ReadString
Debug.Print strImpedance
```

**History** Legacy command (existed before version 3.10).

## :MTEST:INVert

**Command** :MTEST:INVert {{ON | 1} | {OFF | 0}}

The :MTEST:INVert command inverts the mask for testing negative-going pulses. The trigger level and mask offset are also adjusted. Not all masks support negative-going pulse testing, and for these masks, the command is ignored.

**Example** This example inverts the mask for testing negative-going pulses.

```
myScope.WriteString ":MTEST:INVert ON"
```

**Query** :MTEST:INVert?

The :MTEST:INVert? query returns the current inversion setting.

**Returned Format** [:MTEST:INVert] {1 | 0}<NL>

**History** Legacy command (existed before version 3.10).

## :MTEST:LOAD

**Command** :MTEST:LOAD "<filename>"

The :MTEST:LOAD command loads the specified mask file. The default path for mask files is C:\Users\Public\Documents\Infiniium\masks. To use a different path, specify the complete path and file name.

**<filename>** An MS-DOS compatible name of the file, a maximum of 254 characters long (including the path name, if used).

**Example** This example loads the mask file named "140md\_itu\_1.msk".

```
myScope.WriteString _
":MTEST:LOAD " "C:\Users\Public\Documents\Infiniium\masks\
140md_itu_1.msk" " "
```

**History** Legacy command (existed before version 3.10).

## :MTEST:MARGIN:AUTO:HITS

**Command** :MTEST:MARGIN:AUTO:HITS <hit\_count>

<hit\_count> ::= an integer.

When the automatic margin method is selected, and the hit ratio method is selected, the :MTEST:MARGIN:AUTO:HITS command specifies the hit count.

**Query** :MTEST:MARGIN:AUTO:HITS?

The :MTEST:MARGIN:AUTO:HITS? query returns the hit count setting.

**Returned Format** <hit\_count><NL>

- See Also**
- [":MTEST:MARGIN:STATE"](#) on page 865
  - [":MTEST:MARGIN:METHod"](#) on page 863
  - [":MTEST:MARGIN:PERCent"](#) on page 864
  - [":MTEST:MARGIN:AUTO:METHod"](#) on page 862
  - [":MTEST:MARGIN:AUTO:HRATio"](#) on page 861
  - [":MTEST:COUNT:MARGIN:FAILures?"](#) on page 833

**History** New in version 5.70.

## :MTEST:MARGIN:AUTO:HRATIO

**Command** :MTEST:MARGIN:AUTO:HRATIO <hit\_ratio>

<hit\_ratio> ::= a floating-point number from 0.1 to 1E-12.

When the automatic margin method is selected, and the hit ratio method is selected, the :MTEST:MARGIN:AUTO:HRATIO command specifies the hit ratio.

**Query** :MTEST:MARGIN:AUTO:HRATIO?

The :MTEST:MARGIN:AUTO:HRATIO? query returns the hit ratio setting.

**Returned Format** <hit\_ratio><NL>

- See Also**
- [":MTEST:MARGIN:STATE"](#) on page 865
  - [":MTEST:MARGIN:METHod"](#) on page 863
  - [":MTEST:MARGIN:PERCent"](#) on page 864
  - [":MTEST:MARGIN:AUTO:METHod"](#) on page 862
  - [":MTEST:MARGIN:AUTO:HITS"](#) on page 860
  - [":MTEST:COUNT:MARGIN:FAILures?"](#) on page 833

**History** New in version 5.70.

**:MTEST:MARGIN:AUTO:METHod**

**Command** :MTEST:MARGIN:AUTO:METHod <method>

<method> ::= {HITS | HRATio}

When the automatic margin method is selected, the :MTEST:MARGIN:AUTO:METHod command selects between the hit count and hit ratio and automatic margin methods:

- HITS – With the hit count automatic margin method, you specify the hit count with :MTEST:MARGIN:AUTO:HITS.
- HRATio – With the hit ratio automatic margin method, you specify the hit ratio with :MTEST:MARGIN:AUTO:HRATio.

**Query** :MTEST:MARGIN:AUTO:METHod?

The :MTEST:MARGIN:AUTO:METHod? query returns the automatic margin method setting.

**Returned Format** <method><NL>

<method> ::= {HITS | HRATio}

- See Also**
- **":MTEST:MARGIN:STATe"** on page 865
  - **":MTEST:MARGIN:METHod"** on page 863
  - **":MTEST:MARGIN:PERCent"** on page 864
  - **":MTEST:MARGIN:AUTO:HITS"** on page 860
  - **":MTEST:MARGIN:AUTO:HRATio"** on page 861
  - **":MTEST:COUNT:MARGIN:FAILures?"** on page 833

**History** New in version 5.70.

## :MTEST:MARGIN:METHod

**Command** :MTEST:MARGIN:METHod <method>

<method> ::= {MANual | AUTO}

The :MTEST:MARGIN:METHod command selects between the manual and automatic margin methods:

- **MANual** – With the manual margin method, you specify a margin percent using :MTEST:MARGIN:PERCent.
- **AUTO** – With the automatic margin method, you specify the auto margin method using :MTEST:MARGIN:AUTO:METHod.

**Query** :MTEST:MARGIN:METHod?

The :MTEST:MARGIN:METHod? query returns the margin type setting.

**Returned Format** <method><NL>

<method> ::= {MANual | AUTO}

- See Also**
- **":MTEST:MARGIN:STATE"** on page 865
  - **":MTEST:MARGIN:PERCent"** on page 864
  - **":MTEST:MARGIN:AUTO:METHod"** on page 862
  - **":MTEST:MARGIN:AUTO:HITS"** on page 860
  - **":MTEST:MARGIN:AUTO:HRATio"** on page 861
  - **":MTEST:COUNt:MARGIN:FAILures?"** on page 833

**History** New in version 5.70.

## :MTESt:MARGIn:PERCent

**Command** :MTESt:MARGIn:PERCent <percent>

<percent> ::= an integer from -100 to 100.

When the manual margin method is selected, the :MTESt:MARGIn:PERCent command specifies the margin percent.

**Query** :MTESt:MARGIn:PERCent?

The :MTESt:MARGIn:PERCent? query returns the margin percent setting.

**Returned Format** <percent><NL>

- See Also**
- [":MTESt:MARGIn:STATe"](#) on page 865
  - [":MTESt:MARGIn:METHod"](#) on page 863
  - [":MTESt:MARGIn:AUTO:METHod"](#) on page 862
  - [":MTESt:MARGIn:AUTO:HITS"](#) on page 860
  - [":MTESt:MARGIn:AUTO:HRATio"](#) on page 861
  - [":MTESt:COUNT:MARGIn:FAILures?"](#) on page 833

**History** New in version 5.70.



## :MTEST:MARGIN:STATE

**Command** :MTEST:MARGIN:STATE {{0 | OFF} | {1 | ON}}

The :MTEST:MARGIN:STATE command enables or disables mask margin testing.

To enable mask margin testing, there must be a real-time eye and you must load a mask file that has a margin definition (\*.mskx).

**Query** :MTEST:MARGIN:STATE?

The :MTEST:MARGIN:STATE? query returns the mask margin testing state.

**Returned Format** <setting><NL>

<setting ::= {0 | 1}

- See Also**
- [":MTEST:MARGIN:METHod"](#) on page 863
  - [":MTEST:MARGIN:PERCent"](#) on page 864
  - [":MTEST:MARGIN:AUTO:METHod"](#) on page 862
  - [":MTEST:MARGIN:AUTO:HITS"](#) on page 860
  - [":MTEST:MARGIN:AUTO:HRATio"](#) on page 861
  - [":MTEST:COUNt:MARGIN:FAILures?"](#) on page 833

**History** New in version 5.70.

## :MTEST:NREGions?

**Query** :MTEST:NREGions?

The :MTEST:NREGions? query returns the number of regions that define the mask.

**Returned Format** [:MTEST:NREGions] <regions><NL>

<regions> An integer from 0 to 8.

**Example** This example returns the number of mask regions.

```
myScope.WriteString ":SYSTEM:HEADer OFF"  
myScope.WriteString ":MTEST:NREGions?"  
varRegions = myScope.ReadNumber  
Debug.Print FormatNumber(varRegions, 0)
```

**History** Legacy command (existed before version 3.10).

## :MTEST:PROBe:IMPedance?

**Query** :MTEST:PROBe:IMPedance?

The :MTEST:PROBe:IMPedance? query returns the impedance setting for the E2621A and E2622A probes for the current mask test channel.

**Returned Format** [:MTEST:PROBe:IMPedance] <impedance><NL>

<impedance> An unquoted string: 75, 100, 110, 120, or NONE

**Example** This example returns the impedance setting for the probe.

```
Dim strImpedance As String
myScope.WriteString ":SYSTEM:HEADer OFF"
myScope.WriteString ":MTEST:PROBe:IMPedance?"
strImpedance = myScope.ReadString
Debug.Print strImpedance
```

**History** Legacy command (existed before version 3.10).

## :MTEST:RUMode

**Command** :MTEST:RUMode {FOREver | TIME, <time> | {WAVEforms, <number\_of\_waveforms>}}

The :MTEST:RUMode command determines the termination conditions for the mask test. The choices are FOREver, TIME, or WAVEforms.

If WAVEforms is selected, a second parameter is required indicating the number of failures that can occur or the number of samples or waveforms that are to be acquired.

**FOREver** FOREver runs the Mask Test until the test is turned off. This is used when you want a measurement to run continually and not to stop after a fixed number of failures. For example, you may want the Mask Test to run overnight and not be limited by a number of failures.

**TIME** TIME sets the amount of time in minutes that a mask test will run before it terminates.

**<time>** A real number: 0.1 to 1440.0

**WAVEforms** WAVEforms sets the maximum number of waveforms that are required before the mask test terminates.

**<number\_of\_waveforms>** An integer: 1 to 1,000,000,000.

**Example** This example sets the mask test subsystem run until mode to continue testing until 500,000 waveforms have been gathered.

```
myScope.WriteString ":MTEST:RUMode WAVEforms,500E3"
```

**Query** :MTEST:RUMode?

The query returns the currently selected termination condition and value.

**Returned Format** [:MTEST:RUMode] {FOREver | TIME,<time> | {WAVEforms, <number\_of\_waveforms>}}<NL>

**Example** This example gets the current setting of the mask test run until mode from the oscilloscope and prints it on the computer screen.

```
Dim strMTEST_Runmode As String
myScope.WriteString ":MTEST:RUMode?"
strMTEST_Runmode = myScope.ReadString
Debug.Print strMTEST_Runmode
```

**History** Legacy command (existed before version 3.10).

## :MTESt:RUMode:SOFailure

**Command** :MTESt:RUMode:SOFailure {{ON | 1} | {OFF | 0}}

The :MTESt:RUMode:SOFailure command enables or disables the Stop On Failure run until criteria. When a mask test is run and a mask violation is detected, the mask test is stopped and the acquisition system is stopped.

**Example** This example enables the Stop On Failure run until criteria.

```
myScope.WriteString ":MTESt:RUMode:SOFailure ON"
```

**Query** :MTESt:RUMode:SOFailure?

The :MTESt:RUMode:SOFailure? query returns the current state of the Stop on Failure control.

**Returned Format** [:MTESt:RUMode:SOFailure] {1 | 0}<NL>

**History** Legacy command (existed before version 3.10).

**:MTEST:SCALE:BIND**

**Command** :MTEST:SCALE:BIND {{ON | 1} | {OFF | 0}}

The :MTEST:SCALE:BIND command enables or disables Bind 1 & 0 Levels (Bind -1 & 0 Levels for inverted masks) control. If the Bind 1 & 0 Levels control is enabled, the 1 Level and the 0 Level controls track each other. Adjusting either the 1 Level or the 0 Level control shifts the position of the mask up or down without changing its size. If the Bind 1 & 0 Levels control is disabled, adjusting either the 1 Level or the 0 Level control changes the vertical height of the mask.

If the Bind -1 & 0 Levels control is enabled, the -1 Level and the 0 Level controls track each other. Adjusting either the -1 Level or the 0 Level control shifts the position of the mask up or down without changing its size. If the Bind -1 & 0 Levels control is disabled, adjusting either the -1 Level or the 0 Level control changes the vertical height of the mask.

**Example** This example enables the Bind 1 & 0 Levels control.

```
myScope.WriteString ":MTEST:SCALE:BIND ON"
```

**Query** :MTEST:SCALE:BIND?

The :MTEST:SCALE:BIND? query returns the value of the Bind 1&0 control (Bind -1&0 for inverted masks).

**Returned Format** [:MTEST:SCALE:BIND?] {1 | 0}<NL>

**History** Legacy command (existed before version 3.10).

## :MTEST:SCALE:DRAW

**Command** :MTEST:SCALE:DRAW {{0 | OFF} | {1 | ON}}

The :MTEST:SCALE:DRAW command specifies whether the mask bounding region is displayed.

When displayed, the mask bounding region lets you move and perhaps scale the gray mask regions relative to waveforms.

**Query** :MTEST:SCALE:DRAW?

The :MTEST:SCALE:DRAW? query returns whether the mask bounding region is displayed.

**Returned Format** <setting><NL>

<setting> ::= {0 | 1}

**History** New in version 6.40.

**:MTEST:SCALE:X1**

**Command** :MTEST:SCALE:X1 <x1\_value>

The :MTEST:SCALE:X1 command defines where X=0 in the base coordinate system used for mask testing. The other X-coordinate is defined by the SCALE:XDELta command. Once the X1 and XDELta coordinates are set, all X values of vertices in the mask regions are defined with respect to this value, according to the equation:

$$X = (X \times \Delta X) + X1$$

Thus, if you set X1 to 100 ms, and XDELta to 100 ms, an X value of 0.100 is a vertex at 110 ms.

The oscilloscope uses this equation to normalize vertices. This simplifies reprogramming to handle different data rates. For example, if you halve the period of the waveform of interest, you need only to adjust the XDELta value to set up the mask for the new waveform.

<x1\_value> A time value specifying the location of the X1 coordinate, which will then be treated as X=0 for mask regions coordinates.

**Example** This example sets the X1 coordinate at 150 ms.

```
myScope.WriteString ":MTEST:SCALE:X1 150E-3"
```

**Query** :MTEST:SCALE:X1?

The :MTEST:SCALE:X1? query returns the current X1 coordinate setting.

**Returned Format** [:MTEST:SCALE:X1] <x1\_value><NL>

**Example** This example gets the current setting of the X1 coordinate from the oscilloscope and prints it on the computer screen.

```
Dim strScale_x1 As String
myScope.WriteString ":MTEST:SCALE:X1?"
strScale_x1 = myScope.ReadString
Debug.Print strScale_x1
```

**History** Legacy command (existed before version 3.10).



## :MTEST:SCALE:XDELta

**Command** :MTEST:SCALE:XDELta <xdelta\_value>

The :MTEST:SCALE:XDELta command defines the position of the X2 marker with respect to the X1 marker. In the mask test coordinate system, the X1 marker defines where X=0; thus, the X2 marker defines where X=1.

Because all X vertices of the regions defined for mask testing are normalized with respect to X1 and  $\Delta X$ , redefining  $\Delta X$  also moves those vertices to stay in the same locations with respect to X1 and  $\Delta X$ . Thus, in many applications, it is best if you define XDELta as a pulse width or bit period. Then a change in data rate without corresponding changes in the waveform can easily be handled by changing  $\Delta X$ .

The X-coordinate of polygon vertices is normalized using this equation:

$$X = (X \times \Delta X) + X1$$

<xdelta\_value> A time value specifying the distance of the X2 marker with respect to the X1 marker.

**Example** Assume that the period of the waveform you wish to test is 1 ms. Then the following example will set  $\Delta X$  to 1 ms, ensuring that the waveform's period is between the X1 and X2 markers.

```
myScope.WriteString ":MTEST:SCALE:XDELta 1E-6:
```

**Query** :MTEST:SCALE:XDELta?

The :MTEST:SCALE:XDELta? query returns the current value of  $\Delta X$ .

**Returned Format** [:MTEST:SCALE:XDELta] <xdelta\_value><NL>

**Example** This example gets the value of  $\Delta X$  from the oscilloscope and prints it on the computer screen.

```
Dim strScale_xdelta As String
myScope.WriteString ":MTEST:SCALE:XDELta?"
strScale_xdelta = myScope.ReadString
Debug.Print strScale_xdelta
```

**History** Legacy command (existed before version 3.10).

**:MTEST:SCALE:Y1**

**Command** :MTEST:SCALE:Y1 <y\_value>

The :MTEST:SCALE:Y1 command defines where Y=0 in the coordinate system for mask testing. All Y values of vertices in the coordinate system are defined with respect to the boundaries set by SCALE:Y1 and SCALE:Y2 according to the equation:

$$Y = (Y \times (Y2 - Y1)) + Y1$$

Thus, if you set Y1 to 100 mV, and Y2 to 1 V, a Y value of 0.100 in a vertex is at 190 mV.

<y1\_value> A voltage value specifying the point at which Y=0.

**Example** This example sets the Y1 marker to -150 mV.

```
myScope.WriteString ":MTEST:SCALE:Y1 -150E-3"
```

**Query** :MTEST:SCALE:Y1?

The SCALE:Y1? query returns the current setting of the Y1 marker.

**Returned Format** [:MTEST:SCALE:Y1] <y1\_value><NL>

**Example** This example gets the setting of the Y1 marker from the oscilloscope and prints it on the computer screen.

```
Dim strScale_y1 As String
myScope.WriteString ":MTEST:SCALE:Y1?"
strScale_y1 = myScope.ReadString
Debug.Print strScale_y1
```

**History** Legacy command (existed before version 3.10).

## :MTESt:SCALe:Y2

**Command** :MTESt:SCALe:Y2 <y2\_value>

The :MTESt:SCALe:Y2 command defines the Y2 marker in the coordinate system for mask testing. All Y values of vertices in the coordinate system are defined with respect to the boundaries defined by SCALe:Y1 and SCALe:Y2 according to the following equation:

$$Y = (Y \times (Y2 - Y1)) + Y1$$

Thus, if you set Y1 to 100 mV, and Y2 to 1 V, a Y value of 0.100 in a vertex is at 190 mV.

<y2\_value> A voltage value specifying the location of the Y2 marker.

**Example** This example sets the Y2 marker to 2.5 V.

```
myScope.WriteString ":MTESt:SCALe:Y2 2.5"
```

**Query** :MTESt:SCALe:Y2?

The SCALe:Y2? query returns the current setting of the Y2 marker.

**Returned Format** [:MTESt:SCALe:Y2] <y2\_value><NL>

**Example** This example gets the setting of the Y2 marker from the oscilloscope and prints it on the computer screen.

```
Dim strScale_y2 As String
myScope.WriteString ":MTESt:SCALe:Y2?"
strScale_y2 = myScope.ReadString
Debug.Print strScale_y2
```

**History** Legacy command (existed before version 3.10).

**:MTEST:SOURce**

**Command** :MTEST:SOURce {CHANnel<N> | FUNCtion<F> | EQUalized<L> | WMEMory<R> | XT<X>}

The :MTEST:SOURce command selects the channel which is configured by the commands contained in a mask file when it is loaded.

The EQUalized<L> source is available when the Advanced Signal Integrity Software license is installed and the equalized waveform is displayed as a function.

<N> An integer, 1-4 in a single oscilloscope, 1-40 in a MultiScope system.

<F> An integer, 1-16.

<R> An integer, 1-4.

<L> An integer, 1-4.

<X> An integer, 1-4, identifying the crosstalk waveform.

**Example** This example selects channel 1 as the mask test source.

```
myScope.WriteString ":MTEST:SOURce CHANnel1"
```

**Query** :MTEST:SOURce?

The :MTEST:SOURce? query returns the channel which is configured by the commands contained in the current mask file.

**Returned Format** [:MTEST:SOURce] {CHAN<N> | FUNC<F> | EQU<L> | WMEM<R> | XT<X>}<NL>

**Example** This example gets the mask test source setting and prints the result on the computer display.

```
Dim strAmask_source As String
myScope.WriteString ":MTEST:SOURce?"
strAmask_source = myScope.ReadString
Debug.Print strAmask_source
```

**History** Legacy command (existed before version 3.10).

Version 6.00: Waveform memories can now be used as a source for mask testing.

## :MTESt:START

**Command**    :MTESt:START

The :MTESt:START command starts the mask test. The :MTESt:START command also starts the oscilloscope acquisition system.

**Example**    This example starts the mask test and acquisition system.

```
myScope.WriteString ":MTESt:START"
```

**History**    Legacy command (existed before version 3.10).

## :MTEST:STOP

**Command** :MTEST:STOP

The :MTEST:STOP command stops the mask test. The :MTEST:STOP command does not stop the acquisition system.

**Example** This example stops the mask test.

```
myScope.WriteString ":MTEST:STOP"
```

**History** Legacy command (existed before version 3.10).

## :MTEST:STIME

**Command** :MTEST:STIME <timeout>

The :MTEST:STIME command sets the timeout value for the Autoalign feature. If the oscilloscope is unable to align the mask to your waveform within the specified timeout value, it will stop trying to align and will report an alignment failure.

**<timeout>** An integer from 1 to 120 seconds representing the time between triggers (not the time that it takes to finish the alignment.)

**Example** This example sets the timeout value for the Autoalign feature to 10 seconds.

```
myScope.WriteString ":MTEST:STIME 10"
```

**Query** :MTEST:STIME?

The query returns timeout value for the Autoalign feature.

**Returned Format** [:MTEST:STIME] <timeout><NL>

**Example** This example gets the timeout setting and prints the result on the computer display.

```
myScope.WriteString ":MTEST:STIME?"
varValue = myScope.ReadNumber
Debug.Print FormatNumber(varValue, 0)
```

**History** Legacy command (existed before version 3.10).

## :MTEST:TITLe?

**Query** :MTEST:TITLe?

The :MTEST:TITLe? query returns the mask title which is a string of up to 23 characters. The title is displayed in the mask test dialog box and mask test tab when a mask file is loaded.

**Returned Format** [:MTEST:TITLe] <mask\_title><NL>

<mask\_title> A string of up to 23 ASCII characters which is the mask title.

**Example** This example places the mask title in the string variable and prints the contents to the computer's screen.

```
Dim strTitle As String
myScope.WriteString ":MTEST:TITLe?"
strTitle = myScope.ReadString
Debug.Print strTitle
```

**History** Legacy command (existed before version 3.10).



## :MTEST:TRIGger:SOURce

**Command** :MTEST:TRIGger:SOURce CHANnel<N>

The :MTEST:TRIGger:SOURce command sets the channel or function to use as the trigger. Mask testing must be enabled before using this command.

<N> An integer, 1-4.

**Example** This example sets the mask trigger source to channel 1.

```
myScope.WriteString ":MTEST:TRIGger:SOURce CHANnel1"
```

**Query** :MTEST:TRIGger:SOURce?

The query returns the currently selected mask test trigger source.

**Returned Format** [:MTEST:TRIGger:SOURce] CHANnel<N><NL>

**Example** This example gets the trigger source setting and prints the result on the computer display.

```
Dim strAmask_source As String
myScope.WriteString ":MTEST:TRIGger:SOURce?"
strAmask_source = myScope.ReadString
Debug.Print strAmask_source
```

**History** Legacy command (existed before version 3.10).



## 31 Measure Commands

:MEASure:AREA / 894  
:MEASure:BER / 896  
:MEASure:BERPeracq / 897  
:MEASure:BINterval / 898  
:MEASure:BPERiod / 899  
:MEASure:BWIDth / 900  
:MEASure:CDRRate / 901  
:MEASure:CGRade:CROSSing / 902  
:MEASure:CGRade:DCDistortion / 903  
:MEASure:CGRade:EHEight / 904  
:MEASure:CGRade:ELOCation / 906  
:MEASure:CGRade:EWIDth / 907  
:MEASure:CGRade:EWIDth:THReshold / 909  
:MEASure:CGRade:EWINDow / 910  
:MEASure:CGRade:JITTer / 912  
:MEASure:CGRade:OLEVel / 914  
:MEASure:CGRade:QFACTOR / 915  
:MEASure:CGRade:ZLEVel / 916  
:MEASure:CHARge (9000 Series, 9000H Series, S-Series) / 917  
:MEASure:CLEar / 918  
:MEASure:CROSSing / 919  
:MEASure:CTCDutycycle / 920  
:MEASure:CTCJitter / 922  
:MEASure:CTCNwidth / 924  
:MEASure:CTCPwidth / 926  
:MEASure:DATarate / 928  
:MEASure:DCAI / 930  
:MEASure:DCAQ / 931  
:MEASure:DCIPrime / 932  
:MEASure:DCQPrime / 933  
:MEASure:DEEMphasis / 934  
:MEASure:DELTatime / 936

:MEASure:DELTatime:DEFine / 938  
:MEASure:DUTYcycle / 940  
:MEASure:EDGE / 941  
:MEASure:ERATio / 942  
:MEASure:ETAEdges / 943  
:MEASure:ETOedge / 944  
:MEASure:FALLtime / 946  
:MEASure:FFT:CPOWer / 948  
:MEASure:FFT:DFRequency / 949  
:MEASure:FFT:DMAGNitude / 951  
:MEASure:FFT:FREQuency / 953  
:MEASure:FFT:MAGNitude / 955  
:MEASure:FFT:OBW / 957  
:MEASure:FFT:PSD / 958  
:MEASure:FREQuency / 959  
:MEASure:HISTogram:FWMH / 961  
:MEASure:HISTogram:HITS / 962  
:MEASure:HISTogram:M1S / 963  
:MEASure:HISTogram:M2S / 964  
:MEASure:HISTogram:M3S / 965  
:MEASure:HISTogram:MAX / 966  
:MEASure:HISTogram:MEAN / 967  
:MEASure:HISTogram:MEDian / 968  
:MEASure:HISTogram:MIN / 969  
:MEASure:HISTogram:MM3S / 970  
:MEASure:HISTogram:MP3S / 971  
:MEASure:HISTogram:MODE / 972  
:MEASure:HISTogram:PEAK / 973  
:MEASure:HISTogram:PP / 974  
:MEASure:HISTogram:RESolution / 975  
:MEASure:HISTogram:STDDev / 976  
:MEASure:HOLDtime / 977  
:MEASure:JITTer:HISTogram / 979  
:MEASure:JITTer:MEASurement / 980  
:MEASure:JITTer:SPECTrum / 981  
:MEASure:JITTer:SPECTrum:HORizontal / 982  
:MEASure:JITTer:SPECTrum:HORizontal:POSition / 983  
:MEASure:JITTer:SPECTrum:HORizontal:RANGe / 984  
:MEASure:JITTer:SPECTrum:RESolution / 985

:MEASure:JITTer:SPECTrum:VERTical / 986  
 :MEASure:JITTer:SPECTrum:VERTical:OFFSet / 987  
 :MEASure:JITTer:SPECTrum:VERTical:RANGe / 988  
 :MEASure:JITTer:SPECTrum:VERTical:TYPE / 989  
 :MEASure:JITTer:SPECTrum:WINDow / 990  
 :MEASure:JITTer:TREND / 991  
 :MEASure:JITTer:TREND:SMOoth / 992  
 :MEASure:JITTer:TREND:SMOoth:POINts / 993  
 :MEASure:JITTer:TREND:VERTical / 994  
 :MEASure:JITTer:TREND:VERTical:OFFSet / 995  
 :MEASure:JITTer:TREND:VERTical:RANGe / 996  
 :MEASure:MARK / 997  
 :MEASure:NAME / 998  
 :MEASure:NCJitter / 999  
 :MEASure:NOISe / 1001  
 :MEASure:NOISe:ALL? / 1003  
 :MEASure:NOISe:BANDwidth / 1005  
 :MEASure:NOISe:LOCation / 1006  
 :MEASure:NOISe:METHod / 1007  
 :MEASure:NOISe:REPort / 1008  
 :MEASure:NOISe:RN / 1009  
 :MEASure:NOISe:SCOPE:RN / 1010  
 :MEASure:NOISe:STATe / 1011  
 :MEASure:NOISe:UNITs / 1012  
 :MEASure:NPERiod / 1013  
 :MEASure:NPULses / 1014  
 :MEASure:NSIGma / 1015  
 :MEASure:NUI / 1016  
 :MEASure:NWIDth / 1017  
 :MEASure:OMAMplitude / 1018  
 :MEASure:OPOWer / 1019  
 :MEASure:OVERshoot / 1020  
 :MEASure:PAM:ELEVel / 1022  
 :MEASure:PAM:ESKew / 1024  
 :MEASure:PAM:EYE:ELMethod / 1026  
 :MEASure:PAM:EYE:ESTiming / 1027  
 :MEASure:PAM:EYE:PPERcent / 1028  
 :MEASure:PAM:EYE:PROBability / 1029  
 :MEASure:PAM:EYE:TIME:LTDefinition / 1030

:MEASure:PAM:LEVel / 1031  
:MEASure:PAM:LRMS / 1033  
:MEASure:PAM:LTHickness / 1035  
:MEASure:PAM:PRBS13q:COUnT / 1037  
:MEASure:PAM:PRBS13q:EDGE:EOJ / 1038  
:MEASure:PAM:PRBS13q:EDGE:J3U / 1039  
:MEASure:PAM:PRBS13q:EDGE:J4U / 1040  
:MEASure:PAM:PRBS13q:EDGE:J6U / 1041  
:MEASure:PAM:PRBS13q:EDGE:JRMS / 1042  
:MEASure:PAM:PRBS13q:HUNits / 1043  
:MEASure:PAM:PRBS13q:PATtern / 1044  
:MEASure:PAM:PRBS13q:PFILe / 1045  
:MEASure:PAM:PRBS13q:STATe / 1046  
:MEASure:PAM:PRBS13q:UNITs / 1047  
:MEASure:PAMPlitude / 1048  
:MEASure:PBASe / 1049  
:MEASure:PERiod / 1050  
:MEASure:PHASe / 1052  
:MEASure:PJITter / 1054  
:MEASure:PLENght / 1055  
:MEASure:PN:CORRelations / 1056  
:MEASure:PN:DESKew / 1057  
:MEASure:PN:EDGE / 1058  
:MEASure:PN:HORizontal:STARt / 1059  
:MEASure:PN:HORizontal:STOP / 1060  
:MEASure:PN:RSSC / 1061  
:MEASure:PN:SOURce / 1062  
:MEASure:PN:SPURs / 1064  
:MEASure:PN:SSENSitivity / 1065  
:MEASure:PN:STATe / 1066  
:MEASure:PN:VERTical:REFerence / 1067  
:MEASure:PN:VERTical:SCALe / 1068  
:MEASure:PN:WINDow / 1069  
:MEASure:PPContrast / 1070  
:MEASure:PPULses / 1071  
:MEASure:PREShoot / 1072  
:MEASure:PTOP / 1074  
:MEASure:PWIDth / 1075  
:MEASure:QUALifier<M>:CONDition / 1076

:MEASure:QUALifier<M>:SOURce / 1077  
:MEASure:QUALifier<M>:STATe / 1078  
:MEASure:RESults? / 1079  
:MEASure:RISetime / 1083  
:MEASure:RJDJ:ALL? / 1085  
:MEASure:RJDJ:APLength? / 1087  
:MEASure:RJDJ:BANDwidth / 1088  
:MEASure:RJDJ:BER / 1089  
:MEASure:RJDJ:CLOCK / 1091  
:MEASure:RJDJ:EDGE / 1093  
:MEASure:RJDJ:INTerpolate / 1094  
:MEASure:RJDJ:METHod / 1095  
:MEASure:RJDJ:MODE / 1096  
:MEASure:RJDJ:PAMThreshold / 1097  
:MEASure:RJDJ:PLENght / 1098  
:MEASure:RJDJ:REPort / 1099  
:MEASure:RJDJ:RJ / 1100  
:MEASure:RJDJ:SCOPE:RJ / 1101  
:MEASure:RJDJ:SCOPE:RJ:CALibrate / 1102  
:MEASure:RJDJ:SOURce / 1103  
:MEASure:RJDJ:STATe / 1104  
:MEASure:RJDJ:TJRJDJ? / 1105  
:MEASure:RJDJ:UNITs / 1107  
:MEASure:SCRatch / 1108  
:MEASure:SENDvalid / 1109  
:MEASure:SER / 1110  
:MEASure:SERPeracq / 1111  
:MEASure:SETuptime / 1112  
:MEASure:SLEWrate / 1114  
:MEASure:SOURce / 1116  
:MEASure:STATistics / 1117  
:MEASure:TEDGE / 1118  
:MEASure:THResholds:ABSolute / 1119  
:MEASure:THResholds:DISPlay / 1120  
:MEASure:THResholds:GENAUTO / 1121  
:MEASure:THResholds:GENeral:ABSolute / 1122  
:MEASure:THResholds:GENeral:HYSteresis / 1124  
:MEASure:THResholds:GENeral:METHod / 1126  
:MEASure:THResholds:GENeral:PAMCustom / 1128

:MEASure:THResholds:GENeral:PAMAutomatic / 1130  
:MEASure:THResholds:GENeral:PERCent / 1132  
:MEASure:THResholds:GENeral:TOPBase:ABSolute / 1134  
:MEASure:THResholds:GENeral:TOPBase:METhod / 1136  
:MEASure:THResholds:HYSTeresis / 1137  
:MEASure:THResholds:METhod / 1139  
:MEASure:THResholds:PERCent / 1140  
:MEASure:THResholds:RFAL:ABSolute / 1141  
:MEASure:THResholds:RFAL:METhod / 1143  
:MEASure:THResholds:RFAL:PAMAutomatic / 1145  
:MEASure:THResholds:RFAL:PERCent / 1147  
:MEASure:THResholds:RFAL:TOPBase:ABSolute / 1149  
:MEASure:THResholds:RFAL:TOPBase:METhod / 1151  
:MEASure:THResholds:SERauto / 1152  
:MEASure:THResholds:SERial:ABSolute / 1153  
:MEASure:THResholds:SERial:HYSTeresis / 1155  
:MEASure:THResholds:SERial:METhod / 1157  
:MEASure:THResholds:SERial:PERCent / 1158  
:MEASure:THResholds:SERial:TOPBase:ABSolute / 1160  
:MEASure:THResholds:SERial:TOPBase:METhod / 1162  
:MEASure:THResholds:TOPBase:ABSolute / 1163  
:MEASure:THResholds:TOPBase:METhod / 1164  
:MEASure:TIEClock2 / 1165  
:MEASure:TIEData2 / 1167  
:MEASure:TIEFilter:DAMPing / 1168  
:MEASure:TIEFilter:SHAPE / 1169  
:MEASure:TIEFilter:START / 1170  
:MEASure:TIEFilter:STATe / 1171  
:MEASure:TIEFilter:STOP / 1172  
:MEASure:TIEFilter:TYPE / 1173  
:MEASure:TMAX / 1174  
:MEASure:TMIN / 1175  
:MEASure:TVOLT / 1176  
:MEASure:UITouijitter / 1178  
:MEASure:UNDershoot / 1179  
:MEASure:UNITinterval / 1183  
:MEASure:VAMPLitude / 1185  
:MEASure:VAverage / 1186  
:MEASure:VBASe / 1187



```

:MEASure:VLOWer / 1188
:MEASure:VMAX / 1189
:MEASure:VMIDdle / 1190
:MEASure:VMIN / 1191
:MEASure:VOVershoot / 1192
:MEASure:VPP / 1193
:MEASure:VPReshoot / 1194
:MEASure:VRMS / 1195
:MEASure:VTIMe / 1197
:MEASure:VTOP / 1198
:MEASure:VUNDershoot / 1199
:MEASure:VUPPer / 1200
:MEASure:WINDow / 1201
:MEASure:XCORTie / 1202
:MEASure:ZTMAX / 1203
:MEASure:ZTMIN / 1204
:MEASurement<N>:CLEar / 1205
:MEASurement<N>:NAME / 1206
:MEASurement<N>:POSition / 1207
:MEASurement<N>:SOURce / 1208
:MEASurement<N>:ZTMAX / 1209
:MEASurement<N>:ZTMIN / 1210

```

The commands in the MEASure subsystem are used to make parametric measurements on displayed waveforms.

#### Jitter Analysis Software Commands

The following MEASure commands are available when the Jitter Analysis Software license is installed.

- **":MEASure:CTCDutycycle"** on page 920
- **":MEASure:CTCJitter"** on page 922
- **":MEASure:CTCNwidth"** on page 924
- **":MEASure:CTCPwidth"** on page 926
- **":MEASure:DATarate"** on page 928
- **":MEASure:HOLDtime"** on page 977
- **":MEASure:JITTer:HISTogram"** on page 979
- **":MEASure:JITTer:MEASurement"** on page 980
- **":MEASure:JITTer:SPECtrum"** on page 981

- **":MEASure:JITTer:TRENd"** on page 991
- **":MEASure:NCJitter"** on page 999
- **":MEASure:NPERiod"** on page 1013
- **":MEASure:NUI"** on page 1016
- **":MEASure:RJDJ:ALL?"** on page 1085
- **":MEASure:RJDJ:APLength?"** on page 1087
- **":MEASure:RJDJ:BER"** on page 1089
- **":MEASure:RJDJ:CLOCK"** on page 1091
- **":MEASure:RJDJ:EDGE"** on page 1093
- **":MEASure:RJDJ:INTerpolate"** on page 1094
- **":MEASure:RJDJ:PLENght"** on page 1098
- **":MEASure:RJDJ:SOURce"** on page 1103
- **":MEASure:RJDJ:STAtE"** on page 1104
- **":MEASure:RJDJ:TJRJDJ?"** on page 1105
- **":MEASure:RJDJ:UNITs"** on page 1107
- **":MEASure:SETuptime"** on page 1112
- **":MEASure:TIEClock2"** on page 1165
- **":MEASure:TIEData2"** on page 1167
- **":MEASure:UNITinterval"** on page 1183

**FFT Commands** The :MEASure:FFT commands control the FFT measurements that are accessible through the Measure subsystem.

**Measurement Sources** Measurements are made on the displayed waveforms specified by the :MEASure:SOURce command. The :MEASure:SOURce command lets you specify two sources. Most measurements are only made on a single source. Some measurements, such as the DELTatime measurement, require two sources.

Most :MEASure commands also let you specify the source(s) using a <source> parameter:

```
<source> ::= {CHANnel<N> | DIFF<D> | COMMonmode<C> | WMEMory<R>
             | FUNCTion<F> | CLOCK | EQUalized<L> | MTRend | MSPectrum
             | XT<X> | PNOise | DIGital<M>}
```

where:

CHANnel<N>	<N> is an integer, 1-4 in a single oscilloscope, 1-40 in a MultiScope system.
DIFF<D>, COMMonmode<C>	<D> is an integer, 1-2. <C> is an integer, 3-4. The DIFF and COMMonmode sources are just aliases that can be used in place of the channel names to apply to differential or common mode signals. These are just aliases - no state change occurs if you refer to a differential channel and you are not in differential mode. DIFF1 refers to the differential signal between channels 1 and 3 (and COMMonmode3 refers to the common mode channel between these same channels). DIFF2 refers to the differential signal between channels 2 and 4 (and COMMonmode4 refers to the common mode channel between these same channels).
WMEMory<R>	<R> is an integer, 1-4.
FUNCTion<F>	<F> is an integer, 1-16.
CLOCK	The CLOCK source is available when the recovered clock is displayed.
EQUalized<L>	The EQUalized<L> source is available when the Advanced Signal Integrity Software license is installed and the equalized waveform is displayed as a function.
MTRend, MSPectrum	The MTRend and MSPectrum sources are available when the Jitter Analysis Software license is installed and the features are enabled.
HISTogram	HISTogram sources are available in commands that measure Meas Histogram math functions, the histogram waveform, or memories containing histograms.
XT<X>	<X> is an integer, 1-4, identifying the crosstalk waveform.
PNOise	The PNOise source is available when the Jitter and Vertical Noise Analysis Software license is installed and the Phase Noise analysis feature is enabled.
DIGital<M>	<M> is an integer, 0-15. Digital channels are available on mixed-signal oscilloscopes.

### Measurement Setup

To make a measurement, the portion of the waveform required for that measurement must be displayed on the oscilloscope.

- For a period or frequency measurement, at least one and a half complete cycles must be displayed.
- For a pulse width measurement, the entire pulse must be displayed.
- For a rise time measurement, the leading (positive-going) edge of the waveform must be displayed.
- For a fall time measurement, the trailing (negative-going) edge of the waveform must be displayed.

In jitter mode with jitter statistics enabled, measurements are made on all data regardless of what is on screen.

**User-Defined Thresholds** If you choose to set user-defined thresholds, they must be set before actually sending the measurement command or query.

**Measurement Error** If a measurement cannot be made because of a lack of data, because the source waveform is not displayed, the requested measurement is not possible (for example, a period measurement on an FFT waveform), or for some other reason, the following results are returned:

- 9.99999E+37 is returned as the measurement result.
- If SENDvalid is ON, the error code is also returned as well as the questionable value.

**Making Measurements** If more than one period, edge, or pulse is displayed, time measurements are made on the first, left-most portion of the displayed waveform.

When any of the defined measurements are requested, the oscilloscope first determines the top (100%) and base (0%) voltages of the waveform. From this information, the oscilloscope determines the other important voltage values (10%, 90%, and 50% voltage values) for making measurements.

The 10% and 90% voltage values are used in the rise time and fall time measurements when standard thresholds are selected. The 50% voltage value is used for measuring frequency, period, pulse width, and duty cycle with standard thresholds selected.

You can also make measurements using user-defined thresholds instead of the standard thresholds.

When the command form of a measurement is used, the oscilloscope is placed in the continuous measurement mode. The measurement result will be displayed on the front panel. There may be a maximum of 20 measurements running continuously. Use the :MEASure:CLEar command to turn off the measurements.

When the query form of the measurement is used, the measurement is made one time, and the measurement result is returned.

- If the current acquisition is complete, the current acquisition is measured and the result is returned.
- If the current acquisition is incomplete and the oscilloscope is running, acquisitions will continue to occur until the acquisition is complete. The acquisition will then be measured and the result returned.
- If the current acquisition is incomplete and the oscilloscope is stopped, the measurement result will be 9.99999e+37 and the incomplete result state will be returned if SENDvalid is ON.

Because measurement results queries can potentially return before tasks complete (see [Chapter 8](#), “Sequential (Blocking) vs. Overlapped Commands,” starting on page 215), these queries should always follow a wait for commands to complete (see [Chapter 9](#), “Using :PDER? Instead of \*OPC?,” starting on page 217).

All measurements are made using the entire display, except for VAVerage and VRMS which allow measurements on a single cycle. Therefore, if you want to make measurements on a particular cycle, display only that cycle on the screen.

If the waveform is clipped, the measurement result may be questionable. In this case, the value returned is the most accurate value that can be made using the current scaling. You might be able to obtain a more accurate measurement by adjusting the vertical scale to prevent the waveform from being clipped.

Note that you can concatenate measurement queries for much faster throughput. For example:

```
:MEASure:VPP? CHANnel1;:MEASure:FREQuency? CHANnel2
```

When you do this, however, values are returned as a single query result, separated by semicolons.

## :MEASure:AREA

**Command** :MEASure:AREA [CYCLe[, <source>[, <direction>]]]  
 :MEASure:AREA [DISPlay[, <source>]]

The :MEASure:AREA command turns on the area measurement. The area measurement measures between the waveform, or a selected cycle of the waveform, and the waveform ground.

When measuring Area, it is sometimes useful to use the Subtract Math Operator to remove any dc offset from a waveform you want to measure.

When the "Measure All Edges" mode is OFF (see [":ANALyze:AEDGes"](#) on page 273), the first CYCLe from the left side of the display grid is measured or the entire DISPlay is measured.

When the "Measure All Edges" mode is ON, all cycles in the acquisition are measured or the entire acquisition is measured.

**<source>** {CHANnel<N> | FUNCTion<F> | WMEMory<R> | XT<X>}

For more information on <source> parameters, see ["Measurement Sources"](#) on page 890.

**<direction>** {RISing | FALLing}

When the CYCLe option is used, the <direction> option specifies which edge the cycle begins and ends on. When <direction> is specified, the <source> parameter is required.

**Example** This example turns on the area measurement which measures between the waveform and ground. Only that portion of the waveform which is in the waveform viewing area is measured.

```
myScope.WriteString ":MEASure:AREA DISPlay"
```

**Query** :MEASure:AREA? [CYCLe[, <source>[, <direction>]]]  
 :MEASure:AREA? [DISPlay[, <source>]]

The :MEASure:AREA? query returns the area measurement.

**Returned Format** [:MEASure:AREA] <value>[, <result\_state>]<NL>

**Example** This example places the current selection for the area to be measured in the string variable, strSelection, then prints the contents of the variable to the computer's screen.

```
Dim strSelection As String
myScope.WriteString ":MEASure:AREA?"
strSelection = myScope.ReadString
Debug.Print strSelection
```

**History** Legacy command (existed before version 3.10).

Version 5.70: Added a RISing or FALLing edge parameter when measuring a single cycle of the waveform.

**:MEASure:BER**

**Command** :MEASure:BER <source>

When a pattern length and pattern can be determined (see the :ANALyze:SIGNal:PATtern:\* commands), the :MEASure:BER command installs a cumulative bit error rate (BER) measurement of the specified PAM waveform into the user interface's measurement Results pane.

<source> {CHANnel<N> | FUNction<F> | WMEMory<R> | XT<X>}

For more information on <source> parameters, see "[Measurement Sources](#)" on page 890.

**Query** :MEASure:BER? <source>

The :MEASure:BER? query returns the measured cumulative bit error rate value.

**Returned Format** [:MEASure:BER] <value><NL>

<value> ::= the cumulative BER value in NR3 format.

- See Also**
- "[:ANALyze:SIGNal:PATtern:CLEar](#)" on page 306
  - "[:ANALyze:SIGNal:PATtern:LOAD](#)" on page 307
  - "[:ANALyze:SIGNal:PATtern:PLENght](#)" on page 308
  - "[:ANALyze:SIGNal:PATtern:SMAP](#)" on page 309
  - "[:MEASure:BERPeracq](#)" on page 897
  - "[:MEASure:SER](#)" on page 1110
  - "[:MEASure:SERPeracq](#)" on page 1111

**History** New in version 5.60.



## :MEASure:BERPeracq

**Command** :MEASure:BERPeracq <source>

<pattern\_length> ::= integer number of symbols.

When a pattern length and pattern can be determined (see the :ANALyze:SIGNal:PATtern:\* commands), the :MEASure:BERPeracq command installs a bit error rate (BER) per acquisition measurement of the specified PAM waveform into the user interface's measurement Results pane.

<source> {CHANnel<N> | FUNction<F> | WMEMory<R> | XT<X>}

For more information on <source> parameters, see "[Measurement Sources](#)" on page 890.

**Query** :MEASure:BERPeracq? <source>

The :MEASure:BERPeracq? query returns the measured bit error rate per acquisition value.

**Returned Format** [:MEASure:BERPeracq] <value><NL>

<value> ::= the BER per acquisition value in NR3 format.

- See Also**
- "[:ANALyze:SIGNal:PATtern:CLEar](#)" on page 306
  - "[:ANALyze:SIGNal:PATtern:LOAD](#)" on page 307
  - "[:ANALyze:SIGNal:PATtern:PLENght](#)" on page 308
  - "[:ANALyze:SIGNal:PATtern:SMAP](#)" on page 309
  - "[:MEASure:BER](#)" on page 896
  - "[:MEASure:SER](#)" on page 1110
  - "[:MEASure:SERPeracq](#)" on page 1111

**History** New in version 5.60.

## :MEASure:BINterval

**Command** :MEASure:BINterval <source>, <idle time>

The :MEASure:BINterval command measures the amount of time between the end of a burst and beginning of the next burst. The idle time is the minimum time between bursts.

The Burst Interval measurement builds on top of the Burst Width measurement. Two Burst Widths must be identified in order to measure the interval between bursts. To measure a Burst Width, idles are required before and after the burst. Therefore, to measure a Burst Interval, an idle-burst-idle-burst-idle sequence must be captured by the oscilloscope.

<source> {CHANnel<N> | FUNction<F> | WMEMory<R> | XT<X>}

For more information on <source> parameters, see "[Measurement Sources](#)" on page 890.

<idle time> Minimum amount of idle time between bursts.

**Example** This example measures the burst interval between two bursts on channel 4 (and with an idle time of 5 microseconds)

```
myScope.WriteString ":MEASure:BINterval CHAN4, 5e-6"
```

**Query** :MEASure:BINterval? <source>, <idle time>

The :MEASure:BINterval? query returns the burst interval time.

**See Also** • "[:MEASure:BWIDth](#)" on page 900

**History** Legacy command (existed before version 3.10).

## :MEASure:BPERiod

**Command** :MEASure:BPERiod <source>, <idle time>

The :MEASure:BPERiod command measures the time between the beginning of a burst and the beginning of the next burst. The idle time is the minimum time between bursts.

<source> {CHANnel<N> | FUNCTion<F> | WMEMory<R> | XT<X>}

For more information on <source> parameters, see "[Measurement Sources](#)" on page 890.

<idle time> Minimum amount of idle time between bursts.

**Example** This example measures the burst period between two bursts on channel 4 (and with an idle time of 5 microseconds)

```
myScope.WriteString ":MEASure:BPERiod CHAN4, 5e-6"
```

**Query** :MEASure:BPERiod? <source>, <idle time>

The :MEASure:BPERiod? query returns the burst period time.

**History** Legacy command (existed before version 3.10).

## :MEASure:BWIDth

**Command** :MEASure:BWIDth <source>,<idle\_time>

The :MEASure:BWIDth command measures the width of bursts in your waveform. The idle time is the minimum time between bursts.

**<source>** {CHANnel<N> | DIFF<D> | COMMONmode<C> | FUNCTION<F> | WMEMory<R> | CLOCK | MSPectrum | MTRend | EQUALized<L> | XT<X>}

For more information on <source> parameters, see "[Measurement Sources](#)" on page 890.

**<idle\_time>** Amount of idle time between bursts.

**Example** This example measures the width of bursts for the waveform on channel one and sets the idle time to 1 microsecond.

```
myScope.WriteString ":MEASure:BWIDth CHANnel1,1E-6"
```

**Query** :MEASure:BWIDth? <source>,<idle\_time>

The :MEASure:BWIDth? query returns the width of the burst being measured.

**Returned Format** [:MEASure:BWIDth ]<burst\_width><NL>

**Example** This example returns the width of the burst being measured, in the string variable, strBurstwidth, then prints the contents of the variable to the computer's screen.

```
Dim strBurstwidth As String
myScope.WriteString ":MEASure:BWIDth? CHANnel1,1E-6"
strBurstwidth = myScope.ReadString
Debug.Print strBurstwidth
```

**See Also** • "[:MEASure:BINterval](#)" on page 898

**History** Legacy command (existed before version 3.10).

## :MEASure:CDRRate

**Command** :MEASure:CDRRate <source>

The :MEASure:CDRRate command determines the data rate (clock recovery rate) from the clock recovery method being used. It yields one data point per acquisition so trending cannot be performed on this measurement.

<source> {CHANnel<N> | DIFF<D> | COMMONmode<C> | FUNCtion<F> | WMEMory<R> | CLOCK | MSPectrum | MTRend | EQUALized<L> | XT<X>}

For more information on <source> parameters, see "[Measurement Sources](#)" on page 890.

**Example** This example measures the clock recovery rate of channel 1.

```
myScope.WriteString ":MEASure:CDRRate CHANnel1"
```

**Query** :MEASure:CDRRate? <source>

The :MEASure:CDRRate? query returns the data rate (clock recovery rate) for the source waveform.

**NOTE**

This measurement requires the **Measure All Edges** setting to be enabled. You can do this by:

- Installing the measurement on the display (using the command syntax), which automatically enables the **Measure All Edges** setting
- Sending the ":ANALyze:AEDGes ON" command.

**Returned Format** [:MEASure:CDRRate] <cdr\_rate><NL>

**Example** This example places the current data rate of the channel 1 waveform in the numeric variable, varValue, then prints the contents of the variable to the computer's screen.

```
myScope.WriteString ":SYSTEM:HEADer OFF" ' Response headers off.
myScope.WriteString ":MEASure:CDRRate? CHANnel1"
varValue = myScope.ReadNumber
Debug.Print FormatNumber(varValue, 0)
```

**See Also** • "[:ANALyze:AEDGes](#)" on page 273

**History** Legacy command (existed before version 3.10).

## :MEASure:CGRade:CROSSing

**Command** :MEASure:CGRade:CROSSing [<source>]

The :MEASure:CGRade:CROSSing command enables the crossing level percent measurement on the current eye pattern. Before using this command or query, you must use the :DISPlay:CGRade command to enable the color grade persistence feature. Also, there must be a full eye diagram on screen before a valid measurement can be made.

**<source>** {CHANnel<N> | DIFF<D> | COMMONmode<C> | WMEMory<R> | FUNction<F> | CLOCK | EQUalized<L> | MTRend | MSPectrum | XT<X>}

If <source> is omitted, the crossing level measurement will be performed on the first waveform that has color grade enabled.

For more information on <source> parameters, see "[Measurement Sources](#)" on page 890.

**Example** This example measures the crossing level.

```
myScope.WriteString ":MEASure:CGRade:CROSSing"
```

**Query** :MEASure:CGRade:CROSSing? [<source>]

The :MEASure:CGRade:CROSSing? query returns the crossing level percent measurement of the current eye diagram on the color grade display. Before using this command or query, you must use the :DISPlay:CGRade command to enable the color grade persistence feature.

**Returned Format** [:MEASure:CGRade:CROSSing] <value> [, <result\_state>] <NL>

**<value>** The crossing level.

**<result\_state>** If SENDVALID is ON, the result state is returned with the measurement result. Refer to the MEASure:RESults command, for a list of the result states.

**Example** This example places the current crossing level in the numeric variable, varValue, then prints the contents of the variable to the computer's screen.

```
myScope.WriteString ":SYSTEM:HEADer OFF" ' Response headers off.
myScope.WriteString ":MEASure:CGRade:CROSSing?"
varValue = myScope.ReadNumber
Debug.Print FormatNumber(varValue, 0)
```

**History** Legacy command (existed before version 3.10).

Version 5.00: Added the optional <source> parameter for specifying the waveform on which the color grade crossing level percent is measured.

## :MEASure:CGRade:DCDistortion

**Command** :MEASure:CGRade:DCDistortion <format> [,<source>]

The :MEASure:CGRade:DCDistortion command enables the duty cycle distortion measurement on the current eye pattern. The parameter specifies the format for reporting the measurement. Before using this command or query, you must use the :DISPlay:CGRade command to enable the color grade persistence feature. Also, there must be a full eye diagram on screen before a valid measurement can be made.

<format> {TIME | PERCent}

<source> {CHANnel<N> | DIFF<D> | COMMONmode<C> | WMEMory<R> | FUNction<F> | CLOCK | EQUalized<L> | MTRend | MSPectrum | XT<X>}

If <source> is omitted, the duty cycle distortion measurement will be performed on the first waveform that has color grade enabled.

For more information on <source> parameters, see "[Measurement Sources](#)" on page 890.

**Example** This example measures the duty cycle distortion.

```
myScope.WriteString ":MEASure:CGRade:DCDistortion TIME"
```

**Query** :MEASure:CGRade:DCDistortion? <format> [,<source>]

The :MEASure:CGRade:DCDistortion query returns the duty cycle distortion measurement of the color grade display. Before using this command or query, you must use the :DISPlay:CGRade command to enable the color grade persistence feature.

**Returned Format** [:MEASure:CGRade:DCDistortion] <value> [,<result\_state>] <NL>

<value> The duty cycle distortion.

<result\_state> If SENDVALID is ON, the result state is returned with the measurement result. Refer to the MEASure:RESults command, for a list of the result states.

**Example** This example places the current duty cycle distortion in the numeric variable, varValue, then prints the contents of the variable to the computer's screen.

```
myScope.WriteString ":SYSTEM:HEADer OFF"
myScope.WriteString ":MEASure:CGRade:DCDistortion? PERCent"
varValue = myScope.ReadNumber
Debug.Print FormatNumber(varValue, 0)
```

**History** Legacy command (existed before version 3.10).

Version 5.00: Added the optional <source> parameter for specifying the waveform on which the color grade duty cycle distortion is measured.

## :MEASure:CGRade:EHEight

**Command** :MEASure:CGRade:EHEight <algorithm>[,<source>[,<threshold>]]

The :MEASure:CGRade:EHEight command enables the eye height measurement on the current eye pattern. Before using this command or query, you must use the :DISPlay:CGRade command to enable the color grade persistence feature. Also, there must be a full eye diagram on screen before a valid measurement can be made.

<algorithm> {MEASured | EXTRapolated}

- MEASured – depending on the location setting (see :MEASure:CGRade:ELOCation), the eye height will be measured either within a window (see :MEASure:CGRade:EWINDow) or at the location of the recovered clock edge.

When measured within a window, the smallest eye height within the window is reported.

- EXTRapolated – is optional because it is the default if you do not specify an algorithm. Extrapolated will estimate the eye height based upon the mean and standard deviation of the eye top and base.

<source> {CHANnel<N> | DIFF<D> | COMMONmode<C> | WMEMory<R> | FUNCtion<F> | EQUalized<L> | XT<X>}

If <source> is omitted, the eye height measurement will be performed on the first waveform that has color grade enabled.

For more information on <source> parameters, see "[Measurement Sources](#)" on page 890.

<threshold> When the signal type is PAM-4 (see :ANALyze:SIGNal:TYPE), the <threshold> parameter is an integer that specifies which eye to measure, and the <algorithm> parameter is ignored. For PAM-4, the <threshold> may be from 0-2.

**Example** This example enables the eye height measurement.

```
myScope.WriteString ":MEASure:CGRade:EHEight "
```

**Query** :MEASure:CGRade:EHEight? <algorithm>[,<source>[,<threshold>]]

The :MEASure:CGRade:EHEight? query returns the eye height measurement of the color grade display. Before using this command or query, you must use the :DISPlay:CGRade command to enable the color grade persistence feature.

**Returned Format** [:MEASure:CGRade:EHEight] <value>[,<result\_state>]<NL>

<value> The eye height.

<result\_state> If SENDVALID is ON, the result state is returned with the measurement result. Refer to the MEASure:RESults command, for a list of the result states.



**Example** This example places the current eye height in the numeric variable, varValue, then prints the contents of the variable to the computer's screen.

```
myScope.WriteString ":SYSTEM:HEADer OFF" ' Response headers off.  
myScope.WriteString ":MEASure:CGRade:EHEight?"  
varValue = myScope.ReadNumber  
Debug.Print FormatNumber(varValue, 0)
```

- See Also**
- [":MEASure:CGRade:ELOCation"](#) on page 906
  - [":MEASure:CGRade:EWINDow"](#) on page 910
  - [":ANALyze:SIGNal:TYPE"](#) on page 312
  - [":MEASure:PAM:EYE:PROBability"](#) on page 1029

**History** Legacy command (existed before version 3.10).

Version 5.00: Added the optional <source> parameter for specifying the waveform on which the color grade eye height is measured.

Version 5.50: When the signal type is PAM-4, an additional <threshold> parameter is used to specify which eye, and the <algorithm> parameter is ignored.

## :MEASure:CGRade:ELOCation

**Command** :MEASure:CGRade:ELOCation {FIND | CLOCK} [, <source>]

The :MEASure:CGRade:ELOCation command specifies the eye height measurement location:

- FIND – measures eye height within a specified window of the eye.  
The window is defined using the :MEASure:CGRade:EWINDow command.
- CLOCK – measure eye height at the location of the recovered clock edge.

**<source>** {CHANnel<N> | DIFF<D> | COMMONmode<C> | WMEMory<R> | FUNction<F> | EQUalized<L> | XT<X>}

If <source> is omitted, the location setting is applied to the first waveform that has color grade enabled.

For more information on <source> parameters, see "[Measurement Sources](#)" on page 890.

**Query** :MEASure:CGRade:ELOCation? [<source>]

The :MEASure:CGRade:ELOCation? query returns the specified location of the eye height measurement.

**Returned Format** [:MEASure:CGRade:ELOCation] {FIND | CLOC}<NL>

- See Also**
- "[:MEASure:CGRade:EHEight](#)" on page 904
  - "[:MEASure:CGRade:EWINDow](#)" on page 910

**History** New in version 6.30.

## :MEASure:CGRade:EWIDth

**Command** :MEASure:CGRade:EWIDth <algorithm>[,<source>[,<threshold>[,<units>]]]

The :MEASure:CGRade:EWIDth command enables the eye width measurement on the current eye pattern. Before using this command or query, you must use the :DISPlay:CGRade command to enable the color grade persistence feature. Also, there must be a full eye diagram on screen before a valid measurement can be made.

**<algorithm>** {MEASured | EXTRapolated} EXTRapolated is optional because it is the default if you do not specify an algorithm.

MEASured will measure the eye width measurement within the window (see CGRade:EWINDow) of the current data. The smallest eye width is reported. Extrapolated will estimate the eye width based upon the mean and standard deviation of the crossings.

**<source>** {CHANnel<N> | DIFF<D> | COMMONmode<C> | WMEMory<R> | FUNCTion<F> | CLOCK | EQUalized<L> | MTRend | MSPectrum | XT<X>}

If <source> is omitted, the eye width will be performed on the first waveform that has color grade enabled.

For more information on <source> parameters, see "[Measurement Sources](#)" on page 890.

**<threshold>** When the signal type is PAM-4 (see :ANALyze:SIGNal:TYPE), the <threshold> parameter is an integer that specifies which eye to measure, and the <algorithm> parameter is ignored. For PAM-4, the <threshold> may be from 0-2. For NRZ (non-return-to-zero) signals, this value should be 0.

**<units>** {SECond | UNITinterval}

Lets you choose the measurement units. If <units> is omitted, the last specified units are used.

If the eye is not a real-time eye, that is, if the eye is constructed by triggering on a data waveform without using clock recovery, trying to specify UNITinterval units will result in an error because the unknown data rate cannot be converted to UI.

**Example** This example measures the eye width.

```
myScope.WriteString ":MEASure:CGRade:EWIDth"
```

**Query** :MEASure:CGRade:EWIDth? <algorithm>[,<source>[,<threshold>[,<units>]]]

The :MEASure:CGRade:EWIDth? query returns the eye width measurement of the color grade display. Before using this command or query, you must use the :DISPlay:CGRade command to enable the color grade persistence feature.

**Returned Format** [:MEASure:CGRade:EWIDth] <value>[,<result\_state>] <NL>

**<value>** The eye width.

**<result\_state>** If SENDVALID is ON, the result state is returned with the measurement result. Refer to the MEASure:RESults command, for a list of the result states.

**Example** This example places the current eye width in the numeric variable, varValue, then prints the contents of the variable to the computer's screen.

```
myScope.WriteString ":SYSTEM:HEADer OFF" ' Response headers off.
myScope.WriteString ":MEASure:CGRade:EWIDth?"
varValue = myScope.ReadNumber
Debug.Print FormatNumber(varValue, 0)
```

**See Also**

- **":MEASure:CGRade:EWIDth:THReshold"** on page 909
- **":ANALyze:SIGNal:TYPE"** on page 312
- **":MEASure:PAM:EYE:PROBability"** on page 1029

**History** Legacy command (existed before version 3.10).

Version 5.00: Added the optional <source> parameter for specifying the waveform on which the color grade eye width is measured.

Version 5.50: When the signal type is PAM-4, an additional <threshold> parameter is used to specify which eye, and the <algorithm> parameter is ignored.

Version 6.60: Added the ability to select units in UNITinterval or SECond (which was the default before).

## :MEASure:CGRade:EWIDth:THReshold

**Command** :MEASure:CGRade:EWIDth:THReshold {AUTomatic | SPECified}[, <source>]

The :MEASure:CGRade:EWIDth:THReshold command specifies the threshold voltage level used in measuring the eye width:

- AUTomatic – Eye widths are measured at the threshold voltage level of the widest eye opening.
- SPECified – Eye widths are measured at the measurement threshold voltage level.

**<source>** {CHANnel<N> | DIFF<D> | COMMONmode<C> | WMEMory<R> | FUNCTion<F> | EQUalized<L> | XT<X>}

For more information on <source> parameters, see "[Measurement Sources](#)" on page 890.

**Query** :MEASure:CGRade:EWIDth:THReshold? [<source>]

The :MEASure:CGRade:EWIDth:THReshold? query returns the eye width threshold voltage option setting.

**Returned Format** [:MEASure:CGRade:EWIDth:THReshold] {AUT | SPEC}<NL>

**See Also** • "[:MEASure:CGRade:EWIDth](#)" on page 907

**History** New in version 6.40.

## :MEASure:CGRade:EWINDow

**Command** :MEASure:CGRade:EWINDow <start>,<stop>[,<start\_after>][,<source>]

The :MEASure:CGRade:EWINDow command is used to change the starting point and the stopping point of the window used to make the eye pattern measurements of eye height, eye crossing %, and eye q-factor. In addition, the number of waveform hits can be set to ensure that enough data has been collected to make accurate measurements.

<start> An integer from 1 to 100 for horizontal starting point. (Default value is 40%.)

<stop> An integer from 1 to 100 for horizontal stopping point. (Default value is 60%.)

<start\_after> An integer from 1 to 63,488 for number of hits to acquire before making measurements. (Default value is 1.)

<source> {CHANnel<N> | DIFF<D> | COMMONmode<C> | WMemory<R> | FUNCTION<F> | CLOCK | EQUalized<L> | MTRend | MSPectrum | XT<X>}

If <source> is omitted, the eye window will be applied to all sources.

For more information on <source> parameters, see "[Measurement Sources](#)" on page 890.

**Example** This example sets the eye window starting point to 2%, the stopping point to 75% and the start after to 5,000 hits.

```
myScope.WriteString ":SYSTEM:HEADer OFF" ' Response headers off.
myScope.WriteString ":MEASure:CGRade:EWINDow 2,75,5000"
```

**Query** :MEASure:CGRade:EWINDow? [<source>]

The :MEASure:CGRade:EWINDow query returns the starting point, the ending point, and the start after setting for the eye pattern measurements.

On the query, the eye window of channel 1 will be returned.

**Returned Format** [:MEASure:CGRade:EWIDdow] <start>,<stop>,<start\_after> <NL>

The following example returns the values for the eye window.

**Example**

```
myScope.WriteString ":SYSTEM:HEADer OFF" ' Response headers off.
myScope.WriteString ":MEASure:CGRade:EWINDow?"
varStart,Stop,Startafter = myScope.ReadNumber
Debug.Print FormatNumber(varStart,Stop,Startafter, 0)
```

**NOTE****Turn Off Headers**

When receiving numeric data into numeric variables, turn off the headers. Otherwise, the headers may cause misinterpretation of returned data.

**History** Legacy command (existed before version 3.10).

Version 5.00: Added the optional <source> parameter for specifying the waveform on which the color grade eye window is applied.

## :MEASure:CGRade:JITTer

**Command** :MEASure:CGRade:JITTer <format> [, <source> [, <units>]]

The :MEASure:CGRade:JITTer measures the jitter at the eye diagram crossing point. The parameter specifies the format, peak-to-peak or RMS, of the returned results. Before using this command or query, you must use the :DISPlay:CGRade command to enable the color grade persistence feature.

<format> {PP | RMS}

<source> {CHANnel<N> | DIFF<D> | COMMONmode<C> | WMEMory<R> | FUNctIon<F> | CLOCK | EQUalized<L> | MTRend | MSPectrum | XT<X>}

If <source> is omitted, the jitter will be performed on the first waveform that has color grade enabled.

For more information on <source> parameters, see "[Measurement Sources](#)" on page 890.

<units> {SECond | UNITinterval}

Lets you choose the measurement units. If <units> is omitted, the last specified units are used.

If the eye is not a real-time eye, that is, if the eye is constructed by triggering on a data waveform without using clock recovery, trying to specify UNITinterval units will result in an error because the unknown data rate cannot be converted to UI.

**Example** This example measures the jitter.

```
myScope.WriteString ":MEASure:CGRade:JITTer RMS"
```

**Query** :MEASure:CGRade:JITTer? <format> [, <source> [, <units>]]

The :MEASure:CGRade:JITTer? query returns the jitter measurement of the color grade display. Before using this command or query, you must use the :DISPlay:CGRade command to enable the color grade persistence feature.

**Returned Format** [:MEASure:CGRade:JITTer] <value> [, <result\_state>] <NL>

<value> The jitter.

<result\_state> If SENDVALID is ON, the result state is returned with the measurement result. Refer to the MEASure:RESults command, for a list of the result states.

**Example** This example places the current jitter in the numeric variable, varValue, then prints the contents of the variable to the computer's screen.

```
myScope.WriteString ":SYSTem:HEADer OFF" ' Response headers off.
myScope.WriteString ":MEASure:CGRade:JITTer? RMS"
varValue = myScope.ReadNumber
Debug.Print FormatNumber(varValue, 0)
```

**History** Legacy command (existed before version 3.10).



Version 5.00: Added the optional <source> parameter for specifying the waveform on which the color grade jitter is measured.

Version 6.60: Added the ability to select units in UNITinterval or SECond (which was the default before).

## :MEASure:CGRade:OLEVel

**Command** :MEASure:CGRade:OLEVel [<source>]

The :MEASure:CGRade:OLEVel command installs an Eye One Level measurement into the user interface's measurement Results pane. Eye one level is a measure of the mean value of the logical 1 of an eye diagram.

Before using this command or query, you must use the :DISPlay:CGRade command to enable the color grade persistence feature. Also, there must be a full eye diagram on screen before a valid measurement can be made.

**<source>** {CHANnel<N> | DIFF<D> | COMMONmode<C> | FUNCTion<F> | WMEMory<R> | CLOck | MTRend | MSPectrum | EQUalized<L> | XT<X>}

If <source> is omitted, the Q-factor will be performed on the first waveform that has color grade enabled.

For more information on <source> parameters, see "[Measurement Sources](#)" on page 890.

**Query** :MEASure:CGRade:OLEVel? [<source>]

The :MEASure:CGRade:OLEVel? query returns the measured Eye One Level.

**Returned Format** [:MEASure:CGRade:OLEVel] <value>[, <result\_state>] <NL>

**<value>** The measured Eye One Level value.

**<result\_state>** If SENDvalid is ON, the result state is returned with the measurement result. See the :MEASure:RESults table in this chapter for a list of the result states.

- See Also**
- "[:MEASure:CGRade:ZLEVel](#)" on page 916
  - "[:MEASure:ERATio](#)" on page 942
  - "[:MEASure:OPOWer](#)" on page 1019
  - "[:MEASure:OMAMplitude](#)" on page 1018

**History** New in version 5.70.

## :MEASure:CGRade:QFACTOR

**Command** :MEASure:CGRade:QFACTOR [<source>]

The :MEASure:CGRade:QFACTOR command measures the Q factor. Before using this command or query, you must use the :DISPlay:CGRade command to enable the color grade persistence feature. Also, there must be a full eye diagram on screen before a valid measurement can be made.

**<source>** {CHANnel<N> | DIFF<D> | COMMONmode<C> | WMEMory<R> | FUNCTion<F> | CLOCk | EQUalized<L> | MTRend | MSPectrum | XT<X>}

If <source> is omitted, the Q-factor will be performed on the first waveform that has color grade enabled.

For more information on <source> parameters, see "[Measurement Sources](#)" on page 890.

**Example** This example measures the Q factor.

```
myScope.WriteString ":MEASure:CGRade:QFACTOR"
```

**Query** :MEASure:CGRade:QFACTOR? [<source>]

The :MEASure:CGRade:QFACTOR? query returns the Q factor measurement of the color grade display. Before using this command or query, you must use the :DISPlay:CGRade command to enable the color grade persistence feature.

**Returned Format** [:MEASure:CGRade:QFACTOR] <value> [, <result\_state>] <NL>

**<value>** The Q factor.

**<result\_state>** If SENDVALID is ON, the result state is returned with the measurement result. Refer to the MEASure:RESults command, for a list of the result states.

**Example** This example places the Q factor in the numeric variable, varValue, then prints the contents of the variable to the computer's screen.

```
myScope.WriteString ":SYSTEM:HEADer OFF" ' Response headers off.
myScope.WriteString ":MEASure:CGRade:QFACTOR"
varValue = myScope.ReadNumber
Debug.Print FormatNumber(varValue, 0)
```

**History** Legacy command (existed before version 3.10).

Version 5.00: Added the optional <source> parameter for specifying the waveform on which the color grade Q factor is measured.

## :MEASure:CGRade:ZLEVel

**Command** :MEASure:CGRade:ZLEVel [<source>]

The :MEASure:CGRade:ZLEVel command installs an Eye Zero Level measurement into the user interface's measurement Results pane. Eye zero level is a measure of the mean value of the logical 0 of an eye diagram.

Before using this command or query, you must use the :DISPlay:CGRade command to enable the color grade persistence feature. Also, there must be a full eye diagram on screen before a valid measurement can be made.

**<source>** {CHANnel<N> | DIFF<D> | COMMONmode<C> | FUNCTION<F> | WMEMory<R> | CLOck | MTRend | MSPectrum | EQUalized<L> | XT<X>}

If <source> is omitted, the Q-factor will be performed on the first waveform that has color grade enabled.

For more information on <source> parameters, see "[Measurement Sources](#)" on page 890.

**Query** :MEASure:CGRade:ZLEVel? [<source>]

The :MEASure:CGRade:ZLEVel? query returns the measured Eye Zero Level.

**Returned Format** [:MEASure:CGRade:ZLEVel] <value>[, <result\_state>] <NL>

**<value>** The measured Eye Zero Level value.

**<result\_state>** If SENDvalid is ON, the result state is returned with the measurement result. See the :MEASure:RESults table in this chapter for a list of the result states.

- See Also**
- "[:MEASure:CGRade:OLEVel](#)" on page 914
  - "[:MEASure:ERATio](#)" on page 942
  - "[:MEASure:OPOWer](#)" on page 1019
  - "[:MEASure:OMAMplitude](#)" on page 1018

**History** New in version 5.70.

## :MEASure:CHARge (9000 Series, 9000H Series, S-Series)

**Command** :MEASure:CHARge [<primary\_channel\_source>]

When N2820A/N2821A high-sensitivity current probes are connected, the :MEASure:CHARge command adds the Charge measurement to the Measurements tab.

This measurement determines the total current consumption over time with the results listed in ampere-hours (Ah).

When both the primary and secondary cables of a N2820A probe are used, the measurement includes the area under the curve across both Zoomed-In and Zoomed-Out waveforms.

<primary\_channel\_source> {CHANnel<N>}

<N> An integer, 1-4, and should be the primary channel of the N2820A/N2821A probe.

**Example** This example turns on the Charge measurement and adds it to the Measurements tab.

```
myScope.WriteString ":MEASure:CHARge CHANnel1"
```

**Query** :MEASure:CHARge?

The :MEASure:CHARge? query returns the measured Charge value in Amp-hours.

**Returned Format** [:MEASure:CHARge] <value> [, <result\_state>] <NL>

**Example** This example places the measured Charge value in the string variable, strCharge, then prints the contents of the variable to the computer's screen.

```
Dim strCharge As String
myScope.WriteString ":MEASure:CHARge?"
strCharge = myScope.ReadString
Debug.Print strCharge
```

**See Also**

- [":MEASure:WINDow"](#) on page 1201
- [":CHANnel<N>:PROBE:PRIMary \(9000 Series, 9000H Series, S-Series\)"](#) on page 404

**History** New in version 4.20.

## :MEASure:CLEar

**Command** :MEASure:{CLEar | SCRatch}

The :MEASure:CLEar command clears the measurement results from the screen and disables all previously enabled measurements.

**Example** This example clears the current measurement results from the screen.

```
myScope.WriteString ":MEASure:CLEar"
```

**History** Legacy command (existed before version 3.10).

## :MEASure:CROSSing

**Command** :MEASure:CROSSing <source1>,<source2>

The :MEASure:CROSSing command adds the crossing measurement to the screen. The crossing measurement is the voltage where two signals cross (uses edges closest to the center of the screen)

<source1>,<source2> {CHANnel<N> | DIFF<D> | COMMONmode<C> | FUNction<F> | WMEMory<R> | XT<X>}

For more information on <source> parameters, see "[Measurement Sources](#)" on page 890.

<hysteresis> a real number

**Example** This example measures the voltage where channel 1 and 2 cross.

```
myScope.WriteString ":MEASure:CROSSing CHANnel1, CHANnel2"
```

**Query** :MEASure:CROSSing? [<source1>,<source2>]

The :MEASure:CROSSing? query returns the crossing measurement value.

If the <source> parameters are not specified, the two sources specified by the :MEASure:SOURce command are used.

**Returned Format** [:MEASure:CROSSing] <value><NL>

<value> The voltage value where the signals cross.

**Example** This example places the crossing voltage value in the numeric variable, varValue, then prints the contents of the variable to the computer's screen.

```
myScope.WriteString ":SYSTEM:HEADer OFF" ' Response headers off.
myScope.WriteString ":MEASure:CROSSing? CHANnel1, CHANnel2"
varValue = myScope.ReadNumber
Debug.Print FormatNumber(varValue, 0)
```

**See Also** · "[:MEASure:SOURce](#)" on page 1116

**History** Legacy command (existed before version 3.10).

## :MEASure:CTCDutycycle

## Command

## NOTE

This command is available only when the Jitter Analysis Software license is installed.

```
:MEASure:CTCDutycycle <source>,<direction>
```

The :MEASure:CYCDutycycle command measures the cycle-to-cycle duty cycle jitter (%) of the waveform. Another name for this measurement is "duty cycle - duty cycle".

<source> {CHANnel<N> | DIFF<D> | COMMONmode<C> | FUNCtion<F> | WMEMory<R> | CLOCK | MTRend | MSPectrum | EQUalized<L> | XT<X>}

For more information on <source> parameters, see "[Measurement Sources](#)" on page 890.

<direction> {RISing | FALLing}

Specifies direction of waveform edge to make measurement.

**Example** This example measures the cycle-to-cycle duty cycle on the rising edge of channel 1.

```
myScope.WriteString ":MEASure:CTCDutycycle CHANnel1,RISing"
```

**Query** :MEASure:CTCDutycycle? <source>,<direction>

The :MEASure:CTCDutycycle? query returns the cycle-to-cycle duty cycle jitter (%) measurement.

## NOTE

This measurement requires the **Measure All Edges** setting to be enabled. You can do this by:

- Installing the measurement on the display (using the command syntax), which automatically enables the **Measure All Edges** setting
- Sending the ":ANALyze:AEDGes ON" command.

**Returned Format** [:MEASure:CTCDutycycle <value>[,<result\_state>]<NL>

<value> The cycle-to-cycle duty cycle jitter (%) of the waveform.

<result\_state> If SENDVALID is ON, the result state is returned with the measurement result. Refer to the MEASure:RESults command, for a list of the result states.

**Example** This example places the cycle-to-cycle duty cycle of channel 1 in the numeric variable, varValue, then prints the contents of the variable to the computer's screen.

```
myScope.WriteString ":SYSTem:HEADer OFF" ' Response headers off.
myScope.WriteString ":MEASure:CTCDutycycle CHANnel1,RISing"
```



```
varValue = myScope.ReadNumber  
Debug.Print FormatNumber(varValue, 0)
```

- See Also**
- [":ANALyze:AEDGes"](#) on page 273
  - [":MEASure:TIEClock2"](#) on page 1165
  - [":MEASure:CTCJitter"](#) on page 922
  - [":MEASure:NCJitter"](#) on page 999
  - [":MEASure:CTCPwidth"](#) on page 926
  - [":MEASure:CTCNwidth"](#) on page 924

**History** Legacy command (existed before version 3.10).

## :MEASure:CTCJitter

## Command

## NOTE

This command is available only when the Jitter Analysis Software license is installed.

```
:MEASure:CTCJitter <source>,<direction>
```

The :MEASure:CTCJitter command measures the cycle-to-cycle jitter of the waveform. Another name for this measurement is "period-period", where the number of cycles is one.

<source> {CHANnel<N> | DIFF<D> | COMMONmode<C> | FUNCtion<F> | WMEMory<R> | CLOCK | MTRend | MSPectrum | EQUalized<L> | XT<X>}

For more information on <source> parameters, see "[Measurement Sources](#)" on page 890.

<direction> {RISing | FALLing}

Specifies direction of waveform edge to make measurement.

**Example** This example measures the cycle-to-cycle jitter on the rising edge of channel 1.

```
myScope.WriteString ":MEASure:CTCJitter CHANnel1,RISing"
```

**Query** :MEASure:CTCJitter? <source>,<direction>

The :MEASure:CTCJitter? query returns the cycle-to-cycle jitter time measurement.

## NOTE

This measurement requires the **Measure All Edges** setting to be enabled. You can do this by:

- Installing the measurement on the display (using the command syntax), which automatically enables the **Measure All Edges** setting
- Sending the ":ANALyze:AEDGes ON" command.

**Returned Format** [:MEASure:CTCJitter <value>[,<result\_state>]<NL>

<value> The cycle-to-cycle jitter time of the waveform.

<result\_state> If SENDVALID is ON, the result state is returned with the measurement result. Refer to the MEASure:RESults command, for a list of the result states.

**Example** This example places the cycle-to-cycle jitter of channel 1 in the numeric variable, varValue, then prints the contents of the variable to the computer's screen.

```
myScope.WriteString ":SYSTEM:HEADer OFF" ' Response headers off.
myScope.WriteString ":MEASure:CTCJitter CHANnel1,RISing"
varValue = myScope.ReadNumber
Debug.Print FormatNumber(varValue, 0)
```

- See Also**
- [":ANALyze:AEDGes"](#) on page 273
  - [":MEASure:TIEClock2"](#) on page 1165
  - [":MEASure:NCJitter"](#) on page 999
  - [":MEASure:CTCPwidth"](#) on page 926
  - [":MEASure:CTCNwidth"](#) on page 924
  - [":MEASure:CTCDutycycle"](#) on page 920

**History** Legacy command (existed before version 3.10).

## :MEASure:CTCNwidth

## Command

## NOTE

This command is available only when the Jitter Analysis Software license is installed.

```
:MEASure:CTCNwidth [<source>]
```

The :MEASure:CTCNwidth command measures the cycle-to-cycle -width jitter of the waveform. Another name for this measurement is "-width - -width".

```
<source> {CHANnel<N> | DIFF<D> | COMMONmode<C> | FUNCTION<F> | WMEMory<R> |
CLOCK | MTRend | MSPectrum | EQUALized<L> | XT<X>}
```

For more information on <source> parameters, see "[Measurement Sources](#)" on page 890.

**Example** This example measures the cycle-to-cycle -width of channel 1.

```
myScope.WriteString ":MEASure:CTCNwidth CHANnel1"
```

**Query** :MEASure:CTCNwidth? [<source>]

The :MEASure:CTCNwidth? query returns the cycle-to-cycle -width jitter measurement.

## NOTE

This measurement requires the **Measure All Edges** setting to be enabled. You can do this by:

- Installing the measurement on the display (using the command syntax), which automatically enables the **Measure All Edges** setting
- Sending the ":ANALyze:AEDGes ON" command.

**Returned Format** [:MEASure:CTCNwidth <value>[,<result\_state>]<NL>

<value> The cycle-to-cycle - width jitter of the waveform.

<result\_state> If SENDVALID is ON, the result state is returned with the measurement result. Refer to the MEASure:RESuLts command, for a list of the result states.

**Example** This example places the cycle-to-cycle - width of channel 1 in the numeric variable, varValue, then prints the contents of the variable to the computer's screen.

```
myScope.WriteString ":SYSTem:HEADer OFF" ' Response headers off.
myScope.WriteString ":MEASure:CTCNwidth CHANnel1"
varValue = myScope.ReadNumber
Debug.Print FormatNumber(varValue, 0)
```

- See Also**
- "[:ANALyze:AEDGes](#)" on page 273
  - "[:MEASure:TIEClock2](#)" on page 1165
  - "[:MEASure:CTCJitter](#)" on page 922

- **":MEASure:NCJitter"** on page 999
- **":MEASure:CTCPwidth"** on page 926
- **":MEASure:CTCDutycycle"** on page 920

**History** Legacy command (existed before version 3.10).

## :MEASure:CTCPwidth

## Command

## NOTE

This command is available only when the Jitter Analysis Software license is installed.

```
:MEASure:CTCPwidth [<source>]
```

The :MEASure:CTCPwidth command measures the cycle-to-cycle +width jitter of the waveform. Another name for this measurement is "+width - +width".

```
<source> {CHANnel<N> | DIFF<D> | COMMONmode<C> | FUNCTION<F> | WMEMory<R> |
CLOCK | MTRend | MSPectrum | EQUALized<L> | XT<X>}
```

For more information on <source> parameters, see "[Measurement Sources](#)" on page 890.

**Example** This example measures the cycle-to-cycle +width of channel 1.

```
myScope.WriteString ":MEASure:CTCPwidth CHANnel1"
```

**Query** :MEASure:CTCPwidth? [<source>]

The :MEASure:CTCPwidth? query returns the cycle-to-cycle +width jitter measurement.

## NOTE

This measurement requires the **Measure All Edges** setting to be enabled. You can do this by:

- Installing the measurement on the display (using the command syntax), which automatically enables the **Measure All Edges** setting
- Sending the ":ANALyze:AEDGes ON" command.

**Returned Format** [:MEASure:CTCPwidth <value>[,<result\_state>]<NL>

<value> The cycle-to-cycle +width jitter of the waveform.

<result\_state> If SENDVALID is ON, the result state is returned with the measurement result. Refer to the MEASure:RESuLts command, for a list of the result states.

**Example** This example places the cycle-to-cycle + width of channel 1 in the numeric variable, varValue, then prints the contents of the variable to the computer's screen.

```
myScope.WriteString ":SYSTem:HEADer OFF" ' Response headers off.
myScope.WriteString ":MEASure:CTCPwidth CHANnel1"
varValue = myScope.ReadNumber
Debug.Print FormatNumber(varValue, 0)
```

- See Also**
- "[:ANALyze:AEDGes](#)" on page 273
  - "[:MEASure:TIEClock2](#)" on page 1165
  - "[:MEASure:CTCJitter](#)" on page 922

- **":MEASure:NCJitter"** on page 999
- **":MEASure:CTCNwidth"** on page 924
- **":MEASure:CTCDutycycle"** on page 920

**History** Legacy command (existed before version 3.10).

## :MEASure:DATarate

## Command

## NOTE

This command is available only when the Jitter Analysis Software license is installed.

```
:MEASure:DATarate <source>[, {AUTO | (SEMI, <data_rate>)}]
```

The :MEASure:DATarate command measures the data rate in bits per second for the selected source. Use the :MEASure:UNITinterval command/query to measure the unit interval of the source

<source> {CHANnel<N> | DIFF<D> | COMMONmode<C> | FUNCtion<F> | WMEMory<R> | CLOCK | MTRend | MSPectrum | EQUalized<L> | XT<X>}

For more information on <source> parameters, see "[Measurement Sources](#)" on page 890.

<data\_rate> A real number specifying the data rate.

**Example** This example measures the data rate of channel 1.

```
myScope.WriteString ":MEASure:DATarate CHANnel1"
```

**Query** :MEASure:DATarate? <source>[, {Auto | (SEMI, <data\_rate>)}]

The :MEASure:DATarate? query returns the measured data rate.

## NOTE

This measurement requires the **Measure All Edges** setting to be enabled. You can do this by:

- Installing the measurement on the display (using the command syntax), which automatically enables the **Measure All Edges** setting
- Sending the ":ANALyze:AEDGes ON" command.

**Returned Format** [:MEASure:DATarate] <value>[, <result\_state>] <NL>

<value> Data rate frequency in bits per second for the selected source.

<result\_state> If SENDvalid is ON, the result state is returned with the measurement result. See the :MEASure:RESults table in this chapter for a list of the result states.

**Example** This example places the current data rate of the channel 1 waveform in the numeric variable, varValue, then prints the contents of the variable to the computer's screen.

```
myScope.WriteString ":SYSTem:HEADer OFF" ' Response headers off.
myScope.WriteString ":MEASure:DATarate? CHANnel1"
varValue = myScope.ReadNumber
Debug.Print FormatNumber(varValue, 0)
```

**See Also** • "[:ANALyze:AEDGes](#)" on page 273



**History** Legacy command (existed before version 3.10).

## :MEASure:DCAI

**Command** :MEASure:DCAI [<source>]

The :MEASure:DCAI command installs a duty cycle adjustment measurement for the I phase of a DDR5 DQS (strobe) signal. The I phase is the first rising edge to first falling edge.

Duty cycle adjustment measurements are edge-edge measurements that have been modified so that each measurement instance runs on the appropriate UI only.

The duty cycle adjustment measurements are designed to be run on a single acquisition in Measure All Edges mode so that statistics are accumulated across all on-screen UIs.

<source> {CHANnel<N> | DIFF<D> | COMMONmode<C> | FUNCTion<F> | WMEMory<R> | CLOCK | EQUalized<L> | XT<X>}

For more information on <source> parameters, see "[Measurement Sources](#)" on page 890.

**Query** :MEASure:DCAI? [<source>]

The :MEASure:DCAI? query returns the measured duty cycle adjustment value for the I phase of a DDR5 DQS (strobe) signal.

**Returned Format** [:MEASure:DCAI] <value> [, <result\_state>] <NL>

<value> The duty cycle adjustment for I value in NR3 format.

<result\_state> If :MEASure:SENDvalid is ON, the result state is returned with the measurement result. See the :MEASure:RESults table in this chapter for a list of the result states.

- See Also**
- "[:MEASure:DCAQ](#)" on page 931
  - "[:MEASure:DCIPrime](#)" on page 932
  - "[:MEASure:DCQPrime](#)" on page 933

**History** New in version 6.71.

## :MEASure:DCAQ

**Command** :MEASure:DCAQ [<source>]

The :MEASure:DCAQ command installs a duty cycle adjustment measurement for the Q phase of a DDR5 DQS (strobe) signal. The Q phase is the first falling edge to second rising edge.

Duty cycle adjustment measurements are edge-edge measurements that have been modified so that each measurement instance runs on the appropriate UI only.

The duty cycle adjustment measurements are designed to be run on a single acquisition in Measure All Edges mode so that statistics are accumulated across all on-screen UIs.

<source> {CHANnel<N> | DIFF<D> | COMMONmode<C> | FUNction<F> | WMEMory<R> | CLOCK | EQUalized<L> | XT<X>}

For more information on <source> parameters, see "[Measurement Sources](#)" on page 890.

**Query** :MEASure:DCAQ? [<source>]

The :MEASure:DCAQ? query returns the measured duty cycle adjustment value for the Q phase of a DDR5 DQS (strobe) signal.

**Returned Format** [:MEASure:DCAQ] <value> [, <result\_state>] <NL>

<value> The duty cycle adjustment for Q value in NR3 format.

<result\_state> If :MEASure:SENDvalid is ON, the result state is returned with the measurement result. See the :MEASure:RESults table in this chapter for a list of the result states.

- See Also**
- "[:MEASure:DCAI](#)" on page 930
  - "[:MEASure:DCIPrime](#)" on page 932
  - "[:MEASure:DCQPrime](#)" on page 933

**History** New in version 6.71.

## :MEASure:DCIPrime

**Command** :MEASure:DCIPrime [<source>]

The :MEASure:DCIPrime command installs a duty cycle adjustment measurement for the I' (I prime) phase of a DDR5 DQS (strobe) signal. The I' phase is the second rising edge to second falling edge.

Duty cycle adjustment measurements are edge-edge measurements that have been modified so that each measurement instance runs on the appropriate UI only.

The duty cycle adjustment measurements are designed to be run on a single acquisition in Measure All Edges mode so that statistics are accumulated across all on-screen UIs.

**<source>** {CHANnel<N> | DIFF<D> | COMMONmode<C> | FUNctIon<F> | WMEMory<R> | CLOCK | EQUalized<L> | XT<X>}

For more information on <source> parameters, see "[Measurement Sources](#)" on page 890.

**Query** :MEASure:DCIPrime? [<source>]

The :MEASure:DCIPrime? query returns the measured duty cycle adjustment value for the I' (I prime) phase of a DDR5 DQS (strobe) signal.

**Returned Format** [:MEASure:DCIPrime] <value>[, <result\_state>] <NL>

**<value>** The duty cycle adjustment for I' value in NR3 format.

**<result\_state>** If :MEASure:SENDvalid is ON, the result state is returned with the measurement result. See the :MEASure:RESults table in this chapter for a list of the result states.

- See Also**
- "[:MEASure:DCAI](#)" on page 930
  - "[:MEASure:DCAQ](#)" on page 931
  - "[:MEASure:DCQPrime](#)" on page 933

**History** New in version 6.71.

## :MEASure:DCQPrime

**Command** :MEASure:DCQPrime [<source>]

The :MEASure:DCQPrime command installs a duty cycle adjustment measurement for the Q' (Q prime) phase of a DDR5 DQS (strobe) signal. The Q' phase is the second falling edge to the next rising edge. After the Q' phase, the next set of I, Q, I', and Q' phases begin.

Duty cycle adjustment measurements are edge-edge measurements that have been modified so that each measurement instance runs on the appropriate UI only.

The duty cycle adjustment measurements are designed to be run on a single acquisition in Measure All Edges mode so that statistics are accumulated across all on-screen UIs.

<source> {CHANnel<N> | DIFF<D> | COMMONmode<C> | FUNCTION<F> | WMEMory<R> | CLOCK | EQUalized<L> | XT<X>}

For more information on <source> parameters, see "**Measurement Sources**" on page 890.

**Query** :MEASure:DCQPrime? [<source>]

The :MEASure:DCQPrime? query returns the measured duty cycle adjustment value for the Q' (Q prime) phase of a DDR5 DQS (strobe) signal.

**Returned Format** [:MEASure:DCQPrime] <value>[, <result\_state>] <NL>

<value> The duty cycle adjustment for Q' value in NR3 format.

<result\_state> If :MEASure:SENDvalid is ON, the result state is returned with the measurement result. See the :MEASure:RESults table in this chapter for a list of the result states.

- See Also**
- "**:MEASure:DCAI**" on page 930
  - "**:MEASure:DCAQ**" on page 931
  - "**:MEASure:DCIPrime**" on page 932

**History** New in version 6.71.

## :MEASure:DEEMphasis

**Command** :MEASure:DEEMphasis [<source>]

When the Jitter and Vertical Noise Analysis Software is licensed, the Deemphasis serial data measurement becomes available.

The :MEASure:DEEMphasis command adds the deemphasis measurement.

The de-emphasis measurement relies on the clock recovery to recover a clock for each bit in the data waveform. You need to configure clock recovery appropriately for your signal.

Sources are specified with the :MEASure:SOURce command or with the optional parameter following the :MEASure:DEEMphasis command.

<source> {CHANnel<N> | DIFF<D> | COMMONmode<C> | FUNCTION<F> | WMEMory<R> | CLOCK | MTRend | MSPectrum | EQUalized<L> | XT<X>}

For more information on <source> parameters, see "[Measurement Sources](#)" on page 890.

**Example** This example adds the deemphasis measurement on the channel 1 source.

```
myScope.WriteString ":MEASure:DEEMphasis CHANnel1"
```

**Query** :MEASure:DEEMphasis? [<source>]

The :MEASure:DEEMphasis? query returns the measured deemphasis value of the specified source.

Due to random noise, many bits need to be averaged together to average out the noise. Therefore, the current value has little importance and the mean should be used. See "[:MEASure:STATistics](#)" on page 1117.

**NOTE**

This measurement requires the **Measure All Edges** setting to be enabled. You can do this by:

- Installing the measurement on the display (using the command syntax), which automatically enables the **Measure All Edges** setting
- Sending the ":ANALyze:AEDGes ON" command.

**Returned Format** [:MEASure:DEEMphasis] <value> [, <result\_state>] <NL>

<value> For every de-emphasis bit in the waveform, a value is computed using:

$$20 * \log_{10}(\text{de-emphasis voltage} / \text{transition voltage})$$

Where:

- Transition voltage is the voltage at the clock location of the preceding transition bit.
- De-emphasis voltage is the voltage at the clock location of de-emphasis bits following a transition bit.

<result\_state> If SENDvalid is ON, the result state is returned with the measurement result. See the :MEASure:RESults table in this chapter for a list of the result states.

**Example** This example places the current value for deemphasis in the numeric variable, varValue, then prints the contents of the variable to the computer's screen.

```
myScope.WriteString ":SYSTem:HEADer OFF" ' Response headers off.  
myScope.WriteString ":MEASure:DEEMphasis? CHANnel1"  
varValue = myScope.ReadNumber  
Debug.Print FormatNumber(varValue, 0)
```

**See Also** • [":ANALyze:AEDGes"](#) on page 273

**History** Legacy command (existed before version 3.10).

## :MEASure:DELTatime

**Command** :MEASure:DELTatime [<source>[,<source>]]

The :MEASure:DELTatime command measures the delta time between two edges. If one source is specified, the delta time from the leading edge of the specified source to the trailing edge of the specified source is measured. If two sources are specified, the delta time from the leading edge on the first source to the trailing edge on the second source is measured.

Sources are specified with the :MEASure:SOURce command or with the optional parameter following the :MEASure:DELTatime command. The rest of the parameters for this command are specified with the :MEASure:DEFine command.

The necessary waveform edges must be present on the display. The query will return 9.99999E+37 if the necessary edges are not displayed.

**<source>** {CHANnel<N> | DIFF<D> | COMMONmode<C> | FUNCTion<F> | DIGital<M> | WMEMory<R> | CLOCK | MTRend | MSPectrum | EQUalized<L> | XT<X>}

For more information on <source> parameters, see "[Measurement Sources](#)" on page 890.

**Example** This example measures the delta time between channel 1 and channel 2.

```
myScope.WriteString ":MEASure:DELTatime CHANnel1,CHANnel2"
```

**Query** :MEASure:DELTatime? [<source>[,<source>]]

The :MEASure:DELTatime? query returns the measured delta time value.

**Returned Format** [:MEASure:DELTatime] <value>[,<result\_state>]<NL>

**<value>** Delta time from the first specified edge on one source to the next specified edge on another source.

**<result\_state>** If SENDvalid is ON, the result state is returned with the measurement result. See the :MEASure:RESults table in this chapter for a list of the result states.

**Example** This example places the current value of delta time in the numeric variable, varValue, then prints the contents of the variable to the computer's screen. This example assumes the source was set using :MEASure:SOURce.

```
myScope.WriteString ":SYSTEM:HEADer OFF" ' Response headers off.
myScope.WriteString ":MEASure:DELTatime?"
varValue = myScope.ReadNumber
Debug.Print FormatNumber(varValue, 0)
```

**NOTE****Turn Off Headers**

When receiving numeric data into numeric variables, turn off the headers. Otherwise, the headers may cause misinterpretation of returned data.



**History** Legacy command (existed before version 3.10).

## :MEASure:DELTatime:DEFine

**Command** :MEASure:DELTatime:DEFine <start\_edge\_direction>,<start\_edge\_number>,<start\_edge\_position>,<stop\_edge\_direction>,<stop\_edge\_number>,<stop\_edge\_position>

The :MEASure:DELTatime:DEFine command sets the type of direction, the number of the edge, and the edge position for the delta time measurement.

<start\_edge\_direction> {RISing | FALLing | EITHer} for start directions.

<start\_edge\_number> An integer from 1 to 65534 for start edge numbers.

<start\_edge\_position> {UPPer | MIDDle | LOWer} for start edge positions.

<stop\_edge\_direction> {RISing | FALLing | EITHer} for stop directions.

<stop\_edge\_number> An integer from 1 to 65534 for stop edge numbers.

<stop\_edge\_position> {UPPer | MIDDle | LOWer} for stop edge positions.

**Example** This example sets the delta time starting edge to a rising edge on the 5th edge at the middle position and the stopping edge to falling on the 50th edge at the lower position.

```
myScope.WriteString ":SYSTEM:HEADer OFF" ' Response headers off.
myScope.WriteString _
    ":MEASure:DELTatime:DEFine RISing,5,MIDDle,FALLing,50,LOWer"
```

**Query** :MEASure:DELTatime:DEFine?

The :MEASure:DELTatime:DEFine? query returns the measured delta time value.

**Returned Format** [:MEASure:DELTatime:DEFine] <start\_edge\_direction>,<start\_edge\_number>,<start\_edge\_position>,<stop\_edge\_direction>,<stop\_edge\_number>,<stop\_edge\_position><NL>

**Example** This example places the current value of delta time definition in the string variable, strValue, then prints the contents of the variable to the computer's screen. This example assumes the source was set using :MEASure:SOURce.

```
Dim strValue As String ' Dimension variable.
myScope.WriteString ":SYSTEM:HEADer OFF" ' Response headers off.
myScope.WriteString ":MEASure:DELTatime:DEFine?"
strValue = myScope.ReadString
Debug.Print strValue
```

**NOTE****Turn Off Headers**

When receiving numeric data into numeric variables, turn off the headers. Otherwise, the headers may cause misinterpretation of returned data.

---

**History** Legacy command (existed before version 3.10).

## :MEASure:DUTYcycle

**Command** :MEASure:DUTYcycle [<source>[,<direction>]]

The :MEASure:DUTYcycle command measures the ratio (%) of the positive pulse width to the period.

Sources are specified with the :MEASure:SOURce command or with the optional <source> parameter following the :MEASure:DUTYcycle command.

**<source>** {CHANnel<N> | DIFF<D> | COMMONmode<C> | FUNCTION<F> | DIGital<M> | WMemory<R> | CLOCK | MTRend | MSPectrum | EQUalized<L> | XT<X>}

For more information on <source> parameters, see "**Measurement Sources**" on page 890.

**<direction>** {RISing | FALLing}

Specifies whether the duty cycle is measured from rising edge to rising edge or from falling edge to falling edge. When <direction> is specified, the <source> parameter is required.

When the "Measure All Edges" mode is OFF (see "**:ANALyze:AEDGes**" on page 273), the RISing and FALLing options specify whether the first rising or falling edge from the left side of the display grid is used.

When the "Measure All Edges" mode is ON, the RISing and FALLing options specify whether the duty cycle is measured from rising edge to rising edge or from falling edge to falling edge throughout the acquisition.

**Example** This example measures the duty cycle of the channel 1 waveform.

```
myScope.WriteString ":MEASure:DUTYcycle CHANnel1"
```

**Query** :MEASure:DUTYcycle? [<source>],<direction>

The :MEASure:DUTYcycle? query returns the measured duty cycle (%) of the specified source.

**Returned Format** [:MEASure:DUTYcycle] <value>[,<result\_state>]<NL>

**<value>** The ratio (%) of the positive pulse width to the period.

**<result\_state>** If :MEASure:SENDvalid is ON, the result state is returned with the measurement result. See the :MEASure:RESults table in this chapter for a list of the result states.

**Example** This example places the current duty cycle of the channel 1 waveform in the numeric variable, varValue, then prints the contents of the variable to the computer's screen.

```
myScope.WriteString ":SYSTem:HEADer OFF" ' Response headers off.
myScope.WriteString ":MEASure:DUTYcycle? CHANnel1"
varValue = myScope.ReadNumber
Debug.Print FormatNumber(varValue, 0)
```

**History** Legacy command (existed before version 3.10).

## :MEASure:EDGE

**Command** :MEASure:EDGE [<source>[,<direction>]]

The :MEASure:EDGE command measures the time of edges, relative to the timebase reference location.

Sources are specified with the :MEASure:SOURce command or with the optional <source> parameter.

**<source>** {CHANnel<N> | DIFF<D> | COMMONmode<C> | FUNCTION<F> | DIGital<M> | WMemory<R> | CLOCK | MTRend | MSPectrum | EQUalized<L> | XT<X>}

For more information on <source> parameters, see "[Measurement Sources](#)" on page 890.

**<direction>** {RISing | FALLing | BOTH}

Specifies the edge whose time is measured. When <direction> is specified, the <source> parameter is required.

When the "Measure All Edges" mode is OFF (see "[:ANALyze:AEDGes](#)" on page 273), BOTH means whichever edge is nearest to the timebase reference location is used.

When the "Measure All Edges" mode is ON, BOTH specifies that both rising and falling edge times are measured throughout the acquisition.

**Example** This example measures the edge times of the channel 1 waveform.

```
myScope.WriteString ":MEASure:EDGE CHANnel1"
```

**Query** :MEASure:EDGE? [<source>[,<direction>]]

The :MEASure:EDGE? query returns the measured edge time of the specified source.

**Returned Format** [:MEASure:DUTYcycle] <value>[,<result\_state>]<NL>

**<value>** The measured edge time.

**<result\_state>** If SENDvalid is ON, the result state is returned with the measurement result. See the :MEASure:RESuLts table in this chapter for a list of the result states.

**Example** This example places the current duty cycle of the channel 1 waveform in the numeric variable, varValue, then prints the contents of the variable to the computer's screen.

```
myScope.WriteString ":SYSTem:HEADer OFF" ' Response headers off.
myScope.WriteString ":MEASure:EDGE? CHANnel1"
varValue = myScope.ReadNumber
Debug.Print FormatNumber(varValue, 0)
```

**History** New in version 3.10.

## :MEASure:ERATio

**Command** :MEASure:ERATio [<source>[, {RATio | DB | PERCent}]]

The :MEASure:ERATio command measures the ratio of the one level and the zero level of an eye diagram of an optical signal.

**<source>** {CHANnel<N> | DIFF<D> | COMMONmode<C> | FUNCTION<F> | WMEMory<R> | CLOCK | MTRend | MSPectrum | EQUalized<L> | XT<X>}

For more information on <source> parameters, see "**Measurement Sources**" on page 890.

**{RATio | DB | PERCent}** Specifies the extinction-ratio correction factor units in Ratio, Decibel, or percentage.

**Query** :MEASure:ERATio? [<source>[, {RATio | DB | PERCent}]]

The :MEASure:ERATio? query returns the measured Extinction Ratio.

**Returned Format** [:MEASure:ERATio] <value>[, <result\_state>] <NL>

**<value>** The measured Extinction Ratio value.

### NOTE

The Extinction Ratio measurement will give a question mark ("?) result if:

- The dark calibration has not been performed at all.
- The vertical sensitivity, offset, or sample rate has changed since the dark calibration was run.
- The probe temperature has changed by > 2 degrees C.

**<result\_state>** If SENDvalid is ON, the result state is returned with the measurement result. See the :MEASure:RESults table in this chapter for a list of the result states.

- See Also**
- "**:MEASure:OMAMplitude**" on page 1018
  - "**:MEASure:OPOWER**" on page 1019
  - "**:MEASure:CGRade:OLEVel**" on page 914
  - "**:MEASure:CGRade:ZLEVel**" on page 916

**History** New in version 5.70.

## :MEASure:ETAEdges

**Command** :MEASure:ETAEdges <source>[, <n-pulses>[, <direction>]]

The :MEASure:ETAEdges command measures the time between edges (RISing, FALLing, or BOTH) within a certain number of pulses (N) across all groups of N pulses in the acquired waveform. At the end of the waveform, the time between edges in the smaller-than-N remaining pulse groups are also measured.

Sources are specified with the :MEASure:SOURce command or with the optional <source> parameter.

<source> {CHANnel<N> | DIFF<D> | COMMONmode<C> | FUNction<F> | DIGital<M> | WMEMory<R> | CLOCK | MTRend | MSPectrum | EQUalized<L> | XT<X>}

For more information on <source> parameters, see "[Measurement Sources](#)" on page 890.

<n-pulses> An integer from 1 to 1000 in NR1 format.

<direction> {RISing | FALLing | BOTH}

**Query** :MEASure:ETAEdges? <source>[, <n-pulses>[, <direction>]]

The :MEASure:ETAEdges? query returns a value of 0.0 seconds.

**NOTE**

The Edge to All Edges measurement is useful when a histogram is applied.

**Returned Format** [:MEASure:ETAEdges] <value>[, <result\_state>]<NL>

<value> A value of 0.0 seconds is returned.

<result\_state> If SENDvalid is ON, the result state is returned with the measurement result. See the :MEASure:RESults table in this chapter for a list of the result states.

**See Also** · "[:HISTogram:MODE](#)" on page 658

**History** New in version 6.50.

## :MEASure:ETOEge

**Command** :MEASure:ETOEge <source\_1>,<direction\_1>,<position\_1>,<next\_prev>,<relative\_edge\_number>,<source\_2>,<direction\_2>,<position\_2>

The :MEASure:ETOEge command measures the delta time between two edges. It is similar to the delta time measurement, but can be applied to the measurement trend. It also enables you to set whether the measurement is between an edge before or after a specific edge and the number of edges to move forward or backwards.

The necessary waveform edges must be present on the display. The query will return 9.99999E+37 if the necessary edges are not displayed.

The Edge-Edge measurement requires all edges. When you add it, the "Measure All Edges" mode (see **":ANALyze:AEDGes"** on page 273) is automatically set to ON. When the "Measure All Edges" mode is set to OFF, this measurement cannot be made, and there are no measurement results.

When this measurement is tracked with markers, markers are displayed at the measurement nearest to the timebase reference location.

<source\_1>,<source\_2> {CHANnel<N> | DIFF<D> | COMMONmode<C> | FUNCTION<F> | WMEMory<R> | CLOCK | MTRend | MSPectrum | EQUalized<L> | XT<X>}

For more information on <source> parameters, see **"Measurement Sources"** on page 890.

<direction\_1>,<direction\_2> May be RISing, FALLing, or BOTH

<position\_1>,<position\_2> May be UPPer, MIDDle, or LOWer

<next\_prev> May be NEXT or PREVIOUS

<relative\_edge\_number> An integer that is the relative number of the second edge.

**Query** :MEASure:ETOEge? <source\_1>,<direction\_1>,<position\_1>,<next\_prev>,<relative\_edge\_number>,<source\_2>,<direction\_2>,<position\_2>

The :MEASure:ETOEge? query returns the delta time between the two specified edges.

**Returned Format** [:MEASure:ETOEge] <value>[,<result\_state>]<NL>

<value> The measured delta time between two edges value.

<result\_state> If SENDvalid is ON, the result state is returned with the measurement result. See the :MEASure:RESults table in this chapter for a list of the result states.

**Example** This example places the current value for delta time in the numeric variable, varValue, then prints the contents of the variable to the computer's screen.



```
myScope.WriteString ":SYSTem:HEADer OFF" ' Response headers off.  
myScope.WriteString ":MEASure:ETOEdege? CHAN1,RIS,UPP,NEXT,2,CHAN2,RIS,UP  
P"  
varValue = myScope.ReadNumber  
Debug.Print FormatNumber(varValue, 0)
```

**History** Legacy command (existed before version 3.10).

## :MEASure:FALLtime

**Command** :MEASure:FALLtime [<source>[,<start\_level>,<stop\_level>]]

The :MEASure:FALLtime command measures the time at the upper threshold of the falling edge, measures the time at the lower threshold of the falling edge, then calculates the fall time.

Fall time = time at lower threshold point - time at upper threshold point.

The first displayed falling edge is used for the fall-time measurement.

Sources are specified with the :MEASure:SOURce command or with the optional parameter following the :MEASure:FALLtime command.

Four or more sample points on the falling edge of the waveform are required to make this measurement (one above the upper threshold, one below the lower threshold, and two between the thresholds).

**<source>** {CHANnel<N> | DIFF<D> | COMMONmode<C> | FUNCTION<F> | WMEMory<R> | CLOCK | MTRend | MSPectrum | EQUalized<L> | XT<X>}

For more information on <source> parameters, see "[Measurement Sources](#)" on page 890.

**<start\_level>**,  
**<stop\_level>** When the signal type is PAM-4 (see :ANALyze:SIGNal:TYPE), the <start\_level> and <stop\_level> parameters are integers that identify the edge to measure. For PAM-4, the levels may be from 0-3.

For PAM fall time measurements, "Measure All Edges" must be turned on (see :ANALyze:AEDGes).

**Example** This example measures the fall time of the channel 1 waveform.

```
myScope.WriteString ":MEASure:FALLtime CHANnel1"
```

**Query** :MEASure:FALLtime? [<source>[,<start\_level>,<stop\_level>]]

The :MEASure:FALLtime? query returns the fall time of the specified source.

**Returned Format** [:MEASure:FALLtime] <value>[,<result\_state>]<NL>

**<value>** Time at lower threshold - time at upper threshold.

A value of 9.99999E+37 means that the oscilloscope was unable to make the measurement. Check the <result\_state>. If the required four or more sample points are not present on the falling edge of the waveform, you can use a faster sampling rate or more interpolation points.

**<result\_state>** If :MEASure:SENDvalid is ON, the result state is returned with the measurement result. See [Table 14](#) for a list of values and descriptions of the result state value.

**Example** This example places the current value for fall time in the numeric variable, varValue, then prints the contents of the variable to the computer's screen.

```
myScope.WriteString ":SYSTem:HEADer OFF" ' Response headers off.  
myScope.WriteString ":MEASure:FALLtime? CHANnel1"  
varValue = myScope.ReadNumber  
Debug.Print FormatNumber(varValue, 0)
```

- See Also**
- [":ANALyze:SIGNal:TYPE"](#) on page 312
  - [":ANALyze:AEDGes"](#) on page 273

**History** Legacy command (existed before version 3.10).

Version 5.50: With PAM signal types, additional <start\_level> and <stop\_level> parameters are used to identify the edge to measure.

## :MEASure:FFT:CPOWer

**Command** :MEASure:FFT:CPOWer <source>,<center\_freq>,<meas\_bw>

The :MEASure:FFT:CPOWer command installs a channel power measurement into the user interface's measurement Results pane.

The source must be a function that is set to FFT, or a waveform memory that contains an FFT for this command and query to work.

<source> {FUNction<F> | WMEMory<R> | MSPectrum}

For more information on <source> parameters, see "[Measurement Sources](#)" on page 890.

<center\_freq> The center frequency used in the measurement in NR3 format.

<meas\_bw> The width of FFT band in NR3 format.

**Query** :MEASure:FFT:CPOWer? <source>,<center\_freq>,<meas\_bw>

The :MEASure:FFT:CPOWer? query returns the measured channel power.

**Returned Format** [:MEASure:FFT:CPOWer] <channel\_power\_value><NL>  
<channel\_power\_value> ::= in dBm in NR3 format.

**See Also**

- "[:MEASure:FFT:OBW](#)" on page 957
- "[:MEASure:FFT:PSD](#)" on page 958

**History** New in version 5.70.

## :MEASure:FFT:DFRequency

**Command** :MEASure:FFT:DFRequency <source>, <peak1\_number>, <peak2\_number>, <level>

The :MEASure:FFT:DFRequency command installs a measurement of the frequency difference between two FFT peaks. Peaks are numbered from low-to-high frequency. Only peaks above the specified threshold level are numbered.

For this command/query to work, the source must be a function that is set to FFT or a waveform memory that contains an FFT.

<source> {FUNction<F> | WMEMory<R> | CLOCk | MTRend | MSPectrum | EQUalized<L>}

For more information on <source> parameters, see "[Measurement Sources](#)" on page 890.

<peak1\_number>, <peak2\_number> An integer (in NR1 format) that specifies the FFT peak number.

<level> A decimal number (in NR3 format) that specifies the peak threshold level in dBm.

**Query** :MEASure:FFT:DFRequency? <source>, <peak1\_number>, <peak2\_number>, <level>

The :MEASure:FFT:DFRequency? query returns the delta frequency value between two FFT peaks.

**Returned Format** [:MEASure:FFT:DFRequency] <delta\_frequency>[, <result\_state>]<NL>

<result\_state> If SENDvalid is ON, the result state is returned with the measurement result. See the :MEASure:RESults table in this chapter for a list of the result states.

**Example** This example sets up an FFT Magnitude math function on channel 4 and measures the delta frequency between FFT peaks 2 and 4 using a threshold level of -47.0 dBm.

```
' Response headers off:
myScope.WriteString ":SYSTem:HEADer OFF"

' Set up FFT Magnitude math function on channel 4:
myScope.WriteString ":FUNction4:FFTMagnitude CHANNEL4"

' Display the FFT:
myScope.WriteString ":FUNction4:DISPlay ON"

' Install the FFT delta frequency measurement between peaks 2 and 4
' using a peak threshold level of -47 dBm:
myScope.WriteString ":MEASure:FFT:DFRequency FUNction4,2,4,-47.0"

' Get the FFT delta frequency measurement result value:
myScope.WriteString ":MEASure:FFT:DFRequency? FUNction4,2,4,-47.0"
varDeltaFreq = myScope.ReadNumber
Debug.Print FormatNumber(varDeltaFreq, "Scientific")
```

**See Also** • "[:MEASure:FFT:DMAGnitude](#)" on page 951

- **":MEASure:FFT:FREQuency"** on page 953
- **":MEASure:FFT:MAGNitude"** on page 955

**History** Legacy command (existed before version 3.10).

Version 6.20: The command and query now include peak number and level parameters.

## :MEASure:FFT:DMAGnitude

**Command** :MEASure:FFT:DMAGnitude <source>,<peak1\_number>,<peak2\_number>,<level>

The :MEASure:FFT:DMAGnitude command installs a measurement of the magnitude difference between two FFT peaks. Peaks are numbered from low-to-high frequency. Only peaks above the specified threshold level are numbered.

For this command/query to work, the source must be a function that is set to FFT or a waveform memory that contains an FFT.

<source> {FUNction<F> | WMEMory<R> | CLOCk | MTRend | MSPectrum | EQUalized<L>}

For more information on <source> parameters, see "[Measurement Sources](#)" on page 890.

<peak1\_number>,<peak2\_number> An integer (in NR1 format) that specifies the FFT peak number.

<level> A decimal number (in NR3 format) that specifies the peak threshold level in dBm.

**Query** :MEASure:FFT:DMAGnitude? <source>,<peak1\_number>,<peak2\_number>,<level>

The :MEASure:FFT:DMAGnitude? query returns the delta magnitude value between two FFT peaks.

**Returned Format** [:MEASure:FFT:DMAGnitude] <delta\_magnitude>[,<result\_state>]<NL>

<result\_state> If SENDvalid is ON, the result state is returned with the measurement result. See the :MEASure:RESults table in this chapter for a list of the result states.

**Example** This example sets up an FFT Magnitude math function on channel 4 and measures the delta magnitude between FFT peaks 2 and 4 using a threshold level of -47.0 dBm.

```
' Response headers off:
myScope.WriteString ":SYSTem:HEADer OFF"

' Set up FFT Magnitude math function on channel 4:
myScope.WriteString ":FUNction4:FFTMagnitude CHANnel4"

' Display the FFT:
myScope.WriteString ":FUNction4:DISPlay ON"

' Install the FFT delta magnitude measurement between peaks 2 and 4
' using a peak threshold level of -47 dBm:
myScope.WriteString ":MEASure:FFT:DMAGnitude FUNction4,2,4,-47.0"

' Get the FFT delta magnitude measurement result value:
myScope.WriteString ":MEASure:FFT:DMAGnitude? FUNction4,2,4,-47.0"
varDeltaMag = myScope.ReadNumber
Debug.Print FormatNumber(varDeltaMag, "Scientific")
```

**See Also** • "[:MEASure:FFT:DFRequency](#)" on page 949

- **":MEASure:FFT:FREQuency"** on page 953
- **":MEASure:FFT:MAGNitude"** on page 955

**History** Legacy command (existed before version 3.10).

Version 6.20: The command and query now include peak number and level parameters.



## :MEASure:FFT:FREQuency

**Command** :MEASure:FFT:FREQuency <source>,<peak\_number>,<level>

The :MEASure:FFT:FREQuency command installs a measurement of the frequency of an FFT peak. Peaks are numbered from low-to-high frequency. Only peaks above the specified threshold level are numbered.

For this command/query to work, the source must be a function that is set to FFT or a waveform memory that contains an FFT.

<source> {FUNction<F> | WMemory<R> | CLock | MTRend | MSPectrum | EQualized<L>}

For more information on <source> parameters, see **"Measurement Sources"** on page 890.

<peak\_number> An integer (in NR1 format) that specifies the FFT peak number.

<level> A decimal number (in NR3 format) that specifies the peak threshold level in dBm.

**Query** :MEASure:FFT:FREQuency? <source>,<peak\_number>,<level>

The :MEASure:FFT:FREQuency? query returns the frequency value of the FFT peak.

**Returned Format** [:MEASure:FFT:FREQuency] <frequency>[,<result\_state>]<NL>

<result\_state> If SENDvalid is ON, the result state is returned with the measurement result. See the :MEASure:RESults table in this chapter for a list of the result states.

**Example** This example sets up an FFT Magnitude math function on channel 4 and measures the frequency of FFT peak 2 using a threshold level of -47.0 dBm.

```
' Response headers off:
myScope.WriteString ":SYSTEM:HEADer OFF"

' Set up FFT Magnitude math function on channel 4:
myScope.WriteString ":FUNction4:FFTMagnitude CHANnel4"

' Display the FFT:
myScope.WriteString ":FUNction4:DISPlay ON"

' Install the FFT frequency measurement on peak number 2 using a peak
' threshold level of -47 dBm:
myScope.WriteString ":MEASure:FFT:FREQuency FUNction4,2,-47.0"

' Get the FFT frequency measurement result value:
myScope.WriteString ":MEASure:FFT:FREQuency? FUNction4,2,-47.0"
varFrequency = myScope.ReadNumber
Debug.Print FormatNumber(varFrequency, "Scientific")
```

**See Also**

- **"[:MEASure:FFT:DFRequency](#)"** on page 949
- **"[:MEASure:FFT:DMAGnitude](#)"** on page 951
- **"[:MEASure:FFT:MAGNitude](#)"** on page 955

**History** Legacy command (existed before version 3.10).

Version 6.20: The command and query now include peak number and level parameters.

## :MEASure:FFT:MAGNitude

**Command** :MEASure:FFT:MAGNitude <source>,<peak\_number>,<level>

The :MEASure:FFT:MAGNitude command installs a measurement of the magnitude of an FFT peak. Peaks are numbered from low-to-high frequency. Only peaks above the specified threshold level are numbered.

For this command/query to work, the source must be a function that is set to FFT or a waveform memory that contains an FFT.

<source> {FUNction<F> | WMemory<R> | CLock | MTRend | MSPectrum | EQualized<L>}

For more information on <source> parameters, see "[Measurement Sources](#)" on page 890.

<peak\_number> An integer (in NR1 format) that specifies the FFT peak number.

<level> A decimal number (in NR3 format) that specifies the peak threshold level in dBm.

**Query** :MEASure:FFT:MAGNitude? <source>,<peak\_number>,<level>

The :MEASure:FFT:MAGNitude? query returns the magnitude value of the FFT peak.

**Returned Format** [:MEASure:FFT:FMAGNitude] <magnitude>[,<result\_state>]<NL>

<result\_state> If SENDvalid is ON, the result state is returned with the measurement result. See the :MEASure:RESults table in this chapter for a list of the result states.

**Example** This example sets up an FFT Magnitude math function on channel 4 and measures the magnitude of FFT peak 2 using a threshold level of -47.0 dBm.

```
' Response headers off:
myScope.WriteString ":SYSTem:HEADer OFF"

' Set up FFT Magnitude math function on channel 4:
myScope.WriteString ":FUNction4:FFTMagnitude CHANNEL4"

' Display the FFT:
myScope.WriteString ":FUNction4:DISPlay ON"

' Install the FFT magnitude measurement on peak number 2 using a peak
' threshold level of -47 dBm:
myScope.WriteString ":MEASure:FFT:MAGNitude FUNction4,2,-47.0"

' Get the FFT magnitude measurement result value:
myScope.WriteString ":MEASure:FFT:MAGNitude? FUNction4,2,-47.0"
varMagnitude = myScope.ReadNumber
Debug.Print FormatNumber(varMagnitude, "Scientific")
```

**See Also**

- "[:MEASure:FFT:DFRequency](#)" on page 949
- "[:MEASure:FFT:DMAGNitude](#)" on page 951
- "[:MEASure:FFT:FREquency](#)" on page 953

**History** Legacy command (existed before version 3.10).

Version 6.20: The command and query now include peak number and level parameters.

## :MEASure:FFT:OBW

**Command** :MEASure:FFT:OBW <source>,<occupied\_bw\_pct>

The :MEASure:FFT:OBW command installs an occupied bandwidth measurement into the user interface's measurement Results pane.

The source must be a function that is set to FFT, or a waveform memory that contains an FFT for this command and query to work.

<source> {FUNCTION<F> | WMemory<R> | MSPectrum}

For more information on <source> parameters, see "[Measurement Sources](#)" on page 890.

<occupied\_bw\_pct  
> The percentage of the power of the FFT on screen.

**Query** :MEASure:FFT:OBW? <source>,<occupied\_bw\_pct>

The :MEASure:FFT:OBW? query returns the measured occupied bandwidth.

**Returned Format** [:MEASure:FFT:OBW] <bandwidth><NL>

<bandwidth> ::= in Hz in NR3 format.

- See Also**
- "[:MEASure:FFT:CPOWer](#)" on page 948
  - "[:MEASure:FFT:PSD](#)" on page 958

**History** New in version 5.70.

**:MEASure:FFT:PSD**

**Command** :MEASure:FFT:PSD <source>,<center\_freq>,<meas\_bw>

The :MEASure:FFT:PSD command installs a power spectral density measurement into the user interface's measurement Results pane.

The source must be a function that is set to FFT, or a waveform memory that contains an FFT for this command and query to work.

<source> {FUNCTION<F> | WMemory<R> | MSPpectrum}

For more information on <source> parameters, see "[Measurement Sources](#)" on page 890.

<center\_freq> The center frequency used in the measurement in NR3 format.

<meas\_bw> The width of FFT band in NR3 format.

**Query** :MEASure:FFT:PSD? <source>,<center\_freq>,<meas\_bw>

The :MEASure:FFT:PSD? query returns the measured power spectral density.

**Returned Format** [:MEASure:FFT:PSD] <psd\_value><NL>

<psd\_value> ::= in dBm/Hz in NR3 format.

- See Also**
- "[:MEASure:FFT:CPOWer](#)" on page 948
  - "[:MEASure:FFT:OBW](#)" on page 957

**History** New in version 5.70.

## :MEASure:FREQuency

**Command** :MEASure:FREQuency [<source>[,<direction>]]

The :MEASure:FREQuency command measures the frequency of the first complete cycle on the screen using the mid-threshold levels of the waveform (50% levels if standard thresholds are selected).

The source is specified with the :MEASure:SOURce command or with the optional parameter following the :MEASure:FREQuency command.

The algorithm is:

```
If the first edge on the screen is rising,
then
    frequency = 1/(second rising edge time - first rising edge time)
else
    frequency = 1/(second falling edge time - first falling edge time)
```

**<source>** {CHANnel<N> | DIFF<D> | COMMONmode<C> | FUNCTION<F> | DIGital<M> | WMEMory<R> | CLOCK | MTRend | MSPectrum | EQUalized<L> | XT<X>}

For more information on <source> parameters, see "[Measurement Sources](#)" on page 890.

**<direction>** {RISing | FALLing}

Specifies whether the frequency is measured from rising edge to rising edge or from falling edge to falling edge. When <direction> is specified, the <source> parameter is required.

When the "Measure All Edges" mode is OFF (see "[:ANALyze:AEDGes](#)" on page 273), the RISing and FALLing options specify whether the first rising or falling edge from the left side of the display grid is used.

When the "Measure All Edges" mode is ON, the RISing and FALLing options specify whether whether the frequency is measured from rising edge to rising edge or from falling edge to falling edge throughout the acquisition.

**Example** This example measures the frequency of the channel 1 waveform.

```
myScope.WriteString ":MEASure:FREQuency CHANnel1"
```

**Query** :MEASure:FREQuency? [<source>[,<direction>]]

The :MEASure:FREQuency? query returns the measured frequency.

**Returned Format** [:MEASure:FREQuency] <value>[,<result\_state>]<NL>

**<value>** The frequency value in Hertz of the first complete cycle on the screen using the mid-threshold levels of the waveform.

**<result\_state>** If SENDvalid is ON, the result state is returned with the measurement result. See the :MEASure:RESults table in this chapter for a list of the result states.

**Example** This example places the current frequency of the waveform in the numeric variable, `varFreq`, then prints the contents of the variable to the computer's screen.

```
myScope.WriteString ":SYSTem:HEADer OFF" ' Response headers off.  
myScope.WriteString ":MEASure:FREQuency? CHANnel1"  
varFreq = myScope.ReadNumber  
Debug.Print FormatNumber(varFreq, 0)
```

**History** Legacy command (existed before version 3.10).



## :MEASure:HISTogram:FWHM

**Command** :MEASure:HISTogram:FWHM

When a histogram is on, the :MEASure:HISTogram:FWHM command installs a "Full-Width at Half Max" histogram measurement into the user interface's measurement Results pane.

**Query** :MEASure:HISTogram:FWHM?

The :MEASure:HISTogram:FWHM? query returns the measured histogram "Full-Width at Half Max" value.

**Returned Format** <value><NL>

<value> ::= width of histogram at half max height in NR3 format

- See Also**
- [":MEASure:HISTogram:HITS"](#) on page 962
  - [":MEASure:HISTogram:M1S"](#) on page 963
  - [":MEASure:HISTogram:M2S"](#) on page 964
  - [":MEASure:HISTogram:M3S"](#) on page 965
  - [":MEASure:HISTogram:MAX"](#) on page 966
  - [":MEASure:HISTogram:MEAN"](#) on page 967
  - [":MEASure:HISTogram:MEDian"](#) on page 968
  - [":MEASure:HISTogram:MIN"](#) on page 969
  - [":MEASure:HISTogram:MODE"](#) on page 972
  - [":MEASure:HISTogram:PEAK"](#) on page 973
  - [":MEASure:HISTogram:PP"](#) on page 974
  - [":MEASure:HISTogram:RESolution"](#) on page 975
  - [":MEASure:HISTogram:STDDev"](#) on page 976

**History** New in version 6.10.

## :MEASure:HISTogram:HITS

**Command** :MEASure:HISTogram:HITS [<source>]

The :MEASure:HISTogram:HITS command places the histogram hits measurement into the Measurements tab of the oscilloscope's user interface.

The source is specified with the :MEASure:SOURce command or with the optional parameter following the command.

The :MEASure:HISTogram commands only apply to Meas Histogram math functions, the histogram waveform, or memories containing histograms.

<source> { FUNCTION<F> | WMEMory<R> | HISTogram}

<F> An integer, 1-16.

<R> An integer, 1-4.

**Example** This example places into the Measurements tab the number of hits within the histogram stored in WMEMory1.

```
myScope.WriteString ":MEASure:HISTogram:HITS WMEMory1"
```

**Query** :MEASure:HISTogram:HITS? [<source>]

The :MEASure:HISTogram:HITS? query returns the number of hits within the histogram.

**Returned Format** [:MEASure:HISTogram:HITS] <value> [, <result\_state>] <NL>

<value> The number of hits in the histogram.

<result\_state> If SENDVALID is ON, the result state is returned with the measurement result. Refer to the MEASure:RESults command, for a list of the result states.

**Example** This example returns the number of hits within the current histogram and prints the result to the computer's screen.

```
myScope.WriteString ":SYSTEM:HEADer OFF" ' Response headers off.
myScope.WriteString ":MEASure:HISTogram:HITS? WMEMory1"
varHisthits = myScope.ReadNumber
Debug.Print FormatNumber(varHisthits, 0)
```

**See Also**

- **":FUNCTION<F>:MHISTogram"** on page 627
- **":HISTogram:MODE"** on page 658

**History** Legacy command (existed before version 3.10).

Version 3.50: Can now use this command with Meas Histogram math functions.

## :MEASure:HISTogram:M1S

**Command** :MEASure:HISTogram:M1S [<source>]

The :MEASure:HISTogram:M1S command places the histogram percentage of points within one standard deviation of the mean measurement into the Measurements tab of the oscilloscope's user interface.

The source is specified with the :MEASure:SOURce command or with the optional parameter following the command.

The :MEASure:HISTogram commands only apply to Meas Histogram math functions, the histogram waveform, or memories containing histograms.

<source> { FUNCTION<F> | WMEMory<R> | HISTogram}

<F> An integer, 1-16.

<R> An integer, 1-4.

**Example** This example measures the percentage of points that are within one standard deviation of the mean of the histogram of the data stored in waveform memory 3.

```
myScope.WriteString ":MEASure:HISTogram:M1S WMEMory3"
```

**Query** :MEASure:HISTogram:M1S? [<source>]

The :MEASure:HISTogram:M1S? query returns the measurement of the percentage of points within one standard deviation of the mean of the histogram.

**Returned Format** [:MEASure:HISTogram:M1S] <value> [, <result\_state>] <NL>

<value> The percentage of points within one standard deviation of the mean of the histogram.

<result\_state> If SENDVALID is ON, the result state is returned with the measurement result. Refer to the MEASure:RESults command, for a list of the result states.

**Example** This example returns the percentage of points within one standard deviation of the mean of the current histogram and prints the result to the computer's screen.

```
myScope.WriteString ":SYSTem:HEADer OFF" ' Response headers off.
myScope.WriteString ":MEASure:HISTogram:M1S? WMEMory1"
varHistm1s = myScope.ReadNumber
Debug.Print FormatNumber(varHistm1s, 0)
```

**See Also** • [":FUNCTION<F>:MHISTogram"](#) on page 627

• [":HISTogram:MODE"](#) on page 658

**History** Legacy command (existed before version 3.10).

Version 3.50: Can now use this command with Meas Histogram math functions.

## :MEASure:HISTogram:M2S

**Command** :MEASure:HISTogram:M2S [<source>]

The :MEASure:HISTogram:M2S command places the histogram percentage of points within two standard deviations of the mean measurement into the Measurements tab of the oscilloscope's user interface.

The source is specified with the :MEASure:SOURce command or with the optional parameter following the command.

The :MEASure:HISTogram commands only apply to Meas Histogram math functions, the histogram waveform, or memories containing histograms.

<source> { FUNCTION<F> | WMEMory<R> | HISTogram }

<F> An integer, 1-16.

<R> An integer, 1-4.

**Example** This example measures the percentage of points that are within two standard deviations of the mean of the histogram whose source is specified using the MEASure:SOURce command.

```
myScope.WriteString ":MEASure:HISTogram:M2S WMEMory1"
```

**Query** :MEASure:HISTogram:M2S? [<source>]

The :MEASure:HISTogram:M2S? query returns the measurement of the percentage of points within two standard deviations of the mean of the histogram.

**Returned Format** [:MEASure:HISTogram:M2S] <value> [, <result\_state>] <NL>

<value> The percentage of points within two standard deviations of the mean of the histogram.

<result\_state> If SENDVALID is ON, the result state is returned with the measurement result. Refer to the MEASure:RESults command, for a list of the result states.

**Example** This example returns the percentage of points within two standard deviations of the mean of the current histogram and prints the result to the computer's screen.

```
myScope.WriteString ":SYSTEM:HEADer OFF" ' Response headers off.
myScope.WriteString ":MEASure:HISTogram:M2S? WMEMory1"
varHism2s = myScope.ReadNumber
Debug.Print FormatNumber(varHism2s, 0)
```

**See Also**

- [":FUNCTION<F>:MHISTogram"](#) on page 627
- [":HISTogram:MODE"](#) on page 658

**History** Legacy command (existed before version 3.10).

Version 3.50: Can now use this command with Meas Histogram math functions.

## :MEASure:HISTogram:M3S

**Command** :MEASure:HISTogram:M3S [<source>]

The :MEASure:HISTogram:M2S command places the histogram percentage of points within two standard deviations of the mean measurement into the Measurements tab of the oscilloscope's user interface.

The source is specified with the :MEASure:SOURce command or with the optional parameter following the command.

The :MEASure:HISTogram commands only apply to Meas Histogram math functions, the histogram waveform, or memories containing histograms.

<source> { FUNCTION<F> | WMEMory<R> | HISTogram }

<F> An integer, 1-16.

<R> An integer, 1-4.

**Example** This example measures the percentage of points that are within three standard deviations of the mean of the histogram.

```
myScope.WriteString ":MEASure:HISTogram:M3S HISTogram"
```

**Query** :MEASure:HISTogram:M3S? [<source>]

The :MEASure:HISTogram:M3S? query returns the measurement of the percentage of points within three standard deviations of the mean of the histogram.

**Returned Format** [:MEASure:HISTogram:M3S] <value>[,<result\_state>]<NL>

<value> The percentage of points within three standard deviations of the mean of the histogram.

<result\_state> If SENDVALID is ON, the result state is returned with the measurement result. For a list of the result states, refer to the MEASure:RESults command.

**Example** This example returns the percentage of points within three standard deviations of the mean of the current histogram and prints the result to the computer's screen.

```
myScope.WriteString ":SYSTem:HEADer OFF" ' Response headers off.
myScope.WriteString ":MEASure:HISTogram:M3S? WMEMory1"
varHism3s = myScope.ReadNumber
Debug.Print FormatNumber(varHism3s, 0)
```

**See Also** • [":FUNCTION<F>:MHISTogram"](#) on page 627

• [":HISTogram:MODE"](#) on page 658

**History** Legacy command (existed before version 3.10).

Version 3.50: Can now use this command with Meas Histogram math functions.

## :MEASure:HISTogram:MAX

**Command** :MEASure:HISTogram:MAX [<source>]

The :MEASure:HISTogram:MAX command places the histogram maximum value measurement into the Measurements tab of the oscilloscope's user interface.

The source is specified with the :MEASure:SOURce command or with the optional parameter following the command.

The :MEASure:HISTogram commands only apply to Meas Histogram math functions, the histogram waveform, or memories containing histograms.

<source> { FUNCTION<F> | WMEMory<R> | HISTogram}

<F> An integer, 1-16.

<R> An integer, 1-4.

**Example** This example places into the Measurements tab the maximum value of the histogram stored in WMEMory1.

```
myScope.WriteString ":MEASure:HISTogram:MAX WMEMory1"
```

**Query** :MEASure:HISTogram:MAX? [<source>]

The :MEASure:HISTogram:MAX? query returns the measurement of the maximum value of the histogram.

**Returned Format** [:MEASure:HISTogram:MAX] <value> [, <result\_state>] <NL>

<value> The maximum value of the histogram.

<result\_state> If SENDVALID is ON, the result state is returned with the measurement result. Refer to the MEASure:RESults command, for a list of the result states.

**Example** This example returns the maximum value of the current histogram and prints the result to the computer's screen.

```
myScope.WriteString ":SYSTem:HEADer OFF" ' Response headers off.
myScope.WriteString ":MEASure:HISTogram:MAX?"
varHistmax = myScope.ReadNumber
Debug.Print FormatNumber(varHistmax, 0)
```

**See Also**

- **":FUNCTION<F>:MHISTogram"** on page 627
- **":HISTogram:MODE"** on page 658

**History** Legacy command (existed before version 3.10).

Version 3.50: Can now use this command with Meas Histogram math functions.

## :MEASure:HISTogram:MEAN

**Command** :MEASure:HISTogram:MEAN [<source>]

The :MEASure:HISTogram:MEAN command places the histogram mean measurement into the Measurements tab of the oscilloscope's user interface.

The source is specified with the :MEASure:SOURce command or with the optional parameter following the command.

The :MEASure:HISTogram commands only apply to Meas Histogram math functions, the histogram waveform, or memories containing histograms.

<source> { FUNCTION<F> | WMEMory<R> | HISTogram}

<F> An integer, 1-16.

<R> An integer, 1-4.

**Example** This example places into the Measurements tab the mean of the histogram stored in WMEMory1.

```
myScope.WriteString ":MEASure:HISTogram:MEAN WMEMory1"
```

**Query** :MEASure:HISTogram:MEAN? [<source>]

The :MEASure:HISTogram:MEAN? query returns the measurement of the mean of the histogram.

**Returned Format** [:MEASure:HISTogram:MEAN] <value> [, <result\_state>] <NL>

<value> The mean of the histogram.

<result\_state> If SENDVALID is ON, the result state is returned with the measurement result. Refer to the MEASure:RESults command, for a list of the result states.

**Example** This example returns the mean of the current histogram and prints the result to the computer's screen.

```
myScope.WriteString ":SYSTem:HEADer OFF" ' Response headers off.
myScope.WriteString ":MEASure:HISTogram:MEAN? WMEMory1"
varHistmean = myScope.ReadNumber
Debug.Print FormatNumber(varHistmean, 0)
```

**See Also**

- **" :FUNCTION<F>:MHISTogram "** on page 627
- **" :HISTogram:MODE "** on page 658

**History** Legacy command (existed before version 3.10).

Version 3.50: Can now use this command with Meas Histogram math functions.

## :MEASure:HISTogram:MEDian

**Command** :MEASure:HISTogram:MEDian [<source>]

The :MEASure:HISTogram:MEDian command places the histogram median measurement into the Measurements tab of the oscilloscope's user interface.

The source is specified with the :MEASure:SOURce command or with the optional parameter following the command.

The :MEASure:HISTogram commands only apply to Meas Histogram math functions, the histogram waveform, or memories containing histograms.

<source> { FUNCTION<F> | WMEMory<R> | HISTogram}

<F> An integer, 1-16.

<R> An integer, 1-4.

**Example** This example places into the Measurements tab the median of the histogram stored in WMEMory1.

```
myScope.WriteString ":MEASure:HISTogram:MEDian WMEMory1"
```

**Query** :MEASure:HISTogram:MEDian? [<source>]

The :MEASure:HISTogram:MEDian? query returns the measurement of the median of the histogram.

**Returned Format** [:MEASure:HISTogram:MEDian] <value> [, <result\_state>] <NL>

<value> The median of the histogram.

<result\_state> If SENDVALID is ON, the result state is returned with the measurement result. Refer to the MEASure:RESults command, for a list of the result states.

**Example** This example returns the median of the current histogram and prints the result to the computer's screen.

```
myScope.WriteString ":SYSTem:HEADer OFF" ' Response headers off.
myScope.WriteString ":MEASure:HISTogram:MEDian? WMEMory1"
varHistmed = myScope.ReadNumber
Debug.Print FormatNumber(varHistmed, 0)
```

**See Also**

- **":FUNCTion<F>:MHISTogram"** on page 627
- **":HISTogram:MODE"** on page 658

**History** Legacy command (existed before version 3.10).

Version 3.50: Can now use this command with Meas Histogram math functions.



## :MEASure:HISTogram:MIN

**Command** :MEASure:HISTogram:MIN [<source>]

The :MEASure:HISTogram:MIN command places the histogram minimum measurement into the Measurements tab of the oscilloscope's user interface.

The source is specified with the :MEASure:SOURce command or with the optional parameter following the command.

The :MEASure:HISTogram commands only apply to Meas Histogram math functions, the histogram waveform, or memories containing histograms.

<source> { FUNCTION<F> | WMEMory<R> | HISTogram}

<F> An integer, 1-16.

<R> An integer, 1-4.

**Example** This example places into the Measurements tab the minimum the histogram stored in WMEMory1.

```
myScope.WriteString ":MEASure:HISTogram:MIN WMEMory1"
```

**Query** :MEASure:HISTogram:MIN? [<source>]

The :MEASure:HISTogram:MIN? query returns the measurement of the minimum value of the histogram.

**Returned Format** [:MEASure:HISTogram:MIN] <value> [, <result\_state>] <NL>

<value> The minimum value of the histogram.

<result\_state> If SENDVALID is ON, the result state is returned with the measurement result. Refer to the MEASure:RESults command, for a list of the result states.

**Example** This example returns the minimum value of the current histogram and prints the result to the computer's screen.

```
myScope.WriteString ":SYSTem:HEADer OFF" ' Response headers off.
myScope.WriteString ":MEASure:HISTogram:MIN?"
varHistmin = myScope.ReadNumber
Debug.Print FormatNumber(varHistmin, 0)
```

**See Also**

- **":FUNCTION<F>:MHISTogram"** on page 627
- **":HISTogram:MODE"** on page 658

**History** Legacy command (existed before version 3.10).

Version 3.50: Can now use this command with Meas Histogram math functions.

## :MEASure:HISTogram:MM3S

**Command** :MEASure:HISTogram:MM3S [<source>]

The :MEASure:HISTogram:MM3S command installs the  $\mu-3\sigma$  mean minus three standard deviations measurement in the Measurement Results area the graphical user interface.

The source is specified with the :MEASure:SOURce command or with the optional parameter following the command.

The :MEASure:HISTogram commands only apply to Meas Histogram math functions, the histogram waveform, or memories containing histograms.

<source> { FUNCTION<F> | WMemory<R> | HISTogram}

<F> An integer, 1-16.

<R> An integer, 1-4.

**Query** :MEASure:HISTogram:MM3S? [<source>]

The :MEASure:HISTogram:MM3S? query returns the measured value of the mean minus three standard deviations.

**Returned Format** [:MEASure:HISTogram:MM3S] <value> [, <result\_state>] <NL>

<value> The mean minus three standard deviations value in NR3 format.

<result\_state> If SENDVALID is ON, the result state is returned with the measurement result. For a list of the result states, refer to the :MEASure:RESults command.

- See Also**
- [":MEASure:SOURce"](#) on page 1116
  - [":MEASure:HISTogram:MP3S"](#) on page 971
  - [":FUNCTION<F>:MHISTogram"](#) on page 627
  - [":HISTogram:MODE"](#) on page 658
  - [":MEASure:RESults?"](#) on page 1079

**History** New in version 6.55.

## :MEASure:HISTogram:MP3S

**Command** :MEASure:HISTogram:MP3S [<source>]

The :MEASure:HISTogram:MP3S command installs the  $\mu+3\sigma$  mean plus three standard deviations measurement in the Measurement Results area the graphical user interface.

The source is specified with the :MEASure:SOURce command or with the optional parameter following the command.

The :MEASure:HISTogram commands apply only to Meas Histogram math functions, the histogram waveform, or memories containing histograms.

<source> { FUNCTION<F> | WMEMory<R> | HISTogram}

<F> An integer, 1-16.

<R> An integer, 1-4.

**Query** :MEASure:HISTogram:MP3S? [<source>]

The :MEASure:HISTogram:MP3S? query returns the measured value of the mean plus three standard deviations.

**Returned Format** [:MEASure:HISTogram:MP3S] <value> [, <result\_state>] <NL>

<value> The mean plus three standard deviations value in NR3 format.

<result\_state> If SENDVALID is ON, the result state is returned with the measurement result. For a list of the result states, refer to the :MEASure:RESults command.

- See Also**
- [":MEASure:SOURce"](#) on page 1116
  - [":MEASure:HISTogram:MM3S"](#) on page 970
  - [":FUNCTION<F>:MHISTogram"](#) on page 627
  - [":HISTogram:MODE"](#) on page 658
  - [":MEASure:RESults?"](#) on page 1079

**History** New in version 6.55.

## :MEASure:HISTogram:MODE

**Command** :MEASure:HISTogram:MODE [<source>]

The :MEASure:HISTogram:MODE command places the histogram mode measurement into the Measurements tab of the oscilloscope's user interface.

The source is specified with the :MEASure:SOURce command or with the optional parameter following the command.

The :MEASure:HISTogram commands only apply to Meas Histogram math functions, the histogram waveform, or memories containing histograms.

<source> { FUNCTION<F> | WMEMory<R> | HISTogram}

<F> An integer, 1-16.

<R> An integer, 1-4.

**Example** This example places into the Measurements tab the mode of the histogram stored in WMEMory1.

```
myScope.WriteString ":MEASure:HISTogram:MODE WMEMory1"
```

**Query** :MEASure:HISTogram:MODE? [<source>]

The :MEASure:HISTogram:MODE? query returns the measurement histogram's Mode value.

**Returned Format** [:MEASure:HISTogram:MODE] <value> [, <result\_state>] <NL>

<value> The Mode value of the histogram.

<result\_state> If SENDVALID is ON, the result state is returned with the measurement result. Refer to the MEASure:RESults command, for a list of the result states.

**Example** This example returns the Mode value of the current histogram and prints the result to the computer's screen.

```
myScope.WriteString ":SYSTem:HEADer OFF" ' Response headers off.
myScope.WriteString ":MEASure:HISTogram:MODE? WMEMory1"
varHistMode = myScope.ReadNumber
Debug.Print FormatNumber(varHistMode, 0)
```

**See Also**

- **":FUNCTion<F>:MHISTogram"** on page 627
- **":HISTogram:MODE"** on page 658

**History** New in version 3.11.

Version 3.50: Can now use this command with Meas Histogram math functions.

## :MEASure:HISTogram:PEAK

**Command** :MEASure:HISTogram:PEAK [<source>]

The :MEASure:HISTogram:PEAK command places the histogram number of hits in the greatest peak measurement into the Measurements tab of the oscilloscope's user interface.

The source is specified with the :MEASure:SOURce command or with the optional parameter following the command.

The :MEASure:HISTogram commands only apply to Meas Histogram math functions, the histogram waveform, or memories containing histograms.

<source> { FUNCTION<F> | WMEMory<R> | HISTogram }

<F> An integer, 1-16.

<R> An integer, 1-4.

**Example** This example places into the Measurements tab the number of hits in the greatest peak of the histogram stored in WMEMory1.

```
myScope.WriteString ":MEASure:HISTogram:PEAK WMEMory1"
```

**Query** :MEASure:HISTogram:PEAK? [<source>]

The :MEASure:HISTogram:PEAK? query returns the number of hits in the greatest peak of the histogram measurement.

**Returned Format** [:MEASure:HISTogram:PEAK] <value> [, <result\_state>] <NL>

<value> The number of hits in the histogram peak.

<result\_state> If SENDVALID is ON, the result state is returned with the measurement result. Refer to the MEASure:RESults command, for a list of the result states.

**Example** This example returns the number of hits in the greatest peak of the current histogram and prints the result to the computer's screen.

```
myScope.WriteString ":SYSTem:HEADer OFF" ' Response headers off.
myScope.WriteString ":MEASure:HISTogram:PEAK? WMEMory1"
varHistpeak = myScope.ReadNumber
Debug.Print FormatNumber(varHistpeak, 0)
```

**See Also**

- **"[:FUNCTION<F>:MHISTogram](#)"** on page 627
- **"[:HISTogram:MODE](#)"** on page 658

**History** Legacy command (existed before version 3.10).

Version 3.50: Can now use this command with Meas Histogram math functions.

## :MEASure:HISTogram:PP

**Command** :MEASure:HISTogram:PP [<source>]

The :MEASure:HISTogram:PP command places the histogram width measurement into the Measurements tab of the oscilloscope's user interface.

The source is specified with the :MEASure:SOURce command or with the optional parameter following the command.

The :MEASure:HISTogram commands only apply to Meas Histogram math functions, the histogram waveform, or memories containing histograms.

<source> { FUNCTION<F> | WMEMory<R> | HISTogram}

<F> An integer, 1-16.

<R> An integer, 1-4.

**Example** This example places into the Measurements tab the width of the histogram stored in WMEMory1.

```
myScope.WriteString ":MEASure:HISTogram:PP WMEMory1"
```

**Query** :MEASure:HISTogram:PP? [<source>]

The :MEASure:HISTogram:PP? query returns the measurement of the width of the histogram.

**Returned Format** [:MEASure:HISTogram:PP] <value> [, <result\_state>] <NL>

<value> The width of the histogram.

<result\_state> If SENDVALID is ON, the result state is returned with the measurement result. Refer to the MEASure:RESults command, for a list of the result states.

**Example** This example returns the width of the current histogram and prints the result to the computer's screen.

```
myScope.WriteString ":SYSTem:HEADer OFF" ' Response headers off.
myScope.WriteString ":MEASure:HISTogram:PP? WMEMory1"
varHistpp = myScope.ReadNumber
Debug.Print FormatNumber(varHistpp, 0)
```

**See Also**

- **":FUNCTion<F>:MHISTogram"** on page 627
- **":HISTogram:MODE"** on page 658

**History** Legacy command (existed before version 3.10).

Version 3.50: Can now use this command with Meas Histogram math functions.

## :MEASure:HISTogram:RESolution

**Command** :MEASure:HISTogram:RESolution [<source>]

The :MEASure:HISTogram:RESolution command places the histogram bin width measurement into the Measurements tab of the oscilloscope's user interface.

The source is specified with the :MEASure:SOURce command or with the optional parameter following the command.

The :MEASure:HISTogram commands only apply to Meas Histogram math functions, the histogram waveform, or memories containing histograms.

<source> { FUNCTION<F> | WMEMory<R> | HISTogram}

<F> An integer, 1-16.

<R> An integer, 1-4.

**Example** This example places into the Measurements tab the bin width of the histogram stored in WMEMory1.

```
myScope.WriteString ":MEASure:HISTogram:RESolution WMEMory1"
```

**Query** :MEASure:HISTogram:RES? [<source>]

The :MEASure:HISTogram:RES? query returns the measurement of the bin width of the histogram.

**Returned Format** [:MEASure:HISTogram:RES] <value> [, <result\_state>] <NL>

<value> The width of the histogram.

<result\_state> If SENDVALID is ON, the result state is returned with the measurement result. Refer to the MEASure:RESults command, for a list of the result states.

**Example** This example returns the width of the current histogram and prints the result to the computer's screen.

```
myScope.WriteString ":SYSTem:HEADer OFF" ' Response headers off.
myScope.WriteString ":MEASure:HISTogram:RESolution? WMEMory1"
varHistpp = myScope.ReadNumber
Debug.Print FormatNumber(varHistpp, 0)
```

**See Also**

- **":FUNCTION<F>:MHISTogram"** on page 627
- **":HISTogram:MODE"** on page 658

**History** New in version 3.50.

## :MEASure:HISTogram:STDDev

**Command** :MEASure:HISTogram:STDDev [<source>]

The :MEASure:HISTogram:STDDev command places the histogram standard deviation measurement into the Measurements tab of the oscilloscope's user interface.

The source is specified with the :MEASure:SOURce command or with the optional parameter following the command.

The :MEASure:HISTogram commands only apply to Meas Histogram math functions, the histogram waveform, or memories containing histograms.

<source> { FUNCTION<F> | WMEMory<R> | HISTogram }

<F> An integer, 1-16.

<R> An integer, 1-4.

**Example** This example places into the Measurements tab the standard deviation of the histogram stored in WMEMory1.

```
myScope.WriteString ":MEASure:HISTogram:STDDev WMEMory1"
```

**Query** :MEASure:HISTogram:STDDev? [<source>]

The :MEASure:HISTogram:STDDev? query returns the measurement of standard deviation of the histogram.

**Returned Format** [:MEASure:HISTogram:STDDev] <value> [, <result\_state>] <NL>

<value> The standard deviation of the histogram.

<result\_state> If SENDVALID is ON, the result state is returned with the measurement result. Refer to the MEASure:RESults command, for a list of the result states.

**Example** This example returns the standard deviation of the histogram whose source is specified using the MEASure:SOURce command and prints the result to the computer's screen.

```
myScope.WriteString ":SYSTem:HEADer OFF" ' Response headers off.
myScope.WriteString ":MEASure:HISTogram:STDDEV? WMEMory1"
varHiststtd = myScope.ReadNumber
Debug.Print FormatNumber(varHiststtd, 0)
```

**See Also**

- **":FUNCTION<F>:MHISTogram"** on page 627
- **":HISTogram:MODE"** on page 658

**History** Legacy command (existed before version 3.10).

Version 3.50: Can now use this command with Meas Histogram math functions.



## :MEASure:HOLDtime

**Command** :MEASure:HOLDtime  
 [<data\_source>,<data\_source\_dir>,<clock\_source>,<clock\_source\_dir>]

The :MEASure:HOLDtime command measures the hold time between the specified clock and data sources.

This measurement requires all edges. When you add it, the "Measure All Edges" mode (see **":ANALyze:AEDGes"** on page 273) is automatically set to ON. When the "Measure All Edges" mode is set to OFF, this measurement cannot be made, and there are no measurement results.

<data\_source>, {CHANnel<N> | DIFF<D> | COMMONmode<C> | FUNCTION<F> | WMEMory<R> |  
 <clock\_source> CLOCK | MTRend | MSPectrum | EQUalized<L> | XT<X>}

For more information on <source> parameters, see **"Measurement Sources"** on page 890.

<data\_source\_dir> {RISing | FALLing | BOTH}

Selects the direction of the data source edge.

<clock\_source\_dir> {RISing | FALLing}

Selects the direction of the clock source edge.

**Example** This example measures the hold time from the rising edge of channel 1 to the rising edge of channel 2.

```
myScope.WriteString ":MEASure:HOLDtime CHAN1,RIS,CHAN2,RIS"
```

**Query** :MEASure:HOLDtime?  
 [<data\_source>,<data\_source\_dir>,<clock\_source>,<clock\_source\_dir>]

The :MEASure:HOLDtime? query returns the measured hold time between the specified clock and data source.

The necessary waveform edges must be present on the display. Also, the "Measure All Edges" mode must be set (use the :ANALyze:AEDGes command or :MEASure:HOLDtime command before the query).

The query will return 9.99999E+37 if the necessary edges are not displayed or if the "Measure All Edges" mode is not currently set.

**Returned Format** { :MEASure:SETuptime] <value><NL>

<value> Hold time in seconds.

**Example** This example places the current value of hold time in the numeric variable, varTime, then prints the contents of the variable to the computer's screen.

```
myScope.WriteString ":SYSTem:HEADer OFF" ' Response headers off.
myScope.WriteString ":MEASure:HOLDtime? CHAN1,RIS,CHAN2,RIS"
varTime = myScope.ReadNumber
Debug.Print FormatNumber(varTime, 0)
```

**See Also** Refer to the :MEASure:RESults? query for information on the results returned and how they are affected by the SENDvalid command. Refer to the individual measurements for information on how the result state is returned.

**See Also** · [":ANALyze:AEDGes"](#) on page 273

**History** Legacy command (existed before version 3.10).

## :MEASure:JITTer:HISTogram

## Command

**NOTE**

This command is available only when the Jitter Analysis Software license is installed. Note, however, that you can also use the :FUNction<F>:MHISTogram command to display a measurement histogram.

```
:MEASure:JITTer:HISTogram {{ON|1} | {OFF|0}}
```

The :MEASure:JITTer:HISTogram command turns the measurement histogram display on or off when a jitter measurement is displayed.

**Example** This example turns the jitter measurement histogram display on.

```
myScope.WriteString ":MEASure:JITTer:HISTogram ON"
```

**Query** :MEASure:JITTer:HISTogram?

The :MEASure:JITTer:HISTogram? query returns the state of measurement histogram display.

**Returned Format** [:MEASure:JITTer:HISTogram] {1 | 0}

**Example** This example places the current setting of the jitter spectrum mode in the variable varSetting, then prints the contents of the variable to the computer's screen.

```
myScope.WriteString ":SYSTem:HEADer OFF"
myScope.WriteString ":MEASure:JITTer:HISTogram?"
varSetting = myScope.ReadNumber
Debug.Print FormatNumber(varSetting, 0)
```

**See Also** • [":FUNction<F>:MHISTogram"](#) on page 627

**History** Legacy command (existed before version 3.10).

## :MEASure:JITTer:MEASurement

## Command

**NOTE**

This command is available only when the Jitter Analysis Software license is installed.

```
:MEASure:JITTer:MEASurement {MEASurement<N>}
```

The :MEASure :JITTer:MEASurement command selects which measurement displayed on the oscilloscope you are performing the jitter analysis on. MEASurement1 is the most recently added measurement.

<N> An integer, 1-40.

**NOTE**

When <N> is 10-40, the long form of the mnemonic, MEASurement<N>, is too long. In this case, you must use the short form, MEAS<N>.

**Example** This example assigns measurement 2 to the jitter measurement analysis.

```
myScope.WriteString ":MEASure:JITTer:MEASurement MEASurement2"
```

**Query** :MEASure:JITTer:MEASurement?

The :MEASure :JITTer:MEASurement? query returns the measurement number you are performing the jitter analysis on. If no measurements are being displayed on the oscilloscope, the query will return a null string.

**Returned Format** [:MEASure:JITTer:MEASurement MEASurement<N>]

**Example** This example places the current measurement number that you are performing jitter analysis on in the string variable strSetting, then prints the contents of the variable to the computer's screen.

```
myScope.WriteString ":SYSTem:HEADer OFF"
myScope.WriteString ":MEASure:JITTer:MEASurement?"
strSetting = myScope.ReadString
Debug.Print strSetting
```

**History** Legacy command (existed before version 3.10).

Version 6.71: The maximum number of measurements has increased from 20 to 40.

## :MEASure:JITTer:SPECtrum

## Command

## NOTE

This command is available only when the Jitter Analysis Software license is installed. Note, however, that you can also use the :FUNCTION<F>:MTRend command to display a measurement trend waveform and then the :FUNCTION<F>:FTTMagnitude command to display the spectrum of the measurement trend waveform.

```
:MEASure:JITTer:SPECtrum {{ON|1} | {OFF|0}}
```

The :MEASure:JITTer:SPECtrum command turns the jitter spectrum display on or off when a jitter measurement is displayed.

**Example** This example turns the jitter measurement spectrum display on.

```
myScope.WriteString ":MEASure:JITTer:SPECtrum ON"
```

**Query** :MEASure:JITTer:SPECtrum?

The :MEASure:JITTer:SPECtrum? query returns the state of jitter spectrum display.

**Returned Format** [:MEASure:JITTer:SPECtrum] {1 | 0}

**Example** This example places the current setting of the jitter spectrum mode in the variable varSetting, then prints the contents of the variable to the computer's screen.

```
myScope.WriteString ":SYSTem:HEADer OFF"
myScope.WriteString ":MEASure:JITTer:SPECtrum?"
varSetting = myScope.ReadNumber
Debug.Print FormatNumber(varSetting, 0)
```

**See Also**

- [":MEASure:JITTer:SPECtrum:HORizontal"](#) on page 982
- [":MEASure:JITTer:SPECtrum:HORizontal:POSition"](#) on page 983
- [":MEASure:JITTer:SPECtrum:HORizontal:RANGe"](#) on page 984
- [":MEASure:JITTer:SPECtrum:RESolution"](#) on page 985
- [":MEASure:JITTer:SPECtrum:VERTical"](#) on page 986
- [":MEASure:JITTer:SPECtrum:VERTical:OFFSet"](#) on page 987
- [":MEASure:JITTer:SPECtrum:VERTical:RANGe"](#) on page 988
- [":MEASure:JITTer:SPECtrum:VERTical:TYPE"](#) on page 989
- [":MEASure:JITTer:SPECtrum:WINDow"](#) on page 990
- [":FUNCTION<F>:MTRend"](#) on page 631
- [":FUNCTION<F>:FTTMagnitude"](#) on page 605

**History** Legacy command (existed before version 3.10).

## :MEASure:JITTer:SPECtrum:HORizontal

### Command

**NOTE**

This command is available only when the Jitter Analysis Software license is installed.

```
:MEASure:JITTer:SPECtrum:HORizontal {MANual}
```

The :MEASure:JITTer:SPECtrum:HORizontal command sets the jitter spectrum horizontal mode to manual. The AUTO mode, which automatically selected the horizontal scaling and center frequency, is no longer available.

In manual mode, you set your own horizontal scaling and center frequency values.

**Example** This example sets the jitter spectrum horizontal mode to automatic.

```
myScope.WriteString ":MEASure:JITTer:SPECtrum:HORizontal MANual"
```

**Query**

```
:MEASure:JITTer:SPECtrum:HORizontal?
```

The :MEASure:JITTer:SPECtrum:HORizontal? query returns the current jitter spectrum horizontal mode setting.

**Returned Format**

```
[ :MEASure:JITTer:SPECtrum:HORizontal ] {MAN}
```

**Example**

This example places the current setting of the jitter trend horizontal mode in the string variable strSetting, then prints the contents of the variable to the computer's screen.

```
myScope.WriteString ":SYSTEM:HEADer OFF"
myScope.WriteString ":MEASure:JITTer:SPECtrum:HORizontal?"
strSetting = myScope.ReadString
Debug.Print strSetting
```

**See Also**

- [":MEASure:JITTer:SPECtrum"](#) on page 981
- [":MEASure:JITTer:SPECtrum:HORizontal:POSition"](#) on page 983
- [":MEASure:JITTer:SPECtrum:HORizontal:RANGe"](#) on page 984
- [":MEASure:JITTer:SPECtrum:RESolution"](#) on page 985
- [":MEASure:JITTer:SPECtrum:VERTical"](#) on page 986
- [":MEASure:JITTer:SPECtrum:VERTical:OFFSet"](#) on page 987
- [":MEASure:JITTer:SPECtrum:VERTical:RANGe"](#) on page 988
- [":MEASure:JITTer:SPECtrum:VERTical:TYPE"](#) on page 989
- [":MEASure:JITTer:SPECtrum:WINDow"](#) on page 990

**History**

Legacy command (existed before version 3.10).

## :MEASure:JITTer:SPECTrum:HORizontal:POSition

## Command

## NOTE

This command is available only when the Jitter Analysis Software license is installed.

```
:MEASure:JITTer:SPECTrum:HORizontal:POSition <position>
```

The :MEASure:JITTer:SPECTrum:HORizontal:POSition command sets the jitter spectrum horizontal center frequency position.

<position> A real number for the center frequency position in Hertz.

**Example** This example sets the jitter spectrum horizontal center frequency position to 250 kHz.

```
myScope.WriteString ":MEASure:JITTer:SPECTrum:HORizontal:POSition 250E3"
```

**Query** :MEASure:JITTer:SPECTrum:HORizontal:POSition?

The :MEASure:JITTer:SPECTrum:HORizontal:POSition? query returns the current jitter spectrum horizontal center frequency position setting.

**Returned Format** [:MEASure:JITTer:SPECTrum:HORizontal:POSition] <value><NL>

<value> The jitter spectrum horizontal center frequency setting.

**Example** This example places the current setting of the jitter trend horizontal center frequency position in the variable varValue, then prints the contents of the variable to the computer's screen.

```
myScope.WriteString ":SYSTem:HEADer OFF"
myScope.WriteString ":MEASure:JITTer:SPECTrum:HORizontal:POSition?"
varValue = myScope.ReadNumber
Debug.Print FormatNumber(varValue, 0)
```

- See Also**
- [":MEASure:JITTer:SPECTrum"](#) on page 981
  - [":MEASure:JITTer:SPECTrum:HORizontal"](#) on page 982
  - [":MEASure:JITTer:SPECTrum:HORizontal:RANGe"](#) on page 984
  - [":MEASure:JITTer:SPECTrum:RESolution"](#) on page 985
  - [":MEASure:JITTer:SPECTrum:VERTical"](#) on page 986
  - [":MEASure:JITTer:SPECTrum:VERTical:OFFSet"](#) on page 987
  - [":MEASure:JITTer:SPECTrum:VERTical:RANGe"](#) on page 988
  - [":MEASure:JITTer:SPECTrum:VERTical:TYPE"](#) on page 989
  - [":MEASure:JITTer:SPECTrum:WINDow"](#) on page 990

**History** Legacy command (existed before version 3.10).

## :MEASure:JITTer:SPECtrum:HORizontal:RANGe

## Command

## NOTE

This command is available only when the Jitter Analysis Software license is installed.

```
:MEASure:JITTer:SPECtrum:HORizontal:RANGe <range>
```

The :MEASure:JITTer:SPECtrum:HORizontal:RANGe command sets the jitter spectrum horizontal range.

<range> A real number for the horizontal frequency range in Hertz.

**Example** This example sets the jitter spectrum horizontal range to 10 GHz (1 GHz/div).

```
myScope.WriteString ":MEASure:JITTer:SPECtrum:HORizontal:RANGe 10E9"
```

**Query** :MEASure:JITTer:SPECtrum:HORizontal:RANGe?

The :MEASure:JITTer:SPECtrum:HORizontal:RANGe? query returns the current jitter spectrum horizontal range setting.

**Returned Format** [:MEASure:JITTer:SPECtrum:HORizontal:RANGe] <value><NL>

<value> The jitter spectrum horizontal range setting.

**Example** This example places the current setting of the jitter trend horizontal range in the variable varValue, then prints the contents of the variable to the computer's screen.

```
myScope.WriteString ":SYSTem:HEADer OFF"
myScope.WriteString ":MEASure:JITTer:SPECtrum:HORizontal:RANGe?"
varValue = myScope.ReadNumber
Debug.Print FormatNumber(varValue, 0)
```

- See Also**
- [":MEASure:JITTer:SPECtrum"](#) on page 981
  - [":MEASure:JITTer:SPECtrum:HORizontal"](#) on page 982
  - [":MEASure:JITTer:SPECtrum:HORizontal:POSition"](#) on page 983
  - [":MEASure:JITTer:SPECtrum:RESolution"](#) on page 985
  - [":MEASure:JITTer:SPECtrum:VERTical"](#) on page 986
  - [":MEASure:JITTer:SPECtrum:VERTical:OFFSet"](#) on page 987
  - [":MEASure:JITTer:SPECtrum:VERTical:RANGe"](#) on page 988
  - [":MEASure:JITTer:SPECtrum:VERTical:TYPE"](#) on page 989
  - [":MEASure:JITTer:SPECtrum:WINDow"](#) on page 990

**History** Legacy command (existed before version 3.10).



## :MEASure:JITTer:SPECTrum:RESolution

**Query** :MEASure:JITTer:SPECTrum:RESolution?

The :MEASure:JITTer:SPECTrum:RESolution? query returns returns the resolution bandwidth of the measurement analysis spectrum FFT.

**Returned Format** <value><NL>

<value> ::= resolution BW in NR3 format

- See Also**
- [":MEASure:JITTer:SPECTrum"](#) on page 981
  - [":MEASure:JITTer:SPECTrum:HORizontal"](#) on page 982
  - [":MEASure:JITTer:SPECTrum:HORizontal:POSition"](#) on page 983
  - [":MEASure:JITTer:SPECTrum:HORizontal:RANGe"](#) on page 984
  - [":MEASure:JITTer:SPECTrum:VERTical"](#) on page 986
  - [":MEASure:JITTer:SPECTrum:VERTical:OFFSet"](#) on page 987
  - [":MEASure:JITTer:SPECTrum:VERTical:RANGe"](#) on page 988
  - [":MEASure:JITTer:SPECTrum:VERTical:TYPE"](#) on page 989
  - [":MEASure:JITTer:SPECTrum:WINDow"](#) on page 990

**History** New in version 6.20.

## :MEASure:JITTer:SPECtrum:VERTical

## Command

## NOTE

This command is available only when the Jitter Analysis Software license is installed.

```
:MEASure:JITTer:SPECtrum:VERTical {MANual}
```

The :MEASure:JITTer:SPECtrum:VERTical command sets the jitter spectrum vertical mode to manual. The AUTO mode, which automatically selected the vertical scaling and offset, is no longer available.

**Example** This example sets the jitter spectrum vertical mode to manual.

```
myScope.WriteString ":MEASure:JITTer:SPECtrum:VERTical MANual"
```

**Query** :MEASure:JITTer:SPECtrum:VERTical?

The :MEASure:JITTer:SPECtrum:VERTical? query returns the current jitter spectrum vertical mode setting.

**Returned Format** [:MEASure:JITTer:SPECtrum:VERTical] {MAN}

**Example** This example places the current setting of the jitter spectrum vertical mode in the string variable strSetting, then prints the contents of the variable to the computer's screen.

```
myScope.WriteString ":SYSTem:HEADer OFF"
myScope.WriteString ":MEASure:JITTer:SPECtrum:VERTical?"
strSetting = myScope.ReadString
Debug.Print strSetting
```

- See Also**
- [":MEASure:JITTer:SPECtrum"](#) on page 981
  - [":MEASure:JITTer:SPECtrum:HORizontal"](#) on page 982
  - [":MEASure:JITTer:SPECtrum:HORizontal:POSition"](#) on page 983
  - [":MEASure:JITTer:SPECtrum:HORizontal:RANGe"](#) on page 984
  - [":MEASure:JITTer:SPECtrum:RESolution"](#) on page 985
  - [":MEASure:JITTer:SPECtrum:VERTical:OFFSet"](#) on page 987
  - [":MEASure:JITTer:SPECtrum:VERTical:RANGe"](#) on page 988
  - [":MEASure:JITTer:SPECtrum:VERTical:TYPE"](#) on page 989
  - [":MEASure:JITTer:SPECtrum:WINDow"](#) on page 990

**History** Legacy command (existed before version 3.10).

## :MEASure:JITTer:SPECtrum:VERTical:OFFSet

## Command

## NOTE

This command is available only when the Jitter Analysis Software license is installed.

```
:MEASure:JITTer:SPECtrum:VERTical:OFFSet <offset>
```

The :MEASure:JITTer:SPECtrum:VERTical:OFFSet command sets the jitter spectrum vertical offset.

<offset> A real number for the vertical offset of the jitter measurement spectrum.

**Example** This example sets the jitter spectrum vertical offset to 2 ns.

```
myScope.WriteString ":MEASure:JITTer:SPECtrum:VERTical:OFFSet 10E-9"
```

**Query** :MEASure:JITTer:SPECtrum:VERTical:OFFSet?

The :MEASure:JITTer:SPECtrum:VERTical:OFFSet? query returns the jitter spectrum vertical offset time.

**Returned Format** [:MEASure:JITTer:SPECtrum:VERTical:OFFSet] <value> [, <result\_state>] <NL>

<value> The jitter vertical spectrum offset time setting.

**Example** This example places the current value of jitter spectrum vertical offset in the numeric variable, varValue, then prints the contents of the variable to the computer's screen.

```
myScope.WriteString ":SYSTEM:HEADer OFF" ' Response headers off.
myScope.WriteString ":MEASure:JITTer:SPECtrum:VERTical:OFFSet?"
varValue = myScope.ReadNumber
Debug.Print FormatNumber(varValue, 0)
```

- See Also**
- [":MEASure:JITTer:SPECtrum"](#) on page 981
  - [":MEASure:JITTer:SPECtrum:HORizontal"](#) on page 982
  - [":MEASure:JITTer:SPECtrum:HORizontal:POSition"](#) on page 983
  - [":MEASure:JITTer:SPECtrum:HORizontal:RANGe"](#) on page 984
  - [":MEASure:JITTer:SPECtrum:RESolution"](#) on page 985
  - [":MEASure:JITTer:SPECtrum:VERTical"](#) on page 986
  - [":MEASure:JITTer:SPECtrum:VERTical:RANGe"](#) on page 988
  - [":MEASure:JITTer:SPECtrum:VERTical:TYPE"](#) on page 989
  - [":MEASure:JITTer:SPECtrum:WINDow"](#) on page 990

**History** Legacy command (existed before version 3.10).

## :MEASure:JITTer:SPECtrum:VERTical:RANGe

## Command

## NOTE

This command is available only when the Jitter Analysis Software license is installed.

```
:MEASure:JITTer:SPECtrum:VERTical:RANGe <range>
```

The :MEASure:JITTer:SPECtrum:VERTical:RANGe command sets the jitter spectrum vertical range.

<range> A real number for the full-scale vertical range for the jitter measurement spectrum.

**Example** This example sets the jitter spectrum vertical range to 4 ns (500 ps/div X 8 div).

```
myScope.WriteString ":MEASure:JITTer:SPECtrum:VERTical:RANGe 4E-9"
```

## Query

```
:MEASure:JITTer:SPECtrum:VERTical:RANGe?
```

The :MEASure:JITTer:SPECtrum:VERTical:RANGe? query returns the jitter spectrum range time setting.

## Returned Format

```
[ :MEASure:JITTer:SPECtrum:VERTical:RANGe ] <value> [ , <result_state> ] <NL>
```

<value> The jitter spectrum vertical range setting.

**Example** This example places the current value of jitter spectrum vertical range in the numeric variable, varValue, then prints the contents of the variable to the computer's screen.

```
myScope.WriteString ":SYSTEM:HEADer OFF" ' Response headers off.
myScope.WriteString ":MEASure:JITTer:SPECtrum:VERTical:RANGe?"
varValue = myScope.ReadNumber
Debug.Print FormatNumber(varValue, 0)
```

## See Also

- [":MEASure:JITTer:SPECtrum"](#) on page 981
- [":MEASure:JITTer:SPECtrum:HORizontal"](#) on page 982
- [":MEASure:JITTer:SPECtrum:HORizontal:POSition"](#) on page 983
- [":MEASure:JITTer:SPECtrum:HORizontal:RANGe"](#) on page 984
- [":MEASure:JITTer:SPECtrum:RESolution"](#) on page 985
- [":MEASure:JITTer:SPECtrum:VERTical"](#) on page 986
- [":MEASure:JITTer:SPECtrum:VERTical:OFFSet"](#) on page 987
- [":MEASure:JITTer:SPECtrum:VERTical:TYPE"](#) on page 989
- [":MEASure:JITTer:SPECtrum:WINDow"](#) on page 990

## History

Legacy command (existed before version 3.10).

## :MEASure:JITTer:SPECtrum:VERTical:TYPE

## Command

## NOTE

This command is available only when the Jitter Analysis Software license is installed.

```
:MEASure:JITTer:SPECtrum:VERTical:TYPE {LINear | LOGarithmic}
```

The :MEASure:JITTer:SPECtrum:VERTical:TYPE command lets you select either a LINear or a LOGarithmic vertical scale for the jitter spectrum plot.

**Example** This example sets a linear vertical scale for the jitter spectrum plot.

```
myScope.WriteString ":MEASure:JITTer:SPECtrum:VERTical:TYPE LINear"
```

## Query

```
:MEASure:JITTer:SPECtrum:VERTical:TYPE?
```

The :MEASure:JITTer:SPECtrum:VERTical:TYPE? query returns the current jitter spectrum plot vertical scale setting.

## Returned Format

```
[ :MEASure:JITTer:SPECtrum:VERTical:TYPE ] {LINear | LOGarithmic}
```

**Example** This example places the current jitter spectrum plot vertical scale setting in the string variable strType, then prints the contents of the variable to the computer's screen.

```
myScope.WriteString ":SYSTEM:HEADer OFF"
myScope.WriteString ":MEASure:JITTer:SPECtrum:VERTical:TYPE?"
strType = myScope.ReadString
Debug.Print strType
```

## See Also

- [":MEASure:JITTer:SPECtrum"](#) on page 981
- [":MEASure:JITTer:SPECtrum:HORizontal"](#) on page 982
- [":MEASure:JITTer:SPECtrum:HORizontal:POSition"](#) on page 983
- [":MEASure:JITTer:SPECtrum:HORizontal:RANGe"](#) on page 984
- [":MEASure:JITTer:SPECtrum:RESolution"](#) on page 985
- [":MEASure:JITTer:SPECtrum:VERTical"](#) on page 986
- [":MEASure:JITTer:SPECtrum:VERTical:OFFSet"](#) on page 987
- [":MEASure:JITTer:SPECtrum:VERTical:RANGe"](#) on page 988
- [":MEASure:JITTer:SPECtrum:WINDow"](#) on page 990

## History

New in version 3.10.

## :MEASure:JITTer:SPECtrum:WINDow

## Command

## NOTE

This command is available only when the Jitter Analysis Software license is installed.

```
:MEASure:JITTer:SPECtrum:WINDow {RECTangular | HANNing | FLATtop
                                   | BHARris | HAMMING}
```

The :MEASure:JITTer:SPECtrum:WINDow command sets the jitter spectrum window mode. For a description of the window modes, see [":FUNCTION<F>:FFT:WINDow"](#) on page 603.

**Example** This example sets the jitter spectrum window mode to Hanning.

```
myScope.WriteString ":MEASure:JITTer:SPECtrum:WINDow HANNing"
```

## Query

```
:MEASure:JITTer:SPECtrum:WINDow?
```

The :MEASure:JITTer:SPECtrum:WINDow? query returns the current jitter spectrum window mode setting.

## Returned Format

```
[ :MEASure:JITTer:SPECtrum:WINDow ] {RECTangular | HANNing | FLATtop
                                       | BHARris | HAMMING}<NL>
```

**Example** This example places the current setting of the jitter spectrum window mode in the string variable strSetting, then prints the contents of the variable to the computer's screen.

```
myScope.WriteString ":SYSTem:HEADer OFF"
myScope.WriteString ":MEASure:JITTer:SPECtrum:WINDow?"
strSetting = myScope.ReadString
Debug.Print strSetting
```

## See Also

- [":MEASure:JITTer:SPECtrum"](#) on page 981
- [":MEASure:JITTer:SPECtrum:HORizontal"](#) on page 982
- [":MEASure:JITTer:SPECtrum:HORizontal:POSition"](#) on page 983
- [":MEASure:JITTer:SPECtrum:HORizontal:RANGe"](#) on page 984
- [":MEASure:JITTer:SPECtrum:RESolution"](#) on page 985
- [":MEASure:JITTer:SPECtrum:VERTical"](#) on page 986
- [":MEASure:JITTer:SPECtrum:VERTical:OFFSet"](#) on page 987
- [":MEASure:JITTer:SPECtrum:VERTical:RANGe"](#) on page 988
- [":MEASure:JITTer:SPECtrum:VERTical:TYPE"](#) on page 989

## History

Legacy command (existed before version 3.10).

Version 3.11: Added the HAMMING window mode selection.

## :MEASure:JITTer:TREND

## Command

## NOTE

This command is available only when the Jitter Analysis Software license is installed. Note, however, that you can also use the :FUNCTION<F>:MTREnd command to display a measurement trend waveform.

```
:MEASure:JITTer:TREND {{ON|1} | {OFF|0}}
```

The :MEASure:JITTer:TREND command turns the jitter measurement trend display on or off. When on, trend plots measurement results time correlated to the waveform being measured.

**Example** This example turns the jitter measurement trend display on.

```
myScope.WriteString ":MEASure:JITTer:TREND ON"
```

## Query

```
:MEASure:JITTer:TREND?
```

The :MEASure:JITTer:TREND? query returns the state of jitter trend display.

## Returned Format

```
[ :MEASure:JITTer:TREND ] {1 | 0}
```

## Example

This example places the current setting of the jitter trend mode in the string variable strSetting, then prints the contents of the variable to the computer's screen.

```
myScope.WriteString ":SYSTEM:HEADer OFF"
myScope.WriteString ":MEASure:JITTer:TREND?"
strSetting = myScope.ReadString
Debug.Print strSetting
```

**See Also** • [":FUNCTION<F>:MTREnd"](#) on page 631

**History** Legacy command (existed before version 3.10).

## :MEASure:JITTer:TREND:SMOoth

## Command

## NOTE

This command is available only when the Jitter Analysis Software license is installed.

```
:MEASure:JITTer:TREND:SMOoth {{ON|1} | {OFF|0}}
```

The :MEASure:JITTer:TREND:SMOoth command sets jitter trend smoothing to on or off. When on, smoothing creates a running average smoothed by the number of points set by the :JITTer:TREND:SMOoth:POINts command.

**Example** This example sets the jitter trend smoothing mode to on.

```
myScope.WriteString ":MEASure:JITTer:TREND:SMOoth ON"
```

**Query** :MEASure:JITTer:TREND:SMOoth?

The :MEASure:JITTer:TREND:SMOoth? query returns the current jitter trend smoothing mode setting.

**Returned Format** [:MEASure:JITTer:TREND:SMOoth] {1 | 0}

**Example** This example places the current setting of the jitter trend smoothing mode in the string variable strSetting, then prints the contents of the variable to the computer's screen.

```
myScope.WriteString ":SYSTem:HEADer OFF"
myScope.WriteString ":MEASure:JITTer:TREND:SMOoth?"
strSetting = myScope.ReadString
Debug.Print strSetting
```

**History** Legacy command (existed before version 3.10).



## :MEASure:JITTer:TREND:SMOoth:POINts

## Command

**NOTE**

This command is available only when the Jitter Analysis Software license is installed.

```
:MEASure:JITTer:TREND:SMOoth:POINts <points>
```

The :MEASure:JITTer:TREND:SMOoth:POINts command sets the number of points as a set size for the data smoothing feature.

<points> odd integers, 3 to 100001. If out of range, the number will be rounded to nearest lower odd integer.

**Example** This example sets the jitter trend smoothing points to 7.

```
myScope.WriteString ":MEASure:JITTer:TREND:SMOoth:POINts 7"
```

**Query** :MEASure:JITTer:TREND:SMOoth:POINts?

The :MEASure:JITTer:TREND:SMOoth:POINts? query returns the current setting for jitter trend smoothing points.

**Returned Format** [:MEASure:JITTer:TREND:SMOoth:POINts] <value><NL>

<value> The jitter offset smoothing points setting.

**Example** This example places the current value of jitter trend smoothing points in the numeric variable, varValue, then prints the contents of the variable to the computer's screen.

```
myScope.WriteString ":SYSTem:HEADer OFF" ' Response headers off.
myScope.WriteString ":MEASure:JITTer:TREND:SMOoth:POINts?"
varValue = myScope.ReadNumber
Debug.Print FormatNumber(varValue, 0)
```

**History** Legacy command (existed before version 3.10).

## :MEASure:JITTer:TREND:VERTical

### Command

**NOTE**

This command is available only when the Jitter Analysis Software license is installed.

```
:MEASure:JITTer:TREND:VERTical {AUTO | MANual}
```

The :MEASure:JITTer:TREND:VERTical command sets the jitter trend vertical mode to automatic or manual. In automatic mode, the oscilloscope automatically selects the vertical scaling and offset. In manual mode, you can set your own scaling and offset values.

**Example** This example sets the jitter trend vertical mode to automatic.

```
myScope.WriteString ":MEASure:JITTer:TREND:VERTical AUTO"
```

**Query** :MEASure:JITTer:TREND:VERTical?

The :MEASure:JITTer:TREND:VERTical? query returns the current jitter trend vertical mode setting.

**Returned Format** [:MEASure:JITTer:TREND:VERTical] {AUTO | MANual}

**Example** This example places the current setting of the jitter trend vertical mode in the string variable strSetting, then prints the contents of the variable to the computer's screen.

```
myScope.WriteString ":SYSTem:HEADer OFF"
myScope.WriteString ":MEASure:JITTer:TREND:VERTical?"
strSetting = myScope.ReadString
Debug.Print strSetting
```

**History** Legacy command (existed before version 3.10).

## :MEASure:JITTer:TREND:VERTical:OFFSet

## Command

**NOTE**

This command is available only when the Jitter Analysis Software license is installed.

```
:MEASure:JITTer:TREND:VERTical:OFFSet <offset>
```

The :MEASure:JITTer:TREND:VERTical:OFFSet command sets the jitter trend vertical offset.

<offset> A real number for the vertical offset for the jitter measurement trend.

**Example** This example sets the jitter trend vertical offset to 100 ps.

```
myScope.WriteString ":MEASure:JITTer:TREND:VERTical:OFFSet 100E-12"
```

**Query** :MEASure:JITTer:TREND:VERTical:OFFSet?

The :MEASure:JITTer:TREND:VERTical:OFFSet? query returns the jitter trend vertical offset setting.

**Returned Format** [:MEASure:JITTer:TREND:VERTical:OFFSet] <value><NL>

<value> The jitter vertical trend offset setting.

**Example** This example places the current value of jitter trend vertical offset in the numeric variable, varValue, then prints the contents of the variable to the computer's screen.

```
myScope.WriteString ":SYSTEM:HEADer OFF" ' Response headers off.
myScope.WriteString ":MEASure:JITTer:TREND:VERTical:OFFSet?"
varValue = myScope.ReadNumber
Debug.Print FormatNumber(varValue, 0)
```

**History** Legacy command (existed before version 3.10).

## :MEASure:JITTer:TREND:VERTical:RANGe

## Command

**NOTE**

This command is available only when the Jitter Analysis Software license is installed.

```
:MEASure:JITTer:TREND:VERTical:RANGe <range>
```

The :MEASure:JITTer:TREND:VERTical:RANGe command sets the jitter trend vertical range.

<range> A real number for the full-scale vertical range for the jitter measurement trend.

**Example** This example sets the jitter trend vertical range to 4 ns (500 ps/div X 8 div).

```
myScope.WriteString ":MEASure:JITTer:TREND:VERTical:RANGe 4E-9"
```

**Query** :MEASure:JITTer:TREND:VERTical:RANGe?

The :MEASure:JITTer:TREND:VERTical:RANGe? query returns the jitter trend vertical range setting.

**Returned Format** [:MEASure:JITTer:TREND:VERTical:RANGe] <value><NL>

<value> The jitter trend vertical range setting.

<result\_state> If SENDvalid is ON, the result state is returned with the measurement result. See the :MEASure:RESults table in this chapter for a list of the result states.

**Example** This example places the current value of jitter trend vertical range in the numeric variable, varValue, then prints the contents of the variable to the computer's screen.

```
myScope.WriteString ":SYSTem:HEADer OFF" ' Response headers off.
myScope.WriteString ":MEASure:JITTer:TREND:VERTical:RANGe?"
varValue = myScope.ReadNumber
Debug.Print FormatNumber(varValue, 0)
```

**History** Legacy command (existed before version 3.10).

## :MEASure:MARK

**Command** :MEASure:MARK <meas\_name>,{{0 | OFF} | {1 | ON}}

The :MEASure:MARK command turns on or off "track measurement" markers for a specified measurement. "Track measurement" markers show you where the oscilloscope is making an automatic measurement.

**<meas\_name>** This is the measurement name as returned by :MEASurement<N>:NAME? query or as returned by the :MEASure:RESults? query.

**Query** :MEASure:MARK? <meas\_name>

The :MEASure:MARK? query returns returns the "track measurement" marker results as comma-separated values.

**Returned Format** <meas\_marker\_results><NL>

<meas\_marker\_results> ::= <marker\_state>,<first\_X>,<first\_Y>,<second\_X>,<second\_Y>

<marker\_state> ::= {0 | 1}

<first\_X> ::= first horizontal marker value in NR3 format

<first\_Y> ::= first vertical marker value in NR3 format

<second\_X> ::= second horizontal marker value in NR3 format

<second\_Y> ::= second vertical marker value in NR3 format

If the marker measurement does not apply or cannot be made or if the marker state is 0 (OFF), the infinity representation value (9.99999E+37) is returned.

- See Also**
- **" :MEASurement<N>:NAME "** on page 1206
  - **" :MEASure:RESults? "** on page 1079

**History** New in version 6.30.

## :MEASure:NAME

**Command** :MEASure:NAME {MEAS1 | MEAS2 | MEAS3 | ... | MEAS20}, <name>

The :MEASure:NAME commands sets the name of the specified measurement to whatever string is given to <name>. This enables you to give specific names to measurements displayed on the oscilloscope's screen.

<name> a quoted string

**Query** :MEASure:NAME? {MEAS1 | MEAS2 | MEAS3 | ... | MEAS20}

The :MEASure:NAME? query returns the name of the corresponding measurement.

**History** Legacy command (existed before version 3.10).

Version 5.00: Now 20 measurements to choose from.

## :MEASure:NCJitter

## Command

## NOTE

This command is available only when the Jitter Analysis Software license is installed.

```
:MEASure:NCJitter <source>,<direction>,<n>,<start>
```

The :MEASure:NCJitter command measures the N cycle jitter of the waveform. Another name for this measurement is "N period-period", where N is the number of cycles in the period.

**<source>** {CHANnel<N> | DIFF<D> | COMMONmode<C> | FUNCtion<F> | WMEMory<R> | CLOCK | MTRend | MSPectrum | EQUalized<L> | XT<X>}

For more information on <source> parameters, see "[Measurement Sources](#)" on page 890.

**<direction>** {RISing | FALLing}, specifies direction of waveform edge to make measurement.

**<n>** An integer, 1 to 99, the number of cycles in a group.

**<start>** An integer, 1 to <n> - 1, typically 1, the cycle to start measuring.

**Example** This example measures the N cycle jitter on channel 1, rising edge, 5 cycles in a group, starting on the first cycle of the waveform.

```
myScope.WriteString ":MEASure:NCJitter CHANnel1,RISing,5,1"
```

**Query** :MEASure:NCJitter? <source>,<direction>,<n>,<start>

The :MEASure:NCJitter? query returns the measured N cycle jitter time of the waveform.

**Returned Format** [:MEASure:NCJitter] <value>[,<result\_state>]<NL>

**<value>** The N cycle jitter time of the waveform.

**<result\_state>** If SENDvalid is ON, the result state is returned with the measurement result. See the :MEASure:RESults table in this chapter for a list of the result states.

**Example** This example places the current value of N cycle jitter in the numeric variable, varValue, then prints the contents of the variable to the computer's screen.

```
myScope.WriteString ":SYSTEM:HEADer OFF" ' Response headers off.
myScope.WriteString ":MEASure:NCJitter? CHANnel1,RIS,5,1"
varValue = myScope.ReadNumber
Debug.Print FormatNumber(varValue, 0)
```

**See Also**

- "[:MEASure:TIEClock2](#)" on page 1165
- "[:MEASure:CTCJitter](#)" on page 922
- "[:MEASure:CTCPwidth](#)" on page 926
- "[:MEASure:CTCNwidth](#)" on page 924

- **":MEASure:CTCDutycycle"** on page 920

**History** Legacy command (existed before version 3.10).



## :MEASure:NOISe

## Command

**NOTE**

This command is available only when the Jitter and Vertical Noise Analysis Software license is installed.

```
:MEASure:NOISe <source>, {VOLT | UNITamp}, {ZERO | ONE | BOTH}
```

The :MEASure:NOISe command adds a Noise measurement to the oscilloscope display.

The parameters specify the input source to be measured, the units (in volts or unit amplitude), and whether "zeros", "ones", or both "zeros" and "ones" should be measured.

This command is the equivalent of adding a noise measurement via **Measure > Data > Noise** in the front panel user interface.

<source> {CHANnel<N> | DIFF<D> | COMMONmode<C> | FUNCTION<F> | WMEMory<R> | EQUALized<L> | XT<X>}

For more information on <source> parameters, see "[Measurement Sources](#)" on page 890.

**Example** This example adds a "ones" Noise measurement on channel 1, in volt units, to the oscilloscope display. The measurement results appear in the Measurements tab.

```
myScope.WriteString ":MEASure:NOISe CHANnel1,VOLT,ONE"
```

**Query** :MEASure:NOISe? <source>, {VOLT | UNIT}, {ZERO | ONE | BOTH}

The :MEASure:NOISe? query returns the measured noise value.

**NOTE**

This measurement requires the **Measure All Edges** setting to be enabled. You can do this by:

- Installing the measurement on the display (using the command syntax), which automatically enables the **Measure All Edges** setting
- Sending the ":ANALyze:AEDGes ON" command.

**Returned Format** [:MEAS:NOIS] <measured\_value><NL>

<measured\_value> The measured "zeros", "ones", or both noise value in volts or unit amplitude.

**Example** This example places the measurement result in the varMeasuredNoise variable.

```
myScope.WriteString ":SYSTEM:HEADer OFF" ' Response headers off.
myScope.WriteString ":MEASure:NOISe? CHANnel1,VOLT,ONE"
varMeasuredNoise = myScope.ReadNumber
Debug.Print FormatNumber(varMeasuredNoise, 0)
```

**See Also** • [":ANALyze:AEDGes"](#) on page 273

**History** New in version 3.50.

## :MEASure:NOISe:ALL?

## Query

## NOTE

This command is available only when the Jitter and Vertical Noise Analysis Software license is installed.

```
:MEASure:NOISe:ALL? {ZERO | ONE | TWO | THRee}
```

The :MEASure:NOISe:ALL? query returns the NOISe measurement results for the specified level. The parameters TWO and THRee are available for PAM-4 signals.

These values are returned as comma separated values using the following format:

## Returned Format

```
[ :MEASure:NOISe:ALL<space>]
TI(<format>),<result>,<state>,
RN(<format>),<result>,<state>,
DI(<format>),<result>,<state>,
PI(<format>),<result>,<state>,
ABUI(<format>),<result>,<state>,
BUI(<format>),<result>,<state>,
ISI(<format>),<result>,<state>,
Count,<number_of_bits>,<state>,
Level,<nominal_level>,<state>,
Eye Height(<format>),<result>,<state>,<NL>
```

## NOTE

Whether some of these values are included or not depends on the setting of :MEASure:NOISe:METhod and :MEASure:NOISe:REPort.

For example, when :MEASure:NOISe:REPort or :MEASure:NOISe:METhod is SPECTral, the BUI and ABUI values are not returned, and there are two PI values (one "rms" and one "dd").

- <space> White space (ASCII 32) character.
- <format> The format value tells you something about how the measurement is made. For instance, TI(1E-12) means that the TI measurement was derived using a bit error rate of 1E-12. A format of (rms) means the measurement is a root-mean-square measurement. A format of (dd) means the measurement uses a dual-Dirac delta model to derive the measurement. A format of (pp) means the measurement is a peak-to-peak measurement.
- <result> The measured results for the NOISe measurements. A value of 9.99999E+37 means that the oscilloscope was unable to make the measurement.
- <state> The measurement result state. See [Table 14](#) for a list of values and descriptions of the result state value.
- <number\_of\_bits> The number of waveform bits that have been measured.
- <nominal\_level> The Level line returns the nominal one or zero level. The unit amplitude = the nominal one level – nominal zero level.

**Example** This example places the noise measurement result for "ones" in the strResults variable and displays it on the computer's screen.

```
Dim strResult As String ' Dimension variable.
myScope.WriteString ":SYSTem:HEADer OFF" ' Response headers off.
myScope.WriteString ":MEASure:NOISe:ALL? ONE"
strResults = myScope.ReadString
Debug.Print strResults
```

**See Also**

- [":MEASure:NOISe:METHod"](#) on page 1007
- [":MEASure:NOISe:REPort"](#) on page 1008

**History** New in version 3.50.

Version 4.10: New results can be returned depending on the :MEASure:NOISe:METHod and :MEASure:NOISe:REPort settings.

Version 5.50: The parameters TWO and THREE are available for PAM-4 signals.

## :MEASure:NOISe:BANDwidth

## Command

**NOTE**

This command is available only when the Jitter and Vertical Noise Analysis Software license is installed.

```
:MEASure:NOISe:BANDwidth {NARRow | WIDE}
```

The :MEASure:NOISe:BANDwidth command sets the type of filtering used to separate the data dependent noise from the random noise and the periodic noise.

**Example** This example sets the RN bandwidth to WIDE.

```
myScope.WriteString ":MEASure:NOISe:BANDwidth WIDE"
```

**Query**

```
:MEASure:NOISe:BANDwidth?
```

The :MEASure:NOISe:BANDwidth? query returns the RN bandwidth filter setting.

**Returned Format**

```
[ :MEASure:NOISe:BANDwidth ] {NARRow | WIDE}<NL>
```

**Example**

This example places the RN filter setting the strFilter variable and displays it on the computer's screen.

```
myScope.WriteString ":SYSTEM:HEADer OFF" ' Response headers off.
myScope.WriteString ":MEASure:NOISe:BANDwidth?"
strFilter = myScope.ReadString
Debug.Print strFilter
```

**History**

New in version 3.50.

## :MEASure:NOISe:LOCation

## Command

## NOTE

This command is available only when the Jitter and Vertical Noise Analysis Software license is installed.

```
:MEASure:NOISe:LOCation <location>
```

The :MEASure:NOISe:LOCation command specifies the measurement location within the bit where 0% is the beginning of the bit, 50% is the middle of the bit, and 100% is the end of the bit.

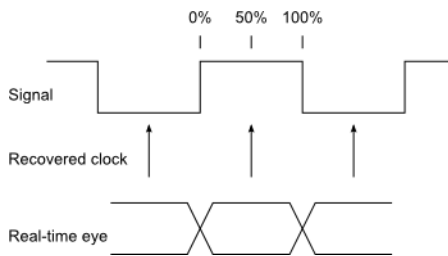

You can specify a location value from 5% to 95%.

**Example** This example sets the measurement location to 60%.

```
myScope.WriteString ":MEASure:NOISe:LOCation 60"
```

**Query** :MEASure:NOISe:LOCation?

The :MEASure:NOISe:LOCation? query returns the measurement location setting.

**Returned Format** [:MEASure:NOISe:LOCation] <location><NL>

**Example** This example places the measurement location setting the varLocation variable and displays it on the computer's screen.

```
myScope.WriteString ":SYSTem:HEADer OFF" ' Response headers off.
myScope.WriteString ":MEASure:NOISe:LOCation?"
varLocation = myScope.ReadNumber
Debug.Print FormatNumber(varLocation, 0)
```

**History** New in version 3.50.

## :MEASure:NOISe:METhod

## Command

## NOTE

This command is available only when the Jitter and Vertical Noise Analysis Software license is installed.

```
:MEASure:NOISe:METhod {SPECTral | BOTH}
```

The :MEASure:NOISe:METhod command lets you select the method for random noise (RN) analysis, either the SPECTral method or BOTH the spectral and tail fit methods.

When analyzing noise with crosstalk or ground bounce effects present in your signal, select BOTH. When this option is selected, the deterministic interference (DI) that is uncorrelated to the data pattern, also known as bounded uncorrelated interference (BUI), is separated into periodic interference (PI) and aperiodic bounded uncorrelated interference (ABUI). ABUI is caused by crosstalk and ground bounce effects.

When there are no crosstalk or ground bounce effects present in your signal, you can select the SPECTral method in order to run faster. When this option is selected, the deterministic interference (DI) that is uncorrelated to the data pattern is all reported as periodic interference (PI).

**Example** This example sets NOISe method to BOTH the spectral and tail fit analysis.

```
myScope.WriteString ":MEASure:NOISe:METhod BOTH"
```

**Query** :MEASure:NOISe:METhod?

The :MEASure:NOISe:METhod? query returns the selected NOISe method.

**Returned Format** [:MEASure:NOISe:METhod] {SPEC | BOTH}<NL>

**Example** This example places the NOISe method setting the strNoiseMethod variable and displays it on the computer's screen.

```
myScope.WriteString ":SYSTem:HEADer OFF" ' Response headers off.
myScope.WriteString ":MEASure:NOISe:METhod?"
strNoiseMethod = myScope.ReadString
Debug.Print strNoiseMethod
```

**See Also** • [":MEASure:NOISe:REPort"](#) on page 1008

**History** New in version 4.10.

**:MEASure:NOISe:REPort****Command****NOTE**

This command is available only when the Jitter and Vertical Noise Analysis Software license is installed.

```
:MEASure:NOISe:REPort {SPEctral | TAILfit}
```

When the :MEASure:NOISe:METhod BOTH command selects both the spectral and tail fit methods for random noise analysis, the :MEASure:NOISe:REPort command specifies which method is used for the reports in the noise graphs / histograms and Noise tab measurements.

**Example** This example specifies that the NOISe report include measurements from both the spectral and tail fit analysis (including aperiodic bounded uncorrelated interference ABUI measurements).

```
myScope.WriteString ":MEASure:NOISe:REPort TAILfit"
```

**Query**

```
:MEASure:NOISe:REPort?
```

The :MEASure:NOISe:REPort? query returns the report setting.

**Returned Format**

```
[ :MEASure:NOISe:REPort ] {SPEC | TAIL}<NL>
```

**Example** This example places the report setting in the strReportSetting variable and displays it on the computer's screen.

```
myScope.WriteString ":SYSTem:HEADer OFF" ' Response headers off.
myScope.WriteString ":MEASure:NOISe:REPort?"
strReportSetting = myScope.ReadString
Debug.Print strReportSetting
```

**See Also** • [":MEASure:NOISe:METhod"](#) on page 1007

**History** New in version 4.10.



## :MEASure:NOISe:RN

## Command

## NOTE

This command is available only when the Jitter and Vertical Noise Analysis Software license is installed.

```
:MEASure:NOISe:RN {ON, <RNrms Zero>, <RNrms One> | OFF}
```

The :MEASure:NOISe:RN command can specify a known amount of random noise. When used, the remaining amount of the total noise measured is reported as periodic interference (PI).

This command is used in situations when crosstalk aggressors influence the random noise measured on a signal. If the random noise on a signal is measured without the aggressor signal crosstalk, this known amount of random noise can be specified when measuring the noise again with the crosstalk aggressors.

- ON – Enables a specified amount of random noise.
- <RNrms Zero> – The known amount of "zeros" random noise.
- <RNrms One> – The known amount of "ones" random noise.
- OFF – Disables the specification of random noise amounts.

Specified amounts of "ones" and "zeros" random noise is shown in the noise measurement results (see [page 1003](#)) as "RN(rms specified)".

**Example** This example specifies 100  $\mu$ V of known "zeros" random noise and 200  $\mu$ V of known "ones" random noise.

```
myScope.WriteString ":MEAS:NOISE:RN ON, 100e-6, 200e-6"
```

**Query** :MEASure:NOISe:RN?

The :MEASure:NOISe:RN? query returns the specified RN settings.

**Returned Format** [:MEASure:NOISe:RN] {ON, <RNrms Zero>, <RNrms One> | OFF}<NL>

**Example** This example places the specified RN settings in the strKnownRandomNoise variable and displays it on the computer's screen.

```
myScope.WriteString ":SYSTEM:HEADer OFF" ' Response headers off.
myScope.WriteString ":MEASure:NOISe:RN?"
strKnownRandomNoise = myScope.ReadString
Debug.Print strKnownRandomNoise
```

**History** New in version 3.50.

## :MEASure:NOISe:SCOPE:RN

## Command

## NOTE

This command is available only when the Jitter and Vertical Noise Analysis Software license is installed.

```
:MEASure:NOISe:SCOPE:RN {ON, <RNrms Zero>, <RNrms One> | OFF}
```

The :MEASure:NOISe:SCOPE:RN command can specify the removal of the oscilloscope's calibrated random noise from the reported RN.

- ON – Enables the removal of the oscilloscope's calibrated random noise from the reported RN.
- <RNrms Zero> – The oscilloscope's "zeros" random noise to remove from the reported RN.
- <RNrms One> – The oscilloscope's "ones" random noise to remove from the reported RN.
- OFF – Disables the removal of the oscilloscope's calibrated random noise from the reported RN.

Running the **Calibrate scope jitter / noise** from the front panel user interface will set <RNrms Zero> and <RNrms One> to the measured values; however, the measures values can be changed by this command.

**Example** This example specifies 100  $\mu\text{V}$  of oscilloscope "zeros" random noise and 200  $\mu\text{V}$  of oscilloscope "ones" random noise.

```
myScope.WriteString ":MEAS:NOISE:SCOPE:RN ON, 100e-6, 200e-6"
```

**Query** :MEASure:NOISe:SCOPE:RN?

The :MEASure:NOISe:SCOPE:RN? query returns the oscilloscope RN settings.

**Returned Format** [:MEASure:NOISe:SCOPE:RN] {ON, <RNrms Zero>, <RNrms One> | OFF}<NL>

**Example** This example places the oscilloscope RN settings in the strScopeRandomNoise variable and displays it on the computer's screen.

```
myScope.WriteString ":SYSTem:HEADer OFF" ' Response headers off.
myScope.WriteString ":MEASure:NOISe:SCOPE:RN?"
strScopeRandomNoise = myScope.ReadString
Debug.Print strScopeRandomNoise
```

**History** New in version 3.50.

## :MEASure:NOISe:STATe

### Command

**NOTE**

This command is available only when the Jitter and Vertical Noise Analysis Software license is installed.

---

```
:MEASure:NOISe:STATe {ON | OFF}
```

The :MEASure:NOISe:STATe command enables or disables the NOISe measurements.

**Example** This example sets the NOISe state to on.

```
myScope.WriteString ":MEASure:NOISe:STATe ON"
```

### Query

```
:MEASure:NOISe:STATe?
```

The :MEASure:NOISe:STATe? query returns the state of the NOISe measurements.

### Returned Format

```
[ :MEASure:NOISe:STATe] {1 | 0}<NL>
```

### Example

This example places the current state of the NOISe measurements in the varState variable and displays it on the computer's screen.

```
myScope.WriteString ":SYSTEM:HEADer OFF" ' Response headers off.
myScope.WriteString ":MEASure:NOISe:STATe?"
varState = myScope.ReadNumber
Debug.Print FormatNumber(varState, 0)
```

### History

New in version 3.50.

## :MEASure:NOISe:UNITs

### Command

**NOTE**

This command is available only when the Jitter and Vertical Noise Analysis Software license is installed.

---

```
:MEASure:NOISe:UNITs {VOLT | UNIT}
```

The :MEASure:NOISe:UNITs command sets the unit of measure for NOISe measurements to volts or unit amplitude.

**Example** This example sets the NOISe units to unit amplitude.

```
myScope.WriteString ":MEASure:NOISe:UNITs UNIT"
```

### Query

```
:MEASure:NOISe:UNITs?
```

The :MEASure:NOISe:UNITs? query returns the units of measure being used for the NOISe measurements.

**Returned Format** [:MEASure:NOISe:UNITs] {VOLT | UNIT}<NL>

**Example** This example places the current units of measure for the NOISe measurements in the strUnits variable and displays it on the computer's screen.

```
myScope.WriteString ":SYSTem:HEADer OFF" ' Response headers off.
myScope.WriteString ":MEASure:NOISe:UNITs?"
strUnits = myScope.ReadString
Debug.Print strUnits
```

**History** New in version 3.50.

## :MEASure:NPERiod

**Command** :MEASure:NPERiod <source>, <slope>, <N>

The :MEASure:NPERiod command measures the span of time of N consecutive periods. The measurement then moves over one period and measures the span of time of the next N consecutive periods.

This measurement requires all edges. When you add it, the "Measure All Edges" mode (see **":ANALyze:AEDGes"** on page 273) is automatically set to ON. When the "Measure All Edges" mode is set to OFF, this measurement cannot be made, and there are no measurement results.

**<source>** The source on which the measurement is made.

For more information on <source> parameters, see **"Measurement Sources"** on page 890.

**<slope>** {RISing | FALLing}

**<N>** An integer greater than or equal to 1.

**Example** This example measures the time span of 3 consecutive periods on channel 1 (rising edge).

```
myScope.WriteString ":MEASure:NPERiod CHANnel1,RISing, 3"
```

**Query** :MEASure:NPERiod?

**History** Legacy command (existed before version 3.10).

## :MEASure:NPULses

**Command** :MEASure:NPULses <source>

The :MEASure:NPULses measures the number of negative pulses on the screen.

This measurement requires all edges. When you add it, the "Measure All Edges" mode (see **":ANALyze:AEDGes"** on page 273) is automatically set to ON. When the "Measure All Edges" mode is set to OFF, this measurement cannot be made, and there are no measurement results.

<source> The source on which the measurement is made.

For more information on <source> parameters, see **"Measurement Sources"** on page 890.

**Example** This example measures the number of negative pulses on channel 1.

```
myScope.WriteString ":MEASure:NPULses CHAN1"
```

**Query** :MEASure:NPULses?

This query returns the result for the NPULses measurement.

**History** Legacy command (existed before version 3.10).

## :MEASure:NSIGma

**Command** :MEASure:NSIGma [<source>[, {PCIE | IEEE}]]

The :MEASure:NSIGma command installs a Sigma-n measurement on a PAM-4 waveform.

The Sigma-n measurement computes the noise parameter,  $\sigma_n$  (Sigma-n), for PAM-4 waveforms according to the PCIe 6.0 and IEEE 802.3 (PRBS13Q) standards. The parameter  $\sigma_n$  measures the uncorrelated RMS amplitude noise of each symbol level (including random noise and bounded uncorrelated noise effects), while not including ISI (inter-symbol interference) and jitter effects.

Sigma-n ( $\sigma_n$ ) is a component of Signal to Noise and Distortion Ratio (SNDR) measurements.

- PCIE – This selection uses a process described in the PCIe 6.0 standard: See the oscilloscope's online help for more information.
- IEEE (PRBS13Q) – This selection uses the technique outlined in the IEEE 802.3 specification clause 120D.3.1.6. The algorithm looks for six or more consecutive identical symbols and places the voltage measurement at the center of the 3rd UI. The variance of all those measurements is taken and then the standard deviations are averaged to get  $\sigma_n$ .

The PRBS13Q pattern provides runs of at least six consecutive identical PAM-4 symbols at each of the PAM-4 levels.

See the oscilloscope's online help for more information on the Sigma-n PAM-4 measurement.

<source> {CHANnel<N> | DIFF<D> | COMMONmode<C> | WMEMory<R> | FUNCTion<F> | EQUalized<L>}

**Query** :MEASure:NSIGma? <source>

The :MEASure:NSIGma? query returns the value of a Sigma-n measurement on a PAM-4 waveform.

**Returned Format** <value><NL>

<value> ::= a real number in NR3 format

- See Also**
- **" :MEASure:PAM:LEVel "** on page 1031
  - **" :MEASure:PAM:LRMS "** on page 1033

**History** New in version 6.70.

## :MEASure:NUI

**Command** :MEASure:NUI <source>, <N>

The :MEASure:NUI command measures N consecutive unit intervals. The measurement then moves over one unit interval and measures the span of time of the next N consecutive unit intervals.

<source> The source on which the measurement is made.

For more information on <source> parameters, see "[Measurement Sources](#)" on page 890.

<N> An integer greater than or equal to 1.

**Example** This example measures the time span of 3 consecutive unit intervals on channel 1.

```
myScope.WriteString ":MEASure:NUI CHAN1, 3"
```

**Query** :MEASure:NUI?

The :MEASure:NUI? query returns the measured N-UI jitter.

**NOTE**

This measurement requires the **Measure All Edges** setting to be enabled. You can do this by:

- Installing the measurement on the display (using the command syntax), which automatically enables the **Measure All Edges** setting
- Sending the ":ANALyze:AEDGes ON" command.

**See Also** · "[:ANALyze:AEDGes](#)" on page 273

**History** Legacy command (existed before version 3.10).



## :MEASure:NWIDth

**Command** :MEASure:NWIDth [<source>]

The :MEASure:NWIDth command measures the width of the first negative pulse on the screen using the mid-threshold levels of the waveform (50% levels with standard threshold selected). Sources are specified with the :MEASure:SOURce command or with the optional parameter following the :MEASure:NWIDth command.

The algorithm is:

```
If the first edge on the screen is rising,
then
    nwidth = time at the second rising edge - time at the first
    falling edge
else
    nwidth = time at the first rising edge - time at the first
    falling edge
```

**<source>** {CHANnel<N> | DIFF<D> | COMMONmode<C> | FUNCtion<F> | DIGital<M> | WMEMory<R> | CLOCK | MTRend | MSPectrum | EQUalized<L> | XT<X>}

For more information on <source> parameters, see "[Measurement Sources](#)" on page 890.

**Example** This example measures the width of the first negative pulse on the screen.

```
myScope.WriteString ":MEASure:NWIDth CHANnel1"
```

**Query** :MEASure:NWIDth? [<source>]

The :MEASure:NWIDth? query returns the measured width of the first negative pulse of the specified source.

**Returned Format** [:MEASure:NWIDth] <value>[,<result\_state>] <NL>

**<value>** The width of the first negative pulse on the screen using the mid-threshold levels of the waveform.

**<result\_state>** If SENDvalid is ON, the result state is returned with the measurement result. See the :MEASure:RESults table in this chapter for a list of the result states.

**Example** This example places the current width of the first negative pulse on the screen in the numeric variable, varWidth, then prints the contents of the variable to the computer's screen.

```
myScope.WriteString ":SYSTem:HEADer OFF" ' Response headers off.
myScope.WriteString ":MEASure:NWIDth? CHANnel1"
varWidth = myScope.ReadNumber
Debug.Print FormatNumber(varWidth, 0)
```

**History** Legacy command (existed before version 3.10).

## :MEASure:OMAMplitude

**Command** :MEASure:OMAMplitude [<source>][,{WATT | DBM}]

The :MEASure:OMAMplitude command installs an Optical Modulation Amplitude (OMA) measurement into the user interface's measurement Results pane.

Optical Modulation Amplitude (OMA) is the measure of the difference between the optical power of an NRZ (non-return-to-zero) one pulse and the optical power of an NRZ zero pulse. It requires an NRZ pattern and is designed to be used with a square wave made of consecutive zeros followed by consecutive ones. Be sure to check any relevant standard for one and zero run requirements. All instances are measured if Measure All Edges is selected. Otherwise, the edges closest to the timebase reference are measured.

**<source>** {CHANnel<N> | DIFF<D> | COMMONmode<C> | FUNCTion<F> | WMEMory<R> | CLOCK | MTRend | MSPectrum | EQUALized<L>}

For more information on <source> parameters, see "[Measurement Sources](#)" on page 890.

**{WATT | DBM}** Specifies the measurement units in Watts or dBm.

**Query** :MEASure:OMAMplitude? [<source>][,{WATT | DBM}]

The :MEASure:OMAMplitude? query returns the measured Optical Modulation Amplitude (OMA).

**Returned Format** [:MEASure:OMAMplitude] <value>[,<result\_state>]<NL>

**<value>** The measured Optical Modulation Amplitude (OMA) value.

**<result\_state>** If SENDvalid is ON, the result state is returned with the measurement result. See the :MEASure:RESults table in this chapter for a list of the result states.

- See Also**
- "[:MEASure:ERATio](#)" on page 942
  - "[:MEASure:OPOWER](#)" on page 1019
  - "[:MEASure:CGRade:OLEVel](#)" on page 914
  - "[:MEASure:CGRade:ZLEVel](#)" on page 916

**History** New in version 5.70.

## :MEASure:OPOWer

**Command** :MEASure:OPOWer [<source>] [, {WATT | DBM}]

The :MEASure:OPOWer command installs an Optical Average Power measurement into the user interface's measurement Results pane.

Optical average power is a measure of the true average component of an optical signal. If markers are tracking this measurement, the marker is placed on the optical power Watts. This measurement is commonly used when identifying the fundamental parameters of a lightwave transmitter. However, it differs from other measurements because it does not rely on the waveform display to determine the measurement. The analog-to-digital converter is in the probe itself, independent of the waveform displayed on the screen. You can measure the optical power of an eye diagram.

**<source>** {CHANnel<N> | DIFF<D> | COMMONmode<C> | FUNCTION<F> | WMEMory<R> | CLOCK | MTRend | MSPectrum | EQUalized<L>}

For more information on <source> parameters, see "[Measurement Sources](#)" on page 890.

**{WATT | DBM}** Specifies the measurement units in Watts or dBm.

**Query** :MEASure:OPOWer? [<source>] [, {WATT | DBM}]

The :MEASure:OPOWer? query returns the measured Optical Average Power.

**Returned Format** [:MEASure:OMAMplitude] <value> [, <result\_state>] <NL>

**<value>** The measured Optical Average Power value.

**<result\_state>** If SENDvalid is ON, the result state is returned with the measurement result. See the :MEASure:RESults table in this chapter for a list of the result states.

- See Also**
- "[:MEASure:ERATio](#)" on page 942
  - "[:MEASure:OMAMplitude](#)" on page 1018
  - "[:MEASure:CGRade:OLEVel](#)" on page 914
  - "[:MEASure:CGRade:ZLEVel](#)" on page 916

**History** New in version 5.70.

## :MEASure:OVERshoot

**Command** :MEASure:OVERshoot [<source>[,<direction>]]

The :MEASure:OVERshoot command measures the overshoot of the first edge on the screen. Sources are specified with the :MEASure:SOURce command or with the optional parameter following the :MEASure:OVERshoot command.

The algorithm is:

```
If the first edge on the screen is rising,
then
    overshoot = (Local Vmax - Vtop) / Vamplitude
else
    overshoot = (Vbase - Local Vmin) / Vamplitude
```

**<source>** {CHANnel<N> | DIFF<D> | COMMONmode<C> | FUNCTION<F> | WMEMory<R> | CLOCK | MTRend | MSPectrum | EQUALized<L> | XT<X>}

For more information on <source> parameters, see "[Measurement Sources](#)" on page 890.

**<direction>** {RISing | FALLing}

Specifies whether rising edge overshoot or falling edge overshoot is measured. When <direction> is specified, the <source> parameter is required.

When the "Measure All Edges" mode is OFF (see "[ANALyze:AEDGes](#)" on page 273), the RISing and FALLing options specify whether the first rising or falling edge from the left side of the display grid is used.

When the "Measure All Edges" mode is ON, the RISing and FALLing options specify whether rising edge overshoot or falling edge overshoot is measured throughout the acquisition.

**Example** This example measures the overshoot of the first edge on the screen.

```
myScope.WriteString ":MEASure:OVERshoot CHANnel1"
```

**Query** :MEASure:OVERshoot? [<source>[,<direction>]]

The :MEASure:OVERshoot? query returns the measured overshoot of the specified source.

**Returned Format** [:MEASure:OVERshoot] <value>[,<result\_state>]<NL>

**<value>** Ratio of overshoot to amplitude, in percent.

**<result\_state>** If :MEASure:SENDvalid is ON, the result state is returned with the measurement result. See the :MEASure:RESults table in this chapter for a list of the result states.

**Example** This example places the current value of overshoot in the numeric variable, varValue, then prints the contents of the variable to the computer's screen.

```
myScope.WriteString ":SYSTem:HEADer OFF" ' Response headers off.
myScope.WriteString ":MEASure:OVERshoot? CHANnel1"
```

```
varValue = myScope.ReadNumber  
Debug.Print FormatNumber(varValue, 0)
```

**History** Legacy command (existed before version 3.10).

**:MEASure:PAM:ELEVel**

**Command** `:MEASure:PAM:ELEVel [<source>[,<threshold>]]`

When the signal type is PAM-4 (see `:ANALyze:SIGNal:TYPE`), the `:MEASure:PAM:ELEVel` command installs a vertical center measurement of the specified PAM-4 eye into the user interface's measurement Results pane.

**<source>** {CHANnel<N> | DIFF<D> | COMMONmode<C> | FUNCTion<F> | WMEMory<R> | XT<X>}

For more information on `<source>` parameters, see **"Measurement Sources"** on page 890.

**<threshold>** Specifies eye to measure as an integer. For PAM-4, this may be from 0-2.

**Query** `:MEASure:PAM:ELEVel? [<source>[,<threshold>]]`

The `:MEASure:PAM:ELEVel?` query returns the measured vertical center value of the specified PAM-4 eye.

**Returned Format** `[:MEASure:PAM:ELEVel] <value><NL>`

`<value>` ::= the vertical center value of the specified PAM-4 eye in NR3 format.

- See Also**
- **"`:ANALyze:CLOCK:METHod:SKEW`"** on page 290
  - **"`:ANALyze:SIGNal:DATarate`"** on page 298
  - **"`:ANALyze:SIGNal:SYMBOLrate`"** on page 310
  - **"`:ANALyze:SIGNal:TYPE`"** on page 312
  - **"`:MEASure:CGRade:EWIDth`"** on page 907
  - **"`:MEASure:CGRade:EHEight`"** on page 904
  - **"`:MEASure:FALLtime`"** on page 946
  - **"`:MEASure:PAM:ESKew`"** on page 1024
  - **"`:MEASure:PAM:LEVel`"** on page 1031
  - **"`:MEASure:PAM:LRMS`"** on page 1033
  - **"`:MEASure:PAM:LTHickness`"** on page 1035
  - **"`:MEASure:RISetime`"** on page 1083
  - **"`:MEASure:THResholds:DISPlay`"** on page 1120
  - **"`:MEASure:THResholds:GENeral:METHod`"** on page 1126
  - **"`:MEASure:THResholds:GENeral:PAMCustom`"** on page 1128
  - **"`:MEASure:THResholds:GENeral:PAMAutomatic`"** on page 1130
  - **"`:MEASure:THResholds:RFALL:METHod`"** on page 1143
  - **"`:MEASure:THResholds:RFALL:PAMAutomatic`"** on page 1145
  - **"`:MEASure:TIEData2`"** on page 1167

**History** New in version 5.50.

**:MEASure:PAM:ESKew**

**Command** :MEASure:PAM:ESKew [`<source>` [, `<threshold>` [, `<units>`]]]

When the signal type is PAM-4 (see :ANALyze:SIGNal:TYPE), the :MEASure:PAM:ESKew command installs a horizontal center skew measurement of the specified PAM-4 eye into the user interface's measurement Results pane.

**<source>** {CHANnel<N> | DIFF<D> | COMMONmode<C> | FUNCTion<F> | WMEMory<R> | XT<X>}

For more information on `<source>` parameters, see "[Measurement Sources](#)" on page 890.

**<threshold>** Specifies eye to measure as an integer. For PAM-4, this may be from 0-2.

**<units>** {SECOnd | UNITinterval}

Lets you choose the measurement units. If `<units>` is omitted, the last specified units are used.

**Query** :MEASure:PAM:ESKew? [`<source>` [, `<threshold>` [, `<units>`]]]

The :MEASure:PAM:ESKew? query returns the measured horizontal center skew value of the specified PAM-4 eye.

**Returned Format** [:MEASure:PAM:ESKew] `<value>`<NL>

**<value>** The horizontal center skew value of the specified PAM-4 eye in NR3 format.

- See Also**
- "[:ANALyze:CLOCK:METHod:SKEW](#)" on page 290
  - "[:ANALyze:SIGNal:DATarate](#)" on page 298
  - "[:ANALyze:SIGNal:SYMBOLrate](#)" on page 310
  - "[:ANALyze:SIGNal:TYPE](#)" on page 312
  - "[:MEASure:CGRade:EWIDth](#)" on page 907
  - "[:MEASure:CGRade:EHEight](#)" on page 904
  - "[:MEASure:PAM:EYE:PROBability](#)" on page 1029
  - "[:MEASure:FALLtime](#)" on page 946
  - "[:MEASure:PAM:ELEVEL](#)" on page 1022
  - "[:MEASure:PAM:LEVEL](#)" on page 1031
  - "[:MEASure:PAM:LRMS](#)" on page 1033
  - "[:MEASure:PAM:LTHickness](#)" on page 1035
  - "[:MEASure:RISetime](#)" on page 1083
  - "[:MEASure:THResholds:DISPlay](#)" on page 1120
  - "[:MEASure:THResholds:GENeral:METHod](#)" on page 1126
  - "[:MEASure:THResholds:GENeral:PAMCustom](#)" on page 1128



- **":MEASure:THResholds:GENeral:PAMAutomatic"** on page 1130
- **":MEASure:THResholds:RFALL:METhod"** on page 1143
- **":MEASure:THResholds:RFALL:PAMAutomatic"** on page 1145
- **":MEASure:TIEData2"** on page 1167

**History** New in version 5.50.

Version 6.60: Added the ability to select units in UNITinterval or SECond. This control has been in the graphical user interface and is now available in the remote SCPI command.

## :MEASure:PAM:EYE:ELMethod

**Command** :MEASure:PAM:EYE:ELMethod <method>

The :MEASure:PAM:EYE:ELMethod command selects the basis for determining the location of an eye's center on the waveform.

<method> {MEWidth | MEHeight}

- MEWidth – The eye's center is located at the eye's maximum width midway between the eye's inside left and right edges. This is the default setting.
- MEHeight – The eye's center is located at the eye's maximum height midway between the eye's inside top and bottom edges.

**Query** :MEASure:PAM:EYE:ELMethod?

The :MEASure:PAM:EYE:ELMethod? query returns the selected method for determining the location of an eye's center.

**Returned Format** <method><NL>

<method> ::= {MEW | MEH}

- See Also**
- [":MEASure:PAM:EYE:ESTiming"](#) on page 1027
  - [":MEASure:PAM:EYE:PPERcent"](#) on page 1028
  - [":MEASure:PAM:EYE:TIME:LTDefinition"](#) on page 1030

**History** New in version 6.10.

## :MEASure:PAM:EYE:ESTiming

**Command** :MEASure:PAM:EYE:ESTiming <timing>

The :MEASure:PAM:EYE:ESTiming command configures the timing for sampling the data. Use this setting to match the timing method used by a receiver. For signals with skewed eyes, measurements results will vary depending on this setting.

<timing> {CEYE | PELevel}

- CEYE – Sampling timing is based on the location of the center eye (of the three stacked eyes). This is the default setting.
- PELevel – Sampling timing is independently based on the location of each of the three eyes.

**Query** :MEASure:PAM:EYE:ESTiming?

The :MEASure:PAM:EYE:ESTiming? query returns the selected "timing for sampling" setting.

**Returned Format** <timing><NL>

<timing> ::= {CEYE | PEL}

- See Also**
- [":MEASure:PAM:EYE:ELMethod"](#) on page 1026
  - [":MEASure:PAM:EYE:PPERcent"](#) on page 1028
  - [":MEASure:PAM:EYE:TIME:LTDefinition"](#) on page 1030

**History** New in version 6.10.

## :MEASure:PAM:EYE:PPERcent

**Command** :MEASure:PAM:EYE:PPERcent <percentage>

The :MEASure:PAM:EYE:PPERcent command defines the timespan over which an eye's amplitude level is measured. The timespan is specified as a percentage of the symbol period.

<percentage> Percentage of symbol period in NR3 format. The default setting is 10%.

**Query** :MEASure:PAM:EYE:PPERcent?

The :MEASure:PAM:EYE:PPERcent? query returns the "eye level width" timespan setting.

**Returned Format** <percentage><NL>

- See Also**
- [":MEASure:PAM:EYE:ELMethod"](#) on page 1026
  - [":MEASure:PAM:EYE:ESTiming"](#) on page 1027
  - [":MEASure:PAM:EYE:TIME:LTDefinition"](#) on page 1030

**History** New in version 6.10.

## :MEASure:PAM:EYE:PROBability

**Command** :MEASure:PAM:EYE:PROBability {ZHITs | PROBability,<probability>}

When making PAM eye height or eye width measurements, the :MEASure:PAM:EYE:PROBability command specifies whether eye boundaries (from the center of each eye) are based on zero hits (ZHITs) or at an eye opening BER (Bit Error Ratio) probability (PROBability,<probability>).

The "at probability" setting defines the ratio of total hits in the waveform database column that can occur in the eye's opening. The eye opening probability can be set from 1.0E-01 to 1.0E-09. The default probability is 1.0E-02. No extrapolation is used to determine Eye Height or Eye Width at a specified probability.

Because the eye center time is determined by the measured eye height, Eye Skew measurements are indirectly affected by the eye measurement boundary setting.

<probability> The "at probability" value in NR3 format.

**Query** :MEASure:PAM:EYE:PROBability?

The :MEASure:PAM:EYE:PROBability? query returns the eye measurement boundary setting.

**Returned Format** <setting><NL>

<setting> ::= {ZHIT | PROB,<probability>}

- See Also**
- [":MEASure:CGRade:EWIDth"](#) on page 907
  - [":MEASure:CGRade:EHEight"](#) on page 904
  - [":MEASure:PAM:ESKew"](#) on page 1024
  - [":MEASure:PAM:EYE:ELMethod"](#) on page 1026

**History** New in version 6.30.

## :MEASure:PAM:EYE:TIME:LTDefinition

**Command** :MEASure:PAM:EYE:TIME:LTDefinition <method>

The :MEASure:PAM:EYE:TIME:LTDefinition command specifies the method used to locate the time at which to measure an eye's level.

<method> {MRMS | ECENter}

- ECENter – The time of a level is the average of the centers of the adjacent eyes. This is the default setting.
- MRMS – The time is located within the eye's level width at the minimum level thickness (RMS values).

**Query** :MEASure:PAM:EYE:TIME:LTDefinition?

The :MEASure:PAM:EYE:TIME:LTDefinition? query returns the specified method used to locate the time at which to measure an eye's level.

**Returned Format** <method><NL>

<method> ::= {MRMS | ECEN}

- See Also**
- [":MEASure:PAM:EYE:ELMethod"](#) on page 1026
  - [":MEASure:PAM:EYE:ESTiming"](#) on page 1027
  - [":MEASure:PAM:EYE:PPERcent"](#) on page 1028

**History** New in version 6.10.

## :MEASure:PAM:LEVel

**Command** :MEASure:PAM:LEVel [<source>[,<level>]]

When the signal type is PAM-4 (see :ANALyze:SIGNal:TYPE), the :MEASure:PAM:LEVel command installs a mean voltage measurement of the specified PAM-4 level into the user interface's measurement Results pane.

**<source>** {CHANnel<N> | DIFF<D> | COMMONmode<C> | FUNCTion<F> | WMEMory<R> | XT<X>}

For more information on <source> parameters, see "[Measurement Sources](#)" on page 890.

**<level>** Specifies the PAM level to measure as an integer. For PAM-4, this may be from 0-3. If omitted, the last specified level is used.

**Query** :MEASure:PAM:LEVel? [<source>[,<level>]]

The :MEASure:PAM:LEVel? query returns the measured mean voltage value of the specified PAM-4 level.

**Returned Format** [:MEASure:PAM:LEVel] <value><NL>

<value> ::= the mean voltage value of the specified PAM-4 level in NR3 format.

- See Also**
- "[:ANALyze:CLOCK:METHod:SKEW](#)" on page 290
  - "[:ANALyze:SIGNal:DATarate](#)" on page 298
  - "[:ANALyze:SIGNal:SYMBOLrate](#)" on page 310
  - "[:ANALyze:SIGNal:TYPE](#)" on page 312
  - "[:MEASure:CGRade:EWIDth](#)" on page 907
  - "[:MEASure:CGRade:EHEight](#)" on page 904
  - "[:MEASure:FALLtime](#)" on page 946
  - "[:MEASure:PAM:ELEVel](#)" on page 1022
  - "[:MEASure:PAM:ESKew](#)" on page 1024
  - "[:MEASure:PAM:LRMS](#)" on page 1033
  - "[:MEASure:PAM:LTHickness](#)" on page 1035
  - "[:MEASure:RISetime](#)" on page 1083
  - "[:MEASure:THResholds:DISPlay](#)" on page 1120
  - "[:MEASure:THResholds:GENeral:METHod](#)" on page 1126
  - "[:MEASure:THResholds:GENeral:PAMCustom](#)" on page 1128
  - "[:MEASure:THResholds:GENeral:PAMAutomatic](#)" on page 1130
  - "[:MEASure:THResholds:RFALL:METHod](#)" on page 1143
  - "[:MEASure:THResholds:RFALL:PAMAutomatic](#)" on page 1145

- **":MEASure:TIEData2"** on page 1167

**History** New in version 5.50.



## :MEASure:PAM:LRMS

**Command** :MEASure:PAM:LRMS [<source>[,<level>]]

When the signal type is PAM-4 (see :ANALyze:SIGNal:TYPE), the :MEASure:PAM:LRMS command installs a RMS voltage measurement of the specified PAM-4 level into the user interface's measurement Results pane.

**<source>** {CHANnel<N> | DIFF<D> | COMMONmode<C> | FUNCTion<F> | WMEMory<R> | XT<X>}

For more information on <source> parameters, see "[Measurement Sources](#)" on page 890.

**<level>** Specifies the PAM level to measure as an integer. For PAM-4, this may be from 0-3. If omitted, the last specified level is used.

**Query** :MEASure:PAM:LRMS? [<source>[,<level>]]

The :MEASure:PAM:LRMS? query returns the measured RMS voltage value of the specified PAM-4 level.

**Returned Format** [:MEASure:PAM:LRMS] <value><NL>

<value> ::= the RMS voltage value of the specified PAM-4 level in NR3 format.

- See Also**
- "[:ANALyze:CLOCK:METHod:SKEW](#)" on page 290
  - "[:ANALyze:SIGNal:DATarate](#)" on page 298
  - "[:ANALyze:SIGNal:SYMBOLrate](#)" on page 310
  - "[:ANALyze:SIGNal:TYPE](#)" on page 312
  - "[:MEASure:CGRade:EWIDth](#)" on page 907
  - "[:MEASure:CGRade:EHEight](#)" on page 904
  - "[:MEASure:FALLtime](#)" on page 946
  - "[:MEASure:PAM:ELEVEL](#)" on page 1022
  - "[:MEASure:PAM:ESKew](#)" on page 1024
  - "[:MEASure:PAM:LEVEL](#)" on page 1031
  - "[:MEASure:PAM:LTHickness](#)" on page 1035
  - "[:MEASure:RISetime](#)" on page 1083
  - "[:MEASure:THResholds:DISPlay](#)" on page 1120
  - "[:MEASure:THResholds:GENeral:METHod](#)" on page 1126
  - "[:MEASure:THResholds:GENeral:PAMCustom](#)" on page 1128
  - "[:MEASure:THResholds:GENeral:PAMAutomatic](#)" on page 1130
  - "[:MEASure:THResholds:RFALL:METHod](#)" on page 1143
  - "[:MEASure:THResholds:RFALL:PAMAutomatic](#)" on page 1145

- **":MEASure:TIEData2"** on page 1167

**History** New in version 5.50.

## :MEASure:PAM:LTHickness

**Command** :MEASure:PAM:LTHickness [<source>[,<level>]]

When the signal type is PAM-4 (see :ANALyze:SIGNal:TYPE), the :MEASure:PAM:LTHickness command installs an eye diagram level thickness measurement of the specified PAM-4 level into the user interface's measurement Results pane.

**<source>** {CHANnel<N> | DIFF<D> | COMMONmode<C> | FUNCTION<F> | WMEMory<R> | XT<X>}

For more information on <source> parameters, see "[Measurement Sources](#)" on page 890.

**<level>** Specifies the PAM level to measure as an integer. For PAM-4, this may be from 0-3. If omitted, the last specified level is used.

**Query** :MEASure:PAM:LTHickness? [<source>[,<level>]]

The :MEASure:PAM:LTHickness? query returns the measured thickness of the specified PAM-4 level.

**Returned Format** [:MEASure:PAM:LTHickness] <value><NL>

<value> ::= the thickness value of the specified PAM-4 level in NR3 format.

- See Also**
- "[:ANALyze:CLOCK:METHod:SKEW](#)" on page 290
  - "[:ANALyze:SIGNal:DATarate](#)" on page 298
  - "[:ANALyze:SIGNal:SYMBOLrate](#)" on page 310
  - "[:ANALyze:SIGNal:TYPE](#)" on page 312
  - "[:MEASure:CGRade:EWIDth](#)" on page 907
  - "[:MEASure:CGRade:EHEight](#)" on page 904
  - "[:MEASure:FALLtime](#)" on page 946
  - "[:MEASure:PAM:ELEVel](#)" on page 1022
  - "[:MEASure:PAM:ESKew](#)" on page 1024
  - "[:MEASure:PAM:LEVel](#)" on page 1031
  - "[:MEASure:PAM:LRMS](#)" on page 1033
  - "[:MEASure:RISetime](#)" on page 1083
  - "[:MEASure:THResholds:DISPlay](#)" on page 1120
  - "[:MEASure:THResholds:GENeral:METHod](#)" on page 1126
  - "[:MEASure:THResholds:GENeral:PAMCustom](#)" on page 1128
  - "[:MEASure:THResholds:GENeral:PAMAutomatic](#)" on page 1130
  - "[:MEASure:THResholds:RFALL:METHod](#)" on page 1143

- `":MEASure:THResholds:RFALL:PAMAutomatic"` on page 1145
- `":MEASure:TIEData2"` on page 1167

**History** New in version 5.50.

## :MEASure:PAM:PRBS13q:COUNT

**Command** :MEASure:PAM:PRBS13q:COUNT <report\_count>

The :MEASure:PAM:PRBS13q:COUNT command lets you change the PRBS13Q edge (12-edge) jitter measurement count.

The IEEE 802.3bs standard specifies PRBS13Q edge (12-edge) jitter measurements must be made 10,000 times, but you can use this command to change the count that is actually used.

<report\_count> Number of acquisitions to measure from 200 to 10000 in NR1 format.

**Query** :MEASure:PAM:PRBS13q:COUNT?

The :MEASure:PAM:PRBS13q:COUNT? query returns the PRBS13Q edge (12-edge) jitter measurement count setting.

**Returned Format** <report\_count><NL>

- See Also**
- [":MEASure:PAM:PRBS13q:EDGE:EOJ"](#) on page 1038
  - [":MEASure:PAM:PRBS13q:EDGE:J3U"](#) on page 1039
  - [":MEASure:PAM:PRBS13q:EDGE:J4U"](#) on page 1040
  - [":MEASure:PAM:PRBS13q:EDGE:J6U"](#) on page 1041
  - [":MEASure:PAM:PRBS13q:EDGE:JRMS"](#) on page 1042
  - [":MEASure:PAM:PRBS13q:HUNits"](#) on page 1043
  - [":MEASure:PAM:PRBS13q:PATtern"](#) on page 1044
  - [":MEASure:PAM:PRBS13q:PFILe"](#) on page 1045
  - [":MEASure:PAM:PRBS13q:STATe"](#) on page 1046
  - [":MEASure:PAM:PRBS13q:UNITs"](#) on page 1047

**History** New in version 6.50.

## :MEASure:PAM:PRBS13q:EDGE:EOJ

**Query** :MEASure:PAM:PRBS13q:EDGE:EOJ?

When the signal type is PAM-4 and PRBS13Q edge (12-edge) jitter measurements are enabled (by the :MEASure:PAM:PRBS13q:STATe command), the :MEASure:PAM:PRBS13q:EDGE:EOJ? query returns the measured PRBS13Q even-odd jitter (EOJ) values.

**Returned Format** <comma-separated\_values><NL>

The returned comma-separated values contain:

- A composite measurement value.
- Values for individual rising and falling edges (R13, F21, F30, R03, F10, R02, R12, R23, R01, F20, F32, and F31).
- A count of the number of edges measured.

If the count is less than (<) the Jrms/J4u Report Count (see :MEASure:PAM:PRBS13q:COUNt), the returned value is the number of edges measured so far.

If the count is greater than or equal to (>=) the Jrms/J4u Report Count, the returned value is the number of edges reflected in the measurement results.

- If :MEASure:SENDvalid is ON, a result state is returned. See **Table 14** for the meaning of the result state codes.

The complete list of comma-separated values is:

(Composite, R13, F21, F30, R03, F10, R02, R12, R23, R01, F20, F32, F31, Count [,<result state>])

- See Also**
- **" :MEASure:PAM:PRBS13q:COUNt "** on page 1037
  - **" :MEASure:PAM:PRBS13q:EDGE:J3U "** on page 1039
  - **" :MEASure:PAM:PRBS13q:EDGE:J4U "** on page 1040
  - **" :MEASure:PAM:PRBS13q:EDGE:J6U "** on page 1041
  - **" :MEASure:PAM:PRBS13q:EDGE:JRMS "** on page 1042
  - **" :MEASure:PAM:PRBS13q:HUNits "** on page 1043
  - **" :MEASure:PAM:PRBS13q:PATtern "** on page 1044
  - **" :MEASure:PAM:PRBS13q:PFIle "** on page 1045
  - **" :MEASure:PAM:PRBS13q:STATe "** on page 1046
  - **" :MEASure:PAM:PRBS13q:UNITs "** on page 1047
  - **" :MEASure:SENDvalid "** on page 1109

**History** New in version 6.50.

## :MEASure:PAM:PRBS13q:EDGE:J3U

**Query** :MEASure:PAM:PRBS13q:EDGE:J3U?

When the signal type is PAM-4 and PRBS13Q edge (12-edge) jitter measurements are enabled (by the :MEASure:PAM:PRBS13q:STATe command), the :MEASure:PAM:PRBS13q:EDGE:J3U? query returns the measured PRBS13Q J3u values.

**Returned Format** <comma-separated\_values><NL>

The returned comma-separated values contain:

- A composite measurement value.
- Values for individual rising and falling edges (R13, F21, F30, R03, F10, R02, R12, R23, R01, F20, F32, and F31).
- A count of the number of edges measured.

If the count is less than (<) the Jrms/J4u Report Count (see :MEASure:PAM:PRBS13q:COUNt), the returned value is the number of edges measured so far.

If the count is greater than or equal to (>=) the Jrms/J4u Report Count, the returned value is the number of edges reflected in the measurement results.

- If :MEASure:SENDvalid is ON, a result state is returned. See **Table 14** for the meaning of the result state codes.

The complete list of comma-separated values is:

(Composite, R13, F21, F30, R03, F10, R02, R12, R23, R01, F20, F32, F31, Count [,<result state>])

- See Also**
- **":MEASure:PAM:PRBS13q:COUNt"** on page 1037
  - **":MEASure:PAM:PRBS13q:EDGE:EOJ"** on page 1038
  - **":MEASure:PAM:PRBS13q:EDGE:J4U"** on page 1040
  - **":MEASure:PAM:PRBS13q:EDGE:J6U"** on page 1041
  - **":MEASure:PAM:PRBS13q:EDGE:JRMS"** on page 1042
  - **":MEASure:PAM:PRBS13q:HUNits"** on page 1043
  - **":MEASure:PAM:PRBS13q:PATtern"** on page 1044
  - **":MEASure:PAM:PRBS13q:PFIle"** on page 1045
  - **":MEASure:PAM:PRBS13q:STATe"** on page 1046
  - **":MEASure:PAM:PRBS13q:UNITs"** on page 1047
  - **":MEASure:SENDvalid"** on page 1109

**History** New in version 6.50.

## :MEASure:PAM:PRBS13q:EDGE:J4U

**Query** :MEASure:PAM:PRBS13q:EDGE:J4U?

When the signal type is PAM-4 and PRBS13Q edge (12-edge) jitter measurements are enabled (by the :MEASure:PAM:PRBS13q:STATe command), the :MEASure:PAM:PRBS13q:EDGE:J4U? query returns the measured PRBS13Q J4u values.

**Returned Format** <comma-separated\_values><NL>

The returned comma-separated values contain:

- A composite measurement value.
- Values for individual rising and falling edges (R13, F21, F30, R03, F10, R02, R12, R23, R01, F20, F32, and F31).
- A count of the number of edges measured.

If the count is less than (<) the Jrms/J4u Report Count (see :MEASure:PAM:PRBS13q:COUNt), the returned value is the number of edges measured so far.

If the count is greater than or equal to (>=) the Jrms/J4u Report Count, the returned value is the number of edges reflected in the measurement results.

- If :MEASure:SENDvalid is ON, a result state is returned. See [Table 14](#) for the meaning of the result state codes.

The complete list of comma-separated values is:

(Composite, R13, F21, F30, R03, F10, R02, R12, R23, R01, F20, F32, F31, Count [,<result state>])

- See Also**
- [":MEASure:PAM:PRBS13q:COUNt"](#) on page 1037
  - [":MEASure:PAM:PRBS13q:EDGE:EOJ"](#) on page 1038
  - [":MEASure:PAM:PRBS13q:EDGE:J3U"](#) on page 1039
  - [":MEASure:PAM:PRBS13q:EDGE:J6U"](#) on page 1041
  - [":MEASure:PAM:PRBS13q:EDGE:JRMS"](#) on page 1042
  - [":MEASure:PAM:PRBS13q:HUNits"](#) on page 1043
  - [":MEASure:PAM:PRBS13q:PATtern"](#) on page 1044
  - [":MEASure:PAM:PRBS13q:PFIle"](#) on page 1045
  - [":MEASure:PAM:PRBS13q:STATe"](#) on page 1046
  - [":MEASure:PAM:PRBS13q:UNITs"](#) on page 1047
  - [":MEASure:SENDvalid"](#) on page 1109

**History** New in version 6.50.



## :MEASure:PAM:PRBS13q:EDGE:J6U

**Query** :MEASure:PAM:PRBS13q:EDGE:J6U?

When the signal type is PAM-4 and PRBS13Q edge (12-edge) jitter measurements are enabled (by the :MEASure:PAM:PRBS13q:STATe command), the :MEASure:PAM:PRBS13q:EDGE:J6U? query returns the measured PRBS13Q J6U values.

**Returned Format** <comma-separated\_values><NL>

The returned comma-separated values contain:

- A composite measurement value.
- Values for individual rising and falling edges (R13, F21, F30, R03, F10, R02, R12, R23, R01, F20, F32, and F31).
- A count of the number of edges measured.

If the count is less than (<) the Jrms/J6u Report Count (see :MEASure:PAM:PRBS13q:COUNt), the returned value is the number of edges measured so far.

If the count is greater than or equal to (>=) the Jrms/J6u Report Count, the returned value is the number of edges reflected in the measurement results.

- If :MEASure:SENDvalid is ON, a result state is returned. See [Table 14](#) for the meaning of the result state codes.

The complete list of comma-separated values is:

(Composite, R13, F21, F30, R03, F10, R02, R12, R23, R01, F20, F32, F31, Count [,<result state>])

- See Also**
- [":MEASure:PAM:PRBS13q:COUNt"](#) on page 1037
  - [":MEASure:PAM:PRBS13q:EDGE:EOJ"](#) on page 1038
  - [":MEASure:PAM:PRBS13q:EDGE:J3U"](#) on page 1039
  - [":MEASure:PAM:PRBS13q:EDGE:J4U"](#) on page 1040
  - [":MEASure:PAM:PRBS13q:EDGE:JRMS"](#) on page 1042
  - [":MEASure:PAM:PRBS13q:HUNits"](#) on page 1043
  - [":MEASure:PAM:PRBS13q:PATtern"](#) on page 1044
  - [":MEASure:PAM:PRBS13q:PFIle"](#) on page 1045
  - [":MEASure:PAM:PRBS13q:STATe"](#) on page 1046
  - [":MEASure:PAM:PRBS13q:UNITs"](#) on page 1047
  - [":MEASure:SENDvalid"](#) on page 1109

**History** New in version 6.70.

## :MEASure:PAM:PRBS13q:EDGE:JRMS

**Query** :MEASure:PAM:PRBS13q:EDGE:JRMS?

When the signal type is PAM-4 and PRBS13Q edge (12-edge) jitter measurements are enabled (by the :MEASure:PAM:PRBS13q:STATe command), the :MEASure:PAM:PRBS13q:EDGE:JRMS? query returns the measured PRBS13Q Jrms values.

**Returned Format** <comma-separated\_values><NL>

The returned comma-separated values contain:

- A composite measurement value.
- Values for individual rising and falling edges (R13, F21, F30, R03, F10, R02, R12, R23, R01, F20, F32, and F31).
- A count of the number of edges measured.

If the count is less than (<) the Jrms/J4u Report Count (see :MEASure:PAM:PRBS13q:COUNt), the returned value is the number of edges measured so far.

If the count is greater than or equal to (>=) the Jrms/J4u Report Count, the returned value is the number of edges reflected in the measurement results.

- If :MEASure:SENDvalid is ON, a result state is returned. See [Table 14](#) for the meaning of the result state codes.

The complete list of comma-separated values is:

(Composite, R13, F21, F30, R03, F10, R02, R12, R23, R01, F20, F32, F31, Count [,<result state>])

- See Also**
- [":MEASure:PAM:PRBS13q:COUNt"](#) on page 1037
  - [":MEASure:PAM:PRBS13q:EDGE:EOJ"](#) on page 1038
  - [":MEASure:PAM:PRBS13q:EDGE:J3U"](#) on page 1039
  - [":MEASure:PAM:PRBS13q:EDGE:J4U"](#) on page 1040
  - [":MEASure:PAM:PRBS13q:EDGE:J6U"](#) on page 1041
  - [":MEASure:PAM:PRBS13q:HUNits"](#) on page 1043
  - [":MEASure:PAM:PRBS13q:PATtern"](#) on page 1044
  - [":MEASure:PAM:PRBS13q:PFIle"](#) on page 1045
  - [":MEASure:PAM:PRBS13q:STATe"](#) on page 1046
  - [":MEASure:PAM:PRBS13q:UNITs"](#) on page 1047
  - [":MEASure:SENDvalid"](#) on page 1109

**History** New in version 6.50.

## :MEASure:PAM:PRBS13q:HUNits

**Command** :MEASure:PAM:PRBS13q:HUNits <graph\_scale>

The :MEASure:PAM:PRBS13q:HUNits command specifies the PRBS13Q edge (12-edge) jitter measurement graph scale (either Linear or Logarithmic).

<graph\_scale> {LINear | LOG}

**Query** :MEASure:PAM:PRBS13q:HUNits?

The :MEASure:PAM:PRBS13q:HUNits? query returns the PRBS13Q edge (12-edge) jitter measurement graph scale setting.

**Returned Format** <graph\_scale><NL>

<graph\_scale> ::= {LIN | LOG}

- See Also**
- [":MEASure:PAM:PRBS13q:COUNT"](#) on page 1037
  - [":MEASure:PAM:PRBS13q:EDGE:EOJ"](#) on page 1038
  - [":MEASure:PAM:PRBS13q:EDGE:J3U"](#) on page 1039
  - [":MEASure:PAM:PRBS13q:EDGE:J4U"](#) on page 1040
  - [":MEASure:PAM:PRBS13q:EDGE:J6U"](#) on page 1041
  - [":MEASure:PAM:PRBS13q:EDGE:JRMS"](#) on page 1042
  - [":MEASure:PAM:PRBS13q:PATtern"](#) on page 1044
  - [":MEASure:PAM:PRBS13q:PFIle"](#) on page 1045
  - [":MEASure:PAM:PRBS13q:STATe"](#) on page 1046
  - [":MEASure:PAM:PRBS13q:UNITs"](#) on page 1047

**History** New in version 6.50.

## :MEASure:PAM:PRBS13q:PATtern

**Command** :MEASure:PAM:PRBS13q:PATtern {P13Q | PCI6 | FILE}

The :MEASure:PAM:PRBS13q:PATtern command specifies the edge definition for the 12-edge jitter measurements' data pattern:

- P13Q – uses the known edge definition for the PRBS13Q data pattern.
- P9Q – uses the known edge definition for the PRBS9Q data pattern.
- PCI6 – uses the known edge definition for the PCIE6 (52 symbols) data pattern.
- FILE – uses the edge definition specified in a file for a custom data pattern.

When the FILE option is selected, use the :MEASure:PAM:PRBS13q:PFILE command to specify the full-path location of the edge definition file.

**Query** :MEASure:PAM:PRBS13q:PATtern?

The :MEASure:PAM:PRBS13q:PATtern? query returns the edge definition being used.

**Returned Format** <option><NL>

<option> ::= {P13Q | P9Q | PCI6 | FILE}

- See Also**
- [":MEASure:PAM:PRBS13q:COUNT"](#) on page 1037
  - [":MEASure:PAM:PRBS13q:EDGE:EOJ"](#) on page 1038
  - [":MEASure:PAM:PRBS13q:EDGE:J3U"](#) on page 1039
  - [":MEASure:PAM:PRBS13q:EDGE:J4U"](#) on page 1040
  - [":MEASure:PAM:PRBS13q:EDGE:J6U"](#) on page 1041
  - [":MEASure:PAM:PRBS13q:EDGE:JRMS"](#) on page 1042
  - [":MEASure:PAM:PRBS13q:HUNits"](#) on page 1043
  - [":MEASure:PAM:PRBS13q:PFILE"](#) on page 1045
  - [":MEASure:PAM:PRBS13q:STATe"](#) on page 1046
  - [":MEASure:PAM:PRBS13q:UNITs"](#) on page 1047

**History** New in version 6.70.

## :MEASure:PAM:PRBS13q:PFIle

**Command** :MEASure:PAM:PRBS13q:PFIle <full-path\_string>

When a custom data pattern is being used, the :MEASure:PAM:PRBS13q:PFIle command specifies the full-path location of the edge definition file for that pattern.

The :MEASure:PAM:PRBS13q:PATtern command specifies whether edge definitions for PRBS13Q, PCIE6 (52 symbols), or a custom data pattern should be used.

<full-path\_string> A quoted string of the full path of the edge definition file for a custom data pattern.

**Query** :MEASure:PAM:PRBS13q:PFIle?

The :MEASure:PAM:PRBS13q:PFIle? query returns the edge definition file's full-path quoted string.

**Returned Format** <full-path\_string><NL>

<full-path\_string> ::= A quoted string.

- See Also**
- [":MEASure:PAM:PRBS13q:COUNT"](#) on page 1037
  - [":MEASure:PAM:PRBS13q:EDGE:EOJ"](#) on page 1038
  - [":MEASure:PAM:PRBS13q:EDGE:J3U"](#) on page 1039
  - [":MEASure:PAM:PRBS13q:EDGE:J4U"](#) on page 1040
  - [":MEASure:PAM:PRBS13q:EDGE:J6U"](#) on page 1041
  - [":MEASure:PAM:PRBS13q:EDGE:JRMS"](#) on page 1042
  - [":MEASure:PAM:PRBS13q:HUNits"](#) on page 1043
  - [":MEASure:PAM:PRBS13q:PATtern"](#) on page 1044
  - [":MEASure:PAM:PRBS13q:STATe"](#) on page 1046
  - [":MEASure:PAM:PRBS13q:UNITs"](#) on page 1047

**History** New in version 6.70.

## :MEASure:PAM:PRBS13q:STATe

**Command** :MEASure:PAM:PRBS13q:STATe <source>, {{ON | 1} | {OFF | 0}}

The :MEASure:PAM:PRBS13q:STATe command enables or disables the PRBS13Q edge (12-edge) jitter measurements on a source waveform.

Before you can enable PRBS13Q edge (12-edge) jitter measurements, the PAM4 signal type must be specified for the source waveform using the :ANALyze:SIGNal:TYPE command.

<source> {CHANnel<N> | DIFF<D> | COMMONmode<C> | WMEMory<R> | FUNCtion<F> | EQUalized<L>}

**Query** :MEASure:PAM:PRBS13q:STATe? <source>

The :MEASure:PAM:PRBS13q:STATe? query returns whether PRBS13Q edge (12-edge) jitter measurements are enabled for the source waveform.

**Returned Format** <setting><NL>

<setting> ::= {1 | 0}

- See Also**
- [":ANALyze:SIGNal:TYPE"](#) on page 312
  - [":MEASure:PAM:PRBS13q:COUNt"](#) on page 1037
  - [":MEASure:PAM:PRBS13q:EDGE:EOJ"](#) on page 1038
  - [":MEASure:PAM:PRBS13q:EDGE:J3U"](#) on page 1039
  - [":MEASure:PAM:PRBS13q:EDGE:J4U"](#) on page 1040
  - [":MEASure:PAM:PRBS13q:EDGE:J6U"](#) on page 1041
  - [":MEASure:PAM:PRBS13q:EDGE:JRMS"](#) on page 1042
  - [":MEASure:PAM:PRBS13q:HUNits"](#) on page 1043
  - [":MEASure:PAM:PRBS13q:PATtern"](#) on page 1044
  - [":MEASure:PAM:PRBS13q:PFILe"](#) on page 1045
  - [":MEASure:PAM:PRBS13q:UNITs"](#) on page 1047

**History** New in version 6.50.

## :MEASure:PAM:PRBS13q:UNITs

**Command** :MEASure:PAM:PRBS13q:UNITs <units>

The :MEASure:PAM:PRBS13q:UNITs command specifies the PRBS13Q edge (12-edge) jitter measurement units (either Seconds or Unit Interval).

<units> {SECond | UNITinterval}

**Query** :MEASure:PAM:PRBS13q:UNITs?

The :MEASure:PAM:PRBS13q:UNITs? query returns the PRBS13Q edge (12-edge) jitter measurement units setting.

**Returned Format** <units><NL>

<units> ::= {SEC | UNIT}

- See Also**
- [":MEASure:PAM:PRBS13q:COUNT"](#) on page 1037
  - [":MEASure:PAM:PRBS13q:EDGE:EOJ"](#) on page 1038
  - [":MEASure:PAM:PRBS13q:EDGE:J3U"](#) on page 1039
  - [":MEASure:PAM:PRBS13q:EDGE:J4U"](#) on page 1040
  - [":MEASure:PAM:PRBS13q:EDGE:J6U"](#) on page 1041
  - [":MEASure:PAM:PRBS13q:EDGE:JRMS"](#) on page 1042
  - [":MEASure:PAM:PRBS13q:HUNits"](#) on page 1043
  - [":MEASure:PAM:PRBS13q:PATtern"](#) on page 1044
  - [":MEASure:PAM:PRBS13q:PFILE"](#) on page 1045
  - [":MEASure:PAM:PRBS13q:STATE"](#) on page 1046

**History** New in version 6.50.

## :MEASure:PAMplitude

**Command** :MEASure:PAMplitude [<source>, <width>, <direction>]

The :MEASure:PAMplitude command measures the pulse amplitude around the specified edge. There is only a single width applied to the top and base for the amplitude measurement.

**<source>** {CHANnel<N> | DIFF<D> | COMMONmode<C> | FUNCTION<F> | WMEMory<R> | XT<X>}

For more information on <source> parameters, see "[Measurement Sources](#)" on page 890.

**<width>** width to measure at the top and base of the pulse (in percent, 0-100)

**<direction>** the edge direction to measure (RISing or FALLing). The pulse measured is to the left and right of the specified edge.

**Example** This example measures the pulse amplitude around a rising edge (width set to 50%)

```
myScope.WriteString ":MEASure:PAMplitude CHAN1, 50, RISing"
```

**Query** :MEASure:PAMplitude? <source>, <width>, <direction>

The :MEASure:PAMplitude? query returns the pulse amplitude around the specified edge.

**History** Legacy command (existed before version 3.10).



## :MEASure:PBASe

**Command** :MEASure:PBASe <source>, <pulse width percent>

The :MEASure:PBASe command measures the average of the data of a negative pulse within the pulse window. The pulse window is a range of data centered within the pulse width using the specified percentage of the data as measured as the middle threshold level. For example, a 50% window would not include in the average the first or last 25% of the pulse width as measured at the middle threshold level. A 100% window would measure the average of the entire positive or negative pulse. In measure all edges mode and EZJIT, these measurements can be trended, histogrammed, etc.

<source> {CHANnel<N> | DIFF<D> | COMMONmode<C> | FUNCTION<F> | WMemory<R> | XT<X>}

For more information on <source> parameters, see "[Measurement Sources](#)" on page 890.

<pulse width percent> pulse width percent to use in average (in percent, 0-100)

**Example** This example measures the average of the data of a negative pulse within the pulse window (width set to 50%)

```
myScope.WriteString ":MEASure:PBASe CHAN1, 50"
```

**Query** :MEASure:PBASe? <source>, <pulse width percentage>

The :MEASure:PBASe? query returns the average pulse base of the data of a negative pulse within the specified pulse window.

**History** Legacy command (existed before version 3.10).

## :MEASure:PERiod

**Command** :MEASure:PERiod [<source>[,<direction>]]

The :MEASure:PERiod command measures the period of the first complete cycle on the screen using the mid-threshold levels of the waveform (50% levels with standard measurements selected).

The source is specified with the :MEASure:SOURce command or with the optional parameter following the :MEASure:PERiod command.

The algorithm is:

```
If the first edge on the screen is rising,
then
    period = second rising edge time - first rising edge time
else
    period = second falling edge time - first falling edge time
```

**<source>** {CHANnel<N> | DIFF<D> | COMMONmode<C> | FUNCTION<F> | DIGital<M> | WMEMory<R> | CLOCK | MTRend | MSPectrum | EQUalized<L> | XT<X>}

For more information on <source> parameters, see "[Measurement Sources](#)" on page 890.

**<direction>** {RISing | FALLing}

Specifies whether the period is measured from rising edge to rising edge or from falling edge to falling edge. When <direction> is specified, the <source> parameter is required.

When the "Measure All Edges" mode is OFF (see "[:ANALyze:AEDGes](#)" on page 273), the RISing and FALLing options specify whether the first rising or falling edge from the left side of the display grid is used.

When the "Measure All Edges" mode is ON, the RISing and FALLing options specify whether whether the period is measured from rising edge to rising edge or from falling edge to falling edge throughout the acquisition.

**Example** This example measures the period of the waveform.

```
myScope.WriteString ":MEASure:PERiod CHANnel1"
```

**Query** :MEASure:PERiod? [<source>[,<direction>]]

The :MEASure:PERiod? query returns the measured period of the specified source.

**Returned Format** [:MEASure:PERiod] <value>[,<result\_state>]<NL>

**<value>** Period of the first complete cycle on the screen.

**<result\_state>** If SENDvalid is ON, the result state is returned with the measurement result. See the :MEASure:RESults table in this chapter for a list of the result states.

**Example** This example places the current period of the waveform in the numeric variable, varValue, then prints the contents of the variable to the computer's screen.

```
myScope.WriteString ":SYSTEM:HEADer OFF" ' Response headers off.  
myScope.WriteString ":MEASure:PERiod? CHANnel1"  
varValue = myScope.ReadNumber  
Debug.Print FormatNumber(varValue, 0)
```

**History** Legacy command (existed before version 3.10).

## :MEASure:PHASe

**Command** :MEASure:PHASe [<source>[,<source>[,<direction>]]]

The :MEASure:PHASe command measures the phase in degrees between two edges. If two sources are specified, the phase from the specified edge of the first source to the specified edge of the second source is measured. If one source is specified, the phase is always 0.0E0.00°.

This measurement requires all edges. When you add it, the "Measure All Edges" mode (see **":ANALyze:AEDGes"** on page 273) is automatically set to ON. When the "Measure All Edges" mode is set to OFF, this measurement cannot be made, and there are no measurement results.

**<source>** {CHANnel<N> | DIFF<D> | COMMONmode<C> | FUNction<F> | WMEMory<R> | CLOCk | MTRend | MSPectrum | EQUalized<L> | XT<X>}

For more information on <source> parameters, see **"Measurement Sources"** on page 890.

**<direction>** {RISing | FALLing}

Specifies direction of edge to measure. When <direction> is specified, the <source> parameter is required.

**Example** This example measures the phase between channel 1 and channel 2.

```
myScope.WriteString ":MEASure:PHASe CHANnel1,CHANnel2"
```

**Query** :MEASure:PHASe? [<source>[,<source>[,<direction>]]]

The :MEASure:PHASe? query returns the measured phase angle value.

The necessary waveform edges must be present on the display. Also, the "Measure All Edges" mode must be set (use the :ANALyze:AEDGes command or :MEASure:PHASe command before the query).

The query will return 9.99999E+37 if the necessary edges are not displayed or if the "Measure All Edges" mode is not currently set.

**Returned Format** [:MEASure:PHASe] <value>[,result\_state]<NL>

**<value>** Phase angle from the first edge on the first source to the first edge on the second source.

**<result\_state>** If SENDvalid is ON, the result state is returned with the measurement result. See the :MEASure:RESults table in this chapter for a list of the result states.

**Example** This example places the current phase angle value between channel 1 and channel 2 in the variable, varValue, then prints the contents of the variable to the computer's screen.

```
myScope.WriteString ":SYSTem:HEADer OFF" ' Response headers off.
myScope.WriteString ":MEASure:PHASe? CHANnel1,CHANnel2"
```

```
varValue = myScope.ReadNumber  
Debug.Print FormatNumber(varValue, 0)
```

**See Also** · [":ANALyze:AEDGes"](#) on page 273

**History** Legacy command (existed before version 3.10).

**:MEASure:PJITter**

**Command** `:MEASure:PJITter PNoise, <start_freq>, <stop_freq>[, {SRMS | DBC}]`

The `:MEASure:PJITter` command adds a Phase Jitter measurement on the phase noise single-sideband (SSB) frequency offset FFT plot.

The SRMS or DBC option lets you specify the measurement units in s(rms) or dBc, respectively. If you do not include this option, the most recent selection is used again.

**<start\_freq>** Start frequency in Hz in NR3 format.

**<stop\_freq>** Stop frequency in Hz in NR3 format.

**Query** `:MEASure:PJITter? PNoise, <start_freq>, <stop_freq>[, {SRMS | DBC}]`

The `:MEASure:PJITter?` query returns the measured Phase Jitter value.

**Returned Format** `<measured_value><NL>`

`<measured_value> ::= phase jitter value in seconds in NR3 format`

**See Also** • [":MEASure:PN:STAtE"](#) on page 1066

**History** New in version 6.30.

Version 6.50: Added the SRMS or DBC option for specifying the measurement units in s(rms) or dBc, respectively.

## :MEASure:PLENgtH

**Command** :MEASure:PLENgtH <source>

The :MEASure:PLENgtH command installs a Pattern Length measurement into the user interface's measurement Results pane.

The Pattern Length measurement looks for at least two error-free copies of an identical repeating bit pattern in acquisition memory. If a repeating bit pattern is found, its length is reported in the measurement results.

<source> {CHANnel<N> | DIFF<D> | COMMONmode<C> | WMEMory<R> | FUNction<F> | EQUalized<L>}

**Query** :MEASure:PLENgtH? <source>

The :MEASure:PLENgtH? query returns the measured pattern length.

**Returned Format** <pattern\_length><NL>

- See Also**
- [":MEASure:DATarate"](#) on page 928
  - [":MEASure:CDRRate"](#) on page 901

**History** New in version 6.30.

## :MEASure:PN:CORrelations

**Command** :MEASure:PN:CORrelations <number>

When two clock sources permit the *two-channel cross-correlation technique* to be used, the :MEASure:PN:CORrelations command specifies the number of correlations that will be accumulated between phase noise analysis plot averages.

<number> The number of correlations from 1 to 65535 in NR1 format.

**Query** :MEASure:PN:CORrelations?

The :MEASure:PN:CORrelations? query returns the specified number of correlations.

**Returned Format** <number><NL>

- See Also**
- [":MEASure:PN:DESKew"](#) on page 1057
  - [":MEASure:PN:EDGE"](#) on page 1058
  - [":MEASure:PN:HORizontal:START"](#) on page 1059
  - [":MEASure:PN:HORizontal:STOP"](#) on page 1060
  - [":MEASure:PN:RSSC"](#) on page 1061
  - [":MEASure:PN:SOURce"](#) on page 1062
  - [":MEASure:PN:SPURs"](#) on page 1064
  - [":MEASure:PN:SSENSitivity"](#) on page 1065
  - [":MEASure:PN:STATe"](#) on page 1066
  - [":MEASure:PN:VERTical:REFerence"](#) on page 1067
  - [":MEASure:PN:VERTical:SCALE"](#) on page 1068
  - [":MEASure:PN:WINDow"](#) on page 1069

**History** New in version 6.30.



**:MEASure:PN:DESKew****Command** :MEASure:PN:DESKew

When two channels are used (see :MEASure:PN:SOURce), the :MEASure:PN:DESKew command will automatically remove time skew due to different length cables connecting the device under test (DUT) to the oscilloscope. This automatic deskew can remove up to half a period of skew for clock-type signals. Greater skews than that must be removed manually (see :CHANnel<N>:PROBe:SKEW).

- See Also**
- **" :MEASure:PN:CORRelations "** on page 1056
  - **" :MEASure:PN:EDGE "** on page 1058
  - **" :MEASure:PN:HORizontal:START "** on page 1059
  - **" :MEASure:PN:HORizontal:STOP "** on page 1060
  - **" :MEASure:PN:RSSC "** on page 1061
  - **" :MEASure:PN:SOURce "** on page 1062
  - **" :MEASure:PN:SPURs "** on page 1064
  - **" :MEASure:PN:SSENSitivity "** on page 1065
  - **" :MEASure:PN:STATE "** on page 1066
  - **" :MEASure:PN:VERTical:REFerence "** on page 1067
  - **" :MEASure:PN:VERTical:SCALE "** on page 1068
  - **" :MEASure:PN:WINDow "** on page 1069
  - **" :CHANnel<N>:PROBe:SKEW "** on page 406

**History** New in version 6.70.

**:MEASure:PN:EDGE**

**Command** :MEASure:PN:EDGE {RISing | FALLing | EITHer}

The :MEASure:PN:EDGE command specifies the clock edge direction on which to measure phase noise.

**Query** :MEASure:PN:EDGE?

The :MEASure:PN:EDGE? query returns the specified clock edge direction.

**Returned Format** <direction><NL>

<direction> ::= {RIS | FALL | EITH}

- See Also**
- [":MEASure:PN:CORrelations"](#) on page 1056
  - [":MEASure:PN:DESKew"](#) on page 1057
  - [":MEASure:PN:HORizontal:START"](#) on page 1059
  - [":MEASure:PN:HORizontal:STOP"](#) on page 1060
  - [":MEASure:PN:RSSC"](#) on page 1061
  - [":MEASure:PN:SOURce"](#) on page 1062
  - [":MEASure:PN:SPURs"](#) on page 1064
  - [":MEASure:PN:SSENSitivity"](#) on page 1065
  - [":MEASure:PN:STATe"](#) on page 1066
  - [":MEASure:PN:VERTical:REFerence"](#) on page 1067
  - [":MEASure:PN:VERTical:SCALE"](#) on page 1068
  - [":MEASure:PN:WINDow"](#) on page 1069

**History** New in version 6.30.

## :MEASure:PN:HORizontal:START

**Command** :MEASure:PN:HORizontal:START <start\_offset>

For the phase noise analysis single-sideband (SSB) frequency offset plot, the :MEASure:PN:HORizontal:START command specifies the left side of the horizontal log frequency scale.

<start\_offset> Start offset frequency in Hz in NR3 format.

**Query** :MEASure:PN:HORizontal:START?

The :MEASure:PN:HORizontal:START? query returns the phase noise analysis plot's left-side start offset frequency setting.

**Returned Format** [:MEASure:PN:HORizontal:START] <start\_offset><NL>

- See Also**
- [":MEASure:PN:CORRelations"](#) on page 1056
  - [":MEASure:PN:DESKew"](#) on page 1057
  - [":MEASure:PN:EDGE"](#) on page 1058
  - [":MEASure:PN:HORizontal:STOP"](#) on page 1060
  - [":MEASure:PN:RSSC"](#) on page 1061
  - [":MEASure:PN:SOURce"](#) on page 1062
  - [":MEASure:PN:SPURs"](#) on page 1064
  - [":MEASure:PN:SSENSitivity"](#) on page 1065
  - [":MEASure:PN:STATe"](#) on page 1066
  - [":MEASure:PN:VERTical:REFerence"](#) on page 1067
  - [":MEASure:PN:VERTical:SCALE"](#) on page 1068
  - [":MEASure:PN:WINDow"](#) on page 1069

**History** New in version 6.30.

**:MEASure:PN:HORizontal:STOP**

**Command** :MEASure:PN:HORizontal:STOP <stop\_offset>

For the phase noise analysis single-sideband (SSB) frequency offset plot, the :MEASure:PN:HORizontal:STOP command specifies the right side of the horizontal log frequency scale.

<stop\_offset> Stop offset frequency in Hz in NR3 format.

**Query** :MEASure:PN:HORizontal:STOP?

The :MEASure:PN:HORizontal:STOP? query returns the phase noise analysis plot's right-side stop offset frequency setting.

**Returned Format** [:MEASure:PN:HORizontal:STOP] <stop\_offset><NL>

- See Also**
- [":MEASure:PN:CORRelations"](#) on page 1056
  - [":MEASure:PN:DESKew"](#) on page 1057
  - [":MEASure:PN:EDGE"](#) on page 1058
  - [":MEASure:PN:HORizontal:START"](#) on page 1059
  - [":MEASure:PN:RSSC"](#) on page 1061
  - [":MEASure:PN:SOURce"](#) on page 1062
  - [":MEASure:PN:SPURs"](#) on page 1064
  - [":MEASure:PN:SSENSitivity"](#) on page 1065
  - [":MEASure:PN:STATe"](#) on page 1066
  - [":MEASure:PN:VERTical:REFerence"](#) on page 1067
  - [":MEASure:PN:VERTical:SCALE"](#) on page 1068
  - [":MEASure:PN:WINDow"](#) on page 1069

**History** New in version 6.30.

**:MEASure:PN:RSSC**

**Command** :MEASure:PN:RSSC {{0 | OFF} | {1 | ON}}

If your clock source uses spread-spectrum clocking (SSC) and the FLATtop FFT windowing function is selected, you can use the :MEASure:PN:RSSC command to enable or disable the removal of the SSC effects from the phase noise analysis results.

**Query** :MEASure:PN:RSSC?

The :MEASure:PN:RSSC? query returns the "remove SSC" setting.

**Returned Format** [:MEASure:PN:RSSC] <setting><NL>  
<setting> ::= {0 | 1}

- See Also**
- [":MEASure:PN:CORRelations"](#) on page 1056
  - [":MEASure:PN:DESKew"](#) on page 1057
  - [":MEASure:PN:EDGE"](#) on page 1058
  - [":MEASure:PN:HORizontal:START"](#) on page 1059
  - [":MEASure:PN:HORizontal:STOP"](#) on page 1060
  - [":MEASure:PN:SOURce"](#) on page 1062
  - [":MEASure:PN:SPURs"](#) on page 1064
  - [":MEASure:PN:SSENSitivity"](#) on page 1065
  - [":MEASure:PN:STATe"](#) on page 1066
  - [":MEASure:PN:VERTical:REFerence"](#) on page 1067
  - [":MEASure:PN:VERTical:SCALE"](#) on page 1068
  - [":MEASure:PN:WINDow"](#) on page 1069

**History** New in version 6.30.

**:MEASure:PN:SOURce**

**Command** :MEASure:PN:SOURce <source1>[, <source2>]

The :MEASure:PN:SOURce command specifies the clock source(s) on which the phase noise analysis is performed.

<source1> {CHANnel<N> | FUNcTion<F>}

<source2> {CHANnel<N> | FUNcTion<F> | NONE}

The oscilloscope phase noise measurement floor is reduced by using two input channels (see "Two-Channel Cross-Correlation Lowers the Oscilloscope Noise Floor" in the oscilloscope's online help). You can split a single-ended signal into two copies or you can use both polarities of a differential signal.

If you do not want to use two input channels, select NONE. With only one input channel, the analysis is not able to lower the oscilloscope's phase noise measurement floor using two-channel cross-correlation.

<N> An integer, 1-4 in a single oscilloscope, 1-40 in a MultiScope system.

<F> An integer, 1-16.

**Query** :MEASure:PN:SOURce?

The :MEASure:PN:SOURce? query returns the phase noise analysis clock source setup.

**Returned Format** [:MEASure:PN:SOURce] <options><NL>

<options> ::= <source1>[, <source2>]

<source1> ::= {CHAN<N> | FUNC<F>}

<source2> ::= {CHAN<N> | FUNC<F> | NONE}

- See Also**
- [":MEASure:PN:CORRelations"](#) on page 1056
  - [":MEASure:PN:DESKew"](#) on page 1057
  - [":MEASure:PN:EDGE"](#) on page 1058
  - [":MEASure:PN:HORizontal:STArT"](#) on page 1059
  - [":MEASure:PN:HORizontal:STOP"](#) on page 1060
  - [":MEASure:PN:RSSC"](#) on page 1061
  - [":MEASure:PN:SPURs"](#) on page 1064
  - [":MEASure:PN:SSEnsitivity"](#) on page 1065
  - [":MEASure:PN:STATe"](#) on page 1066
  - [":MEASure:PN:VERTical:REFerence"](#) on page 1067
  - [":MEASure:PN:VERTical:SCALE"](#) on page 1068
  - [":MEASure:PN:WINDow"](#) on page 1069

**History** New in version 6.30.

## :MEASure:PN:SPURs

**Command** :MEASure:PN:SPURs {NORMalized | OMIT | POWer}

The :MEASure:PN:SPURs command specifies how to display spurs in the phase noise analysis single-sideband (SSB) frequency offset plot:

- **NORMalized** – This is the default setting. Spurs are displayed in the same normalized (dBc/Hz) scale as the rest of the phase noise analysis plot.
- **OMIT** – According to the :MEASure:PN:SSEnsitivity setting, spurs are removed from the phase noise analysis plot.
- **POWer** – According to the :MEASure:PN:SSEnsitivity setting, spurs are displayed in the power (dBc) setting. This shows a better representation of the energy at the spurs.

**Query** :MEASure:PN:SPURs?

The :MEASure:PN:SPURs? query returns the current setting.

**Returned Format** [:MEASure:PN:SPURs] <option><NL>

<option> ::= {NORM | OMIT | POW}

- See Also**
- [":MEASure:PN:CORrelations"](#) on page 1056
  - [":MEASure:PN:DESKew"](#) on page 1057
  - [":MEASure:PN:EDGE"](#) on page 1058
  - [":MEASure:PN:HORizontal:STARt"](#) on page 1059
  - [":MEASure:PN:HORizontal:STOP"](#) on page 1060
  - [":MEASure:PN:RSSC"](#) on page 1061
  - [":MEASure:PN:SOURce"](#) on page 1062
  - [":MEASure:PN:SSEnsitivity"](#) on page 1065
  - [":MEASure:PN:STATe"](#) on page 1066
  - [":MEASure:PN:VERTical:REFerence"](#) on page 1067
  - [":MEASure:PN:VERTical:SCALE"](#) on page 1068
  - [":MEASure:PN:WINDow"](#) on page 1069

**History** New in version 6.30.



## :MEASure:PN:SSENSitivity

**Command** :MEASure:PN:SSENSitivity <spur\_sensitivity>

When omitting spurs from the phase noise analysis single-sideband (SSB) frequency offset plot, or when displaying them in power (dBc) instead of the default normalized (dBc/Hz) scale, the :MEASure:PN:SSENSitivity command specifies the sensitivity used in identifying spurs.

<spur\_sensitivity> 0.1 to 10.0 in NR3 format.

**Query** :MEASure:PN:SSENSitivity?

The :MEASure:PN:SSENSitivity? query returns the phase noise analysis spur sensitivity setting.

**Returned Format** [:MEASure:PN:SSENSitivity] <spur\_sensitivity><NL>

- See Also**
- [":MEASure:PN:CORRelations"](#) on page 1056
  - [":MEASure:PN:DESKew"](#) on page 1057
  - [":MEASure:PN:EDGE"](#) on page 1058
  - [":MEASure:PN:HORizontal:STARt"](#) on page 1059
  - [":MEASure:PN:HORizontal:STOP"](#) on page 1060
  - [":MEASure:PN:RSSC"](#) on page 1061
  - [":MEASure:PN:SOURce"](#) on page 1062
  - [":MEASure:PN:SPURs"](#) on page 1064
  - [":MEASure:PN:STATe"](#) on page 1066
  - [":MEASure:PN:VERTical:REFerence"](#) on page 1067
  - [":MEASure:PN:VERTical:SCALE"](#) on page 1068
  - [":MEASure:PN:WINDow"](#) on page 1069

**History** New in version 6.30.

**:MEASure:PN:STATe**

**Command** :MEASure:PN:STATe {{0 | OFF} | {1 | ON}}

The :MEASure:PN:STATe command turns the phase noise analysis feature on or off.

**Query** :MEASure:PN:STATe?

The :MEASure:PN:STATe? query returns the phase noise analysis state setting.

**Returned Format** [:MEASure:PN:STATe] <setting><NL>  
<setting> ::= {0 | 1}

- See Also**
- [":MEASure:PN:CORrelations"](#) on page 1056
  - [":MEASure:PN:DESKew"](#) on page 1057
  - [":MEASure:PN:EDGE"](#) on page 1058
  - [":MEASure:PN:HORizontal:START"](#) on page 1059
  - [":MEASure:PN:HORizontal:STOP"](#) on page 1060
  - [":MEASure:PN:RSSC"](#) on page 1061
  - [":MEASure:PN:SOURce"](#) on page 1062
  - [":MEASure:PN:SPURs"](#) on page 1064
  - [":MEASure:PN:SSENSitivity"](#) on page 1065
  - [":MEASure:PN:VERTical:REFerence"](#) on page 1067
  - [":MEASure:PN:VERTical:SCALE"](#) on page 1068
  - [":MEASure:PN:WINDow"](#) on page 1069
  - [":MEASure:PJITter"](#) on page 1054

**History** New in version 6.30.

## :MEASure:PN:VERTical:REFerence

**Command** :MEASure:PN:VERTical:REFerence <level>

The :MEASure:PN:VERTical:REFerence command specifies the dBc/Hz value at the top of the phase noise analysis single-sideband (SSB) frequency offset plot.

<level> Reference level in dBc/Hz in NR3 format.

**Query** :MEASure:PN:VERTical:REFerence?

The :MEASure:PN:VERTical:REFerence? query returns the phase noise analysis plot vertical reference setting.

**Returned Format** [:MEASure:PN:VERTical:REFerence] <level><NL>

- See Also**
- [":MEASure:PN:CORRelations"](#) on page 1056
  - [":MEASure:PN:DESKew"](#) on page 1057
  - [":MEASure:PN:EDGE"](#) on page 1058
  - [":MEASure:PN:HORizontal:START"](#) on page 1059
  - [":MEASure:PN:HORizontal:STOP"](#) on page 1060
  - [":MEASure:PN:RSSC"](#) on page 1061
  - [":MEASure:PN:SOURce"](#) on page 1062
  - [":MEASure:PN:SPURs"](#) on page 1064
  - [":MEASure:PN:SSENSitivity"](#) on page 1065
  - [":MEASure:PN:STATe"](#) on page 1066
  - [":MEASure:PN:VERTical:SCALE"](#) on page 1068
  - [":MEASure:PN:WINDow"](#) on page 1069

**History** New in version 6.30.

## :MEASure:PN:VERTical:SCALE

**Command** :MEASure:PN:VERTical:SCALE <scale\_value>

The :MEASure:PN:VERTical:SCALE command specifies the height in dBc/Hz of each vertical division in the phase noise analysis single-sideband (SSB) frequency offset plot.

<scale\_value> Scale in dBc/Hz per division in NR3 format.

**Query** :MEASure:PN:VERTical:SCALE?

The :MEASure:PN:VERTical:SCALE? query returns the phase noise analysis plot vertical scale setting.

**Returned Format** [:MEASure:PN:VERTical:SCALE] <scale\_value><NL>

- See Also**
- [":MEASure:PN:CORRelations"](#) on page 1056
  - [":MEASure:PN:DESKew"](#) on page 1057
  - [":MEASure:PN:EDGE"](#) on page 1058
  - [":MEASure:PN:HORizontal:START"](#) on page 1059
  - [":MEASure:PN:HORizontal:STOP"](#) on page 1060
  - [":MEASure:PN:RSSC"](#) on page 1061
  - [":MEASure:PN:SOURce"](#) on page 1062
  - [":MEASure:PN:SPURs"](#) on page 1064
  - [":MEASure:PN:SSENSitivity"](#) on page 1065
  - [":MEASure:PN:STAtE"](#) on page 1066
  - [":MEASure:PN:VERTical:REFerence"](#) on page 1067
  - [":MEASure:PN:WINDow"](#) on page 1069

**History** New in version 6.30.

## :MEASure:PN:WINDow

**Command** :MEASure:PN:WINDow <window\_type>

<window\_type> ::= {RECTangular | HANNing | FLATtop | BHARris | HAMMING}

The :MEASure:PN:WINDow command specifies the FFT windowing function used in the phase noise analysis.

The FLATtop window generally gives the best results.

**Query** :MEASure:PN:WINDow?

The :MEASure:PN:WINDow? query returns the phase noise analysis FFT windowing function setting.

**Returned Format** [:MEASure:PN:WINDow] <window\_type><NL>

<window\_type> ::= {RECT | HANN | FLAT | BHAR | HAMM}

- See Also**
- [":MEASure:PN:CORrelations"](#) on page 1056
  - [":MEASure:PN:DESKew"](#) on page 1057
  - [":MEASure:PN:EDGE"](#) on page 1058
  - [":MEASure:PN:HORizontal:START"](#) on page 1059
  - [":MEASure:PN:HORizontal:STOP"](#) on page 1060
  - [":MEASure:PN:RSSC"](#) on page 1061
  - [":MEASure:PN:SOURce"](#) on page 1062
  - [":MEASure:PN:SPURs"](#) on page 1064
  - [":MEASure:PN:SSENSitivity"](#) on page 1065
  - [":MEASure:PN:STATE"](#) on page 1066
  - [":MEASure:PN:VERTical:REFerence"](#) on page 1067
  - [":MEASure:PN:VERTical:SCALE"](#) on page 1068
  - [":FUNCTION<F>:FFT:WINDow"](#) on page 603

**History** New in version 6.30.

## :MEASure:PPContrast

**Command** :MEASure:PPContrast [<source>]

The :MEASure:PPContrast command measures the peak-to-peak contrast (also known as Michelson contrast or modulation). This is the relation between the spread and the sum of two luminances.

$$\text{Peak-to-Peak Contrast} = (L_{\text{max}} - L_{\text{min}}) / (L_{\text{max}} + L_{\text{min}})$$

Sources are specified with the :MEASure:SOURce command or with the optional parameter following the :MEASure:PPContrast command.

<source> {CHANnel<N> | DIFF<D> | COMMONmode<C> | FUNCtion<F> | WMEMory<R> | CLOCK | MTRend | MSPectrum | EQUalized<L> | XT<X> | PNOise}

For more information on <source> parameters, see "[Measurement Sources](#)" on page 890.

**Example** This example measures the peak-to-peak contrast of channel 1.

```
myScope.WriteString ":MEASure:PPContrast CHANnel1"
```

**Query** :MEASure:PPContrast? [<source>]

The :MEASure:PPContrast? query returns the measured peak-to-peak contrast value.

**Returned Format** [:MEASure:PPContrast] <value> [, <result\_state>] <NL>

<value> Peak-to-peak contrast of the selected source.

<result\_state> If SENDvalid is ON, the result state is returned with the measurement result. See the :MEASure:RESults table in this chapter for a list of the result states.

**Example** This example places the current peak-to-peak voltage in the numeric variable, varPPContrast, then prints the contents of the variable to the computer's screen.

```
myScope.WriteString ":SYSTem:HEADer OFF" ' Response headers off.
myScope.WriteString ":MEASure:PPContrast? CHANnel1"
varPPContrast = myScope.ReadNumber
Debug.Print FormatNumber (varPPContrast, 0)
```

**History** New in version 5.60.

## :MEASure:PPULses

**Command** :MEASure:PPULses <source>

The :MEASure:PPULses measures the number of positive pulses on the screen.

This measurement requires all edges. When you add it, the "Measure All Edges" mode (see **":ANALyze:AEDGes"** on page 273) is automatically set to ON. When the "Measure All Edges" mode is set to OFF, this measurement cannot be made, and there are no measurement results.

<source> The source on which the measurement is made.

For more information on <source> parameters, see **"Measurement Sources"** on page 890.

**Example** This example measures the number of positive pulses on channel 1.

```
myScope.WriteString ":MEASure:PPULses CHANnel1"
```

**Query** :MEASure:PPULses?

This query returns the result for the PPULses measurement.

**History** Legacy command (existed before version 3.10).

## :MEASure:PREShoot

**Command** :MEASure:PREShoot [<source>] [,<direction>]

The :MEASure:PREShoot command measures the preshoot of the first edge on the screen. Sources are specified with the :MEASure:SOURce command or with the optional parameter following the :MEASure:PREShoot command.

The algorithm is:

```
If the first edge on the screen is rising,
then
    preshoot = (Vbase - Local Vmin) / Vamplitude
else
    preshoot = (Local Vmax - Vtop) / Vamplitude
```

<source> {CHANnel<N> | DIFF<D> | COMMONmode<C> | FUNCTION<F> | WMEMory<R> | CLOCK | MTRend | MSPectrum | EQUALized<L> | XT<X>}

For more information on <source> parameters, see "[Measurement Sources](#)" on page 890.

<direction> {RISing | FALLing}

Specifies whether rising edge preshoot or falling edge preshoot is measured. When <direction> is specified, the <source> parameter is required.

When the "Measure All Edges" mode is OFF (see "[ANALyze:AEDGes](#)" on page 273), the RISing and FALLing options specify whether the first rising or falling edge from the left side of the display grid is used.

When the "Measure All Edges" mode is ON, the RISing and FALLing options specify whether rising edge preshoot or falling edge preshoot is measured throughout the acquisition.

**Example** This example measures the preshoot of the waveform on the screen.

```
myScope.WriteString ":MEASure:PREShoot CHANnel1"
```

**Query** :MEASure:PREShoot? [<source>] [,<direction>]

The :MEASure:PREShoot? query returns the measured preshoot of the specified source.

**Returned Format** [:MEASure:PREShoot] <value> [,<result state>] <NL>

<value> Ratio of preshoot to amplitude, in percent.

<result\_state> If SENDvalid is ON, the result state is returned with the measurement result. See the :MEASure:RESults table in this chapter for a list of the result states.

**Example** This example places the current value of preshoot in the numeric variable, varPreshoot, then prints the contents of the variable to the computer's screen.

```
myScope.WriteString ":SYSTem:HEADer OFF" ' Response headers off.
myScope.WriteString ":MEASure:PREShoot? CHANnel1"
```



```
varPreshoot = myScope.ReadNumber  
Debug.Print FormatNumber(varPreshoot, 0)
```

**History** Legacy command (existed before version 3.10).

**:MEASure:PTOP**

**Command** `:MEASure:PTOP <source>, <pulse width percent>`

The :MEASure:PTOP command measures the average of the data of a positive pulse within the pulse window. The pulse window is a range of data centered within the pulse width using the specified percentage of the data as measured as the middle threshold level. For example, a 50% window would not include in the average the first or last 25% of the pulse width as measured at the middle threshold level. A 100% window would measure the average of the entire positive or negative pulse. In measure all edges mode and EZJIT, these measurements can be trended, histogrammed, etc.

**<source>** {CHANnel<N> | DIFF<D> | COMMONmode<C> | FUNCTion<F> | WMEMory<R> | XT<X>}

For more information on <source> parameters, see "[Measurement Sources](#)" on page 890.

**<pulse width percent>** pulse width percent to use in average (in percent, 0-100)

**Example** This example measures the average of the data of a positive pulse within the pulse window (width set to 50%)

```
myScope.WriteString ":MEASure:PTOP CHANnel1, 50"
```

**Query** `:MEASure:PTOP? <source>, <pulse width percentage>`

The :MEASure:PTOP? query returns the average of the data of a positive pulse within the specified pulse window.

**History** Legacy command (existed before version 3.10).

## :MEASure:PWIDth

**Command** :MEASure:PWIDth [<source>]

The :MEASure:PWIDth command measures the width of the first positive pulse on the screen using the mid-threshold levels of the waveform (50% levels with standard measurements selected). Sources are specified with the :MEASure:SOURce command or with the optional parameter following the :MEASure:PWIDth command.

The algorithm is:

```
If the first edge on the screen is rising,
then
    pwidth = time at the first falling edge - time at the
             first rising edge
else
    pwidth = time at the second falling edge - time at the
             first rising edge
```

<source> {CHANnel<N> | DIFF<D> | COMMONmode<C> | FUNction<F> | DIGital<M> | WMEMory<R> | CLOCK | MTRend | MSPectrum | EQUalized<L> | XT<X>}

For more information on <source> parameters, see "[Measurement Sources](#)" on page 890.

**Example** This example measures the width of the first positive pulse on the screen.

```
myScope.WriteString ":MEASure:PWIDth CHANnel1"
```

**Query** :MEASure:PWIDth? [<source>]

The :MEASure:PWIDth? query returns the measured width of the first positive pulse of the specified source.

**Returned Format** [:MEASure:PWIDth] <value>[,<result\_state>] <NL>

<value> Width of the first positive pulse on the screen in seconds.

<result\_state> If SENDvalid is ON, the result state is returned with the measurement result. See the :MEASure:RESults table in this chapter for a list of the result states.

**Example** This example places the value of the width of the first positive pulse on the screen in the numeric variable, varWidth, then prints the contents of the variable to the computer's screen.

```
myScope.WriteString ":SYSTem:HEADer OFF" ' Response headers off.
myScope.WriteString ":MEASure:PWIDth? CHANnel1"
varWidth = myScope.ReadNumber
Debug.Print FormatNumber(varWidth, 0)
```

**History** Legacy command (existed before version 3.10).

## :MEASure:QUALifier&lt;M&gt;:CONDition

**Command** :MEASure:QUALifier<M>:CONDition {HIGH | LOW |  
INSide | OUTSide}

The :MEASure:QUALifier<M>:CONDition command sets the condition when valid timing measurements are made

- Above Middle Threshold (HIGH)
- Below Middle Threshold (LOW)
- Between Upper, Lower Thresholds (INSide)
- Not Between Thresholds (OUTSide)

<M> An integer, 1-3.

**Example** This example sets the level qualifier 2 condition to HIGH.

```
myScope.WriteString ":MEASure:QUALifier2:CONDition HIGH"
```

**Query** :MEASure:QUALifier<M>:CONDition?

The :MEASure:QUALifier<M>:CONDition? query returns the condition being used of the level qualifier.

**Returned Format** [:MEASure:QUALifier<M>:CONDition] <source><NL>

**Example** This example places the current condition of level qualifier for timing measurements in the source variable and displays it on the computer's screen.

```
myScope.WriteString ":SYSTem:HEADer OFF" ' Response headers off.
myScope.WriteString ":MEASure:QUALifier2:CONDition?"
varSource = myScope.ReadNumber
Debug.Print FormatNumber(varSource, 0)
```

**History** Legacy command (existed before version 3.10).

## :MEASure:QUALifier&lt;M&gt;:SOURce

## Command

**NOTE**

The channel being selected must not be used to make a timing measurement and must be turned on.

```
:MEASure:QUALifier<M>:SOURce <source>
```

The :MEASure:QUALifier<M>:SOURce command sets the source of the level qualify for timing measurements.

<source> CHANnel<N>

<N> An integer, 1-4 in a single oscilloscope, 1-40 in a MultiScope system.

<M> An integer, 1-3.

**Example** This example sets the level qualifier 2 source to the channel 1 waveform.

```
myScope.WriteString ":MEASure:QUALifier2:SOURce CHANnel1"
```

**Query** :MEASure:QUALifier<M>:SOURce?

The :MEASure:QUALifier<M>:SOURce? query returns the source being used of the level qualifier for timing measurements.

**Returned Format** [:MEASure:QUALifier<M>:SOURce] <source><NL>

**Example** This example places the current source of level qualifier for timing measurements in the source variable and displays it on the computer's screen.

```
myScope.WriteString ":SYSTem:HEADer OFF" ' Response headers off.
myScope.WriteString ":MEASure:QUALifier2:SOURce?"
varSource = myScope.ReadNumber
Debug.Print FormatNumber(varSource, 0)
```

**History** Legacy command (existed before version 3.10).

**:MEASure:QUALifier<M>:STATE**

**Command** `:MEASure:QUALifier<M>:STATE {{ON | 1} | {OFF | 0}}`

The `:MEASure:QUALifier<M>:STATE` command enables or disables level qualifying for timing measurements.

**<M>** An integer, 1-3.

**Example** This example sets the level qualifier 2 state to ON.

```
myScope.WriteString ":MEASure:QUALifier2:STATE ON"
```

**Query** `:MEASure:QUALifier<M>:STATE?`

The `:MEASure:QUALifier<M>:STATE?` query returns the state of the level qualifier for timing measurements.

**Returned Format** `[:MEASure:QUALifier<M>:SOURCE] {1 | 0}<NL>`

**Example** This example places the current state of the level qualifier for timing measurements in the state variable and displays it on the computer's screen.

```
myScope.WriteString ":SYSTem:HEADer OFF" ' Response headers off.
myScope.WriteString ":MEASure:QUALifier2:STATE?"
varState = myScope.ReadNumber
Debug.Print FormatNumber(varState, 0)
```

**History** Legacy command (existed before version 3.10).

## :MEASure:RESults?

**Query** :MEASure:RESults? [AORdered | GORdered]

The :MEASure:RESults? query returns the results of the measurements displayed on the front panel graphical user interface (GUI). Results are returned as a list of comma-separated values. If :MEASure:SENDvalid is ON, the result state is also returned.

If more than one measurement is displayed, the values for each measurement are returned according to the option:

- AORdered (or no option) – As measurements are added, either by a remote program or using the front panel GUI, they are displayed in the Results pane with the most recently added measurement at the top. The AORdered option (or no option) returns results in the inverse order that measurements were added. Reordering measurements on the front panel will not change this order.
- GORdered – This option always returns measurement results in the Results pane top-to-bottom order, even after reordering measurements on the front panel.

Up to 20 measurements can be displayed.

**Returned Format** [:MEASure:RESults] <result\_list><NL>

<result\_list> A list of the measurement results separated with commas. The following shows the order of values received for a single measurement if :MEASure:STATistics is set to ON.

Measure ment label	current	result state	min	max	mean	std dev	# of meas

Min, max, mean, std dev, and # of meas are returned only if :MEASure:STATistics is ON. The result state is returned only if :MEASure:SENDvalid is ON. See [Table 14](#) for the meaning of the result state codes.

If the :MEASure:STATistics is set to CURRENT, MAX, MEAN, MIN, or STDDEV only that particular statistic value is returned for each displayed measurement.

**Example** This example places the current results of the measurements in the string variable, strResult, then prints the contents of the variable to the computer's screen.

```
Dim strResult As String    ' Dimension variable.
myScope.WriteString ":MEASure:RESults?"
strResult = myScope.ReadString
Debug.Print strResult
```

**Table 14** Result States

Code	Description
0	Result correct. No problem found.
1	Result questionable but could be measured.
2	Result less than or equal to value returned.
3	Result greater than or equal to value returned.
4	Result returned is invalid.
5	Result invalid. Required edge not found.
6	Result invalid. Max not found.
7	Result invalid. Min not found.
8	Result invalid. Requested time not found.
9	Result invalid. Requested voltage not found.
10	Result invalid. Top and base are equal.
11	Result invalid. Measurement zone too small.
12	Result invalid. Lower threshold not on waveform.
13	Result invalid. Upper threshold not on waveform.
14	Result invalid. Upper and lower thresholds are too close.
15	Result invalid. Top not on waveform.
16	Result invalid. Base not on waveform.
17	Result invalid. Completion criteria not reached.
18	Result invalid. Measurement invalid for this type of waveform.
19	Result invalid. Waveform is not displayed.
20	Result invalid. Waveform is clipped high.
21	Result invalid. Waveform is clipped low.
22	Result invalid. Waveform is clipped high and low.
23	Result invalid. Data contains all holes.
24	Result invalid. No data on screen.
29	Result invalid. FFT peak not found.
30	Result invalid. Eye pattern not found.
31	Result invalid. No NRZ eye pattern found.



**Table 14** Result States (continued)

Code	Description
32	Result invalid. The Extinction Ratio measurement will display a question mark ("?") result if: <ul style="list-style-type: none"> <li>▪ The dark calibration has not been performed at all.</li> <li>▪ The vertical sensitivity, offset, or sample rate has changed since the dark calibration was run.</li> <li>▪ The probe temperature has changed by &gt; 2 °C.</li> </ul> For more information on the extinction ratio measurement, see " <b>MEASure:ERATio</b> " on page 942.
33	Result invalid. There is more than one source on creating the database.
35	Signal may be too small to evaluate.
36	Result invalid. Awaiting completion of averaging.
38	A clock signal waveform or an alternating ones and zeros data signal waveform is expected.
39	Result invalid. Need jitter package to make this measurement or must be in jitter mode to make this measurement.
40	Current measurement is not on screen.
41	Not enough points available to recover the clock.
42	The loop bandwidth of the PLL is too high to recover the clock.
43	RJDJ pattern not found in data.
45	Clock recovery mode is not permitted.
46	Too much jitter to make a RJDJ separation.
52	Signals have a different X-increment or sample rate.
53	Signals do not cross.
54	The signal has too many periodic characteristics for arbitrary analysis.
55	Ran out of memory computing measurement.
56	Lower threshold not on waveform, but noise is okay.
57	Upper threshold not on waveform, but noise is okay.
59	Too much noise to do noise separation.
60	Measurement is not valid for the specified signal type.
61	Measurement requires an open eye and there is no open eye. Applying equalization may be able to open the eye.
62	Measurement does not apply for this configuration.
63	Measurement will not work for this responsivity. See " <b>CHANnel&lt;N&gt;:PROBe:RESPonsivity</b> " on page 405.

**Table 14** Result States (continued)

Code	Description
64	The cross-correlation time range is too big. Lower the memory depth.
65	Invalid edge polarity.
66	Carrier frequency is not available.

- See Also**
- **":MEASure:SENDvalid"** on page 1109
  - **":MEASure:STATistics"** on page 1117

**History** Legacy command (existed before version 3.10).

Version 6.20: There is now an AORdered option for returning the results according to the order in which measurements were added (ignoring any front panel graphical user interface (GUI) reordering) or a GORdered option for returning the results according to the order they appear on the display (even after front panel GUI reordering). Not specifying any option is the same as using the AORdered option.

## :MEASure:RISetime

**Command** :MEASure:RISetime [<source>[,<start\_level>,<stop\_level>]]

The :MEASure:RISetime command measures the rise time of the first displayed edge by measuring the time at the lower threshold of the rising edge, measuring the time at the upper threshold of the rising edge, then calculating the rise time with the following algorithm:

Rise time = time at upper threshold point - time at lower threshold point.

Sources are specified with the :MEASure:SOURce command or with the optional parameter following the RISetime command.

Four or more sample points on the rising edge of the waveform are required to make this measurement (one above the upper threshold, one below the lower threshold, and two between the thresholds).

With standard thresholds selected, the lower threshold is at the 10% point and the upper threshold is at the 90% point on the rising edge.

**<source>** {CHANnel<N> | DIFF<D> | COMMONmode<C> | FUNCtion<F> | WMEMory<R> | CLOCk | MTRend | MSPectrum | EQUalized<L> | XT<X>}

For more information on <source> parameters, see **"Measurement Sources"** on page 890.

**<start\_level>**,  
**<stop\_level>** When the signal type is PAM-4 (see :ANALyze:SIGNal:TYPE), the <start\_level> and <stop\_level> parameters are integers that identify the edge to measure. For PAM-4, the levels may be from 0-3.

For PAM rise time measurements, "Measure All Edges" must be turned on (see :ANALyze:AEDGes).

**Example** This example measures the rise time of the channel 1 waveform.

```
myScope.WriteString ":MEASure:RISetime CHANnel1"
```

**Query** :MEASure:RISetime? [<source>[,<start\_level>,<stop\_level>]]

The :MEASure:RISetime? query returns the rise time of the specified source.

**Returned Format** [:MEASure:RISetime] <value>[,<result\_state>] <NL>

**<value>** Rise time in seconds.

A value of 9.99999E+37 means that the oscilloscope was unable to make the measurement. Check the <result\_state>. If the required four or more sample points are not present on the rising edge of the waveform, you can use a faster sampling rate or more interpolation points.

**<result\_state>** If :MEASure:SENDvalid is ON, the result state is returned with the measurement result. See **Table 14** for a list of values and descriptions of the result state value.

**Example** This example places the current value of rise time in the numeric variable, varRise, then prints the contents of the variable to the computer's screen.

```
myScope.WriteString ":SYSTEM:HEADer OFF" ' Response headers off.  
myScope.WriteString ":MEASure:RISEtime? CHANnel1"  
varRise = myScope.ReadNumber  
Debug.Print FormatNumber(varRise, 0)
```

**See Also**

- [":ANALyze:SIGNal:TYPE"](#) on page 312
- [":ANALyze:AEDGes"](#) on page 273

**History** Legacy command (existed before version 3.10).

Version 5.50: With PAM signal types, additional <start\_level> and <stop\_level> parameters are used to identify the edge to measure.

## :MEASure:RJDJ:ALL?

## Query

## NOTE

This command is available only when the Jitter Analysis Software license is installed.

```
:MEASure:RJDJ:ALL?
```

The :MEASure:RJDJ:ALL? query returns all of the RJDJ jitter measurements. These values are returned as comma separated triples of values using the following format:

## Returned Format

```
[ :MEASure:RJDJ:ALL<space>]
TJ(<format>),<result>,<state>,
RJ(<format>),<result>,<state>,
DJ(<format>),<result>,<state>,
PJ(<format>),<result>,<state>,
BUJ(<format>),<result>,<state>,
DDJ(<format>),<result>,<state>,
DCD,<result>,<state>,
ISI(<format>),<result>,<state>,
Transitions,<number_of_transitions>,<transitions_state>,
Scope RJ(<format>),<result>,<state>,
DDPWS,<result>,<state>,
F/2,<result>,<state>,
ABUJ(<format>),<result>,<state><NL>
```

## NOTE

Whether some of these values are included or not depends on the setting of :MEASure:RJDJ:METHOD and :MEASure:RJDJ:REPort.

For example, when :MEASure:RJDJ:REPort or :MEASure:RJDJ:METHOD is SPECTral, the BUJ and ABUJ values are not returned, and there are two PJ values (one "rms" and one "dd").

With PAM-4 signals, when the ":MEASure:RJDJ:PAMThreshold ALL" command setting has been made, the query results include values for multiple threshold levels. For example:

```
[ :MEASure:RJDJ:ALL<space>]
TJ(<format>) 01,<result>,<state>,
TJ(<format>) 12,<result>,<state>,
TJ(<format>) 23,<result>,<state>,
RJ(<format>) 01,<result>,<state>,
RJ(<format>) 12,<result>,<state>,
RJ(<format>) 23,<result>,<state>,
DJ(<format>) 01,<result>,<state>,
DJ(<format>) 12,<result>,<state>,
DJ(<format>) 23,<result>,<state>,
Transitions 01,<number_of_transitions>,<transitions_state>,
Transitions 12,<number_of_transitions>,<transitions_state>,
Transitions 23,<number_of_transitions>,<transitions_state><NL>
```

Otherwise, the query results are for the specific threshold level specified in the :MEASure:RJDJ:PAMThreshold command.

- <space> White space (ASCII 32) character.
- <format> The format value tells you something about how the measurement is made. For instance, TJ(1E-12) means that the TJ measurement was derived using a bit error rate of 1E-12. A format of (rms) means the measurement is a root-mean-square measurement. A format of (dd) means the measurement uses a dual-Dirac delta model to derive the measurement. A format of (pp) means the measurement is a peak-to-peak measurement.
- <result> The measured results for the RJDJ measurements. A value of 9.99999E+37 means that the oscilloscope was unable to make the measurement.
- <state> The measurement result state. See [Table 14](#) for a list of values and descriptions of the result state value.
- <number\_of\_transitions> The number of waveform transitions that have been measured.

**Example** This example places the jitter measures in the strResults variable and displays it on the computer's screen.

```
Dim strResult As String ' Dimension variable.
myScope.WriteString ":SYSTem:HEADer OFF" ' Response headers off.
myScope.WriteString ":MEASure:RJDJ:ALL?"
strResults = myScope.ReadString
Debug.Print strResults
```

- See Also**
- [":MEASure:RJDJ:METHod"](#) on page 1095
  - [":MEASure:RJDJ:REPort"](#) on page 1099
  - [":MEASure:RJDJ:PAMThreshold"](#) on page 1097

**History** Legacy command (existed before version 3.10).

Version 3.50: There are two possible additional measurement results, Scope RN(rms) and DDPWS.

Version 4.10: New results can be returned depending on the :MEASure:RJDJ:METHod and :MEASure:RJDJ:REPort settings.

Version 6.10: Jitter analysis is supported on PAM-4 signals. When the ":MEASure:RJDJ:PAMThreshold ALL" command setting has been made, the query results include values for multiple threshold levels; otherwise, the query results are for the specific threshold level specified in the :MEASure:RJDJ:PAMThreshold command.

## :MEASure:RJDJ:APLength?

## Query

## NOTE

This command is available only when the Jitter Analysis Software license is installed.

```
:MEASure:RJDJ:APLength?
```

When jitter or noise analysis is enabled and ":MEASure:RJDJ:PLENght AUTO" option has been set to automatically detect the pattern length, the :MEASure:RJDJ:APLength? query returns the determined RjDj pattern length.

**Returned Format** [ :MEASure:RJDJ:APLength] <value><NL>

<value> The determined RjDj pattern length as a numeric data value.

When jitter or noise analysis is not enabled, this query returns an empty value and the -221, "Settings conflict" error message.

If the ":MEASure:RJDJ:PLENght AUTO" option has not been set, or if there is no data, the value 9.99999E+37 is returned.

**Example** This example places the calculated pattern length in the strResults variable and displays it on the computer's screen.

```
Dim strResult As String ' Dimension variable.
myScope.WriteString ":SYSTem:HEADer OFF" ' Response headers off.
myScope.WriteString ":MEASure:RJDJ:APLength?"
strResults = myScope.ReadString
Debug.Print strResults
```

**See Also** • [":MEASure:RJDJ:PLENght"](#) on page 1098

**History** New in version 3.10.

**:MEASure:RJDJ:BANDwidth****Command****NOTE**

This command is available only when the Jitter Analysis Software license is installed.

```
:MEASure:RJDJ:BANDwidth {NARRow | WIDE}
```

The :MEASure:RJDJ:BANDwidth command sets the type of filtering used to separate the data dependent jitter from the random jitter and the periodic jitter.

**Example** This example sets the RJ bandwidth to WIDE.

```
myScope.WriteString ":MEASure:RJDJ:BANDwidth WIDE"
```

**Query**

```
:MEASure:RJDJ:BANDwidth?
```

The :MEASure:RJDJ:BANDwidth? query returns the RJ bandwidth filter setting.

**Returned Format**

```
[ :MEASure:RJDJ:BANDwidth ] {NARRow | WIDE}<NL>
```

**Example**

This example places the RJ filter setting the varFilter variable and displays it on the computer's screen.

```
myScope.WriteString ":SYSTEM:HEADer OFF" ' Response headers off.
myScope.WriteString ":MEASure:RJDJ:BANDwidth?"
varFilter = myScope.ReadNumber
Debug.Print FormatNumber(varFilter, 0)
```

**History**

Legacy command (existed before version 3.10).



## :MEASure:RJDJ:BER

## Command

## NOTE

This command is available only when the Jitter Analysis Software license is installed.

```
:MEASure:RJDJ:BER {E6 | E7 | E8 | E9 | E10 | E11 | E12 | E13 | E14  
                  | E15 | E16 | E17 | E18 | J2 | J4 | J5 | J9}
```

The :MEASure:RJDJ:BER command sets the bit error rate for the Total Jitter (TJ) measurement. The E and J parameters have the following bit error rate meanings:

- E6 = 1E-6
- E7 = 1E-7
- E8 = 1E-8
- E9 = 1E-9
- E10 = 1E-10
- E11 = 1E-11
- E12 = 1E-12
- E13 = 1E-13
- E14 = 1E-14
- E15 = 1E-15
- E16 = 1E-16
- E17 = 1E-17
- E18 = 1E-18
- J2 = 2.5E-3
- J4 = 2.5E-5
- J5 = 2.5E-6
- J9 = 2.5E-10

**Example** This example sets the bit error rate to E16.

```
myScope.WriteString ":MEASure:RJDJ:BER E16"
```

**Query** :MEASure:RJDJ:BER?

The :MEASure:RJDJ:BER? query returns the bit error rate setting.

**Returned Format** [:MEASure:RJDJ:BER] {E6 | E7 | E8 | E9 | E10 | E11 | E12 | E13 | E14  
 | E15 | E16 | E17 | E18 | J2 | J4 | J5 | J9}<NL>

**Example** This example places the bit error rate in the varRate variable and displays it on the computer's screen.

```
myScope.WriteString ":SYSTEM:HEADer OFF" ' Response headers off.  
myScope.WriteString ":MEASure:RJDJ:BER?"  
varRate = myScope.ReadNumber  
Debug.Print FormatNumber(varRate, 0)
```

**History** Legacy command (existed before version 3.10).

Version 3.10: Added J2 and J9 jitter BER levels.

Version 5.75: Added J4 and J5 jitter BER levels.

## :MEASure:RJDJ:CLOCK

### Command

**NOTE**

This command is available when the Jitter Analysis Software license is installed.

```
:MEASure:RJDJ:CLOCK {ON | OFF}
```

When the :MEASure:RJDJ:CLOCK command is set to ON, it forces the pattern to be a clock and sets the jitter for edges not examined to zero (0).

To measure jitter on only rising (or falling) edges of a clock, you must also set :MEASure:CLOCK:METHod:EDGE to RISing or FALLing, and you must set :MEASure:RJDJ:EDGE to the same RISing or FALLing option.

**Example** This example turns on the RJDJ clock option.

```
myScope.WriteString ":MEASure:RJDJ:CLOCK ON"
```

**Query** :MEASure:RJDJ:CLOCK?

The :MEASure:RJDJ:CLOCK? query returns the setting.

**Returned Format** [:MEASure:RJDJ:CLOCK] {ON | OFF}<NL>

**Example** This example places the current RJDJ clock setting in the strSetting variable and displays it on the computer's screen.

```
myScope.WriteString ":SYSTem:HEADer OFF" ' Response headers off.
myScope.WriteString ":MEASure:RJDJ:CLOCK?"
strSetting = myScope.ReadNumber
Debug.Print strSetting
```

**See Also**

- [":ANALyze:CLOCK:METHod:EDGE"](#) on page 281
- [":MEASure:RJDJ:EDGE"](#) on page 1093

**History** New in version 4.30.

## :MEASure:RJDJ:CREference

**Command** :MEASure:RJDJ:CREference {0 | 1 | 2 | 3}

The :MEASure:RJDJ:CREference command specifies the number of UI away from the data edge at which to measure jitter.

Some jitter measurements (for example, in DDR jitter tests) need to be made at several UI away from the data edge. If your measurements do not have these requirements, a value of zero (0) is normally used.

**Query** :MEASure:RJDJ:CREference?

The :MEASure:RJDJ:CREference? query returns the UI away from data edge setting.

**Returned Format** <ui\_from\_edge><NL>  
<ui\_from\_edge> ::= {0 | 1 | 2 | 3}

**History** New in version 6.30.

## :MEASure:RJDJ:EDGE

## Command

## NOTE

This command is available only when the Jitter Analysis Software license is installed.

```
:MEASure:RJDJ:EDGE {RISing | FALLing | BOTH}
```

The :MEASure:RJDJ:EDGE command sets the edge used for the RJDJ measurements.

**Example** This example sets the RJDJ edge to use both edges.

```
myScope.WriteString ":MEASure:RJDJ:EDGE BOTH"
```

## Query

```
:MEASure:RJDJ:EDGE?
```

The :MEASure:RJDJ:EDGE? query returns the edge being used for the RJDJ measurements.

## Returned Format

```
[ :MEASure:RJDJ:EDGE ] {RIS | FALL | BOTH} <NL>
```

**Example** This example places the current edge being used for RJDJ measurements in the varEdge variable and displays it on the computer's screen.

```
myScope.WriteString ":SYSTem:HEADer OFF"      ' Response headers off.
myScope.WriteString ":MEASure:RJDJ:EDGE?"
varEdge = myScope.ReadNumber
Debug.Print FormatNumber(varEdge, 0)
```

**History** Legacy command (existed before version 3.10).

## :MEASure:RJDJ:INTerpolate

### Command

**NOTE**

This command is available only when the Jitter Analysis Software license is installed.

---

```
:MEASure:RJDJ:INTerpolate {LINear | NONE}
```

The :MEASure:RJDJ:INTerpolate command sets the interpolation mode used for the RJDJ measurements.

**Example** This example sets the RJDJ interpolation to use both linear.

```
myScope.WriteString ":MEASure:RJDJ:INTerpolate LINear"
```

**Query** :MEASure:RJDJ:INTerpolate?

The :MEASure:RJDJ:INTerpolate? query returns the interpolation mode being used for the RJDJ measurements.

**Returned Format** [:MEASure:RJDJ:INTerpolate] {LINear | NONE}<NL>

**Example** This example places the current interpolation mode being used for RJDJ measurements in the interpolate variable and displays it on the computer's screen.

```
myScope.WriteString ":SYSTem:HEADer OFF" ' Response headers off.
myScope.WriteString ":MEASure:RJDJ:INTerpolate?"
varInterpolate = myScope.ReadNumber
Debug.Print FormatNumber(varInterpolate, 0)
```

**History** Legacy command (existed before version 3.10).

## :MEASure:RJDJ:METhod

## Command

## NOTE

This command is available only when the Jitter Analysis Software license is installed.

```
:MEASure:RJDJ:METhod {SPEctral | BOTH}
```

The :MEASure:RJDJ:METhod command lets you select the method for random jitter (RJ) analysis, either the SPEctral method or BOTH the spectral and tail fit methods.

When analyzing jitter with crosstalk or ground bounce effects present in your signal, select BOTH. When this option is selected, the deterministic jitter (DJ) that is uncorrelated to the data pattern, also known as bounded uncorrelated jitter (BUJ), is separated into periodic jitter (PJ) and aperiodic bounded uncorrelated jitter (ABUJ). ABUJ is caused by crosstalk and ground bounce effects.

When there are no crosstalk or ground bounce effects present in your signal, you can select the SPEctral method in order to run faster. When this option is selected, the deterministic jitter (DJ) that is uncorrelated to the data pattern is all reported as periodic jitter (PJ).

**Example** This example sets the RJDJ method to BOTH the spectral and tail fit analysis.

```
myScope.WriteString ":MEASure:RJDJ:METhod BOTH"
```

**Query** :MEASure:RJDJ:METhod?

The :MEASure:RJDJ:METhod? query returns the selected RJDJ method.

**Returned Format** [:MEASure:RJDJ:METhod] {SPEC | BOTH}<NL>

**Example** This example places the RJDJ method setting the strJitterMethod variable and displays it on the computer's screen.

```
myScope.WriteString ":SYSTem:HEADer OFF" ' Response headers off.
myScope.WriteString ":MEASure:RJDJ:METhod?"
strJitterMethod = myScope.ReadString
Debug.Print strJitterMethod
```

**See Also** • [":MEASure:RJDJ:REPort"](#) on page 1099

**History** New in version 4.10.

**:MEASure:RJDJ:MODE****Command****NOTE**

This command is available only when the Jitter Analysis Software license is installed.

---

```
:MEASure:RJDJ:MODE {TIE | PERiod | NUI[,<ui>]}
```

The :MEASure:RJDJ:MODE command sets the RJDJ measurement mode. If NUI is selected then <ui> selects the number of unit intervals (for example: :MEASure:RJDJ:MODE NUI,5).

**Example** This example sets the RJDJ mode to TIE.

```
myScope.WriteString ":MEASure:RJDJ:MODE TIE"
```

**Query** :MEASure:RJDJ:MODE?

The :MEASure:RJDJ:MODE? query returns the mode of the RJDJ measurements.

**History** Legacy command (existed before version 3.10).



## :MEASure:RJDJ:PAMThreshold

**Command** :MEASure:RJDJ:PAMThreshold <level>  
<level> ::= {T01 | T12 | T23 | ALL}

The :MEASure:RJDJ:PAMThreshold command specifies which PAM thresholds to measure for PAM-4 signals.

**Query** :MEASure:RJDJ:PAMThreshold?

The :MEASure:RJDJ:PAMThreshold? query returns the PAM threshold setting.

**Returned Format** <level><NL>

- See Also**
- [":DISPlay:JITTer:THReshold"](#) on page 545
  - [":MEASure:RJDJ:ALL?"](#) on page 1085
  - [":MEASure:RJDJ:TJRJDJ?"](#) on page 1105

**History** New in version 6.10.

## :MEASure:RJDJ:PLENgtH

## Command

## NOTE

This command is available only when the Jitter Analysis Software license is installed.

```
:MEASure:RJDJ:PLENgtH {AUTO
| {ARBitrary,<isi_filter_lead>,<isi_filter_lag>}
| <number_of_bits>}
```

The :MEASure:RJDJ:PLENgtH command sets the number of bits used pattern length for the RJDJ measurements.

<isi\_filter\_lead> An integer number that is less than or equal to 0 that is the number of leading bits that are used to calculate the ISI filter.

<isi\_filter\_lag> An integer number that is greater than or equal to 0 that is the number of trailing bits used to calculate the ISI filter.

<number\_of\_bits> An integer number that is the length of pattern from 2 to 1024.

**Example** This example sets the RJDJ bits to 5.

```
myScope.WriteString ":MEASure:RJDJ:PLENgtH 5"
```

**Query** :MEASure:RJDJ:PLENgtH?

The :MEASure:RJDJ:PLENgtH? query returns the number of bits being used for the RJDJ measurements when Periodic pattern length is set. For Arbitrary pattern length, the ISI filter lead and filter lag numbers are returned.

## Returned Format

```
[MEASure:RJDJ:PLENgtH] {AUTO
| ARBitrary,<isi_filter_lead>,<isi_filter_lag>
| <number_of_bits>}<NL>
```

**Example** This example places the current number of bits for RJDJ measurements in the varBits variable and displays it on the computer's screen.

```
myScope.WriteString ":SYSTem:HEADer OFF" ' Response headers off.
myScope.WriteString ":MEASure:RJDJ:PLENgtH?"
varBits = myScope.ReadNumber
Debug.Print FormatNumber(varBits, 0)
```

**History** Legacy command (existed before version 3.10).

## :MEASure:RJDJ:REPort

### Command

**NOTE**

This command is available only when the Jitter Analysis Software license is installed.

```
:MEASure:RJDJ:REPort {SPECTral | TAILfit}
```

When the :MEASure:RJDJ:METHod BOTH command selects both the spectral and tail fit methods for random jitter analysis, the :MEASure:RJDJ:REPort command specifies which method is used for the reports in the jitter graphs/histograms and Jitter tab measurements.

**Example** This example specifies that the RJDJ report include measurements from both the spectral and tail fit analysis (including aperiodic bounded uncorrelated jitter ABUJ measurements).

```
myScope.WriteString ":MEASure:RJDJ:REPort TAILfit"
```

### Query

```
:MEASure:RJDJ:REPort?
```

The :MEASure:RJDJ:REPort? query returns the report setting.

### Returned Format

```
[ :MEASure:RJDJ:REPort ] {SPEC | TAIL}<NL>
```

**Example** This example places the report setting in the strReportSetting variable and displays it on the computer's screen.

```
myScope.WriteString ":SYSTem:HEADer OFF" ' Response headers off.
myScope.WriteString ":MEASure:RJDJ:REPort?"
strReportSetting = myScope.ReadString
Debug.Print strReportSetting
```

**See Also** • [":MEASure:RJDJ:METHod"](#) on page 1095

**History** New in version 4.10.

## :MEASure:RJDJ:RJ

## Command

## NOTE

This command is available when the EZJIT Plus software is installed.

```
:MEASure:RJDJ:RJ {ON, <RJrms> | OFF}
```

The :MEASure:RJDJ:RJ command can specify a known amount of random jitter. When used, the remaining amount of the total jitter measured is reported as periodic jitter (PJ).

This command is used in situations when crosstalk aggressors influence the random jitter measured on a signal. If the random jitter on a signal is measured without the aggressor signal crosstalk, this known amount of random jitter can be specified when measuring the jitter again with the crosstalk aggressors.

- ON – Enables a specified amount of random jitter.
- <RJrms> – The known amount of random jitter.
- OFF – Disables the specification of known random jitter.

The amount of random jitter is shown in the jitter measurement results (see [page 1085](#)) as "RJ(rms specified)".

**Example** This example specifies 500 fs of random jitter.

```
myScope.WriteString ":MEAS:RJDJ:RJ ON, 500e-15"
```

**Query** :MEASure:RJDJ:RJ?

The :MEASure:RJDJ:RJ? query returns the specified RJ settings.

**Returned Format** [:MEASure:RJDJ:RJ] {ON, <RJrms> | OFF}<NL>

**Example** This example places the specified RJ settings in the strKnownRandomJitter variable and displays it on the computer's screen.

```
myScope.WriteString ":SYSTem:HEADer OFF" ' Response headers off.
myScope.WriteString ":MEASure:RJDJ:RJ?"
strKnownRandomJitter = myScope.ReadString
Debug.Print strKnownRandomJitter
```

**History** New in version 3.50.

## :MEASure:RJDJ:SCOPE:RJ

## Command

## NOTE

This command is available when the EZJIT Plus software is installed.

```
:MEASure:RJDJ:SCOPE:RJ {ON, <RJrms> | AUTO | OFF}
```

The :MEASure:RJDJ:SCOPE:RJ command can specify the removal of the oscilloscope's calibrated random jitter from the reported RJ.

- ON – Enables the "manual" removal of a known oscilloscope random jitter from the reported RJ.
- <RJrms> – The known oscilloscope random jitter to remove from the reported RJ.
- AUTO – This option cannot be selected until the oscilloscope jitter calibration has been run (use the **Calibrate scope jitter** button in the front panel user interface). When selected, the calculated oscilloscope random jitter is removed from the reported RJ.

The calculated oscilloscope random jitter is shown in the jitter measurement results (see [page 1085](#)) as "Scope RJ(rms)".

- OFF – Disables the removal of the oscilloscope's calibrated random jitter from the reported RJ.

**Example** This example specifies 300 fs of known oscilloscope random jitter.

```
myScope.WriteString ":MEASure:RJDJ:SCOPE:RJ ON, 300e-15"
```

**Query** :MEASure:RJDJ:SCOPE:RJ?

The :MEASure:RJDJ:SCOPE:RJ? query returns the oscilloscope RJ settings.

**Returned Format** [:MEASure:RJDJ:SCOPE:RJ] {ON, <RJrms> | OFF}<NL>

**Example** This example places the oscilloscope RJ settings in the strScopeRJSettings variable and displays it on the computer's screen.

```
myScope.WriteString ":SYSTem:HEADer OFF" ' Response headers off.
myScope.WriteString ":MEASure:RJDJ:SCOPE:RJ?"
strScopeRJSettings = myScope.ReadString
Debug.Print strScopeRJSettings
```

**See Also** • [":MEASure:RJDJ:SCOPE:RJ:CALibrate"](#) on page 1102

**History** New in version 3.50.

## :MEASure:RJDJ:SCOPE:RJ:CALibrate

**Command** :MEASure:RJDJ:SCOPE:RJ:CALibrate

The :MEASure:RJDJ:SCOPE:RJ:CALibrate command calibrates the oscilloscope's jitter for jitter/noise analysis or for PAM-4 12-edge jitter measurements.

Sending this command is the same as clicking the **Calibrate scope jitter** button in the oscilloscope's front panel user interface "Remove, Specify Jitter, Noise" dialog box.

Before sending this command, you must:

- Disconnect or disable the input to the oscilloscope. The oscilloscope input must remain disconnected during the calibration.
- Enable jitter analysis, noise analysis, or PAM-4 12-edge jitter measurements.
- Specify one of the oscilloscope's analog input channels as the jitter or noise analysis source.
- Specify the **Custom: thresholds +/- hysteresis** thresholds mode.

**See Also** • [":MEASure:RJDJ:SCOPE:RJ"](#) on page 1101

**History** New in version 3.50.

Version 6.50: This command is also used to calibrates the oscilloscope's jitter for PAM-4 12-edge jitter measurements.

## :MEASure:RJDJ:SOURce

## Command

## NOTE

This command is available only when the Jitter Analysis Software license is installed.

```
:MEASure:RJDJ:SOURce <source>
```

The :MEASure:RJDJ:SOURce command sets the source for the RJDJ measurements.

<source> {CHANnel<N> | DIFF<D> | COMMONmode<C> | FUNCTion<F> | WMEMory<R> | EQUalized<L> | XT<X>}

For more information on <source> parameters, see "[Measurement Sources](#)" on page 890.

**Example** This example sets the RJDJ source to the channel 1 waveform.

```
myScope.WriteString ":MEASure:RJDJ:SOURce CHANnel1"
```

**Query** :MEASure:RJDJ:SOURce?

The :MEASure:RJDJ:SOURce? query returns the source being used for the RJDJ measurements.

**Returned Format** [:MEASure:RJDJ:SOURce] <source><NL>

**Example** This example places the current source for RJDJ measurements in the varSource variable and displays it on the computer's screen.

```
myScope.WriteString ":SYSTem:HEADer OFF" ' Response headers off.
myScope.WriteString ":MEASure:RJDJ:SOURce?"
varSource = myScope.ReadNumber
Debug.Print FormatNumber(varSource, 0)
```

**History** Legacy command (existed before version 3.10).

**:MEASure:RJDJ:STATe****Command****NOTE**

This command is available only when the Jitter Analysis Software license is installed.

---

```
:MEASure:RJDJ:STATe {ON | OFF}
```

The :MEASure:RJDJ:STATe command enables or disables the RJDJ measurements.

**Example** This example sets the RJDJ state to on.

```
myScope.WriteString ":MEASure:RJDJ:STATe ON"
```

**Query**

```
:MEASure:RJDJ:STATe?
```

The :MEASure:RJDJ:STATe? query returns the state of the RJDJ measurements.

**Returned Format**

```
[ :MEASure:RJDJ:STATe] {1 | 0}<NL>
```

**Example**

This example places the current state of the RJDJ measurements in the varState variable and displays it on the computer's screen.

```
myScope.WriteString ":SYSTEM:HEADer OFF" ' Response headers off.
myScope.WriteString ":MEASure:RJDJ:STATe?"
varState = myScope.ReadNumber
Debug.Print FormatNumber(varState, 0)
```

**History**

Legacy command (existed before version 3.10).



## :MEASure:RJDJ:TJRJDJ?

## Query

## NOTE

This command is available only when the Jitter Analysis Software license is installed.

```
:MEASure:RJDJ:TJRJDJ?
```

The :MEASure:RJDJ:TJRJDJ? query returns the Total Jitter (TJ), Random Jitter (RJ), and the Deterministic Jitter (DJ) measurements. These values are returned as comma separated triples of values using the following format:

## Returned Format

```
[ :MEASure:RJDJ:TJRJDJ ] TJ(<tj_format>),<tj_result>,<tj_state>,  
RJ(<rj_format>),<rj_result>,<rj_state>,  
DJ(<dj_format>),<dj_result>,<dj_state><NL>
```

With PAM-4 signals, when the ":MEASure:RJDJ:PAMThreshold ALL" command setting has been made, the query results include values for multiple threshold levels. For example:

```
[ :MEASure:RJDJ:TJRJDJ ] TJ(<tj_format>) 01,<tj_result>,<tj_state>,  
TJ(<tj_format>) 12,<tj_result>,<tj_state>,  
TJ(<tj_format>) 23,<tj_result>,<tj_state>,  
RJ(<rj_format>) 01,<rj_result>,<rj_state>,  
RJ(<rj_format>) 12,<rj_result>,<rj_state>,  
RJ(<rj_format>) 23,<rj_result>,<rj_state>,  
DJ(<dj_format>) 01,<dj_result>,<dj_state>,  
DJ(<dj_format>) 12,<dj_result>,<dj_state>,  
DJ(<dj_format>) 23,<dj_result>,<dj_state><NL>
```

Otherwise, the query results are for the specific threshold level specified in the :MEASure:RJDJ:PAMThreshold command.

<tj_format>	The format value tells you something about how the measurement is made. For instance, TJ(1E-12) means that the TJ measurement was derived using a bit error rate of 1E-12. A format of (rms) means the measurement is a root-mean-square measurement. A format of (d-d) means the measurement uses from a dual-Dirac delta model used to derive the measurement. A format of (p-p) means the measurement is a peak-to-peak measurement.
<rj_format>	
<dj_format>	
<tj_result>	The measured results for the RJDJ measurements. A value of 9.99999E+37 means that the oscilloscope was unable to make the measurement.
<rj_result>	
<dj_result>	
<tj_state>	The measurement result state. See <a href="#">Table 14</a> for a list of values and descriptions of the result state value.
<rj_state>	
<dj_state>	

**Example** This example places the Total Jitter (TJ), Random Jitter (RJ), and the Deterministic Jitter (DJ) measurements in the strResults variable and displays it on the computer's screen.

```
Dim strResult As String ' Dimension variable.
myScope.WriteString ":SYSTem:HEADer OFF" ' Response headers off.
myScope.WriteString ":MEASure:RJDJ:TJRJDJ?"
strResult = myScope.ReadString
Debug.Print strResult
```

**See Also** • [":MEASure:RJDJ:PAMThreshold"](#) on page 1097

**History** Legacy command (existed before version 3.10).

Version 6.10: Jitter analysis is supported on PAM-4 signals. When the ":MEASure:RJDJ:PAMThreshold ALL" command setting has been made, the query results include values for multiple threshold levels; otherwise, the query results are for the specific threshold level specified in the :MEASure:RJDJ:PAMThreshold command.

## :MEASure:RJDJ:UNITs

### Command

**NOTE**

This command is available only when the Jitter Analysis Software license is installed.

```
:MEASure:RJDJ:UNITs {SECond | UNITinterval}
```

The :MEASure:RJDJ:UNITs command sets the unit of measure for RJDJ measurements to seconds or unit intervals.

**Example** This example sets the RJDJ units to unit interval.

```
myScope.WriteString ":MEASure:RJDJ:UNITs UNITinterval"
```

### Query

```
:MEASure:RJDJ:UNITs?
```

The :MEASure:RJDJ:UNITs? query returns the units of measure being used for the RJDJ measurements.

### Returned Format

```
[ :MEASure:RJDJ:UNITs ] {SECond | UNITinterval}<NL>
```

### Example

This example places the current units of measure for the RJDJ measurements in the varUnits variable and displays it on the computer's screen.

```
myScope.WriteString ":SYSTem:HEADer OFF" ' Response headers off.
myScope.WriteString ":MEASure:RJDJ:UNITs?"
varUnits = myScope.ReadNumber
Debug.Print FormatNumber(varUnits, 0)
```

### History

Legacy command (existed before version 3.10).

## :MEASure:SCRatch

**Command** :MEASure:{SCRatch | CLear}

The :MEASure:SCRatch command clears the measurement results from the screen. This command performs the same function as :MEASure:CLear.

**Example** This example clears the current measurement results from the screen.

```
myScope.WriteString ":MEASure:SCRatch"
```

**History** Legacy command (existed before version 3.10).

## :MEASure:SENDvalid

**Command** :MEASure:SENDvalid {{OFF|0} | {ON|1}}

The :MEASure:SENDvalid command enables the result state code to be returned with the :MEASure:RESults? query and all other measurement queries.

**Example** This example turns the send valid function on.

```
myScope.WriteString ":MEASure:SENDvalid ON"
```

**Query** :MEASure:SENDvalid?

The :MEASure:SENDvalid? query returns the state of the send valid control.

**Returned Format** {:MEASure:SENDvalid] {0 | 1}<NL>

**Example** This example places the current mode for SENDvalid in the string variable, strMode, then prints the contents of the variable to the computer's screen.

```
Dim strMode As String ' Dimension variable.
myScope.WriteString ":MEASure:SENDvalid?"
strMode = myScope.ReadString
Debug.Print strMode
```

**See Also** Refer to the :MEASure:RESults? query for information on the results returned and how they are affected by the SENDvalid command. Refer to the individual measurements for information on how the result state is returned.

**History** Legacy command (existed before version 3.10).

## :MEASure:SER

**Command** :MEASure:SER <source>

When a pattern length and pattern can be determined (see the :ANALyze:SIGNal:PATtern:\* commands), the :MEASure:SER command installs a cumulative symbol error rate (SER) measurement of the specified PAM waveform into the user interface's measurement Results pane.

With PAM signals, there can be multiple bits per symbol, and symbol error rate is related to bit error rate (BER). For example, with PAM-4 one symbol error can translate to one or two bit errors.

<source> {CHANnel<N> | FUNction<F> | WMEMory<R> | XT<X>}

For more information on <source> parameters, see "[Measurement Sources](#)" on page 890.

**Query** :MEASure:SER? <source>

The :MEASure:SER? query returns the measured cumulative symbol error rate value.

**Returned Format** [:MEASure:SER] <value><NL>

<value> ::= the cumulative SER value in NR3 format.

- See Also**
- "[:ANALyze:SIGNal:PATtern:CLEar](#)" on page 306
  - "[:ANALyze:SIGNal:PATtern:LOAD](#)" on page 307
  - "[:ANALyze:SIGNal:PATtern:PLENght](#)" on page 308
  - "[:ANALyze:SIGNal:PATtern:SMAP](#)" on page 309
  - "[:MEASure:BER](#)" on page 896
  - "[:MEASure:BERPeracq](#)" on page 897
  - "[:MEASure:SERPeracq](#)" on page 1111

**History** New in version 5.60.

## :MEASure:SERPeracq

**Command** :MEASure:SERPeracq <source>

When a pattern length and pattern can be determined (see the :ANALyze:SIGNal:PATtern:\* commands), the :MEASure:SERPeracq command installs a symbol error rate (SER) per acquisition measurement of the specified PAM waveform into the user interface's measurement Results pane.

With PAM signals, there can be multiple bits per symbol, and symbol error rate is related to bit error rate (BER). For example, with PAM-4 one symbol error can translate to one or two bit errors.

<source> {CHANnel<N> | FUNction<F> | WMEMory<R> | XT<X>}

For more information on <source> parameters, see **"Measurement Sources"** on page 890.

**Query** :MEASure:SERPeracq? <source>

The :MEASure:SERPeracq? query returns the measured symbol error rate per acquisition value.

**Returned Format** [:MEASure:SERPeracq] <value><NL>

<value> ::= the SER per acquisition value in NR3 format.

- See Also**
- **":ANALyze:SIGNal:PATtern:CLEar"** on page 306
  - **":ANALyze:SIGNal:PATtern:LOAD"** on page 307
  - **":ANALyze:SIGNal:PATtern:PLENght"** on page 308
  - **":ANALyze:SIGNal:PATtern:SMAP"** on page 309
  - **":MEASure:BER"** on page 896
  - **":MEASure:BERPeracq"** on page 897
  - **":MEASure:SER"** on page 1110

**History** New in version 5.60.

## :MEASure:SETuptime

**Command** :MEASure:SETuptime [<data\_source>,<data\_source\_dir>,<clock\_source>,<clock\_source\_dir>]

The :MEASure:SETuptime command measures the setup time between the specified clock and data source.

This measurement requires all edges. When you add it, the "Measure All Edges" mode (see **":ANALyze:AEDGes"** on page 273) is automatically set to ON. When the "Measure All Edges" mode is set to OFF, this measurement cannot be made, and there are no measurement results.

<data\_source> {CHANnel<N> | FUNction<F> | WMEMory<R> | CLOCk | MTRend | MSPectrum | EQUalized<L>}

<clock\_source> {CHANnel<N> | FUNction<F> | DIGital<M> | WMEMory<R> | CLOCk | MTRend | MSPectrum | EQUalized<L>}

The MTRend and MSPectrum sources are available when the Jitter Analysis Software license is installed and the features are enabled.

The CLOCk source is available when the recovered clock is displayed.

The EQUalized<L> source is available when the Advanced Signal Integrity Software license is installed and the equalized waveform is displayed as a function.

<N> An integer, 1-4 in a single oscilloscope, 1-40 in a MultiScope system.

<F> An integer, 1-16.

<M> An integer, 0-15. Digital channels are available on mixed-signal oscilloscopes.

<R> An integer, 1-4.

<data\_source\_dir> {RISing | FALLing | BOTH}

Selects the direction of the data source edge. BOTH selects both edges to be measured.

<clock\_source\_dir> {RISing | FALLing}

Selects the direction of the clock source edge.

**Example** This example measures the setup time from the rising edge of channel 1 to the rising edge of channel 2.

```
myScope.WriteString ":MEASure:SETuptime CHAN1,RIS,CHAN2,RIS"
```

**Query** :MEASure:SETuptime? [<data\_source>,<data\_source\_dir>,<clock\_source>,<clock\_source\_dir>]

The :MEASure:SETuptime query returns the measured setup time between the specified clock and data source.



The necessary waveform edges must be present on the display. Also, the "Measure All Edges" mode must be set (use the :ANALyze:AEDGes command or :MEASure:SETuptime command before the query).

The query will return 9.99999E+37 if the necessary edges are not displayed or if the "Measure All Edges" mode is not currently set.

**Returned Format** { :MEASure:SETuptime] <value><NL>

<value> Setup time in seconds.

**Example** This example places the current value of setup time in the numeric variable, varTime, then prints the contents of the variable to the computer's screen.

```
myScope.WriteString ":SYSTem:HEADer OFF" ' Response headers off.
myScope.WriteString ":MEASure:SETuptime? CHAN1,RIS,CHAN2,RIS"
varTime = myScope.ReadNumber
Debug.Print FormatNumber(varTime, 0)
```

**See Also** · [":ANALyze:AEDGes"](#) on page 273

**History** Legacy command (existed before version 3.10).

## :MEASure:SLEWrate

## Command

## NOTE

This command is available only when the Jitter Analysis Software license is installed.

```
:MEASure:SLEWrate [<source>[,<direction>]]
```

The :MEASure:SLEWrate command measures the slew rate of the specified data source.

<source> {CHANnel<N> | FUNCTION<F> | WMEMory<R> | CLOCK | MTRend | MSPectrum | EQUalized<L> | XT<X>}

The MTRend and MSPectrum sources are available when the Jitter Analysis Software license is installed and the features are enabled.

The CLOCK source is available when the recovered clock is displayed.

The EQUalized<L> source is available when the Advanced Signal Integrity Software license is installed and the equalized waveform is displayed as a function.

<N> An integer, 1-4 in a single oscilloscope, 1-40 in a MultiScope system.

<F> An integer, 1-16.

<R> An integer, 1-4.

<direction> {RISing | FALLing | BOTH}

Specifies whether slew rate is measured on rising, falling, or either rising or falling edge(s). When <direction> is specified, the <source> parameter is required.

The BOTH option is valid only when the "Measure All Edges" mode is OFF (see **":ANALyze:AEDGes"** on page 273). In this case, the first edge from the left side of the display grid is used (whether the edge is rising or falling).

When the "Measure All Edges" mode is OFF, the RISing and FALLing options specify whether the first rising or falling edge from the left side of the display grid is used.

When the "Measure All Edges" mode is ON, the RISing and FALLing options specify whether slew rate is measured on rising or falling edges throughout the acquisition.

**Example** This example measures the slew rate of channel 1.

```
myScope.WriteString ":MEASure:SLEWrate CHANnel1,RISing"
```

**Query** :MEASure:SLEWrate? [<source>[,<direction>]]

The :MEASure:SLEWrate? query returns the measured slew rate for the specified source.

**Returned Format** { :MEASure:SLEWrate] <value><NL>

<value> Slew rate in volts per second.

**Example** This example places the channel 1 value of slew rate in the numeric variable, varTime, then prints the contents of the variable to the computer's screen.

```
myScope.WriteString ":SYSTEM:HEADer OFF" ' Response headers off.  
myScope.WriteString ":MEASure:SLEWrate? CHANnel1,RISing"  
varTime = myScope.ReadNumber  
Debug.Print FormatNumber(varTime, 0)
```

**History** Legacy command (existed before version 3.10).

## :MEASure:SOURce

**Command** :MEASure:SOURce {<source>[,<source>]}

The :MEASure:SOURce command selects the source for measurements. You can specify one or two sources with this command. All measurements except :MEASure:HOLDtime, :MEASure:SETUptime, and :MEASure:DELtatime are made on the first specified source. The delta time measurement uses two sources if two are specified.

**<source>** {CHANnel<N> | DIFF<D> | COMMONmode<C> | FUNCTION<F> | DIGital<M> | WMEMory<R> | CLOCK | MTRend | MSPectrum | EQUalized<L> | XT<X> | PNOise}

For more information on <source> parameters, see "[Measurement Sources](#)" on page 890.

**Example** This example selects channel 1 as the source for measurements.

```
myScope.WriteString ":MEASure:SOURce CHANnel1"
```

**Query** :MEASure:SOURce?

The :MEASure:SOURce? query returns the current source selection.

**Returned Format** [:MEASure:SOURce] <source>[,<source>] <NL>

**Example** This example places the currently specified sources in the string variable, strSource, then prints the contents of the variable to the computer's screen.

```
Dim strSource As String ' Dimension variable.
myScope.WriteString ":MEASure:SOURce?"
strSource = myScope.ReadString
Debug.Print strSource
```

**History** Legacy command (existed before version 3.10).

## :MEASure:STATistics

**Command** :MEASure:STATistics {{ON | 1} | CURRent | MAXimum | MEAN | MINimum  
| STDDev | COUNT}

The :MEASure:STATistics command determines the type of information returned by the :MEASure:RESults? query. ON means all the statistics are on.

**Example** This example turns all the statistics function on.

```
myScope.WriteString ":MEASure:STATistics ON"
```

**Query** :MEASure:STATistics?

The :MEASure:STATistics? query returns the current statistics mode.

**Returned Format** [:MEASure:STATistics] {ON | CURR | MAX | MEAN | MIN | STDD | COUN}<NL>

**Example** This example places the current mode for statistics in the string variable, strMode, then prints the contents of the variable to the computer's screen.

```
Dim strMode As String ' Dimension variable.
myScope.WriteString ":MEASure:STATistics?"
strMode = myScope.ReadString
Debug.Print strMode
```

**See Also**

- [":MEASure:RESults?"](#) on page 1079 for information on the result returned and how it is affected by the STATistics command.
- [":MEASure:SENDvalid"](#) on page 1109

**History** Legacy command (existed before version 3.10).

Version 6.30: The COUNT option has been added to allow the :MEASure:RESults? query to return the measurement count value.

## :MEASure:TEDGe

**Command** :MEASure:TEDGe <meas\_thres\_txt>, [<slope>] <occurrence> [, <source>]

The :MEASure:TEDGe command measures the time interval between the trigger event and the specified edge (threshold level, slope, and transition). Sources are specified with the :MEASure:SOURce command or with the optional parameter following the :MEASure:TEDGe command.

<meas\_thres\_txt> UPPER, MIDDLE, or LOWER to identify the threshold.

<slope> { - (minus) for falling | + (plus) for rising | <none> (the slope is optional; if no slope is specified, + (plus) is assumed) }

<occurrence> An integer value representing the edge of the occurrence. The desired edge must be present on the display. Edges are counted with 1 being the first edge from the left on the display, and a maximum value of 65534.

<source> {CHANnel<N> | DIFF<D> | COMMONmode<C> | FUNCTION<F> | DIGital<M> | WMemory<R> | CLOCK | MTRend | MSPectrum | EQUalized<L>}

For more information on <source> parameters, see "[Measurement Sources](#)" on page 890.

**Query** :MEASure:TEDGe? <meas\_thres\_txt>, <slope> <occurrence> [, <source>]

The :MEASure:TEDGe? query returns the time interval between the trigger event and the specified edge (threshold level, slope, and transition).

**Returned Format** [:MEASure:TEDGe] <time> [, <result\_state>] <NL>

<time> The time interval between the trigger event and the specified voltage level and transition.

<result\_state> If SENDvalid is ON, the result state is returned with the measurement result. See the :MEASure:RESults table in this chapter for a list of the result states.

**Example** This example returns the time interval between the trigger event and the 90% threshold on the second rising edge of the source waveform to the numeric variable, varTime. The contents of the variable are then printed to the computer's screen.

```
myScope.WriteString ":SYSTEM:HEADer OFF" ' Response headers off.
myScope.WriteString ":MEASure:TEDGe? UPPER,+2,CHANnel1"
varTime = myScope.ReadNumber
Debug.Print FormatNumber(varTime, 0)
```

**NOTE****Turn Off Headers**

When receiving numeric data into numeric variables, turn off the headers. Otherwise, the headers may cause misinterpretation of returned data.

**History** Legacy command (existed before version 3.10).

## :MEASure:THResholds:ABSolute

**Command** :MEASure:THResholds:ABSolute <source>,  
<upper\_volts>,<middle\_volts>,<lower\_volts>

The :MEASure:THResholds:ABSolute command sets the upper level, middle level, and lower level voltages that are used to calculate the measurements that use them.

**<source>** {ALL | CHANnel<N> | FUNction<F> | WMemory<R> | DIGital<M> | CLOck | MTRend | MSPectrum | EQUalized<L> | XT<X> | PNOise}

Setting the source to ALL does not affect the individual channel settings which is the behavior as the user interface.

For more information on <source> parameters, see "[Measurement Sources](#)" on page 890.

**<upper\_volts>** A real number specifying voltage thresholds.  
**<middle\_volts>**  
**<lower\_volts>**

**Example** This example sets the custom voltage thresholds to 0.9 volts for the upper level, 0.5 volts for the middle level and 0.1 volts for the lower level on channel 2.

```
myScope.WriteString ":SYSTem:HEADer OFF" ' Response headers off.
myScope.WriteString ":MEASure:THResholds:ABSolute CHANnel2,0.9,0.5,0.1"
```

**Query** :MEASure:THResholds:ABSolute? <source>

The :MEASure:THResholds:ABSolute? query returns the current settings for upper level, middle level, and lower level voltages for the custom thresholds.

**Returned Format** [:MEASure:THResholds:ABSolute] <upper\_volts>,<middle\_volts>,<lower\_volts>  
><NL>

**Example** This example returns the upper level, middle level, and lower level voltages used to calculate the measurements on channel 1.

```
myScope.WriteString ":SYSTem:HEADer OFF" ' Response headers off.
myScope.WriteString ":MEASure:THResholds:ABSolute? CHANnel1"
strThresholds = myScope.ReadString
Debug.Print strThresholds
```

**NOTE****Turn Off Headers**

When receiving numeric data into numeric variables, turn off the headers. Otherwise, the headers may cause misinterpretation of returned data.

**History** Legacy command (existed before version 3.10).

## :MEASure:THResholds:DISPlay

**Command** :MEASure:THResholds:DISPlay <source>,{0 | OFF} | {1 | ON}}

When the source is a PAM-4 signal type (see :ANALyze:SIGNal:TYPE), the :MEASure:THResholds:DISPlay command turns on or off the display of the PAM measurement thresholds. This is the remote command equivalent of the graphical user interface's **Display Thresholds** check box in the Signal Type Setup dialog box.

<source> ::= {CHANnel<N> | FUNction<F> | WMEMory<N> | EQUalized<L>}

**Query** :MEASure:THResholds:DISPlay? <source>

The :MEASure:THResholds:DISPlay? query returns thresholds display setting.

**Returned Format** <setting><NL>

<setting> ::= {0 | 1}

- See Also**
- [":ANALyze:SIGNal:TYPE"](#) on page 312
  - [":MEASure:THResholds:GENeral:METhod"](#) on page 1126
  - [":MEASure:THResholds:GENeral:PAMCustom"](#) on page 1128
  - [":MEASure:THResholds:GENeral:PAMAutomatic"](#) on page 1130
  - [":MEASure:THResholds:RFALL:METhod"](#) on page 1143
  - [":MEASure:THResholds:RFALL:PAMAutomatic"](#) on page 1145

**History** New in version 6.10.



## :MEASure:THResholds:GENAUTO

**Command** :MEASure:THResholds:GENAUTO <source>

When the "Custom: threshold +/- hysteresis" method is selected (see :MEASure:THResholds:GENeral:METhod) and thresholds apply to individual waveforms, the :MEASure:THResholds:GENAUTO command automatically determines threshold and hysteresis values.

Once the "Custom: threshold +/- hysteresis" method has been selected, this command is the same as pressing the **Auto set thresholds** button in the graphical user interface.

<source> {CHANnel<N> | FUNction<F> | WMemory<R> | CLOck | MTRend | MSPectrum | EQUalized<L> | XT<X> | PNOise}

For more information on <source> parameters, see "**Measurement Sources**" on page 890.

**See Also**

- "**:MEASure:THResholds:GENeral:METhod**" on page 1126
- "**:MEASure:THResholds:GENeral:HYSTeresis**" on page 1124

**History** New in version 6.00.

## :MEASure:THResholds:GENeral:ABSolute

**Command** :MEASure:THResholds:GENeral:ABSolute <source>,  
<upper\_volts>,<middle\_volts>,<lower\_volts>

The :MEASure:THResholds:GENeral:ABSolute command sets the upper level, middle level, and lower level voltages that are used to calculate the measurements that use them.

**NOTE**

These general-purpose threshold settings are used for everything except rise/fall measurements and protocol decode.

<source> {ALL | CHANnel<N> | FUNctIon<F> | WMemOry<R> | DIGital<M> | CLOCK | MTRend | MSPectrum | EQUalized<L> | XT<X> | PNOise}

Setting the source to ALL does not affect the individual channel settings which is the behavior as the user interface.

For more information on <source> parameters, see "[Measurement Sources](#)" on page 890.

<upper\_volts> A real number specifying voltage thresholds.  
<middle\_volts>  
<lower\_volts>

**Example** This example sets the custom voltage thresholds to 0.9 volts for the upper level, 0.5 volts for the middle level and 0.1 volts for the lower level on channel 2.

```
myScope.WriteString ":SYSTEM:HEADer OFF" ' Response headers off.
myScope.WriteString ":MEASure:THResholds:GENeral:ABSolute CHANnel2,0.9,0.5,0.1"
```

**Query** :MEASure:THResholds:GENeral:ABSolute? <source>

The :MEASure:THResholds:GENeral:ABSolute? query returns the current settings for upper level, middle level, and lower level voltages for the custom thresholds.

**Returned Format** [:MEASure:THResholds:GENeral:ABSolute] <upper\_volts>,<middle\_volts>,<lower\_volts><NL>

**Example** This example returns the upper level, middle level, and lower level voltages used to calculate the measurements on channel 1.

```
myScope.WriteString ":SYSTEM:HEADer OFF" ' Response headers off.
myScope.WriteString ":MEASure:THResholds:GENeral:ABSolute? CHANnel1"
strThresholds = myScope.ReadString
Debug.Print strThresholds
```

**NOTE****Turn Off Headers**

When receiving numeric data into numeric variables, turn off the headers. Otherwise, the headers may cause misinterpretation of returned data.

- See Also**
- [":MEASure:THResholds:ABSolute"](#) on page 1119
  - [":MEASure:THResholds:RFALL:ABSolute"](#) on page 1141
  - [":MEASure:THResholds:SERial:ABSolute"](#) on page 1153

**History** New in version 3.10.

## :MEASure:THResholds:GENeral:HYSTeresis

**Command** :MEASure:THResholds:GENeral:HYSTeresis <source>,<range>,<level>

The :MEASure:THResholds:GENeral:HYSTeresis command sets the range and level voltages that are used to calculate the measurements that use them. The range is added to the level to determine the upper level voltage for measurements that use it. The range is subtracted from the level to determine the lower level voltage. The level is the middle level voltage.

**NOTE**

These general-purpose threshold settings are used for everything except rise/fall measurements and protocol decode.

**<source>** {ALL | CHANnel<N> | FUNCTION<F> | DIGital<M> | WMEMory<R> | CLOCk | MTRend | MSPectrum | EQUalized<L> | XT<X> | PNOise}

Setting the source to ALL does not affect the individual channel settings which is the behavior as the user interface.

For more information on <source> parameters, see "[Measurement Sources](#)" on page 890.

**<range>** A real number specifying voltage range for the hysteresis around the level value.

**<level>** A real number specifying voltage level.

**Example** This example sets the hysteresis range to 0.9 volts and 0.1 volts for the level on channel 2.

```
myScope.WriteString ":SYSTEM:HEADER OFF" ' Response headers off.
myScope.WriteString ":MEASure:THResholds:GENeral:HYSTeresis CHANnel2,0.9
,0.1"
```

**Query** :MEASure:THResholds:GENeral:HYSTeresis? <source>

The :MEASure:THResholds:GENeral:HYSTeresis? query returns the current settings for upper level, middle level, and lower level voltages for the custom thresholds.

**Returned Format** [:MEASure:THResholds:GENeral:HYSTeresis] <range>,<level><NL>

**Example** This example returns the range and level voltages used to calculate the measurements on channel 1.

```
myScope.WriteString ":SYSTEM:HEADER OFF" ' Response headers off.
myScope.WriteString ":MEASure:THResholds:GENeral:HYSTeresis? CHANnel1"
strRangeLevel = myScope.ReadString
Debug.Print strRangeLevel
```

**NOTE****Turn Off Headers**

When receiving numeric data into numeric variables, turn off the headers. Otherwise, the headers may cause misinterpretation of returned data.

---

- See Also
- [":MEASure:THResholds:GENAUTO"](#) on page 1121
  - [":MEASure:THResholds:HYSteresis"](#) on page 1137
  - [":MEASure:THResholds:SERial:HYSteresis"](#) on page 1155

History New in version 3.10.

## :MEASure:THResholds:GENeral:METhod

**Command** :MEASure:THResholds:GENeral:METhod <source>,{ABSolute | PERCent  
| HYSteresis | PAMCustom | PAMAutomatic}

The :MEASure:THResholds:GENeral:METhod command determines the way that the top and base of a waveform are calculated for all of the measurements that use them.

**NOTE**

These general-purpose threshold settings are used for everything except rise/fall measurements and protocol decode.

When the signal type is PAM-4 (see :ANALyze:SIGNal:TYPE), you can choose between these methods for setting the general measurement thresholds:

- PAMCustom – Then, use the :MEASure:THResholds:GENeral:PAMCustom command to set the PAM threshold levels for general measurements to the values you specify.
- PAMAutomatic – Then, use the :MEASure:THResholds:GENeral:PAMAutomatic command to specify whether the PAM threshold levels for general measurements are determined automatically or using the PAM-4 levels you specify.

**<source>** {ALL | CHANnel<N> | FUNCTION<F> | DIGital<M> | WMEMory<R> | CLOCk | MTRend | MSPectrum | EQUalized<L> | XT<X> | PNOise}

Setting the source to ALL does not affect the individual channel settings which is the behavior as the user interface.

For more information on <source> parameters, see "[Measurement Sources](#)" on page 890.

**Example** This example sets the method used to calculate the top and base of a waveform to hysteresis.

```
myScope.WriteString ":SYSTEM:HEADer OFF" ' Response headers off.
myScope.WriteString ":MEASure:THResholds:GENeral:METhod CHANnel1,HYStere
sis"
```

**Query** :MEASure:THResholds:GENeral:METhod? <source>

The :MEASure:THResholds:GENeral:METhod? query returns the current method being used to calculate the top and base of a waveform.

**Returned Format** [:MEASure:THResholds:GENeral:METhod <source>],[ ABS | PERC | HYST  
| PAMC | PAMA }

**Example** This example returns the method used to calculate the top and base of a waveform to hysteresis.

```
myScope.WriteString ":SYSTEM:HEADer OFF" ' Response headers off.
myScope.WriteString ":MEASure:THResholds:GENeral:METhod?"
```

```
varMethod = myScope.ReadNumber  
Debug.Print FormatNumber(varMethod, 0)
```

- See Also**
- [":MEASure:THResholds:METHod"](#) on page 1139
  - [":MEASure:THResholds:RFALL:METHod"](#) on page 1143
  - [":MEASure:THResholds:SERial:METHod"](#) on page 1157
  - [":ANALyze:SIGNal:TYPE"](#) on page 312
  - [":MEASure:THResholds:GENeral:PAMCustom"](#) on page 1128
  - [":MEASure:THResholds:GENeral:PAMAutomatic"](#) on page 1130

**History** New in version 3.10.

Version 5.50: When the signal type is PAM-4, you can choose between PAMCustom and PAMAutomatic methods for setting the general measurement thresholds.

## :MEASure:THResholds:GENeral:PAMCustom

**Command** When the signal type is PAM-4 (see :ANALyze:SIGNal:TYPE) and :MEASure:THResholds:GENeral:METhod is set to PAMCustom:

```
:MEASure:THResholds:GENeral:PAMCustom
  <source>,<01_threshold>,<12_threshold>,<23_threshold>[,<hysteresis>]
```

When the signal type is PAM-3 (see :ANALyze:SIGNal:TYPE) and :MEASure:THResholds:GENeral:METhod is set to PAMCustom:

```
:MEASure:THResholds:GENeral:PAMCustom
  <source>,<01_threshold>,<12_threshold>[,<hysteresis>]
```

The :MEASure:THResholds:GENeral:PAMCustom command sets the PAM threshold levels for general measurements to the values you specify.

**<source>** {CHANnel<N> | FUNcTION<F> | WMEMory<R> | XT<X>}

For more information on <source> parameters, see "[Measurement Sources](#)" on page 890.

**<01\_threshold>,<12\_threshold>,<23\_threshold>** Values for the PAM-4 01, 12, and 23 thresholds in NR3 format.

**<01\_threshold>,<12\_threshold>** Values for the PAM-3 01 and 12 thresholds in NR3 format.

**<hysteresis>** Threshold hysteresis value in NR3 format.

**Query** :MEASure:THResholds:GENeral:PAMCustom? <source>

The :MEASure:THResholds:GENeral:PAMCustom? query returns the currently set PAM custom threshold levels for general measurements.

**Returned Format** When the signal type is PAM-4 (see :ANALyze:SIGNal:TYPE) and :MEASure:THResholds:GENeral:METhod is set to PAMCustom:

```
[ :MEASure:THResholds:GENeral:PAMCustom]
  <source>,<01_threshold>,<12_threshold>,<23_threshold>,<hysteresis><NL>
```

When the signal type is PAM-3 (see :ANALyze:SIGNal:TYPE) and :MEASure:THResholds:GENeral:METhod is set to PAMCustom:

```
[ :MEASure:THResholds:GENeral:PAMCustom]
  <source>,<01_threshold>,<12_threshold>,<hysteresis><NL>
```

- See Also**
- "[:ANALyze:CLOCK:METhod:SKEW](#)" on page 290
  - "[:ANALyze:SIGNal:DATarate](#)" on page 298
  - "[:ANALyze:SIGNal:SYMBOLrate](#)" on page 310
  - "[:ANALyze:SIGNal:TYPE](#)" on page 312
  - "[:MEASure:CGRade:EWIDth](#)" on page 907



- `":MEASure:CGRade:EHEight"` on page 904
- `":MEASure:FALLtime"` on page 946
- `":MEASure:PAM:ELEVel"` on page 1022
- `":MEASure:PAM:ESKew"` on page 1024
- `":MEASure:PAM:LEVel"` on page 1031
- `":MEASure:PAM:LRMS"` on page 1033
- `":MEASure:PAM:LTHickness"` on page 1035
- `":MEASure:RISetime"` on page 1083
- `":MEASure:THResholds:DISPlay"` on page 1120
- `":MEASure:THResholds:GENeral:METhod"` on page 1126
- `":MEASure:THResholds:GENeral:PAMAutomatic"` on page 1130
- `":MEASure:THResholds:RFALL:METhod"` on page 1143
- `":MEASure:THResholds:RFALL:PAMAutomatic"` on page 1145
- `":MEASure:TIEData2"` on page 1167

**History** New in version 5.50.

Version 6.10: Added an optional <hysteresis> value at the end of the command parameters.

Version 6.30: Modified to work with the PAM-3 signal type.

## :MEASure:THResholds:GENeral:PAMAutomatic

**Command** :MEASure:THResholds:GENeral:PAMAutomatic  
 <source>,{AUTomatic | <0\_level>,<1\_level>,<2\_level>,<3\_level>}

When the signal type is PAM-4 (see :ANALyze:SIGNal:TYPE) and :MEASure:THResholds:GENeral:METHOD is set to PAMAutomatic, the :MEASure:THResholds:GENeral:PAMAutomatic command specifies whether the PAM threshold levels for general measurements are determined automatically or using the PAM-4 levels you specify.

<source> {CHANnel<N> | FUNction<F> | WMEMory<R> | XT<X>}

For more information on <source> parameters, see **"Measurement Sources"** on page 890.

<0\_level>, Voltage values for the PAM-4 0, 1, 2, and 3 levels in NR3 format.  
 <1\_level>  
 <2\_level>  
 <3\_level>

**Query** :MEASure:THResholds:GENeral:PAMAutomatic? <source>

The :MEASure:THResholds:GENeral:PAMAutomatic? query returns the values used for automatically setting the PAM general threshold levels.

**Returned Format** [:MEASure:THResholds:GENeral:PAMAutomatic]  
 <source>,{AUTomatic | <0\_level>,<1\_level>,<2\_level>,<3\_level>}<NL>

- See Also**
- **" :ANALyze:CLOCK:METHOD:SKEW "** on page 290
  - **" :ANALyze:SIGNal:DATarate "** on page 298
  - **" :ANALyze:SIGNal:SYMBOLrate "** on page 310
  - **" :ANALyze:SIGNal:TYPE "** on page 312
  - **" :MEASure:CGRade:EWIDth "** on page 907
  - **" :MEASure:CGRade:EHEight "** on page 904
  - **" :MEASure:FALLtime "** on page 946
  - **" :MEASure:PAM:ELEVEL "** on page 1022
  - **" :MEASure:PAM:ESKew "** on page 1024
  - **" :MEASure:PAM:LEVEL "** on page 1031
  - **" :MEASure:PAM:LRMS "** on page 1033
  - **" :MEASure:PAM:LTHickness "** on page 1035
  - **" :MEASure:RISetime "** on page 1083
  - **" :MEASure:THResholds:DISPlay "** on page 1120
  - **" :MEASure:THResholds:GENeral:METHOD "** on page 1126
  - **" :MEASure:THResholds:GENeral:PAMCustom "** on page 1128

- `":MEASure:THResholds:RFALL:METhod"` on page 1143
- `":MEASure:THResholds:RFALL:PAMAutomatic"` on page 1145
- `":MEASure:TIEData2"` on page 1167

**History** New in version 5.50.

## :MEASure:THResholds:GENeral:PERCent

**Command** :MEASure:THResholds:GENeral:PERCent <source>,<upper\_pct>,<middle\_pct>,<lower\_pct>

The :MEASure:THResholds:GENeral:PERCent command sets the upper level, middle level, and lower level voltages as a percentage of the top and base voltages which are used to calculate the measurements that use them.

**NOTE**

These general-purpose threshold settings are used for everything except rise/fall measurements and protocol decode.

<source> {ALL | CHANnel<N> | FUNctIon<F> | DIGital<M> | WMEMory<R> | CLOCK | MTRend | MSPectrum | EQUalized<L> | XT<X> | PNOise}

Setting the source to ALL does not affect the individual channel settings which is the behavior as the user interface.

For more information on <source> parameters, see "[Measurement Sources](#)" on page 890.

<upper\_pct> A real number specifying upper percentage from -24.8 to 125.0  
 <middle\_pct> A real number specifying the middle percentage from -24.9 to 124.9.  
 <lower\_pct> A real number specifying the lower percentage from -25.0 to 125.8

**Example** This example sets the percentage to 100% for the upper level, 50% for the middle level and 0% for the lower level on channel 2.

```
myScope.WriteString ":SYSTEM:HEADer OFF" ' Response headers off.
myScope.WriteString ":MEASure:THResholds:GENeral:PERCent CHANnel2,100,50,0"
```

**Query** :MEASure:THResholds:GENeral:PERCent? <source>

The :MEASure:THResholds:GENeral:PERCent? query returns the current settings for upper level, middle level, and lower level percentages.

**Returned Format** [:MEASure:THResholds:GENeral:PERCent] <upper\_pct>,<middle\_pcts>,<lower\_pct><NL>

**Example** This example returns the upper level, middle level, and lower level percentages used to calculate the measurements on channel 1.

```
myScope.WriteString ":SYSTEM:HEADer OFF" ' Response headers off.
myScope.WriteString ":MEASure:THResholds:GENeral:PERCent? CHANnel1"
strThresholdsPct = myScope.ReadString
Debug.Print strThresholdsPct
```

**NOTE****Turn Off Headers**

When receiving numeric data into numeric variables, turn off the headers. Otherwise, the headers may cause misinterpretation of returned data.

- See Also**
- **":MEASure:THResholds:PERCent"** on page 1140
  - **":MEASure:THResholds:RFALL:PERCent"** on page 1147
  - **":MEASure:THResholds:SERial:PERCent"** on page 1158

**History** New in version 3.10.

## :MEASure:THResholds:GENeral:TOPBase:ABSolute

**Command** :MEASure:TOPBase:THResholds:GENeral:ABSolute <source>,<top\_volts>,<base\_volts>

The :MEASure:TOPBase:THResholds:GENeral:ABSolute command sets the top level and base level voltages that are used to calculate the measurements that use them.

**NOTE**

These general-purpose threshold settings are used for everything except rise/fall measurements and protocol decode.

**<source>** {ALL | CHANnel<N> | FUNction<F> | DIGital<M> | WMEMory<R> | CLOCK | MTRend | MSPectrum | EQUalized<L> | XT<X> | PNOise}

Setting the source to ALL does not affect the individual channel settings which is the behavior as the user interface.

For more information on <source> parameters, see "[Measurement Sources](#)" on page 890.

**<top\_volts>**  
**<base\_volts>** A real number specifying voltage levels. The top voltage level must be greater than the base voltage level.

**Example** This example sets the voltage level for the top to 0.9 volts and the voltage level for the base to 0.1 volts on channel 2.

```
myScope.WriteString ":SYSTEM:HEADer OFF" ' Response headers off.
myScope.WriteString ":MEASure:THResholds:GENeral:TOPBase:ABSolute CHANne
l2,0.9,0.1"
```

**Query** :MEASure:THResholds:GENeral:TOPBase:ABSolute? <source>

The :MEASure:THResholds:GENeral:TOPBase:ABSolute? query returns the current settings for top level and base level voltages.

**Returned Format** [:MEASure:THResholds:GENeral:TOPBase:ABSolute] <top\_volts>,<base\_volts><NL>

**Example** This example returns the top level and base level voltages used to calculate the measurements on channel 1.

```
myScope.WriteString ":SYSTEM:HEADer OFF" ' Response headers off.
myScope.WriteString ":MEASure:THResholds:GENeral:TOPBase:ABSolute? CHANn
e1"
strTopBase = myScope.ReadString
Debug.Print strTopBase
```

**NOTE****Turn Off Headers**

When receiving numeric data into numeric variables, turn off the headers. Otherwise, the headers may cause misinterpretation of returned data.

- See Also**
- [":MEASure:THResholds:TOPBase:ABSolute"](#) on page 1163
  - [":MEASure:THResholds:RFALL:TOPBase:ABSolute"](#) on page 1149
  - [":MEASure:THResholds:SERial:TOPBase:ABSolute"](#) on page 1160

**History** New in version 3.10.

## :MEASure:THResholds:GENeral:TOPBase:METhod

**Command** :MEASure:THResholds:GENeral:TOPBase:METhod <source>, {ABSolute | HISTONLY | MINmax | STANdard}

The :MEASure:THResholds:GENeral:TOPBase:METhod command determines the way that the top and base of a waveform are derived for all of the measurements that use them.

**NOTE**

These general-purpose threshold settings are used for everything except rise/fall measurements and protocol decode.

**<source>** {ALL | CHANnel<N> | FUNction<F> | DIGital<M> | WMEMory<R> | CLOCK | MTRend | MSPectrum | EQUalized<L> | XT<X> | PNOise}

Setting the source to ALL does not affect the individual channel settings which is the behavior as the user interface.

For more information on <source> parameters, see "[Measurement Sources](#)" on page 890.

**Example** This example sets the method used to derive the top and base of a waveform to the histogram method.

```
myScope.WriteString ":SYSTem:HEADer OFF" ' Response headers off.
myScope.WriteString ":MEASure:THResholds:GENeral:TOPBase:METhod CHANnel1
,HISTONLY"
```

**Query** :MEASure:THResholds:GENeral:TOPBase:METhod? <source>

The :MEASure:THResholds:GENeral:TOPBase:METhod? query returns the current method being used to calculate the top and base of a waveform.

**Returned Format** [:MEASure:THResholds:GENeral:TOPBase:METhod] {ABSolute | HISTONLY | MINmax | STANdard}

**Example** This example returns the method used to derive the top and base of a waveform for channel 1.

```
myScope.WriteString ":SYSTem:HEADer OFF" ' Response headers off.
myScope.WriteString ":MEASure:THResholds:GENeral:TOPBase:METhod CHANnel1
"
varMethod = myScope.ReadNumber
Debug.Print FormatNumber (varMethod, 0)
```

**See Also**

- "[:MEASure:THResholds:TOPBase:METhod](#)" on page 1164
- "[:MEASure:THResholds:RFALL:TOPBase:METhod](#)" on page 1151
- "[:MEASure:THResholds:SERial:TOPBase:METhod](#)" on page 1162

**History** New in version 3.10.



## :MEASure:THResholds:HYSteresis

**Command** :MEASure:THResholds:HYSteresis <source>,<range>,<level>

The :MEASure:THResholds:HYSteresis command sets the range and level voltages that are used to calculate the measurements that use them. The range is added to the level to determine the upper level voltage for measurements that use it. The range is subtracted from the level to determine the lower level voltage. The level is the middle level voltage.

**NOTE**

This command does not affect Rise/Fall measurement thresholds.

**<source>** {ALL | CHANnel<N> | FUNCTION<F> | DIGital<M> | WMEMory<R> | CLOCk | MTRend | MSPectrum | EQUalized<L> | XT<X> | PNOise}

Setting the source to ALL does not affect the individual channel settings which is the behavior as the user interface.

For more information on <source> parameters, see "[Measurement Sources](#)" on page 890.

**<range>** A real number specifying voltage range for the hysteresis around the level value.

**<level>** A real number specifying voltage level.

**Example** This example sets the hysteresis range to 0.9 volts and 0.1 volts for the level on channel 2.

```
myScope.WriteString ":SYSTEM:HEADer OFF" ' Response headers off.
myScope.WriteString ":MEASure:THResholds:HYSteresis CHANnel2,0.9,0.1"
```

**Query** :MEASure:THResholds:HYSteresis? <source>

The :MEASure:THResholds:HYSteresis? query returns the current settings for upper level, middle level, and lower level voltages for the custom thresholds.

**Returned Format** [:MEASure:THResholds:HYSteresis]<range>,<level><NL>

**Example** This example returns the range and level voltages used to calculate the measurements on channel 1.

```
myScope.WriteString ":SYSTEM:HEADer OFF" ' Response headers off.
myScope.WriteString ":MEASure:THResholds:HYSteresis? CHANnel1"
strRangeLevel = myScope.ReadString
Debug.Print strRangeLevel
```

**NOTE****Turn Off Headers**

When receiving numeric data into numeric variables, turn off the headers. Otherwise, the headers may cause misinterpretation of returned data.

**History** Legacy command (existed before version 3.10).

## :MEASure:THResholds:METhod

**Command** :MEASure:THResholds:METhod <source>,{ABSolute | PERCent | HYSTeresis}

The :MEASure:THResholds:METhod command determines the way that the top and base of a waveform are calculated for all of the measurements that use them.

**NOTE**

This command changes the threshold settings used for rise/fall time measurements, protocol decode, and all other general-purpose measurements that use thresholds. To change the settings used for these types of measurements individually, see:

- [":MEASure:THResholds:GENeral:METhod"](#) on page 1126
- [":MEASure:THResholds:RFALL:METhod"](#) on page 1143
- [":MEASure:THResholds:SERial:METhod"](#) on page 1157

**<source>** {ALL | CHANnel<N> | FUNction<F> | DIGital<M> | WMEMory<R> | CLOCK | MTRend | MSPectrum | EQUalized<L> | XT<X> | PNOise}

Setting the source to ALL does not affect the individual channel settings which is the behavior as the user interface.

For more information on <source> parameters, see ["Measurement Sources"](#) on page 890.

**Example** This example sets the method used to calculate the top and base of a waveform to hysteresis.

```
myScope.WriteString ":SYSTEM:HEADer OFF" ' Response headers off.
myScope.WriteString ":MEASure:THResholds:METhod CHANnel1,HYSTeresis"
```

**Query** :MEASure:THResholds:METhod? <source>

The :MEASure:THResholds:METhod? query returns the current method being used to calculate the top and base of a waveform.

**Returned Format** [:MEASure:THResholds:METhod <source>,{ABSolute | PERCent | HYSTeresis}

**Example** This example returns the method used to calculate the top and base of a waveform to hysteresis.

```
myScope.WriteString ":SYSTEM:HEADer OFF" ' Response headers off.
myScope.WriteString ":MEASure:THResholds:METhod?"
varMethod = myScope.ReadNumber
Debug.Print FormatNumber(varMethod, 0)
```

**History** Legacy command (existed before version 3.10).

## :MEASure:THResholds:PERCent

**Command** :MEASure:THResholds:PERCent <source>,<upper\_pct>,<middle\_pct>,<lower\_pct>

The :MEASure:THResholds:PERCent command sets the upper level, middle level, and lower level voltages as a percentage of the top and base voltages which are used to calculate the measurements that use them.

**<source>** {ALL | CHANnel<N> | FUNction<F> | DIGital<M> | WMEMory<R> | CLOCk | MTRend | MSPectrum | EQUalized<L> | XT<X> | PNOise}

Setting the source to ALL does not affect the individual channel settings which is the behavior as the user interface.

For more information on <source> parameters, see "[Measurement Sources](#)" on page 890.

**<upper\_pct>** A real number specifying upper percentage from -24.8 to 125.0  
**<middle\_pct>** A real number specifying the middle percentage from -24.9 to 124.9  
**<lower\_pct>** A real number specifying the lower percentage from -25.0 to 125.8

**Example** This example sets the percentage to 100% for the upper level, 50% for the middle level and 0% for the lower level on channel 2.

```
myScope.WriteString ":SYSTem:HEADer OFF" ' Response headers off.
myScope.WriteString ":MEASure:THResholds:PERCent CHANnel2,100,50,0"
```

**Query** :MEASure:THResholds:PERCent? <source>

The :MEASure:THResholds:PERCent? query returns the current settings for upper level, middle level, and lower level percentages.

**Returned Format** [:MEASure:THResholds:PERCent] <upper\_pct>,<middle\_pcts>,<lower\_pct><NL>

**Example** This example returns the upper level, middle level, and lower level percentages used to calculate the measurements on channel 1.

```
myScope.WriteString ":SYSTem:HEADer OFF" ' Response headers off.
myScope.WriteString ":MEASure:THResholds:PERCent? CHANnel1"
strThresholdsPct = myScope.ReadString
Debug.Print strThresholdsPct
```

**NOTE****Turn Off Headers**

When receiving numeric data into numeric variables, turn off the headers. Otherwise, the headers may cause misinterpretation of returned data.

**History** Legacy command (existed before version 3.10).

## :MEASure:THResholds:RFALL:ABSolute

**Command** :MEASure:THResholds:RFALL:ABSolute <source>,  
<upper\_volts>,<middle\_volts>,<lower\_volts>

The :MEASure:THResholds:RFALL:ABSolute command sets the upper level, middle level, and lower level voltages that are used to calculate the measurements that use them.

**NOTE**

These threshold settings are used for rise/fall measurements.

<source> {ALL | CHANnel<N> | FUNctIon<F> | WMemOry<R> | DIGital<M> | CLOCK | MTRend | MSPectrum | EQUalized<L> | XT<X> | PNOise}

Setting the source to ALL does not affect the individual channel settings which is the behavior as the user interface.

For more information on <source> parameters, see "[Measurement Sources](#)" on page 890.

<upper\_volts> A real number specifying voltage thresholds.  
<middle\_volts>  
<lower\_volts>

**Example** This example sets the custom voltage thresholds to 0.9 volts for the upper level, 0.5 volts for the middle level and 0.1 volts for the lower level on channel 2.

```
myScope.WriteString ":SYSTEM:HEADer OFF" ' Response headers off.
myScope.WriteString ":MEASure:THResholds:RFALL:ABSolute CHANnel2,0.9,0.5,0.1"
```

**Query** :MEASure:THResholds:RFALL:ABSolute? <source>

The :MEASure:THResholds:RFALL:ABSolute? query returns the current settings for upper level, middle level, and lower level voltages for the custom thresholds.

**Returned Format** [:MEASure:THResholds:RFALL:ABSolute] <upper\_volts>,<middle\_volts>,<lower\_volts><NL>

**Example** This example returns the upper level, middle level, and lower level voltages used to calculate the rise/fall measurements on channel 1.

```
myScope.WriteString ":SYSTEM:HEADer OFF" ' Response headers off.
myScope.WriteString ":MEASure:THResholds:RFALL:ABSolute? CHANnel1"
strThresholds = myScope.ReadString
Debug.Print strThresholds
```

**NOTE****Turn Off Headers**

When receiving numeric data into numeric variables, turn off the headers. Otherwise, the headers may cause misinterpretation of returned data.

- See Also**
- [":MEASure:THResholds:ABSolute"](#) on page 1119
  - [":MEASure:THResholds:GENeral:ABSolute"](#) on page 1122
  - [":MEASure:THResholds:SERial:ABSolute"](#) on page 1153

**History** New in version 3.10.

## :MEASure:THResholds:RFALL:METhod

**Command** :MEASure:THResholds:RFALL:METhod <source>, {ABSolute | PERCent | T1090 | T2080}

The :MEASure:THResholds:RFALL:METhod command determines the way that the top and base of a waveform are calculated for rise/fall measurements:

- ABSolute – Absolute thresholds specified by the :MEASure:THResholds:RFALL:ABSolute command are used.
- PERCent – Percent thresholds specified by the :MEASure:THResholds:RFALL:PERCent command are used.
- T1090, T2080 – Lets you choose T1090 (10% and 90% of levels) or T2080 (20% and 80% of levels) when setting the rise/fall measurement thresholds.

While the T1090 and T2080 selections are available for UNSPecified and NRZ signal types (see :ANALyze:SIGNal:TYPE), they are the only selections available for PAM signal types. With PAM signal types, use the :MEASure:THResholds:RFALL:PAMAutomatic command to specify whether the PAM threshold levels for rise/fall measurements are determined automatically or using PAM-4 levels you specify.

**<source>** {ALL | CHANnel<N> | FUNctIon<F> | DIGital<M> | WMEMory<R> | CLOck | MTRend | MSPectrum | EQUalized<L> | XT<X> | PNOise}

Setting the source to ALL does not affect the individual channel settings which is the behavior as the user interface.

For more information on <source> parameters, see "[Measurement Sources](#)" on page 890.

**Example** This example sets the method used to calculate the top and base of a waveform to hysteresis.

```
myScope.WriteString ":SYSTEM:HEADer OFF" ' Response headers off.
myScope.WriteString ":MEASure:THResholds:RFALL:METhod CHANnel1,HYSteresi
s"
```

**Query** :MEASure:THResholds:RFALL:METhod? <source>

The :MEASure:THResholds:RFALL:METhod? query returns the current method being used to calculate the top and base of a waveform.

**Returned Format** [:MEASure:THResholds:RFALL:METhod <source>,) {ABS | PERC | T1090 | T2080}

**Example** This example returns the method used to calculate the top and base of a waveform to hysteresis.

```
myScope.WriteString ":SYSTEM:HEADer OFF" ' Response headers off.
myScope.WriteString ":MEASure:THResholds:RFALL:METhod?"
varMethod = myScope.ReadNumber
Debug.Print FormatNumber(varMethod, 0)
```

- See Also**
- **":MEASure:THResholds:METHod"** on page 1139
  - **":MEASure:THResholds:GENeral:METHod"** on page 1126
  - **":MEASure:THResholds:SERial:METHod"** on page 1157
  - **":ANALyze:SIGNal:TYPE"** on page 312
  - **":MEASure:THResholds:RFALL:ABSolute"** on page 1141
  - **":MEASure:THResholds:RFALL:PERCent"** on page 1147
  - **":MEASure:THResholds:RFALL:PAMAutomatic"** on page 1145

**History** New in version 3.10.

Version 5.50: When the signal type is PAM-4, you can choose between T1090 (10% and 90% of levels) and T2080 (20% and 80% of levels) when setting the rise/fall measurement thresholds.

Version 6.60: The T1090 (10% and 90% of levels) and T2080 (20% and 80% of levels) settings for rise/fall measurement thresholds now work for NRZ and UNSPecified signal types as well as PAM signal types.



## :MEASure:THResholds:RFALL:PAMAutomatic

**Command** :MEASure:THResholds:RFALL:PAMAutomatic  
 <source>,{AUTomatic | <0\_level>,<1\_level>,<2\_level>,<3\_level>}

When the signal type is PAM-4 (see :ANALyze:SIGNal:TYPE), the :MEASure:THResholds:RFALL:PAMAutomatic command specifies whether the PAM threshold levels for rise/fall measurements are determined automatically or using the PAM-4 levels you specify.

<source> {CHANnel<N> | FUNction<F> | WMEMory<R> | XT<X>}

For more information on <source> parameters, see **"Measurement Sources"** on page 890.

<0\_level>,&br/>
 <1\_level>,&br/>
 <2\_level>,&br/>
 <3\_level>

Voltage values for the PAM-4 0, 1, 2, and 3 levels in NR3 format.

**Query** :MEASure:THResholds:RFALL:PAMAutomatic? <source>

The :MEASure:THResholds:RFALL:PAMAutomatic? query returns the values used for automatically setting the PAM rise/fall threshold levels.

**Returned Format** [:MEASure:THResholds:RFALL:PAMAutomatic]  
 <source>,{AUTomatic | <0\_level>,<1\_level>,<2\_level>,<3\_level>}<NL>

- See Also**
- **":ANALyze:CLOCK:METHOD:SKEW"** on page 290
  - **":ANALyze:SIGNal:DATarate"** on page 298
  - **":ANALyze:SIGNal:SYMBOLrate"** on page 310
  - **":ANALyze:SIGNal:TYPE"** on page 312
  - **":MEASure:CGRade:EWIDth"** on page 907
  - **":MEASure:CGRade:EHEight"** on page 904
  - **":MEASure:FALLtime"** on page 946
  - **":MEASure:PAM:ELEVEL"** on page 1022
  - **":MEASure:PAM:ESKew"** on page 1024
  - **":MEASure:PAM:LEVEL"** on page 1031
  - **":MEASure:PAM:LRMS"** on page 1033
  - **":MEASure:PAM:LTHickness"** on page 1035
  - **":MEASure:RISetime"** on page 1083
  - **":MEASure:THResholds:DISPlay"** on page 1120
  - **":MEASure:THResholds:GENeral:METHOD"** on page 1126
  - **":MEASure:THResholds:GENeral:PAMCustom"** on page 1128
  - **":MEASure:THResholds:GENeral:PAMAutomatic"** on page 1130

- `":MEASure:THResholds:RFALL:METhod"` on page 1143
- `":MEASure:TIEData2"` on page 1167

**History** New in version 5.50.

## :MEASure:THResholds:RFALL:PERCent

**Command** :MEASure:THResholds:RFALL:PERCent <source>,<upper\_pct>,<middle\_pct>,<lower\_pct>

The :MEASure:THResholds:RFALL:PERCent command sets the upper level, middle level, and lower level voltages as a percentage of the top and base voltages which are used to calculate the measurements that use them.

**NOTE**

These threshold settings are used for rise/fall measurements.

**<source>** {ALL | CHANnel<N> | FUNction<F> | DIGital<M> | WMEMory<R> | CLOCK | MTRend | MSPectrum | EQUalized<L> | XT<X> | PNOise}

Setting the source to ALL does not affect the individual channel settings which is the behavior as the user interface.

For more information on <source> parameters, see "[Measurement Sources](#)" on page 890.

**<upper\_pct>** A real number specifying upper percentage from -24.8 to 125.0  
**<middle\_pct>** A real number specifying the middle percentage from -24.9 to 124.9.  
**<lower\_pct>** A real number specifying the lower percentage from -25.0 to 125.8

**Example** This example sets the percentage to 100% for the upper level, 50% for the middle level and 0% for the lower level on channel 2.

```
myScope.WriteString ":SYSTEM:HEADer OFF" ' Response headers off.
myScope.WriteString ":MEASure:THResholds:RFALL:PERCent CHANnel2,100,50,0"
"
```

**Query** :MEASure:THResholds:RFALL:PERCent? <source>

The :MEASure:THResholds:RFALL:PERCent? query returns the current settings for upper level, middle level, and lower level percentages.

**Returned Format** [:MEASure:THResholds:RFALL:PERCent] <upper\_pct>,<middle\_pcts>,<lower\_pct><NL>

**Example** This example returns the upper level, middle level, and lower level percentages used to calculate the rise/fall measurements on channel 1.

```
myScope.WriteString ":SYSTEM:HEADer OFF" ' Response headers off.
myScope.WriteString ":MEASure:THResholds:RFALL:PERCent? CHANnel1"
strThresholdsPct = myScope.ReadString
Debug.Print strThresholdsPct
```

**NOTE****Turn Off Headers**

When receiving numeric data into numeric variables, turn off the headers. Otherwise, the headers may cause misinterpretation of returned data.

- See Also**
- [":MEASure:THResholds:PERCent"](#) on page 1140
  - [":MEASure:THResholds:GENeral:PERCent"](#) on page 1132
  - [":MEASure:THResholds:SERial:PERCent"](#) on page 1158

**History** New in version 3.10.

## :MEASure:THResholds:RFALL:TOPBase:ABSolute

**Command** :MEASure:TOPBase:THResholds:RFALL:ABSolute <source>,<top\_volts>,<base\_volts>

The :MEASure:TOPBase:THResholds:RFALL:ABSolute command sets the top level and base level voltages that are used to calculate the measurements that use them.

**NOTE**

These threshold settings are used for rise/fall measurements.

**<source>** {ALL | CHANnel<N> | FUNction<F> | DIGital<M> | WMEMory<R> | CLOCK | MTRend | MSPectrum | EQUalized<L> | XT<X> | PNOise}

Setting the source to ALL does not affect the individual channel settings which is the behavior as the user interface.

For more information on <source> parameters, see "[Measurement Sources](#)" on page 890.

**<top\_volts>**  
**<base\_volts>** A real number specifying voltage levels. The top voltage level must be greater than the base voltage level.

**Example** This example sets the voltage level for the top to 0.9 volts and the voltage level for the base to 0.1 volts on channel 2.

```
myScope.WriteString ":SYSTEM:HEADer OFF" ' Response headers off.
myScope.WriteString ":MEASure:THResholds:RFALL:TOPBase:ABSolute CHANnel2
,0.9,0.1"
```

**Query** :MEASure:THResholds:RFALL:TOPBase:ABSolute? <source>

The :MEASure:THResholds:RFALL:TOPBase:ABSolute? query returns the current settings for top level and base level voltages.

**Returned Format** [:MEASure:THResholds:RFALL:TOPBase:ABSolute] <top\_volts>,<base\_volts><NL>

**Example** This example returns the top level and base level voltages used to calculate the rise/fall measurements on channel 1.

```
myScope.WriteString ":SYSTEM:HEADer OFF" ' Response headers off.
myScope.WriteString ":MEASure:THResholds:RFALL:TOPBase:ABSolute? CHANnel
1"
strTopBase = myScope.ReadString
Debug.Print strTopBase
```

**NOTE****Turn Off Headers**

When receiving numeric data into numeric variables, turn off the headers. Otherwise, the headers may cause misinterpretation of returned data.

- See Also**
- [":MEASure:THResholds:TOPBase:ABSolute"](#) on page 1163
  - [":MEASure:THResholds:GENeral:TOPBase:ABSolute"](#) on page 1134
  - [":MEASure:THResholds:SERial:TOPBase:ABSolute"](#) on page 1160

**History** New in version 3.10.

## :MEASure:THResholds:RFALL:TOPBase:METhod

**Command** :MEASure:THResholds:RFALL:TOPBase:METhod <source>, {ABSolute | HISTONLY | MINmax | STANdard}

The :MEASure:THResholds:RFALL:TOPBase:METhod command determines the way that the top and base of a waveform are derived for all of the measurements that use them.

**NOTE**

These threshold settings are used for rise/fall measurements.

**<source>** {ALL | CHANnel<N> | FUNctIon<F> | DIGital<M> | WMEMory<R> | CLOCK | MTRend | MSPectrum | EQUalized<L> | XT<X> | PNOise}

Setting the source to ALL does not affect the individual channel settings which is the behavior as the user interface.

For more information on <source> parameters, see "[Measurement Sources](#)" on page 890.

**Example** This example sets the method used to derive the top and base of a waveform to the histogram method.

```
myScope.WriteString ":SYSTEM:HEADer OFF" ' Response headers off.
myScope.WriteString ":MEASure:THResholds:RFALL:TOPBase:METhod CHANnel1,HISTONLY"
```

**Query** :MEASure:THResholds:RFALL:TOPBase:METhod? <source>

The :MEASure:THResholds:RFALL:TOPBase:METhod? query returns the current method being used to calculate the top and base of a waveform.

**Returned Format** [:MEASure:THResholds:RFALL:TOPBase:METhod] {ABSolute | HISTONLY | MINmax | STANdard}

**Example** This example returns the method used to derive the top and base of a waveform for channel 1.

```
myScope.WriteString ":SYSTEM:HEADer OFF" ' Response headers off.
myScope.WriteString ":MEASure:THResholds:RFALL:TOPBase:METhod CHANnel1"
varMethod = myScope.ReadNumber
Debug.Print FormatNumber(varMethod, 0)
```

**See Also**

- "[:MEASure:THResholds:TOPBase:METhod](#)" on page 1164
- "[:MEASure:THResholds:GENeral:TOPBase:METhod](#)" on page 1136
- "[:MEASure:THResholds:SERial:TOPBase:METhod](#)" on page 1162

**History** New in version 3.10.

## :MEASure:THResholds:SERauto

**Command** :MEASure:THResholds:SERauto <source>

For protocol decodes that do not use clock recovery, the :MEASure:THResholds:SERauto command automatically sets the general "Custom: thresholds (low, mid, up)" or "Custom: thresholds +/- hysteresis" when thresholds apply to individual waveforms. This command is the same as pressing the **Auto set thresholds** button in the graphical user interface.

<source> {CHANnel<N> | FUNction<F> | WMEMory<R> | CLOCk | MTRend | MSPectrum | EQUalized<L> | XT<X> | PNOise}

For more information on <source> parameters, see "[Measurement Sources](#)" on page 890.

- See Also**
- "[:MEASure:THResholds:SERial:METHod](#)" on page 1157
  - "[:MEASure:THResholds:SERial:HYSteresis](#)" on page 1155

**History** New in version 6.60.



## :MEASure:THResholds:SERial:ABSolute

**Command** :MEASure:THResholds:SERial:ABSolute <source>,  
<upper\_volts>,<middle\_volts>,<lower\_volts>

The :MEASure:THResholds:SERial:ABSolute command sets the upper level, middle level, and lower level voltages that are used for protocol decode.

**NOTE**

These serial threshold settings are used for protocol decode.

<source> {ALL | CHANnel<N> | FUNction<F> | WMEMory<R> | DIGital<M> | CLOCK | MTRend | MSPectrum | EQUalized<L> | XT<X>}

Setting the source to ALL does not affect the individual channel settings which is the behavior as the user interface.

For more information on <source> parameters, see "[Measurement Sources](#)" on page 890.

<upper\_volts> A real number specifying voltage thresholds.  
<middle\_volts>  
<lower\_volts>

**Example** This example sets the custom voltage thresholds to 0.9 volts for the upper level, 0.5 volts for the middle level and 0.1 volts for the lower level on channel 2.

```
myScope.WriteString ":SYSTem:HEADer OFF" ' Response headers off.
myScope.WriteString ":MEASure:THResholds:SERial:ABSolute CHANnel2,0.9,0.5,0.1"
```

**Query** :MEASure:THResholds:SERial:ABSolute? <source>

The :MEASure:THResholds:SERial:ABSolute? query returns the current settings for upper level, middle level, and lower level voltages for the custom thresholds.

**Returned Format** [:MEASure:THResholds:SERial:ABSolute] <upper\_volts>,<middle\_volts>,<lower\_volts><NL>

**Example** This example returns the upper level, middle level, and lower level voltages used for protocol decode on channel 1.

```
myScope.WriteString ":SYSTem:HEADer OFF" ' Response headers off.
myScope.WriteString ":MEASure:THResholds:SERial:ABSolute? CHANnel1"
strThresholds = myScope.ReadString
Debug.Print strThresholds
```

**NOTE****Turn Off Headers**

When receiving numeric data into numeric variables, turn off the headers. Otherwise, the headers may cause misinterpretation of returned data.

- See Also**
- [":MEASure:THResholds:ABSolute"](#) on page 1119
  - [":MEASure:THResholds:GENeral:ABSolute"](#) on page 1122
  - [":MEASure:THResholds:RFALL:ABSolute"](#) on page 1141

**History** New in version 3.10.

## :MEASure:THResholds:SERial:HYSTeresis

**Command** :MEASure:THResholds:SERial:HYSTeresis <source>,<range>,<level>

The :MEASure:THResholds:SERial:HYSTeresis command sets the range and level voltages that are used for protocol decode. The range is added to the level to determine the upper level voltage. The range is subtracted from the level to determine the lower level voltage. The level is the middle level voltage.

**NOTE**

These serial threshold settings are used for protocol decode.

<source> {ALL | CHANnel<N> | FUNCTION<F> | DIGital<M> | WMEMory<R> | CLOCk | MTRend | MSPectrum | EQUalized<L> | XT<X>}

Setting the source to ALL does not affect the individual channel settings which is the behavior as the user interface.

For more information on <source> parameters, see "[Measurement Sources](#)" on page 890.

<range> A real number specifying voltage range for the hysteresis around the level value.

<level> A real number specifying voltage level.

**Example** This example sets the hysteresis range to 0.9 volts and 0.1 volts for the level on channel 2.

```
myScope.WriteString ":SYSTem:HEADer OFF" ' Response headers off.
myScope.WriteString ":MEASure:THResholds:SERial:HYSTeresis CHANnel2,0.9,
0.1"
```

**Query** :MEASure:THResholds:SERial:HYSTeresis? <source>

The :MEASure:THResholds:SERial:HYSTeresis? query returns the current settings for upper level, middle level, and lower level voltages for the custom thresholds.

**Returned Format** [:MEASure:THResholds:SERial:HYSTeresis] <range>,<level><NL>

**Example** This example returns the range and level voltages used for protocol decode on channel 1.

```
myScope.WriteString ":SYSTem:HEADer OFF" ' Response headers off.
myScope.WriteString ":MEASure:THResholds:SERial:HYSTeresis? CHANnel1"
strRangeLevel = myScope.ReadString
Debug.Print strRangeLevel
```

**NOTE****Turn Off Headers**

When receiving numeric data into numeric variables, turn off the headers. Otherwise, the headers may cause misinterpretation of returned data.

- See Also**
- [":MEASure:THResholds:HYSteresis"](#) on page 1137
  - [":MEASure:THResholds:GENeral:HYSteresis"](#) on page 1124

**History** New in version 3.10.

## :MEASure:THResholds:SERial:METhod

**Command** :MEASure:THResholds:SERial:METhod <source>,{ABSolute | PERCent | HYStere  
sis}

The :MEASure:THResholds:SERial:METhod command determines the way that the top and base of a waveform are calculated for protocol decode.

**NOTE**

These serial threshold settings are used for protocol decode.

**<source>** {ALL | CHANnel<N> | FUNction<F> | DIGital<M> | WMEMory<R> | CLOCk | MTRend  
| MSPectrum | EQUalized<L> | XT<X>}

Setting the source to ALL does not affect the individual channel settings which is the behavior as the user interface.

For more information on <source> parameters, see "[Measurement Sources](#)" on page 890.

**Example** This example sets the method used to calculate the top and base of a waveform to hysteresis.

```
myScope.WriteString ":SYSTEM:HEADer OFF" ' Response headers off.
myScope.WriteString ":MEASure:THResholds:SERial:METhod CHANnel1,HYStere
sis"
```

**Query** :MEASure:THResholds:SERial:METhod? <source>

The :MEASure:THResholds:SERial:METhod? query returns the current method being used to calculate the top and base of a waveform.

**Returned Format** [:MEASure:THResholds:SERial:METhod <source>,) {ABSolute | PERCent | HYStere  
sis}

**Example** This example returns the method used to calculate the top and base of a waveform to hysteresis.

```
myScope.WriteString ":SYSTEM:HEADer OFF" ' Response headers off.
myScope.WriteString ":MEASure:THResholds:SERial:METhod?"
varMethod = myScope.ReadNumber
Debug.Print FormatNumber (varMethod, 0)
```

**See Also**

- "[:MEASure:THResholds:METhod](#)" on page 1139
- "[:MEASure:THResholds:GENeral:METhod](#)" on page 1126
- "[:MEASure:THResholds:RFALL:METhod](#)" on page 1143

**History** New in version 3.10.

## :MEASure:THResholds:SERial:PERCent

**Command** :MEASure:THResholds:SERial:PERCent <source>,<upper\_pct>,<middle\_pct>,<lower\_pct>

The :MEASure:THResholds:SERial:PERCent command sets the upper level, middle level, and lower level voltages as a percentage of the top and base voltages which are used for protocol decode.

**NOTE**

These serial threshold settings are used for protocol decode.

<source> {ALL | CHANnel<N> | FUNction<F> | DIGital<M> | WMEMory<R> | CLOCK | MTRend | MSPectrum | EQUalized<L> | XT<X>}

Setting the source to ALL does not affect the individual channel settings which is the behavior as the user interface.

For more information on <source> parameters, see "[Measurement Sources](#)" on page 890.

<upper\_pct> A real number specifying upper percentage from -24.8 to 125.0  
 <middle\_pct> A real number specifying the middle percentage from -24.9 to 124.9.  
 <lower\_pct> A real number specifying the lower percentage from -25.0 to 125.8

**Example** This example sets the percentage to 100% for the upper level, 50% for the middle level and 0% for the lower level on channel 2.

```
myScope.WriteString ":SYSTEM:HEADER OFF" ' Response headers off.
myScope.WriteString ":MEASure:THResholds:SERial:PERCent CHANnel2,100,50,0"
```

**Query** :MEASure:THResholds:SERial:PERCent? <source>

The :MEASure:THResholds:SERial:PERCent? query returns the current settings for upper level, middle level, and lower level percentages.

**Returned Format** [:MEASure:THResholds:SERial:PERCent] <upper\_pct>,<middle\_pcts>,<lower\_pct><NL>

**Example** This example returns the upper level, middle level, and lower level percentages used for protocol decode on channel 1.

```
myScope.WriteString ":SYSTEM:HEADER OFF" ' Response headers off.
myScope.WriteString ":MEASure:THResholds:SERial:PERCent? CHANnel1"
strThresholdsPct = myScope.ReadString
Debug.Print strThresholdsPct
```

**NOTE****Turn Off Headers**

When receiving numeric data into numeric variables, turn off the headers. Otherwise, the headers may cause misinterpretation of returned data.

- See Also**
- [":MEASure:THResholds:PERCent"](#) on page 1140
  - [":MEASure:THResholds:GENeral:PERCent"](#) on page 1132
  - [":MEASure:THResholds:RFALL:PERCent"](#) on page 1147

**History** New in version 3.10.

## :MEASure:THResholds:SERial:TOPBase:ABSolute

**Command** :MEASure:TOPBase:THResholds:SERial:ABSolute <source>,<top\_volts>,<base\_volts>

The :MEASure:TOPBase:THResholds:SERial:ABSolute command sets the top level and base level voltages that are used for protocol decode.

**NOTE**

These serial threshold settings are used for protocol decode.

**<source>** {ALL | CHANnel<N> | FUNction<F> | DIGital<M> | WMEMory<R> | CLOCK | MTRend | MSPectrum | EQUalized<L> | XT<X>}

Setting the source to ALL does not affect the individual channel settings which is the behavior as the user interface.

For more information on <source> parameters, see "[Measurement Sources](#)" on page 890.

**<top\_volts>** A real number specifying voltage levels. The top voltage level must be greater than the base voltage level.

**Example** This example sets the voltage level for the top to 0.9 volts and the voltage level for the base to 0.1 volts on channel 2.

```
myScope.WriteString ":SYSTEM:HEADer OFF" ' Response headers off.
myScope.WriteString ":MEASure:THResholds:SERial:TOPBase:ABSolute CHANnel
2,0.9,0.1"
```

**Query** :MEASure:THResholds:SERial:TOPBase:ABSolute? <source>

The :MEASure:THResholds:SERial:TOPBase:ABSolute? query returns the current settings for top level and base level voltages.

**Returned Format** [:MEASure:THResholds:SERial:TOPBase:ABSolute] <top\_volts>,<base\_volts><NL>

**Example** This example returns the top level and base level voltages used for protocol decode on channel 1.

```
myScope.WriteString ":SYSTEM:HEADer OFF" ' Response headers off.
myScope.WriteString ":MEASure:THResholds:SERial:TOPBase:ABSolute? CHANne
l1"
strTopBase = myScope.ReadString
Debug.Print strTopBase
```

**NOTE****Turn Off Headers**

When receiving numeric data into numeric variables, turn off the headers. Otherwise, the headers may cause misinterpretation of returned data.



- See Also**
- [":MEASure:THResholds:TOPBase:ABSolute"](#) on page 1163
  - [":MEASure:THResholds:GENeral:TOPBase:ABSolute"](#) on page 1134
  - [":MEASure:THResholds:RFALL:TOPBase:ABSolute"](#) on page 1149

**History** New in version 3.10.

## :MEASure:THResholds:SERial:TOPBase:METhod

**Command** :MEASure:THResholds:SERial:TOPBase:METhod <source>, {ABSolute | HISTONLY | MINmax | STANdard}

The :MEASure:THResholds:SERial:TOPBase:METhod command determines the way that the top and base of a waveform are derived for protocol decode.

**NOTE**

These serial threshold settings are used for protocol decode.

**<source>** {ALL | CHANnel<N> | FUNction<F> | DIGital<M> | WMEMory<R> | CLOCk | MTRend | MSPectrum | EQUalized<L> | XT<X>}

Setting the source to ALL does not affect the individual channel settings which is the behavior as the user interface.

For more information on <source> parameters, see "[Measurement Sources](#)" on page 890.

**Example** This example sets the method used to derive the top and base of a waveform to the histogram method.

```
myScope.WriteString ":SYSTEM:HEADer OFF" ' Response headers off.
myScope.WriteString ":MEASure:THResholds:SERial:TOPBase:METhod CHANnel1,
HISTONLY"
```

**Query** :MEASure:THResholds:SERial:TOPBase:METhod? <source>

The :MEASure:THResholds:SERial:TOPBase:METhod? query returns the current method being used to calculate the top and base of a waveform.

**Returned Format** [:MEASure:THResholds:SERial:TOPBase:METhod] {ABSolute | HISTONLY | MINmax | STANdard}

**Example** This example returns the method used to derive the top and base of a waveform for channel 1.

```
myScope.WriteString ":SYSTEM:HEADer OFF" ' Response headers off.
myScope.WriteString ":MEASure:THResholds:SERial:TOPBase:METhod CHANnel1"
varMethod = myScope.ReadNumber
Debug.Print FormatNumber (varMethod, 0)
```

**See Also**

- "[:MEASure:THResholds:TOPBase:METhod](#)" on page 1164
- "[:MEASure:THResholds:GENeral:TOPBase:METhod](#)" on page 1136
- "[:MEASure:THResholds:RFALL:TOPBase:METhod](#)" on page 1151

**History** New in version 3.10.

## :MEASure:THResholds:TOPBase:ABSolute

**Command** :MEASure:TOPBase:THResholds:ABSolute <source>,<top\_volts>,<base\_volts>

The :MEASure:TOPBase:THResholds:ABSolute command sets the top level and base level voltages that are used to calculate the measurements that use them.

**<source>** {ALL | CHANnel<N> | FUNction<F> | DIGital<M> | WMEMory<R> | CLOCk | MTRend | MSPectrum | EQUalized<L> | XT<X>}

Setting the source to ALL does not affect the individual channel settings which is the behavior as the user interface.

For more information on <source> parameters, see "[Measurement Sources](#)" on page 890.

**<top\_volts>** A real number specifying voltage levels. The top voltage level must be greater than the base voltage level.

**<base\_volts>** A real number specifying voltage levels. The top voltage level must be greater than the base voltage level.

**Example** This example sets the voltage level for the top to 0.9 volts and the voltage level for the base to 0.1 volts on channel 2.

```
myScope.WriteString ":SYSTEM:HEADer OFF" ' Response headers off.
myScope.WriteString ":MEASure:THResholds:TOPBase:ABSolute CHANnel2,0.9,0.1"
```

**Query** :MEASure:THResholds:TOPBase:ABSolute? <source>

The :MEASure:THResholds:TOPBase:ABSolute? query returns the current settings for top level and base level voltages.

**Returned Format** [:MEASure:THResholds:TOPBase:ABSolute] <top\_volts>,<base\_volts><NL>

**Example** This example returns the top level and base level voltages used to calculate the measurements on channel 1.

```
myScope.WriteString ":SYSTEM:HEADer OFF" ' Response headers off.
myScope.WriteString ":MEASure:THResholds:TOPBase:ABSolute? CHANnel1"
strTopBase = myScope.ReadString
Debug.Print strTopBase
```

**NOTE****Turn Off Headers**

When receiving numeric data into numeric variables, turn off the headers. Otherwise, the headers may cause misinterpretation of returned data.

**History** Legacy command (existed before version 3.10).

## :MEASure:THResholds:TOPBase:METhod

**Command** :MEASure:THResholds:TOPBase:METhod <source>,{ABSolute | HISTONLY  
| MINmax | STANdard}

The :MEASure:THResholds:TOPBase:METhod command determines the way that the top and base of a waveform are derived for all of the measurements that use them.

**<source>** {ALL | CHANnel<N> | FUNcTION<F> | DIGital<M> | WMEMory<R> | CLOCk | MTRend  
| MSPectrum | EQUalized<L> | XT<X>}

Setting the source to ALL does not affect the individual channel settings which is the behavior as the user interface.

For more information on <source> parameters, see "[Measurement Sources](#)" on page 890.

**Example** This example sets the method used to derive the top and base of a waveform to the histogram method.

```
myScope.WriteString ":SYSTem:HEADer OFF" ' Response headers off.
myScope.WriteString ":MEASure:THResholds:TOPBase:METhod CHANnel1,HISTONL
Y"
```

**Query** :MEASure:THResholds:TOPBase:METhod? <source>

The :MEASure:THResholds:TOPBase:METhod? query returns the current method being used to calculate the top and base of a waveform.

**Returned Format** [:MEASure:THResholds:TOPBase:METhod] {ABSolute | HISTONLY | MINmax | STA  
Ndard}

**Example** This example returns the method used to derive the top and base of a waveform for channel 1.

```
myScope.WriteString ":SYSTem:HEADer OFF" ' Response headers off.
myScope.WriteString ":MEASure:THResholds:TOPBase:METhod CHANnel1"
varMethod = myScope.ReadNumber
Debug.Print FormatNumber(varMethod, 0)
```

**History** Legacy command (existed before version 3.10).

## :MEASure:TIEClock2

Command

**NOTE****Turn Off Headers**

When receiving numeric data into numeric variables, turn off the headers. Otherwise, the headers may cause misinterpretation of returned data.

**NOTE**

This command is available only when the Jitter Analysis Software license is installed.

```
:MEASure:TIEClock2 <source>,{SECond | UNITinterval},
  <direction>,{AUTO | CUSTOM,<frequency>}
  | {VARiable,<frequency>,<bandwidth>} | CLOck}
```

The :MEASure:TIEClock2 command measures time interval error on a clock. You can set the units of the measurement by selecting SECond (seconds) or UNITinterval. If AUTO is selected, the oscilloscope selects the ideal constant clock frequency. If CUSTOM is selected, you can enter your own ideal clock frequency. If VARiable is selected, a first order PLL clock recovery is used at the give clock frequency and loop bandwidth. If CLOck is given, clock recovery is specified with the :MEASure:CLOCK:METHOD command.

**<source>** {CHANnel<N> | DIFF<D> | COMMONmode<C> | FUNCTion<F> | DIGital<M> | WMEMory<R> | CLOck | MTRend | MSPectrum | EQUalized<L> | XT<X>}

For more information on <source> parameters, see "[Measurement Sources](#)" on page 890.

**<direction>** {RISing | FALLing | BOTH}

Specifies direction of clock edge. BOTH selects the first edge from the left-hand side of the waveform viewing area.

**<frequency>** A real number for the ideal clock frequency for clock recovery.

**<bandwidth>** A real number for the loop bandwidth of the PLL clock recovery method.

**Example** This example measures the clock time interval error on the rising edge of channel 1, ideal clock frequency set to automatic, units set to seconds.

```
myScope.WriteString ":MEASure:TIEClock2 CHANnel1,SECond,RISing,AUTO"
```

**Query** :MEASure:TIEClock2? <source>,{SECond | UNITinterval},  
 <direction>,{AUTO | CUSTOM,<frequency>}  
 | {VARiable,<frequency>,<bandwidth>} | CLOck}

The :MEASure:TIEClock2? query returns the current value of the clock time interval error.

**NOTE**

This measurement requires the **Measure All Edges** setting to be enabled. You can do this by:

- Installing the measurement on the display (using the command syntax), which automatically enables the **Measure All Edges** setting
- Sending the ":ANALyze:AEDGes ON" command.

**Returned Format** [:MEASure:TIEClock2] <value>[,<result\_state>] <NL>

<value> The clock time interval error value.

<result\_state> If SENDvalid is ON, the result state is returned with the measurement result. See the :MEASure:RESults table in this chapter for a list of the result states.

**Example** This example places the current value of the clock time interval error in the variable strValue, then prints the contents of the variable to the computer's screen.

```
myScope.WriteString ":SYSTEM:HEADer OFF"
myScope.WriteString ":MEASure:TIEClock2? CHANnel1,SECond,FALLing,CUSTOM,
2.5E9"
strValue = myScope.ReadString
Debug.Print strValue
```

- See Also**
- [":ANALyze:AEDGes"](#) on page 273
  - [":MEASure:CTCJitter"](#) on page 922
  - [":MEASure:NCJitter"](#) on page 999
  - [":MEASure:CTCPwidth"](#) on page 926
  - [":MEASure:CTCNwidth"](#) on page 924
  - [":MEASure:CTCDutycycle"](#) on page 920

**History** Legacy command (existed before version 3.10).

## :MEASure:TIEData2

**Command** :MEASure:TIEData2 <source>, {SECond | UNITinterval} [, <threshold>]

The :MEASure:TIEData2 command measures data time interval error. You can set the units of the measurement by selecting SECond (seconds) or UNITinterval.

**<source>** {CHANnel<N> | DIFF<D> | COMMONmode<C> | FUNCTION<F> | DIGital<M> | WMEMory<R> | CLOCK | MTRend | MSPectrum | EQUalized<L> | XT<X>}

For more information on <source> parameters, see "**Measurement Sources**" on page 890.

**<threshold>** When the signal type is PAM-4 (see :ANALyze:SIGNal:TYPE), the <threshold> parameter is an integer that specifies which PAM threshold to measure. For PAM-4, the <threshold> may be from 0-2.

**Example** This example measures the data time interval error on channel 1, ideal data rate set to automatic, units set to seconds.

```
myScope.WriteString ":MEASure:TIEData2 CHANnel1,SECond"
```

**Query** :MEASure:TIEData2? <source>, {SECond | UNITinterval} [, <threshold>]

The :MEASure:TIEData2? query returns the current value of the data time interval error.

**NOTE**

This measurement requires the **Measure All Edges** setting to be enabled. You can do this by:

- Installing the measurement on the display (using the command syntax), which automatically enables the **Measure All Edges** setting
- Sending the ":ANALyze:AEDGes ON" command.

**Returned Format** [:MEASure:TIEData2] <value> [, <result\_state>] <NL>

**<value>** The data time interval error value.

**<result\_state>** If SENDvalid is ON, the result state is returned with the measurement result. See the :MEASure:RESults table in this chapter for a list of the result states.

**Example** This example places the current value of the data time interval error in the variable strValue, then prints the contents of the variable to the computer's screen.

```
myScope.WriteString ":SYSTem:HEADer OFF"
myScope.WriteString ":MEASure:TIEData2? CHANnel1,SECond"
strValue = myScope.ReadString
Debug.Print strValue
```

**See Also**

- "**:ANALyze:SIGNal:TYPE**" on page 312
- "**:ANALyze:AEDGes**" on page 273

**History** New in version 5.50. This command replaces the now deprecated command "**:MEASure:TIEData**" on page 1748.

## :MEASure:TIEFilter:DAMPing

**Command** :MEASure:TIEFilter:DAMPing <damping\_factor>

The :MEASure:TIEFilter:DAMPing command specifies the damping factory for a second order low-pass TIE filter.

Use the :MEASure:TIEFilter:TYPE command to set the low-pass filter type.

Use the :MEASure:TIEFilter:SHAPE command to set the Second Order TIE filter shape.

<damping\_factor> The damping factor in NR3 format.

**Query** :MEASure:TIEFilter:DAMPing?

The :MEASure:TIEFilter:DAMPing? query returns the damping factor setting.

**Returned Format** <damping\_factor><NL>

**See Also**

- **"[:MEASure:TIEFilter:TYPE](#)"** on page 1173
- **"[:MEASure:TIEFilter:SHAPE](#)"** on page 1169

**History** New in version 6.55.



## :MEASure:TIEFilter:SHAPE

**Command** :MEASure:TIEFilter:SHAPE {RECTangular | DB20 | DB40 | FIRSt | SECond}

The :MEASure:TIEFilter:SHAPE command specifies the shape of the TIE filter edge(s):

- RECTangular – The TIE filter is a brickwall filter.
- DB20 – The TIE filter edge(s) roll off at 20 dB per decade.
- DB40 – The TIE filter edge(s) roll off at 40 dB per decade.
- FIRSt – First Order TIE filter. This is similar to the 20 dB per decade roll off, but the response is more curved.
- SECond – Second Order TIE filter. This is similar to the 40 dB per decade roll off, but the response is more curved.

When MEASure:TIEFilter:TYPE is BANDpass, the valid shapes are RECTangular, DB20, or DB40.

**Example** This example specifies that the TIE filter edge(s) roll off at 40 dB per decade.

```
myScope.WriteString ":MEASure:TIEFilter:SHAPE DB40"
```

**Query** :MEASure:TIEFilter:SHAPE?

The :MEASure:TIEFilter:SHAPE? query returns the specified shape of the TIE filter edge(s).

**Returned Format** [:MEASure:TIEFilter:SHAPE] {RECTangular | DB20 | DB40 | FIRS | SEC}<NL>

**Example** This example places the specified shape of the TIE filter edge(s) in the string variable, strShape, then prints the contents of the variable to the computer's screen.

```
Dim strShape As String ' Dimension variable.
myScope.WriteString ":MEASure:TIEFilter:SHAPE?"
strShape = myScope.ReadString
Debug.Print strShape
```

- See Also**
- [":MEASure:TIEFilter:TYPE"](#) on page 1173
  - [":MEASure:TIEFilter:DAMPing"](#) on page 1168
  - [":MEASure:TIEFilter:STATe"](#) on page 1171
  - [":MEASure:TIEFilter:START"](#) on page 1170
  - [":MEASure:TIEFilter:STOP"](#) on page 1172

**History** New in version 4.10.

Version 6.55: Added the FIRSt and SECond options for the new First Order and Second Order TIE filter shapes.

## :MEASure:TIEFilter:START

**Command** :MEASure:TIEFilter:START <start\_frequency>

The :MEASure:TIEFilter:START command sets the starting frequency for the TIE filter.

<start\_frequency> A real number.

**Query** :MEASure:TIEFilter:START?

The :MEASure:TIEFilter:START? query returns the current value of the starting frequency of the TIE filter.

**Returned Format** [:MEASure:TIEFilter:START] <value><NL>

<value> The start frequency for the TIE filter.

**Example** This example returns the current value of the starting frequency for the TIE filter then prints the contents of the variable to the computer's screen.

```
myScope.WriteString ":SYSTEM:HEADer OFF" ' Response headers off.
myScope.WriteString ":MEASure:TIEFilter:START?"
varStart = myScope.ReadNumber
Debug.Print FormatNumber(varStart, 0)
```

- See Also**
- [":MEASure:TIEFilter:STAtE"](#) on page 1171
  - [":MEASure:TIEFilter:TYPE"](#) on page 1173
  - [":MEASure:TIEFilter:SHAPE"](#) on page 1169
  - [":MEASure:TIEFilter:STOP"](#) on page 1172

**History** Legacy command (existed before version 3.10).

## :MEASure:TIEFilter:STATE

**Command** :MEASure:TIEFilter:STATE {{ON | 1} | {OFF | 0}}

The :MEASure:TIEFilter:STATE command enables the TIE filter for TIE data measurements.

**Query** :MEASure:TIEFilter:STATE?

The :MEASure:TIEFilter:STATE? query returns the current state of the TIE data filter.

**Returned Format** [:MEASure:TIEFilter:STATE] {0 | 1}<NL>

**Example** This example returns the current state of the TIE data filter then prints the contents of the variable to the computer's screen.

```
myScope.WriteString ":SYSTEM:HEADer OFF" ' Response headers off.
myScope.WriteString ":MEASure:TIEFilter:STATE?"
varState = myScope.ReadNumber
Debug.Print FormatNumber(varState, 0)
```

- See Also**
- [":MEASure:TIEFilter:TYPE"](#) on page 1173
  - [":MEASure:TIEFilter:SHAPE"](#) on page 1169
  - [":MEASure:TIEFilter:START"](#) on page 1170
  - [":MEASure:TIEFilter:STOP"](#) on page 1172

**History** Legacy command (existed before version 3.10).

**:MEASure:TIEFilter:STOP**

**Command** :MEASure:TIEFilter:STOP <stop\_frequency>

The :MEASure:TIEFilter:STOP command sets the stopping frequency for the TIE filter.

<stop\_frequency> A real number.

**Query** :MEASure:TIEFilter:STOP?

The :MEASure:TIEFilter:STOP? query returns the current value of the stopping frequency of the TIE filter.

**Returned Format** [:MEASure:TIEFilter:STOP] <value><NL>

<value> The stop frequency for the TIE filter.

**Example** This example returns the current value of the stopping frequency for the TIE filter then prints the contents of the variable to the computer's screen.

```
myScope.WriteString ":SYSTEM:HEADer OFF" ' Response headers off.
myScope.WriteString ":MEASure:TIEFilter:STOP?"
varStop = myScope.ReadNumber
Debug.Print FormatNumber(varStop, 0)
```

- See Also**
- [":MEASure:TIEFilter:STATe"](#) on page 1171
  - [":MEASure:TIEFilter:TYPE"](#) on page 1173
  - [":MEASure:TIEFilter:SHAPE"](#) on page 1169
  - [":MEASure:TIEFilter:START"](#) on page 1170

**History** Legacy command (existed before version 3.10).

## :MEASure:TIEFilter:TYPE

**Command** :MEASure:TIEFilter:TYPE {BANDpass | LOWPass | HIGHpass}

The :MEASure:TIEFilter:TYPE command sets the type of TIE filter to be used.

**Example** This example sets the TIE filter to highpass.

```
myScope.WriteString ":MEASure:TIEFilter:TYPE HIGHpass"
```

**Query** :MEASure:TIEFilter:TYPE?

The :MEASure:TIEFilter:TYPE? query returns the current type of TIE filter being used.

**Returned Format** [:MEASure:TIEFilter:TYPE] {BANDpass | LOWPass | HIGHpass}<NL>

**Example** This example places the current mode for TIEFilter:TYPE in the string variable, strMode, then prints the contents of the variable to the computer's screen.

```
Dim strMode As String ' Dimension variable.
myScope.WriteString ":MEASure:TIEFilter:TYPE?"
strMode = myScope.ReadString
Debug.Print strMode
```

**See Also**

- [":MEASure:TIEFilter:STATE"](#) on page 1171
- [":MEASure:TIEFilter:SHAPE"](#) on page 1169
- [":MEASure:TIEFilter:START"](#) on page 1170
- [":MEASure:TIEFilter:STOP"](#) on page 1172

**History** Legacy command (existed before version 3.10).

## :MEASure:TMAX

**Command** :MEASure:TMAX [<source>]

The :MEASure:TMAX command measures the first time at which the maximum voltage of the source waveform occurred. Sources are specified with the :MEASure:SOURce command or with the optional parameter following the :MEASure:TMAX command.

**<source>** {CHANnel<N> | DIFF<D> | COMMONmode<C> | FUNCtion<F> | WMEMory<R> | CLOCK | MTRend | MSPectrum | EQUalized<L> | XT<X>}

For more information on <source> parameters, see "[Measurement Sources](#)" on page 890.

**Query** :MEASure:TMAX? [<source>]

The :MEASure:TMAX? query returns the time at which the first maximum voltage occurred.

**Returned Format** [:MEASure:TMAX] <time> [, <result\_state>] <NL>

**<time>** Time at which the first maximum voltage occurred or frequency where the maximum FFT amplitude occurred.

**<result\_state>** If SENDvalid is ON, the result state is returned with the measurement result. See the :MEASure:RESults table in this chapter for a list of the result states.

**Example** This example returns the time at which the first maximum voltage occurred to the numeric variable, varTime, then prints the contents of the variable to the computer's screen.

```
myScope.WriteString ":SYSTEM:HEADer OFF" ' Response headers off.
myScope.WriteString ":MEASure:TMAX? CHANnel1"
varTime = myScope.ReadNumber
Debug.Print FormatNumber(varTime, 0)
```

**History** Legacy command (existed before version 3.10).

## :MEASure:TMIN

**Command** :MEASure:TMIN [<source>]

The :MEASure:TMIN command measures the time at which the first minimum voltage occurred. Sources are specified with the :MEASure:SOURce command or with the optional parameter following the :MEASure:TMIN command.

**<source>** {CHANnel<N> | DIFF<D> | COMMONmode<C> | FUNCtion<F> | WMEMory<R> | CLOCk | MTRend | MSPectrum | EQUALized<L> | XT<X>}

For more information on <source> parameters, see "[Measurement Sources](#)" on page 890.

**Query** :MEASure:TMIN? [<source>]

The :MEASure:TMIN? query returns the time at which the first minimum voltage occurred or the frequency where the minimum FFT amplitude occurred.

**Returned Format** [:MEASure:TMIN] <time> [, <result\_state>] <NL>

**<time>** Time at which the first minimum voltage occurred.

**<result\_state>** If SENDvalid is ON, the result state is returned with the measurement result. See the :MEASure:RESults table in this chapter for a list of the result states.

**Example** This example returns the time at which the first minimum voltage occurred to the numeric variable, varTime, then prints the contents of the variable to the computer's screen.

```
myScope.WriteString ":SYSTEM:HEADer OFF" ' Response headers off.
myScope.WriteString ":MEASure:TMIN? CHANnel1"
varTime = myScope.ReadNumber
Debug.Print FormatNumber(varTime, 0)
```

**History** Legacy command (existed before version 3.10).

## :MEASure:TVOLt

**Command** :MEASure:TVOLt <voltage>, [<slope>] <occurrence> [, <source>]

The :MEASure:TVOLt command measures the time interval between the trigger event and the defined voltage level and transition. Sources are specified with the :MEASure:SOURce command or with the optional parameter following the :MEASure:TVOLt command.

The TEDGe command can be used to get the time of edges.

When the "Measure All Edges" mode is on (see **"ANALyze:AEDGes"** on page 273), the first edge from the beginning of the acquisition is used.

When the "Measure All Edges" mode is off, the first edge from the left side of the display grid is used.

<voltage> Voltage level at which time will be measured.

<slope> The direction of the waveform change when the specified voltage is crossed - rising (+) or falling (-). If no +/- sign is present, + is assumed.

<occurrence> The number of the crossing to be reported (if one, the first crossing is reported; if two, the second crossing is reported, etc.). The desired crossing must be present on the display. Occurrences are counted with 1 being the first occurrence from the left of the display, and a maximum value of 65534.

<source> {CHANnel<N> | DIFF<D> | COMMONmode<C> | FUNCTION<F> | WMEMory<R> | CLOCK | MTRend | MSPectrum | EQUalized<L> | XT<X>}

For more information on <source> parameters, see **"Measurement Sources"** on page 890.

**Query** :MEASure:TVOLt? <voltage>, <slope> <occurrence> [, <source>]

The :MEASure:TVOLt? query returns the time interval between the trigger event and the specified voltage level and transition.

**Returned Format** [:MEASure:TVOLt] <time> [, <result\_state>] <NL>

<time> The time interval between the trigger event and the specified voltage level and transition.

<result\_state> If SENDvalid is ON, the result state is returned with the measurement result. See the :MEASure:RESults table in this chapter for a list of the result states.

**Example** This example returns the time interval between the trigger event and the transition through -0.250 Volts on the third rising occurrence of the source waveform to the numeric variable, varTime. The contents of the variable are then printed to the computer's screen.

```
myScope.WriteString ":SYSTEM:HEADER OFF" ' Response headers off.
myScope.WriteString ":MEASure:TVOLt? -0.250,+3,CHANnel1"
varTime = myScope.ReadNumber
Debug.Print FormatNumber(varTime, 0)
```



**History** Legacy command (existed before version 3.10).

## :MEASure:UITouijitter

**Command** :MEASure:UITouijitter <source>, <N>

The :MEASure:UITouijitter command measures the difference between two consecutive N-UI measurements. The measurement then moves over one unit interval and makes another measurement. When N=1, this is analogous to cycle-cycle jitter, but measures unit intervals instead of periods. When N>1, this is analogous to N-Cycle jitter but measures unit intervals instead of periods.

**<source>** The source on which the measurement is made.

For more information on <source> parameters, see "[Measurement Sources](#)" on page 890.

**<N>** An integer greater than or equal to 1.

**Example** This example measures the UI-UI jitter for 3 consecutive unit intervals on channel 1.

```
myScope.WriteString ":MEASure:UITouijitter CHAN1, 3"
```

**Query** :MEASure:UITouijitter?

The :MEASure:UITouijitter? query returns the measured UI-UI jitter.

**NOTE**

This measurement requires the **Measure All Edges** setting to be enabled. You can do this by:

- Installing the measurement on the display (using the command syntax), which automatically enables the **Measure All Edges** setting
- Sending the ":ANALyze:AEDGes ON" command.

**See Also** · "[:ANALyze:AEDGes](#)" on page 273

**History** Legacy command (existed before version 3.10).

## :MEASure:UNDershoot

**Command** :MEASure:UNDershoot [<source>[,<direction>]]

The :MEASure:UNDershoot command installs an Undershoot measurement. This measurement is visible in the front-panel user interface Measurements window in the Results pane.

Undershoot is a waveform aberration that is less than (<) the Top voltage within a positive pulse region or greater than (>) the Base voltage within a negative pulse region.

**NOTE**

If more than one such waveform aberration exists, the one with the largest magnitude is the undershoot unless otherwise specified.

**NOTE**

Undershoot, unlike Overshoot and Preshoot is measurement in respect of pulse polarity and not rising or falling edge only. Consequently, a minimum of two (2) edges must be in the viewing window for the measurement to occur.

**NOTE**

By definition, undershoot is measured only after the waveform reaches a level greater than or equal to ( $\geq$ ) the Top voltage for positive pulse undershoot measurements or less than equal to ( $\leq$ ) the Base voltage for negative pulse undershoot measurements.

Negative Pulse Undershoot equation:

$$\text{Negative Pulse Undershoot (\%)} = \begin{cases} \frac{\text{localMaximum} - \text{Base}}{\text{Top} - \text{Base}} & \text{localMaximum} > \text{Base} \\ 0 & \text{localMaximum} \leq \text{Base} \end{cases}$$

Where localMaximum is achieved between falling edge mesial (lower) and rising edge mesial (lower) points on the waveform. After the waveform has reached a level less than or equal to ( $\leq$ ) the Base voltage.

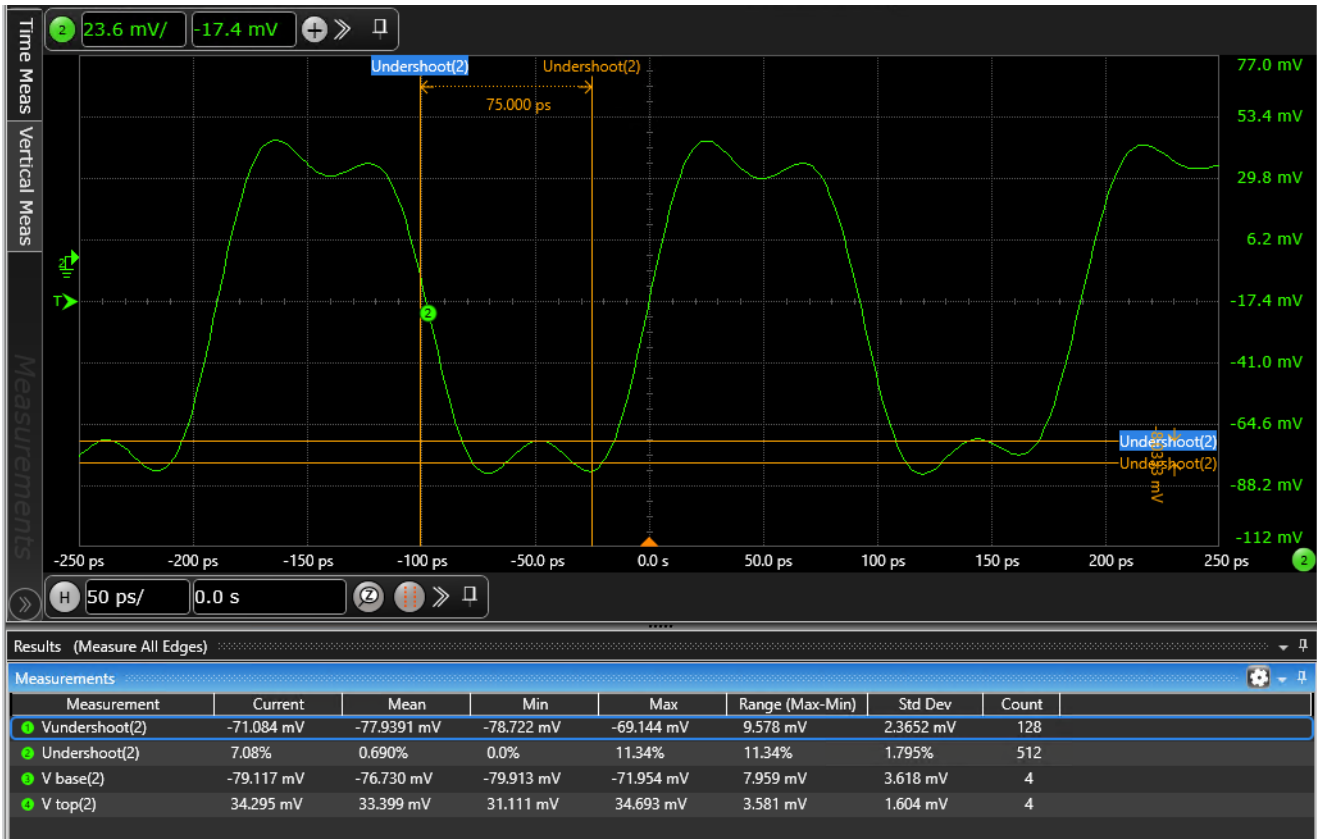

Positive Pulse Undershoot equation:

$$\text{Positive Pulse Undershoot (\%)} = \begin{cases} \frac{Top - localMinimum}{Top - Base} & localMinimum < Top \\ 0 & localMinimum \geq Top \end{cases}$$

Where localMinimum is achieved between rising edge distal (upper) and falling edge distal (upper) points on the waveform. After the waveform has reached a level greater than or equal to ( $\geq$ ) the Top voltage.



**<source>** {CHANnel<N> | DIFF<D> | COMMONmode<C> | FUNCTION<F> | WMEMory<R> | CLOCK | MTRend | EQUalized<L> | XT<X>}

For more information on <source> parameters, see **"Measurement Sources"** on page 890.

**<direction>** {RISing | FALLing}

Specifies whether positive pulse undershoot or negative pulse undershoot is measured. When <direction> is specified, the <source> parameter is required.

When the "Measure All Edges" mode is OFF (see **":ANALyze:AEDGes"** on page 273), the RISing and FALLing options specify whether the first rising or falling edge from the left side of the display grid is used.

When the "Measure All Edges" mode is ON, the RISing and FALLing options specify whether positive pulse undershoot or negative pulse undershoot is measured throughout the acquisition.

**Query** :MEASure:UNDershoot? [<source>[,<direction>]]

The :MEASure:UNDershoot? query returns the value of the Undershoot measurement.

**Returned Format** [:MEASure:UNDershoot] <value>[,<result\_state>]<NL>

- <value>** Ratio of undershoot to amplitude, in percent.
- <result\_state>** If :MEASure:SENDvalid is ON, the result state is returned with the measurement result. See the :MEASure:RESults table in this chapter for a list of the result states.
- See Also**
- **":MEASure:VUNDerShoot"** on page 1199
  - **":MEASure:OVERshoot"** on page 1020
  - **":MEASure:PREShoot"** on page 1072
- History** New in version 6.72.

## :MEASure:UNITinterval

## Command

## NOTE

This command is available only when the Jitter Analysis Software license is installed.

```
:MEASure:UNITinterval <source>[, {AUTO | (SEMI, <data_rate>)}]
```

The :MEASure:UNITinterval command measures the unit interval value of the selected source. Use the :MEASure:DATarate command/query to measure the data rate of the source

<source> {CHANnel<N> | DIFF<D> | COMMONmode<C> | FUNCTion<F> | DIGital<M> | WMEMory<R> | CLOCK | MTRend | MSPectrum | EQUalized<L>}

For more information on <source> parameters, see "[Measurement Sources](#)" on page 890.

<data\_rate> A real number representing the data rate.

**Example** This example measures the unit interval of channel 1.

```
myScope.WriteString ":MEASure:UNITinterval CHANnel1"
```

**Query** :MEASure:UNITinterval? <source>[, {AUTO | (SEMI, <data\_rate>)}]

The :MEASure:UNITinterval? query returns the measured unit interval.

## NOTE

This measurement requires the **Measure All Edges** setting to be enabled. You can do this by:

- Installing the measurement on the display (using the command syntax), which automatically enables the **Measure All Edges** setting
- Sending the ":ANALyze:AEDGes ON" command.

**Returned Format** [:MEASure:UNITinterval] <value>[, <result\_state>]<NL>

<value> Unit interval of the source.

<result\_state> If SENDvalid is ON, the result state is returned with the measurement result. See the :MEASure:RESults table in this chapter for a list of the result states.

**Example** This example places the current unit interval of the channel 1 waveform in the numeric variable, varValue, then prints the contents of the variable to the computer's screen.

```
myScope.WriteString ":SYSTem:HEADer OFF" ' Response headers off.
myScope.WriteString ":MEASure:UNITinterval? CHANnel1"
varValue = myScope.ReadNumber
Debug.Print FormatNumber(varValue, 0)
```

**See Also** • "[:ANALyze:AEDGes](#)" on page 273

**History** Legacy command (existed before version 3.10).



## :MEASure:VAMPlitude

**Command** :MEASure:VAMPlitude [<source>]

The :MEASure:VAMPlitude command calculates the difference between the top and base voltage of the specified source. Sources are specified with the :MEASure:SOURce command or with the optional parameter following the :MEASure:VAMPlitude command.

**<source>** {CHANnel<N> | DIFF<D> | COMMONmode<C> | FUNCTion<F> | WMEMory<R> | CLOCk | MTRend | MSPectrum | EQUalized<L> | XT<X>}

For more information on <source> parameters, see **"Measurement Sources"** on page 890.

**Example** This example calculates the difference between the top and base voltage of the specified source.

```
myScope.WriteString ":MEASure:VAMPlitude CHANnel1"
```

**Query** :MEASure:VAMPlitude? [<source>]

The :MEASure:VAMPlitude? query returns the calculated difference between the top and base voltage of the specified source.

**Returned Format** [:MEASure:VAMPlitude] <value>[,<result\_state>]<NL>

**<value>** Calculated difference between the top and base voltage.

**<result\_state>** If SENDvalid is ON, the result state is returned with the measurement result. See the :MEASure:RESuLts table in this chapter for a list of the result states.

**Example** This example places the current Vamplitude value in the numeric variable, varValue, then prints the contents of the variable to the computer's screen.

```
myScope.WriteString ":SYSTem:HEADer OFF" ' Response headers off.
myScope.WriteString ":MEASure:VAMPlitude? CHANnel1"
varValue = myScope.ReadNumber
Debug.Print FormatNumber(varValue, 0)
```

**History** Legacy command (existed before version 3.10).

## :MEASure:VAverage

**Command** :MEASure:VAverage {CYCLE | DISPLAY}[, <source>]

The :MEASure:VAverage command calculates the average voltage over the displayed waveform. Sources are specified with the :MEASure:SOURce command or with the optional parameter following the :MEASure:VAverage command.

**CYCLE** The CYCLE parameter instructs the average measurement to measure the average voltage across the first period on the display.

**DISPlay** The DISPlay parameter instructs the average measurement to measure all the data on the display.

**<source>** {CHANnel<N> | DIFF<D> | COMMONmode<C> | FUNCTION<F> | WMemory<R> | CLOCK | MTRend | MSPectrum | EQUALized<L> | XT<X>}

For more information on <source> parameters, see "[Measurement Sources](#)" on page 890.

**Example** This example calculates the average voltage over the displayed waveform.

```
myScope.WriteString ":MEASure:VAverage DISPLAY,CHANnel1"
```

**Query** :MEASure:VAverage? {CYCLE | DISPLAY}[, <source>]

The :MEASure:VAverage? query returns the calculated average voltage of the specified source. Sources are specified with the :MEASure:SOURce command or with the optional parameter following the :MEASure:VAverage command.

**Returned Format** [:MEASure:VAverage] <value>[, <result\_state>]<NL>

**<value>** The calculated average voltage.

**<result\_state>** If SENDvalid is ON, the result state is returned with the measurement result. See the :MEASure:RESults table in this chapter for a list of the result states.

**Example** This example places the current average voltage in the numeric variable, varAverage, then prints the contents of the variable to the computer's screen.

```
myScope.WriteString ":SYSTEM:HEADer OFF" ' Response headers off.
myScope.WriteString ":MEASure:VAverage? DISPLAY,CHANnel1 CHANnel1"
varAverage = myScope.ReadNumber
Debug.Print FormatNumber(varAverage, 0)
```

**History** Legacy command (existed before version 3.10).

## :MEASure:VBASe

**Command** :MEASure:VBASe [<source>]

The :MEASure:VBASe command measures the statistical base of the waveform. Sources are specified with the :MEASure:SOURce command or with the optional parameter following the :MEASure:VBASe command.

**<source>** {CHANnel<N> | DIFF<D> | COMMONmode<C> | FUNCTION<F> | WMEMory<R> | CLOCK | MTRend | MSPectrum | EQUALized<L> | XT<X>}

For more information on <source> parameters, see "[Measurement Sources](#)" on page 890.

**Example** This example measures the voltage at the base of the waveform.

```
myScope.WriteString ":MEASure:VBASe CHANnel1"
```

**Query** :MEASure:VBASe? [<source>]

The :MEASure:VBASe? query returns the measured voltage value at the base of the specified source.

**Returned Format** [:MEASure:VBASe] <value>[,<result\_state>]<NL>

**<value>** Voltage at the base of the waveform.

**<result\_state>** If SENDvalid is ON, the result state is returned with the measurement result. See the :MEASure:RESults table in this chapter for a list of the result states.

**Example** This example returns the current voltage at the base of the waveform to the numeric variable, varVoltage, then prints the contents of the variable to the computer's screen.

```
myScope.WriteString ":SYSTem:HEADer OFF" ' Response headers off.
myScope.WriteString ":MEASure:VBASe? CHANnel1"
varVoltage = myScope.ReadNumber
Debug.Print FormatNumber(varVoltage, 0)
```

**History** Legacy command (existed before version 3.10).

**:MEASure:VLOWer**

**Command** :MEASure:VLOWer [<source>]

The :MEASure:VLOWer command measures the voltage value at the lower threshold of the waveform. Sources are specified with the :MEASure:SOURce command or with the optional parameter following the :MEASure:VLOWer command.

**<source>** {CHANnel<N> | DIFF<D> | COMMONmode<C> | FUNCtion<F> | WMEMory<R> | CLOCK | MTRend | MSPectrum | EQUalized<L> | XT<X>}

For more information on <source> parameters, see "[Measurement Sources](#)" on page 890.

**Query** :MEASure:VLOWer?

The :MEASure:VLOWer? query returns the measured lower threshold of the selected source.

**Returned Format** [:MEASure:VLOWer] <value>[,<result\_state>]<NL>

**<value>** Voltage value at the lower threshold.

**<result\_state>** If SENDvalid is ON, the result state is returned with the measurement result. See the :MEASure:RESults table in this chapter for a list of the result states.

**Example** This example returns the measured voltage at the lower threshold of the waveform to the numeric variable, varVlower, then prints the contents of the variable to the computer's screen.

```
myScope.WriteString ":SYSTEM:HEADer OFF" ' Response headers off.
myScope.WriteString ":MEASure:VLOWer? CHANnel1"
varVlower = myScope.ReadNumber
Debug.Print FormatNumber(varVlower, 0)
```

**History** Legacy command (existed before version 3.10).

## :MEASure:VMAX

**Command** :MEASure:VMAX [<source>]

The :MEASure:VMAX command measures the absolute maximum voltage present on the selected source waveform. Sources are specified with the :MEASure:SOURce command or with the optional parameter following the :MEASure:VMAX command.

**<source>** {CHANnel<N> | DIFF<D> | COMMONmode<C> | FUNCTION<F> | WMEMory<R> | CLOCK | MTRend | MSPectrum | EQUALized<L> | PNOise | XT<X>}

For more information on <source> parameters, see "[Measurement Sources](#)" on page 890.

**Example** This example measures the absolute maximum voltage on the waveform.

```
myScope.WriteString ":MEASure:VMAX CHANnel1"
```

**Query** :MEASure:VMAX? [<source>]

The :MEASure:VMAX? query returns the measured absolute maximum voltage or maximum FFT amplitude present on the selected source waveform.

**Returned Format** [:MEASure:VMAX] <value>[, <result\_state>]<NL>

**<value>** Absolute maximum voltage present on the waveform.

**<result\_state>** If SENDvalid is ON, the result state is returned with the measurement result. See the :MEASure:RESults table in this chapter for a list of the result states.

**Example** This example returns the measured absolute maximum voltage on the waveform to the numeric variable, varMaximum, then prints the contents of the variable to the computer's screen.

```
myScope.WriteString ":SYSTEM:HEADer OFF" ' Response headers off.
myScope.WriteString ":MEASure:VMAX? CHANnel1"
varMaximum = myScope.ReadNumber
Debug.Print FormatNumber(varMaximum, 0)
```

**History** Legacy command (existed before version 3.10).

## :MEASure:VMIDdle

**Command** :MEASure:VMIDdle [<source>]

The :MEASure:VMIDdle command measures the voltage level at the middle threshold of the waveform. Sources are specified with the :MEASure:SOURce command or with the optional parameter following the :MEASure:VMIDdle command.

<source> {CHANnel<N> | DIFF<D> | COMMONmode<C> | FUNCTion<F> | WMEMory<R> | CLOCK | MTRend | MSPectrum | EQUALized<L> | XT<X>}

For more information on <source> parameters, see "[Measurement Sources](#)" on page 890.

**Query** :MEASure:VMIDdle? [<source>]

The :MEASure:VMIDdle? query returns the voltage value at the middle threshold of the waveform.

**Returned Format** [MEASure:VMIDdle] <value>[,<result\_state>]<NL>

<value> The middle voltage present on the waveform.

<result\_state> If SENDvalid is ON, the result state is returned with the measurement result. See the :MEASure:RESults table in this chapter for a list of the result states.

**Example** This example returns the measured middle voltage on the waveform to the numeric variable, varMiddle, then prints the contents of the variable to the computer's screen.

```
myScope.WriteString ":SYSTEM:HEADer OFF" ' Response headers off.
myScope.WriteString ":MEASure:VMIDdle? CHANnel1"
varMiddle = myScope.ReadNumber
Debug.Print FormatNumber(varMiddle, 0)
```

**History** Legacy command (existed before version 3.10).

## :MEASure:VMIN

**Command** :MEASure:VMIN [<source>]

The :MEASure:VMIN command measures the absolute minimum voltage present on the selected source waveform. Sources are specified with :MEASure:SOURce or with the optional parameter following the :MEASure:VMIN command.

**<source>** {CHANnel<N> | DIFF<D> | COMMONmode<C> | FUNCTion<F> | WMEMory<R> | CLOCk | MTRend | MSPectrum | EQUalized<L> | XT<X> | PNOise}

For more information on <source> parameters, see "[Measurement Sources](#)" on page 890.

**Example** This example measures the absolute minimum voltage on the waveform.

```
myScope.WriteString ":MEASure:VMIN CHANnel1"
```

**Query** :MEASure:VMIN? [<source>]

The :MEASure:VMIN? query returns the measured absolute minimum voltage or minimum FFT amplitude present on the selected source waveform.

**Returned Format** [:MEASure:VMIN] <value>[,<result\_state>]<NL>

**<value>** Absolute minimum voltage present on the waveform.

**<result\_state>** If SENDvalid is ON, the result state is returned with the measurement result. See the :MEASure:RESults table in this chapter for a list of the result states.

**Example** This example returns the measured absolute minimum voltage on the waveform to the numeric variable, varMinimum, then prints the contents of the variable to the computer's screen.

```
myScope.WriteString ":SYSTem:HEADer OFF" ' Response headers off.
myScope.WriteString ":MEASure:VMIN? CHANnel1"
varMinimum = myScope.ReadNumber
Debug.Print FormatNumber(varMinimum, 0)
```

**History** Legacy command (existed before version 3.10).

**:MEASure:VOVershoot**

**Command** :MEASure:VOVershoot [<source>[,<direction>]]

The :MEASure:VOVershoot command is similar to the overshoot measurement, but instead of returning the ratio of overshoot voltage to amplitude as a percent, it returns the local voltage of the overshoot.

**<source>** {CHANnel<N> | DIFF<D> | COMMONmode<C> | FUNCTION<F> | WMEMory<R> | CLOCk | MTRend | MSPectrum | EQUALized<L> | XT<X>}

For more information on <source> parameters, see "[Measurement Sources](#)" on page 890.

**<direction>** {RISing | FALLing}

Specifies whether rising edge overshoot or falling edge overshoot is measured. When <direction> is specified, the <source> parameter is required.

When the "Measure All Edges" mode is OFF (see "[ANALyze:AEDGes](#)" on page 273), the RISing and FALLing options specify whether the first rising or falling edge from the left side of the display grid is used.

When the "Measure All Edges" mode is ON, the RISing and FALLing options specify whether rising edge overshoot or falling edge overshoot is measured throughout the acquisition.

**Example** This example measures the local voltage of the overshoot.

```
myScope.WriteString ":MEASure:VOVershoot CHAN1"
```

**Query** :MEASure:VOVershoot? [<source>[,<direction>]]

The :MEASure:VOVershoot? query returns the local voltage of the overshoot.

**Returned Format** [:MEASure:VOVershoot] <value>[,<result\_state>]<NL>

**<value>** The local voltage of the overshoot.

**<result\_state>** If :MEASure:SENDvalid is ON, the result state is returned with the measurement result. See the :MEASure:RESults table in this chapter for a list of the result states.

**Example** This example places the current value of overshoot in the numeric variable, varValue, then prints the contents of the variable to the computer's screen.

```
myScope.WriteString ":SYSTem:HEADer OFF" ' Response headers off.
myScope.WriteString ":MEASure:VOVershoot? CHANnel1"
varValue = myScope.ReadNumber
Debug.Print FormatNumber(varValue, 0)
```

**History** Legacy command (existed before version 3.10).



## :MEASure:VPP

**Command** :MEASure:VPP [<source>]

The :MEASure:VPP command measures the maximum and minimum voltages on the selected source, then calculates the peak-to-peak voltage as the difference between the two voltages. Sources are specified with the :MEASure:SOURce command or with the optional parameter following the :MEASure:VPP command.

**<source>** {CHANnel<N> | DIFF<D> | COMMONmode<C> | FUNCTION<F> | WMEMory<R> | CLOCK | MTRend | MSPectrum | EQUalized<L> | XT<X> | PNOise}

For more information on <source> parameters, see **"Measurement Sources"** on page 890.

**Example** This example measures the peak-to-peak voltage or FFT amplitude range of the previously selected source.

```
myScope.WriteString ":MEASure:VPP CHANnel1"
```

**Query** :MEASure:VPP? [<source>]

The :MEASure:VPP? query returns the specified source peak-to-peak voltage.

**Returned Format** [:MEASure:VPP] <value> [, <result\_state>] <NL>

**<value>** Peak-to-peak voltage of the selected source.

**<result\_state>** If SENDvalid is ON, the result state is returned with the measurement result. See the :MEASure:RESults table in this chapter for a list of the result states.

**Example** This example places the current peak-to-peak voltage in the numeric variable, varVoltage, then prints the contents of the variable to the computer's screen.

```
myScope.WriteString ":SYSTem:HEADer OFF" ' Response headers off.
myScope.WriteString ":MEASure:VPP? CHANnel1"
varVoltage = myScope.ReadNumber
Debug.Print FormatNumber(varVoltage, 0)
```

**History** Legacy command (existed before version 3.10).

## :MEASure:VPReshoot

**Command** :MEASure:VPReshoot <source>[,<direction>]

The :MEASure:VPReshoot command is similar to the preshoot measurement, but instead of returning the ratio of preshoot voltage to amplitude as a percent, it returns the local voltage of the preshoot.

**<source>** {CHANnel<N> | DIFF<D> | COMMONmode<C> | FUNCtion<F> | WMEMory<R> | CLOCk | MTRend | MSPectrum | EQUalized<L> | XT<X>}

For more information on <source> parameters, see "[Measurement Sources](#)" on page 890.

**<direction>** {RISing | FALLing}

Specifies whether rising edge preshoot or falling edge preshoot is measured. When <direction> is specified, the <source> parameter is required.

When the "Measure All Edges" mode is OFF (see "[ANALyze:AEDGes](#)" on page 273), the RISing and FALLing options specify whether the first rising or falling edge from the left side of the display grid is used.

When the "Measure All Edges" mode is ON, the RISing and FALLing options specify whether rising edge preshoot or falling edge preshoot is measured throughout the acquisition.

**Example** This example measures the local voltage of the preshoot.

```
myScope.WriteString ":MEASure:VPReshoot CHAN1"
```

**Query** :MEASure:VPReshoot? <source>[,<direction>]

**History** Legacy command (existed before version 3.10).

## :MEASure:VRMS

**Command** :MEASure:VRMS {CYCLe | DISPlay},{AC | DC} [,<source> [, {VOLT | DBM}]]

The :MEASure:VRMS command measures the RMS voltage of the selected waveform by subtracting the average value of the waveform from each data point on the display. Sources are specified with the :MEASure:SOURce command or with the optional parameter following the :MEASure:VRMS command.

**CYCLe** The CYCLe parameter instructs the RMS measurement to measure the RMS voltage across the first period of the display.

**DISPlay** The DISPlay parameter instructs the RMS measurement to measure all the data on the display. Generally, RMS voltage is measured across one waveform or cycle, however, measuring multiple cycles may be accomplished with the DISPlay option. The DISPlay parameter is also useful when measuring noise.

**AC** The AC parameter is used to measure the RMS voltage subtracting the DC component.

**DC** The DC parameter is used to measure RMS voltage including the DC component.

The AC RMS, DC RMS, and VAVG parameters are related as in this formula:

$$DCVRMS^2 = ACVRMS^2 + VAVG^2$$

**<source>** {CHANnel<N> | DIFF<D> | COMMONmode<C> | FUNCTION<F> | WMEMory<R> | CLOCK | MTRend | MSPectrum | EQUalized<L> | XT<X>}

For more information on <source> parameters, see "[Measurement Sources](#)" on page 890.

**VOLT | DBM** Specifies the units of the measurement as either volts or decibels.

**Example** This example measures the RMS voltage of the previously selected waveform.

```
myScope.WriteString ":MEASure:VRMS CYCLe,AC,CHANnel1"
```

**Query** :MEASure:VRMS? {CYCLe | DISPlay},{AC | DC} [,<source> [, {VOLT | DBM}]]

The :MEASure:VRMS? query returns the RMS voltage of the specified source.

**Returned Format** [:MEASure:VRMS] <value>[,<result\_state>]<NL>

**<value>** RMS voltage of the selected waveform.

**<result\_state>** If SENDvalid is ON, the result state is returned with the measurement result. See the :MEASure:RESults table in this chapter for a list of the result states.

**Example** This example places the current AC RMS voltage over one period of the waveform in the numeric variable, varVoltage, then prints the contents of the variable to the computer's screen.

```
myScope.WriteString ":SYSTem:HEADer OFF" ' Response headers off.
myScope.WriteString ":MEASure:VRMS? CYCLe,AC,CHANnel1"
```

```
varVoltage = myScope.ReadNumber  
Debug.Print FormatNumber(varVoltage, 0)
```

**History** Legacy command (existed before version 3.10).

Version 3.10: Added the VOLT and DBM parameters for specifying the measurement units.

## :MEASure:VTIME

**Command** :MEASure:VTIME <time>[,<source>]

The :MEASure:VTIME command measures the voltage at the specified time. The time is referenced to the trigger event and must be on the screen. When an FFT function is the specified source, the amplitude at the specified frequency is measured. Sources are specified with the :MEASure:SOURce command or with the optional parameter following the :MEASure:VTIME command.

**<source>** {CHANnel<N> | DIFF<D> | COMMONmode<C> | FUNCTION<F> | WMEMory<R> | CLOCK | MTRend | MSPectrum | EQUalized<L> | XT<X> | PNOise}

For more information on <source> parameters, see "[Measurement Sources](#)" on page 890.

**<time>** A real number for time from trigger in seconds, or frequency in Hertz for an FFT (when a function is set to FFT or a waveform memory contains an FFT).

**Query** :MEASure:VTIME? <time>[,<source>]

The :MEASure:VTIME? query returns the measured voltage or amplitude.

**Returned Format** [:MEASure:VTIME] <value>[,<result\_state>]<NL>

**<value>** Voltage at the specified time. When the source is an FFT function, the returned value is the vertical value at the horizontal setting passed in the VTIME <time> parameter. The time parameter is in Hertz when an FFT function is the source.

**<result\_state>** If SENDvalid is ON, the result state is returned with the measurement result. See the :MEASure:RESults table in this chapter for a list of the result states.

**Example** This example places the voltage at 500 ms in the numeric variable, varValue, then prints the contents to the computer's screen.

```
myScope.WriteString ":SYSTEM:HEADer OFF" ' Response headers off.
myScope.WriteString ":MEASure:VTIME? 500E-3,CHANnel1"
varValue = myScope.ReadNumber
Debug.Print FormatNumber(varValue, 0)
```

**History** Legacy command (existed before version 3.10).

## :MEASure:VTOP

**Command** :MEASure:VTOP [<source>]

The :MEASure:VTOP command measures the statistical top of the selected source waveform. Sources are specified with the :MEASure:SOURce command or with the optional parameter following the :MEASure:VTOP command.

**<source>** {CHANnel<N> | DIFF<D> | COMMONmode<C> | FUNCTion<F> | WMEMory<R> | CLOCk | MTRend | MSPectrum | EQUALized<L> | XT<X>}

For more information on <source> parameters, see "[Measurement Sources](#)" on page 890.

**Example** This example measures the voltage at the top of the waveform.

```
myScope.WriteString ":MEASure:VTOP CHANnel1"
```

**Query** :MEASure:VTOP? [<source>]

The :MEASure:VTOP? query returns the measured voltage at the top of the specified source.

**Returned Format** [:MEASure:VTOP] <value>[,<result\_state>]<NL>

**<value>** Voltage at the top of the waveform.

**<result\_state>** If SENDvalid is ON, the result state is returned with the measurement result. See the :MEASure:RESults table in this chapter for a list of the result states.

**Example** This example places the value of the voltage at the top of the waveform in the numeric variable, varValue, then prints the contents of the variable to the computer's screen.

```
myScope.WriteString ":SYSTem:HEADer OFF" ' Response headers off.
myScope.WriteString ":MEASure:VTOP? CHANnel1"
varValue = myScope.ReadNumber
Debug.Print FormatNumber(varValue, 0)
```

**History** Legacy command (existed before version 3.10).

## :MEASure:VUNDershoot

**Command** :MEASure:VUNDershoot [<source>[,<direction>]]

The :MEASure:VUNDershoot command installs a V undershoot measurement. This measurement is visible in the front-panel user interface Measurements window in the Results pane.

The Vundershoot measurement is similar to the measurement installed with :MEASure:UNDershoot, but instead of returning the ratio of undershoot voltage to amplitude as a percent, it returns the local Minimum or local Maximum voltage of the undershoot.

**<source>** {CHANnel<N> | DIFF<D> | COMMONmode<C> | FUNCTion<F> | WMEMory<R> | CLOCK | MTRend | EQUalized<L> | XT<X>}

For more information on <source> parameters, see "**Measurement Sources**" on page 890.

**<direction>** {RISing | FALLing}

Specifies whether positive pulse V undershoot or negative pulse V undershoot is measured. When <direction> is specified, the <source> parameter is required.

When the "Measure All Edges" mode is OFF (see "**:ANALyze:AEDGes**" on page 273), the RISing and FALLing options specify whether the first rising or falling edge from the left side of the display grid is used.

When the "Measure All Edges" mode is ON, the RISing and FALLing options specify whether positive pulse V undershoot or negative pulse V undershoot is measured throughout the acquisition.

**Query** :MEASure:VUNDershoot? [<source>[,<direction>]]

The :MEASure:VUNDershoot? query returns the value of the V undershoot measurement.

**Returned Format** [:MEASure:VUNDershoot] <value>[,<result\_state>]<NL>

**<value>** The local Minimum V undershoot value for positive pulses or the local Maximum V undershoot value for negative pulses.

**<result\_state>** If :MEASure:SENDvalid is ON, the result state is returned with the measurement result. See the :MEASure:RESults table in this chapter for a list of the result states.

- See Also**
- "**:MEASure:UNDershoot**" on page 1179
  - "**:MEASure:VOVershoot**" on page 1192
  - "**:MEASure:VPReshoot**" on page 1194

**History** New in version 6.72.

## :MEASure:VUPPer

**Command** :MEASure:VUPPer [<source>]

The :MEASure:VUPPer command measures the voltage value at the upper threshold of the waveform. Sources are specified with the MEASure:SOURce command or with the optional parameter following the :MEASure:VUPPer command.

**<source>** {CHANnel<N> | DIFF<D> | COMMONmode<C> | FUNCtion<F> | WMEMory<R> | CLOCk | MTRend | MSPectrum | EQUalized<L> | XT<X>}

For more information on <source> parameters, see "[Measurement Sources](#)" on page 890.

**Example** This example measures the voltage at the upper threshold of the waveform.

```
myScope.WriteString ":MEASure:VUPPer CHANnel1"
```

**Query** :MEASure:VUPPer? [<source>]

The :MEASure:VUPPer? query returns the measured upper threshold value of the selected source.

**Returned Format** [:MEASure:VUPPer] <value>[,<result\_state>] <NL>

**<value>** Voltage at the upper threshold.

**<result\_state>** If SENDvalid is ON, the result state is returned with the measurement result. See the :MEASure:RESults table in this chapter for a list of the result states.

**Example** This example places the value of the voltage at the upper threshold of the waveform in the numeric variable, varValue, then prints the contents of the variable to the computer's screen.

```
myScope.WriteString ":SYSTem:HEADer OFF" ' Response headers off.
myScope.WriteString ":MEASure:VUPPer? CHANnel1"
varValue = myScope.ReadNumber
Debug.Print FormatNumber(varValue, 0)
```

**History** Legacy command (existed before version 3.10).



## :MEASure:WINDow

**Command** :MEASure:WINDow {ZOOM | CGRade | {MAIN | ALL}}, {MEAS<N>}

The :MEASure:WINDow command specifies whether measurements are made in the ZOOM window (measurement gating), the CGRade (color grade) view, or over the entire acquisition (MAIN or ALL). The MAIN and ALL parameters are equivalent.

Not all measurements can be applied to the color grade view.

If MEAS<N> is omitted, the command attempts to apply the selected window to all active measurements.

<N> Can be an integer from 1 – 40.

**Example** This example gates Measurement 1 to the zoom window.

```
myScope.WriteString ":MEASure:WINDow ZOOM, MEAS1"
```

**Query** :MEASure:WINDow? {MEASN}

This query returns whether the measurement is being performed on the zoomed portion of the waveform (ZOOM), the color grade view of the waveform (CGR) or the entire acquisition (MAIN or ALL).

If MEAS<N> is omitted on the query, it returns the window of the first measurement.

**History** Legacy command (existed before version 3.10).

Version 3.10: The short form of the command was changed from :MEAS:WIN to :MEAS:WIND.

Version 5.00: Added the CGRade (color grade) view as a measurement window option.

Version 6.71: The maximum number of measurements has increased from 20 to 40.

**:MEASure:XCORTie**

**Command** :MEASure:XCORTie <source1>, <source2>, <edge\_dir>, <xcor\_time\_range>

The :MEASure:XCORTie command adds a cross-correlated TIE measurement to the oscilloscope's front-panel display.

This measurement uses the same *two-channel cross-correlation technique* (see "Two-Channel Cross-Correlation Lowers the Oscilloscope Noise Floor" in the oscilloscope's online help) that is used to lower the oscilloscope's phase noise measurement floor.

<source1>, {CHANnel<N>}  
<source2>

<N> An integer, 1-4 in a single oscilloscope, 1-40 in a MultiScope system.

<edge\_dir> {RISing | FALLing | BOTH}

<xcor\_time\_range  
> {AUT | <manual\_range>}

<manual\_range> The time range in seconds in NR3 format.

**Query** :MEASure:XCORTie? <source1>, <source2>, <edge\_dir>, <xcor\_time\_range>

The :MEASure:XCORTie? query returns the measured cross-correlated TIE value.

**Returned Format** <measured\_value><NL>

<measured\_value> ::= cross-correlated TIE value in seconds in NR3 format

**See Also** • [":MEASure:TIEClock2"](#) on page 1165

**History** New in version 6.30.

## :MEASure:ZTMAX

**Command** :MEASure:ZTMAX {MEASurement<N>}

When "Measure All Edges" is enabled and the measurement supports "Zoom To Max", the :MEASure:ZTMAX command adjusts the horizontal scale and position to zoom in on the maximum measured value.

Check the front panel user interface to see if a measurement supports "Zoom To Max" by right-clicking the measurement results. Typically, measurements that involve a time period support "Zoom To Max".

This command is the same as :MEASurement<N>:ZTMAX.

<N> An integer, 1-40.

**NOTE**

When <N> is 10-40, the long form of the mnemonic, MEASurement<N>, is too long. In this case, you must use the short form, MEAS<N>.

- See Also**
- [":MEASure:ZTMIN"](#) on page 1204
  - [":MEASurement<N>:ZTMAX"](#) on page 1209

**History** New in version 6.50.

Version 6.71: The maximum number of measurements has increased from 20 to 40.

## :MEASure:ZTMIN

**Command** :MEASure:ZTMIN {MEASurement<N>}

When "Measure All Edges" is enabled and the measurement supports "Zoom To Min", the :MEASure:ZTMIN command adjusts the horizontal scale and position to zoom in on the minimum measured value.

Check the front panel user interface to see if a measurement supports "Zoom To Min" by right-clicking the measurement results. Typically, measurements that involve a time period support "Zoom To Min".

This command is the same as :MEASurement<N>:ZTMIN.

<N> An integer, 1-40.

### NOTE

When <N> is 10-40, the long form of the mnemonic, MEASurement<N>, is too long. In this case, you must use the short form, MEAS<N>.

- See Also**
- [":MEASure:ZTMAX"](#) on page 1203
  - [":MEASurement<N>:ZTMIN"](#) on page 1210

**History** New in version 6.50.

Version 6.71: The maximum number of measurements has increased from 20 to 40.

## :MEASurement<N>:CLEar

**Command** :MEASurement<N>:CLEar

The :MEASurement<N>:CLEar command clears a single measurement.

**<N>** An integer, 1-40.

### NOTE

When <N> is 10-40, the long form of the mnemonic, MEASurement<N>, is too long. In this case, you must use the short form, MEAS<N>.

---

**See Also** · [":MEASure:CLEar"](#) on page 918

**History** New in version 6.50.

Version 6.71: The maximum number of measurements has increased from 20 to 40.

## :MEASurement&lt;N&gt;:NAME

**Command** :MEASurement<N>:NAME <name>

The :MEASurement<N>:NAME command sets the name of the specified measurement to whatever string is given to <name>. This lets you give specific names to measurements displayed on the oscilloscope's screen.

<N> An integer, 1–40. This number represents the position of the measurement on screen in the Measurements results window.

**NOTE**

When <N> is 10–40, the long form of the mnemonic, MEASurement<N>, is too long. In this case, you must use the short form, MEAS<N>.

<name> A quoted string.

**Query** :MEASurement<N>:NAME?

The :MEASurement<N>:NAME? query returns the name of the corresponding measurement.

**History** New in version 4.50.

Version 6.30: Now supports up to 20 measurements.

Version 6.71: The maximum number of measurements has increased from 20 to 40.

## :MEASurement<N>:POSition

**Command** :MEASurement<N>:POSition <new\_position>

The :MEASurement<N>:POSition command lets you reorder measurements within the Measurements window in the Results pane.

<new\_position> An integer from 1-40.

<N> An integer, 1-40.

### NOTE

When <N> is 10-40, the long form of the mnemonic, MEASurement<N>, is too long. In this case, you must use the short form, MEAS<N>.

**See Also** · [":MEASurement<N>:CLEar"](#) on page 1205

**History** New in version 6.60.

Version 6.71: The maximum number of measurements has increased from 20 to 40.

## :MEASurement&lt;N&gt;:SOURce

**Command** :MEASurement<N>:SOURce <source> [, <source>]

The :MEASurement<N>:SOURce command changes the source of an existing measurement in the Measurements tab of the user interface.

<N> An integer, 1-40. This number represents the position of the measurement on screen in the Measurements tab.

**NOTE**

When <N> is 10-40, the long form of the mnemonic, MEASurement<N>, is too long. In this case, you must use the short form, MEAS<N>.

<source> {CHANnel<N> | DIFF<D> | COMMONmode<C> | FUNction<F> | DIGital<M> | WMEMory<R> | CLOCK | MTRend | MSPectrum | EQUalized<L> | XT<X> | PNOise}

For more information on <source> parameters, see "[Measurement Sources](#)" on page 890.

**Query** :MEASurement<N>:SOURce?

The :MEASurement<N>:SOURce? query returns the source(s) of the selected measurement.

**Returned Format** [:MEASurement<N>:SOURce] <source> [, <source>] <NL>

**Example** This example places the currently specified measurement 1 source(s) in the string variable, strSource, then prints the contents of the variable to the computer's screen.

```
Dim strSource As String ' Dimension variable.
myScope.WriteString ":MEASurement1:SOURce?"
strSource = myScope.ReadString
Debug.Print strSource
```

**See Also** • "[:MEASurement<N>:NAME](#)" on page 1206

**History** New in version 4.50.

Version 6.71: The maximum number of measurements has increased from 20 to 40.



## :MEASurement&lt;N&gt;:ZTMAX

**Command** :MEASurement<N>:ZTMAX

When "Measure All Edges" is enabled and the measurement supports "Zoom To Max", the :MEASurement<N>:ZTMAX command adjusts the horizontal scale and position to zoom in on the maximum measured value.

Check the front panel user interface to see if a measurement supports "Zoom To Max" by right-clicking the measurement results. Typically, measurements that involve a time period support "Zoom To Max".

This command is the same as :MEASure:ZTMAX.

<N> An integer, 1-40.

**NOTE**

When <N> is 10-40, the long form of the mnemonic, MEASurement<N>, is too long. In this case, you must use the short form, MEAS<N>.

**See Also**

- **":MEASurement<N>:ZTMIN"** on page 1210
- **":MEASure:ZTMAX"** on page 1203

**History** New in version 6.50.

Version 6.71: The maximum number of measurements has increased from 20 to 40.

**:MEASurement<N>:ZTMIN****Command** :MEASurement<N>:ZTMIN

When "Measure All Edges" is enabled and the measurement supports "Zoom To Min", the :MEASurement<N>:ZTMIN command adjusts the horizontal scale and position to zoom in on the minimum measured value.

Check the front panel user interface to see if a measurement supports "Zoom To Min" by right-clicking the measurement results. Typically, measurements that involve a time period support "Zoom To Min".

This command is the same as :MEASure:ZTMIN.

<N> An integer, 1-40.

**NOTE**

When <N> is 10-40, the long form of the mnemonic, MEASurement<N>, is too long. In this case, you must use the short form, MEAS<N>.

- See Also**
- **":MEASurement<N>:ZTMAX"** on page 1209
  - **":MEASure:ZTMIN"** on page 1204

**History** New in version 6.50.

Version 6.71: The maximum number of measurements has increased from 20 to 40.

## 32 Pod Commands

:POD<N>:DISPlay / 1212

:POD<N>:PSKew / 1213

:POD<N>:THReshold / 1214

**NOTE**

The POD commands only apply to the MSO oscilloscopes.

---

**:POD<N>:DISPlay****Command****NOTE**

The POD commands only apply to the MSO oscilloscopes.

```
:POD<N>[:DISPlay] {ON | OFF | 1 | 0}
```

The :POD<N>:DISPlay command enables or disables the view for the selected digital channel pod. Pod 1 has the digital channels 0 through 7, and pod 2 has the digital channels 8 through 15.

Displaying a pod automatically enables digital channels. See ENABLE command in the root subsystem.

<N> An integer, 1-2.

**Example** This example turns on the display of bit 5 for the digital channels.

```
myScope.WriteString ":ENABle DIGital"
myScope.WriteString ":POD2:DISPlay ON"
```

**Query** :POD<N>[:DISPlay]?

The :POD<N>:DISPlay? query returns the value of the display setting for the pod.

**Returned Format** [:POD<N>:DISPlay] {1 | 0}<NL>

**See Also**

- **":DIGital<N>:DISPlay"** on page 482
- **":ENABle DIGital"** on page 1233

**History** Legacy command (existed before version 3.10).

**:POD<N>:PSKew**

**Command** :POD<N>:PSKew <skew\_value>

The :POD<N>:PSKew command lets you adjust the digital channels with respect to the analog channels when there is a time delay between the analog and digital channels. This can occur when different length cables are used.

<N> An integer, 1-2.

<skew\_value> A real number for the skew value, in the range -1 ms to +1 ms.

**Example** This example sets the probe skew for all digital channels to 10  $\mu$ s.

```
myScope.WriteString ":POD1:PSKew 10E-6"
```

**Query** :POD<N>:PSKew?

The :POD<N>:PSKew? query returns the current probe skew setting for all digital channels.

**Returned Format** [:POD<N>:PSKew] <skew\_value><NL>

**History** Legacy command (existed before version 3.10).

## :POD&lt;N&gt;:THReshold

## Command

## NOTE

The POD commands only apply to the MSO oscilloscopes.

```
:POD<N>:THReshold {CMOS50 | CMOS33 | CMOS25 | ECL | PECL | TTL
| DIFFerential | <value>}
```

The :POD<N>:THReshold command sets the logic threshold value for a pod. Pod 1 has the digital channels 0 through 7, and pod 2 has the digital channels 8 through 15. This command is equivalent to the :DIGital<N>:THReshold command.

The threshold is used for triggering purposes and for displaying the digital data as high (above the threshold) or low (below the threshold). The voltage values for the predefined thresholds are:

- CMOS50 = 2.5 V
- CMOS33 = 1.65 V
- CMOS25 = 1.25 V
- ECL = -1.3 V
- PECL = 3.7 V
- TTL = 1.4 V
- DIFFerential = 0 V

<N> An integer, 1-2.

<value> A real number representing the voltage value which distinguishes a 1 logic level from a 0 logic level. Waveform voltages greater than the threshold are 1 logic levels while waveform voltages less than the threshold are 0 logic levels.

On 9000 Series, 9000H Series, and S-Series mixed-signal oscilloscopes, the range of the threshold voltage is from -8 volts to 8 volts.

On 90000 X-Series and V-Series mixed-signal oscilloscopes, the range of the threshold voltage is from -3.75 volts to 3.75 volts.

**Example** This example sets the threshold to 1.8 volts for pod 2 (digital channels D15 through D8).

```
myScope.WriteString ":POD2:THReshold 1.8"
```

**Query** :POD<N>:THReshold?

The :POD<N>:THReshold? query returns the threshold value for the specified pod.

**Returned Format** [:POD<N>:THReshold] {CMOS50 | CMOS33 | CMOS25 | ECL | PECL | TTL  
| DIFF | <value>}<NL>

**See Also** • [":DIGital<N>:THReshold"](#) on page 486

**History** Legacy command (existed before version 3.10).

Version 4.50: Added the DIFFerential parameter for specifying the threshold voltage.





## 33 Root Level Commands

:ADER? – Acquisition Done Event Register / 1219

:AER? – Arm Event Register / 1220

:AState? / 1221

:ATER? – Auto Trigger Event Register / 1222

:AUToscale / 1223

:AUToscale:CHANnels / 1224

:AUToscale:PLACement / 1225

:AUToscale:VERTical / 1226

:BEEP / 1227

:BLANK / 1228

:CDISplay / 1229

:DIGitize / 1230

:DISable DIGital / 1232

:ENABle DIGital / 1233

:MTEEnable – Mask Test Enable Register / 1235

:MTERegister? – Mask Test Event Register / 1236

:MODEl? / 1234

:OPEEnable – Operation Status Enable / 1237

:OPERRegister? – Operation Status Register / 1238

:OVLRegister? / 1239

:PDER? – Processing Done Event Register / 1240

:PRINt / 1241

:RECall:SETup / 1242

:RState? / 1243

:RUN / 1244

:SERial – Serial Number / 1245

:SINGle / 1246

:STATus? / 1247

:STOP / 1249

:STORe:JITTer / 1250

:STORe:SETup / 1251

:STORe:WAVEform / 1252

:TERegister? – Trigger Event Register / 1253

:VIEW / 1254

Root level commands control many of the basic operations of the oscilloscope that you can select by pressing the labeled keys on the front panel. These commands are always recognized by the parser if they are prefixed with a colon, regardless of the current tree position. After executing a root level command, the parser is positioned at the root of the command tree.

## :ADDER? – Acquisition Done Event Register

**Query** :ADDER?

The :ADDER? query reads the Acquisition Done Event Register and returns 1 or 0. After the Acquisition Done Event Register is read, the register is cleared. The returned value 1 indicates an acquisition completed event has occurred and 0 indicates an acquisition completed event has not occurred.

Once the Done bit is set, it is cleared only by doing :ADDER? or by sending a \*CLS command.

**Returned Format** {1 | 0}<NL>

**See Also** · ["Example: Blocking and Polling Synchronization"](#) on page 225

**History** Legacy command (existed before version 3.10).

## :AER? – Arm Event Register

**Query** :AER?

The :AER? query reads the Arm Event Register and returns 1 or 0. After the Arm Event Register is read, the register is cleared. The returned value 1 indicates a trigger armed event has occurred and 0 indicates a trigger armed has not occurred.

### NOTE

#### Arm Event Returns

:AER? will allow the Arm Event to return either immediately (if you have armed but not triggered) or on the next arm (if you have already triggered). However, \*CLS is always required to get an SRQ again.

---

Once the AER bit is set, it is cleared only by doing :AER? or by sending a \*CLS command.

**Returned Format** {1 | 0}<NL>

**See Also** · ["Example: Checking for Armed Status"](#) on page 210

**History** Legacy command (existed before version 3.10).

## :AState?

**Query** :AState?

The :AState? query returns the acquisition state:

- ARM – The trigger is armed and the oscilloscope has acquired all of the pre-trigger data.
- TRIG – The trigger condition has occurred and the oscilloscope is acquiring post trigger data.
- ATRIG – The trigger condition has not been met, but the oscilloscope has auto triggered and is acquiring post trigger data.
- ADONE – The acquisition is done, and the data has been processed and is ready to be unloaded.

The :AState? query result has more meaning when you first know the run state (see [":RState?"](#) on page 1243).

**Returned Format** {ARM | TRIG | ATRIG | ADONE}<NL>

**See Also** • [":RState?"](#) on page 1243

**History** New in version 4.60.

## :ATER? – Auto Trigger Event Register

**Query** :ATER?

The :ATER? query reads the Auto Trigger Event Register and returns 1 or 0. After the Auto Trigger Event Register is read, the register is cleared. The returned value 1 indicates an auto trigger event has occurred and 0 indicates an auto trigger event has not occurred.

**Returned Format** {1 | 0}<NL>

**History** Legacy command (existed before version 3.10).

## :AUToscale

**Command** :AUToscale

The :AUToscale command causes the oscilloscope to evaluate all input waveforms and find the optimum conditions for displaying the waveform. It searches each of the channels for input waveforms and shuts off channels where no waveform is found. It adjusts the vertical gain and offset for each channel that has a waveform and sets the time base on the lowest numbered input channel that has a waveform.

The trigger is found by searching each channel, starting with channel 4, then channel 3, channel 2, and channel 1, until a trigger waveform is detected. If waveforms cannot be found on any vertical input, the oscilloscope is returned to its former state.

Autoscale sets the following:

- Channel Display, Scale, and Offset
- Trigger Sweep, Mode, Edge, Source, Level, Slope, Hysteresis, and Holdoff
- Acquisition Sampling Rate and Memory Depth
- Time Base Scale and Position
- Marker Mode Set to Measurement
- Resets Acquisition Completion Criteria to 90%

Autoscale turns off the following:

- Measurements on sources that are turned off
- Functions
- Windows
- Memories
- InfiniiSim

Autoscale does not turn off:

- PrecisionProbe/PrecisionCable

No other controls are affected by Autoscale.

**Example** This example automatically scales the oscilloscope for the input waveform.

```
myScope.WriteString ":AUToscale"
```

**History** Legacy command (existed before version 3.10).

## :AUToscale:CHANnels

**Command** :AUToscale:CHANnels {ALL | DISplayed}

The :AUToscale:CHANnels command selects whether to apply autoscale to all of the input channels or just the input channels that are currently displayed.

**Example** This example automatically scales only the displayed channels.

```
myScope.WriteString ":AUToscale:CHANnels DISplayed"
```

**Query** :AUToscale:CHANnels?

The :AUToscale:CHANnels? query returns the selected channels setting.

**Returned Format** [:AUToscale:CHANnels] {ALL | DISP}<NL>

**History** Legacy command (existed before version 3.10).



## :AUToscale:PLACement

**Command** :AUToscale:PLACement {STACK | SEParate | OVERlay}

The :AUToscale:PLACement command controls how the waveforms are displayed on the oscilloscope when the autoscale command is used. If Stack is chosen then each waveform's amplitude is decreased and then the waveforms are offset so each takes up a different vertical portion of the screen. This makes it easier to view them, but decreases the accuracy of any measurements performed on the waveforms because they no longer take up the full dynamic range of the ADC (analog to digital converter). If Separate is chosen then the screen is divided into the same number of grids that there are waveforms (for example, if three waveforms are displayed then the screen will be divided into three grids). Each grid represents the full dynamic range of the ADC so this choice maximizes measurement accuracy while still separating the waveforms so they are easy to see. If the Overlay option is chosen then the waveforms are displayed on top of each other. This maximizes measurement accuracy, but can make viewing difficult.

**Example** This example automatically overlays the waveforms after an autoscale.

```
myScope.WriteString ":AUToscale:OVERlay ON"
```

**Query** :AUToscale:PLACement?

**History** Legacy command (existed before version 3.10).

## :AUToscale:VERTical

**Command** :AUToscale:VERTical <source>

The :AUToscale:VERTical command autoscales the vertical position and scaling for the corresponding channel without changing anything else (for example, trigger or timebase settings).

<source> {CHANnel<N> | DIFF<D> | COMMONmode<C>}

<N> An integer, 1-4.

<R> An integer, 1-4.

<D>, <C> <D> is an integer, 1-2. <C> is an integer, 3-4.

The DIFF and COMMONmode sources are just aliases that can be used in place of the channel names to apply to differential or common mode signals. These are just aliases - no state change occurs if you refer to a differential channel and you are not in differential mode. DIFF1 refers to the differential signal between channels 1 and 3 (and COMMONmode3 refers to the common mode channel between these same channels). DIFF2 refers to the differential signal between channels 2 and 4 (and COMMONmode4 refers to the common mode channel between these same channels).

**Example** This example automatically autoscales the vertical position and scale for the waveform on Channel 1.

```
myScope.WriteString ":AUToscale:VERTical CHAN1"
```

**NOTE**

If you are using software 2.10 or earlier, the command syntax is (lower-case "t" in "vertical"): AUToscale:VERTical <CHANnel 1 | CHANnel 2 | CHANnel 3 | CHANnel 4>

**History** Legacy command (existed before version 3.10).

## :BEEP

**Command** :BEEP <frequency>,<duration>

The :BEEP command makes the oscilloscope beep at a defined frequency and duration.

<frequency> A real number representing frequency of beep in Hertz.

<duration> A real number representing duration of beep in milliseconds.

**Example** This example will create a beep at 1000 Hz for 500 ms.

```
myScope.WriteString ":BEEP 1000,500"
```

**History** Legacy command (existed before version 3.10).

**:BLANK**

**Command** :BLANK {CHANnel<N> | BUS<B> | DIFF<D> | COMMONmode<C>  
 | DIGital<M> | FUNCTion<F> | HISTogram | WMEMory<R>  
 | MTRend | MSPectrum | EQUalize<L> | POD<P> | ALL}

The :BLANK command turns off an active channel, function, histogram, waveform memory, measurement trend, measurement spectrum, or Feed-Forward Equalized waveform. The :VIEW command turns them on.

<N> An integer, 1-4 in a single oscilloscope, 1-40 in a MultiScope system.

<D>, <C> <D> is an integer, 1-2. <C> is an integer, 3-4.

The DIFF and COMMONmode sources are just aliases that can be used in place of the channel names to apply to differential or common mode signals. These are just aliases - no state change occurs if you refer to a differential channel and you are not in differential mode. DIFF1 refers to the differential signal between channels 1 and 3 (and COMMONmode3 refers to the common mode channel between these same channels). DIFF2 refers to the differential signal between channels 2 and 4 (and COMMONmode4 refers to the common mode channel between these same channels).

<M> An integer, 0-15.

<F> An integer, 1-16.

<R> An integer, 1-4.

<L> An integer, 1-4.

<P> An integer, 1-2.

**Example** This example turns off channel 1.

```
myScope.WriteString ":BLANK CHANnel1"
```

**See Also** • **":VIEW"** on page 1254

**History** Legacy command (existed before version 3.10).

## :CDISplay

**Command** :CDISplay

The :CDISplay command clears the display and resets all associated measurements. If the oscilloscope is stopped, all currently displayed data is erased. If the oscilloscope is running, all of the data in active channels and functions is erased; however, new data is displayed on the next acquisition. Waveform memories are not erased.

**Example** This example clears the oscilloscope display.

```
myScope.WriteString ":CDISplay"
```

**History** Legacy command (existed before version 3.10).

## :DIGitize

**Command** :DIGitize [CHANnel<N> | DIGital<M> | DIFF<D> | COMMONmode<C>  
| POD<P>] [, ...]

The :DIGitize command invokes a special mode of data acquisition that is more efficient than using the :RUN command. This command initializes the selected channels or functions, then acquires them according to the current oscilloscope settings. When all waveforms are completely acquired, the oscilloscope is stopped. The waveform completion criteria is set with the ":ACQUIRE:COMPLETE" command.

If you specify channel parameters, then these are the only waveforms acquired and the display waveforms of the specified channels are turned off.

**NOTE****Full Range of Measurement and Math Operators are Available**

Even though digitized waveforms are not displayed, you may perform the full range of measurement and math operators on them.

**NOTE**

Channel parameters are not supported in a MultiScope system because acquisitions require at least one channel per connected frame. Only the parameterless version of :DIGitize is supported in a MultiScope system.

If you use the :DIGitize command with no parameters, the digitize operation is performed on the channels that are being displayed in the Infiniium waveform viewing area. In this case, the display state of the acquired waveforms is not changed after the :DIGitize command is completed. Because the command executes more quickly without parameters, this form of the command is useful for repetitive measurement sequences. You can also use this mode if you want to view the digitize results because the display state of the digitized waveforms is not affected.

<N> An integer, 1-4.

<M> An integer, 0-15.

<D>, <C> <D> is an integer, 1-2. <C> is an integer, 3-4.

The DIFF and COMMONmode sources are just aliases that can be used in place of the channel names to apply to differential or common mode signals. These are just aliases - no state change occurs if you refer to a differential channel and you are not in differential mode. DIFF1 refers to the differential signal between channels 1 and 3 (and COMMONmode3 refers to the common mode channel between these same channels). DIFF2 refers to the differential signal between channels 2 and 4 (and COMMONmode4 refers to the common mode channel between these same channels).

**Example** This example acquires data on channel 1.

```
myScope.WriteString ":DIGitize CHANnel1"
```

The ACQUIRE subsystem commands set up conditions such as COUNT for the next :DIGitize command. The WAVEFORM subsystem commands determine how the data is transferred out of the oscilloscope, and how to interpret the data.

- See Also**
- ["Example: Blocking and Polling Synchronization"](#) on page 225
  - ["Example: Checking for Armed Status"](#) on page 210
  - See the [Chapter 44](#), "Example Programs," starting on page 1813 for examples of how to use :DIGitize and its related commands.

**History** Legacy command (existed before version 3.10).

## :DISable DIGital

**Command**    `:DISable DIGital`

The `:DISable DIGital` command disables the digital channels 0-15.

**Example**    This example will disable the digital channels.

```
myScope.WriteString ":DISable DIGital"
```

**History**    Legacy command (existed before version 3.10).



## :ENABle DIGital

**Command**    `:ENABle DIGital`

The `:ENABle DIGital` command enables the digital channels 0-15.

**Example**    This example will enable the digital channels.

```
myScope.WriteString ":ENABle DIGital"
```

**History**    Legacy command (existed before version 3.10).

## :MODEl?

**Query** :MODEl?

The :MODEl? query returns the model number for the oscilloscope.

**Returned Format** A six-character alphanumeric model number in quotation marks. Output is determined by header and longform status as in [Table 15](#).

**Table 15** MODEl? Returned Format

:SYSTem:HEADer		:SYSTem:LONGform		Response (for example)
ON	OFF	ON	OFF	
	X		X	DSO90804A
	X	X		DSO90804A
X			X	:MOD DSO90804A
X		X		:MODEL DSO90804A

**Example** This example places the model number in a string variable, strModel, then prints the contents of the variable on the computer's screen.

```
Dim strModel As String ' Dimension variable.
myScope.WriteString ":MODEl?"
strModel = myScope.ReadString
Debug.Print strModel
```

**History** Legacy command (existed before version 3.10).

## :MTEEnable – Mask Test Enable Register

**Command** :MTEEnable <enable\_mask>

The :MTEEnable command is used to set bits in the Mask Test Enable Register.

<enable\_mask> The <enable\_mask> is a 16-bit signed decimal value that enables the following bits of the Mask Test Event Register:

Bit 0	Mask Test Complete
Bit 1	Mask Test Fail
Bit 2	Mask Low Amplitude
Bit 3	Mask High Amplitude
Bit 4	Mask Align Complete
Bit 5	Mask Align Fail
Bits 6-14	are not used

**Query** :MTEEnable?

The :MTEEnable? query returns the value stored in the Mask Test Enable Register.

**Returned Format** [:MTEEnable] <enable\_mask>

**Example** Suppose your application requires an interrupt whenever a Mask Test Fail occurs in the mask test register. You can enable this bit to generate the summary bit by sending:

```
myScope.WriteString "MTEEnable 2"
```

Whenever an error occurs, the oscilloscope sets the MASK bit in the Operation Status Register. Because the bits in the Operation Status Enable Register are all enabled, a summary bit is generated to set bit 7 (OPER) in the Status Byte Register.

If bit 7 (OPER) in the Status Byte Register is enabled (via the \*SRE command), a service request interrupt (SRQ) is sent to the external computer.

**History** Legacy command (existed before version 3.10).

## :MTERegister? – Mask Test Event Register

**Query** :MTERegister?

The :MTERegister? query returns the value stored in the Mask Test Event Register. The bits stored in the register have the following meanings:

Bit 0	Mask Test Complete bit is set whenever the mask test is complete.
Bit 1	Mask Test Fail bit is set whenever the mask test failed.
Bit 2	Mask Low Amplitude bit is set whenever the signal is below the mask amplitude.
Bit 3	Mask High Amplitude bit is set whenever the signal is above the mask amplitude.
Bit 4	Mask Align Complete bit is set whenever the mask align is complete.
Bit 5	Mask Align Fail bit is set whenever the mask align failed.

The Mask Test Event Register is read and cleared by the MTERegister? query. The register output is enabled or disabled using the mask value supplied with the MTEEnable command.

**Returned Format** 0-63 decimal value.

### NOTE

#### **Disabled Mask Test Event Register Bits Respond, but Do Not Generate a Summary Bit**

Mask Test Event Register bits that are not enabled still respond to their corresponding conditions (that is, they are set if the corresponding event occurs). However, because they are not enabled, they do not generate a summary bit in the Operation Status Register.

**History** Legacy command (existed before version 3.10).

## :OPEEnable – Operation Status Enable

**Command** :OPEEnable <mask>

<mask> The decimal weight of the enabled bits.

The :OPEEnable command sets a mask in the Operation Status Enable register. Each bit that is set to a "1" enables that bit to set bit 7 in the status byte register, and potentially causes an SRQ to be generated. Bit 5, Wait for Trig is used. Other bits are reserved.

**Query** :OPEEnable?

The query returns the current value contained in the Operation Status Enable register as a decimal number.

**Returned Format** [OPEEnable] <value><NL>

**History** Legacy command (existed before version 3.10).

## :OPERregister? – Operation Status Register

**Query** :OPERregister?

The :OPERregister? query returns the value contained in the Operation Status Register as a decimal number. This register contains the WAIT TRIG bit (bit 5) and the OVLRL bit (bit 11).

The WAIT TRIG bit is set by the Trigger Armed Event Register and indicates that the trigger is armed. The OVLRL bit is set by the Overload Event Register.

**Returned Format** <value><NL>

**See Also** • ["Example: Checking for Armed Status"](#) on page 210

**History** Legacy command (existed before version 3.10).

## :OVLRegister?

**Query** :OVLRegister?

The :OVLRegister? query returns the value stored in the Overload Event Register.

The integer value returned by this query represents the channels as follows:

- Bit 0 - Channel 1
- Bit 1 - Channel 2
- Bit 2 - Channel 3
- Bit 3 - Channel 4
- Bits 7-4 are not used and are set to zero (0)

**Returned Format** <value><NL>

**History** Legacy command (existed before version 3.10).

## :PDER? – Processing Done Event Register

**Query** :PDER?

The :PDER? query reads the Processing Done Event Register and returns 1 or 0. After the Processing Done Event Register is read, the register is cleared. The returned value 1 indicates that all math and measurements are complete and 0 indicates they are not complete. :PDER? is non-blocking.

:PDER? can be used in place of :ADER?.

**Returned Format** {1 | 0}<NL>

- See Also**
- **Chapter 9**, “Using :PDER? Instead of \*OPC?,” starting on page 217
  - **Chapter 8**, “Sequential (Blocking) vs. Overlapped Commands,” starting on page 215
  - **"Example: Blocking and Polling Synchronization"** on page 225

**History** Legacy command (existed before version 3.10).



## :PRINT

**Command**    :PRINT

The :PRINT command outputs a copy of the screen to a printer or other device destination specified in the HARDcopy subsystem. You can specify the selection of the output and the printer using the HARDcopy subsystem commands.

**Example**    This example outputs a copy of the screen to a printer or a disk file.

```
myScope.WriteString ":PRINT"
```

**History**    Legacy command (existed before version 3.10).

## :RECall:SETup

- Command** :RECall:SETup <setup\_memory\_num>
- <setup\_memory\_num>** Setup memory number, an integer, 0 through 9.
- The :RECall:SETup command recalls a setup that was saved in one of the oscilloscope's setup memories. You can save setups using either the :STORe:SETup command or the front panel.
- Examples** This command recalls a setup from setup memory 2.
- ```
myScope.WriteString ":RECall:SETup 2"
```
- History** Legacy command (existed before version 3.10).

## :RState?

**Query** :RState?

The :RState? query returns the run state:

- RUN – The oscilloscope is acquiring and displaying new waveforms.
- STOP – The oscilloscope is no longer acquiring new waveforms.
- SING – A single acquisition has been started and the oscilloscope is waiting for the trigger condition to be met.

These are the same run states displayed on the front panel and in the user interface.

**Returned Format** {RUN | STOP | SING}<NL>

**See Also** • [":AState?"](#) on page 1221

**History** New in version 4.60.

## :RUN

**Command** :RUN

The :RUN command starts the oscilloscope running. When the oscilloscope is running, it acquires waveform data according to its current settings. Acquisition runs repetitively until the oscilloscope receives a :STOP command, or until there is only one acquisition if Trigger Sweep is set to Single. However, the :TRIGger:SWEep SINGle should not be used in new programs. The :SINGle command should be used instead to acquire a single acquisition.

**Example** This example causes the oscilloscope to acquire data repetitively.

```
myScope.WriteString ":RUN"
```

**History** Legacy command (existed before version 3.10).

## :SERial – Serial Number

**Command** :SERial {<serial\_number>}

The :SERial command sets the serial number of the oscilloscope. A serial number was entered in your oscilloscope by Keysight Technologies before it was shipped to you. Therefore, setting the serial number is not normally required unless the oscilloscope is serialized for a different application.

The oscilloscope's serial number is part of the string returned for the \*IDN? query described in the Common Commands chapter.

<serial\_number> A ten-character alphanumeric serial number enclosed with quotation marks.

**Example** This example sets the serial number for the oscilloscope to "US12345678".

```
myScope.WriteString ":SERial ""US12345678"""
```

**Query** :SERial?

The query returns the current serial number string for the oscilloscope.

**Returned Format** [:SERial] US12345678

**Example** This example places the serial number for the oscilloscope in the string variable strSerial, then prints the contents of the variable to the computer's screen.

```
Dim strSerial As String ' Dimension variable.
myScope.WriteString ":SERial?"
strSerial = myScope.ReadString
Debug.Print strSerial
```

**History** Legacy command (existed before version 3.10).

## :SINGle

**Command**    :SINGle

The :SINGle command causes the oscilloscope to make a single acquisition when the next trigger event occurs. However, this command does not set the :TRIGger:SWEep to SINGle.

**Example**    This example sets up the oscilloscope to make a single acquisition when the next trigger event occurs.

```
myScope.WriteString ":SINGle"
```

**See Also**    • [":TRIGger:SWEep"](#) on page 1400  
              • ["Example: Blocking and Polling Synchronization"](#) on page 225  
              • ["Example: Checking for Armed Status"](#) on page 210

**History**    Legacy command (existed before version 3.10).

## :STATus?

**Query** :STATus? {CHANnel<N> | DIFF<D> | COMMONmode<C> | FUNCTION<F>  
 | HISTogram | WMemory<R> | CLOCK | MTRend | MSPectrum  
 | EQUalized<L> | XT<X> | BUS<B> | DIGital<M> | POD<L>}

The :STATus? query shows whether the specified channel, function, wmemory, histogram, measurement trend, measurement spectrum, or equalized waveform is on or off. A return value of 1 means on and a return value of 0 means off.

The MTRend and MSPectrum sources are available when the Jitter Analysis Software license is installed and the features are enabled.

The CLOCK source is available when the recovered clock is displayed.

The EQUalized<L> source is available when the Advanced Signal Integrity Software license is installed and the equalized waveform is displayed as a function.

<N> An integer, 1-4 in a single oscilloscope, 1-40 in a MultiScope system.

<D>, <C> <D> is an integer, 1-2. <C> is an integer, 3-4.

The DIFF and COMMONmode sources are just aliases that can be used in place of the channel names to apply to differential or common mode signals. These are just aliases - no state change occurs if you refer to a differential channel and you are not in differential mode. DIFF1 refers to the differential signal between channels 1 and 3 (and COMMONmode3 refers to the common mode channel between these same channels). DIFF2 refers to the differential signal between channels 2 and 4 (and COMMONmode4 refers to the common mode channel between these same channels).

<F> An integer, 1-16.

<R> An integer, 1-4.

<L> An integer, 1-4.

<X> An integer, 1-4, identifying the crosstalk waveform.

<B> An integer, 1-4

<M> An integer, 0-15.

POD<L> refers to the two digital channel pods - one that includes all of the activated digital channels in the D0-D7 range and the other that includes all of the activated digital channels in the D8-D15 range.

**Returned Format** [:STATus] {0 | 1}<NL>

**Example** This example returns and prints the current status of channel 1.

```
myScope.WriteString ":STATus? CHANnel1"
strCurrent = myScope.ReadString
Debug.Print strCurrent
```

- See Also**
- **":BLANK"** on page 1228
  - **":VIEW"** on page 1254

**History** Legacy command (existed before version 3.10).



## :STOP

**Command** :STOP

The :STOP command causes the oscilloscope to stop acquiring data. To restart the acquisition, use the :RUN or :SINGLE command.

**Example** This example stops the current data acquisition.

```
myScope.WriteString ":STOP"
```

**History** Legacy command (existed before version 3.10).

## :STORe:JITTer

**Command** :STORe:JITTer <file\_name>

The :STORe:JITTer command saves all of the RJ/DJ jitter measurement data to the specified file name. The file that is created has a header section followed by the RJ/DJ measurement results section. After the RJ/DJ measurement results section is the data for each of the measurements. Each data section has a header showing what the measurement data is that follows.

**<file\_name>** A character-quoted ASCII string which can include subdirectories with the name of the file.

**Example** This example stores the RJ/DJ jitter measurements to a file.

```
myScope.WriteString _  
":STORe:JITTer " "C:\Users\Public\Documents\Infinium\jitter" "
```

**History** Legacy command (existed before version 3.10).

## :STORe:SETup

- Command** :STORe:SETup <setup\_memory\_num>
- <setup\_memory\_num>** Setup memory number, an integer, 0 through 9.
- The :STORe:SETup command saves the current oscilloscope setup in one of the setup memories.
- Example** This example stores the current oscilloscope setup to setup memory 0.
- ```
myScope.WriteString ":STORe:SETup 0"
```
- History** Legacy command (existed before version 3.10).

## :STORe:WAVeform

**Command** :STORe:WAVeform {{CHANnel<N> | DIFF<D> | COMMONmode<C> | FUNCTION<F>  
| WMEMory<R> | EQUalized<L> | XT<X> | MTRend | MSPectrum},  
{WMEMory<R>}}

The :STORe:WAVeform command copies a channel, function, stored waveform, measurement trend, or measurement spectrum to a waveform memory. The parameter preceding the comma specifies the source and can be any channel, function, or waveform memory. The parameter following the comma is the destination, and can be any waveform memory.

The :WAVeform:VIEW command determines the view of the data being stored.

The MTRend and MSPectrum sources are available when the Jitter Analysis Software license is installed and the features are enabled.

<N> An integer, 1-4 in a single oscilloscope, 1-40 in a MultiScope system.

<D>, <C> <D> is an integer, 1-2. <C> is an integer, 3-4.

The DIFF and COMMONmode sources are just aliases that can be used in place of the channel names to apply to differential or common mode signals. These are just aliases - no state change occurs if you refer to a differential channel and you are not in differential mode. DIFF1 refers to the differential signal between channels 1 and 3 (and COMMONmode3 refers to the common mode channel between these same channels). DIFF2 refers to the differential signal between channels 2 and 4 (and COMMONmode4 refers to the common mode channel between these same channels).

<F> An integer, 1-16.

<R> An integer, 1-4.

<L> An integer, 1-4.

<X> An integer, 1-4, identifying the crosstalk waveform.

**Example** This example copies channel 1 to waveform memory 3.

```
myScope.WriteString ":STORe:WAVeform CHANnel1,WMEMory3"
```

**History** Legacy command (existed before version 3.10).

## :TERegister? – Trigger Event Register

**Query** :TERegister?

The :TERegister? query reads the Trigger Event Register. A "1" is returned when an acquisition is complete. A "0" is returned when an acquisition has not completed.

The autotrigger does not set this register.

The register is set to a value of 1 only when the waveform meets the trigger criteria and the acquisition completes.

**Returned Format** {1 | 0}<NL>

**Example** This example checks the current status of the Trigger Event Register, places the status in the string variable, strCurrent, then prints the contents of the variable to the computer's screen.

```
Dim strCurrent As String ' Dimension variable.
myScope.WriteString ":TERegister?"
strCurrent = myScope.ReadString
Debug.Print strCurrent
```

Once this bit is set, you can clear it only by reading the register with the :TERegister? query, or by sending a \*CLS common command. After the Trigger Event Register is read, it is cleared.

**History** Legacy command (existed before version 3.10).

**:VIEW**

**Command** :VIEW {CHANnel<N> | DIFF<D> | COMMONmode<C> | FUNCTION<F>  
 | HISTogram | WMEMory<R> | MSTrend | MSPectrum | BUS<B>  
 | DIGital<M> | POD<P>}

The :VIEW command turns on a channel, function, histogram, or waveform memory. The :BLANK command turns them off.

The MTRend and MSPectrum sources are available when the Jitter Analysis Software license is installed and the features are enabled.

<N> An integer, 1-4 in a single oscilloscope, 1-40 in a MultiScope system.

<D>, <C> <D> is an integer, 1-2. <C> is an integer, 3-4.

The DIFF and COMMONmode sources are just aliases that can be used in place of the channel names to apply to differential or common mode signals. These are just aliases - no state change occurs if you refer to a differential channel and you are not in differential mode. DIFF1 refers to the differential signal between channels 1 and 3 (and COMMONmode3 refers to the common mode channel between these same channels). DIFF2 refers to the differential signal between channels 2 and 4 (and COMMONmode4 refers to the common mode channel between these same channels).

<F> An integer, 1-16.

<R> An integer, 1-4.

<B> An integer, 1-4.

<M> An integer, 0-15.

<P> An integer, 1-2.

**Example** This example turns on channel 1.

```
myScope.WriteString ":VIEW CHANnel1"
```

**See Also** • **":BLANK"** on page 1228

**History** Legacy command (existed before version 3.10).

## 34 Serial Bus Commands

General :SBUS<N> Commands / 1256  
:SBUS<N>:CAN Commands / 1261  
:SBUS<N>:FLEXray Commands / 1277  
:SBUS<N>:GENRaw Commands / 1287  
:SBUS<N>:HS Commands / 1290  
:SBUS<N>:IIC Commands / 1295  
:SBUS<N>:LIN Commands / 1304  
:SBUS<N>:SPI Commands / 1313  
:SBUS<N>:UART Commands / 1334

The :SBUS<N> subsystem commands control the serial decode bus viewing, mode, and other options.

### NOTE

These commands are only valid when the corresponding serial decode option has been licensed.

---

## General :SBUS<N> Commands

- **":SBUS<N>[:DISPlay]"** on page 1257
- **":SBUS<N>:MODE"** on page 1258
- **":SBUS<N>:SEARCh:ENABLE"** on page 1259
- **":SBUS<N>:SEARCh:TRIGger"** on page 1260



**:SBUS<N>[:DISPlay]**

**Command** :SBUS<N>[:DISPlay] <display>  
 <display> ::= {{1 | ON} | {0 | OFF}}

The :SBUS<N>[:DISPlay] command turns displaying of the serial decode bus on or off.

**NOTE**

This command is only valid when a serial decode option has been licensed.

**Query** :SBUS<N>[:DISPlay]?

The :SBUS<N>[:DISPlay]? query returns the current display setting of the serial decode bus.

**Returned Format** [:SBUS<N>[:DISPlay]] <display><NL>  
 <display> ::= {0 | 1}

**See Also** • **":SBUS<N>:MODE"** on page 1258

**History** New in version 3.50.

**:SBUS<N>:MODE****Command** :SBUS<N>:MODE <mode>

&lt;mode&gt; ::= {CAN | IIC | SPI | FLEXray | LIN | GENRaw | UART}

The :SBUS&lt;N&gt;:MODE command determines the decode mode for the serial bus.

**NOTE****This command is only valid when a serial decode option has been licensed.****Query** :SBUS<N>:MODE?

The :SBUS&lt;n&gt;:MODE? query returns the current serial bus decode mode setting.

**Returned Format** [:SBUS<N>:MODE] <mode><NL>

&lt;mode&gt; ::= {CAN | IIC | SPI | FLEX | LIN | GENR | UART}

- See Also**
- [":SBUS<N>:CAN Commands"](#) on page 1261
  - [":SBUS<N>:FLEXray Commands"](#) on page 1277
  - [":SBUS<N>:GENRaw Commands"](#) on page 1287
  - [":SBUS<N>:IIC Commands"](#) on page 1295
  - [":SBUS<N>:LIN Commands"](#) on page 1304
  - [":SBUS<N>:SPI Commands"](#) on page 1313

**History** New in version 3.50.

Version 4.60: Added CAN mode option.

Version 5.20: Added the FLEXray and LIN mode options.

Version 6.20: Added the GENRaw mode option.

Version 6.60: Added the UART mode option.

## :SBUS<N>:SEARCh:ENABle

**Command** :SBUS<N>:SEARCh:ENABle {{0 | OFF} | {1 | ON}}

The :SBUS<N>:SEARCh:ENABle command enables or disables protocol search within acquired data.

**Query** :SBUS<N>:SEARCh:ENABle?

The :SBUS<N>:SEARCh:ENABle? query returns the protocol search setting.

**Returned Format** <setting><NL>

<setting> ::= {0 | 1}

**See Also** • [":SBUS<N>:SEARCh:TRIGger"](#) on page 1260

**History** New in version 6.60.

**:SBUS<N>:SEARCh:TRIGger**

**Command** :SBUS<N>:SEARCh:TRIGger {{0 | OFF} | {1 | ON}}

The :SBUS<N>:SEARCh:TRIGger command enables or disables protocol search being used as a software trigger.

**NOTE**

When enabled, the trigger (time = 0) position is set to the center of the first packet that is found. The trigger position is not at the actual hardware trigger point.

---

For more information on how the :SBUS<N>:SEARCh:ENABle and :SBUS<N>:SEARCh:TRIGger controls work, see the online help.

**Query** :SBUS<N>:SEARCh:TRIGger?

The :SBUS<N>:SEARCh:TRIGger? query returns the protocol search being used as a software trigger setting.

**Returned Format** <setting><NL>

<setting> ::= {0 | 1}

**See Also** • [":SBUS<N>:SEARCh:ENABle"](#) on page 1259

**History** New in version 6.60.

## :SBUS<N>:CAN Commands

- **":SBUS<N>:CAN:FDSPoint"** on page 1262
- **":SBUS<N>:CAN:SAMPlEpoint"** on page 1263
- **":SBUS<N>:CAN:SIGNal:BAUDrate"** on page 1264
- **":SBUS<N>:CAN:SIGNal:DEFinition"** on page 1265
- **":SBUS<N>:CAN:SIGNal:FDBaudrate"** on page 1266
- **":SBUS<N>:CAN:SOURce"** on page 1267
- **":SBUS<N>:CAN:TRIGger (9000 Series, 9000H Series, S-Series)"** on page 1268
- **":SBUS<N>:CAN:TRIGger:PATtern:DATA (9000 Series, 9000H Series, S-Series)"** on page 1271
- **":SBUS<N>:CAN:TRIGger:PATtern:DATA:LENGth (9000 Series, 9000H Series, S-Series)"** on page 1272
- **":SBUS<N>:CAN:TRIGger:PATtern:ID (9000 Series, 9000H Series, S-Series)"** on page 1274
- **":SBUS<N>:CAN:TRIGger:PATtern:ID:MODE (9000 Series, 9000H Series, S-Series)"** on page 1275
- **":SBUS<N>:CAN:TYPE"** on page 1276

### NOTE

These commands are only valid when the automotive CAN serial decode option has been licensed.

- 
- See Also** • **":SBUS<N>:MODE"** on page 1258

**:SBUS<N>:CAN:FDSPoint**

**Command** :SBUS<N>:CAN:FDSPoint <value>

The :SBUS<N>:CAN:FDSPoint command sets the point during the bit time where the bit level is sampled to determine whether the bit is dominant or recessive. The sample point represents the percentage of time between beginning and end of the bit time.

**<value>** Percentage values in the range of 30 and 90 in NR3 format. Values are rounded off to nearest 0.5 resolution.

**Query** :SBUS<n>:CAN:FDSPoint?

The :SBUS<N>:CAN:FDSPoint? query returns the set sample point percentage value

**Returned Format** <value><NL>

- See Also**
- **":SBUS<N>:CAN:SIGNal:FDBaudrate"** on page 1266
  - **":SBUS<N>:CAN:TYPE"** on page 1276

**History** New in version 5.60.

## :SBUS<N>:CAN:SAMPlEpoint

**Command** :SBUS<N>:CAN:SAMPlEpoint <value>

<value><NL>

<value> ::= {60 | 62.5 | 65 | 67.5 | 68 | 70 | 72.5 | 75 | 77.5  
| 80 | 82.5 | 85 | 87.5} in NR3 format

The :SBUS<N>:CAN:SAMPlEpoint command sets the point during the bit time where the bit level is sampled to determine whether the bit is dominant or recessive. The sample point represents the percentage of time between the beginning of the bit time to the end of the bit time.

<N> An integer, 1-4.

**Query** :SBUS<N>:CAN:SAMPlEpoint?

The :SBUS<N>:CAN:SAMPlEpoint? query returns the current CAN sample point setting.

**Returned Format** <value><NL>

<value> ::= {60 | 62.5 | 65 | 67.5 | 68 | 70 | 72.5 | 75 | 77.5  
| 80 | 82.5 | 85 | 87.5} in NR3 format

**See Also** • [":SBUS<N>:MODE"](#) on page 1258

**History** New in version 4.60.

## :SBUS&lt;N&gt;:CAN:SIGNal:BAUDrate

**Command** :SBUS<N>:CAN:SIGNal:BAUDrate <baudrate>

<baudrate> ::= a real number from 10E3 to 5E6

The :SBUS<N>:CAN:SIGNal:BAUDrate command sets the standard baud rate of the CAN signal from 10 kb/s to 5 Mb/s.

If the baud rate you select does not match the system baud rate, false triggers may occur.

<N> An integer, 1-4.

**Query** :SBUS<N>:CAN:SIGNal:BAUDrate?

The :SBUS<N>:CAN:SIGNal:BAUDrate? query returns the current CAN baud rate setting.

**Returned Format** <baudrate><NL>

<baudrate> ::= a real number from 10E3 to 5E6

- See Also**
- **":SBUS<N>:MODE"** on page 1258
  - **":SBUS<N>:CAN:SIGNal:DEFinition"** on page 1265
  - **":SBUS<N>:CAN:SOURce"** on page 1267

**History** New in version 4.60.



## :SBUS<N>:CAN:SIGNal:DEFinition

**Command** :SBUS<N>:CAN:SIGNal:DEFinition <value>

<value> ::= {CANH | CANL | DIFFerential | DIFL}

The :SBUS<N>:CAN:SIGNal:DEFinition command sets the CAN signal type when :SBUS<N>:CAN:TRIGger is set to SOF (start of frame). These signals can be set to:

Dominant high signals:

- CANH – the actual CAN\_H differential bus signal.

Dominant low signals:

- CANL – the actual CAN\_L differential bus signal.
- DIFL – the CAN differential (L-H) bus signal connected to an analog source channel using a differential probe.
- DIFFerential – the CAN differential bus signal connected to an analog source channel using a differential probe. This is the same as DIFL.

<N> An integer, 1-4.

**Query** :SBUS<N>:CAN:SIGNal:DEFinition?

The :SBUS<N>:CAN:SIGNal:DEFinition? query returns the current CAN signal type.

**Returned Format** <value><NL>

<value> ::= {CANH | CANL | DIFL}

- See Also**
- **":SBUS<N>:MODE"** on page 1258
  - **":SBUS<N>:CAN:SIGNal:BAUDrate"** on page 1264
  - **":SBUS<N>:CAN:SOURce"** on page 1267

**History** New in version 4.60.

## :SBUS<N>:CAN:SIGNal:FDBaudrate

**Command** :SBUS<N>:CAN:SIGNal:FDBaudrate <baudrate>

The :SBUS<N>:CAN:SIGNal:FDBaudrate command sets the CAN FD baud rate in the range from 1 Mb/s to 10 Mb/s.

For CAN FD, both the standard rate settings (see :SBUS<n>:CAN:SIGNal:BAUDrate) and the FD rate settings must be set correctly; otherwise, false triggers may occur.

<baudrate> A real number from 1E6 to 10E6

**Query** :SBUS<n>:CAN:SIGNal:FDBaudrate?

The :SBUS<N>:CAN:SIGNal:FDBaudrate? query returns the CAN FD baud rate setting.

**Returned Format** <baudrate><NL>

- See Also**
- **":SBUS<N>:CAN:SIGNal:BAUDrate"** on page 1264
  - **":SBUS<N>:CAN:FDSPoint"** on page 1262
  - **":SBUS<N>:CAN:TYPE"** on page 1276

**History** New in version 5.60.

## :SBUS&lt;N&gt;:CAN:SOURce

**Command** :SBUS<N>:CAN:SOURce <source>

```
<source> ::= {CHANnel<N> | DIFF<D> | COMMONmode<C> | FUNction<F>
              | WMEMory<R> | DIGital<M> | NONE}
```

The :SBUS<N>:CAN:SOURce command sets the source for the CAN signal.

The NONE parameter is the same as selecting "None" for the source in the user interface. It makes the previously selected channel, waveform memory, or math function available for other decodes.

<N> SBUS<N> is an integer, 1-4.

CHANnel<N> is an integer, 1-4 in a single oscilloscope, 1-40 in a MultiScope system.

<D>, <C> <D> is an integer, 1-2. <C> is an integer, 3-4.

The DIFF and COMMONmode sources are just aliases that can be used in place of the channel names to apply to differential or common mode signals. These are just aliases - no state change occurs if you refer to a differential channel and you are not in differential mode. DIFF1 refers to the differential signal between channels 1 and 3 (and COMMONmode3 refers to the common mode channel between these same channels). DIFF2 refers to the differential signal between channels 2 and 4 (and COMMONmode4 refers to the common mode channel between these same channels).

<F> An integer, 1-16.

<R> An integer, 1-4.

<M> An integer, 0-15. Digital channels are available on mixed-signal oscilloscopes.

**Query** :SBUS<N>:CAN:SOURce?

The :SBUS<N>:CAN:SOURce? query returns the current source for the CAN signal.

**Returned Format** <source><NL>

- See Also**
- **":SBUS<N>:MODE"** on page 1258
  - **":SBUS<N>:CAN:SIGNal:DEFinition"** on page 1265

**History** New in version 4.60.

Version 5.20: The NONE parameter was added.

## :SBUS&lt;N&gt;:CAN:TRIGger (9000 Series, 9000H Series, S-Series)

**Command** :SBUS<N>:CAN:TRIGger <condition>

<condition> ::= {SOF | DATA | ERRor | IDData | IDRemote | ALLerrors  
| OVERload | ACKerror}

<condition> ::= {FDData | IDFDdata | EBActive | EBPAssive | CRCDbit  
| BRsBit | STUFerror | FORMerror | CRCerror | EOF} for CAN FD

**NOTE**

You must set the proper :SBUS<N>:MODE, :SBUS<N>:CAN:TRIGger, and :SBUS<N>:CAN:TRIGger:PATtern:ID:MODE before setting any other trigger values.

The :SBUS<N>:CAN:TRIGger command sets the CAN "trigger on" condition:

- SOF - will trigger on the Start of Frame (SOF) bit of a Data frame, Remote Transfer Request (RTR) frame, or an Overload frame.
- DATA - will trigger on CAN Data frames matching the specified ID, Data, and the DLC (Data length code).
- ERRor – will trigger on CAN Error frame.
- IDData – will trigger on CAN frames matching the specified ID of a Data frame.
- IDRemote – will trigger on CAN frames matching the specified ID of a Remote frame.
- ALLerrors – will trigger on CAN active error frames and unknown bus conditions.
- OVERload – will trigger on CAN overload frames.
- ACKerror – will trigger on a data or remote frame acknowledge bit that is recessive.

When :SBUS<N>:CAN:TYPE is set to CANFd, the previous IDData condition is no longer valid, and the following "trigger on" conditions are valid:

- FDData – will trigger on CAN FD Data frames matching the specified ID, Data, and the DLC (Data length code).
- IDFDdata – will trigger on CAN FD frames matching the specified ID of a Data frame.
- EBActive – will trigger on ESI bit if set to active.
- EBPAssive – will trigger on ESI bit if set to passive.
- CRCDbit – will trigger on CRC delimiter bit.
- BRsBit – will trigger on BRS bit.
- STUFerror – will trigger on stuff error.
- FORMerror – will trigger on form error.
- CRCerror – will trigger on CRC error.

- EOF – will trigger on EOF.

**NOTE**

CAN FD triggering is supported on Infiniium S-Series oscilloscopes only.

CAN ID specification is set by the :SBUS<N>:CAN:TRIGger:PATtern:ID and :SBUS<N>:CAN:TRIGger:PATtern:ID:MODE commands.

CAN Data specification is set by the :SBUS<N>:CAN:TRIGger:PATtern:DATA command.

CAN Data Length Code is set by the :SBUS<N>:CAN:TRIGger:PATtern:DATA:LENGth command.

<N> An integer, 1-4.

**Example** To enable the SBUS1 trigger, set the trigger to CAN Data frame matching the specified Standard ID 0x1f, Data 0x7fffff, and DLC 3.

```
myScope.WriteString ":TRIGger:MODE SBUS1"
myScope.WriteString ":SBUS1:MODE CAN"
myScope.WriteString ":SBUS1:CAN:TRIGger DATA"
myScope.WriteString ":SBUS1:CAN:TRIGger:PATtern:ID:MODE STANdard"
myScope.WriteString ":SBUS1:CAN:TRIGger:PATtern:ID '0x1f'"
myScope.WriteString ":SBUS1:CAN:TRIGger:PATtern:DATA:LENGth 3"
myScope.WriteString ":SBUS1:CAN:TRIGger:PATtern:DATA '0x7fffff'"
```

**Query** :SBUS<N>:CAN:TRIGger?

The :SBUS<N>:CAN:TRIGger? query returns the current CAN trigger on condition.

**Returned Format**

```
<condition><NL>
<condition> ::= {SOF | DATA | ERR | IDD | IDE | IDR | ALL | OVER | ACK}
<condition> ::= {FDD | IDFD | EBA | EBP | CRCD | BR SB | STUF | FORM
| CRC | EOF} for CAN FD
```

- See Also**
- **":TRIGger:MODE"** on page 1398
  - **":SBUS<N>:MODE"** on page 1258
  - **":SBUS<N>:CAN:TYPE"** on page 1276
  - **":SBUS<N>:CAN:TRIGger:PATtern:DATA (9000 Series, 9000H Series, S-Series)"** on page 1271
  - **":SBUS<N>:CAN:TRIGger:PATtern:DATA:LENGth (9000 Series, 9000H Series, S-Series)"** on page 1272
  - **":SBUS<N>:CAN:TRIGger:PATtern:ID (9000 Series, 9000H Series, S-Series)"** on page 1274
  - **":SBUS<N>:CAN:TRIGger:PATtern:ID:MODE (9000 Series, 9000H Series, S-Series)"** on page 1275

- **":SBUS<N>:CAN:SIGNal:DEFinition"** on page 1265
- **":SBUS<N>:CAN:SOURce"** on page 1267

**History** New in version 4.60.

Version 5.60: Additional trigger condition options for CAN FD have been added.

## :SBUS<N>:CAN:TRIGger:PATtern:DATA (9000 Series, 9000H Series, S-Series)

**Command** :SBUS<N>:CAN:TRIGger:PATtern:DATA <string>  
 <string> ::= "nn...n" where n ::= {0 | 1 | X | \$}  
 <string ::= "0xnn...n" where n ::= {0,...,9 | A,...,F | X | \$}

### NOTE

You must set the proper :SBUS<N>:MODE, :SBUS<N>:CAN:TRIGger, and :SBUS<N>:CAN:TRIGger:PATtern:ID:MODE before setting any other trigger values.

The :SBUS<N>:CAN:TRIGger:PATtern:DATA command defines the CAN data pattern resource according to the string parameter. This pattern, along with the data length (set by the :SBUS<N>:CAN:TRIGger:PATtern:DATA:LENGth command), control the data pattern searched for in each CAN message.

If the string parameter starts with "0x", it is a hexadecimal string made up of hexadecimal and X (don't care) characters; otherwise, it is a binary string made up of 0, 1, and X (don't care) characters.

### NOTE

If more bits are sent for <string> than specified by the :SBUS<N>:CAN:TRIGger:PATtern:DATA:LENGth command, the most significant bits will be truncated.

<N> An integer, 1-4.

**Query** :SBUS<N>:CAN:TRIGger:PATtern:DATA?

The :SBUS<N>:CAN:TRIGger:PATtern:DATA? query returns the current settings of the specified CAN data pattern resource in the binary string format.

**Returned Format** <string><NL> in nondecimal format

- See Also**
- [":TRIGger:MODE"](#) on page 1398
  - [":SBUS<N>:MODE"](#) on page 1258
  - [":SBUS<N>:CAN:TRIGger \(9000 Series, 9000H Series, S-Series\)"](#) on page 1268
  - [":SBUS<N>:CAN:TRIGger:PATtern:ID:MODE \(9000 Series, 9000H Series, S-Series\)"](#) on page 1275
  - [":SBUS<N>:CAN:TRIGger:PATtern:DATA:LENGth \(9000 Series, 9000H Series, S-Series\)"](#) on page 1272
  - [":SBUS<N>:CAN:TRIGger:PATtern:ID \(9000 Series, 9000H Series, S-Series\)"](#) on page 1274

**History** New in version 4.60.

## :SBUS<N>:CAN:TRIGger:PATtern:DATA:LENGth (9000 Series, 9000H Series, S-Series)

**Command** :SBUS<N>:CAN:TRIGger:PATtern:DATA:LENGth <length>  
 <length> ::= integer from 1 to 8 in NR1 format for standard CAN  
 <length> ::= integer from 1 to 15 in NR1 format for CAN FD

### NOTE

You must set the proper :SBUS<N>:MODE, :SBUS<N>:CAN:TRIGger, and :SBUS<N>:CAN:TRIGger:PATtern:ID:MODE before setting any other trigger values.

The :SBUS<N>:CAN:TRIGger:PATtern:DATA:LENGth command sets the number of 8-bit bytes in the CAN data string.

When ":SBUS<N>:CAN:TYPE CANStandard" is selected, the number of bytes in the string can be anywhere from 1 bytes to 8 bytes (64 bits).

When ":SBUS<N>:CAN:TYPE CANFd" is selected, the number of bytes in the string can be anywhere from 1 bytes to 15 bytes (120 bits).

### NOTE

CAN FD triggering is supported on Infiniium S-Series oscilloscopes only.

The value for these bytes is set by the :SBUS<N>:CAN:TRIGger:PATtern:DATA command.

<N> An integer, 1-4.

**Query** :SBUS<N>:CAN:TRIGger:PATtern:DATA:LENGth?

The :SBUS<N>:CAN:TRIGger:PATtern:DATA:LENGth? query returns the current CAN data pattern length setting.

**Returned Format** <length><NL>

- See Also**
- **" :TRIGger:MODE "** on page 1398
  - **" :SBUS<N>:MODE "** on page 1258
  - **" :SBUS<N>:CAN:TYPE "** on page 1276
  - **" :SBUS<N>:CAN:TRIGger (9000 Series, 9000H Series, S-Series) "** on page 1268
  - **" :SBUS<N>:CAN:TRIGger:PATtern:ID:MODE (9000 Series, 9000H Series, S-Series) "** on page 1275
  - **" :SBUS<N>:CAN:TRIGger:PATtern:DATA (9000 Series, 9000H Series, S-Series) "** on page 1271
  - **" :SBUS<N>:CAN:SOURce "** on page 1267



**History** New in version 4.60.

Version 5.60: Length can be from 1 to 15 bytes for CAN FD.

:SBUS<N>:CAN:TRIGger:PATtern:ID (9000 Series, 9000H Series, S-Series)

**Command** :SBUS<N>:CAN:TRIGger:PATtern:ID <string>  
 <string> ::= "nn...n" where n ::= {0 | 1 | X | \$}  
 <string ::= "0xn...n" where n ::= {0,...,9 | A,...,F | X | \$}

**NOTE**

You must set the proper :SBUS<N>:MODE, :SBUS<N>:CAN:TRIGger, and :SBUS<N>:CAN:TRIGger:PATtern:ID:MODE before setting this value; otherwise, this value is defaulted to "don't care" when the mode is changed.

The :SBUS<N>:CAN:TRIGger:PATtern:ID command defines the CAN identifier pattern resource according to the string parameter. This pattern, along with the identifier mode (set by the :SBUS<N>:CAN:TRIGger:PATtern:ID:MODE command), control the identifier pattern searched for in each CAN message.

If the string parameter starts with "0x", it is a hexadecimal string made up of hexadecimal and X (don't care) characters; otherwise, it is a binary string made up of 0, 1, and X (don't care) characters.

**NOTE**

The ID pattern resource string size changes based on the :SBUS<N>:CAN:TRIGger:PATtern:ID:MODE setting; it is 11 bits when the mode is STANdard, and it is 29 bits when the mode is EXTENDED.

A string longer than 29 bits is truncated to 29 bits when setting the ID pattern resource.

<N> An integer, 1-4.

**Query** :SBUS<N>:CAN:TRIGger:PATtern:ID?

The :SBUS<N>:CAN:TRIGger:PATtern:ID? query returns the current settings of the specified CAN identifier pattern resource in the 29-bit binary string format.

**Returned Format** <string><NL> in 29-bit binary string format

- See Also**
- **":TRIGger:MODE"** on page 1398
  - **":SBUS<N>:MODE"** on page 1258
  - **":SBUS<N>:CAN:TRIGger (9000 Series, 9000H Series, S-Series)"** on page 1268
  - **":SBUS<N>:CAN:TRIGger:PATtern:ID:MODE (9000 Series, 9000H Series, S-Series)"** on page 1275
  - **":SBUS<N>:CAN:TRIGger:PATtern:DATA (9000 Series, 9000H Series, S-Series)"** on page 1271

**History** New in version 4.60.

:SBUS<N>:CAN:TRIGger:PATtern:ID:MODE (9000 Series, 9000H Series, S-Series)

**Command** :SBUS<N>:CAN:TRIGger:PATtern:ID:MODE <value>  
 <value> ::= {STANdard | EXTended}

#### NOTE

You must set the proper :SBUS<N>:MODE, :SBUS<N>:CAN:TRIGger, and :SBUS<N>:CAN:TRIGger:PATtern:ID:MODE before setting any other trigger values.

The :SBUS<N>:CAN:TRIGger:PATtern:ID:MODE command sets the CAN identifier mode. STANdard selects the standard 11-bit identifier. EXTended selects the extended 29-bit identifier. The CAN identifier is set by the :SBUS<N>:CAN:TRIGger:PATtern:ID command.

<N> An integer, 1-4.

**Query** :SBUS<N>:CAN:TRIGger:PATtern:ID:MODE?

The :SBUS<N>:CAN:TRIGger:PATtern:ID:MODE? query returns the current setting of the CAN identifier mode.

**Returned Format** <value><NL>

<value> ::= {STAN | EXT}

- See Also**
- [":TRIGger:MODE"](#) on page 1398
  - [":SBUS<N>:MODE"](#) on page 1258
  - [":SBUS<N>:CAN:TRIGger \(9000 Series, 9000H Series, S-Series\)"](#) on page 1268
  - [":SBUS<N>:CAN:TRIGger:PATtern:DATA \(9000 Series, 9000H Series, S-Series\)"](#) on page 1271
  - [":SBUS<N>:CAN:TRIGger:PATtern:DATA:LENGth \(9000 Series, 9000H Series, S-Series\)"](#) on page 1272
  - [":SBUS<N>:CAN:TRIGger:PATtern:ID \(9000 Series, 9000H Series, S-Series\)"](#) on page 1274

**History** New in version 4.60.

**:SBUS<N>:CAN:TYPE**

**Command** :SBUS<N>:CAN:TYPE <cantype>  
 <cantype> ::= {CANStandard | CANFd}

The :SBUS<N>:CAN:TYPE command selects between standard CAN or Flexible Data Rate CAN (CAN FD) decode types.

**Query** :SBUS<n>:CAN:TYPE?

The :SBUS<N>:CAN:TYPE? query returns the selected decode type.

**Returned Format** <cantype><NL>  
 <cantype> ::= {CANS | CANF}

- See Also**
- **":SBUS<N>:CAN:FDSPoint"** on page 1262
  - **":SBUS<N>:CAN:SIGNal:FDbaudrate"** on page 1266
  - **":SBUS<N>:CAN:TRIGger (9000 Series, 9000H Series, S-Series)"** on page 1268

**History** New in version 5.60.

## :SBUS<N>:FLEXray Commands

- **":SBUS<N>:FLEXray:BAUDrate"** on page 1278
- **":SBUS<N>:FLEXray:CHANnel"** on page 1279
- **":SBUS<N>:FLEXray:SOURce"** on page 1280
- **":SBUS<N>:FLEXray:TRIGger"** on page 1281
- **":SBUS<N>:FLEXray:TRIGger:ERRor:TYPE"** on page 1282
- **":SBUS<N>:FLEXray:TRIGger:FRAMe:CCBase"** on page 1283
- **":SBUS<N>:FLEXray:TRIGger:FRAMe:CCRepetition"** on page 1284
- **":SBUS<N>:FLEXray:TRIGger:FRAMe:ID"** on page 1285
- **":SBUS<N>:FLEXray:TRIGger:FRAMe:TYPE"** on page 1286

**NOTE**

These commands are only valid when the automotive FLEXray serial decode option has been licensed.

- 
- See Also • **":SBUS<N>:MODE"** on page 1258

## :SBUS&lt;N&gt;:FLEXray:BAUDrate

**Command** :SBUS<N>:FLEXray:BAUDrate <baudrate>

<baudrate> ::= {2500000 | 5000000 | 10000000}

The :SBUS<n>:FLEXray:BAUDrate command specifies the baud rate as 2.5 Mb/s, 5 Mb/s, or 10 Mb/s.

<N> An integer, 1–4.

**Query** :SBUS<N>:FLEXray:BAUDrate?

The :SBUS<n>:FLEXray:BAUDrate? query returns the current baud rate setting.

**Returned Format** <baudrate><NL>

<baudrate> ::= {2500000 | 5000000 | 10000000}

- See Also**
- [":SBUS<N>:FLEXray:CHANnel"](#) on page 1279
  - [":SBUS<N>:FLEXray:SOURce"](#) on page 1280
  - [":SBUS<N>:FLEXray:TRIGger"](#) on page 1281
  - [":SBUS<N>:FLEXray:TRIGger:ERRor:TYPE"](#) on page 1282
  - [":SBUS<N>:FLEXray:TRIGger:FRAMe:CCBase"](#) on page 1283
  - [":SBUS<N>:FLEXray:TRIGger:FRAMe:CCRepetition"](#) on page 1284
  - [":SBUS<N>:FLEXray:TRIGger:FRAMe:ID"](#) on page 1285
  - [":SBUS<N>:FLEXray:TRIGger:FRAMe:TYPE"](#) on page 1286

**History** New in version 5.20.

## :SBUS<N>:FLEXray:CHANnel

**Command** :SBUS<N>:FLEXray:CHANnel <channel>

<channel> ::= {A | B}

The :SBUS<n>:FLEXray:CHANnel command specifies the bus channel, A or B, of the FlexRay signal.

<N> An integer, 1–4.

**Query** :SBUS<N>:FLEXray:CHANnel?

The :SBUS<n>:FLEXray:CHANnel? query returns the current bus channel setting.

**Returned Format** <channel><NL>

<channel> ::= {A | B}

- See Also**
- [":SBUS<N>:FLEXray:BAUDrate"](#) on page 1278
  - [":SBUS<N>:FLEXray:SOURce"](#) on page 1280
  - [":SBUS<N>:FLEXray:TRIGger"](#) on page 1281
  - [":SBUS<N>:FLEXray:TRIGger:ERRor:TYPE"](#) on page 1282
  - [":SBUS<N>:FLEXray:TRIGger:FRAMe:CCBase"](#) on page 1283
  - [":SBUS<N>:FLEXray:TRIGger:FRAMe:CCRepetition"](#) on page 1284
  - [":SBUS<N>:FLEXray:TRIGger:FRAMe:ID"](#) on page 1285
  - [":SBUS<N>:FLEXray:TRIGger:FRAMe:TYPE"](#) on page 1286

**History** New in version 5.20.

**:SBUS<N>:FLEXray:SOURce**

**Command** :SBUS<N>:FLEXray:SOURce <source>

```
<source> ::= { CHANnel<N> | DIFF<D> | COMMONmode<C> | FUNction<F>
              | WMEMory<R> | DIGital<M> | NONE }
```

The :SBUS<N>:FLEXray:SOURce command sets the source for the FlexRay signal.

The NONE parameter is the same as selecting "None" for the source in the user interface. It makes the previously selected channel, waveform memory, or math function available for other decodes.

<N> SBUS<N> is an integer, 1-4.

CHANnel<N> is an integer, 1-4 in a single oscilloscope, 1-40 in a MultiScope system.

<D>, <C> <D> is an integer, 1-2. <C> is an integer, 3-4.

The DIFF and COMMONmode sources are just aliases that can be used in place of the channel names to apply to differential or common mode signals. These are just aliases - no state change occurs if you refer to a differential channel and you are not in differential mode. DIFF1 refers to the differential signal between channels 1 and 3 (and COMMONmode3 refers to the common mode channel between these same channels). DIFF2 refers to the differential signal between channels 2 and 4 (and COMMONmode4 refers to the common mode channel between these same channels).

<F> An integer, 1-16.

<R> An integer, 1-4.

<M> An integer, 0-15. Digital channels are available on mixed-signal oscilloscopes.

**Query** :SBUS<N>:FLEXray:SOURce?

The :SBUS<n>:FLEXray:SOURce? query returns the source of the FlexRay signal.

**Returned Format** <source><NL>

- See Also**
- [":SBUS<N>:FLEXray:BAUDrate"](#) on page 1278
  - [":SBUS<N>:FLEXray:CHANnel"](#) on page 1279
  - [":SBUS<N>:FLEXray:TRIGger"](#) on page 1281
  - [":SBUS<N>:FLEXray:TRIGger:ERRor:TYPE"](#) on page 1282
  - [":SBUS<N>:FLEXray:TRIGger:FRAME:CCBase"](#) on page 1283
  - [":SBUS<N>:FLEXray:TRIGger:FRAME:CCRepetition"](#) on page 1284
  - [":SBUS<N>:FLEXray:TRIGger:FRAME:ID"](#) on page 1285
  - [":SBUS<N>:FLEXray:TRIGger:FRAME:TYPE"](#) on page 1286

**History** New in version 5.20.



## :SBUS&lt;N&gt;:FLEXray:TRIGger

**Command** :SBUS<N>:FLEXray:TRIGger <condition>

<condition> ::= {FRAME | ERROR}

The :SBUS<n>:FLEXray:TRIGger command sets the FLEXray "trigger on" condition:

- FRAME – triggers on specified frames (without errors).
- ERROR – triggers on selected active error frames and unknown bus conditions.

**NOTE**

The FlexRay trigger is a software-based protocol trigger which operates on data that has acquired (using an available hardware-based trigger) and decoded. In other words, you are triggering on protocol search. Therefore, the :SBUS<n>:FLEXray:TRIGger commands are valid only when protocol decode is turned on.

<N> An integer, 1-4.

**Query** :SBUS<N>:FLEXray:TRIGger?

The :SBUS<n>:FLEXray:TRIGger? query returns the current FLEXray "trigger on" condition.

**Returned Format** <condition><NL>

<condition> ::= {FRAM | ERR}

- See Also**
- [":SBUS<N>:FLEXray:BAUDrate"](#) on page 1278
  - [":SBUS<N>:FLEXray:CHANnel"](#) on page 1279
  - [":SBUS<N>:FLEXray:SOURce"](#) on page 1280
  - [":SBUS<N>:FLEXray:TRIGger:ERRor:TYPE"](#) on page 1282
  - [":SBUS<N>:FLEXray:TRIGger:FRAME:CCBase"](#) on page 1283
  - [":SBUS<N>:FLEXray:TRIGger:FRAME:CCRepetition"](#) on page 1284
  - [":SBUS<N>:FLEXray:TRIGger:FRAME:ID"](#) on page 1285
  - [":SBUS<N>:FLEXray:TRIGger:FRAME:TYPE"](#) on page 1286

**History** New in version 5.20.

## :SBUS&lt;N&gt;:FLEXray:TRIGger:ERRor:TYPE

**Command** :SBUS<N>:FLEXray:TRIGger:ERRor:TYPE <error\_type>

<error\_type> ::= {ALL | HCRC | FCRC}

Selects the FlexRay error type to trigger on. The error type setting is only valid when the FlexRay trigger mode is set to ERRor.

- ALL – triggers on ALL errors.
- HCRC – triggers on only Header CRC errors.
- FCRC – triggers on only Frame CRC errors.

<N> An integer, 1–4.

**Query** :SBUS<N>:FLEXray:TRIGger:ERRor:TYPE?

The :SBUS<n>:FLEXray:TRIGger:ERRor:TYPE? query returns the currently selected FLEXray error type.

**Returned Format** <error\_type><NL>

<error\_type> ::= {ALL | HCRC | FCRC}

- See Also**
- [":SBUS<N>:FLEXray:BAUDrate"](#) on page 1278
  - [":SBUS<N>:FLEXray:CHANnel"](#) on page 1279
  - [":SBUS<N>:FLEXray:SOURce"](#) on page 1280
  - [":SBUS<N>:FLEXray:TRIGger"](#) on page 1281
  - [":SBUS<N>:FLEXray:TRIGger:FRAME:CCBase"](#) on page 1283
  - [":SBUS<N>:FLEXray:TRIGger:FRAME:CCRepetition"](#) on page 1284
  - [":SBUS<N>:FLEXray:TRIGger:FRAME:ID"](#) on page 1285
  - [":SBUS<N>:FLEXray:TRIGger:FRAME:TYPE"](#) on page 1286

**History** New in version 5.20.

## :SBUS<N>:FLEXray:TRIGger:FRAME:CCBase

**Command** :SBUS<N>:FLEXray:TRIGger:FRAME:CCBase <cycle\_count\_base>  
 <cycle\_count\_base> ::= integer from 0-63

The :SBUS<n>:FLEXray:TRIGger:FRAME:CCBase command sets the base of the FlexRay cycle count (in the frame header) to trigger on. The cycle count base setting is only valid when the FlexRay trigger mode is set to FRAME.

<N> An integer, 1-4.

**Query** :SBUS<N>:FLEXray:TRIGger:FRAME:CCBase?

The :SBUS<n>:FLEXray:TRIGger:FRAME:CCBase? query returns the current cycle count base setting for the FlexRay frame trigger setup.

**Returned Format** <cycle\_count\_base><NL>  
 <cycle\_count\_base> ::= integer from 0-63

- See Also**
- [":SBUS<N>:FLEXray:BAUDrate"](#) on page 1278
  - [":SBUS<N>:FLEXray:CHANnel"](#) on page 1279
  - [":SBUS<N>:FLEXray:SOURce"](#) on page 1280
  - [":SBUS<N>:FLEXray:TRIGger"](#) on page 1281
  - [":SBUS<N>:FLEXray:TRIGger:ERRor:TYPE"](#) on page 1282
  - [":SBUS<N>:FLEXray:TRIGger:FRAME:CCRepetition"](#) on page 1284
  - [":SBUS<N>:FLEXray:TRIGger:FRAME:ID"](#) on page 1285
  - [":SBUS<N>:FLEXray:TRIGger:FRAME:TYPE"](#) on page 1286

**History** New in version 5.20.

## :SBUS<N>:FLEXray:TRIGger:FRAME:CCRepetition

**Command** :SBUS<N>:FLEXray:TRIGger:FRAME:CCRepetition <cycle\_count\_repetition>

<cycle\_count\_repetition> ::= {ALL | <rep\_#>}

<rep\_#> ::= integer values 2, 4, 8, 16, 32, or 64

The :SBUS<n>:FLEXray:TRIGger:FRAME:CCRepetition command sets the repetition number of the FlexRay cycle count (in the frame header) to trigger on. The cycle count repetition setting is only valid when the FlexRay trigger mode is set to FRAME.

<N> An integer, 1-4.

**Query** :SBUS<N>:FLEXray:TRIGger:FRAME:CCRepetition?

The :SBUS<n>:FLEXray:TRIGger:FRAME:CCRepetition? query returns the current cycle count repetition setting for the FlexRay frame trigger setup.

**Returned Format** <cycle\_count\_repetition><NL>

<cycle\_count\_repetition> ::= {ALL | <rep\_#>}

<rep\_#> ::= integer values 2, 4, 8, 16, 32, or 64

- See Also**
- [":SBUS<N>:FLEXray:BAUDrate"](#) on page 1278
  - [":SBUS<N>:FLEXray:CHANnel"](#) on page 1279
  - [":SBUS<N>:FLEXray:SOURce"](#) on page 1280
  - [":SBUS<N>:FLEXray:TRIGger"](#) on page 1281
  - [":SBUS<N>:FLEXray:TRIGger:ERRor:TYPE"](#) on page 1282
  - [":SBUS<N>:FLEXray:TRIGger:FRAME:CCBase"](#) on page 1283
  - [":SBUS<N>:FLEXray:TRIGger:FRAME:ID"](#) on page 1285
  - [":SBUS<N>:FLEXray:TRIGger:FRAME:TYPE"](#) on page 1286

**History** New in version 5.20.

## :SBUS<N>:FLEXray:TRIGger:FRAME:ID

**Command** :SBUS<N>:FLEXray:TRIGger:FRAME:ID <frame\_id>

<frame\_id> ::= {ALL | <frame\_#>}

<frame\_#> ::= integer from 1-2047

The :SBUS<n>:FLEXray:TRIGger:FRAME:ID command sets the FlexRay frame ID to trigger on. The frame ID setting is only valid when the FlexRay trigger mode is set to FRAME.

<N> An integer, 1-4.

**Query** :SBUS<N>:FLEXray:TRIGger:FRAME:ID?

The :SBUS<n>:FLEXray:TRIGger:FRAME:ID? query returns the current frame ID setting for the FlexRay frame trigger setup.

**Returned Format** <frame\_id><NL>

<frame\_id> ::= {ALL | <frame\_#>}

<frame\_#> ::= integer from 1-2047

- See Also**
- [":SBUS<N>:FLEXray:BAUDrate"](#) on page 1278
  - [":SBUS<N>:FLEXray:CHANnel"](#) on page 1279
  - [":SBUS<N>:FLEXray:SOURce"](#) on page 1280
  - [":SBUS<N>:FLEXray:TRIGger"](#) on page 1281
  - [":SBUS<N>:FLEXray:TRIGger:ERRor:TYPE"](#) on page 1282
  - [":SBUS<N>:FLEXray:TRIGger:FRAME:CCBase"](#) on page 1283
  - [":SBUS<N>:FLEXray:TRIGger:FRAME:CCRepetition"](#) on page 1284
  - [":SBUS<N>:FLEXray:TRIGger:FRAME:TYPE"](#) on page 1286

**History** New in version 5.20.

**:SBUS<N>:FLEXray:TRIGger:FRAME:TYPE**

**Command** :SBUS<N>:FLEXray:TRIGger:FRAME:TYPE <frame\_type>

<frame\_type> ::= {NORMAL | STARTup | NULL | SYNC | NNULL | ALL}

The :SBUS<n>:FLEXray:TRIGger:FRAME:TYPE command sets the FlexRay frame type to trigger on. The frame type setting is only valid when the FlexRay trigger mode is set to FRAME.

- NORMAL – will trigger on only normal (NSTARTup & NNULL & NSYNc) frames.
- STARTup – will trigger on only startup frames.
- NULL – will trigger on only null frames.
- SYNC – will trigger on only sync frames.
- NNULL – will trigger on frames other than null frames.
- ALL – will trigger on all FlexRay frame types.

<N> An integer, 1-4.

**Query** :SBUS<N>:FLEXray:TRIGger:FRAME:TYPE?

The :SBUS<n>:FLEXray:TRIGger:FRAME:TYPE? query returns the current frame type setting for the FlexRay frame trigger setup.

**Returned Format** <frame\_type><NL>

<frame\_type> ::= {NORM | STAR | NULL | SYNC | NNUL | ALL}

- See Also**
- [":SBUS<N>:FLEXray:BAUDrate"](#) on page 1278
  - [":SBUS<N>:FLEXray:CHANnel"](#) on page 1279
  - [":SBUS<N>:FLEXray:SOURce"](#) on page 1280
  - [":SBUS<N>:FLEXray:TRIGger"](#) on page 1281
  - [":SBUS<N>:FLEXray:TRIGger:ERRor:TYPE"](#) on page 1282
  - [":SBUS<N>:FLEXray:TRIGger:FRAME:CCBase"](#) on page 1283
  - [":SBUS<N>:FLEXray:TRIGger:FRAME:CCRepetition"](#) on page 1284
  - [":SBUS<N>:FLEXray:TRIGger:FRAME:ID"](#) on page 1285

**History** New in version 5.20.

## :SBUS<N>:GENRaw Commands

- **":SBUS<N>:GENRaw:SOURce"** on page 1288
- **":SBUS<N>:GENRaw:WSIZE"** on page 1289

**See Also** • **":SBUS<N>:MODE"** on page 1258

**:SBUS<N>:GENRaw:SOURce**

**Command** :SBUS<N>:GENRaw:SOURce <source>

The :SBUS<N>:GENRaw:SOURce command sets the source for the Generic Raw signal.

**<source>** {CHANnel<N> | DIFF<D> | COMMONmode<C> | FUNCTion<F> | WMEMory<R> | NONE}

The NONE parameter is the same as selecting "None" for the source in the user interface. It makes the previously selected channel, waveform memory, or math function available for other decodes.

**<N>** SBUS<N> is an integer, 1-4.

CHANnel<N> is an integer, 1-4 in a single oscilloscope, 1-40 in a MultiScope system.

**<D>, <C>** <D> is an integer, 1-2. <C> is an integer, 3-4.

The DIFF and COMMONmode sources are just aliases that can be used in place of the channel names to apply to differential or common mode signals. These are just aliases - no state change occurs if you refer to a differential channel and you are not in differential mode. DIFF1 refers to the differential signal between channels 1 and 3 (and COMMONmode3 refers to the common mode channel between these same channels). DIFF2 refers to the differential signal between channels 2 and 4 (and COMMONmode4 refers to the common mode channel between these same channels).

**<F>** An integer, 1-16.

**<R>** An integer, 1-4.

**Query** :SBUS<N>:GENRaw:SOURce?

The :SBUS<N>:GENRaw:SOURce? query returns the source of the Generic Raw signal.

**Returned Format** <source><NL>

**See Also** • [":SBUS<N>:GENRaw:WSIZE"](#) on page 1289

**History** New in version 6.20.



## :SBUS<N>:GENRaw:WSIZE

**Command** :SBUS<N>:GENRaw:WSIZE <word\_size>

The :SBUS<N>:GENRaw:WSIZE command sets the Generic Raw protocol decode word size.

<word\_size> An integer, 1-32.

**Query** :SBUS<N>:GENRaw:WSIZE?

The :SBUS<N>:GENRaw:WSIZE? query returns the specified word size.

**Returned Format** <word\_size><NL>

**See Also** · [":SBUS<N>:GENRaw:SOURce"](#) on page 1288

**History** New in version 6.20.

## :SBUS<N>:HS Commands

- **":SBUS<N>:HS:DESCramble"** on page 1291
- **":SBUS<N>:HS:FORMat"** on page 1292
- **":SBUS<N>:HS:IDLE"** on page 1293
- **":SBUS<N>:HS:SOURce<S>"** on page 1294

### NOTE

These commands are valid only when the high-speed (HS) serial decode type has been set with the :BUS:B<N>:TYPE command.

- 
- See Also • **":BUS:B<N>:TYPE"** on page 318

**:SBUS<N>:HS:DESCramble**

**Command** :SBUS<N>:HS:DESCramble {{0 | OFF} | {1 | ON}}

The :SBUS<N>:HS:DESCramble command turns high-speed descrambling on or off if supported by the protocol type.

**NOTE**

This command is only valid when a serial decode option has been licensed.

**Query** :SBUS<N>:HS:DESCramble?

The :SBUS<N>:HS:DESCramble? query returns the current descrambling setting of the high-speed serial decode bus.

**Returned Format** [:SBUS<N>:HS:DESCramble] {0 | 1}<NL>

- See Also**
- **":BUS:B<N>:TYPE"** on page 318
  - **":SBUS<N>:HS:FORMat"** on page 1292
  - **":SBUS<N>:HS:IDLE"** on page 1293
  - **":SBUS<N>:HS:SOURce<S>"** on page 1294

**History** New in version 5.00.

**:SBUS<N>:HS:FORMat**

**Command** :SBUS<N>:HS:FORMat <value>

<value> ::= {KDCODE | LABEL | F8BIT | F10BIT}

The :SBUS<N>:HS:FORMat command specifies the high-speed symbol display format.

<N> Is an integer, 1-4.

**Example** This example sets the K/D Code symbol display format.

```
myScope.WriteString ":SYSTEM:HEADer OFF" ' Response headers off.
myScope.WriteString ":SBUS<N>:HS:FORMat KDCODE"
```

**Query** :SBUS<N>:HS:FORMat?

The :SBUS<N>:HS:FORMat? query returns the high-speed symbol display format setting.

**Returned Format** [:SBUS<N>:HS:FORMat] <value><NL>

<value> ::= {KDCODE | LABEL | F8BIT | F10BIT}

- See Also**
- **":BUS:B<N>:TYPE"** on page 318
  - **":SBUS<N>:HS:DESCramble"** on page 1291
  - **":SBUS<N>:HS:IDLE"** on page 1293
  - **":SBUS<N>:HS:SOURce<S>"** on page 1294

**History** New in version 5.00.

**:SBUS<N>:HS:IDLE**

**Command** :SBUS<N>:HS:IDLE {{0 | OFF} | {1 | ON}}

The :SBUS<N>:HS:IDLE command specifies whether electrical idles are present in the signal.

**NOTE**

This command is only valid when a serial decode option has been licensed.

**Query** :SBUS<N>:HS:IDLE?

The :SBUS<N>:HS:IDLE? query returns the current ".electrical idles are present" setting.

**Returned Format** [:SBUS<N>:HS:IDLE] {0 | 1}<NL>

- See Also**
- **":BUS:B<N>:TYPE"** on page 318
  - **":SBUS<N>:HS:DESCramble"** on page 1291
  - **":SBUS<N>:HS:FORMat"** on page 1292
  - **":SBUS<N>:HS:SOURce<S>"** on page 1294

**History** New in version 5.00.

**:SBUS<N>:HS:SOURce<S>**

**Command** :SBUS<N>:HS:SOURce<S> <source>

```
<source> ::= { CHANnel<N> | DIFF<D> | COMMONmode<C> | FUNction<F>
              | WMEMory<R> | NONE }
```

The :SBUS<N>:HS:SOURce<S> command specifies the signal that is the high-speed data source.

<N> SBUS<N> is an integer, 1-4.

CHANnel<N> is an integer, 1-4 in a single oscilloscope, 1-40 in a MultiScope system.

<S> Is an integer, 1-4, for the high-speed serial source.

<D>, <C> <D> is an integer, 1-2. <C> is an integer, 3-4.

The DIFF and COMMONmode sources are just aliases that can be used in place of the channel names to apply to differential or common mode signals. These are just aliases - no state change occurs if you refer to a differential channel and you are not in differential mode. DIFF1 refers to the differential signal between channels 1 and 3 (and COMMONmode3 refers to the common mode channel between these same channels). DIFF2 refers to the differential signal between channels 2 and 4 (and COMMONmode4 refers to the common mode channel between these same channels).

<F> An integer, 1-16.

<R> An integer, 1-4.

**Example** This example specifies channel 2 is the high-speed data source 3 signal.

```
myScope.WriteString ":SYSTEM:HEADer OFF" ' Response headers off.
myScope.WriteString ":SBUS1:HS:SOURce3 CHANnel2"
```

**Query** :SBUS<N>:HS:SOURce<S>?

The :SBUS<N>:HS:SOURce<S>? query returns the current signal for the high-speed data source.

**Returned Format** [:SBUS<N>:HS:SOURce<S>] <source><NL>

```
<source> ::= { CHAN<N> | FUNC<F> | WMEM<N> | NONE }
```

- See Also**
- **":BUS:B<N>:TYPE"** on page 318
  - **":SBUS<N>:HS:DESCramble"** on page 1291
  - **":SBUS<N>:HS:FORMat"** on page 1292
  - **":SBUS<N>:HS:IDLE"** on page 1293

**History** New in version 5.00.

## :SBUS<N>:IIC Commands

- **":SBUS<N>:IIC:ASIZE"** on page 1296
- **":SBUS<N>:IIC:SOURce:CLOCK"** on page 1297
- **":SBUS<N>:IIC:SOURce:DATA"** on page 1298
- **":SBUS<N>:IIC:TRIGger:PATtern:ADDRess (9000 Series, 9000H Series, S-Series)"** on page 1299
- **":SBUS<N>:IIC:TRIGger:PATtern:DATA (9000 Series, 9000H Series, S-Series)"** on page 1301
- **":SBUS<N>:IIC:TRIGger:TYPE (9000 Series, 9000H Series, S-Series)"** on page 1302

**NOTE**

These commands are only valid when the low-speed IIC and SPI serial decode option has been licensed.

- 
- See Also** • **":SBUS<N>:MODE"** on page 1258

**:SBUS<N>:IIC:ASIZe**

**Command** :SBUS<N>:IIC:ASIZe <size>

<size> ::= {BIT7 | BIT8}

The :SBUS<N>:IIC:ASIZe command determines whether the Read/Write bit is included as the LSB in the display of the IIC address field of the decode bus.

<N> An integer, 1-4.

**Query** :SBUS<N>:IIC:ASIZe?

The :SBUS<N>:IIC:ASIZe? query returns the current IIC address width setting.

**Returned Format** [:SBUS<N>:IIC:ASIZe] <size><NL>

- See Also**
- **":SBUS<N>:IIC:TRIGger:PATtern:ADDRes (9000 Series, 9000H Series, S-Series)"** on page 1299
  - **":SBUS<N>:MODE"** on page 1258

**History** New in version 3.50.



**:SBUS<N>:IIC:SOURce:CLOCK**

**Command** :SBUS<N>:IIC:SOURce:CLOCK <source>

```
<source> ::= { CHANnel<N> | DIFF<D> | COMMONmode<C> | FUNction<F>
              | WMEMory<R> | DIGital<M> | NONE }
```

The :SBUS<N>:IIC:SOURce:CLOCK command sets the source for the IIC serial clock (SCL).

The NONE parameter is the same as selecting "None" for the source in the user interface. It makes the previously selected channel, waveform memory, or math function available for other decodes.

<N> SBUS<N> is an integer, 1-4.

CHANnel<N> is an integer, 1-4 in a single oscilloscope, 1-40 in a MultiScope system.

<D>, <C> <D> is an integer, 1-2. <C> is an integer, 3-4.

The DIFF and COMMONmode sources are just aliases that can be used in place of the channel names to apply to differential or common mode signals. These are just aliases - no state change occurs if you refer to a differential channel and you are not in differential mode. DIFF1 refers to the differential signal between channels 1 and 3 (and COMMONmode3 refers to the common mode channel between these same channels). DIFF2 refers to the differential signal between channels 2 and 4 (and COMMONmode4 refers to the common mode channel between these same channels).

<F> An integer, 1-16.

<R> An integer, 1-4.

<M> An integer, 0-15. Digital channels are available on mixed-signal oscilloscopes.

**Example** This example selects channel 2 as the source for IIC serial clock.

```
myScope.WriteString ":SBUS1:IIC:SOURce:CLOCK CHANnel2"
```

**Query** :SBUS<N>:IIC:SOURce:CLOCK?

The :SBUS<N>:IIC:SOURce:CLOCK? query returns the current source for the IIC serial clock.

**Returned Format** [:SBUS<N>:IIC:SOURce:CLOCK] <source><NL>

**See Also**

- **":SBUS<N>:IIC:SOURce:DATA"** on page 1298
- **":SBUS<N>:MODE"** on page 1258

**History** New in version 3.50.

Version 5.20: The NONE parameter was added.

**:SBUS<N>:IIC:SOURce:DATA**

**Command** :SBUS<N>:IIC:SOURce:DATA <source>

```
<source> ::= {CHANnel<N> | DIFF<D> | COMMONmode<C> | FUNction<F>
             | WMEMory<R> | DIGital<M> | NONE}
```

The :SBUS<N>:IIC:SOURce:DATA command sets the source for IIC serial data (SDA).

The NONE parameter is the same as selecting "None" for the source in the user interface. It makes the previously selected channel, waveform memory, or math function available for other decodes.

<N> SBUS<N> is an integer, 1-4.

CHANnel<N> is an integer, 1-4 in a single oscilloscope, 1-40 in a MultiScope system.

<D>, <C> <D> is an integer, 1-2. <C> is an integer, 3-4.

The DIFF and COMMONmode sources are just aliases that can be used in place of the channel names to apply to differential or common mode signals. These are just aliases - no state change occurs if you refer to a differential channel and you are not in differential mode. DIFF1 refers to the differential signal between channels 1 and 3 (and COMMONmode3 refers to the common mode channel between these same channels). DIFF2 refers to the differential signal between channels 2 and 4 (and COMMONmode4 refers to the common mode channel between these same channels).

<F> An integer, 1-16.

<R> An integer, 1-4.

<M> An integer, 0-15. Digital channels are available on mixed-signal oscilloscopes.

**Example** This example selects channel 1 as the source for IIC serial data.

```
myScope.WriteString ":SBUS1:IIC:SOURce:DATA CHANnel1"
```

**Query** :SBUS<N>:IIC:SOURce:DATA?

The :SBUS<N>:IIC:SOURce:DATA? query returns the current source for IIC serial data.

**Returned Format** [:SBUS<N>:IIC:SOURce:DATA] <source><NL>

**See Also**

- **":SBUS<N>:IIC:SOURce:CLOCK"** on page 1297
- **":SBUS<N>:MODE"** on page 1258

**History** New in version 3.50.

Version 5.20: The NONE parameter was added.

:SBUS<N>:IIC:TRIGger:PATtern:ADDRes (9000 Series, 9000H Series, S-Series)

**Command** :SBUS<N>:IIC:TRIGger:PATtern:ADDRes <quoted\_string>

#### NOTE

You must set :SBUS<N>:MODE to IIC before you can send other :SBUS<N>:IIC:TRIGger commands.

The :SBUS<n>:IIC:TRIGger:PATtern:ADDRes command specifies the IIC address value to trigger on. The address can be a 7-, 8-, 10-, or 11-bit address depending upon the :SBUS<n>:IIC:TRIGger:TYPE specification and the :SBUS<n>:IIC:ASize setting.

The :SBUS<N>:IIC:TRIGger:TYPE command must select a type that includes an address value before you can use the :SBUS<N>:IIC:TRIGger:PATtern:ADDRes commands.

<N> An integer, 1-4.

<quoted\_string> If the quoted string parameter starts with "0x", it is a hexadecimal string made up of hexadecimal and X (don't care) characters (for example, "0x34XF"); otherwise, it is a binary string made up of 0, 1, and X (don't care) characters (for example, "00110100XXXX1111").

**Example** To enable the SBUS1 trigger, set the trigger type to a 7-bit address frame read, and specify an address value of 0x3F:

```
myScope.WriteString ":CHANnel1:DISPlay ON"
myScope.WriteString ":CHANnel2:DISPlay ON"
myScope.WriteString ":SBUS1:MODE IIC"
myScope.WriteString ":SBUS1:IIC:SOURce:DATA CHANnel1"
myScope.WriteString ":SBUS1:IIC:SOURce:CLOCK CHANnel2"
myScope.WriteString ":TRIGger:MODE SBUS1"
myScope.WriteString ":SBUS1:IIC:TRIGger:TYPE READ7"
myScope.WriteString ":SBUS1:IIC:TRIGger:PATtern:ADDRes '0x3f'"
myScope.WriteString ":SBUS1:IIC:TRIGger:PATtern:DATA '0x7fffffff'"
```

**Query** :SBUS<N>:IIC:TRIGger:PATtern:ADDRes?

The :SBUS<N>:IIC:TRIGger:PATtern:ADDRes? query returns the current pattern for the IIC address.

**Returned Format** [:SBUS<N>:IIC:TRIGger:PATtern:ADDRes] <binary\_string><NL>

- See Also**
- [":TRIGger:MODE"](#) on page 1398
  - [":SBUS<N>:MODE"](#) on page 1258
  - [":SBUS<N>:IIC:TRIGger:TYPE \(9000 Series, 9000H Series, S-Series\)"](#) on page 1302
  - [":SBUS<N>:IIC:ASize"](#) on page 1296

**History** New in version 3.50.

:SBUS<N>:IIC:TRIGger:PATtern:DATA (9000 Series, 9000H Series, S-Series)

**Command** :SBUS<N>:IIC:TRIGger:PATtern:DATA <quoted\_string>

#### NOTE

You must set :SBUS<N>:MODE to IIC before you can send other :SBUS<N>:IIC:TRIGger commands.

The :SBUS<N>:IIC:TRIGger:PATtern:DATA command sets IIC data.

You can specify 1 to 20 bytes of data in binary or hex format.

The :SBUS<N>:IIC:TRIGger:TYPE command must select a type that includes a data value before you can use the :SBUS<N>:IIC:TRIGger:PATtern:DATA commands.

<N> An integer, 1-4.

<quoted\_string> If the quoted string parameter starts with "0x", it is a hexadecimal string made up of hexadecimal and X (don't care) characters (for example, "0x34XF"); otherwise, it is a binary string made up of 0, 1, and X (don't care) characters (for example, "00110100XXXX1111").

**Example** To enable the SBUS1 trigger, set the trigger type to a 7-bit address frame read, and specify a data value of 0x7FFFFFF:

```
myScope.WriteString ":CHANnel1:DISPlay ON"
myScope.WriteString ":CHANnel2:DISPlay ON"
myScope.WriteString ":SBUS1:MODE IIC"
myScope.WriteString ":SBUS1:IIC:SOURce:DATA CHANnel1"
myScope.WriteString ":SBUS1:IIC:SOURce:CLOCK CHANnel2"
myScope.WriteString ":TRIGger:MODE SBUS1"
myScope.WriteString ":SBUS1:IIC:TRIGger:TYPE READ7"
myScope.WriteString ":SBUS1:IIC:TRIGger:PATtern:ADDRESS '0x3f'"
myScope.WriteString ":SBUS1:IIC:TRIGger:PATtern:DATA '0x7ffffff'"
```

**Query** :SBUS<N>:IIC:TRIGger:PATtern:DATA?

The :SBUS<n>:IIC:TRIGger:PATtern:DATA? query returns the current pattern for IIC data.

**Returned Format** [:SBUS<N>:IIC:TRIGger:PATtern:DATA] <binary\_string><NL>

**See Also**

- **":TRIGger:MODE"** on page 1398
- **":SBUS<N>:MODE"** on page 1258
- **":SBUS<N>:IIC:TRIGger:TYPE (9000 Series, 9000H Series, S-Series)"** on page 1302

**History** New in version 3.50.

## :SBUS&lt;N&gt;:IIC:TRIGger:TYPE (9000 Series, 9000H Series, S-Series)

**Command** :SBUS<N>:IIC:TRIGger:TYPE {START | STOP | REStart7 | REStart10 | AACK  
| ANACK | READ7 | WRITe7 | WRITe10}

**NOTE**

You must set :SBUS<N>:MODE to IIC before you can send other :SBUS<N>:IIC:TRIGger commands.

The :SBUS<N>:IIC:TRIGger:TYPE command sets the IIC trigger type:

- START – Start condition.
- STOP – Stop condition.
- REStart7 – Another 7-bit start condition occurs before a stop condition.
- REStart10 – Another 10-bit start condition occurs before a stop condition.
- AACK – Address with acknowledge.
- ANACK – Address with no acknowledge.
- READ7 – 7-bit address frame containing (Start:Address7:Read:Ack:Data).
- WRITe7 – 7-bit address frame containing (Start:Address7:Write:Ack:Data).
- WRITe10 – 10-bit address frame containing (Start:Address  
byte1:Write:Ack:Address byte 2:Data).

**NOTE**

The short form of READ7 (READ7), WRITe7 (WRIT7), WRITe10 (WRIT10), REStart7 (REST7), and REStart10 (REST10) do not follow the defined long form to short form truncation rules.

The :SBUS<N>:IIC:TRIGger:TYPE command must be sent before the :SBUS<N>:IIC:TRIGger:PATtern:ADDRess or :SBUS<N>:IIC:TRIGger:PATtern:DATA commands.

<N> An integer, 1-4.

**Example** To enable the SBUS1 trigger and set the IIC trigger type to a 7-bit address frame read:

```
myScope.WriteString ":CHANnel1:DISPlay ON"
myScope.WriteString ":CHANnel2:DISPlay ON"
myScope.WriteString ":SBUS1:MODE IIC"
myScope.WriteString ":SBUS1:IIC:SOURce:DATA CHANnel1"
myScope.WriteString ":SBUS1:IIC:SOURce:CLOCK CHANnel2"
myScope.WriteString ":TRIGger:MODE SBUS1"
myScope.WriteString ":SBUS1:IIC:TRIGger:TYPE READ7"
myScope.WriteString ":SBUS1:IIC:TRIGger:PATtern:ADDRess '0x3f'"
myScope.WriteString ":SBUS1:IIC:TRIGger:PATtern:DATA '0x7fffffff'"
```

**See Also**

- **":TRIGger:MODE"** on page 1398
- **":SBUS<N>:MODE"** on page 1258

- **":SBUS<N>:IIC:TRIGger:PATtern:ADDRess (9000 Series, 9000H Series, S-Series)"** on page 1299
- **":SBUS<N>:IIC:TRIGger:PATtern:DATA (9000 Series, 9000H Series, S-Series)"** on page 1301

**History** New in version 3.50.

## :SBUS<N>:LIN Commands

- **":SBUS<N>:LIN:SAMPlEpoint"** on page 1305
- **":SBUS<N>:LIN:SIGNal:BAUDrate"** on page 1306
- **":SBUS<N>:LIN:SOURce"** on page 1307
- **":SBUS<N>:LIN:STANdard"** on page 1308
- **":SBUS<N>:LIN:TRIGger"** on page 1309
- **":SBUS<N>:LIN:TRIGger:ID"** on page 1310
- **":SBUS<N>:LIN:TRIGger:PATTern:DATA"** on page 1311
- **":SBUS<N>:LIN:TRIGger:PATTern:DATA:LENGth"** on page 1312

### NOTE

These commands are only valid when the automotive LIN serial decode option has been licensed.

---

See Also • **":SBUS<N>:MODE"** on page 1258



## :SBUS&lt;N&gt;:LIN:SAMPlepoint

**Command** :SBUS<N>:LIN:SAMPlepoint <value>

<value> ::= {60 | 62.5 | 68 | 70 | 75 | 80 | 87.5} in NR3 format

The :SBUS<n>:LIN:SAMPlepoint command sets the point during the bit time where the bit level is sampled to determine whether the bit is dominant or recessive. The sample point represents the percentage of time between the beginning of the bit time to the end of the bit time.

**NOTE**

The sample point values are not limited by the baud rate.

<N> An integer, 1–4.

**Query** :SBUS<N>:LIN:SAMPlepoint?

The :SBUS<n>:LIN:SAMPlepoint? query returns the current LIN sample point setting.

**Returned Format** <value><NL>

<value> ::= {60 | 62.5 | 68 | 70 | 75 | 80 | 87.5} in NR3 format

- See Also**
- [":SBUS<N>:LIN:SIGNal:BAUDrate"](#) on page 1306
  - [":SBUS<N>:LIN:SOURce"](#) on page 1307
  - [":SBUS<N>:LIN:STANdard"](#) on page 1308
  - [":SBUS<N>:LIN:TRIGger"](#) on page 1309
  - [":SBUS<N>:LIN:TRIGger:ID"](#) on page 1310
  - [":SBUS<N>:LIN:TRIGger:PATtern:DATA"](#) on page 1311
  - [":SBUS<N>:LIN:TRIGger:PATtern:DATA:LENGth"](#) on page 1312

**History** New in version 5.20.

**:SBUS<N>:LIN:SIGNal:BAUDrate**

**Command** :SBUS<N>:LIN:SIGNal:BAUDrate <baudrate>

<baudrate> ::= from 2400 to 625000 in NR3 format

The :SBUS<n>:LIN:SIGNal:BAUDrate command sets the standard baud rate of the LIN signal from 2400 b/s to 625 kb/s.

If you enter a baud rate over 100 kb/s that is not divisible by 10 b/s, the baud rate is set to the nearest baud rate divisible by 10 b/s.

<N> An integer, 1-4.

**Query** :SBUS<N>:LIN:SIGNal:BAUDrate?

The :SBUS<n>:LIN:SIGNal:BAUDrate? query returns the current LIN baud rate setting.

**Returned Format** <baudrate><NL>

<baudrate> ::= from 2400 to 625000 in NR3 format

- See Also**
- [":SBUS<N>:LIN:SAMPlepoint"](#) on page 1305
  - [":SBUS<N>:LIN:SOURce"](#) on page 1307
  - [":SBUS<N>:LIN:STANdard"](#) on page 1308
  - [":SBUS<N>:LIN:TRIGger"](#) on page 1309
  - [":SBUS<N>:LIN:TRIGger:ID"](#) on page 1310
  - [":SBUS<N>:LIN:TRIGger:PATtern:DATA"](#) on page 1311
  - [":SBUS<N>:LIN:TRIGger:PATtern:DATA:LENGth"](#) on page 1312

**History** New in version 5.20.

**:SBUS<N>:LIN:SOURce**

**Command** :SBUS<N>:LIN:SOURce <source>

```
<source> ::= {CHANnel<N> | DIFF<D> | COMMONmode<C> | FUNCTION<F>
              | WMEMory<R> | DIGital<M> | NONE}
```

The :SBUS<n>:LIN:SOURce command sets the source for the LIN signal.

The NONE parameter is the same as selecting "None" for the source in the user interface. It makes the previously selected channel, waveform memory, or math function available for other decodes.

<N> SBUS<N> is an integer, 1-4.

CHANnel<N> is an integer, 1-4 in a single oscilloscope, 1-40 in a MultiScope system.

<D>, <C> <D> is an integer, 1-2. <C> is an integer, 3-4.

The DIFF and COMMONmode sources are just aliases that can be used in place of the channel names to apply to differential or common mode signals. These are just aliases - no state change occurs if you refer to a differential channel and you are not in differential mode. DIFF1 refers to the differential signal between channels 1 and 3 (and COMMONmode3 refers to the common mode channel between these same channels). DIFF2 refers to the differential signal between channels 2 and 4 (and COMMONmode4 refers to the common mode channel between these same channels).

<F> An integer, 1-16.

<R> An integer, 1-4.

<M> An integer, 0-15. Digital channels are available on mixed-signal oscilloscopes.

**Query** :SBUS<N>:LIN:SOURce?

The :SBUS<n>:LIN:SOURce? query returns the current source for the LIN signal.

**Returned Format** <source><NL>

- See Also**
- [":SBUS<N>:LIN:SAMPLEpoint"](#) on page 1305
  - [":SBUS<N>:LIN:SIGNal:BAUDrate"](#) on page 1306
  - [":SBUS<N>:LIN:STANdard"](#) on page 1308
  - [":SBUS<N>:LIN:TRIGger"](#) on page 1309
  - [":SBUS<N>:LIN:TRIGger:ID"](#) on page 1310
  - [":SBUS<N>:LIN:TRIGger:PATtern:DATA"](#) on page 1311
  - [":SBUS<N>:LIN:TRIGger:PATtern:DATA:LENGth"](#) on page 1312

**History** New in version 5.20.

## :SBUS&lt;N&gt;:LIN:STANdard

**Command** :SBUS<N>:LIN:STANdard <std>

<std> ::= {LIN13 | LIN20}

The :SBUS<n>:LIN:STANdard command sets the LIN standard in effect for triggering and decoding to be LIN1.3 or LIN2.0.

<N> An integer, 1–4.

**Query** :SBUS<N>:LIN:STANdard?

The :SBUS<n>:LIN:STANdard? query returns the current LIN standard setting, which is always LIN20.

When triggering, the oscilloscope looks for both the LIN 1.3 and 2.0 checksum.

**Returned Format** <std><NL>

<std> ::= LIN20

- See Also**
- [":SBUS<N>:LIN:SAMPlEpoint"](#) on page 1305
  - [":SBUS<N>:LIN:SIGNal:BAUDrate"](#) on page 1306
  - [":SBUS<N>:LIN:SOURce"](#) on page 1307
  - [":SBUS<N>:LIN:TRIGger"](#) on page 1309
  - [":SBUS<N>:LIN:TRIGger:ID"](#) on page 1310
  - [":SBUS<N>:LIN:TRIGger:PATtern:DATA"](#) on page 1311
  - [":SBUS<N>:LIN:TRIGger:PATtern:DATA:LENGth"](#) on page 1312

**History** New in version 5.20.

## :SBUS&lt;N&gt;:LIN:TRIGger

**Command** :SBUS<N>:LIN:TRIGger <condition>

<condition> ::= {ID | DATA | PARityerror | CSUMerror | ALLerrors}

The :SBUS<n>:LIN:TRIGger command sets the LIN trigger condition to be:

- ID – Frame ID.  
Use the :SBUS<n>:LIN:TRIGger:ID command to specify the frame ID.
- DATA – Frame ID and Data.  
Use the :SBUS<n>:LIN:TRIGger:ID command to specify the frame ID.  
Use the :SBUS<n>:LIN:TRIGger:PATtern:DATA:LENGth and :SBUS<n>:LIN:TRIGger:PATtern:DATA commands to specify the data string length and value.
- PARityerror – parity errors.
- CSUMerror – checksum errors.
- ALLerrors – all errors.

<N> An integer, 1-4.

**Query** :SBUS<N>:LIN:TRIGger?

The :SBUS<n>:LIN:TRIGger? query returns the current LIN trigger value.

**Returned Format** <condition><NL>

<condition> ::= {ID | DATA | PAR | CSUM | ALL}

- See Also**
- [":SBUS<N>:LIN:SAMPlepoint"](#) on page 1305
  - [":SBUS<N>:LIN:SIGNal:BAUDrate"](#) on page 1306
  - [":SBUS<N>:LIN:SOURce"](#) on page 1307
  - [":SBUS<N>:LIN:STANdard"](#) on page 1308
  - [":SBUS<N>:LIN:TRIGger:ID"](#) on page 1310
  - [":SBUS<N>:LIN:TRIGger:PATtern:DATA"](#) on page 1311
  - [":SBUS<N>:LIN:TRIGger:PATtern:DATA:LENGth"](#) on page 1312

**History** New in version 5.20.

**:SBUS<N>:LIN:TRIGger:ID**

**Command** :SBUS<N>:LIN:TRIGger:ID <string>

<string> ::= "nn...n" where n ::= {0 | 1 | X | \$}

<string ::= "0xnn...n" where n ::= {0,...,9 | A,...,F | X | \$}

The :SBUS<n>:LIN:TRIGger:ID command defines the LIN identifier searched for in each CAN message when the LIN trigger mode is set to frame ID.

If the string parameter starts with "0x", it is a hexadecimal string made up of hexadecimal and X (don't care) characters; otherwise, it is a binary string made up of 0, 1, and X (don't care) characters.

<N> An integer, 1–4.

**Query** :SBUS<N>:LIN:TRIGger:ID?

The :SBUS<n>:LIN:TRIGger:ID? query returns the current LIN identifier setting.

**Returned Format** <string><NL> in 6-bit binary string format

- See Also**
- [":SBUS<N>:LIN:SAMPlEpoint"](#) on page 1305
  - [":SBUS<N>:LIN:SIGNal:BAUDrate"](#) on page 1306
  - [":SBUS<N>:LIN:SOURce"](#) on page 1307
  - [":SBUS<N>:LIN:STANdard"](#) on page 1308
  - [":SBUS<N>:LIN:TRIGger"](#) on page 1309
  - [":SBUS<N>:LIN:TRIGger:PATtern:DATA"](#) on page 1311
  - [":SBUS<N>:LIN:TRIGger:PATtern:DATA:LENGth"](#) on page 1312

**History** New in version 5.20.

## :SBUS&lt;N&gt;:LIN:TRIGger:PATtern:DATA

**Command** :SBUS<N>:LIN:TRIGger:PATtern:DATA <string>

<string> ::= "mn...n" where n ::= {0 | 1 | X | \$}

<string ::= "0xn...n" where n ::= {0,...,9 | A,...,F | X | \$}

The :SBUS<N>:LIN:TRIGger:PATtern:DATA command defines the LIN data pattern resource according to the string parameter. This pattern, along with the data length (set by the :SBUS<N>:LIN:TRIGger:PATtern:DATA:LENGth command), control the data pattern searched for in each LIN message.

If the string parameter starts with "0x", it is a hexadecimal string made up of hexadecimal and X (don't care) characters; otherwise, it is a binary string made up of 0, 1, and X (don't care) characters.

**NOTE**

If more bits are sent for <string> than specified by the :SBUS<N>:LIN:TRIGger:PATtern:DATA:LENGth command, the most significant bits will be truncated.

<N> An integer, 1-4.

**Query** :SBUS<N>:LIN:TRIGger:PATtern:DATA?

The :SBUS<N>:LIN:TRIGger:PATtern:DATA? query returns the current settings of the specified LIN data pattern resource in the binary string format.

**Returned Format** <string><NL> in nondecimal format

- See Also**
- [":SBUS<N>:LIN:SAMPlepoint"](#) on page 1305
  - [":SBUS<N>:LIN:SIGNal:BAUDrate"](#) on page 1306
  - [":SBUS<N>:LIN:SOURce"](#) on page 1307
  - [":SBUS<N>:LIN:STANdard"](#) on page 1308
  - [":SBUS<N>:LIN:TRIGger"](#) on page 1309
  - [":SBUS<N>:LIN:TRIGger:ID"](#) on page 1310
  - [":SBUS<N>:LIN:TRIGger:PATtern:DATA:LENGth"](#) on page 1312

**History** New in version 5.20.

## :SBUS<N>:LIN:TRIGger:PATtern:DATA:LENGth

**Command** :SBUS<N>:LIN:TRIGger:PATtern:DATA:LENGth <length>

<length> ::= integer from 1 to 8.

The :SBUS<n>:LIN:TRIGger:PATtern:DATA:LENGth command sets the number of 8-bit bytes in the LIN data string. The number of bytes in the string can be anywhere from 1 bytes to 8 bytes (64 bits). The value for these bytes is set by the :SBUS<n>:LIN:TRIGger:PATtern:DATA command.

**Query** :SBUS<N>:LIN:TRIGger:PATtern:DATA:LENGth?

The :SBUS<n>:LIN:TRIGger:PATtern:DATA:LENGth? query returns the current LIN data pattern length setting.

**Returned Format** <length><NL>

<length> ::= integer from 1 to 8.

- See Also**
- [":SBUS<N>:LIN:SAMPlepoint"](#) on page 1305
  - [":SBUS<N>:LIN:SIGNal:BAUDrate"](#) on page 1306
  - [":SBUS<N>:LIN:SOURce"](#) on page 1307
  - [":SBUS<N>:LIN:STANdard"](#) on page 1308
  - [":SBUS<N>:LIN:TRIGger"](#) on page 1309
  - [":SBUS<N>:LIN:TRIGger:ID"](#) on page 1310
  - [":SBUS<N>:LIN:TRIGger:PATtern:DATA"](#) on page 1311

**History** New in version 5.20.



## :SBUS<N>:SPI Commands

- **":SBUS<N>:SPI:BITOrder"** on page 1314
- **":SBUS<N>:SPI:CLOCK:SLOPe"** on page 1315
- **":SBUS<N>:SPI:CLOCK:TIMEout"** on page 1316
- **":SBUS<N>:SPI:FRAME:STATe"** on page 1317
- **":SBUS<N>:SPI:SOURce:CLOCK"** on page 1318
- **":SBUS<N>:SPI:SOURce:DATA"** on page 1320
- **":SBUS<N>:SPI:SOURce:FRAME"** on page 1322
- **":SBUS<N>:SPI:SOURce:MISO"** on page 1323
- **":SBUS<N>:SPI:SOURce:MOSI"** on page 1324
- **":SBUS<N>:SPI:TRIGger:PATtern:DATA (9000 Series, 9000H Series, S-Series)"** on page 1326
- **":SBUS<N>:SPI:TRIGger:PATtern:WIDTh (9000 Series, 9000H Series, S-Series)"** on page 1328
- **":SBUS<N>:SPI:TRIGger:TYPE (9000 Series, 9000H Series, S-Series)"** on page 1330
- **":SBUS<N>:SPI:TYPE"** on page 1332
- **":SBUS<N>:SPI:WIDTh"** on page 1333

### NOTE

These commands are only valid when the low-speed IIC and SPI serial decode option has been licensed.

---

**See Also** • **":SBUS<N>:MODE"** on page 1258

**:SBUS<N>:SPI:BITOrder**

**Command** :SBUS<N>:SPI:BITOrder <order>

<order> ::= {LSB | MSB}

The :SBUS<N>:SPI:BITOrder command selects the bit order, most significant bit first (MSB) or least significant bit first (LSB), used when displaying data in the serial decode waveform and in the Lister.

<N> An integer, 1-4.

**Query** :SBUS<N>:SPI:BITOrder?

The :SBUS<N>:SPI:BITOrder? query returns the current SPI decode bit order.

**Returned Format** [:SBUS<N>:SPI:BITOrder] <order><NL>

**See Also** • **":SBUS<N>:MODE"** on page 1258

**History** New in version 3.50.

## :SBUS<N>:SPI:CLOCK:SLOPe

**Command** :SBUS<N>:SPI:CLOCK:SLOPe <slope>

<slope> ::= {POSitive | RISing | NEGative | FALLing}

The :SBUS<N>:SPI:CLOCK:SLOPe command specifies the rising edge (POSitive) or falling edge (NEGative) of the SPI clock source that will clock in the data.

<N> An integer, 1-4.

**Query** :SBUS<N>:SPI:CLOCK:SLOPe?

The :SBUS<N>:SPI:CLOCK:SLOPe? query returns the current SPI clock source slope.

**Returned Format** [:SBUS<N>:SPI:CLOCK:SLOPe] <slope><NL>

<slope> ::= {RIS | FALL}

- See Also**
- [":SBUS<N>:SPI:CLOCK:TIMEout"](#) on page 1316
  - [":SBUS<N>:SPI:SOURce:CLOCK"](#) on page 1318
  - [":SBUS<N>:MODE"](#) on page 1258

**History** New in version 3.50.

**:SBUS<N>:SPI:CLOCK:TIMEout**

**Command** :SBUS<N>:SPI:CLOCK:TIMEout <time\_value>

<time\_value> ::= time in seconds in NR3 format

The :SBUS<N>:SPI:CLOCK:TIMEout command sets the SPI signal clock timeout resource in seconds from 100 ns to 10 s when the :SBUS<N>:SPI:FRAMing command is set to TIMEout. The timer is used to frame a signal by a clock timeout.

<N> An integer, 1-4.

**Query** :SBUS<N>:SPI:CLOCK:TIMEout?

The :SBUS<N>:SPI:CLOCK:TIMEout? query returns current SPI clock timeout setting.

**Returned Format** [:SBUS<N>:SPI:CLOCK:TIMEout] <time value><NL>

- See Also**
- [":SBUS<N>:SPI:CLOCK:SLOPe"](#) on page 1315
  - [":SBUS<N>:SPI:SOURce:CLOCK"](#) on page 1318
  - [":SBUS<N>:SPI:FRAME:STATe"](#) on page 1317
  - [":SBUS<N>:MODE"](#) on page 1258

**History** New in version 3.50.

**:SBUS<N>:SPI:FRAME:STATE**

**Command** :SBUS<N>:SPI:FRAME:STATE <value>

<value> ::= {LOW | HIGH}

The :SBUS<N>:SPI:FRAME:STATE command sets the SPI trigger frame state.

<N> An integer, 1-4.

**Query** :SBUS<N>:SPI:FRAME:STATE?

The :SBUS<N>:SPI:FRAME:STATE? query returns the current SPI frame state.

**Returned Format** [:SBUS<N>:SPI:FRAME:STATE] <value><NL>

- See Also**
- **":SBUS<N>:SPI:SOURce:FRAME"** on page 1322
  - **":SBUS<N>:MODE"** on page 1258

**History** New in version 3.50.

**:SBUS<N>:SPI:SOURce:CLOCK**

**Command** :SBUS<N>:SPI:SOURce:CLOCK <source>

```
<source> ::= { CHANnel<N> | DIFF<D> | COMMONmode<C> | FUNction<F>
              | WMEMory<R> | DIGital<M> | NONE }
```

The :SBUS<N>:SPI:SOURce:CLOCK command sets the source for the SPI serial clock.

The NONE parameter is the same as selecting "None" for the source in the user interface. It makes the previously selected channel, waveform memory, or math function available for other decodes.

<N> SBUS<N> is an integer, 1-4.

CHANnel<N> is an integer, 1-4 in a single oscilloscope, 1-40 in a MultiScope system.

<D>, <C> <D> is an integer, 1-2. <C> is an integer, 3-4.

The DIFF and COMMONmode sources are just aliases that can be used in place of the channel names to apply to differential or common mode signals. These are just aliases - no state change occurs if you refer to a differential channel and you are not in differential mode. DIFF1 refers to the differential signal between channels 1 and 3 (and COMMONmode3 refers to the common mode channel between these same channels). DIFF2 refers to the differential signal between channels 2 and 4 (and COMMONmode4 refers to the common mode channel between these same channels).

<F> An integer, 1-16.

<R> An integer, 1-4.

<M> An integer, 0-15. Digital channels are available on mixed-signal oscilloscopes.

**Query** :SBUS<N>:SPI:SOURce:CLOCK?

The :SBUS<N>:SPI:SOURce:CLOCK? query returns the current source for the SPI serial clock.

**Returned Format** [:SBUS<N>:SPI:SOURce:CLOCK] <source><NL>

- See Also**
- [":SBUS<N>:SPI:CLOCK:SLOPe"](#) on page 1315
  - [":SBUS<N>:SPI:CLOCK:TIMEout"](#) on page 1316
  - [":SBUS<N>:SPI:SOURce:FRAME"](#) on page 1322
  - [":SBUS<N>:SPI:SOURce:MOSI"](#) on page 1324
  - [":SBUS<N>:SPI:SOURce:MISO"](#) on page 1323
  - [":SBUS<N>:SPI:SOURce:DATA"](#) on page 1320
  - [":SBUS<N>:MODE"](#) on page 1258

**History** New in version 3.50.

Version 5.20: The NONE parameter was added.

**:SBUS<N>:SPI:SOURce:DATA**

**Command** :SBUS<N>:SPI:SOURce:DATA <source>

```
<source> ::= { CHANnel<N> | DIFF<D> | COMMONmode<C> | FUNction<F>
              | WMEMory<R> | DIGital<M> | NONE }
```

The :SBUS<N>:SPI:SOURce:DATA command sets the source for the SPI serial MOSI data.

This command is the same as the :SBUS<N>:SPI:SOURce:MOSI command.

The NONE parameter is the same as selecting "None" for the source in the user interface. It makes the previously selected channel, waveform memory, or math function available for other decodes.

<N> SBUS<N> is an integer, 1-4.

CHANnel<N> is an integer, 1-4 in a single oscilloscope, 1-40 in a MultiScope system.

<D>, <C> <D> is an integer, 1-2. <C> is an integer, 3-4.

The DIFF and COMMONmode sources are just aliases that can be used in place of the channel names to apply to differential or common mode signals. These are just aliases - no state change occurs if you refer to a differential channel and you are not in differential mode. DIFF1 refers to the differential signal between channels 1 and 3 (and COMMONmode3 refers to the common mode channel between these same channels). DIFF2 refers to the differential signal between channels 2 and 4 (and COMMONmode4 refers to the common mode channel between these same channels).

<F> An integer, 1-16.

<R> An integer, 1-4.

<M> An integer, 0-15. Digital channels are available on mixed-signal oscilloscopes.

**Query** :SBUS<N>:SPI:SOURce:DATA?

The :SBUS<N>:SPI:SOURce:DATA? query returns the current source for the SPI serial MOSI data.

**Returned Format** [:SBUS<N>:SPI:SOURce:DATA] <source><NL>

- See Also**
- **":SBUS<N>:SPI:SOURce:MOSI"** on page 1324
  - **":SBUS<N>:SPI:SOURce:MISO"** on page 1323
  - **":SBUS<N>:SPI:SOURce:CLOCK"** on page 1318
  - **":SBUS<N>:SPI:SOURce:FRAMe"** on page 1322
  - **":SBUS<N>:MODE"** on page 1258

**History** New in version 3.50.



Version 5.20: The NONE parameter was added.

**:SBUS<N>:SPI:SOURce:FRAMe**

**Command** :SBUS<N>:SPI:SOURce:FRAMe <source>

```
<source> ::= { CHANnel<N> | DIFF<D> | COMMONmode<C> | FUNction<F>
              | WMEMory<R> | DIGital<M> | NONE }
```

The :SBUS<N>:SPI:SOURce:FRAMe command sets the frame source.

The NONE parameter is the same as selecting "None" for the source in the user interface. It makes the previously selected channel, waveform memory, or math function available for other decodes.

<N> SBUS<N> is an integer, 1-4.

CHANnel<N> is an integer, 1-4 in a single oscilloscope, 1-40 in a MultiScope system.

<D>, <C> <D> is an integer, 1-2. <C> is an integer, 3-4.

The DIFF and COMMONmode sources are just aliases that can be used in place of the channel names to apply to differential or common mode signals. These are just aliases - no state change occurs if you refer to a differential channel and you are not in differential mode. DIFF1 refers to the differential signal between channels 1 and 3 (and COMMONmode3 refers to the common mode channel between these same channels). DIFF2 refers to the differential signal between channels 2 and 4 (and COMMONmode4 refers to the common mode channel between these same channels).

<F> An integer, 1-16.

<R> An integer, 1-4.

<M> An integer, 0-15. Digital channels are available on mixed-signal oscilloscopes.

**Query** :SBUS<N>:SPI:SOURce:FRAMe?

The :SBUS<N>:SPI:SOURce:FRAMe? query returns the current frame source for the SPI serial frame.

**Returned Format** [:SBUS<N>:SPI:SOURce:FRAMe] <source><NL>

- See Also**
- **":SBUS<N>:SPI:SOURce:CLOCK"** on page 1318
  - **":SBUS<N>:SPI:SOURce:MOSI"** on page 1324
  - **":SBUS<N>:SPI:SOURce:MISO"** on page 1323
  - **":SBUS<N>:SPI:SOURce:DATA"** on page 1320
  - **":SBUS<N>:SPI:FRAMe:STATe"** on page 1317
  - **":SBUS<N>:MODE"** on page 1258

**History** New in version 3.50.

Version 5.20: The NONE parameter was added.

## :SBUS&lt;N&gt;:SPI:SOURce:MISO

**Command** :SBUS<N>:SPI:SOURce:MISO <source>

```
<source> ::= { CHANnel<N> | DIFF<D> | COMMONmode<C> | FUNction<F>
              | WMEMory<R> | DIGital<M> | NONE }
```

The :SBUS<N>:SPI:SOURce:MISO command sets the source for the SPI serial MISO data.

The NONE parameter is the same as selecting "None" for the source in the user interface. It makes the previously selected channel, waveform memory, or math function available for other decodes.

<N> SBUS<N> is an integer, 1-4.

CHANnel<N> is an integer, 1-4 in a single oscilloscope, 1-40 in a MultiScope system.

<D>, <C> <D> is an integer, 1-2. <C> is an integer, 3-4.

The DIFF and COMMONmode sources are just aliases that can be used in place of the channel names to apply to differential or common mode signals. These are just aliases - no state change occurs if you refer to a differential channel and you are not in differential mode. DIFF1 refers to the differential signal between channels 1 and 3 (and COMMONmode3 refers to the common mode channel between these same channels). DIFF2 refers to the differential signal between channels 2 and 4 (and COMMONmode4 refers to the common mode channel between these same channels).

<F> An integer, 1-16.

<R> An integer, 1-4.

<M> An integer, 0-15. Digital channels are available on mixed-signal oscilloscopes.

**Query** :SBUS<N>:SPI:SOURce:MISO?

The :SBUS<N>:SPI:SOURce:MISO? query returns the current source for the SPI serial MISO data.

**Returned Format** [:SBUS<N>:SPI:SOURce:MISO] <source><NL>

- See Also**
- **":SBUS<N>:SPI:SOURce:MOSI"** on page 1324
  - **":SBUS<N>:SPI:SOURce:DATA"** on page 1320
  - **":SBUS<N>:SPI:SOURce:CLOCK"** on page 1318
  - **":SBUS<N>:SPI:SOURce:FRAME"** on page 1322
  - **":SBUS<N>:MODE"** on page 1258

**History** New in version 3.50.

Version 5.20: The NONE parameter was added.

**:SBUS<N>:SPI:SOURce:MOSI**

**Command** :SBUS<N>:SPI:SOURce:MOSI <source>

```
<source> ::= { CHANnel<N> | DIFF<D> | COMMONmode<C> | FUNction<F>
              | WMEMory<R> | DIGital<M> | NONE }
```

The :SBUS<N>:SPI:SOURce:MOSI command sets the source for the SPI serial MOSI data.

You can also use the equivalent :SBUS<N>:SPI:SOURce:DATA command to set the MOSI data source.

The NONE parameter is the same as selecting "None" for the source in the user interface. It makes the previously selected channel, waveform memory, or math function available for other decodes.

<N> SBUS<N> is an integer, 1-4.

CHANnel<N> is an integer, 1-4 in a single oscilloscope, 1-40 in a MultiScope system.

<D>, <C> <D> is an integer, 1-2. <C> is an integer, 3-4.

The DIFF and COMMONmode sources are just aliases that can be used in place of the channel names to apply to differential or common mode signals. These are just aliases - no state change occurs if you refer to a differential channel and you are not in differential mode. DIFF1 refers to the differential signal between channels 1 and 3 (and COMMONmode3 refers to the common mode channel between these same channels). DIFF2 refers to the differential signal between channels 2 and 4 (and COMMONmode4 refers to the common mode channel between these same channels).

<F> An integer, 1-16.

<R> An integer, 1-4.

<M> An integer, 0-15. Digital channels are available on mixed-signal oscilloscopes.

**Query** :SBUS<N>:SPI:SOURce:MOSI?

The :SBUS<N>:SPI:SOURce:MOSI? query returns the current source for the SPI serial MOSI data.

**Returned Format** [ :SBUS<N>:SPI:SOURce:MOSI ] <source><NL>

- See Also**
- **":SBUS<N>:SPI:SOURce:DATA"** on page 1320
  - **":SBUS<N>:SPI:SOURce:MISO"** on page 1323
  - **":SBUS<N>:SPI:SOURce:CLOCK"** on page 1318
  - **":SBUS<N>:SPI:SOURce:FRAME"** on page 1322
  - **":SBUS<N>:MODE"** on page 1258

**History** New in version 3.50.

Version 5.20: The NONE parameter was added.

:SBUS<N>:SPI:TRIGger:PATtern:DATA (9000 Series, 9000H Series, S-Series)

**Command** :SBUS<N>:SPI:TRIGger:PATtern:DATA <quoted\_string>

**NOTE**

You must set :SBUS<N>:MODE to SPI before you can send other :SBUS<N>:SPI:TRIGger commands.

The :SBUS<N>:SPI:TRIGger:PATtern:DATA command defines the SPI data pattern resource according to the string parameter. This pattern, along with the data width, control the data pattern searched for in the data stream.

The :SBUS<N>:SPI:TRIGger:PATtern:DATA command must receive the number of bytes specified by the :SBUS<N>:SPI:TRIGger:PATtern:WIDTh command.

**NOTE**

The :SBUS<N>:SPI:TRIGger:PATtern:WIDTh should be set before :SBUS<N>:SPI:TRIGger:PATtern:DATA.

<N> An integer, 1-4.

<quoted\_string> If the quoted string parameter starts with "0x", it is a hexadecimal string made up of hexadecimal and X (don't care) characters (for example, "0x34XF"); otherwise, it is a binary string made up of 0, 1, and X (don't care) characters (for example, "00110100XXXX1111").

**Example** To enable the SBUS1 trigger, set the SPI trigger type to MOSI, set a 32-bit data pattern width, and specify the 0x0080FFFF data pattern:

```
myScope.WriteString ":CHANnel1:DISPlay ON"
myScope.WriteString ":CHANnel2:DISPlay ON"
myScope.WriteString ":CHANnel3:DISPlay ON"
myScope.WriteString ":CHANnel4:DISPlay ON"
myScope.WriteString ":SBUS1:MODE SPI"
myScope.WriteString ":SBUS1:SPI:WIDTh 16"
myScope.WriteString ":SBUS1:SPI:TYPE WIRE4"
myScope.WriteString ":SBUS1:SPI:SOURce:MOSI CHANnel1"
myScope.WriteString ":SBUS1:SPI:SOURce:CLOCK CHANnel2"
myScope.WriteString ":SBUS1:SPI:SOURce:FRAME CHANnel3"
myScope.WriteString ":SBUS1:SPI:SOURce:MISO CHANnel4"
myScope.WriteString ":TRIGger:MODE SBUS1"
myScope.WriteString ":SBUS1:SPI:TRIGger:TYPE MOSI"
myScope.WriteString ":SBUS1:SPI:TRIGger:PATtern:WIDTh 2"
myScope.WriteString ":SBUS1:SPI:TRIGger:PATtern:DATA '0x0080ffff'"
```

**Query** :SBUS<N>:SPI:TRIGger:PATtern:DATA?

The :SBUS<N>:SPI:TRIGger:PATtern:DATA? query returns the current settings of the specified SPI data pattern resource in the binary string format.

**Returned Format** [:SBUS<N>:SPI:TRIGger:PATtern:DATA] <binary\_string><NL>

- See Also**
- **":TRIGger:MODE"** on page 1398
  - **":SBUS<N>:MODE"** on page 1258
  - **":SBUS<N>:SPI:TRIGger:PATtern:WIDTh (9000 Series, 9000H Series, S-Series)"** on page 1328
  - **":SBUS<N>:SPI:TRIGger:TYPE (9000 Series, 9000H Series, S-Series)"** on page 1330

**History** New in version 3.50.

:SBUS<N>:SPI:TRIGger:PATtern:WIDTh (9000 Series, 9000H Series, S-Series)

**Command** :SBUS<N>:SPI:TRIGger:PATtern:WIDTh {1 - 20}

**NOTE**

You must set :SBUS<N>:MODE to SPI before you can send other :SBUS<N>:SPI:TRIGger commands.

The :SBUS<N>:SPI:TRIGger:PATtern:WIDTh command sets the width of the SPI data pattern. You can specify the width in multiples of the SPI word size up to 20.

**NOTE**

The :SBUS<N>:SPI:TRIGger:PATtern:WIDTh should be set before :SBUS<N>:SPI:TRIGger:PATtern:DATA.

<N> An integer, 1-4.

**Example** To enable the SBUS1 trigger, set the SPI trigger type to MOSI, set a 32-bit data pattern width (two 16-bit words), and specify the 0x0080FFFF data pattern:

```
myScope.WriteString ":CHANnel1:DISPlay ON"
myScope.WriteString ":CHANnel2:DISPlay ON"
myScope.WriteString ":CHANnel3:DISPlay ON"
myScope.WriteString ":CHANnel4:DISPlay ON"
myScope.WriteString ":SBUS1:MODE SPI"
myScope.WriteString ":SBUS1:SPI:WIDTh 16"
myScope.WriteString ":SBUS1:SPI:TYPE WIRE4"
myScope.WriteString ":SBUS1:SPI:SOURce:MOSI CHANnel1"
myScope.WriteString ":SBUS1:SPI:SOURce:CLOCK CHANnel2"
myScope.WriteString ":SBUS1:SPI:SOURce:FRAMe CHANnel3"
myScope.WriteString ":SBUS1:SPI:SOURce:MISO CHANnel4"
myScope.WriteString ":TRIGger:MODE SBUS1"
myScope.WriteString ":SBUS1:SPI:TRIGger:TYPE MOSI"
myScope.WriteString ":SBUS1:SPI:TRIGger:PATtern:WIDTh 2"
myScope.WriteString ":SBUS1:SPI:TRIGger:PATtern:DATA '0x0080ffff'"
```

**Query** :SBUS<N>:SPI:TRIGger:PATtern:WIDTh?

The :SBUS<N>:SPI:TRIGger:PATtern:WIDTh? query returns the current SPI data pattern width setting.

**Returned Format** [:SBUS<N>:SPI:TRIGger:PATtern:WIDTh] {1 - 20}<NL>

- See Also**
- **" :TRIGger:MODE "** on page 1398
  - **" :SBUS<N>:MODE "** on page 1258
  - **" :SBUS<N>:SPI:WIDTh "** on page 1333
  - **" :SBUS<N>:SPI:TRIGger:TYPE (9000 Series, 9000H Series, S-Series) "** on page 1330



- **":SBUS<N>:SPI:TRIGger:PATtern:DATA (9000 Series, 9000H Series, S-Series)"**  
on page 1326

**History** New in version 3.50.

## :SBUS&lt;N&gt;:SPI:TRIGger:TYPE (9000 Series, 9000H Series, S-Series)

**Command** :SBUS<N>:SPI:TRIGger:TYPE <value>  
 <value> ::= {MOSI | MISO}

**NOTE**

You must set :SBUS<N>:MODE to SPI before you can send other :SBUS<N>:SPI:TRIGger commands.

The :SBUS<N>:SPI:TRIGger:TYPE command specifies whether the SPI trigger will be on the MOSI data or the MISO data.

The data value is specified by the :SBUS<N>:SPI:TRIGger:PATtern:DATA and :SBUS<N>:SPI:TRIGger:PATtern:WIDTh commands.

<N> An integer, 1-4.

**Example** To enable the SBUS1 trigger and set the SPI trigger type to MOSI:

```
myScope.WriteString ":CHANnel1:DISPlay ON"
myScope.WriteString ":CHANnel2:DISPlay ON"
myScope.WriteString ":CHANnel3:DISPlay ON"
myScope.WriteString ":CHANnel4:DISPlay ON"
myScope.WriteString ":SBUS1:MODE SPI"
myScope.WriteString ":SBUS1:SPI:WIDTh 16"
myScope.WriteString ":SBUS1:SPI:TYPE WIRE4"
myScope.WriteString ":SBUS1:SPI:SOURce:MOSI CHANnel1"
myScope.WriteString ":SBUS1:SPI:SOURce:CLOCK CHANnel2"
myScope.WriteString ":SBUS1:SPI:SOURce:FRAMe CHANnel3"
myScope.WriteString ":SBUS1:SPI:SOURce:MISO CHANnel4"
myScope.WriteString ":TRIGger:MODE SBUS1"
myScope.WriteString ":SBUS1:SPI:TRIGger:TYPE MOSI"
myScope.WriteString ":SBUS1:SPI:TRIGger:PATtern:WIDTh 2"
myScope.WriteString ":SBUS1:SPI:TRIGger:PATtern:DATA '0x0080ffff'"
```

**Query** :SBUS<N>:SPI:TRIGger:TYPE?

The :SBUS<N>:SPI:TRIGger:TYPE? query returns the trigger type setting.

**Returned Format** [:SBUS<N>:SPI:TRIGger:TYPE] <value><NL>

- See Also**
- [":TRIGger:MODE"](#) on page 1398
  - [":SBUS<N>:MODE"](#) on page 1258
  - [":SBUS<N>:SPI:SOURce:DATA"](#) on page 1320
  - [":SBUS<N>:SPI:SOURce:MOSI"](#) on page 1324
  - [":SBUS<N>:SPI:SOURce:MISO"](#) on page 1323
  - [":SBUS<N>:SPI:TRIGger:PATtern:DATA \(9000 Series, 9000H Series, S-Series\)"](#) on page 1326
  - [":SBUS<N>:SPI:TRIGger:PATtern:WIDTh \(9000 Series, 9000H Series, S-Series\)"](#) on page 1328

**History** New in version 3.50.

**:SBUS<N>:SPI:TYPE**

**Command** :SBUS<N>:SPI:TYPE <value>

<value> ::= {WIRE2 | WIRE3 | WIRE4}

The :SBUS<N>:SPI:TYPE command specifies whether the type of SPI to decode.

<N> An integer, 1-4.

**Example** To set the 3-wire SPI decode type:

```
myScope.WriteString ":SBUS1:SPI:TYPE WIRE3 "
```

**Query** :SBUS<N>:SPI:TYPE?

The :SBUS<N>:SPI:TYPE? query returns the decode type setting.

**Returned Format** [:SBUS<N>:SPI:TYPE] <value><NL>

- See Also**
- [":SBUS<N>:SPI:BITOrder"](#) on page 1314
  - [":SBUS<N>:SPI:SOURce:CLOCK"](#) on page 1318
  - [":SBUS<N>:SPI:SOURce:DATA"](#) on page 1320
  - [":SBUS<N>:SPI:SOURce:FRAMe"](#) on page 1322
  - [":SBUS<N>:SPI:SOURce:MISO"](#) on page 1323
  - [":SBUS<N>:SPI:SOURce:MOSI"](#) on page 1324
  - [":SBUS<N>:MODE"](#) on page 1258

**History** New in version 3.50.

**:SBUS<N>:SPI:WIDTh**

**Command** :SBUS<N>:SPI:WIDTh <word\_width>

<word\_width> ::= integer 4-16 in NR1 format

The :SBUS<N>:SPI:WIDTh command determines the number of bits in a word of data for SPI.

<N> An integer, 1-4.

**Query** :SBUS<N>:SPI:WIDTh?

The :SBUS<N>:SPI:WIDTh? query returns the current SPI decode word width.

**Returned Format** [:SBUS<N>:SPI:WIDTh] <word\_width><NL>

<word\_width> ::= integer 4-16 in NR1 format

**See Also** • **":SBUS<N>:MODE"** on page 1258

**History** New in version 3.50.

## :SBUS<N>:UART Commands

- **":SBUS<N>:UART:BAUDrate"** on page 1335
- **":SBUS<N>:UART:BITOrder"** on page 1336
- **":SBUS<N>:UART:DIRection"** on page 1337
- **":SBUS<N>:UART:EOF:HEX"** on page 1338
- **":SBUS<N>:UART:IDLE"** on page 1339
- **":SBUS<N>:UART:PARity"** on page 1340
- **":SBUS<N>:UART:SOURce:RX"** on page 1341
- **":SBUS<N>:UART:SOURce:TX"** on page 1342
- **":SBUS<N>:UART:WIDTHh"** on page 1343

**NOTE**

These commands are only valid when the Low-Speed Protocol Decode and Trigger option has been licensed.

- 
- See Also • **":SBUS<N>:MODE"** on page 1258

**:SBUS<N>:UART:BAUDrate**

**Command** :SBUS<N>:UART:BAUDrate <baudrate>

The :SBUS<N>:UART:BAUDrate command selects the bit rate (in bps) for the serial decoder and/or trigger when in UART mode.

<N> An integer, 1-4.

<baudrate> Bits/second in NR3 format.

**Query** :SBUS<N>:UART:BAUDrate?

The :SBUS<N>:UART:BAUDrate? query returns the bit rate (in bps) setting.

**Returned Format** <baudrate><NL>

<baudrate> ::= bits/second in NR3 format.

- See Also**
- [":SBUS<N>:UART:BITOrder"](#) on page 1336
  - [":SBUS<N>:UART:DIRection"](#) on page 1337
  - [":SBUS<N>:UART:EOF:HEX"](#) on page 1338
  - [":SBUS<N>:UART:IDLE"](#) on page 1339
  - [":SBUS<N>:UART:PARity"](#) on page 1340
  - [":SBUS<N>:UART:SOURce:RX"](#) on page 1341
  - [":SBUS<N>:UART:SOURce:TX"](#) on page 1342
  - [":SBUS<N>:UART:WIDTH"](#) on page 1343

**History** New in version 6.60.

**:SBUS<N>:UART:BITOrder**

**Command** :SBUS<N>:UART:BITOrder {LSB | MSB}

The :SBUS<N>:UART:BITOrder command selects whether the most significant bit (MSB) or least significant bit (LSB) is presented after the start bit in the signal from your device under test.

For RS-232, select LSB.

<N> An integer, 1-4.

**Query** :SBUS<N>:UART:BITOrder?

The :SBUS<N>:UART:BITOrder? query returns the bit order setting.

**Returned Format** <bitorder><NL>

<bitorder> ::= {LSB | MSB}

- See Also**
- **":SBUS<N>:UART:BAUDrate"** on page 1335
  - **":SBUS<N>:UART:DIRection"** on page 1337
  - **":SBUS<N>:UART:EOF:HEX"** on page 1338
  - **":SBUS<N>:UART:IDLE"** on page 1339
  - **":SBUS<N>:UART:PARity"** on page 1340
  - **":SBUS<N>:UART:SOURce:RX"** on page 1341
  - **":SBUS<N>:UART:SOURce:TX"** on page 1342
  - **":SBUS<N>:UART:WIDTHh"** on page 1343

**History** New in version 6.60.



**:SBUS<N>:UART:DIRection**

**Command** :SBUS<N>:UART:DIRection {RXTX | RX | TX}

The :SBUS<N>:UART:DIRection command specifies whether you are decoding Rx only (RX), Tx only (TX), or Rx and Tx (RXTX).

<N> An integer, 1-4.

**Query** :SBUS<N>:UART:DIRection?

The :SBUS<N>:UART:DIRection? query returns the direction setting.

**Returned Format** <direction><NL>

<direction> ::= {RXTX | RX | TX}

- See Also**
- [":SBUS<N>:UART:BAUDrate"](#) on page 1335
  - [":SBUS<N>:UART:BITorder"](#) on page 1336
  - [":SBUS<N>:UART:EOF:HEX"](#) on page 1338
  - [":SBUS<N>:UART:IDLE"](#) on page 1339
  - [":SBUS<N>:UART:PARity"](#) on page 1340
  - [":SBUS<N>:UART:SOURce:RX"](#) on page 1341
  - [":SBUS<N>:UART:SOURce:TX"](#) on page 1342
  - [":SBUS<N>:UART:WIDTH"](#) on page 1343

**History** New in version 6.60.

**:SBUS<N>:UART:EOF:HEX**

**Command** :SBUS<N>:UART:EOF:HEX <value>

The :SBUS<N>:UART:EOF:HEX command specifies the End-Of-Frame hexadecimal byte value.

<value> End of frame hexadecimal byte value.

**Query** :SBUS<N>:UART:EOF:HEX?

The :SBUS<N>:UART:EOF:HEX? query returns the End-Of-Frame hexadecimal byte value.

**Returned Format** <value><NL>

<value> ::= End of frame hex byte value.

- See Also**
- [":SBUS<N>:UART:BAUDrate"](#) on page 1335
  - [":SBUS<N>:UART:BITOrder"](#) on page 1336
  - [":SBUS<N>:UART:DIRection"](#) on page 1337
  - [":SBUS<N>:UART:IDLE"](#) on page 1339
  - [":SBUS<N>:UART:PARity"](#) on page 1340
  - [":SBUS<N>:UART:SOURce:RX"](#) on page 1341
  - [":SBUS<N>:UART:SOURce:TX"](#) on page 1342
  - [":SBUS<N>:UART:WIDTH"](#) on page 1343

**History** New in version 6.60.

**:SBUS<N>:UART:IDLE**

**Command** :SBUS<N>:UART:IDLE {LOW | HIGH}

The :SBUS<N>:UART:IDLE command selects LOW or HIGH to match the device under test's state when at idle.

For RS-232, select idle LOW.

**Query** :SBUS<N>:UART:IDLE?

The :SBUS<N>:UART:IDLE? query returns the selected idle state value.

**Returned Format** <polarity><NL>

<polarity> ::= {LOW | HIGH}

- See Also**
- [":SBUS<N>:UART:BAUDrate"](#) on page 1335
  - [":SBUS<N>:UART:BITOrder"](#) on page 1336
  - [":SBUS<N>:UART:DIRection"](#) on page 1337
  - [":SBUS<N>:UART:EOF:HEX"](#) on page 1338
  - [":SBUS<N>:UART:PARity"](#) on page 1340
  - [":SBUS<N>:UART:SOURce:RX"](#) on page 1341
  - [":SBUS<N>:UART:SOURce:TX"](#) on page 1342
  - [":SBUS<N>:UART:WIDTH"](#) on page 1343

**History** New in version 6.60.

**:SBUS<N>:UART:PARity**

**Command** :SBUS<N>:UART:PARity {EVEN | ODD | NONE}

The :SBUS<N>:UART:PARity command specifies the type of parity being used.

**Query** :SBUS<N>:UART:PARity?

The :SBUS<N>:UART:PARity? query returns the parity setting.

**Returned Format** <parity><NL>

<parity> ::= {EVEN | ODD | NONE}

- See Also**
- [":SBUS<N>:UART:BAUDrate"](#) on page 1335
  - [":SBUS<N>:UART:BITorder"](#) on page 1336
  - [":SBUS<N>:UART:DIRrection"](#) on page 1337
  - [":SBUS<N>:UART:EOF:HEX"](#) on page 1338
  - [":SBUS<N>:UART:IDLE"](#) on page 1339
  - [":SBUS<N>:UART:SOURce:RX"](#) on page 1341
  - [":SBUS<N>:UART:SOURce:TX"](#) on page 1342
  - [":SBUS<N>:UART:WIDTH"](#) on page 1343

**History** New in version 6.60.

**:SBUS<N>:UART:SOURce:RX**

**Command** :SBUS<N>:UART:SOURce:RX <source>

The :SBUS<N>:UART:SOURce:RX command specifies the receiver signal source.

<source> {CHANnel<N> | FUNCtion<F> | WMEMory<N> | DIGital<M>}

<N> An integer, 1-4.

<F> An integer, 1-16.

<M> An integer, 0-15.

**Query** :SBUS<N>:UART:SOURce:RX?

The :SBUS<N>:UART:SOURce:RX? query returns the receiver signal source setting.

**Returned Format** <source><NL>

<source> ::= {CHAN<N> | FUNC<F> | WMEM<N> | DIG<M>}

- See Also**
- [":SBUS<N>:UART:BAUDrate"](#) on page 1335
  - [":SBUS<N>:UART:BITOrder"](#) on page 1336
  - [":SBUS<N>:UART:DIRection"](#) on page 1337
  - [":SBUS<N>:UART:EOF:HEX"](#) on page 1338
  - [":SBUS<N>:UART:IDLE"](#) on page 1339
  - [":SBUS<N>:UART:PARity"](#) on page 1340
  - [":SBUS<N>:UART:SOURce:TX"](#) on page 1342
  - [":SBUS<N>:UART:WIDTH"](#) on page 1343

**History** New in version 6.60.

**:SBUS<N>:UART:SOURce:TX**

**Command** :SBUS<N>:UART:SOURce:TX <source>

The :SBUS<N>:UART:SOURce:TX command specifies the transmitter signal source.

<source> {CHANnel<N> | FUNCtion<F> | WMEMory<N> | DIGital<M>}

<N> An integer, 1-4.

<F> An integer, 1-16.

<M> An integer, 0-15.

**Query** :SBUS<N>:UART:SOURce:TX?

The :SBUS<N>:UART:SOURce:TX? query returns the transmitter source signal setting.

**Returned Format** <source><NL>

<source> ::= {CHAN<N> | FUNC<F> | WMEM<N> | DIG<M>}

- See Also**
- [":SBUS<N>:UART:BAUDrate"](#) on page 1335
  - [":SBUS<N>:UART:BITOrder"](#) on page 1336
  - [":SBUS<N>:UART:DIRection"](#) on page 1337
  - [":SBUS<N>:UART:EOF:HEX"](#) on page 1338
  - [":SBUS<N>:UART:IDLE"](#) on page 1339
  - [":SBUS<N>:UART:PARity"](#) on page 1340
  - [":SBUS<N>:UART:SOURce:RX"](#) on page 1341
  - [":SBUS<N>:UART:WIDTH"](#) on page 1343

**History** New in version 6.60.

**:SBUS<N>:UART:WIDTH**

**Command** :SBUS<N>:UART:WIDTH <width>

The :SBUS<N>:UART:WIDTH command sets the number of bits in RS-232/UART words to match your device under test.

<width> An integer, 5-9.

**Query** :SBUS<N>:UART:WIDTH?

The :SBUS<N>:UART:WIDTH? query returns the RS-232/UART word size setting.

**Returned Format** <width><NL>

- See Also**
- [":SBUS<N>:UART:BAUDrate"](#) on page 1335
  - [":SBUS<N>:UART:BITOrder"](#) on page 1336
  - [":SBUS<N>:UART:DIRection"](#) on page 1337
  - [":SBUS<N>:UART:EOF:HEX"](#) on page 1338
  - [":SBUS<N>:UART:IDLE"](#) on page 1339
  - [":SBUS<N>:UART:PARity"](#) on page 1340
  - [":SBUS<N>:UART:SOURce:RX"](#) on page 1341
  - [":SBUS<N>:UART:SOURce:TX"](#) on page 1342

**History** New in version 6.60.





## 35 Self-Test Commands

:SELFtest:CANCel / 1346

:SELFtest:SCOPETEST / 1347

The SELFtest subsystem commands set up the self-test dialog and run the Infiniium-Series Oscilloscopes Self-Tests.

### NOTE

#### **Enclose File Name in Quotation Marks**

When specifying a file name, you must enclose it in quotation marks.

---

## :SELFtest:CANCel

**Command**    :SELFtest:CANCel

The :SELFtest:CANCel command stops the currently running selftest.

**Example**    This example stops the currently running selftest.

```
myScope.WriteString ":SELF:CANC"
```

**History**    Legacy command (existed before version 3.10).

## :SELFtest:SCOPETEST

**Command** :SELFtest:SCOPETEST

The :SELFtest:SCOPETEST command brings up the self-test dialog in customer self-test mode (Service Extensions Off) and runs the test, "Scope Self Tests." Use the :SELFtest:SCOPETEST? query to determine the status of the test.

**Example** This example brings up the self-test dialog and runs the oscilloscope self-tests.

```
myScope.WriteString ":SELF:SCOPETEST"
```

**Query** :SELFtest:SCOPETEST?

**Returned Format** [:SELFtest:SCOPETEST] <test\_name>, <test\_status>, <time\_stamp><NL>

<test_status>	Status Description
FAILED	Test completed and failed.
PASSED	Test completed and passed.
WARNING	Test passed but warning message was issued.
CANCELLED	Test was cancelled by user.
NODATA	Self-tests have not been executed on this instrument.
INPROGRESS	Test is in progress.

<test\_name> A string as follows: "Scope Self Tests".

<time\_stamp> The time stamp follows the test name and test status, and is the part of the returned string that includes the date and time, in the format: "20 May 2009 10:13:35".

**Example** This example places the current status of the self-test in the string variable, strTxt, then prints the contents of the variable to the computer's screen.

```
Dim strTxt As String
myScope.WriteString ":SELF:SCOPETEST?"
strTxt = myScope.ReadString
Debug.Print strTxt
```

**History** Legacy command (existed before version 3.10).



## 36 System Commands

:SYSTem:DATE / 1350  
:SYSTem:DEBUg / 1351  
:SYSTem:DIMPedance – (9000 Series, 9000H Series, S-Series) / 1353  
:SYSTem:DONTtabmeas / 1354  
:SYSTem:DSP / 1355  
:SYSTem:ERRor? / 1356  
:SYSTem:GUI / 1357  
:SYSTem:HEADer / 1358  
:SYSTem:HLED (90000 Q-Series, S-Series, V-Series, Z-Series) / 1359  
:SYSTem:LOCK / 1360  
:SYSTem:LONGform / 1361  
:SYSTem:MENU? / 1362  
:SYSTem:PERSONa / 1363  
:SYSTem:PRESet / 1364  
:SYSTem:SETup / 1366  
:SYSTem:TIME / 1368

SYSTem subsystem commands control the way query responses are formatted, send and receive setup strings, and enable reading and writing to the advisory line of the oscilloscope. You can also set and read the date and time in the oscilloscope using the SYSTem subsystem commands.

**:SYSTEM:DATE**

**Command**     :SYSTEM:DATE <day>, <month>, <year>

The :SYSTEM:DATE command sets the date in the oscilloscope, and is not affected by the \*RST common command.

<year>        Specifies the year in the format <yyyy> | <yy>. The values range from 1992 to 2035.

<month>       Specifies the month in the format <1, 2, . . . 12> | <JAN, FEB, MAR . . .>.

<day>         Specifies the day in the format <1 . . . 31>.

**Example**     This example sets the date to December 1, 2002.

```
myScope.WriteString ":SYSTEM:DATE 1,12,02"
```

**Query**       :SYSTEM:DATE?

The :SYSTEM:DATE? query returns the current date in the oscilloscope.

**Returned Format**   [:SYSTEM:DATE] <day> <month> <year><NL>

**Example**     This example queries the date.

```
Dim strDate As String
myScope.WriteString ":SYSTEM:DATE?"
strDate = myScope.ReadString
Debug.Print strDate
```

**History**     Legacy command (existed before version 3.10).

## :SYSTem:DEBUg

**Command** :SYSTem:DEBUg {{ON|1} [, <output\_mode> [, "<file\_name>" [, <create\_mode>]]] | {OFF|0}}

The :SYSTem:DEBUg command turns the debug mode on and off. This mode enables the tracing of incoming remote commands. If you select CREate mode, a new file is created, and/or an existing file is overwritten. If you select APPend mode, the information is appended to an existing file. The :SYSTem:DEBUg command shows any header and/or parameter errors.

The default create mode is CREate, the default output mode is FileSCReen, and the default file name is "C:\Users\Public\Documents\Infiniium\debug.txt". In debug mode, the File View button lets you view the current debug file, or any other debug file. This is a read-only mode.

<output\_mode> {FILE | SCReen | FileSCReen}

<file\_name> An MS-DOS compatible name of the file, a maximum of 254 characters long (including the path name, if used). The file name assumes the present working directory if a path does not precede the file name.

<create\_mode> {CREate | APPend}

**Examples** This example turns on the debug/trace mode and creates a debug file.

```
myScope.WriteString ":SYSTem:DEBUG ON,FILE,
"C:\Users\Public\Documents\Infiniium\pacq8xx.txt",CREate"
```

The created file resembles:

```
Debug information file C:\Users\Public\Documents\Infiniium\pacq8xx.txt
Date:  1 DEC 2002
Time:  09:59:35
Model: DSO90804A
Serial#: sn ?
>:syst:err? string$<NL>
<:SYSTem:ERROR 0,"No error"$
>:ACQuire:BEST FLATness$<NL>

?      ^
?-113, Undefined header
>:syst:err? string$<NL>
<:SYSTem:ERROR -113,"Undefined header"$
>:syst:err? string$<NL>
<:SYSTem:ERROR 0,"No error"$
```

This example appends information to the debug file.

```
myScope.WriteString ":SYSTem:DEBUG ON,FILE,
"C:\Users\Public\Documents\Infiniium\pacq8xx.txt",APPend"
```

After appending information, the file resembles:

```
Debug information file C:\Users\Public\Documents\Infiniium\pacq8xx.txt
Date:  1 DEC 2002
Time:  09:59:35
```

```

Model: DSO90804A
Serial#: sn ?
>:syst:err? string$<NL>
<:SYSTem:ERROR 0,"No error"$
>:ACQuire:BESt FLATness$<NL>

?      ^
?-113, Undefined header
>:syst:err? string$<NL>
<:SYSTem:ERROR -113,"Undefined header"$
>:syst:err? string$<NL>
<:SYSTem:ERROR 0,"No error"$

Debug information file C:\Users\Public\Documents\Infinium\
pacq8xx.txt appended
Date: 1 DEC 2002
Time: 10:10:35
Model: DSO90804A
Serial#: sn ?
>:syst:err? string$<NL>
<:SYSTem:ERROR 0,"No error"$
>:ACQuire:BESt FLATness$<NL>

?      ^
?-113, Undefined header
>:syst:err? string$<NL>
<:SYSTem:ERROR -113,"Undefined header"$

```

**Query** :SYSTem:DEBUg?

The :SYSTem:DEBUg? query returns the current debug mode settings.

**Returned Format** [:SYSTem:DEBUg] {{1,<output\_mode>,"<file\_name>","<create\_mode>} | 0} <NL>

**History** Legacy command (existed before version 3.10).



## :SYSTem:DIMPedance – (9000 Series, 9000H Series, S-Series)

**Command** :SYSTem:DIMPedance {FIFTy | ONEMeg}

The :SYSTem:DIMPedance command sets the **Default Impedance to 1M Ohm** user preference.

- ONEMeg – a default setup will set the analog channels' input impedance to 1M Ohm.
- FIFTy – a default setup does not change the analog channel input impedance settings.

Note that when the oscilloscope powers down, it sets the 1 MOhm high impedance mode on the input channels as a protection mechanism while the unit is off.

**Query** :SYSTem:DIMPedance?

The :SYSTem:DIMPedance? query returns the **Default Impedance to 1M Ohm** user preference setting.

**Returned Format** <setting><NL>

<setting> ::= {FIFT | ONEM}

- See Also**
- **"\*RST – Reset"** on page 471
  - **":SYSTem:PRESet"** on page 1364

**History** New in version 6.55.

## :SYSTem:DONTtabmeas

**Command** :SYSTem:DONTtabmeas {{0 | OFF} | {1 | ON}}

The :SYSTem:DONTtabmeas command enables or disables the **Never tab Measurement Results** user preference.

When this user preference is enabled, and you choose **Display > Windows > Tabbed/Custom Window Layout** in the graphical user interface, the sub panes within the Results pane remain stacked—they are not tabbed as they would have been had this user preference been disabled.

**Query** :SYSTem:DONTtabmeas?

The :SYSTem:DONTtabmeas? query returns the **Never tab Measurement Results** user preference setting.

**Returned Format** <setting><NL>

<setting> ::= {0 | 1}

**History** New in version 5.60.

## :SYSTem:DSP

**Command** :SYSTem:DSP "<string>"

The :SYSTem:DSP command writes a quoted string, excluding quotation marks, to the advisory line of the instrument display. If you want to clear a message on the advisory line, send a null (empty) string.

<string> An alphanumeric character array up to 86 bytes long.

**Example** This example writes the message, "Test 1" to the advisory line of the oscilloscope.

```
myScope.WriteString ":SYSTem:DSP ""Test 1"""
```

**Query** :SYSTem:DSP?

The :SYSTem:DSP? query returns the last string written to the advisory line. This may be a string written with a :SYSTem:DSP command, or an internally generated advisory.

The string is actually read from the message queue. The message queue is cleared when it is read. Therefore, the displayed message can only be read once over the bus.

**Returned Format** [:SYSTem:DSP] <string><NL>

**Example** This example places the last string written to the advisory line of the oscilloscope in the string variable, strAdvisory. Then, it prints the contents of the variable to the computer's screen.

```
Dim strAdvisory As String ' Dimension variable.
myScope.WriteString ":SYSTem:DSP?"
strAdvisory = myScope.ReadString
Debug.Print strAdvisory
```

**History** Legacy command (existed before version 3.10).

## :SYSTem:ERRor?

**Query** :SYSTem:ERRor? [{NUMBER | STRing}]

The :SYSTem:ERRor? query outputs the next error number in the error queue over the remote interface. When either NUMBER or no parameter is specified in the query, only the numeric error code is output. When STRing is specified, the error number is output followed by a comma and a quoted string describing the error. **Table 21** lists the error numbers and their corresponding error messages.

**Returned Format** [:SYSTem:ERRor] <error\_number> [, <quoted\_string>] <NL>

<error\_number> A numeric error code.

<quoted\_string> A quoted string describing the error.

**Example** This example reads the oldest error number and message in the error queue into the string variable, strCondition, then prints the contents of the variable to the computer's screen.

```
Dim strCondition As String    ' Dimension variable.
myScope.WriteString ":SYSTem:ERRor? STRing"
strCondition = myScope.ReadString
Debug.Print strCondition
```

Infiniium Oscilloscopes have an error queue that is 30 errors deep and operates on a first-in, first-out (FIFO) basis. Successively sending the :SYSTem:ERRor? query returns the error numbers in the order that they occurred until the queue is empty. When the queue is empty, this query returns headers of 0, "No error." Any further queries return zeros until another error occurs. Note that front-panel generated errors are also inserted in the error queue and the Event Status Register.

**NOTE****Send \*CLS Before Other Commands or Queries**

Send the \*CLS common command to clear the error queue and Event Status Register before you send any other commands or queries.

**See Also** The "Error Messages" chapter for more information on error messages and their possible causes.

**History** Legacy command (existed before version 3.10).

## :SYSTEM:GUI

**Command** :SYSTEM:GUI {ON | OFF | LOCK}

The :SYSTEM:GUI OFF command enables or disables the front panel user interface.

- ON – Enables the front panel user interface.
- OFF – Disables the front panel user interface and places a Remote Operations In Progress dialog box on the oscilloscope's screen. The front panel knobs, keys, and graphical user interface are disabled. Graphical user interface updates are also disabled.

The :SYSTEM:GUI OFF command lets Infiniium oscilloscopes behave like other Keysight instruments by locking out the GUI (graphical user interface) and the front panel while remote scripts are running. On Infiniium oscilloscopes, the GUI and front panel do not lock automatically during remote operation (as most other instruments do) to preserve the integrity and timing of legacy customer scripts. The recommendation is, however, that all scripts begin with :SYSTEM:GUI OFF when convenient and possible to run more like other Keysight instruments and likely improve performance.

The :SYSTEM:GUI OFF command is similar to the :SYSTEM:LOCK ON command, except the :SYSTEM:LOCK ON command does not disable the graphical user interface (just the knobs and keys).

- LOCK – Disables the front panel graphical user interface as well as the front panel knobs and keys. A Remote Operations In Progress dialog box on the oscilloscope's screen. However, graphical user interface updates are not disabled.

The front panel user interface can be re-enabled by:

- Sending the :SYSTEM:GUI ON command.
- Clicking **Enable** in the Remote Operations In Progress dialog box.

**Example** This example disables the oscilloscope's front panel user interface.

```
myScope.WriteString ":SYSTEM:GUI OFF"
```

**Query** :SYSTEM:GUI?

The :SYSTEM:GUI? query returns the state of the :SYSTEM:GUI command.

**Returned Format** [:SYSTEM:GUI] {ON | OFF | LOCK}<NL>

**See Also** • **":SYSTEM:LOCK"** on page 1360

**History** New in version 5.50.

Version 6.20: The LOCK parameter has been added and the query return value is now a string (ON, OFF, or LOCK) instead of the previous 1 or 0 return values.

## :SYSTem:HEADer

**Command** :SYSTem:HEADer {{ON|1} | {OFF|0}}

The :SYSTem:HEADer command specifies whether the instrument will output a header for query responses. When :SYSTem:HEADer is set to ON, the query responses include the command header.

**Example** This example sets up the oscilloscope to output command headers with query responses.

```
myScope.WriteString ":SYSTem:HEADer ON"
```

**Query** :SYSTem:HEADer?

The :SYSTem:HEADer? query returns the state of the :SYSTem:HEADer command.

**Returned Format** [:SYSTem:HEADer] {1|0}<NL>

**Example** This example prints the system header setting.

```
Dim strSetting As String
myScope.WriteString ":SYSTem:HEADer?"
strSetting = myScope.ReadString
Debug.Print strSetting
```

### NOTE

#### Turn Headers Off when Returning Values to Numeric Variables

Turn headers off when returning values to numeric variables. Headers are always off for all common command queries because headers are not defined in the IEEE 488.2 standard.

**History** Legacy command (existed before version 3.10).

## :SYSTem:HLED (90000 Q-Series, S-Series, V-Series, Z-Series)

**Command** :SYSTem:HLED {{0 | OFF} | {1 | ON}}

The :SYSTem:HLED command turns the "hide front panel LEDs" setting ON or OFF. When ON, all LEDs on the front panel (except the power button LED) will turn off.

You may want to hide front panel LEDs when making measurements in a light-sensitive environment.

**Query** :SYSTem:HLED?

The :SYSTem:HLED? query returns the hide LEDs setting.

**Returned Format** <setting><NL>

<setting> ::= {0 | 1}

**History** New in version 6.00.

**:SYSTem:LOCK**

**Command** :SYSTem:LOCK {{ON | 1} | {OFF | 0}}

The :SYSTem:LOCK ON command disables the front panel knobs and keys.

The front panel knobs and keys can be re-enabled by sending the :SYSTem:LOCK OFF command.

This :SYSTem:LOCK ON command is similar to the :SYSTem:GUI OFF command, except the :SYSTem:GUI OFF command also disables the graphical user interface and GUI updates.

**Example** This example disables the oscilloscope's front panel.

```
myScope.WriteString ":SYSTem:LOCK ON"
```

**Query** :SYSTem:LOCK?

The :SYSTem:LOCK? query returns the state of the :SYSTem:LOCK command.

**Returned Format** [:SYSTem:LOCK] {1 | 0}<NL>

**See Also** • **":SYSTem:GUI"** on page 1357

**History** Legacy command (existed before version 3.10).



## :SYSTem:LONGform

**Command** :SYSTem:LONGform {{ON | 1} | {OFF | 0}}

The :SYSTem:LONGform command specifies the format for query responses. If the LONGform is set to OFF, command headers and alpha arguments are sent from the oscilloscope in the short form (abbreviated spelling). If LONGform is set to ON, the whole word is output.

**Example** This example sets the format for query responses from the oscilloscope to the short form (abbreviated spelling).

```
myScope.WriteString ":SYSTem:LONGform OFF"
```

**Query** :SYSTem:LONGform?

The :SYSTem:LONGform? query returns the current state of the :SYSTem:LONGform command.

**Returned Format** [:SYSTem:LONGform] {1 | 0}<NL>

**Example** This example checks the current format for query responses from the oscilloscope, and places the result in the string variable, strResult. Then, it prints the contents of the variable to the computer's screen.

```
Dim strResult As String ' Dimension variable.
myScope.WriteString ":SYSTem:LONGform?"
strResult = myScope.ReadString
Debug.Print strResult
```

**NOTE****LONGform Does Not Affect Input Headers and Arguments**

LONGform has no effect on input headers and arguments sent to the instrument. You may send headers and arguments to the oscilloscope in either the long form or short form, regardless of the current state of the :SYSTem:LONGform command.

**History** Legacy command (existed before version 3.10).

## :SYSTem:MENU?

**Query** :SYSTem:MENU? <menu\_string>  
 <menu\_string> ::= quoted string

The :SYSTem:MENU? query returns front panel graphical user interface (GUI) menu strings.

**NOTE**

This query is intended to list GUI menu strings that launch other executable programs. Currently, these appear in the "Analyze" menu only. For other menus, this query may return strings that do not actually appear in the GUI.

**Returned Format** <items\_in\_menu><NL>

<items\_in\_menu> ::= comma-separated list of items in the menu

**Example** This example shows queries and responses from the Keysight Interactive IO's Instrument Session History:

```
-> :SYSTem:MENU? "Analyze"
<- Histogram..., Mask Test..., Automated Test Apps,
Measurement Analysis (EZJIT)..., Jitter/Noise (EZJIT Complete)...,
RTEye/Clock Recovery (SDA)..., Equalization...
-> :SYSTem:MENU? "Analyze\Automated Test Apps"
<- N8829A 100GBASE-KR4 Test App, N8830A 100GBASE-CR4 Test App
```

**History** New in version 5.50.0033.

## :SYSTem:PERSONa

**Command** :SYSTem:PERSONa {<manufacturer\_string>, <model\_string> | <manufacturer\_string> | DEFault}

<manufacturer\_string> ::= quoted string, 1-31 characters

<model\_string> ::= quoted string, 1-10 characters

The :SYSTem:PERSONa command sets the manufacturer string and the model number string returned by the \*IDN? query.

**Query** :SYSTem:PERSONa?

The :SYSTem:PERSONa? query returns the manufacturer string and the model number string.

**Returned Format** [:SYSTem:PERSONa] <manufacturer\_string>, <model\_string><NL>

<manufacturer\_string> ::= quoted string, 1-31 characters

<model\_string> ::= quoted string, 1-10 characters

**See Also** • ["\\*IDN? – Identification Number"](#) on page 455

**History** New in version 5.20.

## :SYSTem:PRESet

**Command** :SYSTem:PRESet [ {DEFault | FACTory} ]

The :SYSTem:PRESet command initializes the oscilloscope to a known state. You can use these parameters:

- DEFault (or no parameter) – performs a Default Setup just like the oscilloscope's front panel **[Default Setup]** key.

**NOTE**

On Infiniium Z-Series and 90000 Q-Series oscilloscopes, if Real-Edge channels are turned on when the front panel **[Default Setup]** key is pressed, Real-Edge channels remain on after the default setup. However, with the remote ":SYSTem:PRESet DEFault" command, Real-Edge channels are turned off before the default setup and remain off after.

- FACTory – performs a Factory Default.

**Default Setup** Default Setup returns Infiniium oscilloscope settings, except user preferences and a few other settings, to their defaults.

- Markers, functions, waveforms, bookmarks, and measurements are all turned off in a default setup.
- Multiple waveform windows are closed, leaving only one waveform window in a default setup.
- These are the default settings for the controls that change:

Control	Default Setting
Run/Stop	Run
Channel 1	On, 1 V/div, 0 offset
Horizontal Scale	100 ns/
Horizontal Position	0 s
Reference	Center
Zoom	Disabled
Trigger Mode	Edge
Trigger Level	0 V
Trigger Sweep	Auto
Edge Trigger Source	Channel 1
Edge Trigger Slope	Rising

- Default Setup does not change any of the control settings found in the User Preferences dialog box, display color settings, screen options, probe skew, probe external adapter settings for differential probes, or probe internal attenuation and gain settings for differential probes.

**Factory Default** The Factory Default selection returns the oscilloscope to the settings it had when it left the factory. This places the oscilloscope in a known operating condition. You can use Factory Default when you want to set all values (even the ones not defaulted by Default Setup) back to their default values.

These controls are reset during a factory default (but are not reset during a Default Setup):

- User Preferences dialog box settings
- Customize Multipurpose settings
- Tabbed window layout
- Digital memory size
- Waveform memories
- Channel skew
- Display colors
- Waveform intensity and grid line intensity settings
- Probe skew
- Probe external adapter settings for differential probes
- Probe internal attenuation and gain setting for differential probes
- Lock Display Results (not selected)

**Example** This example performs an oscilloscope default setup.

```
myScope.WriteString ":SYSTem:PRESet"
```

**See Also** • **"\*RST – Reset"** on page 471

**History** Legacy command (existed before version 3.10).

## :SYSTem:SETup

**Command** :SYSTem:SETup <binary\_block\_data>

The :SYSTem:SETup command sets up the oscilloscope as defined by the data in the binary block of data from the computer.

**CAUTION**

Setups saved from Infiniium software versions prior to 2.00 may not load correctly in software versions 4.30 and greater.

You can remedy this by re-saving any pre-2.00 setups using any version of software from version 2.00 to version 4.20.

Setups saved from software versions between 2.00 and 4.20 should load correctly into version 4.30 and greater.

<binary\_block\_data> A binary block of data, consisting of bytes of setup information. The number of bytes is a dynamic number that is read and allocated by oscilloscope's software.

**Example** This example reads setup information from a file and restores it to the oscilloscope.

```
' Read setup from a file:
Dim strPath As String
strPath = "c:\scope\config\setup.dat"
Dim hFile As Long
hFile = FreeFile
Dim varSetup As Variant
Open strPath For Binary Access Read As hFile ' Open file for input.
Get hFile, , varSetup ' Read data.
Close hFile ' Close file.

' Write setup to oscilloscope.
myScope.WriteIEEEBlock ":SYSTem:SETup", varSetup
Debug.Print "Setup bytes restored: " + CStr(LenB(varSetup))
```

**Query** :SYSTem:SETup?

The :SYSTem:SETup? query outputs the oscilloscope's current setup to the computer in binary block data format as defined in the IEEE 488.2 standard.

**Returned Format** [:SYSTem:SETup] #NX...X<setup\_data\_string><NL>

The first character in the setup data block is a number added for disk operations.

**Example** This example stores the current oscilloscope setup to the variable, varSetup, and then saves it to a file.

```
' Get setup from the oscilloscope.
Dim varSetup As Variant
myScope.WriteString ":SYSTem:HEADer OFF" ' Response headers off.
myScope.WriteString ":SYSTem:SETup?"
varSetup = myScope.ReadIEEEBlock(BinaryType_UI1)

' Output setup string to a file:
```

```

Dim strPath As String
strPath = "c:\scope\config\setup.dat"
Dim hFile As Long
hFile = FreeFile
Open strPath For Binary Access Write Lock Write As hFile
Put hFile, , varSetup ' Write data.
Close hFile ' Close file.
Debug.Print "Setup bytes saved: " + CStr(LenB(varSetup))

```

**NOTE****:SYSTem:SEUp Can Operate Just Like \*LRN?**

When headers and LONGform are on, the :SYSTem:SEUp? query operates the same as the \*LRN? query in the common commands. Otherwise, \*LRN? and :SYSTem:SEUp are not interchangeable.

**See Also** · ["Definite-Length Block Response Data"](#) on page 157

**History** Legacy command (existed before version 3.10).

**:SYSTem:TIME**

**Command**     :SYSTem:TIME <hour>,<minute>,<second>

The :SYSTem:TIME command sets the time in the oscilloscope and is not affected by the \*RST common command.

<hour>     0...23

<minute>   0...59

<second>   0...59

**Example**     This example sets the oscilloscope time to 10:30:45 a.m.

```
myScope.WriteString ":SYSTem:TIME 10,30,45"
```

**Query**       :SYSTem:TIME?

The :SYSTem:TIME? query returns the current time in the oscilloscope.

**Returned Format**   [:SYSTem:TIME] <hour>,<minute>,<second>

**History**       Legacy command (existed before version 3.10).



## 37 Time Base Commands

:TIMebase:POSition / 1370  
:TIMebase:RANGe / 1371  
:TIMebase:REFClock / 1372  
:TIMebase:REFerence / 1373  
:TIMebase:REFerence:PERCent / 1374  
:TIMebase:ROLL:ENABLE / 1375  
:TIMebase:SCALe / 1376  
:TIMebase:VIEW / 1377  
:TIMebase:WINDow:DELay / 1378  
:TIMebase:WINDow:POSition / 1379  
:TIMebase:WINDow:RANGe / 1380  
:TIMebase:WINDow:SCALe / 1381

The TIMebase subsystem commands control the horizontal (X axis) oscilloscope functions.

## :TIMebase:POSition

**Command** :TIMebase:POSition <position\_value>

The :TIMebase:POSition command sets the time interval between the trigger event and the delay reference point. The delay reference point is set with the :TIMebase:REFerence command.

<position\_value> A real number for the time in seconds from trigger to the delay reference point.

**Example** This example sets the delay position to 2 ms.

```
myScope.WriteString ":TIMebase:POSition 2E-3"
```

**Query** :TIMebase:POSition?

The :TIMebase:POSition? query returns the current delay value in seconds.

**Returned Format** [:TIMebase:POSition] <position\_value><NL>

**Example** This example places the current delay value in the numeric variable, varValue, then prints the contents of the variable to the computer's screen.

```
myScope.WriteString ":SYSTem:HEADer OFF" ' Response headers off.
myScope.WriteString ":TIMebase:POSition?"
varValue = myScope.ReadNumber
Debug.Print FormatNumber(varValue, 0)
```

**History** Legacy command (existed before version 3.10).

## :TIMebase:RANGe

**Command** :TIMebase:RANGe <full\_scale\_range>

The :TIMebase:RANGe command sets the full-scale horizontal time in seconds. The range value is ten times the time-per-division value.

<full\_scale\_range> A real number for the horizontal time, in seconds. The timebase range is 50 ps (5 ps/div) to 200 s (20 s/div).

**Example** This example sets the full-scale horizontal range to 10 ms.

```
myScope.WriteString ":TIMebase:RANGe 10E-3"
```

**Query** :TIMebase:RANGe?

The :TIMebase:RANGe? query returns the current full-scale horizontal time.

**Returned Format** [:TIMebase:RANGe] <full\_scale\_range><NL>

**Example** This example places the current full-scale horizontal range value in the numeric variable, varSetting, then prints the contents of the variable to the computer's screen.

```
myScope.WriteString ":SYSTem:HEADer OFF" ' Response headers off.
myScope.WriteString ":TIMebase:RANGe?"
varSetting = myScope.ReadNumber
Debug.Print FormatNumber(varSetting, 0)
```

**History** Legacy command (existed before version 3.10).

**:TIMEbase:REFClock**

**Command** :TIMEbase:REFClock {{ON | 1} | {OFF | 0} | HFRequency}

The :TIMEbase:REFClock command enables or disables the 10 MHz REF IN BNC input (ON or OFF) or the 100 MHz REF IN SMA input (HFRequency or OFF) located on the rear panel of the oscilloscope. The 100 MHz REF IN SMA input is available only on 90000 Q-Series and Z-Series oscilloscopes.

When this feature is enabled, the external reference input is used as a reference clock for the oscilloscope's horizontal scale section instead of the internal reference clock.

**Example** This example turns on the 10 MHz reference clock mode.

```
myScope.WriteString ":TIMEbase:REFClock ON"
```

**Query** :TIMEbase:REFClock?

The :TIMEbase:REFClock? query returns the current state of the reference clock mode control.

**Returned Format** [TIMEbase:REFClock] {1 | 0 | HFR}<NL>

**Example** This example places the current value of the reference clock mode control in the variable, varSetting, then prints the contents of the variable to the computer's screen.

```
myScope.WriteString ":SYSTem:HEADer OFF" ' Response headers off.
myScope.WriteString ":TIMEbase:REFClock?"
varSetting = myScope.ReadNumber
Debug.Print FormatNumber(varSetting, 0)
```

**History** Legacy command (existed before version 3.10).

## :TIMebase:REFerence

**Command** :TIMebase:REFerence {LEFT | CENTER | RIGHT}

The :TIMebase:REFerence command sets the .horizontal reference position to the left, center, or right side of the screen.

**Example** This example sets the horizontal reference position to the center of the display.

```
myScope.WriteString ":TIMebase:REFerence CENTER"
```

**Query** :TIMebase:REFerence?

The :TIMebase:REFerence? query returns the current horizontal reference position.

**Returned Format** [:TIMebase:REFerence] {LEFT | CENTER | RIGHT | PERCent}<NL>

PERC is returned when the horizontal reference position is set to a percent-of-screen location (either in the user interface or with the :TIMebase:REFerence:PERCent command).

**Example** This example places the current horizontal reference position in the string variable, strSetting, then prints the contents of the variable to the computer's screen.

```
Dim strSetting As String ' Dimension variable.
myScope.WriteString ":TIMebase:REFerence?"
strSetting = myScope.ReadString
Debug.Print strSetting
```

**See Also** • [":TIMebase:REFerence:PERCent"](#) on page 1374

**History** Legacy command (existed before version 3.10).

Version 5.00: Query can now return PERC when a reference position percent value is being used.

## :TIMebase:REFerence:PERCent

**Command**    :TIMebase:REFerence:PERCent <percent>

The :TIMebase:REFerence:PERCent command sets the horizontal reference position to a percent-of-screen location, from left to right.

<percent>    Integer from 0-100.

**Example**    This example sets the horizontal reference position to a 25% of screen location.

```
myScope.WriteString ":TIMebase:REFerence:PERCent 25"
```

**Query**        :TIMebase:REFerence:PERCent?

The :TIMebase:REFerence:PERCent? query returns the current horizontal reference position as a percent-of-screen value.

**Returned Format**    [:TIMebase:REFerence:PERCent] <percent><NL>

**Example**    This example places the current horizontal reference position in the string variable, strSetting, then prints the contents of the variable to the computer's screen.

```
Dim strSetting As String    ' Dimension variable.
myScope.WriteString ":TIMebase:REFerence:PERCent?"
strSetting = myScope.ReadString
Debug.Print strSetting
```

**See Also**    · [":TIMebase:REFerence"](#) on page 1373

**History**    New in version 5.00.

**:TIMebase:ROLL:ENABLE**

**Command** :TIMebase:ROLL:ENABLE {{ON | 1} | {OFF | 0}}

The :TIMebase:ROLL:ENABLE command enables or disables the roll mode feature.

**NOTE**

Roll mode is not available when RealEdge channels are enabled in the 90000 Q-Series and Z-Series oscilloscopes.

**Example** This example turns on the roll mode.

```
myScope.WriteString ":TIMebase:ROLL:ENABLE ON"
```

**Query** :TIMebase:ROLL:ENABLE?

The :TIMebase:ROLL:ENABLE? query returns the current state of the roll mode enable control.

**Returned Format** [:TIMebase:ROLL:ENABLE] {1 | 0}<NL>

**Example** This example places the current value of the roll mode enable control in the variable, varSetting, then prints the contents of the variable to the computer's screen.

```
myScope.WriteString ":SYSTEM:HEADer OFF" ' Response headers off.
myScope.WriteString ":TIMebase:ROLL:ENABLE?"
varSetting = myScope.ReadNumber
Debug.Print FormatNumber(varSetting, 0)
```

**History** Legacy command (existed before version 3.10).

## :TIMebase:SCALE

**Command** :TIMebase:SCALE <time>

The :TIMebase:SCALE command sets the time base scale. This corresponds to the horizontal scale value displayed as time/div on the oscilloscope screen.

<time> A real number for the time value, in seconds per division. The timebase scale is 5 ps/div to 20 s/div.

**Example** This example sets the scale to 10 ms/div.

```
myScope.WriteString ":TIMebase:SCALE 10E-3"
```

**Query** :TIMebase:SCALE?

The :TIMebase:SCALE? query returns the current scale time setting.

**Returned Format** [:TIMebase:SCALE] <time><NL>

**Example** This example places the current scale value in the numeric variable, varSetting, then prints the contents of the variable to the computer's screen.

```
myScope.WriteString ":SYSTem:HEADer OFF" ' Response headers off.
myScope.WriteString ":TIMebase:SCALE?"
varSetting = myScope.ReadNumber
Debug.Print FormatNumber(varSetting, 0)
```

**History** Legacy command (existed before version 3.10).



## :TIMEbase:VIEW

**Command** :TIMEbase:VIEW {MAIN | WINDow}

The :TIMEbase:VIEW command turns the horizontal zoom mode on and off. This is the same as using the front panel **[Zoom]** key.

**Example** This example turns the horizontal zoom mode on.

```
myScope.WriteString ":TIMEbase:VIEW WINDow"
```

**Query** :TIMEbase:VIEW?

The :TIMEbase:VIEW? query returns the horizontal zoom mode setting.

**Returned Format** [:TIMEbase:VIEW] {MAIN | WINDow}<NL>

**Example** This example places the current view in the string variable, strState, then prints the contents of the variable to the computer's screen.

```
Dim strState As String ' Dimension variable.
myScope.WriteString ":TIMEbase:VIEW?"
strState = myScope.ReadString
Debug.Print strState
```

**History** Legacy command (existed before version 3.10).

## :TIMEbase:WINDow:DELay

**Command** :TIMEbase:WINDow:DELay <delay\_value>

The :TIMEbase:WINDow:DELay sets the horizontal position in the delayed view of the main sweep. The range for this command is determined by the main sweep range and the main sweep horizontal position. The value for this command must keep the time base window within the main sweep range.

### NOTE

#### This Command is Provided for Compatibility

This command is the same as the :TIMEbase:WINDow:POSition command, and is provided for compatibility with programs written for previous oscilloscopes. The preferred command for compatibility with Infiniium oscilloscopes is :TIMEbase:WINDow:POSition.

**<delay\_value>** A real number for the time in seconds from the trigger event to the delay reference point. The maximum position depends on the main sweep range and the main sweep horizontal position.

**Example** This example sets the time base window delay position to 20 ns.

```
myScope.WriteString ":TIMEbase:WINDow:DELay 20E-9"
```

**Query** :TIMEbase:WINDow:DELay?

The :TIMEbase:WINDow:DELay? query returns the current horizontal position in the delayed view.

**Returned Format** [:TIMEbase:WINDow:DELay] <delay\_position><NL>

**Example** This example places the current horizontal position in the delayed view in the numeric variable, varSetting, then prints the contents of the variable to the computer's screen.

```
myScope.WriteString ":SYSTem:HEADer OFF" ' Response headers off.
myScope.WriteString ":TIMEbase:WINDow:DELay?"
varSetting = myScope.ReadNumber
Debug.Print FormatNumber(varSetting, 0)
```

**See Also** The :TIMEbase:WINDow:POSition command performs the same function as this command and should be used in new programs.

**History** Legacy command (existed before version 3.10).

## :TIMEbase:WINDow:POSition

**Command** :TIMEbase:WINDow:POSition <position\_value>

The :TIMEbase:WINDow:POSition sets the horizontal position in the delayed view of the main sweep. The range for this command is determined by the main sweep range and the main sweep horizontal position. The value for this command must keep the time base window within the main sweep range.

**<position\_value>** A real number for the time in seconds from the trigger event to the delay reference point. The maximum position depends on the main sweep range and the main sweep horizontal position.

**Example** This example sets the time base window delay position to 20 ns.

```
myScope.WriteString ":TIMEbase:WINDow:POSition 20E-9"
```

**Query** :TIMEbase:WINDow:POSition?

The :TIMEbase:WINDow:POSition? query returns the current horizontal position in the delayed view.

**Returned Format** [:TIMEbase:WINDow:POSition] <position\_value><NL>

**Example** This example places the current horizontal position in the delayed view in the numeric variable, varSetting, then prints the contents of the variable to the computer's screen.

```
myScope.WriteString ":SYSTEM:HEADer OFF" ' Response headers off.
myScope.WriteString ":TIMEbase:WINDow:POSition?"
varSetting = myScope.ReadNumber
Debug.Print FormatNumber(varSetting, 0)
```

**History** Legacy command (existed before version 3.10).

**:TIMEbase:WINDow:RANGe**

**Command**     :TIMEbase:WINDow:RANGe <full\_scale\_range>

The :TIMEbase:WINDow:RANGe command sets the full-scale range of the delayed view. The range value is ten times the time per division of the delayed view. The maximum range of the delayed view is the current main range. The minimum delayed view range is 10 ps (1 ps/div).

<full\_scale\_range>   A real number for the full-scale range of the time base window, in seconds.

**Example**       This example sets the full-scale range of the delayed view to 100 ns.

```
myScope.WriteString ":TIMEbase:WINDow:RANGe 100E-9"
```

**Query**         :TIMEbase:WINDow:RANGe?

The :TIMEbase:WINDow:RANGe? query returns the current full-scale range of the delayed view.

**Returned Format**   [:TIMEbase:WINDow:RANGe] <full\_scale\_range><NL>

**Example**       This example reads the current full-scale range of the delayed view into the numeric variable, varValue, then prints the contents of the variable to the computer's screen.

```
myScope.WriteString ":SYSTem:HEADer OFF"       ' Response headers off.
myScope.WriteString ":TIMEbase:WINDow:RANGe?"
varValue = myScope.ReadNumber
Debug.Print FormatNumber(varValue, 0)
```

**History**       Legacy command (existed before version 3.10).

**:TIMebase:WINDow:SCALe**

**Command**    `:TIMebase:WINDow:SCALe <time>`

The `:TIMebase:WINDow:SCALe` command sets the time/div in the delayed view. This command rescales the horizontal components of displayed waveforms.

**<time>**    A real number for the delayed windows scale.

**Example**    This example sets the scale of the time base window to 2 milliseconds/div.

```
myScope.WriteString ":TIMebase:WINDow:SCALe 2E-3"
```

**Query**    `:TIMebase:WINDow:SCALe?`

The `:TIMebase:WINDow:SCALe?` query returns the scaled window time, in seconds/div.

**Returned Format**    `[:TIMebase:WINDow:SCALe] <time><NL>`

**History**    Legacy command (existed before version 3.10).



# 38 Trigger Commands

General Trigger Commands /	1385
Comm Trigger Commands /	1401
Delay Trigger Commands /	1407
Edge Trigger Commands /	1417
GBSerial Trigger Commands /	1421
Glitch Trigger Commands /	1432
Pattern Trigger Commands /	1436
Pulse Width Trigger Commands /	1439
Runt Trigger Commands /	1445
Sequence Trigger Commands /	1450
Setup and Hold Trigger Commands /	1459
State Trigger Commands /	1466
Timeout Trigger Commands /	1471
Transition Trigger Commands /	1475
TV Trigger Commands /	1480
Window Trigger Commands /	1491
Advanced Comm Trigger Commands /	1496
Advanced Pattern Trigger Commands /	1503
Advanced State Trigger Commands /	1508
Advanced Delay By Event Trigger Commands /	1514
Advanced Delay By Time Trigger Commands /	1523
Advanced Standard TV Trigger Commands /	1530
Advanced User Defined TV Mode and Commands /	1536
Advanced Violation Trigger Modes /	1542
Advanced Pulse Width Violation Trigger Commands /	1544
Advanced Setup Violation Trigger Commands /	1550
Advanced Transition Violation Trigger Commands /	1576

The oscilloscope trigger circuitry helps you locate the waveform you want to view. There are several different types of triggering, but the one that is used most often is edge triggering. Edge triggering identifies a trigger condition by looking for the slope (rising or falling) and voltage level (trigger level) on the source you select. Any input channel, auxiliary input trigger, or line can be used as the trigger source.

The commands in the TRIGger subsystem define the conditions for triggering. Many of the commands in the TRIGger subsystem are used in more than one of the trigger modes. The command set has been defined to closely represent the front-panel trigger menus. As a trade-off, there may be less compatibility between Infiniium Oscilloscopes and command sets for previous oscilloscopes. Infiniium Oscilloscopes still accept some commands for compatibility with previous instruments. An alternative command that is accepted by the oscilloscope is noted for a particular command.

**Summary of  
Trigger Modes and  
Commands**

Make sure the oscilloscope is in the proper trigger mode for the command you want to send. One method of ensuring that the oscilloscope is in the proper trigger mode is to send the :TRIGger:MODE command in the same program message as the parameter to be set.

For example, to place the instrument in the proper triggering mode you select:

```
:TRIGger:MODE <Trigger_mode>
```

**<Trigger\_mode>**

The trigger modes include COMM, DELay, EDGE, GLITch, PATtern, PWIDth, RUNT, SEQuence, SHOLd, STATE, TIMEout, TRANSition, TV, WINDow, SBUS<N>, and ADVanced. Each mode is described with its command set in this chapter.

To place the instrument in the advanced triggering mode you select:

```
:TRIGger:MODE ADVanced
:TRIGger:ADVanced:MODE <Advanced_trigger_mode>
```

**<Advanced  
\_trigger\_mode>**

Advanced trigger modes include COMM, DELay, PATtern, STATE, TV, and VIOLation. Each mode is described with its command set in this chapter.



## General Trigger Commands

- `":TRIGger:AND:ENABle"` on page 1386
- `":TRIGger:AND:SOURce"` on page 1387
- `":TRIGger:FORCe"` on page 1388
- `":TRIGger:HOLDoff"` on page 1389
- `":TRIGger:HOLDoff:MAX"` on page 1390
- `":TRIGger:HOLDoff:MIN"` on page 1391
- `":TRIGger:HOLDoff:MODE"` on page 1392
- `":TRIGger:HTHReshold"` on page 1393
- `":TRIGger:HYSteresis"` on page 1394
- `":TRIGger:LEVel"` on page 1395
- `":TRIGger:LEVel:FIFTy"` on page 1396
- `":TRIGger:LTHReshold"` on page 1397
- `":TRIGger:MODE"` on page 1398
- `":TRIGger:SWEep"` on page 1400

## :TRIGger:AND:ENABLE

**Command** :TRIGger:AND[{1 | 2}]:ENABle {{ON | 1} | {OFF | 0}}

The :TRIGger:AND:ENABLE command enables the ability to further qualify the trigger using other channels.

The optional [{1 | 2}] parameter sets whether the AND qualifier goes with the TERM1 or TERM2 state if sequential triggering is being used.

**Query** :TRIGger:AND:ENABle?

The query returns the current state of the AND qualifier.

**Returned Format** [:TRIGger:AND:ENABle] {1 | 0}<NL>

**History** Legacy command (existed before version 3.10).

**:TRIGger:AND:SOURce**

**Command** :TRIGger:AND[{1 | 2}]:SOURce CHANnel<N>,{HIGH | LOW | DONTcare}

The :TRIGger:AND:SOURce command sets the logic value used to qualify the trigger for the specified channel. The TRIGger:LEVel command determines what voltage level is considered a HIGH or a LOW logic value. If you set more than one channel to a HIGH or a LOW, then the multiple channels are used to qualify the trigger.

The optional [{1 | 2}] parameter sets whether the AND qualifier goes with the TERM1 or TERM2 state if sequential triggering is being used.

<N> An integer, 1-4.

**Query** :TRIGger:AND:SOURce? CHANnel<N>

The query returns the logic value for the designated channel.

**Returned Format** [:TRIGger:AND:SOURce CHANnel<N>] {HIGH | LOW | DONTcare}<NL>

**History** Legacy command (existed before version 3.10).

## :TRIGger:FORCe

**Command** :TRIGger:FORCe

The :TRIGger:FORCe command causes an acquisition to be captured even though the trigger condition has not been met.

- See Also**
- [":TRIGger:SWEEp"](#) on page 1400
  - [":TRIGger:LEVel"](#) on page 1395
  - [":TRIGger:LEVel:FIFTy"](#) on page 1396

**History** New in version 6.30.

## :TRIGger:HOLDoff

**Command** :TRIGger:HOLDoff <holdoff\_time>

The :TRIGger:HOLDoff command specifies the amount of time the oscilloscope should wait after receiving a trigger before enabling the trigger again.

<holdoff\_time> A real number for the holdoff time, ranging from 100 ns to 10 s.

**Query** :TRIGger:HOLDoff?

The query returns the current holdoff value for the current mode.

**Returned Format** [:TRIGger:HOLDoff] <holdoff><NL>

**History** Legacy command (existed before version 3.10).

## :TRIGger:HOLDoff:MAX

**Command** :TRIGger:HOLDoff:MAX <holdoff\_time>

This command is only used when you set the :TRIGger:HOLDoff:MODE command to RANDom. The RANDom mode varies the trigger holdoff from one acquisition to another by randomizing the time values between triggers. The randomized values can be between the values specified by the :TRIGger:HOLDoff:MAX and :TRIGger:HOLDoff:MIN commands.

The Random holdoff mode ensures that the oscilloscope re-arms after each acquisition in a manner that minimizes or eliminates the likelihood of triggering at the beginning of a DDR burst. Randomizing the holdoff increases the likelihood that the oscilloscope will trigger on different data phases of a multiphase (8 data transfer) burst. This mode mixes up the traffic pattern the oscilloscope triggers on and is very effective when used on repeating patterns.

<holdoff\_time> A real number for the maximum random holdoff time.

**Query** :TRIGger:HOLDoff:MAX?

The query returns the current maximum holdoff value for the random holdoff mode.

**Returned Format** [:TRIGger:HOLDoff:MAX] <holdoff><NL>

**History** Legacy command (existed before version 3.10).

## :TRIGger:HOLDoff:MIN

**Command** :TRIGger:HOLDoff:MIN <holdoff\_time>

This command is only used when you set the :TRIGger:HOLDoff:MODE command to RANDom. The RANDom mode varies the trigger holdoff from one acquisition to another by randomizing the time values between triggers. The randomized values can be between the values specified by the :TRIGger:HOLDoff:MAX and :TRIGger:HOLDoff:MIN commands.

The Random holdoff mode ensures that the oscilloscope re-arms after each acquisition in a manner that minimizes or eliminates the likelihood of triggering at the beginning of a DDR burst. Randomizing the holdoff increases the likelihood that the oscilloscope will trigger on different data phases of a multiphase (8 data transfer) burst. This mode mixes up the traffic pattern the oscilloscope triggers on and is very effective when used on repeating patterns.

<holdoff\_time> A real number for the minimum random holdoff time.

**Query** :TRIGger:HOLDoff:MIN?

The query returns the current minimum holdoff value for the random holdoff mode.

**Returned Format** [:TRIGger:HOLDoff:MIN] <holdoff><NL>

**History** Legacy command (existed before version 3.10).

## :TRIGger:HOLDoff:MODE

**Command** :TRIGger:HOLDoff:MAX {FIXed | RANDom}

The Fixed mode sets the amount of time that the oscilloscope waits before re-arming the trigger circuitry. It can be used to stabilize the display of complex waveforms.

The RANDom mode varies the trigger holdoff from one acquisition to another by randomizing the time values between triggers. The randomized values can be between the values specified by the :TRIGger:HOLDoff:MAX and :TRIGger:HOLDoff:MIN commands.

The Random holdoff mode ensures that the oscilloscope re-arms after each acquisition in a manner that minimizes or eliminates the likelihood of triggering at the beginning of a DDR burst. Randomizing the holdoff increases the likelihood that the oscilloscope will trigger on different data phases of a multiphase (8 data transfer) burst. This mode mixes up the traffic pattern the oscilloscope triggers on and is very effective when used on repeating patterns.

**Query** :TRIGger:HOLDoff:MODE?

The query returns the current holdoff mode.

**Returned Format** [:TRIGger:HOLDoff:MODE] {FIXed | RANDom}<NL>

**History** Legacy command (existed before version 3.10).



## :TRIGger:HTHReshold

**Command** :TRIGger:HTHReshold{{CHANnel<N> | AUXiliary},<level>}

This command specifies the high threshold voltage level for the selected trigger source. Set the high threshold level to a value considered to be a high level for your logic family; your data book gives two values,  $V_{IH}$  and  $V_{OH}$ .

<N> An integer, 1-4.

<level> A real number for the voltage level for the trigger source.

**Query** :TRIGger:HTHReshold? {CHANnel<N> | AUXiliary}

The query returns the currently defined high threshold voltage level for the trigger source.

**Returned Format** [:TRIGger:HTHReshold {CHANnel<N> | AUXiliary},] <level><NL>

**History** Legacy command (existed before version 3.10).

## :TRIGger:HYSteresis

**Command** :TRIGger:HYSteresis {NORMal | NREJect | HSENSitivity}

The :TRIGger:HYSteresis command specifies the trigger hysteresis (noise reject) as:

- NORMal – the typical hysteresis selection.
- NREJect (noise reject) – (available on 9000 Series, 9000H Series, and S-Series oscilloscopes) gives maximum hysteresis but the lowest trigger bandwidth.
- HSENSitivity – (available on 90000A Series, 90000 X-Series, V-Series, 90000 Q-Series, and Z-Series oscilloscopes) lowers the hysteresis of the trigger circuitry and should be used for waveforms of 4 GHz and above.

**Query** :TRIGger:HYSteresis?

The query returns the current hysteresis setting.

**Returned Format** [:TRIGger:HYSteresis] {NORMal | NREJect | HSENSitivity}<NL>

**History** Legacy command (existed before version 3.10).

## :TRIGger:LEVel

**Command** :TRIGger:LEVel {{CHANnel<N> | AUX},<level>}

The :TRIGger:LEVel command specifies the trigger level on the specified channel for the trigger source. Only one trigger level is stored in the oscilloscope for each channel. This level applies to the channel throughout the trigger dialog boxes (Edge, Glitch, and Advanced). This level also applies to all the High Threshold (HTHReshold) values in the Advanced Violation menus.

<N> An integer, 1-4.

<level> A real number for the trigger level on the specified channel or Auxiliary Trigger Input.

**Query** :TRIGger:LEVel? {CHANnel<N> | AUX}

The query returns the specified channel's trigger level.

**Returned Format** [:TRIGger:LEVel {CHANnel<N> | AUX},] <level><NL>

**History** Legacy command (existed before version 3.10).

## :TRIGger:LEVel:FIFTy

**Command** :TRIGger:LEVel:FIFTy

The :TRIGger:LEVel:FIFTy command sets the trigger level to 50%.

This performs the same action as the "push for 50%" front panel trigger level knob.

**See Also** • [":TRIGger:LEVel"](#) on page 1395

**History** New in version 4.30.

## :TRIGger:LTHReshold

**Command** :TRIGger:LTHReshold CHANnel<N>,<level>

This command specifies the low threshold voltage level for the selected trigger source. This command specifies the low threshold voltage level for the selected trigger source. Set the low threshold level to a value considered to be a low level for your logic family; your data book gives two values,  $V_{IL}$  and  $V_{OL}$ .

<N> An integer, 1-4.

<level> A real number for the voltage level for the trigger source.

**Query** :TRIGger:LTHReshold? CHANnel<N>

The query returns the currently defined low threshold for the trigger source.

**Returned Format** [:TRIGger:LTHReshold CHANnel<N>,<level><NL>

**History** Legacy command (existed before version 3.10).

## :TRIGger:MODE

**Command** :TRIGger:MODE {EDGE | GLITCh | PATTErn | STATE | DELay | TIMEout | TV  
| COMM | RUNT | SEQuence | SHOLd | TRANsition | WINDow  
| PWIDth | ADVanced | SBUS<N>}

The :TRIGger:MODE command selects the trigger mode.

**Table 16** :TRIGger:MODE Settings

Mode	Definition
COMM	COMM mode lets you trigger on a serial pattern of bits in a waveform.
DELay	Delay by Events mode lets you view pulses in your waveform that occur a number of events after a specified waveform edge. Delay by Time mode lets you view pulses in your waveform that occur a long time after a specified waveform edge.
EDGE	Edge trigger mode.
GLITCh	Trigger on a pulse that has a width less than a specified amount of time.
PATTErn	Pattern triggering lets you trigger the oscilloscope using more than one channel as the trigger source. You can also use pattern triggering to trigger on a pulse of a given width.
PWIDth	Pulse width triggering lets you trigger on a pulse that is greater than or less than a specified width and of a certain polarity.
RUNT	Runt triggering lets you trigger on positive or negative pulses that are smaller in amplitude than other pulses in your waveform.
SBUS<N>	Serial triggering on SBUS1, SBUS2, SBUS3, or SBUS4.
SEQuence	(Available on 90000A Series, 90000 X-Series, V-Series, 90000 Q-Series, and Z-Series oscilloscopes.) Sequential triggering lets you use multiple events or time/pattern qualifications to define your trigger.
SHOLd	Setup and Hold triggering let you trigger on Setup or Hold violations in your circuit.
STATE	State triggering lets you set the oscilloscope to use several channels as the trigger source, with one of the channels being used as a clock waveform.
TIMEout	Timeout triggering lets you trigger when the waveform remains high too long, low to long, or unchanged too long.
TRANsition	Edge Transition triggering lets you trigger on an edge that violates a rise time or fall time specification.
TV	TV trigger mode lets you trigger the oscilloscope on one of the standard television waveforms. You can also use this mode to trigger on a custom television waveform that you define.

**Table 16** :TRIGger:MODE Settings (continued)

Mode	Definition
WINDow	Window triggering lets you define a window on screen and then trigger when the waveform exits the window, enters it, or stays inside/outside the window for too long/short.
ADVanced	Allows backward compatibility access to the DELay, PATtern, STATe, TV, and VIOLation modes. When this mode is selected, use the :TRIGger:ADVanced:MODE command to select the advanced trigger mode.

**Table 17** :TRIGger:ADVanced:MODE Settings

Mode	Definition
COMM	COMM mode lets you trigger on a serial pattern of bits in a waveform.
DELay	Delay by Events mode lets you view pulses in your waveform that occur a number of events after a specified waveform edge. Delay by Time mode lets you view pulses in your waveform that occur a long time after a specified waveform edge.
PATtern	Pattern triggering lets you trigger the oscilloscope using more than one channel as the trigger source. You can also use pattern triggering to trigger on a pulse of a given width.
STATe	State triggering lets you set the oscilloscope to use several channels as the trigger source, with one of the channels being used as a clock waveform.
TV	TV trigger mode lets you trigger the oscilloscope on one of the standard television waveforms. You can also use this mode to trigger on a custom television waveform that you define.
VIOLation	Trigger violation modes: Pulse WIDTH, SETup, TRANsition. When this mode is selected, use the :TRIGger:ADVanced:VIOLation:MODE command to select the advanced trigger violation mode.

**Query** :TRIGger:MODE?

The query returns the currently selected trigger mode.

**Returned Format** [:TRIGger:MODE] {EDGE | GLITCh | PATtern | STATe | DELay | TIMEout | TV  
| COMM | RUNT | SEQuence | SHOLd | TRANsition | WINDow  
| PWIDth | ADVanced | SBUS<N>}<NL>

**History** Legacy command (existed before version 3.10).

Version 3.50: Added the SBUS1, SBUS2, SBUS3, and SBUS4 selections for triggering on serial buses.

**:TRIGger:SWEep**

**Command** :TRIGger:SWEep {AUTO | TRIGgered | SINGle}

The :TRIGger:SWEep command selects the oscilloscope sweep mode. New programs should use :RUN and :SINGle for run control and this command for AUTO and TRIGgered for sweep control. The SINGle sweep control should not be used.

**AUTO** When you select AUTO, if a trigger event does not occur within a time determined by the oscilloscope settings, the oscilloscope automatically forces a trigger which causes the oscilloscope to sweep. If the frequency of your waveform is 50 Hz or less, you should not use the AUTO sweep mode because it is possible that the oscilloscope will automatically trigger before your waveform trigger occurs.

**TRIGgered** When you select TRIGgered, if no trigger occurs, the oscilloscope will not sweep, and the previously acquired data will remain on the screen.

**SINGle** When you select SINGle, if no trigger occurs, the oscilloscope will not sweep, and the previously acquired data will remain on the screen. Do not use in new programs.

**Query** :TRIGger:SWEep?

The query returns the specified channel's trigger level.

**Returned Format** [:TRIGger:SWEep] {AUTO | TRIGgered}<NL>

**History** Legacy command (existed before version 3.10).



## Comm Trigger Commands

- `":TRIGger:COMM:BWIDth"` on page 1402
- `":TRIGger:COMM:ENCode"` on page 1403
- `":TRIGger:COMM:PATtern"` on page 1404
- `":TRIGger:COMM:POLarity"` on page 1405
- `":TRIGger:COMM:SOURce"` on page 1406

## :TRIGger:COMM:BWIDth

**Command** :TRIGger:COMM:BWIDth <bwidth\_value>

The :TRIGger:COMM:BWIDth command is used to set the width of a bit for your waveform. The bit width is usually defined in the mask standard for your waveform.

<bwidth\_value> A real number that represents the width of a bit.

**Query** :TRIGger:COMM:BWIDth?

The query returns the current bit width.

**Returned Format** [:TRIGger:COMM:BWIDth] <bwidth\_value><NL>

**History** Legacy command (existed before version 3.10).

## :TRIGger:COMM:ENCode

**Command** :TRIGger:COMM:ENCode {RZ | NRZ}

This :TRIGger:COMM:ENCode command sets the type of waveform encoding for your waveform. You should use NRZ for CMI type waveforms and RZ for all other type of waveforms.

**Query** :TRIGger:COMM:ENCode?

The :TRIGger:COMM:ENCode? query returns the current value of encoding

**Returned Format** [:TRIGger:COMM:ENCode] {RZ | NRZ}<NL>

**History** Legacy command (existed before version 3.10).

## :TRIGger:COMM:PATtern

**Command** :TRIGger:COMM:PATtern <bit>[,<bit>[,<bit>[,<bit>[,<bit>[,<bit>]]]]

The :TRIGger:COMM:PATtern command sets the pattern used for triggering the oscilloscope when in communication trigger mode. The pattern can be up to 6 bits long. For NRZ type waveforms with positive polarity, there must be at least one logic 0 to logic 1 transition in the pattern. For NRZ waveforms with negative polarity there must be at least one logic 1 to logic 0 transition in the pattern. For RZ type waveforms the pattern must have at least one logic 1 bit for positive polarity. For RZ type waveforms the pattern must have at least one logic -1 bit for negative polarity.

<bit> A 1, -1, or 0.

**Query** :TRIGger:COMM:PATtern?

The :TRIGger:COMM:PATtern? query returns the current communication trigger pattern.

**Returned Format** [:TRIGger:COMM:PATtern] <pattern><NL>

<pattern> A string of up to 6 characters.

**History** Legacy command (existed before version 3.10).

## :TRIGger:COMM:POLarity

**Command** :TRIGger:COMM:POLarity {POSitive | NEGative}

The :TRIGger:COMM:POLarity command directly controls the trigger slope used for communication trigger. When set to a positive value, the rising edge of a pulse or waveform is used to trigger the oscilloscope. When set to a negative value, the falling edge of a pulse or waveform is used.

The polarity setting is also used to check for valid patterns. If you are trying to trigger on an isolated 1 pattern, you should set the polarity to positive. If you are trying to trigger on an isolated -1 pattern, you should set the polarity to negative.

**Query** :TRIGger:COMM:POLarity?

The :TRIGger:COMM:POLarity? query returns the current setting for polarity.

**Returned Format** [:TRIGger:COMM:POLarity] {POSitive | NEGative}<NL>

**History** Legacy command (existed before version 3.10).

## :TRIGger:COMM:SOURce

**Command** :TRIGger:COMM:SOURce CHANnel<N>

The :TRIGger:COMM:SOURce command selects the channel used for the communication trigger.

<N> An integer, 1-4.

**Query** :TRIGger:COMM:SOURce?

The :TRIGger:COMM:SOURce? query returns the currently selected communication trigger source.

**Returned Format** [:TRIGger:COMM:SOURce] CHANnel<N><NL>

**History** Legacy command (existed before version 3.10).

## Delay Trigger Commands

- `":TRIGger:DElay:ARM:SOURce"` on page 1408
- `":TRIGger:DElay:ARM:SLOPe"` on page 1409
- `":TRIGger:DElay:EDElay:COUNT"` on page 1410
- `":TRIGger:DElay:EDElay:SOURce"` on page 1411
- `":TRIGger:DElay:EDElay:SLOPe"` on page 1412
- `":TRIGger:DElay:MODE"` on page 1413
- `":TRIGger:DElay:TDElay:TIME"` on page 1414
- `":TRIGger:DElay:TRIGger:SOURce"` on page 1415
- `":TRIGger:DElay:TRIGger:SLOPe"` on page 1416

## :TRIGger:DELAy:ARM:SOURce

**Command** :TRIGger:DELAy:ARM:SOURce {CHANnel<N> | DIGital<M>}

This command sets the Arm On source for arming the trigger circuitry when the oscilloscope is in the Delay trigger mode.

<N> An integer, 1-4.

<M> An integer, 0-15. Digital channels are available on mixed-signal oscilloscopes.

**Query** :TRIGger:DELAy:ARM:SOURce?

The query returns the currently defined Arm On source for the Delay trigger mode.

**Returned Format** [:TRIGger:DELAy:EDELAy:ARM:SOURce] {CHANnel<N> | DIGital<M>}<NL>

**History** Legacy command (existed before version 3.10).



## :TRIGger:DELay:ARM:SLOPe

**Command** :TRIGger:DELay:ARM:SLOPe {NEGative | POSitive}

This command sets a positive or negative slope for arming the trigger circuitry when the oscilloscope is in the Delay trigger mode.

**Query** :TRIGger:DELay:ARM:SLOPe?

The query returns the currently defined slope for the Delay trigger mode.

**Returned Format** [:TRIGger:DELay:ARM:SLOPe] {NEGative | POSitive}<NL>

**History** Legacy command (existed before version 3.10).

**:TRIGger:DELay:EDELay:COUNT**

**Command** :TRIGger:DELay:EDELay:COUNT <edge\_number>

This command sets the event count for a Delay By Event trigger event.

**<edge\_num>** An integer from 0 to 16,000,000 specifying the number of edges to delay.

**Query** :TRIGger:DELay:EDELay:COUNT?

The query returns the currently defined number of events to delay before triggering on the next Trigger On condition in the Delay By Event trigger mode.

**Returned Format** [:TRIGger:DELay:EDELay:COUNT] <edge\_number><NL>

**History** Legacy command (existed before version 3.10).

## :TRIGger:DELay:EDELay:SOURce

**Command** :TRIGger:DELay:EDELay:SOURce {CHANnel<N> | DIGital<M>}

This command sets the Event source for a Delay By Event trigger event.

<N> An integer, 1-4.

<M> An integer, 0-15. Digital channels are available on mixed-signal oscilloscopes.

**Query** :TRIGger:DELay:EDELay:SOURce?

The query returns the currently defined Event source in the Delay By Event trigger mode.

**Returned Format** [:TRIGger:DELay:EDELay:SOURce] {CHANnel<N> | DIGital<M>}<NL>

**History** Legacy command (existed before version 3.10).

### :TRIGger:DElay:EDElay:SLOPe

**Command** :TRIGger:DElay:EDElay:SLOPe {NEGative | POSitive}

This command sets the trigger slope for the Delay By Event trigger event.

**Query** :TRIGger:DElay:EDElay:SLOPe?

The query returns the currently defined slope for an event in the Delay By Event trigger mode.

**Returned Format** [:TRIGger:DElay:EDElay:SLOPe] {NEGative | POSitive}<NL>

**History** Legacy command (existed before version 3.10).

## :TRIGger:DELAy:MODE

**Command** :TRIGger:DELAy:MODE {EDELay | TDELay}

The :TRIGger:DELAy:MODE command selects the type of delay trigger mode to either events or to time.

**Query** :TRIGger:DELAy:MODE?

The query returns the currently selected delay trigger mode.

**Returned Format** [:TRIGger:DELAy:MODE] {EDELay | TDELay}<NL>

**History** Legacy command (existed before version 3.10).

## :TRIGger:DElay:TDElay:TIME

**Command** :TRIGger:DElay:TDElay:TIME <delay>

This command sets the delay for a Delay By Time trigger event.

<delay> Time, in seconds, set for the delay trigger, from 10 ns to 10 s.

**Query** :TRIGger:DElay:TDElay:TIME?

The query returns the currently defined time delay before triggering on the next Trigger On condition in the Delay By Time trigger mode.

**Returned Format** [:TRIGger:DElay:TDElay:TIME] <delay><NL>

**History** Legacy command (existed before version 3.10).

## :TRIGger:DELay:TRIGger:SOURce

**Command** :TRIGger:DELay:TRIGger:SOURce {CHANnel<N> | DIGital<M>}

This command sets the Trigger On source for a Delay trigger event.

<N> An integer, 1-4.

<M> An integer, 0-15. Digital channels are available on mixed-signal oscilloscopes.

**Query** :TRIGger:DELay:TRIGger:SOURce?

The query returns the currently defined Trigger On source in the Delay trigger mode.

**Returned Format** [:TRIGger:DELay:TRIGger:SOURce] {CHANnel<N> | DIGital<M>}<NL>

**History** Legacy command (existed before version 3.10).

### :TRIGger:DELay:TRIGger:SLOPe

**Command** :TRIGger:DELay:TRIGger:SLOPe {NEGative | POSitive}

This command sets the trigger slope for the Delay trigger event.

**Query** :TRIGger:DELay:TRIGger:SLOPe?

The query returns the currently defined slope for an event in the Delay trigger mode.

**Returned Format** [:TRIGger:DELay:TRIGger:SLOPe] {NEGative | POSitive}<NL>

**History** Legacy command (existed before version 3.10).



## Edge Trigger Commands

- **":TRIGger:EDGE:COUPling (9000 Series, 9000H Series, S-Series)"** on page 1418
- **":TRIGger:EDGE:SLOPe"** on page 1419
- **":TRIGger:EDGE:SOURce"** on page 1420

**:TRIGger:EDGE:COUPling** (9000 Series, 9000H Series, S-Series)

**Command** :TRIGger:EDGE:COUPling {AC | DC | LFReject | HFReject}

The :TRIGger:EDGE:COUPling command sets the trigger coupling when :TRIG:EDGE:SOURce is set to one of the channels.

**Query** :TRIGger:EDGE:COUPling?

The query returns the currently selected coupling for the specified edge trigger source.

**Returned Format** [:TRIGger:EDGE:COUPling] {AC | DC | LFReject | HFReject}<NL>

**History** Legacy command (existed before version 3.10).

## :TRIGger:EDGE:SLOPe

**Command** :TRIGger:EDGE[{1 | 2}]:SLOPe {POSitive | NEGative | EITHer}

The :TRIGger:EDGE:SLOPe command sets the slope of the trigger source previously selected by the :TRIGger:EDGE:SOURce command. The LINE source has no slope.

The optional [{1 | 2}] parameter sets whether the trigger mode goes with the TERM1 or TERM2 state if sequential triggering is being used. Sequential triggering is available on 90000A Series, 90000 X-Series, V-Series, 90000 Q-Series, and Z-Series oscilloscopes.

**Query** :TRIGger:EDGE:SLOPe?

The query returns the currently selected slope for the specified edge trigger source.

**Returned Format** [:TRIGger:EDGE:SLOPe] {POSitive | NEGative | EITHer}<NL>

**History** Legacy command (existed before version 3.10).

**:TRIGger:EDGE:SOURce**

**Command** :TRIGger:EDGE[{1 | 2}]:SOURce {CHANnel<N> | DIGital<M> | AUX | LINE}

The :TRIGger:EDGE:SOURce command selects the source for edge mode triggering. This is the source that will be used for subsequent :TRIGger:EDGE:SLOPe commands or queries.

**NOTE**

The optional [{1 | 2}] parameter sets whether the trigger mode goes with the TERM1 or TERM2 state if sequential triggering is being used. Sequential triggering is available on 90000A Series, 90000 X-Series, V-Series, 90000 Q-Series, and Z-Series oscilloscopes.

**NOTE**

The LINE parameter is not available with the 90000 Q-Series or Z-Series oscilloscopes.

<N> An integer, 1-4.

<M> An integer, 0-15. Digital channels are available on mixed-signal oscilloscopes.

**Query** :TRIGger:EDGE:SOURce?

The query returns the currently selected edge mode trigger source.

**Returned Format** [:TRIGger:EDGE:SOURce] {CHANnel<N> | DIGital<M> | AUX | LINE}<NL>

**History** Legacy command (existed before version 3.10).

## GBSerial Trigger Commands

- [":TRIGger:GBSerial:CLOCK \(V-Series with HWST Option\)"](#) on page 1422
- [":TRIGger:GBSerial:CLOCK:FREQuency \(V-Series with HWST Option\)"](#) on page 1423
- [":TRIGger:GBSerial:DRATe \(V-Series with HWST Option\)"](#) on page 1425
- [":TRIGger:GBSerial:MODE \(V-Series with HWST Option\)"](#) on page 1427
- [":TRIGger:GBSerial:PATTeRn \(V-Series with HWST Option\)"](#) on page 1428
- [":TRIGger:GBSerial:POLarity \(V-Series with HWST Option\)"](#) on page 1429
- [":TRIGger:GBSerial:PRBS \(V-Series with HWST Option\)"](#) on page 1430
- [":TRIGger:GBSerial:SOURce \(V-Series with HWST Option\)"](#) on page 1431

**:TRIGger:GBSerial:CLOCK (V-Series with HWST Option)**

**Command** :TRIGger:GBSerial:CLOCK <refclk>  
 <refclk> ::= {INTernal | EXTernal}

The :TRIGger:GBSerial:CLOCK command specifies whether an INTernal or EXTernal reference clock (and internal multipliers) are used to support the selected data rate (see :TRIGger:GBSerial:DRATe).

External reference clock signals are supplied to a BNC connector on the oscilloscope's hardware serial trigger I/O panel. When you use an external reference clock, its frequency is specified using the :TRIGger:GBSerial:CLOCK:FREQuency command.

**Query** :TRIGger:GBSerial:CLOCK?

The :TRIGger:GBSerial:CLOCK? query returns the reference clock selection.

**Returned Format** [:TRIGger:GBSerial:CLOCK] <refclk><NL>  
 <refclk> ::= {INTernal | EXTernal}

- See Also**
- [":TRIGger:GBSerial:CLOCK:FREQuency \(V-Series with HWST Option\)"](#) on page 1423
  - [":TRIGger:GBSerial:DRATe \(V-Series with HWST Option\)"](#) on page 1425
  - [":TRIGger:GBSerial:MODE \(V-Series with HWST Option\)"](#) on page 1427
  - [":TRIGger:GBSerial:PATtern \(V-Series with HWST Option\)"](#) on page 1428
  - [":TRIGger:GBSerial:POLarity \(V-Series with HWST Option\)"](#) on page 1429
  - [":TRIGger:GBSerial:PRBS \(V-Series with HWST Option\)"](#) on page 1430
  - [":TRIGger:GBSerial:SOURce \(V-Series with HWST Option\)"](#) on page 1431

**History** New in version 5.50.

## :TRIGger:GBSerial:CLOCK:FREQuency (V-Series with HWST Option)

**Command** :TRIGger:GBSerial:CLOCK:FREQuency <value>

<value> ::= Hertz in NR3 format.

When an external reference clock is used, the :TRIGger:GBSerial:CLOCK:FREQuency command specifies its frequency.

In most cases, depending on the serial signal data rate, a single specific reference clock is required. However, for some data rates, multiple reference clock frequencies can be used; in these cases, you use the :TRIGger:GBSerial:CLOCK:FREQuency command to specify the frequency of the external reference clock signal.

Serial Signal Data Rate	Required Reference Clock Frequency
480 Mb/s	96 MHz
2.5 Gb/s	100 MHz
4 Gb/s	200 MHz
5 Gb/s	100 MHz
6 Gb/s	75 MHz
8 Gb/s	100 MHz
10 Gb/s	100 MHz
10.3125 Gb/s	103.125 MHz or 156.25 MHz
10.3725 Gb/s	103.725 MHz
10.75 Gb/s	107.5 MHz
12 Gb/s	120 MHz
12.125 Gb/s	121.25 MHz
12.5 Gb/s	125 MHz

**Query** :TRIGger:GBSerial:CLOCK:FREQuency?

The :TRIGger:GBSerial:CLOCK:FREQuency? query returns the external reference clock frequency.

**Returned Format** [:TRIGger:GBSerial:CLOCK:FREQuency] <value><NL>

<value> ::= Hertz in NR3 format.

- See Also**
- [":TRIGger:GBSerial:CLOCK \(V-Series with HWST Option\)"](#) on page 1422
  - [":TRIGger:GBSerial:DRATE \(V-Series with HWST Option\)"](#) on page 1425
  - [":TRIGger:GBSerial:MODE \(V-Series with HWST Option\)"](#) on page 1427
  - [":TRIGger:GBSerial:PATTERN \(V-Series with HWST Option\)"](#) on page 1428

- **":TRIGger:GBSerial:POLarity (V-Series with HWST Option)"** on page 1429
- **":TRIGger:GBSerial:PRBS (V-Series with HWST Option)"** on page 1430
- **":TRIGger:GBSerial:SOURce (V-Series with HWST Option)"** on page 1431

**History** New in version 5.50.



## :TRIGger:GBSerial:DRATe (V-Series with HWST Option)

**Command** :TRIGger:GBSerial:DRATe <bps>

<bps> ::= bits/second in NR3 format.

The :TRIGger:GBSerial:DRATe command specifies the data rate of the serial signal. These common data rate values are supported:

- 480 Mb/s.
- 2.5 Gb/s.
- 4 Gb/s.
- 5 Gb/s.
- 6 Gb/s.
- 8 Gb/s.
- 10 Gb/s.
- 10.3125 Gb/s.
- 10.3725 Gb/s.
- 10.75 Gb/s.
- 12 Gb/s.
- 12.125 Gb/s.
- 12.5 Gb/s.

These data rates are supported in hardware using an internal reference clock and multipliers. You can also supply an external reference clock to a BNC connector on the oscilloscope's hardware serial trigger I/O panel. You can choose between the internal reference clock and an external reference clock using the :TRIGger:GBSerial:CLOCK command. When you use an external reference clock, its frequency is specified using the :TRIGger:GBSerial:CLOCK:FREQUENCY command.

**Query** :TRIGger:GBSerial:DRATe?

The :TRIGger:GBSerial:DRATe? query returns the specified serial signal data rate.

**Returned Format** [:TRIGger:GBSerial:DRATe] <bps><NL>

<bps> ::= bits/second in NR3 format.

- See Also**
- [":TRIGger:GBSerial:CLOCK \(V-Series with HWST Option\)"](#) on page 1422
  - [":TRIGger:GBSerial:CLOCK:FREQUENCY \(V-Series with HWST Option\)"](#) on page 1423
  - [":TRIGger:GBSerial:MODE \(V-Series with HWST Option\)"](#) on page 1427
  - [":TRIGger:GBSerial:PATTERN \(V-Series with HWST Option\)"](#) on page 1428
  - [":TRIGger:GBSerial:POLARity \(V-Series with HWST Option\)"](#) on page 1429
  - [":TRIGger:GBSerial:PRBS \(V-Series with HWST Option\)"](#) on page 1430

- **":TRIGger:GBSerial:SOURce (V-Series with HWST Option)"** on page 1431

**History** New in version 5.50.

## :TRIGger:GBSerial:MODE (V-Series with HWST Option)

**Command** :TRIGger:GBSerial:MODE <mode>  
 <mode> ::= {GENeric | GEN8B10B | PERRor}

The :TRIGger:GBSerial:MODE command selects the hardware serial trigger mode:

- GENeric – To trigger on "generic" sequences.  
 This mode is used for simple sequences of 1s and 0s (see :TRIGger:GBSerial:PATtern), such as during a power-up sequence where there may be a unique sequence to trigger on.

- GEN8B10B – To trigger on 8b/10b sequences.

In the front panel user interface, you can specify the number of words and choose from K or D codes. In the remote user interface, you are limited to specifying patterns as binary bit sequences, just as in the GENeric mode (see :TRIGger:GBSerial:PATtern)

- PERRor – To trigger on PRBS errors.

This mode lets you select the type of PRBS pattern to compare against (see :TRIGger:GBSerial:PRBS) and its polarity (see :TRIGger:GBSerial:POLarity).

**Query** :TRIGger:GBSerial:MODE?

The :TRIGger:GBSerial:MODE? query returns the currently selected mode.

**Returned Format** [:TRIGger:GBSerial:MODE] <mode><NL>  
 <mode> ::= {GEN | GEN8B10B | PERR}

- See Also**
- [":TRIGger:GBSerial:CLOCK \(V-Series with HWST Option\)"](#) on page 1422
  - [":TRIGger:GBSerial:CLOCK:FREQUENCY \(V-Series with HWST Option\)"](#) on page 1423
  - [":TRIGger:GBSerial:DRATE \(V-Series with HWST Option\)"](#) on page 1425
  - [":TRIGger:GBSerial:PATtern \(V-Series with HWST Option\)"](#) on page 1428
  - [":TRIGger:GBSerial:POLarity \(V-Series with HWST Option\)"](#) on page 1429
  - [":TRIGger:GBSerial:PRBS \(V-Series with HWST Option\)"](#) on page 1430
  - [":TRIGger:GBSerial:SOURce \(V-Series with HWST Option\)"](#) on page 1431

**History** New in version 5.50.

## :TRIGger:GBSerial:PATtern (V-Series with HWST Option)

**Command** :TRIGger:GBSerial:PATtern "<pattern>"

<pattern> ::= binary number string up to 160 bits

When triggering on "generic" sequences or 8b/10b sequences (see :TRIGger:GBSerial:MODE), the :TRIGger:GBSerial:PATtern command specifies the bit pattern to trigger on. The bit pattern can be up to 160 bits.

**Query** :TRIGger:GBSerial:PATtern?

The :TRIGger:GBSerial:PATtern? query returns the currently specified bit pattern.

**Returned Format** [:TRIGger:GBSerial:PATtern] "<pattern>"<NL>

<pattern> ::= binary number string up to 160 bits

- See Also**
- [":TRIGger:GBSerial:CLOCK \(V-Series with HWST Option\)"](#) on page 1422
  - [":TRIGger:GBSerial:CLOCK:FREQUENCY \(V-Series with HWST Option\)"](#) on page 1423
  - [":TRIGger:GBSerial:DRATe \(V-Series with HWST Option\)"](#) on page 1425
  - [":TRIGger:GBSerial:MODE \(V-Series with HWST Option\)"](#) on page 1427
  - [":TRIGger:GBSerial:POLarity \(V-Series with HWST Option\)"](#) on page 1429
  - [":TRIGger:GBSerial:PRBS \(V-Series with HWST Option\)"](#) on page 1430
  - [":TRIGger:GBSerial:SOURce \(V-Series with HWST Option\)"](#) on page 1431

**History** New in version 5.50.

## :TRIGger:GBSerial:POLarity (V-Series with HWST Option)

**Command** :TRIGger:GBSerial:POLarity <polarity>  
 <polarity> ::= {POSitive | NEGative}

When triggering on PRBS errors (see :TRIGger:GBSerial:MODE), the :TRIGger:GBSerial:POLarity command specifies the polarity of the selected PRBS pattern.

**Query** :TRIGger:GBSerial:POLarity?

The :TRIGger:GBSerial:POLarity? query returns the specified PRBS pattern polarity.

**Returned Format** [:TRIGger:GBSerial:POLarity] <polarity><NL>  
 <polarity> ::= {POSitive | NEGative}

- See Also**
- [":TRIGger:GBSerial:CLOCK \(V-Series with HWST Option\)"](#) on page 1422
  - [":TRIGger:GBSerial:CLOCK:FREQUENCY \(V-Series with HWST Option\)"](#) on page 1423
  - [":TRIGger:GBSerial:DRATE \(V-Series with HWST Option\)"](#) on page 1425
  - [":TRIGger:GBSerial:MODE \(V-Series with HWST Option\)"](#) on page 1427
  - [":TRIGger:GBSerial:PATTERN \(V-Series with HWST Option\)"](#) on page 1428
  - [":TRIGger:GBSerial:PRBS \(V-Series with HWST Option\)"](#) on page 1430
  - [":TRIGger:GBSerial:SOURce \(V-Series with HWST Option\)"](#) on page 1431

**History** New in version 5.50.

## :TRIGger:GBSerial:PRBS (V-Series with HWST Option)

**Command** :TRIGger:GBSerial:PRBS <type>

<type> ::= {PRBS7 | PRBS15 | PRBS23 | PRBS31}

When triggering on PRBS errors (see :TRIGger:GBSerial:MODE), the :TRIGger:GBSerial:PRBS command specifies the pattern to check when looking for errors. You can select PRBS 7, 15, 23, or 31 patterns.

**Query** :TRIGger:GBSerial:PRBS?

The :TRIGger:GBSerial:PRBS? query returns the selected PRBS pattern.

**Returned Format** [:TRIGger:GBSerial:PRBS] <type><NL>

<type> ::= {PRBS7 | PRBS15 | PRBS23 | PRBS31}

- See Also**
- [":TRIGger:GBSerial:CLOCK \(V-Series with HWST Option\)"](#) on page 1422
  - [":TRIGger:GBSerial:CLOCK:FREQUENCY \(V-Series with HWST Option\)"](#) on page 1423
  - [":TRIGger:GBSerial:DRATE \(V-Series with HWST Option\)"](#) on page 1425
  - [":TRIGger:GBSerial:MODE \(V-Series with HWST Option\)"](#) on page 1427
  - [":TRIGger:GBSerial:PATTERN \(V-Series with HWST Option\)"](#) on page 1428
  - [":TRIGger:GBSerial:POLARITY \(V-Series with HWST Option\)"](#) on page 1429
  - [":TRIGger:GBSerial:SOURCE \(V-Series with HWST Option\)"](#) on page 1431

**History** New in version 5.50.

## :TRIGger:GBSerial:SOURce (V-Series with HWST Option)

**Command** :TRIGger:GBSerial:SOURce CHANnel1

The :TRIGger:GBSerial:SOURce command specifies the oscilloscope input channel on which the hardware serial trigger operates. This is always CHANnel1.

**Query** :TRIGger:GBSerial:SOURce?

The :TRIGger:GBSerial:SOURce? query returns the oscilloscope input channel on which the hardware serial trigger operates. This is always CHANnel1.

**Returned Format** [:TRIGger:GBSerial:SOURce] <source><NL>  
<source> ::= CHANnel1

- See Also**
- [":TRIGger:GBSerial:CLOCK \(V-Series with HWST Option\)"](#) on page 1422
  - [":TRIGger:GBSerial:CLOCK:FREQuency \(V-Series with HWST Option\)"](#) on page 1423
  - [":TRIGger:GBSerial:DRATe \(V-Series with HWST Option\)"](#) on page 1425
  - [":TRIGger:GBSerial:MODE \(V-Series with HWST Option\)"](#) on page 1427
  - [":TRIGger:GBSerial:PATtern \(V-Series with HWST Option\)"](#) on page 1428
  - [":TRIGger:GBSerial:POLarity \(V-Series with HWST Option\)"](#) on page 1429
  - [":TRIGger:GBSerial:PRBS \(V-Series with HWST Option\)"](#) on page 1430

**History** New in version 5.50.

## Glitch Trigger Commands

- `":TRIGger:GLITch:POLarity"` on page 1433
- `":TRIGger:GLITch:SOURce"` on page 1434
- `":TRIGger:GLITch:WIDTh"` on page 1435



**:TRIGger:GLITch:POLarity**

**Command** :TRIGger:GLITch[{1 | 2}]:POLarity {POSitive | NEGative}

This command defines the polarity of the glitch as positive or negative. The trigger source must be set using the :TRIGger:GLITch:SOURce command.

The optional [{1 | 2}] parameter sets whether the trigger mode goes with the TERM1 or TERM2 state if sequential triggering is being used. Sequential triggering is available on 90000A Series, 90000 X-Series, V-Series, 90000 Q-Series, and Z-Series oscilloscopes.

**Query** :TRIGger:GLITch:POLarity?

The query returns the currently selected glitch polarity.

**Returned Format** [:TRIGger:GLITch:POLarity] {POS | NEG}<NL>

**History** Legacy command (existed before version 3.10).

**:TRIGger:GLITch:SOURce**

**Command** :TRIGger:GLITch[{1 | 2}]:SOURce {CHANnel<N> | DIGital<M>}

This command sets the source for the glitch trigger mode.

The optional [{1 | 2}] parameter sets whether the trigger mode goes with the TERM1 or TERM2 state if sequential triggering is being used. Sequential triggering is available on 90000A Series, 90000 X-Series, V-Series, 90000 Q-Series, and Z-Series oscilloscopes.

<N> An integer, 1-4.

<M> An integer, 0-15. Digital channels are available on mixed-signal oscilloscopes.

**Query** :TRIGger:GLITch:SOURce?

The query returns the currently selected source for the glitch trigger mode.

**Returned Format** [:TRIGger:GLITch:SOURce] {CHANnel<N> | DIGital<M>}<NL>

**History** Legacy command (existed before version 3.10).

**:TRIGger:GLITch:WIDTh**

**Command** :TRIGger:GLITch[{1 | 2}]:WIDTh <width>

This command sets the glitch width. The oscilloscope will trigger on a pulse that has a width less than the specified width.

The optional [{1 | 2}] parameter sets whether the trigger mode goes with the TERM1 or TERM2 state if sequential triggering is being used. Sequential triggering is available on 90000A Series, 90000 X-Series, V-Series, 90000 Q-Series, and Z-Series oscilloscopes.

<width> A real number for the glitch width, ranging from the minimum detectable pulse width to 10 s.

**Query** :TRIGger:GLITch:WIDTh?

The query returns the currently specified glitch width.

**Returned Format** [:TRIGger:GLITch:WIDTh] <width><NL>

**History** Legacy command (existed before version 3.10).

## Pattern Trigger Commands

- **":TRIGger:PATtern:CONDition"** on page 1437
- **":TRIGger:PATtern:LOGic"** on page 1438

## :TRIGger:PATtern:CONDition

**Command** :TRIGger:PATtern[{1 | 2}]:CONDition {ENTERed | EXITEd  
 | {GT,<time>[, PEXits|TIMEout]}  
 | {LT,<time>}  
 | {RANGe,<gt\_time>,<lt\_time>}  
 | OR}

This command describes the condition applied to the trigger pattern to actually generate a trigger.

The optional [{1 | 2}] parameter sets whether the trigger mode goes with the TERM1 or TERM2 state if sequential triggering is being used. Sequential triggering is available on 90000A Series, 90000 X-Series, V-Series, 90000 Q-Series, and Z-Series oscilloscopes.

**<gt\_time>** The minimum time (greater than time) for the trigger pattern, from 10 ns to 9.999 s.

**<lt\_time>** The maximum time (less than time) for the trigger pattern, from 10.5 ps to 10 s.

**<time>** The time condition, in seconds, for the pattern trigger, from 100 ps to 10 s.

When using the GT (Present >) parameter, the PEXits (Pattern Exits) or the TIMEout parameter controls when the trigger is generated.

**Query** :TRIGger:PATtern:CONDition?

The query returns the currently defined trigger condition.

**Returned Format** [:TRIGger:PATtern:CONDition] {ENTERed|EXITEd  
 | {GT,<time>[, PEXits|TIMEout]}  
 | {LT,<time>}  
 | {RANGe,<gt\_time>,<lt\_time>}  
 | OR}<NL>

**History** Legacy command (existed before version 3.10).

Version 6.20: The OR parameter has been added.

## :TRIGger:PATtern:LOGic

**Command** :TRIGger:PATtern[{1 | 2}]:LOGic {CHANnel<N> | DIGital<M>},  
{HIGH | LOW | DONTcare | RISing | FALLing}

This command defines the logic criteria for a selected channel.

The optional [{1 | 2}] parameter sets whether the trigger mode goes with the TERM1 or TERM2 state if sequential triggering is being used. Sequential triggering is available on 90000A Series, 90000 X-Series, V-Series, 90000 Q-Series, and Z-Series oscilloscopes.

<N> An integer, 1-4.

<M> An integer, 0-15. Digital channels are available on mixed-signal oscilloscopes.

**Query** :TRIGger:PATtern:LOGic? {CHANnel<N> | DIGital<M>}

The query returns the current logic criteria for a selected channel.

**Returned Format** [:TRIGger:PATtern:LOGic {CHANnel<N> | DIGital<M>},]  
{HIGH | LOW | DONTcare | RISing | FALLing}<NL>

**History** Legacy command (existed before version 3.10).

## Pulse Width Trigger Commands

- `":TRIGger:PWIDth:DIRection"` on page 1440
- `":TRIGger:PWIDth:POLarity"` on page 1441
- `":TRIGger:PWIDth:SOURce"` on page 1442
- `":TRIGger:PWIDth:TPOint"` on page 1443
- `":TRIGger:PWIDth:WIDTh"` on page 1444

## :TRIGger:PWIDth:DIRection

**Command** :TRIGger:PWIDth[{1 | 2}]:DIRection {GTHan | LTHan}

This command specifies whether a pulse must be wider or narrower than the width value to trigger the oscilloscope.

The optional [{1 | 2}] parameter sets whether the trigger mode goes with the TERM1 or TERM2 state if sequential triggering is being used. Sequential triggering is available on 90000A Series, 90000 X-Series, V-Series, 90000 Q-Series, and Z-Series oscilloscopes.

**Query** :TRIGger:PWIDth:DIRection?

The query returns the currently defined direction for the pulse width trigger.

**Returned Format** [:TRIGger:PWIDth:DIRection] {GTHan | LTHan}<NL>

**History** Legacy command (existed before version 3.10).



## :TRIGger:PWIDth:POLarity

**Command** :TRIGger:PWIDth[{1 | 2}]:POLarity {NEGative | POSitive}

This command specifies the pulse polarity that the oscilloscope uses to determine a pulse width violation. For a negative polarity pulse, the oscilloscope triggers when the rising edge of a pulse crosses the trigger level. For a positive polarity pulse, the oscilloscope triggers when the falling edge of a pulse crosses the trigger level.

The optional [{1 | 2}] parameter sets whether the trigger mode goes with the TERM1 or TERM2 state if sequential triggering is being used. Sequential triggering is available on 90000A Series, 90000 X-Series, V-Series, 90000 Q-Series, and Z-Series oscilloscopes.

**Query** :TRIGger:PWIDth:POLarity?

The query returns the currently defined polarity for the pulse width trigger.

**Returned Format** [:TRIGger:PWIDth:POLarity] {NEGative | POSitive}<NL>

**History** Legacy command (existed before version 3.10).

**:TRIGger:PWIDth:SOURce**

**Command** :TRIGger:PWIDth[{1 | 2}]:SOURce {CHANnel<N> | DIGital<M>}

This command specifies the channel source used to trigger the oscilloscope with the pulse width trigger.

The optional [{1 | 2}] parameter sets whether the trigger mode goes with the TERM1 or TERM2 state if sequential triggering is being used. Sequential triggering is available on 90000A Series, 90000 X-Series, V-Series, 90000 Q-Series, and Z-Series oscilloscopes.

<N> An integer, 1-4.

<M> An integer, 0-15. Digital channels are available on mixed-signal oscilloscopes.

**Query** :TRIGger:PWIDth:SOURce?

The query returns the currently defined channel source for the pulse width trigger.

**Returned Format** [:TRIGger:PWIDth:SOURce] {CHANnel<N> | DIGital<M>}<NL>

**History** Legacy command (existed before version 3.10).

## :TRIGger:PWIDth:TPOint

**Command** :TRIGger:PWIDth[{1 | 2}]:TPOint {EPULse | TIMEout}

This command specifies whether the pulse width trigger should occur at the end of the pulse or at a specified timeout period. This command is available only when the pulse direction is set to GTHan.

The optional [{1 | 2}] parameter sets whether the trigger mode goes with the TERM1 or TERM2 state if sequential triggering is being used. Sequential triggering is available on 90000A Series, 90000 X-Series, V-Series, 90000 Q-Series, and Z-Series oscilloscopes.

**Query** :TRIGger:PWIDth:TPOint?

The query returns the currently defined trigger on point for the pulse width trigger.

**Returned Format** [:TRIGger:PWIDth:TPOint] {EPULse | TIMEout}<NL>

**History** Legacy command (existed before version 3.10).

**:TRIGger:PWIDth:WIDTh**

**Command** :TRIGger:PWIDth[{1 | 2}]:WIDTh <width>

This command specifies how wide a pulse must be to trigger the oscilloscope.

The optional [{1 | 2}] parameter sets whether the trigger mode goes with the TERM1 or TERM2 state if sequential triggering is being used. Sequential triggering is available on 90000A Series, 90000 X-Series, V-Series, 90000 Q-Series, and Z-Series oscilloscopes.

<width> Pulse width, which can range from 250 ps to 10 s.

**Query** :TRIGger:PWIDth:WIDTh?

The query returns the currently defined width for the pulse.

**Returned Format** [:TRIGger:PWIDth:WIDTh] <width><NL>

**History** Legacy command (existed before version 3.10).

## Runt Trigger Commands

- `":TRIGger:RUNT:POLarity"` on page 1446
- `":TRIGger:RUNT:QUALified"` on page 1447
- `":TRIGger:RUNT:SOURce"` on page 1448
- `":TRIGger:RUNT:TIME"` on page 1449

## :TRIGger:RUNT:POLarity

**Command** :TRIGger:RUNT[{1 | 2}]:POLarity {POSitive | NEGative}

This command defines the polarity of the runt pulse as positive or negative. The trigger source must be set using the :TRIGger:RUNT:SOURce command.

The optional [{1 | 2}] parameter sets whether the trigger mode goes with the TERM1 or TERM2 state if sequential triggering is being used. Sequential triggering is available on 90000A Series, 90000 X-Series, V-Series, 90000 Q-Series, and Z-Series oscilloscopes.

**Query** :TRIGger:RUNT:POLarity?

The query returns the currently selected runt pulse polarity.

**Returned Format** [:TRIGger:RUNT:POLarity] {POSitive | NEGative}<NL>

**History** Legacy command (existed before version 3.10).

## :TRIGger:RUNT:QUALified

**Command** :TRIGger:RUNT[{1 | 2}]:QUALified {{ON | 1} | {OFF | 0}}

This command enables the time qualified runt pulse feature the polarity of the runt pulse as positive or negative. The trigger source must be set using the :TRIGger:RUNT:SOURce command.

The optional [{1 | 2}] parameter sets whether the trigger mode goes with the TERM1 or TERM2 state if sequential triggering is being used. Sequential triggering is available on 90000A Series, 90000 X-Series, V-Series, 90000 Q-Series, and Z-Series oscilloscopes.

**Query** :TRIGger:RUNT:QUALified?

The query returns the current state of the time qualified runt pulse feature.

**Returned Format** [:TRIGger:RUNT:QUALified] {1 | 0}<NL>

**History** Legacy command (existed before version 3.10).

**:TRIGger:RUNT:SOURce**

**Command** :TRIGger:RUNT[{1 | 2}]:SOURce CHANnel<N>

This command sets the source for the runt trigger mode.

The optional [{1 | 2}] parameter sets whether the trigger mode goes with the TERM1 or TERM2 state if sequential triggering is being used. Sequential triggering is available on 90000A Series, 90000 X-Series, V-Series, 90000 Q-Series, and Z-Series oscilloscopes.

<N> An integer, 1-4.

**Query** :TRIGger:RUNT:SOURce?

The query returns the currently selected source for the runt trigger mode.

**Returned Format** [:TRIGger:RUNT:SOURce] CHANnel<N><NL>

**History** Legacy command (existed before version 3.10).



**:TRIGger:RUNT:TIME**

**Command** :TRIGger:RUNT[{1 | 2}]:TIME <time>

This command sets the time qualifier. The oscilloscope will trigger on a runt pulse that has a width greater than the specified time.

The optional [{1 | 2}] parameter sets whether the trigger mode goes with the TERM1 or TERM2 state if sequential triggering is being used. Sequential triggering is available on 90000A Series, 90000 X-Series, V-Series, 90000 Q-Series, and Z-Series oscilloscopes.

<time> A real number for the time greater than qualifier, ranging from 250 ps to 30 ns.

**Query** :TRIGger:RUNT:TIME?

The query returns the currently specified glitch width.

**Returned Format** [:TRIGger:RUNT:TIME] <time><NL>

**History** Legacy command (existed before version 3.10).

## Sequence Trigger Commands

The sequence trigger commands are available on S-Series, 90000A Series, 90000 X-Series, V-Series, 90000 Q-Series, and Z-Series oscilloscopes.

- **":TRIGger:SEquence:TERM1 (S-Series, 90000A Series, 90000 X-Series, V-Series, 90000 Q-Series, Z-Series)"** on page 1451
- **":TRIGger:SEquence:TERM2 (S-Series, 90000A Series, 90000 X-Series, V-Series, 90000 Q-Series, Z-Series)"** on page 1452
- **":TRIGger:SEquence:RESet:ENABle (S-Series, 90000A Series, 90000 X-Series, V-Series, 90000 Q-Series, Z-Series)"** on page 1453
- **":TRIGger:SEquence:RESet:TYPE (S-Series, 90000A Series, 90000 X-Series, V-Series, 90000 Q-Series, Z-Series)"** on page 1454
- **":TRIGger:SEquence:RESet:EVENT (S-Series, 90000A Series, 90000 X-Series, V-Series, 90000 Q-Series, Z-Series)"** on page 1455
- **":TRIGger:SEquence:RESet:TIME (S-Series, 90000A Series, 90000 X-Series, V-Series, 90000 Q-Series, Z-Series)"** on page 1456
- **":TRIGger:SEquence:WAIT:ENABle (S-Series, 90000A Series, 90000 X-Series, V-Series, 90000 Q-Series, Z-Series)"** on page 1457
- **":TRIGger:SEquence:WAIT:TIME (S-Series, 90000A Series, 90000 X-Series, V-Series, 90000 Q-Series, Z-Series)"** on page 1458

## :TRIGger:SEquence:TERM1 (S-Series, 90000A Series, 90000 X-Series, V-Series, 90000 Q-Series, Z-Series)

**Command** :TRIGger:SEquence:TERM1 { EDGE1 | GLITCh1 | PWIDTh1 | PATTeRn1 | RUNT1  
| SHOLd1 | STATe1 | TIMEout1 | TRANsition1 | WINDow1 }

This command specifies the trigger mode for the TERM1 state in the sequential trigger (the Find (A) state in the Trigger Setup dialog box on the oscilloscope).

For the Pattern/State trigger mode, use STATe1 when there is an edge in the pattern; otherwise, use PATTeRn1 when there are only zeros, ones, and don't cares in the pattern.

There are five limitations associated with sequential triggering:

- 1 The Edge followed by Edge and Video trigger modes cannot be used in sequential triggering.
- 2 The AND qualifier cannot be used when the Reset condition is based upon a logical pattern.
- 3 The Pattern/State trigger mode that uses range as the When Pattern selection can only be used for either the Term1 state or the Term2 state, but not both.
- 4 You can only use one long timer (>30 ns). Therefore, trigger modes that use timers greater than 30 ns can only be used for either the Term1 state or the Term2 state, but not both. Some examples of trigger modes where you might use a long timer include Pulse Width, Glitch, Window, Edge Transition, and Timeout.
- 5 The alternating edge trigger mode cannot be used in sequential triggering.

Limitations (3) and (4) deal with extended resources. Extended resources refer to trigger modes or conditions that are available to either the Term1 state or the Term2 state, but not both at the same time. The oscilloscope will figure out which state has access to these extended resources based upon the conditions you setup in each of these states. If you want Term2 to have a timer longer than 30 ns, you must first change the timer associated with Term1 to be less than 30 ns.

**Query** :TRIGger:SEquence:TERM1?

The query returns the currently defined trigger mode for the TERM1 state.

**History** Legacy command (existed before version 3.10).

## :TRIGger:SEQuence:TERM2 (S-Series, 90000A Series, 90000 X-Series, V-Series, 90000 Q-Series, Z-Series)

**Command** :TRIGger:SEQuence:TERM2 { EDGE2 | GLITCh2 | PWIDTh2 | PATTErn2 | RUNT2  
| SHOLd2 | STATe2 | TIMEout2 | TRANsition2 | WINDow2 }

This command specifies the trigger mode for the TERM2 state in the sequential trigger (the Trigger (B) state in the Trigger Setup dialog box on the oscilloscope).

For the Pattern/State trigger mode, use STATe2 when there is an edge in the pattern; otherwise, use PATTErn2 when there are only zeros, ones, and don't cares in the pattern.

There are five limitations associated with sequential triggering:

- 1 The Edge followed by Edge and Video trigger modes cannot be used in sequential triggering.
- 2 The AND qualifier cannot be used when the Reset condition is based upon a logical pattern.
- 3 The Pattern/State trigger mode that uses range as the When Pattern selection can only be used for either the Term1 state or the Term2 state, but not both.
- 4 You can only use one long timer (>30 ns). Therefore, trigger modes that use timers greater than 30 ns can only be used for either the Term1 state or the Term2 state, but not both. Some examples of trigger modes where you might use a long timer include Pulse Width, Glitch, Window, Edge Transition, and Timeout.
- 5 The alternating edge trigger mode cannot be used in sequential triggering.

Limitations (3) and (4) deal with extended resources. Extended resources refer to trigger modes or conditions that are available to either the Term1 state or the Term2 state, but not both at the same time. The oscilloscope will figure out which state has access to these extended resources based upon the conditions you setup in each of these states. If you want Term2 to have a timer longer than 30 ns, you must first change the timer associated with Term1 to be less than 30 ns.

**Query** :TRIGger:SEQuence:TERM2?

The query returns the currently defined trigger mode for the TERM2 state.

**History** Legacy command (existed before version 3.10).

## :TRIGger:SEQuence:RESet:ENABle (S-Series, 90000A Series, 90000 X-Series, V-Series, 90000 Q-Series, Z-Series)

**Command** :TRIGger:SEQuence:RESet:ENABle {{ON | 1} | {OFF | 0}}

This command turns the Reset feature on or off for the sequential trigger.

The Reset feature allows you to specify a length of time such that if this time is exceeded between when the TERM1 event occurs and when the TERM2 event occurs, the sequential trigger is reset and the oscilloscope returns to looking for the TERM1 event without triggering. If the Delay feature (remote command :WAIT) is used as well then the Reset timer does not start counting down until after the delay period is complete.

You can also base the Reset condition on a logical pattern. If the specified pattern is found between when the TERM1 occurs and the TERM2 event occurs, the sequential trigger resets and goes back to looking for the TERM1 event without triggering. The delay feature does not impact a logical pattern Reset as the pattern is searched for immediately after the TERM1 event occurs regardless of whether or not the Delay period is complete.

If the Reset feature is enabled, the AND qualifier cannot be used for the TERM1 state.

**Query** :TRIGger:SEQuence:RESet:ENABle?

The query returns whether or not the Reset feature is enabled.

**History** Legacy command (existed before version 3.10).

:TRIGger:SEQuence:RESet:TYPE (S-Series, 90000A Series, 90000 X-Series, V-Series, 90000 Q-Series, Z-Series)

**Command** :TRIGger:SEQuence:RESet:TYPE { TIME | EVENT }

This command specifies whether the Reset condition is based upon a length of time or a logical pattern.

The Reset feature allows you to specify a length of time such that if this time is exceeded between when the TERM1 event occurs and when the TERM2 event occurs, the sequential trigger is reset and the oscilloscope returns to looking for the TERM1 event without triggering. If the Delay feature (remote command :WAIT) is used as well then the Reset timer does not start counting down until after the delay period is complete.

You can also base the Reset condition on a logical pattern. If the specified pattern is found between when the TERM1 occurs and the TERM2 event occurs, the sequential trigger resets and goes back to looking for the TERM1 event without triggering. The delay feature does not impact a logical pattern Reset as the pattern is searched for immediately after the TERM1 event occurs regardless of whether or not the Delay period is complete.

**Query** :TRIGger:SEQuence:RESet:TYPE?

The query returns whether the Reset condition is based upon a length of time or an event.

**History** Legacy command (existed before version 3.10).

:TRIGger:SEQuence:RESet:EVENT (S-Series, 90000A Series,  
90000 X-Series, V-Series, 90000 Q-Series, Z-Series)

**Command** :TRIGger:SEQuence:RESet:EVENT {CHANnel<N>}, { HIGH | LOW | DONTcare }

This command defines the logical pattern used for an event Reset condition.

You can specify for each channel (1-4) whether you want the value to be high (1), low (0), or you don't care (X).

<N> An integer, 1-4.

**Query** :TRIGger:SEQuence:RESet:EVENT? {CHANnel<N>}

The query returns the logical pattern used for an event Reset condition.

**History** Legacy command (existed before version 3.10).

:TRIGger:SEQuence:RESet:TIME (S-Series, 90000A Series,  
90000 X-Series, V-Series, 90000 Q-Series, Z-Series)

**Command** :TRIGger:SEQuence:RESet:TIME <time>

This command defines the length of time to use for the time-based Reset condition.

<time> A length of time in seconds.

**Query** :TRIGger:SEQuence:RESet:TIME?

The query returns the length of time used for the Reset condition.

**History** Legacy command (existed before version 3.10).



:TRIGger:SEQuence:WAIT:ENABle (S-Series, 90000A Series, 90000 X-Series, V-Series, 90000 Q-Series, Z-Series)

**Command** :TRIGger:SEQuence:WAIT:ENABle { {ON|1} | {OFF|0} }

This command turns the Delay feature on or off for the sequential trigger.

The Delay feature allows you to define a length of time for the sequential trigger system to wait after the TERM1 event occurs before it starts searching for the TERM2 event.

**Query** :TRIGger:SEQuence:WAIT:ENABle?

The query returns whether or not the Delay feature is turned on.

**History** Legacy command (existed before version 3.10).

:TRIGger:SEQuence:WAIT:TIME (S-Series, 90000A Series, 90000 X-Series, V-Series, 90000 Q-Series, Z-Series)

**Command** :TRIGger:SEQuence:WAIT:TIME <time>

This command defines the length of time to use for the Delay condition.

<time> A length of time in seconds.

**Query** :TRIGger:SEQuence:WAIT:TIME?

The query returns the length of time used for the Delay condition.

**History** Legacy command (existed before version 3.10).

## Setup and Hold Trigger Commands

- `":TRIGger:SHOLd:CSource"` on page 1460
- `":TRIGger:SHOLd:CSource:EDGE"` on page 1461
- `":TRIGger:SHOLd:DSource"` on page 1462
- `":TRIGger:SHOLd:HoldTIme (HTIME)"` on page 1463
- `":TRIGger:SHOLd:MODE"` on page 1464
- `":TRIGger:SHOLd:SetupTIme"` on page 1465

## :TRIGger:SHOLd:CSOource

**Command** :TRIGger:SHOLd[{1 | 2}]:CSOource CHANnel<N>

This command specifies the clock source for the clock used for the trigger setup and hold violation. The clock must pass through the voltage level you have set before the trigger circuitry looks for a setup and hold time violation.

The optional [{1 | 2}] parameter sets whether the trigger mode goes with the TERM1 or TERM2 state if sequential triggering is being used. Sequential triggering is available on 90000A Series, 90000 X-Series, V-Series, 90000 Q-Series, and Z-Series oscilloscopes.

<N> An integer, 1-4.

**Query** :TRIGger:SHOLd:CSOource?

The query returns the currently defined clock source for the trigger setup and hold violation.

**Returned Format** [:TRIGger:SHOLd:CSOource] CHANnel<N><NL>

**History** Legacy command (existed before version 3.10).

## :TRIGger:SHOLd:CSOource:EDGE

**Command** :TRIGger:SHOLd[{1 | 2}]:CSOource:EDGE {RISing | FALLing}

This command specifies the clock source trigger edge for the clock used for the trigger setup and hold violation. The clock must pass through the voltage level you have set before the trigger circuitry looks for a setup and hold time violation.

The optional [{1 | 2}] parameter sets whether the trigger mode goes with the TERM1 or TERM2 state if sequential triggering is being used. Sequential triggering is available on 90000A Series, 90000 X-Series, V-Series, 90000 Q-Series, and Z-Series oscilloscopes.

**Query** :TRIGger:SHOLd:CSOource:EDGE?

The query returns the currently defined clock source edge for the trigger setup and hold violation level for the clock source.

**Returned Format** [:TRIGger:SHOLd:CSOource:EDGE] {RISing | FALLing}<NL>

**History** Legacy command (existed before version 3.10).

## :TRIGger:SHOLd:DSOource

**Command** :TRIGger:SHOLd[{1 | 2}]:DSOource CHANnel<N>

The data source commands specify the data source for the trigger setup and hold violation.

The optional [{1 | 2}] parameter sets whether the trigger mode goes with the TERM1 or TERM2 state if sequential triggering is being used. Sequential triggering is available on 90000A Series, 90000 X-Series, V-Series, 90000 Q-Series, and Z-Series oscilloscopes.

<N> An integer, 1-4.

**Query** :TRIGger:SHOLd:DSOource?

The query returns the currently defined data source for the trigger setup and hold violation.

**Returned Format** [:TRIGger:SHOLd:DSOource] CHANnel<N><NL>

**History** Legacy command (existed before version 3.10).

## :TRIGger:SHOLd:HoldTIME (HTIME)

**Command** :TRIGger:SHOLd[{1 | 2}]:HoldTIME <time>

This command specifies the amount of hold time used to test for both a setup and hold trigger violation. The hold time is the amount of time that the data must be stable and valid after a clock edge.

The optional [{1 | 2}] parameter sets whether the trigger mode goes with the TERM1 or TERM2 state if sequential triggering is being used. Sequential triggering is available on 90000A Series, 90000 X-Series, V-Series, 90000 Q-Series, and Z-Series oscilloscopes.

<time> Hold time, in seconds.

**Query** :TRIGger:SHOLD:HoldTIME?

The query returns the currently defined hold time for the setup and hold trigger violation.

**Returned Format** [:TRIGger:SHOLD:HoldTIME] <time><NL>

**History** Legacy command (existed before version 3.10).

## :TRIGger:SHOLd:MODE

**Command** :TRIGger:SHOLd[{1 | 2}]:MODE {SETup | HOLD | SHOLd}

**SETup** When using the setup time mode, a time window is defined where the right edge is the clock edge and the left edge is the selected time before the clock edge. The waveform must stay outside of the trigger level thresholds during this time window. If the waveform crosses a threshold during this time window, a violation event occurs and the oscilloscope triggers.

**HOLD** When using the hold time mode, the waveform must not cross the threshold voltages after the specified clock edge for at least the hold time you have selected. Otherwise, a violation event occurs and the oscilloscope triggers.

**SHOLd** When using the setup and hold time mode, if the waveform violates either a setup time or hold time, the oscilloscope triggers. The total time allowed for the sum of setup time plus hold time is 24 ns maximum.

The optional [{1 | 2}] parameter sets whether the trigger mode goes with the TERM1 or TERM2 state if sequential triggering is being used. Sequential triggering is available on 90000A Series, 90000 X-Series, V-Series, 90000 Q-Series, and Z-Series oscilloscopes.

**Query** :TRIGger:SHOLd:MODE?

The query returns the currently selected trigger setup violation mode.

**Returned Format** [:TRIGger:SHOLd:MODE] {SETup | HOLD | SHOLd}<NL>

**History** Legacy command (existed before version 3.10).



## :TRIGger:SHOLd:SetupTIme

**Command** :TRIGger:SHOLd[{1 | 2}]:SetupTIme <time>

This command specifies the amount of setup time used to test for both a setup and hold trigger violation. The setup time is the amount of time that the data must be stable and valid before a clock edge.

The optional [{1 | 2}] parameter sets whether the trigger mode goes with the TERM1 or TERM2 state if sequential triggering is being used. Sequential triggering is available on 90000A Series, 90000 X-Series, V-Series, 90000 Q-Series, and Z-Series oscilloscopes.

<time> Setup time, in seconds.

**Query** :TRIGger:SHOLd:SetupTIme?

The query returns the currently defined setup time for the setup and hold trigger violation.

**Returned Format** [:TRIGger:SHOLd:SetupTIme] <time><NL>

**History** Legacy command (existed before version 3.10).

## State Trigger Commands

- **":TRIGger:STATe:CLOCK"** on page 1467
- **":TRIGger:STATe:LOGic"** on page 1468
- **":TRIGger:STATe:LTYPe"** on page 1469
- **":TRIGger:STATe:SLOPe"** on page 1470

## :TRIGger:STATe:CLOCK

**Command** :TRIGger:STATe[{1 | 2}]:CLOCK {CHANnel<N> | DIGital<M>}

This command selects the source for the clock waveform in the State Trigger Mode.

The optional [{1 | 2}] parameter sets whether the trigger mode goes with the TERM1 or TERM2 state if sequential triggering is being used. Sequential triggering is available on 90000A Series, 90000 X-Series, V-Series, 90000 Q-Series, and Z-Series oscilloscopes.

<N> An integer, 1-4.

<M> An integer, 0-15. Digital channels are available on mixed-signal oscilloscopes.

**Query** :TRIGger:STATe:CLOCK?

The query returns the currently selected clock source.

**Returned Format** [:TRIGger:STATe:CLOCK] {CHANnel<N> | DIGital<M>}<NL>

**See Also** • [":TRIGger:STATe:SLOPe"](#) on page 1470

• [":TRIGger:STATe:LOGic"](#) on page 1468

**History** Legacy command (existed before version 3.10).

**:TRIGger:STATe:LOGic**

**Command** `:TRIGger:STATe[{1 | 2}]:LOGic {CHANnel<N> | DIGital<M>},  
{LOW | HIGH | DONTcare | RISing | FALLing | EITHer}`

This command defines the logic state of the specified source for the state pattern.

The optional `[[1 | 2]]` parameter sets whether the trigger mode goes with the TERM1 or TERM2 state if sequential triggering is being used. Sequential triggering is available on 90000A Series, 90000 X-Series, V-Series, 90000 Q-Series, and Z-Series oscilloscopes.

The RISing, FALLing, or EITHer options will make the specified source the clock source. In mixed-signal (MSO) oscilloscopes, the EITHer option is available only when all digital channel states are DONTcare.

**<N>** An integer, 1-4.

**<M>** An integer, 0-15. Digital channels are available on mixed-signal oscilloscopes.

**Query** `:TRIGger:STATe:LOGic? {CHANnel<N> | DIGital<M>}`

The query returns the logic state definition for the specified source.

**Returned Format** `[:TRIGger:STATe:LOGic {CHANnel<N> | DIGital<M>},]  
{LOW | HIGH | DONT | RIS | FALL | EITH}<NL>`

**See Also** • [":TRIGger:STATe:CLOCK"](#) on page 1467

**History** Legacy command (existed before version 3.10).

## :TRIGger:STATe:LTYPe

**Command** :TRIGger:STATe[{1 | 2}]:LTYPe {AND | NAND}

This command defines the state trigger logic type. If the logic type is set to AND, then a trigger is generated on the edge of the clock when the input waveforms match the pattern specified by the :TRIGger:STATe:LOGic command. If the logic type is set to NAND, then a trigger is generated on the edge of the clock when the input waveforms do not match the specified pattern.

The optional [{1 | 2}] parameter sets whether the trigger mode goes with the TERM1 or TERM2 state if sequential triggering is being used. Sequential triggering is available on 90000A Series, 90000 X-Series, V-Series, 90000 Q-Series, and Z-Series oscilloscopes.

**Query** :TRIGger:STATe:LTYPe?

The query returns the currently specified state trigger logic type.

**Returned Format** [:TRIGger:STATe:LTYPe] {AND | NAND}<NL>

**History** Legacy command (existed before version 3.10).

**:TRIGger:STATe:SLOPe**

**Command** `:TRIGger:STATe[{1 | 2}]:SLOPe {RISing | FALLing | EITHer}`

This command specifies the edge of the clock that is used to generate a trigger. The waveform source used for the clock is selected by using the `:TRIGger:STATe:CLOCK` command.

The optional `[[1 | 2]]` parameter sets whether the trigger mode goes with the TERM1 or TERM2 state if sequential triggering is being used. Sequential triggering is available on 90000A Series, 90000 X-Series, V-Series, 90000 Q-Series, and Z-Series oscilloscopes.

In mixed-signal (MSO) oscilloscopes, the EITHer option is available only when all digital channel states are DONTcare.

**Query** `:TRIGger:STATe:SLOPe?`

The query returns the currently defined slope for the clock in State Trigger Mode.

**Returned Format** `[:TRIGger:STATe:SLOPe] {RIS | FALL | EITH}<NL>`

**See Also** • [":TRIGger:STATe:CLOCK"](#) on page 1467

**History** Legacy command (existed before version 3.10).

## Timeout Trigger Commands

- `":TRIGger:TIMEout:CONDition"` on page 1472
- `":TRIGger:TIMEout:SOURce"` on page 1473
- `":TRIGger:TIMEout:TIME"` on page 1474

## :TRIGger:TIMEout:CONDition

**Command** :TRIGger:TIMEout[{1 | 2}]:CONDition {HIGH | LOW | UNCHanged}

The optional [{1 | 2}] parameter sets whether the trigger mode goes with the TERM1 or TERM2 state if sequential triggering is being used. Sequential triggering is available on 90000A Series, 90000 X-Series, V-Series, 90000 Q-Series, and Z-Series oscilloscopes.

This command sets the condition used for the timeout trigger.

**HIGH** Trigger when the waveform has been high for a period time longer than the time value which is set by the TRIGger:TIMEout:TIME command.

**LOW** Trigger when the waveform has been low for a period time longer than the time value which is set by the TRIGger:TIMEout:TIME command.

**UNCHanged** Trigger when the waveform has not changed state for a period time longer than the time value which is set by the TRIGger:TIMEout:TIME command.

**Query** :TRIGger:TIMEout:CONDition?

The query returns the currently defined trigger condition for the timeout trigger.

**Returned Format** [:TRIGger:TIMEout:CONDition] {HIGH | LOW | UNCHanged}<NL>

**History** Legacy command (existed before version 3.10).



## :TRIGger:TIMEout:SOURce

**Command** :TRIGger:TIMEout [{1 | 2}]:SOURce CHANnel<N>

This command specifies the channel source used to trigger the oscilloscope with the timeout trigger.

The optional [{1 | 2}] parameter sets whether the trigger mode goes with the TERM1 or TERM2 state if sequential triggering is being used. Sequential triggering is available on 90000A Series, 90000 X-Series, V-Series, 90000 Q-Series, and Z-Series oscilloscopes.

<N> An integer, 1-4.

**Query** :TRIGger:TIMEout:SOURce?

The query returns the currently defined channel source for the timeout trigger.

**Returned Format** [:TRIGger:TIMEout:SOURce] CHANnel<N><NL>

**History** Legacy command (existed before version 3.10).

**:TRIGger:TIMEout:TIME**

**Command** :TRIGger:TIMEout[{1 | 2}]:TIME <time>

This command lets you look for transition violations that are greater than or less than the time specified.

The optional [{1 | 2}] parameter sets whether the trigger mode goes with the TERM1 or TERM2 state if sequential triggering is being used. Sequential triggering is available on 90000A Series, 90000 X-Series, V-Series, 90000 Q-Series, and Z-Series oscilloscopes.

<time> The time for the timeout trigger, in seconds.

**Query** :TRIGger:TIMEout:TIME?

The query returns the currently defined time for the trigger trigger.

**Returned Format** [:TRIGger:TIMEout:TIME] <time><NL>

**History** Legacy command (existed before version 3.10).

## Transition Trigger Commands

- **":TRIGger:TRANSition:DIRection"** on page 1476
- **":TRIGger:TRANSition:SOURce"** on page 1477
- **":TRIGger:TRANSition:TIME"** on page 1478
- **":TRIGger:TRANSition:TYPE"** on page 1479

**:TRIGger:TRANSition:DIRection**

**Command** :TRIGger:TRANSition[{1 | 2}]:DIRection {GTHan | LTHan}

This command lets you look for transition violations that are greater than or less than the time specified by the :TRIGger:TRANSition:TIME command.

The optional [{1 | 2}] parameter sets whether the trigger mode goes with the TERM1 or TERM2 state if sequential triggering is being used. Sequential triggering is available on 90000A Series, 90000 X-Series, V-Series, 90000 Q-Series, and Z-Series oscilloscopes.

**Query** :TRIGger:TRANSition:DIRection?

The query returns the currently defined direction for the trigger transition violation.

**Returned Format** [:TRIGger:TRANSition:DIRection] {GTHan | LTHan}<NL>

**History** Legacy command (existed before version 3.10).

## :TRIGger:TRANSition:SOURce

**Command** :TRIGger:TRANSition[{1 | 2}]:SOURce CHANnel<N>

The transition source command lets you find any edge in your waveform that violates a rise time or fall time specification. The oscilloscope finds a transition violation trigger by looking for any pulses in your waveform with rising or falling edges that do not cross two voltage levels in the amount of time you have specified.

The optional [{1 | 2}] parameter sets whether the trigger mode goes with the TERM1 or TERM2 state if sequential triggering is being used. Sequential triggering is available on 90000A Series, 90000 X-Series, V-Series, 90000 Q-Series, and Z-Series oscilloscopes.

<N> An integer, 1-4.

**Query** :TRIGger:TRANSition:SOURce?

The query returns the currently defined transition source for the trigger transition violation.

**Returned Format** [:TRIGger:TRANSition:SOURce] CHANnel<N><NL>

**History** Legacy command (existed before version 3.10).

**:TRIGger:TRANSition:TIME**

**Command** :TRIGger:TRANSition[{1 | 2}]:TIME <time>

This command lets you look for transition violations that are greater than or less than the time specified.

The optional [{1 | 2}] parameter sets whether the trigger mode goes with the TERM1 or TERM2 state if sequential triggering is being used. Sequential triggering is available on 90000A Series, 90000 X-Series, V-Series, 90000 Q-Series, and Z-Series oscilloscopes.

<time> The time for the trigger violation transition, in seconds.

**Query** :TRIGger:TRANSition:TIME?

The query returns the currently defined time for the trigger transition violation.

**Returned Format** [:TRIGger:TRANSition:TIME] <time><NL>

**History** Legacy command (existed before version 3.10).

**:TRIGger:TRANSition:TYPE**

**Command** :TRIGger:TRANSition[{1 | 2}]:TYPE {RISetime | FALLtime}

This command lets you select either a rise time or fall time transition violation trigger event.

The optional [{1 | 2}] parameter sets whether the trigger mode goes with the TERM1 or TERM2 state if sequential triggering is being used. Sequential triggering is available on 90000A Series, 90000 X-Series, V-Series, 90000 Q-Series, and Z-Series oscilloscopes.

**Query** :TRIGger:TRANSition:TYPE?

The query returns the currently defined transition type for the trigger transition violation.

**Returned Format** [:TRIGger:TRANSition:TYPE] {RISetime | FALLtime}<NL>

**History** Legacy command (existed before version 3.10).

## TV Trigger Commands

- `":TRIGger:TV:LINE"` on page 1481
- `":TRIGger:TV:MODE"` on page 1482
- `":TRIGger:TV:POLarity"` on page 1483
- `":TRIGger:TV:SOURce"` on page 1484
- `":TRIGger:TV:STANdard"` on page 1485
- `":TRIGger:TV:UDTV:ENUMber"` on page 1486
- `":TRIGger:TV:UDTV:HSYNc"` on page 1487
- `":TRIGger:TV:UDTV:HTIME"` on page 1488
- `":TRIGger:TV:UDTV:PGTHan"` on page 1489
- `":TRIGger:TV:UDTV:POLarity"` on page 1490



## :TRIGger:TV:LINE

**Command** :TRIGger:TV:LINE <line\_number>

The :TRIGger:TV:LINE command selects the horizontal line that you want to examine. The allowable line number entry depends on the :TRIGger:TV:MODE selected. Once the vertical sync pulse of the selected field is received, the trigger is delayed by the number of lines specified.

<line\_number> Horizontal line number as shown below.

Video Standard	Field 1	Field 2	Alternate Field
NTSC/PAL-M	1 to 263	1 to 262	1 to 262
PAL/SECAM	1 to 313	314 to 625	1 to 312

EDTV/HDTV	Line numbers
EDTV 480p/60	1 to 525
EDTV 576p/50	1 to 625
HDTV 720p/60	1 to 750
HDTV 720p/50	1 to 750
HDTV 1080i/60	1 to 1125
HDTV 1080i/50	1 to 1125
HDTV1080p/60	1 to 1125
HDTV 1080p/50	1 to 1125
HDTV 1080p/30	1 to 1125
HDTV 1080p/25	1 to 1125
HDTV 1080p/24	1 to 1125

**Query** :TRIGger:TV:LINE?

The query returns the current line number.

**Returned Format** [:TRIGger:TV:LINE] <line\_number><NL>

**History** Legacy command (existed before version 3.10).

**:TRIGger:TV:MODE**

**Command** :TRIGger:TV:MODE {AFIelds | ALINes | ALTernate | FIElds1 | FIElds2 | LINE}

The :TRIGger:TV:MODE command determines which portion of the video waveform is used to trigger.

**Query** :TRIGger:TV:MODE?

The query returns the current TV trigger mode.

**Returned Format** [:TRIGger:TV:MODE] {AFIelds | ALINes | ALTernate | FIElds1 | FIElds2 | LINE}<NL>

**History** Legacy command (existed before version 3.10).

## :TRIGger:TV:POLarity

**Command** :TRIGger:TV:POLarity {NEGative | POSitive}

The :TRIGger:TV:POLarity command specifies the vertical sync pulse polarity for the selected field used during TV mode triggering.

**Query** :TRIGger:TV:POLarity?

The query returns the currently selected sync pulse polarity.

**Returned Format** [:TRIGger:TV:POLarity] {NEGative | POSitive}<NL>

**History** Legacy command (existed before version 3.10).

## :TRIGger:TV:SOURce

**Command** :TRIGger:TV:SOURce CHANnel<N>

The :TRIGger:TV:SOURce command selects the source for the TV mode triggering. This is the source that will be used for subsequent :TRIGger:TV commands and queries.

<N> An integer, 1-4.

**Query** :TRIGger:TV:SOURce?

The query returns the currently selected standard TV trigger mode source.

**Returned Format** [:TRIGger:TV:SOURce] CHANnel<N>NL>

**History** Legacy command (existed before version 3.10).

## :TRIGger:TV:STANdard

**Command** :TRIGger:TV:STANdard {I1080L60HZ | I1080L50HZ | L525 | L625 | P480L60HZ  
 | P576L50HZ | P720L60HZ | P720L50HZ | P1080L60HZ | P1080L50HZ  
 | P1080L30HZ | P1080L25HZ | P1080L24HZ | UDTV}

The TRIGger:TV:STANdard command sets triggering to one of the standard video types. There is also a user defined TV type that can be used to set the triggering to one of the non-standard types of video.

**Query** :TRIGger:TV:STANdard?

The query returns the currently selected video standard.

**Returned Format** [:TRIGger:TV:STANdard] {I1080L60HZ | I1080L50HZ | L525 | L625  
 | P480L60HZ | P576L50HZ | P720L60HZ | P720L50HZ | P1080L60HZ  
 | P1080L50HZ | P1080L40HZ | P1080L30HZ | P1080L25HZ | P1080L24HZ  
 | UDTV}<NL>

**History** Legacy command (existed before version 3.10).

## :TRIGger:TV:UDTV:ENUMber

**Command** :TRIGger:TV:UDTV:ENUMber <count>

The :TRIGger:TV:UDTV:ENUMber command specifies the number of events (horizontal sync pulses) to delay after arming the trigger before looking for the trigger event. Specify conditions for arming the trigger using:

TRIGger:TV:UDTV:PGTHan, and

TRIGger:TV:UDTV:POLarity.

<count> An integer for the number of events to delay. Allowable values range from 1 to 16,000,000.

**Query** :TRIGger:TV:UDTV:ENUMber?

The query returns the currently programmed count value.

**Returned Format** [:TRIGger:TV:UDTV:ENUMber] <count><NL>

**History** Legacy command (existed before version 3.10).

**:TRIGger:TV:UDTV:HSYNc**

**Command** :TRIGger:TV:UDTV:HSYNc {ON | 1} | {OFF | 0}

This command enables the horizontal sync mode of triggering.

**Query** :TRIGger:TV:UDTV:HSYNc?

The query returns the current state of the horizontal sync mode of triggering.

**Returned Format** [:TRIGger:TV:UDTV:HSYNc] {1 | 0}<NL>

**History** Legacy command (existed before version 3.10).

## :TRIGger:TV:UDTV:HTIME

**Command** :TRIGger:TV:UDTV:HTIME <time>

The :TRIGger:TV:UDTV:HTIME command sets the time that a sync pulse must be present to be considered a valid sync pulse.

<time> A real number that is the time width for the sync pulse.

**Query** :TRIGger:TV:UDTV:HTIME?

The query returns the currently defined time for the sync pulse width.

**Returned Format** [:TRIGger:TV:UDTV:HTIME] <time><NL>

**History** Legacy command (existed before version 3.10).



## :TRIGger:TV:UDTV:PGTHan

**Command** :TRIGger:TV:UDTV:PGTHan <lower\_limit>

The :TRIGger:TV:UDTV:PGTHan (Present Greater THan) command specifies the minimum pulse width of the waveform used to arm the trigger used during user-defined trigger mode.

<lower\_limit> Minimum pulse width (time >), from 5 ns to 9.9999999 s.

**Query** :TRIGger:TV:UDTV:PGTHan?

The query returns the currently selected minimum pulse width.

**Returned Format** [:TRIGger:TV:UDTV:PGTHan] <lower\_limit><NL>

**History** Legacy command (existed before version 3.10).

## :TRIGger:TV:UDTV:POLarity

**Command** :TRIGger:TV:UDTV:POLarity {NEGative | POSitive}

The :TRIGger:TV:UDTV:POLarity command specifies the polarity for the sync pulse used to arm the trigger in the user-defined trigger mode.

**Query** :TRIGger:TV:UDTV:POLarity?

The query returns the currently selected UDTV sync pulse polarity.

**Returned Format** [:TRIGger:TV:UDTV:POLarity] {NEGative | POSitive}<NL>

**History** Legacy command (existed before version 3.10).

## Window Trigger Commands

- `":TRIGger:WINDow:CONDition"` on page 1492
- `":TRIGger:WINDow:SOURce"` on page 1493
- `":TRIGger:WINDow:TIME"` on page 1494
- `":TRIGger:WINDow:TPOint"` on page 1495

## :TRIGger:WINDow:CONDition

**Command** :TRIGger:WINDow[[1 | 2]]:CONDition {ENTer | EXIT  
 | INSide [, {GTHan | LTHan}]  
 | OUTSide [, {GTHan | LTHan}]}

This command describes the condition applied to the trigger window to actually generate a trigger.

The optional [[1 | 2]] parameter sets whether the trigger mode goes with the TERM1 or TERM2 state if sequential triggering is being used. Sequential triggering is available on 90000A Series, 90000 X-Series, V-Series, 90000 Q-Series, and Z-Series oscilloscopes.

**Query** :TRIGger:WINDow:CONDition?

The query returns the currently defined trigger condition.

**Returned Format** [:TRIGger:WINDow:CONDition] {ENTer | EXIT  
 | INSide, {GTHan | LTHan}  
 | OUTSide, {GTHan | LTHan}}<NL>

**History** Legacy command (existed before version 3.10).

## :TRIGger:WINDow:SOURce

**Command** :TRIGger:WINDow[{1 | 2}]:SOURce CHANnel<N>

This command specifies the channel source used to trigger the oscilloscope with the window trigger.

The optional [{1 | 2}] parameter sets whether the trigger mode goes with the TERM1 or TERM2 state if sequential triggering is being used. Sequential triggering is available on 90000A Series, 90000 X-Series, V-Series, 90000 Q-Series, and Z-Series oscilloscopes.

<N> An integer, 1-4.

**Query** :TRIGger:WINDow:SOURce?

The query returns the currently defined channel source for the window trigger.

**Returned Format** [:TRIGger:WINDow:SOURce] CHANnel<N><NL>

**History** Legacy command (existed before version 3.10).

**:TRIGger:WINDow:TIME**

**Command** :TRIGger:WINDow[{1 | 2}]:TIME <time>

This command lets you look for transition violations that are greater than or less than the time specified.

The optional [{1 | 2}] parameter sets whether the trigger mode goes with the TERM1 or TERM2 state if sequential triggering is being used. Sequential triggering is available on 90000A Series, 90000 X-Series, V-Series, 90000 Q-Series, and Z-Series oscilloscopes.

<time> The time for the trigger violation transition, in seconds.

**Query** :TRIGger:WINDow:TIME?

The query returns the currently defined time for the trigger window timeout.

**Returned Format** [:TRIGger:WINDow:TIME] <time><NL>

**History** Legacy command (existed before version 3.10).

## :TRIGger:WINDow:TPOint

**Command** :TRIGger:WINDow[{1 | 2}]:TPOint {BOUNDary | TIMEout}

This command specifies whether the window trigger should occur at the boundary of the window or at a specified timeout period.

The optional [{1 | 2}] parameter sets whether the trigger mode goes with the TERM1 or TERM2 state if sequential triggering is being used. Sequential triggering is available on 90000A Series, 90000 X-Series, V-Series, 90000 Q-Series, and Z-Series oscilloscopes.

**Query** :TRIGger:WINDow:TPOint?

The query returns the currently defined trigger on point for the pulse width trigger.

**Returned Format** [:TRIGger:PWIDth:TPOint] {BOUNDary | TIMEout}<NL>

**History** Legacy command (existed before version 3.10).

## Advanced Comm Trigger Commands

Use the COMM Trigger Mode to find a serial pattern of bits in a waveform. The COMM Trigger Mode is primarily used to find an isolated logically one bit in a waveform for mask testing applications. The pattern is defined by the standards used by the telecommunication and data communication industries. Mask testing is used to verify a waveform meets industrial standards which guarantees that equipment made by different manufacturers will work together.

### Set the Mode Before Executing Commands

Before you can execute the :TRIGger:ADVanced:COMMunications commands, mask testing must be enabled at least one time. The :MTEST:ENABLE command enables or disables mask testing. Then you can set the mode by entering:

```
:TRIGger:MODE ADVanced and
:TRIGger:ADVanced:MODE COMM
```

To query the oscilloscope for the advanced trigger mode, enter:

```
:TRIGger:ADVanced:MODE?
```

The :TRIGger:ADVanced:COMM commands define the Communications Trigger Mode. As described in the following commands, you set up the :TRIGger:ADVanced:COMM commands with the following commands and queries.

- **":TRIGger:ADVanced:COMM:BWIDth"** on page 1497
- **":TRIGger:ADVanced:COMM:ENCode"** on page 1498
- **":TRIGger:ADVanced:COMM:LEVel"** on page 1499
- **":TRIGger:ADVanced:COMM:PATtern"** on page 1500
- **":TRIGger:ADVanced:COMM:POLarity"** on page 1501
- **":TRIGger:ADVanced:COMM:SOURce"** on page 1502



## :TRIGger:ADVanced:COMM:BWIDth

**Command** :TRIGger:ADVanced:COMM:BWIDth <bwidth\_value>

The :TRIGger:ADVanced:COMM:BWIDth command is used to set the width of a bit for your waveform. The bit width is usually defined in the mask standard for your waveform.

<bwidth\_value> A real number that represents the width of a bit.

**Query** :TRIGger:ADVanced:COMM:BWIDth?

The query returns the current bit width.

**Returned Format** [:TRIGger:ADVanced:COMM:BWIDth] <bwidth\_value><NL>

**History** Legacy command (existed before version 3.10).

## :TRIGger:ADVanced:COMM:ENCode

**Command** :TRIGger:ADVanced:COMM:ENCode {RZ | NRZ}

This :TRIGger:ADVanced:COMM:ENCode command sets the type of waveform encoding for your waveform. You should use NRZ for CMI type waveforms and RZ for all other type of waveforms.

**Query** :TRIGger:ADVanced:COMM:ENCode?

The :TRIGger:ADVanced:COMM:ENCode? query returns the current value of encoding

**Returned Format** [:TRIGger:ADVanced:COMM:ENCode] {RZ | NRZ}<NL>

**History** Legacy command (existed before version 3.10).

## :TRIGger:ADVanced:COMM:LEVel

**Command** :TRIGger:ADVanced:COMM:LEVel CHANnel<N>, <level>

The :TRIGger:ADVanced:COMM:LEVel command sets the voltage level used to determine a logic 1 from a logic 0 for the communication pattern.

<N> An integer, 1-4.

<level> A real number which is the logic level voltage.

**Query** :TRIGger:ADVanced:COMM:LEVel? CHANnel<N>

The :TRIGger:ADVanced:COMM:LEVel? query returns the current level for the communication pattern.

**Returned Format** [:TRIGger:ADVanced:COMM:LEVel CHANnel<N>], <level><NL>

**History** Legacy command (existed before version 3.10).

## :TRIGger:ADVanced:COMM:PATtern

**Command** :TRIGger:ADVanced:COMM:PATtern <bit>[,<bit [,<bit [,<bit [,<bit [,<bit]]]]]

The :TRIGger:ADVanced:COMM:PATtern command sets the pattern used for triggering the oscilloscope when in communication trigger mode. The pattern can be up to 6 bits long. For NRZ type waveforms with positive polarity, there must be at least one logic 0 to logic 1 transition in the pattern. For NRZ waveforms with negative polarity there must be at least one logic 1 to logic 0 transition in the pattern. For RZ type waveforms the pattern must have at least one logic 1 bit for positive polarity. For RZ type waveforms the pattern must have at least one logic -1 bit for negative polarity.

<bit> A 1, -1, or 0.

**Query** :TRIGger:ADVanced:COMM:PATtern?

The :TRIGger:ADVanced:COMM:PATtern? query returns the current communication trigger pattern.

**Returned Format** [:TRIGger:ADVanced:COMM:PATtern] <pattern><NL>

<pattern> A string of up to 6 characters.

**History** Legacy command (existed before version 3.10).

## :TRIGger:ADVanced:COMM:POLarity

**Command** :TRIGger:ADVanced:COMM:POLarity {POSitive | NEGative}

The :TRIGger:ADVanced:COMM:POLarity command directly controls the trigger slope used for communication trigger. When set to a positive value, the rising edge of a pulse or waveform is used to trigger the oscilloscope. When set to a negative value, the falling edge of a pulse or waveform is used.

The polarity setting is also used to check for valid patterns. If you are trying to trigger on an isolated 1 pattern, you should set the polarity to positive. If you are trying to trigger on an isolated -1 pattern, you should set the polarity to negative.

**Query** :TRIGger:ADVanced:COMM:POLarity?

The :TRIGger:ADVanced:COMM:POLarity? query returns the current setting for polarity.

**Returned Format** [:TRIGger:ADVanced:COMM:POLarity] {1|0}<NL>

**History** Legacy command (existed before version 3.10).

## :TRIGger:ADVanced:COMM:SOURce

**Command** :TRIGger:ADVanced:COMM:SOURce CHANnel<N>

The :TRIGger:ADVanced:COMM:SOURce command selects the channel used for the communication trigger.

<N> An integer, 1-4.

**Query** :TRIGger:ADVanced:COMM:SOURce?

The :TRIGger:ADVanced:COMM:SOURce? query returns the currently selected communication trigger source.

**Returned Format** [:TRIGger:ADVanced:COMM:SOURce] CHANnel<N><NL>

**History** Legacy command (existed before version 3.10).

## Advanced Pattern Trigger Commands

Logic triggering is similar to the way that a logic analyzer captures data. This mode is useful when you are looking for a particular set of ones and zeros on a computer bus or control lines. You determine which channels the oscilloscope uses to form the trigger pattern. Because you can set the voltage level that determines a logic 1 or a logic 0, any logic family that you are probing can be captured.

There are two types of logic triggering: Pattern and State. The difference between pattern and state triggering modes is that state triggering uses one of the oscilloscope channels as a clock.

Use pattern triggering to trigger the oscilloscope using more than one channel as the trigger source. You can also use pattern triggering to trigger on a pulse of a given width.

The Pattern Trigger Mode identifies a trigger condition by looking for a specified pattern. A pattern is a logical combination of the channels. Each channel can have a value of High (H), Low (L) or Don't Care (X). A value is considered a High when your waveform's voltage level is greater than its trigger level, and a Low when the voltage level is less than its trigger level. If a channel is set to Don't Care, it is not used as part of the pattern criteria.

One additional qualifying condition determines when the oscilloscope triggers once the pattern is found. The :PATtern:CONDition command has five possible ways to qualify the trigger:

**Entered** The oscilloscope will trigger on the edge of the source that makes the pattern true.

**Exited** The oscilloscope will trigger on the edge of the source that makes the pattern false.

**Present >** The oscilloscope will trigger when the pattern is present for greater than the time that you specify. An additional parameter allows the oscilloscope to trigger when the pattern goes away or when the time expires.

**Present <** The oscilloscope will trigger when the pattern is present for less than the time that you specify.

**Range** The oscilloscope will trigger on the edge of the waveform that makes the pattern invalid as long as the pattern is present within the range of times that you specify.

Available trigger conditioning includes HOLDoff and HYSTeresis (Noise Reject).

**Set the Mode Before Executing Commands** Before you can execute the :TRIGger:ADVanced:PATtern commands, set the mode by entering:

```
:TRIGger:MODE ADVanced and
:TRIGger:ADVanced:MODE PATtern
```

To query the oscilloscope for the advanced trigger mode, enter:

```
:TRIGger:ADVanced:MODE?
```

The `:TRIGger:ADVanced:PATtern` commands define the conditions for the Pattern Trigger Mode. As described in the following commands, you set up the `:TRIGger:ADVanced:PATtern` commands with the following commands and queries:

- `":TRIGger:ADVanced:PATtern:CONDition"` on page 1505
- `":TRIGger:ADVanced:PATtern:LOGic"` on page 1506
- `":TRIGger:ADVanced:PATtern:THReshold:LEVel"` on page 1507



## :TRIGger:ADVanced:PATtern:CONDition

**Command** :TRIGger:ADVanced:PATtern:CONDition {ENTERed | EXITed  
 | {GT,<time>[,PEXits|TIMEout]}  
 | {LT,<time>}  
 | {RANGe,<gt\_time>,<lt\_time>}  
 | OR}

This command describes the condition applied to the trigger pattern to actually generate a trigger.

**<gt\_time>** The minimum time (greater than time) for the trigger pattern, from 10 ns to 9.9999999 s.

**<lt\_time>** The maximum time (less than time) for the trigger pattern, from 15 ns to 10 s.

**<time>** The time condition, in seconds, for the pattern trigger, from 1.5 ns to 10 s.

When using the GT (Present >) parameter, the PEXits (Pattern Exits) or the TIMEout parameter controls when the trigger is generated.

**Query** :TRIGger:ADVanced:PATtern:CONDition?

The query returns the currently defined trigger condition.

**Returned Format** [:TRIGger:ADVanced:PATtern:CONDition] {ENTERed | EXITed  
 | {GT,<time>[,PEXits|TIMEout]}  
 | {LT,<time>}  
 | {RANGe,<gt\_time>,<lt\_time>}  
 | OR}<NL>

**History** Legacy command (existed before version 3.10).

Version 6.20: The OR parameter has been added.

## :TRIGger:ADVanced:PATtern:LOGic

**Command** :TRIGger:ADVanced:PATtern:LOGic {{CHANnel<N> | <channel\_list> | DIGital<M>}, {HIGH|LOW|DONTcare|RISing|FALLing}}

This command defines the logic criteria for a selected channel.

<N> An integer, 1-4.

<M> An integer, 0-15. The digital channels are available on the MSO oscilloscopes or DSO models with the MSO license installed.

<channel\_list> The channel range is from 0 to 15 in the following format.

(@1,5,7,9)	channels 1, 5, 7, and 9 are turned on.
(@1:15)	channels 1 through 15 are turned on.
(@1:5,8,14)	channels 1 through 5, channel 8, and channel 14 are turned on.

**Query** :TRIGger:ADVanced:PATtern:LOGic? {CHANnel<N> | <channel\_list> | DIGital<M>}

The query returns the current logic criteria for a selected channel.

**Returned Format** [:TRIGger:ADVanced:PATtern:LOGic {CHANnel<N>|<channel\_list> | DIGital<M>},,] {HIGH|LOW|DONTcare|RISing|FALLing}<NL>

**History** Legacy command (existed before version 3.10).

## :TRIGger:ADVanced:PATtern:THReshold:LEVel

**Command** :TRIGger:ADVanced:PATtern:THReshold:LEVel {CHANnel<N>},<level>

The :TRIGger:ADVanced:PATtern:THReshold:LEVel command specifies the trigger level on the specified channel for the trigger source. Only one trigger level is stored in the oscilloscope for each channel. This level applies to the channel throughout the trigger dialogs (Edge, Glitch, and Advanced). This level also applies to all the High Threshold (HTHReshold) values in the Advanced Violation menus.

<N> An integer, 1-4.

<level> A real number for the trigger level on the specified channel, External Trigger, or Auxiliary Trigger Input.

**Query** :TRIGger:ADVanced:PATtern:THReshold:LEVel? {CHANnel<N>}

The query returns the specified channel's trigger level.

**Returned Format** [:TRIGger:ADVanced:PATtern:THReshold:LEVel {CHANnel<N>},] <level><NL>

**History** Legacy command (existed before version 3.10).

## Advanced State Trigger Commands

Logic triggering is similar to the way that a logic analyzer captures data. This mode is useful when you are looking for a particular set of ones and zeros on a computer bus or control lines. You determine which channels the oscilloscope uses to form the trigger pattern. Because you can set the voltage level that determines a logic 1 or a logic 0, any logic family that you are probing can be captured.

There are two types of logic triggering: Pattern and State. The difference between pattern and state triggering modes is that state triggering uses one of the oscilloscope channels as a clock.

Use state triggering when you want the oscilloscope to use several channels as the trigger source, with one of the channels being used as a clock waveform.

The State trigger identifies a trigger condition by looking for a clock edge on one channel and a pattern on the remaining channels. A pattern is a logical combination of the remaining channels. Each channel can have a value of High (H), Low (L) or Don't Care (X). A value is considered a High when your waveform's voltage level is greater than the trigger level and a Low when the voltage level is less than the trigger level. If a channel is set to Don't Care, it is not used as part of the pattern criteria. You can select the clock edge as either rising or falling.

The logic type control determines whether or not the oscilloscope will trigger when the specified pattern is found on a clock edge. When AND is selected, the oscilloscope will trigger on a clock edge when input waveforms match the specified pattern. When NAND is selected, the oscilloscope will trigger when the input waveforms are different from the specified pattern and a clock edge occurs.

Available trigger conditioning includes HOLDoff and HYSTeresis (Noise Reject).

### Set the Mode Before Executing Commands

Before you can execute the :TRIGger:ADVanced:STATe commands, set the mode by entering:

```
:TRIGger:MODE ADVanced and
:TRIGger:ADVanced:MODE STATE
```

To query the oscilloscope for the advanced trigger mode, enter:

```
:TRIGger:ADVanced:MODE?
```

The :TRIGger:ADVanced:STATe commands define the conditions for the State Trigger Mode. As described in the following commands, you set up the :TRIGger:ADVanced:STATe commands with the following commands and queries:

- **":TRIGger:ADVanced:STATe:CLOCK"** on page 1509
- **":TRIGger:ADVanced:STATe:LOGic"** on page 1510
- **":TRIGger:ADVanced:STATe:LTYPe"** on page 1511
- **":TRIGger:ADVanced:STATe:SLOPe"** on page 1512
- **":TRIGger:ADVanced:STATe:THReshold:LEVel"** on page 1513

## :TRIGger:ADVanced:STATe:CLOCK

**Command** :TRIGger:ADVanced:STATe:CLOCK {CHANnel<N> | DIGital<M> | DONTcare  
| <digital\_channel>}

This command selects the source for the clock waveform in the State Trigger Mode.

<N> An integer, 1-2, for two channel Infiniium Oscilloscope. An integer, 1-4, for all other Infiniium Oscilloscope models.

<M> An integer, 0-15. The digital channels are available on the MSO oscilloscopes or DSO models with the MSO license installed.

**Query** :TRIGger:ADVanced:STATe:CLOCK?

The query returns the currently selected clock source.

**Returned Format** [:TRIGger:ADVanced:STATe:CLOCK] {CHANnel<N> | DIGital<M>}<NL>

**History** Legacy command (existed before version 3.10).

## :TRIGger:ADVanced:STATe:LOGic

**Command** :TRIGger:ADVanced:STATe:LOGic {{CHANnel<N> | <channel\_list>  
| DIGital<M>},{LOW|HIGH|DONTcare|RISing| FALling}}

This command defines the logic state of the specified source for the state pattern. The command produces a settings conflict on a channel that has been defined as the clock.

<N> An integer, 1-2, for two channel Infiniium Oscilloscope. An integer, 1-4, for all other Infiniium Oscilloscope models.

<channel\_list> The channel range is from 0 to 15 in the following format.

@1,5,7,9)	channels 1, 5, 7, and 9 are turned on.
@1:15)	channels 1 through 15 are turned on.
@1:5,8,14)	channels 1 through 5, channel 8, and channel 14 are turned on.

<M> An integer, 0-15. The digital channels are available on the MSO oscilloscopes or DSO models with the MSO license installed.

**Query** :TRIGger:ADVanced:STATe:LOGic? {CHANnel<N> | <channel\_list> | DIGital<M>}

The query returns the logic state definition for the specified source.

<N> N is the channel number, an integer in the range of 1 - 4.

**Returned Format** [:TRIGger:ADVanced:STATe:LOGic {CHANnel<N> | <channel\_list> | DIGital<M>},,  
{LOW | HIGH | DONTcare | RISing | FALling}<NL>

**History** Legacy command (existed before version 3.10).

## :TRIGger:ADVanced:STATe:LTYPe

**Command** :TRIGger:ADVanced:STATe:LTYPe {AND | NAND}

This command defines the state trigger logic type. If the logic type is set to AND, then a trigger is generated on the edge of the clock when the input waveforms match the pattern specified by the :TRIGger:ADVanced:STATe:LOGic command. If the logic type is set to NAND, then a trigger is generated on the edge of the clock when the input waveforms do not match the specified pattern.

**Query** :TRIGger:ADVanced:STATe:LTYPe?

The query returns the currently specified state trigger logic type.

**Returned Format** [:TRIGger:ADVanced:STATe:LTYPe] {AND | NAND}<NL>

**History** Legacy command (existed before version 3.10).

**:TRIGger:ADVanced:STATe:SLOPe**

**Command** :TRIGger:ADVanced:STATe:SLOPe {{RISing | POSitive} | {FALLing | NEGative}}}

This command specifies the edge of the clock that is used to generate a trigger. The waveform source used for the clock is selected by using the :TRIGger:ADVanced:STATe:CLOCK command.

**Query** :TRIGger:ADVanced:STATe:SLOPe?

The query returns the currently defined slope for the clock in State Trigger Mode.

**Returned Format** [:TRIGger:ADVanced:STATe:SLOPe] {RIS | FALL}<NL>

**History** Legacy command (existed before version 3.10).



## :TRIGger:ADVanced:STATe:THReshold:LEVel

**Command** :TRIGger:ADVanced:STATe:THReshold:LEVel {CHANnel<N> | DIGItal<M>},<level>

The :TRIGger:ADVanced:STATe:THReshold:LEVel command specifies the trigger level on the specified channel for the trigger source. Only one trigger level is stored in the oscilloscope for each channel. This level applies to the channel throughout the trigger dialogs (Edge, Glitch, and Advanced). This level also applies to all the High Threshold (HTHReshold) values in the Advanced Violation menus.

<N> An integer, 1-4.

<M> An integer, 0-15. The digital channels are available on the MSO oscilloscopes or DSO models with the MSO license installed.

<level> A real number for the trigger level on the specified channel, External Trigger, or Auxiliary Trigger Input.

**Query** :TRIGger:ADVanced:STATe:THReshold:LEVel? {CHANnel<N> | DIGItal<M>}

The query returns the specified channel's trigger level.

**Returned Format** [:TRIGger:ADVanced:STATe:THReshold:LEVel {CHANnel<N> | DIGItal<M>},] <level><NL>

**History** Legacy command (existed before version 3.10).

## Advanced Delay By Event Trigger Commands

You can set the delay mode to delay by events or time. Use Delay By Event mode to view pulses in your waveform that occur a number of events after a specified waveform edge. Infiniium Oscilloscopes identify a trigger by arming on the edge you specify, counting a number of events, then triggering on the specified edge.

- **":TRIGger:ADVanced:DELay:EDLY:ARM:SOURce"** on page 1516
- **":TRIGger:ADVanced:DELay:EDLY:ARM:SLOPe"** on page 1517
- **":TRIGger:ADVanced:DELay:EDLY:EVENT:DELay"** on page 1518
- **":TRIGger:ADVanced:DELay:EDLY:EVENT:SOURce"** on page 1519
- **":TRIGger:ADVanced:DELay:EDLY:EVENT:SLOPe"** on page 1520
- **":TRIGger:ADVanced:DELay:EDLY:TRIGger:SOURce"** on page 1521
- **":TRIGger:ADVanced:DELay:EDLY:TRIGger:SLOPe"** on page 1522

**Arm On** Use Arm On to set the source, level, and slope for arming the trigger circuitry. When setting the arm level for your waveform, it is usually best to choose a voltage value that is equal to the voltage value at the mid point of your waveform. For example, if you have a waveform with a minimum value of 0 (zero) volts and a maximum value of 5 volts, then 2.5 volts is the best place to set your arm level. The reason this is the best choice is that there may be some ringing or noise at both the 0volt and 5volt levels that can cause false triggers.

When you adjust the arm level control, a horizontal dashed line with a T on the right-hand side appears showing you where the arm level is with respect to your waveform. After a period of time the dashed line will disappear. To redisplay the line, adjust the arm level control again, or activate the Trigger dialog.

**Delay By Event** Use Delay By Event to set the source, level, and edge to define an event. When setting the event level for your waveform, it is usually best to choose a voltage value that is equal to the voltage value at the mid point of your waveform. For example, if you have a waveform with a minimum value of 0 (zero) volts and a maximum value of 5 volts, then 2.5 volts is the best place to set your event level. The reason this is the best choice is that there may be some ringing or noise at both the 0volt and 5volt levels that can cause false triggers.

**Event** Use Event to set the number of events (edges) that must occur after the oscilloscope is armed until it starts to look for the trigger edge.

**Trigger On** Use Trigger On to set the trigger source and trigger slope required to trigger the oscilloscope. Each source can have only one level, so if you are arming and triggering on the same source, only one level is used.

**Set the Mode Before Executing Commands** Before you can execute the :TRIGger:ADVanced:DELay commands, set the mode by entering:

```
:TRIGger:MODE ADVanced and
:TRIGger:ADVanced:MODE DELay
```

The ADVanced DELay commands define the conditions for the Delay Trigger Mode. The Delay By Events Mode lets you view pulses in your waveform that occur a number of events after a specified waveform edge. After entering the commands above, to select Delay By Events Mode, enter:

```
:TRIGger:ADVanced:DELAy:MODE EDLY
```

Then you can use the Event Delay (EDLY) commands and queries for ARM, EVENT, and TRIGger on the following pages.

To query the oscilloscope for the advanced trigger mode or the advanced trigger delay mode, enter:

```
:TRIGger:ADVanced:MODE? or  
:TRIGger:ADVanced:DELAy:MODE?
```

## :TRIGger:ADVanced:DELAy:EDLY:ARM:SOURce

**Command** :TRIGger:ADVanced:DELAy:EDLY:ARM:SOURce {CHANnel<N> | DIGital<M>}

This command sets the Arm On source for arming the trigger circuitry when the oscilloscope is in the Delay By Event trigger mode.

<N> An integer, 1-4.

<M> An integer, 0-15. The digital channels are available on the MSO oscilloscopes or DSO models with the MSO license installed.

**Query** :TRIGger:ADVanced:DELAy:EDLY:ARM:SOURce?

The query returns the currently defined Arm On source for the Delay By Event trigger mode.

**Returned Format** [:TRIGger:ADVanced:DELAy:EDLY:ARM:SOURce] {CHANnel<N> | DIGital<M>}<NL>

**History** Legacy command (existed before version 3.10).

**:TRIGger:ADVanced:DELAy:EDLY:ARM:SLOPe**

**Command** :TRIGger:ADVanced:DELAy:EDLY:ARM:SLOPe {NEGative|POSitive}

This command sets a positive or negative slope for arming the trigger circuitry when the oscilloscope is in the Delay By Event trigger mode.

**Query** :TRIGger:ADVanced:DELAy:EDLY:ARM:SLOPe?

The query returns the currently defined slope for the Delay By Event trigger mode.

**Returned Format** [:TRIGger:ADVanced:DELAy:EDLY:ARM:SLOPe] {NEGative|POSitive}<NL>

**History** Legacy command (existed before version 3.10).

## :TRIGger:ADVanced:DELAy:EDLY:EVENT:DELAy

**Command** :TRIGger:ADVanced:DELAy:EDLY:EVENT:DELAy <edge\_number>

This command sets the event count for a Delay By Event trigger event.

<edge\_num> An integer from 0 to 16,000,000 specifying the number of edges to delay.

**Query** :TRIGger:ADVanced:DELAy:EDLY:EVENT:DELAy?

The query returns the currently defined number of events to delay before triggering on the next Trigger On condition in the Delay By Event trigger mode.

**Returned Format** [:TRIGger:ADVanced:DELAy:EDLY:EVENT:DELAy] <edge\_number><NL>

**History** Legacy command (existed before version 3.10).

## :TRIGger:ADVanced:DELAy:EDLY:EVENT:SOURce

**Command** :TRIGger:ADVanced:DELAy:EDLY:EVENT:SOURce {CHANnel<N> | DIGital<M>}

This command sets the Event source for a Delay By Event trigger event.

<N> An integer, 1-2, for two channel Infiniium Oscilloscope. An integer, 1-4, for all other Infiniium Oscilloscope models.

<M> An integer, 0-15. The digital channels are available on the MSO oscilloscopes or DSO models with the MSO license installed.

**Query** :TRIGger:ADVanced:DELAy:EDLY:EVENT:SOURce?

The query returns the currently defined Event source in the Delay By Event trigger mode.

**Returned Format** [:TRIGger:ADVanced:DELAy:EDLY:EVENT:SOURce] {CHANnel<N> | DIGital<M>}<NL>

**History** Legacy command (existed before version 3.10).

## :TRIGger:ADVanced:DELAy:EDLY:EVENT:SLOPe

**Command** :TRIGger:ADVanced:DELAy:EDLY:EVENT:SLOPe  
{NEGAtive|POSitive}

This command sets the trigger slope for the Delay By Event trigger event.

**Query** :TRIGger:ADVanced:DELAy:EDLY:EVENT:SLOPe?

The query returns the currently defined slope for an event in the Delay By Event trigger mode.

**Returned Format** [:TRIGger:ADVanced:EDLY:EVENT:SLOPe] {NEGAtive|POSitive}<NL>

**History** Legacy command (existed before version 3.10).



## :TRIGger:ADVanced:DELAy:EDLY:TRIGger:SOURce

**Command** :TRIGger:ADVanced:DELAy:EDLY:TRIGger:SOURce {CHANnel<N> | DIGital<M>}

This command sets the Trigger On source for a Delay By Event trigger event.

<N> An integer, 1-4.

<M> An integer, 0-15. The digital channels are available on the MSO oscilloscopes or DSO models with the MSO license installed.

**Query** :TRIGger:ADVanced:DELAy:EDLY:TRIGger:SOURce?

The query returns the currently defined Trigger On source for the event in the Delay By Event trigger mode.

**Returned Format** [:TRIGger:ADVanced:DELAy:EDLY:TRIGger:SOURce] {CHANnel<N> | DIGital<M>}<NL>

**History** Legacy command (existed before version 3.10).

## :TRIGger:ADVanced:DElay:EDLY:TRIGger:SLOPe

**Command** :TRIGger:ADVanced:DElay:EDLY:TRIGger:SLOPe  
{NEGative|POSitive}

This command sets the trigger slope for the Delay By Event trigger event.

**Query** :TRIGger:ADVanced:DElay:EDLY:TRIGger:SLOPe?

The query returns the currently defined slope for an event in the Delay By Event trigger mode.

**Returned Format** [:TRIGger:ADVanced:DElay:EDLY:TRIGger:SLOPe] {NEGative|POSitive}<NL>

**History** Legacy command (existed before version 3.10).

## Advanced Delay By Time Trigger Commands

You can set the delay mode to delay by events or time. Use Delay By Time mode to view pulses in your waveform that occur a long time after a specified waveform edge. The Delay by Time identifies a trigger condition by arming on the edge you specify, waiting a specified amount of time, then triggering on a specified edge. This can be thought of as two-edge triggering, where the two edges are separated by a selectable amount of time.

It is also possible to use the Horizontal Position control to view a pulse some period of time after the trigger has occurred. The problem with this method is that the further the pulse is from the trigger, the greater the possibility that jitter will make it difficult to view. Delay by Time eliminates this problem by triggering on the edge of interest.

- **":TRIGger:ADVanced:DELay:TDLY:ARM:SOURce"** on page 1525
- **":TRIGger:ADVanced:DELay:TDLY:ARM:SLOPe"** on page 1526
- **":TRIGger:ADVanced:DELay:TDLY:DELay"** on page 1527
- **":TRIGger:ADVanced:DELay:TDLY:TRIGger:SOURce"** on page 1528
- **":TRIGger:ADVanced:DELay:TDLY:TRIGger:SLOPe"** on page 1529

**Arm On** Use Arm On to set the source, level, and slope for the arming condition. When setting the arm level for your waveform, it is usually best to choose a voltage value that is equal to the voltage value at the mid point of your waveform. For example, if you have a waveform with a minimum value of 0 (zero) volts and a maximum value of 5 volts, then 2.5 volts is the best place to set your arm level. The reason this is the best choice is that there may be some ringing or noise at both the 0-volt and 5-volt levels that can cause false triggers.

When you adjust the arm level control, a horizontal dashed line with a T on the right-hand side appears showing you where the arm level is with respect to your waveform. After a period of time the dashed line will disappear. To redisplay the line, adjust the arm level control again, or activate the Trigger dialog.

**Delay By Time** Use Delay By Time to set the amount of delay time from when the oscilloscope is armed until it starts to look for the trigger edge. The range is from 30 ns to 160 ms.

**Trigger On** Use Trigger On to set the source and slope required to trigger the oscilloscope. Trigger On Level is slaved to Arm On Level.

Available trigger conditioning includes HOLDoff and HYSteresis (Noise Reject).

**Set the Mode Before Executing Commands** Before you can execute the :TRIGger:ADVanced:DELay commands, set the mode by entering:

```
:TRIGger:MODE ADVanced and
:TRIGger:ADVanced:MODE DELay
```

The ADVanced DELay commands define the conditions for the Delay Trigger Mode. The Delay By Time Mode lets you view pulses in your waveform that occur a specified time after a specified waveform edge. After entering the commands above, to select Delay By Time Mode, enter:

```
:TRIGger:ADVanced:DELAy:MODE TDLY
```

Then you can use the Time Delay (TDLY) commands and queries for ARM, DELay, and TRIGger on the following pages.

To query the oscilloscope for the advanced trigger mode or the advanced trigger delay mode, enter:

```
:TRIGger:ADVanced:MODE? or  
:TRIGger:ADVanced:DELAy:MODE?
```

## :TRIGger:ADVanced:DELAy:TDLY:ARM:SOURce

**Command** :TRIGger:ADVanced:DELAy:TDLY:ARM:SOURce {CHANnel<N> | DIGital<M>}

This command sets the Arm On source for arming the trigger circuitry when the oscilloscope is in the Delay By Time trigger mode.

<N> An integer, 1-4.

<M> An integer, 0-15. The digital channels are available on the MSO oscilloscopes or DSO models with the MSO license installed.

**Query** :TRIGger:ADVanced:DELAy:TDLY:ARM:SOURce?

The query returns the currently defined channel source for the Delay By Time trigger mode.

**Returned Format** [:TRIGger:ADVanced:DELAy:TDLY:ARM:SOURce] {CHANnel<N> | DIGital<M>}<NL>

**History** Legacy command (existed before version 3.10).

**:TRIGger:ADVanced:DELAy:TDLY:ARM:SLOPe**

**Command** :TRIGger:ADVanced:DELAy:TDLY:ARM:SLOPe {NEGative|POSitive}

This command sets a positive or negative slope for arming the trigger circuitry when the oscilloscope is in the Delay By Time trigger mode.

**Query** :TRIGger:ADVanced:DELAy:TDLY:ARM:SLOPe?

The query returns the currently defined slope for the Delay By Time trigger mode.

**Returned Format** [:TRIGger:ADVanced:DELAy:TDLY:ARM:SLOPe] {NEGative|POSitive}<NL>

**History** Legacy command (existed before version 3.10).

## :TRIGger:ADVanced:DELAy:TDLY:DELAy

**Command** :TRIGger:ADVanced:DELAy:TDLY:DELAy <delay>

This command sets the delay for a Delay By Time trigger event.

<delay> Time, in seconds, set for the delay trigger, from 5 ns to 10 s.

**Query** :TRIGger:ADVanced:DELAy:TDLY:DELAy?

The query returns the currently defined time delay before triggering on the next Trigger On condition in the Delay By Time trigger mode.

**Returned Format** [:TRIGger:ADVanced:DELAy:TDLY:DELAy] <delay><NL>

**History** Legacy command (existed before version 3.10).

## :TRIGger:ADVanced:DELAy:TDLY:TRIGger:SOURce

**Command** :TRIGger:ADVanced:DELAy:TDLY:TRIGger:SOURce {CHANnel<N> | DIGital<M>}

This command sets the Trigger On source for a Delay By Time trigger event.

<N> An integer, 1-4.

<M> An integer, 0-15. The digital channels are available on the MSO oscilloscopes or DSO models with the MSO license installed.

**Query** :TRIGger:ADVanced:DELAy:TDLY:TRIGger:SOURce?

The query returns the currently defined Trigger On source in the Delay By Time trigger mode.

**Returned Format** [:TRIGger:ADVanced:DELAy:TDLY:TRIGger:SOURce] {CHANnel<N> | DIGital<M>}<NL>

**History** Legacy command (existed before version 3.10).



**:TRIGger:ADVanced:DELAy:TDLY:TRIGger:SLOPe**

**Command** :TRIGger:ADVanced:DELAy:TDLY:TRIGger:SLOPe  
{NEGative|POSitive}

This command sets the trigger slope for the Delay By Time trigger event.

**Query** :TRIGger:ADVanced:DELAy:TDLY:TRIGger:SLOPe?

The query returns the currently defined slope for an event in the Delay By Time trigger mode.

**Returned Format** [:TRIGger:ADVanced:DELAy:TDLY:TRIGger:SLOPe] {NEGative|POSitive}<NL>

**History** Legacy command (existed before version 3.10).

## Advanced Standard TV Trigger Commands

Use TV trigger mode to trigger on one of the standard television waveforms. Also, use this mode to trigger on a custom television waveform that you define, as described in the next section.

There are four types of television (TV) trigger modes: 525 (NTSC or PAL-M), 625 (PAL), and User Defined. The 525 and 625 are predefined video standards used throughout the world. The User Defined TV trigger, described in the next section, lets you trigger on nonstandard TV waveforms.

### 525 and 625 TV Trigger Modes

- Source** Use the Source control to select one of the oscilloscope channels as the trigger source.
- Level** Use to set the trigger voltage level. When setting the trigger level for your waveform, it is usually best to choose a voltage value that is just below the bottom of burst.

When you adjust the trigger level control, a horizontal dashed line with a T on the right-hand side appears showing you where the trigger level is with respect to your waveform. After a period of time the dashed line will disappear. To redisplay the line, adjust the trigger level control again, or activate the Trigger dialog.

- Positive or Negative Sync** Use the Positive and Negative Sync controls to select either a positive sync pulse or a negative sync pulse as the trigger.

- Field** Use the Field control to select video field 1 or video field 2 as the trigger.

- Line** Use the Line control to select the horizontal line you want to view within the chosen video field.

Available trigger conditioning includes HOLDoff and HYSTeresis (Noise Reject).

- STV Commands** These commands set the conditions for the TV trigger mode using standard, predefined parameters (in STV mode), or user-defined parameters (in UDTV mode). The STV commands are used for triggering on television waveforms, and let you select one of the TV waveform frames and one of the lines within that frame.

- Set the Mode Before Executing Commands** Before executing the :TRIGger:ADVanced:STV commands, set the mode by entering:

```
:TRIGger:MODE ADVanced and
:TRIGger:ADVanced:MODE TV and
```

```
:TRIGger:ADVanced:TV:MODE L525 or
:TRIGger:ADVanced:TV:MODE L625
```

To query the oscilloscope for the advanced trigger mode or the advanced trigger TV mode, enter:

:TRIGger:ADVanced:MODE? or  
:TRIGger:ADVanced:TV:MODE?

You set up the :TRIGger:ADVanced:TV:STV commands with the following commands and queries:

- **":TRIGger:ADVanced:TV:STV:FIELD"** on page 1532
- **":TRIGger:ADVanced:TV:STV:LINE"** on page 1533
- **":TRIGger:ADVanced:TV:STV:SOURce"** on page 1534
- **":TRIGger:ADVanced:TV:STV:SPOLarity"** on page 1535

## :TRIGger:ADVanced:TV:STV:FIELD

**Command** :TRIGger:ADVanced:TV:STV:FIELD {1|2}

This command is available in standard TV trigger modes L525 and L626.

The :TRIGger:ADVanced:TV:STV:FIELD command selects which TV waveform field is used during standard TV trigger mode. The line within the selected field is specified using the :TRIGger:ADVanced:TV:STV:LINE <line\_number> command.

**Query** :TRIGger:ADVanced:TV:STV:FIELD?

The query returns the current television waveform field.

**Returned Format** [:TRIGger:ADVanced:TV:STV:FIELD] {1|2}<NL>

**History** Legacy command (existed before version 3.10).

## :TRIGger:ADVanced:TV:STV:LINE

**Command** :TRIGger:ADVanced:TV:STV:LINE <line\_number>

This command is available in standard TV trigger modes L525 and L626.

The :TRIGger:ADVanced:TV:STV:LINE command selects the horizontal line that the instrument will trigger on. Allowable line\_number entry depends on the :TRIGger:ADVanced:TV:STV:FIELD selected. Once the vertical sync pulse of the selected field is received, the trigger is delayed by the number of lines specified.

<line\_number> Horizontal line number. Allowable values range from 1 to 625, depending on :TRIGger:ADVanced:TV:STV:FIELD settings as shown below.

	STV Modes	
	525	625
Field 1	1 to 263	1 to 313
Field 2	1 to 262	314 to 625

**Query** :TRIGger:ADVanced:TV:STV:LINE?

The query returns the current line number.

**Returned Format** [:TRIGger:ADVanced:TV:STV:LINE] <line\_number><NL>

**History** Legacy command (existed before version 3.10).

**:TRIGger:ADVanced:TV:STV:SOURce**

**Command** :TRIGger:ADVanced:TV:STV:SOURce {CHANnel<N>}

This command is available in standard TV trigger modes L525 and L626.

The :TRIGger:ADVanced:TV:STV:SOURce command selects the source for standard TV mode triggering. This is the source that will be used for subsequent :TRIGger:ADVanced:TV:STV commands and queries.

<N> An integer, 1-4.

**Query** :TRIGger:ADVanced:TV:STV:SOURce?

The query returns the currently selected standard TV trigger mode source.

**Returned Format** [:TRIGger:ADVanced:TV:STV:SOURce] {CHANnel<N>|EXTernal}<NL>

**History** Legacy command (existed before version 3.10).

## :TRIGger:ADVanced:TV:STV:SPOLarity

**Command** :TRIGger:ADVanced:TV:STV:SPOLarity {NEGative|POSitive}

This command is available in standard TV trigger modes L525 and L626.

The :TRIGger:ADVanced:TV:STV:SPOLarity (Sync POLarity) command specifies the vertical sync pulse polarity for the selected field used during standard TV mode triggering.

**Query** :TRIGger:ADVanced:TV:STV:SPOLarity?

The query returns the currently selected sync pulse polarity.

**Returned Format** [:TRIGger:ADVanced:TV:STV:SPOLarity] {NEGative|POSitive}<NL>

**History** Legacy command (existed before version 3.10).

## Advanced User Defined TV Mode and Commands

Use TV trigger mode to trigger on one of the standard television waveforms, as described in the previous section, and to trigger on a custom television waveform that you define. The User Defined TV trigger lets you trigger on nonstandard TV waveforms.

### User Defined TV Trigger

**Source** Use the Source control to select one of the oscilloscope channels as the trigger source.

**Level** Use the Level control to set the trigger voltage level.

When setting the trigger level for your waveform, it is usually best to choose a voltage value that is just below the bottom of burst.

When you adjust the trigger level control, a horizontal dashed line with a T on the right-hand side appears showing you where the trigger level is with respect to your waveform. After a period of time the dashed line will disappear. To redisplay the line, adjust the trigger level control again, or activate the Trigger dialog. A permanent icon with arrow (either T, T<sub>L</sub>, or T<sub>H</sub>) is also displayed on the right side of the waveform area, showing the trigger level.

**Pos or Neg** Use the Pos and Neg controls to select either a positive pulse or a negative pulse to arm the trigger circuitry.

**Time >** Use the Time > control to set the minimum time that the pulse must be present to be considered a valid sync pulse.

**Edge Number** Use the Edge Number control to select the number of edges you want the oscilloscope to count before triggering.

Available trigger conditioning includes HOLDoff and HYSTeresis (Noise Reject).

**UDTV Commands** These commands set the conditions for the TV trigger mode using user-defined parameters. They are used for triggering on non-standard television waveforms, and let you define the conditions that must be met before a trigger occurs.

**Set the Mode Before Executing Commands** Before executing the :TRIGger:ADVanced:TV:UDTV commands, set the mode by entering:

```
:TRIGger:MODE ADVanced and
:TRIGger:ADVanced:MODE TV and
:TRIGger:ADVanced:TV:MODE UDTV
```

To query the oscilloscope for the advanced trigger mode or the advanced trigger TV mode, enter:

```
:TRIGger:ADVanced:MODE? or
:TRIGger:ADVanced:TV:MODE?
```



You set up the :TRIGger:ADVanced:TV:UDTV commands with the following commands and queries:

- **":TRIGger:ADVanced:TV:UDTV:ENUMber"** on page 1538
- **":TRIGger:ADVanced:TV:UDTV:PGTHan"** on page 1539
- **":TRIGger:ADVanced:TV:UDTV:POLarity"** on page 1540
- **":TRIGger:ADVanced:TV:UDTV:SOURce"** on page 1541

When triggering for User Defined TV mode:

- Set the channel or trigger source for the trigger using:
  - :TRIGger:ADVanced:TV:UDTV:SOURce
- Set the conditions for arming the trigger using:
  - :TRIGger:ADVanced:TV:UDTV:PGTHan, and
  - :TRIGger:ADVanced:TV:UDTV:POLarity.
- Set the number of events to delay after the trigger is armed using:
  - :TRIGger:ADVanced:TV:UDTV:ENUMber
- Set the waveform edge that causes the trigger to occur after arming and delay using:
  - :TRIGger:ADVanced:TV:UDTV:EDGE

## :TRIGger:ADVanced:TV:UDTV:ENUMber

**Command** :TRIGger:ADVanced:TV:UDTV:ENUMber <count>

The :TRIGger:ADVanced:TV:UDTV:ENUMber command specifies the number of events (horizontal sync pulses) to delay after arming the trigger before looking for the trigger event. Specify conditions for arming the trigger using:

TRIGger:ADVanced:TV:UDTV:PGTHan, and

TRIGger:ADVanced:TV:UDTV:POLarity.

<count> An integer for the number of events to delay. Allowable values range from 1 to 16,000,000.

**Query** :TRIGger:ADVanced:TV:UDTV:ENUMber?

The query returns the currently programmed count value.

**Returned Format** [:TRIGger:ADVanced:TV:UDTV:ENUMber] <count><NL>

**History** Legacy command (existed before version 3.10).

## :TRIGger:ADVanced:TV:UDTV:PGTHan

**Command** :TRIGger:ADVanced:TV:UDTV:PGTHan <lower\_limit>

The :TRIGger:ADVanced:TV:UDTV:PGTHan (Present Greater THan) command specifies the minimum pulse width of the waveform used to arm the trigger used during user-defined trigger mode.

<lower\_limit> Minimum pulse width (time >), from 5 ns to 9.9999999 s.

**Query** :TRIGger:ADVanced:TV:UDTV:PGTHan?

The query returns the currently selected minimum pulse width.

**Returned Format** [:TRIGger:ADVanced:TV:UDTV:PGTHan] <lower\_limit><NL>

**History** Legacy command (existed before version 3.10).

## :TRIGger:ADVanced:TV:UDTV:POLarity

**Command** :TRIGger:ADVanced:TV:UDTV:POLarity {NEGative|POSitive}

The :TRIGger:ADVanced:TV:UDTV:POLarity command specifies the polarity for the sync pulse used to arm the trigger in the user-defined trigger mode.

**Query** :TRIGger:ADVanced:TV:UDTV:POLarity?

The query returns the currently selected UDTV sync pulse polarity.

**Returned Format** [:TRIGger:ADVanced:TV:UDTV:POLarity] {NEGative|POSitive}<NL>

**History** Legacy command (existed before version 3.10).

## :TRIGger:ADVanced:TV:UDTV:SOURce

**Command** :TRIGger:ADVanced:TV:UDTV:SOURce {CHANnel<N>}

The :TRIGger:ADVanced:TV:UDTV:SOURce command selects the source for user-defined TV mode triggering. This is the source that will be used for subsequent :TRIGger:ADVanced:TV:UDTV commands and queries.

<N> An integer, 1-4.

**Query** :TRIGger:ADVanced:TV:UDTV:SOURce?

The query returns the currently selected user-defined TV trigger mode source.

**Returned Format** [:TRIGger:ADVanced:TV:UDTV:SOURce] {CHANnel<N>}<NL>

**History** Legacy command (existed before version 3.10).

## Advanced Violation Trigger Modes

Violation triggering helps you find conditions within your circuit that violate the design rules. There are four types of violation triggering: Pulse Width, Setup and Hold Time, and Transition.

- **":TRIGger:ADVanced:VIOLation:MODE"** on page 1543

<b>PWIDth</b>	This mode lets you find pulses that are wider than the rest of the pulses in your waveform. It also lets you find pulses that are narrower than the rest of the pulses in the waveform.
<b>SETup</b>	This mode lets you find violations of setup and hold times in your circuit. Use this mode to select setup time triggering, hold time triggering, or both setup and hold time triggering.
<b>TRANSition</b>	This mode lets you find any edge in your waveform that violates a rise time or fall time specification. The Infiniium oscilloscope can be set to trigger on rise times or fall times that are too slow or too fast.

## :TRIGger:ADVanced:VIOLation:MODE

**Command** :TRIGger:ADVanced:VIOLation:MODE {PWIDth | SETup | TRANSition}

After you have selected the advanced trigger mode with the commands :TRIGger:MODE ADVanced and :TRIGger:ADVanced:MODE VIOLation, the :TRIGger:ADVanced:VIOLation:MODE <violation\_mode> command specifies the mode for trigger violations. The <violation\_mode> is either PWIDth, SETup, or TRANSition.

**Query** :TRIGger:ADVanced:VIOLation:MODE?

The query returns the currently defined mode for trigger violations.

**Returned Format** [:TRIGger:ADVanced:VIOLation:MODE] {PWIDth | SETup | TRANSition}<NL>

**History** Legacy command (existed before version 3.10).

## Advanced Pulse Width Violation Trigger Commands

Use Pulse Width Violation Mode to find pulses that are wider than the rest of the pulses in your waveform. You can also use this mode to find pulses that are narrower than the rest of the pulses in the waveform.

The oscilloscope identifies a pulse width trigger by looking for a pulse that is either wider than or narrower than other pulses in your waveform. You specify the pulse width and pulse polarity (positive or negative) that the oscilloscope uses to determine a pulse width violation. For a positive polarity pulse, the oscilloscope triggers when the falling edge of a pulse crosses the trigger level. For a negative polarity pulse, the oscilloscope triggers when the rising edge of a pulse crosses the trigger level.

When looking for narrower pulses, pulse width less than (Width <) trigger is the same as glitch trigger.

- **":TRIGger:ADVanced:VIOLation:PWIDth:DIRection"** on page 1546
- **":TRIGger:ADVanced:VIOLation:PWIDth:POLarity"** on page 1547
- **":TRIGger:ADVanced:VIOLation:PWIDth:SOURce"** on page 1548
- **":TRIGger:ADVanced:VIOLation:PWIDth:WIDTh"** on page 1549

**Source** Use Source to select the oscilloscope channel used to trigger the oscilloscope.

**Level** Use the Level control to set the voltage level through which the pulse must pass before the oscilloscope will trigger.

When setting the trigger level for your waveform, it is usually best to choose a voltage value that is equal to the voltage value at the mid point of your waveform. For example, if you have a waveform with a minimum value of 0 (zero) volts and a maximum value of 5 volts, then 2.5 volts is the best place to set your trigger level. The reason this is the best choice is that there may be some ringing or noise at both the 0-volt and 5-volt levels that can cause false triggers.

When you adjust the trigger level control, a horizontal dashed line with a T on the right-hand side appears showing you where the trigger level is with respect to your waveform. After a period of time the dashed line will disappear. To redisplay the line, adjust the trigger level control again, or activate the Trigger dialog. A permanent icon with arrow (either T, T<sub>L</sub>, or T<sub>H</sub>) is also displayed on the right side of the waveform area, showing the trigger level.

**Polarity** Use the Polarity control to specify positive or negative pulses.

**Direction** Use Direction to set whether a pulse must be wider (Width >) or narrower (Width <) than the width value to trigger the oscilloscope.

**Width** Use the Width control to define how wide of a pulse will trigger the oscilloscope. The glitch width range is from 1.5 ns to 10 s.

Available trigger conditioning includes HOLDoff and HYSTeresis (Noise Reject).



**Set the Mode  
Before Executing  
Commands**

Before executing the :TRIGger:ADVanced:VIOLation:PWIDth commands, set the mode by entering:

```
:TRIGger:MODE ADVanced and  
:TRIGger:ADVanced:MODE VIOLation and  
:TRIGger:ADVanced:VIOLation:MODE PWIDth
```

To query the oscilloscope for the advanced trigger violation mode, enter:

```
:TRIGger:ADVanced:VIOLation:MODE?
```

## :TRIGger:ADVanced:VIOLation:PWIDth:DIRection

**Command** :TRIGger:ADVanced:VIOLation:PWIDth:DIRection {GTHan | LTHan}

This command specifies whether a pulse must be wider or narrower than the width value to trigger the oscilloscope.

**Query** :TRIGger:ADVanced:VIOLation:PWIDth:DIRection?

The query returns the currently defined direction for the pulse width trigger.

**Returned Format** [:TRIGger:ADVanced:VIOLation:PWIDth:DIRection] {GTHan | LTHan}<NL>

**History** Legacy command (existed before version 3.10).

## :TRIGger:ADVanced:VIOLation:PWIDth:POLarity

**Command** :TRIGger:ADVanced:VIOLation:PWIDth:POLarity {NEGative | POSitive}

This command specifies the pulse polarity that the oscilloscope uses to determine a pulse width violation. For a negative polarity pulse, the oscilloscope triggers when the rising edge of a pulse crosses the trigger level. For a positive polarity pulse, the oscilloscope triggers when the falling edge of a pulse crosses the trigger level.

**Query** :TRIGger:ADVanced:VIOLation:PWIDth:POLarity?

The query returns the currently defined polarity for the pulse width trigger.

**Returned Format** [:TRIGger:ADVanced:VIOLation:PWIDth:POLarity] {NEGative | POSitive}<NL>

**History** Legacy command (existed before version 3.10).

## :TRIGger:ADVanced:VIOLation:PWIDth:SOURce

**Command** :TRIGger:ADVanced:VIOLation:PWIDth:SOURce {CHANnel<N> | DIGital<M>}

This command specifies the channel source used to trigger the oscilloscope with the pulse width trigger.

<N> An integer, 1-2, for two channel Infiniium Oscilloscope. An integer, 1-4, for all other Infiniium Oscilloscope models.

<level> A real number for the voltage through which the pulse must pass before the oscilloscope will trigger.

<M> An integer, 0-15. The digital channels are available on the MSO oscilloscopes or DSO models with the MSO license installed.

**Query** :TRIGger:ADVanced:VIOLation:PWIDth:SOURce?

The query returns the currently defined channel source for the pulse width trigger.

**Returned Format** [:TRIGger:ADVanced:VIOLation:PWIDth:SOURce] {CHANnel<N> | DIGital<M>}<NL>

**History** Legacy command (existed before version 3.10).

**:TRIGger:ADVanced:VIOLation:PWIDth:WIDTh**

**Command** :TRIGger:ADVanced:VIOLation:PWIDth:WIDTh <width>

This command specifies how wide a pulse must be to trigger the oscilloscope.

<width> Pulse width, which can range from 1.5 ns to 10 s.

**Query** :TRIGger:ADVanced:VIOLation:PWIDth:WIDTh?

The query returns the currently defined width for the pulse.

**Returned Format** [:TRIGger:ADVanced:VIOLation:PWIDth:WIDTh] <width><NL>

**History** Legacy command (existed before version 3.10).

## Advanced Setup Violation Trigger Commands

Use Setup Violation Mode to find violations of setup and hold times in your circuit.

- `":TRIGger:ADVanced:VIOLation:SETup:MODE"` on page 1553
- `":TRIGger:ADVanced:VIOLation:SETup:SETup:CSOurce"` on page 1554
- `":TRIGger:ADVanced:VIOLation:SETup:SETup:CSOurce:LEVel"` on page 1555
- `":TRIGger:ADVanced:VIOLation:SETup:SETup:CSOurce:EDGE"` on page 1556
- `":TRIGger:ADVanced:VIOLation:SETup:SETup:DSOurce"` on page 1557
- `":TRIGger:ADVanced:VIOLation:SETup:SETup:DSOurce:HTHReshold"` on page 1558
- `":TRIGger:ADVanced:VIOLation:SETup:SETup:DSOurce:LTHReshold"` on page 1559
- `":TRIGger:ADVanced:VIOLation:SETup:SETup:TIME"` on page 1560
- `":TRIGger:ADVanced:VIOLation:SETup:HOLD:CSOurce"` on page 1561
- `":TRIGger:ADVanced:VIOLation:SETup:HOLD:CSOurce:LEVel"` on page 1562
- `":TRIGger:ADVanced:VIOLation:SETup:HOLD:CSOurce:EDGE"` on page 1563
- `":TRIGger:ADVanced:VIOLation:SETup:HOLD:DSOurce"` on page 1564
- `":TRIGger:ADVanced:VIOLation:SETup:HOLD:DSOurce:HTHReshold"` on page 1565
- `":TRIGger:ADVanced:VIOLation:SETup:HOLD:DSOurce:LTHReshold"` on page 1566
- `":TRIGger:ADVanced:VIOLation:SETup:HOLD:TIME"` on page 1567
- `":TRIGger:ADVanced:VIOLation:SETup:SHOLd:CSOurce"` on page 1568
- `":TRIGger:ADVanced:VIOLation:SETup:SHOLd:CSOurce:LEVel"` on page 1569
- `":TRIGger:ADVanced:VIOLation:SETup:SHOLd:CSOurce:EDGE"` on page 1570
- `":TRIGger:ADVanced:VIOLation:SETup:SHOLd:DSOurce"` on page 1571
- `":TRIGger:ADVanced:VIOLation:SETup:SHOLd:DSOurce:HTHReshold"` on page 1572
- `":TRIGger:ADVanced:VIOLation:SETup:SHOLd:DSOurce:LTHReshold"` on page 1573
- `":TRIGger:ADVanced:VIOLation:SETup:SHOLd:SetupTIME (STIME)"` on page 1574
- `":TRIGger:ADVanced:VIOLation:SETup:SHOLd:HoldTIME (HTIME)"` on page 1575

**Mode** Use MODE to select Setup, Hold, or both Setup and Hold time triggering.

You can have the oscilloscope trigger on violations of setup time, hold time, or both setup and hold time. To use Setup Violation Type, the oscilloscope needs a clock waveform, used as the reference, and a data waveform for the trigger source.

<b>Setup Time Mode</b>	When using the Setup Time Mode, a time window is defined where the right edge is the clock edge and the left edge is the selected time before the clock edge. The waveform must stay outside of the thresholds during this time window. If the waveform crosses a threshold within the time window, a violation event occurs and the oscilloscope triggers.
<b>Hold Time Mode</b>	When using Hold Time Mode, the waveform must not cross the threshold voltages after the specified clock edge for at least the hold time you have selected. Otherwise, a violation event occurs and the oscilloscope triggers.
<b>Setup and Hold Time Mode</b>	When using the Setup and Hold Time Mode, if the waveform violates either a setup time or hold time, the oscilloscope triggers.
<b>Data Source</b>	Use the data source (DSOURCE) command to select the channel used as the data, the low-level data threshold, and the high-level data threshold. For data to be considered valid, it must be below the lower threshold or above the upper threshold during the time of interest.
<b>DSOURCE</b>	Use DSOURCE to select the channel you want to use for the data source.
<b>Low Threshold</b>	Use the low threshold (LTHRESHOLD) to set the minimum threshold for your data. Data is valid below this threshold.
<b>High Threshold</b>	Use the high threshold (HTHRESHOLD) to set the maximum threshold for your data. Data is valid above this threshold.
<b>Clock Source</b>	Use the clock source (CSOURCE) command to select the clock source, trigger level, and edge polarity for your clock. Before the trigger circuitry looks for a setup or hold time violation, the clock must pass through the voltage level you have set.
<b>CSOURCE</b>	Use CSOURCE to select the channel you want to use for the clock source.
<b>LEVEL</b>	Use LEVEL to set voltage level on the clock waveform as given in the data book for your logic family.
<b>RISing or FALLing</b>	Use RISing or FALLing to select the edge of the clock the oscilloscope uses as a reference for the setup or hold time violation trigger.
<b>Time</b>	
<b>Setup Time</b>	Use SETUP to set the amount of setup time used to test for a violation. The setup time is the amount of time that the data has to be stable and valid prior to a clock edge. The minimum is 1.5 ns; the maximum is 20 ns.
<b>Hold Time</b>	Use HOLD to set the amount of hold time used to test for a violation. The hold time is the amount of time that the data has to be stable and valid after a clock edge. The minimum is 1.5 ns; the maximum is 20 ns.
<b>Setup and Hold</b>	Use SHOLD (Setup and Hold) to set the amount of setup and hold time used to test for a violation.

The setup time is the amount of time that the data has to be stable and valid prior to a clock edge. The hold time is the amount of time that the data waveform has to be stable and valid after a clock edge.

The setup time plus hold time equals 20 ns maximum. So, if the setup time is 1.5 ns, the maximum hold time is 18.5 ns.

Available trigger conditioning includes HOLDoff and HYSTeresis (Noise Reject).

**Set the Mode  
Before Executing  
Commands**

Before executing the :TRIGger:ADVanced:VIOLation:SETup commands, set the mode by entering:

```
:TRIGger:MODE ADVanced and  
:TRIGger:ADVanced:MODE VIOLation and  
:TRIGger:ADVanced:VIOLation:MODE SETup and  
:TRIGger:ADVanced:VIOLation:SETup:MODE <setup_mode>
```

Where <setup\_mode> includes SETup, HOLD, and SHOLd.

To query the oscilloscope for the advanced trigger violation setup mode, enter:

```
:TRIGger:ADVanced:VIOLation:SETup:MODE?
```



## :TRIGger:ADVanced:VIOLation:SETup:MODE

- Command** :TRIGger:ADVanced:VIOLation:SETup:MODE {SETup | HOLD | SHOLd}
- SETup** When using the setup time mode, a time window is defined where the right edge is the clock edge and the left edge is the selected time before the clock edge. The waveform must stay outside of the trigger level thresholds during this time window. If the waveform crosses a threshold during this time window, a violation event occurs and the oscilloscope triggers.
- HOLD** When using the hold time mode, the waveform must not cross the threshold voltages after the specified clock edge for at least the hold time you have selected. Otherwise, a violation event occurs and the oscilloscope triggers.
- SHOLd** When using the setup and hold time mode, if the waveform violates either a setup time or hold time, the oscilloscope triggers. The total time allowed for the sum of setup time plus hold time is 20 ns maximum.
- Query** :TRIGger:ADVanced:VIOLation:SETup:MODE?  
The query returns the currently selected trigger setup violation mode.
- Returned Format** [:TRIGger:ADVanced:VIOLation:SETup:MODE] {SETup | HOLD | SHOLd}<NL>
- History** Legacy command (existed before version 3.10).

## :TRIGger:ADVanced:VIOLation:SETup:SETup:CSOource

**Command** :TRIGger:ADVanced:VIOLation:SETup:SETup:CSOource {CHANnel<N>}

This command specifies the clock source for the clock used for the trigger setup violation. The clock must pass through the voltage level you have set before the trigger circuitry looks for a setup or hold time violation.

<N> An integer, 1-4.

**Query** :TRIGger:ADVanced:VIOLation:SETup:SETup:CSOource?

The query returns the currently defined clock source for the trigger setup violation.

**Returned Format** [:TRIGger:ADVanced:VIOLation:SETup:SETup:CSOource]  
{CHANnel<N>}<NL>

**History** Legacy command (existed before version 3.10).

## :TRIGger:ADVanced:VIOLation:SETup:SETup:CSOurce:LEVel

**Command** :TRIGger:ADVanced:VIOLation:SETup:SETup:CSOurce:LEVel {{CHANnel<N>},<level>}

This command specifies the level for the clock source used for the trigger setup violation. The clock must pass through the voltage level you have set before the trigger circuitry looks for a setup or hold time violation.

<N> An integer, 1-4.

<level> A real number for the voltage level for the trigger setup violation clock waveform, and depends on the type of circuitry logic you are using.

**Query** :TRIGger:ADVanced:VIOLation:SETup:SETup:CSOurce:LEVel? {CHANnel<N>}

The query returns the specified clock source level for the trigger setup violation.

**Returned Format** [:TRIGger:ADVanced:VIOLation:SETup:SETup:CSOurce:LEVel {CHANnel<N>},] <level><NL>

**History** Legacy command (existed before version 3.10).

`:TRIGger:ADVanced:VIOLation:SETup:SETup:CSource:EDGE`

**Command** `:TRIGger:ADVanced:VIOLation:SETup:SETup:CSource:EDGE {RISing | FALLing}`

This command specifies the edge for the clock source used for the trigger setup violation. The clock must pass through the voltage level you have set before the trigger circuitry looks for a setup or hold time violation.

**Query** `:TRIGger:ADVanced:VIOLation:SETup:SETup:CSource:EDGE?`

The query returns the currently defined clock source edge for the trigger setup violation.

**Returned Format** `[:TRIGger:ADVanced:VIOLation:SETup:SETup:CSource:EDGE] {RIS | FALL}<NL>`

**History** Legacy command (existed before version 3.10).

**:TRIGger:ADVanced:VIOLation:SETup:SETup:DSOurce**

**Command** :TRIGger:ADVanced:VIOLation:SETup:SETup:DSOurce {CHANnel<N>}

The data source commands specify the data source for the trigger setup violation.

<N> An integer, 1-4.

**Query** :TRIGger:ADVanced:VIOLation:SETup:SETup:DSOurce?

The query returns the currently defined data source for the trigger setup violation.

**Returned Format** [:TRIGger:ADVanced:VIOLation:SETup:SETup:DSOurce] {CHANnel<N>}<NL>

**History** Legacy command (existed before version 3.10).

## :TRIGger:ADVanced:VIOLation:SETup:SETup:DSource:HTHReshold

**Command** :TRIGger:ADVanced:VIOLation:SETup:SETup:DSource:HTHReshold {{CHANnel<N>},<level>}

This command specifies the data source for the trigger setup violation, and the high-level data threshold for the selected data source. Data is valid when it is above the high-level data threshold, and when it is below the low-level data threshold.

<N> An integer, 1-4.

<level> A real number for the data threshold level for the trigger setup violation, and is used with the high and low threshold data source commands.

**Query** :TRIGger:ADVanced:VIOLation:SETup:SETup:DSource: HTHReshold? {CHANnel<N>}

The query returns the specified data source for the trigger setup violation, and the high data threshold for the data source.

**Returned Format** [:TRIGger:ADVanced:VIOLation:SETup:SETup:DSource:HTHReshold {CHANnel<N>},] <level><NL>

**History** Legacy command (existed before version 3.10).

## :TRIGger:ADVanced:VIOLation:SETup:SETup:DSource:LTHReshold

**Command** :TRIGger:ADVanced:VIOLation:SETup:SETup:DSource:LTHReshold {{CHANnel<N>}  
,<level>}

This command specifies the data source for the trigger setup violation, and the low-level data threshold for the selected data source. Data is valid when it is above the high-level data threshold, and when it is below the low-level data threshold.

<N> An integer, 1-4.

<level> A real number for the data threshold level for the trigger setup violation, and is used with the high and low threshold data source commands.

**Query** :TRIGger:ADVanced:VIOLation:SETup:SETup:DSource: LTHReshold? {CHANnel<N>}  
}

The query returns the specified data source for the trigger setup violation, and the low data threshold for the data source.

**Returned Format** [:TRIGger:ADVanced:VIOLation:SETup:SETup:DSource:LTHReshold {CHANnel<N>}  
,] <level><NL>

**History** Legacy command (existed before version 3.10).

**:TRIGger:ADVanced:VIOLation:SETup:SETup:TIME**

**Command** :TRIGger:ADVanced:VIOLation:SETup:SETup:TIME <time>

This command specifies the amount of setup time used to test for a trigger violation. The setup time is the amount of time that the data must be stable and valid prior to a clock edge.

<time> Setup time, in seconds.

**Query** :TRIGger:ADVanced:VIOLation:SETup:SETup:TIME?

The query returns the currently defined setup time for the trigger violation.

**Returned Format** [:TRIGger:ADVanced:VIOLation:SETup:SETup:TIME] <time><NL>

**History** Legacy command (existed before version 3.10).



`:TRIGger:ADVanced:VIOLation:SETup:HOLD:CSOurce`

**Command** `:TRIGger:ADVanced:VIOLation:SETup:HOLD:CSOurce {CHANnel<N>}`

This command specifies the clock source for the clock used for the trigger hold violation. The clock must pass through the voltage level you have set before the trigger circuitry looks for a setup or hold time violation.

**<N>** An integer, 1-4.

**Query** `:TRIGger:ADVanced:VIOLation:SETup:HOLD:CSOurce?`

The query returns the currently defined clock source for the trigger hold violation.

**Returned Format** `[:TRIGger:ADVanced:VIOLation:SETup:HOLD:CSOurce] {CHANnel<N>}<NL>`

**History** Legacy command (existed before version 3.10).

## :TRIGger:ADVanced:VIOLation:SETup:HOLD:CSOurce:LEVel

**Command** :TRIGger:ADVanced:VIOLation:SETup:HOLD:CSOurce:LEVel {{CHANnel<N>},<level>}

This command specifies the level for the clock source used for the trigger hold violation. The clock must pass through the voltage level you have set before the trigger circuitry looks for a setup or hold time violation.

<N> An integer, 1-4.

<level> A real number for the voltage level for the trigger hold violation clock waveform, and depends on the type of circuitry logic you are using.

**Query** :TRIGger:ADVanced:VIOLation:SETup:HOLD:CSOurce:LEVel? {CHANnel<N>}

The query returns the specified clock source level for the trigger hold violation.

**Returned Format** [:TRIGger:ADVanced:VIOLation:SETup:HOLD:CSOurce:LEVel {CHANnel<N>},] <level><NL>

**History** Legacy command (existed before version 3.10).

`:TRIGger:ADVanced:VIOLation:SETup:HOLD:CSource:EDGE`

**Command** `:TRIGger:ADVanced:VIOLation:SETup:HOLD:CSource:EDGE {RISing | FALLing}`

This command specifies the edge for the clock source used for the trigger hold violation. The clock must pass through the voltage level you have set before the trigger circuitry looks for a setup or hold time violation.

**Query** `:TRIGger:ADVanced:VIOLation:SETup:HOLD:CSource:EDGE?`

The query returns the currently defined clock source edge for the trigger hold violation.

**Returned Format** `[:TRIGger:ADVanced:VIOLation:SETup:HOLD:CSource:EDGE] {RIS | FALL}<NL>`

**History** Legacy command (existed before version 3.10).

### :TRIGger:ADVanced:VIOLation:SETup:HOLD:DSOurce

**Command** :TRIGger:ADVanced:VIOLation:SETup:HOLD:DSOurce {CHANnel<N>}

The data source commands specify the data source for the trigger hold violation.

<N> An integer, 1-4.

**Query** :TRIGger:ADVanced:VIOLation:SETup:HOLD:DSOurce?

The query returns the currently defined data source for the trigger hold violation.

**Returned Format** [:TRIGger:ADVanced:VIOLation:SETup:HOLD:DSOurce] {CHANnel<N>}<NL>

**History** Legacy command (existed before version 3.10).

## :TRIGger:ADVanced:VIOLation:SETup:HOLD:DSOource:HTHReshold

**Command** :TRIGger:ADVanced:VIOLation:SETup:HOLD:DSOource:HTHReshold {{CHANnel<N>}, <level>}

This command specifies the data source for the trigger hold violation, and the high-level data threshold for the selected data source. Data is valid when it is above the high-level data threshold, and when it is below the low-level data threshold.

<N> An integer, 1–4.

<level> A real number for the data threshold level for the trigger hold violation, and is used with the high and low threshold data source commands.

**Query** :TRIGger:ADVanced:VIOLation:SETup:HOLD:DSOource:HTHReshold? {CHANnel<N>}

The query returns the specified data source for the trigger hold violation, and the high data threshold for the data source.

**Returned Format** [:TRIGger:ADVanced:VIOLation:SETup:HOLD:DSOource:HTHReshold {CHANnel<N>}, ] <level><NL>

**History** Legacy command (existed before version 3.10).

## :TRIGger:ADVanced:VIOLation:SETup:HOLD:DSOurce:LTHReshold

**Command** :TRIGger:ADVanced:VIOLation:SETup:HOLD:DSOurce:LTHReshold {{CHANnel<N>}, <level>}

This command specifies the data source for the trigger hold violation, and the low-level data threshold for the selected data source. Data is valid when it is above the high-level data threshold, and when it is below the low-level data threshold.

<N> An integer, 1-4.

<level> A real number for the data threshold level for the trigger hold violation, and is used with the high and low threshold data source commands.

**Query** :TRIGger:ADVanced:VIOLation:SETup:HOLD:DSOurce:LTHReshold? {CHANnel<N>}

The query returns the specified data source for the trigger hold violation, and the low data threshold for the data source.

**Returned Format** [:TRIGger:ADVanced:VIOLation:SETup:HOLD:DSOurce:LTHReshold {CHANnel<N>}, ] <level><NL>

**History** Legacy command (existed before version 3.10).

## :TRIGger:ADVanced:VIOLation:SETup:HOLD:TIME

**Command** :TRIGger:ADVanced:VIOLation:SETup:HOLD:TIME <time>

This command specifies the amount of hold time used to test for a trigger violation. The hold time is the amount of time that the data must be stable and valid after a clock edge.

<time> Hold time, in seconds.

**Query** :TRIGger:ADVanced:VIOLation:SETup:HOLD:TIME?

The query returns the currently defined hold time for the trigger violation.

**Returned Format** [:TRIGger:ADVanced:VIOLation:SETup:HOLD:TIME] <time><NL>

**History** Legacy command (existed before version 3.10).

**:TRIGger:ADVanced:VIOLation:SETup:SHOLd:CSOurce**

**Command** :TRIGger:ADVanced:VIOLation:SETup:SHOLd:CSOurce: {CHANnel<N>}

This command specifies the clock source for the clock used for the trigger setup and hold violation. The clock must pass through the voltage level you have set before the trigger circuitry looks for a setup and hold time violation.

<N> An integer, 1-4.

**Query** :TRIGger:ADVanced:VIOLation:SETup:SHOLd:CSOurce?

The query returns the currently defined clock source for the trigger setup and hold violation.

**Returned Format** [:TRIGger:ADVanced:VIOLation:SETup:SHOLd:CSOurce] {CHANnel<N>}<NL>

**History** Legacy command (existed before version 3.10).



## :TRIGger:ADVanced:VIOLation:SETup:SHOLd:CSource:LEVel

**Command** :TRIGger:ADVanced:VIOLation:SETup:SHOLd:CSource:LEVel {{CHANnel<N>},<level>}

This command specifies the clock source trigger level for the clock used for the trigger setup and hold violation. The clock must pass through the voltage level you have set before the trigger circuitry looks for a setup and hold time violation.

<N> An integer, 1-4.

<level> A real number for the voltage level for the trigger setup and hold violation clock waveform, and depends on the type of circuitry logic you are using.

**Query** :TRIGger:ADVanced:VIOLation:SETup:SHOLd:CSource:LEVel? {CHANnel<N>}

The query returns the specified clock source level for the trigger setup and hold violation level for the clock source.

**Returned Format** [:TRIGger:ADVanced:VIOLation:SETup:SHOLd:CSource:LEVel {CHANnel<N>},] <level><NL>

**History** Legacy command (existed before version 3.10).

**:TRIGger:ADVanced:VIOLation:SETup:SHOLd:CSource:EDGE**

**Command** :TRIGger:ADVanced:VIOLation:SETup:SHOLd:CSource:EDGE {RISing | FALLing}

This command specifies the clock source trigger edge for the clock used for the trigger setup and hold violation. The clock must pass through the voltage level you have set before the trigger circuitry looks for a setup and hold time violation.

**Query** :TRIGger:ADVanced:VIOLation:SETup:SHOLd:CSource:EDGE?

The query returns the currently defined clock source edge for the trigger setup and hold violation level for the clock source.

**Returned Format** [:TRIGger:ADVanced:VIOLation:SETup:SHOLd:CSource:EDGE] {RIS | FALL}<NL>

**History** Legacy command (existed before version 3.10).

**:TRIGger:ADVanced:VIOLation:SETup:SHOLd:DSOurce**

**Command** :TRIGger:ADVanced:VIOLation:SETup:SHOLd:DSOurce {CHANnel<N>}

The data source commands specify the data source for the trigger setup and hold violation.

<N> An integer, 1-4.

**Query** :TRIGger:ADVanced:VIOLation:SETup:SHOLd:DSOurce?

The query returns the currently defined data source for the trigger setup and hold violation.

**Returned Format** [:TRIGger:ADVanced:VIOLation:SETup:SHOLd:DSOurce] {CHANnel<N>}<NL>

**History** Legacy command (existed before version 3.10).

## :TRIGger:ADVanced:VIOLation:SETup:SHOLd:DSource:HTHReshold

**Command** :TRIGger:ADVanced:VIOLation:SETup:SHOLd:DSource:HTHReshold {{CHANnel<N>},<level>}

This command specifies the data source for the trigger setup and hold violation, and the high-level data threshold for the selected data source. Data is valid when it is above the high-level data threshold, and when it is below the low-level data threshold.

<N> An integer, 1-4.

<level> A real number for the data threshold level for the trigger setup and hold violation, and is used with the high and low threshold data source commands.

**Query** :TRIGger:ADVanced:VIOLation:SETup:SHOLd:DSource:HTHReshold? {CHANnel<N>}

The query returns the specified data source for the trigger setup and hold violation, and the high data threshold for the data source.

**Returned Format** [:TRIGger:ADVanced:VIOLation:SETup:SHOLd:DSource:HTHReshold {CHANnel<N>},] <level><NL>

**History** Legacy command (existed before version 3.10).

## :TRIGger:ADVanced:VIOLation:SETup:SHOLd:DSOurce:LTHReshold

**Command** :TRIGger:ADVanced:VIOLation:SETup:SHOLd:DSOurce:LTHReshold {{CHANnel<N>},<level>}

This command specifies the data source for the trigger setup and hold violation, and the low-level data threshold for the selected data source. Data is valid when it is above the high-level data threshold, and when it is below the low-level data threshold.

<N> An integer, 1-4.

<level> A real number for the data threshold level for the trigger setup and hold violation, and is used with the high and low threshold data source commands.

**Query** :TRIGger:ADVanced:VIOLation:SETup:SHOLd:DSOurce:LTHReshold? {CHANnel<N>}

The query returns the specified data source for the setup and trigger hold violation, and the low data threshold for the data source.

**Returned Format** [:TRIGger:ADVanced:VIOLation:SETup:SHOLd:DSOurce:LTHReshold {CHANnel<N>},] <level><NL>

**History** Legacy command (existed before version 3.10).

**:TRIGger:ADVanced:VIOLation:SETup:SHOLd:SetupTIME (STIME)**

**Command** :TRIGger:ADVanced:VIOLation:SETup:SHOLd:SetupTIME <time>

This command specifies the amount of setup time used to test for both a setup and hold trigger violation. The setup time is the amount of time that the data must be stable and valid before a clock edge.

<time> Setup time, in seconds.

**Query** :TRIGger:ADVanced:VIOLation:SETup:SHOLd:SetupTIME?

The query returns the currently defined setup time for the setup and hold trigger violation.

**Returned Format** [:TRIGger:ADVanced:VIOLation:SETup:SHOLd:SetupTIME] <time><NL>

**History** Legacy command (existed before version 3.10).

**:TRIGger:ADVanced:VIOLation:SETup:SHOLd:HoldTIME (HTIME)**

**Command** :TRIGger:ADVanced:VIOLation:SETup:SHOLd:HoldTIME <time>

This command specifies the amount of hold time used to test for both a setup and hold trigger violation. The hold time is the amount of time that the data must be stable and valid after a clock edge.

<time> Hold time, in seconds.

**Query** :TRIGger:ADVanced:VIOLation:SETup:SHOLd:HoldTIME?

The query returns the currently defined hold time for the setup and hold trigger violation.

**Returned Format** [:TRIGger:ADVanced:VIOLation:SETup:SHOLd:HoldTIME] <time><NL>

**History** Legacy command (existed before version 3.10).

## Advanced Transition Violation Trigger Commands

Use Transition Violation Mode to find any edge in your waveform that violates a rise time or fall time specification. Infiniium Oscilloscopes find a transition violation trigger by looking for any pulses in your waveform with rising or falling edges that do not cross two voltage levels in the amount of time you have specified.

The rise time is measured from the time that your waveform crosses the low threshold until it crosses the high threshold. The fall time is measured from the time that the waveform crosses the high threshold until it crosses the low threshold.

- **":TRIGger:ADVanced:VIOLation:TRANSition"** on page 1577
- **":TRIGger:ADVanced:VIOLation:TRANSition:SOURce"** on page 1578
- **":TRIGger:ADVanced:VIOLation:TRANSition:SOURce:HTHReshold"** on page 1579
- **":TRIGger:ADVanced:VIOLation:TRANSition:SOURce:LTHReshold"** on page 1580
- **":TRIGger:ADVanced:VIOLation:TRANSition:TYPE"** on page 1581

<b>Source</b>	Use Source to select the channel used for a transition violation trigger.
<b>Low Threshold</b>	Use Low Threshold to set the low voltage threshold.
<b>High Threshold</b>	Use High Threshold to set the high voltage threshold.
<b>Type</b>	Use Type to select Rise Time or Fall Time violation.
<b>Trigger On</b>	Trigger On parameters include > Time and < Time.
> <b>Time</b>	Use > Time to look for transition violations that are longer than the time specified.
< <b>Time</b>	Use < Time to look for transition violations that are less than the time specified.
<b>Time</b>	Use Time to set the amount of time to determine a rise time or fall time violation.
	Available trigger conditioning includes HOLDoff and HYSTeresis (Noise Reject).
<b>Set the Mode Before Executing Commands</b>	Before executing the :TRIGger:ADVanced:VIOLation:TRANSition commands, set the mode by entering: <pre>:TRIGger:MODE ADVanced and :TRIGger:ADVanced:MODE VIOLation and :TRIGger:ADVanced:VIOLation:MODE TRANSition</pre>
	To query the oscilloscope for the advanced trigger violation mode, enter: <pre>:TRIGger:ADVanced:VIOLation:MODE?</pre>



## :TRIGger:ADVanced:VIOLation:TRANSition

**Command** :TRIGger:ADVanced:VIOLation:TRANSition:{GTHan | LTHan} <time>

This command lets you look for transition violations that are greater than or less than the time specified.

<time> The time for the trigger violation transition, in seconds.

**Query** :TRIGger:ADVanced:VIOLation:TRANSition:{GTHan | LTHan}?

The query returns the currently defined time for the trigger transition violation.

**Returned Format** [:TRIGger:ADVanced:VIOLation:TRANSition:{GTHan | LTHan}] <time><NL>

**History** Legacy command (existed before version 3.10).

## :TRIGger:ADVanced:VIOLation:TRANSition:SOURce

**Command** :TRIGger:ADVanced:VIOLation:TRANSition:SOURce {CHANnel<N>}

The transition source command lets you find any edge in your waveform that violates a rise time or fall time specification. The oscilloscope finds a transition violation trigger by looking for any pulses in your waveform with rising or falling edges that do not cross two voltage levels in the amount of time you have specified.

<N> An integer, 1-4.

**Query** :TRIGger:ADVanced:VIOLation:TRANSition:SOURce?

The query returns the currently defined transition source for the trigger transition violation.

**Returned Format** [:TRIGger:ADVanced:VIOLation:TRANSition:SOURce] {CHANnel<N>}<NL>

**History** Legacy command (existed before version 3.10).

## :TRIGger:ADVanced:VIOLation:TRANSition:SOURce:HTHReshold

**Command** :TRIGger:ADVanced:VIOLation:TRANSition:SOURce:HTHReshold {{CHANnel<N>},<level>}

This command lets you specify the source and high threshold for the trigger violation transition. The oscilloscope finds a transition violation trigger by looking for any pulses in your waveform with rising or falling edges that do not cross two voltage levels in the amount of time you have specified.

<N> An integer, 1–4.

<level> A real number for the voltage threshold level for the trigger transition violation, and is used with the high and low threshold transition source commands.

**Query** :TRIGger:ADVanced:VIOLation:TRANSition:SOURce:HTHReshold? {CHANnel<N>}

The query returns the specified transition source for the trigger transition high threshold violation.

**Returned Format** [:TRIGger:ADVanced:VIOLation:TRANSition:SOURce:HTHReshold {CHANnel<N>},<level><NL>]

**History** Legacy command (existed before version 3.10).

## :TRIGger:ADVanced:VIOLation:TRANSition:SOURce:LTHReshold

**Command** :TRIGger:ADVanced:VIOLation:TRANSition:SOURce:LTHReshold {{CHANnel<N>},<level>}

This command lets you specify the source and low threshold for the trigger violation transition. The oscilloscope finds a transition violation trigger by looking for any pulses in your waveform with rising or falling edges that do not cross two voltage levels in the amount of time you have specified.

<N> An integer, 1-4.

<level> A real number for the voltage threshold level for the trigger transition violation, and is used with the high and low threshold transition source commands.

**Query** :TRIGger:ADVanced:VIOLation:TRANSition:SOURce:LTHReshold? {CHANnel<N>}

The query returns the currently defined transition source for the trigger transition low threshold violation.

**Returned Format** [:TRIGger:ADVanced:VIOLation:TRANSition:SOURce:LTHReshold {CHANnel<N>},<level><NL>]

**History** Legacy command (existed before version 3.10).

## :TRIGger:ADVanced:VIOLation:TRANSition:TYPE

**Command** :TRIGger:ADVanced:VIOLation:TRANSition:TYPE {RISetime | FALLtime}

This command lets you select either a rise time or fall time transition violation trigger event.

**Query** :TRIGger:ADVanced:VIOLation:TRANSition:TYPE?

The query returns the currently defined transition type for the trigger transition violation.

**Returned Format** [:TRIGger:ADVanced:VIOLation:TRANSition:TYPE] {RISetime | FALLtime}<NL>

**History** Legacy command (existed before version 3.10).



## 39 Waveform Commands

:WAVEform:BANDpass? / 1586  
:WAVEform:BYTeorder / 1587  
:WAVEform:CGRade:HEIGht? / 1588  
:WAVEform:CGRade:WIDTh? / 1589  
:WAVEform:COMPLetE? / 1590  
:WAVEform:COUNT? / 1591  
:WAVEform:COUPLing? / 1592  
:WAVEform:DATA / 1593  
:WAVEform:FORMat / 1616  
:WAVEform:PNOise:FREQuency / 1619  
:WAVEform:POINts? / 1620  
:WAVEform:PREamble? / 1621  
:WAVEform:SEGMENTed:ALL / 1625  
:WAVEform:SEGMENTed:COUNT? / 1627  
:WAVEform:SEGMENTed:TTAG? / 1628  
:WAVEform:SEGMENTed:XLIST? / 1629  
:WAVEform:SOURce / 1630  
:WAVEform:STReaming / 1632  
:WAVEform:TYPE? / 1633  
:WAVEform:VIEW / 1634  
:WAVEform:XDISplay? / 1637  
:WAVEform:XINCrement? / 1638  
:WAVEform:XORigin? / 1639  
:WAVEform:XRANge? / 1640  
:WAVEform:XREFerence? / 1641  
:WAVEform:XUNits? / 1642  
:WAVEform:YDISplay? / 1643  
:WAVEform:YINCrement? / 1644  
:WAVEform:YORigin? / 1645  
:WAVEform:YRANge? / 1646  
:WAVEform:YREFerence? / 1647  
:WAVEform:YUNits? / 1648

The WAVEform subsystem is used to transfer waveform data between a computer and the oscilloscope. It contains commands to set up the waveform transfer and to send or receive waveform records to or from the oscilloscope.

**Data Acquisition** When data is acquired using the DIGitize command, the data is placed in the channel or function memory of the specified source. After the DIGitize command executes, the oscilloscope is stopped. If the oscilloscope is restarted by your program or from the front panel, the data acquired with the DIGitize command is overwritten.

You can query the preamble, elements of the preamble, or waveform data while the oscilloscope is running, but the data will reflect only the current acquisition, and subsequent queries will not reflect consistent data. For example, if the oscilloscope is running and you query the X origin, the data is queried in a separate command, it is likely that the first point in the data will have a different time than that of the X origin. This is due to data acquisitions that may have occurred between the queries. For this reason, Keysight Technologies does not recommend this mode of operation. Instead, you should use the DIGitize command to stop the oscilloscope so that all subsequent queries will be consistent.

#### NOTE

Function and channel data are volatile and must be read following a DIGitize command or the data will be lost when the oscilloscope is turned off.

**Waveform Data and Preamble** The waveform record consists of two parts: the preamble and the waveform data. The waveform data is the actual sampled data acquired for the specified source. The preamble contains the information for interpreting the waveform data, including the number of points acquired, the format of the acquired data, and the type of acquired data. The preamble also contains the X and Y increments, origins, and references for the acquired data.

The values in the preamble are set when you execute the DIGitize command. The preamble values are based on the current settings of the oscilloscope's controls.

**Data Conversion** Data sent from the oscilloscope must be scaled for useful interpretation. The values used to interpret the data are the X and Y origins and X and Y increments. These values can be read using the :WAVEform:XORigin?, WAVEform:YORigin?, WAVEform:XINCrement?, and WAVEform:YINCrement? queries.

**Conversion from Data Values to Units** To convert the waveform data values (essentially A/D counts) to real-world units, such as volts, use the following scaling formulas:  

$$\text{Y-axis Units} = \text{data value} \times \text{Yincrement} + \text{Yorigin (analog channels)}$$

$$\text{X-axis Units} = \text{data index} \times \text{Xincrement} + \text{Xorigin}, \quad \text{where the data index starts at zero: } 0, 1, 2, \dots, n-1.$$

The first data point for the time (X-axis units) must be zero, so the time of the first data point is the X origin.



**Data Format for Data Transfer** There are four types of data formats that you can select using the :WAVEform:FORMat command: ASCii, BYTE, WORD, and BINary. Refer to the FORMat command in this chapter for more information on data formats.

## :WAVEform:BANDpass?

**Query** :WAVEform:BANDpass?

The :WAVEform:BANDpass? query returns an estimate of the maximum and minimum bandwidth limits of the source waveform. The bandwidth limits are computed as a function of the coupling and the selected filter mode. The cutoff frequencies are derived from the acquisition path and software filtering.

**Returned Format** [:WAVEform:BANDpass] <lower\_cutoff>, <upper\_cutoff><NL>

<lower\_cutoff> Minimum frequency passed by the acquisition system.

<upper\_cutoff> Maximum frequency passed by the acquisition system.

**Example** This example places the estimated maximum and minimum bandwidth limits of the source waveform in the string variable, strBandwidth, then prints the contents of the variable to the computer's screen.

```
Dim strBandwidth As String ' Dimension variable.
myScope.WriteString ":WAVEform:BANDpass?"
strBandwidth = myScope.ReadString
Debug.Print strBandwidth
```

**History** Legacy command (existed before version 3.10).

## :WAVeform:BYTeorder

**Command** :WAVeform:BYTeorder {MSBFirst | LSBFirst}

The :WAVeform:BYTeorder command selects the order in which bytes are transferred to and from the oscilloscope using WORD and LONG formats. If MSBFirst is selected, the most significant byte is transferred first. Otherwise, the least significant byte is transferred first. The default setting is MSBFirst.

**NOTE**

The data transfer rate is faster using the LSBFirst byte order.

MSBFirst is for microprocessors, where the most significant byte resides at the lower address. LSBFirst is for microprocessors, where the least significant byte resides at the lower address.

**Example** This example sets up the oscilloscope to send the most significant byte first during data transmission.

```
myScope.WriteString ":WAVeform:BYTeorder MSBFirst"
```

**Query** :WAVeform:BYTeorder?

The :WAVeform:BYTeorder? query returns the current setting for the byte order.

**Returned Format** [:WAVeform:BYTeorder] {MSBFirst | LSBFirst}<NL>

**Example** This example places the current setting for the byte order in the string variable, strSetting, then prints the contents of the variable to the computer's screen.

```
Dim strSetting As String ' Dimension variable.
myScope.WriteString ":WAVeform:BYTeorder?"
strSetting = myScope.ReadString
Debug.Print strSetting
```

**History** Legacy command (existed before version 3.10).

## :WAVeform:CGRade:HEIGht?

**Query** :WAVeform:CGRade:HEIGht?

When the CGRade waveform view is selected (:WAVeform:VIEW CGRade), the :WAVeform:CGRade:HEIGht? query returns the color grade (pixel) database data height.

**Returned Format** <height><NL>

<height> ::= integer in NR1 format

- See Also**
- ["Getting Color Grade \(Pixel\) Database Count Values"](#) on page 1635
  - [":WAVeform:VIEW"](#) on page 1634
  - [":WAVeform:FORMat"](#) on page 1616
  - [":WAVeform:CGRade:WIDTh?"](#) on page 1589

**History** New in version 6.00.

## :WAVeform:CGRade:WIDTh?

**Query** :WAVeform:CGRade:WIDTh?

When the CGRade waveform view is selected (:WAVeform:VIEW CGRade), the :WAVeform:CGRade:WIDTh? query returns the color grade (pixel) database data width.

**Returned Format** <width><NL>

<width> ::= integer in NR1 format

- See Also**
- ["Getting Color Grade \(Pixel\) Database Count Values"](#) on page 1635
  - [":WAVeform:VIEW"](#) on page 1634
  - [":WAVeform:FORMat"](#) on page 1616
  - [":WAVeform:CGRade:HEIGHt?"](#) on page 1588

**History** New in version 6.00.

## :WAVeform:COMPLete?

**Query** :WAVeform:COMPLete?

The :WAVeform:COMPLete? query returns the percent of time buckets that are complete for the currently selected waveform.

For the NORMal, RAW, and INTerpolate waveform types, the percent complete is the percent of the number of time buckets that have data in them, compared to the memory depth.

For the AVERage waveform type, the percent complete is the number of time buckets that have had the specified number of hits divided by the memory depth. The hits are specified by the :ACQuire:AVERage:COUnT command.

For the VERSus waveform type, percent complete is the least complete of the X-axis and Y-axis waveforms.

**Returned Format** [:WAVeform:COMPLete] <criteria><NL>

<criteria> 0 to 100 percent, rounded down to the closest integer.

**Example** This example places the current completion criteria in the string variable, strCriteria, then prints the contents of the variable to the computer's screen.

```
Dim strCriteria As String    ' Dimension variable.
myScope.WriteString ":WAVeform:COMPLete?"
strCriteria = myScope.ReadString
Debug.Print strCriteria
```

**History** Legacy command (existed before version 3.10).

## :WAVEform:COUNT?

**Query** :WAVEform:COUNT?

The :WAVEform:COUNT? query returns the fewest number of hits in all of the time buckets for the currently selected waveform. For the AVERage waveform type, the count value is the fewest number of hits for all time buckets. This value may be less than or equal to the value specified with the :ACQUIRE:AVERage:COUNT command.

For the NORMal, RAW, INTerpolate, and VERSus waveform types, the count value returned is one, unless the data contains holes (sample points where no data is acquired). If the data contains holes, zero is returned.

**Returned Format** [:WAVEform:COUNT] <number><NL>

<number> An integer. Values range from 0 to 1 for NORMal, RAW, or INTerpolate types, and VERSus type. If averaging is on values range from 0 to 65536.

**Example** This example places the current count field value in the string variable, strCount, then prints the contents of the variable to the computer's screen.

```
Dim strCount As String ' Dimension variable.
myScope.WriteString ":WAVEform:COUNT?"
strCount = myScope.ReadString
Debug.Print strCount
```

**History** Legacy command (existed before version 3.10).

## :WAVEform:COUPling?

**Query** :WAVEform:COUPling?

The :WAVEform:COUPling? query returns the input coupling of the currently selected source.

**Returned Format** [:WAVEform:COUPling] {AC | DC | DCFifty | LFReject} <NL>

On 9000 Series, 9000H Series, and Z-Series oscilloscopes, this query can return:

- AC.
- DC.
- DCFifty.
- LFReject.

On 90000A Series, 90000 X-Series, V-Series, 90000 Q-Series, and Z-Series oscilloscopes, this query always returns:

- DC – (and is provided for compatibility with other Infiniium oscilloscopes).

**Example** This example places the current input coupling of the selected waveform in the string variable, strSetting, then prints the contents of the variable.

```
Dim strSetting As String ' Dimension variable.
myScope.WriteString ":WAVEform:COUPling?"
strSetting = myScope.ReadString
Debug.Print strSetting
```

**See Also** The :CHANnel<N>:INPut command sets the coupling for a particular channel.

You can use the :WAVEform:SOURce command to set the source for the coupling query.

Source	Return Value
CGRade	Coupling of the lowest numbered channel that is on.
HISTogram	The coupling of the selected channel. For functions, the coupling of the lowest numbered channel in the function.
CHANnel	The coupling of the channel number
FUNcTion	The coupling of the lowest numbered channel in the function
WMEMory	The coupling value of the source that was loaded into the waveform memory. If channel 1 was loaded, it would be the channel 1 coupling value.

**History** Legacy command (existed before version 3.10).



## :WAVEform:DATA

**Command** :WAVEform:DATA <X\_origin>,<X\_increment>,<Y\_origin>,<Y\_increment>,<IEEE\_block\_data>

With Infiniium Offline only, the :WAVEform:DATA command copies the waveform points in the IEEE block data to the channel source specified by the :WAVEform:SOURce command.

After the waveform data upload, the waveform will have a trigger count of "1". Also, statistics are reset and will begin accumulating again with this data.

This command also enables the display state (like the ":CHANnel<N>:DISPlay ON" command).

The :WAVEform:DATA command is not allowed when the Infiniium software is running on an oscilloscope with active hardware.

<X\_origin>,  
<X\_increment>,  
<Y\_origin>,  
<Y\_increment>  
<IEEE\_block\_data>

These values are 64-bit double-precision floating-point numbers.

This a definite-length block of 16-bit integer (WORD format) Q (quantization) data values, as described in "Streaming Off" below. The maximum and minimum Q values (30720 and -32736) indicate clipped data.

**Query** :WAVEform:DATA? [<start>[,<size>]]

The :WAVEform:DATA? query outputs waveform data to the computer over the remote interface. The data is copied from a waveform memory, function, channel, bus, pod, or digital channel previously specified with the :WAVEform:SOURce command.

**NOTE**

The data's returned response depends upon the setting of the :WAVEform:STReaming command. See "**Streaming Off**" on page 1594 or "**Streaming On**" on page 1594 for more detail.

**NOTE**

If the waveform data is ASCII formatted, no header information indicating the number of bytes being downloaded is included, and the waveform data is separated by commas.

The preamble queries, such as :WAVEform:XINCrement, can be used to determine the vertical scaling, the horizontal scaling, and so on.

**NOTE**

When an acquisition is made on multiple channels, the data for each channel has the same X origin and the same number of points.

- <start> An integer value which is the starting point in the source memory which is the first waveform point to transfer.
- <size> An integer value which is the number of points in the source memory to transfer. If the size specified is greater than the amount of available data then the size is adjusted to be the maximum available memory depth minus the <start> value.

**Streaming Off** The returned waveform data response depends upon the setting of the :WAVEform:STReaming command. When the data format is BYTE and streaming is off, the number of waveform points must be less than 1,000,000,000 or an error occurs and only 999,999,999 bytes of data are sent. When the data format is WORD and streaming is off, the number of waveform points must be less than 500,000,000 or an error occurs and only 499,999,999 words of data are sent.

The returned waveform data in response to the :WAVEform:DATA? query is in the following order.

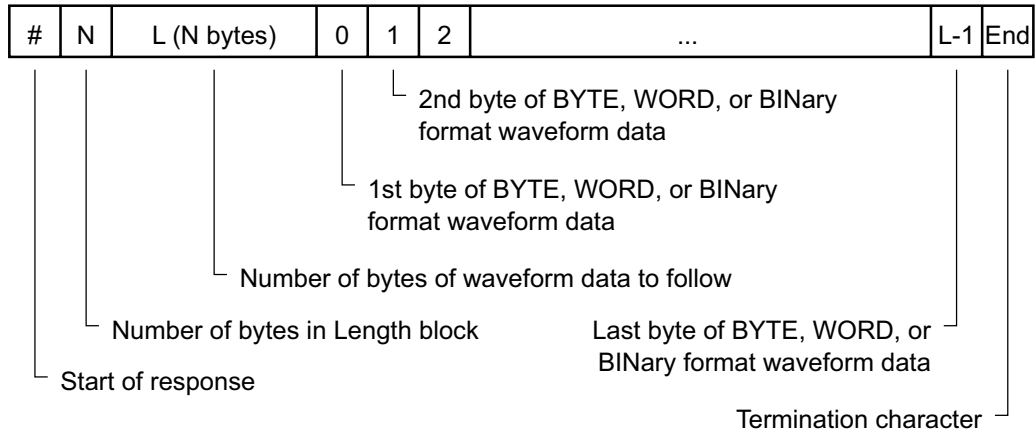

**Figure 5** Streaming Off

**Streaming On** When streaming is on there is no limit on the number of waveform data points that are returned. It is recommended that any new programs use streaming on to send waveform data points. The waveform data response when streaming is on is as follows.

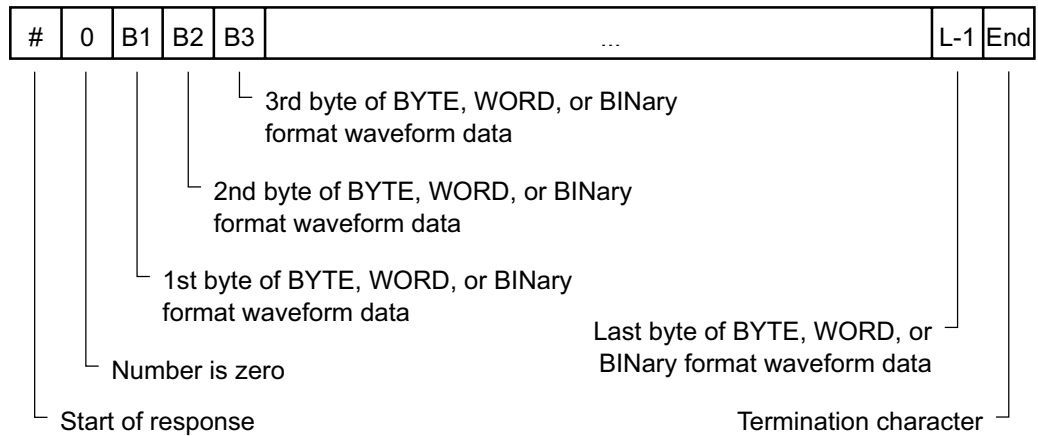

**Figure 6** Streaming On

**Returned Format** [:WAVEform:DATA] <block\_data>[, <block\_data>] <NL>

**Example** This example places the current waveform data from channel 1 into the varWavData array in the word format.

```
myScope.WriteString ":SYSTem:HEADer OFF" ' Response headers off.
myScope.WriteString ":WAVEform:SOURce CHANnel1 ' Select source.
myScope.WriteString ":WAVEform:FORMat WORD" ' Select word format.
myScope.WriteString ":WAVEform:DATA?"
varWavData = myScope.ReadIEEEBlock(BinaryType_I2)
```

The format of the waveform data must match the format previously specified by the :WAVEform:FORMat and :WAVEform:BYTeorder commands.

**DATA? Example for Analog Channels** The following C example shows how to transfer WORD formatted waveform data for analog channels to a computer.

```
/* readdata. c */

/* Reading Word format example. This program demonstrates the order
 * of commands suggested for operation of the Infiniium oscilloscope
 * via LAN. This program initializes the oscilloscope, acquires data,
 * transfers data in WORD format, converts the data into time and
 * voltage values, and stores the data in a file as comma-separated
 * ascii values. This format is useful for spreadsheet and MATLAB
 * applications. It requires a waveform which is connected to Channel 1.
 */

#include <stdio.h> /* location of: printf() */
#include <stdlib.h> /* location of: atof(), atoi() */
#include <string.h> /* location of: strlen() */
#include "sicl.h"

/* Prototypes */
int InitIO( void );
void WriteIO( char *buffer );
unsigned long ReadByte( char *buffer, unsigned long BytesToRead);
```

```

unsigned long ReadWord( char *buffer, int *reason,
                      unsigned long BytesToRead);
void ReadDouble( double *buffer );
void CloseIO( void );
void AcquireData( void );
void GetVoltageConversionFactors( double *yInc, double *yOrg );
void GetTimeConversionFactors( double *xInc, double *xOrg );
void WriteCsvToFile( unsigned long BytesToRead );
void SetupDataTransfer( void );

/* Defines */
#define MAX_LENGTH 10000000
#define INTERFACE "lan[130.29.70.247]:inst0"
#define TRUE 1
#define FALSE 0
#define IO_TIMEOUT 20000

/* Globals */
INST bus;
INST scope;
char buffer[MAX_LENGTH]; /* Buffer for reading data */
double xOrg=0L, xInc=0L; /* Values used to create time data */
double yOrg=0L, yInc=0L; /* Values used to convert data to volts */

void main( void )
{
    unsigned long BytesToRead;

    if ( !InitIO() )
    {
        exit( 1 );
    }

    AcquireData();

    WriteIO( ":WAVEform:FORMat WORD" ); /* Setup transfer format */
    WriteIO( ":WAVEform:BYTeorder LSBFirst" ); /* Setup transfer of
                                                LSB first */
    WriteIO( ":WAVEform:SOURce CHANnel1" ); /* Waveform data source
                                                channel 1 */
    WriteIO( ":WAVEform:STReaming 1" ); /* Turn on waveform
                                                streaming of data */

    GetVoltageConversionFactors( &yInc, &yOrg );
    GetTimeConversionFactors( &xInc, &xOrg );
    BytesToRead = MAX_LENGTH;
    SetupDataTransfer();
    WriteCsvToFile( BytesToRead );

    CloseIO( );
}

/*****
* Function name:  InitIO
* Parameters:    none
*****/

```

```

*   Return value: TRUE if successful otherwise FALSE
*   Description:  This routine initializes the SICL environment.
*                 It sets up error handling, opens both an interface
*                 and device session, sets timeout values, clears
*                 the LAN interface card, and clears the
*                 oscilloscope's LAN interface by performing a
*                 Selected Device Clear.
*****/
int InitIO( void )
{
    ionerror( I_ERROR_EXIT ); /* set-up interface error handling */

    bus = iopen( INTERFACE ); /* open interface session */
    if ( bus == 0 )
    {
        printf( "Bus session invalid\n" );
        return FALSE;
    }

    itimeout( bus, IO_TIMEOUT ); /* set bus timeout */
    iclear( bus );                /* clear the interface */

    scope = bus;                 /* open the scope device session */

    return TRUE;
}

/*****
* Function name:  WriteIO
* Parameters:    char *buffer which is a pointer to the character
*                string to be output
* Return value:  none
* Description:   This routine outputs strings to the oscilloscope
*                device session using SICL commands.
*****/
void WriteIO( char *buffer )
{
    unsigned long actualcnt;
    unsigned long BytesToRead;
    int send_end = 1;

    BytesToRead = strlen( buffer );

    iwrite( scope, buffer, BytesToRead, send_end, &actualcnt );
}

/*****
* Function name:  ReadByte
* Parameters:    char *buffer which is a pointer to the array to
*                store the read bytes
*                unsigned long BytesToRead which indicates the
*                maximum number of bytes to read
* Return value:  integer which indicates the actual number of bytes
*                read
*****/

```

```

*   Description: This routine inputs strings from the scope device
*               session using SICL commands.
*****/

unsigned long ReadByte( char *buffer, unsigned long BytesToRead )
{
    unsigned long BytesRead;
    int reason;

    BytesRead = BytesToRead;

    ired( scope, buffer, BytesToRead, &reason, &BytesRead );

    return BytesRead;
}

/*****
* Function name:  ReadWord
* Parameters:    short *buffer which is a pointer to the word array
*               to store the bytes read
*               int reason which is the reason that the read
*               terminated
*               unsigned long BytesToRead which indicates the
*               maximum number of bytes to read
* Return value: integer which indicates the actual number of
*               bytes read
* Description:  This routine inputs an array of short values from
*               the oscilloscope device session using SICL commands.
*****/

unsigned long ReadWord( char *buffer, int *reason,
                      unsigned long BytesToRead )
{
    long BytesRead;

    ired( scope, buffer, BytesToRead, reason, &BytesRead );

    return BytesRead;
}

/*****
* Function name:  ReadDouble
* Parameters:    double *buffer which is a pointer to the float
*               value to read
* Return value: none
* Description:  This routine inputs a float value from the
*               oscilloscope device session using SICL commands.
*****/

void ReadDouble( double *buffer )
{
    iscanf( scope, "%lf", buffer );
}

/*****
* Function name: close_IO
* Parameters:    none

```

```

*   Return value: none
*   Description:  This routine closes device and interface sessions
*                 for the SICL environment, and calls the routine
*                 _siclcleanup which de-allocates resources
*                 used by the SICL environment.
*****/

void CloseIO( void )
{
    iclose( scope ); /* close device session */
    iclose( bus );  /* close interface session */

    _siclcleanup(); /* required for 16-bit applications */
}

/*****
* Function name:  AcquireData
* Parameters:    none
* Return value:  none
* Description:   This routine acquires data using the current
*               oscilloscope settings.
*****/

void AcquireData( void )
{
    /*
    * The root level :DIGitize command is recommended for
    * acquiring new waveform data. It initializes the
    * oscilloscope's data buffers, acquires new data,
    * and ensures that acquisition criteria are met before the
    * acquisition is stopped. Note that the display is
    * automatically turned off when you use this form of the
    * :DIGitize command and must be turned on to view the
    * captured data on screen.
    */

    WriteIO(":DIGitize CHANnel1");
    WriteIO(":CHANnel1:DISPlay ON");
}

/*****
* Function name:  GetVoltageConversionFactors
* Parameters:    double yInc which is the voltage difference
*               represented by adjacent waveform data digital codes
*
*               double yOrg which is the voltage value of digital
*               code 0.
* Return value:  none
* Description:   This routine reads the conversion factors used to
*               convert waveform data to volts.
*****/

void GetVoltageConversionFactors( double *yInc, double *yOrg )
{

```

```

/* Read values which are used to convert data to voltage values */

WriteIO(":WAVEform:YINCrement?");
ReadDouble( yInc );

WriteIO(":WAVEform:YORigin?");
ReadDouble( yOrg );

}

/*****
* Function name: SetupDataTransfer
* Parameters: none
* Return value: none
* Description: This routine sets up the waveform data transfer and
*              removes the # and 0 characters.
*****/

void SetupDataTransfer( void )
{
    char cData;

    WriteIO( ":WAVEform:DATA?" ); /* Request waveform data */

    /* Find the # character */

    do
    {
        ReadByte( &cData, 1L );
    } while ( cData != '#' );

    /* Find the 0 character */

    do
    {
        ReadByte( &cData, 1L );
    } while ( cData != '0' );
}

/*****
* Function name: GetTimeConversionFactors
* Parameters: double xInc which is the time between consecutive
*              sample points.
*              double xOrg which is the time value of the first
*              data point.
* Return value: none
* Description: This routine transfers the waveform conversion
*              factors for the time values.
*****/

void GetTimeConversionFactors( double *xInc, double *xOrg )
{

    /* Read values which are used to create time values */

    WriteIO(":WAVEform:XINCrement?");

```



```

ReadDouble( xInc );

WriteIO(":WAVEform:XORigin?");
ReadDouble( xOrg );

}

/*****
* Function name: WriteCsvToFile
* Parameters: unsigned long BytesToRead which is the number of
*             data points to read
* Return value: none
* Description: This routine stores the time and voltage
*             information about the waveform as time and
*             voltage separated by commas to a file.
*****/

void WriteCsvToFile( unsigned long BytesToRead )
{
    FILE *fp;
    int done = FALSE;
    int reason = 0;
    unsigned long i;
    unsigned long j = 0;
    unsigned long BytesRead = 0L;
    double Time;
    double Volts;
    short *buff;

    fp = fopen( "pairs.csv", "wb" ); /* Open file in binary mode - clear
                                     file if it already exists */

    if (fp != NULL)
    {
        while( !done )
        {
            BytesRead = ReadWord( buffer, &reason, BytesToRead );

            switch( reason )
            {
                {
            case I_TERM_MAXCNT:
                done = FALSE;
                break;
            case I_TERM_END:
                done = TRUE;
                break;
            case I_TERM_CHR:
                done = TRUE;
                break;
            default:
                done = TRUE;
                break;
            };

            buff = (short *) buffer;

            for( i = 0; i < ((BytesRead - 1)/2); i++)

```

```

        {
            Time = (j * xInc) + xOrg; /* calculate time */
            j = j + 1;

            Volts = (buff[i] * yInc) + yOrg; /* calculate voltage */

            fprintf( fp, "%e,%f\n", Time, Volts );
        }
    }
    fclose( fp );

}
else
{
    printf("Unable to open file 'pairs.csv'\n");
}
}

```

### DATA? Example for Digital Channels

The following C example shows how to transfer both BYTE and WORD formatted waveform data for digital channels to a computer. There is a file on the Infiniium Oscilloscope Example Programs disk called `readdig.c` in the `c` directory that contains this program.

```

/* readdig. c */

/* Reading Byte and Word format Example. This program demonstrates the
order of
commands suggested for operation of the Infiniium oscilloscope by LAN o
r GPIB.
This program initializes the scope, acquires data, transfers data in bo
th the
BYTE and WORD formats, converts the data into hex, octal, binary and ti
me values,
and stores the data in a file as comma-separated values. This format i
s useful
for spreadsheet applications.
*/

#include <stdio.h>          /* location of: printf() */
#include <stdlib.h>        /* location of: atof(), atoi() */
#include <string.h>        /* location of: strlen() */
#include "sicl.h"

/* Prototypes */
int InitIO( void );
void WriteIO( char *buffer );
unsigned long ReadByte( char *buffer, unsigned long BytesToRead);
unsigned long ReadWord( short *buffer, unsigned long BytesToRead);
void ReadDouble( double *buffer );
void CloseIO( void );
void AcquireData( void );
void GetTimeConversionFactors( void );
void CreateTimeData( unsigned long AcquiredLength,
                    double *TimeValues );
void WriteCsvToFile( double *TimeValues, unsigned short *wordData,
                   unsigned char *byteData, unsigned long AcquiredLeng

```

```

th);
unsigned long SetupDataTransfer( double lTime, double rTime );
int Round( double number );

/* Defines */
#define MAX_LENGTH 8192000

#define LAN

#ifdef LAN
    #define INTERFACE "lan[130.29.71.202]:hpib7,7"
#else
    #define INTERFACE "hpib7"
#endif

#define DEVICE_ADDR "hpib7,7"
#define TRUE 1
#define FALSE 0
#define IO_TIMEOUT 20000

/* Globals */
INST bus;
INST scope;
double TimeValues[MAX_LENGTH];          /* Time value of data */
unsigned short wordData[MAX_LENGTH/2]; /* Buffer for reading word format
data */
unsigned char byteData[MAX_LENGTH];     /* Buffer for reading byte format
data */
double xOrg, xInc;                      /* Values necessary to create time
data */

int Start;

void main( void )
{
    char Term;
    unsigned long BytesToRead;

    if ( !InitIO() ) {
        exit( 1 );
    }

    AcquireData();

    WriteIO( ":SYSTem:HEADer OFF" );
    WriteIO( ":SYSTem:LONGform OFF" );
    WriteIO( ":WAVEform:BYTEorder LSBFirst" ); /* Setup byte order */
    WriteIO( ":WAVEform:FORMat WORD" );        /* Setup transfer format */
    /
    WriteIO( ":WAVEform:SOURce POD1" );        /* Waveform data source pod
1 */

    GetTimeConversionFactors( );

    BytesToRead = SetupDataTransfer( -25E-6, 25E-6 );
    ReadWord( wordData, BytesToRead );
    ReadByte( &Term, 1L );                    /* Read termination character */

```

```

/
WriteIO(":WAVeform:FORMat BYTE");      /* Setup transfer format */

BytesToRead = SetupDataTransfer( -25E-6, 25E-6);
ReadByte( byteData, BytesToRead );
ReadByte( &Term, 1L );                /* Read termination character */
/

CreateTimeData( BytesToRead, TimeValues );

WriteCsvToFile( TimeValues, wordData, byteData, BytesToRead );

CloseIO( );

}

/*****
*****
*   Function name: InitIO
*   Parameters:    none
*   Return value: none
*   Description:  This routine initializes the SICL environment. It se
ts up
*                 errorhandling, opens both an interface and device ses
sion,
*                 sets timeout values, clears the GPIB interface card,
and
*                 clears the oscilloscope's GPIB card by performing a
*                 Selected Device Clear.
*****
*****/

int InitIO( void )
{

    ionerror( I_ERROR_EXIT );          /* set-up interface error handling */

    bus = iopen( INTERFACE );          /* open interface session */
    if ( bus == 0 ) {
        printf( "Bus session invalid\n" );
        return FALSE;
    }

    itimeout( bus, IO_TIMEOUT );       /* set bus timeout */
    iclear( bus );                     /* clear the interface */

#ifdef LAN
    scope = bus;
#else
    scope = iopen( DEVICE_ADDR );      /* open the scope device session */
/
    if ( scope == 0 ) {
        printf( "Scope session invalid\n" );
        iclose( bus );                /* close interface session */
        _siclcleanup();                /* required for 16-bit applications */
        return FALSE;
    }

```

```

    }

    itimeout( scope, IO_TIMEOUT );      /* set device timeout */
    iclear( scope );                    /* perform Selected Device Clear on oscilloscop
e */
#endif

    return TRUE;
}

/*****
*****
*   Function name: WriteIO
*   Parameters:   char *buffer which is a pointer to the character stri
ng to
*                 be output
*   Return value: none
*   Description: This routine outputs strings to the oscilloscope device
*                 session using SICL commands.
*****
*****/

void WriteIO( char *buffer )
{
    unsigned long actualcnt;
    unsigned long BytesToWrite;
    int send_end = 1;

    BytesToWrite = strlen( buffer );

    iwrite( scope, buffer, BytesToWrite, send_end, &actualcnt );
}

/*****
*****
*   Function name: ReadByte
*   Parameters:   char *buffer which is a pointer to the array to store
the read bytes unsigned long BytesToRead which indica
tes
*                 the maximum number of bytes to read
*   Return value: integer which indicates the actual number of bytes re
ad
*   Description: This routine inputs strings from the scope device sessi
on
*                 using SICL commands.
*****
*****/

unsigned long ReadByte( char *buffer, unsigned long BytesToRead )
{
    unsigned long BytesRead=0L;
    int reason;

    BytesRead = BytesToRead;
    ired( scope, buffer, BytesToRead, &reason, &BytesRead );
}

```

```

        return BytesRead;
    }

/*****
*****
*   Function name: ReadWord
*   Parameters:   short *buffer which is a pointer to the word array to
store
*               the bytes read unsigned long BytesToRead which indica
tes
*               the maximum number of bytes to read
*   Return value: integer which indicates the actual number of bytes re
ad
*   Description: This routine inputs an array of short values from the
*               oscilloscope device session using SICL commands.
*****/

unsigned long ReadWord( short *buffer, unsigned long BytesToRead )
{
    long BytesRead=0L;
    int reason;

    BytesRead = BytesToRead;
    iread( scope, (char *) buffer, BytesToRead, &reason, &BytesRead );

    return BytesRead;
}

/*****
*****
*   Function name: ReadDouble
*   Parameters:   double *buffer which is a pointer to the float value
to read
*   Return value: none
*   Description:  This routine inputs a float value from the oscillosco
pe
*               device session using SICL commands.
*****/

void ReadDouble( double *buffer )
{
    int error;
    error = iscanf( scope, "%lf", buffer );
}

/*****
*****
*   Function name: close_IO
*   Parameters:   none
*   Return value: none
*   Description:  This routine closes device and interface sessions for
*               the SICL environment, and calls the routine _siclclean
up
*               which de-allocates resources used by the SICL environm

```

```

ent.
*****
*****/

void CloseIO( void )
{
    iclose( scope ); /* close device session */
    iclose( bus ); /* close interface session */

    _siclcleanup(); /* required for 16-bit applications */
}

/*****
*****
* Function name: AcquireData
* Parameters: none
* Return value: none
* Description: This routine acquires data using the current
* oscilloscope settings.
*****
*****/

void AcquireData( void )
{
    /*
    * The root level :DIGitize command is recommended for acquiring ne
w
    * waveform data. It initializes the oscilloscope's data buffers,
    * acquires new data, and ensures that acquisition criteria are met
    * before the acquisition is stopped. Note that the display is
    * automatically turned off when you use this form of the
    * :DIGitize command and must be turned on to view the captured dat
a
    * on screen.
    */

    WriteIO(":DIGitize POD1");
    WriteIO(":POD1:DISPlay ON");
}

/*****
*****
* Function name: SetupDataTransfer
* Parameters: double lTime which is the time value of the first
* waveform memory location of data.
* double rTime which is the time value of the last
* waveform memory location of data.
* Return value: Number of bytes of waveform data to read.
* Description: This routine sets up the waveform data transfer and get
s
* the number of bytes to be read. The beginning of data
* starts with the # character followed by a number which
* tells how many bytes to read for the integer which is t
he

```

```

*           total number of data bytes that are being transferred.
*           Following this is the waveform data.  For example, if 1
024
*           bytes of waveform data is being transferred then this
*           information will be as follows:
*           #41024 <1024 data bytes>
*****/
*****/

unsigned long SetupDataTransfer( double lTime, double rTime )
{
    unsigned long BytesToRead;
    char header_str[8];
    char cData;
    unsigned long BytesRead;
    int Size;
    char Range[100];

    /* Find the index value of the first data memory location */

    Start = Round((lTime - xOrg)/xInc);
    if (Start < 1) {
        Start = 1;
    }

    /* Find the number of data bytes that you want */

    Size = Round((rTime - lTime)/xInc);

    sprintf( Range, ":WAVEform:DATA? %d,%d", Start, Size);
    WriteIO( Range );           /* Request waveform data */

    /* Find the # character */

    do {
        ReadByte( &cData, 1L );
    } while ( cData != '#' );

    /* Read the next byte which tells how many bytes to read for the number
er
* of waveform data bytes to transfer value.
*/

    ReadByte( &cData, 1L );
    BytesToRead = cData - '0'; /* Convert to a number */

    /* Reads the number of data bytes that will be transferred */

    BytesRead = ReadByte( header_str, BytesToRead );
    header_str[BytesRead] = '\0';
    BytesToRead = atoi( header_str );

    return BytesToRead;
}

/*****

```



```

*****
*   Function name: GetTimeConversionFactors
*   Parameters:    none
*   Return value: none
*   Description:  This routine transfers the waveform conversion
*                 factors for the time values.
*****/

Void GetTimeConversionFactors( void )
{
    /* Read values which are used to create time values */

    WriteIO(":WAVEform:XINCrement?");
    ReadDouble( &xInc );

    WriteIO(":WAVEform:XORigin?");
    ReadDouble( &xOrg );
}

/*****
*****
*   Function name: CreateTimeData
*   Parameters:    unsigned long AcquiredLength which is the number of d
ata
*                 points
*                 double TimeValues is a pointer to the array where tim
e
*                 values are stored
*   Return value: none
*   Description:  This routine converts the data to time values using
*                 the values that describe the waveform.  These values ar
e stored
*                 in global variables.
*****/

void CreateTimeData( unsigned long AcquiredLength, double *TimeValues )
{
    unsigned long i;

    for (i = 0; i < AcquiredLength; i++) {
        TimeValues[i] = ((Start + i) * xInc) + xOrg; /* calculate time va
lues */
    }
}

/*****
*****
*   Function name: WriteCsvToFile
*   Parameters:    double *TimeValues which is a pointer to an array of
*                 calculated time values
*                 unsigned short *wordData which is a pointer to an arr
ay of

```

```

*           word format digital values
*           unsigned char *byteData which is a pointer to an arra
y of
*           byte format digital values
*           unsigned long AcquiredLength which is the number of d
ata
*           points read
* Return value: none
* Description: This routine stores the time and digital information
about
*           the waveform as time, word format, and byte format
*           separated by commas to a file.
*****/

void WriteCsvToFile( double *TimeValues, unsigned short *wordData,
                    unsigned char *byteData, unsigned long AcquiredLength )
{
    FILE *fp;
    char Binary[9];
    unsigned long i;
    int j;
    int k;

    fp = fopen( "digital.csv", "wb" ); /* Open file in binary mode - clear
file
                                     if it already exists */

    if (fp != NULL) {

        fprintf( fp, "Time,Decimal Word Data,Hex Word Data,Hex Byte Data,Bi
nary Byte Data\n");
        Binary[8] = '\0';

        for ( i = 0; i < AcquiredLength; i++ ) {

            // Create the binary formatted byte data
            for ( j = 7, k = 0; j >= 0; j--, k++ ) {
                Binary[k] = ((byteData[i] & ( 1 << j )) >> j) + '0';
            }

            fprintf( fp, "%e,%d,%04X,%02X,%s\
n", TimeValues[i], wordData[i], wordData[i],
                                     byteData[i], Binary );
        }

        fclose( fp );
    }
    else {
        printf("Unable to open file 'digital.csv'\n");
    }
}

/*****
*****
* Function name: Round

```

```

* Parameters: double number which is a floating point number
*             to be converted.
* Return value: The rounded integer value for the number parameter.
* Description: This routine takes a floating point number and create
s an
*             integer.
*****/

int Round( double number )
{
    if (number < 0.0f ) {
        return ( (int) (number - 0.5f) );
    }
    else {
        return ( (int) (number + 0.5f) );
    }
}

```

### Understanding WORD and BYTE Formats

Before you can understand how the WORD and BYTE downloads work, it is necessary to understand how Infiniium creates waveform data.

### Analog-to-digital Conversion Basics

The input channel of every digital sampling oscilloscope contains an analog-to-digital converter (ADC) as shown in [Figure 7](#). The 8-bit ADC in some Infiniium oscilloscope models consists of 256 voltage comparators. Each comparator has two inputs. One input is connected to a reference dc voltage level and the other input is connected to the channel input. When the voltage of the waveform on the channel input is greater than the dc level, then the comparator output is a 1 otherwise the output is a 0. Each of the comparators has a different reference dc voltage. The output of the comparators is converted into an 8-bit integer by the encoder.

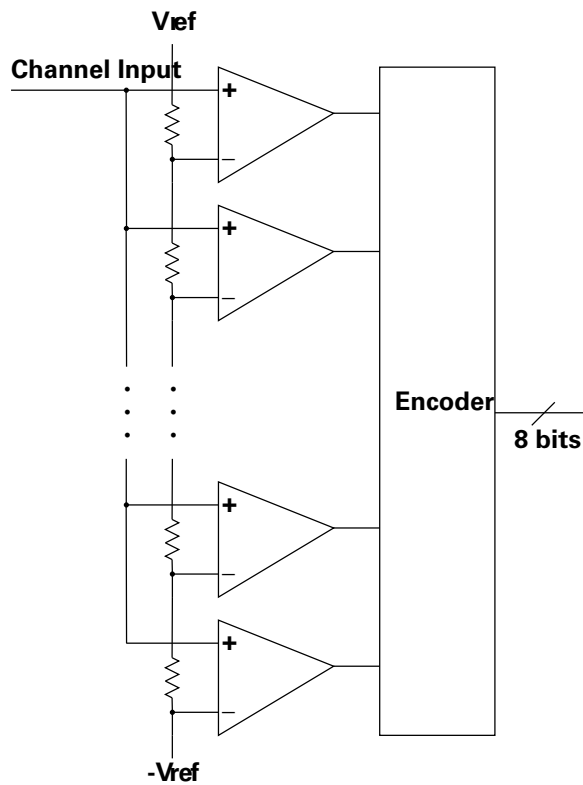

**Figure 7** Block Diagram of an ADC

All ADCs have non-linearity errors which, if not corrected, can give less accurate vertical measurement results. For example, the non-linearity error for a 3-bit ADC is shown in the following figure.

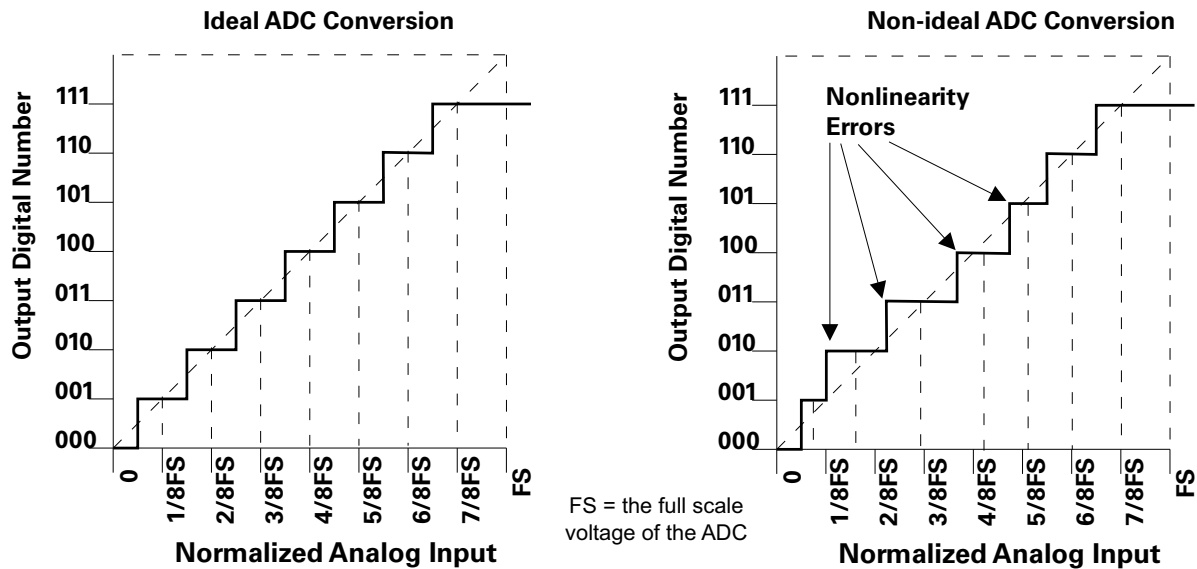

**Figure 8** ADC Non-linearity Errors for a 3-bit ADC

The graph on the left shows an ADC which has no non-linearity errors. All of the voltage levels are evenly spaced producing output codes that represent evenly spaced voltages. In the graph on the right, the voltages are not evenly spaced with some being wider and some being narrower than the others.

When you calibrate your Infiniium, the input to each channel, in turn, is connected to the Aux Out connector. The Aux Out is connected to a 16-bit digital-to-analog converter (DAC) whose input is controlled by Infiniium's CPU. There are 65,536 dc voltage levels that are produced by the 16-bit DAC at the Aux Out. At each dc voltage value, the output of the ADC is checked to see if a new digital code is produced. When this happens, a 16-bit correction factor is calculated for that digital code and this correction factor is stored in a Calibration Look-up Table.

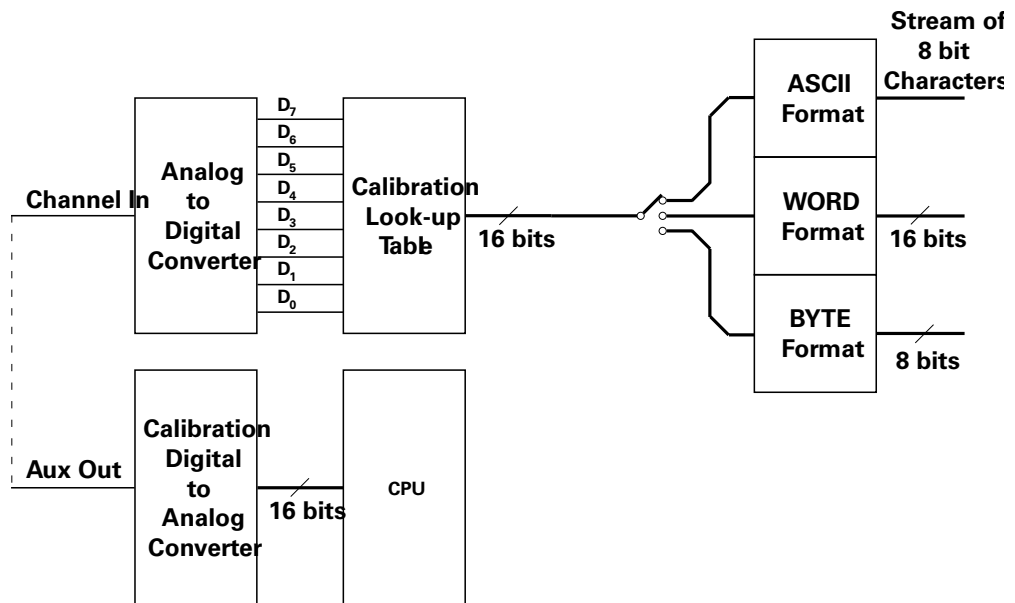

**Figure 9** Data Flow in Infiniium

This process continues until all 256 digital codes are calibrated. The calibration process removes most of the non-linearity error of the ADC which yields more accurate vertical voltage values.

During normal operation of the oscilloscope, the output of the ADC is used as an address to the Calibration Look-up Table which produces 16-bit data for the oscilloscope to process and display. The output of the ADC is a signed 8-bit integer and the output of the Calibration Look-up Table is a signed 16-bit integer. If the amplitude of the input waveform is larger than the maximum dc reference level of the ADC, the ADC will output the maximum 8-bit value that it can (255). This condition is called ADC clipping. When the 255 digital code is applied to the Calibration Look-up Table, a 16-bit value, such as 30720 could be produced which represents an ADC clipped value.

Data values for clipped portions of waveforms are the maximum and minimum Q (quantization) values. For 16-bit waveform data, the maximum Q value is 30720 and the minimum Q value is -32736.

#### **WORD and BYTE Data Formats**

When downloading the waveform data in WORD format, the 16-bit signed integer value for each data point is sent in two consecutive 8-bit bytes over the remote interface. Whether the least significant byte (LSB) or the most significant byte (MSB) is sent first depends on the byte order determined by the BYTeorder command.

Before downloading the waveform data in BYTE format, each 16-bit signed integer is converted into an 8-bit signed integer. Because there are more possible 16-bit integers than there are 8-bit integers, a range of 16-bit integers is converted into single 8-bit numbers. For example, the following 16-bit numbers are all converted into one 8-bit number.

16-Bit Integers			8-Bit Integer	
Decimal	Hex		Hex	Decimal
26,240	0x6680	Truncated to >>	0x66	102
26,200	0x6658			
26,160	0x6630			
26,120	0x6608			

This conversion is what makes the BYTE download format less accurate than the WORD format.

**History** Legacy command (existed before version 3.10).

## :WAVEform:FORMat

**Command** :WAVEform:FORMat {ASCIi | BINary | BYTE | WORD | FLOat}

The :WAVEform:FORMat command sets the data transmission mode for waveform data output. This command controls how the data is formatted when it is sent from the oscilloscope, and pertains to all waveforms.

The default format is ASCIi.

**Table 18** Selecting a Format

Type	Advantages	Disadvantages
ASCIi	<ul style="list-style-type: none"> <li>Data is returned as voltage values and does not need to be converted.</li> <li>Is as accurate as WORD format.</li> <li>Supports HISTogram SOURce.</li> </ul>	<ul style="list-style-type: none"> <li>Very slow data download rate.</li> </ul>
BYTE	<ul style="list-style-type: none"> <li>Data download rate is twice as fast as the WORD format.</li> </ul>	<ul style="list-style-type: none"> <li>Data is less accurate than the WORD format for analog channels.</li> <li>Not compatible with digital bus and pod data.</li> </ul>
WORD	<ul style="list-style-type: none"> <li>Data is the most accurate for analog channels.</li> </ul>	<ul style="list-style-type: none"> <li>Data download rate takes twice as long as the BYTE format.</li> </ul>
BINary	<ul style="list-style-type: none"> <li>Supports HISTogram SOURce.</li> <li>Can be used for analog channels.</li> <li>Can be used for color grade waveform views.</li> </ul>	<ul style="list-style-type: none"> <li>Data download rate takes twice as long as the BYTE format for analog channels.</li> </ul>
FLOat	<ul style="list-style-type: none"> <li>Supports color grade waveform view only (:WAVEform:VIEW CGRade).</li> <li>Supports larger pixel count numbers than BINary with fewer data bytes.</li> </ul>	<ul style="list-style-type: none"> <li>None.</li> </ul>

**ASCIi** ASCIi-formatted data consists of waveform data values converted to the currently selected units, such as volts, and are output as a string of ASCII characters with each value separated from the next value by a comma. The values are formatted in floating point engineering notation. For example:

```
8.0836E+2,8.1090E+2, . . . , -3.1245E-3
```

**NOTE**

The ASCIi format does not send out the header information indicating the number of bytes being downloaded.



In ASCII format:

- The value "99.999E+36" represents a hole value. A hole can occur when you are using the equivalent time sampling mode when during a single acquisition not all of the acquisition memory locations contain sampled waveform data. It can take several acquisitions in the equivalent time sampling mode to fill all of the memory locations.

**BYTE** BYTE-formatted data is formatted as *signed* 8-bit integers. Depending on your programming language and IO library, you may need to create a function to convert these signed bytes to signed integers. In BYTE format:

- The value 125 represents a hole value. A hole can occur when you are using the equivalent time sampling mode when during a single acquisition not all of the acquisition memory locations contain sampled waveform data. It can take several acquisitions in the equivalent time sampling mode to fill all of the memory locations.

The waveform data values are converted from 16-bit integers to 8-bit integers before being downloaded to the computer. For more information, see **"Understanding WORD and BYTE Formats"** on page 1611.

**WORD** WORD-formatted data is transferred as *signed* 16-bit integers in two bytes. If :WAVEform:BYTeorder is set to MSBFirst, the most significant byte of each word is sent first. If the BYTeorder is LSBFirst, the least significant byte of each word is sent first. In WORD format:

- The value 31232 represents a hole level. A hole can occur when you are using the equivalent time sampling mode when during a single acquisition not all of the acquisition memory locations contain sampled waveform data. It can take several acquisitions in the equivalent time sampling mode to fill all of the memory locations.

For more information, see **"Understanding WORD and BYTE Formats"** on page 1611.

**BINary** BINary-formatted data can be used with any SOURce. When a source is any valid source except for HISTogram, the data is returned in WORD format.

When the source is set to HISTogram, the data is transferred as signed 64-bit integers in 8 bytes. There are no hole values in the histogram data.

If :WAVEform:BYTeorder is set to MSBFirst, the most significant byte of each long word is sent first. If the BYTeorder is LSBFirst, the least significant byte of each long word is sent first.

**FLOat** When the color grade waveform view is selected (:WAVEform:VIEW CGRade), the color grade (pixel) database count values can be queried using these formats only:

- **BINary** – the :WAVEform:DATA? query will return a binary block of (8-byte) uint64 values.
- **FLOat** – the :WAVEform:DATA? query will return a binary block of (4-byte) single-precision floating-point values.

**Example** This example selects the WORD format for waveform data transmission.

```
myScope.WriteString ":WAVeform:FORMat WORD"
```

**Query** :WAVeform:FORMat?

The :WAVeform:FORMat? query returns the current output format for transferring waveform data.

**Returned Format** [:WAVeform:FORMat] {ASCIi | BINary | BYTE | WORD}<NL>

**Example** This example places the current output format for data transmission in the string variable, strMode, then prints the contents of the variable to the computer's screen.

```
Dim strMode As String ' Dimension variable.
myScope.WriteString ":WAVeform:FORMat?"
strMode = myScope.ReadString
Debug.Print strMode
```

- See Also**
- [":WAVeform:VIEW"](#) on page 1634
  - [":WAVeform:DATA"](#) on page 1593
  - [":WAVeform:CGRade:WIDTh?"](#) on page 1589
  - [":WAVeform:CGRade:HEIGht?"](#) on page 1588

**History** Legacy command (existed before version 3.10).

Version 6.00: Added the FLOat option for getting the color grade (pixel) database data as single-precision floating-point values.

## :WAVEform:PNOise:FREQUency

**Query** :WAVEform:PNOise:FREQUency?

The :WAVEform:PNOise:FREQUency? query returns the horizontal frequency axis values for the phase noise analysis results waveform. The corresponding vertical values for the waveform are returned by the :WAVEform:DATA? query when the :WAVEform:SOURce is set to PNOise.

With the phase noise analysis results waveform, the :WAVEform:FORMat must be set to ASCii or FLOat.

**Returned Format** <freq\_axis\_values><NL>

```
<freq_axis_values> ::= {<comma-separated-ascii> (with ASCii format)
| <definite-length_block_of_32-bit_floats> (with FLOat format)}
```

- See Also**
- [":WAVEform:DATA"](#) on page 1593
  - [":WAVEform:SOURce"](#) on page 1630
  - [":WAVEform:FORMat"](#) on page 1616
  - [":MEASure:PN:CORRelations"](#) on page 1056
  - [":MEASure:PN:DESKew"](#) on page 1057
  - [":MEASure:PN:EDGE"](#) on page 1058
  - [":MEASure:PN:HORizontal:START"](#) on page 1059
  - [":MEASure:PN:HORizontal:STOP"](#) on page 1060
  - [":MEASure:PN:RSSC"](#) on page 1061
  - [":MEASure:PN:SOURce"](#) on page 1062
  - [":MEASure:PN:SPURs"](#) on page 1064
  - [":MEASure:PN:SSENSitivity"](#) on page 1065
  - [":MEASure:PN:STATe"](#) on page 1066
  - [":MEASure:PN:VERTical:REFerence"](#) on page 1067
  - [":MEASure:PN:VERTical:SCALE"](#) on page 1068
  - [":MEASure:PN:WINDow"](#) on page 1069

**History** New in version 6.55.

## :WAVEform:POINts?

**Query** :WAVEform:POINts?

The :WAVEform:POINts? query returns the points value in the current waveform preamble. The points value is the number of time buckets contained in the waveform selected with the :WAVEform:SOURce command. If the Sin(x)/x interpolation filter is enabled, the number of points can be larger than the oscilloscope's memory depth setting because the waveform includes the interpolated points.

**NOTE**

When an acquisition is made on multiple channels, the data for each channel has the same X origin and the same number of points.

With ":WAVEform:VIEW CGRade", the :WAVEform:POINts? query returns the number of count values in the color grade (pixel) database. See "[Getting Color Grade \(Pixel\) Database Count Values](#)" on page 1635.

**Returned Format** [:WAVEform:POINts] <points><NL>

<points> An integer. See the :ACQUIRE:POINts command for a table of possible values.

**Example** This example places the current acquisition length in the numeric variable, varLength, then prints the contents of the variable to the computer's screen.

```
myScope.WriteString ":SYSTEM:HEADer OFF" ' Response headers off.
myScope.WriteString ":WAVEform:POINts?"
varLength = myScope.ReadNumber
Debug.Print FormatNumber(varLength, 0)
```

**NOTE****Turn Headers Off**

When you are receiving numeric data into numeric variables, you should turn the headers off. Otherwise, the headers may cause misinterpretation of returned data.

**See Also**

- "[:ACQUIRE:POINts\[:ANALog\] – Memory depth](#)" on page 253
- "[:WAVEform:VIEW](#)" on page 1634

**History** Legacy command (existed before version 3.10).

## :WAVeform:PREamble?

**Query** :WAVeform:PREamble?

The :WAVeform:PREamble? query outputs a waveform preamble to the computer from the waveform source, which can be a waveform memory or channel buffer.

**Returned Format** [:WAVeform:PREamble] <preamble\_data><NL>

The preamble can be used to translate raw data into time and voltage values. The following lists the elements in the preamble.

<preamble\_data> <format>, <type>, <points>, <count>, <X increment>, <X origin>, <X reference>, <Y increment>, <Y origin>, <Y reference>, <coupling>, <X display range>, <X display origin>, <Y display range>, <Y display origin>, <date>, <time>, <frame model #>, <acquisition mode>, <completion>, <X units>, <Y units>, <max bandwidth limit>, <min bandwidth limit>[,<segment count>]

**Table 19** Waveform Preamble Elements

Element	Description
<format>	<p>Returned format values can be:</p> <ul style="list-style-type: none"> <li>▪ 0 – ASCII format</li> <li>▪ 1 – BYTE format</li> <li>▪ 2 – WORD format</li> <li>▪ 3 – LONG format</li> <li>▪ 4 – LONGLONG format</li> <li>▪ 5 – FLOat format</li> </ul> <p>The format value describes the data transmission mode for waveform data output. This command controls how the data is formatted when it is sent from the oscilloscope. (See <b>":WAVeform:FORMat"</b> on page 1616.)</p>
<type>	<p>Returned type values can be:</p> <ul style="list-style-type: none"> <li>▪ 1 – RAW</li> <li>▪ 2 – AVERage</li> <li>▪ 3 – VHIStogram</li> <li>▪ 4 – HHIStogram</li> <li>▪ 5 – not used</li> <li>▪ 6 – INTerpolate</li> <li>▪ 7 – not used</li> <li>▪ 8 – not used</li> <li>▪ 9 – DIGITAL</li> <li>▪ 10 – PDEtect</li> </ul> <p>This value describes how the waveform was acquired. (See also the <b>":WAVeform:TYPE?"</b> on page 1633 query.)</p>

**Table 19** Waveform Preamble Elements (continued)

Element	Description
<points>	The number of data points or data pairs contained in the waveform data. (See <a href="#">":ACQUIRE:POINTS:ANALog – Memory depth"</a> on page 253.)
<count>	For the AVERAGE waveform type, the count value is the fewest number of hits for all time buckets. This value may be less than or equal to the value requested with the :ACQUIRE:AVERAge:COUNT command. For RAW and INTerpolate waveform types, this value is 0 or 1. The count value is ignored when it is sent to the oscilloscope in the preamble. (See <a href="#">":WAVEform:TYPE?"</a> on page 1633 and <a href="#">":ACQUIRE[:AVERAge]:COUNT"</a> on page 240.)
<X increment>	The X increment is the duration between data points on the X axis. For time domain waveforms, this is the time between points. If the value is zero then no data has been acquired. (See the <a href="#">":WAVEform:XINCrement?"</a> on page 1638 query.)
<X origin>	The X origin is the X-axis value of the first data point in the data record. For time domain waveforms, it is the time of the first point. This value is treated as a double-precision 64-bit floating-point number. If the value is zero, then no data has been acquired. (See the <a href="#">":WAVEform:XORigin?"</a> on page 1639 query.)
<X reference>	The X reference is the data point associated with the X origin. It is at this data point that the X origin is defined. In this oscilloscope, the value is always zero. (See the <a href="#">":WAVEform:XREFerence?"</a> on page 1641 query.)
<Y increment>	The Y increment is the duration between Y-axis levels. For voltage waveforms, it is the voltage corresponding to one level. If the value is zero, then no data has been acquired. (See the <a href="#">":WAVEform:YINCrement?"</a> on page 1644 query.)
<Y origin>	The Y origin is the Y-axis value at level zero. For voltage waveforms, it is the voltage at level zero. If the value is zero, then no data has been acquired. (See the <a href="#">":WAVEform:YORigin?"</a> on page 1645 query.)
<Y reference>	The Y reference is the level associated with the Y origin. It is at this level that the Y origin is defined. In this oscilloscope, this value is always zero. (See the <a href="#">":WAVEform:YREFerence?"</a> on page 1647 query.)
<coupling>	Returned coupling values can be: <ul style="list-style-type: none"> <li>▪ 0 – AC coupling</li> <li>▪ 1 – DC coupling</li> <li>▪ 2 – DCFIFTY coupling</li> <li>▪ 3 – LFREJECT coupling</li> </ul> The input coupling of the waveform. The coupling value is ignored when sent to the oscilloscope in the preamble. (See the <a href="#">":WAVEform:COUPling?"</a> on page 1592 query.)

**Table 19** Waveform Preamble Elements (continued)

Element	Description
<X display range>	The X display range is the X-axis duration of the waveform that is displayed. For time domain waveforms, it is the duration of time across the display. If the value is zero, then no data has been acquired. (See the <a href="#">":WAVeform:XRANge?"</a> on page 1640 query.)
<X display origin>	The X display origin is the X-axis value at the left edge of the display. For time domain waveforms, it is the time at the start of the display. This value is treated as a double precision 64-bit floating-point number. If the value is zero, then no data has been acquired. (See the <a href="#">":WAVeform:XDISplay?"</a> on page 1637 query.)
<Y display range>	The Y display range is the Y-axis duration of the waveform which is displayed. For voltage waveforms, it is the amount of voltage across the display. If the value is zero, then no data has been acquired. (See the <a href="#">":WAVeform:YRANge?"</a> on page 1646 query.)
<Y display origin>	The Y-display origin is the Y-axis value at the center of the display. For voltage waveforms, it is the voltage at the center of the display. If the value is zero, then no data has been acquired. (See the <a href="#">":WAVeform:YDISplay?"</a> on page 1643 query.)
<date>	A string containing the date in the format DD MMM YYYY, where DD is the day, 1 to 31; MMM is the month; and YYYY is the year.
<time>	A string containing the time in the format HH:MM:SS:TT, where HH is the hour, 0 to 23, MM is the minutes, 0 to 59, SS is the seconds, 0 to 59, and TT is the hundreds of seconds, 0 to 99.
<frame model #>	A string containing the model number and serial number of the oscilloscope in the format of MODEL#:SERIAL#. The frame model number is ignored when it is sent to an oscilloscope in the preamble.
<acquisition mode>	Returned acquisition mode values can be: <ul style="list-style-type: none"> <li>▪ 0 – RTIME or HRESolution mode</li> <li>▪ 1 – ETIME mode</li> <li>▪ 2 – SEGMENTed or SEGHres mode</li> <li>▪ 3 – PDETECT or SEGPdetect mode</li> </ul> The acquisition sampling mode of the waveform. (See <a href="#">":ACQUIRE:MODE"</a> on page 251.)
<completion>	The completion value is the percent of time buckets that are complete. The completion value is ignored when it is sent to the oscilloscope in the preamble. (See the <a href="#">":WAVeform:COMPLete?"</a> on page 1590 query.)

**Table 19** Waveform Preamble Elements (continued)

Element	Description
<X units> <Y units>	<p>Returned type values can be:</p> <ul style="list-style-type: none"> <li>▪ 0 – UNKNOWN units</li> <li>▪ 1 – VOLT units</li> <li>▪ 2 – SECOND units</li> <li>▪ 3 – CONSTANT units</li> <li>▪ 4 – AMP units</li> <li>▪ 5 – DECIBEL units</li> </ul> <p>The X-axis and Y-axis units of the waveform. (See the <a href="#">":WAVEform:XUNits?"</a> on page 1642 query and the <a href="#">":WAVEform:YUNits?"</a> on page 1648 query.)</p>
<max bandwidth limit > <min bandwidth limit >	<p>The band pass consists of two values that are an estimation of the maximum and minimum bandwidth limits of the source waveform. The bandwidth limit is computed as a function of the selected coupling and filter mode. (See the <a href="#">":WAVEform:BANDpass?"</a> on page 1586 query.)</p>
<segment count>	<p>When segmented memory acquisitions are turned on, the <a href="#">":WAVEform:SEGMented:ALL ON"</a> command has been sent, and the waveform source is a channel or pod and has segmented acquisitions, this additional preamble value is returned. It specifies the number of segments in the returned waveform data. (See the <a href="#">":WAVEform:SEGMented:COUNT?"</a> on page 1627 query.)</p>

With [":WAVEform:VIEW CGRade"](#), the X increment, X origin, Y increment, and Y origin information returned by the [:WAVEform:PREamble?](#) query have different meanings for the color grade (pixel) database count values. See ["Getting Color Grade \(Pixel\) Database Count Values"](#) on page 1635.

**Example** This example outputs the current waveform preamble for the selected source to the string variable, strPreamble.

```
Dim strPreamble As String      ' Dimension variable.
myScope.WriteString ":SYSTem:HEADer OFF"      ' Response headers off.
myScope.WriteString ":WAVEform:PREamble?"
strPreamble = myScope.ReadString
```

**See Also**

- [":WAVEform:DATA"](#) on page 1593
- [":WAVEform:VIEW"](#) on page 1634

**History** Legacy command (existed before version 3.10).



## :WAVeform:SEGMENTed:ALL

**Command** :WAVeform:SEGMENTed:ALL {{ON | 1} | {OFF | 0}}

With segmented memory acquisitions are enabled (see :ACQUIRE:MODE), for a selected channel or pod waveform source (see :WAVeform:SOURce), the :WAVeform:SEGMENTed:ALL command specifies whether data for all segments will be returned by the :WAVeform:DATA? query:

- ON – The :WAVeform:DATA? query will return the data for all segments for the selected waveform source.

The number of segments is appended to end of the waveform preamble (see :WAVeform:PREamble?).

The <start> and <size> optional parameters for the :WAVeform:DATA? query are still supported and could be used to download the data for individual segments within the "all segments" data record.

- OFF – The :WAVeform:DATA? query will return the data for the current segment only.

For sources other than channels or pods, for example function sources, the :WAVeform:DATA? query returns data for the current segment only.

Powering on the oscilloscope or performing a Default Setup (\*RST or :SYSTEM:PRESet) sets :WAVeform:SEGMENTed:ALL to OFF.

There is no single query that will get the data for all segments and all configured channels at once, but you can write a program that follows this high-level pseudo code listing:

1. Set up all data conditioning commands, for example: FORMat, BYTeorder, etc.
2. Send the ":WAVeform:SEGMENTed:ALL ON" command.
3. For each channel in your configuration:
  - a. :WAVeform:SOURce CHANnel<N>
  - b. :WAVeform:DATA?
    - The size is equal to NPoints \* NSegments;
    - Data[0] is the first point of the first segment.
    - Data[(NSegments - 1)\*NPoints] is the first point of the last segment.

**Example** To turn on the :WAVeform:DATA? return of data for all segments (of the selected waveform):

```
myScope.WriteString ":WAVeform:SEGMENTed:ALL ON"
```

**Query** :WAVeform:SEGMENTed:ALL?

This query returns whether the return of data for all segments is on or off.

- See Also**
- **" :ACQUIRE:MODE "** on page 251
  - **" :WAVeform:SOURce "** on page 1630
  - **" :WAVeform:DATA "** on page 1593

- **":WAVEform:PREamble?"** on page 1621
- **"\*RST – Reset"** on page 471
- **":SYSTem:PRESet"** on page 1364

**History** Legacy command (existed before version 3.10).

## :WAVeform:SEGMented:COUNT?

**Query** :WAVeform:SEGMented:COUNT?

The :WAVeform:SEGMented:COUNT? query returns the index number of the last captured segment. A return value of zero indicates that the :ACQuire:MODE is not set to SEGMented.

The signal that is queried for the count is the signal set by the :WAVeform:SOURce command.

If you query the COUNT while the segmented acquisition is occurring, it will return the number of segments acquired so far.

<index\_number> An integer number representing the index value of the last segment.

**Returned Format** [:WAVeform:SEGMented:COUNT] <index\_number><NL>

**Example** This example returns the number of the last segment that was captured in the variable varIndex and prints it to the computer screen.

```
myScope.WriteString ":WAVeform:SEGMented:COUNT?"
varIndex = myScope.ReadNumber
Debug.Print FormatNumber(varIndex, 0)
```

- See Also**
- **":WAVeform:SOURce"** on page 1630
  - **":ACQuire:SEGMented:INDEX"** on page 262
  - **":WAVeform:SEGMented:TTAG?"** on page 1628
  - **":WAVeform:SEGMented:ALL"** on page 1625
  - **":WAVeform:SEGMented:XLISt?"** on page 1629

**History** Legacy command (existed before version 3.10).

Version 6.20: The signal that is queried for the count is the signal set by the :WAVeform:SOURce command. If you query the COUNT while the segmented acquisition is occurring, it will return the number of segments acquired so far.

## :WAVeform:SEGMented:TTAG?

**Query** :WAVeform:SEGMented:TTAG?

The :WAVeform:SEGMented:TTAG? query returns the time difference between the first segment's trigger point and the trigger point of the currently displayed segment.

The signal that is queried for the time tag is the signal set by the :WAVeform:SOURce command.

**<delta\_time>** A real number in exponential format representing the time value difference between the first segment's trigger point and the currently displayed segment.

**Returned Format** [:WAVeform:SEGMented:TTAG] <delta\_time> <NL>

**Example** This example returns the time from the first segment's trigger point and the currently displayed segment's trigger point in the variable varDtime and prints it to the computer screen.

```
myScope.WriteString ":WAVeform:SEGMented:TTAG?"
varDtime = myScope.ReadNumber
Debug.Print FormatNumber(varDtime, 0)
```

- See Also**
- [":WAVeform:SOURce"](#) on page 1630
  - [":ACQuire:SEGMented:INDex"](#) on page 262
  - [":WAVeform:SEGMented:COUNT?"](#) on page 1627
  - [":WAVeform:SEGMented:ALL"](#) on page 1625
  - [":WAVeform:SEGMented:XLISt?"](#) on page 1629

**History** Legacy command (existed before version 3.10).

Version 6.20: The signal that is queried for the time tag is the signal set by the :WAVeform:SOURce command.

## :WAVEform:SEGMented:XLISt?

**Query** :WAVEform:SEGMented:XLISt? {RELXorigin | ABSXorigin | TTAG}

The :WAVEform:SEGMented:XLISt? query rapidly downloads x-parameter values for all segments.

RELXorigin = relative X origin for each segment.

ABSXorigin = relative origin + time tag for each segment

TTAG = time tag for each segment

This query uses the DATA query format for the returned data and supports all waveform command options including: BYTeorder, FORmat (only ASCii or BINary (float64 with 8 bytes per value)), SOURce (only CHANnel<N> or POD<N>), STReaming, VIEW.

**History** Legacy command (existed before version 3.10).

## :WAVEform:SOURce

**Command** :WAVEform:SOURce {CHANnel<N> | DIFF<D> | COMMONmode<C> | FUNCTION<F>  
 | HISTogram | WMEMory<R> | CLOCK | MTRend | MSPectrum  
 | EQUalized<L> | XT<X> | PNOise | BUS<B> | POD1 | POD2 | PODALL}

The :WAVEform:SOURce command selects a channel, function, waveform memory, or histogram as the waveform source.

The MTRend and MSPectrum sources are available when the Jitter Analysis Software license is installed and the features are enabled.

The CLOCK source is available when the recovered clock is displayed.

The EQUalized<L> source is available when the Advanced Signal Integrity Software license is installed and the equalized waveform is displayed as a function.

The PNOise source is available when the Jitter and Vertical Noise Analysis Software license is installed and the Phase Noise analysis feature is enabled.

POD1 is the activated digital channels in the D0-D7 set while POD2 is the activated digital channels in the D8-D15 set. PODALL is all the activated digital channels.

<N> An integer, 1-4 in a single oscilloscope, 1-40 in a MultiScope system.

<D>, <C> <D> is an integer, 1-2. <C> is an integer, 3-4.

The DIFF and COMMONmode sources are just aliases that can be used in place of the channel names to apply to differential or common mode signals. These are just aliases - no state change occurs if you refer to a differential channel and you are not in differential mode. DIFF1 refers to the differential signal between channels 1 and 3 (and COMMONmode3 refers to the common mode channel between these same channels). DIFF2 refers to the differential signal between channels 2 and 4 (and COMMONmode4 refers to the common mode channel between these same channels).

<F> An integer, 1-16.

<R> An integer, 1-4.

<L> An integer, 1-4.

<X> An integer, 1-4, identifying the crosstalk waveform.

<B> An integer, 1-4.

**Example** This example selects channel 1 as the waveform source.

```
myScope.WriteString ":WAVEform:SOURce CHANnel1"
```

**Query** :WAVEform:SOURce?

The :WAVEform:SOURce? query returns the currently selected waveform source.

**Returned Format** [:WAVeform:SOURce] {CHAN<N> | DIFF<D> | COMM<C> | FUNC<F>  
 | HIST | WMEM<R> | CLOC | MTR | MSP | EQU<L> | XT<X>  
 | BUS<B> | POD1 | POD2 | PODALL}<NL>

**Example** This example places the current selection for the waveform source in the string variable, strSelection, then prints the contents of the variable to the computer's screen.

```
Dim strSelection As String ' Dimension variable.
myScope.WriteString ":WAVeform:SOURce?"
strSelection = myScope.ReadString
Debug.Print strSelection
```

**History** Legacy command (existed before version 3.10).

## :WAVEform:STReaming

**Command** :WAVEform:STReaming {{ON | 1} | {OFF | 0}}

When enabled, :WAVEform:STReaming allows more than 999,999,999 bytes of data to be transferred from the Infiniium oscilloscope to a PC when using the :WAVEform:DATA? query. See the :WAVEform:DATA? query for information on receiving this much data.

**Example** This example turns on the streaming feature.

```
myScope.WriteString ":WAVEform:STReaming ON"
```

**Query** :WAVEform:STReaming?

The :WAVEform:STReaming? query returns the status of the streaming feature.

**Returned Format** [:WAVEform:STReaming] {1 | 0}<NL>

**History** Legacy command (existed before version 3.10).



## :WAVEform:TYPE?

**Query** :WAVEform:TYPE?

The :WAVEform:TYPE? query returns the current acquisition data type for the currently selected source. The type returned describes how the waveform was acquired. The waveform type may be:

- RAW – data consists of one data point in each time bucket with no interpolation.
- AVERage – data consists of the average of the first n hits in a time bucket, where n is the value in the count portion of the preamble. Time buckets that have fewer than n hits return the average of the data they contain. If the :ACQUIRE:COMPLETE parameter is set to 100%, then each time bucket must contain the number of data hits specified with the :ACQUIRE:AVERAGE:COUNT command.
- VHISTogram – data is a vertical histogram. Histograms are transferred using the LONGLONG format. They can be generated using the Histogram subsystem commands.
- HHISTogram – data is a horizontal histogram. Histograms are transferred using the LONGLONG format. They can be generated using the Histogram subsystem commands.
- INTERpolate – In the INTERpolate acquisition type, the last data point in each time bucket is stored, and additional data points between the acquired data points are filled by interpolation.
- DIGITAL – data consists of digital pod or bus values for each time bucket.
- PDETECT – data consists of two data points in each time bucket: the minimum values and the maximum values.

**Returned Format** [:WAVEform:TYPE] {RAW | AVER | VHIS | HHIS | INT | DIGITAL | PDET}<NL>

**Example** This example places the current acquisition data type in the string variable, strType, then prints the contents of the variable to the computer's screen.

```
Dim strType As String ' Dimension variable.
myScope.WriteString ":WAVEform:TYPE?"
strType = myScope.ReadString
Debug.Print strType
```

**History** Legacy command (existed before version 3.10).

## :WAVEform:VIEW

**Command** :WAVEform:VIEW {ALL | MAIN | WINDow | CGRade}

The :WAVEform:VIEW command selects the view of the waveform that is selected for data and preamble queries. You can set the command to ALL, MAIN, WINDow, or CGRade.

The view has different meanings depending upon the waveform source selected.

The default setting for this command is ALL.

The following table summarizes the parameters for this command for each source.

**Table 20** Waveform View Parameters

Source/Parameter	ALL	MAIN	WINDow	CGRade
CHANnel<N>	All data	Main time base	Zoom	Color grade (pixel) database
WMEMory<R>	All data	Memory time base	Memory time base	Color grade (pixel) database
FUNCTion<F>	All data	All data	All data	Color grade (pixel) database

**Channels** For channels, you may select ALL, MAIN, or WINDow views. If you select ALL, all of the data in the waveform record is referenced. If you select MAIN, only the data in the main time base range is referenced. The first value corresponds to the first time bucket in the main time base range, and the last value corresponds to the last time bucket in the main time base range. If WINDow is selected, only data in the delayed view is referenced. The first value corresponds to the first time bucket in the delayed view and the last value corresponds to the last time bucket in the delayed view.

**Memories** For memories, if you specify ALL, all the data in the waveform record is referenced. WINDow and MAIN refer to the data contained in the memory time base range for the particular memory. The first value corresponds to the first time bucket in the memory time base range, and the last value corresponds to the last time bucket in the memory time base range.

**Functions** For functions, ALL, MAIN, and WINDow refer to all of the data in the waveform record.

**Example** This example sets up the oscilloscope to view all of the data.

```
myScope.WriteString ":WAVEform:VIEW ALL"
```

### Getting Color Grade (Pixel) Database Count Values

Before you can select the CGRade waveform view, you must enable color grade persistence, color grade view, or a real-time eye for the source waveform.

#### NOTE

Getting color grade (pixel) database count values is not supported when segmented memory acquisitions are enabled.

After you select the CGRade waveform view, color grade (pixel) database information is available from the following queries:

Command	Description
:WAVEform:CGRade:HEIGHt? (see <a href="#">page 1588</a> )	Returns the color grade (pixel) database data height.
:WAVEform:CGRade:WIDTh? (see <a href="#">page 1589</a> )	Returns the color grade (pixel) database data width.
:WAVEform:POINts? (see <a href="#">page 1620</a> )	The number of count values in the database (should be the width times the height).
:WAVEform:XINCrement? (see <a href="#">page 1638</a> )	The time per column of the color grade database.
:WAVEform:XORigin? (see <a href="#">page 1639</a> )	The time at column 0 of the color grade database.
:WAVEform:YINCrement? (see <a href="#">page 1644</a> )	The volts per row of the color grade database.
:WAVEform:YORigin? (see <a href="#">page 1645</a> )	The volts at row 0 of the color grade database.
:WAVEform:PREamble? (see <a href="#">page 1621</a> )	Returns the same points, X increment, X origin, Y increment, and Y origin information as the individual queries.

To get the color grade (pixel) database count values:

- 1 Use the :WAVEform:FORMat command to specify the format you in which want the database count values returned:
  - Use the ":WAVEform:FORMat BINary" command to get (8-byte) uint64 values.
  - Use the ":WAVEform:FORMat FLOat" command to get (4-byte) single-precision floating-point values.

When getting color grade database values, the only valid formats are BINary and FLOat.

- 2 Send the :WAVEform:DATA? query.

A binary block of values in the selected format is returned.

The order of the returned values is:

- From the row at the top of the display to the bottom of the display (with "height" number of rows).
- Within a row, values are returned from the left of the display to the right of the display (with "width" number of columns).

**Query** :WAVeform:VIEW?

The :WAVeform:VIEW? query returns the currently selected view.

**Returned Format** [:WAVeform:VIEW] {ALL | MAIN | WIND | CGR}<NL>

**Example** This example returns the current view setting to the string variable, strSetting, then prints the contents of the variable to the computer's screen.

```
Dim strSetting As String ' Dimension variable.
myScope.WriteString ":WAVeform:VIEW?"
strSetting = myScope.ReadString
Debug.Print strSetting
```

- See Also**
- [":WAVeform:FORMat"](#) on page 1616
  - [":WAVeform:DATA"](#) on page 1593
  - [":WAVeform:CGRade:WIDTh?"](#) on page 1589
  - [":WAVeform:CGRade:HEIGht?"](#) on page 1588
  - [":WAVeform:POINts?"](#) on page 1620
  - [":WAVeform:XINCrement?"](#) on page 1638
  - [":WAVeform:XORigin?"](#) on page 1639
  - [":WAVeform:YINCrement?"](#) on page 1644
  - [":WAVeform:YORigin?"](#) on page 1645
  - [":WAVeform:PREAmble?"](#) on page 1621

**History** Legacy command (existed before version 3.10).

Version 6.00: Added the CGRade option for getting the color grade (pixel) database data.

## :WAVEform:XDISplay?

**Query** :WAVEform:XDISplay?

The :WAVEform:XDISplay? query returns the X-axis value at the left edge of the display. For time domain waveforms, it is the time at the start of the display. For VERSus type waveforms, it is the value at the center of the X-axis of the display. This value is treated as a double precision 64-bit floating point number.

**NOTE**

A "Waveform data is not valid" error occurs when there is no data available for a channel. When this occurs, a zero value is returned.

**Returned Format** [:WAVEform:XDISplay] <value><NL>

<value> A real number representing the X-axis value at the left edge of the display.

**Example** This example returns the X-axis value at the left edge of the display to the numeric variable, varValue, then prints the contents of the variable to the computer's screen.

```
myScope.WriteString ":SYSTEM:HEADer OFF"      ' Response headers off.
myScope.WriteString ":WAVEform:XDISplay"
varValue = myScope.ReadNumber
Debug.Print FormatNumber(varValue, 0)
```

**History** Legacy command (existed before version 3.10).

## :WAVeform:XINCrement?

**Query** :WAVeform:XINCrement?

The :WAVeform:XINCrement? query returns the duration between consecutive data points for the currently specified waveform source. For time domain waveforms, this is the time difference between consecutive data points. For VERSus type waveforms, this is the duration between levels on the X axis. For voltage waveforms, this is the voltage corresponding to one level.

**NOTE**

A "Waveform data is not valid" error occurs when there is no data available for a channel. When this occurs, a zero value is returned.

With ":WAVeform:VIEW CGRade", the :WAVeform:XINCrement? query returns the time per column of the color grade (pixel) database. See "[Getting Color Grade \(Pixel\) Database Count Values](#)" on page 1635.

**Returned Format** [:WAVeform:XINCrement] <value><NL>

<value> A real number representing the duration between data points on the X axis.

**Example** This example places the current X-increment value for the currently specified source in the numeric variable, varValue, then prints the contents of the variable to the computer's screen.

```
myScope.WriteString ":SYSTEM:HEADer OFF" ' Response headers off.
myScope.WriteString ":WAVeform:XINCrement?"
varValue = myScope.ReadNumber
Debug.Print FormatNumber(varValue, 0)
```

**See Also**

- You can also obtain the X-increment value through the :WAVeform:PREamble? query. See "[:WAVeform:PREamble?](#)" on page 1621.
- "[:WAVeform:VIEW](#)" on page 1634

**History** Legacy command (existed before version 3.10).

## :WAVeform:XORigin?

**Query** :WAVeform:XORigin?

The :WAVeform:XORigin? query returns the X-axis value of the first data point in the data record. For time domain waveforms, it is the time of the first point. For VERSus type waveforms, it is the X-axis value at level zero. For voltage waveforms, it is the voltage at level zero. The value returned by this query is treated as a double precision 64-bit floating point number.

**NOTE**

A "Waveform data is not valid" error occurs when there is no data available for a channel. When this occurs, a zero value is returned.

**NOTE**

When an acquisition is made on multiple channels, the data for each channel has the same X origin and the same number of points.

With ":WAVeform:VIEW CGRade", the :WAVeform:XORigin? query returns the time at column 0 of the color grade (pixel) database. See "[Getting Color Grade \(Pixel\) Database Count Values](#)" on page 1635.

**Returned Format** [:WAVeform:XORigin] <value><NL>

<value> A real number representing the X-axis value of the first data point in the data record.

**Example** This example places the current X-origin value for the currently specified source in the numeric variable, varValue, then prints the contents of the variable to the computer's screen.

```
myScope.WriteString ":SYSTEM:HEADer OFF" ' Response headers off.
myScope.WriteString ":WAVeform:XORigin?"
varValue = myScope.ReadNumber
Debug.Print FormatNumber(varValue, 0)
```

**See Also**

- You can also obtain the X-origin value through the :WAVeform:PREamble? query. See "[:WAVeform:PREamble?](#)" on page 1621.
- [":WAVeform:VIEW"](#) on page 1634

**History** Legacy command (existed before version 3.10).

## :WAVeform:XRANge?

**Query** :WAVeform:XRANge?

The :WAVeform:XRANge? query returns the X-axis duration of the displayed waveform. For time domain waveforms, it is the duration of the time across the display. For VERSus type waveforms, it is the duration of the waveform that is displayed on the X axis.

**NOTE**

A "Waveform data is not valid" error occurs when there is no data available for a channel. When this occurs, a zero value is returned.

**Returned Format** [:WAVeform:XRANge] <value><NL>

<value> A real number representing the X-axis duration of the displayed waveform.

**Example** This example returns the X-axis duration of the displayed waveform to the numeric variable, varValue, then prints the contents of the variable to the computer's screen.

```
myScope.WriteString ":SYSTEM:HEADer OFF" ' Response headers off.
myScope.WriteString ":WAVeform:XRANge?"
varValue = myScope.ReadNumber
Debug.Print FormatNumber(varValue, 0)
```

**History** Legacy command (existed before version 3.10).



## :WAVeform:XREFerence?

**Query** :WAVeform:XREFerence?

The :WAVeform:XREFerence? query returns the data point or level associated with the X-origin data value. It is at this data point or level that the X origin is defined. In this oscilloscope, the value is always zero.

**Returned Format** [:WAVeform:XREFerence] 0<NL>

**Example** This example places the current X-reference value for the currently specified source in the numeric variable, varValue, then prints the contents of the variable to the computer's screen.

```
myScope.WriteString ":SYSTem:HEADer OFF" ' Response headers off.
myScope.WriteString ":WAVeform:XREFerence?"
varValue = myScope.ReadNumber
Debug.Print FormatNumber(varValue, 0)
```

**See Also** You can obtain the X-reference value through the :WAVeform:PREamble? query.

**History** Legacy command (existed before version 3.10).

## :WAVEform:XUNits?

**Query** :WAVEform:XUNits?

The :WAVEform:XUNits? query returns the X-axis units of the currently selected waveform source. The currently selected source may be a channel, function, or waveform memory.

**Returned Format** [:WAVEform:XUNits] {UNKNown | VOLT | SECond | CONStant | AMP | DECibels | HERTz | WATT}<NL>

**Example** This example returns the X-axis units of the currently selected waveform source to the string variable, strUnit, then prints the contents of the variable to the computer's screen.

```
Dim strUnit As String    ' Dimension variable.
myScope.WriteString ":WAVEform:XUNits?"
strUnit = myScope.ReadString
Debug.Print strUnit
```

**History** Legacy command (existed before version 3.10).

## :WAVEform:YDISplay?

**Query** :WAVEform:YDISplay?

The :WAVEform:YDISplay? query returns the Y-axis value at the center of the display. For voltage waveforms, it is the voltage at the center of the display.

**NOTE**

A "Waveform data is not valid" error occurs when there is no data available for a channel. When this occurs, a zero value is returned.

**Returned Format** [:WAVEform:YDISplay] <value><NL>

<value> A real number representing the Y-axis value at the center of the display.

**Example** This example returns the current Y-display value to the numeric variable, varValue, then prints the contents of the variable to the computer's screen.

```
myScope.WriteString ":SYSTEM:HEADer OFF" ' Response headers off.
myScope.WriteString "":WAVEform:YDISplay?"
varValue = myScope.ReadNumber
Debug.Print FormatNumber(varValue, 0)
```

**History** Legacy command (existed before version 3.10).

## :WAVeform:YINCrement?

**Query** :WAVeform:YINCrement?

The :WAVeform:YINCrement? query returns the y-increment voltage value for the currently specified source. This voltage value is the voltage difference between two adjacent waveform data digital codes. Adjacent digital codes are codes that differ by one least significant bit. For example, the digital codes 24680 and 24681 vary by one least significant bit.

- For BYTE and WORD data, and voltage waveforms, it is the voltage corresponding to one least significant bit change.
- For ASCII data format, the YINCrement is the full scale voltage range covered by the A/D converter.

**NOTE**

A "Waveform data is not valid" error occurs when there is no data available for a channel. When this occurs, a zero value is returned.

With ":WAVeform:VIEW CGRade", the :WAVeform:YINCrement? query returns the volts per row of the color grade (pixel) database. See "[Getting Color Grade \(Pixel\) Database Count Values](#)" on page 1635.

**Returned Format** [:WAVeform:YINCrement] <real\_value><NL>

<real\_value> A real number in exponential format.

**Example** This example places the current Y-increment value for the currently specified source in the numeric variable, varValue, then prints the contents of the variable to the computer's screen.

```
myScope.WriteString ":SYSTem:HEADer OFF" ' Response headers off.
myScope.WriteString ":WAVeform:YINCrement?"
varValue = myScope.ReadNumber
Debug.Print FormatNumber(varValue, 0)
```

- See Also**
- For more information on BYTE and WORD formats, see "[Understanding WORD and BYTE Formats](#)" on page 1611.
  - You can also obtain the Y-increment value through the :WAVeform:PREamble? query. See "[:WAVeform:PREamble?](#)" on page 1621.
  - "[:WAVeform:VIEW](#)" on page 1634

**History** Legacy command (existed before version 3.10).

## :WAVeform:YORigin?

**Query** :WAVeform:YORigin?

The :WAVeform:YORigin? query returns the y-origin voltage value for the currently specified source. The voltage value returned is the voltage value represented by the waveform data digital code 00000.

- For BYTE and WORD data, and voltage waveforms, it is the voltage at digital code zero.
- For ASCII data format, the YORigin is the Y-axis value at the center of the data range. Data range is returned in the Y increment.

**NOTE**

A "Waveform data is not valid" error occurs when there is no data available for a channel. When this occurs, a zero value is returned.

With ":WAVeform:VIEW CGRade", the :WAVeform:YORigin? query returns the volts at row 0 of the color grade (pixel) database. See "[Getting Color Grade \(Pixel\) Database Count Values](#)" on page 1635.

**Returned Format** [:WAVeform:YORigin] <real\_value><NL>

<real\_value> A real number in exponential format.

**Example** This example places the current Y-origin value in the numeric variable, varCenter, then prints the contents of the variable to the computer's screen.

```
myScope.WriteString ":SYSTem:HEADer OFF" ' Response headers off.
myScope.WriteString ":WAVeform:YORigin?"
varCenter = myScope.ReadNumber
Debug.Print FormatNumber(varCenter, 0)
```

- See Also**
- For more information on BYTE and WORD formats, see "[Understanding WORD and BYTE Formats](#)" on page 1611.
  - You can also obtain the Y-origin value through the :WAVeform:PREamble? query. See "[:WAVeform:PREamble?](#)" on page 1621.
  - "[:WAVeform:VIEW](#)" on page 1634

**History** Legacy command (existed before version 3.10).

## :WAVEform:YRANge?

**Query** :WAVEform:YRANge?

The :WAVEform:YRANge? query returns the Y-axis duration of the displayed waveform. For voltage waveforms, it is the voltage across the entire display.

**NOTE**

A "Waveform data is not valid" error occurs when there is no data available for a channel. When this occurs, a zero value is returned.

**Returned Format** [:WAVEform:YRANge] <value><NL>

<value> A real number representing the Y-axis duration of the displayed waveform.

**Example** This example returns the current Y-range value to the numeric variable, varValue, then prints the contents of the variable to the computer's screen.

```
myScope.WriteString ":SYSTEM:HEADer OFF" ' Response headers off.
myScope.WriteString ":WAVEform:YRANge?"
varValue = myScope.ReadNumber
Debug.Print FormatNumber(varValue, 0)
```

**History** Legacy command (existed before version 3.10).

## :WAVeform:YREFerence?

**Query** :WAVeform:YREFerence?

The :WAVeform:YREFerence? query returns the y-reference voltage value for the currently specified source. It is at this level that the Y origin is defined. In this oscilloscope, the value is always zero.

**Returned Format** [:WAVeform:YREFerence] 0<NL>

**Example** This example places the current Y-reference value for the currently specified source in the numeric variable, varValue, then prints the contents of the variable to the computer's screen.

```
myScope.WriteString ":SYSTEM:HEADer OFF" ' Response headers off.
myScope.WriteString ":WAVeform:YREFerence?"
varValue = myScope.ReadNumber
Debug.Print FormatNumber(varValue, 0)
```

**See Also** For more information on BYTE and WORD formats, see "[Understanding WORD and BYTE Formats](#)" on page 1611.

You can obtain the Y-reference value through the :WAVeform:PREamble? query.

**History** Legacy command (existed before version 3.10).

## :WAVEform:YUNits?

**Query** :WAVEform:YUNits?

The :WAVEform:YUNits? query returns the Y-axis units of the currently selected waveform source. The currently selected source may be a channel, function, or waveform memory.

**Returned Format** [:WAVEform:YUNits] {UNKNown | VOLT | SECond | HITS | DECibels | CONStant | AMP}<NL>

**Example** This example returns the Y-axis units of the currently selected waveform source to the string variable, strUnit, then prints the contents of the variable to the computer's screen.

```
Dim strUnit As String    ' Dimension variable.
myScope.WriteString ":WAVEform:YUNits?"
strUnit = myScope.ReadString
Debug.Print strUnit
```

**History** Legacy command (existed before version 3.10).



# 40 Waveform Memory Commands

:WMEMory:TIETimebase / 1650  
:WMEMory<R>:CLEar / 1651  
:WMEMory<R>:DISPlay / 1652  
:WMEMory<R>:FFT:HSCale / 1653  
:WMEMory<R>:LABel / 1654  
:WMEMory<R>:LOAD / 1655  
:WMEMory<R>:SAVE / 1656  
:WMEMory<R>:SEGmented:COUNT? / 1657  
:WMEMory<R>:SEGmented:INDex / 1658  
:WMEMory<R>:SEGmented:PLAY / 1659  
:WMEMory<R>:XOFFset / 1660  
:WMEMory<R>:XRANge / 1661  
:WMEMory<R>:YOFFset / 1662  
:WMEMory<R>:YRANge / 1663

The Waveform Memory Subsystem commands let you save and display waveforms, memories, and functions.

## NOTE

### <N> in WMEMory<R> Indicates the Waveform Memory Number

In Waveform Memory commands, the <N> in WMEMory<R> represents the waveform memory number (1-4).

**:WMEemory:TIETimebase**

**Command** `:WMEemory:TIETimebase {{ON | 1} | {OFF | 0}}`

The `:WMEemory:TIETimebase` command specifies whether the waveform memory horizontal scale is tied to the main horizontal time/div setting or can be adjusted separately.

**Example** This example ties the waveform memory horizontal scale to the main horizontal time/div setting.

```
myScope.WriteString ":WMEemory:TIETimebase ON"
```

**Query** `:WMEemory:TIETimebase?`

The `:WMEemory:TIETimebase?` query returns the state of the "tie to timebase" control.

**Returned Format** `[:WMEemory:TIETimebase] {1 | 0}<NL>`

**History** Legacy command (existed before version 3.10).

## :WMEemory<R>:CLEar

**Command** :WMEemory<R>:CLEar

The :WMEemory<R>:CLEar clears the associated wave memory.

<R> The memory number is an integer from 1 to 4.

**Example** This example clears the waveform memory 1.

```
myScope.WriteString ":WMEemory1:CLEar"
```

**History** Legacy command (existed before version 3.10).

**:WMEMemory<R>:DISPlay**

**Command** :WMEMemory<R>:DISPlay {{ON | 1} | {OFF | 0}}

The :WMEMemory<R>:DISPlay command enables or disables the viewing of the selected waveform memory.

<R> The memory number is an integer from 1 to 4.

**Example** This example turns on the waveform memory 1 display.

```
myScope.WriteString ":WMEMemory1:DISPlay ON"
```

**Query** :WMEMemory<R>:DISPlay?

The :WMEMemory<R>:DISPlay? query returns the state of the selected waveform memory.

**Returned Format** [:WMEMemory<R>:DISPlay] {1 | 0}<NL>

**History** Legacy command (existed before version 3.10).

## :WMEMemory<R>:FFT:HSCale

**Command** :WMEMemory<R>:FFT:HSCale {LINEar | LOG}

For a FFT waveform memory, the :WMEMemory<R>:FFT:HSCale command specifies whether the horizontal scale is linear or logarithmic.

**Query** :WMEMemory<R>:FFT:HSCale?

The :WMEMemory<R>:FFT:HSCale? query returns the horizontal scale setting.

**Returned Format** <type><NL>

<type> ::= {LIN | LOG}

**See Also** • [":FUNCTION<F>:FFT:HSCale"](#) on page 586

**History** New in version 6.30.

**:WMEMemory<R>:LABel**

**Command** :WMEMemory<R>:LABel <quoted\_string>

The :WMEMemory<R>:LABel command sets the waveform memory label to the quoted string.

Labels can be enabled with the :DISPlay:LABel command.

<R> An integer, 1 to the number of waveform memories.

<quoted\_string> A series of 16 or fewer characters as a quoted ASCII string.

**Query** :WMEMemory<R>:LABel?

The :WMEMemory<R>:LABel? query returns the label of the specified waveform memory.

**Returned Format** [:WMEMemory<R>:LABel] <quoted\_string><NL>

- See Also**
- **":DISPlay:LABel"** on page 546
  - **":CHANnel<N>:LABel"** on page 375
  - **":FUNction<F>:LABel"** on page 619

**History** New in version 6.70.

## :WMEMemory<R>:LOAD

**Command** :WMEMemory<R>:LOAD <file\_name>

The :WMEMemory<R>:LOAD command loads an oscilloscope waveform memory location with a waveform from a file that has an internal waveform format (extension .wfm), comma separated xypairs, (extension .csv), tab separated xypairs (extension .tsv), and yvalues text (extension .txt). You can load the file from either the c: or a: drive, or any lan connected drive. See the examples below.

The oscilloscope assumes that the default path for waveforms is C:\Users\Public\Documents\Infiniium. To use a different path, specify the path and file name completely.

<R> The memory number is an integer from 1 to 4.

<file\_name> A quoted string which specifies the file to load, and has a .wfm, .csv, .tsv, or .txt extension.

**Examples** This example loads waveform memory 4 with a file.

```
myScope.WriteString _
":WMEMemory4:LOAD " "C:\Users\Public\Documents\Infiniium\waveform.wfm" "
```

This example loads waveform memory 3 with a file that has the internal waveform format and is stored on drive U:.

```
myScope.WriteString ":WMEMemory3:LOAD " "U:\waveform.wfm" "
```

**Related  
Commands** :DISK:LOAD  
:DISK:STORe

**See Also**

- [":DISK:LOAD"](#) on page 496
- [":DISK:SAVE:SETup"](#) on page 509
- [":DISK:SAVE:WAVEform"](#) on page 510

**History** Legacy command (existed before version 3.10).

## :WMEMory&lt;R&gt;:SAVE

**Command** :WMEMory<R>:SAVE {CHANnel<N> | DIFF<D> | COMMONmode<C> | CLOCK  
| FUNction<F> | EQUalized<L> | MTRend | MSPectrum | WMEMory<R>  
| XT<X> | PNOise}

The :WMEMory<R>:SAVE command stores the specified channel, waveform memory, or function to the waveform memory. You can save waveforms to waveform memories regardless of whether the waveform memory is displayed or not.

The :WAVEform:VIEW command determines the view of the data being saved.

The MTRend and MSPectrum sources are available when the Jitter Analysis Software license is installed and the features are enabled.

The CLOCK source is available when the recovered clock is displayed.

The EQUalized<L> source is available when the Advanced Signal Integrity Software license is installed and the equalized waveform is displayed as a function.

The PNOise source is available when the Jitter and Vertical Noise Analysis Software license is installed and the Phase Noise analysis feature is enabled.

<N> An integer, 1-4 in a single oscilloscope, 1-40 in a MultiScope system.

<D>, <C> <D> is an integer, 1-2. <C> is an integer, 3-4.

The DIFF and COMMONmode sources are just aliases that can be used in place of the channel names to apply to differential or common mode signals. These are just aliases - no state change occurs if you refer to a differential channel and you are not in differential mode. DIFF1 refers to the differential signal between channels 1 and 3 (and COMMONmode3 refers to the common mode channel between these same channels). DIFF2 refers to the differential signal between channels 2 and 4 (and COMMONmode4 refers to the common mode channel between these same channels).

<F> An integer, 1-16.

<L> An integer, 1-4.

<R> An integer, 1-4.

<X> An integer, 1-4, identifying the crosstalk waveform.

**Example** This example saves channel 1 to waveform memory 4.

```
myScope.WriteString ":WMEMory4:SAVE CHANnel1"
```

**History** Legacy command (existed before version 3.10).



## :WMEMemory<R>:SEGmented:COUNT?

**Query** :WMEMemory<R>:SEGmented:COUNT?

When segmented memory acquisitions are saved to waveform memory, the :WMEMemory<R>:SEGmented:COUNT? query returns the number of segments in the waveform memory.

**Returned Format** <#segments><NL>

<#segments> ::= integer in NR1 format

- See Also**
- [":WMEMemory<R>:SEGmented:COUNT?"](#) on page 1657
  - [":WMEMemory<R>:SEGmented:INDEX"](#) on page 1658
  - [":WMEMemory<R>:SEGmented:PLAY"](#) on page 1659

**History** New in version 6.00.

## :WMEMemory&lt;R&gt;:SEGmented:INDEX

**Command** :WMEMemory<R>:SEGmented:INDEX <number>

When segmented memory acquisitions are saved to waveform memory, the :WMEMemory<R>:SEGmented:INDEX command displays the waveform segment at the specified index.

<number> Segment number in NR1 format.

**Query** :WMEMemory<R>:SEGmented:INDEX?

The :WMEMemory<R>:SEGmented:INDEX? query returns the index of the waveform segment that is currently being displayed.

**Returned Format** <number><NL>

<number> ::= segment number in NR1 format

- See Also**
- [":WMEMemory<R>:SEGmented:COUNT?"](#) on page 1657
  - [":WMEMemory<R>:SEGmented:INDEX"](#) on page 1658
  - [":WMEMemory<R>:SEGmented:PLAY"](#) on page 1659

**History** New in version 6.00.

## :WMEemory&lt;R&gt;:SEGmented:PLAY

**Command** :WMEemory<R>:SEGmented:PLAY {{0 | OFF} | {1 | ON}}

When segmented memory acquisitions are saved to waveform memory, the ":WMEemory<R>:SEGmented:PLAY" command plays (or stops) acquired segments.

- ON – is the similar to clicking the Play button in the graphical user interface, except that the display is not updated while segments are played.
- OFF – is the same as clicking the Stop button in the graphical user interface.

Playing waveform memory segments can take a while depending on the analysis taking place. You can query to determine when playing is complete.

The play rate is the same rate set by :ACQUIRE:SEGmented:PRATe command.

**Query** :WMEemory<R>:SEGmented:PLAY?

The :WMEemory<R>:SEGmented:PLAY? query returns whether segments are currently being played (1) or are stopped (0).

**NOTE**

The :WMEemory<R>:SEGmented:PLAY? query is different than the :ACQUIRE:SEGmented:PLAY? query in that it waits until all segments are played before it returns.

**Returned Format** [:WMEemory<R>:SEGmented:PLAY] <status><NL>  
<status> ::= {0 | 1}

- See Also**
- [":ACQUIRE:SEGmented:PRATe"](#) on page 264
  - [":WMEemory<R>:SEGmented:COUNT?"](#) on page 1657
  - [":WMEemory<R>:SEGmented:INDEX"](#) on page 1658

**History** New in version 6.00.

**:WMEMemory<R>:XOFFset**

**Command** :WMEMemory<R>:XOFFset <offset\_value>

The :WMEMemory<R>:XOFFset command sets the x-axis, horizontal position for the selected waveform memory's display scale. The position is referenced to center screen.

<R> The memory number is an integer from 1 to 4.

<offset\_value> A real number for the horizontal offset (position) value.

**Example** This example sets the X-axis, horizontal position for waveform memory 3 to 0.1 seconds (100 ms).

```
myScope.WriteString ":WMEMemory3:XOFFset 0.1"
```

**Query** :WMEMemory<R>:XOFFset?

The :WMEMemory<R>:XOFFset? query returns the current X-axis, horizontal position for the selected waveform memory.

**Returned Format** [:WMEMemory<R>:XOFFset] <offset\_value><NL>

**History** Legacy command (existed before version 3.10).

## :WMEMemory<R>:XRANge

**Command** :WMEMemory<R>:XRANge <range\_value>

The :WMEMemory<R>:XRANge command sets the X-axis, horizontal range for the selected waveform memory's display scale. The horizontal scale is the horizontal range divided by 10.

<R> The memory number is an integer from 1 to 4.

<range\_value> A real number for the horizontal range value.

**Example** This example sets the X-axis, horizontal range of waveform memory 2 to 435 microseconds.

```
myScope.WriteString ":WMEMemory2:XRANge 435E-6"
```

**Query** :WMEMemory<R>:XRANge?

The :WMEMemory<R>:XRANge? query returns the current X-axis, horizontal range for the selected waveform memory.

**Returned Format** [:WMEMemory<R>:XRANge] <range\_value><NL>

**History** Legacy command (existed before version 3.10).

## :WMEMemory&lt;R&gt;:YOFFset

**Command** :WMEMemory<R>:YOFFset <offset\_value>

The :WMEMemory<R>:YOFFset command sets the Y-axis (vertical axis) offset for the selected waveform memory.

<R> The memory number is an integer from 1 to 4.

<offset\_value> A real number for the vertical offset value.

**Example** This example sets the Y-axis (vertical) offset of waveform memory 2 to 0.2V.

```
myScope.WriteString ":WMEMemory2:YOFFset 0.2"
```

**Query** :WMEMemory<R>:YOFFset?

The :WMEMemory<R>:YOFFset? query returns the current Y-axis (vertical) offset for the selected waveform memory.

**Returned Format** [:WMEMemory<R>:YOFFset] <offset\_value><NL>

**History** Legacy command (existed before version 3.10).

## :WMEMory<R>:YRANge

**Command** :WMEMory<R>:YRANge <range\_value>

The :WMEMory<R>:YRANge command sets the Y-axis, vertical range for the selected memory. The vertical scale is the vertical range divided by 8.

<R> The memory number is an integer from 1 to 4.

<range\_value> A real number for the vertical range value.

**Example** This example sets the Y-axis (vertical) range of waveform memory 3 to 0.2 volts.

```
myScope.WriteString ":WMEMory3:YRANge 0.2"
```

**Query** :WMEMory<R>:YRANge?

The :WMEMory<R>:YRANge? query returns the Y-axis, vertical range for the selected memory.

**Returned Format** [:WMEMory<R>:YRANge] <range\_value><NL>

**History** Legacy command (existed before version 3.10).





# 41 Xtalk (Crosstalk Analysis) Commands

:XTALK:ENABle / 1667  
:XTALK:PAADeskew / 1669  
:XTALK:PAIFilter / 1670  
:XTALK:PAISi / 1671  
:XTALK:PASLimit / 1672  
:XTALK:PAXFilter / 1673  
:XTALK:PAXSi / 1674  
:XTALK:PJADeskew / 1675  
:XTALK:PJIFilter / 1676  
:XTALK:PJISi / 1677  
:XTALK:PJSLimit / 1678  
:XTALK:PJXFilter / 1679  
:XTALK:PJXSi / 1680  
:XTALK:RESults? / 1681  
:XTALK:SAADeskew / 1683  
:XTALK:SAIFilter / 1684  
:XTALK:SAISi / 1685  
:XTALK:SASLimit / 1686  
:XTALK:SAXFilter / 1687  
:XTALK:SAXSi / 1688  
:XTALK<X>:AENable<X> / 1689  
:XTALK<X>:ENABle / 1690  
:XTALK<X>:IAGGressor / 1691  
:XTALK<X>:IVICtim / 1692  
:XTALK<X>:PAUTo / 1693  
:XTALK<X>:PLENgtH / 1694  
:XTALK<X>:PTYPe / 1695  
:XTALK<X>:RIDeal / 1696  
:XTALK<X>:RISI / 1697  
:XTALK<X>:ROTHer / 1698

`:XTALK<X>:SOURce / 1699`

`:XTALK<X>:STYPe / 1701`

The XTALK commands and queries control the Crosstalk Analysis application. This application helps you troubleshoot and characterize crosstalk on up to four simultaneously-acquired signals.

## :XTALK:ENABLE

**Command** :XTALK:ENABLE {{0 | OFF} | {1 | ON}}

The :XTALK:ENABLE command enables or disables crosstalk analysis.

**Query** :XTALK:ENABLE?

The :XTALK:ENABLE? query returns whether crosstalk analysis is enabled or disabled.

**Returned Format** <setting><NL>

<setting> ::= {0 | 1}

- See Also**
- [":XTALK:RESults?"](#) on page 1681
  - [":XTALK<X>:AENable<X>"](#) on page 1689
  - [":XTALK<X>:ENABLE"](#) on page 1690
  - [":XTALK<X>:IAGGressor"](#) on page 1691
  - [":XTALK<X>:IVICTim"](#) on page 1692
  - [":XTALK<X>:PAUTo"](#) on page 1693
  - [":XTALK<X>:PLENght"](#) on page 1694
  - [":XTALK<X>:PTYPe"](#) on page 1695
  - [":XTALK<X>:RIDeal"](#) on page 1696
  - [":XTALK<X>:RISI"](#) on page 1697
  - [":XTALK<X>:ROTHer"](#) on page 1698
  - [":XTALK<X>:STYPe"](#) on page 1701
  - [":XTALK<X>:SOURce"](#) on page 1699
  - [":XTALK:SAADeskew"](#) on page 1683
  - [":XTALK:SASLimit"](#) on page 1686
  - [":XTALK:SAISi"](#) on page 1685
  - [":XTALK:SAIFilter"](#) on page 1684
  - [":XTALK:SAXSi"](#) on page 1688
  - [":XTALK:SAXFilter"](#) on page 1687
  - [":XTALK:PAADeskew"](#) on page 1669
  - [":XTALK:PASLimit"](#) on page 1672
  - [":XTALK:PAISi"](#) on page 1671
  - [":XTALK:PAIFilter"](#) on page 1670
  - [":XTALK:PAXSi"](#) on page 1674
  - [":XTALK:PAXFilter"](#) on page 1673
  - [":XTALK:PJADeskew"](#) on page 1675

- [":XTALK:PJSLimit"](#) on page 1678
- [":XTALK:PJISi"](#) on page 1677
- [":XTALK:PJIFilter"](#) on page 1676
- [":XTALK:PJXSi"](#) on page 1680
- [":XTALK:PJXFilter"](#) on page 1679

**History** New in version 5.70.

## :XTALK:PAADeskew

**Command** :XTALK:PAADeskew {{0 | OFF} | {1 | ON}}

The :XTALK:PAADeskew command is an advanced configuration option for power supply aggressors (amplitude) that specifies whether auto deskew is enabled or disabled.

When auto deskew is enabled, the Crosstalk Analysis application uses a proprietary cross-correlation method for aligning the waveforms in time. The algorithm searches over a finite range of delays to find the best possible alignment. The search range corresponds to about 1 m of difference in cable length, which is sufficient for most situations.

When auto deskew is disabled, the deskew time limit is specified by the :XTALK:PASLimit command.

**Query** :XTALK:PAADeskew?

The :XTALK:PAADeskew? query returns the "auto deskew" setting for power supply aggressors (amplitude).

**Returned Format** <setting><NL>

<setting> ::= {0 | 1}

- See Also**
- [":XTALK:PASLimit"](#) on page 1672
  - [":XTALK:PAISi"](#) on page 1671
  - [":XTALK:PAIFilter"](#) on page 1670
  - [":XTALK:PAXSi"](#) on page 1674
  - [":XTALK:PAXFilter"](#) on page 1673

**History** New in version 5.70.

**:XTALK:PAIFilter**

**Command** :XTALK:PAIFilter <time\_span>

<time\_span> ::= time span in seconds in NR3 format.

The :XTALK:PAIFilter command is an advanced configuration option for power supply aggressors (amplitude) that, when auto limit ISI filter time is disabled (:XTALK:PAISi OFF), lets you specify the ISI filter time span.

**Query** :XTALK:PAIFilter?

The :XTALK:PAIFilter? query returns the specified ISI filter time span.

**Returned Format** <time\_span><NL>

<time\_span> ::= time span in seconds in NR3 format.

- See Also**
- **" :XTALK:PAISi "** on page 1671
  - **" :XTALK:PAADeskew "** on page 1669
  - **" :XTALK:PASLimit "** on page 1672
  - **" :XTALK:PAXSi "** on page 1674
  - **" :XTALK:PAXFilter "** on page 1673

**History** New in version 5.70.

**:XTALK:PAISi**

**Command** :XTALK:PAISi {{0 | OFF} | {1 | ON}}

The :XTALK:PAISi command is an advanced configuration option for power supply aggressors (amplitude) that specifies whether auto limit ISI filter time is enabled or disabled.

The ISI filter represents the channel model and can therefore convert an ideal input waveform into the one that is band-limited and containing reflections.

- When auto limit ISI filter time is enabled, the Crosstalk Analysis application uses a proprietary algorithm to automatically determine an ideal ISI filter length for a given situation. The application further tries to optimize the shape of the filter by adaptively placing more taps in areas that are needed.
- When auto limit ISI filter time is disabled, the ISI filter time span is specified by the :XTALK:PAIFilter command.

**Query** :XTALK:PAISi?

The :XTALK:PAISi? query returns the "auto limit ISI filter time" setting for power supply aggressors (amplitude).

**Returned Format** <setting><NL>

<setting> ::= {0 | 1}

- See Also**
- [":XTALK:PAIFilter"](#) on page 1670
  - [":XTALK:PAADes skew"](#) on page 1669
  - [":XTALK:PASLimit"](#) on page 1672
  - [":XTALK:PAXSi"](#) on page 1674
  - [":XTALK:PAXFilter"](#) on page 1673

**History** New in version 5.70.

## :XTALK:PASLimit

**Command** :XTALK:PASLimit <time\_limit>

<time\_limit> ::= time limit in seconds in NR3 format.

The :XTALK:PASLimit command is an advanced configuration option for power supply aggressors (amplitude) that, when auto deskew is disabled (:XTALK:PAADeskew OFF), lets you specify the deskew time limit (search range).

Notice that the default deskew time limit value is larger for a power supply than for serial data transmission lines. This is because buffers and other circuit components can create delays much larger than the propagation distance. These delays may vary greatly from one circuit to another, so keep in mind that changing the default value may produce better results.

**Query** :XTALK:PASLimit?

The :XTALK:PASLimit? query returns the specified deskew time limit.

**Returned Format** <time\_limit><NL>

<time\_limit> ::= time limit in seconds in NR3 format.

- See Also**
- [":XTALK:PAADeskew"](#) on page 1669
  - [":XTALK:PAISi"](#) on page 1671
  - [":XTALK:PAIFilter"](#) on page 1670
  - [":XTALK:PAXSi"](#) on page 1674
  - [":XTALK:PAXFilter"](#) on page 1673

**History** New in version 5.70.



## :XTALK:PAXFilter

**Command** :XTALK:PAXFilter <time\_span>

<time\_span> ::= time span in seconds in NR3 format.

The :XTALK:PAXFilter command is an advanced configuration option for power supply aggressors (amplitude) that, when auto limit XSI filter time is disabled (:XTALK:PAXSi OFF), lets you specify the XSI (crosstalk) filter time span.

**Query** :XTALK:PAXFilter?

The :XTALK:PAXFilter? query returns the specified XSI (crosstalk) filter time span.

**Returned Format** <time\_span><NL>

<time\_span> ::= time span in seconds in NR3 format.

- See Also**
- [":XTALK:PAXSi"](#) on page 1674
  - [":XTALK:PAADeskew"](#) on page 1669
  - [":XTALK:PASLimit"](#) on page 1672
  - [":XTALK:PAISi"](#) on page 1671
  - [":XTALK:PAIFilter"](#) on page 1670

**History** New in version 5.70.

**:XTALK:PAXSi**

**Command**    `:XTALK:PAXSi {{0 | OFF} | {1 | ON}}`

The `:XTALK:PAXSi` command is an advanced configuration option for power supply aggressors (amplitude) that specifies whether auto limit XSI filter time is enabled or disabled

Crosstalk filters describe how an aggressor signal is transformed into a crosstalk signal (such as NEXT or FEXT), and what magnitude it will have.

- When auto limit XSI filter time is enabled, the Crosstalk Analysis application uses a proprietary algorithm to automatically determine an ideal crosstalk filter length for a given situation. The application further tries to optimize the shape of the filter by adaptively placing more taps in areas that are needed.
- When auto limit XSI filter time is disabled, the XSI (crosstalk) filter time span is specified by the `:XTALK:PAXFilter` command.

A FEXT filter length should be at least as long as an edge rise time, and a NEXT filter length should be at least twice the propagation delay of the channel.

**Query**        `:XTALK:PAXSi?`

The `:XTALK:PAXSi?` query returns the "auto limit XSI filter time" setting for power supply aggressors (amplitude).

**Returned Format**    `<setting><NL>`

`<setting> ::= {0 | 1}`

- See Also**
- [":XTALK:PAXFilter"](#) on page 1673
  - [":XTALK:PAADeskew"](#) on page 1669
  - [":XTALK:PASLimit"](#) on page 1672
  - [":XTALK:PAISi"](#) on page 1671
  - [":XTALK:PAIFilter"](#) on page 1670

**History**        New in version 5.70.

## :XTALK:PJADeskew

**Command** :XTALK:PJADeskew {{0 | OFF} | {1 | ON}}

The :XTALK:PJADeskew command is an advanced configuration option for power supply aggressors (jitter) that specifies whether auto deskew is enabled or disabled.

When auto deskew is enabled, the Crosstalk Analysis application uses a proprietary cross-correlation method for aligning the waveforms in time. The algorithm searches over a finite range of delays to find the best possible alignment. The search range corresponds to about 1 m of difference in cable length, which is sufficient for most situations.

When auto deskew is disabled, the deskew time limit is specified by the :XTALK:PJSLimit command.

**Query** :XTALK:PJADeskew?

The :XTALK:PJADeskew? query returns the "auto deskew" setting for power supply aggressors (jitter).

**Returned Format** <setting><NL>

<setting> ::= {0 | 1}

- See Also**
- [":XTALK:PJSLimit"](#) on page 1678
  - [":XTALK:PJISi"](#) on page 1677
  - [":XTALK:PJIFilter"](#) on page 1676
  - [":XTALK:PJXSi"](#) on page 1680
  - [":XTALK:PJXFilter"](#) on page 1679

**History** New in version 5.70.

## :XTALK:PJIFilter

**Command** :XTALK:PJIFilter <time\_span>

<time\_span> ::= time span in seconds in NR3 format.

The :XTALK:PJIFilter command is an advanced configuration option for power supply aggressors (amplitude) that, when auto limit ISI filter time is disabled (:XTALK:PJISi OFF), lets you specify the ISI filter time span.

**Query** :XTALK:PJIFilter?

The :XTALK:PJIFilter? query returns the specified ISI filter time span.

**Returned Format** <time\_span><NL>

<time\_span> ::= time span in seconds in NR3 format.

- See Also**
- [":XTALK:PJISi"](#) on page 1677
  - [":XTALK:PJADeskew"](#) on page 1675
  - [":XTALK:PJSLimit"](#) on page 1678
  - [":XTALK:PJXSi"](#) on page 1680
  - [":XTALK:PJXFilter"](#) on page 1679

**History** New in version 5.70.

**:XTALK:PJISi**

**Command** :XTALK:PJISi {{0 | OFF} | {1 | ON}}

The :XTALK:PJISi command is an advanced configuration option for power supply aggressors (jitter) that specifies whether auto limit ISI filter time is enabled or disabled.

The ISI filter represents the channel model and can therefore convert an ideal input waveform into the one that is band-limited and containing reflections.

- When auto limit ISI filter time is enabled, the Crosstalk Analysis application uses a proprietary algorithm to automatically determine an ideal ISI filter length for a given situation. The application further tries to optimize the shape of the filter by adaptively placing more taps in areas that are needed.
- When auto limit ISI filter time is disabled, the ISI filter time span is specified by the :XTALK:PJIFilter command.

**Query** :XTALK:PJISi?

The :XTALK:PJISi? query returns the "auto limit ISI filter time" setting for power supply aggressors (jitter).

**Returned Format** <setting><NL>

<setting> ::= {0 | 1}

- See Also**
- [":XTALK:PJIFilter"](#) on page 1676
  - [":XTALK:PJADeskew"](#) on page 1675
  - [":XTALK:PJSLimit"](#) on page 1678
  - [":XTALK:PJXSi"](#) on page 1680
  - [":XTALK:PJXFilter"](#) on page 1679

**History** New in version 5.70.

## :XTALK:PJSLimit

**Command** :XTALK:PJSLimit <time\_limit>

<time\_limit> ::= time limit in seconds in NR3 format.

The :XTALK:PJSLimit command is an advanced configuration option for power supply aggressors (jitter) that, when auto deskew is disabled (:XTALK:PJADeskew OFF), lets you specify the deskew time limit (search range).

Notice that the default deskew time limit value is larger for a power supply than for serial data transmission lines. This is because buffers and other circuit components can create delays much larger than the propagation distance. These delays may vary greatly from one circuit to another, so keep in mind that changing the default value may produce better results.

**Query** :XTALK:PJSLimit?

The :XTALK:PJSLimit? query returns the specified deskew time limit.

**Returned Format** <time\_limit><NL>

<time\_limit> ::= time limit in seconds in NR3 format.

- See Also**
- [":XTALK:PJADeskew"](#) on page 1675
  - [":XTALK:PJSi"](#) on page 1677
  - [":XTALK:PJIFilter"](#) on page 1676
  - [":XTALK:PJSi"](#) on page 1680
  - [":XTALK:PJXFilter"](#) on page 1679

**History** New in version 5.70.

## :XTALK:PJXFilter

**Command** :XTALK:PJXFilter <time\_span>

<time\_span> ::= time span in seconds in NR3 format.

The :XTALK:PJXFilter command is an advanced configuration option for power supply aggressors (amplitude) that, when auto limit XSI filter time is disabled (:XTALK:PJSi OFF), lets you specify the XSI (crosstalk) filter time span.

**Query** :XTALK:PJXFilter?

The :XTALK:PJXFilter? query returns the specified XSI (crosstalk) filter time span.

**Returned Format** <opt><NL>

<time\_span> ::= time span in seconds in NR3 format.

- See Also**
- [":XTALK:PJSi"](#) on page 1680
  - [":XTALK:PJADeskew"](#) on page 1675
  - [":XTALK:PJSLimit"](#) on page 1678
  - [":XTALK:PJISi"](#) on page 1677
  - [":XTALK:PJIFilter"](#) on page 1676

**History** New in version 5.70.

**:XTALK:PJXSi**

**Command** :XTALK:PJXSi {{0 | OFF} | {1 | ON}}

The :XTALK:PJXSi command is an advanced configuration option for power supply aggressors (jitter) that specifies whether auto limit XSI filter time is enabled or disabled

Crosstalk filters describe how an aggressor signal is transformed into a crosstalk signal (such as NEXT or FEXT), and what magnitude it will have.

- When auto limit XSI filter time is enabled, the Crosstalk Analysis application uses a proprietary algorithm to automatically determine an ideal crosstalk filter length for a given situation. The application further tries to optimize the shape of the filter by adaptively placing more taps in areas that are needed.
- When auto limit XSI filter time is disabled, the XSI (crosstalk) filter time span is specified by the :XTALK:PJXFilter command.

A FEXT filter length should be at least as long as an edge rise time, and a NEXT filter length should be at least twice the propagation delay of the channel.

**Query** :XTALK:PJXSi?

The :XTALK:PJXSi? query returns the "auto limit XSI filter time" setting for power supply aggressors (jitter).

**Returned Format** <setting><NL>

<setting> ::= {0 | 1}

- See Also**
- [":XTALK:PJXFilter"](#) on page 1679
  - [":XTALK:PJADeskew"](#) on page 1675
  - [":XTALK:PJSLimit"](#) on page 1678
  - [":XTALK:PJISi"](#) on page 1677
  - [":XTALK:PJIFilter"](#) on page 1676

**History** New in version 5.70.



## :XTALK:RESults?

**Query** :XTALK:RESults?

The :XTALK:RESults? query returns the crosstalk analysis results in a comma-separated list of values. The values returned for each victim:aggressor pair in the results are:

Value	Format	Example
Label:	string	c1:c2
Amplitude skew:	floating-point number string in scientific notation	0.0E+00
Jitter skew:	floating-point number string in scientific notation	0.0E+00
Volt, Error(rms), for the non victim:victim lines:	floating-point number string in scientific notation	0.0E+00
Volt, Error(p-p), for the non victim:victim lines:	floating-point number string in scientific notation	0.0E+00
Time, Error(rms), for the non victim:victim lines:	floating-point number string in scientific notation	0.0E+00
Time Error(p-p), for the non victim:victim lines:	floating-point number string in scientific notation	0.0E+00
V high, Error(rms):	floating-point number string in scientific notation	0.0E+00
V high, Error(p-p):	floating-point number string in scientific notation	0.0E+00
V low, Error(rms):	floating-point number string in scientific notation	0.0E+00
V low, Error(p-p):	floating-point number string in scientific notation	0.0E+00
Volt, Error(rms), for the victim:victim line:	floating-point number string in scientific notation	0.0E+00
Volt, Error(p-p), for the victim:victim line:	floating-point number string in scientific notation	0.0E+00
Time, Error(rms), for the victim:victim line:	floating-point number string in scientific notation	0.0E+00
Time, Error(p-p), for the victim:victim line:	floating-point number string in scientific notation	0.0E+00

**Returned Format** <results\_list><NL>

`<results_list> ::= comma-delimited list of values.`

**See Also** · [":XTALK:ENABLE"](#) on page 1667

**History** New in version 5.70.

## :XTALK:SAADeskew

**Command** :XTALK:SAADeskew {{0 | OFF} | {1 | ON}}

The :XTALK:SAADeskew command is an advanced configuration option for serial data aggressors that specifies whether auto deskew is enabled or disabled.

When auto deskew is enabled, the Crosstalk Analysis application uses a proprietary cross-correlation method for aligning the waveforms in time. The algorithm searches over a finite range of delays to find the best possible alignment. The search range corresponds to about 1 m of difference in cable length, which is sufficient for most situations.

When auto deskew is disabled, the deskew time limit is specified by the :XTALK:SASLimit command.

**Query** :XTALK:SAADeskew?

The :XTALK:SAADeskew? query returns the "auto deskew" setting for serial data aggressors.

**Returned Format** <setting><NL>

<setting> ::= {0 | 1}

- See Also**
- [":XTALK:SASLimit"](#) on page 1686
  - [":XTALK:SAISi"](#) on page 1685
  - [":XTALK:SAIFilter"](#) on page 1684
  - [":XTALK:SAXSi"](#) on page 1688
  - [":XTALK:SAXFilter"](#) on page 1687

**History** New in version 5.70.

**:XTALK:SAIFilter**

**Command** :XTALK:SAIFilter <time\_span>

<time\_span> ::= time span in seconds in NR3 format.

The :XTALK:SAIFilter command is an advanced configuration option for serial data aggressors that, when auto limit ISI filter time is disabled (:XTALK:SAISi OFF), lets you specify the ISI filter time span.

**Query** :XTALK:SAIFilter?

The :XTALK:SAIFilter? query returns the specified ISI filter time span.

**Returned Format** <time\_span><NL>

<time\_span> ::= time span in seconds in NR3 format.

- See Also**
- [":XTALK:SAISi"](#) on page 1685
  - [":XTALK:SAADeskew"](#) on page 1683
  - [":XTALK:SASLimit"](#) on page 1686
  - [":XTALK:SAXSi"](#) on page 1688
  - [":XTALK:SAXFilter"](#) on page 1687

**History** New in version 5.70.

**:XTALK:SAISi**

**Command** :XTALK:SAISi {{0 | OFF} | {1 | ON}}

The :XTALK:SAISi command is an advanced configuration option for serial data aggressors that specifies whether auto limit ISI filter time is enabled or disabled.

The ISI filter represents the channel model and can therefore convert an ideal input waveform into the one that is band-limited and containing reflections.

- When auto limit ISI filter time is enabled, the Crosstalk Analysis application uses a proprietary algorithm to automatically determine an ideal ISI filter length for a given situation. The application further tries to optimize the shape of the filter by adaptively placing more taps in areas that are needed.
- When auto limit ISI filter time is disabled, the ISI filter time span is specified by the :XTALK:SAIFilter command.

**Query** :XTALK:SAISi?

The :XTALK:SAISi? query returns the "auto limit ISI filter time" setting for serial data aggressors.

**Returned Format** <setting><NL>

<setting> ::= {0 | 1}

- See Also**
- [":XTALK:SAIFilter"](#) on page 1684
  - [":XTALK:SAADeskew"](#) on page 1683
  - [":XTALK:SASLimit"](#) on page 1686
  - [":XTALK:SAXSi"](#) on page 1688
  - [":XTALK:SAXFilter"](#) on page 1687

**History** New in version 5.70.

## :XTALK:SASLimit

**Command** :XTALK:SASLimit <time\_limit>

<time\_limit> ::= time limit in seconds in NR3 format.

The :XTALK:SASLimit command is an advanced configuration option for serial data aggressors that, when auto deskew is disabled (:XTALK:SAADeskew OFF), lets you specify the deskew time limit (search range).

Notice that the default deskew time limit value is larger for a power supply than for serial data transmission lines. This is because buffers and other circuit components can create delays much larger than the propagation distance. These delays may vary greatly from one circuit to another, so keep in mind that changing the default value may produce better results.

**Query** :XTALK:SASLimit?

The :XTALK:SASLimit? query returns the specified deskew time limit.

**Returned Format** <time\_limit><NL>

<time\_limit> ::= time limit in seconds in NR3 format.

- See Also**
- [":XTALK:SAADeskew"](#) on page 1683
  - [":XTALK:SAISi"](#) on page 1685
  - [":XTALK:SAIFilter"](#) on page 1684
  - [":XTALK:SAXSi"](#) on page 1688
  - [":XTALK:SAXFilter"](#) on page 1687

**History** New in version 5.70.

## :XTALK:SAXFilter

**Command** :XTALK:SAXFilter <time\_span>

<time\_span> ::= time span in seconds in NR3 format.

The :XTALK:SAXFilter command is an advanced configuration option for serial data aggressors that, when auto limit XSI filter time is disabled (:XTALK:SAXSi OFF), lets you specify the XSI (crosstalk) filter time span.

**Query** :XTALK:SAXFilter?

The :XTALK:SAXFilter? query returns the specified XSI (crosstalk) filter time span.

**Returned Format** <time\_span><NL>

<time\_span> ::= time span in seconds in NR3 format.

- See Also**
- [":XTALK:SAXSi"](#) on page 1688
  - [":XTALK:SAADeskew"](#) on page 1683
  - [":XTALK:SASLimit"](#) on page 1686
  - [":XTALK:SAISi"](#) on page 1685
  - [":XTALK:SAIFilter"](#) on page 1684

**History** New in version 5.70.

**:XTALK:SAXSi**

**Command** `:XTALK:SAXSi {{0 | OFF} | {1 | ON}}`

The `:XTALK:SAXSi` command is an advanced configuration option for serial data aggressors that specifies whether auto limit XSI filter time is enabled or disabled

Crosstalk filters describe how an aggressor signal is transformed into a crosstalk signal (such as NEXT or FEXT), and what magnitude it will have.

- When auto limit XSI filter time is enabled, the Crosstalk Analysis application uses a proprietary algorithm to automatically determine an ideal crosstalk filter length for a given situation. The application further tries to optimize the shape of the filter by adaptively placing more taps in areas that are needed.
- When auto limit XSI filter time is disabled, the XSI (crosstalk) filter time span is specified by the `:XTALK:SAXFilter` command.

A FEXT filter length should be at least as long as an edge rise time, and a NEXT filter length should be at least twice the propagation delay of the channel.

**Query** `:XTALK:SAXSi?`

The `:XTALK:SAXSi?` query returns the "auto limit XSI filter time" setting for serial data aggressors.

**Returned Format** `<setting><NL>`

`<setting> ::= {0 | 1}`

- See Also**
- [":XTALK:SAXFilter"](#) on page 1687
  - [":XTALK:SAADeskew"](#) on page 1683
  - [":XTALK:SASLimit"](#) on page 1686
  - [":XTALK:SAISi"](#) on page 1685
  - [":XTALK:SAIFilter"](#) on page 1684

**History** New in version 5.70.



**:XTALk<X>:AENable<X>**

**Command** :XTALk<X>:AENable<X> {{0 | OFF} | {1 | ON}}

When the crosstalk analysis signal is a victim (:XTALk<X>:IVICTim ON), the :XTALk<X>:AENable<X> command specifies whether to remove the crosstalk from another signal in the crosstalk analysis.

<X> An integer from 1-4.

**Example** For example if crosstalk signal1 is a victim, you can specify to remove the crosstalk from the signal3 aggressor with the command:

```
myScope.WriteString ":XTALk1:AENable3 ON"
```

- See Also**
- [":XTALk<X>:ENABLE"](#) on page 1690
  - [":XTALk<X>:IAGGressor"](#) on page 1691
  - [":XTALk<X>:IVICTim"](#) on page 1692
  - [":XTALk<X>:PAUTo"](#) on page 1693
  - [":XTALk<X>:PLENght"](#) on page 1694
  - [":XTALk<X>:PTYPE"](#) on page 1695
  - [":XTALk<X>:RIDeal"](#) on page 1696
  - [":XTALk<X>:RISI"](#) on page 1697
  - [":XTALk<X>:ROTHer"](#) on page 1698
  - [":XTALk<X>:STYPE"](#) on page 1701
  - [":XTALk<X>:SOURce"](#) on page 1699
  - [":XTALk:ENABLE"](#) on page 1667
  - [":XTALk:RESUltS?"](#) on page 1681

**History** New in version 5.70.

**:XTALK<X>:ENABLE**

**Command** :XTALK<X>:ENABLE {{0 | OFF} | {1 | ON}}

The :XTALK<X>:ENABLE command adds or removes a signal from the crosstalk analysis.

Crosstalk analysis can be performed on up to four simultaneously acquired signals.

<X> An integer from 1-4.

**Query** :XTALK<X>:ENABLE?

The :XTALK<X>:ENABLE? query returns whether the signal has been added to the crosstalk analysis.

**Returned Format** <setting><NL>

<setting> ::= {0 | 1}

- See Also**
- [":XTALK<X>:AENable<X>"](#) on page 1689
  - [":XTALK<X>:IAGGressor"](#) on page 1691
  - [":XTALK<X>:IVICTim"](#) on page 1692
  - [":XTALK<X>:PAUTo"](#) on page 1693
  - [":XTALK<X>:PLENght"](#) on page 1694
  - [":XTALK<X>:PTYPE"](#) on page 1695
  - [":XTALK<X>:RIDeal"](#) on page 1696
  - [":XTALK<X>:RISI"](#) on page 1697
  - [":XTALK<X>:ROTHer"](#) on page 1698
  - [":XTALK<X>:STYPE"](#) on page 1701
  - [":XTALK<X>:SOURce"](#) on page 1699
  - [":XTALK:ENABle"](#) on page 1667
  - [":XTALK:RESults?"](#) on page 1681

**History** New in version 5.70.

**:XTALK<X>:IAGGressor**

**Command** :XTALK<X>:IAGGressor {{0 | OFF} | {1 | ON}}

The :XTALK<X>:IAGGressor command specifies whether the signal is an aggressor.

<X> An integer from 1-4.

**Query** :XTALK<X>:IAGGressor?

The :XTALK<X>:IAGGressor? query returns the "is aggressor" setting.

**Returned Format** <setting><NL>

<setting> ::= {0 | 1}

- See Also**
- [":XTALK<X>:AENable<X>"](#) on page 1689
  - [":XTALK<X>:ENABle"](#) on page 1690
  - [":XTALK<X>:I VICtim"](#) on page 1692
  - [":XTALK<X>:PAUTo"](#) on page 1693
  - [":XTALK<X>:PLENght"](#) on page 1694
  - [":XTALK<X>:PTYPE"](#) on page 1695
  - [":XTALK<X>:RIDeal"](#) on page 1696
  - [":XTALK<X>:RISI"](#) on page 1697
  - [":XTALK<X>:ROTHer"](#) on page 1698
  - [":XTALK<X>:STYPE"](#) on page 1701
  - [":XTALK<X>:SOURce"](#) on page 1699
  - [":XTALK:ENABle"](#) on page 1667
  - [":XTALK:RESults?"](#) on page 1681

**History** New in version 5.70.

**:XTALK<X>:IVICtim**

**Command** :XTALK<X>:IVICtim {{0 | OFF} | {1 | ON}}

The :XTALK<X>:IVICtim command specifies whether the signal is a victim.

<X> An integer from 1-4.

**Query** :XTALK<X>:IVICtim?

The :XTALK<X>:IVICtim? query returns the "is victim" setting.

**Returned Format** <setting><NL>

<setting> ::= {0 | 1}

- See Also**
- [":XTALK<X>:AENable<X>"](#) on page 1689
  - [":XTALK<X>:ENABle"](#) on page 1690
  - [":XTALK<X>:IAGGressor"](#) on page 1691
  - [":XTALK<X>:PAUTo"](#) on page 1693
  - [":XTALK<X>:PLENght"](#) on page 1694
  - [":XTALK<X>:PTYPE"](#) on page 1695
  - [":XTALK<X>:RIDeal"](#) on page 1696
  - [":XTALK<X>:RISI"](#) on page 1697
  - [":XTALK<X>:ROTHer"](#) on page 1698
  - [":XTALK<X>:STYPE"](#) on page 1701
  - [":XTALK<X>:SOURce"](#) on page 1699
  - [":XTALK:ENABle"](#) on page 1667
  - [":XTALK:RESults?"](#) on page 1681

**History** New in version 5.70.

**:XTALK<X>:PAUTO**

**Command** :XTALK<X>:PAUTO {{0 | OFF} | {1 | ON}}

When the crosstalk analysis signal type is DIGital (serial data), the :XTALK<X>:PAUTO command specifies whether the pattern length is automatically determined.

<X> An integer from 1-4.

**Query** :XTALK<X>:PAUTO?

The :XTALK<X>:PAUTO? query returns the auto length setting.

**Returned Format** <setting><NL>

<setting> ::= {0 | 1}

- See Also**
- [":XTALK<X>:AENable<X>"](#) on page 1689
  - [":XTALK<X>:ENABLE"](#) on page 1690
  - [":XTALK<X>:IAGGressor"](#) on page 1691
  - [":XTALK<X>:IVICTim"](#) on page 1692
  - [":XTALK<X>:PLENght"](#) on page 1694
  - [":XTALK<X>:PTYPE"](#) on page 1695
  - [":XTALK<X>:RIDeal"](#) on page 1696
  - [":XTALK<X>:RISI"](#) on page 1697
  - [":XTALK<X>:ROTHer"](#) on page 1698
  - [":XTALK<X>:STYPE"](#) on page 1701
  - [":XTALK<X>:SOURce"](#) on page 1699
  - [":XTALK:ENABLE"](#) on page 1667
  - [":XTALK:RESults?"](#) on page 1681

**History** New in version 5.70.

**:XTALK<X>:PLENgtH**

**Command**    :XTALK<X>:PLENgtH <number\_of\_bits>  
                   <number\_of\_bits> ::= integer from 2-1024.

When the crosstalk analysis signal type is DIGital (serial data) and the pattern length is not automatically determined (:XTALK<X>:PAUTo OFF), the :XTALK<X>:PLENgtH command specifies the pattern length.

<X>    An integer from 1-4.

**Query**       :XTALK<X>:PLENgtH?

The :XTALK<X>:PLENgtH? query returns the pattern length setting.

**Returned Format**   <number\_of\_bits><NL>  
                   <number\_of\_bits> ::= integer from 2-1024.

- See Also**
- [":XTALK<X>:AENable<X>"](#) on page 1689
  - [":XTALK<X>:ENABle"](#) on page 1690
  - [":XTALK<X>:IAGGressor"](#) on page 1691
  - [":XTALK<X>:IVICTim"](#) on page 1692
  - [":XTALK<X>:PAUTo"](#) on page 1693
  - [":XTALK<X>:PTYPE"](#) on page 1695
  - [":XTALK<X>:RIDeal"](#) on page 1696
  - [":XTALK<X>:RISI"](#) on page 1697
  - [":XTALK<X>:ROTHer"](#) on page 1698
  - [":XTALK<X>:STYPE"](#) on page 1701
  - [":XTALK<X>:SOURce"](#) on page 1699
  - [":XTALK:ENABle"](#) on page 1667
  - [":XTALK:RESults?"](#) on page 1681

**History**    New in version 5.70.

**:XTALK<X>:PTYPE**

**Command**    :XTALK<X>:PTYPE <pattern\_type>  
                  <pattern\_type> ::= {PERiodic | ARBitrary}

When the crosstalk analysis signal type is DIGital (serial data), the :XTALK<X>:PTYPE command specifies whether the pattern is periodic or arbitrary.

<X>    An integer from 1-4.

**Query**        :XTALK<X>:PTYPE?

The :XTALK<X>:PTYPE? query returns the pattern type setting.

**Returned Format**    <pattern\_type><NL>  
                  <pattern\_type> ::= {PERiodic | ARBitrary}

- See Also**
- [":XTALK<X>:AENable<X>"](#) on page 1689
  - [":XTALK<X>:ENABle"](#) on page 1690
  - [":XTALK<X>:IAGGressor"](#) on page 1691
  - [":XTALK<X>:IVICTim"](#) on page 1692
  - [":XTALK<X>:PAUTo"](#) on page 1693
  - [":XTALK<X>:PLENght"](#) on page 1694
  - [":XTALK<X>:RIDeal"](#) on page 1696
  - [":XTALK<X>:RISI"](#) on page 1697
  - [":XTALK<X>:ROTHer"](#) on page 1698
  - [":XTALK<X>:STYPE"](#) on page 1701
  - [":XTALK<X>:SOURce"](#) on page 1699
  - [":XTALK:ENABle"](#) on page 1667
  - [":XTALK:RESults?"](#) on page 1681

**History**    New in version 5.70.

**:XTALK<X>:RIDEal**

**Command** :XTALK<X>:RIDEal {{0 | OFF} | {1 | ON}}

When the crosstalk analysis signal is a victim (:XTALK<X>:IVICTim ON), the :XTALK<X>:RIDEal command specifies whether to remove the signal's ideal waveform contribution should be removed from the crosstalk-removed waveform.

<X> An integer from 1-4.

**Query** :XTALK<X>:RIDEal?

The :XTALK<X>:RIDEal? query returns the "remove ideal waveform" setting.

**Returned Format** <setting><NL>

<setting> ::= {0 | 1}

- See Also**
- [":XTALK<X>:AENable<X>"](#) on page 1689
  - [":XTALK<X>:ENABLE"](#) on page 1690
  - [":XTALK<X>:IAGGressor"](#) on page 1691
  - [":XTALK<X>:IVICTim"](#) on page 1692
  - [":XTALK<X>:PAUTo"](#) on page 1693
  - [":XTALK<X>:PLENght"](#) on page 1694
  - [":XTALK<X>:PTYPE"](#) on page 1695
  - [":XTALK<X>:RISI"](#) on page 1697
  - [":XTALK<X>:ROTHer"](#) on page 1698
  - [":XTALK<X>:STYPE"](#) on page 1701
  - [":XTALK<X>:SOURce"](#) on page 1699
  - [":XTALK:ENABLE"](#) on page 1667
  - [":XTALK:RESults?"](#) on page 1681

**History** New in version 5.70.



**:XTALK<X>:RISI**

**Command** :XTALK<X>:RISI {{0 | OFF} | {1 | ON}}

When the crosstalk analysis signal is a victim (:XTALK<X>:IVICTim ON), the :XTALK<X>:RISI command specifies whether to remove the signal's ISI (inter-symbol interference) contribution should be removed from the crosstalk-removed waveform.

<X> An integer from 1-4.

**Query** :XTALK<X>:RISI?

The :XTALK<X>:RISI? query returns the "remove ISI" setting.

**Returned Format** <setting><NL>

<setting> ::= {0 | 1}

- See Also**
- [":XTALK<X>:AENable<X>"](#) on page 1689
  - [":XTALK<X>:ENABLE"](#) on page 1690
  - [":XTALK<X>:IAGGressor"](#) on page 1691
  - [":XTALK<X>:IVICTim"](#) on page 1692
  - [":XTALK<X>:PAUTo"](#) on page 1693
  - [":XTALK<X>:PLENght"](#) on page 1694
  - [":XTALK<X>:PTYPE"](#) on page 1695
  - [":XTALK<X>:RIDeal"](#) on page 1696
  - [":XTALK<X>:ROTHer"](#) on page 1698
  - [":XTALK<X>:STYPE"](#) on page 1701
  - [":XTALK<X>:SOURce"](#) on page 1699
  - [":XTALK:ENABLE"](#) on page 1667
  - [":XTALK:RESUltS?"](#) on page 1681

**History** New in version 5.70.

**:XTALk<X>:ROTHer**

**Command** :XTALk<X>:ROTHer {{0 | OFF} | {1 | ON}}

When the crosstalk analysis signal is a victim (:XTALk<X>:IVICTim ON), the :XTALk<X>:ROTHer command specifies whether to remove the signal's unknown crosstalk and noise contribution should be removed from the crosstalk-removed waveform.

<X> An integer from 1-4.

**Query** :XTALk<X>:ROTHer?

The :XTALk<X>:ROTHer? query returns the "remove unknown crosstalk and noise" setting.

**Returned Format** <setting><NL>

<setting> ::= {0 | 1}

- See Also**
- [":XTALk<X>:AENable<X>"](#) on page 1689
  - [":XTALk<X>:ENABLE"](#) on page 1690
  - [":XTALk<X>:IAGGressor"](#) on page 1691
  - [":XTALk<X>:IVICTim"](#) on page 1692
  - [":XTALk<X>:PAUTo"](#) on page 1693
  - [":XTALk<X>:PLENght"](#) on page 1694
  - [":XTALk<X>:PTYPE"](#) on page 1695
  - [":XTALk<X>:RIDeal"](#) on page 1696
  - [":XTALk<X>:RISI"](#) on page 1697
  - [":XTALk<X>:STYPE"](#) on page 1701
  - [":XTALk<X>:SOURce"](#) on page 1699
  - [":XTALk:ENABLE"](#) on page 1667
  - [":XTALk:RESults?"](#) on page 1681

**History** New in version 5.70.

**:XTALK<X>:SOURce**

**Command** :XTALK<X>:SOURce <source>

```
<source> ::= {CHANnel<N> | DIFF<D> | COMMONmode<C> | FUNCtion<F>
              | WMEMory<N> | EQUalized<L> | MTRend}
```

The :XTALK<X>:SOURce command specifies the source of the crosstalk signal.

<X> An integer from 1-4.

<N> An integer from 1-4.

<D>, <C> <D> is an integer, 1-2. <C> is an integer, 3-4.

The DIFF and COMMONmode sources are just aliases that can be used in place of the channel names to apply to differential or common mode signals. These are just aliases - no state change occurs if you refer to a differential channel and you are not in differential mode. DIFF1 refers to the differential signal between channels 1 and 3 (and COMMONmode3 refers to the common mode channel between these same channels). DIFF2 refers to the differential signal between channels 2 and 4 (and COMMONmode4 refers to the common mode channel between these same channels).

<F> An integer from 1-16.

<L> An integer from 1-4.

**Query** :XTALK<X>:SOURce?

The :XTALK<X>:SOURce? query returns the specified source of the crosstalk signal.

**Returned Format** <source><NL>

```
<source> ::= {CHAN<N> | FUNC<F> | WMEM<N> | EQU<L> | MTR}
```

- See Also**
- [":XTALK<X>:AENable<X>"](#) on page 1689
  - [":XTALK<X>:ENABLE"](#) on page 1690
  - [":XTALK<X>:IAGGressor"](#) on page 1691
  - [":XTALK<X>:IVICTim"](#) on page 1692
  - [":XTALK<X>:PAUTo"](#) on page 1693
  - [":XTALK<X>:PLENght"](#) on page 1694
  - [":XTALK<X>:PTYPe"](#) on page 1695
  - [":XTALK<X>:RIDeal"](#) on page 1696
  - [":XTALK<X>:RISI"](#) on page 1697
  - [":XTALK<X>:ROTHer"](#) on page 1698
  - [":XTALK<X>:STYPe"](#) on page 1701
  - [":XTALK:ENABLE"](#) on page 1667
  - [":XTALK:RESults?"](#) on page 1681

**History** New in version 5.70.

**:XTALK<X>:STYPe**

**Command** :XTALK<X>:STYPe <signal\_type>  
 <signal\_type> ::= {POWER | ANALog | DIGital}

The :XTALK<X>:STYPe command specifies the crosstalk analysis signal type:

- POWER – Tells the application to use the specialized algorithms for power supply analysis.

**NOTE**

You cannot have both a power supply victim and a power supply aggressor in the same setup because these require different algorithms.

- ANALog – For increased accuracy, it is recommended to use clock recovery (DIGital) for all data waveforms whenever possible; however, aggressors that are too noisy for clock recovery can be specified as ANALog, which tells the algorithm to skip clock recovery.

If a victim signal is too noisy for clock recovery, another option is to perform equalization on the waveform before sending it to the Crosstalk Analysis application. This can be done directly on the oscilloscope using the Infiniium Equalization application and then selecting FFE as the signal source for crosstalk analysis.

- DIGital – Tells the application that the input signal represents a digital bit stream (serial data), and that it needs to do a clock recovery.

When the signal type is data DIGital, you need to specify the type of pattern (periodic or arbitrary) and whether the pattern length should be automatically determined or specified with :XTALK<X>:PLENgtH.

<X> An integer from 1–4.

**Query** :XTALK<X>:STYPe?

The :XTALK<X>:STYPe? query returns the specified signal type.

**Returned Format** <signal\_type><NL>  
 <signal\_type> ::= {POW | ANAL | DIG}

- See Also**
- **":XTALK<X>:AENable<X>"** on page 1689
  - **":XTALK<X>:ENABle"** on page 1690
  - **":XTALK<X>:IAGGressor"** on page 1691
  - **":XTALK<X>:IVICTim"** on page 1692
  - **":XTALK<X>:PAUTO"** on page 1693
  - **":XTALK<X>:PLENgtH"** on page 1694
  - **":XTALK<X>:PTYPe"** on page 1695

- **":XTALk<X>:RIDeal"** on page 1696
- **":XTALk<X>:RISI"** on page 1697
- **":XTALk<X>:ROTher"** on page 1698
- **":XTALk<X>:SOURce"** on page 1699
- **":XTALk:ENABle"** on page 1667
- **":XTALk:RESults?"** on page 1681

**History** New in version 5.70.

## 42 Obsolete and Discontinued Commands

Obsolete commands are deprecated, older forms of commands that still work but have been replaced by newer commands.

Obsolete Command	Current Command Equivalent	Behavior Differences
:ANALyze:CLOCK:METHod:PAM:B03 (see <a href="#">page 1710</a> )	None	The command works and as before, but changing its default (ON) is not necessary.
:ANALyze:CLOCK:METHod:PAM:B12 (see <a href="#">page 1712</a> )	None	The command works and as before, but changing its default (ON) is not necessary.
:ANALyze:CLOCK:METHod:PAM:NONSymmetric (see <a href="#">page 1714</a> )	None	The command works and as before, but changing its default (OFF) is not necessary.
CHANnel<N>:PROBe (see <a href="#">page 1716</a> )	CHANnel<N>:PROBe:USER (see <a href="#">page 409</a> )	The current command lets you specify the N7019A Type-C active link fixture in addition to voltage probes.
:DISPlay:COLumn (see <a href="#">page 1717</a> )	:DISPlay:BOOKmark<N>:XPOSITION (see <a href="#">page 520</a> )	Bookmarks are now the method used to place text strings or annotations on screen.
:DISPlay:LINE (see <a href="#">page 1718</a> )	:DISPlay:BOOKmark<N>:SET (see <a href="#">page 517</a> )	
:DISPlay:ROW (see <a href="#">page 1719</a> )	:DISPlay:BOOKmark<N>:YPOSITION (see <a href="#">page 521</a> )	
:DISPlay:STRing (see <a href="#">page 1720</a> )	:DISPlay:BOOKmark<N>:SET (see <a href="#">page 517</a> )	
:DISPlay:TAB (see <a href="#">page 1721</a> )	None	This command is not supported in version 5.00 or higher. The query now returns only NONE.

Obsolete Command	Current Command Equivalent	Behavior Differences
:DISPlay:TEXT (see <a href="#">page 1722</a> )	:DISPlay:BOOKmark<N>:DELet e (see <a href="#">page 516</a> )	Bookmarks are now the method used to place text strings or annotations on screen.
:HOSTed:CALibrate:ALIGn (see <a href="#">page 1723</a> )	None	Acquired data is now always aligned, and this command has no effect.
:MEASure:CLOCK:METhod (see <a href="#">page 1727</a> )	<ul style="list-style-type: none"> <li>▪ :MEASure:CLOCK:METhod (see <a href="#">page 1725</a>)</li> <li>▪ :MEASure:CLOCK:METhod:JTF (see <a href="#">page 1733</a>)</li> <li>▪ :MEASure:CLOCK:METhod:OJTF (see <a href="#">page 1735</a>)</li> </ul>	The command options for specifying clock recovery PLL options have been moved to the new commands :MEASure:CLOCK:METhod:JTF and :MEASure:CLOCK:METhod:OJTF.
:MEASure:CLOCK (see <a href="#">page 1724</a> )	:ANALyze:CLOCK (see <a href="#">page 274</a> )	There are no differences in behavior. This is just a remapping of commands into a new subsystem.
:MEASure:CLOCK:METhod (see <a href="#">page 1725</a> )	:ANALyze:CLOCK:METhod (see <a href="#">page 275</a> )	
:MEASure:CLOCK:METhod:ALIGn (see <a href="#">page 1729</a> )	:ANALyze:CLOCK:METhod:ALIGn (see <a href="#">page 279</a> )	
:MEASure:CLOCK:METhod:DEEMphasis (see <a href="#">page 1730</a> )	:ANALyze:CLOCK:METhod:DEEMphasis (see <a href="#">page 280</a> )	
:MEASure:CLOCK:METhod:EDGE (see <a href="#">page 1731</a> )	:ANALyze:CLOCK:METhod:EDGE (see <a href="#">page 281</a> )	
:MEASure:CLOCK:METhod:JTF (see <a href="#">page 1733</a> )	:ANALyze:CLOCK:METhod:JTF (see <a href="#">page 284</a> )	
:MEASure:CLOCK:METhod:OJTF (see <a href="#">page 1735</a> )	:ANALyze:CLOCK:METhod:OJTF (see <a href="#">page 286</a> )	
:MEASure:CLOCK:METhod:PLLTrack (see <a href="#">page 1737</a> )	:ANALyze:CLOCK:METhod:PLLTrack (see <a href="#">page 289</a> )	
:MEASure:CLOCK:METhod:SOURCE (see <a href="#">page 1738</a> )	:ANALyze:CLOCK:METhod:SOURCE (see <a href="#">page 292</a> )	
:MEASure:CLOCK:VERTical (see <a href="#">page 1739</a> )	:ANALyze:CLOCK:VERTical (see <a href="#">page 295</a> )	
:MEASure:CLOCK:VERTical:OFFSet (see <a href="#">page 1740</a> )	:ANALyze:CLOCK:VERTical:OFFSet (see <a href="#">page 296</a> )	
:MEASure:CLOCK:VERTical:RANge (see <a href="#">page 1741</a> )	:ANALyze:CLOCK:VERTical:RANge (see <a href="#">page 297</a> )	



Obsolete Command	Current Command Equivalent	Behavior Differences
:MEASure:DDPWS (see <a href="#">page 1742</a> )	:MEASure:RJDJ:ALL? (see <a href="#">page 1085</a> )	The :MEASure:RJDJ:ALL? query returns all of the RJDJ jitter measurements.
:MEASure:FFT:PEAK1 (see <a href="#">page 1744</a> )	:MEASure:FFT:DFRequency (see <a href="#">page 949</a> )	Peak numbers and threshold levels are now specified in the :MEASure:FFT:DFRequency and :MEASure:FFT:DMAGnitude command/query parameters.
:MEASure:FFT:PEAK2 (see <a href="#">page 1745</a> )	:MEASure:FFT:DMAGnitude (see <a href="#">page 951</a> )	
:MEASure:FFT:THRehold (see <a href="#">page 1746</a> )		
:MEASure:JITTer:STATistics (see <a href="#">page 1747</a> )	:ANALyze:AEDGes (see <a href="#">page 273</a> )	The :ANALyze:AEDGes command maps to the "Measure All Edges" control in the user interface's Measurement Setup dialog box only. It does not affect jitter modes or statistics.
:MEASure:TIEData (see <a href="#">page 1748</a> )	:MEASure:TIEData2 (see <a href="#">page 1167</a> )	Clock recovery options have been removed (clock recovery as specified with the :ANALyze:CLOCK:METHod is used).  When the signal type is PAM-4, an additional <threshold> parameter is used to specify the threshold at which to make the TIE measurements.
:MTESt:FOLDing:COUNT? (see <a href="#">page 1750</a> )	:MTESt:FOLDing:COUNT:UI? (see <a href="#">page 843</a> )  :MTESt:FOLDing:COUNT:WAVeforms? (see <a href="#">page 845</a> )	The :MTESt:FOLDing:COUNT? query returns two values for UI count and waveform count. Now, there are separate queries that return those values individually.  The UI count returned by :MTESt:FOLDing:COUNT? is now a floating-point value instead of an integer value.
:SPROcessing:CTLequalizer:AC Gain (see <a href="#">page 1752</a> )	:LANE1:EQualizer:CTLE:ACGain (see <a href="#">page 718</a> )	All :SPROcessing:CTLequalizer commands apply to Lane 1.
:SPROcessing:CTLequalizer:DC Gain (see <a href="#">page 1753</a> )	:LANE1:EQualizer:CTLE:DCGain (see <a href="#">page 719</a> )	

Obsolete Command	Current Command Equivalent	Behavior Differences
:SPRocessing:CTLequalizer:DIS Play (see <a href="#">page 1754</a> )	:LANE1:EQUalizer:CTLE:STATe (see <a href="#">page 728</a> )	The ":SPRocessing:CTLequalizer:DIS Play ON" command now: (1) turns CTLE on in Lane 1, (2) turns FFE off in Lane 1, and (3) turns on Lane 1.
:SPRocessing:CTLequalizer:NUMPoles (see <a href="#">page 1755</a> )	:LANE1:EQUalizer:CTLE:NUMPoles (see <a href="#">page 720</a> )	All :SPRocessing:CTLequalizer commands apply to Lane 1.
:SPRocessing:CTLequalizer:P1 (see <a href="#">page 1756</a> )	:LANE1:EQUalizer:CTLE:P1 (see <a href="#">page 721</a> )	
:SPRocessing:CTLequalizer:P2 (see <a href="#">page 1757</a> )	:LANE1:EQUalizer:CTLE:P2 (see <a href="#">page 722</a> )	
:SPRocessing:CTLequalizer:P3 (see <a href="#">page 1758</a> )	:LANE1:EQUalizer:CTLE:P3 (see <a href="#">page 723</a> )	
:SPRocessing:CTLequalizer:RA Te (see <a href="#">page 1760</a> )	:LANE1:EQUalizer:CTLE:RATE (see <a href="#">page 727</a> )	
:SPRocessing:CTLequalizer:SOURce (see <a href="#">page 1761</a> )	:LANE1:SOURce (see <a href="#">page 762</a> )	
:SPRocessing:CTLequalizer:VERTical (see <a href="#">page 1762</a> )	:LANE1:VERTical (see <a href="#">page 764</a> )	All :SPRocessing:CTLequalizer commands apply to Lane 1.
:SPRocessing:CTLequalizer:VERTical:OFFSet (see <a href="#">page 1763</a> )	:LANE1:VERTical:OFFSet (see <a href="#">page 765</a> )	
:SPRocessing:CTLequalizer:VERTical:RANGe (see <a href="#">page 1764</a> )	:LANE1:VERTical:RANGe (see <a href="#">page 766</a> )	
:SPRocessing:CTLequalizer:Z1 (see <a href="#">page 1765</a> )	:LANE1:EQUalizer:CTLE:Z1 (see <a href="#">page 729</a> )	
:SPRocessing:CTLequalizer:Z2 (see <a href="#">page 1766</a> )	:LANE1:EQUalizer:CTLE:Z2 (see <a href="#">page 730</a> )	
:SPRocessing:CTLequalizer:ZERo (see <a href="#">page 1767</a> )	<ul style="list-style-type: none"> <li>▪ :SPRocessing:CTLequalizer:Z1 (see <a href="#">page 1765</a>)</li> <li>▪ :SPRocessing:CTLequalizer:Z2 (see <a href="#">page 1766</a>)</li> </ul>	Now that you can specify up to two zeros for a 3-pole CTLE, this command has been replaced by two new commands.
:SPRocessing:DFEQualizer:NTAPs (see <a href="#">page 1768</a> )	:LANE2:EQUalizer:DFE:NTAPs (see <a href="#">page 731</a> )	All :SPRocessing:DFEQualizer commands apply to Lane 2.
:SPRocessing:DFEQualizer:SOURce (see <a href="#">page 1769</a> )	:LANE2:SOURce (see <a href="#">page 762</a> )	Selected source applies to the entire lane.

Obsolete Command	Current Command Equivalent	Behavior Differences
:SPRocessing:DFEQualizer:STATe (see <a href="#">page 1770</a> )	:LANE2:EQualizer:DFE:STATe (see <a href="#">page 732</a> )	The ":SPRocessing:DFEQualizer:STATe ON" command now: (1) turns on DFE in Lane 2, (2) set Lane 2's location to "in-place", and (3) turns on Lane 2.
:SPRocessing:DFEQualizer:TAP (see <a href="#">page 1771</a> )	:LANE2:EQualizer:DFE:TAP (see <a href="#">page 733</a> )	All :SPRocessing:DFEQualizer commands apply to Lane 2.
:SPRocessing:DFEQualizer:TAP:AUTOMATIC (see <a href="#">page 1772</a> )	:LANE2:EQualizer:DFE:TAP:AUTOMATIC (see <a href="#">page 734</a> )	
:SPRocessing:DFEQualizer:TAP:DELAY (see <a href="#">page 1773</a> )	:LANE2:EQualizer:DFE:TAP:DELAY (see <a href="#">page 735</a> )	
:SPRocessing:DFEQualizer:TAP:DELAY:AUTOMATIC (see <a href="#">page 1774</a> )	:LANE2:EQualizer:DFE:TAP:DELAY:AUTOMATIC (see <a href="#">page 736</a> )	
:SPRocessing:DFEQualizer:TAP:GAIN (see <a href="#">page 1775</a> )	:LANE2:EQualizer:DFE:TAP:GAIN (see <a href="#">page 737</a> )	
:SPRocessing:DFEQualizer:TAP:LTARGET (see <a href="#">page 1776</a> )	:LANE2:EQualizer:DFE:TAP:LTARGET (see <a href="#">page 738</a> )	
:SPRocessing:DFEQualizer:TAP:MAX (see <a href="#">page 1777</a> )	:LANE2:EQualizer:DFE:TAP:MAX (see <a href="#">page 739</a> )	
:SPRocessing:DFEQualizer:TAP:MIN (see <a href="#">page 1778</a> )	:LANE2:EQualizer:DFE:TAP:MIN (see <a href="#">page 741</a> )	
:SPRocessing:DFEQualizer:TAP:NORMALIZE (see <a href="#">page 1779</a> )	:LANE2:EQualizer:DFE:TAP:NORMALIZE (see <a href="#">page 743</a> )	
:SPRocessing:DFEQualizer:TAP:UTARGET (see <a href="#">page 1780</a> )	:LANE2:EQualizer:DFE:TAP:UTARGET (see <a href="#">page 744</a> )	
:SPRocessing:DFEQualizer:TAP:WIDTH (see <a href="#">page 1781</a> )	:LANE2:EQualizer:DFE:TAP:WIDTH (see <a href="#">page 745</a> )	
:SPRocessing:FFEQualizer:BANDBWIDTH (see <a href="#">page 1782</a> )	:LANE1:EQualizer:FFE:BANDWIDTH (see <a href="#">page 749</a> )	
:SPRocessing:FFEQualizer:BWMODE (see <a href="#">page 1783</a> )	:LANE1:EQualizer:FFE:BWMODE (see <a href="#">page 750</a> )	
:SPRocessing:FFEQualizer:DISPLAY (see <a href="#">page 1784</a> )	:LANE1:EQualizer:FFE:STATe (see <a href="#">page 754</a> )	The ":SPRocessing:FFEQualizer:DISPLAY ON" command now: (1) turns FFE on in Lane 1, (2) turns CTLE off in Lane 1, and (3) turns on Lane 1.

Obsolete Command	Current Command Equivalent	Behavior Differences
:SPROcessing:FFEQualizer:NPR ecursor (see <a href="#">page 1785</a> )	:LANE1:EQUalizer:FFE:NPR ecursor (see <a href="#">page 751</a> )	All :SPROcessing:FFEQualizer commands apply to Lane 1.
:SPROcessing:FFEQualizer:NTA Ps (see <a href="#">page 1786</a> )	:LANE1:EQUalizer:FFE:NTAPs (see <a href="#">page 752</a> )	
:SPROcessing:FFEQualizer:RAT e (see <a href="#">page 1787</a> )	:LANE1:EQUalizer:FFE:RATE (see <a href="#">page 753</a> )	
:SPROcessing:FFEQualizer:SOU Rce (see <a href="#">page 1788</a> )	:LANE1:SOURce (see <a href="#">page 762</a> )	Selected source applies to the entire lane.
:SPROcessing:FFEQualizer:TAP (see <a href="#">page 1789</a> )	:LANE1:EQUalizer:FFE:TAP (see <a href="#">page 755</a> )	All :SPROcessing:FFEQualizer commands apply to Lane 1.
:SPROcessing:FFEQualizer:TAP: AUTomatic (see <a href="#">page 1790</a> )	:LANE1:EQUalizer:FFE:TAP:AUT omatic (see <a href="#">page 756</a> )	
:SPROcessing:FFEQualizer:TAP: DELay (see <a href="#">page 1791</a> )	:LANE1:EQUalizer:FFE:TAP:DEL ay (see <a href="#">page 757</a> )	
:SPROcessing:FFEQualizer:TAP: WIDTh (see <a href="#">page 1792</a> )	:LANE1:EQUalizer:FFE:TAP:WID Th (see <a href="#">page 758</a> )	
:SPROcessing:FFEQualizer:TDE Lay (see <a href="#">page 1793</a> )	:LANE1:EQUalizer:FFE:TDELay (see <a href="#">page 759</a> )	
:SPROcessing:FFEQualizer:TDM ode (see <a href="#">page 1794</a> )	:LANE1:EQUalizer:FFE:TDMode (see <a href="#">page 760</a> )	
:SPROcessing:FFEQualizer:VER Tical (see <a href="#">page 1795</a> )	:LANE1:VERTical (see <a href="#">page 764</a> )	
:SPROcessing:FFEQualizer:VER Tical:OFFSet (see <a href="#">page 1796</a> )	:LANE1:VERTical:OFFSet (see <a href="#">page 765</a> )	
:SPROcessing:FFEQualizer:VER Tical:RANGe (see <a href="#">page 1797</a> )	:LANE1:VERTical:RANGe (see <a href="#">page 766</a> )	

### Discontinued Commands

Discontinued commands are commands that were supported in previous versions of the Infiniium oscilloscope software, but are not supported by this version of the Infiniium oscilloscope software. Listed below are the Discontinued commands and the nearest equivalent command available (if any).

Discontinued Command	Current Command Equivalent	Comments
:DISK:STORe	":DISK:SAVE:SETup" on page 509 ":DISK:SAVE:WAVEform" on page 510	For saving setups and waveforms to disk.
:DISPlay:GRATICule:SIZE	None	Graticule sizing is different in the version 5.00 next-generation Infiniium user interface software.

**:ANALyze:CLOCK:METHod:PAM:B03**

**Command** :ANALyze:CLOCK:METHod:PAM:B03 {{0 | OFF} | {1 | ON}}

When the signal type is PAM-4 (see :ANALyze:SIGNal:TYPE), the :ANALyze:CLOCK:METHod:PAM:B03 command specifies whether edges from the 0 level to the 3 level and from the 3 level to the 0 level are included in the clock recovery.

Remember, with PAM-4 signals, clock recovery is performed individually for each signal source; therefore, this setting applies to the source specified with the :ANALyze:CLOCK:METHod:SOURce command.

**Query** :ANALyze:CLOCK:METHod:PAM:B03?

The :ANALyze:CLOCK:METHod:PAM:B03? query returns whether 03,30 edges are included in the clock recovery.

**Returned Format** [:ANALyze:CLOCK:METHod:PAM:B03] <setting><NL>  
<setting> ::= {0 | 1}

- See Also**
- [":ANALyze:CLOCK:METHod:SOURce"](#) on page 292
  - [":ANALyze:CLOCK:METHod:PAM:B12"](#) on page 1712
  - [":ANALyze:CLOCK:METHod:PAM:NONSymmetric"](#) on page 1714
  - [":ANALyze:SIGNal:DATarate"](#) on page 298
  - [":ANALyze:SIGNal:SYMBOLrate"](#) on page 310
  - [":ANALyze:SIGNal:TYPE"](#) on page 312
  - [":MEASure:CGRade:EWIDth"](#) on page 907
  - [":MEASure:CGRade:EHEight"](#) on page 904
  - [":MEASure:FALLtime"](#) on page 946
  - [":MEASure:PAM:ELEVel"](#) on page 1022
  - [":MEASure:PAM:ESKew"](#) on page 1024
  - [":MEASure:PAM:LEVel"](#) on page 1031
  - [":MEASure:PAM:LRMS"](#) on page 1033
  - [":MEASure:PAM:LTHickness"](#) on page 1035
  - [":MEASure:RISetime"](#) on page 1083
  - [":MEASure:THResholds:GENeral:METHod"](#) on page 1126
  - [":MEASure:THResholds:GENeral:PAMCustom"](#) on page 1128
  - [":MEASure:THResholds:GENeral:PAMAutomatic"](#) on page 1130
  - [":MEASure:THResholds:RFALL:METHod"](#) on page 1143
  - [":MEASure:THResholds:RFALL:PAMAutomatic"](#) on page 1145
  - [":MEASure:TIEData2"](#) on page 1167

**History** New in version 5.50.

**:ANALyze:CLOCK:METHod:PAM:B12**

**Command** :ANALyze:CLOCK:METHod:PAM:B12 {{0 | OFF} | {1 | ON}}

When the signal type is PAM-4 (see :ANALyze:SIGNal:TYPE), the :ANALyze:CLOCK:METHod:PAM:B12 command specifies whether edges from the 1 level to the 2 level and from the 2 level to the 1 level are included in the clock recovery.

Remember, with PAM-4 signals, clock recovery is performed individually for each signal source; therefore, this setting applies to the source specified with the :ANALyze:CLOCK:METHod:SOURce command.

**Query** :ANALyze:CLOCK:METHod:PAM:B12?

The :ANALyze:CLOCK:METHod:PAM:B12? query returns whether 12,21 edges are included in the clock recovery.

**Returned Format** [:ANALyze:CLOCK:METHod:PAM:B12] <setting><NL>  
<setting ::= {0 | 1}

- See Also**
- [":ANALyze:CLOCK:METHod:SOURce"](#) on page 292
  - [":ANALyze:CLOCK:METHod:PAM:B03"](#) on page 1710
  - [":ANALyze:CLOCK:METHod:PAM:NONSymmetric"](#) on page 1714
  - [":ANALyze:SIGNal:DATarate"](#) on page 298
  - [":ANALyze:SIGNal:SYMBOLrate"](#) on page 310
  - [":ANALyze:SIGNal:TYPE"](#) on page 312
  - [":MEASure:CGRade:EWIDth"](#) on page 907
  - [":MEASure:CGRade:EHEight"](#) on page 904
  - [":MEASure:FALLtime"](#) on page 946
  - [":MEASure:PAM:ELEVel"](#) on page 1022
  - [":MEASure:PAM:ESKew"](#) on page 1024
  - [":MEASure:PAM:LEVel"](#) on page 1031
  - [":MEASure:PAM:LRMS"](#) on page 1033
  - [":MEASure:PAM:LTHickness"](#) on page 1035
  - [":MEASure:RISetime"](#) on page 1083
  - [":MEASure:THResholds:GENeral:METHod"](#) on page 1126
  - [":MEASure:THResholds:GENeral:PAMCustom"](#) on page 1128
  - [":MEASure:THResholds:GENeral:PAMAutomatic"](#) on page 1130
  - [":MEASure:THResholds:RFALL:METHod"](#) on page 1143
  - [":MEASure:THResholds:RFALL:PAMAutomatic"](#) on page 1145
  - [":MEASure:TIEData2"](#) on page 1167



**History** New in version 5.50.

## :ANALyze:CLOCK:METHOD:PAM:NONSymmetric

**Command** :ANALyze:CLOCK:METHOD:PAM:NONSymmetric {{0 | OFF} | {1 | ON}}

When the signal type is PAM-4 (see :ANALyze:SIGNal:TYPE), the :ANALyze:CLOCK:METHOD:PAM:NONSymmetric command specifies whether edges that are non-symmetric about the middle threshold (for example, from the 1 level to the 3 level or from the 2 level to the 0 level) are included in the clock recovery.

Remember, with PAM-4 signals, clock recovery is performed individually for each signal source; therefore, this setting applies to the source specified with the :ANALyze:CLOCK:METHOD:SOURce command.

**Query** :ANALyze:CLOCK:METHOD:PAM:NONSymmetric?

The :ANALyze:CLOCK:METHOD:PAM:NONSymmetric? query returns whether non-symmetric edges are included in the clock recovery.

**Returned Format** [:ANALyze:CLOCK:METHOD:PAM:NONSymmetric] <setting><NL>  
 <setting> ::= {0 | 1}

- See Also**
- [":ANALyze:CLOCK:METHOD:SOURce"](#) on page 292
  - [":ANALyze:CLOCK:METHOD:PAM:B03"](#) on page 1710
  - [":ANALyze:CLOCK:METHOD:PAM:B12"](#) on page 1712
  - [":ANALyze:SIGNal:DATarate"](#) on page 298
  - [":ANALyze:SIGNal:SYMBOLrate"](#) on page 310
  - [":ANALyze:SIGNal:TYPE"](#) on page 312
  - [":MEASure:CGRade:EWIDth"](#) on page 907
  - [":MEASure:CGRade:EHEight"](#) on page 904
  - [":MEASure:FALLtime"](#) on page 946
  - [":MEASure:PAM:ELEVEL"](#) on page 1022
  - [":MEASure:PAM:ESKew"](#) on page 1024
  - [":MEASure:PAM:LEVEL"](#) on page 1031
  - [":MEASure:PAM:LRMS"](#) on page 1033
  - [":MEASure:PAM:LTHickness"](#) on page 1035
  - [":MEASure:RISetime"](#) on page 1083
  - [":MEASure:THResholds:GENERAL:METHOD"](#) on page 1126
  - [":MEASure:THResholds:GENERAL:PAMCustom"](#) on page 1128
  - [":MEASure:THResholds:GENERAL:PAMAutomatic"](#) on page 1130
  - [":MEASure:THResholds:RFALL:METHOD"](#) on page 1143
  - [":MEASure:THResholds:RFALL:PAMAutomatic"](#) on page 1145

- **":MEASure:TIEData2"** on page 1167

**History** New in version 5.50.

**:CHANnel<N>:PROBe**

**Command** :CHANnel<N>:PROBe <attenuation\_factor>[, {RATio | DECibel}]

The :CHANnel<N>:PROBe command sets the probe attenuation factor and the units (ratio or decibels) for the probe attenuation factor for a user-defined probe.

The DECibel and RATio parameters also set the "mode" for the probe attenuation. These parameters, along with attenuation factor, determine the scaling of the display and affect automatic measurements and trigger levels.

This mode also determines the units (ratio or decibels) that may be used for a subsequent command.

<N> An integer, 1-4

<attenuation\_factor> A real number from 0.0001 to 1000 for the RATio attenuation units or from -80 dB to 60 dB for the DECibel attenuation units.

**Example** This example sets the probe attenuation factor for a 10:1 probe on channel 1 in ratio units.

```
myScope.WriteString ":CHANnel1:PROBe 10,RAT"
```

**Query** :CHANnel<N>:PROBe?

The :CHANnel<N>:PROBe? query returns the current probe attenuation setting and units for the selected channel.

**Returned Format** [:CHANnel<N>:PROBe] <attenuation>,{RATio | DECibel}<NL>

**Example** This example places the current attenuation setting for channel 1 in the string variable, strAtten, then the program prints the contents.

```
Dim strAtten As String ' Dimension variable.
myScope.WriteString ":CHANnel1:PROBe?"
strAtten = myScope.ReadString
Debug.Print strAtten
```

If you use a string variable, the query returns the attenuation value and the factor (decibel or ratio). If you use an integer variable, the query returns the attenuation value. You must then read the attenuation units into a string variable.

**History** Legacy command (existed before version 3.10).

Version 6.73: This command has been deprecated and replaced by the **":CHANnel<N>:PROBe:USER"** on page 409 command.

## :DISPlay:COLumn

### Command

#### NOTE

This command is deprecated. It is accepted but ignored. Bookmarks are now the method used to place text strings or annotations on screen. The closest command equivalent is **":DISPlay:BOOKmark<N>:XPOsition"** on page 520.

```
:DISPlay:COLumn <column_number>
```

The :DISPlay:COLumn command specifies the starting column for subsequent :DISPlay:STRing and :DISPlay:LINE commands.

**<column\_number>** An integer representing the starting column for subsequent :DISPlay:STRing and :DISPlay:LINE commands. The range of values is 0 to 90.

**Example** This example sets the starting column for subsequent :DISPlay:STRing and :DISPlay:LINE commands to column 10.

```
myScope.WriteString ":DISPlay:COLumn 10"
```

**Query** :DISPlay:COLumn?

The :DISPlay:COLumn? query returns the column where the next :DISPlay:LINE or :DISPlay:STRing starts.

**Returned Format** [:DISPlay:COLumn] <value><NL>

**Example** This example returns the current column setting to the string variable, strSetting, then prints the contents of the variable to the computer's screen.

```
Dim strSetting As String ' Dimension variable.
myScope.WriteString ":DISPlay:COLumn?"
strSetting = myScope.ReadString
Debug.Print strSetting
```

**History** Legacy command (existed before version 3.10).  
 Obsoleted in version 5.00.

## :DISPlay:LINE

### Command

#### NOTE

This command is deprecated. It is accepted but ignored. Bookmarks are now the method used to place text strings or annotations on screen. The closest command equivalent is **":DISPlay:BOOKmark<N>:SET"** on page 517.

```
:DISPlay:LINE "<string_argument>"
```

The :DISPlay:LINE command writes a quoted string to the screen, starting at the location specified by the :DISPlay:ROW and :DISPlay:COLUmN commands.

### <string\_argument>

Any series of ASCII characters enclosed in quotation marks.

### Example

This example writes the message "Infiniium Test" to the screen, starting at the current row and column location.

```
myScope.WriteString ":DISPlay:LINE "Infiniium Test""
```

When using the C programming language, quotation marks within a string are escaped using the backslash (\) character as shown in the next example. This example writes the message "Infiniium Test" to the screen.

```
printf("\Infiniium Test\");
```

You may write text up to column 94. If the characters in the string do not fill the line, the rest of the line is blanked. If the string is longer than the space available on the current line, the excess characters are discarded.

In any case, the ROW is incremented and the COLUmN remains the same. The next :DISPlay:LINE command will write on the next line of the display. After writing the last line in the display area, the ROW is reset to 0.

### History

Legacy command (existed before version 3.10).

Obsoleted in version 5.00.

## :DISPlay:ROW

### Command

#### NOTE

This command is deprecated. It is accepted but ignored. Bookmarks are now the method used to place text strings or annotations on screen. The closest command equivalent is **":DISPlay:BOOKmark<N>:YPOSITION"** on page 521.

```
:DISPlay:ROW <row_number>
```

The :DISPlay:ROW command specifies the starting row on the screen for subsequent :DISPlay:STRing and :DISPlay:LINE commands. The row number remains constant until another :DISPlay:ROW command is received, or the row is incremented by the :DISPlay:LINE command.

**<row\_number>** An integer representing the starting row for subsequent :DISPlay:STRing and :DISPlay:LINE commands. The range of values is 9 to 23.

**Example** This example sets the starting row for subsequent :DISPlay:STRing and :DISPlay:LINE commands to 10.

```
myScope.WriteString ":DISPlay:ROW 10"
```

**Query** :DISPlay:ROW?

The :DISPlay:ROW? query returns the current value of the row.

**Returned Format** [:DISPlay:ROW] <row\_number><NL>

**Example** This example places the current value for row in the string variable, strSetting, then prints the contents of the variable to the computer's screen.

```
Dim strSetting As String ' Dimension variable.
myScope.WriteString ":DISPlay:ROW?"
strSetting = myScope.ReadString
Debug.Print strSetting
```

**History** Legacy command (existed before version 3.10).

Obsoleted in version 5.00.

## :DISPlay:STRing

### Command

**NOTE**

This command is deprecated. It is accepted but ignored. Bookmarks are now the method used to place text strings or annotations on screen. The closest command equivalent is **":DISPlay:BOOKmark<N>:SET"** on page 517.

---

```
:DISPlay:STRing "<string_argument>"
```

The :DISPlay:STRing command writes text to the oscilloscope screen. The text is written starting at the current row and column settings. If the column limit is reached, the excess text is discarded. The :DISPlay:STRing command does not increment the row value, but :DISPlay:LINE does.

**<string\_argument>** Any series of ASCII characters enclosed in quotation marks.

**Example** This example writes the message "Example 1" to the oscilloscope's display starting at the current row and column settings.

```
myScope.WriteString ":DISPlay:STRING "Example 1""
```

**History** Legacy command (existed before version 3.10).

Obsoleted in version 5.00.



## :DISPlay:TAB

**Command** :DISPlay:TAB <tab>

The :DISPlay:TAB command displays the corresponding tab indicated by the <tab> parameter.

<tab> MEASurement | MARKer | DIGital | LIMittest | JITTer | NOISe | HISTogram | MASKtest | EYE | COLorgrade | NAVigation | STATus | SCALE | BOOKmark | CROStalk | FAILuretable | FFTPeaks | EQSettings

**Example** This example sets the Status tab as the displayed one.

```
myScope.WriteString ":DISPlay:TAB STATus"
```

**Query** :DISPlay:TAB?

The :DISPlay:TAB? query returns the tab that is currently displayed.

**Returned Format** [:DISPlay:TAB] {MEAS | MARK | DIG | LIM | JITT | NOIS | HIST | MASK  
| EYE | COL | NAV | STAT | SCAL | BOOK | CROS | FAIL | FFTP  
| EQS}<NL>

**Example** This example places the currently displayed tab into the string variable, strTab, then prints the contents of the variable to the computer's screen.

```
Dim strTab As String ' Dimension variable.
myScope.WriteString ":DISPlay:TAB?"
strTab = myScope.ReadString
Debug.Print strTab
```

**History** Legacy command (existed before version 3.10).

Obsoleted in version 5.00.

## :DISPlay:TEXT

### Command

#### NOTE

This command is deprecated. It is accepted but ignored. Bookmarks are now the method used to place text strings or annotations on screen. The closest command equivalent is **":DISPlay:BOOKmark<N>:DELeTe"** on page 516.

---

```
:DISPlay:TEXT BLANK
```

The :DISPlay:TEXT command blanks the user text area of the screen.

**Example** This example blanks the user text area of the oscilloscope's screen.

```
myScope.WriteString ":DISPlay:TEXT BLANK"
```

**History** Legacy command (existed before version 3.10).

Obsoleted in version 5.00.

## :HOSTed:CALibrate:ALIGn (MultiScope)

**Command** :HOSTed:CALibrate:ALIGn {{0 | OFF} | {1 | ON}}

**NOTE**

As of software version 5.60, acquired data is always aligned, and this command has no effect.

The :HOSTed:CALibrate:ALIGn command lets you align acquired data in the MultiScope system. When ON, a unique time-shifting FIR filter is applied to each output waveform and the waveforms are truncated so that all of them have the same X origin and number of points values.

Setting ":HOSTed:CALibrate:ALIGn ON" causes longer acquisition times.

**Query** :HOSTed:CALibrate:ALIGn?

The :HOSTed:CALibrate:ALIGn? query returns the align acquired data setting.

**Returned Format** [:HOSTed:CALibrate:ALIGn] <setting><NL>  
<setting> ::= {0 | 1}

- See Also**
- [":HOSTed:CALibrate:CALibrate"](#) on page 669
  - [":HOSTed:CALibrate:CHANnel"](#) on page 670
  - [":HOSTed:CALibrate:DESKew:FRAMes"](#) on page 672
  - [":HOSTed:CALibrate:DESKew:CHANnels"](#) on page 671
  - [":HOSTed:CALibrate:DESKew:SIGNals"](#) on page 673
  - [":HOSTed:CALibrate:DESKew:ZERO"](#) on page 674
  - [":HOSTed:CALibrate:LEVel"](#) on page 675
  - [":HOSTed:CALibrate:PROMpt"](#) on page 677
  - [":HOSTed:CALibrate:STATus:CHANnels?"](#) on page 678
  - [":HOSTed:CALibrate:STATus:FRAMes?"](#) on page 679
  - [":HOSTed:CALibrate:STATus:LEVel?"](#) on page 680
  - [":HOSTed:CALibrate:STATus:SIGNals?"](#) on page 681
  - [":HOSTed:CALibrate:TREF:DETECT"](#) on page 682

**History** New in version 5.50.

Version 5.60: Acquired data is now always aligned, and this command has no effect.

**:MEASure:CLOCK**

**Command** :MEASure:CLOCK {{ON|1},CHANnel<N>} | {OFF|0}

The :MEASure:CLOCK command turns the recovered clock display on or off and sets the clock recovery channel source.

<N> An integer, 1-4 in a single oscilloscope, 1-40 in a MultiScope system.

**Example** This example turns the recovered clock display on for channel 1.

```
myScope.WriteString ":MEASure:CLOCK ON,CHANnel1"
```

**Query** :MEASure:CLOCK?

The :MEASure :CLOCK? query returns the state of the recovered clock display.

**Returned Format** [:MEASure:CLOCK] {1 | 0}<NL>

**Example** This example places the current setting of the recovered clock display in the variable varSetting, then prints the contents of the variable to the computer's screen.

```
myScope.WriteString ":SYSTem:HEADer OFF"
myScope.WriteString ":MEASure:CLOCK?"
varSetting = myScope.ReadNumber
Debug.Print FormatNumber(varSetting, 0)
```

**History** Legacy command (existed before version 3.10).

Version 5.30: This command is deprecated, replaced by **":ANALyze:CLOCK"** on page 274.

## :MEASure:CLOCK:METHOD

**Command** :MEASure:CLOCK:METHOD  
 {FC, {FC1063 | FC2125 | FC425}}  
 | {EXPLICIT, <source>, {RISing | FALLing | BOTH} [, <multiplier>]}  
 | {FIXed, {AUTO | {SEMI [, <data\_rate>]} | <data\_rate>}}  
 | {FLEXR, <baud\_rate>}  
 | {FLEXT, <baud\_rate>}

The :MEASure:CLOCK:METHOD command sets the clock recovery method to:

- FC (Fibre Channel).
- EXPLICIT (Explicit Clock).
- FIXed (Constant Frequency).
- FLEXR (FlexRay Receiver).
- FLEXT (FlexRay Transmitter).

This command applies to the clock recovery method being set up for the waveform source selected by the :MEASure:CLOCK:METHOD:SOURce command.

For setting phase-locked loop (PLL) clock recovery methods in terms of the Observed Jitter Transfer Function (OJTF), see **":MEASure:CLOCK:METHOD:OJTF"** on page 1735.

For setting phase-locked loop (PLL) clock recovery methods in terms of the Jitter Transfer Function (JTF), see **":MEASure:CLOCK:METHOD:JTF"** on page 1733.

<source> {CHANnel<N> | FUNCTION<F> | WMemory<R>}

<N> An integer, 1-4 in a single oscilloscope, 1-40 in a MultiScope system.

<F> An integer, 1-16.

<R> An integer, 1-4.

<data\_rate> A real number for the base data rate in Hertz.

<multiplier> An integer used as the multiplication factor.

<baud\_rate> A real number used for the baud rate.

**Example** This example sets the explicit clock recovery method on channel 1, rising edge, with a multiplier of 2.

```
myScope.WriteString ":MEASure:CLOCK:METHOD EXPLICIT,CHANnel1,RISing,2"
```

**Query** :MEASure:CLOCK:METHOD?

The :MEASure:CLOCK:METHOD? query returns the state of the clock recovery method.

**NOTE**

You can use the `:MEASure:CLOCK:METHOD?` query when phase-locked loop (PLL) clock recovery methods are set up. The format returned will be that of the `:MEASure:CLOCK:METHOD:OJTF?` query. See [":MEASure:CLOCK:METHOD:OJTF"](#) on page 1735.

**Returned Format** `[ :MEASure:CLOCK:METHOD  
 {FC,{FC1063 | FC2125 | FC425}}  
 | {EXPLICIT,<source>,{RISING | FALLING | BOTH},<multiplier>}  
 | {FIXed,{AUTO | {SEMI,<data_rate>} | <data_rate>}}  
 | {FLEXR,<baud_rate>}  
 | {FLEXT,<baud_rate>}`

**Example** This example places the current setting of the clock recovery method in the variable `strSetting`, then prints the contents of the variable to the computer's screen.

```
myScope.WriteString ":SYSTEM:HEADER OFF"
myScope.WriteString ":MEASure:CLOCK:METHOD?"
strSetting = myScope.ReadString
Debug.Print strSetting
```

**See Also**

- [":MEASure:CLOCK:METHOD:SOURce"](#) on page 1738
- [":MEASure:CLOCK:METHOD:OJTF"](#) on page 1735
- [":MEASure:CLOCK:METHOD:JTF"](#) on page 1733
- [":MEASure:CLOCK:METHOD:DEEMphasis"](#) on page 1730
- [":MEASure:CLOCK:METHOD:ALIGN"](#) on page 1729
- [":MEASure:CLOCK:METHOD:PLLTrack"](#) on page 1737
- [":MEASure:CLOCK:METHOD:EDGE"](#) on page 1731

**History** Legacy command (existed before version 3.10).

Version 4.20: The command options for specifying clock recovery PLL options moved to the new commands `:MEASure:CLOCK:METHOD:JTF` and `:MEASure:CLOCK:METHOD:OJTF`.

Version 5.10: The PCIE clock recovery method has been removed.

Version 5.30: This command is deprecated, replaced by [":ANALyze:CLOCK:METHOD"](#) on page 275.

## :MEASure:CLOCK:METHOD (deprecated)

### Command

#### NOTE

Some of these command options have been deprecated – options for specifying clock recovery PLL options have been moved to the new commands

**":MEASure:CLOCK:METHOD:JTF"** on page 1733 and

**":MEASure:CLOCK:METHOD:OJTF"** on page 1735. See also

**":MEASure:CLOCK:METHOD"** on page 1725.

```
:MEASure:CLOCK:METHOD {FOPLL,<data_rate>,<loop_bandwidth>}
| {EQFOPLL,<data_rate>,<loop_bandwidth>}
| {SOPLL,<data_rate>,<loop_bandwidth>,<damping_factor>}
| {EQSOPLL,<data_rate>,<loop_bandwidth>,<damping_factor>}
| {FC,{FC1063 | FC2125 | FC425}}
| {EXPFOPLL,<source>,{RISing | FALLing | BOTH},
  <multiplier>,<clock_freq>,<loop_bandwidth>}
| {EXPSOPLL,<source>,{RISing | FALLing | BOTH},
  <multiplier>,<clock_freq>,<loop_bandwidth>,<damping_fact>}
| {EXPLICIT,<source>,{RISing | FALLing | BOTH}[,<multiplier>]}
| {FIXed,{AUTO | {SEMI[,<data_rate>]} | <data_rate>}}
| {FLEXR,<baud_rate>}
| {FLEXT,<baud_rate>}
```

The :MEASure:CLOCK:METHOD command sets the clock recovery method to:

- FOPLL (first order phase-locked loop).
- SOPLL (second order phase-locked loop).
- EQFOPLL (equalized first order phase-locked loop).
- EQSOPLL (equalized second order phase-locked loop).
- FC (Fibre Channel).
- EXPFOPLL (Explicit First Order PLL).
- EXPSOPLL (Explicit Second Order PLL).
- EXPLICIT (Explicit Clock).
- FIXed (Constant Frequency).
- FLEXR (FlexRay Receiver).
- FLEXT (FlexRay Transmitter).

The equalized clock recovery methods are available when the Advanced Signal Integrity Software license is installed.

**<source>** {CHANnel<N> | FUNCTION<N> | WMemory<R>}

**<N>** An integer, 1-4 in a single oscilloscope, 1-40 in a MultiScope system.

FUNCTION<N> and WMemory<R> are:

An integer, 1-4, representing the selected function or waveform memory.

**<data\_rate>** A real number for the base data rate in Hertz.

- <damping\_factor> A real number for the damping factor of the PLL in bits per second.
- <loop\_bandwidth> A real number for the cutoff frequency for the PLL to track.
- <multiplier> An integer used as the multiplication factor.
- <clock\_freq> A real number used for the clock frequency of the PLL.
- <track\_freq> A real number used for the tracking frequency of the PLL.
- <damping\_fact> A real number used for the damping factor of the PLL.
- <baud\_rate> A real number used for the baud rate.

**Example** This example sets the clock recovery method to phase-locked loop.

```
myScope.WriteString ":MEASure:CLOCK:METHOD FOPLL,2E9,1.19E6"
```

**Query** :MEASure:CLOCK:METHOD?

The :MEASure:CLOCK:METHOD? query returns the state of the clock recovery method.

**Returned Format** [:MEASure:CLOCK:METHOD] {FOPLL,<data\_rate>,<loop\_bandwidth>}  
 | {EQFOPLL,<data\_rate>,<loop\_bandwidth>}  
 | {SOPLL,<data\_rate>,<loop\_bandwidth>,<damping\_factor>}  
 | {EQSOPLL,<data\_rate>,<loop\_bandwidth>,<damping\_factor>}  
 | {FC,{FC1063 | FC2125 | FC425}}  
 | {EXPFOPLL <source>,{RISing | FALLing | BOTH},  
 <multiplier>,<clock\_freq>,<track\_freq>}  
 | {EXPSOPLL <source>,{RISing | FALLing | BOTH},  
 <multiplier>,<clock\_freq>,<track\_freq>,<damping\_fact>}  
 | {EXPLICIT,<source>,{RISing | FALLing | BOTH},<multiplier>}  
 | {FIXed,{AUTO | {SEMI,<data\_rate>} | <data\_rate>}}  
 | {FLEXR,<baud\_rate>}  
 | {FLEXT,<baud\_rate>}

**Example** This example places the current setting of the clock recovery method in the variable strSetting, then prints the contents of the variable to the computer's screen.

```
myScope.WriteString ":SYSTEM:HEADER OFF"
myScope.WriteString ":MEASure:CLOCK:METHOD?"
strSetting = myScope.ReadString
Debug.Print strSetting
```

**History** Legacy command (existed before version 3.10).

Version 5.10: The PCIE clock recovery method has been removed.



## :MEASure:CLOCK:METHod:ALIGn

**Command** :MEASure:CLOCK:METHod:ALIGn {CENTer | EDGE}

When using an explicit method of clock recovery, the :MEASure:CLOCK:METHod:ALIGn command specifies how the clock is aligned with data:

- CENTER – Clock edges are aligned with the center of data.
- EDGE – Clock edges are aligned with data edges. In this case, Time Interval Error (TIE) is measured directly from the data edge to the clock edge.

This command applies to the clock recovery method being set up for the waveform source selected by the :MEASure:CLOCK:METHod:SOURce command.

**Example** When using an explicit method of clock recovery, this example specifies that clock edges are aligned with the center of data.

```
myScope.WriteString ":MEASure:CLOCK:METHod:ALIGn CENTer"
```

**Query** :MEASure:CLOCK:METHod:ALIGn?

The :MEASure:CLOCK:METHod:ALIGn? query returns the clock recovery method's edge alignment setting.

**Returned Format** [:MEASure:CLOCK:METHod:ALIGn] {CENT | EDGE}

**Example** This example places the current edge alignment setting of the clock recovery method in the variable strSetting, then prints the contents of the variable to the computer's screen.

```
myScope.WriteString ":SYSTem:HEADer OFF"
myScope.WriteString ":MEASure:CLOCK:METHod:ALIGn?"
strSetting = myScope.ReadString
Debug.Print strSetting
```

- See Also**
- [":MEASure:CLOCK:METHod:SOURce"](#) on page 1738
  - [":MEASure:CLOCK:METHod"](#) on page 1725
  - [":MEASure:CLOCK:METHod:OJTF"](#) on page 1735
  - [":MEASure:CLOCK:METHod:JTF"](#) on page 1733
  - [":MEASure:CLOCK:METHod:DEEMphasis"](#) on page 1730
  - [":MEASure:CLOCK:METHod:PLLTrack"](#) on page 1737
  - [":MEASure:CLOCK:METHod:EDGE"](#) on page 1731

**History** New in version 3.20.

Version 5.30: This command is deprecated, replaced by [":ANALyze:CLOCK:METHod:ALIGn"](#) on page 279.

## :MEASure:CLOCK:METHOD:DEEMphasis

**Command** :MEASure:CLOCK:METHOD:DEEMphasis {OFF | ON}

The :MEASure:CLOCK:METHOD:DEEMphasis command turns de-emphasis on or off.

This command applies to the clock recovery method being set up for the waveform source selected by the :MEASure:CLOCK:METHOD:SOURce command.

See the help system for more information on de-emphasis.

**Example** This example enables de-emphasis.

```
myScope.WriteString ":MEASure:CLOCK:METHOD:DEEMphasis ON"
```

**Query** :MEASure:CLOCK:METHOD:DEEMphasis?

The :MEASure:CLOCK:METHOD:DEEMphasis? query returns whether or not de-emphasis is turned on.

**Returned Format** [:MEASure:CLOCK:METHOD:DEEMphasis] {OFF | ON}

**Example** This example places the current setting of the de-emphasis mode in the string variable strDeemph, then prints the contents of the variable to the computer's screen.

```
myScope.WriteString ":SYSTEM:HEADer OFF"
myScope.WriteString ":MEASure:CLOCK:METHOD:DEEMphasis?"
strDeemph = myScope.ReadString
Debug.Print strDeemph
```

**See Also**

- [":MEASure:CLOCK:METHOD:SOURce"](#) on page 1738
- [":MEASure:CLOCK:METHOD"](#) on page 1725
- [":MEASure:CLOCK:METHOD:OJTF"](#) on page 1735
- [":MEASure:CLOCK:METHOD:JTF"](#) on page 1733
- [":MEASure:CLOCK:METHOD:ALIGN"](#) on page 1729
- [":MEASure:CLOCK:METHOD:PLLTrack"](#) on page 1737
- [":MEASure:CLOCK:METHOD:EDGE"](#) on page 1731

**History** Legacy command (existed before version 3.10).

Version 5.30: This command is deprecated, replaced by [":ANALyze:CLOCK:METHOD:DEEMphasis"](#) on page 280.

## :MEASure:CLOCK:METHod:EDGE

**Command** :MEASure:CLOCK:METHod:EDGE {RISing | FALLing | BOTH}

The :MEASure:CLOCK:METHod:EDGE command specifies which edge(s) of the data are used to recover a clock. (In the front panel GUI, this control appears in the Advanced Clock Recovery dialog box.) Normally, both edges are used. However, if you are performing clock recovery on a low duty cycle clock signal, for example, you may want to use just the rising or falling edge.

This command applies to the clock recovery method being set up for the waveform source selected by the :MEASure:CLOCK:METHod:SOURce command.

This command applies to the following clock recovery methods:

- FIXed (Constant Frequency).
- FOPLL (First Order PLL).
- SOPLL (Second Order PLL).
- EXPLicit (Explicit Clock).
- EXPFOPLL (Explicit First Order PLL).
- EXPSOPLL (Explicit Second Order PLL).
- EQFOPLL (Equalized First Order PLL).
- EQSOPLL (Equalized Second Order PLL).

To measure jitter on only rising (or falling) edges of a clock, you must also set :MEASure:RJDJ:EDGE to the same RISing or FALLing option, and you must set :MEASure:RJDJ:CLOCK ON to force the pattern to be a clock and set the jitter for edges not examined to zero (0).

**Example** This example specifies that both rising and falling edges of the data are used to recover a clock.

```
myScope.WriteString ":MEASure:CLOCK:METHod:EDGE BOTH"
```

**Query** :MEASure:CLOCK:METHod:EDGE?

The :MEASure:CLOCK:METHod:EDGE? query returns the clock recovery method's edge setting.

**Returned Format** [:MEASure:CLOCK:METHod:EDGE] {RIS | FALL | BOTH}

**Example** This example places the current edge setting of the clock recovery method in the variable strSetting, then prints the contents of the variable to the computer's screen.

```
myScope.WriteString ":SYSTem:HEADer OFF"
myScope.WriteString ":MEASure:CLOCK:METHod:EDGE?"
strSetting = myScope.ReadString
Debug.Print strSetting
```

**See Also** • [":MEASure:CLOCK:METHod:SOURce"](#) on page 1738

- **":MEASure:CLOCK:METHod"** on page 1725
- **":MEASure:CLOCK:METHod:OJTF"** on page 1735
- **":MEASure:CLOCK:METHod:JTF"** on page 1733
- **":MEASure:CLOCK:METHod:DEEMphasis"** on page 1730
- **":MEASure:CLOCK:METHod:ALIGn"** on page 1729
- **":MEASure:CLOCK:METHod:PLLTrack"** on page 1737
- **":MEASure:RJDJ:EDGE"** on page 1093
- **":MEASure:RJDJ:CLOCK"** on page 1091

**History** New in version 4.30.

Version 5.30: This command is deprecated, replaced by **":ANALyze:CLOCK:METHod:EDGE"** on page 281.

## :MEASure:CLOCK:METHod:JTF

**Command** :MEASure:CLOCK:METHod:JTF  
 {FOPLL,<data\_rate>,<jtf\_loop\_bandwidth>}  
 | {EQFOPLL,<data\_rate>,<jtf\_loop\_bandwidth>}  
 | {SOPLL,<data\_rate>,<jtf\_loop\_bandwidth>,<peaking>}  
 | {EQSOPLL,<data\_rate>,<jtf\_loop\_bandwidth>,<peaking>}  
 | {EXPFOPLL,<source>,{RISing | FALLing | BOTH},  
 <multiplier>,<clock\_freq>,<jtf\_loop\_bandwidth>}  
 | {EXPSOPLL,<source>,{RISing | FALLing | BOTH},  
 <multiplier>,<clock\_freq>,<jtf\_loop\_bandwidth>,<peaking>}

The :MEASure:CLOCK:METHod:JTF command specifies the clock recovery PLL's response in terms of the Jitter Transfer Function's (JTF) 3 dB bandwidth.

This command applies to the clock recovery method being set up for the waveform source selected by the :MEASure:CLOCK:METHod:SOURce command.

You can set these types of PLL clock recovery methods:

- FOPLL (First Order PLL).
- SOPLL (Second Order PLL).
- EQFOPLL (Equalized First Order PLL).
- EQSOPLL (Equalized Second Order PLL).
- EXPFOPLL (Explicit First Order PLL).
- EXPSOPLL (Explicit Second Order PLL).

The equalized clock recovery methods are available when the Advanced Signal Integrity Software license is installed.

For setting phase-locked loop (PLL) clock recovery methods in terms of the Observed Jitter Transfer Function (OJTF), see **":MEASure:CLOCK:METHod:OJTF"** on page 1735.

For setting other clock recovery methods, see **":MEASure:CLOCK:METHod"** on page 1725.

<source> {CHANnel<N> | FUNCtion<F> | WMEMory<R>}

<N> An integer, 1-4 in a single oscilloscope, 1-40 in a MultiScope system.

<F> An integer, 1-16.

<R> An integer, 1-4.

<data\_rate> A real number for the base data rate in bits per second.

<peaking> The peaking value in dB.

<jtf\_loop\_bandwidth> A real number for the cutoff frequency for the PLL to track.

<multiplier> An integer used as the multiplication factor.

**<clock\_freq>** A real number used for the clock frequency of the PLL.

**Example** This example sets the clock recovery method to Second Order PLL, a nominal data rate of 4 Gb/s, and a peaking value of 1.25 dB.

```
myScope.WriteString ":MEASure:CLOCK:METHOD:JTF SOPLL,4E9,3.822E6,1.25"
```

**Query** :MEASure:CLOCK:METHOD:JTF?

The :MEASure:CLOCK:METHOD:JTF? query returns the state of the clock recovery method.

**Returned Format** [:MEASure:CLOCK:METHOD:JTF]  
 {FOPLL,<data\_rate>,<jtf\_loop\_bandwidth>}  
 | {EQFOPLL,<data\_rate>,<jtf\_loop\_bandwidth>}  
 | {SOPLL,<data\_rate>,<jtf\_loop\_bandwidth>,<peaking>}  
 | {EQSOPLL,<data\_rate>,<jtf\_loop\_bandwidth>,<peaking>}  
 | {EXPFOPLL <source>,{RISing | FALLing | BOTH},  
 <multiplier>,<clock\_freq>,<jtf\_loop\_bandwidth>}  
 | {EXPSOPLL <source>,{RISing | FALLing | BOTH},  
 <multiplier>,<clock\_freq>,<jtf\_loop\_bandwidth>,<peaking>}

**Example** This example places the current setting of the clock recovery method in the variable strSetting, then prints the contents of the variable to the computer's screen.

```
myScope.WriteString ":SYSTEM:HEADER OFF"
myScope.WriteString ":MEASure:CLOCK:METHOD:JTF?"
strSetting = myScope.ReadString
Debug.Print strSetting
```

- See Also**
- [":MEASure:CLOCK:METHOD:SOURce"](#) on page 1738
  - [":MEASure:CLOCK:METHOD"](#) on page 1725
  - [":MEASure:CLOCK:METHOD:OJTF"](#) on page 1735
  - [":MEASure:CLOCK:METHOD:DEEMphasis"](#) on page 1730
  - [":MEASure:CLOCK:METHOD:ALIGn"](#) on page 1729
  - [":MEASure:CLOCK:METHOD:PLLTrack"](#) on page 1737
  - [":MEASure:CLOCK:METHOD:EDGE"](#) on page 1731

**History** New in version 4.20.

Version 5.30: This command is deprecated, replaced by [":ANALyze:CLOCK:METHOD:JTF"](#) on page 284.

## :MEASure:CLOCK:METHod:OJTF

**Command** :MEASure:CLOCK:METHod:OJTF

```

    {FOPLL,<data_rate>,<ojtf_loop_bandwidth>}
  | {EQFOPLL,<data_rate>,<ojtf_loop_bandwidth>}
  | {SOPLL,<data_rate>,<ojtf_loop_bandwidth>,<damping_factor>}
  | {EQSOPLL,<data_rate>,<ojtf_loop_bandwidth>,<damping_factor>}
  | {EXPFOPLL,<source>,{RISing | FALLing | BOTH},
    <multiplier>,<clock_freq>,<ojtf_loop_bandwidth>}
  | {EXPSOPLL,<source>,{RISing | FALLing | BOTH},
    <multiplier>,<clock_freq>,<ojtf_loop_bandwidth>,<damping_factor>}
  
```

The :MEASure:CLOCK:METHod:OJTF command specifies the clock recovery PLL's response in terms of the Observed Jitter Transfer Function's (OJTF) 3 dB bandwidth.

This command applies to the clock recovery method being set up for the waveform source selected by the :MEASure:CLOCK:METHod:SOURce command.

You can set these types of PLL clock recovery methods:

- FOPLL (First Order PLL).
- SOPLL (Second Order PLL).
- EQFOPLL (Equalized First Order PLL).
- EQSOPLL (Equalized Second Order PLL).
- EXPFOPLL (Explicit First Order PLL).
- EXPSOPLL (Explicit Second Order PLL).

The equalized clock recovery methods are available when the Advanced Signal Integrity Software license is installed.

For setting phase-locked loop (PLL) clock recovery methods in terms of the Jitter Transfer Function (JTF), see [":MEASure:CLOCK:METHod:JTF"](#) on page 1733.

For setting other clock recovery methods, see [":MEASure:CLOCK:METHod"](#) on page 1725.

**<source>** {CHANnel<N> | FUNCtion<F> | WMEMory<R>}

**<N>** An integer, 1-4 in a single oscilloscope, 1-40 in a MultiScope system.

**<F>** An integer, 1-16.

**<R>** An integer, 1-4.

**<data\_rate>** A real number for the base data rate in bits per second.

**<damping\_factor>** A real number for the damping factor of the PLL.

**<ojtf\_loop\_bandwidth>** A real number for the cutoff frequency for the PLL to track.

**<multiplier>** An integer used as the multiplication factor.

**<clock\_freq>** A real number used for the clock frequency of the PLL.

**Example** This example sets the clock recovery method to Second Order PLL, a nominal data rate of 4 Gb/s, and a damping factor of 1.0.

```
myScope.WriteString ":MEASure:CLOCK:METHOD:OJTF SOPLL,4E9,2.4E6,1.0"
```

**Query** :MEASure:CLOCK:METHOD:OJTF?

The :MEASure:CLOCK:METHOD:OJTF? query returns the state of the clock recovery method.

**Returned Format** [:MEASure:CLOCK:METHOD:OJTF]  
 {FOPLL,<data\_rate>,<ojtf\_loop\_bandwidth>}  
 | {EQFOPLL,<data\_rate>,<ojtf\_loop\_bandwidth>}  
 | {SOPLL,<data\_rate>,<ojtf\_loop\_bandwidth>,<damping\_factor>}  
 | {EQSOPLL,<data\_rate>,<ojtf\_loop\_bandwidth>,<damping\_factor>}  
 | {EXPFOPLL <source>,{RISing | FALLing | BOTH},  
 <multiplier>,<clock\_freq>,<ojtf\_loop\_bandwidth>}  
 | {EXPSOPLL <source>,{RISing | FALLing | BOTH},  
 <multiplier>,<clock\_freq>,<ojtf\_loop\_bandwidth>,<damping\_fact>}

**Example** This example places the current setting of the clock recovery method in the variable strSetting, then prints the contents of the variable to the computer's screen.

```
myScope.WriteString ":SYSTEM:HEADER OFF"
myScope.WriteString ":MEASure:CLOCK:METHOD:OJTF?"
strSetting = myScope.ReadString
Debug.Print strSetting
```

- See Also**
- [":MEASure:CLOCK:METHOD:SOURce"](#) on page 1738
  - [":MEASure:CLOCK:METHOD"](#) on page 1725
  - [":MEASure:CLOCK:METHOD:JTF"](#) on page 1733
  - [":MEASure:CLOCK:METHOD:DEEMphasis"](#) on page 1730
  - [":MEASure:CLOCK:METHOD:ALIGn"](#) on page 1729
  - [":MEASure:CLOCK:METHOD:PLLTrack"](#) on page 1737
  - [":MEASure:CLOCK:METHOD:EDGE"](#) on page 1731

**History** New in version 4.20.

Version 5.30: This command is deprecated, replaced by [":ANALyze:CLOCK:METHOD:OJTF"](#) on page 286.



## :MEASure:CLOCK:METHOD:PLLTrack

**Command** :MEASure:CLOCK:METHOD:PLLTrack {OFF | ON}

The :MEASure:CLOCK:METHOD:PLLTrack command turns transition density dependence on or off. See the help system for more information on the Transition Density Dependent setting.

This command applies to the clock recovery method being set up for the waveform source selected by the :MEASure:CLOCK:METHOD:SOURce command.

**Example** This example enables the Transition Density Dependent setting.

```
myScope.WriteString ":MEASure:CLOCK:METHOD:PLLTrack ON"
```

**Query** :MEASure:CLOCK:METHOD:PLLTrack?

The :MEASure:CLOCK:METHOD:PLLTrack? query returns whether or not the Transition Density Dependent setting is turned on.

**Returned Format** [:MEASure:CLOCK:METHOD:PLLTrack] {OFF | ON}

**Example** This example places the current setting of the Transition Density Dependent setting in the string variable strTDD, then prints the contents of the variable to the computer's screen.

```
myScope.WriteString ":SYSTem:HEADer OFF"
myScope.WriteString ":MEASure:CLOCK:METHOD:PLLTrack?"
strTDD = myScope.ReadString
Debug.Print strTDD
```

- See Also**
- [":MEASure:CLOCK:METHOD:SOURce"](#) on page 1738
  - [":MEASure:CLOCK:METHOD"](#) on page 1725
  - [":MEASure:CLOCK:METHOD:OJTF"](#) on page 1735
  - [":MEASure:CLOCK:METHOD:JTF"](#) on page 1733
  - [":MEASure:CLOCK:METHOD:DEEMphasis"](#) on page 1730
  - [":MEASure:CLOCK:METHOD:ALIGN"](#) on page 1729
  - [":MEASure:CLOCK:METHOD:EDGE"](#) on page 1731

**History** New in version 4.20.

Version 5.30: This command is deprecated, replaced by [":ANALyze:CLOCK:METHOD:PLLTrack"](#) on page 289.

**:MEASure:CLOCK:METHOD:SOURce**

**Command** :MEASure:CLOCK:METHOD:SOURce {ALL | <source>}

```
<source> ::= {CHANnel<N> | DIFF<D> | COMMONmode<C>
             | FUNction<F> | WMEMory<R> | MTRend | MSPectrum | EQUalized<L>
             | DIGital<M>}
```

The :MEASure:CLOCK:METHOD:SOURce command selects the waveform source (or ALL sources) to which other clock recovery method setup commands apply.

Clock recovery methods can be set up for each waveform source (or for all waveform sources).

**Query** :MEASure:CLOCK:METHOD:SOURce?

The :MEASure:CLOCK:METHOD:SOURce? query returns the waveform source to which other clock recovery method commands currently apply.

**Returned Format** [:MEASure:CLOCK:METHOD:SOURce] <source><NL>

```
<source> ::= {ALL | CHAN<N> | FUNC<F> | WMEM<N> | MTR | MSP | EQU<L>
             | DIG<M>}
```

- See Also**
- **":MEASure:CLOCK:METHOD"** on page 1725
  - **":MEASure:CLOCK:METHOD:OJTF"** on page 1735
  - **":MEASure:CLOCK:METHOD:JTF"** on page 1733
  - **":MEASure:CLOCK:METHOD:DEEMphasis"** on page 1730
  - **":MEASure:CLOCK:METHOD:ALIGn"** on page 1729
  - **":MEASure:CLOCK:METHOD:PLLTrack"** on page 1737
  - **":MEASure:CLOCK:METHOD:EDGE"** on page 1731

**History** New in version 5.20.

Version 5.30: This command is deprecated, replaced by **":ANALyze:CLOCK:METHOD:SOURce"** on page 292.

## :MEASure:CLOCK:VERTical

**Command** :MEASure:CLOCK:VERTical {AUTO | MANual}

The :MEASure:CLOCK:VERTical command sets the recovered clock vertical scale mode to automatic or manual. In automatic mode, the oscilloscope automatically selects the vertical scaling and offset. In manual mode, you can set your own scaling and offset values.

**Example** This example sets the recovered clock vertical scale mode to automatic.

```
myScope.WriteString ":MEASure:CLOCK:VERTical AUTO"
```

**Query** :MEASure:CLOCK:VERTical?

The :MEASure:CLOCK:VERTical? query returns the current recovered clock vertical scale mode setting.

**Returned Format** [:MEASure:CLOCK:VERTical] {AUTO | MANual}

**Example** This example places the current setting of the recovered clock vertical scale mode in the string variable strSetting, then prints the contents of the variable to the computer's screen.

```
myScope.WriteString ":SYSTem:HEADer OFF"
myScope.WriteString ":MEASure:CLOCK:VERTICAL?"
strSetting = myScope.ReadString
Debug.Print strSetting
```

**History** Legacy command (existed before version 3.10).

Version 5.30: This command is deprecated, replaced by **":ANALyze:CLOCK:VERTical"** on page 295.

**:MEASure:CLOCK:VERTical:OFFSet**

**Command** `:MEASure:CLOCK:VERTical:OFFSet <offset>`

The `:MEASure:CLOCK:VERTical:OFFSet` command sets the recovered clock vertical offset.

**<offset>** A real number for the recovered clock vertical offset.

**Example** This example sets the clock recovery vertical offset to 1 volt.

```
myScope.WriteString ":MEASure:CLOCK:VERTICAL:OFFSET 1"
```

**Query** `:MEASure:CLOCK:VERTical:OFFSet?`

The `:MEASure:CLOCK:VERTical:OFFSet?` query returns the clock recovery vertical offset setting.

**Returned Format** `[:MEASure:CLOCK:VERTical:OFFSet] <value><NL>`

**<value>** The clock recovery vertical offset setting.

**Example** This example places the current value of recovered clock vertical offset in the numeric variable, `varValue`, then prints the contents of the variable to the computer's screen.

```
myScope.WriteString ":SYSTEM:HEADer OFF" ' Response headers off.
myScope.WriteString ":MEASure:CLOCK:VERTICAL:OFFSET?"
varValue = myScope.ReadNumber
Debug.Print FormatNumber(varValue, 0)
```

**History** Legacy command (existed before version 3.10).

Version 5.30: This command is deprecated, replaced by **`:ANALyze:CLOCK:VERTical:OFFSet`** on page 296.

## :MEASure:CLOCK:VERTical:RANGe

**Command** :MEASure:CLOCK:VERTical:RANGe <range>

The :MEASure:CLOCK:VERTical:RANGe command sets the recovered clock vertical range.

<range> A real number for the full-scale recovered clock vertical range.

**Example** This example sets the recovered clock vertical range to 16 volts (2 volts times 8 divisions.)

```
myScope.WriteString ":MEASure:CLOCK:VERTICAL:RANGE 16"
```

**Query** :MEASure:CLOCK:VERTical:RANGe?

The :MEASure:CLOCK:VERTical:RANGe? query returns the recovered clock vertical range setting.

**Returned Format** [:MEASure:CLOCK:VERTical:RANGe] <value><NL>

<value> The recovered clock vertical range setting.

**Example** This example places the current value of recovered clock vertical range in the numeric variable, varValue, then prints the contents of the variable to the computer's screen.

```
myScope.WriteString ":SYSTEM:HEADer OFF" ' Response headers off.
myScope.WriteString ":MEASure:CLOCK:VERTICAL:RANGE?"
varValue = myScope.ReadNumber
Debug.Print FormatNumber(varValue, 0)
```

**History** Legacy command (existed before version 3.10).

Version 5.30: This command is deprecated, replaced by **":ANALyze:CLOCK:VERTical:RANGe"** on page 297.

## :MEASure:DDPWS – Data Dependent Pulse Width Shrinkage

## Command

## NOTE

This command is deprecated. In its place, use the query **":MEASure:RJDJ:ALL?"** on page 1085 which returns all of the RJDJ jitter measurements.

## NOTE

This command is available only when the Jitter Analysis Software license is installed.

```
:MEASure:DDPWS <source>
```

The :MEASure:DDPWS command measures the data dependent pulse width shrinkage for the selected source.

<source> {CHANnel<N> | FUNCTION<F> | WMEMory<R> | CLOCK | MTRend | MSPectrum | EQUalized<L>}

The MTRend and MSPectrum sources are available when the Jitter Analysis Software license is installed and the features are enabled.

The CLOCK source is available when the recovered clock is displayed.

The EQUalized<L> source is available when the Advanced Signal Integrity Software license is installed and the equalized waveform is displayed as a function.

<N> An integer, 1-4 in a single oscilloscope, 1-40 in a MultiScope system.

<F> An integer, 1-16.

<R> An integer, 1-4.

**Example** This example measures the data rate of channel 1.

```
myScope.WriteString ":MEASure:DDPWS CHANnel1"
```

**Query** :MEASure:DDPWS? <source>

The :MEASure:DDPWS? query returns the measured data dependent pulse width shrinkage.

**Returned Format** [:MEASure:DDPWS] <value><NL>

<value> Data dependent pulse width shrinkage in seconds for the selected source.

**Example** This example places the current data dependent pulse width shrinkage value of the channel 1 waveform in the numeric variable, varValue, then prints the contents of the variable to the computer's screen.

```
myScope.WriteString ":SYSTem:HEADer OFF" ' Response headers off.
myScope.WriteString ":MEASure:DDPWS? CHANnel1"
```

```
varValue = myScope.ReadNumber  
Debug.Print FormatNumber(varValue, 0)
```

**History** New in version 3.10.

Version 4.20: Obsoleted, replaced by the :MEASure:RJDJ:ALL? query which returns all of the RJDJ jitter measurements.

**:MEASure:FFT:PEAK1**

**Command** :MEASure:FFT:PEAK1 <1st\_peak\_number>

The :MEASure:FFT:PEAK1 command sets the peak number of the first peak for FFT measurements. The source is specified with the :MEASure:SOURce command as FUNCTION<F> or WMEMory<R>.

<1st\_peak\_number> An integer, 1 to 100 specifying the number of the first peak.

<N> An integer, 1-4.

<F> An integer, 1-16.

<R> An integer, 1-4.

**Query** :MEASure:FFT:PEAK1?

The :MEASure:FFT:PEAK1? query returns the peak number currently set as the first peak.

**Returned Format** [:MEASure:FFT:PEAK1] <1st\_peak\_number><NL>

**See Also** • [":MEASure:FFT:THReshold"](#) on page 1746

**History** Legacy command (existed before version 3.10).



**:MEASure:FFT:PEAK2**

**Command** :MEASure:FFT:PEAK2 <2nd\_peak\_number>

The :MEASure:FFT:PEAK2 command sets the peak number of the second peak for FFT measurements. The source is specified with the :MEASure:SOURce command as FUNction<F> or WMEMory<R>.

<2nd\_peak\_number> An integer, 1 to 100 specifying the number of the second peak.

<N> An integer, 1-4.

<F> An integer, 1-16.

<R> An integer, 1-4.

**Query** :MEASure:FFT:PEAK2?

The :MEASure:FFT:PEAK2? query returns the peak number currently set as the second peak.

**Returned Format** [:MEASure:FFT:PEAK1] <2nd\_peak\_number><NL>

**See Also** • [":MEASure:FFT:THReshold"](#) on page 1746

**History** Legacy command (existed before version 3.10).

**:MEASure:FFT:THReshold**

**Command** :MEASure:FFT:THReshold <threshold\_value>

The :MEASure:FFT:THReshold command sets the peak search threshold value in dB. The dB after the threshold value is optional.

<threshold\_value> A real number specifying the threshold for peaks.

**Query** :MEASure:FFT:THReshold?

The :MEASure:FFT:THReshold? query returns the peak search threshold value.

**Returned Format** [:MEASure:FFT:THReshold] <threshold\_value><NL>

These :MEASure commands also operate on FFT functions:

Measure Command	Measurement Performed
:TMAX	The frequency of the maximum value in the spectrum.
:TMIN	The frequency of the minimum value in the spectrum.
:VMAX	The maximum value in the spectrum.
:VMIN	The minimum value in the spectrum.
:VPP	The range of values in the spectrum.
:VTIM	The value at a specified frequency.

- See Also**
- **":MEASure:FFT:PEAK1"** on page 1744
  - **":MEASure:FFT:PEAK2"** on page 1745

**History** Legacy command (existed before version 3.10).

## :MEASure:JITTer:STATistics

**Command** :MEASure:JITTer:STATistics {{ON|1} | {OFF|0}}

The :MEASure:JITTer:STATistics command enables or disables jitter mode and allows you to view: measurement histogram (:MEASure:JITTer:HISTogram), measurement trend (:MEASure:JITTer:TRENd), and jitter spectrum (:MEASure:JITTer:SPsECtrum) if they are enabled.

The :MEASure:JITTer:STATistics command also turns on or off the ability to measure all edges in the waveform; not just the first edge on screen.

**Example** This example turns the jitter measurement statistics and the "Measure All Edges" mode on.

```
myScope.WriteString ":MEASure:JITTer:STATistics ON"
```

**Query** :MEASure:JITTer:STATistics?

The :MEASure:JITTer:STATistics? query returns the state of jitter statistics.

**Returned Format** [:MEASure:JITTer:STATistics] {1 | 0}

**Example** This example places the current setting of the jitter statistics mode in the variable varSetting, then prints the contents of the variable to the computer's screen.

```
myScope.WriteString ":SYSTem:HEADer OFF"
myScope.WriteString ":MEASure:JITTer:STATistics?"
varSetting = myScope.ReadNumber
Debug.Print FormatNumber(varSetting, 0)
```

**History** Legacy command (existed before version 3.10).

Version 5.30: This command is deprecated, replaced by **":ANALyze:AEDGes"** on page 273.

## :MEASure:TIEData

**Command** :MEASure:TIEData <source>,{SECond | UNITInterval}, {AUTO  
| CUSTOM,<data\_rate> | VARIable,<data\_rate>,<bandwidth>  
| CLOCk}

The :MEASure:TIEData command measures data time interval error. You can set the units of the measurement by selecting SECond (seconds) or UNITInterval.

If AUTO is selected, the oscilloscope selects the ideal data rate. If CUSTom is selected, you can enter your own ideal constant data rate. If VARIable is selected, a first order PLL clock recovery is used at a given data rate and loop bandwidth. If CLOCk is given, clock recovery as specified with the :MEASure:CLOCk:METHod is used.

**<source>** {CHANnel<N> | FUNCTion<F> | DIGital<M> | WMEMory<R> | CLOCk | MTRend | MSPectrum | EQUalized<L> | XT<X>}

The MTRend and MSPectrum sources are available when the Jitter Analysis Software license is installed and the features are enabled.

The CLOCk source is available when the recovered clock is displayed.

The EQUalized<L> source is available when the Advanced Signal Integrity Software license is installed and the equalized waveform is displayed as a function.

**<N>** An integer, 1-4 in a single oscilloscope, 1-40 in a MultiScope system.

**<F>** An integer, 1-16.

**<M>** An integer, 0-15. Digital channels are available on mixed-signal oscilloscope (MSO) models.

**<R>** An integer, 1-4.

**<data\_rate>** A real number for the ideal data rate for clock recovery.

**<bandwidth>** A real number for the loop bandwidth of the PLL clock recovery method.

**Example** This example measures the data time interval error on channel 1, ideal data rate set to automatic, units set to seconds.

```
myScope.WriteString ":MEASure:TIEData CHANnel1,SECond,AUTO"
```

**Query** :MEASure:TIEData? <source>,(SECond | UNITInterval},  
{AUTO | CUSTom,<frequency> | VARIable,<frequency>,<bandwidth> | CLOCk}

The :MEASure:TIEData? query returns the current value of the data time interval error.

**Returned Format** [:MEASure:TIEData] <value>[,<result\_state>]<NL>

**<value>** The data time interval error value.

<result\_state> If SENDvalid is ON, the result state is returned with the measurement result. See the :MEASure:RESults table in this chapter for a list of the result states.

**Example** This example places the current value of the data time interval error in the variable strValue, then prints the contents of the variable to the computer's screen.

```
myScope.WriteString ":SYSTEM:HEADer OFF"  
myScope.WriteString ":MEASure:TIEData? CHANnel1,SECOnd,CUSTOM,1E9"  
strValue = myScope.ReadString  
Debug.Print strValue
```

**History** Legacy command (existed before version 3.10).

Version 5.50: This command is deprecated, replaced by **":MEASure:TIEData2"** on page 1167.

**:MTEST:FOLDing:COUNT?**

**Query** :MTEST:FOLDing:COUNT? [<source>]

The :MTEST:FOLDing:COUNT? query returns the number of waveforms and unit intervals in the real time eye.

**<source>** {CHANnel<N> | DIFF<D> | COMMONmode<C> | FUNCTION<F> | WMEMory<R> | EQUalized<L>}

**<N>** An integer, 1-4 in a single oscilloscope, 1-40 in a MultiScope system.

**<D>, <C>** <D> is an integer, 1-2. <C> is an integer, 3-4.

The DIFF and COMMONmode sources are just aliases that can be used in place of the channel names to apply to differential or common mode signals. These are just aliases - no state change occurs if you refer to a differential channel and you are not in differential mode. DIFF1 refers to the differential signal between channels 1 and 3 (and COMMONmode3 refers to the common mode channel between these same channels). DIFF2 refers to the differential signal between channels 2 and 4 (and COMMONmode4 refers to the common mode channel between these same channels).

If the <source> is not specified, the :MTEST:FOLDing:COUNT? query returns the results of the first real-time eye that is on. Sources are ordered by channels, memories, and then functions.

**<F>** An integer, 1-16.

**<R>** An integer, 1-4.

**<L>** An integer, 1-4.

**Returned Format** [:MTEST:FOLDing:COUNT] Real Time Eye<NL>  
<N> UI<NL>  
<N> Wfm<NL>

The UI count returned is a floating-point value. The Wfm count returned is an integer.

**Example**

```
myScope.WriteString ":MTEST:FOLDing:COUNT? CHANnel1"
strRteCount = myScope.ReadString
Debug.Print strRteCount
```

- See Also**
- [":MTEST:FOLDing \(Clock Recovery software only\)"](#) on page 839
  - [":MTEST:FOLDing:BITS"](#) on page 841
  - [":MTEST:FOLDing:FAST"](#) on page 847
  - [":MTEST:FOLDing:POSITION"](#) on page 849
  - [":MTEST:FOLDing:TPOSITION"](#) on page 853
  - [":MTEST:FOLDing:SCALE"](#) on page 851
  - [":MTEST:FOLDing:TSCALE"](#) on page 855

**History** New in version 5.00.

Version 5.50: The UI count returned is now a floating-point value instead of an integer value. This command is deprecated, replaced by **":MTESt:FOLDing:COUNt:UI?"** on page 843 and **":MTESt:FOLDing:COUNt:WAVeforms?"** on page 845.

Version 5.52: The <source> parameter is now optional.

## :SPRocessing:CTLequalizer:ACGain

**Command** :SPRocessing:CTLequalizer:ACGain <ac\_gain>

The :CTLequalizer:ACGain command sets the AC Gain parameter for the Continuous Time Linear Equalization when USB31 is selected for the "# of Poles" option.

<ac\_gain> A real number

**Example** This example sets the CTLE AC Gain parameter to 1.

```
myScope.WriteString ":SPRocessing:CTLequalizer:ACGain 1"
```

**Query** :SPRocessing:CTLequalizer:ACGain?

The :SPRocessing:CTLequalizer:ACGain? query returns the CTLE's AC Gain parameter setting.

**See Also** • [":SPRocessing:CTLequalizer:NUMPoles"](#) on page 1755

**History** New in version 3.10.



## :SPRocessing:CTLequalizer:DCGain

**Command** :SPRocessing:CTLequalizer:DCGain <dc\_gain>

The :CTLequalizer:DCGain command sets the DC Gain parameter for the Continuous Time Linear Equalization.

<dc\_gain> A real number

**Example** This example sets the CTLE DC Gain parameter to 1.

```
myScope.WriteString ":SPRocessing:CTLequalizer:DCGain 1"
```

**Query** :SPRocessing:CTLequalizer:DCGain?

The :SPRocessing:CTLequalizer:DCGain? query returns the CTLE's DC Gain parameter.

**History** Legacy command (existed before version 3.10).

## :SPROcessing:CTLequalizer:DISPlay

**Command** :SPROcessing:CTLequalizer:DISPlay {(OFF | 0) | (ON | 1)}

The :CTLequalizer:DISPlay command turns the display of a Continuous Time Linear Equalizer (CTLE) waveform on or off.

**Example** This example turns on the display of a CTLE waveform.

```
myScope.WriteString ":SPROcessing:CTLequalizer:DISPlay ON"
```

**Query** :SPROcessing:CTLequalizer:DISPlay?

The :SPROcessing:CTLequalizer:DISPlay? query returns whether or not the CTLE waveform is displayed.

**History** Legacy command (existed before version 3.10).

## :SPRocessing:CTLequalizer:NUMPoles

**Command** :SPRocessing:CTLequalizer:NUMPoles {{P2Z1 | POLE2} | {P3Z1 | POLE3} | P3Z2 | P4Z1 | {P2ACG | USB31}}

The :SPRocessing:CTLequalizer:NUMPoles command selects from these Continuous Time Linear Equalizer (CTLE) options:

- {P2Z1 | POLE2} – 2 Pole 1 Zero.
- {P3Z1 | POLE3} – 3 Pole 1 Zero.
- P3Z2 – 3 Pole 2 Zeros.
- P4Z1 – 4 Pole 1 Zero.
- {P2ACG | USB31} – 2 Pole AC Gain.

**Example** This example selects a 2 Pole, 1 Zero CTLE.

```
myScope.WriteString ":SPRocessing:CTLequalizer:NUMPoles P2Z1"
```

**Query** :SPRocessing:CTLequalizer:NUMPoles?

The :SPRocessing:CTLequalizer:NUMPoles? query returns the current "number of poles" selection.

**Returned Format** [:SPRocessing:CTLequalizer:NUMPoles] {P2Z1 | P3Z1 | P3Z2 | P4Z1 | P2ACG}

- See Also**
- [":SPRocessing:CTLequalizer:Z1"](#) on page 1765
  - [":SPRocessing:CTLequalizer:Z2"](#) on page 1766
  - [":SPRocessing:CTLequalizer:ACGain"](#) on page 1752

**History** New in version 3.10.

Version 5.75: The previous POLE3 option has been replaced by P3Z1 and P3Z2.

Version 6.30: The new option names P2Z1 and P2ACG replace the old option names POLE2 and USB31, respectively (but operations are the same).

## :SPRocessing:CTLequalizer:P1

**Command** :SPRocessing:CTLequalizer:P1 <pole1\_freq>

The :CTLequalizer:P1 command sets the Pole 1 frequency for the Continuous Time Linear Equalization.

<pole1\_freq> A real number

**Example** This example sets the CTLE Pole 1 frequency to 1GHz.

```
myScope.WriteString ":SPRocessing:CTLequalizer:P1 1e9"
```

**Query** :SPRocessing:CTLequalizer:P1?

The :SPRocessing:CTLequalizer:P1? query returns the CTLE's Pole 1 frequency.

**History** Legacy command (existed before version 3.10).

## :SPRocessing:CTLequalizer:P2

**Command** :SPRocessing:CTLequalizer:P2 <pole2\_freq>

The :CTLequalizer:P1 command sets the Pole 2 frequency for the Continuous Time Linear Equalization.

<pole2\_freq> A real number

**Example** This example sets the CTLE Pole 2 frequency to 4 GHz.

```
myScope.WriteString ":SPRocessing:CTLequalizer:P2 4e9"
```

**Query** :SPRocessing:CTLequalizer:P2?

The :SPRocessing:CTLequalizer:P2? query returns the CTLE's Pole 2 frequency.

**History** Legacy command (existed before version 3.10).

## :SPRocessing:CTLequalizer:P3

**Command** :SPRocessing:CTLequalizer:P3 <pole3\_freq>

The :CTLequalizer:P1 command sets the Pole 3 frequency for the Continuous Time Linear Equalization.

<pole3\_freq> A real number

**Example** This example sets the CTLE Pole 3 frequency to 4 GHz.

```
myScope.WriteString ":SPRocessing:CTLequalizer:P3 4e9"
```

**Query** :SPRocessing:CTLequalizer:P3?

The :SPRocessing:CTLequalizer:P3? query returns the CTLE's Pole 3 frequency.

**History** New in version 3.10.

## :SPRocessing:CTLequalizer:P4

**Command** :SPRocessing:CTLequalizer:P4 <pole4\_freq>

The :CTLequalizer:P4 command sets the Pole 4 frequency for the Continuous Time Linear Equalization.

<pole4\_freq> A real number

**Example** This example sets the CTLE Pole 4 frequency to 4 GHz.

```
myScope.WriteString ":SPRocessing:CTLequalizer:P4 4e9"
```

**Query** :SPRocessing:CTLequalizer:P4?

The :SPRocessing:CTLequalizer:P4? query returns the CTLE's Pole 4 frequency.

**History** New in version 3.10.

## :SPROcessing:CTLequalizer:RATE

**Command** :SPROcessing:CTLequalizer:RATE <data\_rate>

The :CTLequalizer:RATE command sets the data rate for the CTLE equalizer.

<data\_rate> A real number.

When the signal type is PAM-4 (see :ANALyze:SIGNal:TYPE), a symbol rate (baud) is specified instead of a data rate (b/s).

**Example** This example sets the CTLE data rate to 3e9.

```
myScope.WriteString ":SPROcessing:CTLequalizer:RATE 3e9"
```

**Query** :SPROcessing:CTLequalizer:RATE?

The :SPROcessing:CTLequalizer:Rate? query returns the CTLE's data rate.

**See Also** • [":ANALyze:SIGNal:TYPE"](#) on page 312

**History** Legacy command (existed before version 3.10).

Version 5.50: When the signal type is PAM-4, a symbol rate (baud) is specified instead of a data rate (b/s).



## :SPROcessing:CTLequalizer:SOURce

**Command** :SPROcessing:CTLequalizer:SOURce {CHANnel<N> | FUNction<F> | WMEMory<R>}

The :CTLequalizer:SOURce command sets the source for the Continuous Time Linear Equalization.

<N> An integer, 1-4 in a single oscilloscope, 1-40 in a MultiScope system.

<F> An integer, 1-16.

<R> An integer, 1-4.

**Example** This example sets the CTLE source to Channel 1.

```
myScope.WriteString ":SPROcessing:CTLequalizer:SOURce CHANnel1"
```

**Query** :SPROcessing:CTLequalizer:SOURce?

The :SPROcessing:CTLequalizer:SOURce? query returns the CTLE source.

**History** Legacy command (existed before version 3.10).

## :SPROcessing:CTLequalizer:VERTical

**Command** :SPROcessing:CTLequalizer:VERTical {AUTO | MANual}

The :SPROcessing:CTLequalizer:VERTical command sets the CTLE signal's vertical scale mode to automatic or manual. In automatic mode, the oscilloscope automatically selects the vertical scaling and offset. In manual mode, you can set your own scaling and offset values.

**Example** This example sets the CTLE signal's vertical scale mode to automatic.

```
myScope.WriteString ":SPROcessing:CTLequalizer:VERTical AUTO"
```

**Query** :SPROcessing:CTLequalizer:VERTical?

The :SPROcessing:CTLequalizer:VERTical? query returns the current CTLE signal's vertical scale mode setting.

**Returned Format** [:SPROcessing:CTLequalizer:VERTical] {AUTO | MANual}

**Example** This example places the current setting of the CTLE signal's vertical scale mode in the string variable strSetting, then prints the contents of the variable to the computer's screen.

```
myScope.WriteString ":SYSTem:HEADer OFF"
myScope.WriteString ":SPROcessing:CTLequalizer:VERTical?"
strSetting = myScope.ReadString
Debug.Print strSetting
```

**History** Legacy command (existed before version 3.10).

## :SPRocessing:CTLequalizer:VERTical:OFFSet

**Command** :SPRocessing:CTLequalizer:VERTical:OFFSet <offset>

The :SPRocessing:CTLequalizer:VERTical:OFFSet command sets the CTLE signal's vertical offset.

<offset> A real number for the CTLE signal's vertical offset.

**Example** This example sets the CTLE signal's vertical offset to 1 volt.

```
myScope.WriteString ":SPRocessing:CTLequalizer:VERTical:OFFSet 1"
```

**Query** :SPRocessing:CTLequalizer:VERTical:OFFSet?

The:SPRocessing:CTLequalizer:VERTical:OFFSet? query returns the CTLE signal's vertical offset setting.

**Returned Format** [:SPRocessing:CTLequalizer:VERTical:OFFSet] <value><NL>

<value> The CTLE signal's vertical offset setting.

**Example** This example places the current value of the CTLE signal's vertical offset in the numeric variable, varValue, then prints the contents of the variable to the computer's screen.

```
myScope.WriteString ":SYSTEM:HEADer OFF" ' Response headers off.
myScope.WriteString ":SPRocessing:CTLequalizer:VERTical:OFFSet?"
varValue = myScope.ReadNumber
Debug.Print FormatNumber(varValue, 0)
```

**History** Legacy command (existed before version 3.10).

## :SPROcessing:CTLequalizer:VERTical:RANGe

**Command** :SPROcessing:CTLequalizer:VERTical:RANGe <range>

The :SPROcessing:CTLequalizer:VERTical:RANGe command sets the CTLE signal's vertical range.

<range> A real number for the full-scale CTLE signal's vertical range.

**Example** This example sets the CTLE signal's vertical range to 16 volts (2 volts times 8 divisions.)

```
myScope.WriteString ":SPROcessing:CTLequalizer:VERTical:RANGe 16"
```

**Query** :SPROcessing:CTLequalizer:VERTical:RANGe?

The :SPROcessing:CTLequalizer:VERTical:RANGe? query returns the CTLE signal's vertical range setting.

**Returned Format** [:SPROcessing:CTLequalizer:VERTical:RANGe] <value><NL>

<value> The CTLE signal's vertical range setting.

**Example** This example places the current value of the CTLE signal's vertical range in the numeric variable, varValue, then prints the contents of the variable to the computer's screen.

```
myScope.WriteString ":SYSTem:HEADer OFF" ' Response headers off.
myScope.WriteString ":SPROcessing:CTLequalizer:VERTical:RANGe?"
varValue = myScope.ReadNumber
Debug.Print FormatNumber(varValue, 0)
```

**History** Legacy command (existed before version 3.10).

## :SPRocessing:CTLequalizer:Z1

**Command** :SPRocessing:CTLequalizer:Z1 <zero\_freq\_1>

The :SPRocessing:CTLequalizer:Z1 command sets the first zero frequency for the 3-pole Continuous Time Linear Equalization.

<zero\_freq\_1> A real number in NR3 format.

**Example** This example sets the 3-pole CTLE's first zero frequency to 900 MHz.

```
myScope.WriteString ":SPRocessing:CTLequalizer:Z1 650e6"
```

**Query** :SPRocessing:CTLequalizer:Z1?

The :SPRocessing:CTLequalizer:Z1? query returns the 3-pole CTLE's first zero frequency.

**Returned Format** <zero\_freq\_1><NL>

- See Also**
- [":SPRocessing:CTLequalizer:Z2"](#) on page 1766
  - [":SPRocessing:CTLequalizer:NUMPoles"](#) on page 1755

**History** New in version 5.75.

**:SPRoceSSing:CTLequalizer:Z2**

**Command** :SPRoceSSing:CTLequalizer:Z2 <zero\_freq\_2>

The :SPRoceSSing:CTLequalizer:Z2 command sets the second zero frequency for the 3-pole Continuous Time Linear Equalization.

<zero\_freq\_2> A real number in NR3 format.

**Example** This example sets the 3-pole CTLE's second zero frequency to 4 GHz.

```
myScope.WriteString ":SPRoceSSing:CTLequalizer:Z2 4e9"
```

**Query** :SPRoceSSing:CTLequalizer:Z2?

The :SPRoceSSing:CTLequalizer:Z2? query returns the 3-pole CTLE's second zero frequency.

**Returned Format** <zero\_freq\_2><NL>

- See Also**
- [":SPRoceSSing:CTLequalizer:Z1"](#) on page 1765
  - [":SPRoceSSing:CTLequalizer:NUMPoles"](#) on page 1755

**History** New in version 5.75.

## :SPRocessing:CTLequalizer:ZEro

**Command** :SPRocessing:CTLequalizer:ZEro <zero\_freq>

The :CTLequalizer:ZEro command sets the zero frequency for the Continuous Time Linear Equalization.

<zero\_freq> A real number.

**Example** This example sets the CTLE zero frequency to 900 MHz.

```
myScope.WriteString ":SPRocessing:CTLequalizer:ZEro 9e6"
```

**Query** :SPRocessing:CTLequalizer:ZEro?

The :SPRocessing:CTLequalizer:ZEro? query returns the CTLE's zero frequency.

**History** Legacy command (existed before version 3.10).

Version 5.75: Now that you can specify up to two zeros for a 3-pole CTLE, this command has been replaced by "**:SPRocessing:CTLequalizer:Z1**" on page 1765 and "**:SPRocessing:CTLequalizer:Z2**" on page 1766.

## :SPRocessing:DFEQualizer:NTAPs

**Command** :SPRocessing:DFEQualizer:NTAPs <number>

The :DFEQualizer:NTAPs command sets the number of taps to be used in the DFE algorithm.

DFE tap indices always begin with 1 and extend to the number of taps.

<number> An integer between 1 and 40

**Example** This example sets the number of DFE taps to 3.

```
myScope.WriteString ":SPRocessing:DFEQualizer:NTAPs 3"
```

**Query** :SPRocessing:DFEQualizer:NTAPs?

The :SPRocessing:DFEQualizer:NTAPs? query returns the number of DFE taps.

**History** Legacy command (existed before version 3.10).



## :SPROcessing:DFEQualizer:SOURce

**Command** :SPROcessing:DFEQualizer:SOURce {CHANnel<N> | DIFF<D> | COMMONmode<C>  
| FUNction<F> | WMEMory<R> | EQUalized}

The :DFEQualizer:SOURce command sets the source for the Decision Feedback Equalization.

Setting the source to EQUalized means the Feed-Forward Equalized (FFE) waveform is used as the DFE source.

<N> An integer, 1-4 in a single oscilloscope, 1-40 in a MultiScope system.

<D>, <C> <D> is an integer, 1-2. <C> is an integer, 3-4.

The DIFF and COMMONmode sources are just aliases that can be used in place of the channel names to apply to differential or common mode signals. These are just aliases - no state change occurs if you refer to a differential channel and you are not in differential mode. DIFF1 refers to the differential signal between channels 1 and 3 (and COMMONmode3 refers to the common mode channel between these same channels). DIFF2 refers to the differential signal between channels 2 and 4 (and COMMONmode4 refers to the common mode channel between these same channels).

<F> An integer, 1-16.

<R> An integer, 1-4.

**Example** This example sets the DFE source to Channel 1.

```
myScope.WriteString ":SPROcessing:DFEQualizer:SOURce CHANnel1"
```

**Query** :SPROcessing:DFEQualizer:SOURce?

The :SPROcessing:DFEQualizer:SOURce? query returns the DFE source.

**History** Legacy command (existed before version 3.10).

## :SPRocessing:DFEQualizer:STAtE

**Command** :SPRocessing:DFEQualizer:STAtE {(OFF | 0) | (ON | 1)}

The :DFEQualizer:STAtE command turns the Decision Feedback Equalization on or off.

**Example** This example turns on DFE.

```
myScope.WriteString ":SPRocessing:DFEQualizer:STAtE ON"
```

**Query** :SPRocessing:DFEQualizer:STAtE?

The :SPRocessing:DFEQualizer:STAtE? query returns whether or not DFE is turned on.

**History** Legacy command (existed before version 3.10).

## :SPRocessing:DFEQualizer:TAP

**Command** :SPRocessing:DFEQualizer:TAP <tap>, <value>

The :DFEQualizer:TAP command sets the tap value for each DFE tap. For example, when <tap> is equal to 1 then the 1st tap is set to <value>.

DFE tap indices always start at 1 and extend to the number of taps.

<tap> The tap number.

<value> The tap value

**Example** This example sets the DFE Tap 1 to 0.432.

```
myScope.WriteString ":SPRocessing:DFEQualizer:TAP 1,0.432"
```

**Query** :SPRocessing:DFEQualizer:TAP? <tap>

The :SPRocessing:DFEQualizer:TAP? query returns the DFE tap values.

**See Also** · [":SPRocessing:DFEQualizer:NTAPs"](#) on page 1768

**History** Legacy command (existed before version 3.10).

## :SPRocessing:DFEQualizer:TAP:AUTomatic

**Command**    :SPRocessing:DFEQualizer:TAP:AUTomatic

The :DFEQualizer:TAP:AUTomatic command starts the DFE tap optimization. Be sure to first specify the number of taps, the max/min tap values, and the Normalize DC Gain setting.

**Example**    This example starts the DFE tap optimization.

```
myScope.WriteString ":SPRocessing:DFEQualizer:TAP:AUTomatic"
```

- See Also**
- [":SPRocessing:DFEQualizer:NTAPs"](#) on page 1768
  - [":SPRocessing:DFEQualizer:TAP:MIN"](#) on page 1778
  - [":SPRocessing:DFEQualizer:TAP:MAX"](#) on page 1777
  - [":SPRocessing:DFEQualizer:TAP:NORMalize"](#) on page 1779

**History**    Legacy command (existed before version 3.10).

## :SPRocessing:DFEQualizer:TAP:DELaY

**Command** :SPRocessing:DFEQualizer:TAP:DELaY <delay>

The :DFEQualizer:TAP:DELaY command specifies the amount of drift the equalized eye diagram has relative to the unequalized one. This drift is then accounted for so the two eyes overlap. For more information on this parameter, refer to the Infiniium Serial Data Equalization User's Guide.

<delay> A real number

**Query** :SPRocessing:DFEQualizer:TAP:DELaY?

The :SPRocessing:DFEQualizer:TAP:DELaY? query returns the value for the DFE Delay field.

**History** Legacy command (existed before version 3.10).

## :SPROcessing:DFEQualizer:TAP:DELay:AUTomatic

**Command** :SPROcessing:DFEQualizer:TAP:DELay:AUTomatic

The :SPROcessing:DFEQualizer:TAP:DELay:AUTomatic command computes a DFE delay value to center a DFE eye on the screen horizontally. The current real-time eye data is used to center the DFE eye.

**See Also** · [":SPROcessing:DFEQualizer:TAP:DELay"](#) on page 1773

**History** New in version 6.30.

## :SPRocessing:DFEQualizer:TAP:GAIN

**Command** :SPRocessing:DFEQualizer:TAP:GAIN <gain>

The eye diagram drawn after DFE is applied is attenuated. To amplify the eye back to its original size (so you can directly compare the eye at the receiver to the eye at the transmitter), a gain factor needs to be applied. The :DFEQualizer:TAP:GAIN command allows you to set this gain. For more information on this parameter, refer to the Infiniium Serial Data Equalization User's Guide.

<gain> A real number

**Example** This example sets the gain to 3.23.

```
myScope.WriteString ":SPRocessing:DFEQualizer:TAP:GAIN 3.23"
```

**Query** :SPRocessing:DFEQualizer:TAP:GAIN?

The :SPRocessing:DFEQualizer:TAP:GAIN? query returns the current gain value.

**History** Legacy command (existed before version 3.10).

## :SPRocessing:DFEQualizer:TAP:LTARget

**Command** :SPRocessing:DFEQualizer:TAP:LTARget <lower\_target>

The Lower Target field dictates the logical low value used in the DFE algorithm. For example, in DFE, when a bit is determined to be a logical low, its value will be equal to Lower Target. The :DFEQualizer:TAP:LTARget command allows you to set this value.

<lower\_target> A real number

**Example** This example sets the Lower Target to 1.0.

```
myScope.WriteString ":SPRocessing:DFEQualizer:TAP:LTARget 1.0"
```

**Query** :SPRocessing:DFEQualizer:TAP:LTARget?

The :SPRocessing:DFEQualizer:TAP:LTARget? query returns the current value for the Lower Target field.

**History** Legacy command (existed before version 3.10).



## :SPRocessing:DFEQualizer:TAP:MAX

**Command** :SPRocessing:DFEQualizer:TAP:MAX <max\_tap\_value>

Some standards have upper and lower limits on the tap values. The :DFEQualizer:TAP:MAX command sets the upper limit on taps determined through optimization.

<max\_tap\_value> A real number

**Example** This example sets the Upper Limit field to 3.23.

```
myScope.WriteString ":SPRocessing:DFEQualizer:TAP:MAX 3.23"
```

**Query** :SPRocessing:DFEQualizer:TAP:MAX?

The :SPRocessing:DFEQualizer:TAP:MAX? query returns the Upper Limit used in the DFE tap optimization.

**History** Legacy command (existed before version 3.10).

## :SPRocessing:DFEQualizer:TAP:MIN

**Command** :SPRocessing:DFEQualizer:TAP:MIN <min\_tap\_value>

Some standards have upper and lower limits on the tap values. The :DFEQualizer:TAP:MIN command sets the lower limit on taps determined through optimization.

<min\_tap\_value> A real number

**Example** This example sets the Lower Limit field to 3.23.

```
myScope.WriteString ":SPRocessing:DFEQualizer:TAP:MIN 3.23"
```

**Query** :SPRocessing:DFEQualizer:TAP:MIN?

The :SPRocessing:DFEQualizer:TAP:MIN? query returns the Lower Limit used in the DFE tap optimization.

**History** Legacy command (existed before version 3.10).

## :SPROcessing:DFEQualizer:TAP:NORMAlize

**Command** :SPROcessing:DFEQualizer:TAP:NORMAlize {{0 | OFF} | {1 | ON}}

The :SPROcessing:DFEQualizer:TAP:NORMAlize command specifies whether the Normalize DC Gain setting is ON or OFF. When ON, the eye diagram is automatically scaled so that it is the same size as the transmitted eye.

the Normalize DC Gain setting should be set (if desired) prior to calling the :SPROcessing:DFEQualizer:TAP:AUTOMatic command.

This command maps to the **Normalize DC Gain** setting in the Equalization Auto Tap Setup dialog box in the front panel graphical user interface.

**Query** :SPROcessing:DFEQualizer:TAP:NORMAlize?

The :SPROcessing:DFEQualizer:TAP:NORMAlize? query returns the Normalize DC Gain setting.

**Returned Format** <setting><NL>

<setting> ::= {0 | 1}

**See Also** • [":SPROcessing:DFEQualizer:TAP:AUTOMatic"](#) on page 1772

**History** New in version 6.20.

## :SPRocessing:DFEQualizer:TAP:UTARget

**Command** :SPRocessing:DFEQualizer:TAP:UTARget <upper\_target>

The Upper Target field dictates the logical high value used in the DFE algorithm. For example, in DFE, when a bit is determined to be a logical high, its value will be equal to Upper Target. The :DFEQualizer:TAP:UTARget command allows you to set this value.

<upper\_target> A real number

**Example** This example sets the Upper Target to 1.0.

```
myScope.WriteString ":SPRocessing:DFEQualizer:TAP:UTARget 1.0"
```

**Query** :SPRocessing:DFEQualizer:TAP:UTARget?

The :SPRocessing:DFEQualizer:TAP:UTARget? query returns the current value for the Upper Target field.

**History** Legacy command (existed before version 3.10).

## :SPROcessing:DFEQualizer:TAP:WIDTh

**Command** :SPROcessing:DFEQualizer:TAP:WIDTh <width>

The :DFEQualizer:TAP:WIDTh command sets the Eye Width field for the DFE tap optimization. Setting the width to 0.0 means the optimization is only performed at the location of the clock. Setting the width to 1.0 means the entire acquisition is used in the optimization. The default value for DFE is 0.0. For more information on this parameter, refer to the Infiniium Serial Data Equalization User's Guide.

<width> A real number between 0.0 and 1.0.

**Example** This example sets the eye width to 0.0.

```
myScope.WriteString ":SPROcessing:DFEQualizer:TAP:WIDTh 0.0"
```

**Query** :SPROcessing:DFEQualizer:TAP:WIDTh?

The :SPROcessing:DFEQualizer:TAP? query returns the eye width used in the DFE tap optimization.

**History** Legacy command (existed before version 3.10).

## :SPRocessing:FFEQualizer:BANDwidth

**Command** :SPRocessing:FFEQualizer:BANDwidth <bandwidth>

The :FFEQualizer:BANDwidth command is only needed if the FFEQualizer:BWMode command is set to CUSTom and in this case it sets the bandwidth at which the response generated by equalization rolls off. To understand more about this parameter, consult the Infiniium Serial Data Equalization User's Guide.

<bandwidth> The bandwidth at which the response generated by equalization rolls off.

**Query** :SPRocessing:FFEQualizer:BANDwidth?

The :SPRocessing:FFEQualizer:BANDwidth? query returns the current value for the BANDwidth parameter.

**History** Legacy command (existed before version 3.10).

## :SPRocessing:FFEQualizer:BWMode

**Command** :SPRocessing:FFEQualizer:BWMode {TSBandwidth | TTDelay | CUSTom}

The :FFEQualizer:BWMode command sets the bandwidth at which the response generated by equalization is rolled off. To understand more about this parameter, consult the Infiniium Serial Data Equalization User's Guide.

**Example** This example sets the FFE Bandwidth Mode to TTDelay.

```
myScope.WriteString ":SPRocessing:FFEQualizer:BWMode TTDelay"
```

**Query** :SPRocessing:FFEQualizer:BWMode?

The :SPRocessing:FFEQualizer:BWMode? query returns the FFE Bandwidth Mode.

**History** Legacy command (existed before version 3.10).

## :SPROcessing:FFEQualizer:DISPlay

**Command** :SPROcessing:FFEQualizer:DISPlay {(OFF | 0) | (ON | 1)}

The :FFEQualizer:DISPlay command turns the display of a Feed-Forward Equalized (FFE) waveform on or off.

**Example** This example turns on the display of a FFE waveform.

```
myScope.WriteString ":SPROcessing:FFEQualizer:DISPlay ON"
```

**Query** :SPROcessing:FFEQualizer:DISPlay?

The :SPROcessing:FFEQualizer:DISPlay? query returns whether or not the FFE waveform is displayed.

**History** Legacy command (existed before version 3.10).



## :SPRocessing:FFEQualizer:NPreursor

**Command** :SPRocessing:FFEQualizer:NPreursor <number>

The :FFEQualizer:NPreursor command sets the number of precursor taps to be used in the FFE algorithm.

<number> An integer between 1 and (NTAPs - 1)

**Example** This example sets the number of FFE precursor taps to 3.

```
myScope.WriteString ":SPRocessing:FFEQualizer:NPreursor 3"
```

**Query** :SPRocessing:FFEQualizer:NPreursor?

The :SPRocessing:FFEQualizer:NPreursor? query returns the number of FFE precursor taps.

**History** Legacy command (existed before version 3.10).

## :SPRocessing:FFEQualizer:NTAPs

**Command** :SPRocessing:FFEQualizer:NTAPs <number>

The :FFEQualizer:NTAPs command sets the number of taps to be used in the FFE algorithm.

The indices of your FFE taps depend on the number of precursor taps being used. For example, if you are using zero precursor taps then your FFE tap indices would range from 0 to (NTAPs - 1). If you are using two precursor taps then your FFE tap indices would range from -2 to (NTAPs - 1 - 2).

<number> an integer between 2 and 40

**Example** This example sets the number of FFE taps to 3.

```
myScope.WriteString ":SPRocessing:FFEQualizer:NTAPs 3"
```

**Query** :SPRocessing:FFEQualizer:NTAPs?

The :SPRocessing:FFEQualizer:NTAPs? query returns the number of FFE taps.

**History** Legacy command (existed before version 3.10).

## :SPROcessing:FFEQualizer:RATE

**Command** :SPROcessing:FFEQualizer:RATE <data\_rate>

The :FFEQualizer:RATE command sets the data rate for the FFE equalizer.

<data\_rate> A real number.

When the signal type is PAM-4 (see :ANALyze:SIGNal:TYPE), a symbol rate (baud) is specified instead of a data rate (b/s).

**Example** This example sets the FFE data rate to 3e9.

```
myScope.WriteString ":SPROcessing:FFEQualizer:RATE 3e9"
```

**Query** :SPROcessing:FFEQualizer:RATE?

The :SPROcessing:FFEQualizer:Rate? query returns the FFE's data rate.

**See Also** • [":ANALyze:SIGNal:TYPE"](#) on page 312

**History** Legacy command (existed before version 3.10).

Version 5.50: When the signal type is PAM-4, a symbol rate (baud) is specified instead of a data rate (b/s).

**:SPROcessing:FFEQualizer:SOURce**

**Command** :SPROcessing:FFEQualizer:SOURce {CHANnel<N> | DIFF<D> | COMMONmode<C>  
| FUNction<F> | WMEMory<R>}

The :FFEQualizer:SOURce command sets the source for the Feed-Forward Equalization.

<N> An integer, 1-4 in a single oscilloscope, 1-40 in a MultiScope system.

<D>, <C> <D> is an integer, 1-2. <C> is an integer, 3-4.

The DIFF and COMMONmode sources are just aliases that can be used in place of the channel names to apply to differential or common mode signals. These are just aliases - no state change occurs if you refer to a differential channel and you are not in differential mode. DIFF1 refers to the differential signal between channels 1 and 3 (and COMMONmode3 refers to the common mode channel between these same channels). DIFF2 refers to the differential signal between channels 2 and 4 (and COMMONmode4 refers to the common mode channel between these same channels).

<F> An integer, 1-16.

<R> An integer, 1-4.

**Example** This example sets the FFE source to Channel 1.

```
myScope.WriteString ":SPROcessing:FFEQualizer:SOURce CHANnel1"
```

**Query** :SPROcessing:FFEQualizer:SOURce?

The :SPROcessing:FFEQualizer:SOURce? query returns the FFE source.

**History** Legacy command (existed before version 3.10).

## :SPRocessing:FFEQualizer:TAP

**Command** :SPRocessing:FFEQualizer:TAP <tap>, <value>

The :FFEQualizer:TAP command sets the tap value for each FFE tap. For example, when <tap> is equal to 0 then the 0th tap is set to <value>.

The indices of your FFE taps depend on the number of precursor taps being used. For example, if you are using zero precursor taps then your FFE tap indices would range from 0 to (NTAPs - 1). If you are using two precursor taps then your FFE tap indices would range from -2 to (NTAPs - 1 - 2).

<tap> The tap number; when <tap> == 0, Tap 0 is set

<value> The tap value

**Example** This example sets the second FFE tap to -1.432.

```
myScope.WriteString ":SPRocessing:FFEQualizer:TAP 2,-1.432"
```

**Query** :SPRocessing:FFEQualizer:TAP? <tap>

The :SPRocessing:FFEQualizer:TAP? query returns the FFE tap values.

**See Also** • [":SPRocessing:FFEQualizer:NTAPs"](#) on page 1786

**History** Legacy command (existed before version 3.10).

## :SPRocessing:FFEQualizer:TAP:AUTomatic

**Command** :SPRocessing:FFEQualizer:TAP:AUTomatic

The :FFEQualizer:TAP:AUTomatic command starts the FFE tap optimization. Be sure to first specify the number of taps and specify the Pattern and Eye Width parameters.

**Example** This example starts the FFE tap optimization.

```
myScope.WriteString ":SPRocessing:FFEQualizer:TAP:AUTomatic"
```

**History** Legacy command (existed before version 3.10).

## :SPRocessing:FFEQualizer:TAP:DELaY

**Command** :SPRocessing:FFEQualizer:TAP:DELaY <delay>

The :FFEQualizer:TAP:DELaY command specifies the amount of drift the equalized eye diagram has relative to the unequalized one. This drift is then accounted for so the two eyes overlap. For more information on this parameter, refer to the Infiniium Serial Data Equalization User's Guide.

<delay> A real number

**Query** :SPRocessing:FFEQualizer:TAP:DELaY?

The :SPRocessing:FFEQualizer:TAP:DELaY? query returns the value for the FFE Delay field.

**History** Legacy command (existed before version 3.10).

## :SPRocessing:FFEQualizer:TAP:WIDTh

**Command** :SPRocessing:FFEQualizer:TAP:WIDTh <width>

The :FFEQualizer:TAP:WIDTh command sets the Eye Width field for the FFE tap optimization. Setting the width to 0.0 means the optimization is only preformed at the location of the clock. Setting the width to 1.0 means the entire acquisition is used in the optimization. The default value for FFE is 0.33. For more information on this parameter, refer to the Infiniium Serial Data Equalization User's Guide.

<width> A real number between 0.0 and 1.0.

**Example** This example sets the eye width to 0.0.

```
myScope.WriteString ":SPRocessing:FFEQualizer:TAP:WIDTh 0.0"
```

**Query** :SPRocessing:FFEQualizer:TAP:WIDTh?

The :SPRocessing:FFEQualizer:TAP:WIDTh? query returns the eye width used in the FFE tap optimization.

**History** Legacy command (existed before version 3.10).



## :SPRocessing:FFEQualizer:TDElay

**Command** :SPRocessing:FFEQualizer:TDElay <delay\_value>

The :FFEQualizer:TDElay command is only needed if the FFEQualizer:TDMODE is set to CUSTOM. To determine what this value should be, use the equation: tap delay = 1/[(data rate)x(# of taps per bit)]. To understand more about this parameter, consult the Infiniium Serial Data Equalization User's Guide.

<delay\_value> A real number

**Query** :SPRocessing:FFEQualizer:TDElay?

The :SPRocessing:FFEQualizer:TDElay? query returns the current value for the tap delay.

**History** Legacy command (existed before version 3.10).

## :SPRocessing:FFEQualizer:TDMode

**Command** :SPRocessing:FFEQualizer:TDMode {TBITrate | CUSTom}

The :FFEQualizer:TDMode command sets Tap Delay field to either Track Data Rate or Custom. If you are using one tap per bit, use the TBITrate selection. If you are using multiple taps per bit, use CUSTom and then use the FFEQualizer:TDElay command to set the value. To understand more about this parameter, consult the Infiniium Serial Data Equalization User's Guide.

**Example** This example sets the FFE Tap Delay mode to TBITrate.

```
myScope.WriteString ":SPRocessing:FFEQualizer:TDMode TBITrate"
```

**Query** :SPRocessing:FFEQualizer:TDMode?

The :SPRocessing:FFEQualizer:TDMode? query returns the current Tap Delay mode.

**History** Legacy command (existed before version 3.10).

## :SPROcessing:FFEQualizer:VERTical

**Command** :SPROcessing:FFEQualizer:VERTical {AUTO | MANual}

The :SPROcessing:FFEQualizer:VERTical command sets the FFE signal's vertical scale mode to automatic or manual. In automatic mode, the oscilloscope automatically selects the vertical scaling and offset. In manual mode, you can set your own scaling and offset values.

**Example** This example sets the FFE signal's vertical scale mode to automatic.

```
myScope.WriteString ":SPROcessing:FFEQualizer:VERTical AUTO"
```

**Query** :SPROcessing:FFEQualizer:VERTical?

The :SPROcessing:FFEQualizer:VERTical? query returns the current FFE signal's vertical scale mode setting.

**Returned Format** [:SPROcessing:FFEQualizer:VERTical] {AUTO | MANual}

**Example** This example places the current setting of the FFE signal's vertical scale mode in the string variable strSetting, then prints the contents of the variable to the computer's screen.

```
myScope.WriteString ":SYSTem:HEADer OFF"
myScope.WriteString ":SPROcessing:FFEQualizer:VERTical?"
strSetting = myScope.ReadString
Debug.Print strSetting
```

**History** Legacy command (existed before version 3.10).

## :SPRoCessing:FFEQualizer:VERTical:OFFSet

**Command** :SPRoCessing:FFEQualizer:VERTical:OFFSet <offset>

The :SPRoCessing:FFEQualizer:VERTical:OFFSet command sets the FFE signal's vertical offset.

<offset> A real number for the FFE signal's vertical offset.

**Example** This example sets the FFE signal's vertical offset to 1 volt.

```
myScope.WriteString ":SPRoCessing:FFEQualizer:VERTical:OFFSet 1"
```

**Query** :SPRoCessing:FFEQualizer:VERTical:OFFSet?

The:SPRoCessing:FFEQualizer:VERTical:OFFSet? query returns the FFE signal's vertical offset setting.

**Returned Format** [:SPRoCessing:FFEQualizer:VERTical:OFFSet] <value><NL>

<value> The FFE signal's vertical offset setting.

**Example** This example places the current value of the FFE signal's vertical offset in the numeric variable, varValue, then prints the contents of the variable to the computer's screen.

```
myScope.WriteString ":SYSTem:HEADer OFF" ' Response headers off.
myScope.WriteString ":SPRoCessing:FFEQualizer:VERTical:OFFSet?"
varValue = myScope.ReadNumber
Debug.Print FormatNumber(varValue, 0)
```

**History** Legacy command (existed before version 3.10).

## :SPROcessing:FFEQualizer:VERTical:RANGe

**Command** :SPROcessing:FFEQualizer:VERTical:RANGe <range>

The :SPROcessing:FFEQualizer:VERTical:RANGe command sets the FFE signal's vertical range.

<range> A real number for the full-scale FFE signal's vertical range.

**Example** This example sets the FFE signal's vertical range to 16 volts (2 volts times 8 divisions.)

```
myScope.WriteString ":SPROcessing:FFEQualizer:VERTical:RANGe 16"
```

**Query** :SPROcessing:FFEQualizer:VERTical:RANGe?

The :SPROcessing:FFEQualizer:VERTical:RANGe? query returns the FFE signal's vertical range setting.

**Returned Format** [:SPROcessing:FFEQualizer:VERTical:RANGe] <value><NL>

<value> The FFE signal's vertical range setting.

**Example** This example places the current value of the FFE signal's vertical range in the numeric variable, varValue, then prints the contents of the variable to the computer's screen.

```
myScope.WriteString ":SYSTem:HEADer OFF" ' Response headers off.
myScope.WriteString ":SPROcessing:FFEQualizer:VERTical:RANGe?"
varValue = myScope.ReadNumber
Debug.Print FormatNumber(varValue, 0)
```

**History** Legacy command (existed before version 3.10).



# 43 Error Messages

- Error Queue / 1800
- Error Numbers / 1801
- Command Errors / 1802
- Execution Errors / 1803
- Device- or Oscilloscope-Specific Errors / 1804
- Query Errors / 1805
- List of Error Messages / 1806

This chapter describes the error messages and how they are generated. The possible causes for the generation of the error messages are also listed in the following table.

## Error Queue

As errors are detected, they are placed in an error queue. This queue is first in, first out. If the error queue overflows, the last error in the queue is replaced with error -350, "Queue overflow". Any time the error queue overflows, the oldest errors remain in the queue, and the most recent error is discarded. The length of the oscilloscope's error queue is 30 (29 positions for the error messages, and 1 position for the "Queue overflow" message).

Reading an error from the head of the queue removes that error from the queue, and opens a position at the tail of the queue for a new error. When all errors have been read from the queue, subsequent error queries return 0, "No error".

The error queue is cleared when any of the following occur:

- the instrument is powered up,
- a \*CLS command is sent,
- the last item from the queue is read, or
- the instrument is switched from talk only to addressed mode on the front panel.



## Error Numbers

The error numbers are grouped according to the type of error that is detected.

- +0 indicates no errors were detected.
- -100 to -199 indicates a command error was detected
- -200 to -299 indicates an execution error was detected.
- -300 to -399 indicates a device-specific error was detected.
- -400 to -499 indicates a query error was detected.
- +1 to +32767 indicates an oscilloscope specific error has been detected.

## Command Errors

An error number in the range -100 to -199 indicates that an IEEE 488.2 syntax error has been detected by the instrument's parser. The occurrence of any error in this class sets the command error bit (bit 5) in the event status register and indicates that one of the following events occurred:

- An IEEE 488.2 syntax error was detected by the parser. That is, a computer-to-oscilloscope message was received that is in violation of the IEEE 488.2 standard. This may be a data element that violates the oscilloscope's listening formats, or a data type that is unacceptable to the oscilloscope.
- An unrecognized header was received. Unrecognized headers include incorrect oscilloscope-specific headers and incorrect or unimplemented IEEE 488.2 common commands.
- A Group Execute Trigger (GET) was entered into the input buffer inside of an IEEE 488.2 program message.

Events that generate command errors do not generate execution errors, oscilloscope-specific errors, or query errors.

## Execution Errors

An error number in the range -200 to -299 indicates that an error was detected by the instrument's execution control block. The occurrence of any error in this class causes the execution error bit (bit 4) in the event status register to be set. It also indicates that one of the following events occurred:

- The program data following a header is outside the legal input range or is inconsistent with the oscilloscope's capabilities.
- A valid program message could not be properly executed due to some oscilloscope condition.

Execution errors are reported by the oscilloscope after expressions are evaluated and rounding operations are completed. For example, rounding a numeric data element will not be reported as an execution error. Events that generate execution errors do not generate command errors, oscilloscope specific errors, or query errors.

## Device- or Oscilloscope-Specific Errors

An error number in the range of -300 to -399 or +1 to +32767 indicates that the instrument has detected an error caused by an oscilloscope operation that did not properly complete. This may be due to an abnormal hardware or firmware condition. For example, this error may be generated by a self-test response error, or a full error queue. The occurrence of any error in this class causes the oscilloscope-specific error bit (bit 3) in the event status register to be set.

## Query Errors

An error number in the range -400 to -499 indicates that the output queue control of the instrument has detected a problem with the message exchange protocol. An occurrence of any error in this class should cause the query error bit (bit 2) in the event status register to be set. An occurrence of an error also means one of the following is true:

- An attempt is being made to read data from the output queue when no output is either present or pending.
- Data in the output queue has been lost.

## List of Error Messages

The following table lists the error messages that can occur.

**Table 21** Error Messages

Error #	Error String	Description
273	Screen captures during Remote Desktop may not work properly.	There is a known issue (occasional crashes) when performing screen captures while the Windows operating system's Remote Desktop application is connected to the Infiniium oscilloscope. This error occurs after :DISK:SAVE:IMAGE commands and :DISPlay:DATA? queries during Remote Desktop control to warn you about the issue. (The issue can also occur when choosing <b>File &gt; Copy Screen Image</b> in the front panel graphical user interface.)  There is no issue (and no message) when VNC is used to remotely control the oscilloscope or when Remote Desktop is disconnected.
270	In order to trigger, multiscope acquisitions require the trigger source to be displayed.	
269	In order to trigger, multiscope acquisitions require an active channel per frame.	
268	In order to trigger, all frames must be connected.	
217	The Disk Save was Cancelled.	
183	Trigger is broken. Please contact a Keysight service center.	
169	Mask align failed, either no trigger or lost trigger.	The mask test mask alignment feature was not able to succeed.
168	Mask align failed, eye not well defined in waveform.	The mask test mask alignment feature was not able to succeed.
167	Mask align failed, waveform clipped or off screen.	The mask test mask alignment feature was not able to succeed.
166	Mask align failed, could not find pulse in waveform.	The mask test mask alignment feature was not able to succeed.
165	Non-differential transfer function is being applied to differential channels.	
164	Mask align failed because more than one channel is on.	

**Table 21** Error Messages (continued)

Error #	Error String	Description
161	Infiniium's probe calibration data has been upgraded. The default values are being used.	
160	Mask align completed with mask failures.	The mask test mask alignment feature completed but resultant fit gives mask failures.
159	Stop mask testing to change control value.	The mask test mask alignment feature completed but eye period exceeds delta T by at least 20%.
150	Operation permitted for standard masks only.	Auto fit works for standard masks only.
143	Please turn on color grade (in the Display dialog) for this measurement.	
141	Please turn on a waveform of the type required for this measurement.	There are no valid signals for this measurement.
140	Exceeded maximum ASCII list length.	When reading in an ASCII waveform, the maximum number of points was exceeded.
136	The waveform is too large to be loaded due to memory constraints.	
130	Infiniium is unable to recover a clock. Adjust loop bandwidth.	
129	Too many vertices.	There are too many data points in a mask test polygon.
128		Mask test errors
126	Waveform is clipped: Instrument setup is unchanged.	Autoscale fails because the signal is too big to fit on the screen.
125	There is something in the header that Infiniium was not able to parse.	The oscilloscope could not parse the waveform header information correctly.
120	Execution not possible: Calibration does not match mainframe.	The calibration file on disk does not go with this oscilloscope model. The oscilloscope cannot accept a mainframe cal block input (over the SCPI interface) because it does not match the mainframe model or serial number.
117	The waveform is too large to save as the selected file type.	
116	The waveform received has more points than expected. The extra points were discarded.	There was an attempt to send too many points into a waveform memory over the SCPI interface.
115	Debug already in use.	

**Table 21** Error Messages (continued)

Error #	Error String	Description
113	This directory is not valid.	
112	Unknown file type.	
111	Infiniium was unable to write to the file. The file may be read-only.	
109	Unable to read the disk: The disk might not be formatted.	
108	The disk is write protected.	
107	Infiniium could not find the destination disk.	
88	Self Test Warning: Please re-calibrate the instrument and re-run the self test.	
85	Combined filter too long to run. Please disable one or more filters.	The combined FIR Filter is too long to run.
79	Probe calibration error found! The attenuation (or gain) exceeds the limits.	
74	A Quick Env Cal is required.	
72	Infiniium has an internal error. Service is required.	Calibration factors were unable to be saved to the disk.
68	Infiniium is not calibrated! Please perform calibration before making measurements.	It is important to calibrate the oscilloscope so that it will work properly.
59	Overload detected! Infiniium changed the impedance and scale.	A channel overload condition occurred. Protective changes were automatically performed.
50	General failure to read disk	
41	Waveform data is not valid.	
40	This command can't be performed on the selected waveform.	The selected operation cannot be performed on the selected waveform.
39	The chosen function can't be performed on the selected waveform.	The selected function cannot be performed on the selected waveform.
38	The measurement you chose can't be performed on the selected waveform.	The selected measurement cannot be performed on the selected waveform.
31	Sorry, you can't make this measurement on the selected source.	There was an attempt to drag-and-drop a measurement on an invalid source for the measurement.



**Table 21** Error Messages (continued)

Error #	Error String	Description
30	Infiniium is running remotely right now.	The instrument is not listening to local commands. It is listening only to remote commands.
26	This entry isn't valid. The control has been set to its default value.	This error occurs when a command tries to perform a setting that is not a valid. In this case, the control is set to its default setting.
25	This entry isn't a valid selection. The control has not been modified.	This error occurs when a command tries to perform a setting that is not a valid.
24	Control is at its maximum value.	An out of range value was entered.
22	Control is at its minimum value.	An out of range value was entered.
15	The requested GPIB operation can't be performed.	This is a generic SCPI error that the requested operation cannot be performed.
11	Signal amplitude too small to build the Real Time Eye. Increase vertical sensitivity.	
8	This function can't be performed on a peak detect waveform.	The function requested is not permitted on peak detect waveforms.
7	Mask align failed.	The mask test mask alignment feature was not able to succeed.
6	File not compatible with destination signal type.	This happens when an internal signal is read from disk and its format is not recognized.
1	Phase noise error. Check phase noise configuration.	
0	No error	The error queue is empty. Every error in the queue has been read (:SYSTEM:ERRor? query) or the queue was cleared by power-up or *CLS.
-100	Command error	This is the generic syntax error used if the oscilloscope cannot detect more specific errors.
-101	Invalid character	A syntactic element contains a character that is invalid for that type.
-102	Syntax error	An unrecognized command or data type was encountered.
-103	Invalid separator	The parser was expecting a separator and encountered an illegal character.
-104	Data type error	The parser recognized a data element different than one allowed. For example, numeric or string data was expected but block data was received.
-105	GET not allowed	A Group Execute Trigger was received within a program message.
-108	Parameter not allowed	More parameters were received than expected for the header.
-109	Missing parameter	Fewer parameters were received than required for the header.
-112	Program mnemonic too long	The header or character data element contains more than twelve characters.

**Table 21** Error Messages (continued)

Error #	Error String	Description
-113	Undefined header	The header is syntactically correct, but it is undefined for the oscilloscope. For example, *XYZ is not defined for the oscilloscope.
-121	Invalid character in number	An invalid character for the data type being parsed was encountered. For example, a "9" in octal data.
-123	Numeric overflow	Number is too large or too small to be represented internally.
-124	Too many digits	The mantissa of a decimal numeric data element contained more than 255 digits excluding leading zeros.
-128	Numeric data not allowed	A legal numeric data element was received, but the oscilloscope does not accept one in this position for the header.
-131	Invalid suffix	The suffix does not follow the syntax described in IEEE 488.2 or the suffix is inappropriate for the oscilloscope.
-138	Suffix not allowed	A suffix was encountered after a numeric element that does not allow suffixes.
-141	Invalid character data	Either the character data element contains an invalid character or the particular element received is not valid for the header.
-144	Character data too long	
-148	Character data not allowed	A legal character data element was encountered where prohibited by the oscilloscope.
-150	String data error	This error can be generated when parsing a string data element. This particular error message is used if the oscilloscope cannot detect a more specific error.
-151	Invalid string data	A string data element was expected, but was invalid for some reason. For example, an END message was received before the terminal quote character.
-158	String data not allowed	A string data element was encountered but was not allowed by the oscilloscope at this point in parsing.
-160	Block data error	This error can be generated when parsing a block data element. This particular error message is used if the oscilloscope cannot detect a more specific error.
-161	Invalid block data	
-168	Block data not allowed	A legal block data element was encountered but was not allowed by the oscilloscope at this point in parsing.
-170	Expression error	This error can be generated when parsing an expression data element. It is used if the oscilloscope cannot detect a more specific error.
-171	Invalid expression	
-178	Expression data not allowed	Expression data was encountered but was not allowed by the oscilloscope at this point in parsing.

**Table 21** Error Messages (continued)

Error #	Error String	Description
-200	Execution error	This is a generic syntax error which is used if the oscilloscope cannot detect more specific errors.
-212	Arm ignored	
-213	Init ignored	
-214	Trigger deadlock	
-215	Arm deadlock	
-220	Parameter error	
-221	Settings conflict	
-222	Data out of range	Indicates that a legal program data element was parsed but could not be executed because the interpreted value is outside the legal range defined by the oscilloscope.
-223	Too much data	Indicates that a legal program data element of block, expression, or string type was received that contained more data than the oscilloscope could handle due to memory or related oscilloscope-specific requirements.
-224	Illegal parameter value	
-230	Data corrupt or stale	
-231	Data questionable	
-240	Hardware error	
-241	Hardware missing	
-250	Mass storage error	
-251	Missing mass storage	
-252	Missing media	
-253	Corrupt media	
-254	Media full	
-255	Directory full	
-256	File name not found	
-257	File name error	
-258	Media protected	
-260	Expression error	
-261	Math error in expression	
-300	Device specific error	
-310	System error	Indicates that a system error occurred.

**Table 21** Error Messages (continued)

Error #	Error String	Description
-311	Memory error	
-312	PUD memory error	
-313	Calibration memory lost	
-314	Save/recall memory lost	
-315	Configuration memory lost	
-321	Out of memory	
-330	Self-test failed	
-350	Queue overflow	Indicates that there is no room in the error queue and an error occurred but was not recorded.
-370	No sub tests are defined for the selected self test	
-371	Self Test status is corrupt or no self test has been executed	
-372	This product configuration does not support the requested self test	
-373	This product configuration does not support the requested source	
-374	The requested self test log file could not be found	
-375	Attenuator relay actuation counts can only be modified during factory service	
-400	Query error	This is the generic query error.
-410	Query INTERRUPTED	
-420	Query UNTERMINATED	
-430	Query DEADLOCKED	
-440	Query UNTERMINATED after indefinite response	

## 44 Example Programs

VISA COM Examples / 1814

VISA Examples / 1853

VISA.NET Examples / 1903

SICL Examples / 1925

SCPI.NET Examples / 1944

Example programs are ASCII text files that can be cut from the help file and pasted into your favorite text editor.

## VISA COM Examples

- ["VISA COM Example in Visual Basic"](#) on page 1814
- ["VISA COM Example in C#"](#) on page 1825
- ["VISA COM Example in Visual Basic .NET"](#) on page 1835
- ["VISA COM Example in Python 3"](#) on page 1844

### VISA COM Example in Visual Basic

To run this example in Visual Basic for Applications (VBA):

- 1 Start the application that provides Visual Basic for Applications (for example, Microsoft Excel).
- 2 Press ALT+F11 to launch the Visual Basic editor.
- 3 Reference the Keysight VISA COM library:
  - a Choose **Tools>References...** from the main menu.
  - b In the References dialog, check:
    - VISA COM 5.11 Type Library
    - Microsoft Scripting Runtime
  - c Click **OK**.
- 4 Choose **Insert > Module**.
- 5 Cut-and-paste the code that follows into the editor.
- 6 Edit the program to use the VISA address of your oscilloscope, and save the changes.
- 7 Run the program.

```
'
' Keysight VISA COM Example in Visual Basic
' -----
' This program illustrates a few commonly-used programming
' features of your Keysight Infiniium Series oscilloscope.
' -----

Option Explicit

Public myMgr As VisaComLib.ResourceManager
Public myScope As VisaComLib.FormattedIO488
Public varQueryResult As Variant
Public strQueryResult As String

' For Sleep subroutine.
Private Declare Sub Sleep Lib "kernel32" (ByVal dwMilliseconds As Long)

'
' Main Program
' -----
```

```

Sub Main()

    On Error GoTo VisaComError

    ' Create the VISA COM I/O resource.
    Set myMgr = New VisaComLib.ResourceManager
    Set myScope = New VisaComLib.FormattedIO488
    Set myScope.IO = _
        myMgr.Open("TCPIP0::141.121.237.226::hislip0::INSTR")
    myScope.IO.Timeout = 15000 ' Set I/O communication timeout.
    myScope.IO.Clear ' Clear the interface.

    ' Initialize - start from a known state.
    Initialize

    ' Capture data.
    Capture

    ' Analyze the captured waveform.
    Analyze

    Exit Sub

VisaComError:
    MsgBox "VISA COM Error:" + vbCrLf + Err.Description
    End

End Sub

'
' Initialize the oscilloscope to a known state.
' -----

Private Sub Initialize()

    On Error GoTo VisaComError

    ' Clear status.
    DoCommand "*CLS"

    ' Get and display the device's *IDN? string.
    strQueryResult = DoQueryString("*IDN?")
    Debug.Print "Identification string: " + strQueryResult

    ' Load the default setup.
    DoCommand "*RST"

    Exit Sub

VisaComError:
    MsgBox "VISA COM Error:" + vbCrLf + Err.Description
    End

End Sub

'

```

```

' Capture the waveform.
' -----

Private Sub Capture()

    On Error GoTo VisaComError

    ' Set probe attenuation factor.
    DoCommand ":CHANnel1:PROBe 1.0"
    Debug.Print "Channel 1 probe attenuation factor: " + _
        DoQueryString(":CHANnel1:PROBe?")

    ' Use auto-scale to automatically set up oscilloscope.
    ' -----
    Debug.Print "Autoscale."
    DoCommand ":AUToscale"

    ' Set trigger mode.
    DoCommand ":TRIGger:MODE EDGE"
    Debug.Print "Trigger mode: " + _
        DoQueryString(":TRIGger:MODE?")

    ' Set EDGE trigger parameters.
    DoCommand ":TRIGger:EDGE:SOURCe CHANnel1"
    Debug.Print "Trigger edge source: " + _
        DoQueryString(":TRIGger:EDGE:SOURce?")

    DoCommand ":TRIGger:LEVel CHANnel1,-2E-3"
    Debug.Print "Trigger level, channel 1: " + _
        DoQueryString(":TRIGger:LEVel? CHANnel1")

    DoCommand ":TRIGger:EDGE:SLOPe POSitive"
    Debug.Print "Trigger edge slope: " + _
        DoQueryString(":TRIGger:EDGE:SLOPe?")

    ' Save oscilloscope setup.
    ' -----
    varQueryResult = DoQueryIEEEBlock_UI1(":SYSTem:SETup?")

    ' Output setup string to a file:
    Dim strPath As String
    strPath = "c:\scope\config\setup.dat"
    Dim hFile As Long
    hFile = FreeFile
    Open strPath For Binary Access Write Lock Write As hFile
    Put hFile, , varQueryResult ' Write data.
    Close hFile ' Close file.
    Debug.Print "Setup bytes saved: " + CStr(LenB(varQueryResult))

    ' Change oscilloscope settings with individual commands:
    ' -----

    ' Set vertical scale and offset.
    DoCommand ":CHANnel1:SCALe 0.1"
    Debug.Print "Channel 1 vertical scale: " + _
        DoQueryString(":CHANnel1:SCALe?")

```



```

DoCommand ":CHANnel1:OFFSet 0.0"
Debug.Print "Channel 1 vertical offset: " + _
    DoQueryString(":CHANnel1:OFFSet?")

' Set horizontal scale and offset.
DoCommand ":TIMEbase:SCALE 200E-6"
Debug.Print "Timebase scale: " + _
    DoQueryString(":TIMEbase:SCALE?")

DoCommand ":TIMEbase:POSition 0.0"
Debug.Print "Timebase position: " + _
    DoQueryString(":TIMEbase:POSition?")

' Set the acquisition mode.
DoCommand ":ACquire:MODE RTIME"
Debug.Print "Acquire mode: " + _
    DoQueryString(":ACquire:MODE?")

' Or, configure by loading a previously saved setup.
' -----
Dim varSetupString As Variant
strPath = "c:\scope\config\setup.dat"
Open strPath For Binary Access Read As hFile ' Open file for input.
Get hFile, , varSetupString ' Read data.
Close hFile ' Close file.
' Write learn string back to oscilloscope using ":SYSTEM:SETup"
' command:
DoCommandIEEEBlock ":SYSTEM:SETup", varSetupString
Debug.Print "Setup bytes restored: " + CStr(LenB(varSetupString))

' Set the desired number of waveform points,
' and capture an acquisition.
' -----
DoCommand ":ACquire:POINTs 32000"
DoCommand ":DIGitize"

Exit Sub

VisaComError:
MsgBox "VISA COM Error:" + vbCrLf + Err.Description
End

End Sub

'
' Analyze the captured waveform.
' -----

Private Sub Analyze()

On Error GoTo VisaComError

' Make measurements.
' -----
DoCommand ":MEASure:SOURce CHANnel1"
Debug.Print "Measure source: " + _
    DoQueryString(":MEASure:SOURce?")

```

```

DoCommand ":MEASure:FREQuency"
varQueryResult = DoQueryNumber(":MEASure:FREQuency?")
MsgBox "Frequency:" + vbCrLf + _
    FormatNumber(varQueryResult / 1000, 4) + " kHz"

DoCommand ":MEASure:VAMPlitude"
varQueryResult = DoQueryNumber(":MEASure:VAMPlitude?")
MsgBox "Vertical amplitude:" + vbCrLf + _
    FormatNumber(varQueryResult, 4) + " V"

' Download the screen image.
' -----
' Get screen image.
Dim byteData() As Byte
byteData = DoQueryIEEEBlock_UI1(":DISPlay:DATA? PNG")

' Save screen image to a file.
Dim strPath As String
strPath = "c:\scope\data\screen.png"
If Len(Dir(strPath)) Then
    Kill strPath ' Remove file if it exists.
End If

Dim hFile As Long
hFile = FreeFile
Open strPath For Binary Access Write Lock Write As hFile
Put hFile, , byteData ' Write data.
Close hFile ' Close file.
MsgBox "Screen image (" + CStr(UBound(byteData) + 1) + _
    " bytes) written to " + strPath

' Download waveform data.
' -----
' Get the waveform type.
Debug.Print "Waveform type: " + _
    DoQueryString(":WAVEform:TYPE?")

' Get the number of waveform points.
Debug.Print "Waveform points available: " + _
    DoQueryString(":WAVEform:POINTS?")

' Set the waveform source.
DoCommand ":WAVEform:SOURce CHANnel1"
Debug.Print "Waveform source: " + _
    DoQueryString(":WAVEform:SOURce?")

' Choose the format of the data returned:
DoCommand ":WAVEform:FORMat WORD"
Debug.Print "Waveform format: " + _
    DoQueryString(":WAVEform:FORMat?")

' Display the waveform settings from preamble:
Dim Preamble()

```

```

Dim intFormat As Integer
Dim intType As Integer
Dim lngPoints As Long
Dim lngCount As Long
Dim dblXIncrement As Double
Dim dblXOrigin As Double
Dim lngXReference As Long
Dim sngYIncrement As Single
Dim sngYOrigin As Single
Dim lngYReference As Long
Dim intCoupling As Integer
Dim dblXDispRange As Double
Dim dblXDispOrigin As Double
Dim dblYDispRange As Double
Dim dblYDispOrigin As Double
Dim strDate As String
Dim strTime As String
Dim strFrameModel As String
Dim intAcqMode As Integer
Dim intCompletion As Integer
Dim intXUnits As Integer
Dim intYUnits As Integer
Dim dblMaxBwLimit As Double
Dim dblMinBwLimit As Double

Dim dctWavFormat As Scripting.Dictionary
Set dctWavFormat = New Scripting.Dictionary
dctWavFormat.Add 0, "ASCII"
dctWavFormat.Add 1, "BYTE"
dctWavFormat.Add 2, "WORD"
dctWavFormat.Add 3, "LONG"
dctWavFormat.Add 4, "LONGLONG"

Dim dctAcqType As Scripting.Dictionary
Set dctAcqType = New Scripting.Dictionary
dctAcqType.Add 1, "RAW"
dctAcqType.Add 2, "AVERAGE"
dctAcqType.Add 3, "VHISTOGRAM"
dctAcqType.Add 4, "HHISTOGRAM"
dctAcqType.Add 6, "INTERPOLATE"
dctAcqType.Add 10, "PDETECT"

Dim dctAcqMode As Scripting.Dictionary
Set dctAcqMode = New Scripting.Dictionary
dctAcqMode.Add 0, "RTIME"
dctAcqMode.Add 1, "ETIME"
dctAcqMode.Add 3, "PDETECT"

Dim dctCoupling As Scripting.Dictionary
Set dctCoupling = New Scripting.Dictionary
dctCoupling.Add 0, "AC"
dctCoupling.Add 1, "DC"
dctCoupling.Add 2, "DCFIFTY"
dctCoupling.Add 3, "LFREJECT"

Dim dctUnits As Scripting.Dictionary
Set dctUnits = New Scripting.Dictionary

```

```

dctUnits.Add 0, "UNKNOWN"
dctUnits.Add 1, "VOLT"
dctUnits.Add 2, "SECOND"
dctUnits.Add 3, "CONSTANT"
dctUnits.Add 4, "AMP"
dctUnits.Add 5, "DECIBEL"

Preamble() = DoQueryNumbers(":WAVEform:PREamble?")

intFormat = Preamble(0)
intType = Preamble(1)
lngPoints = Preamble(2)
lngCount = Preamble(3)
dblXIncrement = Preamble(4)
dblXOrigin = Preamble(5)
lngXReference = Preamble(6)
sngYIncrement = Preamble(7)
sngYOrigin = Preamble(8)
lngYReference = Preamble(9)
intCoupling = Preamble(10)
dblXDispRange = Preamble(11)
dblXDispOrigin = Preamble(12)
dblYDispRange = Preamble(13)
dblYDispOrigin = Preamble(14)
strDate = Preamble(15)
strTime = Preamble(16)
strFrameModel = Preamble(17)
intAcqMode = Preamble(18)
intCompletion = Preamble(19)
intXUnits = Preamble(20)
intYUnits = Preamble(21)
dblMaxBwLimit = Preamble(22)
dblMinBwLimit = Preamble(23)

Debug.Print "Waveform format: " + dctWavFormat.Item(intFormat)
Debug.Print "Acquisition type: " + dctAcqType.Item(intType)

Debug.Print "Waveform points desired: " + _
    FormatNumber(lngPoints, 0)

Debug.Print "Waveform average count: " + _
    FormatNumber(lngCount, 0)

Debug.Print "Waveform X increment: " + _
    Format(dblXIncrement, "Scientific")

Debug.Print "Waveform X origin: " + _
    Format(dblXOrigin, "Scientific")

Debug.Print "Waveform X reference: " + _
    FormatNumber(lngXReference, 0)

Debug.Print "Waveform Y increment: " + _
    Format(sngYIncrement, "Scientific")

Debug.Print "Waveform Y origin: " + _
    FormatNumber(sngYOrigin, 0)

```

```

Debug.Print "Waveform Y reference: " + _
    FormatNumber(lngYReference, 0)

Debug.Print "Coupling: " + dctCoupling.Item(intCoupling)

Debug.Print "Waveform X display range: " + _
    Format(dblXDispRange, "Scientific")

Debug.Print "Waveform X display origin: " + _
    Format(dblXDispOrigin, "Scientific")

Debug.Print "Waveform Y display range: " + _
    Format(dblYDispRange, "Scientific")

Debug.Print "Waveform Y display origin: " + _
    Format(dblYDispOrigin, "Scientific")

Debug.Print "Date: " + strDate
Debug.Print "Time: " + strTime
Debug.Print "Frame model: " + strFrameModel
Debug.Print "Acquire mode: " + dctAcqMode.Item(intAcqMode)

Debug.Print "Completion pct: " + _
    FormatNumber(intCompletion, 0)

Debug.Print "Waveform X units: " + dctUnits.Item(intXUnits)
Debug.Print "Waveform Y units: " + dctUnits.Item(intYUnits)

Debug.Print "Max BW limit: " + _
    Format(dblMaxBwLimit, "Scientific")

Debug.Print "Min BW limit: " + _
    Format(dblMinBwLimit, "Scientific")

' Get the waveform data.
DoCommand ":WAVEform:STReaming OFF"
varQueryResult = DoQueryIEEEBlock_I2(":WAVEform:DATA?")
Debug.Print "Number of data values: " + _
    CStr(UBound(varQueryResult) + 1)

' Set up output file:
strPath = "c:\scope\data\waveform_data.csv"

' Open file for output.
Open strPath For Output Access Write Lock Write As hFile

' Output waveform data in CSV format.
Dim lngDataValue As Long
Dim lngI As Long

For lngI = 0 To UBound(varQueryResult)
    lngDataValue = varQueryResult(lngI)

    ' Write time value, voltage value.
    Print #hFile, _
        FormatNumber(dblXOrigin + (lngI * dblXIncrement), 9) + _

```

```

        ", " + _
        FormatNumber((lngDataValue * sngYIncrement) + sngYOrigin)

    Next lngI

    ' Close output file.
    Close hFile ' Close file.
    MsgBox "Waveform format WORD data written to " + _
        "c:\scope\data\waveform_data.csv."

    Exit Sub

VisaComError:
    MsgBox "VISA COM Error:" + vbCrLf + Err.Description
    End

End Sub

Private Sub DoCommand(command As String)

    On Error GoTo VisaComError

    myScope.WriteString command
    CheckInstrumentErrors

    Exit Sub

VisaComError:
    MsgBox "VISA COM Error: " + vbCrLf + CStr(Err.Number) + ", " + _
        Err.Source + ", " + _
        Err.Description, vbExclamation, "VISA COM Error"
    End

End Sub

Private Sub DoCommandIEEEBlock(command As String, data As Variant)

    On Error GoTo VisaComError

    Dim strErrors As String

    myScope.WriteIEEEBlock command, data
    CheckInstrumentErrors

    Exit Sub

VisaComError:
    MsgBox "VISA COM Error: " + vbCrLf + CStr(Err.Number) + ", " + _
        Err.Source + ", " + _
        Err.Description, vbExclamation, "VISA COM Error"
    End

End Sub

Private Function DoQueryString(query As String) As String

    On Error GoTo VisaComError

```

```

myScope.WriteString query
DoQueryString = myScope.ReadString
CheckInstrumentErrors

Exit Function

VisaComError:
MsgBox "VISA COM Error: " + vbCrLf + CStr(Err.Number) + ", " + _
    Err.Source + ", " + _
    Err.Description, vbExclamation, "VISA COM Error"
End

End Function

Private Function DoQueryNumber(query As String) As Variant

    On Error GoTo VisaComError

    myScope.WriteString query
    DoQueryNumber = myScope.ReadNumber
    CheckInstrumentErrors

    Exit Function

VisaComError:
MsgBox "VISA COM Error: " + vbCrLf + CStr(Err.Number) + ", " + _
    Err.Source + ", " + _
    Err.Description, vbExclamation, "VISA COM Error"
End

End Function

Private Function DoQueryNumbers(query As String) As Variant()

    On Error GoTo VisaComError

    Dim strErrors As String

    myScope.WriteString query
    DoQueryNumbers = myScope.ReadList
    CheckInstrumentErrors

    Exit Function

VisaComError:
MsgBox "VISA COM Error: " + vbCrLf + CStr(Err.Number) + ", " + _
    Err.Source + ", " + _
    Err.Description, vbExclamation, "VISA COM Error"
End

End Function

Private Function DoQueryIEEEBlock_UI1(query As String) As Variant

    On Error GoTo VisaComError

```

```

myScope.WriteString query
DoQueryIEEEBlock_UI1 = myScope.ReadIEEEBlock(BinaryType_UI1)
CheckInstrumentErrors

Exit Function

VisaComError:
MsgBox "VISA COM Error: " + vbCrLf + CStr(Err.Number) + ", " + _
    Err.Source + ", " + _
    Err.Description, vbExclamation, "VISA COM Error"
End

End Function

Private Function DoQueryIEEEBlock_I2(query As String) As Variant

On Error GoTo VisaComError

myScope.WriteString query
DoQueryIEEEBlock_I2 = myScope.ReadIEEEBlock(BinaryType_I2)
CheckInstrumentErrors

Exit Function

VisaComError:
MsgBox "VISA COM Error: " + vbCrLf + CStr(Err.Number) + ", " + _
    Err.Source + ", " + _
    Err.Description, vbExclamation, "VISA COM Error"
End

End Function

Private Sub CheckInstrumentErrors()

On Error GoTo VisaComError

Dim strErrVal As String
Dim strOut As String

myScope.WriteString ":SYSTEM:ERROR? STRING" ' Query any errors data.
strErrVal = myScope.ReadString ' Read: Errnum,"Error String".
While Val(strErrVal) <> 0 ' End if find: 0,"No Error".
    strOut = strOut + "INST Error: " + strErrVal
    myScope.WriteString ":SYSTEM:ERROR? STRING" ' Request error message.
    strErrVal = myScope.ReadString ' Read error message.
Wend

If Not strOut = "" Then
    MsgBox strOut, vbExclamation, "INST Error Messages"
    myScope.FlushWrite (False)
    myScope.FlushRead

End If

Exit Sub

VisaComError:

```



```

        MsgBox "VISA COM Error: " + vbCrLf + Err.Description
    End Sub

```

## VISA COM Example in C#

To compile and run this example in Microsoft Visual Studio 2008:

- 1 Open Visual Studio.
- 2 Create a new Visual C#, Windows, Console Application project.
- 3 Cut-and-paste the code that follows into the C# source file.
- 4 Edit the program to use the VISA address of your oscilloscope.
- 5 Add a reference to the VISA COM 5.11 Type Library:
  - a Right-click the project you wish to modify (not the solution) in the Solution Explorer window of the Microsoft Visual Studio environment.
  - b Choose **Add Reference...**
  - c In the Add Reference dialog, select the **COM** tab.
  - d Select **VISA COM 5.11 Type Library**; then click **OK**.
- 6 Build and run the program.

For more information, see the VISA COM Help that comes with Keysight IO Libraries Suite 15.

```

/*
 * Keysight VISA COM Example in C#
 * -----
 * This program illustrates a few commonly used programming
 * features of your Keysight Infiniium Series oscilloscope.
 * -----
 */

using System;
using System.IO;
using System.Text;
using System.Collections.Generic;
using Ivi.Visa.Interop;
using System.Runtime.InteropServices;

namespace Infiniium
{
    class VisaComInstrumentApp
    {
        private static VisaComInstrument myScope;

        public static void Main(string[] args)
        {
            try
            {
                myScope = new
                    VisaComInstrument ("TCPIP0::141.121.237.226::hislip0::INSTR");
            }
        }
    }
}

```

```

myScope.SetTimeoutSeconds(10);

// Initialize - start from a known state.
Initialize();

// Capture data.
Capture();

// Analyze the captured waveform.
Analyze();

Console.WriteLine("Press any key to exit");
Console.ReadKey();
}
catch (System.ApplicationException err)
{
    Console.WriteLine("*** VISA COM Error : " + err.Message);
}
catch (System.SystemException err)
{
    Console.WriteLine("*** System Error Message : " + err.Message);
}
catch (System.Exception err)
{
    System.Diagnostics.Debug.Fail("Unexpected Error");
    Console.WriteLine("*** Unexpected Error : " + err.Message);
}
finally
{
    myScope.Close();
}
}

/*
 * Initialize the oscilloscope to a known state.
 * -----
 */
private static void Initialize()
{
    string strResults;

    // Clear status.
    myScope.DoCommand("*CLS");

    // Get and display the device's *IDN? string.
    strResults = myScope.DoQueryString("*IDN?");
    Console.WriteLine("*IDN? result is: {0}", strResults);

    // Load the default setup.
    myScope.DoCommand("*RST");
}

/*
 * Capture the waveform.
 * -----
 */
private static void Capture()

```

```

{
    // Set probe attenuation factor.
    myScope.DoCommand(":CHANnel1:PROBE 1.0");
    Console.WriteLine("Channel 1 probe attenuation factor: {0}",
        myScope.DoQueryString(":CHANnel1:PROBE?"));

    // Use auto-scale to automatically set up oscilloscope.
    myScope.DoCommand(":AUToscale");

    // Set trigger mode.
    myScope.DoCommand(":TRIGger:MODE EDGE");
    Console.WriteLine("Trigger mode: {0}",
        myScope.DoQueryString(":TRIGger:MODE?"));

    // Set EDGE trigger parameters.
    myScope.DoCommand(":TRIGger:EDGE:SOURCe CHANnel1");
    Console.WriteLine("Trigger edge source: {0}",
        myScope.DoQueryString(":TRIGger:EDGE:SOURce?"));

    myScope.DoCommand(":TRIGger:LEVel CHANnel1,-2E-3");
    Console.WriteLine("Trigger level, channel 1: {0}",
        myScope.DoQueryString(":TRIGger:LEVel? CHANnel1"));

    myScope.DoCommand(":TRIGger:EDGE:SLOPe POSitive");
    Console.WriteLine("Trigger edge slope: {0}",
        myScope.DoQueryString(":TRIGger:EDGE:SLOPe?"));

    // Save oscilloscope setup.
    byte[] ResultsArray; // Results array.
    int nLength; // Number of bytes returned from instrument.
    string strPath;

    // Query and read setup string.
    ResultsArray = myScope.DoQueryIEEEBlock_UI1(":SYSTem:SETup?");
    nLength = ResultsArray.Length;

    // Write setup string to file.
    strPath = "c:\\scope\\config\\setup.stp";
    FileStream fStream = File.Open(strPath, FileMode.Create);
    fStream.Write(ResultsArray, 0, nLength);
    fStream.Close();
    Console.WriteLine("Setup bytes saved: {0}", nLength);

    // Change settings with individual commands:

    // Set vertical scale and offset.
    myScope.DoCommand(":CHANnel1:SCALe 0.1");
    Console.WriteLine("Channel 1 vertical scale: {0}",
        myScope.DoQueryString(":CHANnel1:SCALe?"));

    myScope.DoCommand(":CHANnel1:OFFSet 0.0");
    Console.WriteLine("Channel 1 vertical offset: {0}",
        myScope.DoQueryString(":CHANnel1:OFFSet?"));

    // Set horizontal scale and offset.
    myScope.DoCommand(":TIMEbase:SCALe 0.0002");
    Console.WriteLine("Timebase scale: {0}",

```

```

        myScope.DoQueryString(":TIMEbase:SCALE?"));

myScope.DoCommand(":TIMEbase:POSition 0.0");
Console.WriteLine("Timebase position: {0}",
    myScope.DoQueryString(":TIMEbase:POSition?"));

// Set the acquisition mode.
myScope.DoCommand(":ACquire:MODE RTIME");
Console.WriteLine("Acquire mode: {0}",
    myScope.DoQueryString(":ACquire:MODE?"));

// Or, configure by loading a previously saved setup.
byte[] dataArray;
int nBytesWritten;

// Read setup string from file.
strPath = "c:\\scope\\config\\setup.stp";
dataArray = File.ReadAllBytes(strPath);
nBytesWritten = dataArray.Length;

// Restore setup string.
myScope.DoCommandIEEEBlock(":SYSTem:SETup", dataArray);
Console.WriteLine("Setup bytes restored: {0}", nBytesWritten);

// Set the desired number of waveform points,
// and capture an acquisition.
myScope.DoCommand(":ACquire:POINTs 32000");
myScope.DoCommand(":DIGitize");
}

/*
 * Analyze the captured waveform.
 * -----
 */
private static void Analyze()
{
    byte[] resultsArray; // Results array.
    int nLength; // Number of bytes returned from instrument.
    string strPath;

    // Make measurements.
    // -----
    myScope.DoCommand(":MEASure:SOURce CHANnel1");
    Console.WriteLine("Measure source: {0}",
        myScope.DoQueryString(":MEASure:SOURce?"));

    double fResult;
    myScope.DoCommand(":MEASure:FREquency");
    fResult = myScope.DoQueryNumber(":MEASure:FREquency?");
    Console.WriteLine("Frequency: {0:F4} kHz", fResult / 1000);

    myScope.DoCommand(":MEASure:VAMplitude");
    fResult = myScope.DoQueryNumber(":MEASure:VAMplitude?");
    Console.WriteLine("Vertical amplitude: {0:F2} V", fResult);

    // Download the screen image.
    // -----

```

```

// Get the screen data.
ResultsArray =
    myScope.DoQueryIEEEBlock_UI1(":DISPlay:DATA? PNG");
nLength = ResultsArray.Length;

// Store the screen data to a file.
strPath = "c:\\scope\\data\\screen.png";
FileStream fStream = File.Open(strPath, FileMode.Create);
fStream.Write(ResultsArray, 0, nLength);
fStream.Close();
Console.WriteLine("Screen image ({0} bytes) written to {1}",
    nLength, strPath);

// Download waveform data.
// -----

// Get the waveform points mode.
Console.WriteLine("Waveform type: {0}",
    myScope.DoQueryString(":WAVEform:TYPE?"));

// Get the number of waveform points.
Console.WriteLine("Waveform points: {0}",
    myScope.DoQueryString(":WAVEform:POINTs?"));

// Set the waveform source.
myScope.DoCommand(":WAVEform:SOURce CHANnel1");
Console.WriteLine("Waveform source: {0}",
    myScope.DoQueryString(":WAVEform:SOURce?"));

// Choose the format of the data returned:
myScope.DoCommand(":WAVEform:FORMat WORD");
Console.WriteLine("Waveform format: {0}",
    myScope.DoQueryString(":WAVEform:FORMat?"));

// Display the waveform settings from preamble:
Dictionary<string, string> dctWavFormat =
    new Dictionary<string, string>()
    {
        {"0", "ASCIi"},
        {"1", "BYTE"},
        {"2", "WORD"},
        {"3", "LONG"},
        {"4", "LONGLONG"},
    };
Dictionary<string, string> dctAcqType =
    new Dictionary<string, string>()
    {
        {"1", "RAW"},
        {"2", "AVERAge"},
        {"3", "VHISTogram"},
        {"4", "HHISTogram"},
        {"6", "INTerpolate"},
        {"10", "PDETECT"},
    };
Dictionary<string, string> dctAcqMode =
    new Dictionary<string, string>()

```

```

{
    {"0", "RTIME"},
    {"1", "ETIME"},
    {"3", "PDETECT"},
};
Dictionary<string, string> dctCoupling =
    new Dictionary<string, string>()
{
    {"0", "AC"},
    {"1", "DC"},
    {"2", "DCFIFTY"},
    {"3", "LFREJECT"},
};
Dictionary<string, string> dctUnits =
    new Dictionary<string, string>()
{
    {"0", "UNKNOWN"},
    {"1", "VOLT"},
    {"2", "SECOND"},
    {"3", "CONSTANT"},
    {"4", "AMP"},
    {"5", "DECIBEL"},
};
string strPreamble;
string[] strspreamble;

strPreamble = myScope.DoQueryString(":WAVEFORM:PREAmble?");
strspreamble = strPreamble.Split(',');

Console.WriteLine("Waveform format: {0}",
    dctWavFormat[strspreamble[0]]);

Console.WriteLine("Acquire type: {0}",
    dctAcqType[strspreamble[1]]);

Console.WriteLine("Waveform points: {0}", strspreamble[2]);
Console.WriteLine("Waveform average count: {0}", strspreamble[3]);
Console.WriteLine("Waveform X increment: {0}", strspreamble[4]);
Console.WriteLine("Waveform X origin: {0}", strspreamble[5]);
Console.WriteLine("Waveform X reference: {0}", strspreamble[6]);
Console.WriteLine("Waveform Y increment: {0}", strspreamble[7]);
Console.WriteLine("Waveform Y origin: {0}", strspreamble[8]);
Console.WriteLine("Waveform Y reference: {0}", strspreamble[9]);
Console.WriteLine("Coupling: {0}", dctCoupling[strspreamble[10]]);
Console.WriteLine("Waveform X display range: {0}",
    strspreamble[11]);
Console.WriteLine("Waveform X display origin: {0}",
    strspreamble[12]);
Console.WriteLine("Waveform Y display range: {0}",
    strspreamble[13]);
Console.WriteLine("Waveform Y display origin: {0}",
    strspreamble[14]);
Console.WriteLine("Date: {0}", strspreamble[15]);
Console.WriteLine("Time: {0}", strspreamble[16]);
Console.WriteLine("Frame model: {0}", strspreamble[17]);
Console.WriteLine("Acquire mode: {0}",
    dctAcqMode[strspreamble[18]]);

```

```

Console.WriteLine("Completion pct: {0}", strsPreamble[19]);
Console.WriteLine("Waveform X inits: {0}",
    dctUnits[strsPreamble[20]]);
Console.WriteLine("Waveform Y units: {0}",
    dctUnits[strsPreamble[21]]);
Console.WriteLine("Max BW limit: {0}", strsPreamble[22]);
Console.WriteLine("Min BW limit: {0}", strsPreamble[23]);

// Get numeric values for later calculations.
double fXincrement;
fXincrement = myScope.DoQueryNumber(":WAVEform:XINCrement?");
double fXorigin;
fXorigin = myScope.DoQueryNumber(":WAVEform:XORigin?");
double fYincrement;
fYincrement = myScope.DoQueryNumber(":WAVEform:YINCrement?");
double fYorigin;
fYorigin = myScope.DoQueryNumber(":WAVEform:YORigin?");

// Get the waveform data.
myScope.DoCommand(":WAVEform:STReaming OFF");
short[] WordDataArray; // Results array.
WordDataArray = myScope.DoQueryIEEEBlock_I2(":WAVEform:DATA?");
nLength = WordDataArray.Length;
Console.WriteLine("Number of data values: {0}", nLength);

// Set up output file:
strPath = "c:\\scope\\data\\waveform_data.csv";
if (File.Exists(strPath)) File.Delete(strPath);

// Open file for output.
StreamWriter writer = File.CreateText(strPath);

// Output waveform data in CSV format.
for (int i = 0; i < nLength - 1; i++)
    writer.WriteLine("{0:f9}, {1:f6}",
        fXorigin + ((float)i * fXincrement),
        (((float)WordDataArray[i]
            * fYincrement) + fYorigin));

// Close output file.
writer.Close();
Console.WriteLine("Waveform format WORD data written to {0}",
    strPath);
}
}

class VisaComInstrument
{
    private ResourceManagerClass m_ResourceManager;
    private FormattedIO488Class m_IoObject;
    private string m_strVisaAddress;

    // Constructor.
    public VisaComInstrument(string strVisaAddress)
    {
        // Save VISA address in member variable.
        m_strVisaAddress = strVisaAddress;
    }
}

```

```

        // Open the default VISA COM IO object.
        OpenIo();

        // Clear the interface.
        m_IoObject.IO.Clear();
    }

    public void DoCommand(string strCommand)
    {
        // Send the command.
        m_IoObject.WriteString(strCommand, true);

        // Check for inst errors.
        CheckInstrumentErrors(strCommand);
    }

    public void DoCommandIEEEBlock(string strCommand,
        byte[] DataArray)
    {
        // Send the command to the device.
        m_IoObject.WriteIEEEBlock(strCommand, DataArray, true);

        // Check for inst errors.
        CheckInstrumentErrors(strCommand);
    }

    public string DoQueryString(string strQuery)
    {
        // Send the query.
        m_IoObject.WriteString(strQuery, true);

        // Get the result string.
        string strResults;
        strResults = m_IoObject.ReadString();

        // Check for inst errors.
        CheckInstrumentErrors(strQuery);

        // Return results string.
        return strResults;
    }

    public double DoQueryNumber(string strQuery)
    {
        // Send the query.
        m_IoObject.WriteString(strQuery, true);

        // Get the result number.
        double fResult;
        fResult = (double)m_IoObject.ReadNumber(
            IEEEASCIIType.ASCIIType_R8, true);

        // Check for inst errors.
        CheckInstrumentErrors(strQuery);

        // Return result number.
    }

```



```

    return fResult;
}

public double[] DoQueryNumbers(string strQuery)
{
    // Send the query.
    m_IoObject.WriteString(strQuery, true);

    // Get the result numbers.
    double[] fResultsArray;
    fResultsArray = (double[])m_IoObject.ReadList(
        IEEEASCIIType.ASCIIType_R8, ",;");

    // Check for inst errors.
    CheckInstrumentErrors(strQuery);

    // Return result numbers.
    return fResultsArray;
}

public byte[] DoQueryIEEEBlock_UI1(string strQuery)
{
    // Send the query.
    m_IoObject.WriteString(strQuery, true);

    // Get the results array.
    System.Threading.Thread.Sleep(2000); // Delay before reading.
    byte[] ResultsArray;
    ResultsArray = (byte[])m_IoObject.ReadIEEEBlock(
        IEEEBinaryType.BinaryType_UI1, false, true);

    // Check for inst errors.
    CheckInstrumentErrors(strQuery);

    // Return results array.
    return ResultsArray;
}

public short[] DoQueryIEEEBlock_I2(string strQuery)
{
    // Send the query.
    m_IoObject.WriteString(strQuery, true);

    // Get the results array.
    System.Threading.Thread.Sleep(2000); // Delay before reading.
    short[] ResultsArray;
    ResultsArray = (short[])m_IoObject.ReadIEEEBlock(
        IEEEBinaryType.BinaryType_I2, false, true);

    // Check for inst errors.
    CheckInstrumentErrors(strQuery);

    // Return results array.
    return ResultsArray;
}

private void CheckInstrumentErrors(string strCommand)

```

```

{
    // Check for instrument errors.
    string strInstrumentError;
    bool bFirstError = true;

    do    // While not "0,No error".
    {
        m_JsonObject.WriteString(":SYSTEM:ERROR? STRing", true);
        strInstrumentError = m_JsonObject.ReadString();

        if (!strInstrumentError.ToString().StartsWith("0, "))
        {
            if (bFirstError)
            {
                Console.WriteLine("ERROR(s) for command '{0}': ",
                    strCommand);
                bFirstError = false;
            }
            Console.Write(strInstrumentError);
        }
    } while (!strInstrumentError.ToString().StartsWith("0, "));
}

private void OpenIo()
{
    m_ResourceManager = new ResourceManagerClass();
    m_JsonObject = new FormattedIO488Class();

    // Open the default VISA COM IO object.
    try
    {
        m_JsonObject.IO =
            (IMessage)m_ResourceManager.Open(m_strVisaAddress,
                AccessMode.NO_LOCK, 0, "");
    }
    catch (Exception e)
    {
        Console.WriteLine("An error occurred: {0}", e.Message);
    }
}

public void SetTimeoutSeconds(int nSeconds)
{
    m_JsonObject.IO.Timeout = nSeconds * 1000;
}

public void Close()
{
    try
    {
        m_JsonObject.IO.Close();
    }
    catch { }

    try
    {
        Marshal.ReleaseComObject(m_JsonObject);
    }
}

```

```

    }
    catch { }

    try
    {
        Marshal.ReleaseComObject (m_ResourceManager);
    }
    catch { }
}
}
}

```

## VISA COM Example in Visual Basic .NET

To compile and run this example in Microsoft Visual Studio 2008:

- 1 Open Visual Studio.
- 2 Create a new Visual Basic, Windows, Console Application project.
- 3 Cut-and-paste the code that follows into the Visual Basic source file.
- 4 Edit the program to use the VISA address of your oscilloscope.
- 5 Add a reference to the VISA COM Type Library:
  - a Right-click the project you wish to modify (not the solution) in the Solution Explorer window of the Microsoft Visual Studio environment.
  - b Choose **Add Reference...**
  - c In the Add Reference dialog, select the **COM** tab.
  - d Select **VISA COM 5.11 Type Library**; then click **OK**.
  - e Right-click the project you wish to modify (not the solution) in the Solution Explorer window of the Microsoft Visual Studio environment and choose **Properties**; then, select "Infiniium.VisaComInstrumentApp" as the **Startup object**.
- 6 Build and run the program.

For more information, see the VISA COM Help that comes with Keysight IO Libraries Suite 15.

```

'
' Keysight VISA COM Example in Visual Basic .NET
' -----
' This program illustrates a few commonly used programming
' features of your Keysight Infiniium Series oscilloscope.
' -----

Imports System
Imports System.IO
Imports System.Text
Imports System.Collections.Generic
Imports Ivi.Visa.Interop
Imports System.Runtime.InteropServices

```

```

Namespace Infiniium
Class VisaComInstrumentApp
  Private Shared myScope As VisaComInstrument

  Public Shared Sub Main(ByVal args As String())
    Try
      myScope = New _
        VisaComInstrument("TCPIP0::141.121.237.226::hislip0::INSTR")
      myScope.SetTimeoutSeconds(10)

      ' Initialize - start from a known state.
      Initialize()

      ' Capture data.
      Capture()

      ' Analyze the captured waveform.
      Analyze()

    Catch err As System.ApplicationException
      Console.WriteLine("*** VISA Error Message : " + err.Message)
    Catch err As System.SystemException
      Console.WriteLine("*** System Error Message : " + err.Message)
    Catch err As System.Exception
      System.Diagnostics.Debug.Fail("Unexpected Error")
      Console.WriteLine("*** Unexpected Error : " + err.Message)
    Finally
      myScope.Close()
    End Try
  End Sub

  ' Initialize the oscilloscope to a known state.
  ' -----

  Private Shared Sub Initialize()
    Dim strResults As String

    ' Clear status.
    myScope.DoCommand("*CLS")

    ' Get and display the device's *IDN? string.
    strResults = myScope.DoQueryString("*IDN?")
    Console.WriteLine("*IDN? result is: {0}", strResults)

    ' Load the default setup.
    myScope.DoCommand("*RST")

  End Sub

  ' Capture the waveform.
  ' -----

  Private Shared Sub Capture()

    ' Set probe attenuation factor.
    myScope.DoCommand(":CHANnel1:PROBe 1.0")
    Console.WriteLine("Channel 1 probe attenuation factor: {0}", _

```

```

        myScope.DoQueryString(":CHANnel1:PROBE?")

' Use auto-scale to automatically configure oscilloscope.
myScope.DoCommand(":AUToscale")

' Set trigger mode.
myScope.DoCommand(":TRIGger:MODE EDGE")
Console.WriteLine("Trigger mode: {0}", _
    myScope.DoQueryString(":TRIGger:MODE?"))

' Set EDGE trigger parameters.
myScope.DoCommand(":TRIGger:EDGE:SOURCe CHANnel1")
Console.WriteLine("Trigger edge source: {0}", _
    myScope.DoQueryString(":TRIGger:EDGE:SOURce?"))

myScope.DoCommand(":TRIGger:LEVel CHANnel1,-2E-3")
Console.WriteLine("Trigger level, channel 1: {0}", _
    myScope.DoQueryString(":TRIGger:LEVel? CHANnel1"))

myScope.DoCommand(":TRIGger:EDGE:SLOPe POSitive")
Console.WriteLine("Trigger edge slope: {0}", _
    myScope.DoQueryString(":TRIGger:EDGE:SLOPe?"))

' Save oscilloscope configuration.
Dim ResultsArray As Byte() ' Results array.
Dim nLength As Integer ' Number of bytes returned from inst.
Dim strPath As String
Dim fStream As FileStream

' Query and read setup string.
ResultsArray = myScope.DoQueryIEEEBlock_UI1(":SYSTem:SETup?")
nLength = ResultsArray.Length

' Write setup string to file.
strPath = "c:\scope\config\setup.stp"
fStream = File.Open(strPath, FileMode.Create)
fStream.Write(ResultsArray, 0, nLength)
fStream.Close()
Console.WriteLine("Setup bytes saved: {0}", nLength)

' Change settings with individual commands:

' Set vertical scale and offset.
myScope.DoCommand(":CHANnel1:SCALe 0.1")
Console.WriteLine("Channel 1 vertical scale: {0}", _
    myScope.DoQueryString(":CHANnel1:SCALe?"))

myScope.DoCommand(":CHANnel1:OFFSet 0.0")
Console.WriteLine("Channel 1 vertical offset: {0}", _
    myScope.DoQueryString(":CHANnel1:OFFSet?"))

' Set horizontal scale and offset.
myScope.DoCommand(":TIMebase:SCALe 0.0002")
Console.WriteLine("Timebase scale: {0}", _
    myScope.DoQueryString(":TIMebase:SCALe?"))

myScope.DoCommand(":TIMebase:POSition 0.0")

```

```

Console.WriteLine("Timebase position: {0}", _
    myScope.DoQueryString(":TIMEbase:POSition?"))

' Set the acquisition mode.
myScope.DoCommand(":ACQuire:MODE RTIME")
Console.WriteLine("Acquire mode: {0}", _
    myScope.DoQueryString(":ACQuire:MODE?"))

' Or, configure by loading a previously saved setup.
Dim dataArray As Byte()
Dim nBytesWritten As Integer

' Read setup string from file.
strPath = "c:\scope\config\setup.stp"
dataArray = File.ReadAllBytes(strPath)
nBytesWritten = dataArray.Length

' Restore setup string.
myScope.DoCommandIEEEBlock(":SYSTem:SETup", dataArray)
Console.WriteLine("Setup bytes restored: {0}", nBytesWritten)

' Set the desired number of waveform points,
' and capture an acquisition.
myScope.DoCommand(":ACQuire:POINts 32000")
myScope.DoCommand(":DIGitize")

End Sub

' Analyze the captured waveform.
' -----

Private Shared Sub Analyze()

    Dim fResult As Double
    Dim ResultsArray As Byte() ' Results array.
    Dim nLength As Integer ' Number of bytes returned from inst.
    Dim strPath As String

    ' Make measurements.
    ' -----
    myScope.DoCommand(":MEASure:SOURce CHANnel1")
    Console.WriteLine("Measure source: {0}", _
        myScope.DoQueryString(":MEASure:SOURce?"))

    myScope.DoCommand(":MEASure:FREQuency")
    fResult = myScope.DoQueryNumber(":MEASure:FREQuency?")
    Console.WriteLine("Frequency: {0:F4} kHz", fResult / 1000)

    myScope.DoCommand(":MEASure:VAMPlitude")
    fResult = myScope.DoQueryNumber(":MEASure:VAMPlitude?")
    Console.WriteLine("Vertical amplitude: {0:F2} V", fResult)

    ' Download the screen image.
    ' -----

    ' Get the screen data.
    ResultsArray = myScope.DoQueryIEEEBlock_UI1(":DISPlay:DATA? PNG")

```

```

nLength = ResultsArray.Length

' Store the screen data to a file.
strPath = "c:\scope\data\screen.png"
Dim fStream As FileStream
fStream = File.Open(strPath, FileMode.Create)
fStream.Write(ResultsArray, 0, nLength)
fStream.Close()
Console.WriteLine("Screen image ({0} bytes) written to {1}", _
    nLength, strPath)

' Download waveform data.
' -----

' Get the waveform type.
Console.WriteLine("Waveform type: {0}", _
    myScope.DoQueryString(":WAVEform:TYPE?"))

' Get the number of waveform points.
Console.WriteLine("Waveform points: {0}", _
    myScope.DoQueryString(":WAVEform:POINTS?"))

' Set the waveform source.
myScope.DoCommand(":WAVEform:SOURce CHANnel")
Console.WriteLine("Waveform source: {0}", _
    myScope.DoQueryString(":WAVEform:SOURce?"))

' Choose the format of the data returned:
myScope.DoCommand(":WAVEform:FORMat WORD")
Console.WriteLine("Waveform format: {0}", _
    myScope.DoQueryString(":WAVEform:FORMat?"))

' Display the waveform settings from preamble:
Dim dctWavFormat As New Dictionary(Of String, String)
dctWavFormat.Add("0", "ASCIi")
dctWavFormat.Add("1", "BYTE")
dctWavFormat.Add("2", "WORD")
dctWavFormat.Add("3", "LONG")
dctWavFormat.Add("4", "LONGLONG")

Dim dctAcqType As New Dictionary(Of String, String)
dctAcqType.Add("1", "RAW")
dctAcqType.Add("2", "AVERage")
dctAcqType.Add("3", "VHISTogram")
dctAcqType.Add("4", "HHISTogram")
dctAcqType.Add("6", "INTerpolate")
dctAcqType.Add("10", "PDETECT")

Dim dctAcqMode As New Dictionary(Of String, String)()
dctAcqMode.Add("0", "RTIME")
dctAcqMode.Add("1", "ETIME")
dctAcqMode.Add("3", "PDETECT")

Dim dctCoupling As New Dictionary(Of String, String)()
dctCoupling.Add("0", "AC")
dctCoupling.Add("1", "DC")
dctCoupling.Add("2", "DCFIFTY")

```

```

dctCoupling.Add("3", "LFREJECT")

Dim dctUnits As New Dictionary(Of String, String)()
dctUnits.Add("0", "UNKNOWN")
dctUnits.Add("1", "VOLT")
dctUnits.Add("2", "SECOND")
dctUnits.Add("3", "CONSTANT")
dctUnits.Add("4", "AMP")
dctUnits.Add("5", "DECIBEL")

Dim strPreamble As String
Dim strsPreamble As String()

strPreamble = myScope.DoQueryString(":WAVEform:PREamble?")
strsPreamble = strPreamble.Split(",")

Console.WriteLine("Waveform format: {0}", _
    dctWavFormat(strsPreamble(0)))

Console.WriteLine("Acquire type: {0}", _
    dctAcqType(strsPreamble(1)))

Console.WriteLine("Waveform points: {0}", strsPreamble(2))
Console.WriteLine("Waveform average count: {0}", strsPreamble(3))
Console.WriteLine("Waveform X increment: {0}", strsPreamble(4))
Console.WriteLine("Waveform X origin: {0}", strsPreamble(5))
Console.WriteLine("Waveform X reference: {0}", strsPreamble(6))
Console.WriteLine("Waveform Y increment: {0}", strsPreamble(7))
Console.WriteLine("Waveform Y origin: {0}", strsPreamble(8))
Console.WriteLine("Waveform Y reference: {0}", strsPreamble(9))
Console.WriteLine("Coupling: {0}", dctCoupling(strsPreamble(10)))
Console.WriteLine("Waveform X display range: {0}", _
    strsPreamble(11))
Console.WriteLine("Waveform X display origin: {0}", _
    strsPreamble(12))
Console.WriteLine("Waveform Y display range: {0}", _
    strsPreamble(13))
Console.WriteLine("Waveform Y display origin: {0}", _
    strsPreamble(14))
Console.WriteLine("Date: {0}", strsPreamble(15))
Console.WriteLine("Time: {0}", strsPreamble(16))
Console.WriteLine("Frame model: {0}", strsPreamble(17))
Console.WriteLine("Acquire mode: {0}", _
    dctAcqMode(strsPreamble(18)))
Console.WriteLine("Completion pct: {0}", strsPreamble(19))
Console.WriteLine("Waveform X inits: {0}", _
    dctUnits(strsPreamble(20)))
Console.WriteLine("Waveform Y units: {0}", _
    dctUnits(strsPreamble(21)))
Console.WriteLine("Max BW limit: {0}", strsPreamble(22))
Console.WriteLine("Min BW limit: {0}", strsPreamble(23))

' Get numeric values for later calculations.
Dim fXincrement As Double
fXincrement = myScope.DoQueryNumber(":WAVEform:XINcrement?")
Dim fXorigin As Double
fXorigin = myScope.DoQueryNumber(":WAVEform:XORigin?")

```



```

Dim fYincrement As Double
fYincrement = myScope.DoQueryNumber(":WAVEform:YINCrement?")
Dim fYorigin As Double
fYorigin = myScope.DoQueryNumber(":WAVEform:YORigin?")

' Get the waveform data.
myScope.DoCommand(":WAVEform:STReaming OFF")
Dim WorddataArray As Short()
WorddataArray = myScope.DoQueryIEEEBlock_I2(":WAVEform:DATA?")
nLength = WorddataArray.Length
Console.WriteLine("Number of data values: {0}", nLength)

' Set up output file:
strPath = "c:\scope\data\waveform_data.csv"
If File.Exists(strPath) Then
    File.Delete(strPath)
End If

' Open file for output.
Dim writer As StreamWriter = File.CreateText(strPath)

' Output waveform data in CSV format.
For index As Integer = 0 To nLength - 1
    ' Write time value, voltage value.
    writer.WriteLine("{0:f9}, {1:f6}", _
        fXorigin + (CSng(index) * fXincrement), _
        (CSng(WorddataArray(index)) * fYincrement) + fYorigin)
Next

' Close output file.
writer.Close()
Console.WriteLine("Waveform format WORD data written to {0}", _
    strPath)

End Sub

End Class

Class VisaComInstrument
    Private m_ResourceManager As ResourceManagerClass
    Private m_IoObject As FormattedIO488Class
    Private m_strVisaAddress As String

    ' Constructor.
    Public Sub New(ByVal strVisaAddress As String)

        ' Save VISA address in member variable.
        m_strVisaAddress = strVisaAddress

        ' Open the default VISA COM IO object.
        OpenIo()

        ' Clear the interface.
        m_IoObject.IO.Clear()

    End Sub

```

```

Public Sub DoCommand(ByVal strCommand As String)

    ' Send the command.
    m_IoObject.WriteString(strCommand, True)

    ' Check for inst errors.
    CheckInstrumentErrors(strCommand)

End Sub

Public Sub DoCommandIEEEBlock(ByVal strCommand As String, _
    ByVal dataArray As Byte())

    ' Send the command to the device.
    m_IoObject.WriteIEEEBlock(strCommand, dataArray, True)

    ' Check for inst errors.
    CheckInstrumentErrors(strCommand)

End Sub

Public Function DoQueryString(ByVal strQuery As String) As String
    ' Send the query.
    m_IoObject.WriteString(strQuery, True)

    ' Get the result string.
    Dim strResults As String
    strResults = m_IoObject.ReadString()

    ' Check for inst errors.
    CheckInstrumentErrors(strQuery)

    ' Return results string.
    Return strResults
End Function

Public Function DoQueryNumber(ByVal strQuery As String) As Double
    ' Send the query.
    m_IoObject.WriteString(strQuery, True)

    ' Get the result number.
    Dim fResult As Double
    fResult = _
        Cdbl(m_IoObject.ReadNumber(IEEEASCIIType.ASCIIType_R8, True))

    ' Check for inst errors.
    CheckInstrumentErrors(strQuery)

    ' Return result number.
    Return fResult
End Function

Public Function DoQueryNumbers(ByVal strQuery As String) As _
    Double()
    ' Send the query.
    m_IoObject.WriteString(strQuery, True)

```

```

' Get the result numbers.
Dim fResultsArray As Double()
fResultsArray = _
    m_IoObject.ReadList(IEEEASCIIType.ASCIIType_R8, ",;")

' Check for inst errors.
CheckInstrumentErrors(strQuery)

' Return result numbers.
Return fResultsArray
End Function

Public _
    Function _
        DoQueryIEEEBlock_UI1(ByVal strQuery As String) As Byte()
' Send the query.
m_IoObject.WriteString(strQuery, True)

' Get the results array.
System.Threading.Thread.Sleep(2000) ' Delay before reading data.
Dim ResultsArray As Byte()
ResultsArray = _
    m_IoObject.ReadIEEEBlock(IEEEBinaryType.BinaryType_UI1, _
        False, True)

' Check for inst errors.
CheckInstrumentErrors(strQuery)

' Return results array.
Return ResultsArray
End Function

Public _
    Function _
        DoQueryIEEEBlock_I2(ByVal strQuery As String) As Short()
' Send the query.
m_IoObject.WriteString(strQuery, True)

' Get the results array.
System.Threading.Thread.Sleep(2000) ' Delay before reading data.
Dim ResultsArray As Short()
ResultsArray = _
    m_IoObject.ReadIEEEBlock(IEEEBinaryType.BinaryType_I2, _
        False, True)

' Check for inst errors.
CheckInstrumentErrors(strQuery)

' Return results array.
Return ResultsArray
End Function

Private Sub CheckInstrumentErrors(ByVal strCommand As String)
' Check for instrument errors.
Dim strInstrumentError As String
Dim bFirstError As Boolean = True
Do ' While not "0,No error".

```

```

    m_IoObject.WriteString(":SYSTEM:ERROR? STRing", True)
    strInstrumentError = m_IoObject.ReadString()

    If Not strInstrumentError.ToString().StartsWith("0,") Then
        If bFirstError Then
            Console.WriteLine("ERROR(s) for command '{0}': ", _
                strCommand)
            bFirstError = False
        End If
        Console.Write(strInstrumentError)
    End If
    Loop While Not strInstrumentError.ToString().StartsWith("0,")
End Sub

Private Sub OpenIo()
    m_ResourceManager = New ResourceManagerClass()
    m_IoObject = New FormattedIO488Class()

    ' Open the default VISA COM IO object.
    Try
        m_IoObject.IO = _
            DirectCast(m_ResourceManager.Open(m_strVisaAddress, _
                AccessMode.NO_LOCK, 0, ""), IMessage)
    Catch e As Exception
        Console.WriteLine("An error occurred: {0}", e.Message)
    End Try
End Sub

Public Sub SetTimeoutSeconds(ByVal nSeconds As Integer)
    m_IoObject.IO.Timeout = nSeconds * 1000
End Sub

Public Sub Close()
    Try
        m_IoObject.IO.Close()
    Catch
    End Try

    Try
        Marshal.ReleaseComObject(m_IoObject)
    Catch
    End Try

    Try
        Marshal.ReleaseComObject(m_ResourceManager)
    Catch
    End Try
End Sub
End Class
End Namespace

```

## VISA COM Example in Python 3

You can use the Python programming language with the "comtypes" package to control Keysight oscilloscopes.

The Python language and "comtypes" package can be downloaded from the web at <http://www.python.org/> and <https://pypi.org/project/comtypes/>, respectively.

To run this example with Python and "comtypes":

- 1 Cut-and-paste the code that follows into a file named "example.py".
- 2 Edit the program to use the VISA address of your oscilloscope.
- 3 If "python.exe" can be found via your PATH environment variable, open a Command Prompt window; then, change to the folder that contains the "example.py" file, and enter:

```
python example.py

#!python3
#
# Keysight VISA COM Example in Python using "comtypes"
# *****
# This program illustrates a few commonly used programming
# features of your Keysight Infiniium Series oscilloscope.
# *****

# Import Python modules.
# -----
import string
import time
import sys
import array

from comtypes.client import GetModule
from comtypes.client import CreateObject
from comtypes.automation import VARIANT

# Run GetModule once to generate comtypes.gen.VisaComLib.
if not hasattr(sys, "frozen"):
    GetModule("C:\Program Files (x86)\IVI Foundation\VISA\VisaCom\
GlobMgr.dll")

import comtypes.gen.VisaComLib as VisaComLib

# Global variables (booleans: 0 = False, 1 = True).
# -----

# =====
# Initialize:
# =====
def initialize():
    # Get and display the device's *IDN? string.
    idn_string = do_query_string("*IDN?")
    print("Identification string '%s'" % idn_string)

# Clear status and load the default setup.
do_command("*CLS")
do_command("*RST")
```

```

# =====
# Capture:
# =====
def capture():

    # Set probe attenuation factor.
    do_command(":CHANnel1:PROBe 1.0")
    qresult = do_query_string(":CHANnel1:PROBE?")
    print("Channel 1 probe attenuation factor: %s" % qresult)

    # Use auto-scale to automatically set up oscilloscope.
    print("Autoscale.")
    do_command(":AUToscale")

    # Set trigger mode.
    do_command(":TRIGger:MODE EDGE")
    qresult = do_query_string(":TRIGger:MODE?")
    print("Trigger mode: %s" % qresult)

    # Set EDGE trigger parameters.
    do_command(":TRIGger:EDGE:SOURce CHANnel1")
    qresult = do_query_string(":TRIGger:EDGE:SOURce?")
    print("Trigger edge source: %s" % qresult)

    do_command(":TRIGger:LEVel CHANnel1,336E-3")
    qresult = do_query_string(":TRIGger:LEVel? CHANnel1")
    print("Trigger level, channel 1: %s" % qresult)

    do_command(":TRIGger:EDGE:SLOPe POSitive")
    qresult = do_query_string(":TRIGger:EDGE:SLOPe?")
    print("Trigger edge slope: %s" % qresult)

    # Save oscilloscope setup.
    setup_bytes = do_query_ieee_block_UI1(":SYSTem:SETup?")
    nLength = len(setup_bytes)
    f = open("setup.stp", "wb")
    f.write(bytearray(setup_bytes))
    f.close()
    print("Setup bytes saved: %d" % nLength)

    # Change oscilloscope settings with individual commands:

    # Set vertical scale and offset.
    do_command(":CHANnel1:SCALe 0.1")
    qresult = do_query_number(":CHANnel1:SCALe?")
    print("Channel 1 vertical scale: %f" % qresult)

    do_command(":CHANnel1:OFFSet 0.0")
    qresult = do_query_number(":CHANnel1:OFFSet?")
    print("Channel 1 offset: %f" % qresult)

    # Set horizontal scale and offset.
    do_command(":TIMEbase:SCALe 200e-6")
    qresult = do_query_string(":TIMEbase:SCALe?")
    print("Timebase scale: %s" % qresult)

```

```

do_command(":TIMEbase:POSition 0.0")
qresult = do_query_string(":TIMEbase:POSition?")
print("Timebase position: %s" % qresult)

# Set the acquisition mode.
do_command(":ACQuire:MODE RTIME")
qresult = do_query_string(":ACQuire:MODE?")
print("Acquire mode: %s" % qresult)

# Or, configure by loading a previously saved setup.
f = open("setup.stp", "rb")
setup_bytes = f.read()
f.close()
do_command_ieee_block(":SYSTem:SETup", array.array('B', setup_bytes))
print("Setup bytes restored: %d" % len(setup_bytes))

# Set the desired number of waveform points,
# and capture an acquisition.
do_command(":ACQuire:POINts 32000")
do_command(":DIGitize")

# =====
# Analyze:
# =====
def analyze():

    # Make measurements.
    # -----
    do_command(":MEASure:SOURce CHANnel1")
    qresult = do_query_string(":MEASure:SOURce?")
    print("Measure source: %s" % qresult)

    do_command(":MEASure:FREQuency")
    qresult = do_query_string(":MEASure:FREQuency?")
    print("Measured frequency on channel 1: %s" % qresult)

    do_command(":MEASure:VAMPlitude")
    qresult = do_query_string(":MEASure:VAMPlitude?")
    print("Measured vertical amplitude on channel 1: %s" % qresult)

    # Download the screen image.
    # -----
    image_bytes = do_query_ieee_block_UI1(":DISPlay:DATA? PNG")
    nLength = len(image_bytes)
    f = open("screen_image.png", "wb")
    f.write(bytearray(image_bytes))
    f.close()
    print("Screen image written to 'screen_image.png'.")

    # Download waveform data.
    # -----

    # Get the waveform type.
    qresult = do_query_string(":WAVEform:TYPE?")
    print("Waveform type: %s" % qresult)

```

```

# Get the number of waveform points.
qresult = do_query_string(":WAVEform:POINTs?")
print("Waveform points: %s" % qresult)

# Set the waveform source.
do_command(":WAVEform:SOURce CHANnel1")
qresult = do_query_string(":WAVEform:SOURce?")
print("Waveform source: %s" % qresult)

# Choose the format of the data returned:
do_command(":WAVEform:FORMat WORD")
print("Waveform format: %s" % do_query_string(":WAVEform:FORMat?"))

# Display the waveform settings from preamble:
wav_form_dict = {
    0 : "ASCIi",
    1 : "BYTE",
    2 : "WORD",
    3 : "LONG",
    4 : "LONGLONG",
}
acq_type_dict = {
    1 : "RAW",
    2 : "AVERage",
    3 : "VHISTogram",
    4 : "HHISTogram",
    6 : "INTErpolate",
    10 : "PDETEct",
}
acq_mode_dict = {
    0 : "RTIME",
    1 : "ETIME",
    3 : "PDETEct",
}
coupling_dict = {
    0 : "AC",
    1 : "DC",
    2 : "DCFIFTY",
    3 : "LFREJECT",
}
units_dict = {
    0 : "UNKNOWN",
    1 : "VOLT",
    2 : "SECOND",
    3 : "CONSTANT",
    4 : "AMP",
    5 : "DECIBEL",
}

preamble_string = do_query_string(":WAVEform:PREAmble?")
(
    wav_form, acq_type, wfmpmts, avgcnt, x_increment, x_origin,
    x_reference, y_increment, y_origin, y_reference, coupling,
    x_display_range, x_display_origin, y_display_range,
    y_display_origin, date, time, frame_model, acq_mode,
    completion, x_units, y_units, max_bw_limit, min_bw_limit
) = preamble_string.split(",")

```



```

print("Waveform format: %s" % wav_form_dict[int(wav_form)])
print("Acquire type: %s" % acq_type_dict[int(acq_type)])
print("Waveform points desired: %s" % wfmppts)
print("Waveform average count: %s" % avgcnt)
print("Waveform X increment: %s" % x_increment)
print("Waveform X origin: %s" % x_origin)
print("Waveform X reference: %s" % x_reference) # Always 0.
print("Waveform Y increment: %s" % y_increment)
print("Waveform Y origin: %s" % y_origin)
print("Waveform Y reference: %s" % y_reference) # Always 0.
print("Coupling: %s" % coupling_dict[int(coupling)])
print("Waveform X display range: %s" % x_display_range)
print("Waveform X display origin: %s" % x_display_origin)
print("Waveform Y display range: %s" % y_display_range)
print("Waveform Y display origin: %s" % y_display_origin)
print("Date: %s" % date)
print("Time: %s" % time)
print("Frame model #: %s" % frame_model)
print("Acquire mode: %s" % acq_mode_dict[int(acq_mode)])
print("Completion pct: %s" % completion)
print("Waveform X units: %s" % units_dict[int(x_units)])
print("Waveform Y units: %s" % units_dict[int(y_units)])
print("Max BW limit: %s" % max_bw_limit)
print("Min BW limit: %s" % min_bw_limit)

# Get numeric values for later calculations.
x_increment = do_query_number(":WAVEform:XINCrement?")
x_origin = do_query_number(":WAVEform:XORigin?")
y_increment = do_query_number(":WAVEform:YINCrement?")
y_origin = do_query_number(":WAVEform:YORigin?")

# Get the waveform data.
do_command(":WAVEform:STReaming OFF")
data_words = do_query_ieee_block_I2(":WAVEform:DATA?")
nLength = len(data_words)
print("Number of data values: %d" % nLength)

# Open file for output.
strPath = "waveform_data.csv"
f = open(strPath, "w")

# Output waveform data in CSV format.
for i in range(0, nLength - 1):
    time_val = x_origin + (i * x_increment)
    voltage = (data_words[i] * y_increment) + y_origin
    f.write("%E, %f\n" % (time_val, voltage))

# Close output file.
f.close()
print("Waveform format WORD data written to %s." % strPath)

# =====
# Send a command and check for errors:
# =====
def do_command(command):

```

```

myScope.WriteString("%s" % command, True)
check_instrument_errors(command)

# =====
# Send a command and check for errors:
# =====
def do_command_ieee_block(command, data):
    myScope.WriteIEEEBlock(command, VARIANT(array.array('B', data)), True)
    check_instrument_errors(command)

# =====
# Send a query, check for errors, return string:
# =====
def do_query_string(query):
    myScope.WriteString("%s" % query, True)
    result = myScope.ReadString()
    check_instrument_errors(query)
    return result

# =====
# Send a query, check for errors, return string:
# =====
def do_query_ieee_block_UI1(query):
    myScope.WriteString("%s" % query, True)
    result = myScope.ReadIEEEBlock(VisaComLib.BinaryType_UI1, \
        False, True)
    check_instrument_errors(query)
    return result

# =====
# Send a query, check for errors, return string:
# =====
def do_query_ieee_block_I2(query):
    myScope.WriteString("%s" % query, True)
    result = myScope.ReadIEEEBlock(VisaComLib.BinaryType_I2, \
        False, True)
    check_instrument_errors(query)
    return result

# =====
# Send a query, check for errors, return values:
# =====
def do_query_number(query):
    myScope.WriteString("%s" % query, True)
    result = myScope.ReadNumber(VisaComLib.ASCIIType_R8, True)
    check_instrument_errors(query)
    return result

# =====
# Send a query, check for errors, return values:
# =====

```

```

def do_query_numbers(query):
    myScope.WriteString("%s" % query, True)
    result = myScope.ReadList(VisaComLib.ASCIIType_R8, ",;")
    check_instrument_errors(query)
    return result

# =====
# Check for instrument errors:
# =====
def check_instrument_errors(command):

    while True:
        myScope.WriteString(":SYSTem:ERRor? STRing", True)
        error_string = myScope.ReadString()
        if error_string: # If there is an error string value.

            if error_string.find("0,", 0, 2) == -1: # Not "No error".
                print("ERROR: %s, command: '%s'" % (error_string, command))
                print("Exited because of error.")
                sys.exit(1)

            else: # "No error"
                break

        else: # :SYSTem:ERRor? STRing should always return string.
            print("ERROR: :SYSTem:ERRor? STRing returned nothing, command: '%s'"
                \
                % command)
            print("Exited because of error.")
            sys.exit(1)

# =====
# Main program:
# =====
rm = CreateObject("VISA.GlobalRM", \
    interface=VisaComLib.IResourceManager)
myScope = CreateObject("VISA.BasicFormattedIO", \
    interface=VisaComLib.IFormattedIO488)
myScope.IO = \
    rm.Open("TCPIP0::141.121.231.13::hislip0::INSTR")

# Clear the interface.
myScope.IO.Clear
print("Interface cleared.")

# Set the Timeout to 15 seconds.
myScope.IO.Timeout = 15000 # 15 seconds.
print("Timeout set to 15000 milliseconds.")

# Initialize the oscilloscope, capture data, and analyze.
initialize()
capture()
analyze()

myScope.IO.Close()

```

```
print("End of program")  
sys.exit()
```

## VISA Examples

- ["VISA Example in C"](#) on page 1853
- ["VISA Example in Visual Basic"](#) on page 1862
- ["VISA Example in C#"](#) on page 1872
- ["VISA Example in Visual Basic .NET"](#) on page 1884
- ["VISA Example in Python 3"](#) on page 1896

### VISA Example in C

To compile and run this example in Microsoft Visual Studio 2008:

- 1 Open Visual Studio.
- 2 Create a new Visual C++, Win32, Win32 Console Application project.
- 3 In the Win32 Application Wizard, click **Next >**. Then, check **Empty project**, and click **Finish**.
- 4 Cut-and-paste the code that follows into a file named "example.c" in the project directory.
- 5 In Visual Studio 2008, right-click the Source Files folder, choose **Add > Add Existing Item...**, select the example.c file, and click **Add**.
- 6 Edit the program to use the VISA address of your oscilloscope.
- 7 Choose **Project > Properties....** In the Property Pages dialog, update these project settings:
  - a Under Configuration Properties, Linker, Input, add "visa32.lib" to the Additional Dependencies field.
  - b Under Configuration Properties, C/C++, Code Generation, select Multi-threaded DLL for the Runtime Library field.
  - c Click **OK** to close the Property Pages dialog.
- 8 Add the include files and library files search paths:
  - a Choose **Tools > Options....**
  - b In the Options dialog, under Projects and Solutions, select **VC++ Directories**.
  - c Show directories for **Include files**, and add the include directory (for example, Program Files (x86)\IVI Foundation\VISA\WinNT\Include).
  - d Show directories for **Library files**, and add the library files directory (for example, Program Files (x86)\IVI Foundation\VISA\WinNT\lib\msc).
  - e Click **OK** to close the Options dialog.
- 9 Build and run the program.

```
/*
 * Keysight VISA Example in C
 * -----
```

```

* This program illustrates a few commonly-used programming
* features of your Keysight Infiniium Series oscilloscope.
*/

#include <stdio.h>           /* For printf(). */
#include <string.h>         /* For strcpy(), strcat(). */
#include <time.h>           /* For clock(). */
#include <visa.h>           /* Keysight VISA routines. */

#define VISA_ADDRESS "TCPIP0::141.121.237.226::hislip0::INSTR"
#define IEEEBLOCK_SPACE 500000

/* Function prototypes */
void initialize(void);      /* Initialize to known state. */
void capture(void);        /* Capture the waveform. */
void analyze(void);        /* Analyze the captured waveform. */

void do_command(char *command); /* Send command. */
int do_command_ieeeblock(char *command); /* Command w/IEEE block. */
void do_query_string(char *query); /* Query for string. */
void do_query_number(char *query); /* Query for number. */
void do_query_numbers(char *query); /* Query for numbers. */
int do_query_ieeeblock(char *query); /* Query for IEEE byte block. */
int do_query_ieeeblock_words(char *query); /* Query for word block. */
void check_instrument_errors(); /* Check for inst errors. */
void error_handler(); /* VISA error handler. */

/* Global variables */
ViSession defaultRM, vi; /* Device session ID. */
ViStatus err; /* VISA function return value. */
char str_result[256] = {0}; /* Result from do_query_string(). */
double num_result; /* Result from do_query_number(). */
unsigned char ieeeblock_data[IEEBLOCK_SPACE]; /* Result from
do_query_ieeeblock(). */
signed short ieeeblock_data_words[IEEBLOCK_SPACE]; /* Result from
do_query_ieeeblock_words(). */
double dbl_results[10]; /* Result from do_query_numbers(). */

/* Main Program
* ----- */
void main(void)
{
    /* Open the default resource manager session. */
    err = viOpenDefaultRM(&defaultRM);
    if (err != VI_SUCCESS) error_handler();

    /* Open the session using the oscilloscope's VISA address. */
    err = viOpen(defaultRM, VISA_ADDRESS, VI_NULL, VI_NULL, &vi);
    if (err != VI_SUCCESS) error_handler();

    /* Set the I/O timeout to fifteen seconds. */
    err = viSetAttribute(vi, VI_ATTR_TMO_VALUE, 15000);
    if (err != VI_SUCCESS) error_handler();

    /* Clear the interface. */
    err = viClear(vi);
    if (err != VI_SUCCESS) error_handler();
}

```

```

/* Initialize - start from a known state. */
initialize();

/* Capture data. */
capture();

/* Analyze the captured waveform. */
analyze();

/* Close the vi session and the resource manager session. */
viClose(vi);
viClose(defaultRM);
}

/* Initialize the oscilloscope to a known state.
 * ----- */
void initialize (void)
{
    /* Clear status. */
    do_command("*CLS");

    /* Get and display the device's *IDN? string. */
    do_query_string("*IDN?");
    printf("Oscilloscope *IDN? string: %s\n", str_result);

    /* Load the default setup. */
    do_command("*RST");
}

/* Capture the waveform.
 * ----- */
void capture (void)
{
    int num_values;
    FILE *fp;

    /* Set probe attenuation factor. */
    do_command(":CHANnel1:PROBE 1.0");
    do_query_string(":CHANnel1:PROBE?");
    printf("Channel 1 probe attenuation factor: %s\n", str_result);

    /* Use auto-scale to automatically configure oscilloscope. */
    do_command(":AUToscale");

    /* Set trigger mode. */
    do_command(":TRIGger:MODE EDGE");
    do_query_string(":TRIGger:MODE?");
    printf("Trigger mode: %s\n", str_result);

    /* Set EDGE trigger parameters. */
    do_command(":TRIGger:EDGE:SOURCe CHANnel1");
    do_query_string(":TRIGger:EDGE:SOURce?");
    printf("Trigger edge source: %s\n", str_result);

    do_command(":TRIGger:LEVel CHANnel1,-2E-3");
    do_query_string(":TRIGger:LEVel? CHANnel1");
}

```

```

printf("Trigger level, channel 1: %s\n", str_result);

do_command(":TRIGger:EDGE:SLOPe POSitive");
do_query_string(":TRIGger:EDGE:SLOPe?");
printf("Trigger edge slope: %s\n", str_result);

/* Save oscilloscope setup. */

/* Read system setup. */
num_values = do_query_ieeeblock(":SYSTem:SETUp?");
printf("Read setup string query (%d bytes).\n", num_values);

/* Write setup string to file. */
fp = fopen ("c:\\scope\\config\\setup.stp", "wb");
num_values = fwrite(ieeeblock_data, sizeof(unsigned char), num_values,
    fp);
fclose (fp);
printf("Wrote setup string (%d bytes) to ", num_values);
printf("c:\\scope\\config\\setup.stp.\n");

/* Change settings with individual commands:

/* Set vertical scale and offset. */
do_command(":CHANnel1:SCALe 0.1");
do_query_string(":CHANnel1:SCALe?");
printf("Channel 1 vertical scale: %s\n", str_result);

do_command(":CHANnel1:OFFSet 0.0");
do_query_string(":CHANnel1:OFFSet?");
printf("Channel 1 offset: %s\n", str_result);

/* Set horizontal scale and offset. */
do_command(":TIMEbase:SCALe 0.0002");
do_query_string(":TIMEbase:SCALe?");
printf("Timebase scale: %s\n", str_result);

do_command(":TIMEbase:POSition 0.0");
do_query_string(":TIMEbase:POSition?");
printf("Timebase position: %s\n", str_result);

/* Set the acquisition mode. */
do_command(":ACQuire:MODE RTIME");
do_query_string(":ACQuire:MODE?");
printf("Acquire mode: %s\n", str_result);

/* Or, set up by loading a previously saved setup. */

/* Read setup string from file. */
fp = fopen ("c:\\scope\\config\\setup.stp", "rb");
num_values = fread (ieeeblock_data, sizeof(unsigned char),
    IEEEBLOCK_SPACE, fp);
fclose (fp);
printf("Read setup string (%d bytes) from file ", num_values);
printf("c:\\scope\\config\\setup.stp.\n");

/* Restore setup string. */
num_values = do_command_ieeeblock(":SYSTem:SETUp", num_values);

```



```

printf("Restored setup string (%d bytes).\n", num_values);

/* Set the desired number of waveform points,
 * and capture an acquisition. */
do_command(":ACquire:POINts 32000");
do_command(":DIGitize");
}

/* Analyze the captured waveform.
 * ----- */
void analyze (void)
{
    double wav_format;
    double acq_type;
    double wav_points;
    double avg_count;
    double x_increment;
    double x_origin;
    double y_increment;
    double y_origin;

    FILE *fp;
    int num_values; /* Number of bytes returned from instrument. */
    int i;

    /* Make measurements.
     * ----- */
    do_command(":MEASure:SOURce CHANnel1");
    do_query_string(":MEASure:SOURce?");
    printf("Measure source: %s\n", str_result);

    do_command(":MEASure:FREQuency");
    do_query_number(":MEASure:FREQuency?");
    printf("Frequency: %.4f kHz\n", num_result / 1000);

    do_command(":MEASure:VAMplitude");
    do_query_number(":MEASure:VAMplitude?");
    printf("Vertical amplitude: %.2f V\n", num_result);

    /* Download the screen image.
     * ----- */

    /* Read screen image. */
    num_values = do_query_ieeeblock(":DISPlay:DATA? PNG");
    printf("Screen image bytes: %d\n", num_values);

    /* Write screen image bytes to file. */
    fp = fopen ("c:\\scope\\data\\screen.png", "wb");
    num_values = fwrite(ieeeblock_data, sizeof(unsigned char), num_values,
        fp);
    fclose (fp);
    printf("Wrote screen image (%d bytes) to ", num_values);
    printf("c:\\scope\\data\\screen.bmp.\n");

    /* Download waveform data.
     * ----- */

```

```

/* Get the waveform type. */
do_query_string(":WAVEform:TYPE?");
printf("Waveform type: %s\n", str_result);

/* Get the number of waveform points. */
do_query_string(":WAVEform:POINTs?");
printf("Waveform points: %s\n", str_result);

/* Set the waveform source. */
do_command(":WAVEform:SOURce CHANnel1");
do_query_string(":WAVEform:SOURce?");
printf("Waveform source: %s\n", str_result);

/* Choose the format of the data returned: */
do_command(":WAVEform:FORMat WORD");
do_query_string(":WAVEform:FORMat?");
printf("Waveform format: %s\n", str_result);

/* Display the waveform settings: */
do_query_number(":WAVEform:XINCrement?");
x_increment = num_result;
printf("Waveform X increment: %e\n", x_increment);

do_query_number(":WAVEform:XORigin?");
x_origin = num_result;
printf("Waveform X origin: %e\n", x_origin);

do_query_number(":WAVEform:YINCrement?");
y_increment = num_result;
printf("Waveform Y increment: %e\n", y_increment);

do_query_number(":WAVEform:YORigin?");
y_origin = num_result;
printf("Waveform Y origin: %e\n", y_origin);

/* Read waveform data. */
num_values = do_query_ieeeblock_words(":WAVEform:DATA?");
printf("Number of data values: %d\n", num_values);

/* Open file for output. */
fp = fopen("c:\\scope\\data\\waveform_data.csv", "wb");

/* Output waveform data in CSV format. */
for (i = 0; i < num_values - 1; i++)
{
    /* Write time value, voltage value. */
    fprintf(fp, "%9f, %6f\n",
        x_origin + ((float)i * x_increment),
        ((float)ieeeblock_data_words[i] * y_increment) + y_origin);
}

/* Close output file. */
fclose(fp);
printf("Waveform format WORD data written to ");
printf("c:\\scope\\data\\waveform_data.csv.\n");
}

```

```

/* Send a command to the instrument.
 * ----- */
void do_command(command)
char *command;
{
    char message[80];

    strcpy(message, command);
    strcat(message, "\n");
    err = viPrintf(vi, message);
    if (err != VI_SUCCESS) error_handler();

    check_instrument_errors();
}

/* Command with IEEE definite-length block.
 * ----- */
int do_command_ieeeblock(command, num_bytes)
char *command;
int num_bytes;
{
    char message[80];
    int data_length;

    strcpy(message, command);
    strcat(message, " #8%08d");
    err = viPrintf(vi, message, num_bytes);
    if (err != VI_SUCCESS) error_handler();

    err = viBufWrite(vi, ieeeblock_data, num_bytes, &data_length);
    if (err != VI_SUCCESS) error_handler();

    check_instrument_errors();

    return(data_length);
}

/* Query for a string result.
 * ----- */
void do_query_string(query)
char *query;
{
    char message[80];

    strcpy(message, query);
    strcat(message, "\n");

    err = viPrintf(vi, message);
    if (err != VI_SUCCESS) error_handler();

    err = viScanf(vi, "%t", str_result);
    if (err != VI_SUCCESS) error_handler();

    check_instrument_errors();
}

/* Query for a number result.

```

```

* ----- */
void do_query_number(query)
char *query;
{
    char message[80];

    strcpy(message, query);
    strcat(message, "\n");

    err = viPrintf(vi, message);
    if (err != VI_SUCCESS) error_handler();

    err = viScanf(vi, "%lf", &num_result);
    if (err != VI_SUCCESS) error_handler();

    check_instrument_errors();
}

/* Query for numbers result.
* ----- */
void do_query_numbers(query)
char *query;
{
    char message[80];

    strcpy(message, query);
    strcat(message, "\n");

    err = viPrintf(vi, message);
    if (err != VI_SUCCESS) error_handler();

    err = viScanf(vi, "%,10lf\n", dbl_results);
    if (err != VI_SUCCESS) error_handler();

    check_instrument_errors();
}

/* Query for an IEEE definite-length byte block result.
* ----- */
int do_query_ieeeblock(query)
char *query;
{
    char message[80];
    int data_length;

    strcpy(message, query);
    strcat(message, "\n");
    err = viPrintf(vi, message);
    if (err != VI_SUCCESS) error_handler();

    data_length = IEEEBLOCK_SPACE;
    err = viScanf(vi, "%#b\n", &data_length, ieeeblock_data);
    if (err != VI_SUCCESS) error_handler();

    if (data_length == IEEEBLOCK_SPACE )
    {
        printf("IEEE block buffer full: ");
    }
}

```

```

        printf("May not have received all data.\n");
    }

    check_instrument_errors();

    return(data_length);
}

/* Query for an IEEE definite-length word block result.
 * ----- */
int do_query_ieeeblock_words(query)
char *query;
{
    char message[80];
    int data_length;

    strcpy(message, query);
    strcat(message, "\n");
    err = viPrintf(vi, message);
    if (err != VI_SUCCESS) error_handler();

    data_length = IEEEBLOCK_SPACE;
    err = viScanf(vi, "%#hb\n", &data_length, ieeeblock_data_words);
    if (err != VI_SUCCESS) error_handler();

    if (data_length == IEEEBLOCK_SPACE )
    {
        printf("IEEE block buffer full: ");
        printf("May not have received all data.\n");
    }

    check_instrument_errors();

    return(data_length);
}

/* Check for instrument errors.
 * ----- */
void check_instrument_errors()
{
    char str_err_val[256] = {0};
    char str_out[800] = "";

    err = viQueryf(vi, ":SYSTEM:ERROR? STRING\n", "%t", str_err_val);
    if (err != VI_SUCCESS) error_handler();
    while(strncmp(str_err_val, "0,", 2) != 0 )
    {
        strcat(str_out, ", ");
        strcat(str_out, str_err_val);
        err = viQueryf(vi, ":SYSTEM:ERROR? STRING\n", "%t", str_err_val);
        if (err != VI_SUCCESS) error_handler();
    }

    if (strcmp(str_out, "") != 0)
    {
        printf("INST Error%s\n", str_out);
        err = viFlush(vi, VI_READ_BUF);
    }
}

```

```

        if (err != VI_SUCCESS) error_handler();
        err = viFlush(vi, VI_WRITE_BUF);
        if (err != VI_SUCCESS) error_handler();
    }
}

/* Handle VISA errors.
 * ----- */
void error_handler()
{
    char err_msg[1024] = {0};

    viStatusDesc(vi, err, err_msg);
    printf("VISA Error: %s\n", err_msg);
    if (err < VI_SUCCESS)
    {
        exit(1);
    }
}

```

## VISA Example in Visual Basic

To run this example in Visual Basic for Applications:

- 1 Start the application that provides Visual Basic for Applications (for example, Microsoft Excel).
- 2 Press ALT+F11 to launch the Visual Basic editor.
- 3 Add the visa32.bas file to your project:
  - a Choose **File > Import File...**
  - b Navigate to the header file, visa32.bas (installed with Keysight IO Libraries Suite and found in the Program Files (x86)\IVI Foundation\VISA\WinNT\Include), select it, and click **Open**.
- 4 Choose **Insert > Module**.
- 5 Cut-and-paste the code that follows into the editor.
- 6 Edit the program to use the VISA address of your oscilloscope, and save the changes.
- 7 Run the program.

```

'
' Keysight VISA Example in Visual Basic
' -----
' This program illustrates a few commonly-used programming
' features of your Keysight Infiniium Series oscilloscope.
' -----

Option Explicit

Public err As Long ' Error returned by VISA function calls.
Public drm As Long ' Session to Default Resource Manager.
Public vi As Long ' Session to instrument.

```

```

' Declare variables to hold numeric values returned by
' viVScanf/viVQueryf.
Public dblQueryResult As Double
Public Const ByteArraySize = 5000000
Public Const WordArraySize = 5000000
Public retCount As Long
Public byteArray(ByteArraySize) As Byte
Public wordArray(WordArraySize) As Integer
Public paramsArray(2) As Long
Public Const DblArraySize = 20
Public dblArray(DblArraySize) As Double

' Declare fixed length string variable to hold string value returned
' by viVScanf/viVQueryf.
Public strQueryResult As String * 200

' For Sleep subroutine.
Private Declare Sub Sleep Lib "kernel32" (ByVal dwMilliseconds As Long)

'
' Main Program
' -----

Sub Main()

' Open the default resource manager session.
err = viOpenDefaultRM(drm)
If (err <> VI_SUCCESS) Then HandleVISAError drm

' Open the session using the oscilloscope's VISA address.
err = viOpen(drm, _
    "TCPIP0::141.121.237.226::hislip0::INSTR", 0, 15000, vi)
If (err <> VI_SUCCESS) Then HandleVISAError drm

' Set the I/O timeout to ten seconds.
err = viSetAttribute(vi, VI_ATTR_TMO_VALUE, 10000)
If (err <> VI_SUCCESS) Then HandleVISAError vi

' Clear the interface.
err = viClear(vi)
If Not (err = VI_SUCCESS) Then HandleVISAError vi

' Initialize - start from a known state.
Initialize

' Capture data.
Capture

' Analyze the captured waveform.
Analyze

' Close the vi session and the resource manager session.
err = viClose(vi)
err = viClose(drm)

End Sub

```

```

'
' Initialize the oscilloscope to a known state.
' -----

Private Sub Initialize()

    ' Clear status.
    DoCommand "*CLS"

    ' Get and display the device's *IDN? string.
    strQueryResult = DoQueryString("*IDN?")
    MsgBox "*IDN? string: " + strQueryResult, vbOKOnly, "*IDN? Result"

    ' Load the default setup.
    DoCommand "*RST"

End Sub

'
' Capture the waveform.
' -----

Private Sub Capture()

    ' Set probe attenuation factor.
    DoCommand ":CHANnel1:PROBe 1.0"
    Debug.Print "Channel 1 probe attenuation factor: " + _
        DoQueryString(":CHANnel1:PROBe?")

    ' Use auto-scale to automatically configure oscilloscope.
    ' -----
    DoCommand ":AUToscale"

    ' Set trigger mode (EDGE, PULSe, PATtern, etc., and input source.
    DoCommand ":TRIGger:MODE EDGE"
    Debug.Print "Trigger mode: " + _
        DoQueryString(":TRIGger:MODE?")

    ' Set EDGE trigger parameters.
    DoCommand ":TRIGger:EDGE:SOURCe CHANnel1"
    Debug.Print "Trigger edge source: " + _
        DoQueryString(":TRIGger:EDGE:SOURce?")

    DoCommand ":TRIGger:LEVel CHANnel1,-2E-3"
    Debug.Print "Trigger level, channel 1: " + _
        DoQueryString(":TRIGger:LEVel? CHANnel1")

    DoCommand ":TRIGger:EDGE:SLOPe POSitive"
    Debug.Print "Trigger edge slope: " + _
        DoQueryString(":TRIGger:EDGE:SLOPe?")

    ' Save oscilloscope configuration.
    ' -----
    Dim lngSetupStringSize As Long
    lngSetupStringSize = DoQueryIEEEBlock_Bytes(":SYSTem:SETup?")
    Debug.Print "Setup bytes saved: " + CStr(lngSetupStringSize)

```



```

' Output setup string to a file:
Dim strPath As String
strPath = "c:\scope\config\setup.dat"
If Len(Dir(strPath)) Then
    Kill strPath ' Remove file if it exists.
End If

' Open file for output.
Dim hFile As Long
hFile = FreeFile
Open strPath For Binary Access Write Lock Write As hFile
Dim lngI As Long
For lngI = 0 To lngSetupStringSize - 1
    Put hFile, , byteArray(lngI) ' Write data.
Next lngI
Close hFile ' Close file.

' Change settings with individual commands:
' -----

' Set vertical scale and offset.
DoCommand ":CHANnel1:SCALE 0.1"
Debug.Print "Channel 1 vertical scale: " + _
    DoQueryString(":CHANnel1:SCALE?")

DoCommand ":CHANnel1:OFFSet 0.0"
Debug.Print "Channel 1 vertical offset: " + _
    DoQueryString(":CHANnel1:OFFSet?")

' Set horizontal scale and position.
DoCommand ":TIMEbase:SCALE 0.0002"
Debug.Print "Timebase scale: " + _
    DoQueryString(":TIMEbase:SCALE?")

DoCommand ":TIMEbase:POSition 0.0"
Debug.Print "Timebase position: " + _
    DoQueryString(":TIMEbase:POSition?")

' Set the acquisition mode.
DoCommand ":ACquire:MODE RTIME"
Debug.Print "Acquire mode: " + _
    DoQueryString(":ACquire:MODE?")

' Or, configure by loading a previously saved setup.
' -----
strPath = "c:\scope\config\setup.dat"
Open strPath For Binary Access Read As hFile ' Open file for input.
Dim lngSetupFileSize As Long
lngSetupFileSize = LOF(hFile) ' Length of file.
Get hFile, , byteArray ' Read data.
Close hFile ' Close file.
' Write learn string back to oscilloscope using ":SYSTEM:SETup"
' command:
Dim lngRestored As Long
lngRestored = DoCommandIEEEBlock(":SYSTEM:SETup", lngSetupFileSize)
Debug.Print "Setup bytes restored: " + CStr(lngRestored)

```

```

' Set the desired number of waveform points,
' and capture an acquisition.
' -----
DoCommand ":ACquire:POINts 32000"
DoCommand ":DIGitize"

End Sub

'
' Analyze the captured waveform.
' -----

Private Sub Analyze()

' Make a couple of measurements.
' -----
DoCommand ":MEASure:SOURce CHANnel1"
Debug.Print "Measure source: " + _
    DoQueryString(":MEASure:SOURce?")

DoCommand ":MEASure:FREQuency"
dblQueryResult = DoQueryNumber(":MEASure:FREQuency?")
MsgBox "Frequency:" + vbCrLf + _
    FormatNumber(dblQueryResult / 1000, 4) + " kHz"

DoCommand ":MEASure:VAMPlitude"
dblQueryResult = DoQueryNumber(":MEASure:VAMPlitude?")
MsgBox "Vertical amplitude:" + vbCrLf + _
    FormatNumber(dblQueryResult, 4) + " V"

' Download the screen image.
' -----

' Get screen image.
Dim lngBlockSize As Long
lngBlockSize = DoQueryIEEEBlock_Bytes(":DISPlay:DATA? PNG")
Debug.Print "Screen image bytes: " + CStr(lngBlockSize)

' Save screen image to a file:
Dim strPath As String
strPath = "c:\scope\data\screen.png"
If Len(Dir(strPath)) Then
    Kill strPath ' Remove file if it exists.
End If
Dim hFile As Long
hFile = FreeFile
Open strPath For Binary Access Write Lock Write As hFile
Dim lngI As Long
For lngI = 0 To lngBlockSize - 1
    Put hFile, , byteArray(lngI) ' Write data.
Next lngI
Close hFile ' Close file.
MsgBox "Screen image written to " + strPath

```

```

' Download waveform data.
' -----

' Get the waveform type.
Debug.Print "Waveform type: " + _
    DoQueryString(":WAVEform:TYPE?")

' Get the number of waveform points.
Debug.Print "Waveform points: " + _
    DoQueryString(":WAVEform:POINTS?")

' Set the waveform source.
DoCommand ":WAVEform:SOURce CHANnel1"
Debug.Print "Waveform source: " + _
    DoQueryString(":WAVEform:SOURce?")

' Choose the format of the data returned:
DoCommand ":WAVEform:FORMat WORD"
Debug.Print "Waveform format: " + _
    DoQueryString(":WAVEform:FORMat?")

' Display the waveform settings:
Dim dblXIncrement As Double
Dim dblXOrigin As Double
Dim dblYIncrement As Double
Dim dblYOrigin As Double

dblXIncrement = DoQueryNumber(":WAVEform:XINCrement?")
Debug.Print "Waveform X increment: " + _
    Format(dblXIncrement, "Scientific")

dblXOrigin = DoQueryNumber(":WAVEform:XORigin?")
Debug.Print "Waveform X origin: " + _
    Format(dblXOrigin, "Scientific")

dblYIncrement = DoQueryNumber(":WAVEform:YINCrement?")
Debug.Print "Waveform Y increment: " + _
    Format(dblYIncrement, "Scientific")

dblYOrigin = DoQueryNumber(":WAVEform:YORigin?")
Debug.Print "Waveform Y origin: " + _
    FormatNumber(dblYOrigin, 0)

' Get the waveform data
DoCommand ":WAVEform:STReaming OFF"
Dim lngNumWords As Long
lngNumWords = DoQueryIEEEBlock_Words(":WAVEform:DATA?")
Debug.Print "Number of data values: " + CStr(lngNumWords)

' Set up output file:
strPath = "c:\scope\data\waveform_data.csv"

' Open file for output.
Open strPath For Output Access Write Lock Write As hFile

' Output waveform data in CSV format.
For lngI = 0 To lngNumWords - 1

```

```

    ' Write time value, voltage value.
    Print #hFile, _
        FormatNumber(dblXOrigin + (lngI * dblXIncrement), 9) + _
        ", " + _
        FormatNumber((wordArray(lngI) * dblYIncrement) + dblYOrigin)

Next lngI

' Close output file.
Close hFile ' Close file.
MsgBox "Waveform format WORD data written to " + _
    "c:\scope\data\waveform_data.csv."

End Sub

Private Sub DoCommand(command As String)

    err = viVPrintf(vi, command + vbLf, 0)
    If (err <> VI_SUCCESS) Then HandleVISAError vi

    CheckInstrumentErrors

End Sub

Private Function DoCommandIEEEBlock(command As String, _
    lngBlockSize As Long)

    retCount = lngBlockSize

    Dim strCommandAndLength As String
    strCommandAndLength = command + " %#" + _
        Format(lngBlockSize) + "b"

    err = viVPrintf(vi, strCommandAndLength + vbLf, paramsArray(1))
    If (err <> VI_SUCCESS) Then HandleVISAError vi

    DoCommandIEEEBlock = retCount

    CheckInstrumentErrors

End Function

Private Function DoQueryString(query As String) As String

    Dim strResult As String * 200

    err = viVPrintf(vi, query + vbLf, 0)
    If (err <> VI_SUCCESS) Then HandleVISAError vi

    err = viVScanf(vi, "%t", strResult)
    If (err <> VI_SUCCESS) Then HandleVISAError vi

    DoQueryString = strResult

    CheckInstrumentErrors

```

```

End Function

Private Function DoQueryNumber(query As String) As Variant

    Dim dblResult As Double

    err = viVPrintf(vi, query + vbLf, 0)
    If (err <> VI_SUCCESS) Then HandleVISAError vi

    err = viVScanf(vi, "%lf" + vbLf, VarPtr(dblResult))
    If (err <> VI_SUCCESS) Then HandleVISAError vi

    DoQueryNumber = dblResult

    CheckInstrumentErrors

End Function

Private Function DoQueryNumbers(query As String) As Long

    Dim dblResult As Double

    ' Send query.
    err = viVPrintf(vi, query + vbLf, 0)
    If (err <> VI_SUCCESS) Then HandleVISAError vi

    ' Set up paramsArray for multiple parameter query returning array.
    paramsArray(0) = VarPtr(retCount)
    paramsArray(1) = VarPtr(dblArray(0))

    ' Set retCount to max number of elements array can hold.
    retCount = DblArraySize

    ' Read numbers.
    err = viVScanf(vi, "%,#lf" + vbLf, paramsArray(0))
    If (err <> VI_SUCCESS) Then HandleVISAError vi

    ' retCount is now actual number of values returned by query.
    DoQueryNumbers = retCount

    CheckInstrumentErrors

End Function

Private Function DoQueryIEEEBlock_Bytes(query As String) As Long

    ' Send query.
    err = viVPrintf(vi, query + vbLf, 0)
    If (err <> VI_SUCCESS) Then HandleVISAError vi

    ' Set up paramsArray for multiple parameter query returning array.
    paramsArray(0) = VarPtr(retCount)
    paramsArray(1) = VarPtr(byteArray(0))

    ' Set retCount to max number of elements array can hold.
    retCount = ByteArraySize

```

```

' Get unsigned integer bytes.
err = viVScanf(vi, "%#b" + vbLf, paramsArray(0))
If (err <> VI_SUCCESS) Then HandleVISAError vi

err = viFlush(vi, VI_READ_BUF)
If (err <> VI_SUCCESS) Then HandleVISAError vi

err = viFlush(vi, VI_WRITE_BUF)
If (err <> VI_SUCCESS) Then HandleVISAError vi

' retCount is now actual number of bytes returned by query.
DoQueryIEEEBlock_Bytes = retCount

CheckInstrumentErrors

End Function

Private Function DoQueryIEEEBlock_Words(query As String) As Long

' Send query.
err = viVPrintf(vi, query + vbLf, 0)
If (err <> VI_SUCCESS) Then HandleVISAError vi

' Set up paramsArray for multiple parameter query returning array.
paramsArray(0) = VarPtr(retCount)
paramsArray(1) = VarPtr(wordArray(0))

' Set retCount to max number of elements array can hold.
retCount = WordArraySize

' Get signed integer words.
err = viVScanf(vi, "%#hb" + vbLf, paramsArray(0))
If (err <> VI_SUCCESS) Then HandleVISAError vi

err = viFlush(vi, VI_READ_BUF)
If (err <> VI_SUCCESS) Then HandleVISAError vi

err = viFlush(vi, VI_WRITE_BUF)
If (err <> VI_SUCCESS) Then HandleVISAError vi

' retCount is now actual number of bytes returned by query.
DoQueryIEEEBlock_Words = retCount

CheckInstrumentErrors

End Function

Private Sub CheckInstrumentErrors()

On Error GoTo ErrorHandler

Dim strErrVal As String * 200
Dim strOut As String

err = viVPrintf(vi, ":SYSTEM:ERROR? STRING" + vbLf, 0) ' Query any errors.
If (err <> VI_SUCCESS) Then HandleVISAError vi

```

```

err = viVScanf(vi, "%t", strErrVal) ' Read: Errnum,"Error String".
If (err <> VI_SUCCESS) Then HandleVISAError vi

While Val(strErrVal) <> 0 ' End if find: 0,"No Error".
    strOut = strOut + "INST Error: " + strErrVal

    err = viVPrintf(vi, ":SYSTEM:ERROR? STRING" + vbLf, 0) ' Request error
or.
    If (err <> VI_SUCCESS) Then HandleVISAError vi

    err = viVScanf(vi, "%t", strErrVal) ' Read error message.
    If (err <> VI_SUCCESS) Then HandleVISAError vi

Wend

If Not strOut = "" Then
    MsgBox strOut, vbExclamation, "INST Error Messages"

    err = viFlush(vi, VI_READ_BUF)
    If (err <> VI_SUCCESS) Then HandleVISAError vi

    err = viFlush(vi, VI_WRITE_BUF)
    If (err <> VI_SUCCESS) Then HandleVISAError vi

End If

Exit Sub

ErrorHandler:

MsgBox "*** Error : " + Error, vbExclamation
End

End Sub

Private Sub HandleVISAError(session As Long)

Dim strVisaErr As String * 200
Call viStatusDesc(session, err, strVisaErr)
MsgBox "*** VISA Error : " + strVisaErr, vbExclamation

' If the error is not a warning, close the session.
If err < VI_SUCCESS Then
    If session <> 0 Then Call viClose(session)
    End
End If

End Sub

```

## VISA Example in C#

To compile and run this example in Microsoft Visual Studio 2008:

- 1 Open Visual Studio.
- 2 Create a new Visual C#, Windows, Console Application project.
- 3 Cut-and-paste the code that follows into the C# source file.
- 4 Edit the program to use the VISA address of your oscilloscope.
- 5 Add Keysight's VISA header file to your project:
  - a Right-click the project you wish to modify (not the solution) in the Solution Explorer window of the Microsoft Visual Studio environment.
  - b Click **Add** and then click **Add Existing Item...**
  - c Navigate to the header file, visa32.cs (installed with Keysight IO Libraries Suite and found in the Program Files (x86)\IVI Foundation\VISA\WinNT\Include directory), select it, but *do not click the Open button*.
  - d Click the down arrow to the right of the **Add** button, and choose **Add as Link**.

You should now see the file underneath your project in the Solution Explorer. It will have a little arrow icon in its lower left corner, indicating that it is a link.

- 6 Build and run the program.

For more information, see the tutorial on using VISA in Microsoft .NET in the VISA Help that comes with Keysight IO Libraries Suite 15.

```

/*
 * Keysight VISA Example in C#
 * -----
 * This program illustrates a few commonly used programming
 * features of your Keysight Infiniium Series oscilloscope.
 * -----
 */

using System;
using System.IO;
using System.Text;
using System.Collections.Generic;

namespace Infiniium
{
    class VisaInstrumentApp
    {
        private static VisaInstrument myScope;

        public static void Main(string[] args)
        {
            try
            {
                myScope = new
                    VisaInstrument("TCPIP0::141.121.237.226::hislip0::INSTR");
            }
        }
    }
}

```



```

myScope.SetTimeoutSeconds(10);

// Initialize - start from a known state.
Initialize();

// Capture data.
Capture();

// Analyze the captured waveform.
Analyze();

}
catch (System.ApplicationException err)
{
    Console.WriteLine("*** VISA Error Message : " + err.Message);
}
catch (System.SystemException err)
{
    Console.WriteLine("*** System Error Message : " + err.Message);
}
catch (System.Exception err)
{
    System.Diagnostics.Debug.Fail("Unexpected Error");
    Console.WriteLine("*** Unexpected Error : " + err.Message);
}
finally
{
    myScope.Close();
}
}

/*
 * Initialize the oscilloscope to a known state.
 * -----
 */
private static void Initialize()
{
    StringBuilder strResults;

    // Clear status.
    myScope.DoCommand("*CLS");

    // Get and display the device's *IDN? string.
    strResults = myScope.DoQueryString("*IDN?");
    Console.WriteLine("*IDN? result is: {0}", strResults);

    // Load the default setup.
    myScope.DoCommand("*RST");
}

/*
 * Capture the waveform.
 * -----
 */
private static void Capture()
{
    // Set probe attenuation factor.

```

```

myScope.DoCommand(":CHANnel1:PROBe 1.0");
Console.WriteLine("Channel 1 probe attenuation factor: {0}",
    myScope.DoQueryString(":CHANnel1:PROBE?"));

// Use auto-scale to automatically set up oscilloscope.
myScope.DoCommand(":AUToscale");

// Set trigger mode.
myScope.DoCommand(":TRIGger:MODE EDGE");
Console.WriteLine("Trigger mode: {0}",
    myScope.DoQueryString(":TRIGger:MODE?"));

// Set EDGE trigger parameters.
myScope.DoCommand(":TRIGger:EDGE:SOURCe CHANnel1");
Console.WriteLine("Trigger edge source: {0}",
    myScope.DoQueryString(":TRIGger:EDGE:SOURce?"));

myScope.DoCommand(":TRIGger:LEVel CHANnel1,-2E-3");
Console.WriteLine("Trigger level, channel 1: {0}",
    myScope.DoQueryString(":TRIGger:LEVel? CHANnel1"));

myScope.DoCommand(":TRIGger:EDGE:SLOPe POSitive");
Console.WriteLine("Trigger edge slope: {0}",
    myScope.DoQueryString(":TRIGger:EDGE:SLOPe?"));

// Save oscilloscope configuration.
byte[] ResultsArray; // Results array.
int nLength; // Number of bytes returned from instrument.
string strPath;

// Query and read setup string.
nLength = myScope.DoQueryIEEEBlock_Bytes(":SYSTem:SETup?",
    out ResultsArray);

// Write setup string to file.
strPath = "c:\\scope\\config\\setup.stp";
FileStream fStream = File.Open(strPath, FileMode.Create);
fStream.Write(ResultsArray, 0, nLength);
fStream.Close();
Console.WriteLine("Setup bytes saved: {0}", nLength);

// Change settings with individual commands:

// Set vertical scale and offset.
myScope.DoCommand(":CHANnel1:SCALe 0.1");
Console.WriteLine("Channel 1 vertical scale: {0}",
    myScope.DoQueryString(":CHANnel1:SCALE?"));

myScope.DoCommand(":CHANnel1:OFFSet 0.0");
Console.WriteLine("Channel 1 vertical offset: {0}",
    myScope.DoQueryString(":CHANnel1:OFFSet?"));

// Set horizontal scale and position.
myScope.DoCommand(":TIMEbase:SCALe 0.0002");
Console.WriteLine("Timebase scale: {0}",
    myScope.DoQueryString(":TIMEbase:SCALE?"));

```

```

myScope.DoCommand(":TIMEbase:POSition 0.0");
Console.WriteLine("Timebase position: {0}",
    myScope.DoQueryString(":TIMEbase:POSition?"));

// Set the acquisition mode.
myScope.DoCommand(":ACquire:MODE RTIME");
Console.WriteLine("Acquire mode: {0}",
    myScope.DoQueryString(":ACquire:MODE?"));

// Or, set up by loading a previously saved setup.
byte[] dataArray;
int nBytesWritten;

// Read setup string from file.
strPath = "c:\\scope\\config\\setup.stp";
dataArray = File.ReadAllBytes(strPath);

// Restore setup string.
nBytesWritten = myScope.DoCommandIEEEBlock(":SYSTEM:SETup",
    dataArray);
Console.WriteLine("Setup bytes restored: {0}", nBytesWritten);

// Set the desired number of waveform points,
// and capture an acquisition.
myScope.DoCommand(":ACquire:POINTs 32000");
myScope.DoCommand(":DIGitize");
}

/*
 * Analyze the captured waveform.
 * -----
 */
private static void Analyze()
{
    byte[] resultsArray; // Results array.
    short[] wordResultsArray; // Results array for WORD data.
    int nLength; // Number of bytes returned from instrument.
    string strPath;

    // Make measurements.
    // -----
    myScope.DoCommand(":MEASure:SOURce CHANnel1");
    Console.WriteLine("Measure source: {0}",
        myScope.DoQueryString(":MEASure:SOURce?"));

    double fResult;
    myScope.DoCommand(":MEASure:FREquency");
    fResult = myScope.DoQueryNumber(":MEASure:FREquency?");
    Console.WriteLine("Frequency: {0:F4} kHz", fResult / 1000);

    myScope.DoCommand(":MEASure:VAMplitude");
    fResult = myScope.DoQueryNumber(":MEASure:VAMplitude?");
    Console.WriteLine("Vertical amplitude: {0:F2} V", fResult);

    // Download the screen image.
    // -----

```

```

// Get the screen data.
nLength = myScope.DoQueryIEEEBlock_Bytes(":DISPlay:DATA? PNG",
    out ResultsArray);

// Store the screen data to a file.
strPath = "c:\\scope\\data\\screen.png";
FileStream fStream = File.Open(strPath, FileMode.Create);
fStream.Write(ResultsArray, 0, nLength);
fStream.Close();
Console.WriteLine("Screen image ({0} bytes) written to {1}",
    nLength, strPath);

// Download waveform data.
// -----

// Get the waveform type.
Console.WriteLine("Waveform type: {0}",
    myScope.DoQueryString(":WAVEform:TYPE?"));

// Get the number of waveform points.
Console.WriteLine("Waveform points: {0}",
    myScope.DoQueryString(":WAVEform:POINTs?"));

// Set the waveform source.
myScope.DoCommand(":WAVEform:SOURce CHANnel1");
Console.WriteLine("Waveform source: {0}",
    myScope.DoQueryString(":WAVEform:SOURce?"));

// Choose the format of the data returned:
myScope.DoCommand(":WAVEform:FORMat WORD");
Console.WriteLine("Waveform format: {0}",
    myScope.DoQueryString(":WAVEform:FORMat?"));

// Display the waveform settings from preamble:
Dictionary<string, string> dctWavFormat =
    new Dictionary<string, string>()
    {
        {"0", "ASCIi"},
        {"1", "BYTE"},
        {"2", "WORD"},
        {"3", "LONG"},
        {"4", "LONGLONG"},
    };
Dictionary<string, string> dctAcqType =
    new Dictionary<string, string>()
    {
        {"1", "RAW"},
        {"2", "AVERage"},
        {"3", "VHIStogram"},
        {"4", "HHIStogram"},
        {"6", "INTerpolate"},
        {"10", "PDETECT"},
    };
Dictionary<string, string> dctAcqMode =
    new Dictionary<string, string>()
    {
        {"0", "RTIME"},
    }

```

```

        {"1", "ETIME"},
        {"3", "PDETECT"},
    };
Dictionary<string, string> dctCoupling =
    new Dictionary<string, string>()
    {
        {"0", "AC"},
        {"1", "DC"},
        {"2", "DCFIFTY"},
        {"3", "LFREJECT"},
    };
Dictionary<string, string> dctUnits =
    new Dictionary<string, string>()
    {
        {"0", "UNKNOWN"},
        {"1", "VOLT"},
        {"2", "SECOND"},
        {"3", "CONSTANT"},
        {"4", "AMP"},
        {"5", "DECIBEL"},
    };
string strPreamble;
string[] strsPreamble;

strPreamble =
    myScope.DoQueryString(":WAVEform:PREamble?").ToString();
strsPreamble = strPreamble.Split(',');

Console.WriteLine("Waveform format: {0}",
    dctWavFormat[strsPreamble[0]]);

Console.WriteLine("Acquire type: {0}",
    dctAcqType[strsPreamble[1]]);

Console.WriteLine("Waveform points: {0}", strPreamble[2]);
Console.WriteLine("Waveform average count: {0}", strPreamble[3]);
Console.WriteLine("Waveform X increment: {0}", strPreamble[4]);
Console.WriteLine("Waveform X origin: {0}", strPreamble[5]);
Console.WriteLine("Waveform X reference: {0}", strPreamble[6]);
Console.WriteLine("Waveform Y increment: {0}", strPreamble[7]);
Console.WriteLine("Waveform Y origin: {0}", strPreamble[8]);
Console.WriteLine("Waveform Y reference: {0}", strPreamble[9]);
Console.WriteLine("Coupling: {0}", dctCoupling[strsPreamble[10]]);
Console.WriteLine("Waveform X display range: {0}",
    strPreamble[11]);
Console.WriteLine("Waveform X display origin: {0}",
    strPreamble[12]);
Console.WriteLine("Waveform Y display range: {0}",
    strPreamble[13]);
Console.WriteLine("Waveform Y display origin: {0}",
    strPreamble[14]);
Console.WriteLine("Date: {0}", strPreamble[15]);
Console.WriteLine("Time: {0}", strPreamble[16]);
Console.WriteLine("Frame model: {0}", strPreamble[17]);
Console.WriteLine("Acquire mode: {0}",
    dctAcqMode[strsPreamble[18]]);
Console.WriteLine("Completion pct: {0}", strPreamble[19]);

```

```

Console.WriteLine("Waveform X units: {0}",
    dctUnits[strsPreamble[20]]);
Console.WriteLine("Waveform Y units: {0}",
    dctUnits[strsPreamble[21]]);
Console.WriteLine("Max BW limit: {0}", strsPreamble[22]);
Console.WriteLine("Min BW limit: {0}", strsPreamble[23]);

// Get numeric values for later calculations.
double fXincrement;
fXincrement = myScope.DoQueryNumber(":WAVEform:XINCrement?");
double fXorigin;
fXorigin = myScope.DoQueryNumber(":WAVEform:XORigin?");
double fYincrement;
fYincrement = myScope.DoQueryNumber(":WAVEform:YINCrement?");
double fYorigin;
fYorigin = myScope.DoQueryNumber(":WAVEform:YORigin?");

// Get the waveform data.
myScope.DoCommand(":WAVEform:STReaming OFF");
nLength = myScope.DoQueryIEEEBlock_Words(":WAVEform:DATA?",
    out WordResultsArray);
Console.WriteLine("Number of data values: {0}", nLength);

// Set up output file:
strPath = "c:\\scope\\data\\waveform_data.csv";
if (File.Exists(strPath)) File.Delete(strPath);

// Open file for output.
StreamWriter writer = File.CreateText(strPath);

// Output waveform data in CSV format.
for (int i = 0; i < nLength - 1; i++)
    writer.WriteLine("{0:f9}, {1:f6}",
        fXorigin + ((float)i * fXincrement),
        ((float)WordResultsArray[i] * fYincrement) + fYorigin);

// Close output file.
writer.Close();
Console.WriteLine("Waveform format WORD data written to {0}",
    strPath);
}
}

class VisaInstrument
{
    private int m_nResourceManager;
    private int m_nSession;
    private string m_strVisaAddress;

    // Constructor.
    public VisaInstrument(string strVisaAddress)
    {
        // Save VISA address in member variable.
        m_strVisaAddress = strVisaAddress;

        // Open the default VISA resource manager.
        OpenResourceManager();
    }
}

```

```

    // Open a VISA resource session.
    OpenSession();

    // Clear the interface.
    int nViStatus;
    nViStatus = visa32.viClear(m_nSession);
}

public void DoCommand(string strCommand)
{
    // Send the command.
    VisaSendCommandOrQuery(strCommand);

    // Check for inst errors.
    CheckInstrumentErrors(strCommand);
}

public int DoCommandIEEEBlock(string strCommand,
    byte[] dataArray)
{
    // Send the command to the device.
    string strCommandAndLength;
    int nViStatus, nLength, nBytesWritten;

    nLength = dataArray.Length;
    strCommandAndLength = String.Format("{0} #8%08d",
        strCommand);

    // Write first part of command to formatted I/O write buffer.
    nViStatus = visa32.viPrintf(m_nSession, strCommandAndLength,
        nLength);
    CheckVisaStatus(nViStatus);

    // Write the data to the formatted I/O write buffer.
    nViStatus = visa32.viBufWrite(m_nSession, dataArray, nLength,
        out nBytesWritten);
    CheckVisaStatus(nViStatus);

    // Check for inst errors.
    CheckInstrumentErrors(strCommand);

    return nBytesWritten;
}

public StringBuilder DoQueryString(string strQuery)
{
    // Send the query.
    VisaSendCommandOrQuery(strQuery);

    // Get the result string.
    StringBuilder strResults = new StringBuilder(1000);
    strResults = VisaGetResultString();

    // Check for inst errors.
    CheckInstrumentErrors(strQuery);
}

```

```

    // Return string results.
    return strResults;
}

public double DoQueryNumber(string strQuery)
{
    // Send the query.
    VisaSendCommandOrQuery(strQuery);

    // Get the result string.
    double fResults;
    fResults = VisaGetResultNumber();

    // Check for inst errors.
    CheckInstrumentErrors(strQuery);

    // Return string results.
    return fResults;
}

public double[] DoQueryNumbers(string strQuery)
{
    // Send the query.
    VisaSendCommandOrQuery(strQuery);

    // Get the result string.
    double[] fResultsArray;
    fResultsArray = VisaGetResultNumbers();

    // Check for inst errors.
    CheckInstrumentErrors(strQuery);

    // Return string results.
    return fResultsArray;
}

public int DoQueryIEEEBlock_Bytes(string strQuery,
    out byte[] ResultsArray)
{
    // Send the query.
    VisaSendCommandOrQuery(strQuery);

    // Get the result string.
    int length; // Number of bytes returned from instrument.
    length = VisaGetResultIEEEBlock_Bytes(out ResultsArray);

    // Check for inst errors.
    CheckInstrumentErrors(strQuery);

    // Return string results.
    return length;
}

public int DoQueryIEEEBlock_Words(string strQuery,
    out short[] ResultsArray)
{
    // Send the query.

```



```

VisaSendCommandOrQuery(strQuery);

// Get the result string.
int length; // Number of bytes returned from instrument.
length = VisaGetResultIEEEBlock_Words(out ResultsArray);

// Check for inst errors.
CheckInstrumentErrors(strQuery);

// Return string results.
return length;
}

private void VisaSendCommandOrQuery(string strCommandOrQuery)
{
    // Send command or query to the device.
    string strWithNewline;
    strWithNewline = String.Format("{0}\n", strCommandOrQuery);
    int nViStatus;
    nViStatus = visa32.viPrintf(m_nSession, strWithNewline);
    CheckVisaStatus(nViStatus);
}

private StringBuilder VisaGetResultString()
{
    StringBuilder strResults = new StringBuilder(1000);

    // Read return value string from the device.
    int nViStatus;
    nViStatus = visa32.viScanf(m_nSession, "%1000t", strResults);
    CheckVisaStatus(nViStatus);

    return strResults;
}

private double VisaGetResultNumber()
{
    double fResults = 0;

    // Read return value string from the device.
    int nViStatus;
    nViStatus = visa32.viScanf(m_nSession, "%lf", out fResults);
    CheckVisaStatus(nViStatus);

    return fResults;
}

private double[] VisaGetResultNumbers()
{
    double[] fResultsArray;
    fResultsArray = new double[10];

    // Read return value string from the device.
    int nViStatus;
    nViStatus = visa32.viScanf(m_nSession, "%,10lf\n",
        fResultsArray);
    CheckVisaStatus(nViStatus);
}

```

```

    return fResultsArray;
}

private int VisaGetResultIEEEBlock_Bytes(out byte[] ResultsArray)
{
    // Results array, big enough to hold a PNG.
    ResultsArray = new byte[5000000];
    int length;    // Number of bytes returned from instrument.

    // Set the default number of bytes that will be contained in
    // the ResultsArray to 5,000,000.
    length = 5000000;

    // Read return value string from the device.
    int nViStatus;
    nViStatus = visa32.viScanf(m_nSession, "%#b", ref length,
        ResultsArray);
    CheckVisaStatus(nViStatus);

    // Write and read buffers need to be flushed after IEEE block?
    nViStatus = visa32.viFlush(m_nSession, visa32.VI_WRITE_BUF);
    CheckVisaStatus(nViStatus);

    nViStatus = visa32.viFlush(m_nSession, visa32.VI_READ_BUF);
    CheckVisaStatus(nViStatus);

    return length;
}

private int VisaGetResultIEEEBlock_Words(out short[] ResultsArray)
{
    // Results array, big enough to hold a PNG.
    ResultsArray = new short[5000000];
    int length;    // Number of words returned from instrument.

    // Set the default number of words that will be contained in
    // the ResultsArray to 5,000,000.
    length = 5000000;

    // Read return value string from the device.
    int nViStatus;
    nViStatus = visa32.viScanf(m_nSession, "%#hb", ref length,
        ResultsArray);
    CheckVisaStatus(nViStatus);

    // Write and read buffers need to be flushed after IEEE block?
    nViStatus = visa32.viFlush(m_nSession, visa32.VI_WRITE_BUF);
    CheckVisaStatus(nViStatus);

    nViStatus = visa32.viFlush(m_nSession, visa32.VI_READ_BUF);
    CheckVisaStatus(nViStatus);

    return length;
}

private void CheckInstrumentErrors(string strCommand)

```

```

{
    // Check for instrument errors.
    StringBuilder strInstrumentError = new StringBuilder(1000);
    bool bFirstError = true;

    do // While not "0,No error"
    {
        VisaSendCommandOrQuery(":SYSTem:ERRor? STRing");
        strInstrumentError = VisaGetResultString();

        if (!strInstrumentError.ToString().StartsWith("0, "))
        {
            if (bFirstError)
            {
                Console.WriteLine("ERROR(s) for command '{0}': ",
                    strCommand);
                bFirstError = false;
            }
            Console.Write(strInstrumentError);
        }
    } while (!strInstrumentError.ToString().StartsWith("0, "));
}

private void OpenResourceManager()
{
    int nViStatus;
    nViStatus =
        visa32.viOpenDefaultRM(out this.m_nResourceManager);
    if (nViStatus < visa32.VI_SUCCESS)
        throw new
            ApplicationException("Failed to open Resource Manager");
}

private void OpenSession()
{
    int nViStatus;
    nViStatus = visa32.viOpen(this.m_nResourceManager,
        this.m_strVisaAddress, visa32.VI_NO_LOCK,
        visa32.VI_TMO_IMMEDIATE, out this.m_nSession);
    CheckVisaStatus(nViStatus);
}

public void SetTimeoutSeconds(int nSeconds)
{
    int nViStatus;
    nViStatus = visa32.viSetAttribute(this.m_nSession,
        visa32.VI_ATTR_TMO_VALUE, nSeconds * 1000);
    CheckVisaStatus(nViStatus);
}

public void CheckVisaStatus(int nViStatus)
{
    // If VISA error, throw exception.
    if (nViStatus < visa32.VI_SUCCESS)
    {
        StringBuilder strError = new StringBuilder(256);
        visa32.viStatusDesc(this.m_nResourceManager, nViStatus,

```

```

        strError);
        throw new ApplicationException(strError.ToString());
    }
}

public void Close()
{
    if (m_nSession != 0)
        visa32.viClose(m_nSession);
    if (m_nResourceManager != 0)
        visa32.viClose(m_nResourceManager);
}
}
}

```

## VISA Example in Visual Basic .NET

To compile and run this example in Microsoft Visual Studio 2008:

- 1 Open Visual Studio.
- 2 Create a new Visual Basic, Windows, Console Application project.
- 3 Cut-and-paste the code that follows into the Visual Basic .NET source file.
- 4 Edit the program to use the VISA address of your oscilloscope.
- 5 Add Keysight's VISA header file to your project:
  - a Right-click the project you wish to modify (not the solution) in the Solution Explorer window of the Microsoft Visual Studio environment.
  - b Choose **Add** and then choose **Add Existing Item...**
  - c Navigate to the header file, visa32.vb (installed with Keysight IO Libraries Suite and found in the Program Files (x86)\IVI Foundation\VISA\WinNT\Include directory), select it, but *do not click the Open button*.
  - d Click the down arrow to the right of the **Add** button, and choose **Add as Link**.

You should now see the file underneath your project in the Solution Explorer. It will have a little arrow icon in its lower left corner, indicating that it is a link.

  - e Right-click the project again and choose **Properties**; then, select "Infiniium.VisaInstrumentApp" as the **Startup object**.
- 6 Build and run the program.

For more information, see the tutorial on using VISA in Microsoft .NET in the VISA Help that comes with Keysight IO Libraries Suite 15.

```

'
' Keysight VISA Example in Visual Basic .NET
' -----
' This program illustrates a few commonly-used programming
' features of your Keysight Infiniium Series oscilloscope.
' -----

```

```

Imports System
Imports System.IO
Imports System.Text

Namespace Infiniium
Class VisaInstrumentApp
Private Shared myScope As VisaInstrument

Public Shared Sub Main(ByVal args As String())
Try
myScope = _
New VisaInstrument("TCPIP0::141.121.237.226::hislip0::INSTR")
myScope.SetTimeoutSeconds(10)

' Initialize - start from a known state.
Initialize()

' Capture data.
Capture()

' Analyze the captured waveform.
Analyze()

Catch err As System.ApplicationException
Console.WriteLine("*** VISA Error Message : " + err.Message)
Catch err As System.SystemException
Console.WriteLine("*** System Error Message : " + err.Message)
Catch err As System.Exception
Debug.Fail("Unexpected Error")
Console.WriteLine("*** Unexpected Error : " + err.Message)
Finally
myScope.Close()
End Try
End Sub

'
' Initialize the oscilloscope to a known state.
' -----

Private Shared Sub Initialize()
Dim strResults As StringBuilder

' Clear status.
myScope.DoCommand("*CLS")

' Get and display the device's *IDN? string.
strResults = myScope.DoQueryString("*IDN?")
Console.WriteLine("*IDN? result is: {0}", strResults)

' Load the default setup.
myScope.DoCommand("*RST")

End Sub

'
' Capture the waveform.
' -----

```

```

Private Shared Sub Capture()

    ' Set probe attenuation factor.
    myScope.DoCommand(":CHANnel1:PROBE 1.0")
    Console.WriteLine("Channel 1 probe attenuation factor: {0}", _
        myScope.DoQueryString(":CHANnel1:PROBE?"))

    ' Use auto-scale to automatically set up oscilloscope.
    myScope.DoCommand(":AUToscale")

    ' Set trigger mode.
    myScope.DoCommand(":TRIGger:MODE EDGE")
    Console.WriteLine("Trigger mode: {0}", _
        myScope.DoQueryString(":TRIGger:MODE?"))

    ' Set EDGE trigger parameters.
    myScope.DoCommand(":TRIGger:EDGE:SOURCe CHANnel1")
    Console.WriteLine("Trigger edge source: {0}", _
        myScope.DoQueryString(":TRIGger:EDGE:SOURce?"))

    myScope.DoCommand(":TRIGger:LEVel CHANnel1, -2E-3")
    Console.WriteLine("Trigger edge level: {0}", _
        myScope.DoQueryString(":TRIGger:LEVel? CHANnel1"))

    myScope.DoCommand(":TRIGger:EDGE:SLOPe POSitive")
    Console.WriteLine("Trigger edge slope: {0}", _
        myScope.DoQueryString(":TRIGger:EDGE:SLOPe?"))

    ' Save oscilloscope setup.
    Dim ResultsArray As Byte() ' Results array.
    Dim nLength As Integer ' Number of bytes returned from inst.
    Dim strPath As String
    Dim fStream As FileStream

    ' Query and read setup string.
    nLength = myScope.DoQueryIEEEBlock_Bytes(":SYSTem:SETup?", _
        ResultsArray)

    ' Write setup string to file.
    strPath = "c:\scope\config\setup.stp"
    fStream = File.Open(strPath, FileMode.Create)
    fStream.Write(ResultsArray, 0, nLength)
    fStream.Close()
    Console.WriteLine("Setup bytes saved: {0}", nLength)

    ' Change settings with individual commands:

    ' Set vertical scale and offset.
    myScope.DoCommand(":CHANnel1:SCALe 0.1")
    Console.WriteLine("Channel 1 vertical scale: {0}", _
        myScope.DoQueryString(":CHANnel1:SCALe?"))

    myScope.DoCommand(":CHANnel1:OFFSet 0.0")
    Console.WriteLine("Channel 1 vertical offset: {0}", _
        myScope.DoQueryString(":CHANnel1:OFFSet?"))

```

```

' Set horizontal scale and position.
myScope.DoCommand(":TIMEbase:SCALE 0.0002")
Console.WriteLine("Timebase scale: {0}", _
    myScope.DoQueryString(":TIMEbase:SCALE?"))

myScope.DoCommand(":TIMEbase:POSition 0.0")
Console.WriteLine("Timebase position: {0}", _
    myScope.DoQueryString(":TIMEbase:POSition?"))

' Set the acquisition mode.
myScope.DoCommand(":ACQuire:MODE RTIME")
Console.WriteLine("Acquire mode: {0}", _
    myScope.DoQueryString(":ACQuire:MODE?"))

' Or, set up by loading a previously saved setup.
Dim dataArray As Byte()
Dim nBytesWritten As Integer

' Read setup string from file.
strPath = "c:\scope\config\setup.stp"
dataArray = File.ReadAllBytes(strPath)

' Restore setup string.
nBytesWritten = myScope.DoCommandIEEEBlock(":SYSTem:SETup", _
    dataArray)
Console.WriteLine("Setup bytes restored: {0}", nBytesWritten)

' Set the desired number of waveform points,
' and capture an acquisition.
myScope.DoCommand(":ACQuire:POINts 32000")
myScope.DoCommand(":DIGitize")

End Sub

'
' Analyze the captured waveform.
' -----

Private Shared Sub Analyze()

    Dim fResult As Double
    Dim ResultsArray As Byte() ' Results array.
    Dim WordResultsArray As Short() ' Results array for WORD data.
    Dim nLength As Integer ' Number of bytes returned from inst.
    Dim strPath As String

    ' Make measurements.
    ' -----
    myScope.DoCommand(":MEASure:SOURce CHANnel1")
    Console.WriteLine("Measure source: {0}", _
        myScope.DoQueryString(":MEASure:SOURce?"))

    myScope.DoCommand(":MEASure:FREQuency")
    fResult = myScope.DoQueryNumber(":MEASure:FREQuency?")
    Console.WriteLine("Frequency: {0:F4} kHz", fResult / 1000)

    myScope.DoCommand(":MEASure:VAMPLitude")

```

```

fResult = myScope.DoQueryNumber(":MEASure:VAMplitude?")
Console.WriteLine("Vertical amplitude: {0:F2} V", fResult)

' Download the screen image.
' -----

' Get the screen data.
nLength = myScope.DoQueryIEEEBlock_Bytes(":DISPlay:DATA? PNG", _
    ResultsArray)

' Store the screen data to a file.
strPath = "c:\scope\data\screen.png"
Dim fStream As FileStream
fStream = File.Open(strPath, FileMode.Create)
fStream.Write(ResultsArray, 0, nLength)
fStream.Close()
Console.WriteLine("Screen image ({0} bytes) written to {1}", _
    nLength, strPath)

' Download waveform data.
' -----

' Get the waveform type.
Console.WriteLine("Waveform type: {0}", _
    myScope.DoQueryString(":WAVEform:TYPE?"))

' Get the number of waveform points.
Console.WriteLine("Waveform points: {0}", _
    myScope.DoQueryString(":WAVEform:POINTs?"))

' Set the waveform source.
myScope.DoCommand(":WAVEform:SOURce CHANnel1")
Console.WriteLine("Waveform source: {0}", _
    myScope.DoQueryString(":WAVEform:SOURce?"))

' Choose the format of the data returned:
myScope.DoCommand(":WAVEform:FORMat WORD")
Console.WriteLine("Waveform format: {0}", _
    myScope.DoQueryString(":WAVEform:FORMat?"))

' Display the waveform settings from preamble:
Dim dctWavFormat As New Dictionary(Of String, String)
dctWavFormat.Add("0", "AScii")
dctWavFormat.Add("1", "BYTE")
dctWavFormat.Add("2", "WORD")
dctWavFormat.Add("3", "LONG")
dctWavFormat.Add("4", "LONGLONG")

Dim dctAcqType As New Dictionary(Of String, String)
dctAcqType.Add("1", "RAW")
dctAcqType.Add("2", "AVERage")
dctAcqType.Add("3", "VHISTogram")
dctAcqType.Add("4", "HHISTogram")
dctAcqType.Add("6", "INTerpolate")
dctAcqType.Add("10", "PDETECT")

Dim dctAcqMode As New Dictionary(Of String, String)()

```



```

dctAcqMode.Add("0", "RTIME")
dctAcqMode.Add("1", "ETIME")
dctAcqMode.Add("3", "PDETECT")

Dim dctCoupling As New Dictionary(Of String, String)()
dctCoupling.Add("0", "AC")
dctCoupling.Add("1", "DC")
dctCoupling.Add("2", "DCFIFTY")
dctCoupling.Add("3", "LFREJECT")

Dim dctUnits As New Dictionary(Of String, String)()
dctUnits.Add("0", "UNKNOWN")
dctUnits.Add("1", "VOLT")
dctUnits.Add("2", "SECOND")
dctUnits.Add("3", "CONSTANT")
dctUnits.Add("4", "AMP")
dctUnits.Add("5", "DECIBEL")

Dim strPreamble As String
Dim strSPreamble As String()

strPreamble = _
    myScope.DoQueryString(":WAVEFORM:PREAmble?").ToString()
strSPreamble = strPreamble.Split(",")

Console.WriteLine("Waveform format: {0}", _
    dctWavFormat(strSPreamble(0)))

Console.WriteLine("Acquire type: {0}", _
    dctAcqType(strSPreamble(1)))

Console.WriteLine("Waveform points: {0}", strSPreamble(2))
Console.WriteLine("Waveform average count: {0}", strSPreamble(3))
Console.WriteLine("Waveform X increment: {0}", strSPreamble(4))
Console.WriteLine("Waveform X origin: {0}", strSPreamble(5))
Console.WriteLine("Waveform X reference: {0}", strSPreamble(6))
Console.WriteLine("Waveform Y increment: {0}", strSPreamble(7))
Console.WriteLine("Waveform Y origin: {0}", strSPreamble(8))
Console.WriteLine("Waveform Y reference: {0}", strSPreamble(9))
Console.WriteLine("Coupling: {0}", dctCoupling(strSPreamble(10)))
Console.WriteLine("Waveform X display range: {0}", _
    strSPreamble(11))
Console.WriteLine("Waveform X display origin: {0}", _
    strSPreamble(12))
Console.WriteLine("Waveform Y display range: {0}", _
    strSPreamble(13))
Console.WriteLine("Waveform Y display origin: {0}", _
    strSPreamble(14))
Console.WriteLine("Date: {0}", strSPreamble(15))
Console.WriteLine("Time: {0}", strSPreamble(16))
Console.WriteLine("Frame model: {0}", strSPreamble(17))
Console.WriteLine("Acquire mode: {0}", _
    dctAcqMode(strSPreamble(18)))
Console.WriteLine("Completion pct: {0}", strSPreamble(19))
Console.WriteLine("Waveform X inits: {0}", _
    dctUnits(strSPreamble(20)))
Console.WriteLine("Waveform Y units: {0}", _

```

```

        dctUnits(strsPreamble(21))
    Console.WriteLine("Max BW limit: {0}", strsPreamble(22))
    Console.WriteLine("Min BW limit: {0}", strsPreamble(23))

    ' Get numeric values for later calculations.
    Dim fXincrement As Double
    fXincrement = myScope.DoQueryNumber(":WAVEform:XINcrement?")
    Dim fXorigin As Double
    fXorigin = myScope.DoQueryNumber(":WAVEform:XORigin?")
    Dim fYincrement As Double
    fYincrement = myScope.DoQueryNumber(":WAVEform:YINcrement?")
    Dim fYorigin As Double
    fYorigin = myScope.DoQueryNumber(":WAVEform:YORigin?")

    ' Get the waveform data.
    myScope.DoCommand(":WAVEform:STReaming OFF")
    nLength = myScope.DoQueryIEEEBlock_Words(":WAVEform:DATA?", _
        WordResultsArray)
    Console.WriteLine("Number of data values: {0}", nLength)

    ' Set up output file:
    strPath = "c:\scope\data\waveform_data.csv"
    If File.Exists(strPath) Then
        File.Delete(strPath)
    End If

    ' Open file for output.
    Dim writer As StreamWriter = File.CreateText(strPath)

    ' Output waveform data in CSV format.
    For index As Integer = 0 To nLength - 1
        ' Write time value, voltage value.
        writer.WriteLine("{0:f9}, {1:f6}", _
            fXorigin + (CSng(index) * fXincrement), _
            (CSng(WordResultsArray(index)) * fYincrement) + _
            fYorigin)
    Next

    ' Close output file.
    writer.Close()
    Console.WriteLine("Waveform format WORD data written to {0}", _
        strPath)

End Sub

End Class

Class VisaInstrument
    Private m_nResourceManager As Integer
    Private m_nSession As Integer
    Private m_strVisaAddress As String

    ' Constructor.
    Public Sub New(ByVal strVisaAddress As String)
        ' Save VISA address in member variable.
        m_strVisaAddress = strVisaAddress
    End Sub
End Class

```

```

' Open the default VISA resource manager.
OpenResourceManager()

' Open a VISA resource session.
OpenSession()

' Clear the interface.
Dim nViStatus As Integer
nViStatus = visa32.viClear(m_nSession)
End Sub

Public Sub DoCommand(ByVal strCommand As String)
' Send the command.
VisaSendCommandOrQuery(strCommand)

' Check for inst errors.
CheckInstrumentErrors(strCommand)

End Sub

Public Function DoCommandIEEEBlock(ByVal strCommand As String, _
    ByVal dataArray As Byte()) As Integer

' Send the command to the device.
Dim strCommandAndLength As String
Dim nViStatus As Integer
Dim nLength As Integer
Dim nBytesWritten As Integer

nLength = dataArray.Length
strCommandAndLength = [String].Format("{0} #8{1:D8}", _
    strCommand, nLength)

' Write first part of command to formatted I/O write buffer.
nViStatus = visa32.viPrintf(m_nSession, strCommandAndLength)
CheckVisaStatus(nViStatus)

' Write the data to the formatted I/O write buffer.
nViStatus = visa32.viBufWrite(m_nSession, dataArray, nLength, _
    nBytesWritten)
CheckVisaStatus(nViStatus)

' Check for inst errors.
CheckInstrumentErrors(strCommand)

Return nBytesWritten
End Function

Public Function DoQueryString(ByVal strQuery As String) _
    As StringBuilder
' Send the query.
VisaSendCommandOrQuery(strQuery)

' Get the result string.
Dim strResults As New StringBuilder(1000)
strResults = VisaGetResultString()

```

```

    ' Check for inst errors.
    CheckInstrumentErrors(strQuery)

    ' Return string results.
    Return strResults
End Function

Public Function DoQueryNumber(ByVal strQuery As String) As Double
    ' Send the query.
    VisaSendCommandOrQuery(strQuery)

    ' Get the result string.
    Dim fResults As Double
    fResults = VisaGetResultNumber()

    ' Check for inst errors.
    CheckInstrumentErrors(strQuery)

    ' Return string results.
    Return fResults
End Function

Public Function DoQueryNumbers(ByVal strQuery As String) _
    As Double()
    ' Send the query.
    VisaSendCommandOrQuery(strQuery)

    ' Get the result string.
    Dim fResultsArray As Double()
    fResultsArray = VisaGetResultNumbers()

    ' Check for instrument errors (another command and result).
    CheckInstrumentErrors(strQuery)

    ' Return string results.
    Return fResultsArray
End Function

Public Function DoQueryIEEEBlock_Bytes(ByVal strQuery As String, _
    ByRef ResultsArray As Byte()) As Integer
    ' Send the query.
    VisaSendCommandOrQuery(strQuery)

    ' Get the result string.
    Dim length As Integer
    ' Number of bytes returned from instrument.
    length = VisaGetResultIEEEBlock_Bytes(ResultsArray)

    ' Check for inst errors.
    CheckInstrumentErrors(strQuery)

    ' Return string results.
    Return length
End Function

Public Function DoQueryIEEEBlock_Words(ByVal strQuery As String, _

```

```

        ByRef ResultsArray As Short() As Integer
    ' Send the query.
    VisaSendCommandOrQuery(strQuery)

    ' Get the result string.
    Dim length As Integer
    ' Number of bytes returned from instrument.
    length = VisaGetResultIEEEBlock_Words(ResultsArray)

    ' Check for inst errors.
    CheckInstrumentErrors(strQuery)

    ' Return string results.
    Return length
End Function

Private Sub VisaSendCommandOrQuery(ByVal strCommandOrQuery _
    As String)
    ' Send command or query to the device.
    Dim strWithNewline As String
    strWithNewline = [String].Format("{0}" & Chr(10) & "", _
        strCommandOrQuery)
    Dim nViStatus As Integer
    nViStatus = visa32.viPrintf(m_nSession, strWithNewline)
    CheckVisaStatus(nViStatus)
End Sub

Private Function VisaGetResultString() As StringBuilder
    Dim strResults As New StringBuilder(1000)

    ' Read return value string from the device.
    Dim nViStatus As Integer
    nViStatus = visa32.viScanf(m_nSession, "%1000t", strResults)
    CheckVisaStatus(nViStatus)

    Return strResults
End Function

Private Function VisaGetResultNumber() As Double
    Dim fResults As Double = 0

    ' Read return value string from the device.
    Dim nViStatus As Integer
    nViStatus = visa32.viScanf(m_nSession, "%lf", fResults)
    CheckVisaStatus(nViStatus)

    Return fResults
End Function

Private Function VisaGetResultNumbers() As Double()
    Dim fResultsArray As Double()
    fResultsArray = New Double(9) {}

    ' Read return value string from the device.
    Dim nViStatus As Integer
    nViStatus = visa32.viScanf(m_nSession, _
        "%,10lf" & Chr(10) & "", fResultsArray)

```

```

    CheckVisaStatus(nViStatus)

    Return fResultsArray
End Function

Private Function VisaGetResultIEEEBlock_Bytes(ByRef ResultsArray _
    As Byte()) As Integer
    ' Results array, big enough to hold a PNG.
    ResultsArray = New Byte(4999999) {}
    Dim length As Integer
    ' Number of bytes returned from instrument.
    ' Set the default number of bytes that will be contained in
    ' the ResultsArray to 5,000,000.
    length = 5000000

    ' Read return value string from the device.
    Dim nViStatus As Integer
    nViStatus = visa32.viScanf(m_nSession, "%#b", length, _
        ResultsArray)
    CheckVisaStatus(nViStatus)

    ' Write and read buffers need to be flushed after IEEE block?
    nViStatus = visa32.viFlush(m_nSession, visa32.VI_WRITE_BUF)
    CheckVisaStatus(nViStatus)

    nViStatus = visa32.viFlush(m_nSession, visa32.VI_READ_BUF)
    CheckVisaStatus(nViStatus)

    Return length
End Function

Private Function VisaGetResultIEEEBlock_Words(ByRef ResultsArray _
    As Short()) As Integer
    ' Results array, big enough to hold a PNG.
    ResultsArray = New Short(4999999) {}
    Dim length As Integer
    ' Number of bytes returned from instrument.
    ' Set the default number of bytes that will be contained in
    ' the ResultsArray to 5,000,000.
    length = 5000000

    ' Read return value string from the device.
    Dim nViStatus As Integer
    nViStatus = visa32.viScanf(m_nSession, "%#hb", length, _
        ResultsArray)
    CheckVisaStatus(nViStatus)

    ' Write and read buffers need to be flushed after IEEE block?
    nViStatus = visa32.viFlush(m_nSession, visa32.VI_WRITE_BUF)
    CheckVisaStatus(nViStatus)

    nViStatus = visa32.viFlush(m_nSession, visa32.VI_READ_BUF)
    CheckVisaStatus(nViStatus)

    Return length
End Function

```

```

Private Sub CheckInstrumentErrors(ByVal strCommand As String)
    ' Check for instrument errors.
    Dim strInstrumentError As New StringBuilder(1000)
    Dim bFirstError As Boolean = True
    Do ' While not "0,No error"
        VisaSendCommandOrQuery(":SYSTem:ERRor? STRing")
        strInstrumentError = VisaGetResultString()

        If Not strInstrumentError.ToString().StartsWith("0,") Then
            If bFirstError Then
                Console.WriteLine("ERROR(s) for command '{0}': ", _
                    strCommand)
                bFirstError = False
            End If
            Console.Write(strInstrumentError)
        End If
    Loop While Not strInstrumentError.ToString().StartsWith("0,")
End Sub

Private Sub OpenResourceManager()
    Dim nViStatus As Integer
    nViStatus = visa32.viOpenDefaultRM(Me.m_nResourceManager)
    If nViStatus < visa32.VI_SUCCESS Then
        Throw New _
            ApplicationException("Failed to open Resource Manager")
    End If
End Sub

Private Sub OpenSession()
    Dim nViStatus As Integer
    nViStatus = visa32.viOpen(Me.m_nResourceManager, _
        Me.m_strVisaAddress, visa32.VI_NO_LOCK, _
        visa32.VI_TMO_IMMEDIATE, Me.m_nSession)
    CheckVisaStatus(nViStatus)
End Sub

Public Sub SetTimeoutSeconds(ByVal nSeconds As Integer)
    Dim nViStatus As Integer
    nViStatus = visa32.viSetAttribute(Me.m_nSession, _
        visa32.VI_ATTR_TMO_VALUE, nSeconds * 1000)
    CheckVisaStatus(nViStatus)
End Sub

Public Sub CheckVisaStatus(ByVal nViStatus As Integer)
    ' If VISA error, throw exception.
    If nViStatus < visa32.VI_SUCCESS Then
        Dim strError As New StringBuilder(256)
        visa32.viStatusDesc(Me.m_nResourceManager, nViStatus, strError)
        Throw New ApplicationException(strError.ToString())
    End If
End Sub

Public Sub Close()
    If m_nSession <> 0 Then
        visa32.viClose(m_nSession)
    End If
    If m_nResourceManager <> 0 Then

```

```

        visa32.viClose(m_nResourceManager)
    End If
End Sub
End Class
End Namespace

```

## VISA Example in Python 3

You can use the Python programming language with the PyVISA package to control Keysight Infiniium Series oscilloscopes.

The Python language and PyVISA package can be downloaded from the web at <http://www.python.org/> and <http://pyvisa.readthedocs.org/>, respectively.

To run this example with Python and PyVISA:

- 1 Cut-and-paste the code that follows into a file named "example.py".
- 2 Edit the program to use the VISA address of your oscilloscope.
- 3 If "python.exe" can be found via your PATH environment variable, open a Command Prompt window; then, change to the folder that contains the "example.py" file, and enter:

```

python example.py

#!python3

# *****
# This program illustrates a few commonly-used programming
# features of your Keysight Infiniium Series oscilloscope.
# *****

# Import modules.
# -----
import pyvisa
import string
import struct
import sys

# Global variables (booleans: 0 = False, 1 = True).
# -----
debug = 0

# =====
# Initialize:
# =====
def initialize():

    # Clear status.
    do_command("*CLS")

    # Get and display the device's *IDN? string.
    idn_string = do_query_string("*IDN?")
    print("Identification string: '%s'" % idn_string)

```



```

# Load the default setup.
do_command("*RST")

# =====
# Capture:
# =====
def capture():

    # Set probe attenuation factor.
    do_command(":CHANnel1:PROBe 1.0")
    qresult = do_query_string(":CHANnel1:PROBe?")
    print("Channel 1 probe attenuation factor: %s" % qresult)

    # Use auto-scale to automatically set up oscilloscope.
    print("Autoscale.")
    do_command(":AUToscale")

    # Set trigger mode.
    do_command(":TRIGger:MODE EDGE")
    qresult = do_query_string(":TRIGger:MODE?")
    print("Trigger mode: %s" % qresult)

    # Set EDGE trigger parameters.
    do_command(":TRIGger:EDGE:SOURce CHANnel1")
    qresult = do_query_string(":TRIGger:EDGE:SOURce?")
    print("Trigger edge source: %s" % qresult)

    do_command(":TRIGger:LEVel CHANnel1,330E-3")
    qresult = do_query_string(":TRIGger:LEVel? CHANnel1")
    print("Trigger level, channel 1: %s" % qresult)

    do_command(":TRIGger:EDGE:SLOPe POSitive")
    qresult = do_query_string(":TRIGger:EDGE:SLOPe?")
    print("Trigger edge slope: %s" % qresult)

    # Save oscilloscope setup.
    setup_bytes = do_query_ieee_block(":SYSTem:SETup?")

    f = open("setup.set", "wb")
    f.write(setup_bytes)
    f.close()
    print("Setup bytes saved: %d" % len(setup_bytes))

    # Change oscilloscope settings with individual commands:

    # Set vertical scale and offset.
    do_command(":CHANnel1:SCALe 0.1")
    qresult = do_query_number(":CHANnel1:SCALe?")
    print("Channel 1 vertical scale: %f" % qresult)

    do_command(":CHANnel1:OFFSet 0.0")
    qresult = do_query_number(":CHANnel1:OFFSet?")
    print("Channel 1 offset: %f" % qresult)

    # Set horizontal scale and offset.
    do_command(":TIMEbase:SCALe 200e-6")

```

```

qresult = do_query_string(":TIMEbase:SCALE?")
print("Timebase scale: %s" % qresult)

do_command(":TIMEbase:POSition 0.0")
qresult = do_query_string(":TIMEbase:POSition?")
print("Timebase position: %s" % qresult)

# Set the acquisition mode.
do_command(":ACQUIRE:MODE RTIME")
qresult = do_query_string(":ACQUIRE:MODE?")
print("Acquire mode: %s" % qresult)

# Or, set up oscilloscope by loading a previously saved setup.
setup_bytes = ""
f = open("setup.set", "rb")
setup_bytes = f.read()
f.close()
do_command_ieee_block(":SYSTEM:SETup", setup_bytes)
print("Setup bytes restored: %d" % len(setup_bytes))

# Set the desired number of waveform points,
# and capture an acquisition.
do_command(":ACQUIRE:POINTS 32000")
do_command(":DIGitize")

# =====
# Analyze:
# =====
def analyze():

    # Make measurements.
    # -----
    do_command(":MEASure:SOURce CHANnel1")
    qresult = do_query_string(":MEASure:SOURce?")
    print("Measure source: %s" % qresult)

    do_command(":MEASure:FREQuency")
    qresult = do_query_string(":MEASure:FREQuency?")
    print("Measured frequency on channel 1: %s" % qresult)

    do_command(":MEASure:VAMPlitude")
    qresult = do_query_string(":MEASure:VAMPlitude?")
    print("Measured vertical amplitude on channel 1: %s" % qresult)

    # Download the screen image.
    # -----
    screen_bytes = do_query_ieee_block(":DISPlay:DATA? PNG")

    # Save display data values to file.
    f = open("screen_image.png", "wb")
    f.write(screen_bytes)
    f.close()
    print("Screen image written to screen_image.png.")

    # Download waveform data.
    # -----

```

```

# Get the waveform type.
qresult = do_query_string(":WAVEform:TYPE?")
print("Waveform type: %s" % qresult)

# Get the number of waveform points.
qresult = do_query_string(":WAVEform:POINTs?")
print("Waveform points: %s" % qresult)

# Set the waveform source.
do_command(":WAVEform:SOURce CHANnel1")
qresult = do_query_string(":WAVEform:SOURce?")
print("Waveform source: %s" % qresult)

# Choose the format of the data returned:
do_command(":WAVEform:FORMat BYTE")
print("Waveform format: %s" % do_query_string(":WAVEform:FORMat?"))

# Display the waveform settings from preamble:
wav_form_dict = {
    0 : "ASCIi",
    1 : "BYTE",
    2 : "WORD",
    3 : "LONG",
    4 : "LONGLONG",
}
acq_type_dict = {
    1 : "RAW",
    2 : "AVERage",
    3 : "VHISTogram",
    4 : "HHISTogram",
    6 : "INTErpolate",
    10 : "PDETEct",
}
acq_mode_dict = {
    0 : "RTIME",
    1 : "ETIME",
    3 : "PDETEct",
}
coupling_dict = {
    0 : "AC",
    1 : "DC",
    2 : "DCFIFTY",
    3 : "LFREJECT",
}
units_dict = {
    0 : "UNKNOWN",
    1 : "VOLT",
    2 : "SECOND",
    3 : "CONSTANT",
    4 : "AMP",
    5 : "DECIBEL",
}

preamble_string = do_query_string(":WAVEform:PREamble?")
(
    wav_form, acq_type, wfmpnts, avgcnt, x_increment, x_origin,

```

```

x_reference, y_increment, y_origin, y_reference, coupling,
x_display_range, x_display_origin, y_display_range,
y_display_origin, date, time, frame_model, acq_mode,
completion, x_units, y_units, max_bw_limit, min_bw_limit
) = preamble_string.split(",")

print("Waveform format: %s" % wav_form_dict[int(wav_form)])
print("Acquire type: %s" % acq_type_dict[int(acq_type)])
print("Waveform points desired: %s" % wfmpnts)
print("Waveform average count: %s" % avgcnt)
print("Waveform X increment: %s" % x_increment)
print("Waveform X origin: %s" % x_origin)
print("Waveform X reference: %s" % x_reference) # Always 0.
print("Waveform Y increment: %s" % y_increment)
print("Waveform Y origin: %s" % y_origin)
print("Waveform Y reference: %s" % y_reference) # Always 0.
print("Coupling: %s" % coupling_dict[int(coupling)])
print("Waveform X display range: %s" % x_display_range)
print("Waveform X display origin: %s" % x_display_origin)
print("Waveform Y display range: %s" % y_display_range)
print("Waveform Y display origin: %s" % y_display_origin)
print("Date: %s" % date)
print("Time: %s" % time)
print("Frame model #: %s" % frame_model)
print("Acquire mode: %s" % acq_mode_dict[int(acq_mode)])
print("Completion pct: %s" % completion)
print("Waveform X units: %s" % units_dict[int(x_units)])
print("Waveform Y units: %s" % units_dict[int(y_units)])
print("Max BW limit: %s" % max_bw_limit)
print("Min BW limit: %s" % min_bw_limit)

# Get numeric values for later calculations.
x_increment = do_query_number(":WAVEform:XINcrement?")
x_origin = do_query_number(":WAVEform:XORigin?")
y_increment = do_query_number(":WAVEform:YINcrement?")
y_origin = do_query_number(":WAVEform:YORigin?")

# Get the waveform data.
do_command(":WAVEform:STReaming OFF")
sData = do_query_ieee_block(":WAVEform:DATA?")

# Unpack signed byte data.
values = struct.unpack("%db" % len(sData), sData)
print("Number of data values: %d" % len(values))

# Save waveform data values to CSV file.
f = open("waveform_data.csv", "w")

for i in range(0, len(values) - 1):
    time_val = x_origin + (i * x_increment)
    voltage = (values[i] * y_increment) + y_origin
    f.write("%E, %f\n" % (time_val, voltage))

f.close()
print("Waveform format BYTE data written to waveform_data.csv.")

```

```

# =====
# Send a command and check for errors:
# =====
def do_command(command, hide_params=False):

    if hide_params:
        (header, data) = command.split(" ", 1)
        if debug:
            print("\nCmd = '%s'" % header)
        else:
            if debug:
                print("\nCmd = '%s'" % command)

    Infiniium.write("%s" % command)

    if hide_params:
        check_instrument_errors(header)
    else:
        check_instrument_errors(command)

# =====
# Send a command and binary values and check for errors:
# =====
def do_command_ieee_block(command, values):
    if debug:
        print("Cmb = '%s'" % command)
    Infiniium.write_binary_values("%s " % command, values, datatype='B')
    check_instrument_errors(command)

# =====
# Send a query, check for errors, return string:
# =====
def do_query_string(query):
    if debug:
        print("Qys = '%s'" % query)
    result = Infiniium.query("%s" % query)
    check_instrument_errors(query)
    return result

# =====
# Send a query, check for errors, return floating-point value:
# =====
def do_query_number(query):
    if debug:
        print("Qyn = '%s'" % query)
    results = Infiniium.query("%s" % query)
    check_instrument_errors(query)
    return float(results)

# =====
# Send a query, check for errors, return binary values:
# =====
def do_query_ieee_block(query):

```

```

if debug:
    print("Qyb = '%s'" % query)
    result = Infiniium.query_binary_values("%s" % query, datatype='s', container=bytes)
    check_instrument_errors(query, exit_on_error=False)
    return result

# =====
# Check for instrument errors:
# =====
def check_instrument_errors(command, exit_on_error=True):

    while True:
        error_string = Infiniium.query(":SYSTem:ERRor? STRing")
        if error_string: # If there is an error string value.

            if error_string.find("0,", 0, 2) == -1: # Not "No error".

                print("ERROR: %s, command: '%s'" % (error_string, command))
                if exit_on_error:
                    print("Exited because of error.")
                    sys.exit(1)

            else: # "No error"
                break

        else: # :SYSTem:ERRor? STRing should always return string.
            print("ERROR: :SYSTem:ERRor? STRing returned nothing, command: '%s'"
% command)
            print("Exited because of error.")
            sys.exit(1)

# =====
# Main program:
# =====

rm = pyvisa.ResourceManager("C:\\Windows\\System32\\visa64.dll")
Infiniium = rm.open_resource("TCPIP0::141.121.231.13::hislip0::INSTR")

Infiniium.timeout = 20000
Infiniium.clear()

# Initialize the oscilloscope, capture data, and analyze.
initialize()
capture()
analyze()

Infiniium.close()
print("End of program.")
sys.exit()

```

## VISA.NET Examples

These programming examples show how to use the VISA.NET drivers that come with Keysight IO Libraries Suite.

- "VISA.NET Example in C#" on page 1903
- "VISA.NET Example in Visual Basic .NET" on page 1910
- "VISA.NET Example in Python 3" on page 1917

### VISA.NET Example in C#

To compile and run this example in Microsoft Visual Studio 2013:

- 1 Open Visual Studio.
- 2 Choose **FILE > New > Project...**
- 3 In the New Project dialog box, select **.NET Framework 4.5.2**.
- 4 Create a new Visual C#, Console Application project.
- 5 Cut-and-paste the code that follows into the C# source file.
- 6 Edit the program to use the VISA address of your oscilloscope.
- 7 Add a reference to the VISA.NET driver:
  - a Right-click the project you wish to modify (not the solution) in the Solution Explorer window of the Microsoft Visual Studio environment.
  - b Choose **Add Reference...**
  - c In the Reference Manager dialog box, under **Assemblies**, select **Extensions**.
  - d In the "Targeting: .NET Framework 4.5.2" list, select the **Ivi.Visa Assembly** check box; then, click **OK**.
- 8 Build and run the program.

For more information, see the VISA.NET Help that comes with Keysight IO Libraries Suite.

```

/*
 * Keysight VISA.NET Example in C#
 * -----
 * This program illustrates a few commonly used programming
 * features of your Keysight Infiniium Series oscilloscope.
 * -----
 */

using System;
using System.IO;
using System.Collections.Generic;
using System.Text;

using Ivi.Visa;
using Ivi.Visa.FormattedIO;

```

```

namespace Example
{
    class Program
    {
        static void Main(string[] args)
        {
            // Change this variable to the address of your instrument
            string VISA_ADDRESS = "TCPIP0::141.121.231.13::hislip0::INSTR";

            // Create a connection (session) to the instrument
            IMessageBasedSession session;
            try
            {
                session = GlobalResourceManager.Open(VISA_ADDRESS) as
                    IMessageBasedSession;
            }
            catch (NativeVisaException visaException)
            {
                Console.WriteLine("Couldn't connect.");
                Console.WriteLine("Error is:\r\n{0}\r\n", visaException);
                Console.WriteLine("Press any key to exit...");
                Console.ReadKey();
                return;
            }

            // Create a formatted I/O object which will help us format the
            // data we want to send/receive to/from the instrument
            MessageBasedFormattedIO myScope =
                new MessageBasedFormattedIO(session);

            // For Serial and TCP/IP socket connections enable the read
            // Termination Character, or read's will timeout
            if (session.ResourceName.Contains("ASRL") ||
                session.ResourceName.Contains("SOCKET"))
                session.TerminationCharacterEnabled = true;

            session.TimeoutMilliseconds = 20000;

            // Initialize - start from a known state.
            // =====
            string strResults;
            FileStream fStream;

            // Clear status.
            myScope.WriteLine("*CLS");

            // Get and display the device's *IDN? string.
            myScope.WriteLine("*IDN?");
            strResults = myScope.ReadLine();
            Console.WriteLine("*IDN? result is: {0}", strResults);

            // Load the default setup.
            myScope.WriteLine("*RST");
        }
    }
}

```



```

// Capture data.
// =====
// Set probe attenuation factor.
myScope.WriteLine(":CHANnel1:PROBE 1.0");
myScope.WriteLine(":CHANnel1:PROBE?");
strResults = myScope.ReadLine();
Console.WriteLine("Channel 1 probe attenuation factor: {0}",
    strResults);

// Use auto-scale to automatically configure oscilloscope.
myScope.WriteLine(":AUToscale");

// Set trigger mode (EDGE, PULSe, PATTeRn, etc., and input source.
myScope.WriteLine(":TRIGger:MODE EDGE");
myScope.WriteLine(":TRIGger:MODE?");
strResults = myScope.ReadLine();
Console.WriteLine("Trigger mode: {0}", strResults);

// Set EDGE trigger parameters.
myScope.WriteLine(":TRIGger:EDGE:SOURce CHANnel1");
myScope.WriteLine(":TRIGger:EDGE:SOURce?");
strResults = myScope.ReadLine();
Console.WriteLine("Trigger edge source: {0}", strResults);

myScope.WriteLine(":TRIGger:LEVel CHANnel1, -2E-3");
myScope.WriteLine(":TRIGger:LEVel? CHANnel1");
strResults = myScope.ReadLine();
Console.WriteLine("Trigger level, channel 1: {0}", strResults);

myScope.WriteLine(":TRIGger:EDGE:SLOPe POSitive");
myScope.WriteLine(":TRIGger:EDGE:SLOPe?");
strResults = myScope.ReadLine();
Console.WriteLine("Trigger edge slope: {0}", strResults);

// Save oscilloscope configuration.
byte[] ResultsArray; // Results array.
int nLength; // Number of bytes returned from instrument.
string strPath;

// Query and read setup string.
myScope.WriteLine(":SYSTem:SETUp?");
ResultsArray = myScope.ReadLineBinaryBlockOfByte();
nLength = ResultsArray.Length;

// Write setup string to file.
strPath = "c:\\scope\\config\\setup.stp";
FileStream = File.Open(strPath, FileMode.Create);
FileStream.Write(ResultsArray, 0, nLength);
FileStream.Close();
Console.WriteLine("Setup bytes saved: {0}", nLength);

// Change settings with individual commands:

// Set vertical scale and offset.
myScope.WriteLine(":CHANnel1:SCALe 0.1");
myScope.WriteLine(":CHANnel1:SCALe?");
strResults = myScope.ReadLine();

```

```

Console.WriteLine("Channel 1 vertical scale: {0}", strResults);

myScope.WriteLine(":CHANnel1:OFFSet 0.0");
myScope.WriteLine(":CHANnel1:OFFSet?");
strResults = myScope.ReadLine();
Console.WriteLine("Channel 1 vertical offset: {0}", strResults);

// Set horizontal scale and offset.
myScope.WriteLine(":TIMEbase:SCALE 0.0002");
myScope.WriteLine(":TIMEbase:SCALE?");
strResults = myScope.ReadLine();
Console.WriteLine("Timebase scale: {0}", strResults);

myScope.WriteLine(":TIMEbase:POSition 0.0");
myScope.WriteLine(":TIMEbase:POSition?");
strResults = myScope.ReadLine();
Console.WriteLine("Timebase position: {0}", strResults);

// Set the acquisition mode.
myScope.WriteLine(":ACQUIRE:MODE RTIME");
myScope.WriteLine(":ACQUIRE:MODE?");
strResults = myScope.ReadLine();
Console.WriteLine("Acquire mode: {0}", strResults);

// Or, configure by loading a previously saved setup.
byte[] dataArray;
int nBytesWritten;

// Read setup string from file.
strPath = "c:\\scope\\config\\setup.stp";
dataArray = File.ReadAllBytes(strPath);
nBytesWritten = dataArray.Length;

// Restore setup string.
myScope.Write(":SYSTEM:SETUP ");
myScope.WriteBinary(dataArray);
myScope.WriteLine("");
Console.WriteLine("Setup bytes restored: {0}", nBytesWritten);

// Set the desired number of waveform points,
// and capture an acquisition.
myScope.WriteLine(":ACQUIRE:POINTS 32000");
myScope.WriteLine(":DIGITIZE");

// Analyze the captured waveform.
// =====

// Make a couple of measurements.
// -----
myScope.WriteLine(":MEASURE:SOURCE CHANNEL1");
myScope.WriteLine(":MEASURE:SOURCE?");
strResults = myScope.ReadLine();
Console.WriteLine("Measure source: {0}", strResults);

double fResult;
myScope.WriteLine(":MEASURE:FREQUENCY");
myScope.WriteLine(":MEASURE:FREQUENCY?");

```

```

fResult = myScope.ReadLineDouble();
Console.WriteLine("Frequency: {0:F4} kHz", fResult / 1000);

myScope.WriteLine(":MEASURE:VAMPLITUDE");
myScope.WriteLine(":MEASURE:VAMPLITUDE?");
fResult = myScope.ReadLineDouble();
Console.WriteLine("Vertical amplitude: {0:F2} V", fResult);

// Download the screen image.
// -----

// Get the screen data.
myScope.WriteLine(":DISPLAY:DATA? PNG");
ResultsArray = myScope.ReadLineBinaryBlockOfByte();
nLength = ResultsArray.Length;

// Store the screen data to a file.
strPath = "c:\\scope\\data\\screen.png";
fStream = File.Open(strPath, FileMode.Create);
fStream.Write(ResultsArray, 0, nLength);
fStream.Close();
Console.WriteLine("Screen image ({0} bytes) written to {1}",
    nLength, strPath);

// Download waveform data.
// -----

// Get the waveform type.
myScope.WriteLine(":WAVEFORM:TYPE?");
strResults = myScope.ReadLine();
Console.WriteLine("Waveform type: {0}", strResults);

// Get the number of waveform points.
myScope.WriteLine(":WAVEFORM:POINTS?");
strResults = myScope.ReadLine();
Console.WriteLine("Waveform points: {0}", strResults);

// Set the waveform source.
myScope.WriteLine(":WAVEFORM:SOURCE CHANNEL1");
myScope.WriteLine(":WAVEFORM:SOURCE?");
strResults = myScope.ReadLine();
Console.WriteLine("Waveform source: {0}", strResults);

// Choose the format of the data returned:
myScope.WriteLine(":WAVEFORM:FORMAT WORD");
myScope.WriteLine(":WAVEFORM:FORMAT?");
strResults = myScope.ReadLine();
Console.WriteLine("Waveform format: {0}", strResults);

// Display the waveform settings from preamble:
Dictionary<string, string> dctWavFormat =
    new Dictionary<string, string>()
    {
        {"0", "ASCII"},
        {"1", "BYTE"},
        {"2", "WORD"},
        {"3", "LONG"},
    }

```

```

        {"4", "LONGLONG"},
    };
    Dictionary<string, string> dctAcqType =
        new Dictionary<string, string>()
    {
        {"1", "RAW"},
        {"2", "AVERage"},
        {"3", "VHIStogram"},
        {"4", "HHIStogram"},
        {"6", "INTerpolate"},
        {"10", "PDETect"},
    };
    Dictionary<string, string> dctAcqMode =
        new Dictionary<string, string>()
    {
        {"0", "RTIME"},
        {"1", "ETIME"},
        {"3", "PDETect"},
    };
    Dictionary<string, string> dctCoupling =
        new Dictionary<string, string>()
    {
        {"0", "AC"},
        {"1", "DC"},
        {"2", "DCFIFTY"},
        {"3", "LFREJECT"},
    };
    Dictionary<string, string> dctUnits =
        new Dictionary<string, string>()
    {
        {"0", "UNKNOWN"},
        {"1", "VOLT"},
        {"2", "SECOND"},
        {"3", "CONSTANT"},
        {"4", "AMP"},
        {"5", "DECIBEL"},
    };
    string strPreamble;
    string[] strsPreamble;

    myScope.WriteLine(":WAVEform:PREamble?");
    strPreamble = myScope.ReadLine();
    strsPreamble = strPreamble.Split(',');

    Console.WriteLine("Waveform format: {0}",
        dctWavFormat[strsPreamble[0]]);

    Console.WriteLine("Acquire type: {0}",
        dctAcqType[strsPreamble[1]]);

    Console.WriteLine("Waveform points: {0}", strsPreamble[2]);
    Console.WriteLine("Waveform average count: {0}", strsPreamble[3]);
    Console.WriteLine("Waveform X increment: {0}", strsPreamble[4]);
    Console.WriteLine("Waveform X origin: {0}", strsPreamble[5]);
    Console.WriteLine("Waveform X reference: {0}", strsPreamble[6]);
    Console.WriteLine("Waveform Y increment: {0}", strsPreamble[7]);
    Console.WriteLine("Waveform Y origin: {0}", strsPreamble[8]);

```

```

Console.WriteLine("Waveform Y reference: {0}", strspreamble[9]);
Console.WriteLine("Coupling: {0}", dctCoupling[strspreamble[10]]);
Console.WriteLine("Waveform X display range: {0}",
    strspreamble[11]);
Console.WriteLine("Waveform X display origin: {0}",
    strspreamble[12]);
Console.WriteLine("Waveform Y display range: {0}",
    strspreamble[13]);
Console.WriteLine("Waveform Y display origin: {0}",
    strspreamble[14]);
Console.WriteLine("Date: {0}", strspreamble[15]);
Console.WriteLine("Time: {0}", strspreamble[16]);
Console.WriteLine("Frame model: {0}", strspreamble[17]);
Console.WriteLine("Acquire mode: {0}",
    dctAcqMode[strspreamble[18]]);
Console.WriteLine("Completion pct: {0}", strspreamble[19]);
Console.WriteLine("Waveform X inits: {0}",
    dctUnits[strspreamble[20]]);
Console.WriteLine("Waveform Y units: {0}",
    dctUnits[strspreamble[21]]);
Console.WriteLine("Max BW limit: {0}", strspreamble[22]);
Console.WriteLine("Min BW limit: {0}", strspreamble[23]);

// Get numeric values for later calculations.
double fXincrement;
myScope.WriteLine(":WAVEform:XINCrement?");
fXincrement = myScope.ReadLineDouble();

double fXorigin;
myScope.WriteLine(":WAVEform:XORigin?");
fXorigin = myScope.ReadLineDouble();

double fYincrement;
myScope.WriteLine(":WAVEform:YINCrement?");
fYincrement = myScope.ReadLineDouble();

double fYorigin;
myScope.WriteLine(":WAVEform:YORigin?");
fYorigin = myScope.ReadLineDouble();

// Read waveform data.
myScope.WriteLine(":WAVEform:STReaming OFF");
short[] WordDataArray; // Waveform data array.
myScope.WriteLine(":WAVEform:DATA?");
WordDataArray = myScope.ReadBinaryBlockOfInt16();
//WordDataArray = myScope.ReadBinaryBlockOfInt16(true);
nLength = WordDataArray.Length;
Console.WriteLine("Number of data values: {0}", nLength);

// Set up output file:
strPath = "c:\\scope\\data\\waveform_data.csv";
if (File.Exists(strPath)) File.Delete(strPath);

// Open file for output.
StreamWriter writer = File.CreateText(strPath);

// Output waveform data in CSV format.

```

```

for (int i = 0; i < nLength - 1; i++)
    writer.WriteLine("{0:f9}, {1:f6}",
        fXorigin + ((float)i * fXincrement),
        (((float)WordDataArray[i])
        * fYincrement) + fYorigin);

// Close output file.
writer.Close();
Console.WriteLine("Waveform format WORD data written to {0}",
    strPath);

// Close the connection to the instrument
// -----
session.Dispose();

Console.WriteLine("Press any key to exit...");
Console.ReadKey();

    }
}
}

```

## VISA.NET Example in Visual Basic .NET

To compile and run this example in Microsoft Visual Studio 2013:

- 1 Open Visual Studio.
- 2 Choose **FILE > New > Project...**
- 3 In the New Project dialog box, select **.NET Framework 4.5.2**.
- 4 Create a new Visual Basic, Console Application project.
- 5 Cut-and-paste the code that follows into the Visual Basic .NET source file.
- 6 Edit the program to use the VISA address of your oscilloscope.
- 7 Add a reference to the VISA.NET driver:
  - a Right-click the project you wish to modify (not the solution) in the Solution Explorer window of the Microsoft Visual Studio environment.
  - b Choose **Add Reference...**
  - c In the Reference Manager dialog box, under **Assemblies**, select **Extensions**.
  - d In the "Targeting: .NET Framework 4.5.2" list, select the **Ivi.Visa Assembly** check box; then, click **OK**.
- 8 Specify the Startup object:
  - a Right-click the project you wish to modify (not the solution) in the Solution Explorer window of the Microsoft Visual Studio environment.
  - b Choose **Properties**.
  - c In the Properties dialog box, under **Application**, select the **Startup object:** field and choose **Sub Main**.
  - d Save your change and close the Properties dialog box.

## 9 Build and run the program.

For more information, see the VISA.NET driver help that comes with Keysight Command Expert.

```
'
' Keysight VISA.NET Example in VB.NET
' -----
' This program illustrates a few commonly used programming
' features of your Keysight Infiniium Series oscilloscope.
' -----

Imports System
Imports System.IO
Imports System.Collections.Generic
Imports System.Text

Imports Ivi.Visa
Imports Ivi.Visa.FormattedIO

Namespace Example
    Class Program

        Public Shared Sub Main(args As String())
            ' Change this variable to the address of your instrument
            Dim VISA_ADDRESS As String = "TCPIP0::141.121.231.13::hislip0::INS
TR"

            ' Create a connection (session) to the instrument
            Dim session As IMessageBasedSession
            Try
                session = TryCast(GlobalResourceManager.Open(VISA_ADDRESS), _
                    IMessageBasedSession)
            Catch visaException As NativeVisaException
                Console.WriteLine("Couldn't connect.")
                Console.WriteLine("Error is:" & vbCrLf & vbCrLf & "{0}" _
                    & vbCrLf & vbCrLf, visaException)
                Console.WriteLine("Press any key to exit...")
                Console.ReadKey()
                Return
            End Try

            ' Create a formatted I/O object which will help us format the
            ' data we want to send/receive to/from the instrument
            Dim myScope As New MessageBasedFormattedIO(session)

            ' For Serial and TCP/IP socket connections enable the read
            ' Termination Character, or read's will timeout
            If session.ResourceName.Contains("ASRL") OrElse _
                session.ResourceName.Contains("SOCKET") Then
                session.TerminationCharacterEnabled = True
            End If

            session.TimeoutMilliseconds = 20000

            ' Initialize - start from a known state.
```

```

' =====
Dim strResults As String
Dim fStream As FileStream

' Clear status.
myScope.WriteLine("*CLS")

' Get and display the device's *IDN? string.
myScope.WriteLine("*IDN?")
strResults = myScope.ReadLine()
Console.WriteLine("*IDN? result is: {0}", strResults)

' Load the default setup.
myScope.WriteLine("*RST")

' Capture data.
' =====
' Set probe attenuation factor.
myScope.WriteLine(":CHANnel1:PROBe 1.0")
myScope.WriteLine(":CHANnel1:PROBe?")
strResults = myScope.ReadLine()
Console.WriteLine("Channel 1 probe attenuation factor: {0}",
    strResults)

' Use auto-scale to automatically configure oscilloscope.
myScope.WriteLine(":AUToscale")

' Set trigger mode (EDGE, PULSe, PATtern, etc., and input source.
myScope.WriteLine(":TRIGger:MODE EDGE")
myScope.WriteLine(":TRIGger:MODE?")
strResults = myScope.ReadLine()
Console.WriteLine("Trigger mode: {0}", strResults)

' Set EDGE trigger parameters.
myScope.WriteLine(":TRIGger:EDGE:SOURce CHANnel1")
myScope.WriteLine(":TRIGger:EDGE:SOURce?")
strResults = myScope.ReadLine()
Console.WriteLine("Trigger edge source: {0}", strResults)

myScope.WriteLine(":TRIGger:LEVel CHANnel1,-2E-3")
myScope.WriteLine(":TRIGger:LEVel? CHANnel1")
strResults = myScope.ReadLine()
Console.WriteLine("Trigger edge level: {0}", strResults)

myScope.WriteLine(":TRIGger:EDGE:SLOPe POSitive")
myScope.WriteLine(":TRIGger:EDGE:SLOPe?")
strResults = myScope.ReadLine()
Console.WriteLine("Trigger edge slope: {0}", strResults)

' Save oscilloscope configuration.
Dim ResultsArray As Byte()
' Results array.
Dim nLength As Integer
' Number of bytes returned from instrument.
Dim strPath As String

' Query and read setup string.

```



```

myScope.WriteLine(":SYSTEM:SETup?")
ResultsArray = myScope.ReadLineBinaryBlockOfByte()
nLength = ResultsArray.Length

' Write setup string to file.
strPath = "c:\scope\config\setup.stp"
fStream = File.Open(strPath, FileMode.Create)
fStream.Write(ResultsArray, 0, nLength)
fStream.Close()
Console.WriteLine("Setup bytes saved: {0}", nLength)

' Change settings with individual commands:

' Set vertical scale and offset.
myScope.WriteLine(":CHANnel1:SCALe 0.1")
myScope.WriteLine(":CHANnel1:SCALe?")
strResults = myScope.ReadLine()
Console.WriteLine("Channel 1 vertical scale: {0}", strResults)

myScope.WriteLine(":CHANnel1:OFFSet 0.0")
myScope.WriteLine(":CHANnel1:OFFSet?")
strResults = myScope.ReadLine()
Console.WriteLine("Channel 1 vertical offset: {0}", strResults)

' Set horizontal scale and offset.
myScope.WriteLine(":TIMEbase:SCALe 0.0002")
myScope.WriteLine(":TIMEbase:SCALe?")
strResults = myScope.ReadLine()
Console.WriteLine("Timebase scale: {0}", strResults)

myScope.WriteLine(":TIMEbase:POSition 0.0")
myScope.WriteLine(":TIMEbase:POSition?")
strResults = myScope.ReadLine()
Console.WriteLine("Timebase position: {0}", strResults)

' Set the acquisition mode.
myScope.WriteLine(":ACQuire:MODE RTIME")
myScope.WriteLine(":ACQuire:MODE?")
strResults = myScope.ReadLine()
Console.WriteLine("Acquire mode: {0}", strResults)

' Or, configure by loading a previously saved setup.
Dim dataArray As Byte()
Dim nBytesWritten As Integer

' Read setup string from file.
strPath = "c:\scope\config\setup.stp"
dataArray = File.ReadAllBytes(strPath)
nBytesWritten = dataArray.Length

' Restore setup string.
myScope.Write(":SYSTEM:SETup ")
myScope.WriteBinary(dataArray)
myScope.WriteLine("")
Console.WriteLine("Setup bytes restored: {0}", nBytesWritten)

' Set the desired number of waveform points,

```

```

' and capture an acquisition.
myScope.WriteLine(":ACQUIRE:POINTS 32000")
myScope.WriteLine(":DIGITIZE")

' Analyze the captured waveform.
' =====

' Make a couple of measurements.
' -----
myScope.WriteLine(":MEASURE:SOURCE CHANNEL1")
myScope.WriteLine(":MEASURE:SOURCE?")
strResults = myScope.ReadLine()
Console.WriteLine("Measure source: {0}", strResults)

Dim fResult As Double
myScope.WriteLine(":MEASURE:FREQUENCY")
myScope.WriteLine(":MEASURE:FREQUENCY?")
fResult = myScope.ReadLineDouble()
Console.WriteLine("Frequency: {0:F4} kHz", fResult / 1000)

myScope.WriteLine(":MEASURE:VAMPLITUDE")
myScope.WriteLine(":MEASURE:VAMPLITUDE?")
fResult = myScope.ReadLineDouble()
Console.WriteLine("Vertical amplitude: {0:F2} V", fResult)

' Download the screen image.
' -----

' Get the screen data.
myScope.WriteLine(":DISPLAY:DATA? PNG")
ResultsArray = myScope.ReadLineBinaryBlockOfByte()
nLength = ResultsArray.Length

' Store the screen data to a file.
strPath = "c:\scope\data\screen.png"
fStream = File.Open(strPath, FileMode.Create)
fStream.Write(ResultsArray, 0, nLength)
fStream.Close()
Console.WriteLine("Screen image ({0} bytes) written to {1}", _
    nLength, strPath)

' Download waveform data.
' -----

' Set the waveform type.
myScope.WriteLine(":WAVEFORM:TYPE?")
strResults = myScope.ReadLine()
Console.WriteLine("Waveform type: {0}", strResults)

' Get the number of waveform points.
myScope.WriteLine(":WAVEFORM:POINTS?")
strResults = myScope.ReadLine()
Console.WriteLine("Waveform points: {0}", strResults)

' Set the waveform source.
myScope.WriteLine(":WAVEFORM:SOURCE CHANNEL1")
myScope.WriteLine(":WAVEFORM:SOURCE?")

```

```

strResults = myScope.ReadLine()
Console.WriteLine("Waveform source: {0}", strResults)

' Choose the format of the data returned:
myScope.WriteLine(":WAVEform:FORMat WORD")
myScope.WriteLine(":WAVEform:FORMat?")
strResults = myScope.ReadLine()
Console.WriteLine("Waveform format: {0}", strResults)

' Display the waveform settings from preamble:
Dim dctWavFormat As New Dictionary(Of String, String)
dctWavFormat.Add("0", "AScii")
dctWavFormat.Add("1", "BYTE")
dctWavFormat.Add("2", "WORD")
dctWavFormat.Add("3", "LONG")
dctWavFormat.Add("4", "LONGLONG")

Dim dctAcqType As New Dictionary(Of String, String)
dctAcqType.Add("1", "RAW")
dctAcqType.Add("2", "AVERage")
dctAcqType.Add("3", "VHISTogram")
dctAcqType.Add("4", "HHISTogram")
dctAcqType.Add("6", "INTerpolate")
dctAcqType.Add("10", "PDETECT")

Dim dctAcqMode As New Dictionary(Of String, String)()
dctAcqMode.Add("0", "RTIME")
dctAcqMode.Add("1", "ETIME")
dctAcqMode.Add("3", "PDETECT")

Dim dctCoupling As New Dictionary(Of String, String)()
dctCoupling.Add("0", "AC")
dctCoupling.Add("1", "DC")
dctCoupling.Add("2", "DCFIFTY")
dctCoupling.Add("3", "LFREJECT")

Dim dctUnits As New Dictionary(Of String, String)()
dctUnits.Add("0", "UNKNOWN")
dctUnits.Add("1", "VOLT")
dctUnits.Add("2", "SECOND")
dctUnits.Add("3", "CONSTANT")
dctUnits.Add("4", "AMP")
dctUnits.Add("5", "DECIBEL")

Dim strPreamble As String
Dim strSPreamble As String()

myScope.WriteLine(":WAVEform:PREamble?")
strPreamble = myScope.ReadLine()
strSPreamble = strPreamble.Split(",")

Console.WriteLine("Waveform format: {0}", _
    dctWavFormat(strSPreamble(0)))

Console.WriteLine("Acquire type: {0}", _
    dctAcqType(strSPreamble(1)))

```

```

Console.WriteLine("Waveform points: {0}", strspreamble(2))
Console.WriteLine("Waveform average count: {0}", strspreamble(3))
Console.WriteLine("Waveform X increment: {0}", strspreamble(4))
Console.WriteLine("Waveform X origin: {0}", strspreamble(5))
Console.WriteLine("Waveform X reference: {0}", strspreamble(6))
Console.WriteLine("Waveform Y increment: {0}", strspreamble(7))
Console.WriteLine("Waveform Y origin: {0}", strspreamble(8))
Console.WriteLine("Waveform Y reference: {0}", strspreamble(9))
Console.WriteLine("Coupling: {0}", dctCoupling(strspreamble(10)))
Console.WriteLine("Waveform X display range: {0}", _
    strspreamble(11))
Console.WriteLine("Waveform X display origin: {0}", _
    strspreamble(12))
Console.WriteLine("Waveform Y display range: {0}", _
    strspreamble(13))
Console.WriteLine("Waveform Y display origin: {0}", _
    strspreamble(14))
Console.WriteLine("Date: {0}", strspreamble(15))
Console.WriteLine("Time: {0}", strspreamble(16))
Console.WriteLine("Frame model: {0}", strspreamble(17))
Console.WriteLine("Acquire mode: {0}", _
    dctAcqMode(strspreamble(18)))
Console.WriteLine("Completion pct: {0}", strspreamble(19))
Console.WriteLine("Waveform X inits: {0}", _
    dctUnits(strspreamble(20)))
Console.WriteLine("Waveform Y units: {0}", _
    dctUnits(strspreamble(21)))
Console.WriteLine("Max BW limit: {0}", strspreamble(22))
Console.WriteLine("Min BW limit: {0}", strspreamble(23))

' Get numeric values for later calculations.
Dim fXincrement As Double
myScope.WriteLine(":WAVEform:XINcrement?")
fXincrement = myScope.ReadLineDouble()

Dim fXorigin As Double
myScope.WriteLine(":WAVEform:XORigin?")
fXorigin = myScope.ReadLineDouble()

Dim fYincrement As Double
myScope.WriteLine(":WAVEform:YINcrement?")
fYincrement = myScope.ReadLineDouble()

Dim fYorigin As Double
myScope.WriteLine(":WAVEform:YORigin?")
fYorigin = myScope.ReadLineDouble()

' Read waveform data.
myScope.WriteLine(":WAVEform:STReaming OFF")
Dim WorddataArray As Short()
myScope.WriteLine(":WAVEform:DATA?")
WorddataArray = myScope.ReadLineBinaryBlockOfInt16()
nLength = WorddataArray.Length
Console.WriteLine("Number of data values: {0}", nLength)

' Set up output file:
strPath = "c:\scope\data\waveform_data.csv"

```

```

If File.Exists(strPath) Then
    File.Delete(strPath)
End If

' Open file for output.
Dim writer As StreamWriter = File.CreateText(strPath)

' Output waveform data in CSV format.
For index As Integer = 0 To nLength - 1
    ' Write time value, voltage value.
    writer.WriteLine("{0:f9}, {1:f6}", _
        fXorigin + (CSng(index) * fXincrement), _
        (CSng(WordDataArray(index)) * fYincrement) + fYorigin)
Next

' Close output file.
writer.Close()
Console.WriteLine("Waveform format WORD data written to {0}", _
    strPath)

' Close the connection to the instrument
' -----
session.Dispose()

Console.WriteLine("Press any key to exit...")
Console.ReadKey()

End Sub
End Class
End Namespace

```

## VISA.NET Example in Python 3

You can use the Python programming language with the "Python.NET" package to control Keysight oscilloscopes.

The Python language and "Python.NET" package can be downloaded from the web at <http://www.python.org/> and <http://pythonnet.github.io/>, respectively.

To run this example with Python and "Python.NET":

- 1 Cut-and-paste the code that follows into a file named "example.py".
- 2 Edit the program to use the VISA address of your oscilloscope.
- 3 If "python.exe" can be found via your PATH environment variable, open a Command Prompt window; then, change to the folder that contains the "example.py" file, and enter:

```

python example.py

#!python3
#
# Keysight VISA.NET Example in Python.NET
# *****
# This program illustrates a few commonly used programming
# features of your Keysight InfiniiVision oscilloscope.

```

```

# Prerequisites: "pip install pythonnet"
# *****

# Import Python modules.
# -----
import sys
import array
sys.path.append("C:\\Program Files\\IVI Foundation\\VISA\\Microsoft.NET\\
\\Framework64\\v2.0.50727\\VISA.NET Shared Components 5.11.0")

# Import .NET modules.
# -----
import clr
clr.AddReference("Ivi.Visa")
from Ivi.Visa import *
from Ivi.Visa.FormattedIO import *
from System import *
from System.IO import *

# Global variables.
# -----
visa_addr = "TCPIP0::lab-myst-lp2-41.cos.is.keysight.com::inst0::INSTR"
io_timeout_ms = 60000
input_channel = "CHANNEL2"
waveform_format = "WORD" # "BYTE" also supported

# =====
# Check for instrument errors:
# =====
def check_instrument_errors(when):

    errors_found = False
    while True:
        # Keep reading errors until "No error".
        myScope.WriteLine(":SYSTem:ERRor? STRing")
        error_string = myScope.ReadLine().strip()
        if error_string: # If there is an error string value.

            if error_string.find("0,", 0, 2) == -1: # Not "No error".
                errors_found = True
                print(f"ERROR: {error_string}")

            else: # "No error"
                break

        else: # :SYSTem:ERRor? STRing should always return string.
            errors_found = True
            print("ERROR: ':SYSTem:ERRor?' empty.")
            break

    if errors_found:
        print(f"Exited because error(s) found when: '{when}'")
        sys.exit(1)

# =====

```

```

# Initialize:
# =====
def initialize():

    # Get and display the device's *IDN? string.
    myScope.WriteLine("*IDN?")
    idn_string = myScope.ReadLine().strip()
    print(f"Identification string '{idn_string}'")

    # Clear status and load the default setup.
    myScope.WriteLine("*CLS")
    myScope.WriteLine("*RST")

# =====
# Capture:
# =====
def capture():

    # Display the input channel.
    myScope.WriteLine(":CHANnel:DISPlay OFF")
    myScope.WriteLine(f":{input_channel}:DISPlay ON")

    # Use auto-scale to automatically set up oscilloscope.
    print("Autoscale.")
    myScope.WriteLine(":AUToscale:CHANnels DISPlayed")
    myScope.WriteLine(":AUToscale")

    # Set trigger mode.
    myScope.WriteLine(":TRIGger:MODE EDGE")
    myScope.WriteLine(":TRIGger:MODE?")
    qresult = myScope.ReadLine().strip()
    print(f"Trigger mode: {qresult}")

    # Set EDGE trigger parameters.
    myScope.WriteLine(f":TRIGger:EDGE:SOURce {input_channel}")
    myScope.WriteLine(":TRIGger:EDGE:SOURce?")
    qresult = myScope.ReadLine().strip()
    print(f"Trigger edge source: {qresult}")

    myScope.WriteLine(f":TRIGger:LEVel {input_channel},1.75")
    myScope.WriteLine(f":TRIGger:LEVel? {input_channel}")
    qresult = myScope.ReadLine().strip()
    print(f"Trigger level, {input_channel}: {qresult}")

    myScope.WriteLine(":TRIGger:EDGE:SLOPe POSitive")
    myScope.WriteLine(":TRIGger:EDGE:SLOPe?")
    qresult = myScope.ReadLine().strip()
    print(f"Trigger edge slope: {qresult}")

    # Save oscilloscope setup to file.
    myScope.WriteLine(":SYSTem:SETup?")
    setup_bytes = myScope.ReadLineBinaryBlockOfByte()
    File.WriteAllBytes("setup.set", setup_bytes)
    print(f"Setup bytes saved: {len(setup_bytes)}")

    # Change settings with individual commands:

```

```

# Set vertical scale and offset.
myScope.WriteLine(f":{input_channel}:SCALE 0.1")
myScope.WriteLine(f":{input_channel}:SCALE?")
qresult = myScope.ReadLine().strip()
print(f"{input_channel} vertical scale: {qresult}")

myScope.WriteLine(f":{input_channel}:OFFSET 0.0")
myScope.WriteLine(f":{input_channel}:OFFSET?")
qresult = myScope.ReadLine().strip()
print(f"{input_channel} offset: {qresult}")

# Set horizontal scale and offset.
myScope.WriteLine(":TIMEbase:SCALE 0.0002")
myScope.WriteLine(":TIMEbase:SCALE?")
qresult = myScope.ReadLine().strip()
print(f"Timebase scale: {qresult}")

myScope.WriteLine(":TIMEbase:POSITION 0.0")
myScope.WriteLine(":TIMEbase:POSITION?")
qresult = myScope.ReadLine().strip()
print(f"Timebase position: {qresult}")

# Set the acquisition mode.
myScope.WriteLine(":ACQUIRE:MODE RTIME")
myScope.WriteLine(":ACQUIRE:MODE?")
qresult = myScope.ReadLine().strip()
print(f"Acquire mode: {qresult}")

# Or, configure by loading a previously saved setup.

# Read setup string from file.
setup_bytes = File.ReadAllBytes("setup.set")

# Restore setup string.
myScope.Write(":SYSTEM:SETUP ")
write_binary = myScope.WriteBinary.Overloads[Array[Byte]]
write_binary(setup_bytes)
myScope.WriteLine("")
print(f"Setup bytes restored: {len(setup_bytes)}")

# Set the desired number of waveform points.
myScope.WriteLine(":ACQUIRE:POINTS 32000")
myScope.WriteLine(":ACQUIRE:POINTS?")
qresult = myScope.ReadLine().strip()
print(f"Acquire points setting: {qresult}")

# Capture an acquisition using :DIGITIZE.
myScope.WriteLine(":DIGITIZE")

# =====
# Analyze:
# =====
def analyze():

# Make measurements.

```



```

# -----
myScope.WriteLine(f":MEASure:SOURce {input_channel}")
myScope.WriteLine(":MEASure:SOURce?")
qresult = myScope.ReadLine().strip()
print(f"Measure source: {qresult}")

myScope.WriteLine(":MEASure:FREQuency")
myScope.WriteLine(":MEASure:FREQuency?")
qresult = myScope.ReadLineDouble()
print(f"Measured frequency on {input_channel}: {qresult}")

myScope.WriteLine(":MEASure:VAMPlitude")
myScope.WriteLine(":MEASure:VAMPlitude?")
qresult = myScope.ReadLineDouble()
print(f"Measured vertical amplitude on {input_channel}: {qresult}")

# Download the screen image.
# -----

# Get the screen data.
myScope.WriteLine(":DISPlay:DATA? PNG")
image_bytes = myScope.ReadLineBinaryBlockOfByte()
nLength = len(image_bytes)
fStream = File.Open("screen_image.png", FileMode.Create)
fStream.Write(image_bytes, 0, nLength)
fStream.Close()
print("Screen image written to screen_image.png.")

# Download waveform data.
# -----

# Set the waveform source.
myScope.WriteLine(f":WAVeform:SOURce {input_channel}")
myScope.WriteLine(":WAVeform:SOURce?")
qresult = myScope.ReadLine().strip()
print(f"Waveform source: {qresult}")

# Get the waveform type.
myScope.WriteLine(":WAVeform:TYPE?")
qresult = myScope.ReadLine().strip()
print(f"Waveform type: {qresult}")

# Get the number of waveform points available.
myScope.WriteLine(":WAVeform:POINts?")
qresult = myScope.ReadLine().strip()
print(f"Waveform points available: {qresult}")

# Choose the format of the data returned:
myScope.WriteLine(f":WAVeform:FORMat {waveform_format}")
myScope.WriteLine(":WAVeform:FORMat?")
qresult = myScope.ReadLine().strip()
print(f"Waveform format: {qresult}")

if waveform_format == "WORD":
    # Use the LSB first byte ordering.
    myScope.WriteLine(":WAVeform:BYTeorder LSBFirst")
    myScope.WriteLine(":WAVeform:BYTeorder?")

```

```

qresult = myScope.ReadLine().strip()
print(f"Waveform byte order: {qresult}")

# Display the waveform settings from preamble:
wav_form_dict = {
    0 : "AScii",
    1 : "BYTE",
    2 : "WORD",
    3 : "LONG",
    4 : "LONGLONG",
}
acq_type_dict = {
    1 : "RAW",
    2 : "AVERage",
    3 : "VHISTogram",
    4 : "HHISTogram",
    6 : "INTErpolate",
    10 : "PDETECT",
}
acq_mode_dict = {
    0 : "RTIME",
    1 : "ETIME",
    3 : "PDETECT",
}
coupling_dict = {
    0 : "AC",
    1 : "DC",
    2 : "DCFIFTY",
    3 : "LFREJECT",
}
units_dict = {
    0 : "UNKNOWN",
    1 : "VOLT",
    2 : "SECOND",
    3 : "CONSTANT",
    4 : "AMP",
    5 : "DECIBEL",
}

myScope.WriteLine(":WAVEform:PREamble?")
(
    wav_form, acq_type, wfmppts, avgcnt, x_increment, x_origin,
    x_reference, y_increment, y_origin, y_reference, coupling,
    x_display_range, x_display_origin, y_display_range,
    y_display_origin, date, time, frame_model, acq_mode,
    completion, x_units, y_units, max_bw_limit, min_bw_limit
) = myScope.ReadLine().strip().split(",")

print(f"Waveform format: {wav_form_dict[int(wav_form)]}")
print(f"Acquire type: {acq_type_dict[int(acq_type)]}")
print(f"Waveform points desired: {wfmppts}")
print(f"Waveform average count: {avgcnt}")
print(f"Waveform X increment: {x_increment}")
print(f"Waveform X origin: {x_origin}")
print(f"Waveform X reference: {x_reference}") # Always 0.
print(f"Waveform Y increment: {y_increment}")
print(f"Waveform Y origin: {y_origin}")

```

```

print(f"Waveform Y reference: {y_reference}") # Always 0.
print(f"Coupling: {coupling_dict[int(coupling)]}")
print(f"Waveform X display range: {x_display_range}")
print(f"Waveform X display origin: {x_display_origin}")
print(f"Waveform Y display range: {y_display_range}")
print(f"Waveform Y display origin: {y_display_origin}")
print(f>Date: {date}")
print(f"Time: {time}")
print(f"Frame model #: {frame_model}")
print(f"Acquire mode: {acq_mode_dict[int(acq_mode)]}")
print(f"Completion pct: {completion}")
print(f"Waveform X units: {units_dict[int(x_units)]}")
print(f"Waveform Y units: {units_dict[int(y_units)]}")
print(f"Max BW limit: {max_bw_limit}")
print(f"Min BW limit: {min_bw_limit}")

# Get numeric values for later calculations.
myScope.WriteLine(":WAVEform:XINcrement?")
x_increment = myScope.ReadLineDouble()
myScope.WriteLine(":WAVEform:XORigin?")
x_origin = myScope.ReadLineDouble()
myScope.WriteLine(":WAVEform:YINcrement?")
y_increment = myScope.ReadLineDouble()
myScope.WriteLine(":WAVEform:YORigin?")
y_origin = myScope.ReadLineDouble()

# Get the waveform data.
myScope.WriteLine(":WAVEform:STReaming OFF")
myScope.WriteLine(":WAVEform:DATA?")
if waveform_format == "BYTE":
    block_data = myScope.ReadLineBinaryBlockOfSByte()
    data = array.array("b", block_data)
else: # waveform_format == "WORD":
    block_data = myScope.ReadLineBinaryBlockOfInt16()
    data = array.array("h", block_data)
    data.byteswap()
nLength = len(data)
print(f"Number of data values: {nLength}")

# Open file for output.
strPath = "waveform_data.csv"
writer = File.CreateText(strPath)

# Output waveform data in CSV format.
for i in range(0, nLength - 1):
    time_val = x_origin + (i * x_increment)
    voltage = (data[i] * y_increment) + y_origin
    writer.WriteLine("%E, %f" % (time_val, voltage))

# Close output file.
writer.Close()
print(f"Waveform format {waveform_format} data written to {strPath}.")

# =====
# Main program:
# =====

```

```
session = GlobalResourceManager.Open(visa_addr)
session.TimeoutMilliseconds = io_timeout_ms
myScope = MessageBasedFormattedIO(session)

# Initialize the oscilloscope, capture data, and analyze.
initialize()
capture()
analyze()

# Check for oscilloscope instrument errors.
check_instrument_errors("End of program")

# Close the connection to the instrument
session.Dispose()
print("End of program.")

# Wait for a key press before exiting.
print("Press any key to exit...")
Console.ReadKey(True)
```

## SICL Examples

- **"SICL Example in C"** on page 1925
- **"SICL Example in Visual Basic"** on page 1934

### SICL Example in C

To compile and run this example in Microsoft Visual Studio 2008:

- 1 Open Visual Studio.
- 2 Create a new Visual C++, Win32, Win32 Console Application project.
- 3 In the Win32 Application Wizard, click **Next >**. Then, check **Empty project**, and click **Finish**.
- 4 Cut-and-paste the code that follows into a file named "example.c" in the project directory.
- 5 In Visual Studio 2008, right-click the Source Files folder, choose **Add > Add Existing Item...**, select the example.c file, and click **Add**.
- 6 Edit the program to use the SICL address of your oscilloscope.
- 7 Choose **Project > Properties....** In the Property Pages dialog, update these project settings:
  - a Under Configuration Properties, Linker, Input, add "sicl32.lib" to the Additional Dependencies field.
  - b Under Configuration Properties, C/C++, Code Generation, select Multi-threaded DLL for the Runtime Library field.
  - c Click **OK** to close the Property Pages dialog.
- 8 Add the include files and library files search paths:
  - a Choose **Tools > Options....**
  - b In the Options dialog, under Projects and Solutions, select **VC++ Directories**.
  - c Show directories for **Include files**, and add the include directory (for example, Program Files\Agilent\IO Libraries Suite\include).
  - d Show directories for **Library files**, and add the library files directory (for example, Program Files\Agilent\IO Libraries Suite\lib).
  - e Click **OK** to close the Options dialog.
- 9 Build and run the program.

```

/*
 * Keysight SICL Example in C
 * -----
 * This program illustrates a few commonly-used programming
 * features of your Keysight Infiniium Series oscilloscope.
 */

#include <stdio.h>                                /* For printf(). */

```

```

#include <string.h>          /* For strcpy(), strcat(). */
#include <time.h>           /* For clock(). */
#include <sicl.h>           /* Keysight SICL routines. */

#define SICL_ADDRESS       "lan,4880;hislip[141.121.237.226]:hislip0"
#define TIMEOUT           15000
#define IEEEBLOCK_SPACE   5000000

/* Function prototypes */
void initialize(void);      /* Initialize to known state. */
void capture(void);        /* Capture the waveform. */
void analyze(void);        /* Analyze the captured waveform. */

void do_command(char *command); /* Send command. */
int do_command_ieeeblock(char *command); /* Command w/IEEE block. */
void do_query_string(char *query); /* Query for string. */
void do_query_number(char *query); /* Query for number. */
void do_query_numbers(char *query); /* Query for numbers. */
int do_query_ieeeblock(char *query); /* Query for IEEE block. */
int do_query_ieeeblock_words(char *query); /* Query for word data. */
void check_instrument_errors(); /* Check for inst errors. */

/* Global variables */
INST id; /* Device session ID. */
char str_result[256] = {0}; /* Result from do_query_string(). */
double num_result; /* Result from do_query_number(). */
unsigned char ieeeblock_data[IEEBLOCK_SPACE]; /* Result from
do_query_ieeeblock(). */
signed short ieeeblock_data_words[IEEBLOCK_SPACE]; /* Result from
do_query_ieeeblock_words(). */
double dbl_results[10]; /* Result from do_query_numbers(). */

/* Main Program
* ----- */
void main(void)
{
    /* Install a default SICL error handler that logs an error message
    * and exits. On Windows 98SE or Windows Me, view messages with
    * the SICL Message Viewer. For Windows 2000 or XP, use the Event
    * Viewer.
    */
    ionerror(I_ERROR_EXIT);

    /* Open a device session using the SICL_ADDRESS */
    id = iopen(SICL_ADDRESS);

    if (id == 0)
    {
        printf ("Oscilloscope iopen failed!\n");
    }
    else
    {
        printf ("Oscilloscope session opened!\n");
    }

    /* Set the I/O timeout value for this session to 5 seconds. */
    itimeout(id, TIMEOUT);
}

```

```

/* Clear the interface. */
iclear(id);

/* Initialize - start from a known state. */
initialize();

/* Capture data. */
capture();

/* Analyze the captured waveform. */
analyze();

/* Close the device session to the instrument. */
iclose(id);
printf ("Program execution is complete...\n");

/* For WIN16 programs, call _siclcleanup before exiting to release
 * resources allocated by SICL for this application. This call is
 * a no-op for WIN32 programs.
 */
_siclcleanup();
}

/* Initialize the oscilloscope to a known state.
 * ----- */
void initialize (void)
{
    /* Clear status. */
    do_command("*CLS");

    /* Get and display the device's *IDN? string. */
    do_query_string("*IDN?");
    printf("Oscilloscope *IDN? string: %s\n", str_result);

    /* Load the default setup. */
    do_command("*CLS");
    do_command("*RST");
}

/* Capture the waveform.
 * ----- */
void capture (void)
{
    int num_values;
    FILE *fp;

    /* Set probe attenuation factor. */
    do_command(":CHANnel1:PROBe 1.0");
    do_query_string(":CHANnel1:PROBe?");
    printf("Channel 1 probe attenuation factor: %s\n", str_result);

    /* Use auto-scale to automatically configure oscilloscope.
     * ----- */
    do_command(":AUToscale");

    /* Set trigger mode. */

```

```

do_command(":TRIGger:MODE EDGE");
do_query_string(":TRIGger:MODE?");
printf("Trigger mode: %s\n", str_result);

/* Set EDGE trigger parameters. */
do_command(":TRIGger:EDGE:SOURCe CHANnel1");
do_query_string(":TRIGger:EDGE:SOURce?");
printf("Trigger edge source: %s\n", str_result);

do_command(":TRIGger:LEVel CHANnel1, -2E-3");
do_query_string(":TRIGger:LEVel? CHANnel1");
printf("Trigger level, channel 1: %s\n", str_result);

do_command(":TRIGger:EDGE:SLOPe POSitive");
do_query_string(":TRIGger:EDGE:SLOPe?");
printf("Trigger edge slope: %s\n", str_result);

/* Save oscilloscope configuration.
 * ----- */

/* Read system setup. */
num_values = do_query_ieeeblock(":SYSTem:SETUp?");
printf("Read setup string query (%d bytes).\n", num_values);

/* Write setup string to file. */
fp = fopen ("c:\\scope\\config\\setup.stp", "wb");
num_values = fwrite(ieeeblock_data, sizeof(unsigned char), num_values,
    fp);
fclose (fp);
printf("Wrote setup string (%d bytes) to ", num_values);
printf("c:\\scope\\config\\setup.stp.\n");

/* Change settings with individual commands:
 * ----- */

/* Set vertical scale and offset. */
do_command(":CHANnel1:SCALe 0.1");
do_query_string(":CHANnel1:SCALe?");
printf("Channel 1 vertical scale: %s\n", str_result);

do_command(":CHANnel1:OFFSet 0.0");
do_query_string(":CHANnel1:OFFSet?");
printf("Channel 1 offset: %s\n", str_result);

/* Set horizontal scale and position. */
do_command(":TIMEbase:SCALe 0.0002");
do_query_string(":TIMEbase:SCALe?");
printf("Timebase scale: %s\n", str_result);

do_command(":TIMEbase:POSition 0.0");
do_query_string(":TIMEbase:POSition?");
printf("Timebase position: %s\n", str_result);

/* Set the acquisition mode. */
do_command(":ACQuire:MODE RTIME");
do_query_string(":ACQuire:MODE?");
printf("Acquire mode: %s\n", str_result);

```



```

/* Or, configure by loading a previously saved setup.
* ----- */

/* Read setup string from file. */
fp = fopen ("c:\\scope\\config\\setup.stp", "rb");
num_values = fread (ieeeblock_data, sizeof(unsigned char),
    IEEEBLOCK_SPACE, fp);
fclose (fp);
printf("Read setup string (%d bytes) from file ", num_values);
printf("c:\\scope\\config\\setup.stp.\n");

/* Restore setup string. */
num_values = do_command_ieeeblock(":SYSTEM:SETup", num_values);
printf("Restored setup string (%d bytes).\n", num_values);

/* Set the desired number of waveform points,
* and capture an acquisition. */
do_command(":ACQUIRE:POINTS 32000");
do_command(":DIGitize");
}

/* Analyze the captured waveform.
* ----- */
void analyze (void)
{
    double wav_format;
    double acq_type;
    double wav_points;
    double avg_count;
    double x_increment;
    double x_origin;
    double y_increment;
    double y_origin;

    FILE *fp;
    int num_values; /* Number of bytes returned from instrument. */
    int i;

    /* Make measurements.
    * ----- */
    do_command(":MEASure:SOURce CHANnel1");
    do_query_string(":MEASure:SOURce?");
    printf("Measure source: %s\n", str_result);

    do_command(":MEASure:FREQuency");
    do_query_number(":MEASure:FREQuency?");
    printf("Frequency: %.4f kHz\n", num_result / 1000);

    do_command(":MEASure:VAMPlitude");
    do_query_number(":MEASure:VAMPlitude?");
    printf("Vertical amplitude: %.2f V\n", num_result);

    /* Download the screen image.
    * ----- */

    /* Read screen image. */

```

```

num_values = do_query_ieeeblock(":DISPlay:DATA? PNG");
printf("Screen image bytes: %d\n", num_values);

/* Write screen image bytes to file. */
fp = fopen("c:\\scope\\data\\screen.png", "wb");
num_values = fwrite(ieeeblock_data, sizeof(unsigned char), num_values,
    fp);
fclose(fp);
printf("Wrote screen image (%d bytes) to ", num_values);
printf("c:\\scope\\data\\screen.png.\n");

/* Download waveform data.
 * ----- */

/* Get the waveform type. */
do_query_string(":WAVeform:TYPE?");
printf("Waveform type: %s\n", str_result);

/* Get the number of waveform points. */
do_query_string(":WAVeform:POINTs?");
printf("Waveform points: %s\n", str_result);

/* Set the waveform source. */
do_command(":WAVeform:SOURce CHANnel1");
do_query_string(":WAVeform:SOURce?");
printf("Waveform source: %s\n", str_result);

/* Choose the format of the data returned: */
do_command(":WAVeform:FORMat WORD");
do_query_string(":WAVeform:FORMat?");
printf("Waveform format: %s\n", str_result);

/* Display the waveform settings: */
do_query_number(":WAVeform:XINCrement?");
x_increment = num_result;
printf("Waveform X increment: %e\n", x_increment);

do_query_number(":WAVeform:XORigin?");
x_origin = num_result;
printf("Waveform X origin: %e\n", x_origin);

do_query_number(":WAVeform:YINCrement?");
y_increment = num_result;
printf("Waveform Y increment: %e\n", y_increment);

do_query_number(":WAVeform:YORigin?");
y_origin = num_result;
printf("Waveform Y origin: %e\n", y_origin);

/* Read waveform data. */
num_values = do_query_ieeeblock_words(":WAVeform:DATA?");
printf("Number of data values: %d\n", num_values);

/* Open file for output. */
fp = fopen("c:\\scope\\data\\waveform_data.csv", "wb");

/* Output waveform data in CSV format. */

```

```

for (i = 0; i < num_values - 1; i++)
{
    /* Write time value, voltage value. */
    fprintf(fp, "%9f, %6f\n",
        x_origin + ((float)i * x_increment),
        ((float)ieeeblock_data_words[i] * y_increment) + y_origin);
}

/* Close output file. */
fclose(fp);
printf("Waveform format WORD data written to ");
printf("c:\\scope\\data\\waveform_data.csv.\n");
}

/* Send a command to the instrument.
 * ----- */
void do_command(command)
char *command;
{
    char message[80];

    strcpy(message, command);
    strcat(message, "\n");
    fprintf(id, message);

    check_instrument_errors();
}

/* Command with IEEE definite-length block.
 * ----- */
int do_command_ieeeblock(command, num_bytes)
char *command;
int num_bytes;
{
    char message[80];
    int data_length;

    strcpy(message, command);
    strcat(message, " #8%08d");
    fprintf(id, message, num_bytes);
    ifwrite(id, ieeeblock_data, num_bytes, 1, &data_length);

    check_instrument_errors();

    return(data_length);
}

/* Query for a string result.
 * ----- */
void do_query_string(query)
char *query;
{
    char message[80];

    strcpy(message, query);
    strcat(message, "\n");
    fprintf(id, message);
}

```

```

        iscanf(id, "%t\n", str_result);

        check_instrument_errors();
    }

    /* Query for a number result.
     * ----- */
    void do_query_number(query)
    char *query;
    {
        char message[80];

        strcpy(message, query);
        strcat(message, "\n");
        iprintf(id, message);

        iscanf(id, "%lf", &num_result);

        check_instrument_errors();
    }

    /* Query for numbers result.
     * ----- */
    void do_query_numbers(query)
    char *query;
    {
        char message[80];

        strcpy(message, query);
        strcat(message, "\n");
        iprintf(id, message);

        iscanf(id, "%,10lf\n", dbl_results);

        check_instrument_errors();
    }

    /* Query for an IEEE definite-length block result.
     * ----- */
    int do_query_ieeeblock(query)
    char *query;
    {
        char message[80];
        int data_length;

        strcpy(message, query);
        strcat(message, "\n");
        iprintf(id, message);

        data_length = IEEEBLOCK_SPACE;
        iscanf(id, "%#b", &data_length, ieeeblock_data);

        if (data_length == IEEEBLOCK_SPACE )
        {
            printf("IEEE block buffer full: ");
            printf("May not have received all data.\n");
        }
    }

```

```

    }

    check_instrument_errors();

    return(data_length);
}

/* Query for an IEEE definite-length block word data result.
 * ----- */
int do_query_ieeeblock_words(query)
char *query;
{
    char message[80];
    int data_length;

    strcpy(message, query);
    strcat(message, "\n");
    fprintf(id, message);

    data_length = IEEEBLOCK_SPACE;
    iscanf(id, "%#wb", &data_length, ieeeblock_data_words);

    if (data_length == IEEEBLOCK_SPACE )
    {
        printf("IEEE block buffer full: ");
        printf("May not have received all data.\n");
    }

    check_instrument_errors();

    return(data_length);
}

/* Check for instrument errors.
 * ----- */
void check_instrument_errors()
{
    char str_err_val[256] = {0};
    char str_out[800] = "";

    ipromptf(id, ":SYSTem:ERRor? STRing\n", "%t", str_err_val);
    while(strncmp(str_err_val, "0,", 2) != 0 )
    {
        strcat(str_out, ", ");
        strcat(str_out, str_err_val);
        ipromptf(id, ":SYSTem:ERRor? STRing\n", "%t", str_err_val);
    }

    if (strcmp(str_out, "") != 0)
    {
        printf("INST Error%s\n", str_out);
        fflush(id, I_BUF_READ | I_BUF_WRITE);
    }
}

```

## SICL Example in Visual Basic

To run this example in Visual Basic for Applications:

- 1 Start the application that provides Visual Basic for Applications (for example, Microsoft Excel).
- 2 Press ALT+F11 to launch the Visual Basic editor.
- 3 Add the sicl32.bas file to your project:
  - a Choose **File > Import File...**
  - b Navigate to the header file, sicl32.bas (installed with Keysight IO Libraries Suite and found in the Program Files\Agilent\IO Libraries Suite\include directory), select it, and click **Open**.
- 4 Choose **Insert > Module**.
- 5 Cut-and-paste the code that follows into the editor.
- 6 Edit the program to use the SICL address of your oscilloscope, and save the changes.
- 7 Run the program.

```
'
' Keysight SICL Example in Visual Basic
' -----
' This program illustrates a few commonly-used programming
' features of your Keysight Infiniium Series oscilloscope.
' -----

Option Explicit

Public id As Integer ' Session to instrument.

' Declare variables to hold numeric values returned by
' ivscanf/ifread.
Public dblQueryResult As Double
Public Const ByteArraySize = 5000000
Public retCount As Long
Public byteArray(ByteArraySize) As Byte

' Declare fixed length string variable to hold string value returned
' by ivscanf.
Public strQueryResult As String * 200

' For Sleep subroutine.
Private Declare Sub Sleep Lib "kernel32" (ByVal dwMilliseconds As Long)

'
' Main Program
' -----

Sub Main()

    On Error GoTo ErrorHandler
```

```

' Open a device session using the SICL_ADDRESS.
id = iopen("lan,4880;hislip[141.121.237.226]:hislip0")
Call itimeout(id, 15000)

' Clear the interface.
Call iclear(id)

' Initialize - start from a known state.
Initialize

' Capture data.
Capture

' Analyze the captured waveform.
Analyze

' Close the vi session and the resource manager session.
Call iclose(id)

Exit Sub

ErrorHandler:

MsgBox "*** Error : " + Error, vbExclamation
End

End Sub

'
' Initialize the oscilloscope to a known state.
' -----

Private Sub Initialize()

On Error GoTo ErrorHandler

' Clear status.
DoCommand "*CLS"

' Get and display the device's *IDN? string.
strQueryResult = DoQueryString("*IDN?")
MsgBox "Result is: " + RTrim(strQueryResult), vbOKOnly, "*IDN? Result"

' Load the default setup.
DoCommand "*RST"

Exit Sub

ErrorHandler:

MsgBox "*** Error : " + Error, vbExclamation
End

End Sub

'
' Capture the waveform.

```

```

' -----
Private Sub Capture()

    On Error GoTo ErrorHandler

    ' Set probe attenuation factor.
    DoCommand ":CHANnel1:PROBe 1.0"
    Debug.Print "Channel 1 probe attenuation factor: " + _
        DoQueryString(":CHANnel1:PROBe?")

    ' Use auto-scale to automatically configure oscilloscope.
    ' -----
    DoCommand ":AUToscale"

    ' Set trigger mode.
    DoCommand ":TRIGger:MODE EDGE"
    Debug.Print "Trigger mode: " + _
        DoQueryString(":TRIGger:MODE?")

    ' Set EDGE trigger parameters.
    DoCommand ":TRIGger:EDGE:SOURCe CHANnel1"
    Debug.Print "Trigger edge source: " + _
        DoQueryString(":TRIGger:EDGE:SOURce?")

    DoCommand ":TRIGger:LEVel CHANnel1,-2E-3"
    Debug.Print "Trigger level, channel 1: " + _
        DoQueryString(":TRIGger:LEVel? CHANnel1")

    DoCommand ":TRIGger:EDGE:SLOPe POSitive"
    Debug.Print "Trigger edge slope: " + _
        DoQueryString(":TRIGger:EDGE:SLOPe?")

    ' Save oscilloscope configuration.
    ' -----
    Dim lngSetupStringSize As Long
    lngSetupStringSize = DoQueryIEEEBlock_Bytes(":SYSTem:SETUp?")
    Debug.Print "Setup bytes saved: " + CStr(lngSetupStringSize)

    ' Output setup string to a file:
    Dim strPath As String
    strPath = "c:\scope\config\setup.dat"
    If Len(Dir(strPath)) Then
        Kill strPath ' Remove file if it exists.
    End If

    ' Open file for output.
    Dim hFile As Long
    hFile = FreeFile
    Open strPath For Binary Access Write Lock Write As hFile
    Dim lngI As Long
    For lngI = 0 To lngSetupStringSize - 1
        Put hFile, , byteArray(lngI) ' Write data.
    Next lngI
    Close hFile ' Close file.

    ' Change settings with individual commands:

```



```

' -----
' Set vertical scale and offset.
DoCommand ":CHANnel1:SCALE 0.1"
Debug.Print "Channel 1 vertical scale: " + _
    DoQueryString(":CHANnel1:SCALE?")

DoCommand ":CHANnel1:OFFSet 0.0"
Debug.Print "Channel 1 vertical offset: " + _
    DoQueryString(":CHANnel1:OFFSet?")

' Set horizontal scale and position.
DoCommand ":TIMEbase:SCALE 0.0002"
Debug.Print "Timebase scale: " + _
    DoQueryString(":TIMEbase:SCALE?")

DoCommand ":TIMEbase:POSition 0.0"
Debug.Print "Timebase position: " + _
    DoQueryString(":TIMEbase:POSition?")

' Set the acquisition mode.
DoCommand ":ACQuire:MODE RTIME"
Debug.Print "Acquire mode: " + _
    DoQueryString(":ACQuire:MODE?")

' Or, configure by loading a previously saved setup.
' -----
strPath = "c:\scope\config\setup.dat"
Open strPath For Binary Access Read As hFile ' Open file for input.
Dim lngSetupFileSize As Long
lngSetupFileSize = LOF(hFile) ' Length of file.
Get hFile, , byteArray ' Read data.
Close hFile ' Close file.
' Write setup string back to oscilloscope using ":SYSTEM:SETup"
' command:
Dim lngRestored As Long
lngRestored = DoCommandIEEEBlock(":SYSTEM:SETup", lngSetupFileSize)
Debug.Print "Setup bytes restored: " + CStr(lngRestored)

' Set the desired number of waveform points,
' and capture an acquisition.
' -----
DoCommand ":ACQuire:POINTs 32000"
DoCommand ":DIGitize"

Exit Sub

ErrorHandler:

MsgBox "*** Error : " + Error, vbExclamation
End

End Sub

'
' Analyze the captured waveform.
' -----

```

```

Private Sub Analyze()

    On Error GoTo ErrorHandler

    ' Make measurements.
    ' -----
    DoCommand ":MEASure:SOURce CHANnel1"
    Debug.Print "Measure source: " + _
        DoQueryString(":MEASure:SOURce?")

    DoCommand ":MEASure:FREQuency"
    dblQueryResult = DoQueryNumber(":MEASure:FREQuency?")
    MsgBox "Frequency:" + vbCrLf + _
        FormatNumber(dblQueryResult / 1000, 4) + " kHz"

    DoCommand ":MEASure:VAMPlitude"
    dblQueryResult = DoQueryNumber(":MEASure:VAMPlitude?")
    MsgBox "Vertical amplitude:" + vbCrLf + _
        FormatNumber(dblQueryResult, 4) + " V"

    ' Download the screen image.
    ' -----

    ' Get screen image.
    Dim lngBlockSize As Long
    lngBlockSize = DoQueryIEEEBlock_Bytes(":DISPlay:DATA? PNG")
    Debug.Print "Screen image bytes: " + CStr(lngBlockSize)

    ' Save screen image to a file:
    Dim strPath As String
    strPath = "c:\scope\data\screen.png"
    If Len(Dir(strPath)) Then
        Kill strPath ' Remove file if it exists.
    End If
    Dim hFile As Long
    hFile = FreeFile
    Open strPath For Binary Access Write Lock Write As hFile
    Dim lngI As Long
    ' Skip past header.
    For lngI = CInt(Chr(byteArray(1))) + 2 To lngBlockSize - 1
        Put hFile, , byteArray(lngI) ' Write data.
    Next lngI
    Close hFile ' Close file.
    MsgBox "Screen image written to " + strPath

    ' Download waveform data.
    ' -----

    ' Get the waveform type.
    Debug.Print "Waveform type: " + _
        DoQueryString(":WAVeform:TYPE?")

    ' Get the number of waveform points.
    Debug.Print "Waveform points: " + _
        DoQueryString(":WAVeform:POINTs?")

```

```

' Set the waveform source.
DoCommand ":WAVeform:SOURce CHANnel1"
Debug.Print "Waveform source: " + _
    DoQueryString(":WAVeform:SOURce?")

' Choose the format of the data returned:
DoCommand ":WAVeform:FORMat BYTE"
Debug.Print "Waveform format: " + _
    DoQueryString(":WAVeform:FORMat?")

' Display the waveform settings:
Dim dblXIncrement As Double
Dim dblXOrigin As Double
Dim dblYIncrement As Double
Dim dblYOrigin As Double

dblXIncrement = DoQueryNumber(":WAVeform:XINCrement?")
Debug.Print "Waveform X increment: " + _
    Format(dblXIncrement, "Scientific")

dblXOrigin = DoQueryNumber(":WAVeform:XORigin?")
Debug.Print "Waveform X origin: " + _
    Format(dblXOrigin, "Scientific")

dblYIncrement = DoQueryNumber(":WAVeform:YINCrement?")
Debug.Print "Waveform Y increment: " + _
    Format(dblYIncrement, "Scientific")

dblYOrigin = DoQueryNumber(":WAVeform:YORigin?")
Debug.Print "Waveform Y origin: " + _
    FormatNumber(dblYOrigin, 0)

' Get the waveform data
DoCommand ":WAVeform:STReaming OFF"
Dim lngNumBytes As Long
lngNumBytes = DoQueryIEEEBlock_Bytes(":WAVeform:DATA?")
Debug.Print "Number of data values: " + _
    CStr(lngNumBytes - CInt(Chr(byteArray(1))) - 2)

' Set up output file:
strPath = "c:\scope\data\waveform_data.csv"

' Open file for output.
Open strPath For Output Access Write Lock Write As hFile

' Output waveform data in CSV format.
Dim lngDataValue As Long
Dim byteUnsigned As Byte

' Skip past header.
For lngI = CInt(Chr(byteArray(1))) + 2 To lngNumBytes - 2
    byteUnsigned = byteArray(lngI)
    ' Oscilloscope BYTE format sends signed bytes. VBA Byte is
    ' interpreted as unsigned, so convert the bits to signed value.
    lngDataValue = byteUnsigned - ((byteUnsigned And &H80) * 2)

    ' Write time value, voltage value.

```

```

Print #hFile, _
    FormatNumber(dblXOrigin + (lngI * dblXIncrement), 9) + _
    ", " + _
    FormatNumber((lngDataValue * dblyIncrement) + dblyOrigin)

Next lngI

' Close output file.
Close hFile ' Close file.
MsgBox "Waveform format BYTE data written to " + _
    "c:\scope\data\waveform_data.csv."

Exit Sub

ErrorHandler:

MsgBox "*** Error : " + Error, vbExclamation
End

End Sub

Private Sub DoCommand(command As String)

    On Error GoTo ErrorHandler

    Call ivprintf(id, command + vbLf)

    CheckInstrumentErrors

    Exit Sub

ErrorHandler:

MsgBox "*** Error : " + Error, vbExclamation
End

End Sub

Private Function DoCommandIEEEBlock(command As String, _
    lngBlockSize As Long)

    On Error GoTo ErrorHandler

    ' Send command part.
    Call ivprintf(id, command + " ")

    ' Write definite-length block bytes.
    Call ifwrite(id, byteArray(), lngBlockSize, vbNull, retCount)

    ' retCount is now actual number of bytes written.
    DoCommandIEEEBlock = retCount

    CheckInstrumentErrors

    Exit Function

ErrorHandler:

```

```

    MsgBox "*** Error : " + Error, vbExclamation
End

End Function

Private Function DoQueryString(query As String) As String

    Dim actual As Long

    On Error GoTo ErrorHandler

    Dim strResult As String * 200

    Call ivprintf(id, query + vbLf)
    Call ivscanf(id, "%200t", strResult)
    DoQueryString = strResult

    CheckInstrumentErrors

    Exit Function

ErrorHandler:

    MsgBox "*** Error : " + Error, vbExclamation
End

End Function

Private Function DoQueryNumber(query As String) As Double

    On Error GoTo ErrorHandler

    Dim dblResult As Double

    Call ivprintf(id, query + vbLf)
    Call ivscanf(id, "%lf" + vbLf, dblResult)
    DoQueryNumber = dblResult

    CheckInstrumentErrors

    Exit Function

ErrorHandler:

    MsgBox "*** Error : " + Error, vbExclamation
End

End Function

Private Function DoQueryNumbers(query As String) As Double()

    On Error GoTo ErrorHandler

    Dim dblResults(10) As Double

    Call ivprintf(id, query + vbLf)

```

```

    Call ivscanf(id, "%,10lf" + vbCrLf, dblResults)
    DoQueryNumbers = dblResults

    CheckInstrumentErrors

    Exit Function

ErrorHandler:

    MsgBox "*** Error : " + Error, vbExclamation
    End

End Function

Private Function DoQueryIEEEBlock_Bytes(query As String) As Long

    On Error GoTo ErrorHandler

    ' Send query.
    Call ivprintf(id, query + vbCrLf)

    ' Read definite-length block bytes.
    Call ifread(id, byteArray(), byteArraySize, vbNull, retCount)

    ' Get number of block length digits.
    Dim intLengthDigits As Integer
    intLengthDigits = CInt(Chr(byteArray(1)))

    ' Get block length from those digits.
    Dim strBlockLength As String
    strBlockLength = ""
    Dim i As Integer
    For i = 2 To intLengthDigits + 1
        strBlockLength = strBlockLength + Chr(byteArray(i))
    Next

    ' Return number of bytes in block plus header.
    DoQueryIEEEBlock_Bytes = CLng(strBlockLength) + intLengthDigits + 2

    CheckInstrumentErrors

    Exit Function

ErrorHandler:

    MsgBox "*** Error : " + Error, vbExclamation
    End

End Function

Private Sub CheckInstrumentErrors()

    On Error GoTo ErrorHandler

    Dim strErrVal As String * 200
    Dim strOut As String

```

```

    Call ivprintf(id, ":SYSTEM:ERROR? STRING" + vbLf) ' Query any errors d
ata.
    Call ivscanf(id, "%200t", strErrVal) ' Read: Errnum,"Error String".
    While Val(strErrVal) <> 0 ' End if find: 0,"No Error".
        strOut = strOut + "INST Error: " + strErrVal
        Call ivprintf(id, ":SYSTEM:ERROR? STRING" + vbLf) ' Request error me
ssage.
        Call ivscanf(id, "%200t", strErrVal) ' Read error message.
    Wend

    If Not strOut = "" Then
        MsgBox strOut, vbExclamation, "INST Error Messages"
        Call iflush(id, I_BUF_READ Or I_BUF_WRITE)

    End If

    Exit Sub

ErrorHandler:

    MsgBox "*** Error : " + Error, vbExclamation
    End

End Sub

```

## SCPI.NET Examples

You can also program the oscilloscope using the SCPI.NET drivers that come with Keysight's free Command Expert software.

While you can write code manually using the SCPI.NET drivers, you can also use the Command Expert software to:

- Connect to instruments and control them interactively using SCPI command sets.
- Quickly prototype and test command sequences.
- Generate C#, VB.NET, or C/C++ code for command sequences.
- Find, download, and install SCPI command sets.
- Browse command trees, search for commands, and view command descriptions.

The Command Expert suite also comes with Add-ons for easy instrument control and measurement data retrieval in NI LabVIEW, Microsoft Excel, Keysight VEE, and Keysight SystemVue.

To download the Keysight Command Expert software, see:

<http://www.keysight.com/find/commandexpert>

For more on programming with the SCPI.NET drivers, see "Using SCPI.NET Drivers" in the help that comes with Keysight Command Expert.



# 45 Reference

HDF5 Example / 1946

CSV and TSV Header Format / 1947

BIN Header Format / 1949

## HDF5 Example

Here is an example of a captured HDF5 file.

```
Channel 1(6576)
Group Size = 1
Number of Attributes = 17
Waveform Type = 1
Start = 1
NumPoints = 1000000
NumSegments = 0
Count = 1
XDispRange = 1.0E-6
XDispOrigin = -5.0E-7
XInc = 5.0E-11
XOrg = -2.4999999E-5
XUnits = Second
YDispRange = 8.0
YDispOrigin = 0.0
YInc = 1.327218738E-4
YOrg = 0.11645629362732
YUnits = Volt
MinBandwidth = 0.0
MaxBandwidth = 6.0E9
```

## CSV and TSV Header Format

<b>Revision</b>	Always 0 (zero).
<b>Type</b>	How the waveform was acquired: normal, raw, interpolate, average, or versus. When this field is read back into the scope, all modes, except versus, are converted to raw. The default value is raw.
<b>Start</b>	Starting point in the waveform of the first data point in the file. This is usually zero.
<b>Points</b>	The number of points in the waveform record. The number of points is set by the Memory Depth control. The default value is 1.
<b>Count or Segments</b>	<p>For count, it is the number of hits at each time bucket in the waveform record when the waveform was created using an acquisition mode like averaging. For example, when averaging, a count of four would mean every waveform data point in the waveform record has been averaged at least four times. Count is ignored when it is read back into the scope. The default value is 0.</p> <p>Segments is used instead of Count when the data is acquired using the Segmented acquisition mode. This number is the total number of segments that were acquired.</p>
<b>XDispRange</b>	The number of X display range columns (n) depends on the number of sources being stored. The X display range is the X-axis duration of the waveform that is displayed. For time domain waveforms, it is the duration of time across the display. If the value is zero then no data has been acquired.
<b>XDispOrg</b>	The number of X display origin columns (n) depends on the number of sources being stored. The X display origin is the X-axis value at the left edge of the display. For time domain waveforms, it is the time at the start of the display. This value is treated as a double precision 64-bit floating point number. If the value is zero then no data has been acquired.
<b>XInc</b>	The number of X increment columns (n) depends on the number of sources being store. The X increment is the duration between data points on the X axis. For time domain waveforms, this is the time between points. If the value is zero then no data has been acquired.
<b>XOrg</b>	The number of X origin columns (n) depends on the number of sources being store. The X origin is the X-axis value of the first data point in the data record. For time domain waveforms, it is the time of the first point. This value is treated as a double precision 64-bit floating point number. If the value is zero then no data has been acquired.
<b>XUnits</b>	The number of X units columns (n) depends on the number of sources being store. The X units is the unit of measure for each time value of the acquired data.

<b>YDispRange</b>	The number of Y display range columns (n) depends on the number of sources being store. The Y display range is the Y-axis duration of the waveform which is displayed. For voltage waveforms, it is the amount of voltage across the display. If the value is zero then no data has been acquired.
<b>YDispOrg</b>	The number of Y display origin columns (n) depends on the number of sources being store. The Y-display origin is the Y-axis value at the center of the display. For voltage waveforms, it is the voltage at the center of the display. If the value is zero then no data has been acquired.
<b>YInc</b>	The number of Y increment columns (n) depends on the number of sources being store. The Y increment is the duration between Y-axis levels. For voltage waveforms, it is the voltage corresponding to one level. If the value is zero then no data has been acquired.
<b>YOrg</b>	The number of Y origin columns (n) depends on the number of sources being store. The Y origin is the Y-axis value at level zero. For voltage waveforms, it is the voltage at level zero. If the value is zero then no data has been acquired.
<b>YUnits</b>	The number of Y units columns (n) depends on the number of sources being stored. The Y units is the unit of measure of each voltage value of the acquired waveform.
<b>Frame</b>	A string containing the model number and serial number of the scope in the format of MODEL#:SERIAL#.
<b>Date</b>	The date when the waveform was acquired. The default value is 27 DEC 1996.
<b>Time</b>	The time when the waveform was acquired. The default value is 01:00:00:00.
<b>Max bandwidth</b>	An estimation of the maximum bandwidth of the waveform. The default value is 0.
<b>Min bandwidth</b>	An estimation of the minimum bandwidth of the waveform. The default value is 0.
<b>Time Tags</b>	The Time Tags only occur when the data was acquired using the Segmented acquisition mode with time tags enabled and the file format is YValues. The number of columns depends on the number of Segments being saved.
<b>Data</b>	The data values follow this header entry.

## BIN Header Format

- ["File Header"](#) on page 1949
- ["Waveform Header"](#) on page 1949
- ["Waveform Data Header"](#) on page 1951
- ["Example Program for Reading Binary Data"](#) on page 1952

### File Header

There is only one file header in a binary file. The file header consists of the following information.

<b>Cookie</b>	Two byte characters, AG, which indicates that the file is in the Keysight Binary Data file format.
<b>Version</b>	Two bytes which represent the file version.
<b>File Size</b>	An integer (4 byte signed) which is the number of bytes that are in the file.
<b>Number of Waveforms</b>	An integer (4 byte signed) which is the number of waveforms that are stored in the file.

### Waveform Header

The waveform header contains information about the type of waveform data that is stored following the waveform data header which is located after each waveform header. Because it is possible to store more than one waveform in the file, there will be a waveform header and a waveform data header for each waveform.

<b>Header Size</b>	An integer (4 byte signed) which is the number of bytes in the header.
<b>Waveform Type</b>	An integer (4 byte signed) which is the type of waveform that is stored in the file. The follow shows what each value means. <ul style="list-style-type: none"> <li>0 = Unknown</li> <li>1 = Normal</li> <li>2 = Peak Detect</li> <li>3 = Average</li> <li>4 = Horizontal Histogram</li> <li>5 = Vertical Histogram</li> <li>6 = Logic</li> </ul>
<b>Number of Waveform Buffers</b>	An integer (4 byte signed) which is the number of waveform buffers required to read the data. This value is one except for peak detect data and digital data.

<b>Points</b>	An integer (4 byte signed) that is the number of waveform points in the data.
<b>Count</b>	An integer (4 byte signed) which is the number of hits at each time bucket in the waveform record when the waveform was created using an acquisition mode like averaging. For example, when averaging, a count of four would mean every waveform data point in the waveform record has been averaged at least four times. The default value is 0.
<b>X Display Range</b>	A float (4 bytes) which is the X-axis duration of the waveform that is displayed. For time domain waveforms, it is the duration of time across the display. If the value is zero then no data has been acquired.
<b>X Display Origin</b>	A double (8 bytes) which is the X-axis value at the left edge of the display. For time domain waveforms, it is the time at the start of the display. This value is treated as a double precision 64-bit floating point number. If the value is zero then no data has been acquired.
<b>X Increment</b>	A double (8 bytes) which is the duration between data points on the X axis. For time domain waveforms, this is the time between points. If the value is zero then no data has been acquired.
<b>X Origin</b>	A double (8 bytes) which is the X-axis value of the first data point in the data record. For time domain waveforms, it is the time of the first point. This value is treated as a double precision 64-bit floating point number. If the value is zero then no data has been acquired.
<b>X Units</b>	An integer (4 byte signed) which is the number of X units columns (n) depends on the number of sources being stored. The X units is the unit of measure for each time value of the acquired data. X unit definitions are: <ul style="list-style-type: none"> <li>0 = Unknown</li> <li>1 = Volt</li> <li>2 = Second</li> <li>3 = Constant</li> <li>4 = Amp</li> <li>5 = Decibel</li> <li>6 = Hz</li> </ul>
<b>Y Units</b>	An integer (4 byte signed) which is the number of Y units columns (n) depends on the number of sources being stored. The Y units is the unit of measure of each voltage value of the acquired waveform. Y units definitions are: <ul style="list-style-type: none"> <li>0 = Unknown</li> <li>1 = Volt</li> <li>2 = Second</li> <li>3 = Constant</li> </ul>

	4 = Amp
	5 = Decibel
	6 = Hz
<b>Date</b>	A 16 character array which is the date when the waveform was acquired. The default value is 27 DEC 1996.
<b>Time</b>	A 16 character array which is the time when the waveform was acquired. The default value is 01:00:00:00.
<b>Frame</b>	A 24 character array which is the model number and serial number of the scope in the format of MODEL#:SERIAL#.
<b>Waveform Label</b>	A 16 character array which is the waveform label.
<b>Time Tags</b>	A double (8 bytes) which is the time tag value of the segment being saved.
<b>Segment Index</b>	An unsigned integer (4 byte signed) which is the segment index of the data that follows the waveform data header.

## Waveform Data Header

The waveform data header consists of information about the waveform data points that are stored immediately after the waveform data header.

<b>Waveform Data Header Size</b>	An integer (4 byte signed) which is the size of the waveform data header.
<b>Buffer Type</b>	A short (2 byte signed) which is the type of waveform data that is stored in the file. The following shows what each value means.
	0 = Unknown data
	1 = Normal 32 bit float data
	2 = Maximum float data
	3 = Minimum float data
	4 = Time float data
	5 = Counts 32 bit float data
	6 = Digital unsigned 8 bit char data
<b>Bytes Per Point</b>	A short (2 byte signed) which is the number of bytes per data point.
<b>Buffer Size</b>	An integer (4 byte signed) which is the size of the buffer required to hold the data bytes.

## Example Program for Reading Binary Data

The following is a programming example of reading a Binary Data (.bin) file and converting it to a CSV (.csv) file without a file header.

```

/* bintoascii.c */

/* Reads the binary file format.
   This program demonstrates how to import the Infiniium
   oscilloscope binary file format and how to export it to an
   ascii comma separated file format.
*/
#pragma pack(4)

#include <stdio.h>           /* location of: printf() */
#include <stdlib.h>          /* location of: atof(), atoi() */
#include <string.h>          /* location of: strlen() */
#include "sicl.h"

/* Defines */
#define MAX_LENGTH 10000000
#define INTERFACE "lan[130.29.70.247]:inst0" /* Change the IP address
                                             * to the one found in
                                             * the Remote Setup
                                             * dialog box.
                                             */

#define TRUE 1
#define FALSE 0
#define IO_TIMEOUT 20000

/* Type definitions */
typedef unsigned _int64 UINT64; /* This defines a 64-bit unsigned
                               * integer for Microsoft platforms.
                               */

/* Structure and Union definitions */
union DATATYPE
{
    char buffer[MAX_LENGTH]; /* Buffer for reading word format data */
    char byte[MAX_LENGTH];
    unsigned short word[MAX_LENGTH/2];
    UINT64 longlong[MAX_LENGTH/4];
};

typedef struct
{
    char Cookie[2];
    char Version[2];
    int FileSize;
    int NumberOfWaveforms;
} FileHeader;

const char COOKIE[2] = {'A', 'G'};
const char VERSION[2] = {'1', '0'};

```



```

#define DATE_TIME_STRING_LENGTH 16
#define FRAME_STRING_LENGTH 24
#define SIGNAL_STRING_LENGTH 16

typedef struct
{
    int    HeaderSize;
    int    WaveformType;
    int    NWaveformBuffers;
    int    Points;
    int    Count;
    float  XDisplayRange;
    double XDisplayOrigin;
    double XIncrement;
    double XOrigin;
    int    XUnits;
    int    YUnits;
    char   Date[DATE_TIME_STRING_LENGTH];
    char   Time[DATE_TIME_STRING_LENGTH];
    char   Frame[FRAME_STRING_LENGTH];
    char   WaveformLabel[SIGNAL_STRING_LENGTH];
    double TimeTag;
    unsigned int SegmentIndex;
} WaveformHeader;

typedef struct
{
    int    HeaderSize;
    short  BufferType;
    short  BytesPerPoint;
    int    BufferSize;
} WaveformDataHeader;

typedef enum
{
    PB_UNKNOWN,
    PB_NORMAL,
    PB_PEAK_DETECT,
    PB_AVERAGE,
    PB_HORZ_HISTOGRAM,
    PB_VERT_HISTOGRAM,
    PB_LOGIC
} WaveformType;

typedef enum
{
    PB_DATA_UNKNOWN,
    PB_DATA_NORMAL,
    PB_DATA_MAX,
    PB_DATA_MIN,
    PB_DATA_TIME,
    PB_DATA_COUNTS,
    PB_DATA_LOGIC
} DataType;

/* Prototypes */
void GetTimeConversionFactors( WaveformHeader waveformHeader,

```

```

                                double *xInc, double *xOrg );
void OutputNormalWaveform( WaveformHeader waveformHeader );
void OutputPeakDetectWaveform( WaveformHeader waveformHeader );
void OutputHistogramWaveform( WaveformHeader waveformHeader );
void OutputData( FILE *PeakFile,
                WaveformDataHeader waveformDataHeader );

/* Globals */
double xOrg=0L, xInc=0L;      /* Values necessary to create time data */
union DATATYPE WaveFormData; /* Used to input and output data */
FILE *InputFile = NULL;
FILE *OutputFile;
errno_t err;
char *buffer;
float Volts[MAX_LENGTH];
float MaxVolts[MAX_LENGTH];
float MinVolts[MAX_LENGTH];
UINT64 HistogramData[MAX_LENGTH];

int main( int argc, char **argv )
{
    FileHeader fileHeader;
    WaveformHeader waveformHeader;

    if( argc > 1 )
    {
        InputFile = fopen( argv[1], "rb" );

        if( InputFile )
        {
            OutputFile = fopen( argv[2], "wb" );

            if( OutputFile )
            {
                /* Read the File Header */
                fread( &fileHeader, 1, sizeof( FileHeader ), InputFile );

                /* Make sure that this is a Keysight Binary File */
                if( (fileHeader.Cookie[0] == COOKIE[0]) &&
                    (fileHeader.Cookie[1] == COOKIE[1]) )
                {
                    fread( &waveformHeader, 1,
                        sizeof( WaveformHeader ), InputFile );

                    switch( waveformHeader.WaveformType )
                    {
                        case PB_NORMAL:
                        case PB_AVERAGE:
                            OutputNormalWaveform( waveformHeader );
                            break;
                        case PB_PEAK_DETECT:
                            OutputPeakDetectWaveform( waveformHeader );
                            break;
                        case PB_HORZ_HISTOGRAM:
                        case PB_VERT_HISTOGRAM:
                            OutputHistogramWaveform( waveformHeader );
                            break;
                    }
                }
            }
        }
    }
}

```

```

        default:
        case PB_UNKNOWN:
            printf( "Unknown waveform type: %d\n" );
            break;
    }
}
}
else
{
    printf( "Unable to open output file %s\n", OutputFile);
}
}
else
{
    printf( "Unable to open input file %s\n", argv[1] );
}

fclose( InputFile );
fclose( OutputFile );
}
else
{
    printf( "Usage: bintoascii inputfile outputfile\n" );
}
}

/*****
* Function name:   GetTimeConversionFactors
* Parameters:     double xInc which is the time between consecutive
*                 sample points.
*                 double xOrg which is the time value of the first
*                 data point.
* Return value:  none
* Description:    This routine transfers the waveform conversion
*                 factors for the time values.
*****/
void GetTimeConversionFactors( WaveformHeader waveformHeader,
                              double *xInc, double *xOrg )
{
    /* Read values which are used to create time values */

    *xInc = waveformHeader.XIncrement;
    *xOrg = waveformHeader.XOrigin;
}

/*****
* Function name:   OutputNormalWaveform
* Parameters:     WaveformHeader *waveformHeader which is a structure
*                 that contains the waveform header information.
* Return value:  none
* Description:    This routine stores the time and voltage information
*                 about the waveform as time and voltage separated by
*                 commas to a file.
*****/

```

```

void OutputNormalWaveform( WaveformHeader waveformHeader )
{
    WaveformDataHeader waveformDataHeader;
    int done = FALSE;
    unsigned long i;
    unsigned long j = 0;
    size_t BytesRead = 0L;
    double Time;

    BytesRead = fread( &waveformDataHeader, 1,
                      sizeof( WaveformDataHeader ), InputFile );
    GetTimeConversionFactors( waveformHeader, &xInc, &xOrg );
    while( !done )
    {
        BytesRead = fread( (char *) Volts, 1, MAX_LENGTH, InputFile );
        for( i = 0; i < (BytesRead/waveformDataHeader.BytesPerPoint); i++)
        {
            Time = (j * xInc) + xOrg; /* calculate time */
            j = j + 1;
            fprintf( OutputFile, "%e,%f\n", Time, Volts[i] );
        }
        if( BytesRead < MAX_LENGTH )
        {
            done = TRUE;
        }
    }
}

/*****
* Function name: OutputHistogramWaveform
* Parameters:   WaveformHeader *waveformHeader which is a structure
*              that contains the waveform header information.
* Return value: none
* Description: This routine stores the time and hits information
*              as time and hits separated by commas to a file.
*****/
void OutputHistogramWaveform( WaveformHeader waveformHeader )
{
    WaveformDataHeader waveformDataHeader;
    int done = FALSE;
    unsigned long i;
    unsigned long j = 0;
    size_t BytesRead = 0L;

    fread( &waveformDataHeader, 1,
          sizeof( WaveformDataHeader ), InputFile );
    GetTimeConversionFactors( waveformHeader, &xInc, &xOrg );
    while( !done )
    {
        BytesRead = fread( (char *) HistogramData, 1, MAX_LENGTH,
                          InputFile );

        for( i = 0; i < (BytesRead/waveformDataHeader.BytesPerPoint); i++)
        {
            fprintf( OutputFile, "%d,%u64l\n", j, HistogramData[i] );
            j = j + 1;
        }
    }
}

```

```

        if( BytesRead < MAX_LENGTH )
        {
            done = TRUE;
        }
    }
}

/*****
* Function name: OutputData
* Parameters:   FILE *PeakFile which is the pointer to the file
*              to be written.
*              WaveformDataHeader waveformDataHeader
*              which is a structure that contains the waveform
*              header information.
* Return value: none
* Description: This routine stores the time, minimum voltage, and
*              maximum voltage for the peak detect waveform as comma
*              separated values to a file.
*****/
void OutputData( FILE *PeakFile, WaveformDataHeader waveformDataHeader )
{
    int done = FALSE;
    size_t BytesRead = 0L;
    int NumberToRead;

    NumberToRead = waveformDataHeader.BufferSize;

    while( !done )
    {
        BytesRead = fread( (char *) Volts, 1, NumberToRead, InputFile ) +
            BytesRead;

        fwrite( Volts, 1, BytesRead, PeakFile );

        if( BytesRead <= NumberToRead )
        {
            done = TRUE;
        }
    }
}

/*****
* Function name: OutputPeakDetectWaveform
* Parameters:   WaveformHeader waveformHeader which is a
*              structure that contains the waveform header
*              information.
* Return value: none
* Description: This routine stores the time, minimum voltage, and
*              maximum voltage for the peak detect waveform as comma
*              separated values to a file.
*****/
void OutputPeakDetectWaveform( WaveformHeader waveformHeader )
{
    WaveformDataHeader waveformDataHeader;
    int done = FALSE;
    unsigned long i;
    unsigned long j = 0;

```

```

size_t BytesRead = 0L;
double Time;
FILE *MaxFile;
FILE *MinFile;

fread( &waveformDataHeader, 1,
       sizeof( WaveformDataHeader ), InputFile );
GetTimeConversionFactors( waveformHeader, &xInc, &xOrg );

MaxFile = fopen( "maxdata.bin", "wb" );
MinFile = fopen( "mindata.bin", "wb" );

if( MaxFile && MinFile )
{
    if( waveformDataHeader.BufferType == PB_DATA_MAX )
    {
        OutputData( MaxFile, waveformDataHeader );
        OutputData( MinFile, waveformDataHeader );
    }
    else
    {
        OutputData( MinFile, waveformDataHeader );
        OutputData( MaxFile, waveformDataHeader );
    }

    fclose( MaxFile );
    fclose( MinFile );

    MaxFile = fopen( "maxdata.bin", "rb" );
    MinFile = fopen( "mindata.bin", "rb" );

    while( !done )
    {
        BytesRead = fread( (char *) MaxVolts, 1, MAX_LENGTH, MaxFile );
        fread( (char *) MinVolts, 1, MAX_LENGTH, MinFile );

        for( i = 0; i < BytesRead/4; i++)
        {
            Time = (j * xInc) + xOrg; /* calculate time */
            j = j + 1;
            fprintf( OutputFile, "%9.5e,%f,%f\n", Time, MinVolts[i],
                    MaxVolts[i] );
        }

        if( BytesRead < MAX_LENGTH )
        {
            done = TRUE;
        }
    }

    fclose( MaxFile );
    fclose( MinFile );
}
}

```

# Index

## Symbols

- :ACQUIRE:AVERAGE command/query, 239
- :ACQUIRE:AVERAGE:COUNT command/query, 240
- :ACQUIRE:BANDWIDTH, command/query, 241
- :ACQUIRE:BANDWIDTH:FRAME? query, 243
- :ACQUIRE:BANDWIDTH:TESTLIMITS? query, 244
- :ACQUIRE:COMPLETE command/query, 245
- :ACQUIRE:COMPLETE:STATE command/query, 247
- :ACQUIRE:HRESOLUTION command/query, 248
- :ACQUIRE:INTERPOLATE command/query, 250
- :ACQUIRE:MODE command/query, 251
- :ACQUIRE:POINTS:ANALOG command/query, 253
- :ACQUIRE:POINTS:AUTO command/query, 255
- :ACQUIRE:POINTS:DIGITAL? query, 256
- :ACQUIRE:POINTS:TESTLIMITS? query, 257
- :ACQUIRE:REDGE command/query, 258
- :ACQUIRE:RESPONSE command/query, 259
- :ACQUIRE:SEGMENTED:AUTOPLAY command/query, 260
- :ACQUIRE:SEGMENTED:COUNT command/query, 261
- :ACQUIRE:SEGMENTED:INDEX command/query, 262
- :ACQUIRE:SEGMENTED:PLAY command/query, 263
- :ACQUIRE:SEGMENTED:PRATE command/query, 264
- :ACQUIRE:SEGMENTED:TTAGS command/query, 265
- :ACQUIRE:SRATE:ANALOG command/query, 266
- :ACQUIRE:SRATE:ANALOG:AUTO command/query, 267
- :ACQUIRE:SRATE:DIGITAL command/query, 268
- :ACQUIRE:SRATE:DIGITAL:AUTO command/query, 269
- :ACQUIRE:SRATE:TESTLIMITS? query, 270
- :ADER? query, 1219
- :AER? query, 1220
- :ANALYZE:AEDGES command/query, 273
- :ANALYZE:CLOCK command/query, 274
- :ANALYZE:CLOCK:METHOD command/query, 275
- :ANALYZE:CLOCK:METHOD:ALIGN command/query, 279
- :ANALYZE:CLOCK:METHOD:DEEMPHASIS command/query, 280
- :ANALYZE:CLOCK:METHOD:EDGE command/query, 281
- :ANALYZE:CLOCK:METHOD:IDLE command/query, 283
- :ANALYZE:CLOCK:METHOD:JTF command/query, 284
- :ANALYZE:CLOCK:METHOD:OJTF command/query, 286
- :ANALYZE:CLOCK:METHOD:PAM:B03 command/query, 1710
- :ANALYZE:CLOCK:METHOD:PAM:B12 command/query, 1712
- :ANALYZE:CLOCK:METHOD:PAM:NONSYMMETRIC command/query, 1714
- :ANALYZE:CLOCK:METHOD:PLLADVANCED command/query, 288
- :ANALYZE:CLOCK:METHOD:PLLTRACK command/query, 289
- :ANALYZE:CLOCK:METHOD:SKEW command/query, 290
- :ANALYZE:CLOCK:METHOD:SKEW:AUTOMATIC command, 291
- :ANALYZE:CLOCK:METHOD:SOURCE command/query, 292
- :ANALYZE:CLOCK:TIME? query, 293
- :ANALYZE:CLOCK:VERTICAL command/query, 295
- :ANALYZE:CLOCK:VERTICAL:OFFSET command/query, 296
- :ANALYZE:CLOCK:VERTICAL:RANGE command/query, 297
- :ANALYZE:SIGNAL:DATARATE command/query, 298
- :ANALYZE:SIGNAL:MIXER:CABLELOSS command/query, 300
- :ANALYZE:SIGNAL:MMWAVE:CALIBRATE command, 301
- :ANALYZE:SIGNAL:MMWAVE:CFREQUENCY command/query, 302
- :ANALYZE:SIGNAL:MMWAVE:CONNECT command/query, 303
- :ANALYZE:SIGNAL:MMWAVE:LOADADDRESS command/query, 304
- :ANALYZE:SIGNAL:MMWAVE:MBANDWIDTH command/query, 305
- :ANALYZE:SIGNAL:PATTERN:CLEAR command, 306
- :ANALYZE:SIGNAL:PATTERN:LOAD command, 307
- :ANALYZE:SIGNAL:PATTERN:LENGTH command/query, 308
- :ANALYZE:SIGNAL:PATTERN:SMAP command/query, 309
- :ANALYZE:SIGNAL:SYMBOLRATE command/query, 310
- :ANALYZE:SIGNAL:TYPE command/query, 312
- :ANALYZE:VIEW command/query, 315
- :ASTATE? query, 1221
- :ATER? query, 1222
- :AUTOSCALE command, 1223
- :AUTOSCALE:CHANNELS command, 1224
- :AUTOSCALE:PLACEMENT command/query, 1225
- :AUTOSCALE:VERTICAL command, 1226
- :BEEP command, 1227
- :BLANK command, 1228
- :BUS<B>:TYPE command/query, 318
- :BUS<B>:BIT<M> command/query, 320
- :BUS<B>:BITS command/query, 321
- :BUS<B>:CLEAR command/query, 322
- :BUS<B>:CLOCK command/query, 323
- :BUS<B>:CLOCK:SLOPE command/query, 324
- :BUS<B>:DISPLAY command/query, 325
- :BUS<B>:LABEL command/query, 326
- :BUS<B>:READOUT command/query, 327
- :CALIBRATE:DATE? query, 331
- :CALIBRATE:OUTPUT command/query, 332
- :CALIBRATE:OUTPUT:AUX command/query, 334
- :CALIBRATE:OUTPUT:AUX:RTIME command/query, 335
- :CALIBRATE:OUTPUT:CAL command/query, 336
- :CALIBRATE:SKEW command/query, 337
- :CALIBRATE:STATUS? query, 338
- :CALIBRATE:TEMP? query, 339
- :CDISPLAY command, 1229
- :CHANNEL<N>:BWLIMIT command/query, 344
- :CHANNEL<N>:COMMONMODE command/query, 345
- :CHANNEL<N>:DIFFERENTIAL command/query, 346
- :CHANNEL<N>:DIFFERENTIAL:SKEW command/query, 347
- :CHANNEL<N>:DISPLAY command/query, 348
- :CHANNEL<N>:DISPLAY:AUTO command/query, 349

- :CHANnel<N>:DISPlay:OFFSet  
command/query, 351
- :CHANnel<N>:DISPlay:RANGe  
command/query, 353
- :CHANnel<N>:DISPlay:SCALe  
command/query, 355
- :CHANnel<N>:INPut command/query, 357
- :CHANnel<N>:INVert command/query, 358
- :CHANnel<N>:ISIM:APPLy  
command/query, 359
- :CHANnel<N>:ISIM:BANDwidth  
command/query, 360
- :CHANnel<N>:ISIM:BWLimit  
command/query, 362
- :CHANnel<N>:ISIM:BWLimit:TYPE  
command/query, 364
- :CHANnel<N>:ISIM:CONVolve  
command/query, 365
- :CHANnel<N>:ISIM:CORRection  
command/query, 366
- :CHANnel<N>:ISIM:DEConvolve  
command/query, 368
- :CHANnel<N>:ISIM:DELay  
command/query, 369
- :CHANnel<N>:ISIM:NORMalize  
command/query, 370
- :CHANnel<N>:ISIM:PEXTraction  
command/query, 371
- :CHANnel<N>:ISIM:SPAN  
command/query, 373
- :CHANnel<N>:ISIM:STATe  
command/query, 374
- :CHANnel<N>:LABel command/query, 375
- :CHANnel<N>:OFFSet  
command/query, 376
- :CHANnel<N>:PROBe  
command/query, 1716
- :CHANnel<N>:PROBe:ACCAL  
command/query, 377
- :CHANnel<N>:PROBe:ATTenuation  
command/query, 379
- :CHANnel<N>:PROBe:AUTOzero  
command/query, 380
- :CHANnel<N>:PROBe:COUPLing  
command/query, 381
- :CHANnel<N>:PROBe:EADapter  
command/query, 382
- :CHANnel<N>:PROBe:ECOuPLing  
command/query, 385
- :CHANnel<N>:PROBe:EXTernal  
command/query, 386
- :CHANnel<N>:PROBe:EXTernal:GAIN  
command/query, 387
- :CHANnel<N>:PROBe:EXTernal:OFFSet  
command/query, 388
- :CHANnel<N>:PROBe:EXTernal:UNITs  
command/query, 389
- :CHANnel<N>:PROBe:GAIN  
command/query, 390
- :CHANnel<N>:PROBe:HEAD:ADD  
command, 391
- :CHANnel<N>:PROBe:HEAD:DELeTe  
command, 392
- :CHANnel<N>:PROBe:HEAD:SELeCt  
command/query, 393
- :CHANnel<N>:PROBe:HEAD:VTERm  
command/query, 394
- :CHANnel<N>:PROBe:ID? query, 395
- :CHANnel<N>:PROBe:INFO? query, 396
- :CHANnel<N>:PROBe:MODE  
command/query, 397
- :CHANnel<N>:PROBe:PRECProbe:BANDwidTh  
command, 398
- :CHANnel<N>:PROBe:PRECProbe:CALibratioN  
command, 399
- :CHANnel<N>:PROBe:PRECProbe:DELay  
command, 400
- :CHANnel<N>:PROBe:PRECProbe:MODE  
command, 401
- :CHANnel<N>:PROBe:PRECProbe:ZSRC  
command, 402
- :CHANnel<N>:PROBe:PRIMary  
command/query, 404
- :CHANnel<N>:PROBe:RESPonsivity  
command/query, 405
- :CHANnel<N>:PROBe:SKEW  
command/query, 406
- :CHANnel<N>:PROBe:SKEW:AUTO  
command, 407
- :CHANnel<N>:PROBe:STYPe  
command/query, 408
- :CHANnel<N>:PROBe:USER  
command/query, 409
- :CHANnel<N>:PROBe:WAVelength  
command/query, 411
- :CHANnel<N>:RANGe  
command/query, 412
- :CHANnel<N>:SCALe command/query, 413
- :CHANnel<N>:SiMulation:AMPLITude  
command/query, 414
- :CHANnel<N>:SiMulation:DATA:LENGTh  
command/query, 415
- :CHANnel<N>:SiMulation:DATA:ODD  
command/query, 416
- :CHANnel<N>:SiMulation:DATA:PAM  
command/query, 417
- :CHANnel<N>:SiMulation:DATA:RESeed  
command/query, 418
- :CHANnel<N>:SiMulation:DATA:SELection  
command/query, 419
- :CHANnel<N>:SiMulation:DRATE  
command/query, 420
- :CHANnel<N>:SiMulation:FiLTer:ISIM:ADDRess  
command/query, 421
- :CHANnel<N>:SiMulation:FiLTer:ISIM:PEXTraction  
command/query, 422
- :CHANnel<N>:SiMulation:FiLTer:SELection  
command/query, 423
- :CHANnel<N>:SiMulation:FLOAd:ADDRess  
command/query, 424
- :CHANnel<N>:SiMulation:FLOAd:LOOP  
command/query, 425
- :CHANnel<N>:SiMulation:FREQUency  
command/query, 426
- :CHANnel<N>:SiMulation:FUNCTion:SELeCt  
on command/query, 427
- :CHANnel<N>:SiMulation:FUNCTion:SQUare:  
DCYCLe command/query, 428
- :CHANnel<N>:SiMulation:FUNCTion:SQUare:  
FTIME command/query, 429
- :CHANnel<N>:SiMulation:FUNCTion:SQUare:  
RTIME command/query, 430
- :CHANnel<N>:SiMulation:JITTer  
command/query, 431
- :CHANnel<N>:SiMulation:JITTer:ABUJ  
command/query, 432
- :CHANnel<N>:SiMulation:JITTer:PERiodic<M>:  
ENABLE command/query, 433
- :CHANnel<N>:SiMulation:JITTer:PERiodic<M>:  
FREQUency command/query, 434
- :CHANnel<N>:SiMulation:JITTer:PERiodic<M>:  
MAGNITude command/query, 435
- :CHANnel<N>:SiMulation:JITTer:PERiodic<M>:  
SHAPE command/query, 436
- :CHANnel<N>:SiMulation:JITTer:RANDom  
command/query, 437
- :CHANnel<N>:SiMulation:NOISe  
command/query, 438
- :CHANnel<N>:SiMulation:NOISe:BWLimit  
command/query, 439
- :CHANnel<N>:SiMulation:NOISe:PERiodic<M>:  
ENABLE command/query, 440
- :CHANnel<N>:SiMulation:NOISe:PERiodic<M>:  
FREQUency command/query, 441
- :CHANnel<N>:SiMulation:NOISe:PERiodic<M>:  
MAGNITude command/query, 442
- :CHANnel<N>:SiMulation:NOISe:PERiodic<M>:  
SHAPE command/query, 443
- :CHANnel<N>:SiMulation:NOISe:RANDom  
command/query, 444
- :CHANnel<N>:SiMulation:OFFSet  
command/query, 445
- :CHANnel<N>:SiMulation:WAVEform  
command/query, 446
- :CHANnel<N>:UNITs command/query, 447
- :DIGital<N>:DISPlay command/query, 482
- :DIGital<N>:LABel command/query, 483
- :DIGital<N>:POSITION command/query, 484
- :DIGital<N>:SIZE command/query, 485
- :DIGital<N>:THReshold  
command/query, 486
- :DIGitize command, 1230
- :DISable DIGital command, 1232
- :DISK:CDIRectory command, 491
- :DISK:COpy command, 492
- :DISK:DELeTe command, 493
- :DISK:DIRectory? query, 494
- :DISK:GETFILE? query, 495
- :DISK:LOAD command, 496
- :DISK:MDIRectory command, 498
- :DISK:PUTFILE command, 499
- :DISK:PWD? query, 500
- :DISK:SAVE:COMPOSITE command, 501
- :DISK:SAVE:IMAGe command, 502



- :DISK:SAVE:JITTer command, 503
- :DISK:SAVE:LISTing command, 504
- :DISK:SAVE:MEASurements command, 505
- :DISK:SAVE:MREPort command, 506
- :DISK:SAVE:NOISe command, 507
- :DISK:SAVE:PRECprobe command, 508
- :DISK:SAVE:SETup command, 509
- :DISK:SAVE:WAVEform command, 510
- :DISK:SEGmented command/query, 512
- :DISK:STORe command, 1709
- :DISPlay: ROW command query, 1719
- :DISPlay:BOOKmark:DELeTe:ALL command, 515
- :DISPlay:BOOKmark<N>:DELeTe command, 516
- :DISPlay:BOOKmark<N>:SET command, 517
- :DISPlay:BOOKmark<N>:VERTical? query, 519
- :DISPlay:BOOKmark<N>:XPOStion command/query, 520
- :DISPlay:BOOKmark<N>:YPOStion command/query, 521
- :DISPlay:CGRade command/query, 522
- :DISPlay:CGRade:LEGend command/query, 524
- :DISPlay:CGRade:LEVel? query, 525
- :DISPlay:CGRade:SCHeme command/query, 527
- :DISPlay:COLumn command/query, 1717
- :DISPlay:CONNect command/query, 529
- :DISPlay:DATA? query, 530
- :DISPlay:GRATicule command/query, 531
- :DISPlay:GRATicule:AREA<N>:HSCale command/query, 532
- :DISPlay:GRATicule:AREA<N>:STATe command/query, 533
- :DISPlay:GRATicule:AREA<N>:VSCale command/query, 534
- :DISPlay:GRATicule:GLAYout command/query, 535
- :DISPlay:GRATicule:INTensity command/query, 536
- :DISPlay:GRATicule:NUMBer command/query, 537
- :DISPlay:GRATicule:SETGrat command, 538
- :DISPlay:GRATicule:SIZE command, 103, 1709
- :DISPlay:ISIM:GCOunt command/query, 539
- :DISPlay:ISIM:SElectgraph command, 540
- :DISPlay:ISIM:SOURce command, 541
- :DISPlay:JITTer:GCOunt command/query, 542
- :DISPlay:JITTer:SElectgraph command, 543
- :DISPlay:JITTer:THReshold command, 545
- :DISPlay:LABel command/query, 546
- :DISPlay:LAYout command/query, 547
- :DISPlay:LINE command, 1718
- :DISPlay:MAIN command/query, 548
- :DISPlay:NOISe:LEVel command, 550
- :DISPlay:PAM:GRAPh command, 551
- :DISPlay:PAM:SOURce command, 552
- :DISPlay:PAM:TABLE command, 553
- :DISPlay:PERsistence command/query, 554
- :DISPlay:PRECprobe:GCOunt command/query, 558
- :DISPlay:PRECprobe:SElectgraph command, 559
- :DISPlay:PRECprobe:SOURce command, 560
- :DISPlay:PROPortion command/query, 556
- :DISPlay:PROPortion:RESults command/query, 557
- :DISPlay:RESults:LAYout command/query, 561
- :DISPlay:SCOLor command/query, 562
- :DISPlay:STATus:COL command query, 564
- :DISPlay:STATus:ROW command query, 565
- :DISPlay:STRing command, 1720
- :DISPlay:TAB command/query, 1721
- :DISPlay:TEXT command, 1722
- :DISPlay:THEMe command/query, 566
- :DISPlay:WINDow:MAXimize command, 567
- :ENABLE DIGital command, 1233
- :FUNCTION:FFT:PEAK:SORT command/query, 589
- :FUNCTION<F>:ABSolute command, 574
- :FUNCTION<F>:ADD command, 575
- :FUNCTION<F>:ADEMod command, 576
- :FUNCTION<F>:AVERage command, 577
- :FUNCTION<F>:COMMonmode command, 578
- :FUNCTION<F>:DElay command, 579
- :FUNCTION<F>:DIFF command, 580
- :FUNCTION<F>:DISPlay command/query, 581
- :FUNCTION<F>:DIVide command, 582
- :FUNCTION<F>:FFT:DETECTOR:POINts command/query, 583
- :FUNCTION<F>:FFT:DETECTOR:TYPE command/query, 584
- :FUNCTION<F>:FFT:FREQuency command/query, 585
- :FUNCTION<F>:FFT:HSCale command/query, 586
- :FUNCTION<F>:FFT:IMPedance command/query, 587
- :FUNCTION<F>:FFT:PEAK:COUNT command/query, 590
- :FUNCTION<F>:FFT:PEAK:FREQuency? query, 591
- :FUNCTION<F>:FFT:PEAK:LEVel command/query, 592
- :FUNCTION<F>:FFT:PEAK:MAGNitude? query, 593
- :FUNCTION<F>:FFT:PEAK:STATe command/query, 594
- :FUNCTION<F>:FFT:REFeRence command/query, 595
- :FUNCTION<F>:FFT:RESolution command/query, 596
- :FUNCTION<F>:FFT:SPAN command/query, 598
- :FUNCTION<F>:FFT:STARt command/query, 599
- :FUNCTION<F>:FFT:STOP command/query, 600
- :FUNCTION<F>:FFT:TDElay command/query, 601
- :FUNCTION<F>:FFT:VUNits command/query, 602
- :FUNCTION<F>:FFT:WINDow command/query, 603
- :FUNCTION<F>:FFTMagnitude command, 605
- :FUNCTION<F>:FFTPHase command, 606
- :FUNCTION<F>:GATING command, 607
- :FUNCTION<F>:GATING:GLOBal command, 608
- :FUNCTION<F>:GATING:STARt command, 609
- :FUNCTION<F>:GATING:STOP command, 610
- :FUNCTION<F>:HIGHpass command, 611
- :FUNCTION<F>:HORizontal command/query, 612
- :FUNCTION<F>:HORizontal:POStion command, 613
- :FUNCTION<F>:HORizontal:RANGE command/query, 615
- :FUNCTION<F>:INTEgrate command, 617
- :FUNCTION<F>:INVert command, 618
- :FUNCTION<F>:LABel command/query, 619
- :FUNCTION<F>:LOWPass command, 620
- :FUNCTION<F>:MAGNify command, 621
- :FUNCTION<F>:MATLab command, 622
- :FUNCTION<F>:MATLab:CONTRol<N> command/query, 623
- :FUNCTION<F>:MATLab:OPERator command/query, 625
- :FUNCTION<F>:MAXimum command, 626
- :FUNCTION<F>:MHISTogram command, 627
- :FUNCTION<F>:MINimum command, 629
- :FUNCTION<F>:MLOG command/query, 630
- :FUNCTION<F>:MTRend command, 631
- :FUNCTION<F>:MULTIply command, 632
- :FUNCTION<F>:OFFSet command/query, 633
- :FUNCTION<F>:PAVERage command, 634
- :FUNCTION<F>:RANGE command/query, 635
- :FUNCTION<F>:SMOoth command, 636
- :FUNCTION<F>:SQRT command, 637
- :FUNCTION<F>:SQUare command, 638
- :FUNCTION<F>:SUBTract command, 639
- :FUNCTION<F>:VERSus command, 640
- :FUNCTION<F>:VERTical command/query, 641
- :FUNCTION<F>:VERTical:OFFSet command/query, 642

- :FUNCTION<F>:VERTICAL:RANGE command/query, 643
- :FUNCTION<F>:VERTICAL:SIZE command/query, 644
- :FUNCTION<F>? query, 573
- :HARDcopy:AREA command/query, 646
- :HARDcopy:DPRINTER command/query, 647
- :HARDcopy:FACTORS command/query, 648
- :HARDcopy:IMAGE command/query, 649
- :HARDcopy:PRINTERS? query, 650
- :HISTogram:AXIS command/query, 653
- :HISTogram:HORIZONTAL:BINS command/query, 654
- :HISTogram:MEASUREMENT:BINS command/query, 655
- :HISTogram:MEASUREMENT:MAX command/query, 656
- :HISTogram:MEASUREMENT:MIN command/query, 657
- :HISTogram:MODE command/query, 658
- :HISTogram:SCALE:SIZE command/query, 659
- :HISTogram:VERTICAL:BINS command/query, 660
- :HISTogram:WINDOW:BLIMIT command/query, 665
- :HISTogram:WINDOW:DEFAULT command, 661
- :HISTogram:WINDOW:LLIMIT command/query, 663
- :HISTogram:WINDOW:RLIMIT command/query, 664
- :HISTogram:WINDOW:SOURCE command/query, 662
- :HISTogram:WINDOW:TLIMIT command/query, 666
- :HOSTed:CALIBRATE:ALIGN command/query, 1723
- :HOSTed:CALIBRATE:CALIBRATE command, 669
- :HOSTed:CALIBRATE:CHANNEL command/query, 670
- :HOSTed:CALIBRATE:DESKew:CHANNELS command, 671
- :HOSTed:CALIBRATE:DESKew:FRAMES command, 672
- :HOSTed:CALIBRATE:DESKew:SIGNALS command, 673
- :HOSTed:CALIBRATE:DESKew:ZERO command, 674
- :HOSTed:CALIBRATE:LEVEL command/query, 675
- :HOSTed:CALIBRATE:PROMPT command/query, 677
- :HOSTed:CALIBRATE:STATUS:CHANNELS? query, 678
- :HOSTed:CALIBRATE:STATUS:FRAMES? query, 679
- :HOSTed:CALIBRATE:STATUS:LEVEL? query, 680
- :HOSTed:CALIBRATE:STATUS:SIGNALS? query, 681
- :HOSTed:CALIBRATE:TREF:DETECT command, 682
- :HOSTed:FOLLOWer<N>:ACHANNELS? query, 683
- :HOSTed:FOLLOWer<N>:CONFIGURE command, 684
- :HOSTed:FOLLOWer<N>:CONNECT command, 685
- :HOSTed:FOLLOWer<N>:DISCONNECT command, 686
- :HOSTed:LEADER:ACHANNELS? query, 687
- :HOSTed:LEADER:CONFIGURE command, 688
- :HOSTed:LEADER:CONNECT command, 689
- :HOSTed:LEADER:DISCONNECT command, 690
- :HOSTed:NCONNECT? query, 691
- :HOSTed:PERIODIC command/query, 692
- :ISCAN:DELAY command/query, 694
- :ISCAN:MEASUREMENT command/query, 697
- :ISCAN:MEASUREMENT:FAIL command/query, 695
- :ISCAN:MEASUREMENT:LLIMIT command/query, 696
- :ISCAN:MEASUREMENT:ULIMIT command/query, 698
- :ISCAN:MODE command/query, 699
- :ISCAN:NONMONOTONIC:EDGE command/query, 700
- :ISCAN:NONMONOTONIC:HISTERESIS command/query, 701
- :ISCAN:NONMONOTONIC:SOURCE command/query, 702
- :ISCAN:RUNT:HISTERESIS command/query, 703
- :ISCAN:RUNT:LLEVEL command/query, 704
- :ISCAN:RUNT:SOURCE command/query, 705
- :ISCAN:RUNT:ULEVEL command/query, 706
- :ISCAN:SERIAL:PATTERN command/query, 707
- :ISCAN:SERIAL:SOURCE command/query, 708
- :ISCAN:ZONE:HIDE command/query, 709
- :ISCAN:ZONE:SOURCE command/query, 710
- :ISCAN:ZONE<Z>:MODE command/query, 711
- :ISCAN:ZONE<Z>:PLACEMENT command/query, 712
- :ISCAN:ZONE<Z>:SOURCE command/query, 713
- :ISCAN:ZONE<Z>:STATE command/query, 714
- :LANeXtensions for Instrumentation (LXI), 781
- :LANE<N>:COPYto command, 717
- :LANE<N>:EQUALIZER:CTLE:ACGain command/query, 718
- :LANE<N>:EQUALIZER:CTLE:DCGain command/query, 719
- :LANE<N>:EQUALIZER:CTLE:NUMPoles command/query, 720
- :LANE<N>:EQUALIZER:CTLE:P1 command/query, 721
- :LANE<N>:EQUALIZER:CTLE:P2 command/query, 722
- :LANE<N>:EQUALIZER:CTLE:P3 command/query, 723
- :LANE<N>:EQUALIZER:CTLE:P4 command/query, 724
- :LANE<N>:EQUALIZER:CTLE:P5 command/query, 725
- :LANE<N>:EQUALIZER:CTLE:P6 command/query, 726
- :LANE<N>:EQUALIZER:CTLE:RATE command/query, 727
- :LANE<N>:EQUALIZER:CTLE:STATE command/query, 728
- :LANE<N>:EQUALIZER:CTLE:Z1 command/query, 729
- :LANE<N>:EQUALIZER:CTLE:Z2 command/query, 730
- :LANE<N>:EQUALIZER:DFE:NTAPs command/query, 731
- :LANE<N>:EQUALIZER:DFE:STATE command/query, 732
- :LANE<N>:EQUALIZER:DFE:TAP command/query, 733
- :LANE<N>:EQUALIZER:DFE:TAP:AUTOMATIC command, 734
- :LANE<N>:EQUALIZER:DFE:TAP:DELAY command/query, 735
- :LANE<N>:EQUALIZER:DFE:TAP:DELAY:AUTOMATIC command, 736
- :LANE<N>:EQUALIZER:DFE:TAP:GAIN command/query, 737
- :LANE<N>:EQUALIZER:DFE:TAP:LTARGET command/query, 738
- :LANE<N>:EQUALIZER:DFE:TAP:MAX command/query, 739
- :LANE<N>:EQUALIZER:DFE:TAP:MAXV command/query, 740
- :LANE<N>:EQUALIZER:DFE:TAP:MIN command/query, 741
- :LANE<N>:EQUALIZER:DFE:TAP:MINV command/query, 742
- :LANE<N>:EQUALIZER:DFE:TAP:NORMALIZE command/query, 743
- :LANE<N>:EQUALIZER:DFE:TAP:UTARGET command/query, 744
- :LANE<N>:EQUALIZER:DFE:TAP:WIDTH command/query, 745
- :LANE<N>:EQUALIZER:DFE:THRESHOLD:BANDwidth command/query, 746
- :LANE<N>:EQUALIZER:DFE:THRESHOLD:BWMODE command/query, 747
- :LANE<N>:EQUALIZER:DFE:THRESHOLD:DELAY command/query, 748
- :LANE<N>:EQUALIZER:FFE:BANDwidth command/query, 749
- :LANE<N>:EQUALIZER:FFE:BWMODE command/query, 750

- :LANE<N>:EQUalizer:FFE:NPRcursor command/query, 751
- :LANE<N>:EQUalizer:FFE:NTAPs command/query, 752
- :LANE<N>:EQUalizer:FFE:RATE command/query, 753
- :LANE<N>:EQUalizer:FFE:STATe command/query, 754
- :LANE<N>:EQUalizer:FFE:TAP command/query, 755
- :LANE<N>:EQUalizer:FFE:TAP:AUTomatic command, 756
- :LANE<N>:EQUalizer:FFE:TAP:DELay command/query, 757
- :LANE<N>:EQUalizer:FFE:TAP:WIDTh command/query, 758
- :LANE<N>:EQUalizer:FFE:TDELay command/query, 759
- :LANE<N>:EQUalizer:FFE:TDMode command/query, 760
- :LANE<N>:EQUalizer:L0Cation command/query, 761
- :LANE<N>:SOURce command/query, 762
- :LANE<N>:STATe command/query, 763
- :LANE<N>:VERTical command/query, 764
- :LANE<N>:VERTical:OFFSet command/query, 765
- :LANE<N>:VERTical:RANGe command/query, 766
- :LISTer:DATA? query, 778
- :LISTer:DISPlay command/query, 779
- :LTEST:ADDStats command/query, 768
- :LTEST:FAIL command/query, 769
- :LTEST:LLIMit command/query, 771
- :LTEST:MEASurement command/query, 772
- :LTEST:RESults? query, 773
- :LTEST:RUMode:SOFailure command/query, 774
- :LTEST:TEST command/query, 775
- :LTEST:ULIMit command/query, 776
- :LXI commands, 781
- :LXI:IDENtify[:STATe] command/query, 782
- :MARKer:CURSor? query, 785
- :MARKer:DELTA command/query, 786
- :MARKer:MEASurement:MEASurement command, 787
- :MARKer:MODE command/query, 789
- :MARKer:TSTArt command/query, 790
- :MARKer:TSTOp command/query, 791
- :MARKer:VSTArt command/query, 792
- :MARKer:VSTOp command/query, 793
- :MARKer:X1Position command/query, 794
- :MARKer:X1Y1 source command/query, 796
- :MARKer:X2Position command/query, 795
- :MARKer:X2Y2source command/query, 798
- :MARKer:XDELTA? query, 800
- :MARKer:Y1Position command/query, 801
- :MARKer:Y2Position command/query, 802
- :MARKer:YDELTA? query, 803
- :MARKer<K>:CMODE command/query, 804
- :MARKer<K>:COLor command/query, 805
- :MARKer<K>:DELTA command/query, 808
- :MARKer<K>:ENABle command/query, 809
- :MARKer<K>:NAME command/query, 810
- :MARKer<K>:SOURce command/query, 811
- :MARKer<K>:TYPE command/query, 813
- :MARKer<K>:X:POSition command/query, 815
- :MARKer<K>:Y:POSition command/query, 816
- :MEASure:AREA command/query, 894
- :MEASure:BER command/query, 896
- :MEASure:BERPeracq command/query, 897
- :MEASure:BINTErval command/query, 898
- :MEASure:BPERiod command/query, 899
- :MEASure:BWIDth command/query, 900
- :MEASure:CDRRate command, 901
- :MEASure:CGRade:CROSSing command/query, 902
- :MEASure:CGRade:DCDistortion command/query, 903
- :MEASure:CGRade:EHEight command/query, 904
- :MEASure:CGRade:EL0Cation command/query, 906
- :MEASure:CGRade:EWIDth command/query, 907
- :MEASure:CGRade:EWIDth:THReshold command/query, 909
- :MEASure:CGRade:EWINDow command/query, 910
- :MEASure:CGRade:JITTer command/query, 912
- :MEASure:CGRade:OLEVel command/query, 914
- :MEASure:CGRade:QFACtor command/query, 915
- :MEASure:CGRade:ZLEVel command/query, 916
- :MEASure:CHARge command/query, 917
- :MEASure:CLEar command, 918
- :MEASure:CLOCK command/query, 1724
- :MEASure:CLOCK:METHod command/query, 1725, 1727
- :MEASure:CLOCK:METHod:ALIGn command/query, 1729
- :MEASure:CLOCK:METHod:DEEMphasis command/query, 1730
- :MEASure:CLOCK:METHod:EDGE command/query, 1731
- :MEASure:CLOCK:METHod:JTF command/query, 1733
- :MEASure:CLOCK:METHod:OJTF command/query, 1735
- :MEASure:CLOCK:METHod:PLLTrack command/query, 1737
- :MEASure:CLOCK:METHod:SOURce command/query, 1738
- :MEASure:CLOCK:VERTical command/query, 1739
- :MEASure:CLOCK:VERTical:OFFSet command/query, 1740
- :MEASure:CLOCK:VERTical:RANGe command/query, 1741
- :MEASure:CROSSing command/query, 919
- :MEASure:CTCDutyCycle command/query, 920
- :MEASure:CTCJitter command/query, 922
- :MEASure:CTCNwidth command/query, 924
- :MEASure:CTCPwidth command/query, 926
- :MEASure:DATarate command/query, 928
- :MEASure:DCAI command/query, 930
- :MEASure:DCAQ command/query, 931
- :MEASure:DCIPrime command/query, 932
- :MEASure:DCQPrime command/query, 933
- :MEASure:DDPWS command/query, 107, 1742
- :MEASure:DEEMphasis command/query, 934
- :MEASure:DELTatime command/query, 936
- :MEASure:DELTatime:DEFine command/query, 938
- :MEASure:DUTYCycle command/query, 940
- :MEASure:EDGE command/query, 941
- :MEASure:ERATio command/query, 942
- :MEASure:ETAEdges command/query, 943
- :MEASure:ETOedge command, 944
- :MEASure:FALLtime command/query, 946
- :MEASure:FFT:CPOWER command/query, 948
- :MEASure:FFT:DFRequency command/query, 949
- :MEASure:FFT:DMAGNitude command/query, 951
- :MEASure:FFT:FREQuency command/query, 953
- :MEASure:FFT:MAGNitude command/query, 955
- :MEASure:FFT:OBW command/query, 957
- :MEASure:FFT:PEAK1 command/query, 1744
- :MEASure:FFT:PEAK2 command/query, 1745
- :MEASure:FFT:PSD command/query, 958
- :MEASure:FFT:THReshold command/query, 1746
- :MEASure:FREQuency command/query, 959
- :MEASure:HISTogram:FWMH command/query, 961
- :MEASure:HISTogram:HITS command/query, 962
- :MEASure:HISTogram:M1S command/query, 963
- :MEASure:HISTogram:M2S command/query, 964
- :MEASure:HISTogram:M3S command/query, 965
- :MEASure:HISTogram:MAX command/query, 966
- :MEASure:HISTogram:MEAN command/query, 967

- :MEASure:HISTogram:MEdian command/query, 968
- :MEASure:HISTogram:MIN command/query, 969
- :MEASure:HISTogram:MM3S command/query, 970
- :MEASure:HISTogram:MODE command/query, 972
- :MEASure:HISTogram:MP3S command/query, 971
- :MEASure:HISTogram:PEAK command/query, 973
- :MEASure:HISTogram:PP command/query, 974
- :MEASure:HISTogram:REsolution command/query, 975
- :MEASure:HISTogram:STDDev command/query, 976
- :MEASure:HOLDtime command/query, 977
- :MEASure:JITTer:HISTogram command/query, 979
- :MEASure:JITTer:MEASurement command/query, 980
- :MEASure:JITTer:SPECTrum command/query, 981
- :MEASure:JITTer:SPECTrum:HORizontal command/query, 982
- :MEASure:JITTer:SPECTrum:HORizontal:POsition command/query, 983
- :MEASure:JITTer:SPECTrum:HORizontal:RANGe command/query, 984
- :MEASure:JITTer:SPECTrum:REsolution? query, 985
- :MEASure:JITTer:SPECTrum:VERTical command/query, 986
- :MEASure:JITTer:SPECTrum:VERTical:OFFSet command/query, 987
- :MEASure:JITTer:SPECTrum:VERTical:RANGe command/query, 988
- :MEASure:JITTer:SPECTrum:VERTical:TYPE command/query, 989
- :MEASure:JITTer:SPECTrum:WINDow command/query, 990
- :MEASure:JITTer:STATistics command/query, 1747
- :MEASure:JITTer:TRENd command/query, 991
- :MEASure:JITTer:TRENd:SMOoth command/query, 992
- :MEASure:JITTer:TRENd:SMOoth:POINts command/query, 993
- :MEASure:JITTer:TRENd:VERTical command/query, 994
- :MEASure:JITTer:TRENd:VERTical:OFFSet command/query, 995
- :MEASure:JITTer:TRENd:VERTical:RANGe command/query, 996
- :MEASure:MARK command/query, 997
- :MEASure:NAME command/query, 998
- :MEASure:NCJitter command/query, 999
- :MEASure:NOISe command/query, 1001
- :MEASure:NOISe:ALL? query, 1003
- :MEASure:NOISe:BANdwidth command/query, 1005
- :MEASure:NOISe:LOCation command/query, 1006
- :MEASure:NOISe:METHod command/query, 1007
- :MEASure:NOISe:REPort command/query, 1008
- :MEASure:NOISe:RN command/query, 1009
- :MEASure:NOISe:SCOPE:RN command/query, 1010
- :MEASure:NOISe:STATe command/query, 1011
- :MEASure:NOISe:UNITs command/query, 1012
- :MEASure:NPERiod command/query, 1013
- :MEASure:NPULses command/query, 1014
- :MEASure:NSIGma command/query, 1015
- :MEASure:NUI command/query, 1016
- :MEASure:NWIDth command/query, 1017
- :MEASure:OMAMplitude command/query, 1018
- :MEASure:OPOWer command/query, 1019
- :MEASure:OVERshoot command/query, 1020
- :MEASure:PAM:ELVEL command/query, 1022
- :MEASure:PAM:EOJ command, 60
- :MEASure:PAM:ESKew command/query, 1024
- :MEASure:PAM:EYE:ELMethod command/query, 1026
- :MEASure:PAM:EYE:ESTiming command/query, 1027
- :MEASure:PAM:EYE:PPERcent command/query, 1028
- :MEASure:PAM:EYE:PROBability command/query, 1029
- :MEASure:PAM:EYE:TIME:LTDefinition command/query, 1030
- :MEASure:PAM:J3U command, 60
- :MEASure:PAM:J4U command, 60
- :MEASure:PAM:JRMS command, 60
- :MEASure:PAM:LEVel command/query, 1031
- :MEASure:PAM:LRMS command/query, 1033
- :MEASure:PAM:LTHickness command/query, 1035
- :MEASure:PAM:PRBS13q:COUNt command/query, 1037
- :MEASure:PAM:PRBS13q:EDGE:EOJ? query, 1038
- :MEASure:PAM:PRBS13q:EDGE:J3U? query, 1039
- :MEASure:PAM:PRBS13q:EDGE:J4U? query, 1040
- :MEASure:PAM:PRBS13q:EDGE:J6U? query, 1041
- :MEASure:PAM:PRBS13q:EDGE:JRMS? query, 1042
- :MEASure:PAM:PRBS13q:HUNits command/query, 1043
- :MEASure:PAM:PRBS13q:PATtern command/query, 1044
- :MEASure:PAM:PRBS13q:PFILe command/query, 1045
- :MEASure:PAM:PRBS13q:STATe command/query, 1046
- :MEASure:PAM:PRBS13q:UNITs command/query, 1047
- :MEASure:PAMPliitude command/query, 1048
- :MEASure:PBASe command/query, 1049
- :MEASure:PERiod command/query, 1050
- :MEASure:PHASe command/query, 1052
- :MEASure:PJITter command/query, 1054
- :MEASure:PLENght command/query, 1055
- :MEASure:PN:CORRrelations command/query, 1056
- :MEASure:PN:DESKew command, 1057
- :MEASure:PN:EDGE command/query, 1058
- :MEASure:PN:HORizontal:STARt command/query, 1059
- :MEASure:PN:HORizontal:STOP command/query, 1060
- :MEASure:PN:RSSC command/query, 1061
- :MEASure:PN:SOURce command/query, 1062
- :MEASure:PN:SPURs command/query, 1064
- :MEASure:PN:SSENSitivity command/query, 1065
- :MEASure:PN:STATe command/query, 1066
- :MEASure:PN:VERTical:REference command/query, 1067
- :MEASure:PN:VERTical:SCALE command/query, 1068
- :MEASure:PN:WINDow command/query, 1069
- :MEASure:PPContrast command/query, 1070
- :MEASure:PPULses command/query, 1071
- :MEASure:PREShoot command/query, 1072
- :MEASure:PTOP command/query, 1074
- :MEASure:PWIDth command/query, 1075
- :MEASure:QUALifier<M>:CONDition command/query, 1076
- :MEASure:QUALifier<M>:SOURce command/query, 1077
- :MEASure:QUALifier<M>:STATe command/query, 1078
- :MEASure:RESults? query, 1079
- :MEASure:RISetime command/query, 1083
- :MEASure:RJDJ:ALL? query, 1085
- :MEASure:RJDJ:APLength? query, 1087
- :MEASure:RJDJ:BANdwidth command/query, 1088
- :MEASure:RJDJ:BER command/query, 1089

- :MEASure:RJDJ:CLOCK  
command/query, 1091
- :MEASure:RJDJ:CREference  
command/query, 1092
- :MEASure:RJDJ:EDGE  
command/query, 1093
- :MEASure:RJDJ:INTerpolate  
command/query, 1094
- :MEASure:RJDJ:METHod  
command/query, 1095
- :MEASure:RJDJ:MODE  
command/query, 1096
- :MEASure:RJDJ:PAMThreshold  
command/query, 1097
- :MEASure:RJDJ:PLENgtH  
command/query, 1098
- :MEASure:RJDJ:REPort  
command/query, 1099
- :MEASure:RJDJ:RJ command/query, 1100
- :MEASure:RJDJ:SCOPE:RJ  
command/query, 1101
- :MEASure:RJDJ:SCOPE:RJ:CALibrate  
command, 1102
- :MEASure:RJDJ:SOURce  
command/query, 1103
- :MEASure:RJDJ:STATe  
command/query, 1104
- :MEASure:RJDJ:TJRJDJ? query, 1105
- :MEASure:RJDJ:UNITs  
command/query, 1107
- :MEASure:SCRatch command, 1108
- :MEASure:SENDvalid  
command/query, 1109
- :MEASure:SER command/query, 1110
- :MEASure:SERPeracq  
command/query, 1111
- :MEASure:SETuptime  
command/query, 1112
- :MEASure:SLEWrate  
command/query, 1114
- :MEASure:SOURce command/query, 1116
- :MEASure:STATistics  
command/query, 1117
- :MEASure:TEDGE command/query, 1118
- :MEASure:THResholds:ABSolute  
command/query, 1119
- :MEASure:THResholds:DISPlay  
command/query, 1120
- :MEASure:THResholds:GENAUTO  
command, 1121
- :MEASure:THResholds:GENeral:ABSolute  
command/query, 1122
- :MEASure:THResholds:GENeral:HYSTeresis  
command/query, 1124
- :MEASure:THResholds:GENeral:METHod  
command/query, 1126
- :MEASure:THResholds:GENeral:PAMAutoma  
tic command/query, 1130
- :MEASure:THResholds:GENeral:PAMCustom  
command/query, 1128
- :MEASure:THResholds:GENeral:PERCent  
command/query, 1132
- :MEASure:THResholds:GENeral:TOPBase:AB  
Solute command/query, 1134
- :MEASure:THResholds:GENeral:TOPBase:ME  
THod command/query, 1136
- :MEASure:THResholds:HYSTeresis  
command/query, 1137
- :MEASure:THResholds:METHod  
command/query, 1139
- :MEASure:THResholds:PERCent  
command/query, 1140
- :MEASure:THResholds:RFALL:ABSolute  
command/query, 1141
- :MEASure:THResholds:RFALL:HYSTeresis  
command, 79
- :MEASure:THResholds:RFALL:METHod  
command/query, 1143
- :MEASure:THResholds:RFALL:PAMAutomatic  
command/query, 1145
- :MEASure:THResholds:RFALL:PERCent  
command/query, 1147
- :MEASure:THResholds:RFALL:TOPBase:ABSolute  
command/query, 1149
- :MEASure:THResholds:RFALL:TOPBase:MET  
Hod command/query, 1151
- :MEASure:THResholds:SERauto  
command, 1152
- :MEASure:THResholds:SERial:ABSolute  
command/query, 1153
- :MEASure:THResholds:SERial:HYSTeresis  
command/query, 1155
- :MEASure:THResholds:SERial:METHod  
command/query, 1157
- :MEASure:THResholds:SERial:PERCent  
command/query, 1158
- :MEASure:THResholds:SERial:TOPBase:ABSolute  
command/query, 1160
- :MEASure:THResholds:SERial:TOPBase:MET  
Hod command/query, 1162
- :MEASure:THResholds:TOPBase:ABSolute  
command/query, 1163
- :MEASure:THResholds:TOPBase:METHod  
command/query, 1164
- :MEASure:TIEClock2  
command/query, 1165
- :MEASure:TIEData command/query, 1748
- :MEASure:TIEData2 command/query, 1167
- :MEASure:TIEFilter:DAMPing  
command/query, 1168
- :MEASure:TIEFilter:SHAPE  
command/query, 1169
- :MEASure:TIEFilter:START  
command/query, 1170
- :MEASure:TIEFilter:STATe  
command/query, 1171
- :MEASure:TIEFilter:STOP  
command/query, 1172
- :MEASure:TIEFilter:TYPE  
command/query, 1173
- :MEASure:TMAX command/query, 1174
- :MEASure:TMIN command/query, 1175
- :MEASure:TVOLt command/query, 1176
- :MEASure:UITouijitter  
command/query, 1178
- :MEASure:UNDerShoot  
command/query, 1179
- :MEASure:UNITinterval  
command/query, 1183
- :MEASure:VAMPLitude  
command/query, 1185
- :MEASure:VAverage  
command/query, 1186
- :MEASure:VBASe command/query, 1187
- :MEASure:VLOWer command/query, 1188
- :MEASure:VMAX command/query, 1189
- :MEASure:VMIDdle command/query, 1190
- :MEASure:VMIN command/query, 1191
- :MEASure:VOVershoot  
command/query, 1192
- :MEASure:VPP command/query, 1193
- :MEASure:VPReshoot  
command/query, 1194
- :MEASure:VRMS command/query, 1195
- :MEASure:VTIME command/query, 1197
- :MEASure:VTOP command/query, 1198
- :MEASure:VUNDerShoot  
command/query, 1199
- :MEASure:VUPPer command/query, 1200
- :MEASure:WINDow command/query, 1201
- :MEASure:XCORtie command/query, 1202
- :MEASure:ZTMAX command, 1203
- :MEASure:ZTMIN command, 1204
- :MEASurement<N>:CLEar command, 1205
- :MEASurement<N>:NAME  
command/query, 1206
- :MEASurement<N>:POSITION  
command, 1207
- :MEASurement<N>:SOURce  
command/query, 1208
- :MEASurement<N>:ZTMAX  
command, 1209
- :MEASurement<N>:ZTMIN command, 1210
- :MODEL? query, 1234
- :MTEEnable command/query, 1235
- :MTERegister? query, 1236
- :MTEST:ALIGN command, 819
- :MTEST:AlignFIT command, 70
- :MTEST:AMASK:CREate command, 820
- :MTEST:AMASK:SAVE command, 823
- :MTEST:AMASK:SOURce  
command/query, 821
- :MTEST:AMASK:UNITs  
command/query, 824
- :MTEST:AMASK:XDELta  
command/query, 825
- :MTEST:AMASK:YDELta  
command/query, 826
- :MTEST:AUTO command/query, 827
- :MTEST:AVERAGE command/query, 828
- :MTEST:AVERAGE:COUNT  
command/query, 829
- :MTEST:COUNT:FAILures? query, 830
- :MTEST:COUNT:FUI? query, 831
- :MTEST:COUNT:FWAVEforms? query, 832

- .MTESt:COUNT:MARGIn:FAILures? query, 833
- .MTESt:COUNT:SUI? query, 834
- .MTESt:COUNT:UI? query, 835
- .MTESt:COUNT:WAVEforms? query, 836
- .MTESt:DELeTe command, 837
- .MTESt:ENABle command/query, 838
- .MTESt:FOLDing command/query, 839
- .MTESt:FOLDing:BITS command/query, 841
- .MTESt:FOLDing:COUNT query, 1750
- .MTESt:FOLDing:COUNT:UI query, 843
- .MTESt:FOLDing:COUNT:WAVEforms query, 845
- .MTESt:FOLDing:FAST command/query, 847
- .MTESt:FOLDing:POSItion command/query, 849
- .MTESt:FOLDing:SCAlE command/query, 851
- .MTESt:FOLDing:TPOSItion command/query, 853
- .MTESt:FOLDing:TSCAlE command/query, 855
- .MTESt:HAMPlitude command, 49
- .MTESt:IMPedance command/query, 857
- .MTESt:INVert command/query, 858
- .MTESt:LAMPlitude command, 49
- .MTESt:LOAD command, 859
- .MTESt:MARGIn:AUTO:HITS command/query, 860
- .MTESt:MARGIn:AUTO:HRATio command/query, 861
- .MTESt:MARGIn:AUTO:METHod command/query, 862
- .MTESt:MARGIn:METHod command/query, 863
- .MTESt:MARGIn:PERCent command/query, 864
- .MTESt:MARGIn:STATe command/query, 865
- .MTESt:NREGions? query, 866
- .MTESt:PROBe:IMPedance? query, 867
- .MTESt:RUMode command/query, 868
- .MTESt:RUMode:SOFAilure command/query, 869
- .MTESt:SCAlE:BIND command/query, 870
- .MTESt:SCAlE:DRAW command/query, 871
- .MTESt:SCAlE:X1 command/query, 872
- .MTESt:SCAlE:XDELtA command/query, 873
- .MTESt:SCAlE:Y1 command/query, 874
- .MTESt:SCAlE:Y2 command/query, 875
- .MTESt:SOURce command/query, 876
- .MTESt:START command, 877
- .MTESt:STIMe command/query, 879
- .MTESt:STOP command, 878
- .MTESt:TITLe? query, 880
- .MTESt:TRIGger:SOURce command/query, 881
- .OPEEnable command/query, 1237
- .OPERegister? query, 1238
- .OVLRegister? query, 1239
- .PDER? (Processing Done Event Register) query, 217
- .PDER? (Processing Done Event Register) query, using, 215, 217, 1240
- .POD<N>:DISPlay command/query, 1212
- .POD<N>:PSKew command/query, 1213
- .POD<N>:THReshold command/query, 1214
- .PRINt command, 1241
- .RECall:SETup command, 1242
- .RSTate? query, 1243
- .RUN command, 1244
- .SBUS<N>:CAN:FDSPoint command/query, 1262
- .SBUS<N>:CAN:SAMPlepoint command/query, 1263
- .SBUS<N>:CAN:SIGNal:BAUDrate command/query, 1264
- .SBUS<N>:CAN:SIGNal:DEFinition command/query, 1265
- .SBUS<N>:CAN:SIGNal:FDBaudrate command/query, 1266
- .SBUS<N>:CAN:SOURce command/query, 1267
- .SBUS<N>:CAN:TRIGger command/query, 1268
- .SBUS<N>:CAN:TRIGger:PATtern:DATA command/query, 1271
- .SBUS<N>:CAN:TRIGger:PATtern:DATA:LENGTh command/query, 1272
- .SBUS<N>:CAN:TRIGger:PATtern:ID command/query, 1274
- .SBUS<N>:CAN:TRIGger:PATtern:ID:MODE command/query, 1275
- .SBUS<N>:CAN:TYPE command/query, 1276
- .SBUS<N>:FLEXray:BAUDrate command/query, 1278
- .SBUS<N>:FLEXray:CHANnel command/query, 1279
- .SBUS<N>:FLEXray:SOURce command/query, 1280
- .SBUS<N>:FLEXray:TRIGger command/query, 1281
- .SBUS<N>:FLEXray:TRIGger:ERRor:TYPE command/query, 1282
- .SBUS<N>:FLEXray:TRIGger:FRAMe:CCBase command/query, 1283
- .SBUS<N>:FLEXray:TRIGger:FRAMe:CCRepeTition command/query, 1284
- .SBUS<N>:FLEXray:TRIGger:FRAMe:ID command/query, 1285
- .SBUS<N>:FLEXray:TRIGger:FRAMe:TYPE command/query, 1286
- .SBUS<N>:GENRaw:SOURce command/query, 1288
- .SBUS<N>:GENRaw:WSIZe command/query, 1289
- .SBUS<N>:HS:DESCramble command/query, 1291
- .SBUS<N>:HS:FORMat command/query, 1292
- .SBUS<N>:HS:IDLE command/query, 1293
- .SBUS<N>:HS:SOURce<S> command/query, 1294
- .SBUS<N>:IIC:ASIZe command/query, 1296
- .SBUS<N>:IIC:SOURce:CLOCK command/query, 1297
- .SBUS<N>:IIC:SOURce:DATA command/query, 1298
- .SBUS<N>:IIC:TRIGger:PATtern:ADDReSS command/query, 1299, 1301
- .SBUS<N>:IIC:TRIGger:TYPE command, 1302
- .SBUS<N>:LIN:SAMPlepoint command/query, 1305
- .SBUS<N>:LIN:SIGNal:BAUDrate command/query, 1306
- .SBUS<N>:LIN:SOURce command/query, 1307
- .SBUS<N>:LIN:STANdard command/query, 1308
- .SBUS<N>:LIN:TRIGger command/query, 1309
- .SBUS<N>:LIN:TRIGger:ID command/query, 1310
- .SBUS<N>:LIN:TRIGger:PATtern:DATA command/query, 1311
- .SBUS<N>:LIN:TRIGger:PATtern:DATA:LENGTh command/query, 1312
- .SBUS<N>:SEARch:ENABle command/query, 1259
- .SBUS<N>:SEARch:TRIGger command/query, 1260
- .SBUS<N>:SPI:BITOrder command/query, 1314
- .SBUS<N>:SPI:CLOCK:SLOPe command/query, 1315
- .SBUS<N>:SPI:CLOCK:TIMEout command/query, 1316
- .SBUS<N>:SPI:FRAMe:STATe command/query, 1317
- .SBUS<N>:SPI:SOURce:CLOCK command/query, 1318
- .SBUS<N>:SPI:SOURce:DATA command/query, 1320
- .SBUS<N>:SPI:SOURce:FRAMe command/query, 1322
- .SBUS<N>:SPI:SOURce:MISO command/query, 1323
- .SBUS<N>:SPI:SOURce:MOSI command/query, 1324
- .SBUS<N>:SPI:TRIGger:PATtern:DATA command/query, 1326
- .SBUS<N>:SPI:TRIGger:PATtern:WIDTh command/query, 1328
- .SBUS<N>:SPI:TRIGger:TYPE command/query, 1330
- .SBUS<N>:SPI:TYPE command/query, 1332

- :SBUS<N>:SPI:WIDTH  
command/query, 1333
- :SBUS<N>:UART:BAUDrate  
command/query, 1335
- :SBUS<N>:UART:BITOrder  
command/query, 1336
- :SBUS<N>:UART:DIRection  
command/query, 1337
- :SBUS<N>:UART:EOF:HEX  
command/query, 1338
- :SBUS<N>:UART:IDLE  
command/query, 1339
- :SBUS<N>:UART:PARity  
command/query, 1340
- :SBUS<N>:UART:SOURce:RX  
command/query, 1341
- :SBUS<N>:UART:SOURce:TX  
command/query, 1342
- :SBUS<N>:UART:WIDTH  
command/query, 1343
- :SELFtest:CANcel command, 1346
- :SELFtest:SCOPETEST  
command/query, 1347
- :SERial command/query, 1245
- :SINGle command, 1246
- :SPROcessing:CTLequalizer:ACGain  
command/query, 1752
- :SPROcessing:CTLequalizer:DCGain  
command/query, 1753
- :SPROcessing:CTLequalizer:DISPlay  
command/query, 1754
- :SPROcessing:CTLequalizer:NUMPoles  
command/query, 1755
- :SPROcessing:CTLequalizer:P1  
command/query, 1756
- :SPROcessing:CTLequalizer:P2  
command/query, 1757
- :SPROcessing:CTLequalizer:P3  
command/query, 1758
- :SPROcessing:CTLequalizer:P4  
command/query, 1759
- :SPROcessing:CTLequalizer:RATE  
command/query, 1760
- :SPROcessing:CTLequalizer:SOURce  
command/query, 1761
- :SPROcessing:CTLequalizer:VERTical  
command/query, 1762
- :SPROcessing:CTLequalizer:VERTical:OFFSet  
command/query, 1763
- :SPROcessing:CTLequalizer:VERTical:RANGe  
command/query, 1764
- :SPROcessing:CTLequalizer:Z1  
command/query, 1765
- :SPROcessing:CTLequalizer:Z2  
command/query, 1766
- :SPROcessing:CTLequalizer:ZERO  
command/query, 1767
- :SPROcessing:DFEQualizer:NTAPs  
command/query, 1768
- :SPROcessing:DFEQualizer:SOURce  
command/query, 1769
- :SPROcessing:DFEQualizer:STATE  
command/query, 1770
- :SPROcessing:DFEQualizer:TAP  
command/query, 1771
- :SPROcessing:DFEQualizer:TAP:AUTomatic  
command, 1772
- :SPROcessing:DFEQualizer:TAP:DELay  
command/query, 1773
- :SPROcessing:DFEQualizer:TAP:DELay:AUTO  
matic command, 1774
- :SPROcessing:DFEQualizer:TAP:GAIN  
command/query, 1775
- :SPROcessing:DFEQualizer:TAP:LTARget  
command/query, 1776
- :SPROcessing:DFEQualizer:TAP:MAX  
command/query, 1777
- :SPROcessing:DFEQualizer:TAP:MIN  
command/query, 1778
- :SPROcessing:DFEQualizer:TAP:NORMALize  
command/query, 1779
- :SPROcessing:DFEQualizer:TAP:UTARget  
command/query, 1780
- :SPROcessing:DFEQualizer:TAP:WIDTH  
command/query, 1781
- :SPROcessing:FFEQualizer:BANDwidth  
command/query, 1782
- :SPROcessing:FFEQualizer:BWMode  
command/query, 1783
- :SPROcessing:FFEQualizer:DISPlay  
command/query, 1784
- :SPROcessing:FFEQualizer:NPREcursor  
command/query, 1785
- :SPROcessing:FFEQualizer:NTAPs  
command/query, 1786
- :SPROcessing:FFEQualizer:RATE  
command/query, 1787
- :SPROcessing:FFEQualizer:SOURce  
command/query, 1788
- :SPROcessing:FFEQualizer:TAP  
command/query, 1789
- :SPROcessing:FFEQualizer:TAP:AUTomatic  
command, 1790
- :SPROcessing:FFEQualizer:TAP:DELay  
command/query, 1791
- :SPROcessing:FFEQualizer:TAP:PLENght  
command, 73
- :SPROcessing:FFEQualizer:TAP:WIDTH  
command/query, 1792
- :SPROcessing:FFEQualizer:TDELay  
command/query, 1793
- :SPROcessing:FFEQualizer:TDMode  
command/query, 1794
- :SPROcessing:FFEQualizer:VERTical  
command/query, 1795
- :SPROcessing:FFEQualizer:VERTical:OFFSet  
command/query, 1796
- :SPROcessing:FFEQualizer:VERTical:RANGe  
command/query, 1797
- :STATus? query, 1247
- :STOP command, 1249
- :STORe:JITter command, 1250
- :STORe:SETup command, 1251
- :STORe:WAVeform command, 1252
- :SYSTem:DATE command/query, 1350
- :SYSTem:DEBUg command/query, 1351
- :SYSTem:DIMPedance  
command/query, 1353
- :SYSTem:DONTtabmeas  
command/query, 1354
- :SYSTem:DSP command/query, 1355
- :SYSTem:ERRor? query, 1356
- :SYSTem:GUI command/query, 1357
- :SYSTem:HEADer command/query, 1358
- :SYSTem:HLED command/query, 1359
- :SYSTem:LOCK command/query, 1360
- :SYSTem:LONGform  
command/query, 1361
- :SYSTem:MENU? query, 1362
- :SYSTem:PERSONa command/query, 1363
- :SYSTem:PRESet command, 1364
- :SYSTem:SETup command block data, 128
- :SYSTem:SETup command/query, 1366
- :SYSTem:TIME command/query, 1368
- :TERegister? query, 1253
- :TIMEbase:POSition command/query, 1370
- :TIMEbase:RANGe command/query, 1371
- :TIMEbase:REFClock  
command/query, 1372
- :TIMEbase:REFerence  
command/query, 1373
- :TIMEbase:REFerence:PERCent  
command/query, 1374
- :TIMEbase:ROLL:ENABLE  
command/query, 1375
- :TIMEbase:SCALe command/query, 1376
- :TIMEbase:VIEW command/query, 1377
- :TIMEbase:WINDow:DELay  
command/query, 1378
- :TIMEbase:WINDow:POSition  
command/query, 1379
- :TIMEbase:WINDow:RANGe  
command/query, 1380
- :TIMEbase:WINDow:SCALe  
command/query, 1381
- :TRIGger:ADVanced:COMM:BWIDth  
command/query, 1497
- :TRIGger:ADVanced:COMM:ENCode  
command/query, 1498
- :TRIGger:ADVanced:COMM:LEVel  
command/query, 1499
- :TRIGger:ADVanced:COMM:PATtern  
command/query, 1500
- :TRIGger:ADVanced:COMM:POLarity  
command/query, 1501
- :TRIGger:ADVanced:COMM:SOURce  
command/query, 1502
- :TRIGger:ADVanced:DELay:EDLY:ARM:SLOPe  
command/query, 1517
- :TRIGger:ADVanced:DELay:EDLY:ARM:SOUR  
ce command/query, 1516
- :TRIGger:ADVanced:DELay:EDLY:EVENT:DELa  
y command/query, 1518
- :TRIGger:ADVanced:DELay:EDLY:EVENT:SLOP  
e command/query, 1520

- :TRIGger:ADVanced:DElay:EDLY:EVENT:SOURce command/query, [1519](#)
- :TRIGger:ADVanced:DElay:EDLY:TRIGger:SLOPe command/query, [1522](#)
- :TRIGger:ADVanced:DElay:EDLY:TRIGger:SOURce command/query, [1521](#)
- :TRIGger:ADVanced:DElay:TDLy:ARM:SLOPe command/query, [1526](#)
- :TRIGger:ADVanced:DElay:TDLy:ARM:SOURce command/query, [1525](#)
- :TRIGger:ADVanced:DElay:TDLy:DElay command/query, [1527](#)
- :TRIGger:ADVanced:DElay:TDLy:TRIGger:SLOPe command/query, [1529](#)
- :TRIGger:ADVanced:DElay:TDLy:TRIGger:SOURce command/query, [1528](#)
- :TRIGger:ADVanced:PATtern:CONDition command/query, [1505](#)
- :TRIGger:ADVanced:PATtern:LOGic command/query, [1506](#)
- :TRIGger:ADVanced:PATtern:THReshold:LEVel command/query, [1507](#)
- :TRIGger:ADVanced:PATtern:THReshold:POD<N> command, [70](#)
- :TRIGger:ADVanced:STATe:CLOCK command/query, [1509](#)
- :TRIGger:ADVanced:STATe:LOGic command/query, [1510](#)
- :TRIGger:ADVanced:STATe:LTYPe command/query, [1511](#)
- :TRIGger:ADVanced:STATe:SLOPe command/query, [1512](#)
- :TRIGger:ADVanced:STATe:THReshold:LEVel command/query, [1513](#)
- :TRIGger:ADVanced:TV:STV:FIELD command/query, [1532](#)
- :TRIGger:ADVanced:TV:STV:LINE command/query, [1533](#)
- :TRIGger:ADVanced:TV:STV:SOURce command/query, [1534](#)
- :TRIGger:ADVanced:TV:STV:SPOlarity command/query, [1535](#)
- :TRIGger:ADVanced:TV:UDTV:ENUMber command/query, [1538](#)
- :TRIGger:ADVanced:TV:UDTV:PGTHan command/query, [1539](#)
- :TRIGger:ADVanced:TV:UDTV:POLarity command/query, [1540](#)
- :TRIGger:ADVanced:TV:UDTV:SOURce command/query, [1541](#)
- :TRIGger:ADVanced:VIOLation:MODE command/query, [1543](#)
- :TRIGger:ADVanced:VIOLation:PWIDth:DIRection command/query, [1546](#)
- :TRIGger:ADVanced:VIOLation:PWIDth:POLarity command/query, [1547](#)
- :TRIGger:ADVanced:VIOLation:PWIDth:SOURce command/query, [1548](#)
- :TRIGger:ADVanced:VIOLation:PWIDth:WIDTh command/query, [1549](#)
- :TRIGger:ADVanced:VIOLation:SETup:HOLD:CSOURce command/query, [1561](#)
- :TRIGger:ADVanced:VIOLation:SETup:HOLD:CSOURce:EDGE command/query, [1563](#)
- :TRIGger:ADVanced:VIOLation:SETup:HOLD:CSOURce:LEVel command/query, [1562](#)
- :TRIGger:ADVanced:VIOLation:SETup:HOLD:DSOURce command/query, [1564](#)
- :TRIGger:ADVanced:VIOLation:SETup:HOLD:DSOURce:HTHReshold command/query, [1565](#)
- :TRIGger:ADVanced:VIOLation:SETup:HOLD:DSOURce:LTHReshold command/query, [1566](#)
- :TRIGger:ADVanced:VIOLation:SETup:HOLD:TIME command/query, [1567](#)
- :TRIGger:ADVanced:VIOLation:SETup:MODE command/query, [1553](#)
- :TRIGger:ADVanced:VIOLation:SETup:SETup:CSOURce command/query, [1554](#)
- :TRIGger:ADVanced:VIOLation:SETup:SETup:CSOURce:EDGE command/query, [1556](#)
- :TRIGger:ADVanced:VIOLation:SETup:SETup:CSOURce:LEVel command/query, [1555](#)
- :TRIGger:ADVanced:VIOLation:SETup:SETup:DSOURce command/query, [1557](#)
- :TRIGger:ADVanced:VIOLation:SETup:SETup:DSOURce:HTHReshold command/query, [1558](#)
- :TRIGger:ADVanced:VIOLation:SETup:SETup:DSOURce:LTHReshold command/query, [1559](#)
- :TRIGger:ADVanced:VIOLation:SETup:SETup:TIME command/query, [1560](#)
- :TRIGger:ADVanced:VIOLation:SETup:SHOLd:CSOURce command/query, [1568](#)
- :TRIGger:ADVanced:VIOLation:SETup:SHOLd:CSOURce:EDGE command/query, [1570](#)
- :TRIGger:ADVanced:VIOLation:SETup:SHOLd:CSOURce:LEVel command/query, [1569](#)
- :TRIGger:ADVanced:VIOLation:SETup:SHOLd:DSOURce command/query, [1571](#)
- :TRIGger:ADVanced:VIOLation:SETup:SHOLd:DSOURce:HTHReshold command/query, [1572](#)
- :TRIGger:ADVanced:VIOLation:SETup:SHOLd:DSOURce:LTHReshold command/query, [1573](#)
- :TRIGger:ADVanced:VIOLation:SETup:SHOLd:HoldTIME (HTIME) command/query, [1575](#)
- :TRIGger:ADVanced:VIOLation:SETup:SHOLd:SetupTIME (STIME) command/query, [1574](#)
- :TRIGger:ADVanced:VIOLation:TRANSition command/query, [1577](#)
- :TRIGger:ADVanced:VIOLation:TRANSition:SOURce command/query, [1578](#)
- :TRIGger:ADVanced:VIOLation:TRANSition:SOURce:HTHReshold command/query, [1579](#)
- :TRIGger:ADVanced:VIOLation:TRANSition:SOURce:LTHReshold command/query, [1580](#)
- :TRIGger:ADVanced:VIOLation:TRANSition:TYPE command/query, [1581](#)
- :TRIGger:AND:ENABLE command/query, [1386](#)
- :TRIGger:AND:SOURce command/query, [1387](#)
- :TRIGger:COMM:BWIDth command/query, [1402](#)
- :TRIGger:COMM:ENCode command/query, [1403](#)
- :TRIGger:COMM:PATtern command/query, [1404](#)
- :TRIGger:COMM:POLarity command/query, [1405](#)
- :TRIGger:COMM:SOURce command/query, [1406](#)
- :TRIGger:DElay:ARM:SLOPe command/query, [1409](#)
- :TRIGger:DElay:ARM:SOURce command/query, [1408](#)
- :TRIGger:DElay:EDElay:COUNT command/query, [1410](#)
- :TRIGger:DElay:EDElay:SLOPe command/query, [1412](#)
- :TRIGger:DElay:EDElay:SOURce command/query, [1411](#)
- :TRIGger:DElay:MODE command/query, [1413](#)
- :TRIGger:DElay:TDElay:TIME command/query, [1414](#)
- :TRIGger:DElay:TRIGger:SLOPe command/query, [1416](#)
- :TRIGger:DElay:TRIGger:SOURce command/query, [1415](#)
- :TRIGger:EDGE:COUPLing command/query, [1418](#)
- :TRIGger:EDGE:SLOPe command/query, [1419](#)
- :TRIGger:EDGE:SOURce command/query, [1420](#)
- :TRIGger:FORCe command, [1388](#)
- :TRIGger:GBSerial:CLOCK command/query, [1422](#)
- :TRIGger:GBSerial:CLOCK:FREQuency command/query, [1423](#)
- :TRIGger:GBSerial:DRate command/query, [1425](#)
- :TRIGger:GBSerial:MODE command/query, [1427](#)
- :TRIGger:GBSerial:PATtern command/query, [1428](#)
- :TRIGger:GBSerial:POLarity command/query, [1429](#)
- :TRIGger:GBSerial:PRBS command/query, [1430](#)
- :TRIGger:GBSerial:SOURce command/query, [1431](#)
- :TRIGger:GLITch:POLarity command/query, [1433](#)
- :TRIGger:GLITch:SOURce command/query, [1434](#)



- :TRIGger:GLITch:WIDTH  
command/query, 1435
- :TRIGger:HOLDoff command/query, 1389
- :TRIGger:HOLDoff:MAX  
command/query, 1390
- :TRIGger:HOLDoff:MIN  
command/query, 1391
- :TRIGger:HOLDoff:MODE  
command/query, 1392
- :TRIGger:HTHReshold  
command/query, 1393
- :TRIGger:HYSteresis  
command/query, 1394
- :TRIGger:LEVel command/query, 1395
- :TRIGger:LEVel:FIFTy command, 1396
- :TRIGger:LTHReshold  
command/query, 1397
- :TRIGger:MODE command/query, 1398
- :TRIGger:PATtern:CONDition  
command/query, 1437
- :TRIGger:PATtern:LOGic  
command/query, 1438
- :TRIGger:PWIDth:DIRectioN  
command/query, 1440
- :TRIGger:PWIDth:POLarity  
command/query, 1441
- :TRIGger:PWIDth:SOURce  
command/query, 1442
- :TRIGger:PWIDth:TPOint  
command/query, 1443
- :TRIGger:PWIDth:WIDTh  
command/query, 1444
- :TRIGger:RUNT:POLarity  
command/query, 1446
- :TRIGger:RUNT:QUALified  
command/query, 1447
- :TRIGger:RUNT:SOURce  
command/query, 1448
- :TRIGger:RUNT:TIME  
command/query, 1449
- :TRIGger:SEquence:RESet:ENABle  
command/query, 1453
- :TRIGger:SEquence:RESet:EVENT  
command, 1455
- :TRIGger:SEquence:RESet:TIME  
command/query, 1456
- :TRIGger:SEquence:RESet:TYPE  
command/query, 1454
- :TRIGger:SEquence:TERM1  
command/query, 1451
- :TRIGger:SEquence:TERM2  
command/query, 1452
- :TRIGger:SEquence:WAIT:ENABle  
command/query, 1457
- :TRIGger:SEquence:WAIT:TIME  
command/query, 1458
- :TRIGger:SHOLd:CSOURce  
command/query, 1460
- :TRIGger:SHOLd:CSOURce:EDGE  
command/query, 1461
- :TRIGger:SHOLd:DSOURce  
command/query, 1462
- :TRIGger:SHOLd:HoldTIME (HTIME)  
command/query, 1463
- :TRIGger:SHOLd:MODE  
command/query, 1464
- :TRIGger:SHOLd:SetupTIME  
command/query, 1465
- :TRIGger:STATe:CLOCK  
command/query, 1467
- :TRIGger:STATe:LOGic  
command/query, 1468
- :TRIGger:STATe:LTYPE  
command/query, 1469
- :TRIGger:STATe:SLOPe  
command/query, 1470
- :TRIGger:SWEEp command/query, 1400
- :TRIGger:TIMEout:CONDition  
command/query, 1472
- :TRIGger:TIMEout:SOURce  
command/query, 1473
- :TRIGger:TIMEout:TIME  
command/query, 1474
- :TRIGger:TRANSition:DIRectioN  
command/query, 1476
- :TRIGger:TRANSition:SOURce  
command/query, 1477
- :TRIGger:TRANSition:TIME  
command/query, 1478
- :TRIGger:TRANSition:TYPE  
command/query, 1479
- :TRIGger:TV:LINE command/query, 1481
- :TRIGger:TV:MODE command/query, 1482
- :TRIGger:TV:POLarity  
command/query, 1483
- :TRIGger:TV:SOURce  
command/query, 1484
- :TRIGger:TV:STANdard  
command/query, 1485
- :TRIGger:TV:UDTV:ENUMber  
command/query, 1486
- :TRIGger:TV:UDTV:HSYNc  
command/query, 1487
- :TRIGger:TV:UDTV:HTIME  
command/query, 1488
- :TRIGger:TV:UDTV:PGTHan  
command/query, 1489
- :TRIGger:TV:UDTV:POLarity  
command/query, 1490
- :TRIGger:WINDow:CONDition  
command/query, 1492
- :TRIGger:WINDow:SOURce  
command/query, 1493
- :TRIGger:WINDow:TIME  
command/query, 1494
- :TRIGger:WINDow:TPOint  
command/query, 1495
- :VIEW command, 1254
- :WAVEform:BANdpass? query, 1586
- :WAVEform:BYTeorder  
command/query, 1587
- :WAVEform:CGRade:HEIGHt? query, 1588
- :WAVEform:CGRade:WIDTh? query, 1589
- :WAVEform:COMPLete? query, 1590
- :WAVEform:COUNT? query, 1591
- :WAVEform:COUPLing? query, 1592
- :WAVEform:DATA command, 1593
- :WAVEform:DATA? query, 1593
- :WAVEform:FORMat  
command/query, 1616
- :WAVEform:PNOise:FREQuency?  
query, 1619
- :WAVEform:POINts? query, 1620
- :WAVEform:PREAmble? query, 1621
- :WAVEform:SEGMENTed:ALL  
command/query, 1625
- :WAVEform:SEGMENTed:COUNT?  
query, 1627
- :WAVEform:SEGMENTed:TTAG? query, 1628
- :WAVEform:SEGMENTed:XLISt? query, 1629
- :WAVEform:SOURce  
command/query, 1630
- :WAVEform:STReaming  
command/query, 1632
- :WAVEform:TYPE? query, 1633
- :WAVEform:VIEW command/query, 1634
- :WAVEform:XDISplay? query, 1637
- :WAVEform:XINCrement? query, 1638
- :WAVEform:XORigin? query, 1639
- :WAVEform:XRANge? query, 1640
- :WAVEform:XREFerence? query, 1641
- :WAVEform:XUNits? query, 1642
- :WAVEform:YDISplay? query, 1643
- :WAVEform:YINCrement? query, 1644
- :WAVEform:YORigin? query, 1645
- :WAVEform:YRANge? query, 1646
- :WAVEform:YREFerence? query, 1647
- :WAVEform:YUNits? query, 1648
- :WMEMorY:TIETimebase  
command/query, 1650
- :WMEMorY<R>:CLear command, 1651
- :WMEMorY<R>:DISPlay  
command/query, 1652
- :WMEMorY<R>:FFT:HSCale  
command/query, 1653
- :WMEMorY<R>:LABel  
command/query, 1654
- :WMEMorY<R>:LOAD command, 1655
- :WMEMorY<R>:SAVE command, 1656
- :WMEMorY<R>:SEGMENTed:COUNT?  
query, 1657
- :WMEMorY<R>:SEGMENTed:INDEX  
command/query, 1658
- :WMEMorY<R>:SEGMENTed:PLAY  
command/query, 1659
- :WMEMorY<R>:XOFFset  
command/query, 1660
- :WMEMorY<R>:XRANge  
command/query, 1661
- :WMEMorY<R>:YOFFset  
command/query, 1662
- :WMEMorY<R>:YRANge  
command/query, 1663
- :XTALK:ENABle command/query, 1667
- :XTALK:PAADeskeW command/query, 1669
- :XTALK:PAIFilter command/query, 1670

:XTALK:PAISi command/query, 1671  
 :XTALK:PAStLimit command/query, 1672  
 :XTALK:PAXFilter command/query, 1673  
 :XTALK:PAXSi command/query, 1674  
 :XTALK:PJADeskew command/query, 1675  
 :XTALK:PJIFilter command/query, 1676  
 :XTALK:PJISi command/query, 1677  
 :XTALK:PJSLimit command/query, 1678  
 :XTALK:PJXFilter command/query, 1679  
 :XTALK:PJXSi command/query, 1680  
 :XTALK:RESults? query, 1681  
 :XTALK:SAADeskew command/query, 1683  
 :XTALK:SAIFilter command/query, 1684  
 :XTALK:SAISi command/query, 1685  
 :XTALK:SASLimit command/query, 1686  
 :XTALK:SAXFilter command/query, 1687  
 :XTALK:SAXSi command/query, 1688  
 :XTALK<X>:AENable<X> command, 1689  
 :XTALK<X>:ENABle command/query, 1690  
 :XTALK<X>:IAGGressor  
   command/query, 1691  
 :XTALK<X>:IVICTim command/query, 1692  
 :XTALK<X>:PAUTo command/query, 1693  
 :XTALK<X>:PLENth command/query, 1694  
 :XTALK<X>:PTYPe command/query, 1695  
 :XTALK<X>:RIDeal command/query, 1696  
 :XTALK<X>:RISI command/query, 1697  
 :XTALK<X>:ROTher command/query, 1698  
 :XTALK<X>:SOURce command/query, 1699  
 :XTALK<X>:STYPe command/query, 1701  
 ..., Ellipsis, 132  
 (Event Status Enable (\*ESE)  
   command/query, 452  
 \*CLS (Clear Status) command, 451  
 \*ESE (Event Status Enable)  
   command/query, 452  
 \*ESR? (Event Status Register) query, 454,  
   458  
 \*IDN? (Identification Number) query, 455  
 \*LRN? (Learn) query, 456  
 \*LRN?, and SYStem SETup?[LRN], 1367  
 \*OP?T (Option) query, 460  
 \*OPC (Operation Complete)  
   command/query, 458  
 \*OPC? (operation complete) query, 217  
 \*PSC (Power-on Status Clear)  
   command/query, 469  
 \*RCL (Recall) command, 470  
 \*RST (Reset) command, 471  
 \*SAV (Save) command, 472  
 \*SRE (Service Request Enable)  
   command/query, 473  
 \*STB? (Status Byte) query, 475  
 \*TRG (Trigger) command, 477  
 \*TST? (Test) query, 478  
 \*WAI (Wait-to-Continue) command, 479  
 +width - +width measurement, 926

## Numerics

82350A GPIB interface, 5

9.99999E+37, Infinity Representation, 166

## A

Aborting a digitize operation, 179  
 aborting a digitize operation, 153  
 absolute voltage, and VMAX, 1189  
 absolute voltage, and VMIN, 1191  
 ABSolute, :FUNctIon<F>:ABSolute  
   command, 574  
 ABSolute, :MEASure:THResholdS:ABSolute  
   command/query, 1119  
 ABSolute,  
   :MEASure:THResholdS:GENeral:ABSolut  
   e command/query, 1122  
 ABSolute,  
   :MEASure:THResholdS:GENeral:TOPBas  
   e:ABSolute command/query, 1134  
 ABSolute,  
   :MEASure:THResholdS:RFALL:ABSolute  
   command/query, 1141  
 ABSolute,  
   :MEASure:THResholdS:RFALL:TOPBase:A  
   BSolute command/query, 1149  
 ABSolute,  
   :MEASure:THResholdS:SERial:ABSolute  
   command/query, 1153  
 ABSolute,  
   :MEASure:THResholdS:SERial:TOPBase:  
   ABSolute command/query, 1160  
 ABSolute,  
   :MEASure:THResholdS:TOPBase:ABSolu  
   te command/query, 1163  
 ABUJ,  
   :CHANnel<N>:SIMulation:JITter:ABUJ  
   command/query, 432  
 ACCAL, :CHANnel<N>:PROBe:ACCAL  
   command/query, 377  
 accuracy and probe calibration, 330  
 ACGain, :LANE<N>:EQUalizer:CTLE:ACGain  
   command/query, 718  
 ACGain, :SPROcessing:CTLequalizer:ACGain  
   command/query, 1752  
 ACHannels,  
   :HOSTed:FOLLowEr<N>:ACHannels?  
   query, 683  
 ACHannels, :HOSTed:LEADer:ACHannels?  
   query, 687  
 Acquire Commands, 237  
 Acquire Commands, SRATe, 268  
 acquiring a waveform, 222  
 acquisition state, 1221  
 acquisition synchronization, 224  
 acquisition, ACQuire AVER and  
   completion, 245  
 acquisition, points, 253  
 acquisition, record length, 253  
 acquisition, sample rate, 266, 268  
 ADD, :CHANnel<N>:PROBe:HEAD:ADD  
   command, 391  
 ADD, :FUNctIon<F>:ADD command, 575  
 address field size, IIC serial decode, 1296  
 ADDRESS,  
   :CHANnel<N>:SIMulation:FILTer:ISIM:A  
   DDress command/query, 421  
 ADDRESS,  
   :CHANnel<N>:SIMulation:FLOad:ADDRe  
   ss command/query, 424  
 ADDRESS,  
   :SBUS<N>:IIC:TRIGger:PATtern:ADDRes  
   s command/query, 1299  
 address, GPIB default, 175  
 ADDStats, :LTEST:ADDStats  
   command/query, 768  
 ADEMod, :FUNctIon<F>:ADEMod  
   command, 576  
 Advanced PLL for closed eyes, 58, 288  
 advanced trigger violation modes, 1542  
 advanced trigger violation modes, pulse  
   width violation mode, 1544  
 advanced trigger violation modes, setup  
   violation mode, 1550  
 advanced trigger violation modes, transition  
   violation mode, 1576  
 ADVanced,  
   :TRIGger:ADVanced:COMM:BWIDth  
   command/query, 1497  
 ADVanced,  
   :TRIGger:ADVanced:COMM:ENCode  
   command/query, 1498  
 ADVanced, :TRIGger:ADVanced:COMM:LEVEl  
   command/query, 1499  
 ADVanced,  
   :TRIGger:ADVanced:COMM:PATtern  
   command/query, 1500  
 ADVanced,  
   :TRIGger:ADVanced:COMM:POLarity  
   command/query, 1501  
 ADVanced,  
   :TRIGger:ADVanced:COMM:SOURce  
   command/query, 1502  
 ADVanced,  
   :TRIGger:ADVanced:DElay:EDLY:ARM:SL  
   OPe command/query, 1517  
 ADVanced,  
   :TRIGger:ADVanced:DElay:EDLY:ARM:S  
   OURce command/query, 1516  
 ADVanced,  
   :TRIGger:ADVanced:DElay:EDLY:EVENT:  
   DElay command/query, 1518  
 ADVanced,  
   :TRIGger:ADVanced:DElay:EDLY:EVENT:  
   SLOPe command/query, 1520  
 ADVanced,  
   :TRIGger:ADVanced:DElay:EDLY:EVENT:  
   SOURce command/query, 1519  
 ADVanced,  
   :TRIGger:ADVanced:DElay:EDLY:TRIGge  
   r:SLOPe command/query, 1522  
 ADVanced,  
   :TRIGger:ADVanced:DElay:EDLY:TRIGge  
   r:SOURce command/query, 1521

- ADVanced, :TRIGger:ADVanced:DElay:TDLY:ARM:SLOPe command/query, [1526](#)
- ADVanced, :TRIGger:ADVanced:DElay:TDLY:ARM:SOURce command/query, [1525](#)
- ADVanced, :TRIGger:ADVanced:DElay:TDLY:DElay command/query, [1527](#)
- ADVanced, :TRIGger:ADVanced:DElay:TDLY:TRIGger:SLOPe command/query, [1529](#)
- ADVanced, :TRIGger:ADVanced:DElay:TDLY:TRIGger:SOURce command/query, [1528](#)
- ADVanced, :TRIGger:ADVanced:PATtern:CONDition command/query, [1505](#)
- ADVanced, :TRIGger:ADVanced:PATtern:LOGic command/query, [1506](#)
- ADVanced, :TRIGger:ADVanced:PATtern:THReshold:LEVel command/query, [1507](#)
- ADVanced, :TRIGger:ADVanced:STATe:CLOCK command/query, [1509](#)
- ADVanced, :TRIGger:ADVanced:STATe:LOGic command/query, [1510](#)
- ADVanced, :TRIGger:ADVanced:STATe:LTYpe command/query, [1511](#)
- ADVanced, :TRIGger:ADVanced:STATe:SLOPe command/query, [1512](#)
- ADVanced, :TRIGger:ADVanced:STATe:THReshold:LEVel command/query, [1513](#)
- ADVanced, :TRIGger:ADVanced:TV:STV:FIELD command/query, [1532](#)
- ADVanced, :TRIGger:ADVanced:TV:STV:LINE command/query, [1533](#)
- ADVanced, :TRIGger:ADVanced:TV:STV:SOURce command/query, [1534](#)
- ADVanced, :TRIGger:ADVanced:TV:STV:SPOlarity command/query, [1535](#)
- ADVanced, :TRIGger:ADVanced:TV:UDTV:ENUMber command/query, [1538](#)
- ADVanced, :TRIGger:ADVanced:TV:UDTV:PGTHan command/query, [1539](#)
- ADVanced, :TRIGger:ADVanced:TV:UDTV:POLarity command/query, [1540](#)
- ADVanced, :TRIGger:ADVanced:TV:UDTV:SOURce command/query, [1541](#)
- ADVanced, :TRIGger:ADVanced:VIOLation:MODE command/query, [1543](#)
- ADVanced, :TRIGger:ADVanced:VIOLation:PWIDth:DIRrection command/query, [1546](#)
- ADVanced, :TRIGger:ADVanced:VIOLation:PWIDth:POLarity command/query, [1547](#)
- ADVanced, :TRIGger:ADVanced:VIOLation:PWIDth:SOURce command/query, [1548](#)
- ADVanced, :TRIGger:ADVanced:VIOLation:PWIDth:WIDTh command/query, [1549](#)
- ADVanced, :TRIGger:ADVanced:VIOLation:SETup:HOLD:CSOURce command/query, [1561](#)
- ADVanced, :TRIGger:ADVanced:VIOLation:SETup:HOLD:CSOURce:EDGE command/query, [1563](#)
- ADVanced, :TRIGger:ADVanced:VIOLation:SETup:HOLD:CSOURce:LEVel command/query, [1562](#)
- ADVanced, :TRIGger:ADVanced:VIOLation:SETup:HOLD:DSOURce command/query, [1564](#)
- ADVanced, :TRIGger:ADVanced:VIOLation:SETup:HOLD:DSOURce:HTHReshold command/query, [1565](#)
- ADVanced, :TRIGger:ADVanced:VIOLation:SETup:HOLD:DSOURce:LTHReshold command/query, [1566](#)
- ADVanced, :TRIGger:ADVanced:VIOLation:SETup:HOLD:TIME command/query, [1567](#)
- ADVanced, :TRIGger:ADVanced:VIOLation:SETup:MODE command/query, [1553](#)
- ADVanced, :TRIGger:ADVanced:VIOLation:SETup:SETup:CSOURce command/query, [1554](#)
- ADVanced, :TRIGger:ADVanced:VIOLation:SETup:SETup:CSOURce:EDGE command/query, [1556](#)
- ADVanced, :TRIGger:ADVanced:VIOLation:SETup:SETup:CSOURce:LEVel command/query, [1555](#)
- ADVanced, :TRIGger:ADVanced:VIOLation:SETup:SETup:DSOURce command/query, [1557](#)
- ADVanced, :TRIGger:ADVanced:VIOLation:SETup:SETup:DSOURce:HTHReshold command/query, [1558](#)
- ADVanced, :TRIGger:ADVanced:VIOLation:SETup:SETup:DSOURce:LTHReshold command/query, [1559](#)
- ADVanced, :TRIGger:ADVanced:VIOLation:SETup:SETup:TIME command/query, [1560](#)
- ADVanced, :TRIGger:ADVanced:VIOLation:SETup:SHOLD:CSOURce command/query, [1568](#)
- ADVanced, :TRIGger:ADVanced:VIOLation:SETup:SHOLD:CSOURce:EDGE command/query, [1570](#)
- ADVanced, :TRIGger:ADVanced:VIOLation:SETup:SHOLD:CSOURce:LEVel command/query, [1569](#)
- ADVanced, :TRIGger:ADVanced:VIOLation:SETup:SHOLD:DSOURce command/query, [1571](#)
- ADVanced, :TRIGger:ADVanced:VIOLation:SETup:SHOLD:DSOURce:HTHReshold command/query, [1572](#)
- ADVanced, :TRIGger:ADVanced:VIOLation:SETup:SHOLD:DSOURce:LTHReshold command/query, [1573](#)
- ADVanced, :TRIGger:ADVanced:VIOLation:SETup:SHOLD:HoldTIME (HTIME) command/query, [1575](#)
- ADVanced, :TRIGger:ADVanced:VIOLation:SETup:SHOLD:SetupTIME (STIME) command/query, [1574](#)
- ADVanced, :TRIGger:ADVanced:VIOLation:TRANSition command/query, [1577](#)
- ADVanced, :TRIGger:ADVanced:VIOLation:TRANSition:SOURce command/query, [1578](#)
- ADVanced, :TRIGger:ADVanced:VIOLation:TRANSition:SOURce:HTHReshold command/query, [1579](#)
- ADVanced, :TRIGger:ADVanced:VIOLation:TRANSition:SOURce:LTHReshold command/query, [1580](#)
- ADVanced, :TRIGger:ADVanced:VIOLation:TRANSition:TYpe command/query, [1581](#)
- advanced, COMM triggering, [1496](#)
- advanced, delay trigger modes, [1514](#), [1523](#)
- advanced, delay triggering, [1514](#), [1523](#)
- advanced, logic triggering, [1503](#), [1508](#)
- advanced, pattern triggering, [1503](#)
- advanced, state triggering, [1508](#)
- advanced, TV commands, [1530](#), [1536](#)

- advisory line, reading and writing to, **1349**  
 AEDGes, :ANALyze:AEDGes  
   command/query, **273**  
 AENable<X>, :XTALK<X>:AENable<X>  
   command, **1689**  
 algebraic sum of functions, **575**  
 ALIGn, :ANALyze:CLOCK:METhod:ALIGn  
   command/query, **279**  
 ALIGn, :HOSTed:CALibrate:ALIGn  
   command/query, **1723**  
 ALIGn, :MEASure:CLOCK:METhod:ALIGn  
   command/query, **1729**  
 ALIGn, :MTEST:ALIGn command, **819**  
 all edges, measure, **894, 940, 941, 944,**  
**959, 977, 1013, 1014, 1020, 1050,**  
**1052, 1071, 1072, 1112, 1114,**  
**1176, 1181, 1192, 1194, 1199,**  
**1747**  
 ALL, :DISPlay:BOOKmark:DElete:ALL  
   command, **515**  
 ALL, :WAVEform:SEGmented:ALL  
   command/query, **1625**  
 ALL?, :MEASure:NOISE:ALL? query, **1003**  
 ALL?, :MEASure:RJdJ:ALL? query, **1085**  
 ALL?, :MEASure:RJdJ:APLength?  
   query, **1087**  
 alphanumeric, characters in embedded  
   string, **142**  
 alphanumeric, strings, **140**  
 AMASk, :MTEST:AMASk:CREate  
   command, **820**  
 AMASk, :MTEST:AMASk:SAVE  
   command, **823**  
 AMASk, :MTEST:AMASk:SOURce  
   command/query, **821**  
 AMASk, :MTEST:AMASk:UNITS  
   command/query, **824**  
 AMASk, :MTEST:AMASk:XDELta  
   command/query, **825**  
 AMASk, :MTEST:AMASk:YDELta  
   command/query, **826**  
 AMPLitude,  
   :CHANnel<N>:SIMulation:AMPLitude  
   command/query, **414**  
 AMPS as vertical units, **389, 447**  
 ANALog, :ACQUIRE:POINts:ANALog  
   command/query, **253**  
 ANALog, :ACQUIRE:SRATE:ANALog  
   command/query, **266**  
 ANALog, :ACQUIRE:SRATE:ANALog:AUTO  
   command/query, **267**  
 Analyze Commands, **271**  
 AND, :TRIGger:AND:ENABLE  
   command/query, **1386**  
 AND, :TRIGger:AND:SOURce  
   command/query, **1387**  
 APPLY, :CHANnel<N>:ISIM:APPLY  
   command/query, **359**  
 AREA, :HARDcopy:AREA  
   command/query, **646**  
 AREA, :MEASure:AREA  
   command/query, **894**  
 AREA<N>,  
   :DISPlay:GRATICule:AREA<N>:HSCale  
   command/query, **532**  
 AREA<N>,  
   :DISPlay:GRATICule:AREA<N>:STATe  
   command/query, **533**  
 AREA<N>,  
   :DISPlay:GRATICule:AREA<N>:VSCale  
   command/query, **534**  
 ARM,  
   :TRIGger:ADVanced:DElay:EDLY:ARM:SL  
   Ope command/query, **1517**  
 ARM,  
   :TRIGger:ADVanced:DElay:EDLY:ARM:S  
   OURce command/query, **1516**  
 ARM,  
   :TRIGger:ADVanced:DElay:TDLy:ARM:SL  
   Ope command/query, **1526**  
 ARM,  
   :TRIGger:ADVanced:DElay:TDLy:ARM:S  
   OURce command/query, **1525**  
 ARM, :TRIGger:DElay:ARM:SLOPe  
   command/query, **1409**  
 ARM, :TRIGger:DElay:ARM:SOURce  
   command/query, **1408**  
 armed status, checking for, **210**  
 Arming the trigger, **179**  
 ASCII, character 32, **130**  
 ASCII, linefeed, **143**  
 ASCII, waveform data FORMat, **1616**  
 ASIZe, :SBUS<N>:IIC:ASIZe  
   command/query, **1296**  
 attenuation factor for probe, **330, 409,**  
**1716**  
 ATTenuation,  
   :CHANnel<N>:PROBe:ATTenuation  
   command/query, **379**  
 AUTO, :ACQUIRE:POINts:AUTO  
   command/query, **255**  
 AUTO, :ACQUIRE:SRATE:ANALog:AUTO  
   command/query, **267**  
 AUTO, :ACQUIRE:SRATE:DIGital:AUTO  
   command/query, **269**  
 AUTO, :CHANnel<N>:DISPlay:AUTO  
   command/query, **349**  
 AUTO, :CHANnel<N>:PROBe:SKEW:AUTO  
   command, **407**  
 AUTO, :MTEST:AUTO command/query, **827**  
 AUTO, :MTEST:MARGin:AUTO:HITS  
   command/query, **860**  
 AUTO, :MTEST:MARGin:AUTO:HRATio  
   command/query, **861**  
 AUTO, :MTEST:MARGin:AUTO:METhod  
   command/query, **862**  
 AUTomatic,  
   :ANALyze:CLOCK:METhod:SKEW:AUToma  
   tic command, **291**  
 AUTomatic,  
   :LANE<N>:EQUalizer:DFE:TAP:AUTomati  
   c command, **734**  
 AUTomatic,  
   :LANE<N>:EQUalizer:DFE:TAP:DElay:AU  
   Tomatic command, **736**  
 AUTomatic,  
   :LANE<N>:EQUalizer:FFE:TAP:AUTomati  
   c command, **756**  
 AUTomatic,  
   :SPROcessing:DFEQUalizer:TAP:AUToma  
   tic command, **1772**  
 AUTomatic,  
   :SPROcessing:DFEQUalizer:TAP:DElay:A  
   UTomatic command, **1774**  
 AUTomatic,  
   :SPROcessing:FFEQUalizer:TAP:AUTomat  
   ic command, **1790**  
 AUToplay, :ACQUIRE:SEGmented:AUToplay  
   command/query, **260**  
 AUToscale, during initialization, **149**  
 AUTozero, :CHANnel<N>:PROBe:AUTozero  
   command/query, **380**  
 Aux Out connector, **332**  
 AUX, :CALibrate:OUTPut:AUX  
   command/query, **334**  
 AUX, :CALibrate:OUTPut:AUX:RTIME  
   command/query, **335**  
 availability of measured data, **185**  
 AVERage, :ACQUIRE:AVERage  
   command/query, **239**  
 AVERage, :ACQUIRE:AVERage:COUNT  
   command/query, **240**  
 AVERage, :FUNction<F>:AVERage  
   command, **577**  
 AVERage, :MTEST:AVERage  
   command/query, **828**  
 AVERage, :MTEST:AVERage:COUNT  
   command/query, **829**  
 AVERage, and acquisition completion, **245**  
 AVERage, and count, **829**  
 AXIS, :HISTogram:AXIS  
   command/query, **653**
- ## B
- B<N>, :BUS:B<N>:TYPE  
   command/query, **318**  
 B03, :ANALyze:CLOCK:METhod:PAM:B03  
   command/query, **1710**  
 B12, :ANALyze:CLOCK:METhod:PAM:B12  
   command/query, **1712**  
 BANDpass?, :WAVEform:BANDpass?  
   query, **1586**  
 bandwidth limit, **1586**  
 BANDwidth, :ACQUIRE:BANDwidth,  
   command/query, **241**  
 BANDwidth, :ACQUIRE:BANDwidth:FRAME?  
   query, **243**  
 BANDwidth,  
   :ACQUIRE:BANDwidth:TESTLIMITS?  
   query, **244**  
 BANDwidth, :CHANnel<N>:ISIM:BANDwidth  
   command/query, **360**

- BANDwidth, :CHANnel<N>:PROBe:PRECprobe:BA  
NDwidth command, **398**
- BANDwidth, :LANE<N>:EQUalizer:DFE:THReshold:BA  
NDwidth command/query, **746**
- BANDwidth, :LANE<N>:EQUalizer:FFE:BA<sup>D</sup>width  
command/query, **749**
- BANDwidth, :MEASure:NOISe:BA<sup>D</sup>width  
command/query, **1005**
- BANDwidth, :MEASure:RJDJ:BA<sup>D</sup>width  
command/query, **1088**
- BANDwidth, :SPRocessing:FFEQualizer:BA<sup>D</sup>width  
command/query, **1782**
- basic command structure, **151**
- basic operations, **126**
- baud rate, **1264, 1306**
- BAUDrate, :SBUS<N>:CAN:SIGNal:BAUDrate  
command/query, **1264**
- BAUDrate, :SBUS<N>:FLEXray:BAUDrate  
command/query, **1278**
- BAUDrate, :SBUS<N>:LIN:SIGNal:BAUDrate  
command/query, **1306**
- BAUDrate, :SBUS<N>:UART:BAUDrate  
command/query, **1335**
- BER, :MEASure:BER command/query, **896**
- BER, :MEASure:RJDJ:BER  
command/query, **1089**
- BERPeracq, :MEASure:BERPeracq  
command/query, **897**
- BINary, waveform data FORMat, **1617**
- BIND, :MTEST:SCALe:BIN<sup>D</sup>  
command/query, **870**
- BINS, :HISTogram:HORIZontal:BINS  
command/query, **654**
- BINS, :HISTogram:MEASurement:BINS  
command/query, **655**
- BINS, :HISTogram:VERTical:BINS  
command/query, **660**
- BINTerval, :MEASure:BIN<sup>T</sup>erval  
command/query, **898**
- Bit Definitions in Status Reporting, **186**
- bit order, SPI decode, **1314**
- BIT<M>, :BUS<B>:BIT<M>  
command/query, **320**
- BITorder, :SBUS<N>:UART:BITorder  
command/query, **1336**
- BITS, :BUS<B>:BITS command/query, **321**
- BITS, :MTEST:FOLDing:BITS  
command/query, **841**
- blanking the user text area, **1722**
- BLIMit, :HISTogram:WINDow:BLIMit  
command/query, **665**
- block data, **128, 157**
- block data, in :SYSTem:SETup  
command, **128**
- Block Diagram, Status Reporting  
Overview, **186**
- blocking commands, **215**
- blocking synchronization, **224**
- blocking synchronization example, **225**
- BOOKmark, :DISPlay:BOOKmark:DELeTe:ALL  
command, **515**
- BOOKmark<N>, :DISPlay:BOOKmark<N>:DELeTe  
command, **516**
- BOOKmark<N>, :DISPlay:BOOKmark<N>:SET  
command, **517**
- BOOKmark<N>, :DISPlay:BOOKmark<N>:VERTical?  
query, **519**
- BOOKmark<N>, :DISPlay:BOOKmark<N>:XPOSITion  
command/query, **520**
- BOOKmark<N>, :DISPlay:BOOKmark<N>:YPOSITion  
command/query, **521**
- BPERiod, :MEASure:BPERiod  
command/query, **899**
- Braces, **131**
- Brackets, Square, **133**
- brickwall filter, TIE, **1169**
- buffer, output, **138, 154**
- buffered responses, **167**
- Bus Activity, Halting, **179**
- Bus Commands, **179**
- BWIDth, :MEASure:BWIDth  
command/query, **900**
- BWIDth, :TRIGger:ADVanced:COMM:BWIDth  
command/query, **1497**
- BWIDth, :TRIGger:COMM:BWIDth  
command/query, **1402**
- BWLimit, :CHANnel<N>:BWLimit  
command/query, **344**
- BWLimit, :CHANnel<N>:ISIM:BWLimit  
command/query, **362**
- BWLimit, :CHANnel<N>:ISIM:BWLimit:TYPE  
command/query, **364**
- BWLimit, :CHANnel<N>:SIMulation:NOISe:BWLim  
it command/query, **439**
- BWMode, :LANE<N>:EQUalizer:DFE:THReshold:B  
WMode command/query, **747**
- BWMode, :LANE<N>:EQUalizer:FFE:BWMode  
command/query, **750**
- BWMode, :SPRocessing:FFEQualizer:BWMode  
command/query, **1783**
- BYTE, Understanding the format, **1611**
- BYTE, waveform data FORMat, **1617**
- BYTeorder, :WAVEform:BYTeorder  
command/query, **1587**
- BYTeorder, and DATA, **1595**
- C
- C, SICL library example, **1925**
- C, VISA library example, **1853**
- C#, VISA COM example, **1825**
- C#, VISA example, **1872**
- C#, VISA.NET example, **1903**
- CABLEloss, :ANALyze:SIGNal:MIXer:CABLEloss  
command/query, **300**
- CAL, :CALibrate:OUTPut:CAL  
command/query, **336**
- CALibrate, :ANALyze:SIGNal:MMWave:CALibrate  
command, **301**
- CALibrate, :HOSTed:CALibrate:ALIGN  
command/query, **1723**
- CALibrate, :HOSTed:CALibrate:CALibrate  
command, **669**
- CALibrate, :HOSTed:CALibrate:CHANnel  
command/query, **670**
- CALibrate, :HOSTed:CALibrate:DESKew:CHANnels  
command, **671**
- CALibrate, :HOSTed:CALibrate:DESKew:FRAMES  
command, **672**
- CALibrate, :HOSTed:CALibrate:DESKew:SIGNals  
command, **673**
- CALibrate, :HOSTed:CALibrate:DESKew:ZERO  
command, **674**
- CALibrate, :HOSTed:CALibrate:LEVel  
command/query, **675**
- CALibrate, :HOSTed:CALibrate:PROMpt  
command/query, **677**
- CALibrate, :HOSTed:CALibrate:STATus:CHANnels?  
query, **678**
- CALibrate, :HOSTed:CALibrate:STATus:FRAMES?  
query, **679**
- CALibrate, :HOSTed:CALibrate:STATus:LEVel?  
query, **680**
- CALibrate, :HOSTed:CALibrate:STATus:SIGNals?  
query, **681**
- CALibrate, :HOSTed:CALibrate:TREF:DETECT  
command, **682**
- CALibrate, :MEASure:RJDJ:SCOPE:RJ:CALibrate  
command, **1102**
- Calibration Commands, **329**
- calibration status, **338**
- CALibration, :CHANnel<N>:PROBe:PRECprobe:CALib  
ration command, **399**
- CAN acknowledge, **1263**
- CAN baud rate, **1264**
- CAN serial bus commands, **1261**
- CAN signal definition, **1265**
- CAN source, **1267**
- C Program, DATA? Analog Channels, **1595**
- C Program, DATA? Digital Channels, **1602**

- CAN trigger, [1268](#), [1272](#)
- CAN trigger data pattern, [1271](#)
- CAN trigger ID pattern, [1274](#)
- CAN trigger pattern id mode, [1275](#)
- CAN, :SBUS<N>:CAN:FDSPoint  
command/query, [1262](#)
- CAN, :SBUS<N>:CAN:SAMPlEpoint  
command/query, [1263](#)
- CAN, :SBUS<N>:CAN:SIGNal:BAUDrate  
command/query, [1264](#)
- CAN, :SBUS<N>:CAN:SIGNal:DEFinition  
command/query, [1265](#)
- CAN, :SBUS<N>:CAN:SIGNal:FDBaudrate  
command/query, [1266](#)
- CAN, :SBUS<N>:CAN:SOURce  
command/query, [1267](#)
- CAN, :SBUS<N>:CAN:TRIGger  
command/query, [1268](#)
- CAN, :SBUS<N>:CAN:TRIGger:PATtern:DATA  
command/query, [1271](#)
- CAN,  
:SBUS<N>:CAN:TRIGger:PATtern:DATA:  
LENGth command/query, [1272](#)
- CAN, :SBUS<N>:CAN:TRIGger:PATtern:ID  
command/query, [1274](#)
- CAN,  
:SBUS<N>:CAN:TRIGger:PATtern:ID:MO  
DE command/query, [1275](#)
- CAN, :SBUS<N>:CAN:TYPE  
command/query, [1276](#)
- CANcEl, :SELftest:CANcEl command, [1346](#)
- CCBase,  
:SBUS<N>:FLEXray:TRIGger:FRAME:CC  
Base command/query, [1283](#)
- CCRepetition,  
:SBUS<N>:FLEXray:TRIGger:FRAME:CC  
Repetition command/query, [1284](#)
- CDIRectory, :DISK:CDIRectory  
command, [491](#)
- CDRRate, :MEASure:CDRRate  
command, [901](#)
- center screen voltage, [376](#), [388](#)
- CFRequency,  
:ANALyze:SIGNal:MMWave:CFRequency  
command/query, [302](#)
- CGRade, :DISPlay:CGRade  
command/query, [522](#)
- CGRade, :DISPlay:CGRade:LEGend  
command/query, [524](#)
- CGRade, :DISPlay:CGRade:LEVelS?  
query, [525](#)
- CGRade, :DISPlay:CGRade:SCHeme  
command/query, [527](#)
- CGRade, :MEASure:CGRade:CROSSing  
command/query, [902](#)
- CGRade, :MEASure:CGRade:DCDistortion  
command/query, [903](#)
- CGRade, :MEASure:CGRade:EHEight  
command/query, [904](#)
- CGRade, :MEASure:CGRade:ELOCation  
command/query, [906](#)
- CGRade, :MEASure:CGRade:EWIDth  
command/query, [907](#)
- CGRade,  
:MEASure:CGRade:EWIDth:THReshold  
command/query, [909](#)
- CGRade, :MEASure:CGRade:EWINdow  
command/query, [910](#)
- CGRade, :MEASure:CGRade:JITter  
command/query, [912](#)
- CGRade, :MEASure:CGRade:OLEVel  
command/query, [914](#)
- CGRade, :MEASure:CGRade:QFACtor  
command/query, [915](#)
- CGRade, :MEASure:CGRade:ZLEVel  
command/query, [916](#)
- CGRade, :WAVEform:CGRade:HEIGHt?  
query, [1588](#)
- CGRade, :WAVEform:CGRade:WIDTh?  
query, [1589](#)
- Channel Commands, [341](#)
- CHANnel, :HOSTed:CALibrate:CHANnel  
command/query, [670](#)
- CHANnel, :SBUS<N>:FLEXray:CHANnel  
command/query, [1279](#)
- CHANnels, :AUToscale:CHANnels  
command, [1224](#)
- CHANnels,  
:HOSTed:CALibrate:DESKew:CHANnels  
command, [671](#)
- CHANnels,  
:HOSTed:CALibrate:STATus:CHANnels?  
query, [678](#)
- channels, and VIEW, [1634](#)
- channel-to-channel skew factor, [337](#)
- character program data, [140](#)
- CHARge, :MEASure:CHARge  
command/query, [917](#)
- CLASSic color grade scheme, [527](#)
- Clear method, [149](#)
- Clear Status (\*CLS) command, [451](#)
- CLEar, :ANALyze:SIGNal:PATtern:CLEar  
command, [306](#)
- CLEar, :BUS<B>:CLEar  
command/query, [322](#)
- CLEar, :MEASure:CLEar command, [918](#)
- CLEar, :MEASurement<N>:CLEar  
command, [1205](#)
- CLEar, :WMEMory<R>:CLEar  
command, [1651](#)
- Clearing, Buffers, [179](#)
- clearing, DONE bit, [201](#)
- clearing, error queue, [205](#), [1800](#)
- Clearing, Pending Commands, [179](#)
- clearing, registers and queues, [208](#)
- clearing, Standard Event Status  
Register, [195](#), [454](#)
- clearing, status data structures, [451](#)
- clearing, TRG bit, [194](#), [203](#)
- clipped waveform data values, [1614](#)
- clipped waveforms, and measurement  
error, [893](#)
- clock recovery methods, [275](#)
- clock recovery methods, JTF, [284](#)
- clock recovery methods, OJTF, [286](#)
- clock timeout, SPI, [1316](#)
- CLOCK, :ANALyze:CLOCK  
command/query, [274](#)
- CLOCK, :ANALyze:CLOCK:METHod  
command/query, [275](#)
- CLOCK, :ANALyze:CLOCK:METHod:ALIGN  
command/query, [279](#)
- CLOCK,  
:ANALyze:CLOCK:METHod:DEEMphasis  
command/query, [280](#)
- CLOCK, :ANALyze:CLOCK:METHod:EDGE  
command/query, [281](#)
- CLOCK, :ANALyze:CLOCK:METHod:IDLe  
command/query, [283](#)
- CLOCK, :ANALyze:CLOCK:METHod:JTF  
command/query, [284](#)
- CLOCK, :ANALyze:CLOCK:METHod:OJTF  
command/query, [286](#)
- CLOCK, :ANALyze:CLOCK:METHod:PAM:B03  
command/query, [1710](#)
- CLOCK, :ANALyze:CLOCK:METHod:PAM:B12  
command/query, [1712](#)
- CLOCK,  
:ANALyze:CLOCK:METHod:PAM:NONSy  
mmetric command/query, [1714](#)
- CLOCK,  
:ANALyze:CLOCK:METHod:PLLAdvanced  
command/query, [288](#)
- CLOCK, :ANALyze:CLOCK:METHod:PLLTrack  
command/query, [289](#)
- CLOCK, :ANALyze:CLOCK:METHod:SKEW  
command/query, [290](#)
- CLOCK,  
:ANALyze:CLOCK:METHod:SKEW:AUTom  
atic command, [291](#)
- CLOCK, :ANALyze:CLOCK:METHod:SOURce  
command/query, [292](#)
- CLOCK, :ANALyze:CLOCK:TIME? query, [293](#)
- CLOCK, :ANALyze:CLOCK:VERTical  
command/query, [295](#)
- CLOCK, :ANALyze:CLOCK:VERTical:OFFSet  
command/query, [296](#)
- CLOCK, :ANALyze:CLOCK:VERTical:RANGE  
command/query, [297](#)
- CLOCK, :BUS<B>:CLOCK  
command/query, [323](#)
- CLOCK, :BUS<B>:CLOCK:SLOPe  
command/query, [324](#)
- CLOCK, :MEASure:CLOCK  
command/query, [1724](#)
- CLOCK, :MEASure:CLOCK:METHod  
command/query, [1725](#), [1727](#)
- CLOCK, :MEASure:CLOCK:METHod:ALIGN  
command/query, [1729](#)
- CLOCK,  
:MEASure:CLOCK:METHod:DEEMphasis  
command/query, [1730](#)
- CLOCK, :MEASure:CLOCK:METHod:EDGE  
command/query, [1731](#)

- CLOCK, :MEASure:CLOCK:METHOD:JTF command/query, [1733](#)
- CLOCK, :MEASure:CLOCK:METHOD:OJTF command/query, [1735](#)
- CLOCK, :MEASure:CLOCK:METHOD:PLLTrack command/query, [1737](#)
- CLOCK, :MEASure:CLOCK:METHOD:SOURce command/query, [1738](#)
- CLOCK, :MEASure:CLOCK:VERTical command/query, [1739](#)
- CLOCK, :MEASure:CLOCK:VERTical:OFFSet command/query, [1740](#)
- CLOCK, :MEASure:CLOCK:VERTical:RANGe command/query, [1741](#)
- CLOCK, :MEASure:RJdJ:CLOCK command/query, [1091](#)
- CLOCK, :SBUS<N>:IIC:SOURce:CLOCK command/query, [1297](#)
- CLOCK, :SBUS<N>:SPI:BITOrder command/query, [1314](#)
- CLOCK, :SBUS<N>:SPI:CLOCK:SLOPe command/query, [1315](#)
- CLOCK, :SBUS<N>:SPI:CLOCK:TIMEout command/query, [1316](#)
- CLOCK, :SBUS<N>:SPI:SOURce:CLOCK command/query, [1318](#)
- CLOCK, :TRIGger:ADVanced:STATe:CLOCK command/query, [1509](#)
- CLOCK, :TRIGger:GBSerial:CLOCK command/query, [1422](#)
- CLOCK, :TRIGger:GBSerial:CLOCK:FREQuency command/query, [1423](#)
- CLOCK, :TRIGger:STATe:CLOCK command/query, [1467](#)
- CME bit, [452](#), [454](#)
- CMODE, :MARKer<K>:CMODE command/query, [804](#)
- code, SICL library example in C, [1925](#)
- code, SICL library example in Visual Basic, [1934](#)
- code, VISA COM library example in C#, [1825](#)
- code, VISA COM library example in Python, [1844](#)
- code, VISA COM library example in Visual Basic, [1814](#)
- code, VISA COM library example in Visual Basic .NET, [1835](#)
- code, VISA library example in C, [1853](#)
- code, VISA library example in C#, [1872](#)
- code, VISA library example in Python, [1896](#)
- code, VISA library example in Visual Basic, [1862](#)
- code, VISA library example in Visual Basic .NET, [1884](#)
- code, VISA.NET library example in C#, [1903](#)
- code, VISA.NET library example in Python, [1917](#)
- code, VISA.NET library example in Visual Basic .NET, [1910](#)
- COL, :DISPlay:STATus:COL command query, [564](#)
- color grade (pixel) database count values, getting, [1635](#)
- COLor, :MARKer<K>:COLor command/query, [805](#)
- COLumn, :DISPlay:COLumn command/query, [1717](#)
- combining compound and simple commands, [145](#)
- combining, commands in same subsystem, [137](#)
- combining, long- and short-form headers, [139](#)
- COMM, :TRIGger:ADVanced:COMM:BWIDth command/query, [1497](#)
- COMM, :TRIGger:ADVanced:COMM:ENCode command/query, [1498](#)
- COMM, :TRIGger:ADVanced:COMM:LEVel command/query, [1499](#)
- COMM, :TRIGger:ADVanced:COMM:PATtern command/query, [1500](#)
- COMM, :TRIGger:ADVanced:COMM:POLarity command/query, [1501](#)
- COMM, :TRIGger:ADVanced:COMM:SOURce command/query, [1502](#)
- COMM, :TRIGger:COMM:BWIDth command/query, [1402](#)
- COMM, :TRIGger:COMM:ENCode command/query, [1403](#)
- COMM, :TRIGger:COMM:PATtern command/query, [1404](#)
- COMM, :TRIGger:COMM:POLarity command/query, [1405](#)
- COMM, :TRIGger:COMM:SOURce command/query, [1406](#)
- Command and Data Concepts, GPIB, [174](#)
- Command Error, Status Bit, [186](#)
- command errors, [1802](#)
- Command Expert, [1903](#), [1944](#)
- Command tree, [163](#)
- Command Types, [163](#)
- Command, DIGitize, [152](#)
- command, execution and order, [183](#)
- Command, GPIB Mode, [174](#)
- command, structure, [151](#)
- Command, TRIGger MODE, [1384](#)
- commands embedded in program messages, [144](#)
- commands, obsolete and discontinued, [1703](#)
- commas and spaces, [135](#)
- Common Command Header, [137](#)
- Common Commands, [449](#)
- Common Commands, Reset (\*RST), [471](#)
- Common Commands, within a program message, [449](#)
- commonmode voltage of operands, [578](#)
- COMMONmode, :CHANnel<N>:COMMONmode command/query, [345](#)
- COMMONmode, :FUNCTION<F>:COMMONmode command, [578](#)
- Communicating Over the GPIB Interface, [175](#)
- Communicating Over the LAN Interface, [176](#)
- COMPLete, :ACQuire:COMPLete command/query, [245](#)
- COMPLete, :ACQuire:COMPLete:STATe command/query, [247](#)
- COMPLete?, :WAVEform:COMPLete? query, [1590](#)
- COMPosite, :DISK:SAVE:COMPosite command, [501](#)
- compound command header, [136](#)
- compound queries, [183](#)
- Computer Code and Capability, [173](#)
- computer control examples, [1813](#)
- concurrent commands, [215](#)
- CONDition, :MEASure:QUALifier<M>:CONDition command/query, [1076](#)
- CONDition, :TRIGger:ADVanced:PATtern:CONDition command/query, [1505](#)
- CONDition, :TRIGger:PATtern:CONDition command/query, [1437](#)
- CONDition, :TRIGger:TIMEout:CONDition command/query, [1472](#)
- CONDition, :TRIGger:WINDow:CONDition command/query, [1492](#)
- CONFigure, :HOSTed:FOLLower<N>:CONFigure command, [684](#)
- CONFigure, :HOSTed:LEADer:CONFigure command, [688](#)
- connect oscilloscope, [119](#)
- CONNect, :ANALyze:SIGNal:MMWave:CONNect command/query, [303](#)
- CONNect, :DISPlay:CONNect command/query, [529](#)
- CONNect, :HOSTed:FOLLower<N>:CONNect command, [685](#)
- CONNect, :HOSTed:LEADer:CONNect command, [689](#)
- Connection Expert, [120](#)
- Constant Frequency clock recovery method, [275](#)
- CONTRol<N>, :FUNCTION<F>:MATLab:CONTRol<N> command/query, [623](#)
- conventions of programming, [161](#)
- converting waveform data, from data value to Y-axis units, [1584](#)
- CONVolve, :CHANnel<N>:ISIM:CONVolve command/query, [365](#)
- COPY, :DISK:COPY command, [492](#)
- copying files, [492](#)
- copyright, [2](#)
- COPYto, :LANE<N>:COPYto command, [717](#)

- CORRection,  
:CHANnel<N>:ISIM:CORRection  
command/query, **366**
- CORRections, :MEASure:PN:CORRections  
command/query, **1056**
- COUNT, :ACQUIRE:AVERage:COUNT  
command/query, **240**
- COUNT, :ACQUIRE:SEGmented:COUNT  
command/query, **261**
- COUNT, :FUNCTION<F>:FFT:PEAK:COUNT  
command/query, **590**
- COUNT, :MEASure:PAM:PRBS13q:COUNT  
command/query, **1037**
- COUNT, :MTEST:AVERage:COUNT  
command/query, **829**
- COUNT, :MTEST:COUNT:FAILures?  
query, **830**
- COUNT, :MTEST:COUNT:FUI? query, **831**
- COUNT, :MTEST:COUNT:FWAVEforms?  
query, **832**
- COUNT, :MTEST:COUNT:MARGin:FAILures?  
query, **833**
- COUNT, :MTEST:COUNT:SUI? query, **834**
- COUNT, :MTEST:COUNT:UI? query, **835**
- COUNT, :MTEST:COUNT:WAVEforms?  
query, **836**
- COUNT, :MTEST:FOLDing:COUNT  
query, **1750**
- COUNT, :MTEST:FOLDing:COUNT:UI  
query, **843**
- COUNT, :MTEST:FOLDing:COUNT:WAVEforms  
query, **845**
- COUNT, :TRIGGER:DElay:EDElay:COUNT  
command/query, **1410**
- COUNT, :WMEMemory<R>:SEGmented:COUNT?  
query, **1657**
- COUNT?, :WAVEform:COUNT? query, **1591**
- COUNT?, :WAVEform:SEGmented:COUNT?  
query, **1627**
- COUPLing, :CHANnel<N>:PROBe:COUPLing  
command/query, **381**
- COUPLing, :TRIGGER:EDGE:COUPLing  
command/query, **1418**
- coupling, input, **357**
- COUPLing?, :WAVEform:COUPLing?  
query, **1592**
- CPOWer, :MEASure:FFT:CPOWer  
command/query, **948**
- CREate, :MTEST:AMASK:CREate  
command, **820**
- CREference, :MEASure:RJDJ:CREference  
command/query, **1092**
- CROSSing, :MEASure:CGRade:CROSSing  
command/query, **902**
- CROSSing, :MEASure:CROSSing  
command/query, **919**
- CSource,  
:TRIGGER:ADVanced:VIOLation:SETup:H  
OLD:CSource command/query, **1561**
- CSource,  
:TRIGGER:ADVanced:VIOLation:SETup:H  
OLD:CSource:LEVel  
command/query, **1562**
- CSource,  
:TRIGGER:ADVanced:VIOLation:SETup:SE  
Tup:CSource command/query, **1554**
- CSource,  
:TRIGGER:ADVanced:VIOLation:SETup:SE  
Tup:CSource:LEVel  
command/query, **1555**
- CSource,  
:TRIGGER:ADVanced:VIOLation:SETup:SH  
Old:CSource command/query, **1568**
- CSource,  
:TRIGGER:ADVanced:VIOLation:SETup:SH  
Old:CSource:EDGE  
command/query, **1570**
- CSource,  
:TRIGGER:ADVanced:VIOLation:SETup:SH  
Old:CSource:LEVel  
command/query, **1569**
- CSource, :TRIGGER:SHOLd:CSource  
command/query, **1460**
- CSource, :TRIGGER:SHOLd:CSource:EDGE  
command/query, **1461**
- CTCDutycycle, :MEASure:CTCDutycycle  
command/query, **920**
- CTCJitter, :MEASure:CTCJitter  
command/query, **922**
- CTCNwidth, :MEASure:CTCNwidth  
command/query, **924**
- CTCPwidth, :MEASure:CTCPwidth  
command/query, **926**
- CTLE, :LANE<N>:EQUalizer:CTLE:ACGain  
command/query, **718**
- CTLE, :LANE<N>:EQUalizer:CTLE:DCGain  
command/query, **719**
- CTLE, :LANE<N>:EQUalizer:CTLE:NUMPoles  
command/query, **720**
- CTLE, :LANE<N>:EQUalizer:CTLE:P1  
command/query, **721**
- CTLE, :LANE<N>:EQUalizer:CTLE:P2  
command/query, **722**
- CTLE, :LANE<N>:EQUalizer:CTLE:P3  
command/query, **723**
- CTLE, :LANE<N>:EQUalizer:CTLE:P4  
command/query, **724**
- CTLE, :LANE<N>:EQUalizer:CTLE:P5  
command/query, **725**
- CTLE, :LANE<N>:EQUalizer:CTLE:P6  
command/query, **726**
- CTLE, :LANE<N>:EQUalizer:CTLE:RATE  
command/query, **727**
- CTLE, :LANE<N>:EQUalizer:CTLE:STATE  
command/query, **728**
- CTLE, :LANE<N>:EQUalizer:CTLE:Z1  
command/query, **729**
- CTLE, :LANE<N>:EQUalizer:CTLE:Z2  
command/query, **730**
- CTLequalizer,  
:SPROcessing:CTLequalizer:ACGain  
command/query, **1752**
- CTLequalizer,  
:SPROcessing:CTLequalizer:DCGain  
command/query, **1753**
- CTLequalizer,  
:SPROcessing:CTLequalizer:DISPlay  
command/query, **1754**
- CTLequalizer,  
:SPROcessing:CTLequalizer:NUMPoles  
command/query, **1755**
- CTLequalizer, :SPROcessing:CTLequalizer:P1  
command/query, **1756**
- CTLequalizer, :SPROcessing:CTLequalizer:P2  
command/query, **1757**
- CTLequalizer, :SPROcessing:CTLequalizer:P3  
command/query, **1758**
- CTLequalizer, :SPROcessing:CTLequalizer:P4  
command/query, **1759**
- CTLequalizer,  
:SPROcessing:CTLequalizer:RATE  
command/query, **1760**
- CTLequalizer,  
:SPROcessing:CTLequalizer:SOURce  
command/query, **1761**
- CTLequalizer,  
:SPROcessing:CTLequalizer:VERTical  
command/query, **1762**
- CTLequalizer,  
:SPROcessing:CTLequalizer:VERTical:OF  
FSet command/query, **1763**
- CTLequalizer,  
:SPROcessing:CTLequalizer:VERTical:RA  
NGe command/query, **1764**
- CTLequalizer, :SPROcessing:CTLequalizer:Z1  
command/query, **1765**
- CTLequalizer, :SPROcessing:CTLequalizer:Z2  
command/query, **1766**
- CTLequalizer,  
:SPROcessing:CTLequalizer:ZERO  
command/query, **1767**
- CURSor?, :MARKer:CURSor? query, **785**
- ## D
- DAMPing, :MEASure:TIEFilter:DAMPing  
command/query, **1168**
- data in a :SYSTEM:SETup command, **128**
- data in a program, **135**
- Data Mode, GPIB, **174**
- data pattern length, **1272**
- data pattern, CAN trigger, **1271**
- data source, SPI trigger, **1320**
- Data Structures, and Status Reporting, **188**
- data transmission mode, and  
FORMat, **1616**



- DATA, :CHANnel<N>:SIMulation:DATA:LENGth command/query, [415](#)
- DATA, :CHANnel<N>:SIMulation:DATA:ODD command/query, [416](#)
- DATA, :CHANnel<N>:SIMulation:DATA:PAM command/query, [417](#)
- DATA, :CHANnel<N>:SIMulation:DATA:RESeed command/query, [418](#)
- DATA, :CHANnel<N>:SIMulation:DATA:SElecti on command/query, [419](#)
- DATA, :DISPlay:DATA? query, [530](#)
- DATA, :SBUS<N>:CAN:TRIGger:PATtern:DATA command/query, [1271](#)
- DATA, :SBUS<N>:CAN:TRIGger:PATtern:DATA: LENGth command/query, [1272](#)
- DATA, :SBUS<N>:IIC:SOURce:DATA command/query, [1298](#)
- DATA, :SBUS<N>:IIC:TRIGger:PATtern:ADDRes s command/query, [1301](#)
- DATA, :SBUS<N>:LIN:TRIGger:PATtern:DATA command/query, [1311](#)
- DATA, :SBUS<N>:LIN:TRIGger:PATtern:DATA:L ENGth command/query, [1312](#)
- DATA, :SBUS<N>:SPI:SOURce:DATA command/query, [1320](#)
- DATA, :SBUS<N>:SPI:TRIGger:PATtern:DATA command/query, [1326](#)
- DATA, :WAVeform:DATA command, [1593](#)
- data, acquisition, [1584](#)
- data, conversion, [1584](#)
- DATA?, :LISTer:DATA? query, [778](#)
- DATA?, :WAVeform:DATA? query, [1593](#)
- DATA?, Analog Channels C Program, [1595](#)
- DATA?, Digital Channels C Program, [1602](#)
- DATarate, :ANALyze:SIGnal:DARate command/query, [298](#)
- DATarate, :MEASure:DARate command/query, [928](#)
- DATE, :CALibrate:DATE? query, [331](#)
- DATE, :SYSTem:DATE command/query, [1350](#)
- DCAI, :MEASure:DCAI command/query, [930](#)
- DCAQ, :MEASure:DCAQ command/query, [931](#)
- DCDistortion, :MEASure:CGrade:DCDistortion command/query, [903](#)
- DCGain, :LANE<N>:EQualizer:CTLe:DCGain command/query, [719](#)
- DCGain, :SPRocessing:CTLequalizer:DCGain command/query, [1753](#)
- DCIPrime, :MEASure:DCIPrime command/query, [932](#)
- DCQPrime, :MEASure:DCQPrime command/query, [933](#)
- DCYCLE, :CHANnel<N>:SIMulation:FUNCTion:SQUare:DCYCLE command/query, [428](#)
- DDE bit, [452](#), [454](#)
- DDPWS, :MEASure:DDPWS command/query, [107](#), [1742](#)
- DEBug, :SYSTem:DEBug command/query, [1351](#)
- decimal 32 (ASCII space), [130](#)
- Decision Chart for Status Reporting, [209](#)
- decode type, SPI, [1332](#)
- DEConvolve, :CHANnel<N>:ISIM:DEConvolve command/query, [368](#)
- DEEMphasis, :ANALyze:CLOCK:METHod:DEEMphasis command/query, [280](#)
- DEEMphasis, :MEASure:CLOCK:METHod:DEEMphasis command/query, [1730](#)
- DEEMphasis, :MEASure:DEEMphasis command/query, [934](#)
- default impedance to 1M Ohm, user preference setting, [1353](#)
- default setup, [1364](#)
- Default Setup front panel key, [1364](#)
- Default Startup Conditions, [172](#)
- DEFault, :HISTogram:WINDow:DEFault command, [661](#)
- Default, GPIB Address, [175](#)
- Default, Startup Conditions, [172](#)
- DEFine, :MEASure:DELtetime:DEFine command/query, [938](#)
- defining functions, [570](#)
- DEFinition, :SBUS<N>:CAN:SIGnal:DEFinition command/query, [1265](#)
- def-length block response data, [157](#)
- delay trigger modes, [1514](#), [1523](#)
- DElay, :CHANnel<N>:ISIM:DElay command/query, [369](#)
- DElay, :CHANnel<N>:PROBe:PREcprobe:DElay command, [400](#)
- DElay, :FUNction<F>:DElay command, [579](#)
- DElay, :ISCan:DElay command/query, [694](#)
- DElay, :LANE<N>:EQualizer:DFE:TAP:DElay command/query, [735](#)
- DElay, :LANE<N>:EQualizer:DFE:TAP:DElay:AU Tomatic command, [736](#)
- DElay, :LANE<N>:EQualizer:DFE:THReshold:DE lay command/query, [748](#)
- DElay, :LANE<N>:EQualizer:FFE:TAP:DElay command/query, [757](#)
- DElay, :SPRocessing:DFEQualizer:TAP:DElay command/query, [1773](#)
- DElay, :SPRocessing:DFEQualizer:TAP:DElay:A UTomatic command, [1774](#)
- DElay, :SPRocessing:FFEQualizer:TAP:DElay command/query, [1791](#)
- DElay, :TIMEbase:WINDow:DElay command/query, [1378](#)
- DElay, :TRIGger:ADVanced:DElay:EDLY:ARM:SL OPe command/query, [1517](#)
- DElay, :TRIGger:ADVanced:DElay:EDLY:ARM:S OURce command/query, [1516](#)
- DElay, :TRIGger:ADVanced:DElay:EDLY:EVENT: DElay command/query, [1518](#)
- DElay, :TRIGger:ADVanced:DElay:EDLY:EVENT: SLOPe command/query, [1520](#)
- DElay, :TRIGger:ADVanced:DElay:EDLY:EVENT: SOURce command/query, [1519](#)
- DElay, :TRIGger:ADVanced:DElay:EDLY:TRIGge r:SLOPe command/query, [1522](#)
- DElay, :TRIGger:ADVanced:DElay:EDLY:TRIGge r:SOURce command/query, [1521](#)
- DElay, :TRIGger:ADVanced:DElay:TDLY:ARM:SL OPe command/query, [1526](#)
- DElay, :TRIGger:ADVanced:DElay:TDLY:ARM:S OURce command/query, [1525](#)
- DElay, :TRIGger:ADVanced:DElay:TDLY:DElay command/query, [1527](#)
- DElay, :TRIGger:ADVanced:DElay:TDLY:TRIGge r:SLOPe command/query, [1529](#)
- DElay, :TRIGger:ADVanced:DElay:TDLY:TRIGge r:SOURce command/query, [1528](#)
- DElay, :TRIGger:DElay:ARM:SLOPe command/query, [1409](#)
- DElay, :TRIGger:DElay:ARM:SOURce command/query, [1408](#)
- DElay, :TRIGger:DElay:EDElay:COUNT command/query, [1410](#)
- DElay, :TRIGger:DElay:EDElay:SLOPe command/query, [1412](#)
- DElay, :TRIGger:DElay:EDElay:SOURce command/query, [1411](#)
- DElay, :TRIGger:DElay:MODE command/query, [1413](#)
- DElay, :TRIGger:DElay:TDElay:TIME command/query, [1414](#)
- DElay, :TRIGger:DElay:TRIGger:SLOPe command/query, [1416](#)
- DElay, :TRIGger:DElay:TRIGger:SOURce command/query, [1415](#)
- delay, and WINDow DElay, [1378](#)

- DELeTe, :CHANnel<N>:PROBe:HEAD:DELeTe command, [392](#)
- DELeTe, :DISK:DELeTe command, [493](#)
- DELeTe, :DISPlay:BOOKmark:DELeTe:ALL command, [515](#)
- DELeTe, :DISPlay:BOOKmark<N>:DELeTe command, [516](#)
- DELeTe, :MTESt:DELeTe command, [837](#)
- deleting files, [493](#)
- DELTA, :MARKer:DELTA command/query, [786](#)
- DELTA, :MARKer<K>:DELTA command/query, [808](#)
- DELTAtime, :MEASure:DELTAtime command/query, [936](#)
- DELTAtime, :MEASure:DELTAtime:DEFine command/query, [938](#)
- derivative function, [580](#)
- DESCramble, :SBUS<N>:HS:DESCramble command/query, [1291](#)
- DESKew, :HOSTed:CALibrate:DESKew:CHANnels command, [671](#)
- DESKew, :HOSTed:CALibrate:DESKew:FRAMES command, [672](#)
- DESKew, :HOSTed:CALibrate:DESKew:SIGNals command, [673](#)
- DESKew, :HOSTed:CALibrate:DESKew:ZERO command, [674](#)
- DESKew, :MEASure:PN:DESKew command, [1057](#)
- DETEct, :HOSTed:CALibrate:TREF:DETEct command, [682](#)
- DETEctor, :FUNCTION<F>:FFT:DETEctor:POINTs command/query, [583](#)
- DETEctor, :FUNCTION<F>:FFT:DETEctor:TYPE command/query, [584](#)
- Device Address, GPIB, [175](#)
- Device Address, LAN, [176](#)
- Device Clear (DCL), [179](#)
- Device Clear Code and Capability, [173](#)
- Device Clear to abort a sequential (blocking) command, [216](#)
- Device Dependent Error (DDE), Status Bit, [187](#)
- device- or oscilloscope-specific errors, [1804](#)
- Device Trigger Code and Capability, [173](#)
- device-dependent data, [157](#)
- DFE, :LANE<N>:EQUalizer:DFE:NTAPs command/query, [731](#)
- DFE, :LANE<N>:EQUalizer:DFE:STATe command/query, [732](#)
- DFE, :LANE<N>:EQUalizer:DFE:TAP command/query, [733](#)
- DFE, :LANE<N>:EQUalizer:DFE:TAP:AUTomati c command, [734](#)
- DFE, :LANE<N>:EQUalizer:DFE:TAP:DELay command/query, [735](#)
- DFE, :LANE<N>:EQUalizer:DFE:TAP:DELay:AUTomati c command, [736](#)
- DFE, :LANE<N>:EQUalizer:DFE:TAP:GAIN command/query, [737](#)
- DFE, :LANE<N>:EQUalizer:DFE:TAP:LTARget command/query, [738](#)
- DFE, :LANE<N>:EQUalizer:DFE:TAP:MAX command/query, [739](#)
- DFE, :LANE<N>:EQUalizer:DFE:TAP:MAXV command/query, [740](#)
- DFE, :LANE<N>:EQUalizer:DFE:TAP:MIN command/query, [741](#)
- DFE, :LANE<N>:EQUalizer:DFE:TAP:MINV command/query, [742](#)
- DFE, :LANE<N>:EQUalizer:DFE:TAP:NORMAlize command/query, [743](#)
- DFE, :LANE<N>:EQUalizer:DFE:TAP:UTARget command/query, [744](#)
- DFE, :LANE<N>:EQUalizer:DFE:TAP:WIDTH command/query, [745](#)
- DFE, :LANE<N>:EQUalizer:DFE:THREshold:BA NDwidth command/query, [746](#)
- DFE, :LANE<N>:EQUalizer:DFE:THREshold:BWMode command/query, [747](#)
- DFE, :LANE<N>:EQUalizer:DFE:THREshold:DELay command/query, [748](#)
- DFE, :LANE<N>:SOURce command/query, [762](#)
- DFEQualizer, :SPROcessing:DFEQualizer:NTAPs command/query, [1768](#)
- DFEQualizer, :SPROcessing:DFEQualizer:SOURce command/query, [1769](#)
- DFEQualizer, :SPROcessing:DFEQualizer:STATe command/query, [1770](#)
- DFEQualizer, :SPROcessing:DFEQualizer:TAP command/query, [1771](#)
- DFEQualizer, :SPROcessing:DFEQualizer:TAP:AUTomati c command, [1772](#)
- DFEQualizer, :SPROcessing:DFEQualizer:TAP:DELay command/query, [1773](#)
- DFEQualizer, :SPROcessing:DFEQualizer:TAP:DELay:AUTomati c command, [1774](#)
- DFEQualizer, :SPROcessing:DFEQualizer:TAP:GAIN command/query, [1775](#)
- DFEQualizer, :SPROcessing:DFEQualizer:TAP:LTARget command/query, [1776](#)
- DFEQualizer, :SPROcessing:DFEQualizer:TAP:MAX command/query, [1777](#)
- DFEQualizer, :SPROcessing:DFEQualizer:TAP:MIN command/query, [1778](#)
- DFEQualizer, :SPROcessing:DFEQualizer:TAP:NORMAlize command/query, [1779](#)
- DFEQualizer, :SPROcessing:DFEQualizer:TAP:UTARget command/query, [1780](#)
- DFEQualizer, :SPROcessing:DFEQualizer:TAP:WIDTH command/query, [1781](#)
- DFRequency, :MEASure:FFT:DFRequency command/query, [949](#)
- DIFF, :FUNCTION<F>:DIFF command, [580](#)
- DIFFerential, :CHANnel<N>:DIFFerential command/query, [346](#)
- DIFFerential, :CHANnel<N>:DIFFerential:SKEW command/query, [347](#)
- Digital Commands, [481](#)
- DIGital, :ACQUIRE:POINTs:DIGital? query, [256](#)
- DIGital, :ACQUIRE:SRATE:DIGital command/query, [268](#)
- DIGital, :ACQUIRE:SRATE:DIGital:AUTO command/query, [269](#)
- Digitize, Aborting, [179](#)
- Digitize, setting up for execution, [238](#)
- DIMPedance, :SYSTEM:DIMPedance command/query, [1353](#)
- DIRection, :SBUS<N>:UART:DIRection command/query, [1337](#)
- DIRection, :TRIGGER:ADVanced:VIOLation:PWIDth:DIRection command/query, [1546](#)
- DIRection, :TRIGGER:PWIDth:DIRection command/query, [1440](#)
- DIRection, :TRIGGER:TRANSition:DIRection command/query, [1476](#)
- DIRectory, :DISK:DIRectory? query, [494](#)
- Disabling Serial Poll, [179](#)
- DISConnect, :HOSTed:FOLLOWer<N>:DISConnect command, [686](#)
- DISConnect, :HOSTed:LEADer:DISConnect command, [690](#)
- discontinued and obsolete commands, [1703](#)
- discrete derivative function, [580](#)
- Disk Commands, [489](#)
- Disk Commands, SEGmented, [512](#)
- display colors, default setup and, [1365](#)
- Display Commands, [513](#)
- display persistence, [554](#)
- DISPlay, :BUS<B>:DISPlay command/query, [325](#)
- DISPlay, :CHANnel<N>:DISPlay command/query, [348](#)

- DISPlay, :CHANnel<N>:DISPlay:AUTO  
 command/query, **349**  
 DISPlay, :CHANnel<N>:DISPlay:OFFSet  
 command/query, **351**  
 DISPlay, :CHANnel<N>:DISPlay:RANGe  
 command/query, **353**  
 DISPlay, :CHANnel<N>:DISPlay:SCALe  
 command/query, **355**  
 DISPlay, :DIGital<N>:DISPlay  
 command/query, **482**  
 DISPlay, :FUNctioN<F>:DISPlay  
 command/query, **581**  
 DISPlay, :LISTer:DISPlay  
 command/query, **779**  
 DISPlay, :MEASure:THReshold:DISPlay  
 command/query, **1120**  
 DISPlay, :POD<N>:DISPlay  
 command/query, **1212**  
 DISPlay, :SPROcessing:CTLequalizer:DISPlay  
 command/query, **1754**  
 DISPlay, :SPROcessing:FFEQualizer:DISPlay  
 command/query, **1784**  
 DISPlay, :WMEMory<R>:DISPlay  
 command/query, **1652**  
 display, serial decode bus, **1257**  
 DIVide, :FUNctioN<F>:DIVide  
 command, **582**  
 dividing functions, **582**  
 DMAGnitude, :MEASure:FFT:DMAGnitude  
 command/query, **951**  
 DONTabmeas, :SYSTem:DONTabmeas  
 command/query, **1354**  
 DPRinter, :HARDcopy:DPRinter  
 command/query, **647**  
 DRATe, :CHANnel<N>:SIMulation:DRATe  
 command/query, **420**  
 DRATe, :TRIGger:GBSerial:DRATe  
 command/query, **1425**  
 DRAW, :MTESt:SCALe:DRAW  
 command/query, **871**  
 Driver Electronics Code and Capability, **173**  
 DSOurce,  
 :TRIGger:ADVanced:VIOLation:SETup:H  
 OLD:DSOurce command/query, **1564**  
 DSOurce,  
 :TRIGger:ADVanced:VIOLation:SETup:H  
 OLD:DSOurce:HTHReshold  
 command/query, **1565**  
 DSOurce,  
 :TRIGger:ADVanced:VIOLation:SETup:H  
 OLD:DSOurce:LTHReshold  
 command/query, **1566**  
 DSOurce,  
 :TRIGger:ADVanced:VIOLation:SETup:SE  
 TUp:DSOurce command/query, **1557**  
 DSOurce,  
 :TRIGger:ADVanced:VIOLation:SETup:SE  
 TUp:DSOurce:HTHReshold  
 command/query, **1558**  
 DSOurce,  
 :TRIGger:ADVanced:VIOLation:SETup:SE  
 TUp:DSOurce:LTHReshold  
 command/query, **1559**  
 DSOurce,  
 :TRIGger:ADVanced:VIOLation:SETup:SH  
 Old:DSOurce command/query, **1571**  
 DSOurce,  
 :TRIGger:ADVanced:VIOLation:SETup:SH  
 Old:DSOurce:HTHReshold  
 command/query, **1572**  
 DSOurce,  
 :TRIGger:ADVanced:VIOLation:SETup:SH  
 Old:DSOurce:LTHReshold  
 command/query, **1573**  
 DSOurce, :TRIGger:SHOLd:DSOurce  
 command/query, **1462**  
 DSP, :SYSTem:DSP command/query, **1355**  
 duplicate mnemonics, **137**  
 duty cycle - duty cycle measurement, **920**  
 DUTYcycle, :MEASure:DUTYcycle  
 command/query, **940**
- ## E
- EADapter, :CHANnel<N>:PROBE:EADapter  
 command/query, **382**  
 ECOupling, :CHANnel<N>:PROBE:ECOupling  
 command/query, **385**  
 EDElay, :TRIGger:DElay:EDElay:COUNT  
 command/query, **1410**  
 EDElay, :TRIGger:DElay:EDElay:SLOPe  
 command/query, **1412**  
 EDElay, :TRIGger:DElay:EDElay:SOURce  
 command/query, **1411**  
 edge trigger slope, default setup, **1364**  
 edge trigger source, default setup, **1364**  
 EDGE, :ANALyze:CLOCK:METHod:EDGE  
 command/query, **281**  
 EDGE, :ISCan:NONMonotonic:EDGE  
 command/query, **700**  
 EDGE, :MEASure:CLOCK:METHod:EDGE  
 command/query, **1731**  
 EDGE, :MEASure:EDGE  
 command/query, **941**  
 EDGE, :MEASure:PAM:PRBS13q:EDGE:EOJ?  
 query, **1038**  
 EDGE, :MEASure:PAM:PRBS13q:EDGE:J3U?  
 query, **1039**  
 EDGE, :MEASure:PAM:PRBS13q:EDGE:J4U?  
 query, **1040**  
 EDGE, :MEASure:PAM:PRBS13q:EDGE:J6U?  
 query, **1041**  
 EDGE,  
 :MEASure:PAM:PRBS13q:EDGE:JRMS?  
 query, **1042**  
 EDGE, :MEASure:PN:EDGE  
 command/query, **1058**  
 EDGE, :MEASure:RJDJ:EDGE  
 command/query, **1093**  
 EDGE,  
 :TRIGger:ADVanced:VIOLation:SETup:H
- OLD:CSOurce:EDGE  
 command/query, **1563**  
 EDGE,  
 :TRIGger:ADVanced:VIOLation:SETup:SE  
 TUp:CSOurce:EDGE  
 command/query, **1556**  
 EDGE,  
 :TRIGger:ADVanced:VIOLation:SETup:SH  
 Old:CSOurce:EDGE  
 command/query, **1570**  
 EDGE, :TRIGger:EDGE:COUpling  
 command/query, **1418**  
 EDGE, :TRIGger:EDGE:SLOPe  
 command/query, **1419**  
 EDGE, :TRIGger:EDGE:SOURce  
 command/query, **1420**  
 EDGE, :TRIGger:SHOLd:CSOurce:EDGE  
 command/query, **1461**  
 edges, measure all, **894, 940, 941, 944,**  
**959, 977, 1013, 1014, 1020, 1050,**  
**1052, 1071, 1072, 1112, 1114,**  
**1176, 1181, 1192, 1194, 1199,**  
**1747**  
 EDLY,  
 :TRIGger:ADVanced:DElay:EDLY:ARM:SL  
 OPe command/query, **1517**  
 EDLY,  
 :TRIGger:ADVanced:DElay:EDLY:ARM:S  
 OURce command/query, **1516**  
 EDLY,  
 :TRIGger:ADVanced:DElay:EDLY:EVENT:  
 DElay command/query, **1518**  
 EDLY,  
 :TRIGger:ADVanced:DElay:EDLY:EVENT:  
 SLOPe command/query, **1520**  
 EDLY,  
 :TRIGger:ADVanced:DElay:EDLY:EVENT:  
 SOURce command/query, **1519**  
 EDLY,  
 :TRIGger:ADVanced:DElay:EDLY:TRIGge  
 r:SLOPe command/query, **1522**  
 EDLY,  
 :TRIGger:ADVanced:DElay:EDLY:TRIGge  
 r:SOURce command/query, **1521**  
 EHEight, :MEASure:CGRade:EHEight  
 command/query, **904**  
 ELEVel, :MEASure:PAM:ELEVel  
 command/query, **1022**  
 Ellipsis, ..., **132**  
 ELMethod, :MEASure:PAM:EYE:ELMethod  
 command/query, **1026**  
 ELOCation, :MEASure:CGRade:ELOCation  
 command/query, **906**  
 embedded, commands, **144**  
 embedded, strings, **127, 128, 142**  
 Enable Register, **450**  
 ENABle,  
 :CHANnel<N>:SIMulation:JITTer:PERiod  
 ic<M>:ENABle command/query, **433**  
 ENABle,  
 :CHANnel<N>:SIMulation:NOISe:PERiod  
 ic<M>:ENABle command/query, **440**

- ENABle, :MARKer<K>:ENABle  
   command/query, 809  
 ENABle, :MTEST:ENABle  
   command/query, 838  
 ENABle, :SBUS<N>:SEARCH:ENABle  
   command/query, 1259  
 ENABle, :TIMEbase:ROLL:ENABle  
   command/query, 1375  
 ENABle, :TRIGger:AND:ENABle  
   command/query, 1386  
 ENABle, :TRIGger:SEquence:RESet:ENABle  
   command/query, 1453  
 ENABle, :TRIGger:SEquence:WAIT:ENABle  
   command/query, 1457  
 ENABle, :XTALK:ENABle  
   command/query, 1667  
 ENABle, :XTALK<X>:ENABle  
   command/query, 1690  
 ENCode,  
   :TRIGger:ADVanced:COMM:ENCode  
   command/query, 1498  
 ENCode, :TRIGger:COMM:ENCode  
   command/query, 1403  
 End Of String (EOS), 143  
 End Of Text (EOT), 143  
 End-Or-Identify (EOI), 143  
 ENUMber,  
   :TRIGger:ADVanced:TV:UDTV:ENUMber  
   command/query, 1538  
 ENUMber, :TRIGger:TV:UDTV:ENUMber  
   command/query, 1486  
 EOF, :SBUS<N>:UART:EOF:HEX  
   command/query, 1338  
 EOI and IEEE 488.2, 168  
 EOJ, :MEASure:PAM:PRBS13q:EDGE:EOJ?  
   query, 1038  
 Equalized First Order PLL clock recovery  
   method, JTF, 284  
 Equalized First Order PLL clock recovery  
   method, OJTF, 286  
 Equalized Second Order PLL clock recovery  
   method, JTF, 284  
 Equalized Second Order PLL clock recovery  
   method, OJTF, 286  
 Equalized Third Order PLL clock recovery  
   method, 275  
 EQUalizer,  
   :LANE<N>:EQUalizer:DFE:TAP:MAXV  
   command/query, 740  
 EQUalizer,  
   :LANE<N>:EQUalizer:DFE:TAP:MINV  
   command/query, 742  
 EQUalizer,  
   :LANE<N>:EQUalizer:DFE:THReshold:BA  
   NDwidth command/query, 746  
 EQUalizer,  
   :LANE<N>:EQUalizer:DFE:THReshold:B  
   WMode command/query, 747  
 EQUalizer,  
   :LANE<N>:EQUalizer:DFE:THReshold:DE  
   Lay command/query, 748  
 EQUalizer, :LANE<N>:EQUalizer:LOCation  
   command/query, 761  
 ERATio, :MEASure:ERATio  
   command/query, 942  
 error messages, 1799  
 Error Messages table, 1806  
 error messages, list of, 1806  
 error queue, 1800  
 error queue, and status reporting, 205  
 error queue, overflow, 1800  
 ERRor,  
   :SBUS<N>:FLEXray:TRIGger:ERRor:TYPE  
   command/query, 1282  
 error, in measurements, 892  
 error, numbers, 1801  
 error, query interrupt, 138, 154  
 ERRor?, :SYSTem:ERRor? query, 1356  
 errors, exceptions to protocol, 183  
 ESB (Event Status Bit), 187, 473, 475  
 ESB (Event Summary Bit), 452  
 ESKew, :MEASure:PAM:ESKew  
   command/query, 1024  
 ESR (Standard Event Status Register), 195  
 ESTiming, :MEASure:PAM:EYE:ESTiming  
   command/query, 1027  
 ETAEdges, :MEASure:ETAEdges  
   command/query, 943  
 ETIme acquisition mode, 251  
 ETOedge, :MEASure:ETOedge  
   command, 944  
 event monitoring, 185  
 Event Registers Default, 172  
 Event Status Bit (ESB), 187  
 Event Status Enable (\*ESE), Status  
   Reporting, 196  
 Event Status Register (\*ESR?) query, 454  
 Event Summary Bit (ESB), 452  
 EVENT,  
   :TRIGger:ADVanced:DElay:EDLY:EVENT:  
   DElay command/query, 1518  
 EVENT,  
   :TRIGger:ADVanced:DElay:EDLY:EVENT:  
   SLOPe command/query, 1520  
 EVENT,  
   :TRIGger:ADVanced:DElay:EDLY:EVENT:  
   SOURce command/query, 1519  
 EVENT, :TRIGger:SEquence:RESet:EVENT  
   command, 1455  
 EWIDth, :MEASure:CGRade:EWIDth  
   command/query, 907  
 EWIDth,  
   :MEASure:CGRade:EWIDth:THReshold  
   command/query, 909  
 EWINDow, :MEASure:CGRade:EWINDow  
   command/query, 910  
 Example Program, 151  
 Example Program, in initialization, 151  
 example programs, 1813  
 exceptions to protocol, 183  
 EXE bit, 452, 454  
 executing DIGITIZE, 238  
 Execution Error (EXE), Status Bit, 186  
 execution errors, 1803  
 execution errors and command  
   errors, 1802  
 execution, of commands and order, 183  
 Explicit Clock clock recovery method, 275  
 Explicit First Order PLL clock recovery  
   method, JTF, 284  
 Explicit First Order PLL clock recovery  
   method, OJTF, 286  
 Explicit Second Order PLL clock recovery  
   method, JTF, 284  
 Explicit Second Order PLL clock recovery  
   method, OJTF, 286  
 Explicit Third Order PLL clock recovery  
   method, 275  
 exponential notation, 141  
 exponents, 141  
 EXTernal, :CHANnel<N>:PROBe:EXTernal  
   command/query, 386  
 EXTernal,  
   :CHANnel<N>:PROBe:EXTernal:GAIN  
   command/query, 387  
 EXTernal,  
   :CHANnel<N>:PROBe:EXTernal:OFFSet  
   command/query, 388  
 EXTernal,  
   :CHANnel<N>:PROBe:EXTernal:UNITs  
   command/query, 389  
 eye center location, PAM measurement  
   definition, 1026  
 eye level width, PAM measurement  
   definition, 1028  
 EYE, :MEASure:PAM:EYE:ELMethod  
   command/query, 1026  
 EYE, :MEASure:PAM:EYE:ESTiming  
   command/query, 1027  
 EYE, :MEASure:PAM:EYE:PPERcent  
   command/query, 1028  
 EYE, :MEASure:PAM:EYE:PROBability  
   command/query, 1029  
 EYE, :MEASure:PAM:EYE:TIME:LTDefinition  
   command/query, 1030  
**F**  
 FACTors, :HARDcopy:FACTors  
   command/query, 648  
 FAIL, :ISCan:MEASurement:FAIL  
   command/query, 695  
 FAIL, :LTEST:FAIL command/query, 769  
 FAILures, :MTEST:COUNT:MARGin:FAILures?  
   query, 833  
 FAILures?, :MTEST:COUNT:FAILures?  
   query, 830  
 fall time measurement setup, 891  
 FALLtime, :MEASure:FALLtime  
   command/query, 946  
 FAST, :MTEST:FOLDing:FAST  
   command/query, 847  
 Fast, Worst Case Only option, 105, 847

- FDBaudrate, :SBUS<N>:CAN:SIGNal:FDBaudrate command/query, [1266](#)
- FDSPoint, :SBUS<N>:CAN:FDSPoint command/query, [1262](#)
- FFE, :LANE<N>:EQualizer:FFE:BAWdwidth command/query, [749](#)
- FFE, :LANE<N>:EQualizer:FFE:BWMode command/query, [750](#)
- FFE, :LANE<N>:EQualizer:FFE:NPRecursor command/query, [751](#)
- FFE, :LANE<N>:EQualizer:FFE:NTAPs command/query, [752](#)
- FFE, :LANE<N>:EQualizer:FFE:RATE command/query, [753](#)
- FFE, :LANE<N>:EQualizer:FFE:STATE command/query, [754](#)
- FFE, :LANE<N>:EQualizer:FFE:TAP command/query, [755](#)
- FFE, :LANE<N>:EQualizer:FFE:TAP:AUToMatic command, [756](#)
- FFE, :LANE<N>:EQualizer:FFE:TAP:DElay command/query, [757](#)
- FFE, :LANE<N>:EQualizer:FFE:TAP:WIDTh command/query, [758](#)
- FFE, :LANE<N>:EQualizer:FFE:TDElay command/query, [759](#)
- FFE, :LANE<N>:EQualizer:FFE:TDMoDe command/query, [760](#)
- FFEQualizer, :SPRoceSSing:FFEQualizer:BAWdwidth command/query, [1782](#)
- FFEQualizer, :SPRoceSSing:FFEQualizer:BWMode command/query, [1783](#)
- FFEQualizer, :SPRoceSSing:FFEQualizer:DISPlay command/query, [1784](#)
- FFEQualizer, :SPRoceSSing:FFEQualizer:NPRecursor command/query, [1785](#)
- FFEQualizer, :SPRoceSSing:FFEQualizer:NTAPs command/query, [1786](#)
- FFEQualizer, :SPRoceSSing:FFEQualizer:RATE command/query, [1787](#)
- FFEQualizer, :SPRoceSSing:FFEQualizer:SOURce command/query, [1788](#)
- FFEQualizer, :SPRoceSSing:FFEQualizer:TAP command/query, [1789](#)
- FFEQualizer, :SPRoceSSing:FFEQualizer:TAP:AUToMatic command, [1790](#)
- FFEQualizer, :SPRoceSSing:FFEQualizer:TAP:DElay command/query, [1791](#)
- FFEQualizer, :SPRoceSSing:FFEQualizer:TAP:WIDTh command/query, [1792](#)
- FFEQualizer, :SPRoceSSing:FFEQualizer:TDElay command/query, [1793](#)
- FFEQualizer, :SPRoceSSing:FFEQualizer:TDMoDe command/query, [1794](#)
- FFEQualizer, :SPRoceSSing:FFEQualizer:VERTical command/query, [1795](#)
- FFEQualizer, :SPRoceSSing:FFEQualizer:VERTical:OFF Set command/query, [1796](#)
- FFEQualizer, :SPRoceSSing:FFEQualizer:VERTical:RANGe command/query, [1797](#)
- FFT Commands, [890](#)
- FFT resolution, [596](#)
- FFT, :FUNctioN<F>:FFT:PEAK:SORT command/query, [589](#)
- FFT, :FUNctioN<F>:FFT:DETEctor:POINts command/query, [583](#)
- FFT, :FUNctioN<F>:FFT:DETEctor:TYPE command/query, [584](#)
- FFT, :FUNctioN<F>:FFT:FREQuency command/query, [585](#)
- FFT, :FUNctioN<F>:FFT:HSCale command/query, [586](#)
- FFT, :FUNctioN<F>:FFT:IMPedance command/query, [587](#)
- FFT, :FUNctioN<F>:FFT:PEAK:COUNt command/query, [590](#)
- FFT, :FUNctioN<F>:FFT:PEAK:FREQuency? query, [591](#)
- FFT, :FUNctioN<F>:FFT:PEAK:LEvel command/query, [592](#)
- FFT, :FUNctioN<F>:FFT:PEAK:MAGNitude? query, [593](#)
- FFT, :FUNctioN<F>:FFT:PEAK:STATE command/query, [594](#)
- FFT, :FUNctioN<F>:FFT:REFErence command/query, [595](#)
- FFT, :FUNctioN<F>:FFT:RESolution command/query, [596](#)
- FFT, :FUNctioN<F>:FFT:SPAN command/query, [598](#)
- FFT, :FUNctioN<F>:FFT:STARt command/query, [599](#)
- FFT, :FUNctioN<F>:FFT:STOP command/query, [600](#)
- FFT, :FUNctioN<F>:FFT:TDElay command/query, [601](#)
- FFT, :FUNctioN<F>:FFT:VUNits command/query, [602](#)
- FFT, :FUNctioN<F>:FFT:WINDow command/query, [603](#)
- FFT, :MEASure:FFT:CPOwer command/query, [948](#)
- FFT, :MEASure:FFT:DFRequency command/query, [949](#)
- FFT, :MEASure:FFT:DMAGnitude command/query, [951](#)
- FFT, :MEASure:FFT:FREQuency command/query, [953](#)
- FFT, :MEASure:FFT:MAGNitude command/query, [955](#)
- FFT, :MEASure:FFT:OBW command/query, [957](#)
- FFT, :MEASure:FFT:PEAK1 command/query, [1744](#)
- FFT, :MEASure:FFT:PEAK2 command/query, [1745](#)
- FFT, :MEASure:FFT:PSD command/query, [958](#)
- FFT, :MEASure:FFT:THReShold command/query, [1746](#)
- FFT, :WMEMory<R>:FFT:HSCale command/query, [1653](#)
- FFTMagnitude, :FUNctioN<F>:FFTMagnitude command, [605](#)
- FFTPhase, :FUNctioN<F>:FFTPhase command, [606](#)
- Fibre Channel clock recovery method, [275](#)
- FIELD, :TRIGger:ADVanced:TV:STV:FIELD command/query, [1532](#)
- FILTer, :CHANnel<N>:SIMulation:FILTer:ISIM:ADDRESS command/query, [421](#)
- FILTer, :CHANnel<N>:SIMulation:FILTer:ISIM:PEXtraction command/query, [422](#)
- FILTer, :CHANnel<N>:SIMulation:FILTer:SElectioN command/query, [423](#)
- First Order PLL clock recovery method, JTF, [284](#)
- First Order PLL clock recovery method, QJTF, [286](#)
- FlexRay Receiver clock recovery method, [275](#)
- FLEXray serial bus commands, [1277](#)
- FlexRay Transmitter clock recovery method, [275](#)
- FLEXray, :SBUS<N>:FLEXray:BAUdRate command/query, [1278](#)
- FLEXray, :SBUS<N>:FLEXray:CHANnel command/query, [1279](#)
- FLEXray, :SBUS<N>:FLEXray:SOURce command/query, [1280](#)
- FLEXray, :SBUS<N>:FLEXray:TRIGger command/query, [1281](#)
- FLEXray, :SBUS<N>:FLEXray:TRIGger:ERRor:TYPE command/query, [1282](#)
- FLEXray, :SBUS<N>:FLEXray:TRIGger:FRAME:CC Base command/query, [1283](#)
- FLEXray, :SBUS<N>:FLEXray:TRIGger:FRAME:CC Repetition command/query, [1284](#)
- FLEXray, :SBUS<N>:FLEXray:TRIGger:FRAME:ID command/query, [1285](#)

- FLEXray,
    - :SBUS<N>:FLEXray:TRIGger:FRAMe:TYPE command/query, [1286](#)
  - FLOad,
    - :CHANnel<N>:SIMulation:FLOad:ADDRESS command/query, [424](#)
  - FLOad,
    - :CHANnel<N>:SIMulation:FLOad:LOOP command/query, [425](#)
  - FLOat, waveform data FORMat, [1617](#)
  - floats, H5 data saved as, [511](#)
  - flow, programming, [220](#)
  - FOLDing, :MTEST:FOLDing
    - command/query, [839](#)
  - FOLDing, :MTEST:FOLDing:BITS
    - command/query, [841](#)
  - FOLDing, :MTEST:FOLDing:COUNT
    - query, [1750](#)
  - FOLDing, :MTEST:FOLDing:COUNT:UI
    - query, [843](#)
  - FOLDing,
    - :MTEST:FOLDing:COUNT:WAVEforms query, [845](#)
  - FOLDing, :MTEST:FOLDing:FAST
    - command/query, [847](#)
  - FOLDing, :MTEST:FOLDing:POSITION
    - command/query, [849](#)
  - FOLDing, :MTEST:FOLDing:SCALE
    - command/query, [851](#)
  - FOLDing, :MTEST:FOLDing:TPOSITION
    - command/query, [853](#)
  - FOLDing, :MTEST:FOLDing:TSCALE
    - command/query, [855](#)
  - FOLLOWer<N>,
    - :HOSTed:FOLLOWer<N>:ACHannels? query, [683](#)
  - FOLLOWer<N>,
    - :HOSTed:FOLLOWer<N>:CONFigure command, [684](#)
  - FOLLOWer<N>,
    - :HOSTed:FOLLOWer<N>:CONNect command, [685](#)
  - FOLLOWer<N>,
    - :HOSTed:FOLLOWer<N>:DISConnect command, [686](#)
  - FORCe, :TRIGger:FORCe command, [1388](#)
  - FORMat, :SBUS<N>:HS:FORMat
    - command/query, [1292](#)
  - FORMat, :WAVEform:FORMat
    - command/query, [1616](#)
  - FORMat, and DATA, [1595](#)
  - FormattedIO488 object, [148](#)
  - formatting query responses, [1349](#)
  - fractional values, [141](#)
  - FRAMe, :ACQUIRE:Bandwidth:FRAMe?
    - query, [243](#)
  - FRAMe,
    - :SBUS<N>:FLEXray:TRIGger:FRAMe:CC Base command/query, [1283](#)
  - FRAMe,
    - :SBUS<N>:FLEXray:TRIGger:FRAMe:CC Repetition command/query, [1284](#)
  - FRAMe,
    - :SBUS<N>:FLEXray:TRIGger:FRAMe:ID command/query, [1285](#)
  - FRAMe,
    - :SBUS<N>:FLEXray:TRIGger:FRAMe:TYPE command/query, [1286](#)
  - FRAMe, :SBUS<N>:SPI:FRAMe:STATe
    - command/query, [1317](#)
  - FRAMe, :SBUS<N>:SPI:SOURce:FRAMe
    - command/query, [1322](#)
  - FRAMes,
    - :HOSTed:CALibrate:DESKew:FRAMes command, [672](#)
  - FRAMes,
    - :HOSTed:CALibrate:STATus:FRAMes? query, [679](#)
  - frequency measurement setup, [891](#)
  - FREQuency,
    - :CHANnel<N>:SIMulation:FREQuency command/query, [426](#)
  - FREQuency,
    - :CHANnel<N>:SIMulation:JITTer:PERiodic<M>:FREQuency command/query, [434](#)
  - FREQuency,
    - :CHANnel<N>:SIMulation:NOISe:PERiodic<M>:FREQuency command/query, [441](#)
  - FREQuency, :FUNCTION<F>:FFT:FREQuency
    - command/query, [585](#)
  - FREQuency,
    - :FUNCTION<F>:FFT:PEAK:FREQuency? query, [591](#)
  - FREQuency, :MEASure:FFT:FREQuency
    - command/query, [953](#)
  - FREQuency, :MEASure:FREQuency
    - command/query, [959](#)
  - FREQuency,
    - :TRIGger:GBSerial:CLOCK:FREQuency command/query, [1423](#)
  - FREQuency,
    - :WAVEform:PNOise:FREQuency? query, [1619](#)
  - FTIME,
    - :CHANnel<N>:SIMulation:FUNCTION:SQUare:FTIME command/query, [429](#)
  - FUI?, :MTEST:COUNT:FUI? query, [831](#)
  - full-scale vertical axis, [412](#)
  - Function Commands, [569](#)
  - FUNCTION,
    - :CHANnel<N>:SIMulation:FUNCTION:SELECTION command/query, [427](#)
  - FUNCTION,
    - :CHANnel<N>:SIMulation:FUNCTION:SQUare:DCYCLE command/query, [428](#)
  - FUNCTION,
    - :CHANnel<N>:SIMulation:FUNCTION:SQUare:FTIME command/query, [429](#)
  - FUNCTION,
    - :CHANnel<N>:SIMulation:FUNCTION:SQUare:RTIME command/query, [430](#)
  - function, and vertical scaling, [635](#)
  - function, time scale, [571](#)
  - functional elements of protocol, [182](#)
  - functions, and VIEW, [1634](#)
  - functions, combining in instructions, [137](#)
  - FWAVEforms?, :MTEST:COUNT:FWAVEforms?
    - query, [832](#)
  - FWHM, :MEASure:HISTogram:FWHM
    - command/query, [961](#)
- ## G
- gain and offset of a probe, [330](#)
  - gain factor for user-defined probe, [387](#)
  - GAIN, :CHANnel<N>:PROBe:EXtERnal:GAIN
    - command/query, [387](#)
  - GAIN, :CHANnel<N>:PROBe:GAIN
    - command/query, [390](#)
  - GAIN, :LANE<N>:EQualizer:DFE:TAP:GAIN
    - command/query, [737](#)
  - GAIN, :SPROcessing:DFEQualizer:TAP:GAIN
    - command/query, [1775](#)
  - GATING, :FUNCTION<F>:GATING
    - command, [607](#)
  - GATING, :FUNCTION<F>:GATING:GLOBAL
    - command, [608](#)
  - GATING, :FUNCTION<F>:GATING:START
    - command, [609](#)
  - GATING, :FUNCTION<F>:GATING:STOP
    - command, [610](#)
  - GBSerial, :TRIGger:GBSerial:CLOCK
    - command/query, [1422](#)
  - GBSerial,
    - :TRIGger:GBSerial:CLOCK:FREQuency command/query, [1423](#)
  - GBSerial, :TRIGger:GBSerial:DRATE
    - command/query, [1425](#)
  - GBSerial, :TRIGger:GBSerial:MODE
    - command/query, [1427](#)
  - GBSerial, :TRIGger:GBSerial:PATtern
    - command/query, [1428](#)
  - GBSerial, :TRIGger:GBSerial:POLarity
    - command/query, [1429](#)
  - GBSerial, :TRIGger:GBSerial:PRBS
    - command/query, [1430](#)
  - GBSerial, :TRIGger:GBSerial:SOURce
    - command/query, [1431](#)
  - GCOunt, :DISPlay:ISIM:GCOunt
    - command/query, [539](#)
  - GCOunt, :DISPlay:JITTer:GCOunt
    - command/query, [542](#)
  - GCOunt, :DISPlay:PRECProbe:GCOunt
    - command/query, [558](#)
  - GENAUTO, :MEASure:THResholds:GENAUTO
    - command, [1121](#)
  - general SBUS<N> commands, [1256](#)
  - GENeral,
    - :MEASure:THResholds:GENeral:ABSolute command/query, [1122](#)
  - GENeral,
    - :MEASure:THResholds:GENeral:HYSTeresis command/query, [1124](#)

GENeral,  
   :MEASure:THResholds:GENeral:METHOD  
   command/query, **1126**  
 GENeral,  
   :MEASure:THResholds:GENeral:PAMAut  
   omatic command/query, **1130**  
 GENeral,  
   :MEASure:THResholds:GENeral:PAMCus  
   tom command/query, **1128**  
 GENeral,  
   :MEASure:THResholds:GENeral:PERCen  
   t command/query, **1132**  
 GENeral,  
   :MEASure:THResholds:GENeral:TOPBas  
   e:ABSolute command/query, **1134**  
 GENeral,  
   :MEASure:THResholds:GENeral:TOPBas  
   e:METHOD command/query, **1136**  
 GENRaw serial bus commands, **1287**  
 GENRaw, :SBUS<N>:GENRaw:SOURce  
   command/query, **1288**  
 GENRaw, :SBUS<N>:GENRaw:WSIZe  
   command/query, **1289**  
 GETFILE, :DISK:GETFILE? query, **495**  
 GLAYout, :DISPlay:GRATicule:GLAYout  
   command/query, **535**  
 GLITCh, :TRIGger:GLITCh:POLarity  
   command/query, **1433**  
 GLITCh, :TRIGger:GLITCh:SOURce  
   command/query, **1434**  
 GLITCh, :TRIGger:GLITCh:WIDTh  
   command/query, **1435**  
 GLOBal, :FUNctioN<F>:GATing:GLOBal  
   command, **608**  
 GPIB interface, **119**  
 GPIB, Interface Connector, **171**  
 GRAPh, :DISPlay:PAM:GRAPh  
   command, **551**  
 GRATicule, :DISPlay:GRATicule  
   command, **538**  
 GRATicule, :DISPlay:GRATicule  
   command/query, **531**  
 GRATicule,  
   :DISPlay:GRATicule:AREA<N>:HSCale  
   command/query, **532**  
 GRATicule,  
   :DISPlay:GRATicule:AREA<N>:STATe  
   command/query, **533**  
 GRATicule,  
   :DISPlay:GRATicule:AREA<N>:VSCale  
   command/query, **534**  
 GRATicule, :DISPlay:GRATicule:GLAYout  
   command/query, **535**  
 GRATicule, :DISPlay:GRATicule:INTensity  
   command/query, **536**  
 GRATicule, :DISPlay:GRATicule:NUMBer  
   command/query, **537**  
 GRATicule, HARdcopy AREA, **646**  
 grid line intensity, default setup and, **1365**  
 Group Execute Trigger (GET), **179**  
 GUI, :SYSTem:GUI command/query, **1357**

## H

H5 data saved as floats, **511**  
 H5 data saved as integers, **511**  
 Halting bus activity, **179**  
 Hardcopy Commands, **645**  
 Hardcopy Commands, AREA, **646**  
 hardcopy of the screen, **645**  
 hardcopy output and message  
   termination, **183**  
 HEAD, :CHANnel<N>:PROBe:HEAD:ADD  
   command, **391**  
 HEAD, :CHANnel<N>:PROBe:HEAD:DELeTe  
   command, **392**  
 HEAD, :CHANnel<N>:PROBe:HEAD:SELeCt  
   command/query, **393**  
 HEAD, :CHANnel<N>:PROBe:HEAD:VTERm  
   command/query, **394**  
 HEADer, :SYSTem:HEADer  
   command/query, **1358**  
 header, within instruction, **128**  
 headers, **129**  
 headers, types, **136**  
 HEIGHt, :WAVEform:CGRAde:HEIGHt?  
   query, **1588**  
 HEX, :SBUS<N>:UART:EOF:HEX  
   command/query, **1338**  
 HIDE, :ISCan:ZONE:HIDE  
   command/query, **709**  
 HIGHpass, :FUNctioN<F>:HIGHpass  
   command, **611**  
 HiSLIP protocol, **121**  
 Histogram Commands, **651**  
 HISTogram, :MEASure:HISTogram:FWMH  
   command/query, **961**  
 HISTogram, :MEASure:HISTogram:HITS  
   command/query, **962**  
 HISTogram, :MEASure:HISTogram:M1S  
   command/query, **963**  
 HISTogram, :MEASure:HISTogram:M2S  
   command/query, **964**  
 HISTogram, :MEASure:HISTogram:M3S  
   command/query, **965**  
 HISTogram, :MEASure:HISTogram:MAX  
   command/query, **966**  
 HISTogram, :MEASure:HISTogram:MEAN  
   command/query, **967**  
 HISTogram, :MEASure:HISTogram:MEDian  
   command/query, **968**  
 HISTogram, :MEASure:HISTogram:MIN  
   command/query, **969**  
 HISTogram, :MEASure:HISTogram:MM3S  
   command/query, **970**  
 HISTogram, :MEASure:HISTogram:MODE  
   command/query, **972**  
 HISTogram, :MEASure:HISTogram:MP3S  
   command/query, **971**  
 HISTogram, :MEASure:HISTogram:PEAK  
   command/query, **973**  
 HISTogram, :MEASure:HISTogram:PP  
   command/query, **974**

HISTogram,  
   :MEASure:HISTogram:RESolution  
   command/query, **975**  
 HISTogram, :MEASure:HISTogram:STDDev  
   command/query, **976**  
 HISTogram, :MEASure:JITTer:HISTogram  
   command/query, **979**  
 HITS, :MEASure:HISTogram:HITS  
   command/query, **962**  
 HITS, :MTESt:MARGin:AUTO:HITS  
   command/query, **860**  
 HLED, :SYSTem:HLED  
   command/query, **1359**  
 HOLD,  
   :TRIGger:ADVanced:VIOLation:SETup:H  
   OLD:CSORce command/query, **1561**  
 HOLD,  
   :TRIGger:ADVanced:VIOLation:SETup:H  
   OLD:CSORce:EDGE  
   command/query, **1563**  
 HOLD,  
   :TRIGger:ADVanced:VIOLation:SETup:H  
   OLD:CSORce:LEVel  
   command/query, **1562**  
 HOLD,  
   :TRIGger:ADVanced:VIOLation:SETup:H  
   OLD:DSORce command/query, **1564**  
 HOLD,  
   :TRIGger:ADVanced:VIOLation:SETup:H  
   OLD:DSORce:HTHReshold  
   command/query, **1565**  
 HOLD,  
   :TRIGger:ADVanced:VIOLation:SETup:H  
   OLD:DSORce:LTHReshold  
   command/query, **1566**  
 HOLD,  
   :TRIGger:ADVanced:VIOLation:SETup:H  
   OLD:TIME command/query, **1567**  
 HOLDoff, :TRIGger:HOLDoff  
   command/query, **1389**  
 HOLDoff, :TRIGger:HOLDoff:MAX  
   command/query, **1390**  
 HOLDoff, :TRIGger:HOLDoff:MIN  
   command/query, **1391**  
 HOLDoff, :TRIGger:HOLDoff:MODE  
   command/query, **1392**  
 HoldTIME (HTIME),  
   :TRIGger:ADVanced:VIOLation:SETup:SH  
   OLD:HoldTIME (HTIME)  
   command/query, **1575**  
 HoldTIME (HTIME),  
   :TRIGger:SHOLd:HoldTIME (HTIME)  
   command/query, **1463**  
 HOLDtime, :MEASure:HOLDtime  
   command/query, **977**  
 horizontal position, default setup, **1364**  
 horizontal scale, default setup, **1364**  
 horizontal scaling, functions, **571**  
 HORizontal, :FUNctioN<F>:HORizontal  
   command/query, **612**

- HORizontal, :FUNctioN<F>:HORizontal:POSition command/query, [613](#)
  - HORizontal, :FUNctioN<F>:HORizontal:RANGe command/query, [615](#)
  - HORizontal, :HISTogram:HORizontal:BINS command/query, [654](#)
  - HORizontal, :MEASure:JITTer:SPECTrum:HORizontal command/query, [982](#)
  - HORizontal, :MEASure:JITTer:SPECTrum:HORizontal:POSition command/query, [983](#)
  - HORizontal, :MEASure:JITTer:SPECTrum:HORizontal:RANGe command/query, [984](#)
  - HORizontal, :MEASure:PN:HORizontal:START command/query, [1059](#)
  - HORizontal, :MEASure:PN:HORizontal:STOP command/query, [1060](#)
  - horizontal, functions, controlling, [1369](#)
  - horizontal, offset, and XOFFset, [1660](#)
  - horizontal, range, and XRANGe, [1661](#)
  - Host language, [128](#)
  - Hosted Commands, [667](#)
  - HRATio, :MTESt:MARGin:AUTO:HRATio command/query, [861](#)
  - HRESolution acquisition mode, [251](#)
  - HRESolution, :ACQuire:HRESolution command/query, [248](#)
  - HS serial bus commands, [1290](#)
  - HS, :SBUS<N>:HS:DESCramble command/query, [1291](#)
  - HS, :SBUS<N>:HS:FORMat command/query, [1292](#)
  - HS, :SBUS<N>:HS:IDLE command/query, [1293](#)
  - HS, :SBUS<N>:HS:SOURce<S> command/query, [1294](#)
  - HSCale, :DISPlay:GRATICule:AREA<N>:HSCale command/query, [532](#)
  - HSCale, :FUNctioN<F>:FFT:HSCale command/query, [586](#)
  - HSCale, :WMEMory<R>:FFT:HSCale command/query, [1653](#)
  - HSYNc, :TRIGger:TV:UDTV:HSYNc command/query, [1487](#)
  - HTHReshold, :TRIGger:ADVanced:VIOLation:SETup:HTHReshold:DSOource:HTHReshold command/query, [1565](#)
  - HTHReshold, :TRIGger:ADVanced:VIOLation:SETup:SETup:DSOource:HTHReshold command/query, [1558](#)
  - HTHReshold, :TRIGger:ADVanced:VIOLation:SETup:SHOLd:DSOource:HTHReshold command/query, [1572](#)
  - HTHReshold, :TRIGger:ADVanced:VIOLation:TRANSition:SOURce:HTHReshold command/query, [1579](#)
  - HTHReshold, :TRIGger:HTHReshold command/query, [1393](#)
  - HTIME, :TRIGger:TV:UDTV:HTIME command/query, [1488](#)
  - hue, [562](#)
  - HUNits, :MEASure:PAM:PRBS13q:HUNits command/query, [1043](#)
  - HYSTeresis, :IScan:NONMonotonic:HYSTeresis command/query, [701](#)
  - HYSTeresis, :IScan:RUNT:HYSTeresis command/query, [703](#)
  - HYSTeresis, :MEASure:THResholds:GENeral:HYSTeresis command/query, [1124](#)
  - HYSTeresis, :MEASure:THResholds:HYSTeresis command/query, [1137](#)
  - HYSTeresis, :MEASure:THResholds:SERial:HYSTeresis command/query, [1155](#)
  - HYSTeresis, :TRIGger:HYSTeresis command/query, [1394](#)
- ## I
- IAGGressor, :XTALK<X>:IAGGressor command/query, [1691](#)
  - id mode, [1275](#)
  - ID pattern, CAN trigger, [1274](#)
  - ID, :CHANnel<N>:PROBe:ID? query, [395](#)
  - ID, :SBUS<N>:CAN:TRIGger:PATtern:ID command/query, [1274](#)
  - ID, :SBUS<N>:CAN:TRIGger:PATtern:ID:MODE command/query, [1275](#)
  - ID, :SBUS<N>:FLEXray:TRIGger:FRAME:ID command/query, [1285](#)
  - ID, :SBUS<N>:LIN:TRIGger:ID command/query, [1310](#)
  - Identification Number (\*IDN?) query, [455](#)
  - IDENTify[, :LXI:IDENTify[:STATe] command/query, [782](#)
  - IDLe, :ANALyze:CLOCK:METHOD:IDLe command/query, [283](#)
  - IDLE, :SBUS<N>:HS:IDLE command/query, [1293](#)
  - IDLE, :SBUS<N>:UART:IDLE command/query, [1339](#)
  - IEEE 488.1, [181](#)
  - IEEE 488.1, and IEEE 488.2 relationship, [181](#)
  - IEEE 488.2, [181](#)
  - IEEE 488.2, compliance, [181](#)
  - IEEE 488.2, conformity, [126](#)
  - IEEE 488.2, Standard, [126](#)
  - IEEE 488.2, Standard Status Data Structure Model, [186](#)
  - IIC clock source, [1297](#)
  - IIC data source, [1298](#)
  - IIC serial decode address field size, [1296](#)
  - IIC trigger commands, [1295](#)
  - IIC, :SBUS<N>:IIC:ASIZe command/query, [1296](#)
  - IIC, :SBUS<N>:IIC:SOURce:CLOCK command/query, [1297](#)
  - IIC, :SBUS<N>:IIC:SOURce:DATA command/query, [1298](#)
  - IIC, :SBUS<N>:IIC:TRIGger:PATtern:ADDRes command/query, [1299](#), [1301](#)
  - IIC, :SBUS<N>:IIC:TRIGger:TYPE command, [1302](#)
  - IMAGe, :DISK:SAVE:IMAGe command, [502](#)
  - IMAGe, :HARDcopy:IMAGe command/query, [649](#)
  - IMPedance, :FUNctioN<F>:FFT:IMPedance command/query, [587](#)
  - IMPedance, :MTESt:IMPedance command/query, [857](#)
  - impedance, input, [357](#)
  - IMPedance?, :MTESt:PROBe:IMPedance? query, [867](#)
  - INDex, :ACQuire:SEGmented:INDex command/query, [262](#)
  - INDex, :WMEMory<R>:SEGmented:INDex command/query, [1658](#)
  - individual commands language, [126](#)
  - InfiniiMode probes, [397](#)
  - InfiniiScan Commands, [693](#)
  - InfiniiSim function controls, [623](#)
  - InfiniiSim function operands, [622](#)
  - Infinity Representation, [166](#)
  - INFO, :CHANnel<N>:PROBe:INFO? query, [396](#)
  - initialization, [149](#)
  - initialization, event status, [185](#)
  - input buffer, [182](#)
  - Input Buffer, Clearing, [179](#)
  - input buffer, default condition, [183](#)
  - input coupling, and COUPling?, [1592](#)
  - INPut, :CHANnel<N>:INPut command/query, [357](#)
  - instruction headers, [129](#)
  - Instrument Address, GPIB, [175](#)
  - instrument status, [159](#)
  - integer definition, [141](#)
  - integers, H5 data saved as, [511](#)
  - INTEgrate, :FUNctioN<F>:INTEgrate command, [617](#)
  - intensity, [536](#)
  - INTensity, :DISPlay:GRATICule:INTensity command/query, [536](#)
  - Interface, Capabilities, [173](#)
  - Interface, Clear (IFC), [179](#)
  - interface, functions, [169](#)
  - Interface, GPIB Select Code, [175](#)



INterpolate, :ACquire:INterpolate  
   command/query, 250  
 INterpolate, :MEASure:RJDJ:INterpolate  
   command/query, 1094  
 interpreting commands, parser, 182  
 interrupted query, 138, 154  
 Introduction to Programming, 125  
 INVert, :CHANnel<N>:INVert  
   command/query, 358  
 INVert, :FUNctIon<F>:INVert  
   command, 618  
 INVert, :MTESt:INVert  
   command/query, 858  
 inverting functions, 618  
 IO library, referencing, 147  
 ISIM, :CHANnel<N>:ISIM:APPLy  
   command/query, 359  
 ISIM, :CHANnel<N>:ISIM:BANDwidth  
   command/query, 360  
 ISIM, :CHANnel<N>:ISIM:BWLimit  
   command/query, 362  
 ISIM, :CHANnel<N>:ISIM:BWLimit:TYPE  
   command/query, 364  
 ISIM, :CHANnel<N>:ISIM:CONVolve  
   command/query, 365  
 ISIM, :CHANnel<N>:ISIM:CORRection  
   command/query, 366  
 ISIM, :CHANnel<N>:ISIM:DECONVolve  
   command/query, 368  
 ISIM, :CHANnel<N>:ISIM:DELay  
   command/query, 369  
 ISIM, :CHANnel<N>:ISIM:NORMalize  
   command/query, 370  
 ISIM, :CHANnel<N>:ISIM:PEXTraction  
   command/query, 371  
 ISIM, :CHANnel<N>:ISIM:SPAN  
   command/query, 373  
 ISIM, :CHANnel<N>:ISIM:STATE  
   command/query, 374  
 ISIM,  
   :CHANnel<N>:SIMulation:FILTer:ISIM:A  
   DDRess command/query, 421  
 ISIM,  
   :CHANnel<N>:SIMulation:FILTer:ISIM:PE  
   XTraction command/query, 422  
 ISIM, :DISPlay:ISIM:GCOunt  
   command/query, 539  
 ISIM, :DISPlay:ISIM:SElectgraph  
   command, 540  
 ISIM, :DISPlay:ISIM:SOURce  
   command, 541  
 IVICTim, :XTAlk<X>:IVICTim  
   command/query, 1692

**J**

J3U, :MEASure:PAM:PRBS13q:EDGE:J3U?  
   query, 1039  
 J4U, :MEASure:PAM:PRBS13q:EDGE:J4U?  
   query, 1040

J6U, :MEASure:PAM:PRBS13q:EDGE:J6U?  
   query, 1041  
 JITTER, :CHANnel<N>:SIMulation:JITTER  
   command/query, 431  
 JITTER,  
   :CHANnel<N>:SIMulation:JITTER:ABUJ  
   command/query, 432  
 JITTER,  
   :CHANnel<N>:SIMulation:JITTER:PERiod  
   ic<M>:ENABle command/query, 433  
 JITTER,  
   :CHANnel<N>:SIMulation:JITTER:PERiod  
   ic<M>:FREQUency  
   command/query, 434  
 JITTER,  
   :CHANnel<N>:SIMulation:JITTER:PERiod  
   ic<M>:MAGNitude  
   command/query, 435  
 JITTER,  
   :CHANnel<N>:SIMulation:JITTER:PERiod  
   ic<M>:SHAPE command/query, 436  
 JITTER,  
   :CHANnel<N>:SIMulation:JITTER:RANDo  
   m command/query, 437  
 JITTER, :DISK:SAVE:JITTER command, 503  
 JITTER, :DISK:SAVE:LISTing command, 504  
 JITTER, :DISPlay:JITTER:GCOunt  
   command/query, 542  
 JITTER, :DISPlay:JITTER:SElectgraph  
   command, 543  
 JITTER, :DISPlay:JITTER:THReshold  
   command, 545  
 JITTER, :MEASure:CGRade:JITTER  
   command/query, 912  
 JITTER, :MEASure:JITTER:HISTogram  
   command/query, 979  
 JITTER, :MEASure:JITTER:MEASurement  
   command/query, 980  
 JITTER, :MEASure:JITTER:SPECTrum  
   command/query, 981  
 JITTER,  
   :MEASure:JITTER:SPECTrum:HORizontal  
   command/query, 982  
 JITTER,  
   :MEASure:JITTER:SPECTrum:HORizontal:  
   POSition command/query, 983  
 JITTER,  
   :MEASure:JITTER:SPECTrum:HORizontal:  
   RANGe command/query, 984  
 JITTER,  
   :MEASure:JITTER:SPECTrum:RESolution?  
   query, 985  
 JITTER, :MEASure:JITTER:SPECTrum:VERTical  
   command/query, 986  
 JITTER,  
   :MEASure:JITTER:SPECTrum:VERTical:OF  
   FSet command/query, 987  
 JITTER,  
   :MEASure:JITTER:SPECTrum:VERTical:RA  
   NGe command/query, 988

JITTER,  
   :MEASure:JITTER:SPECTrum:VERTical:TY  
   PE command/query, 989  
 JITTER, :MEASure:JITTER:SPECTrum:WINDow  
   command/query, 990  
 JITTER, :MEASure:JITTER:STATistics  
   command/query, 1747  
 JITTER, :MEASure:JITTER:TREnd  
   command/query, 991  
 JITTER, :MEASure:JITTER:TREnd:SMOoth  
   command/query, 992  
 JITTER,  
   :MEASure:JITTER:TREnd:SMOoth:POINts  
   command/query, 993  
 JITTER, :MEASure:JITTER:TREnd:VERTical  
   command/query, 994  
 JITTER,  
   :MEASure:JITTER:TREnd:VERTical:OFFSe  
   t command/query, 995  
 JITTER,  
   :MEASure:JITTER:TREnd:VERTical:RANG  
   e command/query, 996  
 JITTER, :STORe:JITTER command, 1250  
 JRMS,  
   :MEASure:PAM:PRBS13q:EDGE:JRMS?  
   query, 1042  
 JTF, :ANALyze:CLOCK:METHod:JTF  
   command/query, 284  
 JTF, :MEASure:CLOCK:METHod:JTF  
   command/query, 1733

**K**

Keysight Interactive IO application, 122  
 Keysight IO Control icon, 120  
 Keysight IO Libraries Suite, 5, 117, 121,  
   147, 149  
 Keysight IO Libraries Suite, installing, 118

**L**

LABEL, :BUS<B>:LABEL  
   command/query, 326  
 LABEL, :CHANnel<N>:LABEL  
   command/query, 375  
 LABEL, :DIGital<N>:LABEL  
   command/query, 483  
 LABEL, :DISPlay:LABEL  
   command/query, 546  
 LABEL, :FUNctIon<F>:LABEL  
   command/query, 619  
 LABEL, :WMEMory<R>:LABEL  
   command/query, 1654  
 LAN instrument, 121  
 LAN interface, 119, 120  
 Lane (Equalization) Commands, 715  
 language for program examples, 126  
 LAYout, :DISPlay:LAYout  
   command/query, 547

- LAYout, :DISPlay:RESults:LAYout  
command/query, **561**
- LEADer, :HOSTed:LEADer:ACHannels?  
query, **687**
- LEADer, :HOSTed:LEADer:CONFigure  
command, **688**
- LEADer, :HOSTed:LEADer:CONNect  
command, **689**
- LEADer, :HOSTed:LEADer:DISConnect  
command, **690**
- Learn (\*LRN?) query, **456**
- LEGend, :DISPlay:CGRade:LEGend  
command/query, **524**
- LENGth,  
:CHANnel<N>:SIMulation:DATA:LENGth  
command/query, **415**
- LENGth,  
:SBUS<N>:CAN:TRIGger:PATtern:DATA:  
LENGth command/query, **1272**
- LENGth,  
:SBUS<N>:LIN:TRIGger:PATtern:DATA:L  
ENgth command/query, **1312**
- LEVel, :DISPlay:NOISe:LEVel  
command, **550**
- LEVel, :FUNctioN<F>:FFT:PEAK:LEVel  
command/query, **592**
- LEVel, :HOSTed:CALibrate:LEVel  
command/query, **675**
- LEVel, :HOSTed:CALibrate:STATus:LEVel?  
query, **680**
- LEVel, :MEASure:PAM:LEVel  
command/query, **1031**
- LEVel, :TRIGger:ADVanced:COMM:LEVel  
command/query, **1499**
- LEVel,  
:TRIGger:ADVanced:PATtern:THReshold  
:LEVel command/query, **1507**
- LEVel,  
:TRIGger:ADVanced:STATe:THReshold:L  
EVel command/query, **1513**
- LEVel,  
:TRIGger:ADVanced:VIOLation:SETup:H  
OLD:CSourCe:LEVel  
command/query, **1562**
- LEVel,  
:TRIGger:ADVanced:VIOLation:SETup:SE  
Tup:CSourCe:LEVel  
command/query, **1555**
- LEVel,  
:TRIGger:ADVanced:VIOLation:SETup:SH  
OLd:CSourCe:LEVel  
command/query, **1569**
- LEVel, :TRIGger:LEVel  
command/query, **1395**
- LEVel, :TRIGger:LEVel:FIFTy  
command, **1396**
- LEVelS, :DISPlay:CGRade:LEVelS?  
query, **525**
- Limit Test Commands, **767**
- LIN acknowledge, **1305**
- LIN baud rate, **1306**
- LIN serial bus commands, **1304**
- LIN source, **1307**
- LIN standard, **1308**
- LIN, :SBUS<N>:LIN:SAMplepoint  
command/query, **1305**
- LIN, :SBUS<N>:LIN:SIGNal:BAUDrate  
command/query, **1306**
- LIN, :SBUS<N>:LIN:SOURce  
command/query, **1307**
- LIN, :SBUS<N>:LIN:STANdard  
command/query, **1308**
- LIN, :SBUS<N>:LIN:TRIGger  
command/query, **1309**
- LIN, :SBUS<N>:LIN:TRIGger:ID  
command/query, **1310**
- LIN, :SBUS<N>:LIN:TRIGger:PATtern:DATA  
command/query, **1311**
- LIN,  
:SBUS<N>:LIN:TRIGger:PATtern:DATA:L  
ENgth command/query, **1312**
- LINE, :DISPlay:LINE command, **1718**
- LINE, :TRIGger:ADVanced:TV:STV:LINE  
command/query, **1533**
- LINE, :TRIGger:TV:LINE  
command/query, **1481**
- linefeed, **143**
- list of error messages, **1806**
- Listener Code and Capability, **173**
- Listeners, Unaddressing All, **179**
- Lister Commands, **777**
- LLEVel, :ISCan:RUNT:LLEVel  
command/query, **704**
- LLIMit, :HISTogram:WINDow:LLIMit  
command/query, **663**
- LLIMit, :ISCan:MEASurement:LLIMit  
command/query, **696**
- LLIMit, :LTEST:LLIMit command/query, **771**
- LOAD, :ANALyze:SIGNal:PATtern:LOAD  
command, **307**
- LOAD, :DISK:LOAD command, **496**
- LOAD, :MTEST:LOAD command, **859**
- LOAD, :WMEMemory<R>:LOAD  
command, **1655**
- LOADdress,  
:ANALyze:SIGNal:MMWave:LOADdress  
command/query, **304**
- loading and saving, **489**
- LOCation, :LANE<N>:EQUalizer:LOCation  
command/query, **761**
- LOCation, :MEASure:NOISe:LOCation  
command/query, **1006**
- LOCK, :SYSTem:LOCK  
command/query, **1360**
- LOGic, :TRIGger:ADVanced:PATtern:LOGic  
command/query, **1506**
- LOGic, :TRIGger:ADVanced:STATe:LOGic  
command/query, **1510**
- LOGic, :TRIGger:PATtern:LOGic  
command/query, **1438**
- LOGic, :TRIGger:STATe:LOGic  
command/query, **1468**
- long-form headers, **139**
- LONGform, :SYSTem:LONGform  
command/query, **1361**
- LOOP,  
:CHANnel<N>:SIMulation:FLOad:LOOP  
command/query, **425**
- lowercase, **139**
- lowercase, headers, **139**
- LOWPass, :FUNctioN<F>:LOWPass  
command, **620**
- LRMS, :MEASure:PAM:LRMS  
command/query, **1033**
- LTARget,  
:LANE<N>:EQUalizer:DfE:TAP:LTARget  
command/query, **738**
- LTARget,  
:SPRocessing:DfEQUalizer:TAP:LTARget  
command/query, **1776**
- LTDefinition,  
:MEASure:PAM:EYE:TIME:LTDefinition  
command/query, **1030**
- LTHickness, :MEASure:PAM:LTHickness  
command/query, **1035**
- LTHReshold,  
:TRIGger:ADVanced:VIOLation:SETup:H  
OLD:DSourCe:LTHReshold  
command/query, **1566**
- LTHReshold,  
:TRIGger:ADVanced:VIOLation:SETup:SE  
Tup:DSourCe:LTHReshold  
command/query, **1559**
- LTHReshold,  
:TRIGger:ADVanced:VIOLation:SETup:SH  
OLd:DSourCe:LTHReshold  
command/query, **1573**
- LTHReshold,  
:TRIGger:ADVanced:VIOLation:TRANSitio  
n:SOURce:LTHReshold  
command/query, **1580**
- LTHReshold, :TRIGger:LTHReshold  
command/query, **1397**
- LTYPe, :TRIGger:ADVanced:STATe:LTYPe  
command/query, **1511**
- LTYPe, :TRIGger:STATe:LTYPe  
command/query, **1469**
- luminosity, **563**
- ## M
- M1S, :MEASure:HISTogram:M1S  
command/query, **963**
- M2S, :MEASure:HISTogram:M2S  
command/query, **964**
- M3S, :MEASure:HISTogram:M3S  
command/query, **965**
- MAGNify, :FUNctioN<F>:MAGNify  
command, **621**
- MAGNitude,  
:CHANnel<N>:SIMulation:JITTer:PERiod  
ic<M>:MAGNitude  
command/query, **435**

- MAGNitude,  
:CHANnel<N>:SIMulation:NOISe:PERiod  
ic<M>:MAGNitude  
command/query, **442**
- MAGNitude,  
:FUNction<F>:FFT:PEAK:MAGNitude?  
query, **593**
- MAGNitude, :MEASure:FFT:MAGNitude  
command/query, **955**
- MAIN, :DISPlay:MAIN command/query, **548**
- making measurements, **892**
- MARGin, :MTESt:COUnT:MARGin:FAILures?  
query, **833**
- MARGin, :MTESt:MARGin:AUTO:HITS  
command/query, **860**
- MARGin, :MTESt:MARGin:AUTO:HRATio  
command/query, **861**
- MARGin, :MTESt:MARGin:AUTO:METHod  
command/query, **862**
- MARGin, :MTESt:MARGin:METHod  
command/query, **863**
- MARGin, :MTESt:MARGin:PERCent  
command/query, **864**
- MARGin, :MTESt:MARGin:STATe  
command/query, **865**
- MARK, :MEASure:MARK  
command/query, **997**
- Marker Commands, **783**
- Mask Test Commands, **817**
- Mask Test Commands, DELeTe, **837**
- mask, Service Request Enable  
Register, **473**
- Master Summary Status (MSS), and  
\*STB, **475**
- Master Summary Status (MSS), Status  
Bit, **187**
- math function, Pattern Average, **634**
- MATLab, :FUNction<F>:MATLab  
command, **622**
- MATLab,  
:FUNction<F>:MATLab:CONTRol<N>  
command/query, **623**
- MATLab, :FUNction<F>:MATLab:OPERator  
command/query, **625**
- MAV (Message Available), **187**
- MAV (Message Available), bit, **473, 475**
- MAX, :HISTogram:MEASurement:MAX  
command/query, **656**
- MAX, :LANE<N>:EQUalizer:DFE:TAP:MAX  
command/query, **739**
- MAX, :MEASure:HISTogram:MAX  
command/query, **966**
- MAX, :SPROcessing:DFEQualizer:TAP:MAX  
command/query, **1777**
- MAX, :TRIGger:HOLDOff:MAX  
command/query, **1390**
- MAXimize, :DISPlay:WINDOw:MAXimize  
command, **567**
- maximum Q value, 16-bit waveform  
data, **1614**
- MAXimum, :FUNction<F>:MAXimum  
command, **626**
- MAXV, :LANE<N>:EQUalizer:DFE:TAP:MAXV  
command/query, **740**
- MBANdwidth,  
:ANALyze:SIGNal:MMWave:MBANdwid  
th command/query, **305**
- MDIRectory, :DISK:MDIRectory  
command, **498**
- MEAN, :MEASure:HISTogram:MEAN  
command/query, **967**
- Measure All Edges, **96, 273, 1203, 1204,  
1209, 1210, 1705**
- measure all edges, **894, 940, 941, 944,  
959, 977, 1013, 1014, 1020, 1050,  
1052, 1071, 1072, 1112, 1114,  
1176, 1181, 1192, 1194, 1199,  
1747**
- Measure Commands, **883**
- Measure Commands, TMAX, **1174**
- Measure Commands, TMIN, **1175**
- Measure Commands, TVOLt, **1176**
- Measure Commands, VMIDdle, **1190**
- MEASure, RESults and statistics, **1117**
- MEASurement,  
:HISTogram:MEASurement:BINs  
command/query, **655**
- MEASurement,  
:HISTogram:MEASurement:MAX  
command/query, **656**
- MEASurement,  
:HISTogram:MEASurement:MIN  
command/query, **657**
- MEASurement, :ISCan:MEASurement  
command/query, **697**
- MEASurement, :ISCan:MEASurement:FAIL  
command/query, **695**
- MEASurement, :ISCan:MEASurement:LLIMit  
command/query, **696**
- MEASurement, :ISCan:MEASurement:ULIMit  
command/query, **698**
- MEASurement, :LTEST:MEASurement  
command/query, **772**
- MEASurement,  
:MARKer:MEASurement:MEASurement  
command, **787**
- MEASurement,  
:MEASure:JITTer:MEASurement  
command/query, **980**
- measurement, error, **892**
- measurement, setup, **891**
- measurement, sources, **890**
- MEASurements, :DISK:SAVE:MEASurements  
command, **505**
- MEDian, :MEASure:HISTogram:MEDian  
command/query, **968**
- memories, and VIEW, **1634**
- MENU, :SYSTem:MENU?  
command/query, **1362**
- Message (MSG), Status Bit, **187**
- Message Available (MAV), and \*OPC, **458**
- Message Available (MAV), Status Bit, **187**
- Message Communications and System  
Functions, **181**
- Message Event Register, **193**
- message exchange protocols, of IEEE  
488.2, **182**
- message, queue, **207**
- message, termination with hardcopy, **183**
- METHod, :ANALyze:CLOCK:METHod  
command/query, **275**
- METHod, :ANALyze:CLOCK:METHod:ALIGn  
command/query, **279**
- METHod,  
:ANALyze:CLOCK:METHod:DEEMphasis  
command/query, **280**
- METHod, :ANALyze:CLOCK:METHod:EDGE  
command/query, **281**
- METHod, :ANALyze:CLOCK:METHod:IDLe  
command/query, **283**
- METHod, :ANALyze:CLOCK:METHod:JTF  
command/query, **284**
- METHod, :ANALyze:CLOCK:METHod:OJTF  
command/query, **286**
- METHod,  
:ANALyze:CLOCK:METHod:PAM:B03  
command/query, **1710**
- METHod,  
:ANALyze:CLOCK:METHod:PAM:B12  
command/query, **1712**
- METHod,  
:ANALyze:CLOCK:METHod:PAM:NONSy  
mmetric command/query, **1714**
- METHod,  
:ANALyze:CLOCK:METHod:PLLAdvanced  
command/query, **288**
- METHod,  
:ANALyze:CLOCK:METHod:PLLTrack  
command/query, **289**
- METHod, :ANALyze:CLOCK:METHod:SKEW  
command/query, **290**
- METHod,  
:ANALyze:CLOCK:METHod:SKEW:AUTOm  
atic command, **291**
- METHod, :ANALyze:CLOCK:METHod:SOURce  
command/query, **292**
- METHod, :MEASure:CLOCK:METHod  
command/query, **1725, 1727**
- METHod, :MEASure:CLOCK:METHod:ALIGn  
command/query, **1729**
- METHod,  
:MEASure:CLOCK:METHod:DEEMphasis  
command/query, **1730**
- METHod, :MEASure:CLOCK:METHod:EDGE  
command/query, **1731**
- METHod, :MEASure:CLOCK:METHod:JTF  
command/query, **1733**
- METHod, :MEASure:CLOCK:METHod:OJTF  
command/query, **1735**
- METHod,  
:MEASure:CLOCK:METHod:PLLTrack  
command/query, **1737**
- METHod, :MEASure:CLOCK:METHod:SOURce  
command/query, **1738**
- METHod, :MEASure:NOISe:METHod  
command/query, **1007**

- METHod, :MEASure:RJDJ:METHod  
command/query, **1095**
- METHod,  
:MEASure:THResholds:General:METHod  
command/query, **1126**
- METHod,  
:MEASure:THResholds:General:TOPBase:  
METHod command/query, **1136**
- METHod, :MEASure:THResholds:METHod  
command/query, **1139**
- METHod,  
:MEASure:THResholds:RFALL:METHod  
command/query, **1143**
- METHod,  
:MEASure:THResholds:RFALL:TOPBase:  
METHod command/query, **1151**
- METHod,  
:MEASure:THResholds:Serial:METHod  
command/query, **1157**
- METHod,  
:MEASure:THResholds:Serial:TOPBase:  
METHod command/query, **1162**
- METHod,  
:MEASure:THResholds:TOPBase:METHod  
command/query, **1164**
- METHod, :MTEST:MARGIN:AUTO:METHod  
command/query, **862**
- METHod, :MTEST:MARGIN:METHod  
command/query, **863**
- MHISTogram, :FUNCTION<F>:MHISTogram  
command, **627**
- MIN, :HISTogram:MEASurement:MIN  
command/query, **657**
- MIN, :LANE<N>:EQUALizer:DFE:TAP:MIN  
command/query, **741**
- MIN, :MEASure:HISTogram:MIN  
command/query, **969**
- MIN, :SPROcessing:DFEQUALizer:TAP:MIN  
command/query, **1778**
- MIN, :TRIGger:HOLDoff:MIN  
command/query, **1391**
- minimum Q value, 16-bit waveform  
data, **1614**
- MINimum, :FUNCTION<F>:MINimum  
command, **629**
- MINV, :LANE<N>:EQUALizer:DFE:TAP:MINV  
command/query, **742**
- MIPI C-PHY clock recovery method, **275**
- MIPI M-PHY PWM clock recovery  
method, **275**
- MISO data source, SPI, **1323**
- MISO, :SBUS<N>:SPI:SOURce:MISO  
command/query, **1323**
- MIXer, :ANALyze:SIGNal:MIXer:CABLeLoss  
command/query, **300**
- MLOG, :FUNCTION<F>:MLOG  
command/query, **630**
- MM3S, :MEASure:HISTogram:MM3S  
command/query, **970**
- MMWave,  
:ANALyze:SIGNal:MMWave:CALibrate  
command, **301**
- MMWave,  
:ANALyze:SIGNal:MMWave:CFrequency  
command/query, **302**
- MMWave,  
:ANALyze:SIGNal:MMWave:CONNect  
command/query, **303**
- MMWave,  
:ANALyze:SIGNal:MMWave:LOADdress  
command/query, **304**
- MMWave,  
:ANALyze:SIGNal:MMWave:MBANDwidth  
command/query, **305**
- Mnemonic Truncation, **162**
- MODE, :ACQUIRE:MODE  
command/query, **251**
- MODE, :CHANnel<N>:PROBE:MODE  
command/query, **397**
- MODE,  
:CHANnel<N>:PROBE:PRECprobe:MODE  
command, **401**
- MODE, :HISTogram:MODE  
command/query, **658**
- MODE, :ISCan:MODE command/query, **699**
- MODE, :ISCan:ZONE<Z>:MODE  
command/query, **711**
- MODE, :MARKer:MODE  
command/query, **789**
- MODE, :MEASure:HISTogram:MODE  
command/query, **972**
- MODE, :MEASure:RJDJ:MODE  
command/query, **1096**
- MODE,  
:SBUS<N>:CAN:TRIGger:PATtern:ID:MO  
DE command/query, **1275**
- MODE, :TRIGger:ADVanced:VIOLation:MODE  
command/query, **1543**
- MODE,  
:TRIGger:ADVanced:VIOLation:SETup:MO  
DE command/query, **1553**
- MODE, :TRIGger:DElay:MODE  
command/query, **1413**
- MODE, :TRIGger:GBSerial:MODE  
command/query, **1427**
- MODE, :TRIGger:HOLDoff:MODE  
command/query, **1392**
- MODE, :TRIGger:MODE  
command/query, **1398**
- MODE, :TRIGger:SHOld:MODE  
command/query, **1464**
- MODE, :TRIGger:TV:MODE  
command/query, **1482**
- mode, serial decode, **1258**
- monitoring events, **185**
- MOSI data source, SPI, **1324**
- MOSI, :SBUS<N>:SPI:SOURce:MOSI  
command/query, **1324**
- MP3S, :MEASure:HISTogram:MP3S  
command/query, **971**
- MREPort, :DISK:SAVE:MREPort  
command, **506**
- MSG bit, **473, 475**
- MSG, bit in the status register, **193**
- MSS bit and \*STB, **475**
- MTRend, :FUNCTION<F>:MTRend  
command, **631**
- Multiple numeric variables, **158**
- multiple, program commands, **145**
- multiple, queries, **158**
- multiple, subsystems, **145**
- MULTIply, :FUNCTION<F>:MULTIply  
command, **632**
- MultiScope system, :DIGitize  
command, **1230**
- MX0020A/21A/22A/24A/25A probe  
amplifiers, **394, 397**
- ## N
- N period-period measurement, **999**
- N2893A probe, **380**
- N5444A probe head, **394**
- N7010A active termination adapter, **394**
- NAME, :MARKer<K>:NAME  
command/query, **810**
- NAME, :MEASure:NAME  
command/query, **998**
- NAME, :MEASurement<N>:NAME  
command/query, **1206**
- NCJitter, :MEASure:NCJitter  
command/query, **999**
- NCONnected, :HOSTed:NCONnected?  
query, **691**
- Never tab Measurement Results, **1354**
- NL (New Line), **143**
- NOISE, :CHANnel<N>:SIMulation:NOISE  
command/query, **438**
- NOISE,  
:CHANnel<N>:SIMulation:NOISE:BWLim  
it command/query, **439**
- NOISE,  
:CHANnel<N>:SIMulation:NOISE:PERiod  
ic<M>:ENABle command/query, **440**
- NOISE,  
:CHANnel<N>:SIMulation:NOISE:PERiod  
ic<M>:FREQuency  
command/query, **441**
- NOISE,  
:CHANnel<N>:SIMulation:NOISE:PERiod  
ic<M>:MAGNitude  
command/query, **442**
- NOISE,  
:CHANnel<N>:SIMulation:NOISE:PERiod  
ic<M>:SHApe command/query, **443**
- NOISE,  
:CHANnel<N>:SIMulation:NOISE:RANDom  
command/query, **444**
- NOISE, :DISK:SAVE:NOISE command, **507**
- NOISE, :DISPlay:NOISE:LEVel  
command, **550**
- NOISE, :MEASure:NOISE  
command/query, **1001**
- NOISE, :MEASure:NOISE:ALL? query, **1003**

- NOISe, :MEASure:NOISe:BANDwidth  
command/query, 1005
- NOISe, :MEASure:NOISe:LOCation  
command/query, 1006
- NOISe, :MEASure:NOISe:METhod  
command/query, 1007
- NOISe, :MEASure:NOISe:REPort  
command/query, 1008
- NOISe, :MEASure:NOISe:RN  
command/query, 1009
- NOISe, :MEASure:NOISe:SCOPE:RN  
command/query, 1010
- NOISe, :MEASure:NOISe:STATe  
command/query, 1011
- NOISe, :MEASure:NOISe:UNITs  
command/query, 1012
- NONMonotonic,  
:ISCan:NONMonotonic:EDGE  
command/query, 700
- NONMonotonic,  
:ISCan:NONMonotonic:HYSTeresis  
command/query, 701
- NONMonotonic,  
:ISCan:NONMonotonic:SOURce  
command/query, 702
- NONSymmetric,  
:ANALyze:CLOCK:METhod:PAM:NONSy  
mmetric command/query, 1714
- NORMALize, :CHANnel<N>:SIM:NORMALize  
command/query, 370
- NORMALize,  
:LANE<N>:EQUalizer:DFE:TAP:NORMALiz  
e command/query, 743
- NORMALize,  
:SPROcessing:DFEQualizer:TAP:NORMAL  
ize command/query, 1779
- notices, 2
- NPERiod, :MEASure:NPERiod  
command/query, 1013
- NPREcursor,  
:LANE<N>:EQUalizer:FFE:NPREcursor  
command/query, 751
- NPREcursor,  
:SPROcessing:FFEQualizer:NPREcursor  
command/query, 1785
- NPULses, :MEASure:NPULses  
command/query, 1014
- NREGions?, :MTEST:NREGions? query, 866
- NSIGma, :MEASure:NSIGma  
command/query, 1015
- NTAPs, :LANE<N>:EQUalizer:DFE:NTAPs  
command/query, 731
- NTAPs, :LANE<N>:EQUalizer:FFE:NTAPs  
command/query, 752
- NTAPs, :SPROcessing:DFEQualizer:NTAPs  
command/query, 1768
- NTAPs, :SPROcessing:FFEQualizer:NTAPs  
command/query, 1786
- NTSC TV trigger mode, 1530
- NUI, :MEASure:NUI command/query, 1016
- NUMBer, :DISPlay:GRATICule:NUMBer  
command/query, 537
- numeric, program data, 141
- numeric, variable example, 156
- numeric, variables, 156
- NUMPoles,  
:LANE<N>:EQUalizer:CTLE:NUMPoles  
command/query, 720
- NUMPoles,  
:SPROcessing:CTLequalizer:NUMPoles  
command/query, 1755
- NWIDth, :MEASure:NWIDth  
command/query, 1017
- ## O
- obsolete and discontinued  
commands, 1703
- OBW, :MEASure:FFT:OBW  
command/query, 957
- ODD, :CHANnel<N>:SIMulation:DATA:ODD  
command/query, 416
- offset and gain of a probe, 330
- OFFSet, :ANALyze:CLOCK:VERTical:OFFSet  
command/query, 296
- OFFSet, :CHANnel<N>:DISPlay:OFFSet  
command/query, 351
- OFFSet, :CHANnel<N>:OFFSet  
command/query, 376
- OFFSet,  
:CHANnel<N>:PROBe:EXTErnal:OFFSet  
command/query, 388
- OFFSet, :CHANnel<N>:SIMulation:OFFSet  
command/query, 445
- OFFSet, :FUNCTion<F>:OFFSet  
command/query, 633
- OFFSet, :FUNCTion<F>:VERTical:OFFSet  
command/query, 642
- OFFSet, :LANE<N>:VERTical:OFFSet  
command/query, 765
- OFFSet, :MEASure:CLOCK:VERTical:OFFSet  
command/query, 1740
- OFFSet,  
:MEASure:JITTer:SPECTrum:VERTical:OF  
FSet command/query, 987
- OFFSet,  
:MEASure:JITTer:TREnd:VERTical:OFFSe  
t command/query, 995
- OFFSet,  
:SPROcessing:CTLequalizer:VERTical:OF  
FSet command/query, 1763
- OFFSet,  
:SPROcessing:FFEQualizer:VERTical:OFF  
Set command/query, 1796
- OJTF, :ANALyze:CLOCK:METhod:OJTF  
command/query, 286
- OJTF, :MEASure:CLOCK:METhod:OJTF  
command/query, 1735
- OLEVel, :MEASure:CGRade:OLEVel  
command/query, 914
- OMAMplitude, :MEASure:OMAMplitude  
command/query, 1018
- OPC bit, 453, 454
- Open method, 148
- OPER bit, 473, 475
- operands and time scale, 571
- operating the disk, 489
- Operation Complete (\*OPC)  
command/query, 458
- Operation Complete (\*OPC), Status Bit, 187
- operation status, 185
- OPERator, :FUNCTion<F>:MATLab:OPERator  
command/query, 625
- OPOWer, :MEASure:OPOWer  
command/query, 1019
- Option (\*OPT?) query, 460
- Options, Program Headers, 139
- order of commands and execution, 183
- oscilloscope connection, opening, 148
- oscilloscope connection, verifying, 120
- Oscilloscope Default GPIB Address, 175
- oscilloscope, connecting, 119
- oscilloscope, operation, 5
- oscilloscope, setting up, 119
- oscilloscope, trigger modes and  
commands, 1384
- output buffer, 138, 154
- output queue, 138, 206
- Output Queue, Clearing, 179
- output queue, default condition, 183
- output queue, definition, 182
- OUTPut, :CALibrate:OUTPut  
command/query, 332
- OUTPut, :CALibrate:OUTPut:AUX  
command/query, 334
- OUTPut, :CALibrate:OUTPut:AUX:RTIME  
command/query, 335
- OUTPut, :CALibrate:OUTPut:CAL  
command/query, 336
- overlapped commands, 215
- OVERshoot, :MEASure:OVERshoot  
command/query, 1020
- ## P
- P1, :LANE<N>:EQUalizer:CTLE:P1  
command/query, 721
- P1, :SPROcessing:CTLequalizer:P1  
command/query, 1756
- P2, :LANE<N>:EQUalizer:CTLE:P2  
command/query, 722
- P2, :SPROcessing:CTLequalizer:P2  
command/query, 1757
- P3, :LANE<N>:EQUalizer:CTLE:P3  
command/query, 723
- P3, :SPROcessing:CTLequalizer:P3  
command/query, 1758
- P4, :LANE<N>:EQUalizer:CTLE:P4  
command/query, 724
- P4, :SPROcessing:CTLequalizer:P4  
command/query, 1759
- P5, :LANE<N>:EQUalizer:CTLE:P5  
command/query, 725

- P6, :LANE<N>:EQualizer:CTLE:P6  
command/query, 726
- PAADeskew, :XTALK:PAADeskew  
command/query, 1669
- PAIFilter, :XTALK:PAIFilter  
command/query, 1670
- PAISi, :XTALK:PAISi command/query, 1671
- PAL-M TV trigger mode, 1530
- PAM, :ANALyze:CLOCK:METHod:PAM:B03  
command/query, 1710
- PAM, :ANALyze:CLOCK:METHod:PAM:B12  
command/query, 1712
- PAM,  
:ANALyze:CLOCK:METHod:PAM:NONSy  
mmetric command/query, 1714
- PAM, :CHANnel<N>:SIMulation:DATA:PAM  
command/query, 417
- PAM, :DISPlay:PAM:GRAPh command, 551
- PAM, :DISPlay:PAM:SOURce  
command, 552
- PAM, :DISPlay:PAM:TABLE command, 553
- PAM, :MEASure:PAM:ELEVel  
command/query, 1022
- PAM, :MEASure:PAM:ESKew  
command/query, 1024
- PAM, :MEASure:PAM:EYE:ELMethod  
command/query, 1026
- PAM, :MEASure:PAM:EYE:ESTiming  
command/query, 1027
- PAM, :MEASure:PAM:EYE:PPERcent  
command/query, 1028
- PAM, :MEASure:PAM:EYE:PROBability  
command/query, 1029
- PAM, :MEASure:PAM:EYE:TIME:LTDefinition  
command/query, 1030
- PAM, :MEASure:PAM:LEVel  
command/query, 1031
- PAM, :MEASure:PAM:LRMS  
command/query, 1033
- PAM, :MEASure:PAM:LTHickness  
command/query, 1035
- PAM, :MEASure:PAM:PRBS13q:COUNT  
command/query, 1037
- PAM, :MEASure:PAM:PRBS13q:EDGE:EOJ?  
query, 1038
- PAM, :MEASure:PAM:PRBS13q:EDGE:J3U?  
query, 1039
- PAM, :MEASure:PAM:PRBS13q:EDGE:J4U?  
query, 1040
- PAM, :MEASure:PAM:PRBS13q:EDGE:J6U?  
query, 1041
- PAM, :MEASure:PAM:PRBS13q:EDGE:J RMS?  
query, 1042
- PAM, :MEASure:PAM:PRBS13q:HUNits  
command/query, 1043
- PAM, :MEASure:PAM:PRBS13q:PATtern  
command/query, 1044
- PAM, :MEASure:PAM:PRBS13q:PFILe  
command/query, 1045
- PAM, :MEASure:PAM:PRBS13q:STATe  
command/query, 1046
- PAM, :MEASure:PAM:PRBS13q:UNITs  
command/query, 1047
- PAMAutomatic,  
:MEASure:THResholds:GENeral:PAMAu  
tomatic command/query, 1130
- PAMAutomatic,  
:MEASure:THResholds:RFALL:PAMAu  
tomatic command/query, 1145
- PAMCustom,  
:MEASure:THResholds:GENeral:PAMCus  
tom command/query, 1128
- PAMPplitude, :MEASure:PAMPplitude  
command/query, 1048
- PAMThreshold,  
:MEASure:RJDJ:PAMThreshold  
command/query, 1097
- Parallel Poll Code and Capability, 173
- parametric measurements, 889
- PARity, :SBUS<N>:UART:PARity  
command/query, 1340
- parser, 182
- parser, default condition, 183
- Parser, Resetting, 179
- PASLimit, :XTALK:PASLimit  
command/query, 1672
- passing values across the bus, 138
- Pattern Average math function, 634
- pattern length, 1272
- Pattern Length measurement, 1055
- PATtern, :ANALyze:SIGNal:PATtern:CLEar  
command, 306
- PATtern, :ANALyze:SIGNal:PATtern:LOAD  
command, 307
- PATtern, :ANALyze:SIGNal:PATtern:PLENght  
command/query, 308
- PATtern, :ANALyze:SIGNal:PATtern:SMAP  
command/query, 309
- PATtern, :ISCAN:SERIAL:PATtern  
command/query, 707
- PATtern, :MEASure:PAM:PRBS13q:PATtern  
command/query, 1044
- PATtern,  
:SBUS<N>:CAN:TRIGger:PATtern:DATA  
command/query, 1271
- PATtern,  
:SBUS<N>:CAN:TRIGger:PATtern:DATA:  
LENGth command/query, 1272
- PATtern,  
:SBUS<N>:CAN:TRIGger:PATtern:ID  
command/query, 1274
- PATtern,  
:SBUS<N>:CAN:TRIGger:PATtern:ID:MO  
DE command/query, 1275
- PATtern,  
:SBUS<N>:IIC:TRIGger:PATtern:ADDRes  
s command/query, 1299, 1301
- PATtern,  
:SBUS<N>:LIN:TRIGger:PATtern:DATA  
command/query, 1311
- PATtern,  
:SBUS<N>:LIN:TRIGger:PATtern:DATA:L  
ENGLth command/query, 1312
- PATtern,  
:SBUS<N>:SPI:TRIGger:PATtern:DATA  
command/query, 1326
- PATtern,  
:SBUS<N>:SPI:TRIGger:PATtern:WIDTh  
command/query, 1328
- PATtern,  
:TRIGger:ADVanced:COMM:PATtern  
command/query, 1500
- PATtern,  
:TRIGger:ADVanced:PATtern:CONDition  
command/query, 1505
- PATtern, :TRIGger:ADVanced:PATtern:LOGic  
command/query, 1506
- PATtern,  
:TRIGger:ADVanced:PATtern:THReshold  
:LEVel command/query, 1507
- PATtern, :TRIGger:COMM:PATtern  
command/query, 1404
- PATtern, :TRIGger:GBSerial:PATtern  
command/query, 1428
- PATtern, :TRIGger:PATtern:CONDition  
command/query, 1437
- PATtern, :TRIGger:PATtern:LOGic  
command/query, 1438
- PAUTO, :XTALK<X>:PAUTO  
command/query, 1693
- PAVerage, :FUNctIon<F>:PAVerage  
command, 634
- PAXFilter, :XTALK:PAXFilter  
command/query, 1673
- PAXSi, :XTALK:PAXSi  
command/query, 1674
- PBASE, :MEASure:PBASe  
command/query, 1049
- PCIe 4 Behavioral SRIS clock recovery  
method, 275
- PCIe 5 CXL Behavioral SRIS CC clock  
recovery method, 275
- PCIe 6 CXL Behavioral SRIS CC clock  
recovery method, 275
- PDETECT acquisition mode, 251
- PEAK, :FUNctIon:FFT:PEAK:SORT  
command/query, 589
- PEAK, :FUNctIon<F>:FFT:PEAK:COUNT  
command/query, 590
- PEAK, :FUNctIon<F>:FFT:PEAK:FREQuency?  
query, 591
- PEAK, :FUNctIon<F>:FFT:PEAK:LEVel  
command/query, 592
- PEAK, :FUNctIon<F>:FFT:PEAK:MAGNitude?  
query, 593
- PEAK, :FUNctIon<F>:FFT:PEAK:STATe  
command/query, 594
- PEAK, :MEASure:HISTogram:PEAK  
command/query, 973
- PEAK1, :MEASure:FFT:PEAK1  
command/query, 1744
- PEAK2, :MEASure:FFT:PEAK2  
command/query, 1745
- peak-to-peak contrast, and  
PPContrast, 1070

- peak-to-peak voltage, and VPP, [1193](#)
- Pending Commands, Clearing, [179](#)
- PERCent,
  - :MEASure:THResholds:General:PERCent command/query, [1132](#)
- PERCent,:MEASure:THResholds:PERCent command/query, [1140](#)
- PERCent,
  - :MEASure:THResholds:RFALL:PERCent command/query, [1147](#)
- PERCent,
  - :MEASure:THResholds:SERial:PERCent command/query, [1158](#)
- PERCent,:MTEST:MARGin:PERCent command/query, [864](#)
- PERCent,:TIMEbase:REference:PERCent command/query, [1374](#)
- period measurement setup, [891](#)
- PERiod,:MEASure:PERiod command/query, [1050](#)
- PERiodic,:HOSTed:PERiodic command/query, [692](#)
- PERiodic<M>,
  - :CHANnel<N>:SIMulation:JITTer:PERiodic<M>:ENABle command/query, [433](#)
- PERiodic<M>,
  - :CHANnel<N>:SIMulation:JITTer:PERiodic<M>:FREQuency command/query, [434](#)
- PERiodic<M>,
  - :CHANnel<N>:SIMulation:JITTer:PERiodic<M>:MAGNitude command/query, [435](#)
- PERiodic<M>,
  - :CHANnel<N>:SIMulation:JITTer:PERiodic<M>:SHApe command/query, [436](#)
- PERiodic<M>,
  - :CHANnel<N>:SIMulation:NOISe:PERiodic<M>:ENABle command/query, [440](#)
- PERiodic<M>,
  - :CHANnel<N>:SIMulation:NOISe:PERiodic<M>:FREQuency command/query, [441](#)
- PERiodic<M>,
  - :CHANnel<N>:SIMulation:NOISe:PERiodic<M>:MAGNitude command/query, [442](#)
- PERiodic<M>,
  - :CHANnel<N>:SIMulation:NOISe:PERiodic<M>:SHApe command/query, [443](#)
- period-period measurement, [922](#)
- PERSistence,:DISPlay:PERSistence command/query, [554](#)
- PERSONa,:SYSTem:PERSONa command/query, [1363](#)
- PEXtraction,
  - :CHANnel<N>:ISIM:PEXtraction command/query, [371](#)
- PEXtraction,
  - :CHANnel<N>:SIMulation:FILTer:ISIM:PEXtraction command/query, [422](#)
- PFILE,:MEASure:PAM:PRBS13q:PFILE command/query, [1045](#)
- PGTHan,
  - :TRIGger:ADVanced:TV:UDTV:PGTHan command/query, [1539](#)
- PGTHan,:TRIGger:TV:UDTV:PGTHan command/query, [1489](#)
- PHASe,:MEASure:PHASe command/query, [1052](#)
- PJADeskeW,:XTALK:PJADeskeW command/query, [1675](#)
- PJIFilter,:XTALK:PJIFilter command/query, [1676](#)
- PJISi,:XTALK:PJISi command/query, [1677](#)
- PJITter,:MEASure:PJITter command/query, [1054](#)
- PJSLimit,:XTALK:PJSLimit command/query, [1678](#)
- PJXFilter,:XTALK:PJXFilter command/query, [1679](#)
- PJXSi,:XTALK:PJXSi command/query, [1680](#)
- PLACement,:AUToscale:PLACement command/query, [1225](#)
- PLACement,:ISCan:ZONE<Z>:PLACement command/query, [712](#)
- PLAY,:ACQUIRE:SEGmented:PLAY command/query, [263](#)
- PLAY,:WMEMory<R>:SEGmented:PLAY command/query, [1659](#)
- PLENght,:ANALyze:SIGNal:PATtern:PLENght command/query, [308](#)
- PLENght,:MEASure:PLENght command/query, [1055](#)
- PLENght,:MEASure:RJDD:PLENght command/query, [1098](#)
- PLENght,:XTALK<X>:PLENght command/query, [1694](#)
- PLL idle clocks, [283](#)
- PLLadvanced,
  - :ANALyze:CLOCK:METHod:PLLadvanced command/query, [288](#)
- PLLTrack,
  - :ANALyze:CLOCK:METHod:PLLTrack command/query, [289](#)
- PLLTrack,
  - :MEASure:CLOCK:METHod:PLLTrack command/query, [1737](#)
- PN,:MEASure:PN:CORrelations command/query, [1056](#)
- PN,:MEASure:PN:DESKew command, [1057](#)
- PN,:MEASure:PN:EDGE command/query, [1058](#)
- PN,:MEASure:PN:HORizontal:START command/query, [1059](#)
- PN,:MEASure:PN:HORizontal:STOP command/query, [1060](#)
- PN,:MEASure:PN:RSSC command/query, [1061](#)
- PN,:MEASure:PN:SOURce command/query, [1062](#)
- PN,:MEASure:PN:SPURs command/query, [1064](#)
- PN,:MEASure:PN:SSEnsitivity command/query, [1065](#)
- PN,:MEASure:PN:STATE command/query, [1066](#)
- PN,:MEASure:PN:VERTical:REference command/query, [1067](#)
- PN,:MEASure:PN:VERTical:SCALE command/query, [1068](#)
- PN,:MEASure:PN:WINDow command/query, [1069](#)
- PNOise,:WAVEform:PNOise:FREQuency? query, [1619](#)
- Pod Commands, [1211](#)
- POINTs,:ACQUIRE:POINTs:ANALog command/query, [253](#)
- POINTs,:ACQUIRE:POINTs:AUTO command/query, [255](#)
- POINTs,:ACQUIRE:POINTs:DIGital? query, [256](#)
- POINTs,:ACQUIRE:POINTs:TESTLIMITS? query, [257](#)
- POINTs,:FUNCTION<F>:FFT:DETECTOR:POINTs command/query, [583](#)
- POINTs,
  - :MEASure:JITTer:TREnd:SMOoth:POINTs command/query, [993](#)
- POINTs?, :WAVEform:POINTs? query, [1620](#)
- POLarity,
  - :TRIGger:ADVanced:COMM:POLarity command/query, [1501](#)
- POLarity,
  - :TRIGger:ADVanced:TV:UDTV:POLarity command/query, [1540](#)
- POLarity,
  - :TRIGger:ADVanced:VIOLation:PWIDth:POLarity command/query, [1547](#)
- POLarity,:TRIGger:COMM:POLarity command/query, [1405](#)
- POLarity,:TRIGger:GBSerial:POLarity command/query, [1429](#)
- POLarity,:TRIGger:GLITCh:POLarity command/query, [1433](#)
- POLarity,:TRIGger:PWIDth:POLarity command/query, [1441](#)
- POLarity,:TRIGger:RUNT:POLarity command/query, [1446](#)
- POLarity,:TRIGger:TV:POLarity command/query, [1483](#)
- POLarity,:TRIGger:TV:UDTV:POLarity command/query, [1490](#)
- polling synchronization example, [225](#)
- polling synchronization with timeout, [224](#)
- PON bit, [454](#)
- POSITION,:DIGital<N>:POSITION command/query, [484](#)
- POSITION,
  - :FUNCTION<F>:HORizontal:POSITION command/query, [613](#)
- POSITION,:MARKer<K>:X:POSITION command/query, [815](#)
- POSITION,:MARKer<K>:Y:POSITION command/query, [816](#)

- POsition, :MEASure:JITter:SPECTrum:HORizontal: POSition command/query, [983](#)
- POsition, :MEASurement<N>:POsition command, [1207](#)
- POsition, :MTESt:FOLDing:POsition command/query, [849](#)
- POsition, :TIMebase:POsition command/query, [1370](#)
- POsition, :TIMebase:WINDow:POsition command/query, [1379](#)
- position, and WINDow POSition, [1379](#)
- pound sign (#) and block data, [157](#)
- Power On (PON) status bit, [186](#), [452](#)
- Power-on Status Clear (\*PSC) command/query, [469](#)
- Power-up Condition, [172](#)
- PP, :MEASure:HISTogram:PP command/query, [974](#)
- PPContrast, :MEASure:PPContrast command/query, [1070](#)
- PPERcent, :MEASure:PAM:EYE:PPERcent command/query, [1028](#)
- PPULses, :MEASure:PPULses command/query, [1071](#)
- PRATe, :ACQuire:SEGmented:PRATe command/query, [264](#)
- PRBS, :TRIGger:GBSerial:PRBS command/query, [1430](#)
- PRBS13q, :MEASure:PAM:PRBS13q:COUNT command/query, [1037](#)
- PRBS13q, :MEASure:PAM:PRBS13q:EDGE:EOJ? query, [1038](#)
- PRBS13q, :MEASure:PAM:PRBS13q:EDGE:J3U? query, [1039](#)
- PRBS13q, :MEASure:PAM:PRBS13q:EDGE:J4U? query, [1040](#)
- PRBS13q, :MEASure:PAM:PRBS13q:EDGE:J6U? query, [1041](#)
- PRBS13q, :MEASure:PAM:PRBS13q:EDGE:JRMS? query, [1042](#)
- PRBS13q, :MEASure:PAM:PRBS13q:HUNits command/query, [1043](#)
- PRBS13q, :MEASure:PAM:PRBS13q:PATtern command/query, [1044](#)
- PRBS13q, :MEASure:PAM:PRBS13q:PFILe command/query, [1045](#)
- PRBS13q, :MEASure:PAM:PRBS13q:STATe command/query, [1046](#)
- PRBS13q, :MEASure:PAM:PRBS13q:UNITs command/query, [1047](#)
- PREamble, :WAVeform:PREamble? query, [1621](#)
- PRECprobe, :CHANnel<N>:PROBe:PRECprobe:BAND width command, [398](#)
- PRECprobe, :CHANnel<N>:PROBe:PRECprobe:CALibration command, [399](#)
- PRECprobe, :CHANnel<N>:PROBe:PRECprobe:DELAy command, [400](#)
- PRECprobe, :CHANnel<N>:PROBe:PRECprobe:MODE command, [401](#)
- PRECprobe, :CHANnel<N>:PROBe:PRECprobe:ZSRC command, [402](#)
- PRECprobe, :DISK:SAVE:PRECprobe command, [508](#)
- PRECprobe, :DISPlay:PRECprobe:GCOunt command/query, [558](#)
- PRECprobe, :DISPlay:PRECprobe:SElectgraph command, [559](#)
- PRECprobe, :DISPlay:PRECprobe:SOURce command, [560](#)
- PRESet, :SYSTem:PRESet command, [1364](#)
- PREShoot, :MEASure:PREShoot command/query, [1072](#)
- PRIMary, :CHANnel<N>:PROBe:PRIMary command/query, [404](#)
- PRINters?, :HARDcopy:PRINters? query, [650](#)
- printing, specific screen data, [646](#)
- printing, the screen, [645](#)
- PROBability, :MEASure:PAM:EYE:PROBability command/query, [1029](#)
- probe attenuation and gain, default setup and, [1365](#)
- probe attenuation factor, [330](#)
- Probe Calibration, [330](#)
- probe external adapter, default setup and, [1365](#)
- probe skew, default setup and, [1365](#)
- PROBe, :CHANnel<N>:PROBe command/query, [1716](#)
- PROBe, :CHANnel<N>:PROBe:ACCAL command/query, [377](#)
- PROBe, :CHANnel<N>:PROBe:ATTenuation command/query, [379](#)
- PROBe, :CHANnel<N>:PROBe:AUTOzero command/query, [380](#)
- PROBe, :CHANnel<N>:PROBe:COUpling command/query, [381](#)
- PROBe, :CHANnel<N>:PROBe:EADapter command/query, [382](#)
- PROBe, :CHANnel<N>:PROBe:ECOupling command/query, [385](#)
- PROBe, :CHANnel<N>:PROBe:EXTernal command/query, [386](#)
- PROBe, :CHANnel<N>:PROBe:EXTernal:GAIN command/query, [387](#)
- PROBe, :CHANnel<N>:PROBe:EXTernal:OFFSet command/query, [388](#)
- PROBe, :CHANnel<N>:PROBe:EXTernal:UNITs command/query, [389](#)
- PROBe, :CHANnel<N>:PROBe:GAIN command/query, [390](#)
- PROBe, :CHANnel<N>:PROBe:HEAD:ADD command, [391](#)
- PROBe, :CHANnel<N>:PROBe:HEAD:DELeTe command, [392](#)
- PROBe, :CHANnel<N>:PROBe:HEAD:SELeCt command/query, [393](#)
- PROBe, :CHANnel<N>:PROBe:HEAD:VTERm command/query, [394](#)
- PROBe, :CHANnel<N>:PROBe:ID? query, [395](#)
- PROBe, :CHANnel<N>:PROBe:INFO? query, [396](#)
- PROBe, :CHANnel<N>:PROBe:MODE command/query, [397](#)
- PROBe, :CHANnel<N>:PROBe:PRECprobe:BAND width command, [398](#)
- PROBe, :CHANnel<N>:PROBe:PRECprobe:CALibration command, [399](#)
- PROBe, :CHANnel<N>:PROBe:PRECprobe:DELAy command, [400](#)
- PROBe, :CHANnel<N>:PROBe:PRECprobe:MODE command, [401](#)
- PROBe, :CHANnel<N>:PROBe:PRECprobe:ZSRC command, [402](#)
- PROBe, :CHANnel<N>:PROBe:PRIMary command/query, [404](#)
- PROBe, :CHANnel<N>:PROBe:RESPonsivity command/query, [405](#)
- PROBe, :CHANnel<N>:PROBe:SKEW command/query, [406](#)
- PROBe, :CHANnel<N>:PROBe:SKEW:AUTO command, [407](#)
- PROBe, :CHANnel<N>:PROBe:STYPe command/query, [408](#)
- PROBe, :CHANnel<N>:PROBe:USER command/query, [409](#)
- PROBe, :CHANnel<N>:PROBe:WAVelength command/query, [411](#)
- PROBe, :MTESt:PROBe:IMPedance? query, [867](#)
- program data, [135](#)
- Program example, [151](#)
- Program Header Options, [139](#)
- program message, [148](#)
- program message terminator, [143](#)
- program overview, initialization example, [151](#)
- programming basics, [126](#)
- Programming Conventions, [161](#)
- programming examples, [1813](#)
- programming examples language, [126](#)
- Programming Getting Started, [146](#)



- PROMpt, :HOSTed:CALibrate:PROMpt  
command/query, 677
- PROPortion, :DISPlay:PROPortion  
command/query, 556
- PROPortion, :DISPlay:PROPortion:RESults  
command/query, 557
- protocol, exceptions and operation, 182
- PSD, :MEASure:FFT:PSD  
command/query, 958
- PSKew, :POD<N>:PSKew  
command/query, 1213
- PTOP, :MEASure:PTOP  
command/query, 1074
- PTYPe, :XTALK<X>:PTYPe  
command/query, 1695
- pulse width measurement setup, 891
- pulse width violation mode, 1544
- PUTFILE, :DISK:PUTFILE command, 499
- PWD, :DISK:PWD? query, 500
- PWIDth, :MEASure:PWIDth  
command/query, 1075
- PWIDth,  
:TRIGger:ADVanced:VIOLation:PWIDth:DIRection  
command/query, 1546
- PWIDth,  
:TRIGger:ADVanced:VIOLation:PWIDth:POLarity  
command/query, 1547
- PWIDth,  
:TRIGger:ADVanced:VIOLation:PWIDth:SOURCE  
command/query, 1548
- PWIDth,  
:TRIGger:ADVanced:VIOLation:PWIDth:WIDTH  
command/query, 1549
- PWIDth, :TRIGger:PWIDth:DIRection  
command/query, 1440
- PWIDth, :TRIGger:PWIDth:POLarity  
command/query, 1441
- PWIDth, :TRIGger:PWIDth:SOURCE  
command/query, 1442
- PWIDth, :TRIGger:PWIDth:TPOint  
command/query, 1443
- PWIDth, :TRIGger:PWIDth:WIDTH  
command/query, 1444
- Python, VISA COM example, 1844
- Python, VISA example, 1896
- Python, VISA.NET example, 1917
- PyVISA package, 1896
- Q**
- QFACtor, :MEASure:CGRade:QFACtor  
command/query, 915
- QUALified, :TRIGger:RUNT:QUALified  
command/query, 1447
- QUALifier<M>,  
:MEASure:QUALifier<M>:CONDition  
command/query, 1076
- QUALifier<M>,  
:MEASure:QUALifier<M>:SOURCE  
command/query, 1077
- QUALifier<M>,  
:MEASure:QUALifier<M>:STATE  
command/query, 1078
- Query, 129, 138
- Query Error, QYE Status Bit, 187
- query errors, 1805
- query interrupt, 154
- query, headers, 138
- query, interrupt, 138
- query, response, 154
- query, responses, formatting, 1349
- question mark, 138
- queue, output, 138
- quoted strings, 1718
- quotes, with embedded strings, 142
- QYE bit, 453, 454
- R**
- random jitter, specified, 1100
- random noise, specified, 1009
- RANdom,  
:CHANnel<N>:SIMulation:JITTer:RANdo  
m command/query, 437
- RANdom,  
:CHANnel<N>:SIMulation:NOISe:RANdo  
m command/query, 444
- RANge, :ANALyze:CLOCK:VERTical:RANge  
command/query, 297
- RANge, :CHANnel<N>:DISPlay:RANge  
command/query, 353
- RANge, :CHANnel<N>:RANge  
command/query, 412
- RANge, :FUNctioN<F>:HORizontal:RANge  
command/query, 615
- RANge, :FUNctioN<F>:RANge  
command/query, 635
- RANge, :FUNctioN<F>:VERTical:RANge  
command/query, 643
- RANge, :LANE<N>:VERTical:RANge  
command/query, 766
- RANge, :MEASure:CLOCK:VERTical:RANge  
command/query, 1741
- RANge,  
:MEASure:JITTer:SPECTrum:HORizontal:  
RANge command/query, 984
- RANge,  
:MEASure:JITTer:SPECTrum:VERTical:RA  
Nge command/query, 988
- RANge,  
:MEASure:JITTer:TRENd:VERTical:RAN  
ge command/query, 996
- RANge,  
:SPROcessing:CTLequalizer:VERTical:RA  
Nge command/query, 1764
- RANge,  
:SPROcessing:FFEQualizer:VERTical:RA  
Nge command/query, 1797
- RANge, :TIMEbase:RANge  
command/query, 1371
- RANge, :TIMEbase:WINDow:RANge  
command/query, 1380
- range, and WINDow RANge, 1380
- RATE, :LANE<N>:EQUalizer:CTLE:RATE  
command/query, 727
- RATE, :LANE<N>:EQUalizer:FFE:RATE  
command/query, 753
- RATE, :SPROcessing:CTLequalizer:RATE  
command/query, 1760
- RATE, :SPROcessing:FFEQualizer:RATE  
command/query, 1787
- ReadIEEEblock mark, 148
- ReadList method, 148
- ReadNumber method, 148
- READout, :BUS<B>:READout  
command/query, 327
- ReadSTB example, 191
- ReadString method, 148
- real number definition, 141
- real time mode, 251
- real time mode, and interpolation, 250
- Recall (\*RCL) command, 470
- receiver sample timing, PAM measurement  
definition, 1027
- Receiving Common Commands, 449
- Receiving Information from the  
Instrument, 154
- REDge, :ACQuire:REDge  
command/query, 258
- REFClock, :TIMEbase:REFClock  
command/query, 1372
- reference impedance, FFT magnitude, 587
- REFerence, :FUNctioN<F>:FFT:REFerence  
command/query, 595
- REFerence,  
:MEASure:PN:VERTical:REFerence  
command/query, 1067
- REFerence, :TIMEbase:REFerence  
command/query, 1373
- REFerence, :TIMEbase:REFerence:PERCent  
command/query, 1374
- reference, default setup, 1364
- register, save/recall, 470, 472
- register, Standard Event Status Enable, 196
- reliability of measured data, 185
- remote control examples, 1813
- Remote Local Code and Capability, 173
- remote programming basics, 126
- REPort, :MEASure:NOISe:REPort  
command/query, 1008
- REPort, :MEASure:RJDj:REPort  
command/query, 1099
- representation of infinity, 166
- Request Control (RQC), Status Bit, 187
- Request Service (RQS), Default, 172
- Request Service (RQS), status bit, 187
- RESeed,  
:CHANnel<N>:SIMulation:DATA:RESeed  
command/query, 418
- Reset (\*RST) command, 471
- RESet, :TRIGger:SEQUence:RESet:ENABle  
command/query, 1453

- RESet, :TRIGger:SEquence:RESet:EVENT  
command, [1455](#)
- RESet, :TRIGger:SEquence:RESet:TIME  
command/query, [1456](#)
- RESet, :TRIGger:SEquence:RESet:TYPE  
command/query, [1454](#)
- Resetting the Parser, [179](#)
- RESolution, :FUNctioN<F>:FFT:RESolution  
command/query, [596](#)
- RESolution,  
:MEASure:HISTogram:RESolution  
command/query, [975](#)
- RESolution,  
:MEASure:JITter:SPECTrum:RESolution?  
query, [985](#)
- resource session object, [149](#)
- ResourceManager object, [148](#)
- RESPonse, :ACQuire:RESPonse  
command/query, [259](#)
- response, data, [157](#)
- response, generation, [167](#)
- responses, buffered, [167](#)
- RESPonsivity,  
:CHANnel<N>:PROBe:RESPonsivity  
command/query, [405](#)
- result state code, and SENDvalid, [1109](#)
- RESults, :DISPlay:PROPortion:RESults  
command/query, [557](#)
- RESults, :DISPlay:RESults:LAYout  
command/query, [561](#)
- RESults, :XTALK:RESults? query, [1681](#)
- results, retrieving, [223](#)
- RESults?, :LTEST:RESults? query, [773](#)
- RESults?, :MEASure:RESults? query, [1079](#)
- Returning control to system computer, [179](#)
- RFALL,  
:MEASure:THResholds:RFALL:ABSolute  
command/query, [1141](#)
- RFALL, :MEASure:THResholds:RFALL:METHod  
command/query, [1143](#)
- RFALL,  
:MEASure:THResholds:RFALL:PAMAutom  
atic command/query, [1145](#)
- RFALL,  
:MEASure:THResholds:RFALL:PERCent  
command/query, [1147](#)
- RFALL,  
:MEASure:THResholds:RFALL:TOPBase:A  
BSolute command/query, [1149](#)
- RFALL,  
:MEASure:THResholds:RFALL:TOPBase:  
METHod command/query, [1151](#)
- RIDeal, :XTALK<X>:RIDeal  
command/query, [1696](#)
- rise time measurement setup, [891](#)
- RISetime, :MEASure:RISetime  
command/query, [1083](#)
- RISI, :XTALK<X>:RISI  
command/query, [1697](#)
- RJ, :MEASure:RJDJ:RJ  
command/query, [1100](#)
- RJ, :MEASure:RJDJ:SCOPE:RJ  
command/query, [1101](#)
- RJ, :MEASure:RJDJ:SCOPE:RJ:CALibrate  
command, [1102](#)
- RJDJ, :MEASure:RJDJ:ALL? query, [1085](#)
- RJDJ, :MEASure:RJDJ:APLength?  
query, [1087](#)
- RJDJ, :MEASure:RJDJ:BANDwidth  
command/query, [1088](#)
- RJDJ, :MEASure:RJDJ:BER  
command/query, [1089](#)
- RJDJ, :MEASure:RJDJ:CLOCK  
command/query, [1091](#)
- RJDJ, :MEASure:RJDJ:CREference  
command/query, [1092](#)
- RJDJ, :MEASure:RJDJ:EDGE  
command/query, [1093](#)
- RJDJ, :MEASure:RJDJ:INterpolate  
command/query, [1094](#)
- RJDJ, :MEASure:RJDJ:METHod  
command/query, [1095](#)
- RJDJ, :MEASure:RJDJ:MODE  
command/query, [1096](#)
- RJDJ, :MEASure:RJDJ:PAMThreshold  
command/query, [1097](#)
- RJDJ, :MEASure:RJDJ:PLENght  
command/query, [1098](#)
- RJDJ, :MEASure:RJDJ:REPort  
command/query, [1099](#)
- RJDJ, :MEASure:RJDJ:RJ  
command/query, [1100](#)
- RJDJ, :MEASure:RJDJ:SCOPE:RJ  
command/query, [1101](#)
- RJDJ, :MEASure:RJDJ:SCOPE:RJ:CALibrate  
command, [1102](#)
- RJDJ, :MEASure:RJDJ:SOURce  
command/query, [1103](#)
- RJDJ, :MEASure:RJDJ:STATe  
command/query, [1104](#)
- RJDJ, :MEASure:RJDJ:TJRJDJ?  
query, [1105](#)
- RJDJ, :MEASure:RJDJ:UNITs  
command/query, [1107](#)
- RLIMit, :HISTogram:WINDow:RLIMit  
command/query, [664](#)
- RMS voltage, and VRMS, [1195](#)
- RN, :MEASure:NOISe:RN  
command/query, [1009](#)
- RN, :MEASure:NOISe:SCOPE:RN  
command/query, [1010](#)
- ROLL, :TIMEbase:ROLL:ENABLE  
command/query, [1375](#)
- Root level commands, [1217](#)
- ROTHER, :XTALK<X>:ROTHER  
command/query, [1698](#)
- ROW, :DISPlay: ROW command  
query, [1719](#)
- ROW, :DISPlay:STATus:ROW command  
query, [565](#)
- RQC (Request Control), [187](#)
- RQC (Request Control), bit, [453, 454](#)
- RQS (Request Service), [187](#)
- RQS (Request Service), and \*STB, [475](#)
- RQS (Request Service), Default, [172](#)
- RQS/MSS bit, [475](#)
- RSSC, :MEASure:PN:RSSC  
command/query, [1061](#)
- RTIME acquisition mode, [251](#)
- RTIME, :CALibrate:OUTPut:AUX:RTIME  
command/query, [335](#)
- RTIME,  
:CHANnel<N>:SIMulation:FUNCTioN:SQ  
Uare:RTIME command/query, [430](#)
- rule of truncation, [162](#)
- rules of traversal, [163](#)
- RUMode, :LTEST:RUMode:SOFailure  
command/query, [774](#)
- RUMode, :MTEST:RUMode  
command/query, [868](#)
- RUMode, :MTEST:RUMode:SOFailure  
command/query, [869](#)
- run state, [1243](#)
- RUN, and GET relationship, [179](#)
- Run/Stop, default setup, [1364](#)
- RUNT, :ISCan:RUNT:HYSTeresis  
command/query, [703](#)
- RUNT, :ISCan:RUNT:LLEVEL  
command/query, [704](#)
- RUNT, :ISCan:RUNT:SOURce  
command/query, [705](#)
- RUNT, :ISCan:RUNT:ULEVel  
command/query, [706](#)
- RUNT, :TRIGger:RUNT:POLarity  
command/query, [1446](#)
- RUNT, :TRIGger:RUNT:QUALified  
command/query, [1447](#)
- RUNT, :TRIGger:RUNT:SOURce  
command/query, [1448](#)
- RUNT, :TRIGger:RUNT:TIME  
command/query, [1449](#)
- RX, :SBUS<N>:UART:SOURce:RX  
command/query, [1341](#)
- ## S
- SAADeskew, :XTALK:SAADeskew  
command/query, [1683](#)
- SAIFilter, :XTALK:SAIFilter  
command/query, [1684](#)
- SAISi, :XTALK:SAISi command/query, [1685](#)
- SAMplepoint, :SBUS<N>:CAN:SAMplepoint  
command/query, [1263](#)
- SAMplepoint, :SBUS<N>:LIN:SAMplepoint  
command/query, [1305](#)
- sampling mode, [251](#)
- SASLimit, :XTALK:SASLimit  
command/query, [1686](#)
- saturation, [562](#)
- Save (\*SAV) command, [472](#)
- SAVE, :DISK:SAVE:COMPOSITE  
command, [501](#)
- SAVE, :DISK:SAVE:IMAGe command, [502](#)
- SAVE, :DISK:SAVE:JITTer command, [503](#)

- SAVE, :DISK:SAVE:LISTing command, 504
- SAVE, :DISK:SAVE:MEASurements command, 505
- SAVE, :DISK:SAVE:MREPort command, 506
- SAVE, :DISK:SAVE:NOISe command, 507
- SAVE, :DISK:SAVE:PRECprobe command, 508
- SAVE, :DISK:SAVE:SETup command, 509
- SAVE, :DISK:SAVE:WAVEform command, 510
- SAVE, :MTEST:AMASK:SAVE command, 823
- SAVE, :WMEemory<R>:SAVE command, 1656
- save/recall register, 470, 472
- saving and loading, 489
- SAXFilter, :XTALK:SAXFilter command/query, 1687
- SAXSi, :XTALK:SAXSi command/query, 1688
- SBUS CAN commands, 1261
- SBUS FLEXray commands, 1277
- SBUS GENRaw commands, 1287
- SBUS HS commands, 1290
- SBUS LIN commands, 1304
- SBUS UART commands, 1334
- SBUS<N> commands, general, 1256
- SCALE, :CHANnel<N>:DISPlay:SCALE command/query, 355
- SCALE, :CHANnel<N>:SCALE command/query, 413
- SCALE, :HISTogram:SCALE:SIZE command/query, 659
- SCALE, :MEASure:PN:VERTical:SCALE command/query, 1068
- SCALE, :MTEST:FOLDing:SCALE command/query, 851
- SCALE, :MTEST:SCALE:BIND command/query, 870
- SCALE, :MTEST:SCALE:DRAW command/query, 871
- SCALE, :MTEST:SCALE:X1 command/query, 872
- SCALE, :MTEST:SCALE:XDELta command/query, 873
- SCALE, :MTEST:SCALE:Y1 command/query, 874
- SCALE, :MTEST:SCALE:Y2 command/query, 875
- SCALE, :TIMEbase:SCALE command/query, 1376
- SCALE, :TIMEbase:WINDow:SCALE command/query, 1381
- SCHeme, :DISPlay:CGRade:SCHeme command/query, 527
- SCOLor, :DISPlay:SCOLor command/query, 562
- SCOPE, :MEASure:NOISe:SCOPE:RN command/query, 1010
- SCOPE, :MEASure:RJJD:SCOPE:RJ command/query, 1101
- SCOPE, :MEASure:RJJD:SCOPE:RJ:CALibrate command, 1102
- SCOPETEST, :SELFtest:SCOPETEST command/query, 1347
- SCPI.NET examples, 1944
- SCRatch, :MEASure:SCRatch command, 1108
- SCReen, HARDcopy AREA, 646
- SEARCh, :SBUS<N>:SEARCh:ENABLE command/query, 1259
- SEARCh, :SBUS<N>:SEARCh:TRIGger command/query, 1260
- Second Order PLL clock recovery method, JTF, 284
- Second Order PLL clock recovery method, OJTF, 286
- Secure Instrument Communication, 117
- SEGHres acquisition mode, 252
- SEGMENTed acquisition mode, 252
- SEGMENTed, :ACQUIRE:SEGMENTed:AUTOplay command/query, 260
- SEGMENTed, :ACQUIRE:SEGMENTed:COUNt command/query, 261
- SEGMENTed, :ACQUIRE:SEGMENTed:INDEX command/query, 262
- SEGMENTed, :ACQUIRE:SEGMENTed:PLAY command/query, 263
- SEGMENTed, :ACQUIRE:SEGMENTed:PRATE command/query, 264
- SEGMENTed, :ACQUIRE:SEGMENTed:TTAGs command/query, 265
- SEGMENTed, :DISK:SEGMENTed command/query, 512
- SEGMENTed, :WAVEform:SEGMENTed:ALL command/query, 1625
- SEGMENTed, :WAVEform:SEGMENTed:COUNt? query, 1627
- SEGMENTed, :WAVEform:SEGMENTed:TTAG? query, 1628
- SEGMENTed, :WAVEform:SEGMENTed:XLIST? query, 1629
- SEGMENTed, :WMEemory<R>:SEGMENTed:COUNt? query, 1657
- SEGMENTed, :WMEemory<R>:SEGMENTed:INDEX command/query, 1658
- SEGMENTed, :WMEemory<R>:SEGMENTed:PLAY command/query, 1659
- SEGPdetect acquisition mode, 252
- SElect, :CHANnel<N>:PROBe:HEAD:SElect command/query, 393
- Selected Device Clear (SDC), 179
- SElectgraph, :DISPlay:ISIM:SElectgraph command, 540
- SElectgraph, :DISPlay:JITTer:SElectgraph command, 543
- SElectgraph, :DISPlay:PRECprobe:SElectgraph command, 559
- Selecting Multiple Subsystems, 145
- SElection, :CHANnel<N>:SIMulation:DATA:SElecti on command/query, 419
- SElection, :CHANnel<N>:SIMulation:FILTer:SElecti on command/query, 423
- SElection, :CHANnel<N>:SIMulation:FUNCTion:SEL ection command/query, 427
- self test, 478
- Self-Test Commands, 1345
- semicolon usage, 137
- sending compound queries, 183
- SENDvalid, :MEASure:SENDvalid command/query, 1109
- separator, 130
- SEQUence, :TRIGger:SEQUence:RESet:ENABLE command/query, 1453
- SEQUence, :TRIGger:SEQUence:RESet:EVENT command, 1455
- SEQUence, :TRIGger:SEQUence:RESet:TIME command/query, 1456
- SEQUence, :TRIGger:SEQUence:RESet:TYPE command/query, 1454
- SEQUence, :TRIGger:SEQUence:TERM1 command/query, 1451
- SEQUence, :TRIGger:SEQUence:TERM2 command/query, 1452
- SEQUence, :TRIGger:SEQUence:WAIT:ENABLE command/query, 1457
- SEQUence, :TRIGger:SEQUence:WAIT:TIME command/query, 1458
- sequential commands, 215
- SER, :MEASure:SER command/query, 1110
- SERauto, :MEASure:THResholds:SERauto command, 1152
- Serial Bus Commands, 1255
- serial decode bus display, 1257
- serial decode mode, 1258
- serial poll, (ReadSTB) in example, 191
- Serial Poll, Disabling, 179
- serial poll, of the Status Byte Register, 191
- serial prefix, reading, 455
- SERial, :ISCan:SERial:PATTern command/query, 707
- SERial, :ISCan:SERial:SOURce command/query, 708
- SERial, :MEASure:THResholds:SERial:ABSolute command/query, 1153
- SERial, :MEASure:THResholds:SERial:HYSTeresi s command/query, 1155
- SERial, :MEASure:THResholds:SERial:METHod command/query, 1157



- short-form mnemonics, 162
- SICL example in C, 1925
- SICL example in Visual Basic, 1934
- SICL examples, 1925
- SIGNal, :ANALyze:SIGNal:DATArate command/query, 298
- SIGNal, :ANALyze:SIGNal:MIXer:CABLeLoss command/query, 300
- SIGNal, :ANALyze:SIGNal:MMWave:CALibrate command, 301
- SIGNal, :ANALyze:SIGNal:MMWave:CFRequency command/query, 302
- SIGNal, :ANALyze:SIGNal:MMWave:CONNect command/query, 303
- SIGNal, :ANALyze:SIGNal:MMWave:LOADdress command/query, 304
- SIGNal, :ANALyze:SIGNal:MMWave:MBANdwidTh command/query, 305
- SIGNal, :ANALyze:SIGNal:PATtern:CLear command, 306
- SIGNal, :ANALyze:SIGNal:PATtern:LOAD command, 307
- SIGNal, :ANALyze:SIGNal:PATtern:PLENght command/query, 308
- SIGNal, :ANALyze:SIGNal:PATtern:SMAP command/query, 309
- SIGNal, :ANALyze:SIGNal:SYMBolrate command/query, 310
- SIGNal, :ANALyze:SIGNal:TYPE command/query, 312
- SIGNal, :SBUS<N>:CAN:SIGNal:BAUDrate command/query, 1264
- SIGNal, :SBUS<N>:CAN:SIGNal:DEFinition command/query, 1265
- SIGNal, :SBUS<N>:CAN:SIGNal:FDbaudrate command/query, 1266
- SIGNal, :SBUS<N>:LIN:SIGNal:BAUDrate command/query, 1306
- SIGNals, :HOSTed:CALibrate:DESKew:SIGNals command, 673
- SIGNals, :HOSTed:CALibrate:STATus:SIGNals? query, 681
- simple command header, 136
- SIMulation, :CHANnel<N>:SIMulation:AMPLitude command/query, 414
- SIMulation, :CHANnel<N>:SIMulation:DATA:LENGTh command/query, 415
- SIMulation, :CHANnel<N>:SIMulation:DATA:ODD command/query, 416
- SIMulation, :CHANnel<N>:SIMulation:DATA:PAM command/query, 417
- SIMulation, :CHANnel<N>:SIMulation:DATA:RESeed command/query, 418
- SIMulation, :CHANnel<N>:SIMulation:DATA:SElectiOn command/query, 419
- SIMulation, :CHANnel<N>:SIMulation:DRATe command/query, 420
- SIMulation, :CHANnel<N>:SIMulation:FILTer:ISIM:ADDRess command/query, 421
- SIMulation, :CHANnel<N>:SIMulation:FILTer:ISIM:PEXTRaction command/query, 422
- SIMulation, :CHANnel<N>:SIMulation:FILTer:SElectiOn command/query, 423
- SIMulation, :CHANnel<N>:SIMulation:FLOAd:ADDRess command/query, 424
- SIMulation, :CHANnel<N>:SIMulation:FLOAd:LOOP command/query, 425
- SIMulation, :CHANnel<N>:SIMulation:FREquency command/query, 426
- SIMulation, :CHANnel<N>:SIMulation:FUNCTion:SELECTION command/query, 427
- SIMulation, :CHANnel<N>:SIMulation:FUNCTion:SQUare:DCYCLE command/query, 428
- SIMulation, :CHANnel<N>:SIMulation:FUNCTion:SQUare:FTIME command/query, 429
- SIMulation, :CHANnel<N>:SIMulation:FUNCTion:SQUare:RTIME command/query, 430
- SIMulation, :CHANnel<N>:SIMulation:JITTer command/query, 431
- SIMulation, :CHANnel<N>:SIMulation:JITTer:ABUJ command/query, 432
- SIMulation, :CHANnel<N>:SIMulation:JITTer:PERiodic<M>:ENABLe command/query, 433
- SIMulation, :CHANnel<N>:SIMulation:JITTer:PERiodic<M>:FREquency command/query, 434
- SIMulation, :CHANnel<N>:SIMulation:JITTer:PERiodic<M>:MAGNitude command/query, 435
- SIMulation, :CHANnel<N>:SIMulation:JITTer:PERiodic<M>:SHAPE command/query, 436
- SIMulation, :CHANnel<N>:SIMulation:JITTer:RANDOm command/query, 437
- SIMulation, :CHANnel<N>:SIMulation:NOISE command/query, 438
- SIMulation, :CHANnel<N>:SIMulation:NOISE:BWLimit command/query, 439
- SIMulation, :CHANnel<N>:SIMulation:NOISE:PERiodic<M>:ENABLe command/query, 440
- SIMulation, :CHANnel<N>:SIMulation:NOISE:PERiodic<M>:FREquency command/query, 441
- SIMulation, :CHANnel<N>:SIMulation:NOISE:PERiodic<M>:MAGNitude command/query, 442
- SIMulation, :CHANnel<N>:SIMulation:NOISE:PERiodic<M>:SHAPE command/query, 443
- SIMulation, :CHANnel<N>:SIMulation:NOISE:RANDOm command/query, 444
- SIMulation, :CHANnel<N>:SIMulation:OFFSet command/query, 445
- SIMulation, :CHANnel<N>:SIMulation:WAVEform command/query, 446
- SIZE, :DIGital<N>:SIZE command/query, 485
- SIZE, :FUNCTion<F>:VERTical:SIZE command/query, 644
- SIZE, :HISTogram:SCALE:SIZE command/query, 659
- SKEW, :ANALyze:CLOCK:METHOD:SKEW command/query, 290
- SKEW, :ANALyze:CLOCK:METHOD:SKEW:AUTomatic command, 291
- SKEW, :CALibrate:SKEW command/query, 337
- SKEW, :CHANnel<N>:DIFFerential:SKEW command/query, 347
- SKEW, :CHANnel<N>:PROBe:SKEW command/query, 406
- SKEW, :CHANnel<N>:PROBe:SKEW:AUTO command, 407
- SLEWrate, :MEASure:SLEWrate command/query, 1114
- SLOPe, :BUS<B>:CLOCK:SLOPe command/query, 324
- SLOPe, :SBUS<N>:SPI:CLOCK:SLOPe command/query, 1315
- SLOPe, :TRIGger:ADVanced:DELay:EDLY:ARMSLOPe command/query, 1517
- SLOPe, :TRIGger:ADVanced:DELay:EDLY:EVENT:SLOPe command/query, 1520
- SLOPe, :TRIGger:ADVanced:DELay:EDLY:TRIGger:SLOPe command/query, 1522

- SLOPe,  
:TRIGger:ADVanced:DElay:TDLY:ARM:SL  
OPe command/query, **1526**
- SLOPe,  
:TRIGger:ADVanced:DElay:TDLY:TRIGge  
r:SLOPe command/query, **1529**
- SLOPe,:TRIGger:ADVanced:STAtE:SLOPe  
command/query, **1512**
- SLOPe,:TRIGger:DElay:ARM:SLOPe  
command/query, **1409**
- SLOPe,:TRIGger:DElay:EDElay:SLOPe  
command/query, **1412**
- SLOPe,:TRIGger:DElay:TRIGger:SLOPe  
command/query, **1416**
- SLOPe,:TRIGger:EDGE:SLOPe  
command/query, **1419**
- SLOPe,:TRIGger:STAtE:SLOPe  
command/query, **1470**
- SMAP,:ANALyze:SIGNal:PATtern:SMAP  
command/query, **309**
- SMOoth,:FUNctioN<F>:SMOoth  
command, **636**
- SMOoth,:MEASure:JITter:TREnd:SMOoth  
command/query, **992**
- SMOoth,  
:MEASure:JITter:TREnd:SMOoth:POINts  
command/query, **993**
- SOFailure,:LTEST:RUMode:SOFailure  
command/query, **774**
- SOFailure,:MTEST:RUMode:SOFailure  
command/query, **869**
- software version, reading, **455**
- SORT,:FUNctioN:FFT:PEAK:SORT  
command/query, **589**
- source, **1267, 1307**
- SOURce,:ANALyze:CLOCK:MEthod:SOURce  
command/query, **292**
- SOURce,:DISPlay:ISIM:SOURce  
command, **541**
- SOURce,:DISPlay:PAM:SOURce  
command, **552**
- SOURce,:DISPlay:PREcprobe:SOURce  
command, **560**
- SOURce,:HISTogram:WINDow:SOURce  
command/query, **662**
- SOURce,:ISCan:NONMonotonic:SOURce  
command/query, **702**
- SOURce,:ISCan:RUNT:SOURce  
command/query, **705**
- SOURce,:ISCan:SERial:SOURce  
command/query, **708**
- SOURce,:ISCan:ZONE:SOURce  
command/query, **710**
- SOURce,:ISCan:ZONE<Z>:SOURce  
command/query, **713**
- SOURce,:LANE<N>:SOURce  
command/query, **762**
- SOURce,:MARkeR<K>:SOURce  
command/query, **811**
- SOURce,:MEASure:CLOCK:MEthod:SOURce  
command/query, **1738**
- SOURce,:MEASure:PN:SOURce  
command/query, **1062**
- SOURce,:MEASure:QUALifier<M>:SOURce  
command/query, **1077**
- SOURce,:MEASure:RJJD:SOURce  
command/query, **1103**
- SOURce,:MEASure:SOURce  
command/query, **1116**
- SOURce,:MEASurement<N>:SOURce  
command/query, **1208**
- SOURce,:MTEST:AMASK:SOURce  
command/query, **821**
- SOURce,:MTEST:SOURce  
command/query, **876**
- SOURce,:MTEST:TRIGger:SOURce  
command/query, **881**
- SOURce,:SBUS<N>:CAN:SOURce  
command/query, **1267**
- SOURce,:SBUS<N>:FLEXray:SOURce  
command/query, **1280**
- SOURce,:SBUS<N>:GENRaw:SOURce  
command/query, **1288**
- SOURce,:SBUS<N>:IIC:SOURce:CLOCK  
command/query, **1297**
- SOURce,:SBUS<N>:IIC:SOURce:DATA  
command/query, **1298**
- SOURce,:SBUS<N>:LIN:SOURce  
command/query, **1307**
- SOURce,:SBUS<N>:SPI:SOURce:CLOCK  
command/query, **1318**
- SOURce,:SBUS<N>:SPI:SOURce:DATA  
command/query, **1320**
- SOURce,:SBUS<N>:SPI:SOURce:FRAME  
command/query, **1322**
- SOURce,:SBUS<N>:SPI:SOURce:MISO  
command/query, **1323**
- SOURce,:SBUS<N>:SPI:SOURce:MOSI  
command/query, **1324**
- SOURce,:SBUS<N>:UART:SOURce:RX  
command/query, **1341**
- SOURce,:SBUS<N>:UART:SOURce:TX  
command/query, **1342**
- SOURce,  
:SPROcessing:CTLequalizer:SOURce  
command/query, **1761**
- SOURce,  
:SPROcessing:DFEQualizer:SOURce  
command/query, **1769**
- SOURce,:SPROcessing:FFEQualizer:SOURce  
command/query, **1788**
- SOURce,  
:TRIGger:ADVanced:COMM:SOURce  
command/query, **1502**
- SOURce,  
:TRIGger:ADVanced:DElay:EDLY:ARM:S  
OURce command/query, **1516**
- SOURce,  
:TRIGger:ADVanced:DElay:EDLY:EVENT:  
SOURce command/query, **1519**
- SOURce,  
:TRIGger:ADVanced:DElay:EDLY:TRIGge  
r:SOURce command/query, **1521**
- SOURce,  
:TRIGger:ADVanced:DElay:TDLY:ARM:S  
OURce command/query, **1525**
- SOURce,  
:TRIGger:ADVanced:DElay:TDLY:TRIGge  
r:SOURce command/query, **1528**
- SOURce,  
:TRIGger:ADVanced:TV:STV:SOURce  
command/query, **1534**
- SOURce,  
:TRIGger:ADVanced:TV:UDTV:SOURce  
command/query, **1541**
- SOURce,  
:TRIGger:ADVanced:VIOLation:PWIDth:S  
OURce command/query, **1548**
- SOURce,  
:TRIGger:ADVanced:VIOLation:TRANSitio  
n:SOURce command/query, **1578**
- SOURce,  
:TRIGger:ADVanced:VIOLation:TRANSitio  
n:SOURce:HTHReshold  
command/query, **1579**
- SOURce,  
:TRIGger:ADVanced:VIOLation:TRANSitio  
n:SOURce:LTHReshold  
command/query, **1580**
- SOURce,:TRIGger:AND:SOURce  
command/query, **1387**
- SOURce,:TRIGger:COMM:SOURce  
command/query, **1406**
- SOURce,:TRIGger:DElay:ARM:SOURce  
command/query, **1408**
- SOURce,:TRIGger:DElay:EDElay:SOURce  
command/query, **1411**
- SOURce,:TRIGger:DElay:TRIGger:SOURce  
command/query, **1415**
- SOURce,:TRIGger:EDGE:SOURce  
command/query, **1420**
- SOURce,:TRIGger:GBSerial:SOURce  
command/query, **1431**
- SOURce,:TRIGger:GLITCh:SOURce  
command/query, **1434**
- SOURce,:TRIGger:PWIDth:SOURce  
command/query, **1442**
- SOURce,:TRIGger:RUNT:SOURce  
command/query, **1448**
- SOURce,:TRIGger:TIMEout:SOURce  
command/query, **1473**
- SOURce,:TRIGger:TRANSition:SOURce  
command/query, **1477**
- SOURce,:TRIGger:TV:SOURce  
command/query, **1484**
- SOURce,:TRIGger:WINDow:SOURce  
command/query, **1493**
- SOURce,:WAVEform:SOURce  
command/query, **1630**
- SOURce,:XTALK<X>:SOURce  
command/query, **1699**
- SOURce, and measurements, **890**
- SOURce<S>,:SBUS<N>:HS:SOURce<S>  
command/query, **1294**
- spaces and commas, **135**

- SPAN, :CHANnel<N>:ISIM:SPAN command/query, [373](#)
- SPAN, :FUNCTION<F>:FFT:SPAN command/query, [598](#)
- specified random jitter, [1100](#)
- specified random noise, [1009](#)
- SPECTrum, :MEASure:JITTer:SPECTrum command/query, [981](#)
- SPECTrum, :MEASure:JITTer:SPECTrum:HORizontal command/query, [982](#)
- SPECTrum, :MEASure:JITTer:SPECTrum:HORizontal:POSition command/query, [983](#)
- SPECTrum, :MEASure:JITTer:SPECTrum:HORizontal:RANGE command/query, [984](#)
- SPECTrum, :MEASure:JITTer:SPECTrum:RESolution? query, [985](#)
- SPECTrum, :MEASure:JITTer:SPECTrum:VERTical command/query, [986](#)
- SPECTrum, :MEASure:JITTer:SPECTrum:VERTical:OFSet command/query, [987](#)
- SPECTrum, :MEASure:JITTer:SPECTrum:VERTical:RANGE command/query, [988](#)
- SPECTrum, :MEASure:JITTer:SPECTrum:VERTical:TYPE command/query, [989](#)
- SPECTrum, :MEASure:JITTer:SPECTrum:WINDow command/query, [990](#)
- spelling of headers, [139](#)
- SPI clock slope, [1315](#)
- SPI clock source, [1318](#)
- SPI clock timeout, [1316](#)
- SPI decode bit order, [1314](#)
- SPI decode type, [1332](#)
- SPI decode word width, [1333](#)
- SPI frame source, [1322](#)
- SPI frame state, [1317](#)
- SPI trigger commands, [1313](#)
- SPI trigger data pattern, [1326](#)
- SPI trigger pattern width, [1328](#)
- SPI trigger type, [1330](#)
- SPI, :SBUS<N>:SPI:BITorder command/query, [1314](#)
- SPI, :SBUS<N>:SPI:CLOCK:SLOPe command/query, [1315](#)
- SPI, :SBUS<N>:SPI:CLOCK:TIMEout command/query, [1316](#)
- SPI, :SBUS<N>:SPI:FRAMe:STATe command/query, [1317](#)
- SPI, :SBUS<N>:SPI:SOURce:CLOCK command/query, [1318](#)
- SPI, :SBUS<N>:SPI:SOURce:DATA command/query, [1320](#)
- SPI, :SBUS<N>:SPI:SOURce:FRAMe command/query, [1322](#)
- SPI, :SBUS<N>:SPI:SOURce:MISO command/query, [1323](#)
- SPI, :SBUS<N>:SPI:SOURce:MOSI command/query, [1324](#)
- SPI, :SBUS<N>:SPI:TRIGger:PATtern:DATA command/query, [1326](#)
- SPI, :SBUS<N>:SPI:TRIGger:PATtern:WIDTh command/query, [1328](#)
- SPI, :SBUS<N>:SPI:TRIGger:TYPE command/query, [1330](#)
- SPI, :SBUS<N>:SPI:TYPE command/query, [1332](#)
- SPI, :SBUS<N>:SPI:WIDTh command/query, [1333](#)
- SPOLarity, :TRIGger:ADVanced:TV:STV:SPOLarity command/query, [1535](#)
- SPURs, :MEASure:PN:SPURs command/query, [1064](#)
- SQRT, :FUNCTION<F>:SQRT command, [637](#)
- Square Brackets, [133](#)
- SQUare, :CHANnel<N>:SIMulation:FUNCTION:SQUare:DCYCLE command/query, [428](#)
- SQUare, :CHANnel<N>:SIMulation:FUNCTION:SQUare:FTIME command/query, [429](#)
- SQUare, :CHANnel<N>:SIMulation:FUNCTION:SQUare:RTIME command/query, [430](#)
- SQUare, :FUNCTION<F>:SQUare command, [638](#)
- SRATe, :ACQUIRE:SRATe:ANALog command/query, [266](#)
- SRATe, :ACQUIRE:SRATe:ANALog:AUTO command/query, [267](#)
- SRATe, :ACQUIRE:SRATe:DIGital command/query, [268](#)
- SRATe, :ACQUIRE:SRATe:DIGital:AUTO command/query, [269](#)
- SRATe, :ACQUIRE:SRATe:TESTLIMITS? query, [270](#)
- SRE (Service Request Enable Register), [192](#)
- SSENSitivity, :MEASure:PN:SSENSitivity command/query, [1065](#)
- Standard Event Status Enable Register, (SESER), [196](#)
- Standard Event Status Enable Register, Bits, [452](#)
- Standard Event Status Enable Register, Default, [172](#)
- Standard Event Status Register (ESR), [195](#)
- Standard Event Status Register, bits, [454](#)
- Standard Status Data Structure Model, [186](#)
- STANDard, :SBUS<N>:LIN:STANDard command/query, [1308](#)
- STANDard, :TRIGger:TV:STANDard command/query, [1485](#)
- standard, LIN, [1308](#)
- START, :FUNCTION<F>:FFT:START command/query, [599](#)
- START, :FUNCTION<F>:GATING:START command, [609](#)
- START, :MEASure:PN:HORizontal:START command/query, [1059](#)
- START, :MEASure:TIEFilter:START command/query, [1170](#)
- START, :MTEST:START command, [877](#)
- STATe, :ACQUIRE:COMPLETE:STATe command/query, [247](#)
- STATe, :CHANnel<N>:ISIM:STATe command/query, [374](#)
- STATe, :DISPlay:GRATICule:AREA<N>:STATe command/query, [533](#)
- STATe, :FUNCTION<F>:FFT:PEAK:STATe command/query, [594](#)
- STATe, :ISCAN:ZONE<Z>:STATe command/query, [714](#)
- STATe, :LANE<N>:EQUalizer:CTLE:STATe command/query, [728](#)
- STATe, :LANE<N>:EQUalizer:DFE:STATe command/query, [732](#)
- STATe, :LANE<N>:EQUalizer:FFE:STATe command/query, [754](#)
- STATe, :LANE<N>:STATe command/query, [763](#)
- STATe, :MEASure:NOISE:STATe command/query, [1011](#)
- STATe, :MEASure:PAM:PRBS13q:STATe command/query, [1046](#)
- STATe, :MEASure:PN:STATe command/query, [1066](#)
- STATe, :MEASure:QUALifier<M>:STATe command/query, [1078](#)
- STATe, :MEASure:RJDD:STATe command/query, [1104](#)
- STATe, :MEASure:TIEFilter:STATe command/query, [1171](#)
- STATe, :MTEST:MARGIN:STATe command/query, [865](#)
- STATe, :SBUS<N>:SPI:FRAMe:STATe command/query, [1317](#)
- STATe, :SPROcessing:DFEQualizer:STATe command/query, [1770](#)
- STATe, :TRIGger:ADVanced:STATe:CLOCK command/query, [1509](#)
- STATe, :TRIGger:ADVanced:STATe:LOGic command/query, [1510](#)
- STATe, :TRIGger:ADVanced:STATe:LTYPE command/query, [1511](#)
- STATe, :TRIGger:ADVanced:STATe:SLOPe command/query, [1512](#)
- STATe, :TRIGger:ADVanced:STATe:THReshold:LEVEL command/query, [1513](#)
- STATe, :TRIGger:STATe:CLOCK command/query, [1467](#)
- STATe, :TRIGger:STATe:LOGic command/query, [1468](#)
- STATe, :TRIGger:STATe:LTYPE command/query, [1469](#)
- STATe, :TRIGger:STATe:SLOPe command/query, [1470](#)

state, acquisition, [1221](#)  
 state, run, [1243](#)  
 STATE], :LXI:IDENTify[:STATE]  
   command/query, [782](#)  
 STATistics, :MEASure:JITter:STATistics  
   command/query, [1747](#)  
 STATistics, :MEASure:STATistics  
   command/query, [1117](#)  
 status, [159](#)  
 Status Byte (\*STB?) query, [475](#)  
 Status Byte Register, [190](#)  
 Status Byte Register, and serial  
   polling, [191](#)  
 Status Byte Register, bits, [475](#)  
 Status Registers, [159, 450](#)  
 Status Reporting, [185](#)  
 Status Reporting Decision Chart, [209](#)  
 Status Reporting, Bit Definitions, [186](#)  
 Status Reporting, Data Structures, [188](#)  
 STATus, :CALibrate:STATus? query, [338](#)  
 STATus, :DISPlay:STATus:COL command  
   query, [564](#)  
 STATus, :DISPlay:STATus:ROW command  
   query, [565](#)  
 STATus,  
   :HOSTed:CALibrate:STATus:CHANnels?  
   query, [678](#)  
 STATus,  
   :HOSTed:CALibrate:STATus:FRAMES?  
   query, [679](#)  
 STATus, :HOSTed:CALibrate:STATus:LEVel?  
   query, [680](#)  
 STATus,  
   :HOSTed:CALibrate:STATus:SIGNals?  
   query, [681](#)  
 status, of an operation, [185](#)  
 STDDev, :MEASure:HISTogram:STDDev  
   command/query, [976](#)  
 STIME, :MTEST:STIME  
   command/query, [879](#)  
 STOP, :FUNCTION<F>:FFT:STOP  
   command/query, [600](#)  
 STOP, :FUNCTION<F>:GATing:STOP  
   command, [610](#)  
 STOP, :MEASure:PN:HORizontal:STOP  
   command/query, [1060](#)  
 STOP, :MEASure:TIEFilter:STOP  
   command/query, [1172](#)  
 STOP, :MTEST:STOP command, [878](#)  
 STReaming, :WAVEform:STReaming  
   command/query, [1632](#)  
 string variables, [155](#)  
 string variables, example, [155](#)  
 STRing, :DISPlay:STRing command, [1720](#)  
 string, quoted, [1718](#)  
 strings, alphanumeric, [140](#)  
 STV commands, [1530](#)  
 STV, :TRIGger:ADVanced:TV:STV:FIELD  
   command/query, [1532](#)  
 STV, :TRIGger:ADVanced:TV:STV:LINE  
   command/query, [1533](#)

STV, :TRIGger:ADVanced:TV:STV:SOURce  
   command/query, [1534](#)  
 STV, :TRIGger:ADVanced:TV:STV:SPOLarity  
   command/query, [1535](#)  
 STYPE, :CHANnel<N>:PROBe:STYPE  
   command/query, [408](#)  
 STYPE, :XTALK<X>:STYPE  
   command/query, [1701](#)  
 SUBTract, :FUNCTION<F>:SUBTract  
   command, [639](#)  
 suffix multipliers, [141, 183](#)  
 suffix units, [184](#)  
 SUI, :MTEST:COUNt:SUI? query, [834](#)  
 summary bits, [190](#)  
 SWEep, :TRIGger:SWEep  
   command/query, [1400](#)  
 SYMBolrate, :ANALyze:SIGNal:SYMBolrate  
   command/query, [310](#)  
 synchronization, acquisition, [224](#)  
 syntax error, [1802](#)  
 System Commands, [1349](#)  
 System Computer, Returning control  
   to, [179](#)  
 SYSTem:SETup and \*LRN, [457](#)

## T

TAB, :DISPlay:TAB command/query, [1721](#)  
 TABLE, :DISPlay:PAM:TABLE command, [553](#)  
 Talker, Code and Capability, [173](#)  
 Talker, Unaddressing, [179](#)  
 TAP, :LANE<N>:EQUalizer:DFE:TAP  
   command/query, [733](#)  
 TAP,  
   :LANE<N>:EQUalizer:DFE:TAP:AUTomati  
   c command, [734](#)  
 TAP, :LANE<N>:EQUalizer:DFE:TAP:DELay  
   command/query, [735](#)  
 TAP,  
   :LANE<N>:EQUalizer:DFE:TAP:DELay:AU  
   Tomatic command, [736](#)  
 TAP, :LANE<N>:EQUalizer:DFE:TAP:GAIN  
   command/query, [737](#)  
 TAP, :LANE<N>:EQUalizer:DFE:TAP:LTARget  
   command/query, [738](#)  
 TAP, :LANE<N>:EQUalizer:DFE:TAP:MAX  
   command/query, [739](#)  
 TAP, :LANE<N>:EQUalizer:DFE:TAP:MAXV  
   command/query, [740](#)  
 TAP, :LANE<N>:EQUalizer:DFE:TAP:MIN  
   command/query, [741](#)  
 TAP, :LANE<N>:EQUalizer:DFE:TAP:MINV  
   command/query, [742](#)  
 TAP,  
   :LANE<N>:EQUalizer:DFE:TAP:NORMal  
   ize command/query, [743](#)  
 TAP, :LANE<N>:EQUalizer:DFE:TAP:UTARget  
   command/query, [744](#)  
 TAP, :LANE<N>:EQUalizer:DFE:TAP:WIDTh  
   command/query, [745](#)

TAP, :LANE<N>:EQUalizer:FFE:TAP  
   command/query, [755](#)  
 TAP,  
   :LANE<N>:EQUalizer:FFE:TAP:AUTomati  
   c command, [756](#)  
 TAP, :LANE<N>:EQUalizer:FFE:TAP:DELay  
   command/query, [757](#)  
 TAP, :LANE<N>:EQUalizer:FFE:TAP:WIDTh  
   command/query, [758](#)  
 TAP, :SPROcessing:DFEQUalizer:TAP  
   command/query, [1771](#)  
 TAP,  
   :SPROcessing:DFEQUalizer:TAP:AUToma  
   tic command, [1772](#)  
 TAP, :SPROcessing:DFEQUalizer:TAP:DELay  
   command/query, [1773](#)  
 TAP,  
   :SPROcessing:DFEQUalizer:TAP:DELay:A  
   UTomatic command, [1774](#)  
 TAP, :SPROcessing:DFEQUalizer:TAP:GAIN  
   command/query, [1775](#)  
 TAP, :SPROcessing:DFEQUalizer:TAP:LTARget  
   command/query, [1776](#)  
 TAP, :SPROcessing:DFEQUalizer:TAP:MAX  
   command/query, [1777](#)  
 TAP, :SPROcessing:DFEQUalizer:TAP:MIN  
   command/query, [1778](#)  
 TAP,  
   :SPROcessing:DFEQUalizer:TAP:NORM  
   alize command/query, [1779](#)  
 TAP,  
   :SPROcessing:DFEQUalizer:TAP:UTARget  
   command/query, [1780](#)  
 TAP, :SPROcessing:DFEQUalizer:TAP:WIDTh  
   command/query, [1781](#)  
 TAP, :SPROcessing:FFEQUalizer:TAP  
   command/query, [1789](#)  
 TAP,  
   :SPROcessing:FFEQUalizer:TAP:AUToma  
   tic command, [1790](#)  
 TAP, :SPROcessing:FFEQUalizer:TAP:DELay  
   command/query, [1791](#)  
 TAP, :SPROcessing:FFEQUalizer:TAP:WIDTh  
   command/query, [1792](#)  
 TDElay, :FUNCTION<F>:FFT:TDElay  
   command/query, [601](#)  
 TDElay, :LANE<N>:EQUalizer:FFE:TDElay  
   command/query, [759](#)  
 TDElay, :SPROcessing:FFEQUalizer:TDElay  
   command/query, [1793](#)  
 TDElay, :TRIGger:DELay:TDElay:TIME  
   command/query, [1414](#)  
 TDLY,  
   :TRIGger:ADVanced:DELay:TDLY:ARM:SL  
   OPe command/query, [1526](#)  
 TDLY,  
   :TRIGger:ADVanced:DELay:TDLY:ARM:S  
   OURce command/query, [1525](#)  
 TDLY, :TRIGger:ADVanced:DELay:TDLY:DELay  
   command/query, [1527](#)



- TDLY,  
:TRIGger:ADVanced:DElay:TDLY:TRIGger:  
:SLOPe command/query, **1529**
- TDLY,  
:TRIGger:ADVanced:DElay:TDLY:TRIGger:  
:SOURce command/query, **1528**
- TDMode, :LANE<N>:EQUalizer:FFE:TDMode  
command/query, **760**
- TDMode, :SPROcessing:FFEQualizer:TDMode  
command/query, **1794**
- TEDGe, :MEASure:TEDGe  
command/query, **1118**
- TEMP, :CALibrate:TEMP? query, **339**  
temperature and calibration, **329**  
temperature color grade scheme, **527**
- TERM1, :TRIGger:SEQuence:TERM1  
command/query, **1451**
- TERM2, :TRIGger:SEQuence:TERM2  
command/query, **1452**
- termination of message during  
hardcopy, **183**
- termination voltage for N5444A probe  
head, **394**
- termination voltage for N7010A active  
termination adapter, **394**
- Terminator, **143**
- Test (\*TST?) query, **478**
- TEST, :LTEST:TEST command/query, **775**
- TESTLIMITS,  
:ACQUIRE:Bandwidth:TESTLIMITS?  
query, **244**
- TESTLIMITS, :ACQUIRE:POINTS:TESTLIMITS?  
query, **257**
- TESTLIMITS, :ACQUIRE:SRATE:TESTLIMITS?  
query, **270**
- TEXT, :DISPlay:TEXT command, **1722**
- THEME, :DISPlay:THEME  
command/query, **566**
- Third Order PLL clock recovery  
method, **275**
- THReshold, :DIGital<N>:THReshold  
command/query, **486**
- THReshold, :DISPlay:JITter:THReshold  
command, **545**
- THReshold,  
:LANE<N>:EQUalizer:DFE:THReshold:BA  
NDwidth command/query, **746**
- THReshold,  
:LANE<N>:EQUalizer:DFE:THReshold:BW  
Mode command/query, **747**
- THReshold,  
:LANE<N>:EQUalizer:DFE:THReshold:DE  
LAY command/query, **748**
- THReshold,  
:MEASure:CGRade:EWIDth:THReshold  
command/query, **909**
- THReshold, :MEASure:FFT:THReshold  
command/query, **1746**
- THReshold, :POD<N>:THReshold  
command/query, **1214**
- THReshold,  
:TRIGger:ADVanced:PATtern:THReshold  
:LEVel command/query, **1507**
- THReshold,  
:TRIGger:ADVanced:STATE:THReshold:L  
EVel command/query, **1513**
- THResholds,  
:MEASure:THResholds:ABSolute  
command/query, **1119**
- THResholds, :MEASure:THResholds:DISPlay  
command/query, **1120**
- THResholds,  
:MEASure:THResholds:GENAUTO  
command, **1121**
- THResholds,  
:MEASure:THResholds:GENeral:ABSolut  
e command/query, **1122**
- THResholds,  
:MEASure:THResholds:GENeral:HYSTere  
sis command/query, **1124**
- THResholds,  
:MEASure:THResholds:GENeral:METHod  
command/query, **1126**
- THResholds,  
:MEASure:THResholds:GENeral:PAMAu  
tomatic command/query, **1130**
- THResholds,  
:MEASure:THResholds:GENeral:PAMCus  
tom command/query, **1128**
- THResholds,  
:MEASure:THResholds:GENeral:PERCen  
t command/query, **1132**
- THResholds,  
:MEASure:THResholds:GENeral:TOPBas  
e:ABSolute command/query, **1134**
- THResholds,  
:MEASure:THResholds:GENeral:TOPBas  
e:METHod command/query, **1136**
- THResholds,  
:MEASure:THResholds:HYSTeresis  
command/query, **1137**
- THResholds,  
:MEASure:THResholds:METHod  
command/query, **1139**
- THResholds,  
:MEASure:THResholds:PERCent  
command/query, **1140**
- THResholds,  
:MEASure:THResholds:RFALL:ABSolute  
command/query, **1141**
- THResholds,  
:MEASure:THResholds:RFALL:METHod  
command/query, **1143**
- THResholds,  
:MEASure:THResholds:RFALL:PAMAu  
tomatic command/query, **1145**
- THResholds,  
:MEASure:THResholds:RFALL:PERCent  
command/query, **1147**
- THResholds,  
:MEASure:THResholds:RFALL:TOPBase:ABSolute  
command/query, **1149**
- THResholds,  
:MEASure:THResholds:RFALL:TOPBase:  
METHod command/query, **1151**
- THResholds,  
:MEASure:THResholds:SERauto  
command, **1152**
- THResholds,  
:MEASure:THResholds:SERial:ABSolute  
command/query, **1153**
- THResholds,  
:MEASure:THResholds:SERial:HYSTeresi  
s command/query, **1155**
- THResholds,  
:MEASure:THResholds:SERial:METHod  
command/query, **1157**
- THResholds,  
:MEASure:THResholds:SERial:PERCent  
command/query, **1158**
- THResholds,  
:MEASure:THResholds:SERial:TOPBase:  
ABSolute command/query, **1160**
- THResholds,  
:MEASure:THResholds:SERial:TOPBase:  
METHod command/query, **1162**
- THResholds,  
:MEASure:THResholds:TOPBase:ABSolu  
te command/query, **1163**
- THResholds,  
:MEASure:THResholds:TOPBase:METHod  
command/query, **1164**
- TIEClock2, :MEASure:TIEClock2  
command/query, **1165**
- TIEData, :MEASure:TIEData  
command/query, **1748**
- TIEData, :MEASure:TIEData2  
command/query, **1167**
- TIEFilter, :MEASure:TIEFilter:DAMPing  
command/query, **1168**
- TIEFilter, :MEASure:TIEFilter:SHApe  
command/query, **1169**
- TIEFilter, :MEASure:TIEFilter:START  
command/query, **1170**
- TIEFilter, :MEASure:TIEFilter:STATE  
command/query, **1171**
- TIEFilter, :MEASure:TIEFilter:STOP  
command/query, **1172**
- TIEFilter, :MEASure:TIEFilter:TYPE  
command/query, **1173**
- TIETimebase, :WMEMemory:TIETimebase  
command/query, **1650**
- time and date, setting, **1349**
- Time Base Commands, **1369**
- time buckets, and POINTs?, **1620**
- time of level, PAM measurement  
definition, **1030**
- time scale, operands and functions, **571**
- TIME, :ANALyze:CLOCK:TIME? query, **293**
- TIME, :MEASure:PAM:EYE:TIME:LTDefinition  
command/query, **1030**
- TIME, :SYSTem:TIME  
command/query, **1368**

- TIME,
  - :TRIGger:ADVanced:VIOLation:SETup:HOLD:TIME command/query, [1567](#)
- TIME,
  - :TRIGger:ADVanced:VIOLation:SETup:SETup:TIME command/query, [1560](#)
- TIME, :TRIGger:DELAY:TDElay:TIME command/query, [1414](#)
- TIME, :TRIGger:RUNT:TIME command/query, [1449](#)
- TIME, :TRIGger:SEQUence:RESet:TIME command/query, [1456](#)
- TIME, :TRIGger:SEQUence:WAIT:TIME command/query, [1458](#)
- TIME, :TRIGger:TIMEout:TIME command/query, [1474](#)
- TIME, :TRIGger:TRANSition:TIME command/query, [1478](#)
- TIME, :TRIGger:WINDow:TIME command/query, [1494](#)
- TIMEout, :SBUS<N>:SPI:CLOCK:TIMEout command/query, [1316](#)
- TIMEout, :TRIGger:TIMEout:CONDition command/query, [1472](#)
- TIMEout, :TRIGger:TIMEout:SOURce command/query, [1473](#)
- TIMEout, :TRIGger:TIMEout:TIME command/query, [1474](#)
- timeout, SPI clock, [1316](#)
- TITLE?, :MTESt:TITLe? query, [880](#)
- TJRJDJ?, :MEASure:RJDJ:TJRJDJ? query, [1105](#)
- TLIMit, :HISTogram:WINDow:TLIMit command/query, [666](#)
- TMAX, :MEASure:TMAX command/query, [1174](#)
- TMIN, :MEASure:TMIN command/query, [1175](#)
- TOPBase,
  - :MEASure:THResholds:GENeral:TOPBase:ABSolute command/query, [1134](#)
- TOPBase,
  - :MEASure:THResholds:GENeral:TOPBase:METhod command/query, [1136](#)
- TOPBase,
  - :MEASure:THResholds:RFAl:TOPBase:ABSolute command/query, [1149](#)
- TOPBase,
  - :MEASure:THResholds:RFAl:TOPBase:METhod command/query, [1151](#)
- TOPBase,
  - :MEASure:THResholds:SERial:TOPBase:ABSolute command/query, [1160](#)
- TOPBase,
  - :MEASure:THResholds:SERial:TOPBase:METhod command/query, [1162](#)
- TOPBase,
  - :MEASure:THResholds:TOPBase:ABSolute command/query, [1163](#)
- TOPBase,
  - :MEASure:THResholds:TOPBase:METhod command/query, [1164](#)
- TPOint, :TRIGger:PWIDTH:TPOint command/query, [1443](#)
- TPOint, :TRIGger:WINDow:TPOint command/query, [1495](#)
- TPOsition, :MTESt:FOLDing:TPOsition command/query, [853](#)
- trademarks, [2](#)
- transferring waveform data, [1584](#)
- transition violation mode, [1576](#)
- TRANSition,
  - :TRIGger:ADVanced:VIOLation:TRANSITION command/query, [1577](#)
- TRANSition,
  - :TRIGger:ADVanced:VIOLation:TRANSITION:SOURce command/query, [1578](#)
- TRANSition,
  - :TRIGger:ADVanced:VIOLation:TRANSITION:SOURce:HTHReshold command/query, [1579](#)
- TRANSition,
  - :TRIGger:ADVanced:VIOLation:TRANSITION:SOURce:LTHReshold command/query, [1580](#)
- TRANSition,
  - :TRIGger:ADVanced:VIOLation:TRANSITION:TYPE command/query, [1581](#)
- TRANSition, :TRIGger:TRANSition:DIRection command/query, [1476](#)
- TRANSition, :TRIGger:TRANSition:SOURce command/query, [1477](#)
- TRANSition, :TRIGger:TRANSition:TIME command/query, [1478](#)
- TRANSition, :TRIGger:TRANSition:TYPE command/query, [1479](#)
- transmission mode, and FORMat, [1616](#)
- traversal rules, [163](#)
- Tree Traversal, Examples, [164](#)
- Tree Traversal, Rules, [163](#)
- TREF, :HOSTed:CALibrate:TREF:DETECT command, [682](#)
- TREnd, :MEASure:JITTer:TREnd command/query, [991](#)
- TREnd, :MEASure:JITTer:TREnd:SMOoth command/query, [992](#)
- TREnd,
  - :MEASure:JITTer:TREnd:SMOoth:POINts command/query, [993](#)
- TREnd, :MEASure:JITTer:TREnd:VERTical command/query, [994](#)
- TREnd,
  - :MEASure:JITTer:TREnd:VERTical:OFFSet command/query, [995](#)
- TREnd,
  - :MEASure:JITTer:TREnd:VERTical:RANGe command/query, [996](#)
- TRG, bit, [474](#), [476](#)
- TRG, bit in the status byte, [194](#)
- TRG, Event Enable Register, [187](#)
- Trigger (\*TRG) command, [477](#)
- trigger armed status, checking for, [210](#)
- Trigger Commands, [1383](#)
- Trigger Event Register (TRG), [194](#)
- TRIGger IIC commands, [1295](#)
- trigger level, default setup, [1364](#)
- trigger mode, [1384](#)
- trigger mode, ADVanced, [1384](#)
- trigger mode, advanced delay, [1514](#), [1523](#)
- trigger mode, advanced TV, [1530](#), [1536](#)
- trigger mode, COMM, [1496](#)
- trigger mode, default setup, [1364](#)
- trigger mode, delay, [1514](#), [1523](#)
- trigger mode, NTSC TV, [1530](#)
- trigger mode, PAL-M TV, [1530](#)
- trigger mode, pattern, [1503](#)
- trigger mode, state, [1508](#)
- trigger mode, User Defined TV, [1536](#)
- trigger mode, violation types, [1542](#)
- trigger modes, summary, [1384](#)
- trigger other instruments, [332](#)
- TRIGger SPI commands, [1313](#)
- trigger sweep, default setup, [1364](#)
- trigger type, SPI, [1330](#)
- TRIGger, :MTESt:TRIGger:SOURce command/query, [881](#)
- TRIGger, :SBUS<N>:CAN:TRIGger command/query, [1268](#)
- TRIGger,
  - :SBUS<N>:CAN:TRIGger:PATtern:DATA command/query, [1271](#)
- TRIGger,
  - :SBUS<N>:CAN:TRIGger:PATtern:DATA:LENGth command/query, [1272](#)
- TRIGger,
  - :SBUS<N>:CAN:TRIGger:PATtern:ID command/query, [1274](#)
- TRIGger,
  - :SBUS<N>:CAN:TRIGger:PATtern:ID:MODE command/query, [1275](#)
- TRIGger, :SBUS<N>:FLEXray:TRIGger command/query, [1281](#)
- TRIGger,
  - :SBUS<N>:FLEXray:TRIGger:ERRor:TYPE command/query, [1282](#)
- TRIGger,
  - :SBUS<N>:FLEXray:TRIGger:FRAMe:CCBase command/query, [1283](#)
- TRIGger,
  - :SBUS<N>:FLEXray:TRIGger:FRAMe:CCRepetition command/query, [1284](#)
- TRIGger,
  - :SBUS<N>:FLEXray:TRIGger:FRAMe:ID command/query, [1285](#)
- TRIGger,
  - :SBUS<N>:FLEXray:TRIGger:FRAMe:TYPE command/query, [1286](#)
- TRIGger,
  - :SBUS<N>:IIC:TRIGger:PATtern:ADDRes command/query, [1299](#), [1301](#)
- TRIGger, :SBUS<N>:IIC:TRIGger:TYPE command, [1302](#)
- TRIGger, :SBUS<N>:LIN:TRIGger command/query, [1309](#)
- TRIGger, :SBUS<N>:LIN:TRIGger:ID command/query, [1310](#)

- TRIGger,  
:SBUS<N>:LIN:TRIGger:PATtern:DATA  
command/query, **1311**
- TRIGger,  
:SBUS<N>:LIN:TRIGger:PATtern:DATA:LENGth  
command/query, **1312**
- TRIGger, :SBUS<N>:SEARch:TRIGger  
command/query, **1260**
- TRIGger,  
:SBUS<N>:SPI:TRIGger:PATtern:DATA  
command/query, **1326**
- TRIGger,  
:SBUS<N>:SPI:TRIGger:PATtern:WIDTh  
command/query, **1328**
- TRIGger, :SBUS<N>:SPI:TRIGger:TYPE  
command/query, **1330**
- TRIGger,  
:TRIGger:ADVanced:DElay:EDLY:TRIGger  
r:SLOPe command/query, **1522**
- TRIGger,  
:TRIGger:ADVanced:DElay:EDLY:TRIGger  
r:SOURce command/query, **1521**
- TRIGger,  
:TRIGger:ADVanced:DElay:TDLy:TRIGger  
r:SLOPe command/query, **1529**
- TRIGger,  
:TRIGger:ADVanced:DElay:TDLy:TRIGger  
r:SOURce command/query, **1528**
- TRIGger, :TRIGger:DElay:TRIGger:SLOPe  
command/query, **1416**
- TRIGger, :TRIGger:DElay:TRIGger:SOURce  
command/query, **1415**
- Trigger, \*TRG status bit, **187**
- trigger, CAN, **1268**
- trigger, CAN pattern data length, **1272**
- trigger, CAN pattern ID mode, **1275**
- trigger, CAN sample point, **1263**
- trigger, CAN signal baudrate, **1264**
- trigger, CAN signal definition, **1265**
- trigger, CAN source, **1267**
- trigger, IIC signal baudrate, **1306**
- trigger, LIN sample point, **1305**
- trigger, LIN source, **1307**
- triggering, for User Defined TV mode, **1537**
- truncating numbers, **141**
- Truncation Rule, **162**
- TSCale, :MTESt:FOLDing:TSCale  
command/query, **855**
- TSTArt, :MARKer:TSTArt  
command/query, **790**
- TSTOp, :MARKer:TSTOp  
command/query, **791**
- TTAG?, :WAVEform:SEGmented:TTAG?  
query, **1628**
- TTAGs, :ACQuire:SEGmented:TTAGs  
command/query, **265**
- TV, :TRIGger:ADVanced:TV:STV:FIELD  
command/query, **1532**
- TV, :TRIGger:ADVanced:TV:STV:LINE  
command/query, **1533**
- TV, :TRIGger:ADVanced:TV:STV:SOURce  
command/query, **1534**
- TV, :TRIGger:ADVanced:TV:STV:SPOLarity  
command/query, **1535**
- TV, :TRIGger:ADVanced:TV:UDTV:ENUMber  
command/query, **1538**
- TV, :TRIGger:ADVanced:TV:UDTV:PGTHan  
command/query, **1539**
- TV, :TRIGger:ADVanced:TV:UDTV:POLarity  
command/query, **1540**
- TV, :TRIGger:ADVanced:TV:UDTV:SOURce  
command/query, **1541**
- TV, :TRIGger:TV:LINE  
command/query, **1481**
- TV, :TRIGger:TV:MODE  
command/query, **1482**
- TV, :TRIGger:TV:POLarity  
command/query, **1483**
- TV, :TRIGger:TV:SOURce  
command/query, **1484**
- TV, :TRIGger:TV:STANdard  
command/query, **1485**
- TV, :TRIGger:TV:UDTV:ENUMber  
command/query, **1486**
- TV, :TRIGger:TV:UDTV:HSYNc  
command/query, **1487**
- TV, :TRIGger:TV:UDTV:HTIME  
command/query, **1488**
- TV, :TRIGger:TV:UDTV:PGTHan  
command/query, **1489**
- TV, :TRIGger:TV:UDTV:POLarity  
command/query, **1490**
- TVOLt, :MEASure:TVOLt  
command/query, **1176**
- TX, :SBUS<N>:UART:SOURce:TX  
command/query, **1342**
- TYPE, :ANALyze:SIGNal:TYPE  
command/query, **312**
- TYPE, :BUS:B<N>:TYPE  
command/query, **318**
- TYPE, :CHANnel<N>:ISIM:BWLimit:TYPE  
command/query, **364**
- TYPE, :FUNctioN<F>:FFT:DETEctor:TYPE  
command/query, **584**
- TYPE, :MARKer<K>:TYPE  
command/query, **813**
- TYPE,  
:MEASure:JITter:SPECTrum:VERTical:TY  
PE command/query, **989**
- TYPE, :MEASure:TIEFilter:TYPE  
command/query, **1173**
- TYPE, :SBUS<N>:CAN:TYPE  
command/query, **1276**
- TYPE,  
:SBUS<N>:FLEXray:TRIGger:ERRor:TYPE  
command/query, **1282**
- TYPE,  
:SBUS<N>:FLEXray:TRIGger:FRAME:TY  
PE command/query, **1286**
- TYPE, :SBUS<N>:IIC:TRIGger:TYPE  
command, **1302**
- TYPE, :SBUS<N>:SPI:TRIGger:TYPE  
command/query, **1330**
- TYPE, :SBUS<N>:SPI:TYPE  
command/query, **1332**
- TYPE,  
:TRIGger:ADVanced:VIOLation:TRANSitio  
n:TYPE command/query, **1581**
- TYPE, :TRIGger:SEQUence:RESet:TYPE  
command/query, **1454**
- TYPE, :TRIGger:TRANSition:TYPE  
command/query, **1479**
- TYPE?, :WAVEform:TYPE? query, **1633**
- ## U
- UART serial bus commands, **1334**
- UART, :SBUS<N>:UART:BAUDRate  
command/query, **1335**
- UART, :SBUS<N>:UART:BITOrder  
command/query, **1336**
- UART, :SBUS<N>:UART:DIRectioN  
command/query, **1337**
- UART, :SBUS<N>:UART:EOF:HEX  
command/query, **1338**
- UART, :SBUS<N>:UART:IDLE  
command/query, **1339**
- UART, :SBUS<N>:UART:PARity  
command/query, **1340**
- UART, :SBUS<N>:UART:SOURce:RX  
command/query, **1341**
- UART, :SBUS<N>:UART:SOURce:TX  
command/query, **1342**
- UART, :SBUS<N>:UART:WIDTh  
command/query, **1343**
- UDTV commands, **1536**
- UDTV,  
:TRIGger:ADVanced:TV:UDTV:ENUMber  
command/query, **1538**
- UDTV, :TRIGger:ADVanced:TV:UDTV:PGTHan  
command/query, **1539**
- UDTV, :TRIGger:ADVanced:TV:UDTV:POLarity  
command/query, **1540**
- UDTV, :TRIGger:ADVanced:TV:UDTV:SOURce  
command/query, **1541**
- UDTV, :TRIGger:TV:UDTV:ENUMber  
command/query, **1486**
- UDTV, :TRIGger:TV:UDTV:HSYNc  
command/query, **1487**
- UDTV, :TRIGger:TV:UDTV:HTIME  
command/query, **1488**
- UDTV, :TRIGger:TV:UDTV:PGTHan  
command/query, **1489**
- UDTV, :TRIGger:TV:UDTV:POLarity  
command/query, **1490**
- UI, :MTESt:FOLDing:COUNT:UI query, **843**
- UI?, :MTESt:COUNT:UI? query, **835**
- UITouijitter, :MEASure:UITouijitter  
command/query, **1178**
- ULEVel, :ISCan:RUNT:ULEVel  
command/query, **706**
- ULIMit, :ISCan:MEASurement:ULIMit  
command/query, **698**
- ULIMit, :LTEST:ULIMit command/query, **776**

Unaddressing all listeners, [179](#)  
 UNDershoot, :MEASure:UNDershoot  
   command/query, [1179](#)  
 UNITInterval, :MEASure:UNITInterval  
   command/query, [1183](#)  
 UNITS, :CHANnel<N>:PROBe:EXtErnal:UNITS  
   command/query, [389](#)  
 UNITS, :CHANnel<N>:UNITS  
   command/query, [447](#)  
 UNITS, :MEASure:NOISe:UNITS  
   command/query, [1012](#)  
 UNITS, :MEASure:PAM:PRBS13q:UNITS  
   command/query, [1047](#)  
 UNITS, :MEASure:RJDD:UNITS  
   command/query, [1107](#)  
 UNITS, :MTEST:AMASK:UNITS  
   command/query, [824](#)  
 units, vertical, [389](#), [447](#)  
 UNKNown vertical units, [389](#), [447](#)  
 uppercase, [139](#)  
 uppercase, headers, [139](#)  
 uppercase, letters and responses, [140](#)  
 URQ bit (User Request), [452](#)  
 USB (Device) interface, [119](#)  
 USB 3 low frequency periodic signaling  
   clock recovery method, [275](#)  
 USB PD bi-phase mark coding clock  
   recovery method, [275](#)  
 user preferences, default setup and,  
   User Request (URQ) status bit, [1365](#)  
   User Request (URQ) status bit, [186](#)  
   User Request Bit (URQ), [452](#)  
 USER, :CHANnel<N>:PROBe:USER  
   command/query, [409](#)  
 User's Guide, [5](#)  
 user-defined function controls, [623](#)  
 user-defined function operands, [622](#)  
 User-Defined Measurements, [892](#)  
 Using the Digitize Command, [152](#)  
 USR bit, [474](#), [476](#)  
 UTARget,  
   :LANE<N>:EQUalizer:DFE:TAP:UTARget  
   command/query, [744](#)  
 UTARget,  
   :SPROcessing:DFEQualizer:TAP:UTARget  
   command/query, [1780](#)

**V**

VAMPliitude, :MEASure:VAMPliitude  
   command/query, [1185](#)  
 VAVerage, :MEASure:VAVerage  
   command/query, [1186](#)  
 VBA, [147](#), [1814](#)  
 VBASe, :MEASure:VBASe  
   command/query, [1187](#)  
 version of software, reading, [455](#)  
 VERSus, :FUNctIon<F>:VERSus  
   command, [640](#)  
 vertical axis, full-scale, [412](#)  
 vertical scaling, functions, [571](#)  
 vertical units, [389](#), [447](#)

VERTical, :ANALyze:CLOCK:VERTical  
   command/query, [295](#)  
 VERTical, :ANALyze:CLOCK:VERTical:OFFSet  
   command/query, [296](#)  
 VERTical, :ANALyze:CLOCK:VERTical:RANGe  
   command/query, [297](#)  
 VERTical, :AUToscale:VERTical  
   command, [1226](#)  
 VERTical, :DISPlay:BOOKmark<N>:VERTical?  
   query, [519](#)  
 VERTical, :FUNctIon<F>:VERTical  
   command/query, [641](#)  
 VERTical, :FUNctIon<F>:VERTical:OFFSet  
   command/query, [642](#)  
 VERTical, :FUNctIon<F>:VERTical:RANGe  
   command/query, [643](#)  
 VERTical, :FUNctIon<F>:VERTical:SIZE  
   command/query, [644](#)  
 VERTical, :HISTogram:VERTical:BINS  
   command/query, [660](#)  
 VERTical, :LANE<N>:VERTical  
   command/query, [764](#)  
 VERTical, :LANE<N>:VERTical:OFFSet  
   command/query, [765](#)  
 VERTical, :LANE<N>:VERTical:RANGe  
   command/query, [766](#)  
 VERTical, :MEASure:CLOCK:VERTical  
   command/query, [1739](#)  
 VERTical, :MEASure:CLOCK:VERTical:OFFSet  
   command/query, [1740](#)  
 VERTical, :MEASure:CLOCK:VERTical:RANGe  
   command/query, [1741](#)  
 VERTical,  
   :MEASure:JITTer:SPECTrum:VERTical  
   command/query, [986](#)  
 VERTical,  
   :MEASure:JITTer:SPECTrum:VERTical:OF  
   FSet command/query, [987](#)  
 VERTical,  
   :MEASure:JITTer:SPECTrum:VERTical:RA  
   NGe command/query, [988](#)  
 VERTical,  
   :MEASure:JITTer:SPECTrum:VERTical:TY  
   PE command/query, [989](#)  
 VERTical, :MEASure:JITTer:TREnd:VERTical  
   command/query, [994](#)  
 VERTical,  
   :MEASure:JITTer:TREnd:VERTical:OFFSe  
   t command/query, [995](#)  
 VERTical,  
   :MEASure:JITTer:TREnd:VERTical:RANG  
   e command/query, [996](#)  
 VERTical, :MEASure:PN:VERTical:REFerence  
   command/query, [1067](#)  
 VERTical, :MEASure:PN:VERTical:SCALE  
   command/query, [1068](#)  
 VERTical,  
   :SPROcessing:CTLequalizer:VERTical  
   command/query, [1762](#)  
 VERTical,  
   :SPROcessing:CTLequalizer:VERTical:OF  
   FSet command/query, [1763](#)

VERTical,  
   :SPROcessing:CTLequalizer:VERTical:RA  
   NGe command/query, [1764](#)  
 VERTical,  
   :SPROcessing:FFEQualizer:VERTical  
   command/query, [1795](#)  
 VERTical,  
   :SPROcessing:FFEQualizer:VERTical:OFF  
   Set command/query, [1796](#)  
 VERTical,  
   :SPROcessing:FFEQualizer:VERTical:RA  
   NGe command/query, [1797](#)  
 vertical, axis control, [343](#)  
 vertical, axis offset, and YRANge, [1662](#)  
 vertical, scaling, and YRANge, [1663](#)  
 VIEW and BLANK, [1228](#)  
 VIEW, :ANALyze:VIEW  
   command/query, [315](#)  
 VIEW, :TIMEbase:VIEW  
   command/query, [1377](#)  
 VIEW, :WAVEform:VIEW  
   command/query, [1634](#)  
 violation modes for trigger, [1542](#)  
 VIOLation,  
   :TRIGger:ADVanced:VIOLation:MODE  
   command/query, [1543](#)  
 VIOLation,  
   :TRIGger:ADVanced:VIOLation:PWIDth:D  
   IRection command/query, [1546](#)  
 VIOLation,  
   :TRIGger:ADVanced:VIOLation:PWIDth:P  
   OLarity command/query, [1547](#)  
 VIOLation,  
   :TRIGger:ADVanced:VIOLation:PWIDth:S  
   OURce command/query, [1548](#)  
 VIOLation,  
   :TRIGger:ADVanced:VIOLation:PWIDth:OF  
   FSet command/query, [1549](#)  
 VIOLation,  
   :TRIGger:ADVanced:VIOLation:SETup:H  
   OLD:CSORce command/query, [1561](#)  
 VIOLation,  
   :TRIGger:ADVanced:VIOLation:SETup:H  
   OLD:CSORce:EDGE  
   command/query, [1563](#)  
 VIOLation,  
   :TRIGger:ADVanced:VIOLation:SETup:H  
   OLD:CSORce:LEVel  
   command/query, [1562](#)  
 VIOLation,  
   :TRIGger:ADVanced:VIOLation:SETup:H  
   OLD:DSORce command/query, [1564](#)  
 VIOLation,  
   :TRIGger:ADVanced:VIOLation:SETup:H  
   OLD:DSORce:HTHReshold  
   command/query, [1565](#)  
 VIOLation,  
   :TRIGger:ADVanced:VIOLation:SETup:H  
   OLD:DSORce:LTHReshold  
   command/query, [1566](#)

- VIOLation,  
   :TRIGger:ADVanced:VIOLation:SETup:SH  
   OLD:TIME command/query, [1567](#)
- VIOLation,  
   :TRIGger:ADVanced:VIOLation:SETup:M  
   ODE command/query, [1553](#)
- VIOLation,  
   :TRIGger:ADVanced:VIOLation:SETup:SE  
   Tup:CSOource command/query, [1554](#)
- VIOLation,  
   :TRIGger:ADVanced:VIOLation:SETup:SE  
   Tup:CSOource:EDGE  
   command/query, [1556](#)
- VIOLation,  
   :TRIGger:ADVanced:VIOLation:SETup:SE  
   Tup:CSOource:LEVel  
   command/query, [1555](#)
- VIOLation,  
   :TRIGger:ADVanced:VIOLation:SETup:SE  
   Tup:DSOource command/query, [1557](#)
- VIOLation,  
   :TRIGger:ADVanced:VIOLation:SETup:SE  
   Tup:DSOource:HTHReshold  
   command/query, [1558](#)
- VIOLation,  
   :TRIGger:ADVanced:VIOLation:SETup:SE  
   Tup:DSOource:LTHReshold  
   command/query, [1559](#)
- VIOLation,  
   :TRIGger:ADVanced:VIOLation:SETup:SE  
   Tup:TIME command/query, [1560](#)
- VIOLation,  
   :TRIGger:ADVanced:VIOLation:SETup:SH  
   OLd:CSOource command/query, [1568](#)
- VIOLation,  
   :TRIGger:ADVanced:VIOLation:SETup:SH  
   OLd:CSOource:EDGE  
   command/query, [1570](#)
- VIOLation,  
   :TRIGger:ADVanced:VIOLation:SETup:SH  
   OLd:CSOource:LEVel  
   command/query, [1569](#)
- VIOLation,  
   :TRIGger:ADVanced:VIOLation:SETup:SH  
   OLd:DSOource command/query, [1571](#)
- VIOLation,  
   :TRIGger:ADVanced:VIOLation:SETup:SH  
   OLd:DSOource:HTHReshold  
   command/query, [1572](#)
- VIOLation,  
   :TRIGger:ADVanced:VIOLation:SETup:SH  
   OLd:DSOource:LTHReshold  
   command/query, [1573](#)
- VIOLation,  
   :TRIGger:ADVanced:VIOLation:SETup:SH  
   OLd:HoldTIME (HTIME)  
   command/query, [1575](#)
- VIOLation,  
   :TRIGger:ADVanced:VIOLation:SETup:SH  
   OLd:SetupTIME (STIME)  
   command/query, [1574](#)
- VIOLation,  
   :TRIGger:ADVanced:VIOLation:TRANSitio  
   n command/query, [1577](#)
- VIOLation,  
   :TRIGger:ADVanced:VIOLation:TRANSitio  
   n:SOURce command/query, [1578](#)
- VIOLation,  
   :TRIGger:ADVanced:VIOLation:TRANSitio  
   n:SOURce:HTHReshold  
   command/query, [1579](#)
- VIOLation,  
   :TRIGger:ADVanced:VIOLation:TRANSitio  
   n:SOURce:LTHReshold  
   command/query, [1580](#)
- VIOLation,  
   :TRIGger:ADVanced:VIOLation:TRANSitio  
   n:TYPE command/query, [1581](#)
- VISA COM example in C#, [1825](#)
- VISA COM example in Python, [1844](#)
- VISA COM example in Visual Basic, [1814](#)
- VISA COM example in Visual Basic  
   .NET, [1835](#)
- VISA example in C, [1853](#)
- VISA example in C#, [1872](#)
- VISA example in Python, [1896](#)
- VISA example in Visual Basic, [1862](#)
- VISA example in Visual Basic .NET, [1884](#)
- VISA examples, [1814](#), [1853](#)
- VISA.NET example in C#, [1903](#)
- VISA.NET example in Python, [1917](#)
- VISA.NET example in Visual Basic  
   .NET, [1910](#)
- VISA.NET examples, [1903](#)
- Visual Basic .NET, VISA COM  
   example, [1835](#)
- Visual Basic .NET, VISA example, [1884](#)
- Visual Basic .NET, VISA.NET example, [1910](#)
- Visual Basic 6.0, [147](#)
- Visual Basic for Applications, [147](#), [1814](#)
- Visual Basic for Applications (VBA), [126](#)
- Visual Basic, SICL library example, [1934](#)
- Visual Basic, VISA COM example, [1814](#)
- Visual Basic, VISA example, [1862](#)
- VLOWer, :MEASure:VLOWer  
   command/query, [1188](#)
- VMAX, :MEASure:VMAX  
   command/query, [1189](#)
- VMIDdle, :MEASure:VMIDdle  
   command/query, [1190](#)
- VMIN, :MEASure:VMIN  
   command/query, [1191](#)
- voltage at center screen, [376](#), [388](#)
- VOLTS as vertical units, [389](#), [447](#)
- VOVershoot, :MEASure:VOVershoot  
   command/query, [1192](#)
- VPP, :MEASure:VPP command/query, [1193](#)
- VPReshoot, :MEASure:VPReshoot  
   command/query, [1194](#)
- VRMS, :MEASure:VRMS  
   command/query, [1195](#)
- VSCale,  
   :DISPlay:GRATicule:AREA<N>:VSCale  
   command/query, [534](#)
- VSTArt, :MARKer:VSTArt  
   command/query, [792](#)
- VSTOp, :MARKer:VSTOp  
   command/query, [793](#)
- VTERm, :CHANnel<N>:PROBE:HEAD:VTERm  
   command/query, [394](#)
- VTIme, :MEASure:VTIme  
   command/query, [1197](#)
- VTOP, :MEASure:VTOp  
   command/query, [1198](#)
- VUNDershoot, :MEASure:VUNDershoot  
   command/query, [1199](#)
- VUNits, :FUNCTio<F>:FFT:VUNits  
   command/query, [602](#)
- VUPPer, :MEASure:VUPPer  
   command/query, [1200](#)
- ## W
- WAIT, :TRIGger:SEQuence:WAIT:ENABle  
   command/query, [1457](#)
- WAIT, :TRIGger:SEQuence:WAIT:TIME  
   command/query, [1458](#)
- Wait-to-Continue (\*WAI) command, [479](#)
- warranty, [2](#)
- WATTS as vertical units, [389](#), [447](#)
- Waveform Commands, [1583](#)
- waveform data values for clipped  
   portions, [1614](#)
- waveform intensity, default setup  
   and, [1365](#)
- Waveform Memory Commands, [1649](#)
- waveform type, and COMPLETE?, [1590](#)
- waveform type, and COUNT?, [1591](#)
- WAVEform,  
   :CHANnel<N>:SIMulation:WAVEform  
   command/query, [446](#)
- WAVEform, :DISK:SAVE:WAVEform  
   command, [510](#)
- WAVEform, :STORE:WAVEform  
   command, [1252](#)
- waveform, acquiring, [222](#)
- waveform, data and preamble, [1584](#)
- waveform, saving, [510](#)
- waveform, view parameters, [1634](#)
- WAVEforms,  
   :MTESt:FOLDing:COUNT:WAVEforms  
   query, [845](#)
- WAVEforms?, :MTESt:COUNT:WAVEforms?  
   query, [836](#)
- WAVElength,  
   :CHANnel<N>:PROBE:WAVElength  
   command/query, [411](#)
- what's new, [47](#)
- white space (separator), [130](#)
- width - -width measurement, [924](#)

WIDTH,  
   :LANE<N>:EQUalizer:DFE:TAP:WIDTH  
   command/query, **745**  
 WIDTH,:LANE<N>:EQUalizer:FFE:TAP:WIDTH  
   command/query, **758**  
 WIDTH,  
   :SBUS<N>:SPI:TRIGger:PATtern:WIDTH  
   command/query, **1328**  
 WIDTH,:SBUS<N>:SPI:WIDTH  
   command/query, **1333**  
 WIDTH,:SBUS<N>:UART:WIDTH  
   command/query, **1343**  
 WIDTH,  
   :SPROcessing:DFEQualizer:TAP:WIDTH  
   command/query, **1781**  
 WIDTH,  
   :SPROcessing:FFEQualizer:TAP:WIDTH  
   command/query, **1792**  
 WIDTH,  
   :TRIGger:ADVanced:VIOLation:PWIDth:  
   WIDTH command/query, **1549**  
 WIDTH,:TRIGger:GLITCh:WIDTH  
   command/query, **1435**  
 WIDTH,:TRIGger:PWIDth:WIDTH  
   command/query, **1444**  
 WIDTH,:WAVEform:CGRade:WIDTH?  
   query, **1589**  
 Window All Data, **315**  
 WINDOW,:DISPlay:WINDOW:MAXimize  
   command, **567**  
 WINDOW,:FUNCTion<F>:FFT:WINDOW  
   command/query, **603**  
 WINDOW,:HISTogram:WINDOW:BLIMit  
   command/query, **665**  
 WINDOW,:HISTogram:WINDOW:DEFault  
   command, **661**  
 WINDOW,:HISTogram:WINDOW:LLIMit  
   command/query, **663**  
 WINDOW,:HISTogram:WINDOW:RLIMit  
   command/query, **664**  
 WINDOW,:HISTogram:WINDOW:SOURce  
   command/query, **662**  
 WINDOW,:HISTogram:WINDOW:TLMit  
   command/query, **666**  
 WINDOW,  
   :MEASure:JITter:SPECTrum:WINDOW  
   command/query, **990**  
 WINDOW,:MEASure:PN:WINDOW  
   command/query, **1069**  
 WINDOW,:MEASure:WINDOW  
   command/query, **1201**  
 WINDOW,:TIMebase:WINDOW:DELay  
   command/query, **1378**  
 WINDOW,:TIMebase:WINDOW:POSition  
   command/query, **1379**  
 WINDOW,:TIMebase:WINDOW:RANGe  
   command/query, **1380**  
 WINDOW,:TIMebase:WINDOW:SCALE  
   command/query, **1381**  
 WINDOW,:TRIGger:WINDOW:CONDition  
   command/query, **1492**

WINDOW,:TRIGger:WINDOW:SOURce  
   command/query, **1493**  
 WINDOW,:TRIGger:WINDOW:TIME  
   command/query, **1494**  
 WINDOW,:TRIGger:WINDOW:TPOint  
   command/query, **1495**  
 word width, SPI decode, **1333**  
 WORD, Understanding the format, **1611**  
 WORD, waveform data FORMat, **1617**  
 WriteIEEEBlock method, **148**  
 WriteList method, **148**  
 WriteNumber method, **148**  
 WriteString method, **148**  
 WriteString VISA COM method, **127**  
 writing, text to the screen, **1720**  
 WSIZE,:SBUS<N>:GENRaw:WSIZE  
   command/query, **1289**

## X

x axis, controlling, **1369**  
 X vs Y, **640**  
 X,:MARKer<K>:X:POSition  
   command/query, **815**  
 X1,:MTEST:SCALE:X1 command/query, **872**  
 X1Position,:MARKer:X1Position  
   command/query, **794**  
 X1Y1source,:MARKer:X1Y1source  
   command/query, **796**  
 X2Position,:MARKer:X2Position  
   command/query, **795**  
 X2Y2source,:MARKer:X2Y2source  
   command/query, **798**  
 x-axis duration, and XRange?, **1640**  
 x-axis, offset, and XOffset, **1660**  
 x-axis, range, and XRange, **1661**  
 x-axis, units and XUNits, **1642**  
 XCORTie,:MEASure:XCORTie  
   command/query, **1202**  
 XDELta,:MTEST:AMASK:XDELta  
   command/query, **825**  
 XDELta,:MTEST:SCALE:XDELta  
   command/query, **873**  
 XDELta?,:MARKer:XDELta? query, **800**  
 XDISplay?,:WAVEform:XDISplay?  
   query, **1637**  
 XINCrement?,:WAVEform:XINCrement?  
   query, **1638**  
 XLIST?,:WAVEform:SEGmented:XLIST?  
   query, **1629**  
 XOFFset,:WMEMory<R>:XOFFset  
   command/query, **1660**  
 XORigin?,:WAVEform:XORigin?  
   query, **1639**  
 XPOSITION,  
   :DISPlay:BOOKmark<N>:XPOSITION  
   command/query, **520**  
 XRange,:WMEMory<R>:XRange  
   command/query, **1661**  
 XRange?,:WAVEform:XRange?  
   query, **1640**

XREFERENCE?,:WAVEform:XREFERENCE?  
   query, **1641**  
 XTALK Commands, **1665**  
 XUNits?,:WAVEform:XUNits? query, **1642**

## Y

Y,:MARKer<K>:Y:POSition  
   command/query, **816**  
 Y1,:MTEST:SCALE:Y1 command/query, **874**  
 Y1Position,:MARKer:Y1Position  
   command/query, **801**  
 Y2,:MTEST:SCALE:Y2 command/query, **875**  
 Y2Position,:MARKer:Y2Position  
   command/query, **802**  
 Y-axis control, **343**  
 YDELta,:MTEST:AMASK:YDELta  
   command/query, **826**  
 YDELta?,:MARKer:YDELta? query, **803**  
 YDISplay?,:WAVEform:YDISplay?  
   query, **1643**  
 YINCrement?,:WAVEform:YINCrement?  
   query, **1644**  
 YOFFset,:WMEMory<R>:YOFFset  
   command/query, **1662**  
 YORigin?,:WAVEform:YORigin?  
   query, **1645**  
 YPOSITION,  
   :DISPlay:BOOKmark<N>:YPOSITION  
   command/query, **521**  
 YRANGe,:WMEMory<R>:YRANGe  
   command/query, **1663**  
 YRANGe?,:WAVEform:YRANGe?  
   query, **1646**  
 YREFERENCE?,:WAVEform:YREFERENCE?  
   query, **1647**  
 YUNits?,:WAVEform:YUNits? query, **1648**

## Z

Z1,:LANE<N>:EQUalizer:CTLE:Z1  
   command/query, **729**  
 Z1,:SPROcessing:CTLequalizer:Z1  
   command/query, **1765**  
 Z2,:LANE<N>:EQUalizer:CTLE:Z2  
   command/query, **730**  
 Z2,:SPROcessing:CTLequalizer:Z2  
   command/query, **1766**  
 ZERO,:HOSTed:CALibrate:DESKew:ZERO  
   command, **674**  
 ZERO,:SPROcessing:CTLequalizer:ZERO  
   command/query, **1767**  
 ZLEVEL,:MEASure:CGRade:ZLEVEL  
   command/query, **916**  
 ZONE,:ISCan:ZONE:HIDE  
   command/query, **709**  
 ZONE,:ISCan:ZONE:SOURce  
   command/query, **710**  
 ZONE,:ISCan:ZONE<Z>:SOURce  
   command/query, **713**

ZONE<Z>, :ISCan:ZONE<Z>:MODE  
command/query, 711

ZONE<Z>, :ISCan:ZONE<Z>:PLACement  
command/query, 712

ZONE<Z>, :ISCan:ZONE<Z>:STATe  
command/query, 714

Zoom To Max, 1203, 1209

Zoom To Min, 1204, 1210

zoom, default setup, 1364

ZSRC,  
:CHANnel<N>:PROBe:PRECprobe:ZSRC  
command, 402

ZTMAX, :MEASure:ZTMAX command, 1203

ZTMAX, :MEASurement<N>:ZTMAX  
command, 1209

ZTMIN, :MEASure:ZTMIN command, 1204

ZTMIN, :MEASurement<N>:ZTMIN  
command, 1210

