

Errata

Title & Document Type: 6632A, 6633A and 6634A HP-IB System DC Power Supply Operating Manual

Manual Part Number: 5957-6360

Revision Date: May 1992

HP References in this Manual

This manual may contain references to HP or Hewlett-Packard. Please note that Hewlett-Packard's former test and measurement, semiconductor products and chemical analysis businesses are now part of Agilent Technologies. We have made no changes to this manual copy. The HP XXXX referred to in this document is now the Agilent XXXX. For example, model number HP8648A is now model number Agilent 8648A.

About this Manual

We've added this manual to the Agilent website in an effort to help you support your product. This manual provides the best information we could find. It may be incomplete or contain dated information, and the scan quality may not be ideal. If we find a better copy in the future, we will add it to the Agilent website.

Support for Your Product

Agilent no longer sells or supports this product. You will find any other available product information on the Agilent Test & Measurement website:

www.tm.agilent.com

Search for the model number of this product, and the resulting product page will guide you to any available information. Our service centers may be able to perform calibration if no repair parts are needed, but no other support from Agilent is available.

Operating Manual
**HP-IB SYSTEM
DC POWER SUPPLIES
HP MODELS
6632A, 6633A, and 6634A**
HP Part No 5957-6360



**HEWLETT
PACKARD**



HEWLETT
PACKARD

Operating Manual
**HP-IB SYSTEM
DC POWER SUPPLIES
HP MODELS
6632A, 6633A, and 6634A**
HP Part No 5957-6360

FOR INSTRUMENTS WITH SERIAL NUMBERS
HP MODEL 6632A, SERIALS 2709A-00101 AND ABOVE*
HP MODEL 6633A, SERIALS 2709A-00101 AND ABOVE*
HP MODEL 6634A, SERIALS 2710A-00101 AND ABOVE*

* For instruments with higher Serial Numbers,
a change page may be included.

SAFETY SUMMARY

The following general safety precautions must be observed during all phases of operation, service, and repair of this instrument. Failure to comply with these precautions or with specific warnings elsewhere in this manual violates safety standards of design, manufacture, and intended use of the instrument. Hewlett-Packard Company assumes no liability for the customer's failure to comply with these requirements.

BEFORE APPLYING POWER.

Verify that the product is set to match the available line voltage and the correct fuse is installed.

GROUND THE INSTRUMENT.

This product is a Safety Class 1 instrument (provided with a protective earth terminal). To minimize shock hazard, the instrument chassis and cabinet must be connected to an electrical ground. The instrument must be connected to the ac power supply mains through a three-conductor power cable, with the third wire firmly connected to an electrical ground (safety ground) at the power outlet. For instruments designed to be hard-wired to the ac power lines (supply mains), connect the protective earth terminal to a protective conductor before any other connection is made. Any interruption of the protective (grounding) conductor or disconnection of the protective earth terminal will cause a potential shock hazard that could result in personal injury. If the instrument is to be energized via an external autotransformer for voltage reduction, be certain that the autotransformer common terminal is connected to the neutral (earthed pole) of the ac power lines (supply mains).

FUSES

Only fuses with the required rated current, voltage, and specified type (normal blow, time delay, etc.) should be used. Do not use repaired fuses or short circuited fuseholders. To do so could cause a shock or fire hazard.

DO NOT OPERATE IN AN EXPLOSIVE ATMOSPHERE.

Do not operate the instrument in the presence of flammable gases or fumes.

KEEP AWAY FROM LIVE CIRCUITS.

Operating personnel must not remove instrument covers. Component replacement and internal adjustments must be made by qualified service personnel. Do not replace components with power cable connected. Under certain conditions, dangerous voltages may exist even with the power cable removed. To avoid injuries, always disconnect power, discharge circuits and remove external voltage sources before touching components.

DO NOT SERVICE OR ADJUST ALONE.

Do not attempt internal service or adjustment unless another person, capable of rendering first aid and resuscitation, is present.

DO NOT EXCEED INPUT RATINGS.

This instrument may be equipped with a line filter to reduce electromagnetic interference and must be connected to a properly grounded receptacle to minimize electric shock hazard. Operation at line voltages or frequencies in excess of those stated on the data plate may cause leakage currents in excess of 5.0 mA peak.

SAFETY SYMBOLS.



Instruction manual symbol: the product will be marked with this symbol when it is necessary for the user to refer to the instruction manual (refer to Table of Contents).



Indicates hazardous voltages.



or



Indicate earth (ground) terminal.

WARNING

OR



The WARNING sign denotes a hazard. It calls attention to a procedure, practice, or the like, which, if not correctly performed or adhered to, could result in personal injury. Do not proceed beyond a WARNING sign until the indicated conditions are fully understood and met.

CAUTION

OR

Caution



The CAUTION sign denotes a hazard. It calls attention to an operating procedure, or the like, which, if not correctly performed or adhered to, could result in damage to or destruction of part or all of the product. Do not proceed beyond a CAUTION sign until the indicated conditions are fully understood and met.

DO NOT SUBSTITUTE PARTS OR MODIFY INSTRUMENT.

Because of the danger of introducing additional hazards, do not install substitute parts or perform any unauthorized modification to the instrument. Return the instrument to a Hewlett-Packard Sales and Service Office for service and repair to ensure that safety features are maintained.

Instruments which appear damaged or defective should be made inoperative and secured against unintended operation until they can be repaired by qualified service personnel.

DECLARATION OF CONFORMITY
according to ISO/IEC Guide 22 and EN 45014

Manufacturer's Name: Hewlett-Packard Company

Manufacturer's Address: 150 Green Pond Road
Rockaway, New Jersey 07866
U.S.A.

declares that the product

Product Name: Power Supply

Model Number(s): HP 6632A, HP 6633A, HP 6634A

conforms to the following Product Specifications:

Safety: HD 401S1/IEC 348

EMC: EN 55011 (1991)/CISPR-11 Group 1 Class B
EN 50082-1 (1991)/IEC 801-2 4 kV CD, 8 kV AD
EN 50082-1 (1991)/IEC 801-3 3 V/m
EN 50082-1 (1991)/IEC 801-4 1 kV

Supplementary Information:

New Jersey
Location

01 January 1992
Date

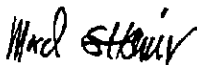

Mord Shamir/Quality Manager

Herstellerbescheinigung

Diese Information steht im Zusammenhang mit den Anforderungen der Maschinenlärminformationsverordnung vom 18 Januar 1991.

* Schalldruckpegel $L_p < 70$ dB(A) * Am Arbeitsplatz * Normaler Betrieb * Nach EN 27779 (Typprüfung)

Manufacturer's Declaration

This statement is provided to comply with the requirements of the German Sound Emission Directive, from 18 January 1991.

* Sound Pressure $L_p < 70$ dB(A) * At Operator Position * Normal Operation * According to EN 27779 (Type Test).

USING THIS MANUAL

This Operating manual contains all the information necessary to install, checkout, and program your power supply.

The following listing highlights the main topics covered in each section in this manual.

Section I – GENERAL INFORMATION

- General Description
- Options & Accessories
- Specifications

Section II – INSTALLATION

- Locating your supply
- Environmental Considerations
- Line Voltage Conversion

Section III – TURN-ON CHECK-OUT

- Preliminary Checkout
- Power-on Checkout (Self-test)
- Simple Local Programming Examples

Section IV – OUTPUT CONNECTIONS AND OPERATING DETAILS

- Output Characteristic
- Connecting the Load
- Local & Remote Sensing

Section V – LOCAL PROGRAMMING

- LCD Display
- Output Control Keys
- Mode Control Keys
- System Control Keys

Section VI – REMOTE PROGRAMMING

- Programming Syntax
- Essential Programming Features
- Advanced Programming Features
- Error Handling

Appendix A – CALIBRATION PROCEDURES

- Calibration Equation
- General Calibration Procedures
- Calibration Example Program

HOW TO USE THIS MANUAL

This manual can be used both as a reference and as a tutorial operating manual. When used as a reference manual, there is no defined reading sequence to follow. Each section contains all the information necessary to serve as a stand-alone section.

As a tutorial manual, it presents two paths to the user: one for the experienced user, and the other for the inexperienced user. For the experienced user, the purpose of the reading path is to enable you to begin programming the supply over the HP-IB as soon as possible. Having accomplished this, you can then read the other sections as is necessary. The following are the suggested paths for these two user groups:

The Experienced User

After reading through this introduction, read the following in sequence making sure you observe all the notes, cautions and warnings.

Section II

Section III

Section VI

The Inexperienced User

After reading through this introduction, read every section in the same sequence as is contained in the manual. You will find that each section builds on the knowledge gained in the previous section and also prepares you for a better understanding of the following section.

CONTENTS

Section I GENERAL INFORMATION

1-1	INTRODUCTION.....	1-1
1-2	SAFETY CONSIDERATIONS.....	1-1
1-3	INSTRUMENT AND MANUAL IDENTIFICATION.....	1-1
1-4	OPTIONS.....	1-1
1-5	ACCESSORIES.....	1-1
1-6	DESCRIPTION.....	1-1
1-7	SPECIFICATIONS.....	1-2

Section II INSTALLATION

2-1	INTRODUCTION.....	2-1
2-2	INITIAL INSPECTION.....	2-1
2-3	LOCATION AND COOLING.....	2-1
2-4	INPUT POWER REQUIREMENTS.....	2-3
2-5	POWER CORD.....	2-3
2-6	LINE VOLTAGE CONVERSION.....	2-3
2-7	FAST MODE/NORMAL MODE SELECTION.....	2-3
2-8	HP-IB INTERFACE CONNECTOR.....	2-3

SECTION III TURN-ON CHECKOUT

3-1	INTRODUCTION.....	3-1
3-2	Preliminary Check-Out.....	3-1
3-3	Power-on Check-Out.....	3-2
3-4	Programming Voltage & Current.....	3-1

Section IV OUTPUT CONNECTIONS AND OPERATING DETAILS

4-1	INTRODUCTION.....	4-1
4-2	OUTPUT CHARACTERISTIC.....	4-1
4-3	UNREGULATED STATE.....	4-1
4-4	NORMAL/FAST MODES.....	4-1
4-5	CONNECTING THE LOAD.....	4-2
4-6	Wire Size Selection.....	4-2
4-7	Local Sensing.....	4-2
4-8	Remote Voltage Sensing.....	4-2
4-9	Multiple Load Connections.....	4-3

4-10	LOAD CONSIDERATIONS.....	4-4
4-11	Output Isolation.....	4-4
4-12	Capacitive Loading.....	4-4
4-13	Inductive Loading.....	4-4
4-14	Battery Charging.....	4-4
4-15	SCR Removal.....	4-5

Section V LOCAL PROGRAMMING

5-1	INTRODUCTION.....	5-1
5-2	Programming Overview.....	5-1
5-3	THE LCD DISPLAY.....	5-3
5-4	OUTPUT CONTROL KEYS.....	5-3
5-5	Programming Voltage & Current.....	5-3
5-6	Programming Overvoltage Protection.....	5-3
5-7	MODE CONTROL KEYS.....	5-3
5-8	Enabling/Disabling the Output.....	5-4
5-9	Enabling/Disabling Overcurrent Protection (OCP).....	5-4
5-10	Resetting OVP and OCP.....	5-4
5-11	SYSTEM CONTROL KEYS.....	5-4
5-12	Local Model Operation.....	5-4
5-13	Setting the HP-IB Address.....	5-4
5-14	Displaying Error Codes.....	5-4

Section VI REMOTE PROGRAMMING

6-1	INTRODUCTION.....	6-1
6-2	PROGRAMMING SYNTAX.....	6-1
6-3	Numeric Data.....	6-1
6-4	Terminators.....	6-2
6-5	Order of Execution.....	6-2
6-6	INTRODUCTION TO PROGRAMMING.....	6-2
6-7	HP-IB Address Selection.....	6-2
6-8	Sending a Remote Command.....	6-2
6-9	Getting Data from Supply.....	6-2
6-10	ESSENTIAL PROGRAMMING FEATURES.....	6-2
6-11	Programming & Reading Back Voltage and Current.....	6-2
6-12	Programming Overvoltage (OVP) & Overcurrent (OC) Protection Features.....	6-5
6-13	Resetting OV & OCP.....	6-5
6-14	Output On/Off.....	6-5
6-15	Clear.....	6-6
6-16	Example Program.....	6-6
6-17	ADVANCED PROGRAMMING FEATURES.....	6-7
6-18	Status Reporting.....	6-7

CONTENTS (continued)

Section VI (continued)

6-19	The Status Register.....	6-7	6-38	Remote/Local.....	6-16
6-20	The Accumulated Status Register.....	6-8	6-39	Parallel Poll.....	6-16
6-21	The Mask & Fault Registers.....	6-8	6-40	Serial Poll.....	6-16
6-22	Reprogramming Delay.....	6-9	6-41	Device Clear.....	6-16
6-23	Serial Poll.....	6-10			
6-24	Service Request (SRQ).....	6-11			
6-27	Display On/Off.....	6-11			
6-29	ERROR REPORTING.....	6-13			
6-30	Self Test.....	6-13			
6-34	System ID Query.....	6-13			
6-35	Version (Rom) Query.....	6-13			
6-36	HP-IB INTERFACE FUNCTIONS.....	6-13			
6-37	Service Request.....	6-16			

Appendix A CALIBRATION PROCEDURES

A-1	INTRODUCTION.....	A-1
A-2	CALIBRATION EQUATIONS.....	A-1
A-3	CHECKING & INSTALLING CAL CONSTANTS.....	A-1
A-4	GENERAL CALIBRATION PROCEDURE.....	A-2
A-5	CALIBRATION EXAMPLE PROGRAM.....	A-4

Section I GENERAL INFORMATION

1-1 INTRODUCTION

This section contains a general description of your power supply as well as its performance specifications. Information about options, accessories, and HP-IB cables is also provided. This manual describes all three models in the HP 6632A-34A power supply family and unless stated otherwise, the information in this manual applies to all models.

1-2 SAFETY CONSIDERATIONS

This product is a Safety Class I instrument, which means that it is provided with a protective earth terminal. This terminal must be connected to a power source that has a 3-wire ground receptacle. Review the instrument and this manual for safety markings and instructions before operation. Refer to the Safety Summary page at the beginning of this manual for a summary of general safety information. Safety information for specific procedures is located at appropriate places in this manual.

1-3 INSTRUMENT AND MANUAL IDENTIFICATION

Hewlett-Packard power supplies are identified by a two-part serial number eg. 2601A-00101. The first part of the serial number (the prefix) denotes either the date of manufacture or the date of a significant design change. It also indicates the country of origin. With the year 1960 representing 0, the prefix above is decoded as follows: 26 = 1986; 01 = first week if the year; A = USA. The second part of the serial number is a sequential number assigned to each instrument starting with 00101.

If the serial number prefix on your supply differs from that shown on the title page of this manual, a yellow Manual Changes sheet is supplied with this manual to explain the difference between your instrument and the instrument described by this manual. The change sheet may also contain information for correcting errors in the manual.

1-4 OPTIONS

Options 100, 120, 220, and 240 determine which line voltage is selected at the factory. For information about changing the line voltage setting see paragraph 2-6.

- #100 Input power, 100 Vac, 48-63 Hz
- #120 Input power, 120 Vac, 48-63 Hz
- #220 Input power, 220 Vac, 48-63 Hz
- #240 Input power, 240 Vac, 48-63 Hz
- #020 Front Output Binding Posts
- #908 One rack mount kit
- #909 One rack mount kit with handles
- #910 One service manual with extra operating manual

1-5 ACCESSORIES

- 10833A HP-IB cable, 1m (3.3 ft)
- 10833B HP-IB cable, 2m (6.6 ft)
- 10833C HP-IB cable, 4m (13.2 ft)
- 10833D HP-IB cable, 0.5m (1.6 ft)
- 10834A HP-IB connector extender
- 1494-0060 Slide mount kit

1-6 DESCRIPTION

The HP 6632A-34A power supplies feature a combination of programming capabilities and linear power supply performance that make them ideal for power systems applications. The models in this family offer 100 watts of output power, with voltages up to 100 volts and current up to 5 amps as shown below:

Model	Output Voltage	Output Current
6632A	20 V	± 5 A
6633A	50 V	± 2 A
6634A	100 V	± 1 A

The power supply is a single range unit with the capability of sinking as well as sourcing current. The output can be programmed both locally from the front panel and remotely over the HP-IB. Using the front panel keypad, you can program the voltage, current, and overvoltage; enable and disable the output; enable overcurrent protection; return the supply to local operating mode; set the address; and reset the supply following an overvoltage or overcurrent condition. From the front panel display, you can monitor the output voltage and current settings, check the operating status of the supply from the annunciators, and check the type of error from the displayed error message.

When operated remotely, your supply can be both a listener and a talker. Using an external controller, you can instruct the supply to send measurement and status data back over the HP-IB. HP-IB readback capabilities include reading back output voltage and current; present and accumulated status; faults; and error messages. The following functions are implemented via the HP-IB.

- Voltage and current programming
- Voltage and current measurement and readback
- Programmable overvoltage and overcurrent
- Output enable and disable
- Present and accumulated status readback
- Programmable fault detection and reporting
- Programming syntax error detection
- Voltage and current calibration
- Internal self-test

Output connections are made to the rear panel screw terminals. Either the positive or negative output terminal can be grounded, or the output can be floated up to $\pm 240\text{Vdc}$ from the chassis ground. The output voltage can be sensed locally or remotely but when shipped, the supply is jumpered for local sensing.

The supply has no potentiometers and is calibrated over the HP-IB using the calibration commands described in Table 6-1. Correction factors, calculated from the equations given in Appendix A, are stored in non-volatile memory and are used during calibration. Software calibration eliminates the need to remove the top cover or even the need to remove the supply from your system cabinet. You can guard against unauthorized calibration by using the calibration jumper

inside the unit. Access to this is described in the Service Manual (Option 910). It is recommended that you calibrate your supply once every year.

1-7 SPECIFICATIONS

Table 1-1 lists the performance specifications for the HP 6632A–34A Linear Power Supplies. All specifications are at rear terminals with a resistive load, and local sensing unless otherwise stated. All specifications apply over the full operating temperature range of 0 to 55°C unless otherwise specified. All specifications describe the instrument's warranted performance except for those which are listed as typical; these are provided to aid in application of the supply. The Service Manual, Option 910, contains procedures for verifying the performance specifications.

Table 1-1. Specifications

Models	6632A (20 V)	6633A (50 V)	6634A (100 V)
AC INPUT			
Two internal switches permit operation from 100, 120, 220 or 240 Vac lines.			
Input Current	100 Vac — 3.3 A 120 Vac — 2.9 A 220 Vac — 1.7 A 240 Vac — 1.6 A		
Fuse Rating			
AC input is protected by a rear panel mounted fuse 4 A for 100 Vac and 120 Vac and 2 A for 220 Vac and 240 Vac.			
Amplitude: - 13% to +6% of nominal line voltage			
Frequency: 48 to 63 Hz			
Maximum VA: 350 VA			
Maximum power: 250 W			
Peak inrush current: 25 A (typical)			
DC OUTPUT—MAXIMUM RATINGS			
Voltage	0 - 20 V	0 - 50 V	0 - 100 V
Current	-5 to +5 A	-2 to +2 A	-1 to +1 A
DC OUTPUT—PROGRAMMING RANGE			
Voltage	0 - 20.475 V	0 - 51.188 V	0 - 102.38 V
Current *	0.02 - 5.1188 A	0.008 - 2.0475 A	0.004 - 1.0238 A
OVP	0 to 22 V	0 to 55 V	0 to 110 V
* The negative current limit tracks the positive programmed value with a fixed nominal offset. See Section IV for details.			
PROGRAMMING RESOLUTION (Typical)			
Voltage	5 mV	12.5 mV	25 mV
Current	1.25 mA	0.5 mA	0.25 mA
OVP	100 mV	250 mV	500 mV
Voltage and current programming are monotonic over the full temperature range.			

Table 1-1 Specifications (continued)

Models	6632A (20 V)	6633A (50 V)	6634A (100 V)
PROGRAMMING ACCURACY (25°C ± 5°C)			
If the unit is recalibrated at a temperature other than 25°C, then these specifications apply over a temperature band of ±5°C around the calibration temperature.			
Voltage	0.05% + 10 mV	0.06% + 20 mV	0.05% + 50 mV
+ Current	0.15% + 7 mA	0.15% + 2 mA	0.15% + 1 mA
- Current *	0.8% + 150 mA	0.8% + 60 mA	0.8% + 30 mA
OVP	2.4% + 0.24 V	2.4% + 0.6 V	2.4% + 1.2 V
* The negative current tracks the programmed value with a nominal offset as shown in the following specification. The negative current programming accuracy is specified with respect to this nominal offset. See Section IV for details.			
- Current offset	250 mA	100 mA	50 mA
LOAD EFFECT			
Maximum change in output due to a load change up to the maximum voltage or current rating.			
Voltage	2 mV	4 mV	5 mV
Current	1 mA	1 mA	1 mA
Remote sensing operation is possible with up to 2 V drop per load lead. When remote sensing, add 5 mV to the voltage load effect specification for each 1 V drop in the negative output load lead. See Section IV for details.			
SOURCE EFFECT			
Maximum output change for a line voltage change within rating.			
Voltage:	0.5 mV	1 mV	1 mV
Current:	0.5 mA	0.25 mA	0.25 mA
PARD (Ripple and Noise)			
RMS/pk-pk (20 Hz-20 MHz) with output ungrounded, or with either output terminal grounded.			
Voltage: NORMAL	0.3 mV/3 mV	0.5 mV/3 mV	0.5 mV/3 mV
FAST	1 mV/10 mV	1 mV/15 mV	2 mV/25 mV
Current:	2 mA RMS	2 mA RMS	2 mA RMS
TEMPERATURE COEFFICIENT			
Change in output per degree C after a 30 minute warmup.			
Voltage	70 ppm + 0.25 mV	70 ppm + 0.5 mV	70 ppm + 1 mV
+ Current	150 ppm + 500 μA	150 ppm + 150 μA	150 ppm + 75 μA
- Current	200 ppm + 1.0 mA	200 ppm + 0.3 mA	200 ppm + 0.15 mA
OVP	150 ppm + 4 mV	150 ppm + 10 mV	150 ppm + 20 mV

Table 1-1 Specifications (continued)

Models	6632A (20 V)	6633A (50 V)	6634A (100 V)
DRIFT (Stability)			
Change in output over an 8 hr. interval under constant line, load and ambient temperature after 30 minute warm-up.			
Voltage	0.01% + 0.5 mV	0.01% + 1 mV	0.01% + 1 mV
Current	0.01% + 1 mA	0.01% + 0.5 mA	0.01% + 0.3 mA
OUTPUT IMPEDANCE (Typical)			
HP 6632 OUTPUT IMPEDANCE (TYPICAL)	HP 6633 OUTPUT IMPEDANCE (TYPICAL)	HP 6634 OUTPUT IMPEDANCE (TYPICAL)	
LOAD TRANSIENT RESPONSE			
The time required for the output voltage to recover within a band of 0.1% of rated voltage around the nominal voltage following a 50% change in load current.			
NORMAL	100 μ s	100 μ s	100 μ s
FAST	50 μ s	50 μ s	50 μ s
PROGRAMMING RESPONSE TIME			
The total programming response time is the sum of the output response time and the programming command processing time.			
Output Response Time			
(LSB) is the maximum time for the output voltage to change to within $\pm 0.025\%$ of final value. Rise and fall times (T_r/T_f) are the maximum time for the output to change from 10% to 90% or 90% to 10% of its total excursion.			
NORMAL: T_r/T_f	15 ms	15 ms	15 ms
LSB	60 ms	60 ms	60 ms
FAST: T_r/T_f	400 μ s	400 μ s	400 μ s
LSB	2 ms	2 ms	2 ms

Table 1-1 Specifications (continued)

Models	6632A (20 V)	6633A (50 V)	6634A (100 V)
Programming Command Processing Time			
The time required for an HP-IB command to be processed (typ/max):			
Front panel display enabled: 10/55 ms			
Front panel display disabled: 10/15 ms			
READBACK RESOLUTION (Typical)			
Voltage	5 mV	12.5 mV	25 mV
Current	1.25 mA	0.5 mA	0.25 mA
READBACK ACCURACY (25°C ± 5°C)			
Voltage	0.07% + 15 mV	0.07% + 30 mV	0.06% + 70 mV
+ Current	0.18% + 9 mA	0.17% + 3 mA	0.15% + 2 mA
- Current	0.50% + 15 mA	0.50% + 7 mA	0.50% + 6 mA
READBACK TEMPERATURE COEFFICIENT			
Change in reading per °C after a 30 minute warmup.			
Voltage	100 ppm + 0.4 mV	100 ppm + 1 mV	100 ppm + 2 mV
+ Current	150 ppm + 500µA	150 ppm + 100µA	150 ppm + 60µA
- Current	250 ppm + 650µA	250 ppm + 120µA	250 ppm + 70µA
OUTPUT ISOLATION			
Neither output terminal may be more than ±240 Vdc from chassis ground.			
REVERSE VOLTAGE PROTECTION			
Maximum permissible current caused by reverse voltage impressed across output terminals with AC power on or off.			
Maximum current	5 A	2 A	1 A
TEMPERATURE RATINGS			
Operating: 0 to 55°C			
Storage: -40 to +75°C			
HP-IB INTERFACE CAPABILITIES			
SH1, AH1, T6, L4, SR1, RL1, PP1, DC1, DT0, C0, E1			
ENVIRONMENTAL AND SAFETY COMPLIANCE			
This series of power supplies is designed to comply with the following safety and environmental requirements:			
IEC 348—Safety Requirements for Electronic Measuring Apparatus.			
CSA 556B—Electronic Instruments and Scientific Apparatus for Special use and Applications.			
UL1244 — Electrical and Electronic Measuring and Testing Equipment			
WEIGHT			
Net: 23 lb / 10.5 kg			
Shipping: 27 lb / 12.3 kg			

Section II INSTALLATION

2-1 INTRODUCTION

This section contains instructions for checking and mounting your power supply, connecting your supply to ac power, converting it from one line voltage to another and connecting the HP-IB cable.

2-2 INITIAL INSPECTION

Your supply was thoroughly inspected and tested before it left the factory. As soon as you receive it, remove it from its packing case and check to make sure it has not been damaged in shipment. Check that there are no broken connectors or keys, and that the cabinet and panel surfaces are free from dents and scratches.

If any damage is found, you should file a claim with the carrier immediately and notify the Hewlett-Packard Sales and service office nearest you. Keep the original packing materials for the carrier's inspection or in the event the supply has to be returned to Hewlett-Packard. Warranty information is printed on the inside cover of this manual. Remember to fill out and attach the customer repair tag that is included with this manual to your supply when returning it for any reason. Your Hewlett-Packard Sales and Service office will furnish the address of the nearest service office to which the supply can be shipped.

Section III describes a turn-on checkout procedure which, when successfully completed, verifies to a high level of confidence that the supply is operating in accordance with

its specifications. Detailed electrical checks complete with verification procedures are included in the Service Manual.

2-3 LOCATION AND COOLING

NOTE:

The HP663xA power supplies generate operating magnetic fields which may affect the operation of other instruments. If your instrument is susceptible to operating magnetic fields, position it more than 3 inches from the HP663xA supply.

Figure 2-1 gives the dimensions of the power supply cabinet. These dimensions apply to all models. The cabinet has plastic feet that are shaped to ensure self-alignment when stacked with other Hewlett-Packard System II cabinets. The feet may be removed for rack mounting.

The supply can be mounted in a standard 19 inch rack panel or enclosure. Rack mounting accessories for this unit are listed in Section I. Complete installation instructions are included with each rack mounting kit. It is recommended to use instrument support rails for non-stationary applications.

The power supply can operate without loss of performance within the temperature range of 0 to 55°C (measured at the intake.) The fan cools the supply by drawing air in through the openings on the side panel and exhausting it through openings on the rear. Using Hewlett-Packard rack mount kits or slide kits will not impede the flow of air.

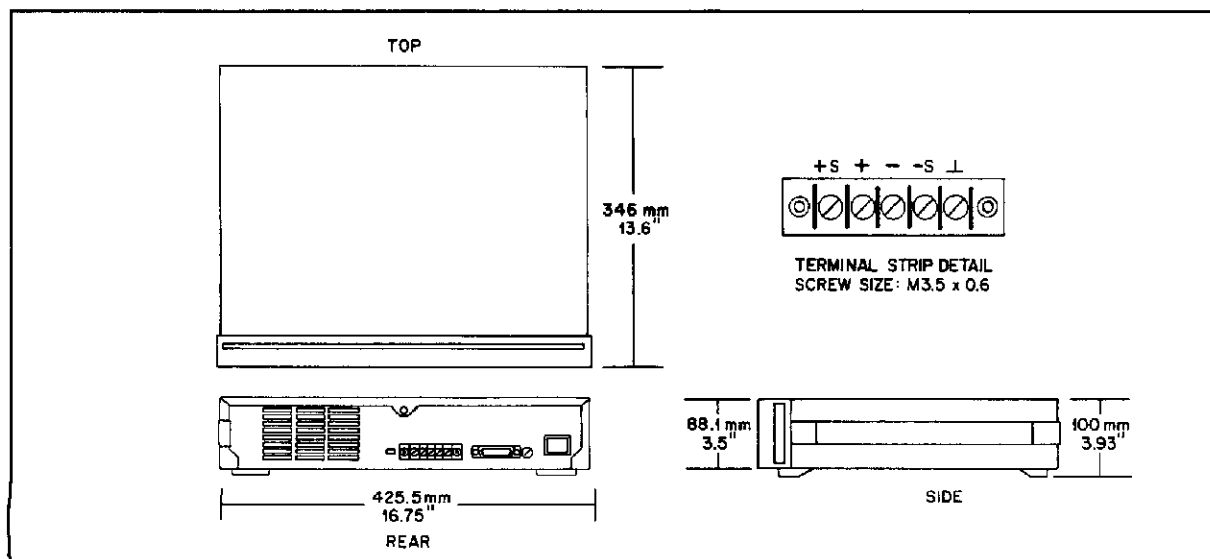

Figure 2-1. Power Supply Outline Diagram

Because the supply is fan cooled, it must be installed in a location that allows sufficient space at the rear and sides for adequate circulation of air.

2-4 INPUT POWER REQUIREMENTS

You can operate your supply from a nominal 100 V, 120 V, 220 V or 240 V single phase power source at 48 to 63 Hz. The input voltage range, maximum input current, peak inrush current and the fuse required for each of the nominal inputs are listed in Table 1-1. If necessary, you can convert the supply from one line setting to another by following the instructions in paragraph 2-6.

2-5 POWER CORD

Your supply is shipped from the factory with a power cord that has a plug appropriate for your location. Figure 2-2 shows the standard configuration of plugs used by Hewlett-Packard. Below each drawing is the HP part number for the replacement power cord equipped with a plug of that configuration. If a different power cord is required, contact the nearest Hewlett-Packard Sales and Service office.

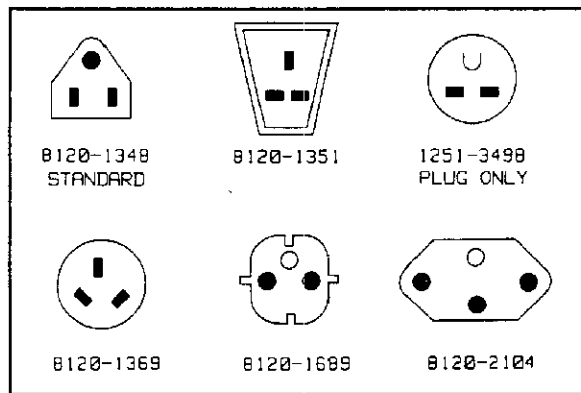

Figure 2-2. Power cord Plug Configurations

For your protection, the National Electrical Manufacturer's Association (NEMA) recommends that the instrument panel and cabinet be grounded. Your supply is equipped with a three-conductor power cord; the third conductor being the ground. The supply is grounded only when the power cord is plugged into an appropriate receptacle. Do not operate your supply without adequate cabinet ground connection.

WARNING

SHOCK HAZARD

Connect the power cord to a grounded receptacle before you connect any external voltages to the output.

The offset pin on the standard three-prong power cord connector is the ground connection. If a two contact receptacle is encountered, it must be replaced with a properly grounded three-contact receptacle in accordance with the National Electrical Code, local codes and ordinances. The work should be done by a qualified electrician.

2-6 LINE VOLTAGE CONVERSION

Line voltage conversion is accomplished by adjusting three components: line select switches S2 and S3 and the rear panel fuse F1. To convert the supply from one line voltage to another, proceed as follows:

1. Turn off the supply and remove the top cover by removing five screws: two M5 on each side and one M4 on the rear panel. Use a #2 pozidriv.
2. Locate the line voltage select switches S2 and S3 (See Figure 2-3).
3. Note that each switch can have two possible positions. Representation of these positions are silk screened on the PC board next to the switches as shown in Figure 2-3.
4. To change the line voltage, consult the silk screen drawing and adjust the switches accordingly. For example to change the voltage from 120 V (as shown in Figure 2-3) to 240 V, change the position of switch S2 only.
5. Check the rating of the fuse F1 installed in the rear panel fuse holder and replace with the correct fuse if necessary. For 120 V operation, use 4 A fuses HP Part #2110-0055 and for 220 or 240 V use 2A fuse HP Part #2110-0002. Do not use "Slow Blow" fuses.
6. Replace the cover and mark the supply clearly on the label indicating the correct line voltage and fuse that is in use.

2-7 FAST MODE/NORMAL MODE SELECTION

Your supply is set at the factory to operate in the Normal Mode. If you require faster response times, you can change to the Fast Mode of operation. To do this, turn off your supply and change the position of the mode switch located on the rear panel to FAST. See Section IV for operating details and and Table 1-1 for the specification.

2-8 HP-IB INTERFACE CONNECTOR

The HP-IB connector on the rear panel connects your supply to the computer and other HP-IB devices. Section I lists the cables and cable accessories that are available from Hewlett-Packard. An HP-IB system can be connected together in any configuration (star, linear, or both) as long as the following rules are observed:

1. The total number of devices including the computer is no more than 15.
2. The total length of all the cables used is no more than 2m times the number of devices connected together, up to a maximum of 20 m.

NOTE

IEEE Std 488-1978 states that you should exercise caution if your individual cable lengths exceed 4 m.

Do not stack more than three connector blocks together on any HP-IB connector. The resultant leverage can exert excessive force on the mounting panels. Make sure that all connectors are fully seated and that the lock screws are firmly finger tightened. Do not use a screwdriver. Use a screwdriver only for the removal of the screws.

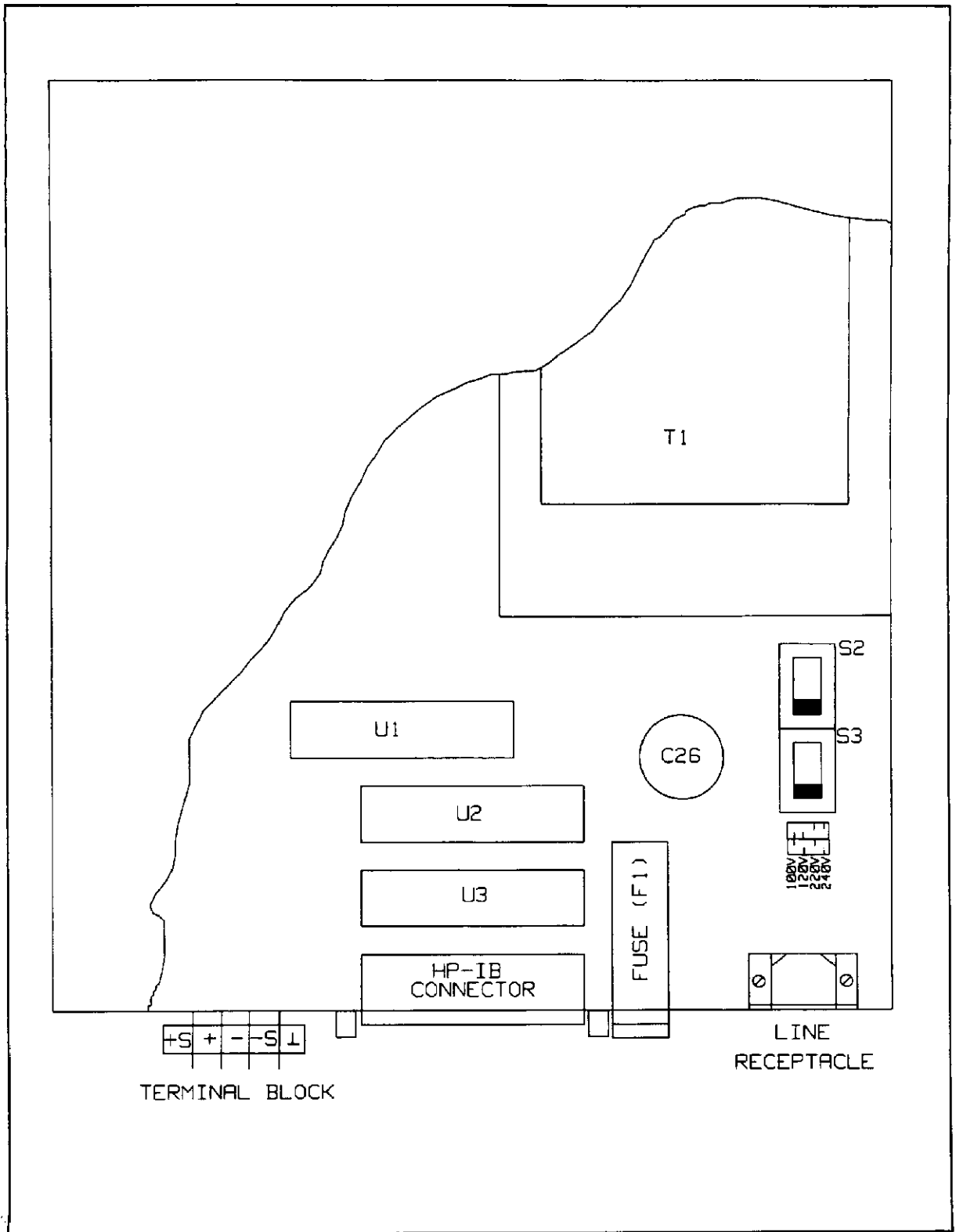

Figure 2-3. Line Voltage Conversion Components

Section III TURN-ON CHECKOUT

3-1 INTRODUCTION

In Section II you learned about mounting your supply in a rack; the optimum operating environment for your supply; and converting the input line voltage. With these tasks complete, you are now ready to turn on and use your supply. This section discusses the turn on sequence and introduces you to programming your supply. Once successfully completed, this checkout verifies to about a 90% confidence level that your supply is operating correctly. The Service Manual, Option #910, contains more detailed performance and verification tests.

This section is intended for both the experienced and the inexperienced user since it calls attention to certain checks that should be made prior to operation and introduces information that will be used throughout the manual.

3-2 Preliminary Check-Out

The checks in this section ensure that all connections are correctly made. Before you turn on your power supply, perform the following:

1. Check that the rear panel label indicates that the supply is set to match your input line voltage.
2. Check that the fuse on the rear panel is correct for your line voltage.
3. Check that the rear panel jumpers are correctly connected and tightened. (+S connected to + and -S to -).
4. Check that the FAST/NORMAL switch on the rear panel is in the NORMAL position.
5. Connect the line cord and turn on your supply using the LINE switch on the front panel.

3-3 Power-On Check-out (Self-Test)

Immediately after turn-on, the supply undergoes a self-test during which it will not accept any input from the front panel nor from the HP-IB. During self-test, you will observe the following sequence on the LCD display:

1. All segments of the display as well as all annunciators will be turned on and remain on for about 1.5 sec.
2. The HP-IB address message will then be displayed for about 1 sec. Note that the power supply address is factory set to 5.

When self test is successfully completed, the output voltage and current readings will be about the same as shown in Figure 3-1 and only the CV annunciator will be on. Now your supply is ready to be programmed.

NOTE

The number of digits used to display volts and amps vary among models. The examples shown in Figures 3-1 through 3-3 use the HP6632A.

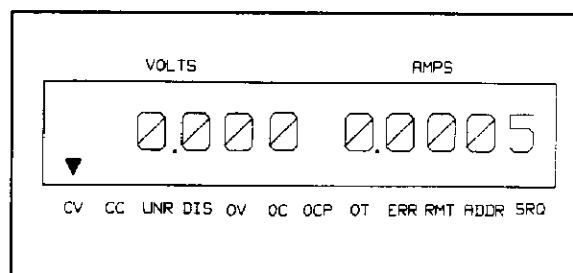

Figure 3-1. Front Panel Display (approx.) Following a Successful Self-Test

If the supply fails the power-on self-test, the output will remain disabled and the display will indicate the type of failure. See Section VI for a description of the power-on self-test failures.

3-4 Programming Voltage & Current

The following procedures use the front panel keys to program the supply's output.

3-5 Program Voltage: To program voltage, use the VSET key as shown in the following example to program the output voltage to 9.5 V. Press

VSET 9 . 5 ENTER

Check that the response is about the same as shown in Figure 3-2. Note that the Constant Voltage (CV) annunciator remains on, indicating that the supply is operating in CV mode.

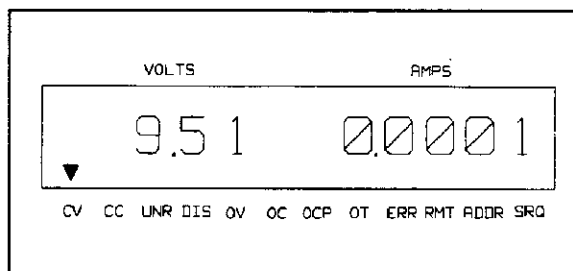

Figure 3-2. Front Panel Display (approx.) After Programming Voltage

3-6 Program Current: To program current, perform the following tasks in the same sequence given:

1. Turn off the supply
2. Remove the barrier block cover from the output and connect a short circuit (jumper) wire between the + and - terminals.
3. Turn on the supply.
4. Program the output to 8 V as described previously.
5. Check that the display reads approximately 0 V and the minimum current limit value (this depends on the model # as shown in Table 6-2). Check that the Constant Current (CC) annunciator is on, indicating that the supply is in CC mode.

6. Program the current to 0.5 A as follows: Press

ISSET **.** **5** **ENTER**

7. Check that the response is about the same as shown in Figure 3-3.

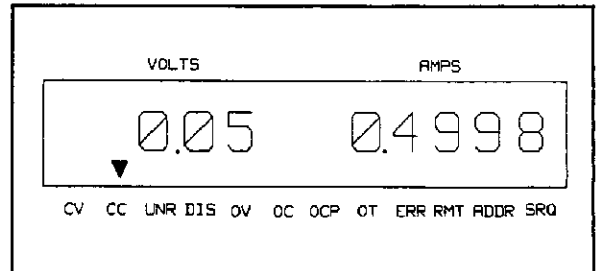

**Figure 3-3. Front Panel Display (approx.)
After Programming Current**

Section IV OUTPUT CONNECTIONS AND OPERATING DETAILS

4-1 INTRODUCTION

This section provides greater details of the power supply operation. It describes all load connections to the output and provides hints on how to maximize operating performance. Major sub-sections covered include the Output Characteristic; Unregulated state; NORMAL/FAST Operating Modes; Connecting the Load; and Load Considerations.

4-2 OUTPUT CHARACTERISTIC

The supply can operate in either constant voltage (CV) or constant current (CC) over the rated output voltage and current. Under certain fault conditions, the supply cannot operate in either CV or CC states and becomes unregulated. The unregulated state (UNR) is discussed in greater detail in paragraph 4-3.

The operating locus (Figure 4-1) shows a single range, two quadrant capability. This means that the supply is capable of sourcing as well as sinking current over the output voltage range from 0 volts to the rated maximum. The operating point is determined by the voltage setting, the current setting and the load resistance. In quadrant 1, Figure 4-1, two operating points are shown. Point (1) is the operating point defined by the load line cutting the operating locus in the constant voltage region. In this region, the supply is operating in CV mode. At operating point (2), defined by the load line cutting the operating locus at the vertical CC line, the supply is operating in CC mode.

Operation in quadrant 2 is essentially identical to quadrant 1, and the operating points defined in the same manner. However, the current setting in quadrant 2 cannot be set independently; it tracks the value programmed for quadrant 1. That is, if the command ISET 1.0 is sent, the nominal value of the negative current will be slightly more negative than -1.0 A by the amount shown in Table 1-1 under -Current Offset. The accuracy of the negative current setting is then specified with respect to this nominal value.

4-3 UNREGULATED STATE

An unregulated (UNR) indication means that both the CV and CC control circuits are asking for more output, and the power circuits are unable to deliver it. In these circumstances, the ac line voltage is usually below the specifications stated in Table 1-1. The UNR condition can also occur if you attempt to operate the supply beyond its output ratings. For example, if you are remote sensing with a 1 V drop in each load lead and you program the output to its maximum programmable

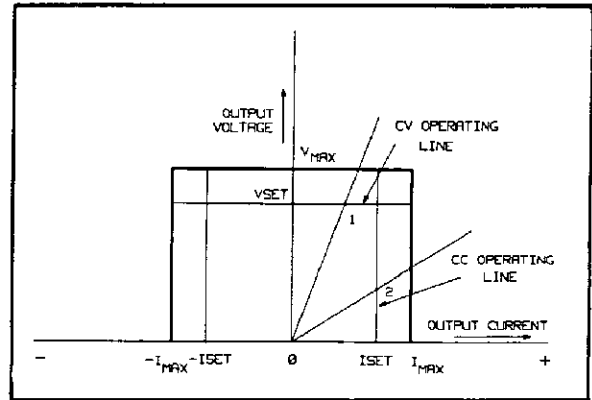

Figure 4-1. Output Characteristic

voltage the output would actually have to go to 2 V above its maximum to provide the required output.

The UNR state can also be entered momentarily during normal operation. For example, it can happen if the output voltage is rapidly programmed upward with a large capacitive load. This will be too brief to be observed on the front panel or in the Status register, but it will show up in the Astatus register. The DLY function, if properly set, will prevent this momentary condition from reaching the Fault register.

The supply may momentarily be unregulated for at least one other reason. If the load is short-circuited, causing a sudden transition from CV to CC mode, UNR state may be entered briefly during the transition. As above, this will be too brief to be observed on the front panel or in the Status register, but will show up in the Astatus register. However, in this case, the condition will also appear in the Fault register if the UNR bit is unmasked. See paragraph 6-21.

4-4 NORMAL/FAST MODES

The power supply can operate either in NORMAL mode or FAST mode. These modes are selected by a switch located on the rear panel. If the FAST mode is selected, the supply will demonstrate enhanced characteristics in certain specifications and degraded characteristics in others. The following paragraphs discuss these specifications and the manner in which they are affected.

1. In FAST mode, the programming time for voltage programming is shorter than it is for NORMAL mode operation, but the output noise is greater. See Table 1-1.

2. When FAST mode is selected, there is no internal output capacitor, and any substantial addition of an external capacitor will reduce the stability of the supply in constant voltage operation. In NORMAL mode, a large internal capacitor is always present across the output, and in addition, the supply can maintain stability for large external load capacitors. See paragraph 4-12. In NORMAL mode, the internal output capacitor helps to control peak voltage excursions away from the nominal value for sudden changes in load current. However, if the output current is programmed to less than 40% of its full scale value, this capacitor may affect programming times, since the output voltage slew rate will be limited to the programmed current divided by the output capacitance.
3. When the supply is in constant current and FAST mode is selected, the absence of the output capacitor gives rise to increased output impedance and therefore enhanced overall performance. Under these conditions, the supply can drive an inductive load and exhibit greater stability. See paragraph 4-13.
4. In FAST mode, the output noise can be substantially reduced if you disable the front panel metering using the DSP 0 command, and refrain from sending the VOUT?, IOUT? commands. This occurs because the largest contribution to output noise is from the internal A/D converter, which operates whenever the front panel meters are updated, or voltage and current queries are made. In NORMAL mode, the A/D converter does not contribute to the output noise. If your application is such that you have no strong reason to select either NORMAL or FAST mode, it is recommended that you use NORMAL mode.

4-5 CONNECTING THE LOAD

This sub-section discusses the procedures and precautions you should follow when connecting the load. A major consideration in connecting the load is the wire size. This is discussed and selection details are presented in Table 4-1. The two load sensing configurations (local and remote sensing) are then discussed in detail together with procedures for strapping the supply's output and setups for multiple load applications. All load connections are made to the supply at the "+" and "-" terminals on the rear panel terminal block.

4-6 Wire Size Selection

WARNING

FIRE HAZARD

To satisfy safety requirements, load wires must be heavy enough not to overheat while carrying the short-circuit output current of the unit. Table 4-1 lists the current-carrying capacity (ampacity) for various sizes of stranded wire.

The minimum wire size required to prevent overheating may not be large enough to prevent OV trip and to maintain good regulation. The load wires should be large enough to limit the voltage drop to no more than 2.0 volt per lead. When sensing locally, any voltage drop in the load leads appears directly as CV load regulation. With remote sensing, the CV load regulation specification depends on the load lead drop discussed in paragraph 4-8.

Table 4-1. Wire Size Selection Guide

Wire Size		Ampacity Per Wire (Amps)	Resistance Per unit length (Ω /ft.)
AWG	Area (mm^2)	2 Wire Bundle at 20°C rise	
20	0.62	3.6	0.010
18	0.81	5.8	0.0064
16	1.32	9.4	0.0040
14	2.08	14.8	0.0025
12	3.29	23.4	0.0016

4-7 Local Sensing

The supply is shipped from the factory with its terminal block at the rear panel configured for local sensing—that is, with its +S terminal strapped to + and -S to - as shown in Figure 4-2.

When sensing locally, the resistance of the load leads will severely degrade the CV load regulation of the supply (measured at the load). For this reason, use local sensing in applications where CV load regulations is not critical, for example, in applications where the load current is virtually constant, or where the supply is operating in CC mode.

4-8 Remote Voltage Sensing

When the supply is strapped for local sensing, an unavoidable voltage drop is developed in the load leads and this adds to its voltage regulation. By connecting the supply for remote voltage sensing, (Figure 4-3) voltage is sensed at the load rather than at the supply's output terminals. This will allow the supply to automatically compensate for the voltage drop in the load leads and improve regulation. In remote sensing, the VOUT? query and the front-panel meter monitor the load voltage at the sense points.

When the supply is connected for remote sensing, the OVP circuit senses at the main output terminals and not at the sense leads. The voltage sensed by the OVP circuit could be significantly higher than the voltage being regulated at the load. Program the OVP trip voltage accordingly.

CV Regulation: The CV load effect specification in Table 1-1 applies at the rear terminals of the supply. When remote sensing, add 5 mV to this specification for each 1 V drop in the negative load lead. For example, if the voltage drop on the negative load lead is 300 mV, add 0.3×5 mV to the CV load effect specification.

Any voltage drop in the sense leads adds directly to the CV load effect. In order to maintain the above specified performance, keep sense lead resistance to 0.5 ohms per lead or less.

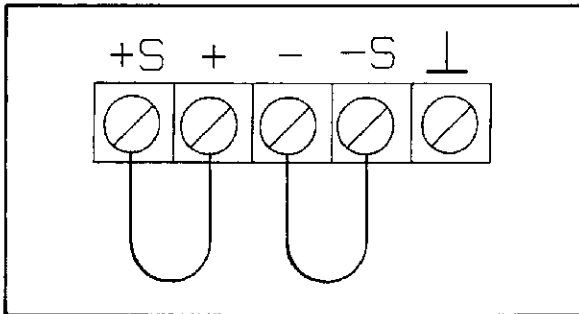

Figure 4-2. Set-up For Local Sensing

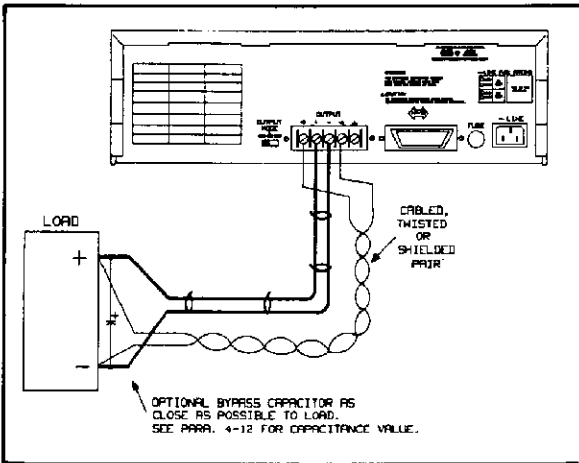

Figure 4-3. Remote Voltage Sensing

Remote Sense Connections: Turn off the supply before making or changing any connections on the rear panel terminal blocks. Connect the unit for remote sensing by first disconnecting the jumpers between sense and load terminals and then make the connections as shown in Figure 4-3. Connect the sense leads as close to the load as possible. Select your load lead from Table 4-1. The length of the leads should be as short as is practical.

The sense leads are part of the supply's feedback path. Connect them carefully so that they do not become open circuited. Keep their resistance at or below 0.5 ohms per lead. The supply includes protection resistors that reduce the effect of open sense leads during remote sensing. If sense leads open during operation, the supply returns to local sensing mode with the voltage at the output terminals approximately 2% higher than the programmed value.

Output Noise: Any noise picked up on the sense leads will appear at the supply's output and may adversely affect CV load regulation. Twist the sense leads to minimize the pickup

of external noise and run them parallel and close to the load leads. In noisy environments, it may be necessary to shield the sense leads. Ground the shield at the power supply end only. Do not use the shield as one of the sensing conductors.

Stability: When the supply is connected for remote sensing, it is possible for the impedance of the load wires and the capacitance of the load to form a filter, which will become part of the supply's CV feedback loop. The extra phase shift created by this filter can degrade the supply's stability and can result in poor transient response performance. In extreme cases, it can cause oscillations.

It is difficult to state simple rules defining the conditions under which this can occur, and what corrective action to take. A certain amount of trial and error may be called for. Two guidelines which are almost always valid are:

- a. keep the leads as short as possible.
- b. twist the load leads together to minimize inductance.

In most circumstances, once these two guidelines are followed, problems associated with the load lead inductance are eliminated, leaving the load lead resistance and load capacitance as the major cause of the reduced stability. In this case, you may obtain further improvement to the stability by:

1. keeping the load capacitance as small as possible, and
2. increasing the diameter of the load leads to reduce resistance.

If heavier gauge load leads (#10 and greater) are used, circumstances may arise when the load lead inductance and the load capacitance can form an underdamped filter, which can sometimes have a highly destabilizing phase response. In this case, steps 1 and 2 can worsen the stability since they will reduce the damping in the system.

If you experience any difficulty contact an HP service engineer through your local Hewlett-Packard Sales and Service office.

4-9 Multiple Load Connections

When the supply is in local sensing mode and you are connecting multiple loads to the output, connect each load to the output terminal using separate connecting wires. This minimizes mutual coupling effects and takes full advantage of the power supply's low output impedance. Each pair of wires should be as short as possible and twisted or bundled to reduce lead inductance and noise pickup.

If cabling considerations require the use of distribution terminals that are located remotely from the supply, connect the power supply output terminals to the remote distribution terminals by a pair of twisted or bundled wires. Connect each load to the distribution terminals separately. Remote voltage sensing is recommended in these circumstances. Sense either at the remote distribution terminals or, if one load is more sensitive than the others, directly at the critical load.

4-10 LOAD CONSIDERATIONS

This sub-section provides information on operating your supply with various types of loads connected to its output.

4-11 Output Isolation

The output of the power supply is isolated from earth ground. Either output terminal may be grounded, or an external source of voltage may be connected between either output and ground. However, both output terminals must be kept within ± 240 Vdc of ground. This includes the output voltage. An earth ground terminal is provided on the rear panel terminal block.

4-12 Capacitive Loading

When set to FAST mode, the supply can maintain stability only for small capacitive loads. Specifically, the maximum values are:

6632A: 1.0 μ F
6633A: 0.22 μ F
6634A: 0.10 μ F

In NORMAL mode, the supply will be stable for almost any size load capacitance (for remote sense stability considerations, see paragraph 4-8). However, large load capacitors may cause ringing in the supply's transient response. It is even possible that certain combinations of capacitance and ESR (Equivalent Series Resistance) will result in instability. If this occurs, the problem may often be solved by either increasing or decreasing the total load capacitance.

In addition, the OVP circuit's SCR crowbar has been designed to discharge capacitances up to a specific limit. These limits are:

6632A: 50,000 μ F
6633A: 20,000 μ F
6634A: 10,000 μ F

If your load capacitance approaches these limits, it is recommended that you do not intentionally trip the OVP and discharge the capacitance through the SCR as part of your normal testing procedure, as this may lead to long term fatiguing of some components. If desired, the SCR may be disconnected, as described in paragraph 4-15.

A large load capacitance may cause the supply to cross into CC or Unregulated mode momentarily when the output voltage is reprogrammed. In CC mode, the slew rate of the output voltage will be limited to the programmed current divided by the total load capacitance (internal and external). This will affect programming times.

4-13 Inductive Loading

The specified mode for driving inductive load is the FAST mode, although the user will typically experience stable condition in NORMAL mode. Inductive loads present no loop stability problem for CV operation but it may cause problems for CC operation if the load impedance is outside the boundaries mentioned below.

The ratio of the load inductance (L) to the sum of the ESR (Equivalent Series Resistance) for the load (R1) and power supply (Rs) determines whether the supply can drive a load without becoming unstable. To help you determine this ratio, the value of Rs is listed as:

Model	Rs
6632	0.2 ohm
6633	1.0 ohm
6634	2.0 ohm

If the ratio, $L/(R1 + Rs)$ is less than 0.005, the supply can reliably drive the load. However, if you require ratios larger than 0.005, up to a maximum of 0.10, four additional compensation components must be installed in the CC control loop. To insert these components, do the following:

CAUTION

Conversion of the supply to drive larger inductive loads must be done by service-trained personnel.

1. Turn off the ac power, disconnect the line cord, and remove the PC board from the unit. See the Service Manual - Option 910 for details.
2. Find the four components locations (R400, R401, C400, and C401) located at the front edge of the board.
3. Insert a 1/8 W, 1%, 21.5 K ohm resistor in locations R400 and R401, HP 0757-0199.
4. Insert a 0.47 μ F, 50 V, 10% ceramic capacitor in C400 and C401, HP 0160-4441.
5. Solder components. Trim exposed lead at the underside of the PC board to less than 1/8 inch. Replace the cover, power up the supply and check for proper operation.

4-14 Battery Charging

The power supply's OVP circuit contains a crowbar SCR, which effectively shorts the output of the supply whenever the OVP trips. If an external voltage source such as a battery is connected across the output, and the OVP is inadvertently triggered, the SCR will continuously sink a large current from the source; possibly damaging the supply. To avoid this one of two steps must be taken. Either the SCR must be removed from the circuit (see para. 4-15), or a diode must be connected in series with the output as shown in Figure 4-4.

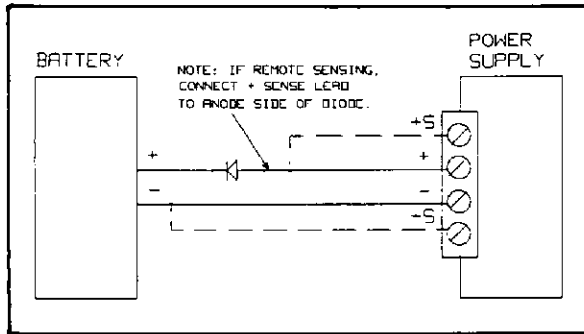

Figure 4-4. Recommended Protection Circuit for Battery Charging

4-15 SCR Removal

In some applications, it is necessary to disconnect the crowbar SCR from the output. This is accomplished by removing two jumpers W3 and W4 (shown in Figure 4-5) which are soldered to the board. With the jumpers removed, the OVP circuit continues to function. However, when it trips, it simply disables the supply's output stage without crowbaring the output to zero through the SCR. Re-solder the jumpers to reconnect the SCR.

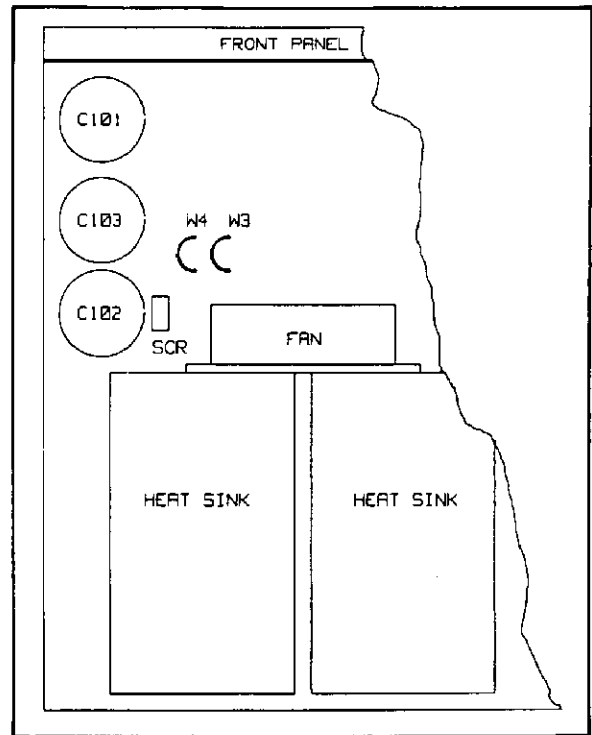

Figure 4-5. SCR Removal

Section V LOCAL PROGRAMMING

5-1 INTRODUCTION

So far you have learned how to install your supply, perform turn-on checkout, and connect an external load to your supply. During the turn-on checkout, you were briefly introduced to programming from the front panel as you learned how to program voltage and current. This section will describe in greater detail the use of these front panel keys and show how they are used to accomplish basic power supply operations.

This section breaks down the Front Panel (shown in Figure 5-1) into five major groups organized by the task they perform. These groups are the LCD display; the output control keys; the mode control keys; the system control keys; and the entry keys. However, before these groups are discussed, a brief overview of the important programming features of the supply is given. Some of these features are also discussed in the Remote Programming Section.

5-2 Programming Overview

The HP 6632A—34A power supplies will accept programming values directly in volts and amps. The maximum programmable voltage, current, and overvoltage ranges for each model are given in Table 6-2. The power supply will round off values received to the nearest multiple of the resolution. If you send a value outside the valid range, it will be ignored and the display will read "OUT OF RANGE".

When you press the **VSET**, **ISET** or **OVSET** key, the present setting for that function will be displayed. Press the numeric keys to change the setting and use the **CLEAR** **ENTRY** key to erase partial entry if you made a mistake.

Pressing the **ENTER** key will enter the values displayed for the function indicated, and return the display to the metering mode. In this mode, the measured output voltage and current are displayed. If you press the **ENTER** key without entering numbers, the previous values will be retained and the display will return to the metering mode.

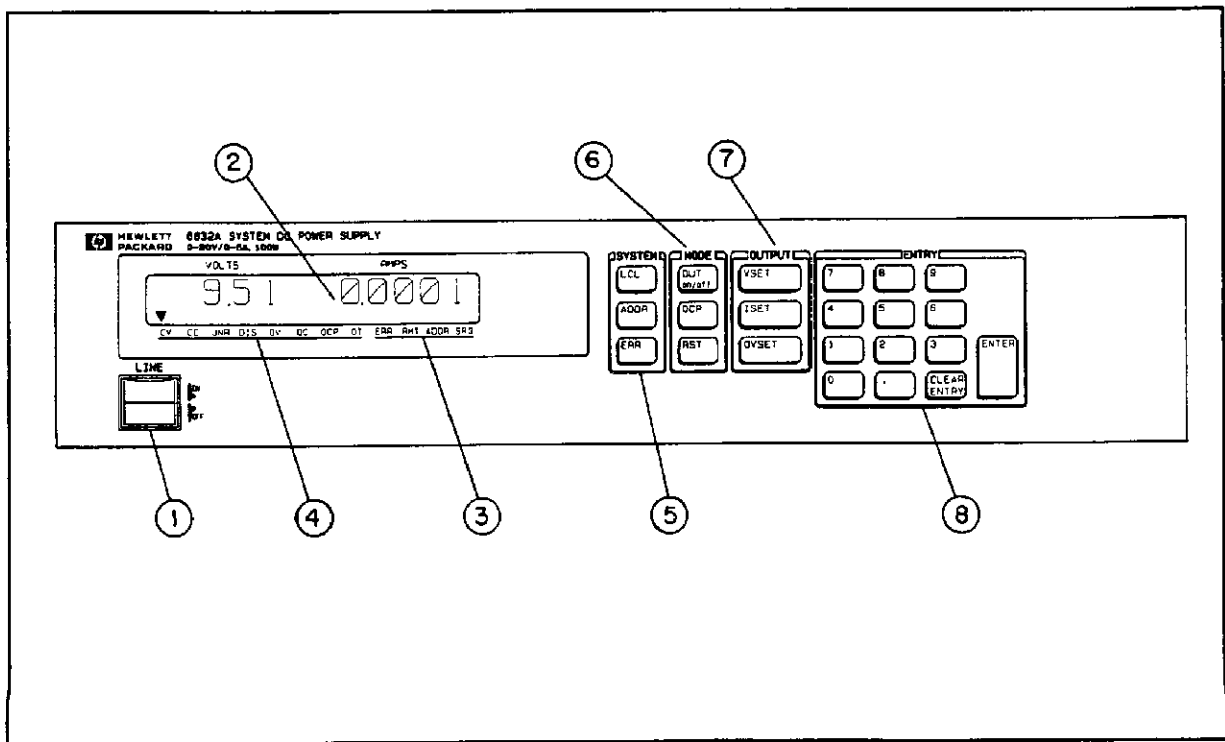

Figure 5-1. HP 6632A Front Panel

Table 5-1. Controls and Indicators

Number	Controls/Indicators	Description	Para. Ref.
1	LINE SWITCH	Turns the ac power on and off.	3-2
2	LCD DISPLAY	Displays the measured output voltage and current; indicates errors; and indicates the HP-IB address.	5-3
3	HP-IB STATUS ANNUNCIATORS	<p>RMT — The supply is operating under remote control.</p> <p>ADDR — The supply is addressed to talk or listen.</p> <p>SRQ — The supply is requesting service.</p> <p>ERR — a programming or calibration error has occurred.</p>	<p>6-38</p> <p>6-36</p> <p>6-25</p> <p>5-14</p>
4	POWER SUPPLY STATUS ANNUNCIATORS	<p>CV — The output is operating in the constant voltage mode.</p> <p>CC — The output is operating in the positive or the negative constant current mode.</p> <p>UNR — The output is unregulated ie, it is neither in the CV nor CC mode and it is not disabled.</p> <p>DIS — The output was disabled by the user.</p> <p>OV — The overvoltage circuit has tripped and has disabled the output.</p> <p>OC — The overcurrent circuit has tripped and has disabled the output.</p> <p>OCP — The overcurrent protection function is enabled.</p> <p>OT — The overtemperature circuit has tripped and has disabled the output.</p>	<p>4-2</p> <p>4-2</p> <p>4-3</p> <p>5-8</p> <p>5-6</p> <p>5-9</p> <p>5-9</p> <p>6-19</p>
5	SYSTEM CONTROL KEYS	<p>LCL — Returns the supply to Local Mode and turns on the display if it was off provided the local lock out command was not previously sent.</p> <p>ADDR — Provides the only means to display or change the HP-IB address.</p> <p>ERR — Displays a programming or calibration error and clears the Error register and the ERR bit in the Serial Poll register if SRQ is not sent. See para. 5-14.</p>	<p>5-12</p> <p>5-13</p> <p>5-14</p>
6	MODE CONTROL KEYS	<p>OUT ON/OFF — Toggles the output on/off. When the output is disabled, the DIS annunciator is on.</p> <p>OCP — Enables or disables the OCP circuit. When enabled, the OCP annunciator is on.</p> <p>RST — Resets the OVP & OCP circuits and returns the output to its previous setting provided the condition that caused the fault was removed.</p>	<p>5-8</p> <p>5-9</p> <p>5-10</p>

Table 5-1. Controls and Indicators (continued)

Number	Controls/Indicators	Description	Para. Ref.
7	OUTPUT CONTROL KEYS	VSET — Used to display or change the present voltage setting.	5-5
		ISET — Used to display or change the present current setting.	5-5
		OVSET — Used to display or change the present overvoltage trip setting.	5-6
8	NUMERIC ENTRY KEYS Used in conjunction with VSET, ISET, OVSET and ADDR	0–9 — Used to set the value of the specified function.	5-2
		CLEAR ENTRY — Clears the partially built command and returns the display to the metering mode.	
		ENTER — Enters the values on the display for the specified function and returns the display to the metering mode.	

5-3 THE LCD DISPLAY

The LCD Display is the window of the power supply. It indicates the voltage and current settings and informs the user of any malfunction such as an error or overvoltage. The display also communicates with the user via twelve annunciators (▼) which are used to indicate the present status of the supply. For example, if the unit is operating in the constant voltage (CV) mode and controlled via the front panel, then only the CV annunciator is turned on. If however, the supply is remotely controlled, the annunciators above CV and RMT will be turned on, and if the supply is being addressed, the ADDR annunciator will also be turned on. Table 5-1 discusses the annunciators in detail.

5-4 OUTPUT CONTROL KEYS

The 6632A-34A power supplies will accept programming values directly in volts and amps. The programmable voltage, current, and overvoltage ranges for the output of each model are given in Table 6-2. The supply will round off the values received to the nearest multiple of its resolution. If you send a value out of the valid range, it will be ignored and an "OUT OF RANGE" message will be displayed.

5-5 Programming Voltage & Current

The output's voltage is programmed locally using the **VSET** key and the current is programmed using the **ISET** key. The output is programmed in volts and amps. For example to program the output to 5.25 volts, press

VSET **5** **.** **2** **5** **ENTER**

To program the output to 0.5 amps, press

ISET **0** **.** **5** **ENTER**

In both examples, once the new programmed values are entered, the display will revert to the metering mode and display the actual voltage and current at the output terminals. However, if you want to re-check the voltage or current settings, press **VSET** or **ISET** and the last programmed value will be displayed.

If you program the current to a value less than the minimum programmable current, the supply will reject this value and automatically set the current to the minimum programmable value. See Table 6-2 for minimum programmable current values.

5-6 Programming Overvoltage Protection

Programmable overvoltage protection guards your load against overvoltage. If the programmed overvoltage is exceeded, the OVP circuit is activated. This circuit will fire the SCR crowbar, disable the output, and turn on the OV annunciator. The supply's OVP setting is programmed locally using the **OVSET** key. For example to program the overvoltage to 9.5 volts, press

OVSET **9** **.** **5** **ENTER**

5-7 MODE CONTROL KEYS

These keys affect the state of the output by enabling and disabling the output and the protection circuits; and restoring the output following an overcurrent or overvoltage condition.

5-8 Enabling/Disabling the Output

The output can be turned on and off from the front panel using the **OUT ON/OFF** key. When the supply is in the OFF state, the DIS annunciator is turned on, and the output is disabled. While disabled the supply will continue to accept new commands that will change the output settings when the output is re-enabled. The **OUT ON/OFF** key will not affect any other programmed functions nor will it reset an over-voltage or overcurrent condition.

5-9 Enabling/Disabling Overcurrent Protection (OCP)

The overcurrent protection guards against excessive output currents. When the output goes into the +CC or -CC mode and OCP is enabled, the OCP feature is tripped, the OC annunciator is turned on and the output is disabled.

The output's overcurrent protection feature can be toggled on and off from the front panel using the **OCP** key. When the OCP feature is enabled, the OCP annunciator is turned on.

5-10 Resetting OVP and OCP

The condition that caused the OVP or OCP must first be removed before you can successfully reset the supply. To clear the OVP condition, either program the voltage below the OV setting or program the OV above the voltage setting then press the **RST** key to return the supply to its previous state.

To clear the OCP condition, you can either program the current above the current demanded by the load, or you can disable the OCP circuit by pressing the **OCP** key and then press the **RST** key to return the supply to its previous state.

5-11 SYSTEM CONTROL KEYS

These keys consist of the **LCL**, **ADDR**, and **ERR** keys as shown in Figure 5-1. These keys are used for returning the supply to local operation, setting the supply's HP-IB address, and displaying error messages.

5-12 Local Mode Operation

At power-on, the supply is automatically set to operate in the local mode. When in this mode, the front panel keys can be used for programming. If during operation the supply is in remote mode, you can return to local mode at any time by pressing the **LCL** key provided you did not previously send the local lockout command. In remote mode, the RMT annunciator is turned on; the keypad is disabled (except the **LCL** key); and the supply is controlled by an external HP-IB controller. A change between the local and remote modes will not result in a change in the output parameters.

5-13 Setting the Supply's HP-IB Address

Before you can operate the supply remotely, you must know its HP-IB address. The only means of checking the present address or changing to a new address is the **ADDR** key. To find out the present address setting, simply press

ADDR

The supply's present address will then be displayed. Address 5 is the factory set address. If you want to keep this address setting, return to metering mode by pressing the **CLEAR ENTRY** or **ENTER** key. If you want to change the address, enter a new value from 0 through 30.

5-14 Displaying Error Codes

When the supply detects a programming error, the **ERR** annunciator is lit. You can find out the type of error by first returning to local mode and then pressing the **ERR** key. If the SRQ is being sent, pressing the **ERR** key will turn off the error annunciator, clear the error register, and clear the error bits in the Status and Serial Poll registers. (See Table 6-6 for a listing of the error codes.)

When the supply is operating in local mode and you program an out of range value, it will reject the value and display the "OUT OF RANGE" message but it will not set the error bit. You can clear this message by pressing the **ADDR**, **ERR**, output control keys, the **ENTER** or **CLEAR ENTRY** key.

Section VI REMOTE PROGRAMMING

6-1 INTRODUCTION

This section describes how you should remotely program your power supply. You should already have gained some experience in programming your supply using the front panel keys. This section builds on these programming concepts as it describes in detail the programming commands and how they can be used in your applications. All application examples are written using the HP Series 200/300 controller and the HP BASIC Language. You should be familiar with the use of your computer and its instruction set and how the power supply commands can be incorporated into your computer commands. This section is organized with the following sub-headings:

Programming Syntax and Introduction to Programming

These two sub-sections introduce you to the pre-requisites of programming and describe the following tasks you must complete before you begin programming:

1. Set the HP-IB address of the supply.
2. Use this address as part of your command string to send information to and get information from your supply.

Essential Programming & Advanced Programming Features

These sub-sections describe the commands needed to program your supply. Essential Programming Features discusses the fundamental power supply operations such as programming voltage and current. A programming example presented at the end of this sub-section demonstrates how the commands are used in a typical program. Advanced Programming Features discusses implementation of the more difficult power supply concepts such as the supply's status reporting capability.

Error Reporting & System Queries

Error handling capability is described in this sub-section. All error codes are described in a table. The way the supply deals with its own system function queries is discussed next. Here all system queries such as queries to invoke self-test and ROM version are described along with examples.

HP-IB Interface Functions

Finally, the HP-IB Interface functions are briefly discussed to show which HP-IB interface functions are supported and how they can be used in programming your supply.

6-2 PROGRAMMING SYNTAX

The following paragraphs describe the syntax of the device command that is used to program your supply. Figure 6-1 shows the structure of a typical programming statement for an HP Series 200/300 computer using BASIC. The Device Command is the command to the power supply which your computer will send. The Computer Command is computer specific and language specific. If you are using a different computer or programming language, refer to your computer programming manual to determine the correct syntax of the program statement.

Figure 6-2 shows the syntax form for the device commands that are used to program the HP 6632A -34A system power supplies. Figure 6-2 (a) is the generic syntax diagram for all commands whereas Figure 6-2 (b) and (c) are details of blocks contained in Figure 6-2 (a). The header must be entered as shown in Table 6-1 and is accepted in either uppercase or lowercase letters (ASCII characters). Delimiters and signs contained in the small circles must be entered exactly as shown. A space may be inserted anywhere within the command string to improve readability. A line feed <LF>, semi-colon <;> or carriage return-linefeed <CR-LF> is used to terminate the command or it may be terminated by asserting EOI (End Or Identify) concurrent with the last data byte, (see Figure 6-2 (c)).

6-3 Numeric Data

The HP 6632A-34A will accept numeric data in implicit point, explicit point, or scientific notation. Implicit point notation means that numbers do not contain a decimal point—i.e., integers. Numbers written in explicit notation contain a decimal point eg. 12.5. In scientific notation, the number has an exponent E associated with it. E is read as "10 raised to", for example 1.2E3 is read as 1.2 times 10 raised to the 3rd power which equals 1200. Plus or minus signs are considered numeric characters and are optional. Except during calibration, sending a negative number will generate a programming error.

The supply will also return numeric data (ASCII characters) to your computer. The format of the numbers returned depends upon the type of data requested. See Table 6-1.

If you program a number with a accuracy greater than the resolution of the supply, the number will automatically be rounded to the nearest multiple of the power supply's resolution. Table 6-1 gives the ranges for numeric data sent to the supply.

6-4 Terminators

Terminators mark the end of a command string. As shown in Figure 6-2 (c) the semi-colon <:;>, line feed <LF>, carriage return-line feed <CR> <LF> and EOI are used to indicate the end of a message to the power supply. When using the HP Series 200/300 computer with Basic to send a command using the standard format, the computer will automatically send <CR> <LF> on the data bus following the command.

6-5 Order Of Execution

When you send a set of instructions to the supply, they are executed in the order in which they are received. The supply completes the execution of the current command before executing another command. To send more than one command within the supply's command string, use a semi-colon to separate the commands.

6-6 INTRODUCTION TO PROGRAMMING

This sub-section discusses how to send information to the supply and how to get information back. The HP-IB address of the supply plays an integral part in this process and is described first. This is followed by explanations of how to send a remote command and how to get back a response from the supply via the HP-IB. The Input/Output statements used in the examples are from the HP Series 200/300 computer using BASIC language. You should be familiar with the Input/Output statements of your own computer and how they can be used to implement the power supply commands

6-7 HP-IB Address Selection

Before you can operate your supply remotely, you need to know its HP-IB address. You can find out, or change the present address by using the front panel **ADDR** key. To find out the present address, press the **ADDR** key. The displayed response is the power supply's HP-IB address which is stored in its non-volatile memory. When sending a remote command, append this address to the HP-IB interface select code to uniquely identify the supply on the HP-IB bus. See Figure 6-1.

The supply's address is factory set to decimal 5. Any address from 0 through 30 is a valid address. If you need to change the supply's address, for example from the address 5 to address 14, press:

ADDR **1** **4** **ENTER**

6-8 Sending a Remote Command

To send the power supply a remote command, combine your computer's output statement with the HP-IB interface select code, the HP-IB device address and the power supply command as shown in Figure 6-1. For example, to set the output voltage to 2 volts, send the following:

OUTPUT 705; "VSET 2"

6-9 Getting Data From Your Supply

Your supply is capable of measuring the values of its output parameters in response to queries and returning these values to the controller. In this example, the supply is asked to measure its output voltage:

OUTPUT 705; "VOUT?"

After the command is sent, address the supply to talk. This allows the supply to output the measurement to the computer for display. Use your computer's enter and display statements to accomplish this. For example in the following program segment:

ENTER 705:A
DISP A

the ENTER statement enters whatever is in the supply's output buffer into the computer defined variable A. The DISP statement displays the contents of A on the computer's screen.

6-10 ESSENTIAL PROGRAMMING FEATURES

This section discusses the often used commands which are needed to remotely program your supply. Before programming, you should be aware of the maximum programmable values of voltage, current, and overvoltage. These are listed in Table 6-2. Check also the default values of the power supply parameters and become familiar with the program syntax listed in Table 6-1.

6-11 Programming & Reading Back Voltage and Current

NOTE

The supply will round the VSET and ISET settings to the nearest multiple of their resolution. Table 6-2 lists the approximate resolution of these settings. The actual resolution varies slightly with the calibration of the supply.

When the output is operating in the CV mode, the actual voltage is the programmed voltage and the programmed current is the current limit. When in CC mode, the actual current is the programmed current and the programmed voltage is the voltage limit.

To program voltage, always send the programmed value in volts. For example, to program the output to 5 V, send:

VSET 5

To program the output to 450 millivolts, send:

VSET 0.45

To readback the value of the actual output voltage, instruct the supply to measure its output voltage by sending

VOUT?

and address the supply to talk. The results are placed on the HP-IB and read into the computer.

To program current, always send the programmed value in amps. For example to program the output to 0.9 amps, send:

ISET 0.9

To program the output to 95 milliamps, send:

ISET 95E-3

To measure the value of the actual output current send the query:

IOUT?

and address the supply to talk. The results are placed on the HP-IB and read into the computer.

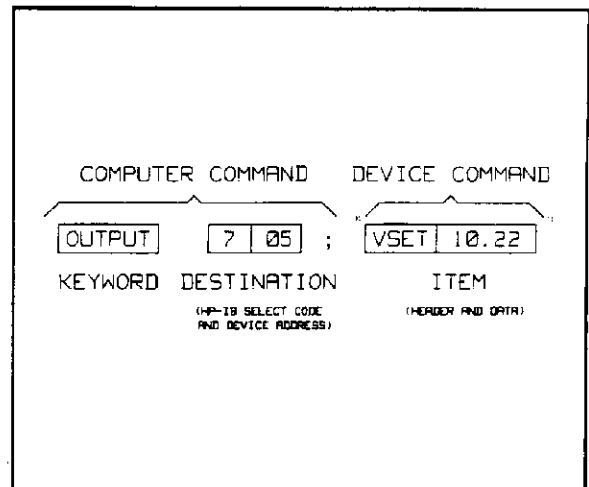
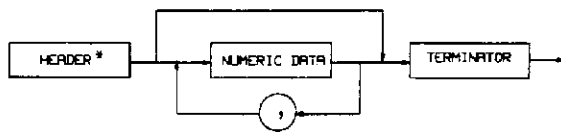

Figure 6-1. Typical Program Statement for Series 200 Computers



*SEE TABLE 6-1.

Figure 6-2(a). Syntax Diagram for Power Supply Commands

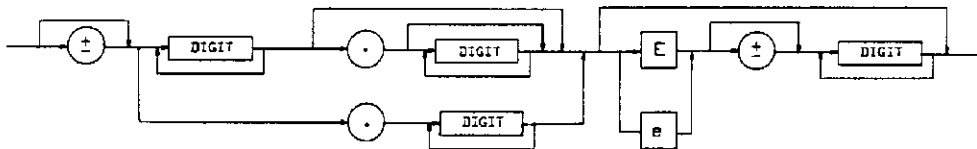
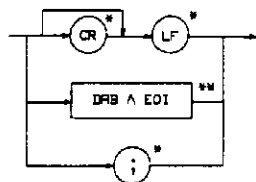

Figure 6-2(b). Syntax Diagram for Numeric Data



*EOI MAY BE INSERTED DURING THIS BYTE WITHOUT ERROR.

**EOI SENT CONCURRENTLY WITH LAST DATA BYTE.

NOTE: SPACES MAY BE INSERTED ANYWHERE IN THE COMMAND.

Figure 6-2(c). Syntax Diagram for Terminator

Figure 6-2. Syntax Diagrams

Table 6-1. Summary of Power Supply Instruction Set

Description	Header	Instr. Type	Data Range	Data Representation	Power-On Default Value	Page Ref.
Program Voltage	VSET	C	See Table 6-2	DATA	0	6-2
Program Current	ISET	C	See Table 6-2	DATA	Min. Value	6-3
Query Voltage	VOUT?	Q	See Table 6-2	SZD.DDD** SZZD.DD	0 (approx.)	6-2
Query Current	IOUT?	Q	See Table 6-2	SD.DDDD	0 (approx.)	6-3
Program OVP	OVSET	C	See Table 6-2	DATA	Max. Value	6-5
Set Overcurrent Protect.	OCP	C	0,1	DATA	0(OFF)	6-5
Reset OV and OC	RST	C	—	—	—	6-5
Output On/Off	OUT	C	0,1	DATA	1(ON)	6-5
Set Supply To Power-on Default Settings	CLR	C	—	—	—	6-6
Set Mask Register	UNMASK	C	0-4095	DATA	0	6-8
Query Fault Register	FAULT?	Q	0-4095	ZZZZD	0	6-9
Query Status Register	STS?	Q	0-4095	ZZZZD	Depends on output state	6-7
Query Accumulated Status	ASTS?	Q	0-4095	ZZZZD	Same as Status	6-8
Service Request	SRQ	C	0,1	DATA	0(OFF)	6-11
Power-on Service Request	PON	C	0,1	DATA	Last stored value	6-11
Reprogramming Delay	DLY	C	0-32.767	DATA	8 ms FAST 80 ms NORMAL	
Display On/Off	DSP	C	0,1	DATA	1(ON)	6-11
Query Error Register	ERR?	Q	0-59	ZZZZD	0	6-13
Self-Test Results	TEST?	Q	0-24,51	ZZZZD	0	6-13
Model Number	ID?	Q	—	HP663XA	—	
Query ROM Version	ROM?	Q	—	AAA AAA	—	6-13
Calibration Mode	CMODE	C	0,1	DATA	0(OFF)	
Send Calibration Data	CDATA	C	D1,D2,D3	DATA,DATA DATA	Last stored value	
Save Calibration Const.	CSAVE	C	—	—	—	

A = Alpha C = Command D = Digit Z = Digit with leading zeros output as spaces

Q = Query DATA = +65535 E+63 to -65535 E-64 D1=1-4; D2=0-65535; D3=DATA

S = Sign (blank for positive and "-" for negative numbers)

**SZD.DDD describes the data representation for HP6632A and HP6633A. SZZD.DD describes the data for HP6634A

Table 6-2. Programmable Output Ranges

Model	Output Voltage * (avg. resolution)	Output Current** (avg. resolution)	Overvoltage (avg. resolution)
6632A	0 to 20.475 V (0.005 V)	0.02 to 5.1188 A (0.00125 A)	0 to 22 V (0.1 V)
6633A	0 to 51.188 V (0.0125 V)	0.008 to 2.0475 A (0.0005 A)	0 to 55 V (0.25 V)
6634A	0 to 102.38 V (0.025 V)	0.004 to 1.0238 A (0.00025 A)	0 to 110 V (0.5 V)

* The maximum programmable voltage and current are 2.375% higher than the rated output voltage and current. The programmable ranges for voltage and current are approximately the same as the data range for voltage and current readback.

** The output "wakes up" with current programmed to a small positive value. The output cannot be programmed to zero amps. This permits the voltage to be programmed up without programming the current. If the output receives a command to go to zero amps, or any positive current below the minimum programmable current, it will default to the minimum programmable value and no error will be generated.

6-12 Programming the Overvoltage (OVP) & Overcurrent (OCP) Protection Features

The programmable OVP and Overcurrent protection (OCP) are two protection features which you can set to protect the load against excessive voltages and excessive currents respectively. The OVP circuit is tripped when the actual output voltage exceeds the programmed overvoltage setting. Once tripped, the OVP circuit fires the SCR crowbar which shorts the output and disables the supply. The output will remain in the disabled state until the reset or the clear command is sent.

As an example to program the OVP to 9.5 V, send:

OVSET 9.5

For the OCP to become activated and disable the output, two conditions must be met. First, the OCP feature must be enabled. Second, the output must change from the CV mode to the CC mode of operation. When these two conditions exist, the OCP trips and disables the output. The output remains disabled until the reset or the clear command is sent. To enable the OCP, send:

OCP 1

To disable the OCP, send:

OCP 0

The delay feature can be used to prevent false tripping of the OCP. For more detailed discussion, see paragraph 6-22.

6-13 Resetting OVP & OCP

To reset OVP or OCP and restore the output after it went into OV or OC, you must first remove the cause of the overvoltage or overcurrent condition and then send:

RST

If the condition causing the OVP or OCP to trip is not removed, the output will be disabled again after you send the reset command. To remove the condition causing the OV, first program the output below the OVP setting, then send the reset command. To remove the condition causing the OC, either disable the OCP or program the output current above the current demanded by the load, then send the reset command.

6-14 Output On/Off

The output on/off command is used to temporarily disable the power supply output. When disabled (off), the supply will still continue to accept new commands that will change the output settings when the output is re-enabled.

To disable the output send:

OUT 0

To enable the output send:

OUT 1

6-15 Clear

This command will return the supply to its power-on state. This is useful for initializing the supply to a known state at the beginning of a program. CLR will clear the PON bit in the Serial Poll register (see paragraph 6-23). All other parameters are returned to their power-on default values and the power supply remains addressed to listen. The CLR command does not complete until the supply's internal circuits have had time to settle. Because of this, the command will take a longer than average time to execute. To invoke this command send the following:

CLR

Sending the HP-IB command DEVICE CLEAR or SELECTED DEVICE CLEAR will have the same effect as the CLR command.

6-16 Example Program

The following program illustrates the use of some power supply commands. Its first puts the supply in its power-on state. Then it programs the voltage, current, and OVP settings. Then it calls a subroutine which reads back the actual output voltage and current, and power supply status, and prints the results. It then programs the voltage above the OVP set point, causing the OVP to trip. And finally, it calls the above mentioned subroutine again, to read back and print the condition of the supply. Note that this program makes use of the status register which is discussed in the next section.

```
10  ASSIGN @Ps TO 705      ! Assume power supply is set to address 5.
20  OUTPUT @Ps;"CLR"      ! Resets supply to power-on state.
30  OUTPUT @Ps;"VSET 5"
40  OUTPUT @Ps;"ISET .5"
50  OUTPUT @Ps;"OVSET 7"
60  GOSUB Readback        ! Print out voltage, current, and status.
70  OUTPUT @Ps;"VSET 10" ! Should cause OVP to trip.
80  GOSUB Readback        ! Print out voltage, current, and status.
90  STOP
100 !
110 !
120 Readback:            !
130  OUTPUT @Ps;"VOUT?"
140  ENTER @Ps;Vout
150  OUTPUT @Ps;"IOUT?"
160  ENTER @Ps;Iout
170  OUTPUT @Ps;"STS?"
180  ENTER @Ps;Sts
190  !
200  PRINT "VOUT = ";Vout;"    IOUT = ";Iout
210  IF BIT(Sts,0) THEN PRINT "CV ";
220  IF BIT(Sts,1) THEN PRINT "+CC ";
230  IF BIT(Sts,2) THEN PRINT "UNR ";
240  IF BIT(Sts,3) THEN PRINT "OV ";
250  IF BIT(Sts,4) THEN PRINT "OT ";
260  ! Bit 5 is unused.
270  IF BIT(Sts,6) THEN PRINT "OC ";
280  IF BIT(Sts,7) THEN PRINT "ERR ";
290  ! Bit 8 is reserved for the Inhibit option.
300  IF BIT(Sts,9) THEN PRINT "-CC ";
310  IF BIT(Sts,10) THEN PRINT "FAST "
320  IF BIT(Sts,11) THEN PRINT "NORM "
330  PRINT
340  RETURN
350  !
360  END
```

6-17 ADVANCED PROGRAMMING FEATURES

This sub-section discusses more complex programmable features which are implemented by your supply. Most of these features can be used independently or can be combined with other features to enhance the supply's operating performance and widen the application possibilities. An example program is given to show how these commands can be combined in a typical application.

6-18 STATUS REPORTING

The power supply has the ability to report its internal status to the user whenever it is asked to do so. Status reporting involves reporting the power supply's operating state. The supply has four internal 12-bit registers that are used for reporting status. These are the Status, Accumulated Status, Mask, and Fault registers. The manner in which information is passed between these registers is shown by a conceptual model in Figure 6-3. Not only can you get the supply to report status, you can also program it to ignore any fault condition for a given time interval using the reprogramming delay feature. These features can be implemented by one of the following methods discussed below and summarized in Table 6-3.

1. Simply read the Status and the Accumulated Status registers any time you require status. The supply will respond with a number which you can decode (see Table 6-4) to obtain the present status or accumulated

status reading.

or

2. Define a set of fault conditions using the mask register and query the Fault register to check if one or more of these conditions has occurred. If you wish to suppress the reporting of transient power supply fault conditions for a given period, use the reprogramming delay feature to accomplish this.

or

3. Use the serial poll command to periodically check for a fault.

or

4. Set up the condition for the supply to automatically interrupt the controller whenever a fault occurs and use serial poll to find out the nature of the service request.

6-19 The Status Register

The power supply maintains its present status in its 12-bit Status register which reports the status of the supply whenever it is queried. A "1" in any of the bit positions indicates that the condition is true. As long as the condition continues to be true, the bit will remain set. Assignments for the bits are shown in Table 6-4. You can find out the present status of the supply by sending the following query and addressing the supply to talk:

STS?

Table 6-3. Summary Of Methods Used To Report Power Supply Status

Status Inquiries	Steps Required to Obtain Response	Paragraph Reference
Read present status	<ul style="list-style-type: none"> • Query Status Register. • If error bit is set in this register, query the Error register. 	6-19 6-29
Read Accumulated status	<ul style="list-style-type: none"> • Query Astatus Register. 	6-20
Poll supply for a Fault using a. Power supply registers	<ul style="list-style-type: none"> • Define fault condition(s) using the Mask register. • Query the Fault register. • If error bit is set in this register, query the Error register. 	6-21 6-29
b. Serial Poll	<ul style="list-style-type: none"> • Define fault condition(s) using the Mask register. • Send Serial Poll command. • If fault bit is set in Serial Poll register, query the Fault register. • If error bit is set in Fault register, query the Error register. 	6-21 6-23,6-40 6-21 6-29
Interrupt the Controller upon detection of a fault	<ul style="list-style-type: none"> • Define fault condition(s) using the Mask register. • Enable SRQ. If interrupted, then • Send the Serial Poll command • If fault bit is set in Serial Poll register, query the Fault register. • If error bit is set in the Fault register, query the Error register. 	6-21 6-25 6-23,6-40 6-21 6-29

The supply will respond with a number between 1 and 4095 which can be decoded from Table 6-4. Decoding of the reading is based on the weighted number placed on each bit. As shown in Table 6-4, bit position 3 has the bit weight of 8. Each bit is assigned to a particular condition and the corresponding bit weight is used to identify that condition.

6-20 Accumulated Status Register

In applications where a condition only momentarily occurs, even frequent polling may not detect it. To circumvent this problem, the supply maintains an Accumulated Status (Astatus) register which is similar to the Status register. Bits in the Astatus register are set if the corresponding bits in the Status register were set at any time since the Astatus register was last read. The Astatus register is reset to the present value of the Status register after it is queried. To query the Astatus register, send:

ASTS?

and address the supply to talk. The supply will respond with a decimal number between 1 and 4095. The bits are assigned as in Table 6-4. Here is an example to help you decode the power supply response following an Astatus register query.

If the supply was in +CC mode since the last reading of the Astatus register but it is presently operating in CV MODE and in NORM position, then the reading you will get when

you query the register will be 2051.

$$1 + 2 + 2048 = 2051$$

$$CV + CC + NORM$$

6-21 Fault & Mask Registers

These two registers are also arranged like the Status register. The Mask register works in conjunction with the Fault register. It is programmed by the user who selects the conditions (see Table 6-4) that will cause the supply to report a fault. A bit in the Fault register is automatically set by the supply when the following conditions are satisfied.

1. the corresponding bit in the Status register must change from "0" to "1" .
2. the corresponding bit in the Mask register must be previously set (unmasked).

To unmask a condition, send the following command:

UNMASK XXXX

where XXXX specifies the numeric code (0-4095) for the unmasked conditions selected from Table 6-4. The conditions will remain unmasked until you change them. If any of the unmasked conditions occur during operation, then the appropriate bit(s) in the status register will be set. With corresponding bit(s) in the Status and Mask registers set, the

Table 6-4. Bit Assignment for the Status, Astatus, Fault, & Mask Registers

Bit Position	11	10	9	8	7	6	5	4	3	2	1	0
Bit Weight	2048	1024	512	256	128	64	32	16	8	4	2	1
Condition	NORM	FAST	-CC	INH	ERR	OC	0*	OT	OV	UNR	+CC	CV
*not used												
<p>CV = Constant Voltage Mode +CC = Positive Constant Current Mode UNR = Output Unregulated OV = Overvoltage Protection tripped OT = Over-temperature Protection Tripped OC = Overcurrent Protection Tripped ERR = Programming Error INH = Remote Inhibit -CC = Negative Constant Current Mode FAST = Output in Fast operating mode NORM = Output in Normal operating mode</p> <p>UNR — indicates the supply is unable to regulate either in CV or CC mode. This may be caused by a low AC line condition or excessive voltage drop in the load leads when remote sensing.</p> <p>ERR — the ERR bit is set when a programming or calibration error occurs, and is cleared when the ERR? query is received.</p> <p>INH — indicates the output has been inhibited. This feature is available as an option. See Section I.</p> <p>NORMAL/FAST — the supply is always operating either in the NORMAL mode or in FAST mode. Therefore at all times one (not both) of these bits will be set.</p> <p>OT — indicates that the overtemperature circuit has tripped and has disabled the output. After the supply is sufficiently cooled, the output is re-enabled with all programming settings intact.</p>												

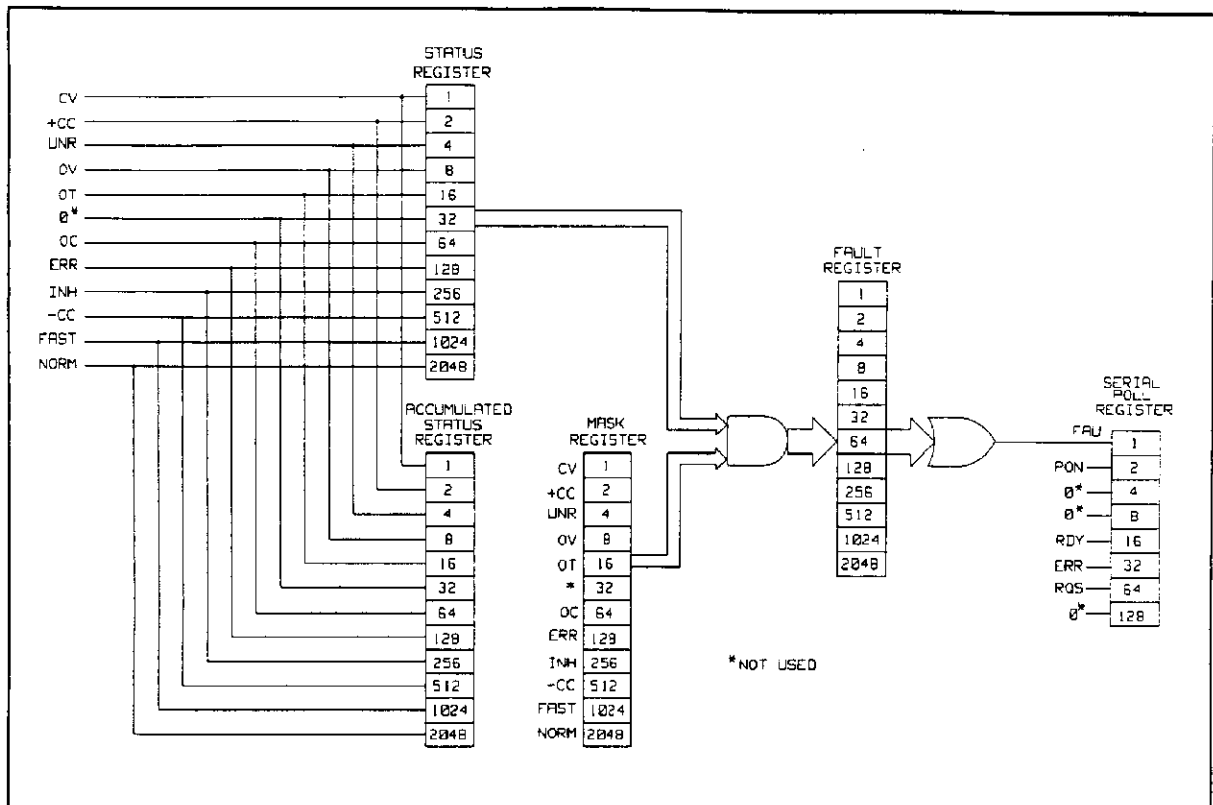

Figure 6-3. Conceptual Model of Power Supply Registers

supply automatically sets the same bit(s) in the Fault register. You can find out if a fault occurred by querying the Fault register. To do so send:

FAULT?

and address the supply to talk. The supply responds with a number which can be decoded from Table 6-4. Bits in the Fault register will remain set until the register is read, at which time they are cleared.

If both the Status and Mask register bits remain set after the Fault register was read (and cleared), the fault register will remain cleared as long as there are no changes in either the Status or Mask registers with the following exceptions: Executing a VSET, ISET, RST, OUT 0, or OUT 1 command will cause the CV, +CC, -CC or UNR bit (as applicable) in the Fault register to be set if they were already set in the Status register.

6-22 Reprogramming Delay

The supply may switch modes or become unregulated momentarily after a new output value is programmed. Because of their short duration, these cases may not ordinarily be considered a fault but the supply will recognize this deviation and generate a fault signal. In addition, if the OCP circuit is enabled, it may be falsely triggered. To prevent

these occurrences, the reprogramming delay feature is implemented.

Reprogramming delay will temporarily mask detection of certain fault conditions and prevent the supply from registering a fault when these conditions are true. When the delay is in effect, the CV, +CC, -CC and UNR bits of the Status register are masked and cannot communicate with the Mask and Fault registers and the OCP function. This will prevent the supply from registering a fault or triggering the OCP should any of these bits become momentarily set during the delay period. Reprogramming delay is initiated when any of the following functions are executed:

VSET, ISET, CLR, RST, OUT 0, and OUT 1

NOTE

The delay command only masks these conditions from appearing in the fault register. You can find if these conditions ever occurred by querying the Astatus register

The default delay time is 8 mS when the supply is operating in the FAST mode and 80 mS when it is in NORMAL mode. However you can program any value for the reprogramming

delay between 0 and 32.767 seconds in steps of 4 mS. If you specify a value which is not a multiple of 4 mS, the supply will round off the set value to the nearest 4 mS multiple. For example, to program a new delay value of 100 mS, send:

DLY 0.1

If you send a value outside the 0 to 32.767 S range, you will get a programming error. A common example which requires a delay time greater than the default, is driving a large capacitive load with a low current limit setting. In this case, when the output voltage is re-programmed, the supply may enter CC mode for an extended time while it charges the capacitor. If you want to Unmask the CC bit to generate faults or make use of the OCP feature, programming an appropriate delay time will allow you to avoid false indications or tripping.

6-23 Serial Poll

In paragraph 6-21, it was described that a fault bit in the Fault register is set when the same bit in the Status and Mask registers are both set. When any bit in the Fault register is set, the FAU bit in the Serial Poll register is also set (see Table 6-5). To find out if a fault occurred, send the serial poll command and check the status of the FAU bit. If the FAU bit is set, send the Fault query to find out exactly which condition caused the fault as discussed in paragraph 6-21.

In a serial poll, the controller polls a device on the bus. The power supply responds to a serial poll by placing the contents of its serial poll register on the HP-IB and this is read by the controller. The bits in this register are assigned as shown in Table 6-5.

6-24 Service Request (SRQ)

A service request is a message from the power supply to interrupt the controller whenever it is requesting service. You can use service request to report events to the controller when they occur without requiring the controller to periodically poll the power supply. While this will often result in faster execution of your program, it also often results in a program that is more complex and difficult to maintain.

6-25 Using SRQ as Controller Interrupt. Before you can use the SRQ to interrupt the controller as discussed above, it must be enabled. To enable the SRQ, send the command:

SRQ 1

Now, you have set up the supply to interrupt the controller whenever a fault condition occurs. When the controller is interrupted, the SRQ annunciator on the front panel display is turned on and will remain on until the SRQ is cleared. Send the serial poll command to find out the nature of the service request, then query the Fault register (para 6-21) to find out the exact cause. When queried, this register is also cleared.

After a serial poll, the SRQ is cleared; the RQS bit in the Serial Poll register is reset and the SRQ annunciator on the front panel is turned off. However the condition that generated the SRQ may still be present.

If you do not wish the supply to generate an SRQ, you can disable this feature by sending the command:

SRQ 0

Table 6-5. Bit Assignment of the Serial Poll Register

Bit Position	7	6	5	4	3	2	1	0
Bit Weight	128	64	32	16	8	4	2	1
Condition	—	RQS	ERR	RDY	—	—	PON	FAU
FAU:	The FAU bit is a summary status bit associated with the Fault register. If any bits in the Fault register are set, the FAU bit will be set and is cleared when the FAULT? command is received.							
PON:	This bit is set at power-on and cleared by the CLR command or the HP-IB Device Clear command. You can use it to check whether the supply experienced a momentary power loss during its operation by first clearing this bit and later checking to see if it is set. If it is, power drop-out occurred and the supply has returned to its power-on state.							
RDY:	This bit is defined by IEEE 728. RDY is cleared when the supply is busy processing commands and is set automatically when processing is complete. RDY can be used after sending VOUT? or IOUT? to determine when the reading is available.							
ERR:	The ERR bit is defined by IEEE 728. ERR follows the ERR bit in the status word. It is set when a programming error occurs and cleared when the ERR? query is received.							
RQS:	The RQS bit is defined by IEEE 488. RQS is set when the supply generates a service request. It is cleared after a serial poll is conducted.							

6-26 Using SRQ at power-on. To cause the supply to generate an SRQ at power-on (PON), you must first enable the PON feature. The state of the PON feature is stored in the non-volatile memory of the supply so that although the supply may be switched off, it will remember the last PON command and respond accordingly. To enable the PON feature, send:

```
PON 1
and to disable it, send
PON 0
```

NOTE

The non-volatile memory is specified to accept a finite number (approx 10,000) of write cycles before failing. Therefore the supply will only accept one PON command each time the AC power is cycled off and on. Further PON commands will generate a programming error.

If you have enabled the PON feature, then when a service request occurs, you should check the PON bit in the serial Poll register to determine if it is the cause of the service request. In addition, at power on, your program should send a CLR command to clear this bit. By doing this, you can now accurately track the supply for momentary ac dropout.

```
100  Hpib=7
110  ASSIGN @Ps TO 705          ! Power supply is set to address 5.
120  !
130  ! Assign names to other instruments here.
140  !
150  ON INTR Hpib GOSUB Srq_handler
160  !
170  OUTPUT @Ps;"CLR"          ! Clears power supply; resets PON bit & SRQ.
180  Ov=8
190  Err=128
200  OUTPUT @Ps;"UNMASK";Ov+Err ! Define OV & ERR as power supply faults.
210  OUTPUT @Ps;"SRQ 1"       ! Generate SRQ when a fault occurs.
220  !
230  ! Send commands to other instruments to enable SRQ here.
240  !
250  ENABLE INTR Hpib;2        ! Start accepting interrupts from HP-IB.
260  !
270  ! Main body of program goes here.
280  !
290  STOP
300  !
310  !
320  Srq_handler:              ! Somebody is requesting service.
330  IF BIT(SPOLL(@Ps),6) THEN ! Is it the power supply?
340  GOSUB Ps_srq
350  GOTO Done
360  END IF
```

6-27 Display On/Off

If the display is not required in a particular application or during a critical test procedure, it may be turned off to improve command processing time. The processor must spend time to update the display and any command received during this time will be subject to this delay. By turning off the display, this delay is eliminated. In addition, with the display off, the typical output noise of the supply in FAST mode is substantially reduced. To turn off the display, send the following command.

```
DSP 0
```

To re-enable the display, send the command:

```
DSP 1
```

6-28 Example Program

The following program illustrates how to instruct the power supply to request service when it detects a fault condition, and how to setup an interrupt service routine that will determine the cause of the service request when one occurs. The program shows specific details of how to handle power supply service requests, and also shows where to insert similar routines to handle any other instruments in the system.

```

370 !
380 ! Poll other instruments here, and GOSUB to appropriate SRQ routine.
390 !
400 GOSUB Nobody_home ! No known instrument was requesting service.
410 Done: ENABLE INTR Hpib ! Re-enable interrupts.
420 RETURN
430 !
440 !
450 Ps_srq: ! Power supply was requesting service.
460 IF BIT(SPOLL(@Ps),1) THEN GOSUB Ps_pon ! AC was cycled; may be omitted
470 ! if you know PON SRQ is disabled.
480 OUTPUT @Ps;"FAULT?" ! All SRQ's except PON are generated by
490 ENTER @Ps;Fault ! bits in the FAULT register becoming true.
500 IF BIT(Fault,3) THEN GOSUB Ps_ov
510 IF BIT(Fault,7) THEN GOSUB Ps_err
520 ! Test for other bits here, or don't bother if you
530 ! know they were not unmasked to generate faults.
540 RETURN
550 !
560 !
570 Ps_pon: ! AC power was cycled.
580 !
590 ! Whatever you want to do when power supply is reset to power-on state.
600 !
610 STOP ! Usually a fatal error.
620 !
630 !
640 Ps_ov: !
650 !
660 ! Whatever you want to do when overvoltage protection trips.
670 !
680 RETURN
690 !
700 !
710 Ps_err: ! ERR was true in the FAULT register.
720 OUTPUT @Ps;"ERR?"
730 ENTER @Ps;Errnum
740 PRINT "Power supply programming error # ";Errnum
750 STOP ! Usually a fatal error.
760 !
770 ! SRQ routines for other instruments go here.
780 !
790 Nobody_home: !
800 PRINT "Service was requested by an undetermined instrument."
810 STOP ! Usually a fatal error.
820 !
830 END

```

6-29 ERROR REPORTING

The supply can detect programming errors and calibration errors. Upon detecting an error, the supply will set the error bit in the Status register, and turn on the ERROR annunciator on the front panel. If the error bit is set, you can find out the type of error by sending the error query and addressing the supply to talk. Send:

ERR?

The supply will respond with an error code number which can be decoded from Table 6-6. Once the error query is received, the supply clears the error bit in the registers and turns off the front panel annunciator.

6-30 QUERYING SYSTEM FUNCTIONS

In the programming example, you saw how to use queries to get the supply to respond to programming information. The following paragraphs describe queries which the supply uses to return information relating to its internal operation and instrument identification.

6-31 Self-Test

At power-on and when requested during its operation, the supply runs a series of self tests which check the internal circuits and report any failures that occur. Following a self-test, the power supply will respond with a decimal number which will uniquely identify the failure. If 0 is returned, there are no failures. If errors 1 to 5 are returned, there is a failure in the HP-IB interface and if errors 11 to 24, 51 are returned, check the power supply interface circuit for the failure. Table 6-7 contains a listing of the failures.

6-32 Power-On Self-Test. The test at power on is initiated automatically by the power supply as part of its start-up routine. If there is a failure at power-on, an error message is displayed on the front panel. For example if error 5 is detected, the message will read:

TEST 5 ERR

The message will flash on the display about every second and the power supply will not operate until the failure is corrected.

6-33 Test Query. At any time during the operation of the supply, you can initiate the self-test routine by the Test query. To do this, send:

TEST?

and address the supply to talk. The supply will respond with a number that can be decoded from Table 6-7. If there is a self test failure following the TEST query, no indication of the failure is given on the front panel and the display will not be disabled. In addition, the test query does not affect the programmed state nor the analog control circuits of the

supply and can be performed while the output is connected to an external circuit.

The following tests are performed at power-on and when the test query is sent:

RAM TEST
ROM TEST
EEPROM TEST
CLOCK TEST
ANALOG TO DIGITAL CONVERTER TEST
DIGITAL TO ANALOG CONVERTER TEST

6-34 System ID Query

If you want to know the model number of the supply you are working with, you can send the ID query. To do this send the following query and address the supply to talk:

ID?

The supply will respond with its model number.

6-35 Version (ROM) Query

The version number of the firmware may be determined by sending the ROM query. Send:

ROM?

and address the supply to talk. It will respond with a 7 character string variable. The first three characters represent the version number of the ROM in the HP-IB interface circuit, and the last three characters represent the version number of the ROM in the power supply interface circuit. The middle character is a space.

6-36 HP-IB INTERFACE FUNCTIONS

Remote control is implemented by the HP-IB. It enables instructions to be sent from an external computer equipped with an HP-IB interface. The power supply implements the following IEEE-488 Interface Functions:

SH1 — Source Handshake
AH1 — Acceptor Handshake
T6 — Talker
L4 — Listener
SR1 — Service Request
RL1 — Remote/Local
PP1 — Parallel Poll
DC1 — Device Clear
DT0 — No Device Trigger Capability
C0 — No Controller Capability
E1 — Open Collector Drivers

The Source handshake, acceptor handshake, talker and listener functions enable the power supply to send and receive messages over the HP-IB. They also allow the supply to respond to a serial poll.

Table 6-6. Programming Error Codes

Error Code	Name	Explanation
ERR 0	No Errors	
ERR 1	EEPROM save failed	A command was executed which caused data to be written to nonvolatile memory, and the write failed.
ERR 2	Second PON after power-on	More than one PON (Power-On) command was received after power on. Only one is allowed.
ERR 4	Second DC PON after power-on	More than one DC PON command was received after power-on. One is allowed.
ERR 5	No relay option present	A command requiring the relay option was sent and the option was not present.
ERR 8	Addressed to talk and nothing to say	The supply was addressed to talk without first receiving a query.
ERR 10	Header Expected	A non-alpha character was received where a header was expected.
ERR 11	Unrecognized Header	A string of alpha characters was received but was not found in the table of valid commands.
ERR 20	Number Expected	A non-numeric character was received when a number was expected.
ERR 21	Number Syntax	A numeric character (+ - . 0 ..9) was encountered but the following characters did not represent a proper number.
ERR 22	Number Out of Internal Range	A number was received in a valid form, but it was too large or too small to be represented in internal format.
ERR 30	Comma	A comma was not received where one was expected.
ERR 31	Terminator Expected	A valid terminator was not received where one was expected.
ERR 41	Parameter Out	A valid number was received, but it exceeded valid limits for the command with which it was received.
ERR 42	Voltage Programming Error	A voltage programming number was received but it exceeded valid limits of voltage.
ERR 43	Current Programming Error	A current programming number was received but it exceeded valid limits for current.
ERR 44	Overvoltage Programming Error	An overvoltage programming number was received but it exceeded valid limits for overvoltage.
ERR 45	Delay Programming Error	A delay programming number was received but it exceeded valid limits for delay.
ERR 46	Mask Programming Error	A mask programming number was received but it exceeded valid limits for the fault mask.
ERR 50	Multiple CSAVE Commands	More than one CSAVE command was received after the unit was powered-on. Only one is allowed.
ERR 51	EEPROM Checksum	The EEPROM has failed, or a new uncalibrated EEPROM was installed.

Table 6-6. Programming Error Codes (continued)

Error Code	Name	Explanation
ERR 52	Calibration Mode Disabled	Calibration Commands have been sent with calibration mode disabled.
ERR 53	CAL Channel Out of Range	An invalid channel # was received.
ERR 54	CAL FS (Full Scale) Out	A CDATA command FS number was received which exceeded the limits for FS.
ERR 55	CAL Offset	A CDATA command offset was received which exceeded the limits for offset.
ERR 59	CAL Disable Jumper in	An attempt to enable calibration was made with the CAL DISABLE jumper in.

Table 6-7. Self-Test Failures

Type of Failure	Code	Description of Failure
NONE	0	No failure; Self-test Passed
HP-IB Circuit Failures	1	ROM Check-sum failure
	2	RAM test failure
	3	HP-IB chip failure
	4	HP-IB microprocessor timer slow
	5	HP-IB microprocessor timer fast
PSI* Circuit Failure	11	PSI* ROM check-sum failure
	12	PSI RAM test failure
	14	PSI microprocessor timer slow
	15	PSI microprocessor timer fast
	16	A/D test reads high
	17	A/D test reads low
	18	CV/CC zero too high
	19	CV/CC zero too low
	20	CV Ref FS too high
	21	CV Ref FS too low
	22	CC Ref FS too high
	23	CC Ref FS too low
	24	DAC TEST failed during TEST?
	51	EEROM checksum failed

*PSI = Power Supply Interface

6-37 Service Request

This function enables the power supply to interrupt the controller by initiating a service request. See paragraph 6-24 for further details of how it is implemented.

6-38 Remote/Local

The power supply can receive programming information either from the HP-IB (remote) or from the front panel (local). When in remote, all front panel keys except the LCL key are disabled and the display is in metering mode. Remote operation takes precedence over Local operation, hence if the supply is accepting commands remotely and you attempt to change it to local operation, the supply will not allow any local settings and will remain in remote. However, when in local operation, the supply will also accept commands over the HP-IB. The transition from local to remote will clear any partial front panel command entry and return the display to metering mode. No changes to the supply's output occur when the supply changes between local and remote. You can prevent local programming altogether by sending the local lockout command. This command disables the LCL key and can be sent only from the HP-IB.

6-39 Parallel Poll

Parallel Poll is handled completely by the power supply's HP-IB interface circuits and represents a rapid means of getting status information from the supply. The manner in which Parallel Poll is conducted is defined by the IEEE 488. When sent, the Parallel Poll command enables the controller to receive simultaneously one bit of data from each of up to eight instruments connected to the bus. HP power supplies designate bit #6, the RQS bit, of the Serial Poll register for this operation. By checking the status of this bit, the computer can quickly determine which instruments on the bus requested service. Once an instrument is identified, the computer can perform a serial poll to find out the exact cause of the request. Parallel Poll does not reset this service request (RQS) bit in the power supply.

NOTE

IEEE-488 does not define what data an instrument should put on a bus line in response to parallel poll. Many instruments such as HP power supplies indicate the state of their RQS bit, but the user should not assume that all instruments on the bus respond to parallel poll with their RQS bit.

Unless remotely configured, the supply will respond with a 1 on one of the HP-IB data lines if it is requesting service and its address is between 0 and 7. Address 0 through 7 define which data line (1 through 8) the supply will respond on. If the address is set to 8 or greater, the supply will not respond unless remotely configured. The supply may be remotely configured to respond with a 0 or 1 on any of the data lines to indicate that it is requesting service. This is done in accordance with IEEE-488 1978.

6-40 Serial Poll

Serial Poll is another rapid means of getting status information from the supply. Serial poll is part of the Talker interface function. No microprocessor interaction is required to respond to a serial poll. It is handled completely by the supply's HP-IB interface hardware.

The manner in which a serial poll is conducted is defined by IEEE 488. The standard dictates that one 8-bit data byte be returned to the controller during a serial poll. This data is maintained by the power supply in the serial poll register. See paragraph 6-23 for a description of the serial poll register.

6-41 Device Clear

Device clear is typically used in systems to send all device in the system to a known state with a single command. It may be implemented as an addressed or unaddressed command. The power supply CLR command performs the same function. See paragraph 6-15.

Appendix A CALIBRATION PROCEDURES

A-1 INTRODUCTION

This appendix describes the calibration procedure the HP Models 6632A–34A Power Supplies and gives a sample calibration program. This program may be used without modification if you have an HP 3456A voltmeter and an HP Series 200 computer with BASIC, or it may be modified for use with other equipment.

There are no hardware adjustments and calibration is accomplished entirely in software by sending calibration constants to the supply via the HP-IB. This means that the supply can be calibrated without removing its covers, or removing it for its cabinet, if it is rack mounted. These supplies should be calibrated annually or whenever certain repairs are made (See Service Manual).

Four parameters must be calibrated: output voltage, output current, readback voltage and readback current. These calibrations may be performed independently or together. To begin, the calibration mode is enabled using the CMODE 1 command. This means that the D/A and A/D converters are programmed and readback directly in counts. For 12 bit D/A converters, the maximum count available is 4095 and the minimum is 0. For each of the parameters to be calibrated, two points within the parameter's operating range must be established — a high point and a low point. At each point, the actual value of the parameter is measured with a digital voltmeter and the results are inserted into the calibration equations to derive the Gain Constant and the Offset. These two constants are then sent to the power supply using the CDATA command and are stored temporarily in RAM. After all parameters are calibrated, the calibration mode is disabled using the CMODE 0 command, and the supply is returned to normal operation. You may now check the calibration for accuracy. If the calibration is correct, send the CSAVE command to install the constants in the non-volatile EEROM. If there are errors, cycle the power and recalibrate.

A-2 CALIBRATION EQUATIONS

The following calibration equations describe the Gain Constant and Offset Constant for each parameter to be calibrated.

Program Voltage Gain and Offset Equations

$$K_{V\text{prog}} = \frac{G_{V\text{prog}}}{(V_{\text{out hi}} - V_{\text{out lo}})} \quad \dots 1$$

$$O_{V\text{prog}} = -V_{\text{out lo}} \quad \dots 2$$

Where

$K_{V\text{prog}}$ = program voltage gain constant

$O_{V\text{prog}}$ = program voltage offset constant

$V_{\text{out hi}}$ = output voltage at high counts

$V_{\text{out lo}}$ = output voltage at low counts

$G_{V\text{prog}}$ = constant (See Table A-1)

Readback Voltage Gain and Offset Equations

$$K_{V\text{rb}} = \frac{G_{V\text{rb}} * (V_{\text{rb hi}} - V_{\text{rb lo}})}{(V_{\text{out hi}} - V_{\text{out lo}})} \quad \dots 3$$

$$O_{V\text{rb}} = \frac{V_{\text{rb lo}} * (V_{\text{out hi}} - V_{\text{out lo}})}{(V_{\text{rb hi}} - V_{\text{rb lo}})} - V_{\text{out lo}} \quad \dots 4$$

Where

$K_{V\text{rb}}$ = readback voltage gain constant

$O_{V\text{rb}}$ = readback voltage offset constant

$V_{\text{rb hi}}$ = readback voltage at high counts

$V_{\text{rb lo}}$ = readback voltage at low counts

$G_{V\text{rb}}$ = constant (See Table A-1)

Program Current Gain and Offset Equations

$$K_{I\text{prog}} = \frac{G_{I\text{prog}}}{(I_{\text{out hi}} - I_{\text{out lo}})} \quad \dots 5$$

$$O_{I\text{prog}} = -I_{\text{out lo}} \quad \dots 6$$

Where

$K_{I\text{prog}}$ = program current gain constant

$O_{I\text{prog}}$ = program current offset constant

$I_{\text{out hi}}$ = output current at high counts

$I_{\text{out lo}}$ = output current at low counts

$G_{I\text{prog}}$ = constant (See Table A-1)

Readback Current Gain and Offset Equations

$$K_{Irb} = \frac{G_{Irb} * (I_{rb\ hi} - I_{rb\ 50})}{(I_{out\ hi} - I_{out\ 50})} \quad \dots 7$$

$$O_{Irb} = \frac{I_{rb\ 50} * (I_{out\ hi} - I_{out\ 50})}{(I_{rb\ hi} - I_{rb\ 50})} - I_{out\ 50} \quad \dots 8$$

Where

K_{Irb} = readback current gain constant

O_{Irb} = readback current offset constant

$I_{rb\ hi}$ = readback current at high counts

$I_{rb\ 50}$ = readback current at 50 counts

G_{Irb} = constant (See Table A-1)

$I_{out\ 50}$ = Output Current at 50 counts

A-3 CHECKING & INSTALLING CAL CONSTANTS

The Cal constants for each calibration are stored in a designated location in the non-volatile memory. These locations are specified by channel numbers 1 through 4 as follows:

Channel #1 specifies the location for program voltage gain & offset Cal Constants (K_{Vprog} and O_{Vprog})

Channel #2 specifies the location for readback voltage gain & offset Cal Constants (K_{Vrb} and O_{Vrb})

Channel #3 specifies the location for program current gain & offset Cal Constants (K_{Iprog} and O_{Iprog})

Channel #4 specifies the location for readback current gain & offset Cal constants (K_{Irb} and O_{Irb})

To temporarily store the Cal constants in volatile RAM, send the command

CDATA X,K,O

where X is the channel #
K is the gain cal constant
O is the offset cal constant

Having stored the Cal Constants in RAM, turn off the calibration mode by sending the CMODE 0 command and check that the calibration is accurate throughout the operating range of the supply. If there are any errors, do not send the CSAVE command. It will replace the previously stored constants with the inaccurate constants. Instead, cycle the power and recalibrate the supply. The inaccurate Cal constants, initially stored in RAM will be lost at power down. If there are no errors, send the save command, CSAVE, to install these new constants in the non-volatile memory.

NOTE

For each time the ac power is cycled off and then on, the supply will accept only one CSAVE command. Further CSAVE commands will generate a programming error.

Security against accidental calibration is available. A jumper inside the unit may be moved to disable all calibration commands. Access to this jumper requires opening the unit (See the Service Manual-Option 910).

You can either execute the calibration commands directly from the keyboard or you can use them in a program to reduce the calibration time. Refer to Table 6-1 for the calibration commands and their data ranges, and to Figure 6-2 for their syntax structure.

A-4 GENERAL CALIBRATION PROCEDURE

The following steps describe the calibration procedure for the supply. Follow each step in the sequence given and observe any precautions expressed.

CAUTION

In this procedure, voltages may exceed full scale value. Take all necessary precautions.

Table A-1 Constants Used in Calibration Equations

HP Model	G_{Vprog}	G_{Vrb}	G_{Iprog}	G_{Irb}
6632A	268369.9	65.536	26836.99	6.5536
6633A	268369.9	65.536	26836.99	6.5536
6634A	2683699	655.36	26836.99	6.5536

Table A-2. Equipment Required for Calibration

Equipment	Characteristics Type	Recommended Model
Shunt	0.1 ohm, 0.05%, 20 ppm 25 W min.	L&N 4221B
Voltmeter	DC Accuracy 0.005%, 6 digit	HP 3456 A HP 3457 A
Controller	HP-IB	HP 9826 A HP 9836 A HP 85 A HP 9825 A

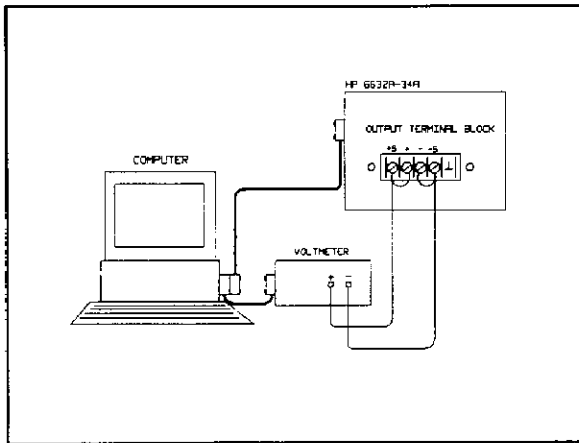

Figure A-1. Setup for Voltage Calibration

1. Disconnect all loads from your supply and strap the supply for local sensing. Connect the voltmeter to the +S and -S terminals as shown in the calibration setup—Figure A-1. See Table A-2 for a list of equipment required.
2. Turn on your supply and send the command

CMODE1

to put the supply in Calibration mode (Note all program and readback values are now given in DAC Counts). In this procedure, high counts = 4095 and low counts = 0.

NOTE

Do not turn off the supply during calibration as this will erase the calibration constants. Exercise care when moving the leads.

VOLTAGE CALIBRATION

3. Program OVP to 255.
4. Program current to high counts .

5. Program voltage to high counts.
6. Readback and record the output voltage in counts (Vrb hi) using either the VOUT? command, or the front panel display.
7. Measure and record the output voltage (Vout hi) from the voltmeter.
8. Program voltage to low counts.
9. Readback and record the output voltage in counts (Vrb lo) using either the VOUT? command or the front panel display.
10. Measure and record the output voltage (Vout lo) from the voltmeter.
11. Calculate the voltage programming and voltage readback Cal Constants K and O from equations 1 through 4 respectively.
12. Send the program voltage Cal Constants to the supply using the CDATE 1 command in the same order described in paragraph A-2.
13. Send the readback voltage Cal Constants to the supply using the CDATE 2 command in the same order as described in paragraph A-2.
14. Test the accuracy of these constants using the following procedure:
 - a. Turn off Cal Mode by sending the CMODE 0 command
 - b. Program the supply to zero volts.
 - c. Read the voltmeter and record the reading (Vout).
 - d. Readback the output voltage and record the reading (Vrb).
 - e. Test that Vout is within specifications.
 - f. Test that Vrb is within specifications.
 - g. Program the supply to full-scale voltage.
 - h. Repeat steps c and d.
 - i. Test that Vout is within specifications.
 - j. Test that Vrb is within specifications.

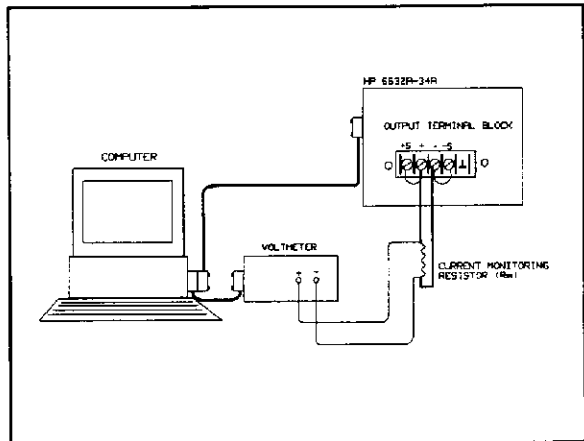

Figure A-2. Setup for Current Calibration

CURRENT CALIBRATION

15. Enable calibration mode by sending the CMODE 1 command. Disable the output using either the OUT 0 command or the front panel key. Connect the shunt resistor to the output terminals and the voltmeter to the resistor's sense terminals as shown in Figure A-2.
16. Re-enable the output and program voltage to high counts.
17. Program current to high counts.
18. Readback and record the output current in counts (Irb hi) using either the IOUT? command or the front panel display.
19. Measure and record the voltage drop across the current monitoring resistor (Rm) using the DVM, and divide the result by the shunt resistor to obtain Iout hi.
20. Program the current to low counts (ISET 0).
21. Measure and record the voltage drop across the current monitoring resistor (Rm) using the DVM, and divide the result by the shunt resistor to obtain Iout lo.
22. Calculate the current programming constants K and O from equations 5 and 6.
23. Program the current to 50 counts (ISET 50).
24. Measure and record the voltage drop across the current monitoring resistor (Rm) using the DVM, and divide the result by the shunt resistor to obtain Iout 50.
25. Read back and record the output current in counts (Irb 50) using either the IOUT? command or the front panel display.
26. Calculate the current readback constants K and O from equations 7 and 8.
27. Send the program current Cal Constants to the supply using the CDATE 3 command.
28. Send the readback current Cal Constants to the supply using the CDATE 4 command.
29. Test the accuracy of these constants using the following procedure.
 - a. Turn off Cal mode by sending the CMODE 0 command.
 - b. Program the supply to full-scale voltage.
 - c. Program the current to zero amps.
 - d. Read the voltmeter and divide the result by the shunt resistor to obtain the output current (Iout).
 - e. Readback the output current (Irb).
 - f. Test that Iout is within specifications.
 - g. Test that Irb is within specifications.
 - h. Program output current to full scale.
 - i. Repeat steps d and e.
 - j. Test that Iout is within specifications.
 - k. Test that Irb is within specifications.
30. Save the new Cal Constants by sending the CSAVE command.

A-5 CALIBRATION EXAMPLE PROGRAM

The following calibration program can be used as is, provided you have an HP Series 200 computer with the BASIC programming language and an HP 3456A voltmeter. The calibration program is written with the assumption that your supply is at address 705 and the voltmeter is at address 722. The program will prompt you to make voltage and current calibration connections as shown in Figures A-1 and A-2.

After voltage and current calibration, the program tests the accuracy of the voltage and current Cal constants (lines 1080 and 2100). The variables used are FS_V—full scale voltage; FS_I—full scale current; I_min—minimum programmable current. See Table 6-2 for their values.

```
10 !PROGRAM TO CALIBRATE THE HP6632-34 POWER
20 !SUPPLIES. THIS SECTION, LINES 10 TO 100
30 !ASSIGNS I/O PATH NAMES, INITIALIZES THE DVM
40 !AND THE SHUNT RESISTOR, AND CLEARS THE CRT
50 ASSIGN @Printer TO 1
60 ASSIGN @Ps TO 705
70 ASSIGN @Dvm TO 722
80 OUTPUT @Dvm;"H T3 100STI"
90 Shunt_r=.1
100 PRINT CHR$(12)
110 !
120 !BEGIN CALIBRATION PROGRAM *****
130 !THIS SECTION TURNS ON CAL MODE, SELECTS THE
140 !APPROPRIATE MODEL# AND READS IN THE DATA
150 !PERTAINING TO THAT MODEL #.
160 OUTPUT @Ps;"CMODE 1:ID?"
170 !
180 ENTER @Ps;Id$
190 !
200 SELECT Id$
210 !
220 !
230 CASE "HP6632A"
240 RESTORE Data_6632a
250 !
260 CASE "HP6633A"
270 RESTORE Data_6633a
280 !
290 CASE "HP6634A"
300 RESTORE Data_6634a
310 !
!TURN ON CAL MODE AND
!QUERY MODEL #
! ENTER MODEL #
!SELECT DATA FOR A
!PARTICULAR MODEL #
```



```

1180!
1190 TRIGGER @Dvm
1200 ENTER @Dvm;V_out !ENTER OUTPUT VOLTAGE
1210!
1220 OUTPUT @Ps;"VOUT?" !QUERY READBACK VOLTAGE
1230 ENTER @Ps;V_rb !ENTER READBACK VOLTAGE
1240!
1250!
1260 OUTPUT @Printer;"OUTPUT VOLTAGE @ 0 VOLTS =" ;V_out
1270 OUTPUT @Printer;"READBACK @";V_out;" VOLTS =" ;V_rb
1280!
1290!
1300 OUTPUT @Ps;"VSET";Fs_v !PROGRAM OUTPUT VOLTAGE
1310! TO FULL SCALE
1320 WAIT .2 !WAIT FOR OUTPUT TO SETTLE
1330!
1340 TRIGGER @Dvm
1350 ENTER @Dvm;V_out !ENTER OUTPUT VOLTAGE
1360!
1370 OUTPUT @Ps;"VOUT?" !QUERY READBACK VOLTAGE
1380 ENTER @Ps;V_rb !ENTER READBACK VOLTAGE
1390!
1400!
1410 OUTPUT @Printer;"OUTPUT VOLTAGE @";Fs_v;" VOLTS =" ;V_out
1420 OUTPUT @Printer;"READBACK @";V_out;" VOLTS =" ;V_rb
1430 OUTPUT @Printer;"
1440!
1450 DISP "CHECK OUTPUT & READBACK AGAINST SPEC,PRESS CONT."
1460 PAUSE
1470 DISP ""
1480 !
1490 OUTPUT @Ps;"CMODE 1" !TURN ON CAL MODE
1500!
1510 OUTPUT @Ps;"OUT 0" !DISABLE OUTPUT
1520!
1530 !
1540 Cal_current:!!!!!!!!!!!!!!!!!!!!!!!!!!!!!!!!!!!!!!!!!!!!!!!!!!!!!!!!!!!!!!!!!!!!!!!!!!!!!!
1550 !
1560 DISP "SHORT OUTPUT W/SHUNT AND CONNECT DVM TO SHUNT"
1570 BEEP
1580 PAUSE
1590!
1600 DISP "CALIBRATING CURRENT"
1610 OUTPUT @Ps;"OUT 1" !ENABLE OUTPUT
1620 !
1630 OUTPUT @Ps;"VSET 4095" !PROGRAM OUTPUT VOLTAGE
1640! TO FULL SCALE
1650 OUTPUT @Ps;"ISET 4095" !PROGRAM OUTPUT CURRENT
1660! TO FULL SCALE
1670 WAIT .2 !WAIT FOR OUTPUT TO SETTLE
1680!
1690 OUTPUT @Ps;"IOUT?" !QUERY READBACK CURRENT
1700 ENTER @Ps;Irb_hi !ENTER READBACK CURRENT
1710!
1720 TRIGGER @Dvm
1730 ENTER @Dvm;Iout_hi !ENTER OUTPUT CURRENT
1740 Iout_hi=Iout_hi/Shunt_r !CONVERT TO AMPS
1750!
1760 OUTPUT @Ps;"ISET 0" !PROGRAM OUTPUT CURRENT
1770! TO ZERO
1780 WAIT .2 !WAIT FOR OUTPUT TO SETTLE
1790!
1800 TRIGGER @Dvm
1810 ENTER @Dvm;Iout_lo !ENTER OUTPUT CURRENT
1820 Iout_lo=Iout_lo/Shunt_r !CONVERT TO AMPS
1830!
1831 OUTPUT @Ps;"ISET 50"
1832!
1833 WAIT .2
1834!
1835 OUTPUT @Ps;"IOUT?" !QUERY READBACK CURRENT
1836 ENTER @Ps;Irb_50 !ENTER READBACK CURRENT
1837!
1838 TRIGGER @Dvm
1840 ENTER @Dvm;Iout_50 !ENTER OUTPUT CURRENT
1850 Iout_50=Iout_50/Shunt_r !CONVERT TO AMPS
1860!
1870!
1880 Calc_i_cal: !CALCULATE CURRENT GAIN
1890! AND OFFSET CONSTANTS
1900 K_iprog=G_iprog/((Iout_hi-Iout_lo)) !PROG. CURRENT GAIN
1910 K_irb=G_irb*(Irb_hi-Irb_50)/((Iout_hi-Iout_50)) !READBACK CURRENT GAIN
1920 O_iprog=-Iout_lo !PROGRAM CURRENT OFFSET
1930 O_irb=(Iout_hi-Iout_50)*Irb_50/(Irb_hi-Irb_50)-Iout_50
1940! READBACK CURRENT OFFSET
1950!

```

```

1960 !SEND PROGRAM CURRENT GAIN AND OFFSET DATA TO PRINTER AND SUPPLY
1970 OUTPUT @Printer;"PROG CURRENT GAIN CONST (K_IPROG)=";K_iprog
1980 OUTPUT @Printer;"PROG CURRENT OFFSET (O_IPROG)=";O_iprog
1990!
2000 OUTPUT @Ps;"CDATA 3,";K_iprog,";O_iprog          !STORE PROG CURRENT CAL
2010!                                     CONSTANTS
2020 OUTPUT @Printer;"READBK CURRENT GAIN CONST (K_IRB)=";K_irb
2030 OUTPUT @Printer;"READBK CURRENT OFFSET(O_IRB)=";O_irb
2040 OUTPUT @Printer;"
2050!
2060 OUTPUT @Ps;"CDATA 4,";K_irb,";O_irb          !STORE READBACK CURRENT
2070!                                     CAL CONSTANTS
2080 OUTPUT @Ps;"CMODE 0"                          !TURN OFF CAL MODE
2090!
2100! CURRENT ACCURACY TESTS *****
2110! THIS SECTION CHECKS THAT THE CURRENT CAL CONSTANTS ARE WITHIN SPECS.
2120 DISP "TESTING CURRENT ACCURACY"
2130 OUTPUT @Ps;"VSET";Fs_v                        !PROGRAM OUTPUT VOLTAGE
2140!                                     TO FULL SCALE
2150 OUTPUT @Ps;"ISET 0"                          !PROGRAM OUTPUT CURRENT
2160!                                     TO ZERO
2170 WAIT .2                                       !WAIT FOR OUTPUT TO SETTLE
2180!
2190 TRIGGER @Dvm
2200 ENTER @Dvm;I_out                             !ENTER OUTPUT CURRENT
2210 I_out=I_out/Shunt_r                          !CONVERT TO AMPS
2220!
2230 OUTPUT @Ps;"IOUT?"                            !QUERY OUTPUT CURRENT
2240 ENTER @Ps;I_rb                               !ENTER OUTPUT CURRENT
2250!
2260!
2270 OUTPUT @Printer;"OUTPUT CURRENT @;Min i;" AMPS =" ;I_out
2280 OUTPUT @Printer;"READBACK @;I_out;" AMPS =" ;I_rb
2290!
2300!
2310 OUTPUT @Ps;"ISET";Fs_i                      !PROGRAM OUTPUT CURRENT
2320!                                     TO FULL SCALE
2330 WAIT .2                                       !WAIT FOR OUTPUT TO SETTLE
2340!
2350 TRIGGER @Dvm
2360 ENTER @Dvm;I_out                             !ENTER OUTPUT CURRENT
2370 I_out=I_out/Shunt_r                          !CONVERT TO AMPS
2380!
2390 OUTPUT @Ps;"IOUT?"                            !QUERY CURRENT READBACK
2400 ENTER @Ps;I_rb                               !ENTER CURRENT READBACK
2410 OUTPUT @Ps;"OUT 0"                          !DISABLE OUTPUT
2420!
2430!
2440 OUTPUT @Printer;"OUTPUT CURRENT @;Fs i;" AMPS =" ;I_out
2450 OUTPUT @Printer;"READBACK @;I_out;" AMPS =" ;I_rb
2460 OUTPUT @Printer;"
2470!
2480!
2490 DISP "CHECK OUTPUT @ READBACK AGAINST SPEC,PRESS CONT."
2500 PAUSE
2510 DISP ""
2520!
2530 OUTPUT @Printer;"IF OUTPUTS AND READBACKS ARE WITHIN SPECIFICATION"
2540 OUTPUT @Printer;"PRESS CONTINUE; IF NOT, TURN OFF SUPPLY TO SAVE"
2550 OUTPUT @Printer;"OLD CAL CONSTANTS"
2560 PAUSE
2570 PRINT CHR$(12)                                !CLEAR CRT
2580!
2590!
2600 OUTPUT @Ps;"CSAVE"                          !SAVE CAL CONSTANTS
2610 OUTPUT @Printer;"CAL COMPLETE---NEW CAL CONSTANTS SAVED"
2620 END

```

INDEX

A

Accuracy, Programming	1-3
Accuracy, Readback	1-5
Address, HP-IB	5-4, 6-2
Annunciators, Status	5-2

B

Bit Assignment	
Serial Poll Register	6-10
Status Registers	6-8

C

Calibration	
Example Program	A-4
Frequency	A-1
General Procedure	A-3
Saving Cal Constants	A-2
Security	1-2, A-2
Set-up	A-3
Storing Cal Constants	A-2
Commands, Remote	6-2
Execution	6-3
Structure	6-3
Summary	6-4
Terminator	6-2
Constant Current (CC) State	4-1
Constant Voltage (CV) State	4-1
CV Regulation	4-3
Controls & Indicators	5-2, 5-3
Cover, Removal of	2-3

D

Data, Ranges	6-4
Data, Representation	6-4
Default, Power-on values	6-4
Delay	6-9
Commands which invoke delay	6-9
Default Time	6-9
Display, Enable/Disable	6-11
Display, LCD	5-3

E

Equivalent Series Resistance (ESR)	4-4
Erasing Partial Entry	5-1
Error Bit	6-7, 6-10
Error Codes	5-4, 6-14
Error Reporting	6-13
Example Programs	6-6, 6-11

F

Fuse, Line	2-3
------------------	-----

H

HP-IB Address, Selection	5-4, 6-2
HP-IB Functions	6-13
Device Clear	6-16
Local Lockout	5-4, 6-16
Parallel Poll	6-16
Serial Poll	6-10, 6-16

I

Impedance, Output	4-2
-------------------------	-----

L

Loads Considerations	4-4
Capacitive	4-4
Inductive	4-4
Load Lead	4-2, 4-3
Local/Remote Mode	5-4, 6-16

M

Mode Selection	2-3, 4-1
Mounting, Rack	2-1

INDEX (continued)

N

Noise, Output.....	4-3
Noise Reduction in FAST Mode.....	4-2
Numeric Data.....	6-1
Negative Numbers.....	6-1
Rounding numbers.....	5-1,6-1

O

Output Characteristic.....	4-1
Output, Connections.....	4-2
Local Sensing.....	4-2
Remote Sensing.....	4-3
Output, Enable/Disable.....	5-4,6-5
OCP.....	5-4
Enabling/disabling.....	5-4
False Tripping.....	6-5,6-10
Resetting.....	5-4,6-5

P

Power-on	
Bit.....	6-10
Feature.....	6-11
Self-Test.....	6-13
SRQ.....	6-10
State.....	6-6
Programmable Current, Minimum.....	5-5
Programmable Output Ranges.....	6-8
Programming, Introduction.....	6-2

R

Registers, Power Supply.....	6-7
Accumulated Status.....	6-8
Conceptual Model.....	6-9
Fault & Mask.....	6-8
Status.....	6-7
Resolution.....	6-5
Programming.....	1-2,6-5
Readback.....	1-5

S

Safety Concerns.....	1-1,2-2
SCR,Crowbar.....	5-3,6-5
Removal.....	4-5
Service Request (SRQ).....	6-10
Annunciator.....	5-2,6-10
Sense Leads.....	4-3
Slew Rate.....	4-2, 4-4
Specification.....	1-4
Stability.....	4-7
Status Reporting.....	6-7
Decoding Responses.....	6-8
Decoding Serial Poll Responses.....	6-10
Summary of Inquires.....	6-7
Syntax Diagrams.....	6-3

T

Temperature, Operating range.....	2-1
Test Query.....	6-26
Power-on Self Test.....	6-13
Self Test Failures.....	6-15

U

Unregulated State.....	4-1
------------------------	-----

W

Warranty.....	2-1
---------------	-----

ADDENDUM (HP 6632A)

I. Generally Applicable Annotations

Consistent with good engineering practice, leads attached to customer accessible signal/monitoring ports (such as the 10-pin Control Connector, the 7-pin Analog Connector, the 4-pin Digital Port/Trigger Connector, screw terminal Barrier Blocks, etc.) should be twisted and shielded to maintain the instrument's specified performance.

II. CE'92 Product Specific Annotations

When tested for radiated susceptibility as called for in EN 50082-1 per the EC EMC directive, the following changes in the Supplementary Characteristics of the 6632A have been noted:

When subjected to radiated field strengths of 3 volts/meter in the vicinity of 77 MHz and 102 MHz, the full scale programming accuracy increases from 20 millivolts at 20 volts output to 40 millivolts.

The accuracy reverts to the published value of 20 millivolts when the field is reduced to 2 volts/meter.