

[ECU Testing] Easy Characterization of Power Supply IC on a Bench Top

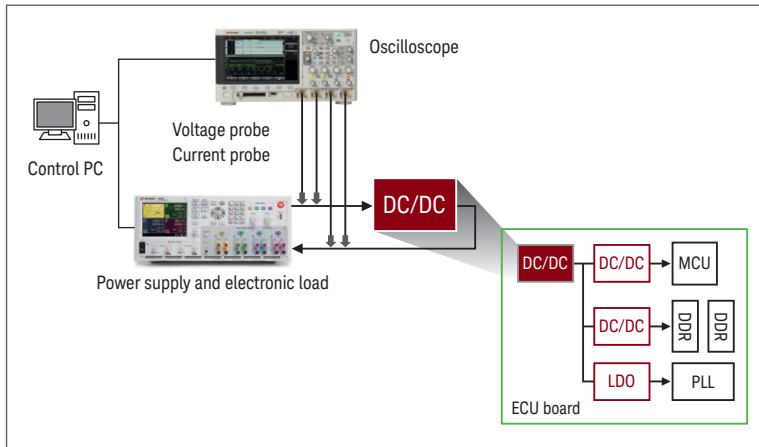

Characterization of power supply IC using N6705B DC power supply/analyzer and InfiniiVision 3000T X-series oscilloscope

“Want to accurately characterize the DC/DC IC and LDO IC but finding process strenuous?”

“Want to verify that the output is stable even if the input fluctuates significantly?”

“Want to reduce connection errors but find working with multiple instruments very messy on your workbench?”

We can support you!

Do it the easy way. “Automatic” characterization of power supply IC for ECU design

While the power supply IC of an ECU must have high stability against fluctuations in input voltage and load, IC vendors often do not provide specifications. However, statistical evaluation involving a number of measurement items and parameters to change has been extremely time-consuming for ECU designers.

We, therefore, offer a sample program for measurement in addition to measuring instruments. This helps you quickly create an automatic measurement environment for painstaking data acquisition.

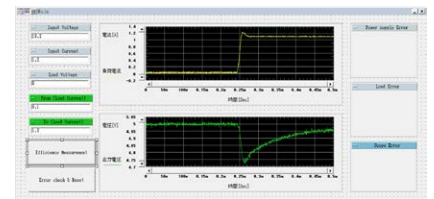

Power supply and e-load in a box. It can be placed on your desk

A power supply and electronic load that are indispensable for the evaluation of power supply IC. Having multiple large measuring instruments require a large space and is likely to cause connection errors.

So, we have placed the power supply and electronic load together in one casing. This reduces both the footprints required and connection errors at the same time.

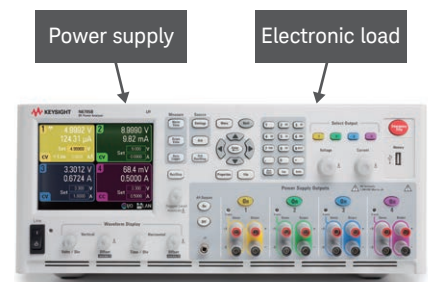

Reliability test is also made possible

Ever want to verify the operation of a device with ON/OFF waveforms, cranking waveforms, or waveforms with previous errors, etc.?

This solution supports arbitrary waveform output. Various voltage waveforms can now be input for the power supply IC to verify the behavior. The reliability test of power supply IC that was impossible with the conventional power supply can also be performed.

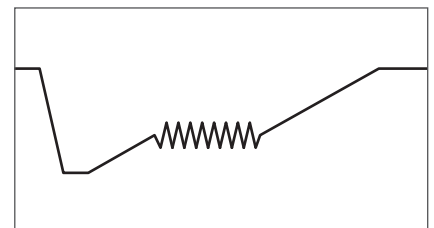

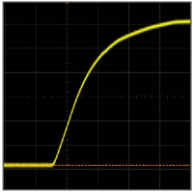

Quick changes (power and load)

The voltage can be changed from 0 V to 29 V in an instant of 0.7 msec, using the N6766A power supply module.



Corresponding to various measurement items

It helps achieve measurements for efficiency, load fluctuations (steady state, transient), input fluctuation (steady state, transient), and arbitrary waveform input (cranking, ON/OFF).



Selecting the optimal power supply and electronic load

N6705B is a mainframe system in which up to four modules can be inserted. It can be installed with customized configurations from modules of various specifications.

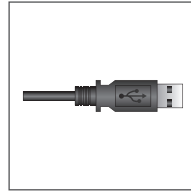

USB and LAN used for connection. Easy automation

Both the power supply and oscilloscope can be connected via USB or LAN. This makes it easy to build an automation environment.



Providing a more compact testing environment

N6700B 1U thin mainframe is available as a model compatible with N6705B. It allows you to create a more compact environment with the same power supply and electronic load module configuration.

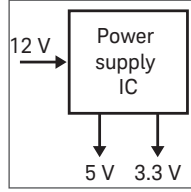

The device can also be used for the power supply IC of multi-channel output

The environment can be expanded to become a power supply IC for multi-channel output by adding the mainframe, load modules, and oscilloscopes.

Configuration

Model Number	Description
N6705B	Power main frame
N6766A	Power supply module 60 V, 17 A, 500 W * Used as the primary side power supply
N6785A	2-quadrant power supply module 20 V/4 A, 15 V/5 A, 10 V/6.7 A, 6 V/8 A (80 W) * Used as current load
DSOX3104T	1 GHz 4-channel oscilloscope
N2783B	100 MHz, 30 Arms current probe
N2779A	External power supply for current probe
N2790A	100 MHz high-voltage differential active probe
W4000D	Programming environment Keysight VEE

Contact / Support:

For more information on Keysight Technologies' products, applications or services, please contact your local Keysight office. The complete list is available at: www.keysight.com/find/contactus