

M983xA Series PXIe Vector Network Analyzer

M9834A: 10 MHz to 20 GHz

M9837A: 10 MHz to 44 GHz

Introduction

Characterizing sub-systems such as Transmit/Receive (T/R), or multiport Front-End Modules (FEM) is not easy. Requiring beyond just the standard S-parameter and noise figure measurements, these modules additionally need you to do high sensitivity and high-power performance characterization, as well as modulated signal tests such as EVM and ACPR. Juggling a network analyzer, signal analyzer, and a switch matrix not only takes up valuable time, but also introduces even more measurement complexity.

The M983xA PXIe Vector Network Analyzer (VNA) combines all your measurements into a single instrument, enabling system characterization with faster speeds and greater flexibility, at a lower cost. The PXI's form factor scalability, built-in noise receivers, and configurable test set combined with modulated signal measurements allow you to characterize highly integrated components with a single connection. Easily perform RF measurements with software wizards to guide you through advanced wideband measurements.



Table of Contents

Definition	3
Dynamic Range.....	4
Corrected System Performance.....	7
Uncorrected System Performance	13
Test Port Output ¹	15
Test Port Input.....	19
Noise Receiver Input (Option 029 only).....	23
Dynamic Accuracy	25
Spectrum Analysis (with Option 190 and S95090xB).....	26
Modulation Distortion Analysis (with Option 190 and S95070B)	33
Pulsed-RF Measurements (with Option 021 and S95024B/S95025B).....	38
Enhanced Time Domain Analysis with TDR (with S95011B)	41
Multi-module Measurements with S95551B Software	42
General Information	47
Measurement Throughput.....	51
Front-Panel Jumpers.....	55
Test Set Block Diagrams.....	63
Keysight Support Services	65
Literature Information	67
Web Resources.....	67

Definition

Specification (spec)¹

Warranted performance. Specifications include guardbands to account for the expected statistical performance distribution, measurement uncertainties, and changes in performance due to environmental conditions. All specifications and characteristics apply over a $25\text{ °C} \pm 5\text{ °C}$ and relative humidity of 25 to 70% range (unless otherwise stated).

The following conditions must be met:

- Module temperature is between 40 to 53 °C.
- Instrument has been turned on for 90 minutes with VNA application running.
- Instrument is within its calibration cycle.
- Instrument remains at a stable surrounding environment temperature (between -10 °C to 55 °C) for 60 minutes prior to turn-on.

Characteristics (char.)

A performance parameter that the product is expected to meet before it leaves the factory, but that is not verified in the field and is not covered by the product warranty. A characteristic includes the same guardbands as a specification.

Typical (typ.)

Expected performance of an average unit at a stable temperature between $25\text{ °C} \pm 5\text{ °C}$ for 60 minutes prior to turn-on and during operation; does not include guardbands. It is not covered by the product warranty. The instrument must be within its calibration cycle.

Nominal (nom.)

A general, descriptive term or design parameter. It is not tested, and not covered by the product warranty.

Supplemental Information

A performance parameter that is tested on sampled product during design validation. It does not include guardbands and is not covered by the product warranty.

Calibration

The process of measuring known standards to characterize an instrument's systematic (repeatable) errors.

Corrected (residual)

Indicates performance after error correction (calibration). It is determined by the quality of calibration standards and how well "known" they are, plus system repeatability, stability, and noise.

Uncorrected (raw)

Indicates instrument performance without error correction. The uncorrected performance affects the stability of a calibration.

1. For all tables in this data sheet, the specified performance at the exact frequency of a break is the better value of the two specifications at that frequency.

Dynamic Range

The specifications in this section apply to measurements made with the Keysight M983xA vector network analyzer under the following conditions:

- 10 Hz IF bandwidth
- No averaging applied to data
- Does not include crosstalk effects

Table 1. System Dynamic Range at Test Port (dB) ¹

Description	Specification	Typical
100 kHz to 300 kHz	--	71
300 kHz to 1 MHz	--	89
1 MHz to 10 MHz	--	100
10 MHz to 100 MHz ²	112	121
100 MHz to 1 GHz	130	140
1 GHz to 2 GHz	146	153
2 GHz to 5 GHz	143	151
5 GHz to 6.5 GHz	144	152
6.5 GHz to 9 GHz	142	149
9 GHz to 10 GHz	141	148
10 GHz to 15 GHz	140	147
15 GHz to 19 GHz	136	146
19 GHz to 20 GHz	134 ³	142
20 GHz to 22 GHz	137	145
22 GHz to 24 GHz	137	143
24 GHz to 25 GHz	134	140
25 GHz to 27 GHz	132	139
27 GHz to 30 GHz	129	140
30 GHz to 32 GHz	127	138
32 GHz to 33 GHz	123	134
33 GHz to 35 GHz	123	133
35 GHz to 37.5 GHz	119	130
37.5 GHz to 40 GHz	119	129
40 GHz to 41 GHz	108	123
41 GHz to 42 GHz	97	114
42 GHz to 43 GHz	94	109
43 GHz to 44 GHz	94	111

1. System dynamic range = source maximum output power minus receiver noise floor.

2. It may typically be degraded at 25 MHz.

3. Applies to the specification at 20 GHz.

Table 2. Extended Dynamic Range at Direct Receiver Access Input (dB) ¹

Description	Specification	Typical
100 kHz to 300 kHz	--	157
300 kHz to 1 MHz	--	168
1 MHz to 10 MHz	--	169
10 MHz to 100 MHz ²	--	168
100 MHz to 1 GHz	--	167
1 GHz to 2 GHz	--	166
2 GHz to 5 GHz	--	164
5 GHz to 6.5 GHz	--	164
6.5 GHz to 9 GHz	--	163
9 GHz to 10 GHz	--	161
10 GHz to 15 GHz	--	160
15 GHz to 19 GHz	--	158
19 GHz to 20 GHz	--	154
20 GHz to 22 GHz	--	156
22 GHz to 24 GHz	--	155
24 GHz to 25 GHz	--	153
25 GHz to 27 GHz	--	152
27 GHz to 30 GHz	--	150
30 GHz to 32 GHz	--	150
32 GHz to 33 GHz	--	146
33 GHz to 35 GHz	--	144
35 GHz to 37.5 GHz	--	141
37.5 GHz to 40 GHz	--	136
40 GHz to 41 GHz	--	132
41 GHz to 42 GHz	--	127
42 GHz to 44 GHz	--	120

1. Extended dynamic range at direct receiver access input is defined as source maximum output power minus receiver noise floor using direct receiver access input.
2. It may typically be degraded at 25 MHz.

Table 3. Extended Dynamic Range at Test Port with Low Noise Path (dB) ^{1,2}

Description	Specification	Typical
100 kHz to 300 kHz	--	138
300 kHz to 1 MHz	--	145
1 MHz to 10 MHz	--	152
10 MHz to 100 MHz ³	--	168
100 MHz to 2 GHz	--	173
2 GHz to 5 GHz	--	171
5 GHz to 6.5 GHz	--	172
6.5 GHz to 9 GHz	--	170
9 GHz to 10 GHz	--	170
10 GHz to 15 GHz	--	169
15 GHz to 19 GHz	--	166
19 GHz to 20 GHz	--	163
20 GHz to 22 GHz	--	164
22 GHz to 24 GHz	--	165
24 GHz to 25 GHz	--	163
25 GHz to 27 GHz	--	163
27 GHz to 30 GHz	--	163
30 GHz to 32 GHz	--	163
32 GHz to 33 GHz	--	159
33 GHz to 35 GHz	--	156
35 GHz to 40 GHz	--	153
40 GHz to 41 GHz	--	149
41 GHz to 42 GHz	--	140
42 GHz to 43 GHz	--	137
43 GHz to 44 GHz	--	138

1. Extended dynamic range at test port with low noise path is defined as source maximum output power minus receiver noise floor using the low noise path.
2. Full 2-port calibrated measurements are not supported with this configuration using the low noise path. Enhanced response calibrations are supported.
3. It may typically be degraded at 25 MHz

Table 4. Receiver Dynamic Range (dB) ¹

Description	Specification	Typical
100 kHz to 300 kHz	--	72
300 kHz to 1 MHz	--	83
1 MHz to 10 MHz	--	93
10 MHz to 100 MHz ²	--	114
100 MHz to 1 GHz	--	134
1 GHz to 2 GHz	--	145
2 GHz to 5 GHz	--	144
5 GHz to 10 GHz	--	143
10 GHz to 15 GHz	--	141
15 GHz to 20 GHz	--	136
20 GHz to 25 GHz	--	139
25 GHz to 26.5 GHz	--	137
26.5 GHz to 30 GHz	--	132
30 GHz to 35 GHz	--	130
35 GHz to 38 GHz	--	127
38 GHz to 40 GHz	--	126
40 GHz to 44 GHz	--	119

1. Receiver dynamic range is defined as the typical test port 0.15 dB compression minus the typical noise floor.

2. It may typically be degraded at 25 MHz.

Corrected System Performance

This section provides specifications for the corrected performance of the M983xA PXIe VNA using Mechanical Calibration Kit or Electronic Calibration (ECal) Module. To determine transmission and reflection uncertainty curves with other calibration kits, please download the Uncertainty Calculator from http://www.keysight.com/find/na_calculator to generate the curves for your specific calibration kit.

Measured with 10 Hz IF bandwidth, no averaging applied to data. Measurement uncertainty values are achieved when the module has been stored for 48 hours in a stable environment and has been on for 24 hours prior to calibration. The average environmental humidity for 24 hours before and after calibration must be in the 25% to 70% range and have less than 5% deviation. The environmental temperature must be within 23 °C ± 3 °C, with less than 1 °C deviation from the calibration temperature. The calibration is valid for 24 hours.

Table 5. M9834A or M9837A with 85052D Economy Mechanical Calibration Kit

Corrected error terms (dB) – Specifications

Description	10 MHz to 50 MHz	50 MHz to 500 MHz	500 MHz to 2 GHz	2 GHz to 8 GHz	8 GHz to 20 GHz
Directivity	42	42	42	38	36
Source match	37	37	37	31	28
Load match	42	42	42	38	36
Reflection tracking	± 0.003	± 0.003	± 0.003	± 0.004	± 0.008
Transmission tracking	± 0.021	± 0.021	± 0.030	± 0.089	± 0.147

Transmission uncertainty (magnitude and phase)

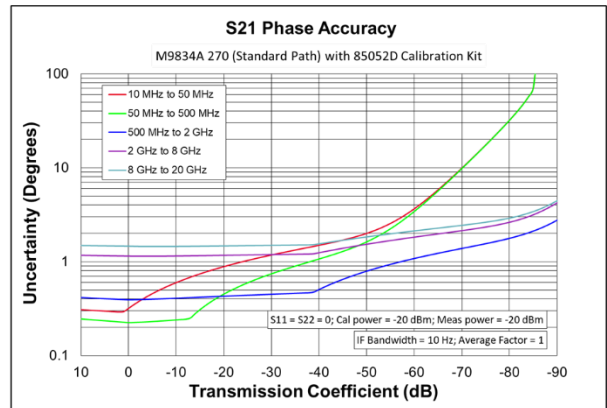
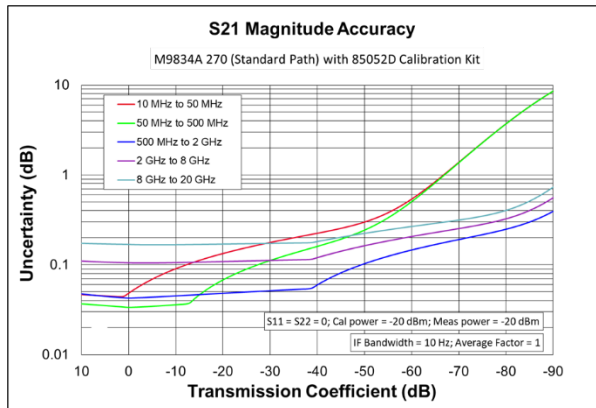

Reflection uncertainty (magnitude and phase)

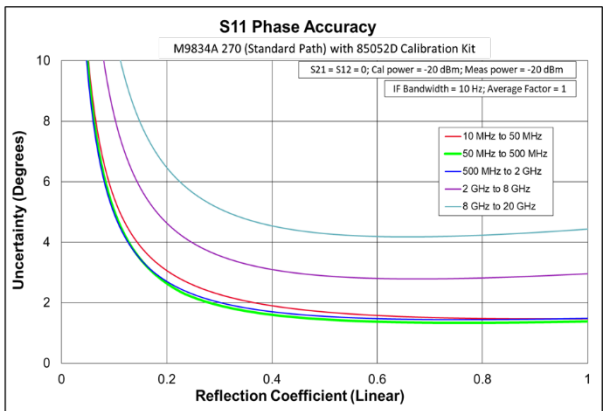
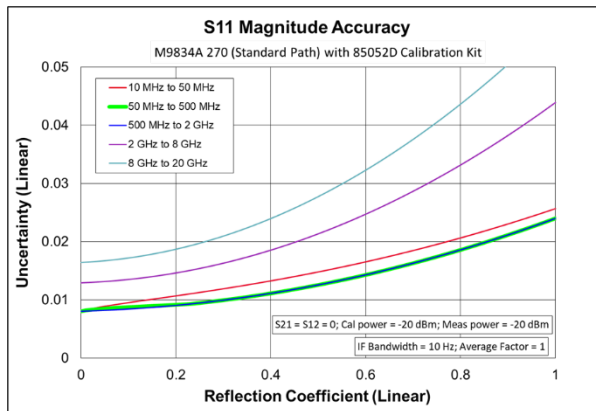
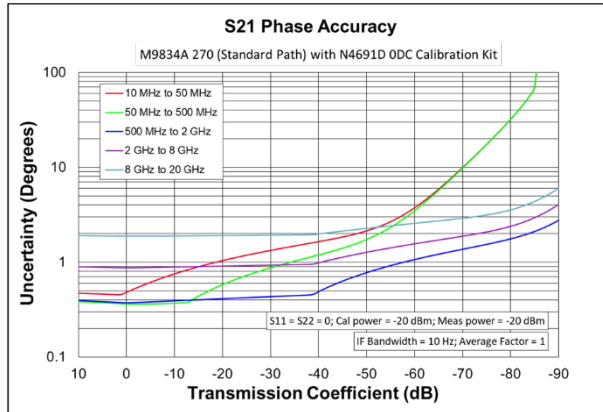
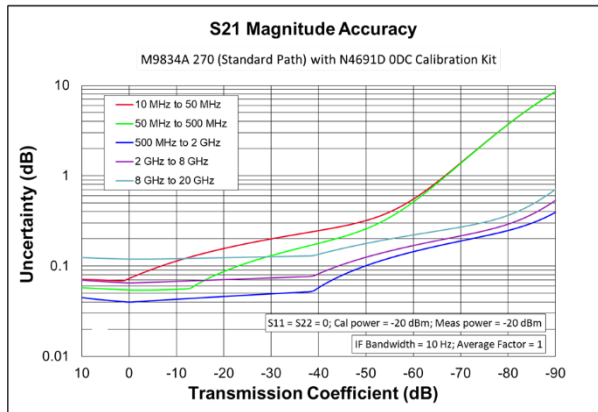

Table 6. M9834A or M9837A with N4691D Electronic Calibration (ECal) Module with Option 0DC

Corrected error terms (dB) – Specifications

Description	10 MHz to 50 MHz	50 MHz to 500 MHz	500 MHz to 2 GHz	2 GHz to 8 GHz	8 GHz to 20 GHz
Directivity	46	46	47	46	43
Source match	41	41	47	45	42
Load match	42	42	44	41	37
Reflection tracking	± 0.050	± 0.050	± 0.020	± 0.030	± 0.040
Transmission tracking	± 0.045	± 0.041	± 0.028	± 0.051	± 0.1

Transmission uncertainty (magnitude and phase)



Reflection uncertainty (magnitude and phase)

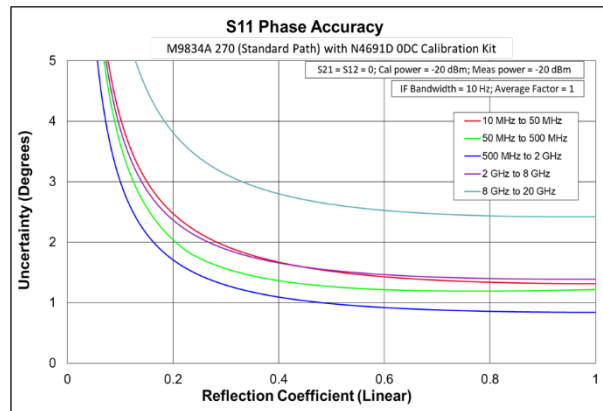
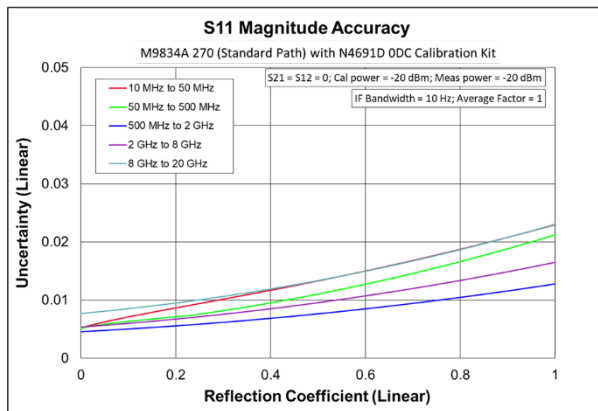
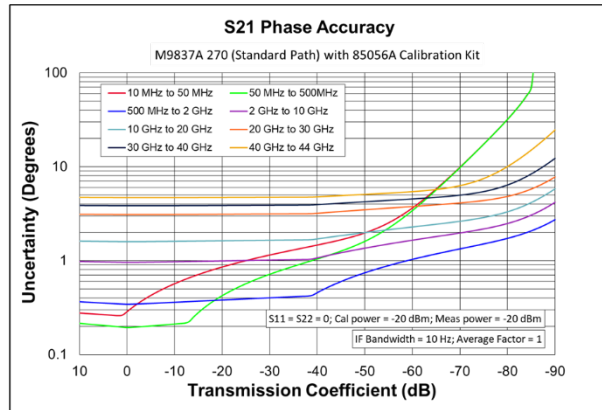
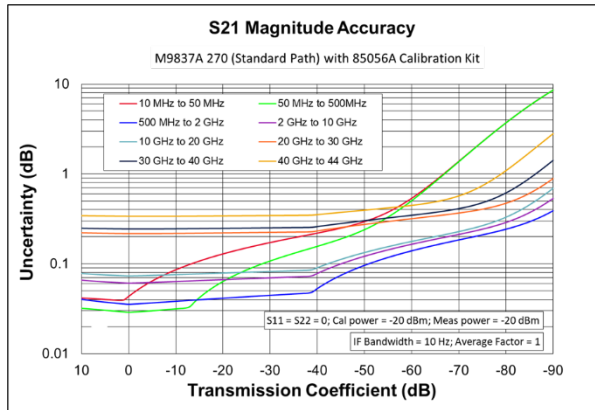

Table 7. M9834A or M9837A with 85056A Mechanical Calibration Kit
Corrected error terms (dB) – Specifications

Description	10 MHz to 50 MHz	50 MHz to 500 MHz	500 MHz to 2 GHz	2 GHz to 10 GHz	10 GHz to 20 GHz	20 GHz to 30 GHz	30 GHz to 40 GHz	40 GHz to 44 GHz
Directivity	42	42	42	42	42	38	38	36
Source match	41	41	41	38	38	33	33	31
Load match	42	42	42	42	42	37	37	35
Reflection tracking	± 0.001	± 0.001	± 0.001	± 0.008	± 0.008	± 0.020	± 0.020	± 0.027
Transmission tracking	± 0.016	± 0.016	± 0.023	± 0.045	± 0.058	± 0.197	± 0.222	± 0.314

Transmission uncertainty (magnitude and phase)



Reflection uncertainty (magnitude and phase)

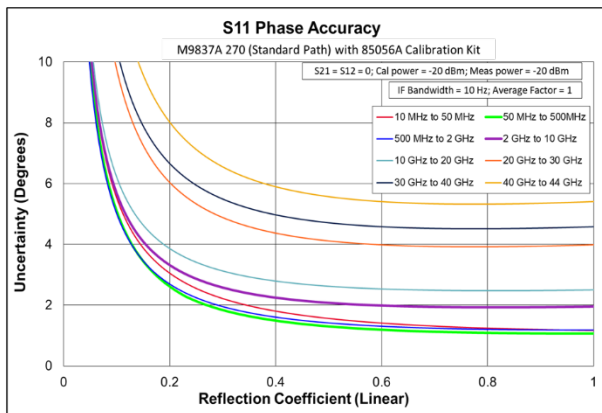
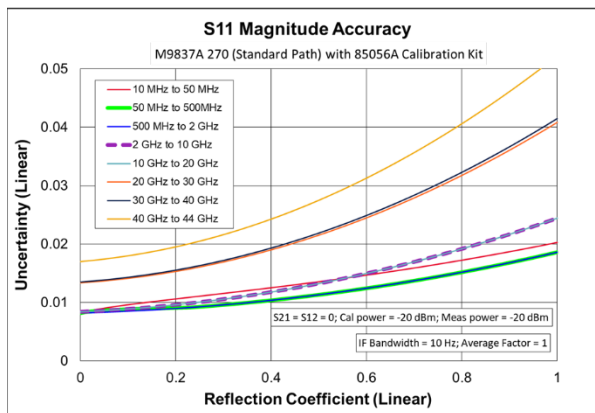
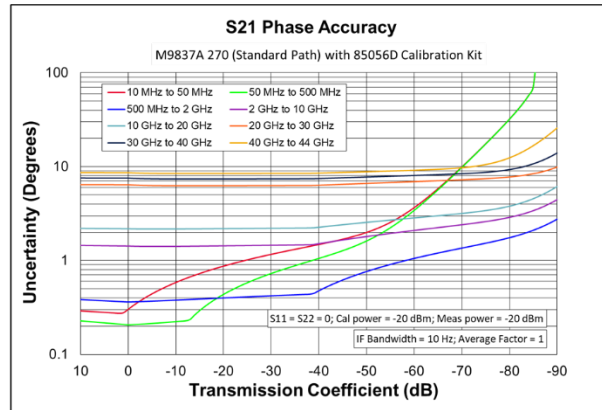
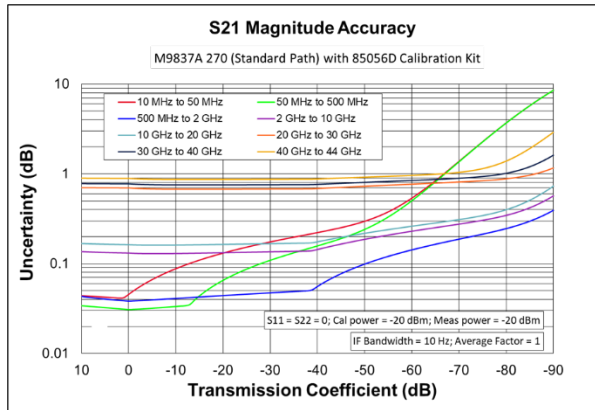

Table 8. M9834A or M9837A with 85056D Mechanical Calibration Kit
Corrected error terms (dB) – Specifications

Description	10 MHz to 50 MHz	50 MHz to 500 MHz	500 MHz to 2 GHz	2 GHz to 10 GHz	10 GHz to 20 GHz	20 GHz to 30 GHz	30 GHz to 40 GHz	40 GHz to 44 GHz
Directivity	42	42	42	34	34	26	26	26
Source match	40	40	40	30	30	23	23	23
Load match	42	42	42	34	33	25	25	25
Reflection tracking	± 0.002	± 0.002	± 0.002	± 0.029	± 0.029	± 0.079	± 0.079	± 0.075
Transmission tracking	± 0.018	± 0.018	± 0.025	± 0.111	± 0.142	± 0.651	± 0.731	± 0.843

Transmission uncertainty (magnitude and phase)



Reflection uncertainty (magnitude and phase)

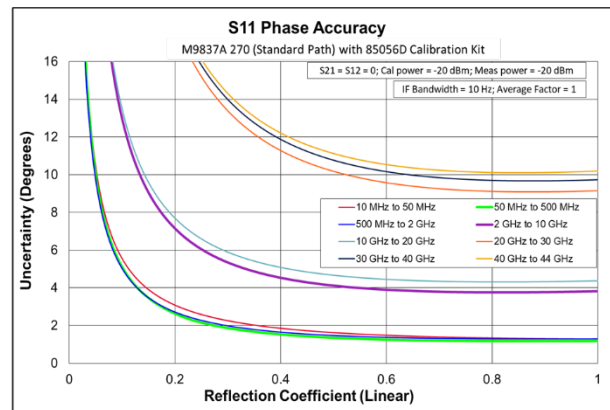
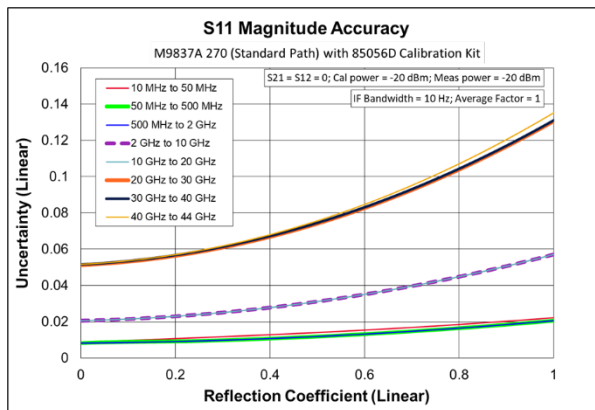
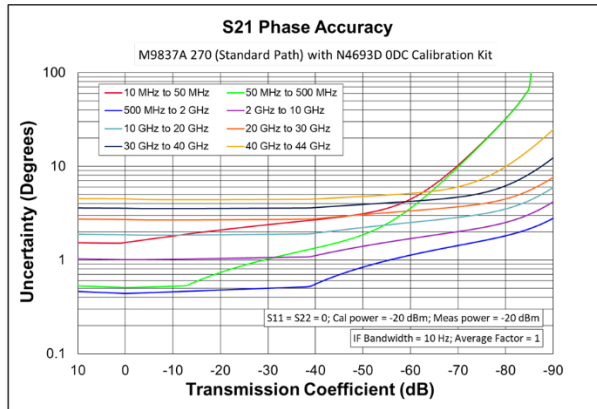
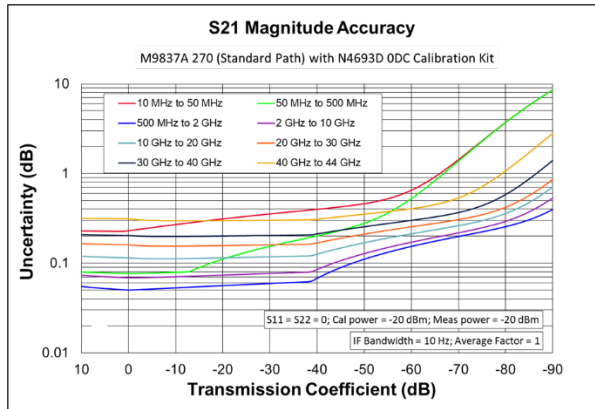

Table 9. M9834A or M9837A with N4693D Electronic Calibration (ECal) Module with Option 0DC

Corrected error terms (dB) – Specifications

Description	10 MHz to 50 MHz	50 MHz to 500 MHz	500 MHz to 2 GHz	2 GHz to 10 GHz	10 GHz to 20 GHz	20 GHz to 30 GHz	30 GHz to 40 GHz	40 GHz to 44 GHz
Directivity	40	40	46	47	44	38	38	34
Source match	38	44	46	42	37	35	35	32
Load match	33	37	42	42	39	34	33	29
Reflection tracking	± 0.050	± 0.050	± 0.030	± 0.040	± 0.050	± 0.060	± 0.060	± 0.080
Transmission tracking	± 0.2	± 0.064	± 0.037	± 0.052	± 0.093	± 0.133	± 0.176	± 0.271

Transmission uncertainty (magnitude and phase)



Reflection uncertainty (magnitude and phase)

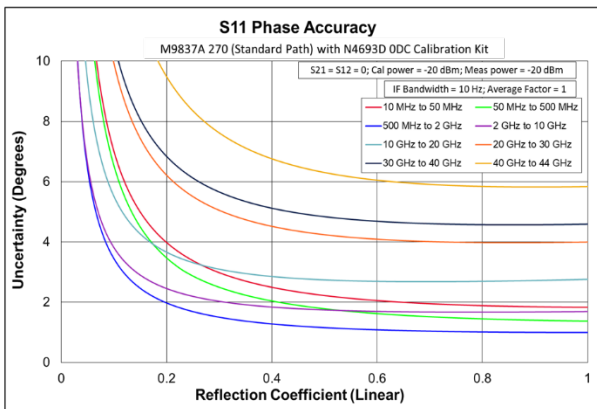
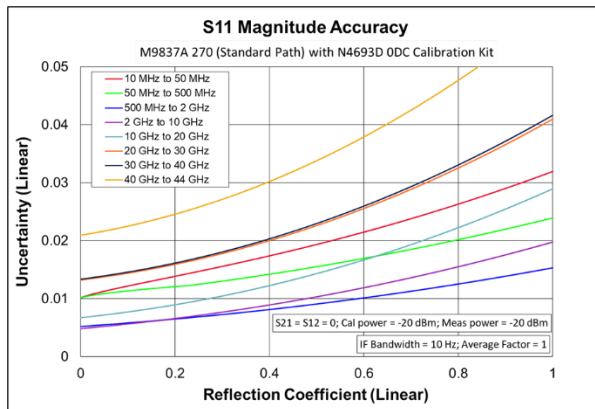

Uncorrected System Performance

Table 10. Uncorrected Error Terms (dB)^{1, 2} – Specification

Description	Directivity	Source match	Load match	Transmission tracking	Reflection tracking	Crosstalk
10 MHz to 100 MHz	20	20	19	--	--	--
100 MHz to 500 MHz	25	25	19	--	--	--
500 MHz to 5 GHz	25	25	16	--	--	--
5 GHz to 10 GHz	20	20	12	--	--	--
10 GHz to 20 GHz	20	20	10	--	--	--
20 GHz to 25 GHz	14	15	7	--	--	--
25 GHz to 33 GHz	14	15	4	--	--	--
33 GHz to 40 GHz	14	15	3	--	--	--
40 GHz to 44 GHz	9	10	2	--	--	--

1. Specifications apply to following conditions: Factory correction is turned on and gain coupling is turned on.
2. Instrument has been stored for a minimum of 24 hours in a stable environment before measurement.

Table 11. Uncorrected Error Terms (dB)¹ – Typical

Description	Directivity	Source match	Load match	Transmission tracking	Reflection tracking	Crosstalk
10 MHz to 100 MHz	40	35	22	± 0.5	± 0.5	-121 ²
100 MHz to 500 MHz	40	35	22	± 0.5	± 0.5	-140
500 MHz to 1 GHz	50	50	20	± 0.2	± 0.2	-140
1 GHz to 2 GHz	50	50	20	± 0.2	± 0.2	-153
2 GHz to 5 GHz	50	50	20	± 0.2	± 0.2	-151
5 GHz to 6.5 GHz	45	40	15	± 0.2	± 0.2	-152
6.5 GHz to 9 GHz	45	40	15	± 0.2	± 0.2	-149
9 GHz to 10 GHz	45	40	15	± 0.2	± 0.2	-148
10 GHz to 15 GHz	30	35	12	± 0.3	± 0.3	-147
15 GHz to 19 GHz	30	35	12	± 0.3	± 0.3	-146
19 GHz to 20 GHz	30	35	12	± 0.3	± 0.3	-142
20 GHz to 22 GHz	30	35	10	± 0.3	± 0.3	-145
22 GHz to 24 GHz	30	35	10	± 0.3	± 0.3	-143
24 GHz to 25 GHz	30	35	10	± 0.3	± 0.3	-140
25 GHz to 27 GHz	30	35	7	± 0.3	± 0.3	-139
27 GHz to 30 GHz	30	35	7	± 0.3	± 0.3	-140
30 GHz to 32 GHz	20	30	7	± 0.3	± 0.3	-138
32 GHz to 33 GHz	20	30	7	± 0.3	± 0.3	-134
33 GHz to 35 GHz	20	30	5	± 0.3	± 0.3	-133
35 GHz to 37.5 GHz	20	20	5	± 1.0	± 1.0	-130
37.5 GHz to 40 GHz	20	20	5	± 1.0	± 1.0	-129
40 GHz to 41 GHz	20	20	4	± 1.5	± 1.5	-123
41 GHz to 42 GHz	20	20	4	± 1.5	± 1.5	-114
42 GHz to 43 GHz	20	20	4	± 1.5	± 1.5	-109
43 GHz to 44 GHz	20	20	4	± 1.5	± 1.5	-111

1. Cable loss not included in transmission tracking.
2. It may typically be degraded at 25 MHz.

Table 12. Noise Mode Uncorrected System Performance, Option 029 (dB) – Specification

Description	Source match	Load match
50 MHz to 500 MHz	8	8
500 MHz to 1 GHz	8	12
1 GHz to 4 GHz	13	12
4 GHz to 5 GHz	7	12
5 GHz to 10 GHz	7	10
10 GHz to 20 GHz	4	6
20 GHz to 25 GHz	4	5
25 GHz to 33 GHz	4	3
33 GHz to 37 GHz	4	2
37 GHz to 44 GHz	2	2

Table 13. Noise Mode Uncorrected System Performance, Option 029 (dB) ¹ – Typical

Description	Source match	Load match	Reflection tracking	Transmission tracking
50 MHz to 100 MHz	11	11	± 5	± 5
100 MHz to 500 MHz	11	11	± 5	± 5
500 MHz to 1 GHz	11	15	± 2	± 2
1 GHz to 2 GHz	18	15	± 1	± 1
2 GHz to 4 GHz	18	15	± 1	± 1
4 GHz to 5 GHz	10	15	± 1	± 1
5 GHz to 10 GHz	10	12	± 2	± 2
10 GHz to 15 GHz	7	10	+2 / -4	+2 / -4
15 GHz to 20 GHz	7	10	+2 / -3	+2 / -3
20 GHz to 25 GHz	7	9	+2 / -3	+2 / -3
25 GHz to 30 GHz	7	6	+3 / -4	+3 / -4
30 GHz to 33 GHz	7	6	+3 / -4	+3 / -4
33 GHz to 35 GHz	7	5	+3 / -4	+3 / -4
35 GHz to 37 GHz	7	5	+4 / -8	+4 / -8
37 GHz to 40 GHz	4	5	+4 / -8	+4 / -8
40 GHz to 42 GHz	4	5	+4 / -10	+4 / -10
42 GHz to 44 GHz	4	5	+4 / -10	+4 / -10

1. Cable loss not included in transmission tracking.

Test Port Output ¹

Table 14. Frequency Resolution, Accuracy, Stability

Description	Specification	Typical
Frequency range	100 kHz to 20 GHz (M9834A) 100 kHz to 44 GHz (M9837A)	
Frequency resolution	1 Hz	--
Frequency accuracy	± 7 ppm (25 ± 5 °C)	--
Frequency stability	--	± 7 ppm ² ± 3 ppm/year maximum ³

1. The specifications do not apply to parallel measurements of multiple devices under test (DUT).

2. 0 to 50 °C. Assumes no variation in time.

3. Assumes no variation in temperature.

Table 15. Maximum Output Port Power (dBm)

Description	Specification	Typical
100 kHz to 1 MHz	9	11
1 MHz to 5 GHz	16	17
5 GHz to 6.5 GHz	18	20
6.5 GHz to 9 GHz	16	17
9 GHz to 15 GHz	15	16
15 GHz to 19 GHz	13	15
19 GHz to 20 GHz	11 ¹	12
20 GHz to 24 GHz	14	15
24 GHz to 27 GHz	11	12
27 GHz to 30 GHz	8	12
30 GHz to 32 GHz	8	11
32 GHz to 33 GHz	4	9
33 GHz to 35 GHz	4	7
35 GHz to 40 GHz	3	5
40 GHz to 41 GHz	-1	0
41 GHz to 42 GHz	-12	-10
42 GHz to 44 GHz	-15	-10

1. Applies to the specification at 20 GHz.

Table 16. Power Sweep Range (dBm)

Description	Specification	Typical
100 kHz to 1 MHz	--	-80 to 11
1 MHz to 5 GHz	--	-80 to 17
5 GHz to 6.5 GHz	--	-80 to 20
6.5 GHz to 9 GHz	--	-80 to 17
9 GHz to 15 GHz	--	-80 to 16
15 GHz to 19 GHz	--	-80 to 15
19 GHz to 20 GHz	--	-80 to 12
20 GHz to 24 GHz	--	-80 to 15
24 GHz to 30 GHz	--	-80 to 12
30 GHz to 32 GHz	--	-80 to 11
32 GHz to 33 GHz	--	-80 to 9
33 GHz to 35 GHz	--	-80 to 7
35 GHz to 40 GHz	--	-80 to 5
40 GHz to 41 GHz	--	-80 to 0
41 GHz to 44 GHz	--	-80 to -10

Table 17. Power Level Accuracy (dB)^{1, 2}

Description	Specification	Typical
100 kHz to 1 MHz	± 2.0	± 0.3
1 MHz to 50 MHz	± 2.0	± 0.4
50 MHz to 15 GHz	± 1.5	± 0.4
15 GHz to 20 GHz	± 2.0	± 0.6
20 GHz to 25 GHz	± 2.0	± 0.5
25 GHz to 30 GHz	± 2.5	± 0.6
30 GHz to 37.5 GHz	± 3.5	± 1.2
37.5 GHz to 40 GHz	± 3.5	± 0.8
40 GHz to 44 GHz	± 5.0	± 1.8

1. At nominal power of 0 dBm (M9834A) or -15 dBm (M9837A), stepped sweep mode.

2. Instrument has been stored for a minimum of 48 hours in a stable environment before measurement. Instrument has been turned on for 24 hours with VNA application running.

Table 18. Power Level Linearity (dB) ¹

Description	Specification ²	Typical ^{3,4}
100 kHz to 1 MHz	± 2.0	± 0.2
1 MHz to 10 GHz	± 0.75	± 0.2
10 GHz to 20 GHz	± 1.0	± 0.2
20 GHz to 30 GHz	± 1.5	± 0.4
30 GHz to 35 GHz	± 2.0	± 0.4
35 GHz to 44 GHz	± 2.5	± 0.5

1. Level linearity given is relative to 0 dBm (M9834A) or -15 dBm (M9837A).

2. Stepped sweep mode. $-20 \text{ dBm} \leq P \leq$ maximum specified power.

3. Swept sweep mode. $-80 \text{ dBm} \leq P \leq$ maximum specified power.

4. Stepped sweep mode. $-80 \text{ dBm} \leq P < -20 \text{ dBm}$.

Table 19. 2nd Harmonics (dBc) - Typical

Description ¹	At -15 dBm	At max specified power
100 kHz to 500 MHz	-30	-24
500 MHz to 1 GHz	-50	-24
1 GHz to 10 GHz	-50	-20
10 GHz to 15 GHz	-50	-18
15 GHz to 19 GHz	-45	-16
19 GHz to 22 GHz	-35	-12

1. Listed frequency is fundamental frequency.

Table 20. 3rd Harmonics (dBc) - Typical

Description ¹	At -15 dBm	At max specified power
100 kHz to 500 MHz	-30	-26
500 MHz to 1 GHz	-60	-26
1 GHz to 10 GHz	-60	-30
10 GHz to 14.67 GHz	-50	-25

1. Listed frequency is fundamental frequency.

Table 21. Sub-harmonics at Nominal Power (dBc)

Description ¹	Specification	Typical
100 kHz to 5 GHz	--	-60
5 GHz to 20 GHz	--	-43
20 GHz to 42 GHz	--	-55
42 GHz to 44 GHz	--	-25

1. Listed frequency is fundamental frequency. Tested at power of 0 dBm (M9834A) or -15 dBm (M9837A).

Table 22. Non-harmonic Spurs at Nominal Power (dBc)

Description ¹	Specification	Typical
100 kHz to 5 GHz	--	-60
5 GHz to 20 GHz	--	-43
20 GHz to 42 GHz	--	-55
42 GHz to 44 GHz	--	-25

1. Listed frequency is fundamental frequency. Tested at power of 0 dBm (M9834A) or -15 dBm (M9837A). Includes spurious related to LO signal and frac-N.

Table 23. Nominal Power (Preset Power Level)

Description	Specification
M9834A	0 dBm
M9837A	-15 dBm

Table 24. Power Resolution, Maximum/minimum Settable Power

Description	Specification	Typical
Settable resolution	--	0.01 dB
Maximum settable power	--	+30 dBm
Minimum settable power	--	-100 dBm

Test Port Input

Table 25. Noise Floor (dBm) ¹

Test port

Description	Specification	Typical
100 kHz to 300 kHz	--	-59
300 kHz to 1 MHz	--	-70
1 MHz to 10 MHz	--	-80
10 MHz to 100 MHz ²	-96	-101
100 MHz to 1 GHz	-114	-121
1 GHz to 2 GHz	-130	-132
2 GHz to 5 GHz	-127	-131
5 GHz to 10 GHz	-126	-130
10 GHz to 15 GHz	-125	-128
15 GHz to 20 GHz	-123	-126
20 GHz to 25 GHz	-123	-126
25 GHz to 30 GHz	-121	-124
30 GHz to 35 GHz	-119	-122
35 GHz to 40 GHz	-116	-119
40 GHz to 44 GHz	-109	-114

Test port with low noise path

Description	Specification	Typical
100 kHz to 300 kHz	--	-125
300 kHz to 1 MHz	--	-126
1 MHz to 10 MHz	--	-132
10 MHz to 100 MHz ²	--	-147
100 MHz to 2 GHz	--	-152
2 GHz to 5 GHz	--	-151
5 GHz to 10 GHz	--	-151
10 GHz to 15 GHz	--	-150
15 GHz to 20 GHz	--	-148
20 GHz to 25 GHz	--	-146
25 GHz to 30 GHz	--	-148
30 GHz to 35 GHz	--	-146
35 GHz to 40 GHz	--	-144
40 GHz to 44 GHz	--	-140

Direct receiver access port (A In, B In, R1 In, R2 In)

Description	Specification	Typical
100 kHz to 300 kHz	--	-144
300 kHz to 1 MHz	--	-148
1 MHz to 10 MHz	--	-149
10 MHz to 100 MHz ²	--	-147
100 MHz to 1 GHz	--	-147
1 GHz to 2 GHz	--	-145
2 GHz to 5 GHz	--	-144
5 GHz to 10 GHz	--	-142
10 GHz to 15 GHz	--	-140
15 GHz to 20 GHz	--	-139
20 GHz to 25 GHz	--	-137
25 GHz to 30 GHz	--	-134
30 GHz to 35 GHz	--	-133
35 GHz to 40 GHz	--	-127
40 GHz to 44 GHz	--	-123

1. Noise floor in a 10 Hz IF Bandwidth. Measured with 30 kHz IF bandwidth. Test port terminated.

2. It may typically be degraded at 25 MHz.

Table 26. Receiver Compression at Test Port ^{1,2}

Description	Specification			Typical	
	Input power at test port (dBm)	Magnitude (dB)	Phase (°)	Magnitude (dB)	Phase (°)
500 MHz to 15 GHz	+13	0.15	1.5	--	--
15 GHz to 20 GHz	+10	0.15	1.5	--	--
20 GHz to 26.5 GHz	+13	0.15	1.5	--	--
26.5 GHz to 38 GHz	+8	0.15	1.5	--	--
38 GHz to 40 GHz	+7	0.15	1.5	--	--
40 GHz to 44 GHz	+5	0.15	1.5	--	--

1. Tested with receiver gain AUTO. (18 dB receiver attenuator is selected for measurements)

2. Receiver compression at test port below 500 MHz is negligible due to the coupler roll off.

Table 27. Trace Noise Magnitude (dB rms) ¹

Description	Specification	Typical
10 MHz to 100 MHz ²	0.03	0.0125
100 MHz to 500 MHz	0.0045	0.0017
500 MHz to 2 GHz	0.0015	0.0005
2 GHz to 10 GHz	0.0015	0.0006
10 GHz to 15 GHz	0.002	0.0008
15 GHz to 17 GHz	0.0025	0.001
17 GHz to 20 GHz	0.0025	0.0015
20 GHz to 24 GHz	0.003	0.0015
24 GHz to 25 GHz	0.004	0.002
25 GHz to 30 GHz	0.005	0.0021
30 GHz to 32 GHz	0.005	0.0035
32 GHz to 35 GHz	0.008	0.0056
35 GHz to 37 GHz	0.008	0.0056
37 GHz to 40 GHz	0.011	0.0075
40 GHz to 41 GHz	0.011	0.005
41 GHz to 42 GHz	0.02	0.015
42 GHz to 44 GHz	0.06	0.045

1. Transmission and reflection trace noise in a 10 kHz IF bandwidth. At maximum specified power.

2. It may typically be degraded at particular frequencies such as 108 MHz, 120 MHz, 132 MHz, 143 MHz, 149 MHz or 156 MHz.

Table 28. Trace Noise Phase (degree rms) ¹

Description	Specification	Typical
10 MHz to 100 MHz ²	0.2	0.0707
100 MHz to 500 MHz	0.03	0.0112
500 MHz to 1 GHz	0.01	0.0034
1 GHz to 2 GHz	0.01	0.0028
2 GHz to 5 GHz	0.01	0.0033
5 GHz to 10 GHz	0.01	0.0045
10 GHz to 15 GHz	0.011	0.006
15 GHz to 17 GHz	0.015	0.0081
17 GHz to 20 GHz	0.016	0.013
20 GHz to 24 GHz	0.021	0.013
24 GHz to 25 GHz	0.026	0.017
25 GHz to 30 GHz	0.026	0.0159
30 GHz to 32 GHz	0.045	0.025
32 GHz to 37 GHz	0.07	0.045
37 GHz to 40 GHz	0.08	0.0495
40 GHz to 41 GHz	0.08	0.041
41 GHz to 42 GHz	0.2	0.085
42 GHz to 44 GHz	0.45	0.29

1. Transmission and reflection trace noise in a 10 kHz IF bandwidth. At maximum specified power.

2. It may typically be degraded at particular frequencies such as 108 MHz, 120 MHz, 132 MHz, 143 MHz, 149 MHz or 156 MHz.

Table 29. Temperature Stability – Typical

Description	Magnitude (dB/°C)	Phase (degree/°C)
10 MHz to 10 GHz	0.005	0.1
10 GHz to 20 GHz	0.01	0.2
20 GHz to 25 GHz	0.015	0.25
25 GHz to 30 GHz	0.015	0.3
30 GHz to 35 GHz	0.02	0.3
35 GHz to 40 GHz	0.025	0.5
40 GHz to 44 GHz	0.04	0.7

Table 30. Damage Input Level at Test Ports (Port 1, Port 2)

Description	
Damage Input Level	+27 dBm or ± 35 VDC (Warranted)

Noise Receiver Input (Option 029 only)

Table 31. Noise Receiver Bandwidth

Description	Allowable bandwidth
50 MHz to 44 GHz	800 kHz, 1/2/4/8/12/24 MHz ¹

1. 8 to 24 MHz bandwidths are available only with calibration using noise source.

Table 32. Receiver Noise Figure (dB)

Description	Specification	Typical
50 MHz to 100 MHz	18	14
100 MHz to 200 MHz	12	9
200 MHz to 2 GHz	11	10
2 GHz to 5 GHz	12	10
5 GHz to 15 GHz	13	11
15 GHz to 20 GHz ¹	15	13
20 GHz to 25 GHz	17	15
25 GHz to 30 GHz	16	13
30 GHz to 35 GHz	17	15
35 GHz to 40 GHz	20	17
40 GHz to 44 GHz ^{2, 3}	26	21

1. For M9834A, tested at up to 19.975 GHz

2. Above 40 GHz, an external bandpass filter may be required for NF measurements.

3. Tested at up to 43.975 GHz.

Table 33. Noise Figure Trace Noise (dB rms) at 4 MHz BW ¹

Description	Specification	Typical
50 MHz to 44 GHz	0.11	0.07

1. All gain settings. Trace noise magnitude performance on noise figure trace or sometime called noise jitter, 201 points, 15 noise average, port 1 and 2 terminated.

Table 34. Noise Receiver Linearity (dB) at 4 MHz BW ¹ – Specification

Low Gain Setting Reference to -35 dBm	Medium Gain Setting Reference to -55 dBm	High Gain Setting Reference to -80 dBm	
-10 to -5	-30 to -25	-60 to -55	± 0.09 (Low Gain and Medium Gain) ± 0.15 (High Gain)
-40 to -10	-60 to -30	-85 to -60	± 0.05
-85 to -40	-105 to -60	-130 to -85	± 0.07

1. The VNA receiver is linear by design when signal levels are below -65 dBm for low gain setting, -85 dBm for medium gain setting, and -110 dBm for high gain setting.

Table 35. Noise Receiver Input Range – Specification

Serial number prefix MY621/SG621 and below

Description	Max DUT NF + Gain (dB) ¹			Max input power (dBm) for < 0.2 dB compression		
	High Gain Setting	Medium Gain Setting	Low Gain Setting	High Gain Setting	Medium Gain Setting	Low Gain Setting ³
50 MHz to 500 MHz ²	30	-	-	-58	-	-
500 MHz to 2 GHz ²	35	73	101	-53	-15	13
2 GHz to 4.5 GHz ²	37	73	101	-51	-15	13
4.5 GHz to 10 GHz ²	42	73	101	-46	-15	13
10 GHz to 15 GHz	42	78	101	-46	-10	13
15 GHz to 20 GHz	42	78	98	-46	-10	10
20 GHz to 26.5 GHz	41	78	101	-47	-10	13
26.5 GHz to 32 GHz ²	41	78	96	-47	-10	8
32 GHz to 38 GHz	45	78	96	-43	-10	8
38 GHz to 40 GHz ²	45	78	95	-43	-10	7
40 GHz to 44 GHz	48	78	93	-40	-10	5

Serial number prefix MY622/SG622 and above

Description	Max DUT NF + Gain (dB) ¹			Max input power (dBm) for < 0.2 dB compression		
	High Gain Setting	Medium Gain Setting	Low Gain Setting	High Gain Setting	Medium Gain Setting	Low Gain Setting ³
50 MHz to 500 MHz	38	-	-	-50	-	-
500 MHz to 2 GHz	45	73	101	-43	-15	13
2 GHz to 4.5 GHz	45	73	101	-43	-15	13
4.5 GHz to 10 GHz	50	73	101	-38	-15	13
10 GHz to 15 GHz	50	78	101	-38	-10	13
15 GHz to 20 GHz	50	78	98	-38	-10	10
20 GHz to 26.5 GHz	49	78	101	-39	-10	13
26.5 GHz to 32 GHz	49	78	96	-39	-10	8
32 GHz to 37.16 GHz	53	78	96	-35	-10	8
37.16 GHz to 38 GHz	45	78	96	-43	-10	8
38 GHz to 40 GHz	45	78	95	-43	-10	7
40 GHz to 44 GHz	48	78	93	-40	-10	5

1. Limited by 0.2 dB receiver compression. Applies to devices with bandwidth <400 MHz. For devices with higher bandwidths, calculate the DUT output noise power as $-174 \text{ dBm} + 10 \cdot \log_{10}(B) + \text{Gain (dB)} + \text{NF (dB)}$, where B is the bandwidth of the DUT in Hz, and use the Max Input Power specification.

2. Applies to the specification at maximum frequency points (ex. 500 MHz, 2 GHz, 4.5 GHz, 10 GHz, 32 GHz, and 40 GHz).

3. The performance is tested at Receiver Compression at Test Port (Table 26).

Dynamic Accuracy

Accuracy of the test port input power relative to the reference input power level. Measured with 10 Hz IF bandwidth.

Dynamic accuracy¹ – specification

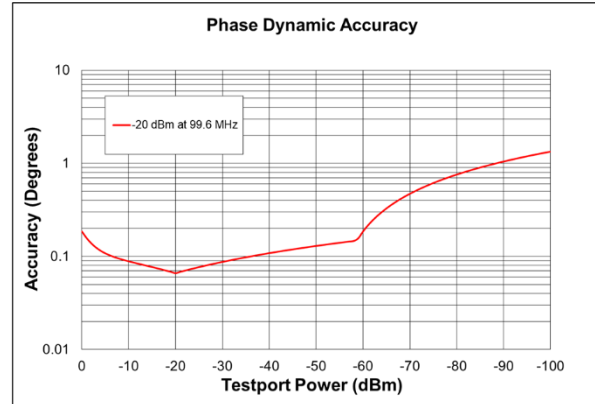
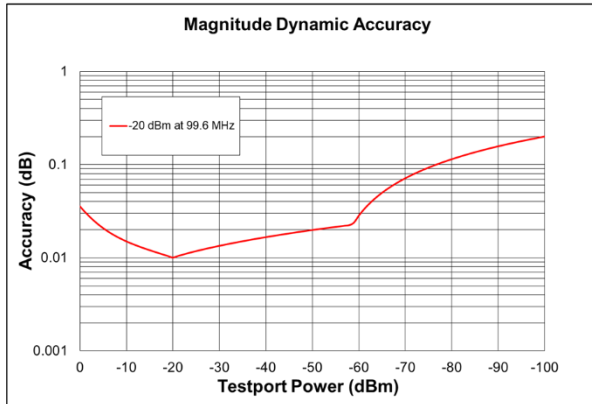

1. Dynamic accuracy is verified with the following measurements:
 - Compression over frequency.
 - IF linearity at the test ports using a reference level of -20 dBm for an input power range of 0 to -60 dBm. Tested at a single frequency (99.6MHz) to cover the whole frequency range. The VNA receiver is linear by design when signal levels are below -60 dBm. For more details, refer to [VNA Receiver Dynamic Accuracy Specifications and Uncertainties](#).
 - Tested at the direct receiver access ports while the IF input level is adjusted to the equivalent input power level at the test ports.
2. Download Uncertainty Calculator from http://www.keysight.com/find/na_calculator to generate the curves of dynamic accuracy at the test ports.

Spectrum Analysis (with Option 190 and S95090xB)

This section provides specifications for spectrum analysis with Option 190 of the M983xA Series PXIe VNA. The S95090B Software is required to enable spectrum analysis functionality of the M983xA.

Table 36. Frequency Specifications

Description	Specification	Typical
Frequency reference ¹		
Accuracy	--	± [(time since last adjustment x aging rate) + temperature stability + calibration accuracy], typical
Aging rate	--	± 3 ppm/year maximum, typical
Temperature stability	--	± 7 ppm (0 to 50 °C)
Achievable initial calibration accuracy	± 7 ppm (25 ± 5 °C)	--
Frequency readout accuracy (Start, Stop, Center, Marker)	--	± [(readout frequency x frequency reference accuracy) + (< 1% x RBW)], nominal
Frequency span		
Minimum/Maximum	Analyzer's full span ²	--
Resolution	1 Hz	--
Sweep (Trace) point range	11 to 100,003	--
Resolution Bandwidth (RBW)		
Range (-3 dB bandwidth)	10 Hz to 3 MHz in 10% steps	--
Bandwidth range accuracy	--	± 1%, all RBW, except below 100 MHz with 3 MHz RBW
Selectivity (-60 dB/-3 dB)	--	Gaussian: 4.5:1, Flat top: 2.47:1, Kaiser: 3.82:1, Blackman: 3.58:1
Video Bandwidth (VBW)		
Range	10 Hz to 3 MHz	--

1. Frequency reference accuracy can be improved by using external frequency reference with better accuracy.

2. When multitone is enabled, measurement frequency range is limited from 100 MHz to the maximum frequency minus 30 MHz.

Table 37. Time Specifications

Description	Specification	Supplemental information
Sweep time and triggering		
Sweep time range	Auto	--
Trigger types	Continuous, Single, Group, Manual, External	--
Trigger delay range	0 to 3 s	--
Trigger delay resolution	1 μ s	--
Measuring and display update rate (milliseconds) ¹		
20 MHz Span, 3 kHz RBW, 3 kHz VBW	--	63
100 MHz Span, Auto RBW, Auto VBW	--	60
1 GHz Span, 3 kHz RBW, 3 kHz VBW	--	199
1 GHz Span, 300 kHz RBW, 300 kHz VBW	--	62
10 GHz Span, 3 kHz RBW, 3 kHz VBW	--	1832
10 GHz Span, 300 kHz RBW, 300 kHz VBW	--	277
10 MHz to 20 GHz, RBW/VBW = 1 MHz	--	253
10 MHz to 44 GHz, RBW/VBW = 1 MHz	--	571

1. Measured with firmware revision A.16.70.00.

Table 38. Amplitude Accuracy and Range Specifications

Description	Specification
Amplitude range	
Measurement range	DANL to maximum input level
Input attenuator range	0 to 30 dB, 2 dB step
Maximum safe input level	+27 dBm
Display range	
Log scale	0.001 to 500 dB/div in 0.001 steps
Linear scale	10 divisions (default)
Scale units	dBm, mW
Trace detectors types	Average, Sample, Peak, Normal, Negative Peak, Peak sample, Peak average

Table 39. SA Detector Accuracy (dB) ^{1, 2} – Specifications

Description	Specification
10 MHz to 20 GHz	± 0.1
20 GHz to 40 GHz	± 0.15
40 GHz to 44 GHz ³	± 0.18

1. With 18 dB attenuation. SA detector accuracy is residual error of IF response calibration. IF response is characterized with M983xA's standard measurement class after power and S-parameter calibration. Therefore, the SA total absolute amplitude accuracy includes power meter, S-parameter and SA detector accuracies. Add input attenuation switching uncertainty if receiver attenuator is changed after user calibration.

2. Tested at the test ports (without low noise path).

3. Tested up to 43.99 GHz.

Table 40. Input Attenuation Switching Uncertainty (dB) – Supplemental Information

Description	Supplemental information
100 kHz to 50 MHz	± 0.5
50 MHz to 44 GHz	± 1.0

Table 41. Input VSWR¹ – Specifications

Description	Specification
10 MHz to 500 MHz	1.253
500 MHz to 5 GHz	1.377
5 GHz to 10 GHz	1.671
10 GHz to 20 GHz	1.925
20 GHz to 25 GHz	2.615
25 GHz to 33 GHz	4.419
33 GHz to 40 GHz	5.848
40 GHz to 44 GHz	8.724

1. Calculated by load match of uncorrected error terms (Table 10). $VSWR = \frac{1+10^{(-1 \cdot load\ match/20)}}{1-10^{(-1 \cdot load\ match/20)}}$

Table 42. Other Amplitude Accuracy – Supplemental Information

Description	Supplemental information
RBW switching uncertainty	0.02 dB
Display scale fidelity	See dynamic accuracy specification. Specification applied to SA measurement class with user calibration between -10 dBm and -40 dBm input power and measurement between +10 dBm and -120 dBm input power.

Table 43. Spurious Response – Supplemental Information

Description	Supplemental information
Image response	Mostly eliminated. Intermittent image response may be seen when making multi-tone or modulated signal measurements.
LO related spurious	Eliminated

Table 44. Displayed Average Noise Level (DANL) at Test Ports with 0 dB Attenuation (dBm/Hz) ¹

Description	Specification	Typical
100 kHz to 300 kHz	--	-72
300 kHz to 1 MHz	--	-83
1 MHz to 10 MHz	--	-93
10 MHz to 100 MHz	-108	-113
100 MHz to 1 GHz	-128	-135
1 GHz to 2 GHz	-144	-146
2 GHz to 5 GHz	-141	-145
5 GHz to 10 GHz	-140	-144
10 GHz to 15 GHz	-139	-142
15 GHz to 25 GHz	-137	-140
25 GHz to 30 GHz	-135	-138
30 GHz to 35 GHz	-133	-136
35 GHz to 40 GHz	-130	-133
40 GHz to 44 GHz	-123	-128

1. Tested with 1 kHz RBW up to 50 MHz and 10 kHz RBW for above 50 MHz, test port terminated, average detector, averaging type = Log, IF gain = AUTO, image rejection = normal, random LO OFF.

Table 45. Displayed Average Noise Level (DANL) at Test Ports with 18 dB Attenuation (dBm/Hz) ¹ – Typical

Description	Specification	Typical
100 kHz to 300 kHz	--	-47
300 kHz to 1 MHz	--	-59
1 MHz to 10 MHz	--	-69
10 MHz to 100 MHz	--	-87
100 MHz to 1 GHz	--	-110
1 GHz to 2 GHz	--	-121
2 GHz to 5 GHz	--	-119
5 GHz to 10 GHz	--	-118
10 GHz to 15 GHz	--	-117
15 GHz to 30 GHz	--	-114
30 GHz to 35 GHz	--	-113
35 GHz to 40 GHz	--	-111
40 GHz to 44 GHz	--	-103

1. Tested with 1 kHz RBW up to 50 MHz and 10 kHz RBW for above 50 MHz, test port terminated, average detector, averaging type = Log, IF gain = AUTO, image rejection = normal, random LO OFF.

Table 46. Second Harmonic Intercept at Test Ports (dBm) – Characteristic

Description	With 0 dB attenuation ¹	With 18 dB attenuation ²
50 MHz to 100 MHz	47	59
100 MHz to 4 GHz	31	49
4 GHz to 6.5 GHz	28	46
6.5 GHz to 10 GHz	27	45
10 GHz to 16.5 GHz	26	44
16.5 GHz to 19.5 GHz	22	40
19.5 GHz to 21.5 GHz	11	29
21.5 GHz to 22 GHz	2	20

1. Tested with -15 dBm for 50 MHz to 150 MHz, -25 dBm for 150 MHz to 10 GHz, and -20 dBm for 10 GHz to 22 GHz input at test ports, 10 MHz tone separations.
2. Tested with 0 dBm for 50 MHz to 10 GHz, -5 dBm for 10 GHz to 22 GHz input at test ports, 10 MHz tone separations.

Table 47. Second Harmonic Intercept at Direct Access Input Ports (dBm) – Characteristic

Description	With 0 dB attenuation ¹	With 18 dB attenuation ²
50 MHz to 1 GHz	12	30
1 GHz to 10 GHz	16	34
10 GHz to 16.5 GHz	13	31
16.5 GHz to 19.5 GHz	10	28
19.5 GHz to 21.5 GHz	-5	13
21.5 GHz to 22 GHz	-10	8

1. Tested with -40 dBm for 50 MHz to 1 GHz, -35 dBm for 1 GHz to 22 GHz input at direct access input ports, 10 MHz tone separations. Tested high-side intermodulation only. ($F_{test} = f_1 + f_2$)
2. Tested with -10 dBm input at direct access input ports, 10 MHz tone separations. Tested high-side intermodulation only. ($F_{test} = f_1 + f_2$).

Table 48. Third Harmonic Distortion at Test Ports (dBc) – Characteristic

Description	With 0 dB attenuation ¹	With 18 dB attenuation ²
50 MHz to 150 MHz	-66	-46
150 MHz to 10 GHz	-68	-58
10 GHz to 15 GHz	-64	-62
15 GHz to 25 GHz	-64	-54
25 GHz to 32 GHz	-62	-48
32 GHz to 40 GHz	-58	-48
40 GHz to 44 GHz	-56	-30

1. Tested with -15 dBm for 50 MHz to 150 MHz, -25 dBm for 150 MHz to 10 GHz, and -20 dBm for 10 GHz to 44 GHz input at test ports, 10 MHz tone separations.
2. Tested with 0 dBm for 50 MHz to 10 GHz, -5 dBm for 10 GHz to 44 GHz input at test ports, 10 MHz tone separations

Table 49. Third Harmonic Distortion at Direct Access Input Ports (dBc) – Characteristic

Description	With 0 dB attenuation ¹	With 18 dB attenuation ²
50 MHz to 1 GHz	-62	-46
1 GHz to 3 GHz	-66	-52
3 GHz to 15 GHz	-66	-60
15 GHz to 25 GHz	-64	-60
25 GHz to 32 GHz	-60	-58
32 GHz to 35 GHz	-56	-58
35 GHz to 44 GHz	-56	-54

1. Tested with -40 dBm for 50 MHz to 1 GHz, -35 dBm for 1 GHz to 25 GHz, and -30 dBm for 25 GHz to 44 GHz input at direct access input ports, 10 MHz tone separations.
2. Tested with -10 dBm input at direct access input ports, 10 MHz tone separations.

Table 50. Third Order Intermodulation Distortion at Test Ports (dBm) ¹ – Characteristic

Description	With 0 dB attenuation ¹	With 18 dB attenuation ²
50 MHz to 100 MHz	18	23
100 MHz to 150 MHz	18	29
150 MHz to 1 GHz	9	29
1 GHz to 10 GHz	9	29
10 GHz to 15 GHz	12	26
15 GHz to 25 GHz	12	22
25 GHz to 32 GHz	11	19
32 GHz to 35 GHz	9	19
35 GHz to 40 GHz	9	19
40 GHz to 44 GHz	8	10

1. Tested with -15 dBm for 50 MHz to 150 MHz, -25 dBm for 150 MHz to 10 GHz, and -20 dBm for 10 GHz to 44 GHz input at test ports, 10 MHz tone separations.
2. Tested with 0 dBm for 50 MHz to 10 GHz, -5 dBm for 10 GHz to 44 GHz input at test ports, 10 MHz tone separations.

Table 51. Third Order Intermodulation Distortion at Direct Access Input Ports (dBm) ¹ – Characteristic

Description	With 0 dB attenuation ¹	With 18 dB attenuation ²
50 MHz to 1 GHz	-9	13
1 GHz to 3 GHz	-2	16
3 GHz to 15 GHz	-2	20
15 GHz to 25 GHz	-3	20
25 GHz to 32 GHz	0	19
32 GHz to 35 GHz	-2	19
35 GHz to 44 GHz	-2	17

1. Tested with -40 dBm for 50 MHz to 1 GHz, -35 dBm for 1 GHz to 25 GHz, and -30 dBm for 25 GHz to 44 GHz input at direct access input ports, 10 MHz tone separations.
2. Tested with -10 dBm input at direct access input ports, 10 MHz tone separations

DANL and Distortion Relative to Test Port Level (dB)¹ – Nominal

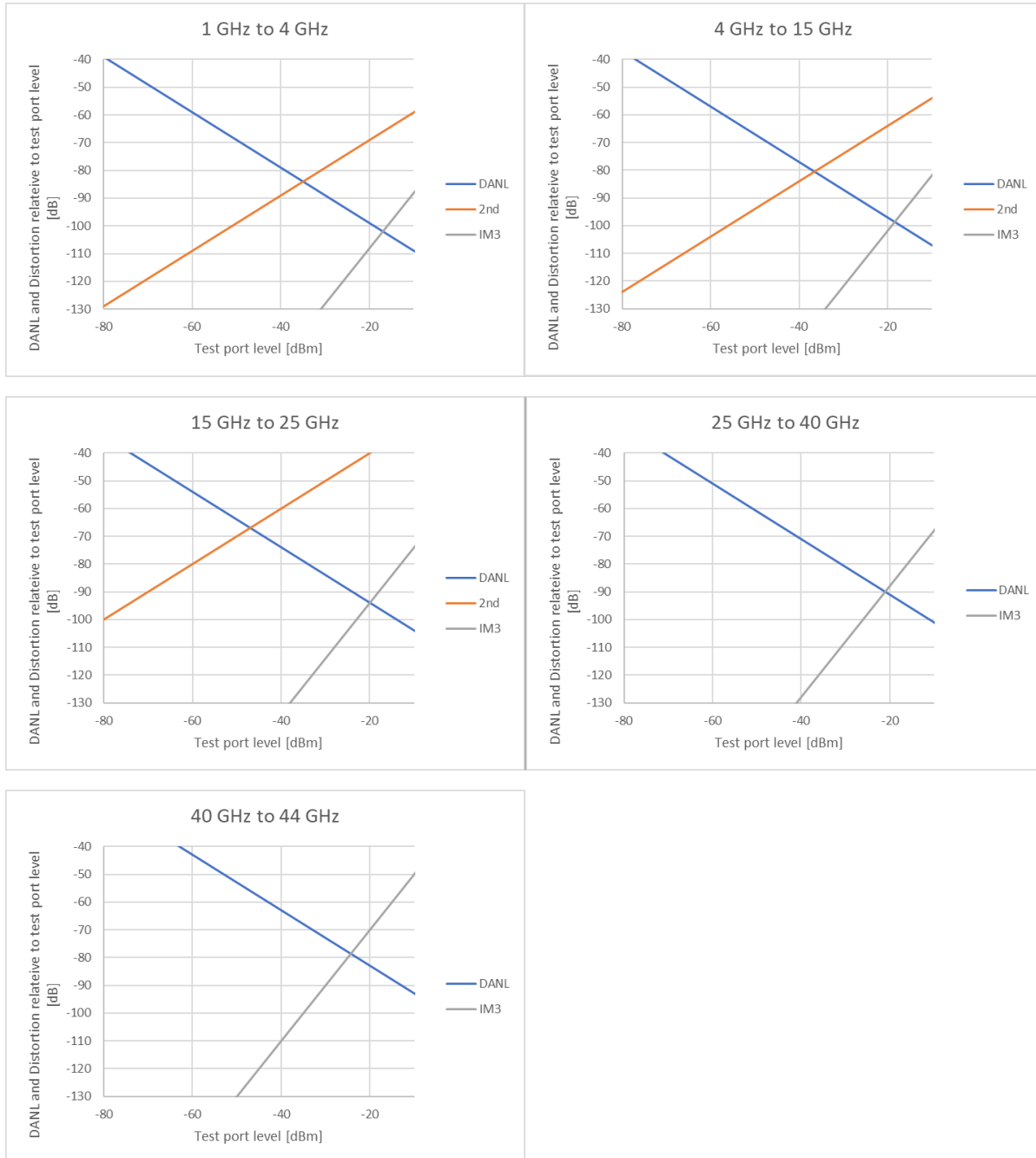

1. With 18 dB Attenuation. 2nd harmonic distortion applies up to 22 GHz

Table 52. Receiver Phase Noise (dBc/Hz) ¹ – Typical

Description	1 kHz	10 kHz	100 kHz	1 MHz	10 MHz
CF = 1 GHz	-103	-103	-103	-128	-130
CF = 3 GHz	-96	-96	-96	-120	-130
CF = 10 GHz	-83	-83	-83	-116	-127
CF = 20 GHz ²	-76	-76	-76	-110	-121

1. Tested with 15 dBm at 1 GHz, 3 GHz, or 10 GHz, 10 dBm at 20 GHz. Spurious signals are excluded. With the SA class, phase noise of VNA's source is equivalent to the receiver phase noise.
2. Tested at 19.99 GHz.

Modulation Distortion Analysis (with Option 190 and S95070B)

This section provides specifications for modulation distortion analysis using Option 190 of the M983xA Series PXIe VNA and an external vector signal generator. The S95070B Software is required to enable modulation analysis functions of the M983xA. Refer to M983xA and M980xA PXIe VNA configuration guide (literature number: [5992-3597EN](#)) for the list of supported signal generators by this application.

Typical measured performance (EVM and ACPR) of a thru adapter and N4985A power amp is provided.

Typical Configuration for Modulation Distortion Analysis

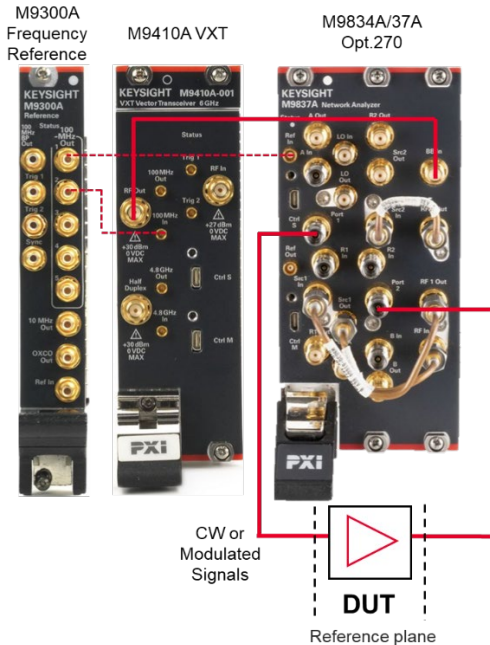

Table 53. General Information

Description	
Measurement parameters	Error Vector Magnitude (EVM) <ul style="list-style-type: none"> Equalized EVM of the DUT (non-linear contribution) Unequalized EVM of the DUT (Includes non-linear and linear distortion due to frequency dispersion)
	Adjacent Channel Power (ACP) <ul style="list-style-type: none"> Upper and lower side bands of the input signal Upper and lower side bands of the output signal Upper and lower side bands contribution of the DUT
	Noise Power Ratio (NPR) <ul style="list-style-type: none"> Input NPR Output NPR NPR contribution of the DUT
	Band power <ul style="list-style-type: none"> Input band power Output band power Band power gain of the DUT (magnitude and phase)

Table 54. Frequency Range – Specifications

Description	Specification
Frequency range ^{1,2}	100 MHz to 19.97 GHz (with M9834A) 100 MHz to 43.97 GHz ³ (with M9837A)

1. Lower edge of modulated signal and upper edge of modulated signal should be within the frequency range.
2. The lowest frequency is limited by the modulation source.
3. For the carrier frequency above 41 GHz, an external bandpass filter or high-pass filter is required to avoid the measurement error due to LO leakage from the source port. Filters such as Marki P/N FH-4000 (for 41 GHz to 42 GHz) or Eravant P/N: SWF-45310360-2F2F-B1 (for 41 GHz to 43.5 GHz) are recommended. Two cascaded Keysight V281A waveguide adapters can be used as a high-pass filter for 42 GHz to 43.97 GHz.

Table 55. Maximum Modulation Bandwidth ¹ – Typical

Description	With Opt.270	With Opt.271
100 MHz to 31.8 GHz	2 GHz	2 GHz
31.8 GHz to 37 GHz	2 GHz	550 MHz
37 GHz to 44 GHz	2 GHz	2 GHz

1. The maximum modulation bandwidth is limited by the modulation source. For example, the maximum bandwidth for modulation distortion analysis is 1.2 GHz when used with the M9410A VXT with option B12 (1.2 GHz analysis bandwidth). Use M9383A/B or M9384B for a 2 GHz bandwidth.

Table 56. Power Level Accuracy (dB)^{1, 2} – Typical

Description	Typical
100 MHz to 15 GHz	± 0.4
15 GHz to 20 GHz	± 0.6
20 GHz to 25 GHz	± 0.5
25 GHz to 30 GHz	± 0.6
30 GHz to 37.5 GHz	± 1.2
37.5 GHz to 40 GHz	± 0.8
40 GHz to 44 GHz	± 1.8

1. At -10 dBm source power

2. Without user power calibration. Power level accuracy can be improved by user power calibration.

Measured Maximum Output Power¹

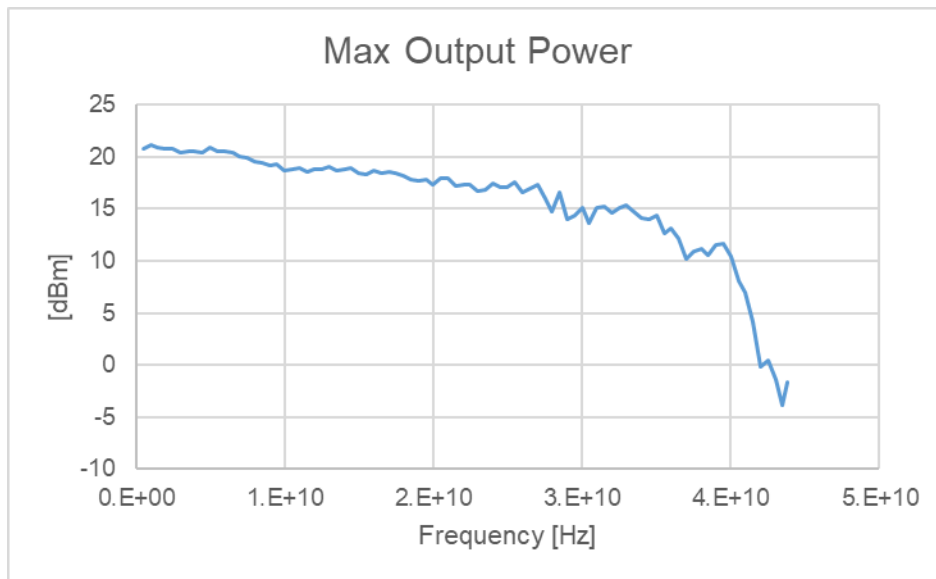

1. Flat tone modulation. 100 MHz modulation bandwidth, Random phase, 1,001 tones, PAPR = 9.2 dB.

Table 57. Settable Frequency and Power Range

Description	
Settable frequency range	100 MHz to 19.97 GHz (M9834A) 100 MHz to 43.97 GHz (M9837A)
Settable power range	-100 to +25 dBm
Settable power resolution	0.01 dB

Measured Source Output Third Order Intermodulation Distortion (IM3) ¹ – Typical

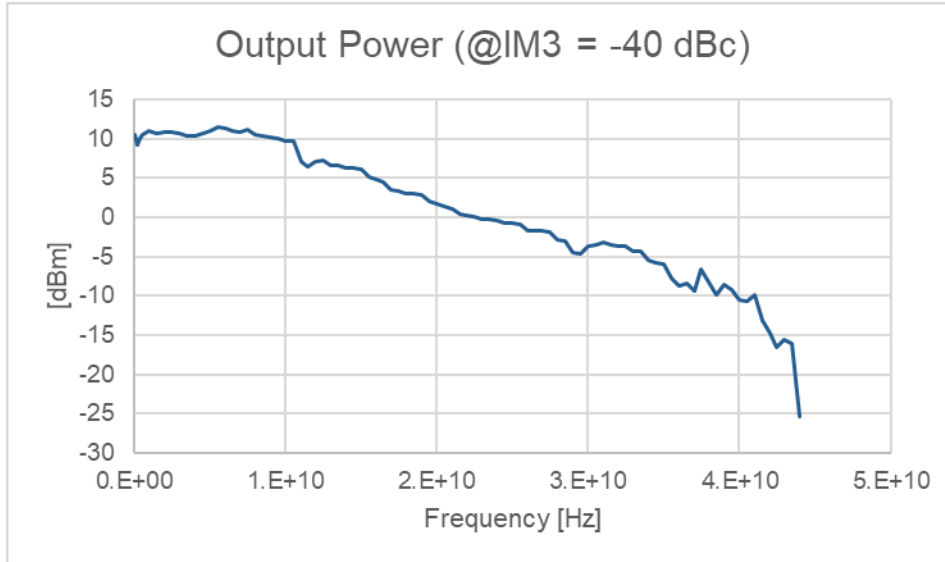

1. Measured tone power at test port 1 with -40 dBc IM3 with two-tone signals. 1 MHz tone separation, 0 dB source mixer attenuator.

Measured Adjacent Channel Power (ACP) Loopback ^{1,2} – Typical

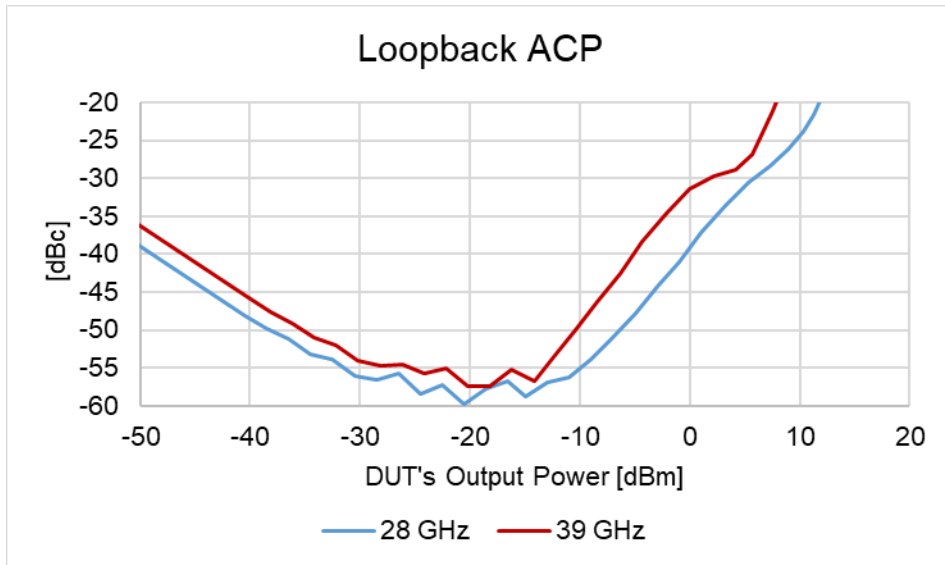

Measured Error Vector Magnitude (EVM) Loopback ^{1,2} – Typical

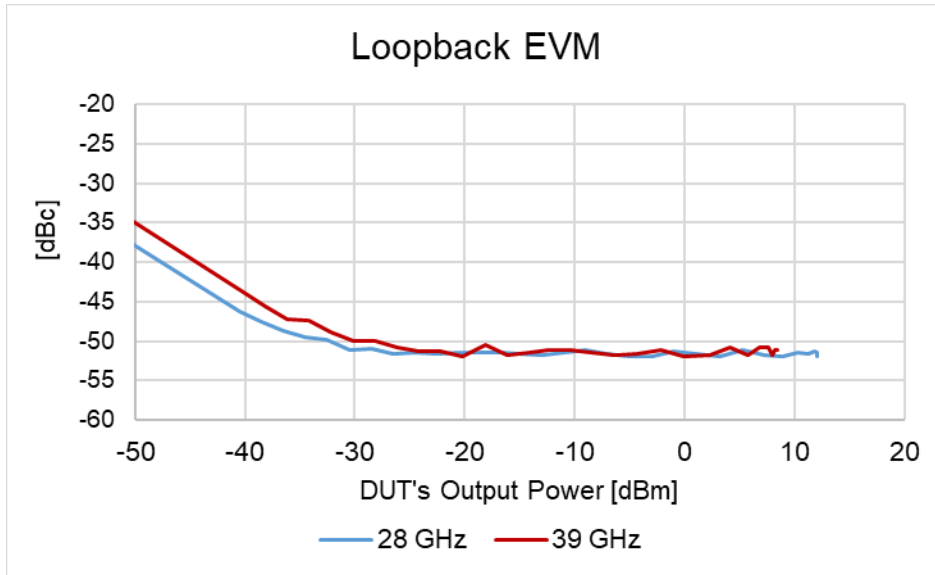

1. Measured ACP & EVM of 11900B adapter (female-female, 2.4-mm connectors) using a compact waveform of 5G NR (32 μ s period). 100 MHz bandwidth, 64QAM, 60 kHz SCS, 2,979 Number of tones.
2. 10 Hz noise bandwidth, Cal All is performed with 100 Hz noise reduction, source mixer attenuator: Auto, Receiver RF attenuator is optimized for measurement power.

Measured Adjacent Channel Power (ACP) ^{1,2} – Typical

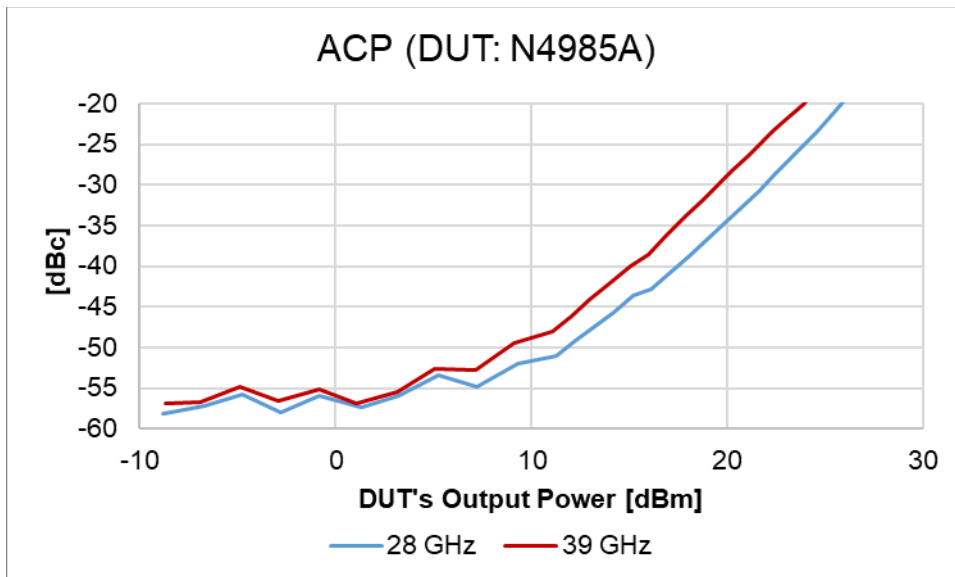

Measured Error Vector Magnitude (EVM) ^{1,2} – Typical

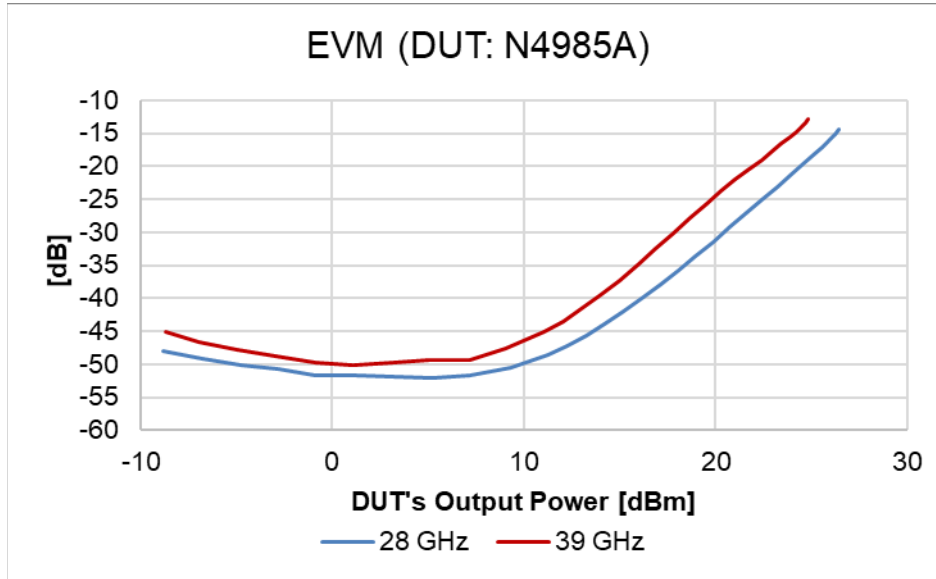

1. Measured ACP & EVM of Keysight N4985A (power amplifier, 2 GHz to 50 GHz with option P25) using a compact waveform of 5G NR (32 μ s period). 100 MHz bandwidth, 64QAM, 60 kHz SCS, 2,979 Number of tones.
2. 10 Hz noise bandwidth, Cal All is performed with 100 Hz noise reduction, source mixer attenuator: Auto, Receiver RF attenuator is optimized for measurement power.

Pulsed-RF Measurements (with Option 021 and S95024B/S95025B)

This section provides specifications for the pulse modulation hardware (Option 021) on the M983xA Series PXIe VNA. The S95024B or S95025B Software is required to enable pulsed-RF measurement functions of the M983xA.

Table 58. Pulse Modulation On/Off Ratio (dB) – Typical

Description	Typical
10 MHz to 44 GHz	80

Pulse Modulation Shape Examples

1 GHz to 20 GHz¹

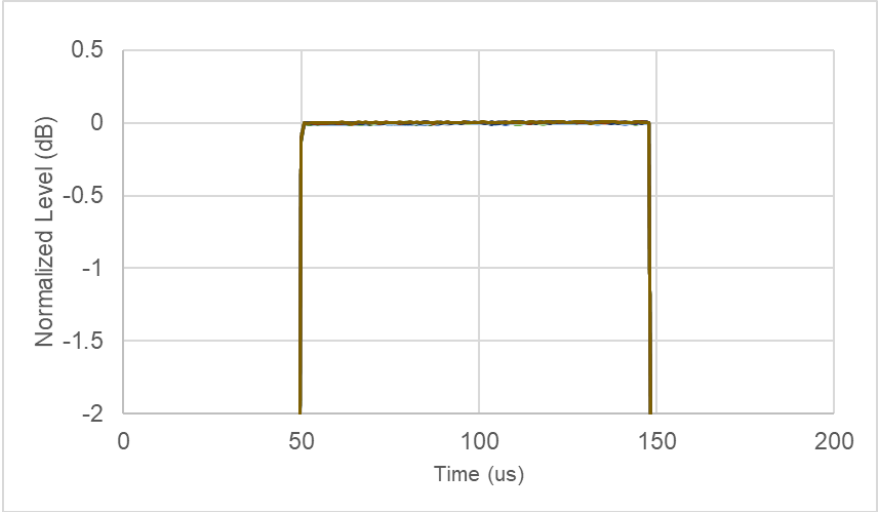

20 GHz to 44 GHz¹

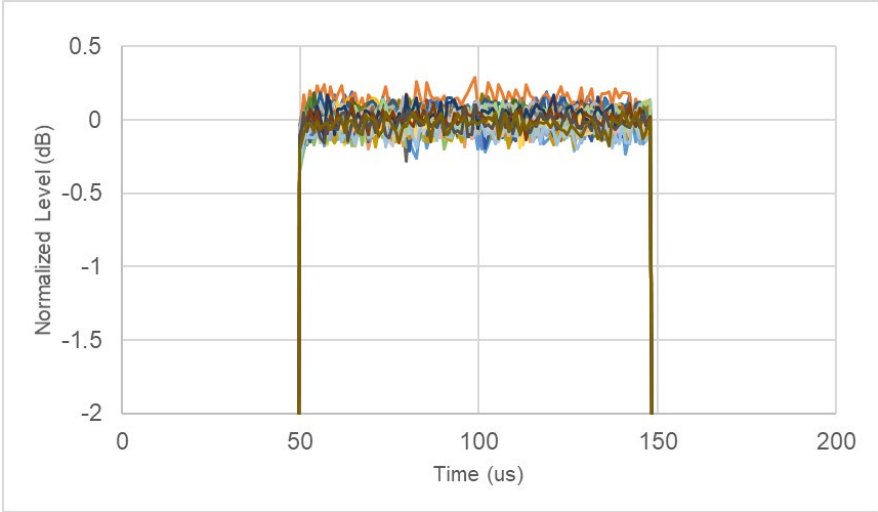

1. Measured with a 500 kHz IF bandwidth, no averaging. With 100 μs pulse width setting. 50 μs/div.

1 GHz to 20 GHz²

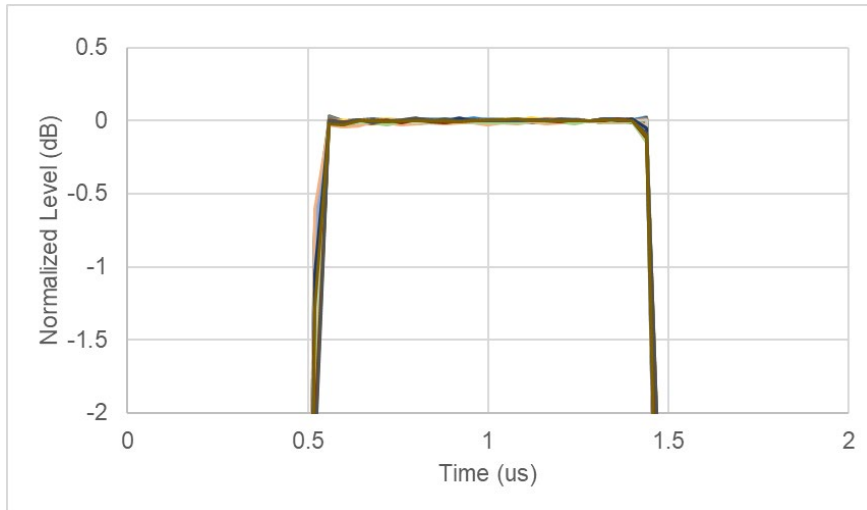

20 GHz to 44 GHz²

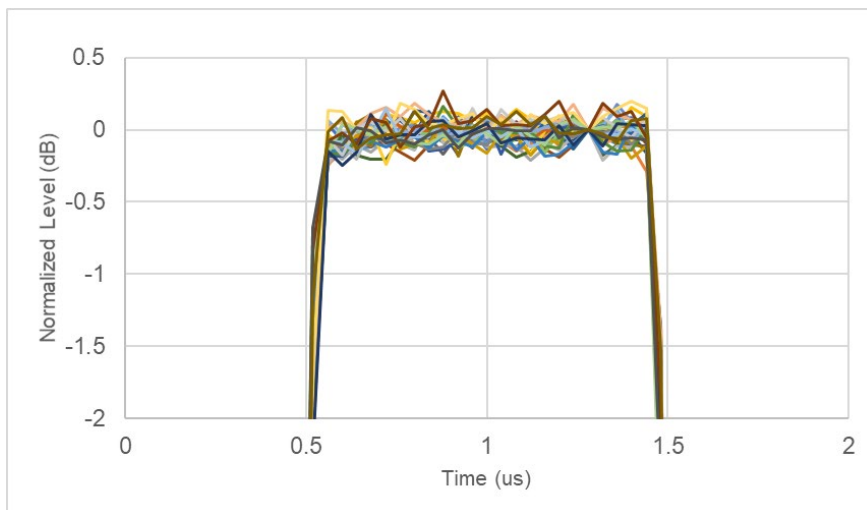

1. Measured with a 15 MHz IF bandwidth, averaging factor of 16 (Average Type = Point). With 1 μ s pulse width setting. 0.5 μ s/div. S95025B software is required. (Minimum pulse width with S95024B is 50 μ s.)

Table 59. Pulse Modulation (Source Modulators) - Typical

Description	Typical
Minimum pulse width	200 ns
Minimum pulse period	1 μ s
Maximum pulse period	10 s

Enhanced Time Domain Analysis with TDR (with S95011B)

This section provides specifications for the enhanced time domain analysis on the M983xA PXIe VNA. The S95011B Software is required to enable enhanced time domain analysis functions of the M983xA.

Table 60. Key Specifications of Enhanced Time Domain Analysis

Description		M9837A	M9834A
Bandwidth	Spec.	44 GHz	20 GHz
Input impedance	Nom.	50 Ω	50 Ω
DC damage level at test port	Spec.	35 V	35 V
Maximum test port input voltage (Hot TDR mode)	Typ.	1.5 Vpp (10 MHz to 26.5 GHz) 1.2 Vpp (26.5 GHz to 38 GHz) 1.1 Vpp (38 GHz to 40 GHz) 0.8 Vpp (40 GHz to 44 GHz)	1.5 Vpp
TDR stimulus ¹	Nom.	Step, Impulse	Step, Impulse
TDR step amplitude ²	Nom.	1 mV to 5 V	1 mV to 5 V
TDR step rise time ³ (min) (10% to 90%)	Spec.	10.2 ps	22.3 ps
TDR step response resolution in free space ⁴ ($\epsilon_r = 1$) (min)	Nom.	1.5 mm	3.3 mm
TDR impulse width (min) ³	Spec.	13.8 ps	30.2 ps
TDR deskew range (max) ⁵ (test cable length)	Typ.	12.5 ns	12.5 ns
DUT length (max) ⁶	Spec.	12.5 ns	12.5 ns
TDR stimulus repetition rate (max)	Spec.	43.9 MHz	19.9 MHz
RMS noise level ⁷	Typ.	110 μ Vrms	110 μ Vrms
Eye diagram data rate (max) ⁸	Spec.	35.2 Gb/s	16 Gb/s

1. The time domain function of the S95011B is similar to the time domain reflectometry (TDR) measurement on a TDR oscilloscope in that it displays the response in the time domain. In the TDR oscilloscope measurement, a pulse or step stimulus is input to the DUT and the change of the reflected wave over time is measured. In the S95011B TDR measurement, a sine wave stimulus is input to the DUT and the change of the reflected wave over frequency is measured. Then, the frequency domain response is transformed to the time domain using the Inverse Fourier Transform.
2. The TDR step amplitude setting does not vary the actual stimulus level input to the device but is used when calculating the Inverse Fourier Transform.
3. Minimum values may be limited by the DUT length setting.
4. To convert from rise time to response resolution, multiply the rise time by c , the speed of light in free space. To calculate the actual physical length, multiply this value in free space by vf , the relative velocity of propagation in the transmission medium. (Most cables have a relative velocity of 0.66 for a polyethylene dielectric or 0.7 for a PTFE dielectric.)
5. Using high quality cables to connect the DUT is recommended in order to minimize measurement degradation. The cables should have low loss, low reflections, and minimum performance variation when flexed.
6. Maximum DUT length is the sum of the DUT and test cable lengths. Settable DUT length (max) is 1.25 μ s.
7. RMS noise level with 50 Ω DUT and default setup.
8. Maximum values may be limited by the DUT length setting.

Multi-module Measurements with S9551B Software

When the S9551B software is installed, the M983xA PXIe VNA can be configured into a multiport network analyzer with multiple M983xA modules. Adding a second module to the PXI chassis provides additional test ports allowing the configuration of a multiport VNA. This configuration provides a full featured multiport vector network analyzer with full crossbar S-parameter measurement capability.

Multiport configurations using up to 18 M983xA modules (ex. 36-ports with 2-port modules) have been evaluated. M980xA PXI VNA modules can be added to a multiport configuration as well. Multiport configurations using two M983xA modules and ten M980xA modules in a single PXI chassis (ex. maximum 24-port, 44 GHz configuration) have been evaluated.

For multi-module operation, all single-module specifications apply except trace noise, test port noise floor, system dynamic range, Displayed Average Noise Level (DANL) and SA detector accuracy. The other performance of multi-module configurations will meet the single-module specifications. The guidance provided here is given as general reference based on Keysight's evaluation of multiport PXI VNA configurations. Not all multiport setups using multiple PXI VNAs are tested as a multiport instrument in the factory. Tested multiport configurations using multiple PXI VNA modules are listed below. Interconnect cables included in the Y1730A must be used for connection among multiple M983xA and M980xA modules. For more detail of multi-module configurations, refer to the "M980xA and M983xA Multi-module Installation Guide" at <http://www.keysight.com/find/m980xa-mm>.

Verified PXI VNA configurations:

- M980xA: 17 2-port modules = 34 ports
- M980xA: 11 6-port modules = 66 ports
- M983xA: 18 2-port modules = 36 ports
- M983xA + M980xA = 5 M983xA (2-ports) + 2 M9804A (2-ports) = 10 + 4 = 14 ports
- M983xA + M980xA = 4 M983xA (2-ports) + 5 M9808A (2-ports) = 8 + 10 = 18 ports
- M983xA + M980xA = 2 M983xA (2-ports) + 10 M980xA (2-ports) = 4 + 20 = 24 ports

For other PXI VNA configurations, please contact your Keysight representative.

Table 61. Multi-module Performance

- Expected performance is given with multi-module configurations recommended in the "M980xA and M983xA Multi-module Installation Guide" at <http://www.keysight.com/find/m980xa-mm>.
- A check mark, ✓, indicates the performance parameter is the same as the corresponding single-module performance.
- An empty diamond, ◇, indicates that the performance parameter may be degraded as the number of modules increases.

Description	Setups with 18x M983xA modules
System dynamic range	◇ (see Table 62)
Frequency accuracy	✓
Uncorrected directivity	✓
Uncorrected load match	✓
Uncorrected source match	✓
Maximum output port power	✓
Power level accuracy	✓
Power level linearity	✓
Noise floor	◇ (see Table 63)
Receiver compression	✓
Trace noise	◇ (see Table 64 and 65)
Dynamic accuracy	✓
Crosstalk	✓
Receiver noise figure	◇ (see Table 66)

Table 62. System Dynamic Range of Multi-module Configuration (dB) ¹

2 to 18 M983xA modules		
Description	Char.	Typical
100 kHz to 300 kHz	--	71
300 kHz to 1 MHz	--	89
1 MHz to 10 MHz	--	100
10 MHz to 100 MHz ²	112	121
100 MHz to 1 GHz	130	140
1 GHz to 2 GHz	146	153
2 GHz to 5 GHz	143	151
5 GHz to 6.5 GHz	144	152
6.5 GHz to 9 GHz	142	149
9 GHz to 10 GHz	141	148
10 GHz to 15 GHz	140	147
15 GHz to 19 GHz	136	146
19 GHz to 20 GHz	134	142
20 GHz to 22 GHz	137	145
22 GHz to 24 GHz	137	143
24 GHz to 25 GHz	134	140
25 GHz to 27 GHz	132	139
27 GHz to 30 GHz	129	140
30 GHz to 32 GHz	127	138
32 GHz to 33 GHz	123	134
33 GHz to 35 GHz	123	133

2 to 18 M983xA modules

35 GHz to 37.5 GHz	119	130
37.5 GHz to 40 GHz	119	129
40 GHz to 41 GHz	108	123
41 GHz to 42 GHz	97	114
42 GHz to 43 GHz	94	109
43 GHz to 44 GHz	94	111

1. System dynamic range = source maximum output power minus receiver noise floor.
 2. It may typically be degraded at 25 MHz.

Table 63. Noise Floor of Multi-module Configuration (dBm) ¹

2 to 18 M983xA modules

Description	Char.	Typical
100 kHz to 300 kHz	--	-59
300 kHz to 1 MHz	--	-70
1 MHz to 10 MHz	--	-80
10 MHz to 100 MHz ²	-96	-101
100 MHz to 1 GHz	-114	-121
1 GHz to 2 GHz	-130	-132
2 GHz to 5 GHz	-127	-131
5 GHz to 10 GHz	-126	-130
10 GHz to 15 GHz	-125	-128
15 GHz to 20 GHz	-123	-126
20 GHz to 25 GHz	-123	-126
25 GHz to 30 GHz	-121	-124
30 GHz to 35 GHz	-119	-122
35 GHz to 40 GHz	-116	-119
40 GHz to 44 GHz	-109	-114

1. Noise floor in a 10 Hz IF Bandwidth. Measured with 30 kHz IF bandwidth. Test port terminated.
 2. It may typically be degraded at 25 MHz.

Table 64. Trace Noise Magnitude (dB rms) of Multi-module Configuration ¹

2 to 3 M983xA modules

4 to 18 M983xA modules

Description	2 to 3 M983xA modules		4 to 18 M983xA modules	
	Char.	Typical	Char.	Typical
10 MHz to 100 MHz ²	0.03	0.0125	0.03	0.0125
100 MHz to 500 MHz	0.0045	0.0017	0.0045	0.0017
500 MHz to 2 GHz	0.0015	0.0005	0.0015	0.0005
2 GHz to 10 GHz	0.0015	0.0006	0.0015	0.0006
10 GHz to 15 GHz	0.002	0.0008	0.002	0.0008

	2 to 3 M983xA modules		4 to 18 M983xA modules	
15 GHz to 17 GHz	0.0025	0.001	0.0025	0.001
17 GHz to 20 GHz	0.0025	0.0015	0.0025	0.0015
20 GHz to 24 GHz	0.003	0.0015	0.004	0.0015
24 GHz to 25 GHz	0.004	0.002	0.004	0.002
25 GHz to 30 GHz	0.005	0.0021	0.005	0.0021
30 GHz to 32 GHz	0.005	0.0035	0.005	0.0035
32 GHz to 35 GHz	0.008	0.0056	0.008	0.0056
35 GHz to 37 GHz	0.008	0.0056	0.008	0.0056
37 GHz to 40 GHz	0.011	0.0075	0.011	0.0075
40 GHz to 41 GHz	0.011	0.005	0.011	0.005
41 GHz to 42 GHz	0.02	0.015	0.02	0.015
42 GHz to 44 GHz	0.06	0.045	0.06	0.045

1. Transmission and reflection trace noise in a 10 kHz IF bandwidth. At maximum specified power.

2. It may typically be degraded at particular frequencies such as 108 MHz, 120 MHz, 132 MHz, 143 MHz, 149 MHz or 156 MHz.

Table 65. Trace Noise Phase (degree rms) of Multi-module Configuration ¹

Description	2 to 3 M983xA modules		4 to 18 M983xA modules	
	Char.	Typical	Char.	Typical
10 MHz to 100 MHz ²	0.2	0.0707	0.2	0.0707
100 MHz to 500 MHz	0.03	0.0112	0.03	0.0112
500 MHz to 1 GHz	0.01	0.0034	0.015	0.0034
1 GHz to 2 GHz	0.01	0.0028	0.015	0.0028
2 GHz to 5 GHz	0.01	0.0033	0.015	0.0033
5 GHz to 10 GHz	0.01	0.0045	0.015	0.0045
10 GHz to 15 GHz	0.011	0.006	0.015	0.006
15 GHz to 17 GHz	0.015	0.0081	0.015	0.0081
17 GHz to 20 GHz	0.016	0.013	0.016	0.013
20 GHz to 24 GHz	0.021	0.013	0.040	0.013
24 GHz to 25 GHz	0.026	0.017	0.040	0.017
25 GHz to 30 GHz	0.026	0.0159	0.040	0.0159
30 GHz to 32 GHz	0.045	0.025	0.045	0.025
32 GHz to 37 GHz	0.07	0.045	0.07	0.045
37 GHz to 40 GHz	0.08	0.0495	0.08	0.0495
40 GHz to 41 GHz	0.08	0.041	0.08	0.041
41 GHz to 42 GHz	0.2	0.085	0.2	0.085
42 GHz to 44 GHz	0.45	0.29	0.45	0.29

1. Transmission and reflection trace noise in a 10 kHz IF bandwidth. At maximum specified power.

2. It may typically be degraded at particular frequencies such as 108 MHz, 120 MHz, 132 MHz, 143 MHz, 149 MHz or 156 MHz.

Table 66. Receiver Noise Figure (dB) of Multi-module Configuration

2 to 18 M983xA modules		
Description	Char.	Typical
50 MHz to 100 MHz	18	14
100 MHz to 200 MHz	12	9
200 MHz to 2 GHz	11	10
2 GHz to 5 GHz	12	10
5 GHz to 15 GHz	13	11
15 GHz to 20 GHz ¹	15	13
20 GHz to 25 GHz	17	15
25 GHz to 30 GHz	16	13
30 GHz to 35 GHz	17	15
35 GHz to 40 GHz	24	17
40 GHz to 44 GHz ^{2,3}	32	21

1. For M9834A, tested at up to 19.975 GHz

2. Above 40 GHz, an external bandpass filter may be required for NF measurements.

3. Tested at up to 43.975 GHz.

General Information

Table 67. Miscellaneous Information

Description	Specification
System IF bandwidth range	1 Hz to 15 MHz
Number of points	1 to 100,003

Table 68. System Requirements

PC system requirements	
Operating systems	Windows 10 and Windows 11 (64-bit)
Recommended CPU	Intel Core i7 10th Generation or later recommended
Available memory	16 GB recommended, 4 GB minimum
Available disk space	4 GB minimum
Display resolution	1024 x 768 minimum
Instrument drivers	
Keysight IO libraries	Keysight IO Libraries Suite 2022 Update 1 (18.2.28014.7) or later (for Windows 10) Keysight IO Libraries Suite 2023 Update 1 (18.3.29324.3) or later (for Windows 11)





Table 69. Environmental and Physical Specifications

Description		
Description	<p>Samples of this product have been type tested in accordance with the Keysight Environmental Test Manual and verified to be robust against the environmental stresses of Storage, Transportation and End-use; those stresses include, but are not limited to, temperature, humidity, shock, vibration, altitude, and power line conditions.</p> <p>Test Methods are aligned with IEC 60068-2 and levels are similar to MIL-PRF-28800F Class 3.</p>	
Temperature	Operating	0 to 50 °C ambient 10 to 70 °C module temperature
	Non-operating	-40 to 70 °C
Humidity	Operating	Type tested at 20 to 80 %, wet bulb temperature < 29 °C (non-condensing)
	Non-operating	Type tested at 20 to 90 %, wet bulb temperature < 40 °C (non-condensing)
Altitude	Operating	Up to 2,000 meters (6,561 feet)
	Non-operating	Up to 4,572 meters (15,000 feet)
Vibration	Operating	0.3 G maximum, 5 Hz to 500 Hz
	Non-operating	0.75 G maximum, 5 Hz to 500 Hz
Instrument protection	IP 30 IEC/EN 60529	
Warm-up time	90 minutes	

Table 70. Regulatory and Safety Compliance

EMC ¹

Complies with the essential requirements of the European EMC Directive as well as current editions of the following standards (dates and editions are cited in the Declaration of Conformity).

	<p>The CE mark is a registered trademark of the European Community (if accompanied by a year, it is the year when the design was proven). This product complies with all relevant directives.</p> <ul style="list-style-type: none"> • IEC 61326-1 <p>CISPR 11 Group 1, Class A</p>		
	<p>UK conformity mark is a UK government owned mark. When affixed to the product is declaring all applicable Directives and Regulations have been met in full.</p>		
<p>CAN ICES/NMB-001(A)</p>	<p>This ISM device complies with Canadian ICES-001. Cet appareil ISM est conforme a la norme NMB du Canada.</p>		
	<p>The RCM mark is a registered trademark of the Australian Communications and Media Authority. AS/NZS CISPR 11</p>		
	<p>South Korean Certification (KC) mark; includes the marking's identifier code: R-R-Kst-WN21752 (M9834A), R-R-Kst-WN21753 (M9837A)</p>		
	<p>South Korean Class A EMC declaration: Information to the user: This equipment has been conformity assessed for use in business environments. In a residential environment this equipment may cause radio interference. ※ This EMC statement applies to the equipment only for use in business environment.</p>		
	<table border="1" style="width: 100%;"> <tr> <td style="background-color: #e1eef6; text-align: center;">사용자 안내문</td> </tr> <tr> <td>이 기기는 업무용 환경에서 사용할 목적으로 적합성평가를 받은 기기로서 가정용 환경에서 사용하는 경우 전파간섭의 우려가 있습니다.</td> </tr> </table>	사용자 안내문	이 기기는 업무용 환경에서 사용할 목적으로 적합성평가를 받은 기기로서 가정용 환경에서 사용하는 경우 전파간섭의 우려가 있습니다.
사용자 안내문			
이 기기는 업무용 환경에서 사용할 목적으로 적합성평가를 받은 기기로서 가정용 환경에서 사용하는 경우 전파간섭의 우려가 있습니다.			
	<p>※ 사용자 안내문은 “업무용 방송통신기자재”에만 적용한다.</p>		
<p>Instrument calibration cycle</p>	<p>1 year</p>		

1. To find a current Declaration of Conformity for a specific Keysight product, go to: <http://www.keysight.com/go/conformity>

Table 71. Physical Size and Weight

Description	M9834A-205	M9834A-270, M9837A- 200/270/271	Note
Width	42 mm (1.65 in.)	64 mm (2.52 in.)	Including the backplane connector alignment tabs, and front panel ground clip in free state
Height	130 mm (5.12 in.)	130 mm (5.12 in.)	Including the ejector hook
Depth	210 mm (8.27 in.)	210 mm (8.27 in.)	From tip of ejector to tip of backplane connector
Weight	1,300 g (2.9 lbs)	2,000 g (4.4 lbs)	

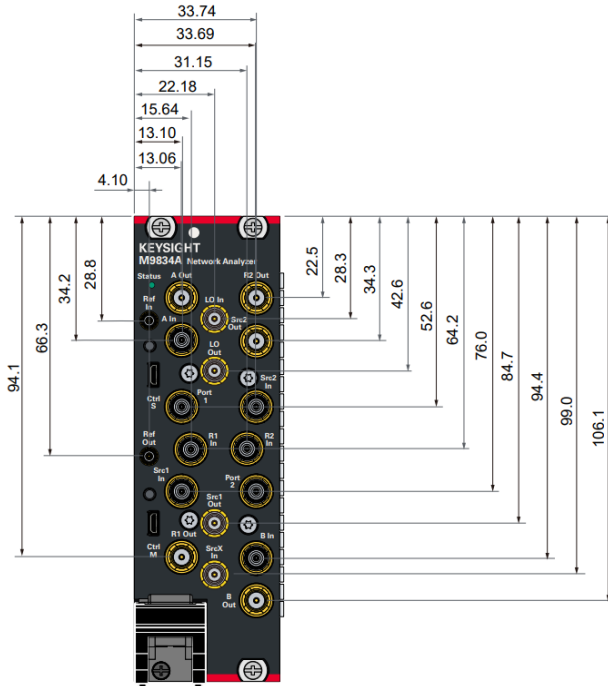

Dimensions (front view, M9834A with option 205, in millimeters)

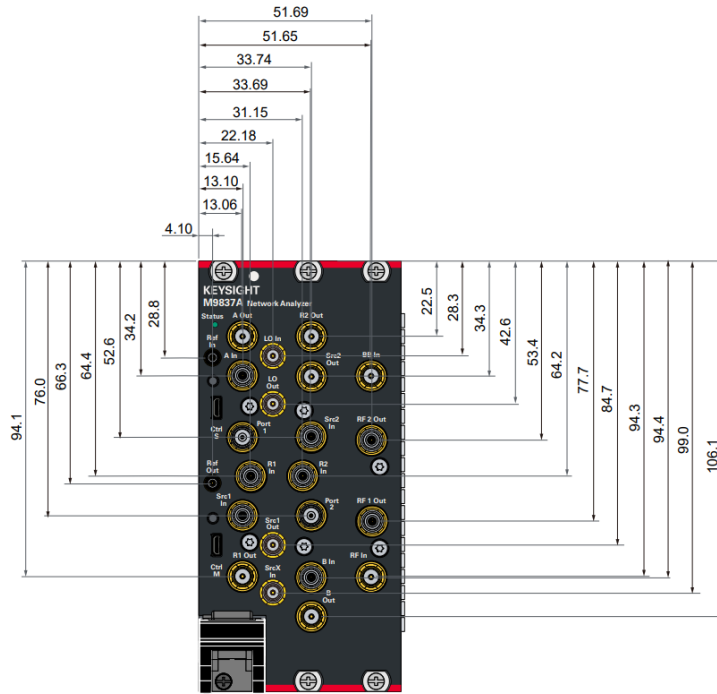

Dimensions (front view, M9834A with option 270, M9837A with option 205/270/271, in millimeters)

Table 72. Electrical Power

Description				
M9834A-205				
Total power dissipation	54.6 W (maximum)			
Supply voltage	+3.3 V	+5 V	+12 V	-12 V
Nominal current	1.72 A	0 A	4.08 A	0 A
M9834A-270, M9837A-205, 270, 271				
Total power dissipation	85.9 W (maximum)			
Supply voltage	+3.3 V	+5 V	+12 V	-12 V
Nominal current	4.58 A	0 A	5.90 A	0 A

Table 73. Front Panel Information

Description	
Test port (Port 1, Port 2)	
Connector type	3.5 mm female (M9834A), 2.4 mm female (M9837A)
Center pin recession	0.003 inch (characteristic)
Impedance	50 Ω (nominal)
Direct receiver access input (A In, B In, R1 In, R2 In)	
Connector type	3.5 mm female (M9834A), 2.4 mm female (M9837A)
Impedance	50 Ω (nominal)
Source output (Src1 Out, Src2 Out)	
Connector type	SMA
Impedance	50 Ω (nominal)
BB In	
Connector type	SMA
Impedance	50 Ω (nominal)
RF input (RF In)	
Connector type	SMA
Impedance	50 Ω (nominal)
RF output (RF1 Out, RF2 Out)	
Connector type	3.5 mm female (M9834A), 2.4 mm female (M9837A)
Impedance	50 Ω (nominal)
Source input (Src1 In, Src2 In)	
Connector type	3.5 mm female (M9834A), 2.4 mm female (M9837A)
Impedance	50 Ω (nominal)
External source input (SrcX In)	
Connector type	SMA
Impedance	50 Ω (nominal)
IF Out (A Out, B Out, R1 Out, R2 Out)	
Connector type	SMA
Impedance	50 Ω (nominal)
External LO input (LO In)	

Description

Connector type	SMA
Impedance	50 Ω (nominal)
External LO output (LO Out)	
Connector type	SMA
Impedance	50 Ω (nominal)
External reference input	
Connector type	MCX
Input amplitude range	-3 to +10 dBm
Input frequency ¹	10 MHz ± 10 ppm
Impedance	50 Ω (nominal)
External reference output	
Connector type	MCX
Output amplitude range	0 to ± 3 dBm
Output frequency	10 MHz ± 7 ppm
Impedance	50 Ω (nominal)

1. Input frequency reference of 100 MHz is also acceptable with some limitations. See [PXI VNA webhelp](#) for more details.

Measurement Throughput

Table 74. Cycle Time for Measurement Completion (milliseconds)¹ – Typical

Description	Sweep mode: Auto			Sweep mode: Stepped		
9 GHz – 10 GHz frequency span, 1 MHz IF bandwidth						
Number of points	201	401	1601	201	401	1601
Uncorrected	1.4	1.7	3.8	2.0	2.7	6.3
2-port calibration	2.1	2.8	7.0	3.2	4.8	12.1
4-port calibration ²	4.7	6.5	15.5	7.0	10.3	25.5
10 MHz – 20 GHz frequency span, 1 MHz IF bandwidth						
Number of points	201	401	1601	201	401	1601
Uncorrected	5.7	7.5	9.7	5.8	7.5	15.9
2-port calibration	11.1	14.6	19.3	11.1	14.5	31.6
4-port calibration ²	23.2	30.6	40.7	23.2	30.4	65.2
10 MHz – 44 GHz frequency span, 1 MHz IF bandwidth						
Number of points	201	401	1601	201	401	1601
Uncorrected	7.5	9.7	15.5	7.5	9.7	20.0
2-port calibration	14.4	18.9	30.6	14.4	18.9	39.7
4-port calibration ²	30.5	39.9	63.7	30.6	39.9	82.0

1. Analyzer display turned off with DISPLAY:VISible OFF. Measured using a Keysight M9019A PXIe chassis, and an M9037A embedded controller with Intel Core i7-4700EQ 2.40 GHz CPU and 16 GB RAM running Windows 10 (64-bit), with firmware revision A.16.00.07. Data for one trace (S11) measurement. Uncorrected measurements are for one sweep direction
 2. Measured with two M983xA modules.

Table 75. Cycle Time for Amplifier Noise Figure Measurement (with Option 029 and S95029B) (milliseconds) ¹ – Typical

Conditions:

- Frequency range: 4 – 6 GHz
- IF bandwidth: 1 kHz
- Noise settings: 4 MHz noise bandwidth, 200 averages, low-noise receiver
- Impedance states for vector noise cal: 5
- Other: NA application display on; correction on

Description				
Number of points	51	101	201	401
Scalar noise cal cycle time	1,134	2,231	4,425	8,811
Vector noise cal cycle time	5,239	10,338	20,533	40,925

1. Measured with firmware revision A.16.20.02.

Table 76. Cycle Time for Amplifier Gain Compression Measurement (with S95086B) (milliseconds) ¹ – Typical

Conditions:

- Frequency range: 4 – 6 GHz
- IF bandwidth: 1 kHz
- Sweep type: Smart
- Compression type: 1 dB compression from linear gain (0.05 dB tolerance)
- Other: NA application display on; correction on

Description				
Number of points	51	101	201	401
Cycle time	234	449	868	1,730

1. Measured with firmware revision A.16.20.02, iteration = 1.

Table 77. Cycle Time for Amplifier Swept Intermodulation Distortion Measurement (with S95087B) (milliseconds) ¹ – Typical

Conditions:

- Frequency range: 4 – 6 GHz
- Main tone IF bandwidth: 10 kHz
- IM tone IF bandwidth: 1 kHz

- Measurement parameters: PwrMain (avg), IM3 (dB relative to carrier)
- Other: NA application display on; correction on

Description

	51	101	201	401
Number of points	51	101	201	401
Cycle time	140	263	511	1,010

1. Measured using a 4-port VNA with an M9037A-270 and an M9808A-200, with firmware revision A.16.20.02.

Table 78. Cycle Time for Converter Noise Figure Measurement (with Option 029 and S95029B) (milliseconds) ¹ – Typical

Conditions:

- Input frequency: 3 GHz CF, 75 MHz span
- LO frequency: 2.12 GHz fixed
- Output frequency: 880 MHz CF, 75 MHz span
- IF bandwidth: 1 kHz
- Noise settings: 4 MHz noise bandwidth, 200 averages, low-noise receiver
- Impedance states for vector noise cal: 5
- Other: NA application display on; correction on

Description

	51	101	201	401
Number of points	51	101	201	401
Scalar noise cal cycle time	1,268	2,481	4,904	9,751
Vector noise cal cycle time	5,388	10,612	21,057	41,945

1. Measured using a 4-port VNA with an M9037A-270 and an M9808A-200, with firmware revision A.16.20.02.

Table 79. Cycle Time for Converter Measurement with SMC + Phase (with S95083B) (milliseconds) – Typical

Conditions:

- Input frequency: 3 GHz CF, 75 MHz span
- LO frequency: 2.12 GHz fixed
- Output frequency: 880 MHz CF, 75 MHz span
- Measurement parameter: SC21
- Other: NA application display on; correction on (includes match correction but not SC12 sweep)

Description

	51	101	201	401
Number of points	51	101	201	401
Cycle time, 10 kHz IF bandwidth	65	90	138	234
Cycle time, 1 kHz IF bandwidth	198	354	659	1,275

1. Measured using a 4-port VNA with an M9037A-270 and an M9808A-200, with firmware revision A.16.20.02.

Table 80. Cycle Time for Converter Gain Compression Measurement (with S95086B) (milliseconds)¹ – Typical

Conditions:

- Input frequency: 3 GHz CF, 75 MHz span
- LO frequency: 2.12 GHz fixed
- Output frequency: 880 MHz CF, 75 MHz span
- IF bandwidth: 1 kHz
- Sweep type: Smart
- Compression type: 1 dB compression from linear gain (0.05 dB tolerance)
- Other: NA application display on; correction on

Description				
Number of points	51	101	201	401
Cycle time	498	969	1,954	3,932

1. Measured using a 4-port VNA with an M9037A-270 and an M9808A-200, with firmware revision A.16.20.02, iteration = 1.

Table 81. Cycle Time for Converter Swept Intermodulation Distortion Measurement (with S95087B) (milliseconds)¹ – Typical

Conditions:

- Input frequency: 3 GHz CF, 75 MHz span
- LO frequency: 2.12 GHz fixed
- Output frequency: 880 MHz CF, 75 MHz span
- Main tone IF bandwidth: 10 kHz
- IM tone IF bandwidth: 1 kHz
- Measurement parameters: PwrMain (avg), IM3 (dB relative to carrier)
- Other: NA application display on; correction on

Description				
Number of points	51	101	201	401
Cycle time	268	520	520	1,026

1. Measured using a 4-port VNA with an M9037A-270 and an M9808A-200, with firmware revision A.16.20.02.

Front-Panel Jumpers

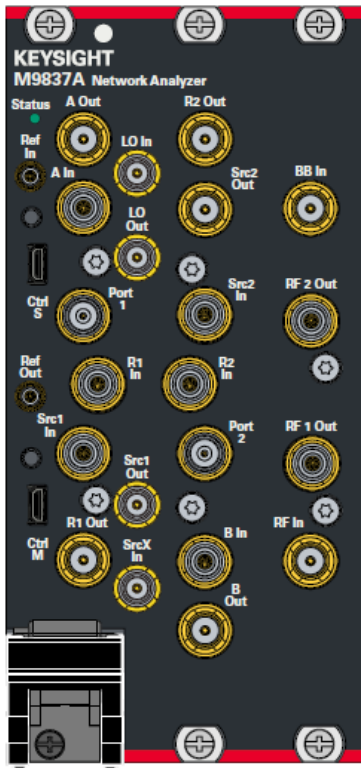

Table 82. Frequency Range – Typical

Description	Typical
BB In	100 kHz to 20 GHz
RF input (RF In)	100 kHz to 20 GHz
RF output (RF1 Out, RF2 Out)	100 kHz to 20 GHz (M9834A), 100 kHz to 44 GHz (M9837A)
Source input (Src1 In, Src2 In)	100 kHz to 20 GHz (M9834A), 100 kHz to 44 GHz (M9837A)
External source input (SrcX In)	100 kHz to 20 GHz
IF out (A Out, B Out, R1 Out, R2 Out)	100 kHz to 8.5 GHz
External LO input (LO In)	13 MHz to 20 GHz
External LO output (LO Out)	13 MHz to 20 GHz

Table 83. Receiver Compression at Direct Receiver Access Input - Typical ¹

Description	Input power at test port (dBm)	Magnitude (dB)	Phase (°)
100 kHz to 500 MHz	-3	0.15	1.5
500 MHz to 5 GHz	+5	0.15	1.5
5 GHz to 10 GHz	+8	0.15	1.5
10 GHz to 20 GHz	+5	0.15	1.5
20 GHz to 26.5 GHz	+11	0.15	1.5
26.5 GHz to 38 GHz	+8	0.15	1.5
38 GHz to 44 GHz	+1	0.15	1.5

1. Tested with receiver gain AUTO. (18 dB receiver attenuator is selected for measurements)

Table 84. External Source Input and Source Output – Typical

Gain (dB) between External Source Input (SrcX In) and Source Output (Src1 Out, Src2 Out), Return Loss (dB) of External Source Input (SrcX In) and Source Output (Src1 Out, Src2 Out)

Description	Gain @ SrcX In and Src1/2 Out ¹ (dB)	Return Loss @ SrcX In (dB)	Return Loss @ Src1 Out, Src2 Out (dB)
100 kHz to 1 GHz	3 to 12	-4	-4
1 GHz to 3.5 GHz	3 to 12	-8	-8
3.5 GHz to 6.13 GHz	3 to 12	-8	-5
6.13 GHz to 10 GHz	-4 to 8	-8	-5
10 GHz to 15 GHz	-6 to 7	-6	-5
15 GHz to 17 GHz	-10 to 6	-6	-5
17 GHz to 20 GHz	-10 to 6	-6	-4

1. With minimum attenuation, tested at -20 dBm.

Table 85. External Source Input and Test Port – Typical

Gain (dB) between External Source Input (SrcX In) and test ports (Port 1, Port 2)

Description	Gain @ SrcX In and Port 1/2 ¹ (dB)
100 kHz to 1 MHz	17 to 33
1 MHz to 6.13 GHz	22 to 33
6.13 GHz to 10 GHz	16 to 27
10 GHz to 15 GHz	13 to 25
15 GHz to 20 GHz	9 to 25

1. With minimum attenuation, tested at -20 dBm.

Table 86. Source Output

Frequency resolution, accuracy, stability at Src1 Out and Src2 Out

Description	Specification	Typical
Frequency range	100 kHz to 20 GHz	
Frequency resolution	1 Hz	--
Frequency accuracy	± 7 ppm (25 ± 5 °C)	--
Frequency stability	--	± 3 ppm/year maximum ¹

1. Assumes no variation in temperature.

Maximum leveled output power at Src1 Out and Src2 Out (dBm) - Typical

Description	Src1 Out	Src2 Out
100 kHz to 100 MHz	8	7
100 MHz to 500 MHz	7	6
500 MHz to 1 GHz	6	5
1 GHz to 6.13 GHz	5	2
6.13 to 10 GHz	2	-2
10 GHz to 15 GHz	1	-3
15 GHz to 18 GHz	0	-5
18 GHz to 20 GHz	-1	-5

Power level accuracy at Src1 Out and Src2 Out (dB) ¹ - Typical

Description	Typical
100 kHz to 1 MHz	± 0.4
1 MHz to 1 GHz	± 0.3
1 GHz to 5 GHz	± 0.4
5 GHz to 10 GHz	± 0.5
10 GHz to 15 GHz	± 0.7
15 GHz to 20 GHz	± 1.1

1. At reference power of -10 dBm, stepped sweep mode.

Power level linearity at Src1 Out and Src2 Out (dB) ¹ - Typical

Description	Typical
100 kHz to 5 GHz	± 0.4
5 GHz to 20 GHz	± 0.5

1. Level linearity given is relative to -10 dBm, stepped sweep mode.

2. Swept sweep mode. -60 dBm $\leq P \leq$ maximum typical power.

3. Stepped sweep mode. -60 dBm $\leq P < -20$ dBm.

Power sweep range Src1 Out and Src2 Out (dBm) - Typical

Description	Src1 Out	Src2 Out
100 kHz to 1 MHz	-60 to 8	-60 to 7
1 MHz to 10 MHz	-60 to 8	-60 to 7
10 MHz to 100 MHz	-60 to 8	-60 to 7
100 MHz to 500 MHz	-60 to 7	-60 to 6
500 MHz to 1 GHz	-60 to 6	-60 to 5
1 GHz to 6.13 GHz	-60 to 5	-60 to 2
6.13 GHz to 10 GHz	-60 to 2	-60 to -2
10 GHz to 15 GHz	-60 to 1	-60 to -3
15 GHz to 18 GHz	-60 to 0	-60 to -5
18 GHz to 20 GHz	-60 to -1	-60 to -5

2nd harmonics at Src1 Out and Src2 Out (dBc)¹ - Typical

Description	Typical
100 kHz to 10 MHz	-20
10 MHz to 500 MHz	-25
500 MHz to 20 GHz	-55

1. Listed frequency is fundamental frequency. Tested at maximum typical power or maximum leveled power.

3rd harmonics at Src1 Out and Src2 Out (dBc)¹ - Typical

Description	Typical
100 kHz to 500 MHz	-22
500 MHz to 14.67 GHz	-63

1. Listed frequency is fundamental frequency. Tested at maximum typical power.

Non-harmonic spurs at Src1 Out and Src2 Out (dBc)¹ - Typical

Description	Typical
100 kHz to 5 GHz	-60
5 GHz to 20 GHz	-40

1. Listed frequency is fundamental frequency. Tested at power of -10 dBm. Includes spurious related to LO signal and frac-N.

Table 87. Source Input and Test Port – Typical

Gain between Source Input (Src1 In, Src2 In) and Test Port (dB)

Description	Amplified Path ¹	Thru Path
10 MHz to 200 MHz	3 to 9	-3 to 0
200 MHz to 1 GHz	3 to 9	-4 to -1
1 GHz to 3 GHz	2 to 9	-5 to -1.5
3 GHz to 5 GHz	2 to 7	-5 to -2.5
5 GHz to 8 GHz	2 to 7	-5.5 to -3
8 GHz to 10 GHz	0 to 7	-6 to -3
10 GHz to 15 GHz	0 to 6	-8 to -4
15 GHz to 20 GHz	-2 to 6	-9 to -5
20 GHz to 25 GHz	-4 to 4	-12 to -6
25 GHz to 30 GHz	-9 to 2	-14 to -8
30 GHz to 35 GHz	-9 to 0	-14 to -9
35 GHz to 37 GHz	-12 to 0	-16 to -10
37 GHz to 38 GHz	-12 to 0	-18 to -10
38 GHz to 40 GHz	-12 to -1	-18 to -10
40 GHz to 42 GHz	-21 to -2	-22 to -12
42 GHz to 44 GHz	-21 to -5	-22 to -12

1. Amplified with pre-amp, tested at -20 dBm.

Table 88. RF Output – Typical

Maximum output power at RF1 Out and RF2 Out (dBm) - Typical

Description	Typical
10 MHz to 1 GHz	18.5
1 GHz to 3 GHz	20.5
3 GHz to 5 GHz	19.5
5 GHz to 7 GHz	18.5
7 GHz to 9 GHz	17.5
9 GHz to 12 GHz	16.5
12 GHz to 13 GHz	15.5
13 GHz to 17 GHz	14.5
17 GHz to 20 GHz	13.5
20 GHz to 21 GHz	17.5
21 GHz to 22 GHz	16.5
22 GHz to 23.6 GHz	14
23.6 GHz to 24 GHz	14.5
24 GHz to 25 GHz	16
25 GHz to 27 GHz	17
27 GHz to 28.2 GHz	17.5
28.2 GHz to 30 GHz	18
30 GHz to 31 GHz	17.5
31 GHz to 35 GHz	16.5
35 GHz to 36 GHz	15
36 GHz to 39 GHz	13.5
39 GHz to 40 GHz	12.5
40 GHz to 41 GHz	11
41 GHz to 42 GHz	6
42 GHz to 44 GHz	3.5

1. Listed frequency is fundamental frequency. Tested at maximum typical power.

Table 89. IF Output - Typical

Output power of IF output (A Out, B Out, R1 Out, R2 Out) ¹ (dBm) – Typical

Frequencies listed are the VNA's source fundamental frequency.

Description	Typical
100 kHz to 1 MHz	-28 to -18
1 MHz to 30.6 MHz	-22 to -18
30.6 MHz to 500 MHz	-30 to -21
500 MHz to 5 GHz	-32 to -25
5 GHz to 10 GHz	-35 to -28
10 GHz to 20 GHz	-38 to -30
20 GHz to 25 GHz	-40 to -31
25 GHz to 40 GHz	-44 to -31
40 GHz to 44 GHz	-53 to -33

1. Listed frequency is fundamental (RF) frequency. RF frequency at Direct Receiver Access Input (A In, B In, R1 In, or R2 In) is fixed at power of -15 dBm.

Output power of IF output (A Out, B Out, R1 Out, R2 Out) ¹ (dBm) – Typical

IF Out frequency, when using an External LO.

Description	Typical
30.6 MHz to 1 GHz	-33 to -29
1 GHz to 5 GHz	-36 to -30
5 GHz to 8 GHz	-38 to -31
8 GHz to 8.5 GHz	-39 to -32

1. Listed frequency is IF frequency. RF frequency at Direct Receiver Access Input (A In, B In, R1 In, or R2 In) is fixed to 5 GHz (M9834A) or 10 GHz (M9837A), at power of -15 dBm

Return loss of IF Output (A Out, B Out, R1 Out, R2 Out) ¹ (dB) – Typical

Description	Typical
10 MHz to 6 GHz	-8
6 GHz to 8 GHz	-6
8 GHz to 8.5 GHz	-2

Table 90. Damage level - Typical

Description	RF (dBm)	DC (V)
A In, B In, R1 In, R2 In	+27	± 35
Src In	+27	± 35
SrcX In	+27	± 35
RF In	+4	± 35
BB In	+20	± 35
RF1 Out, RF2 Out	+26	± 35

Table 91. Software

Description	Typical
Keysight IO library	The IO library suite offers a single entry point for connection to the most common instruments including AXIe, PXI, GPIB, USB, Ethernet/LAN, RS-232, and VXI test instrument from Keysight and other vendors. It automatically discovers interfaces, chassis, and instruments. The graphical user interface allows you to search for, verify, and update IVI instrument and soft front panel drivers for modular and traditional instruments. The IO suite safely installs in side-by-side mode with NI I/O software. Free software download at www.keysight.com/find/iosuite
Keysight soft front panel	The PXI module includes a soft front panel (SFP), a software based graphical user interface (GUI) which enables the instrument's capabilities from your PC.
Command Expert	Assists in finding the right instrument commands and setting correct parameters. A simple interface includes documentation, examples, syntax checking, command execution, and debug tools to build sequences for integration in Excel, MATLAB, LabVIEW, VEE, and System VUE. Free software download at www.keysight.com/find/commandexpert
Example programs	Setting up a measurement Guided calibration Data acquisition Data transfer
Example programming languages	C, C++, C#, VB, LabVIEW

Test Set Block Diagrams

Legend

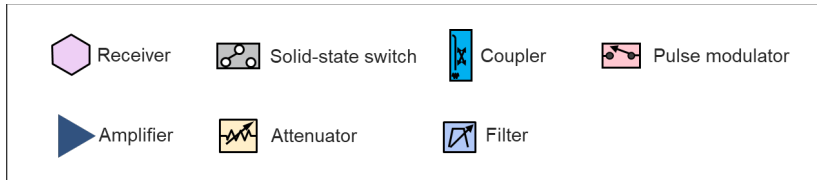

M9834A Option 205 (2-port base model without upconverter)

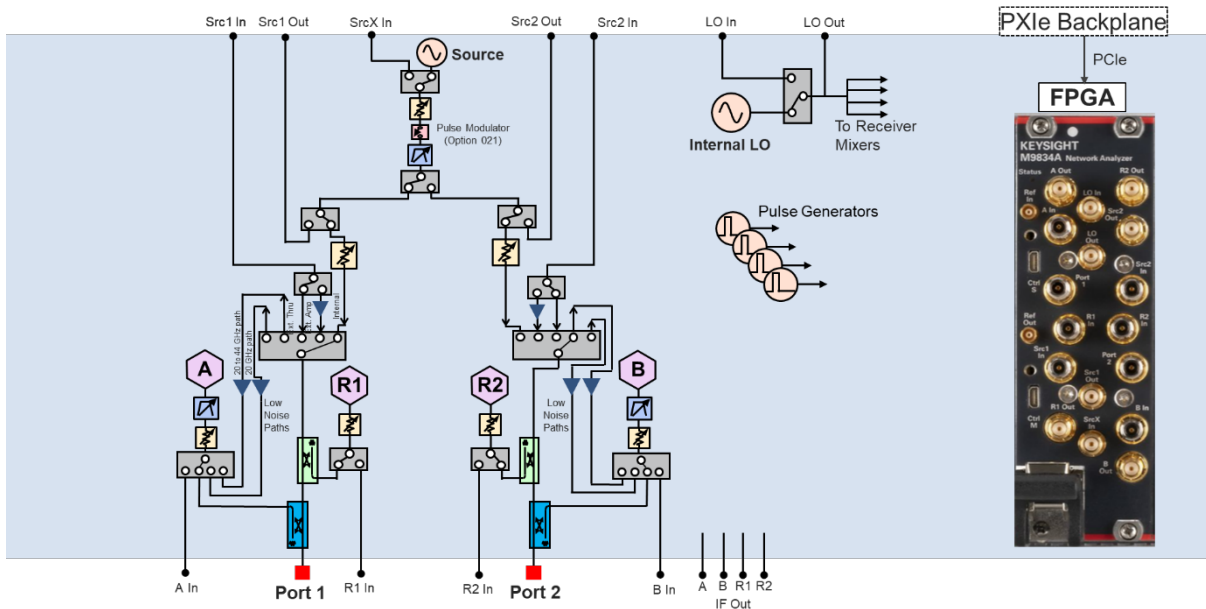

M9837A Option 205 (2-port base model without upconverter)

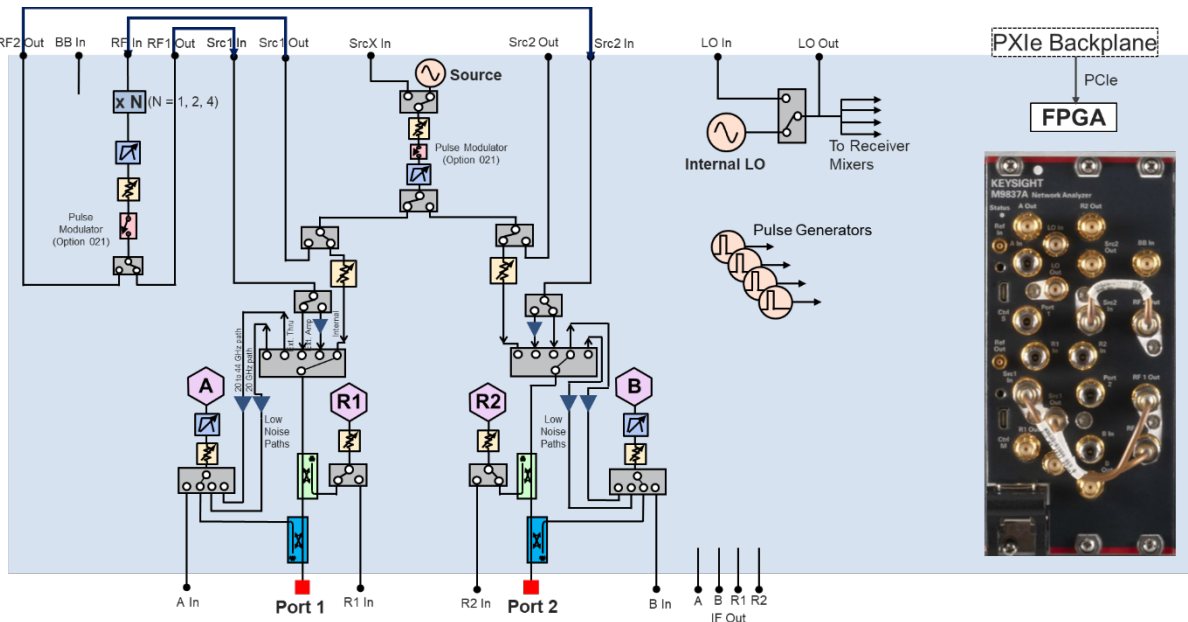

M9834A Option 270, M9837A Option 270/271 (2-port base model with upconverter)

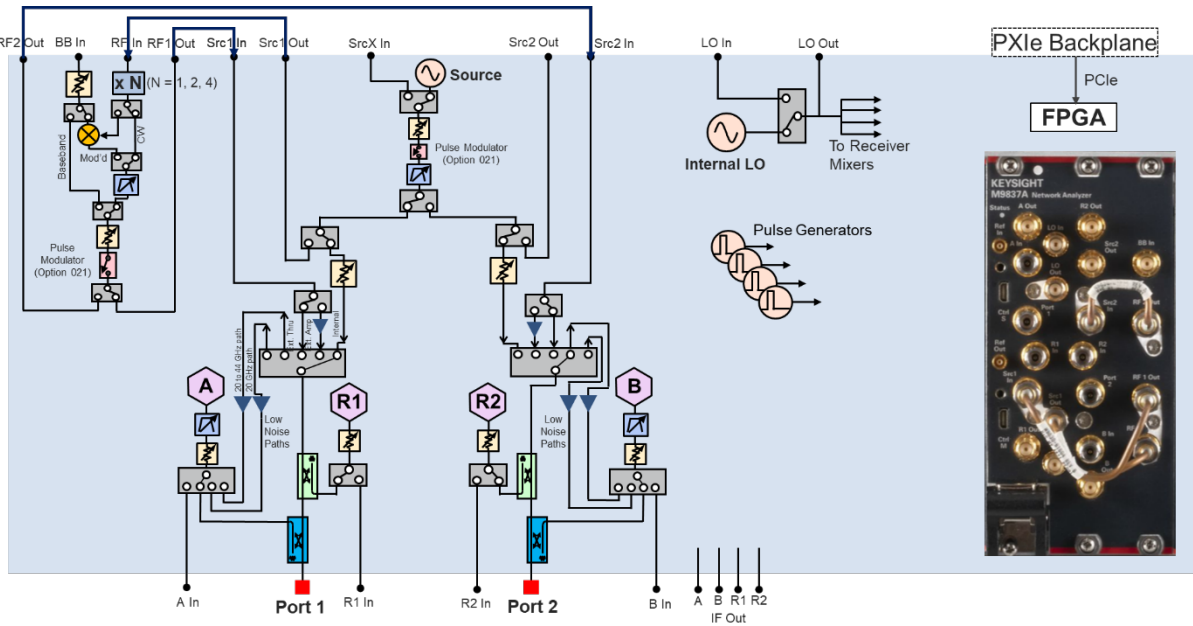

Receiver block diagram

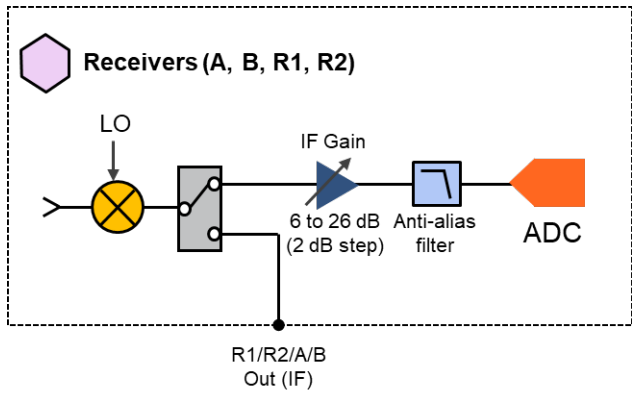

Keysight Support Services

Accelerate your learning curve, enhance your test uptime, and confidently guarantee your instrument accuracy with Keysight Support Services. Keysight Services are here to support your test needs with expert technical support, instrument repair and calibration, training, alternative acquisition program options, and more.

A KeysightCare agreement provides dedicated, proactive support through a single point of contact for an extensive group of instruments, software, and solutions to ensure optimal uptime, with fast response times and resolution. Explore the services that are right for you.

Keysight Services

Offering	Benefits
KeysightCare 	KeysightCare provides elevated support for Keysight instruments and software, with access to technical support experts who respond within a specified time and ensure committed repair and calibration turnaround times (TAT). KeysightCare offers multiple service agreement tiers, including KeysightCare Assured, Enhanced, and Application Software Support. See the KeysightCare data sheet for details.
KeysightCare Assured	KeysightCare Assured provides a commitment to respond to your engineer's technical needs quickly. When unexpected repairs are necessary, you can count on a committed repair service turnaround time to get you back up and running.
KeysightCare Enhanced	KeysightCare Enhanced includes all the benefits of KeysightCare Assured plus Keysight's accurate and reliable Calibration Services , accelerated and committed TAT, and technical response.
Keysight Support Portal & Knowledge Center	All KeysightCare tiers include access to the Keysight Support Portal, where you can manage support and service resources related to your assets, such as service requests and status, or browse the Knowledge Center.
Education Services	Build confidence and gain new skills to make accurate measurements, with flexible Education Services developed by Keysight experts. Including Start-up Assistance.
Alternative acquisition options	
KeysightAccess	Reduce budget challenges with a lease-based subscription service that offers low monthly payments, enabling you to get the instruments, software, and technical support you want for your test needs.

Recommended services

Maximize your instrument uptime and confidently make accurate measurements by securing technical support, repair, and calibration services with committed response and turnaround times. High-performance instruments include 1 year of KeysightCare Assured or KeysightCare Warranty Plus. Obtain multi-year KeysightCare upfront to eliminate the need for lengthy and tedious paperwork and yearly requests for maintenance budget. Plus, you benefit from secured service for 2, 3, or 5 years.

Service	Function
KeysightCare Enhanced*	Includes tech support, warranty and calibration
R-55B-001-1	KeysightCare Enhanced – Upgrade 1 year
R-55B-001-2	KeysightCare Enhanced – Extend to 2 years
R-55B-001-3	KeysightCare Enhanced – Extend to 3 years (Recommended)
R-55B-001-5	KeysightCare Enhanced – Extend to 5 years (Recommended)
KeysightCare Assured*	Includes tech support and warranty
R-55A-001-2	KeysightCare Assured – Extend to 2 years
R-55A-001-3	KeysightCare Assured – Extend to 3 years
R-55A-001-5	KeysightCare Assured – Extend to 5 years
Start-Up Assistance	
PS-S40-01	Included – instrument fundamentals and operations starter
PS-S40-04	Recommended – instrument fundamentals and operations starter
PS-S40-02	Optional, technology & measurement science standard learning

* Limited availability might apply. Please review the [service definition tool](#) for model number availability and the [datasheet](#) for country availability. Coverage might be limited to KeysightCare Warranty Plus (R-55F-001). If KeysightCare Enhanced is available, R-55B-001-2/3/5 must be ordered with R-55B-001-1.

Literature Information

- M983x/M980xA PXIe Vector Network Analyzer – Configuration Guide, [5992-3597EN](#)
- Keysight PXI Vector Network Analyzer – Product Fact Sheet, [3122-2110.EN](#)
- Keysight Network Analyzer – Selection Guide, [5989-7603EN](#)
- Electronic Calibration (ECal) Modules for Network Analyzer – Technical Overview, [5963-3743E](#)

Web Resources

- Keysight Vector Network Analyzer Page - www.keysight.com/find/na
- Keysight PXI Vector Network Analyzer Page - www.keysight.com/find/pxivna
- Keysight Vector Network Analyzer Software Page - www.keysight.com/find/vnasoftware
- Keysight Electronic Calibration (ECal) Module Page - www.keysight.com/find/ecal

Keysight enables innovators to push the boundaries of engineering by quickly solving design, emulation, and test challenges to create the best product experiences. Start your innovation journey at www.keysight.com.