

# **U4998A HDMI 1.4a Protocol/Audio/Video Analyzer and Generator**

## **Installation Guide**



**Agilent Technologies**

# Notices

© Agilent Technologies, Inc. 2011

No part of this manual may be reproduced in any form or by any means (including electronic storage and retrieval or translation into a foreign language) without prior agreement and written consent from Agilent Technologies, Inc. as governed by United States and international copyright laws.

## Trademarks

Windows 2000®, Windows XP®, and Microsoft .NET Framework 1.1® are U.S. registered trademarks of Microsoft Corporation.

## Manual Part Number

Second Edition

## Edition

June 2011

Available in electronic format only

Agilent Technologies, Inc.  
1900 Garden of the Gods Road  
Colorado Springs, CO 80907 USA

## Warranty

**The material contained in this document is provided “as is,” and is subject to being changed, without notice, in future editions. Further, to the maximum extent permitted by applicable law, Agilent disclaims all warranties, either express or implied, with regard to this manual and any information contained herein, including but not limited to the implied warranties of merchantability and fitness for a particular purpose. Agilent shall not be liable for errors or for incidental or consequential damages in connection with the furnishing, use, or performance of this document or of any information contained herein. Should Agilent and the user have a separate written agreement with warranty terms covering the material in this document that conflict with these terms, the warranty terms in the separate agreement shall control.**

## Technology Licenses

The hardware and/or software described in this document are furnished under a license and may be used or copied only in accordance with the terms of such license.

## Restricted Rights Legend

If software is for use in the performance of a U.S. Government prime contract or sub-contract, Software is delivered and licensed as “Commercial computer software” as defined in DFAR 252.227-7014 (June 1995), or as a “commercial item” as defined in FAR 2.101(a) or as “Restricted computer software” as defined in FAR 52.227-19 (June 1987) or any equivalent

agency regulation or contract clause. Use, duplication or disclosure of Software is subject to Agilent Technologies’ standard commercial license terms, and non-DOD Departments and Agencies of the U.S. Government will receive no greater than Restricted Rights as defined in FAR 52.227-19(c)(1-2) (June 1987). U.S. Government users will receive no greater than Limited Rights as defined in FAR 52.227-14 (June 1987) or DFAR 252.227-7015 (b)(2) (November 1995), as applicable in any technical data.

## Safety Notices

### CAUTION









A **CAUTION** notice denotes a hazard. It calls attention to an operating procedure, practice, or the like that, if not correctly performed or adhered to, could result in damage to the product or loss of important data. Do not proceed beyond a **CAUTION** notice until the indicated conditions are fully understood and met.

### WARNING

A **WARNING** notice denotes a hazard. It calls attention to an operating procedure, practice, or the like that, if not correctly performed or adhered to, could result in personal injury or death. Do not proceed beyond a **WARNING** notice until the indicated conditions are fully understood and met.

# Safety Summary

## Safety Symbols on Instruments

Safety Symbol	Description
	Indicates warning or caution. If you see this symbol on a product, you must refer to the manuals for specific Warning or Caution information to avoid personal injury or damage to the product.
	Frame or chassis ground terminal. Typically connects to the equipment's metal frame.
	Indicates hazardous voltages and potential for electrical shock.
	Indicates that antistatic precautions should be taken.
	Indicates hot surface. Please do not touch.
	Indicates laser radiation turned on.
	CSA is the Canadian certification mark to demonstrate compliance with the Safety requirements.
	CE compliance marking to the EU Safety and EMC Directives. ISM GRP-1A classification according to the international EMC standard. ICES/NMB-001 compliance marking to the Canadian EMC standard.

## General Safety Precautions

The following general safety precautions must be observed during all phases of operation of this instrument. Failure to comply with these precautions or with specific warnings elsewhere in this manual violates safety standards of design, manufacture, and intended use of the instrument.

Agilent Technologies Inc. assumes no liability for the customer's failure to comply with these requirements.

Before operation, review the instrument and manual for safety markings and instructions. You must follow these to ensure safe operation and to maintain the instrument in safe condition.

### General

This product is a Safety Class 1 instrument (provided with a protective earth terminal). The protective features of this product may be impaired if it is used in a manner not specified in the operation instructions.

All Light Emitting Diodes (LEDs) used in this product are Class 1 LEDs as per IEC 60825-1.

## Environment Conditions

This instrument is intended for indoor use in an installation category II, pollution degree 2 environment. It is designed to operate at a maximum relative humidity of 95% and at altitudes of up to 2000 meters.

Refer to the specifications tables for the ac mains voltage requirements and ambient operating temperature range.

**Before Applying Power**

Verify that all safety precautions are taken. The power cable inlet of the instrument serves as a device to disconnect from the mains in case of hazard. The instrument must be positioned so that the operator can easily access the power cable inlet. When the instrument is rack mounted the rack must be provided with an easily accessible mains switch.

**Ground the Instrument**

To minimize shock hazard, the instrument chassis and cover must be connected to an electrical protective earth ground. The instrument must be connected to the ac power mains through a grounded power cable, with the ground wire firmly connected to an electrical ground (safety ground) at the power outlet. Any interruption of the protective (grounding) conductor or disconnection of the protective earth terminal will cause a potential shock hazard that could result in personal injury.

**Do Not Operate in an Explosive Atmosphere**



Do not operate the instrument in the presence of flammable gases or fumes.

**Do Not Remove the Instrument Cover**

Operating personnel must not remove instrument covers. Component replacement and internal adjustments must be made only by qualified personnel.

Instruments that appear damaged or defective should be made inoperative and secured against unintended operation until they can be repaired by qualified service personnel.

**Environmental Information**

 	<p>This product complies with the WEEE Directive (2002/96/EC) marking requirements. The affixed label indicates that you must not discard this electrical/ electronic product in domestic household waste.</p> <p><i>Product Category: With reference to the equipment types in the WEEE Directive Annex I, this product is classed as a "Monitoring and Control instrumentation" product.</i></p> <p><b>Do not dispose in domestic household waste.</b></p> <p>To return unwanted products, contact your local Agilent office, or see <a href="http://www.agilent.com/environment/product/">www.agilent.com/environment/product/</a> for more information.</p>
--	---

# Contents

## 1 Introduction

About the U4998A HDMI 1.4a Protocol/Audio/Video Analyzer and Generator 8

What's Included in the U4998A Standard License 9

## 2 Components

Hardware Components 12

U4998A HDMI 1.4a Protocol/Audio/Video Analyzer and Generator Module 12

Chassis 12

System Controller 13

Software Components 14

Logic Analyzer 14

HDMI Evaluator 14

U4998A HDMI Video Generator Files software 14

Agilent Generate Module CSV from HDMI Capture File utility 14

## 3 U4998A Module Details

U4998A Module Components 16

## 4 Setting up the Hardware for U4998A

Hardware Setup Steps 20

Sample Setup 21

## 5 Installing Software Components

Hardware and software requirements 24

Installing Agilent Logic Analyzer 25

Verifying the Installation 25

Installing HDMI Evaluator 26

Verifying the Installation 26

Installing Agilent U4998A HDMI Video Generator Files Utility 27

Verifying the Installation 28

Installing the Generate Module CSV from HDMI Capture File Utility	29
Verifying the Installation	29
Accessing U4998A Documents	30



# 1 Introduction

**About the U4998A HDMI 1.4a Protocol/Audio/Video Analyzer and  
Generator 8**

**What's Included in the U4998A Standard License 9**

## About the U4998A HDMI 1.4a Protocol/Audio/Video Analyzer and Generator

The Agilent U4998A HDMI 1.4a Protocol/Audio/Video Analyzer and Generator (hereafter referred to as U4998A) is a module installed in an Agilent AMP chassis (for example the U4002A portable 2-slot chassis) or an Agilent AXIe chassis (for example the M9502A 2-slot chassis).

U4998A provides features for testing the HDMI sink and source devices. You can use it to perform HDMI Compliance testing as per the HDMI Compliance Test Specifications or debugging HDMI devices.

To test a HDMI sink device, U4998A can act as an HDMI Generator and transmit data to the sink DUT. It can also act as a HDMI sink device to receive and capture data from a HDMI source device.

Refer to the *U4998A HDMI 1.4a Protocol/Audio/Video Analyzer and Generator User Guide* to get detailed information on the various roles and usage scenarios for U4998A and how to configure and use it in each of the supported roles.



## What's Included in the U4998A Standard License

- 4 GB memory depth for capturing the data received from a source DUT
- Support for HDMI CTS 1.4 at 3.4 Gbps
- HDMI sink and source device emulation
- Support for transmission of predefined audio and video files to a sink DUT
- Offline evaluation of the captured data by running HDMI source tests

# 1 Introduction



## 2 Components

**Hardware Components** 12

**Software Components** 14

The chapter describes the hardware and software components of U4998A.



## Hardware Components

Refer to the chapter [“Setting up the Hardware for U4998A”](#) on page 19 to know how to set up these hardware components.

### U4998A HDMI 1.4a Protocol/Audio/Video Analyzer and Generator Module

The U4998A module is an application module that you can install in one of the empty slots of either Agilent AMP or Agilent AXIe chassis to perform HDMI testing. Refer to the topic [“U4998A Module Components”](#) on page 16 to know about the various components of this module.

The module connects to the HDMI DUT via a HDMI cable.

#### NOTE

You must use a Category-2 Certified HDMI cable (supporting transfer rates of up to 340Mhz or 10.2gbps).

The following are some of the recommendations for the HDMI cable that you use to connect U4998A to DUT:

- Once you connect U4998A to a DUT using a HDMI cable, you should not plug/unplug the end of the HDMI cable that is plugged into U4998A. To disconnect or reconnect, it is recommended to plug/unplug the other end of the HDMI cable that plugs into the DUT.
- The maximum recommended gage of the HDMI cable is 28AWG.
- There should be no ferrites on the HDMI cable used.

### Chassis

You can use the Agilent AMP or AXIe chassis to install U4998A hardware. The chassis has slots marked 1, 2 and so on for installing application modules such as U4998A module. Besides these slots, the bottom slot of the AMP chassis has the chassis manager and the AXIe chassis has the AXIe Embedded System Module (ESM). These are factory-installed. This chassis manager/ESM has a PCIe ( Gen1 and Gen2 compliant) interface that connects an external system controller to the chassis via PCIe. Refer to the topic [“Sample Setup”](#) on page 21 to see the U4998A module installed in the chassis.

## System Controller

A system controller is a laptop or a desktop PC with a PCIe interface. This PC connects to the Agilent AMP/AXIe chassis via PCIe Host Interface board.

The system controller is used to host all the required software components of U4998A for configuring, controlling, and using this module.

## Software Components

Refer to the chapter “[Installing Software Components](#)” on page 23 to know how to install these software components.

Refer to the *U4998A HDMI 1.4a Protocol/Audio/Video Analyzer and Generator online help* to know how to use these software components for various HDMI testing tasks.

### Logic Analyzer

You use the Agilent Logic Analyzer software to configure the connection mode for U4998A module. This software lets you capture the HDMI data that a source DUT transmits to U4998A module. It also lets you transmit predefined audio and video files from U4998A module to a sink DUT.

### HDMI Evaluator

You use the HDMI Evaluator software to perform offline evaluation on the captured HDMI data that a source DUT transmitted to U4998A. This software lets you run various HDMI source tests on the captured data and view whether or not the DUT meets the requirements of these tests.

### U4998A HDMI Video Generator Files software

You use this software to install:

- a set of predefined Video and Audio Generator (.vgf and .aaf) files that you can transmit to a sink DUT. These files are as per the requirements of various sink tests in the HDMI CTS.
- a set of EDID sample data files that you can use to define the EDID of U4998A (emulating a sink device).

### Agilent Generate Module CSV from HDMI Capture File utility

This utility requires a software license. It converts the data that you captured from HDMI source DUT into a module CSV file. You can import the converted module CSV file into the Agilent Logic Analyzer GUI for deeper analysis of the captured data.

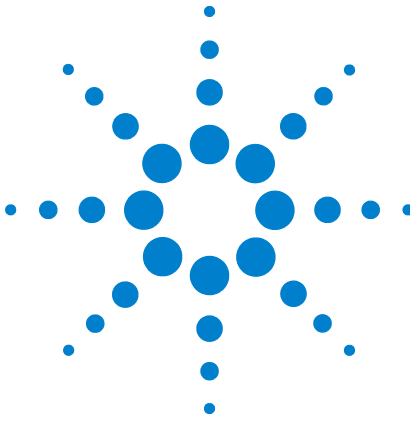

## 3 U4998A Module Details

### U4998A Module Components 16

This chapter provides information on the hardware components of U4998A module.



## U4998A Module Components

Figure 1 displays the U4998A module with its various components labelled.

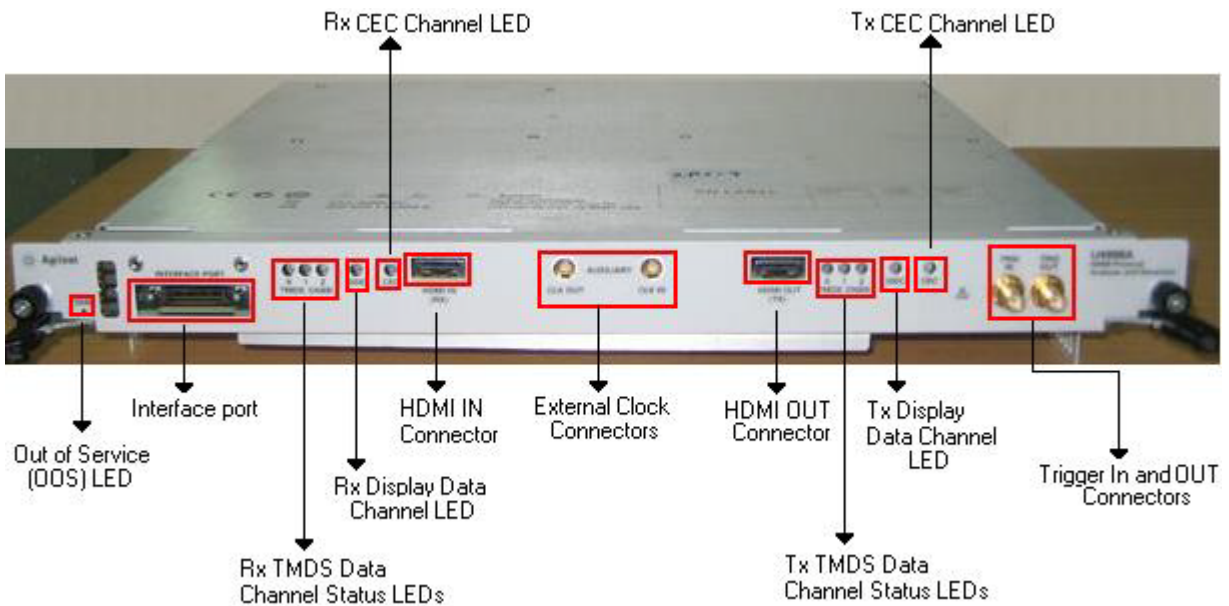

**Figure 1** U4998A module

As displayed in Figure 1, the module has the following components.

- **HDMI IN Connector** - This component is used to connect U4998A module with a source HDMI DUT via an HDMI cable.
- **HDMI OUT Connector** - This component is used to connect the U4998A module with a sink HDMI DUT via an HDMI cable.



- **LEDs** - The following table lists various LEDs on the U4998A module along with a brief description of each of these LEDs.

LED	Description
OOS (Out of Service)	<p>Indicates the U4998A module health:</p> <ul style="list-style-type: none"> <li>• <b>Red, steady</b> - The module has detected a failure, for example, an unsuccessful bootup test or corrupted firmware.</li> <li>• <b>Off</b> - The module has detected no failures and is functioning properly.</li> </ul>
TMDS Channel LEDs	<p>A set of three TMDS Channel LEDs are available for both HDMI IN and HDMI OUT Connectors. These LEDs are labelled 0 to 2 in each set and display the status of the three TMDS data channels. The following colors are applicable for these LEDs:</p> <ul style="list-style-type: none"> <li>• <b>Red:</b> Indicates the transmission or reception (as applicable) of the non HDMI data on the TMDS data channel.</li> <li>• <b>Orange:</b> Indicates that HDMI data is transmitted / received (as applicable) on the TMDS data channel but the three TMDS data channels are not aligned.</li> <li>• <b>Green:</b> Indicates that HDMI data is transmitted / received (as applicable) on the TMDS data channel and the three TMDS data channels are aligned.</li> </ul>
DDC	<p>This LED displays the status of the Display Data Channel (DDC) used for configuration and status exchange between the U4998A module and DUT.</p> <p>The LED is not functional in this release.</p>
CEC	<p>This LED displays the status of the CEC channel.</p> <p>The LED is not functional in this release.</p>

- **Interface Port** – This component is used to share information with another module installed in the same chassis in which U4998A module is installed. The features of this component are not yet supported by the Digital Test Console platform.

- **TRIG OUT Connector** – This component is used to connect the U4998A module with other instruments to trigger these instruments. The features of this component are not yet supported.
- **TRIG IN Connector** – This component is used to connect the U4998A module with other instruments to receive a trigger from these instruments when a specified condition is met. The features of this component are not yet supported.
- **CLK IN Connector** - This component is used to receive input from an external clock source. The features of this component are not yet supported.
- **CLK OUT Connector** - This component is used to send output to an external clock source. The features of this component are not yet supported.

To know about the various components on the Agilent Digital Test Console chassis in which the U4998A module is installed, refer to the *Agilent Digital Test Console Installation guide*.

---

**WARNING**

**Do not directly touch any component on the U4998A module. It may be hot.**

---

**CAUTION**

Components on the U4998A module are sensitive to the static electricity. Therefore, take necessary anti-static precautions, such as wear a grounded wrist strap, to minimize the possibility of electrostatic damage.

---

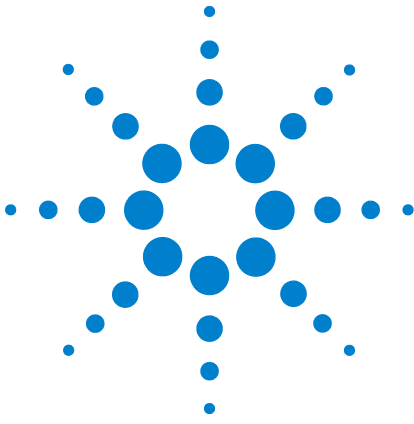

## 4 Setting up the Hardware for U4998A

**Hardware Setup Steps** 20

**Sample Setup** 21



## Hardware Setup Steps

**Step 1-** Set up the chassis in which you want to install the U4998A module. Refer to the *Agilent Digital Test Console Installation Guide* if you are using the AMP chassis. Refer to the *Agilent M9502A/M9505A AXIe Chassis Startup Guide* if you are using the AXIe chassis.

**Step 2** - Insert the U4998A module in an empty slot of the chassis. Refer to the chassis's *Installation Guide* of chassis.

**Step 3** - Connect the chassis to a controller PC via PCI Express Gen1/Gen2 interface. Refer to the *Installation Guide* of chassis.

**Step 4** - Connect the U4998A module to the HDMI DUT using the HDMI cable. As per the testing scenario, use the appropriate HDMI IN/OUT Connector component on the front panel of the U4998A module. Refer to the "[U4998A Module Components](#)" on page 16 topic to know more about this Connector component. You must use a Category-2 Certified HDMI cable (supporting transfer rates of up to 340Mhz or 10.2gbps).

**Step 5** - Power up all the connected hardware components. Refer to the *Installation Guide* of chassis to know how to power up the chassis.

## Sample Setup



**Figure 2** U4998A module in Agilent AMP chassis

The following figure displays a sample setup of the U4998A module. The module is installed in slot 1 of Agilent U4002A portable 2-slot chassis. A HDMI cable is used to connect the module to a HDMI sink DUT. A PCIe x4 Host Interface board is used to connect the chassis to the controller PC that hosts the software components of U4998A.

## **4 Setting up the Hardware for U4998A**



## 5 Installing Software Components

<b>Hardware and software requirements</b>	<b>24</b>
<b>Installing Agilent Logic Analyzer</b>	<b>25</b>
<b>Installing HDMI Evaluator</b>	<b>26</b>
<b>Installing Agilent U4998A HDMI Video Generator Files Utility</b>	<b>27</b>
<b>Installing the Generate Module CSV from HDMI Capture File Utility</b>	<b>29</b>
<b>Accessing U4998A Documents</b>	<b>30</b>

Once the hardware setup for HDMI testing is ready, you need to start installing the software components of U4998A on the designated controller PC. This chapter describes the installation of each of these components.



## Hardware and software requirements

The following are the hardware and software requirements that should be met on the controller PC before the installation of software components:

### Hardware requirements

- PCIe interface x4 (Gen1 and Gen2 compliant)
- Pentium® processor 1 GHz or equivalent
- 512 MB available RAM
- VGA resolution 1024 x 768
- 5 GB or more free disc space

### Software requirements

Windows XP Service Pack 2 or Windows 7 (32 bit) operating system

### Other Requirements

For electrical, environmental, and mechanical specifications for the 2-slot chassis and U4998A module, refer to the *Agilent Digital Test Console Installation guide*.



## Installing Agilent Logic Analyzer

Check if the controller PC meets the hardware and software requirements prior to the installation. Refer to the topic “Software Components” on page 14 to know more about this software component and its use.

### To install Agilent Logic Analyzer

- 1 Download the Agilent Logic Analyzer software (version 5.0 or greater) from the Agilent web site at: [www.agilent.com/find/](http://www.agilent.com/find/)
- 2 Once the application software install package is downloaded to the controller PC, double-click the installer .exe file.

The Agilent Logic Analyzer Installation Welcome message is displayed.

- 3 Click **OK** to continue.
- 4 Click **Next** if the system controller meets the minimum system configuration requirements displayed by the wizard.
- 5 Accept the license agreement and click **Next**.
- 6 Choose the setup type and click **Next**.
- 7 Click **Install** to start the installation.
- 8 Click **OK** to install the additional components such as Demo center.

### Verifying the Installation

You can verify the successful installation of the Agilent Logic Analyzer software by performing the following steps:

- The Agilent Logic Analyzer folder is added in the Programs folder.
- The Agilent Logic Analyzer GUI is accessible by clicking **Start > Programs > Agilent Logic Analyzer > Agilent Logic Analyzer** option on the Windows task bar.

## Installing HDMI Evaluator

Check if the controller PC meets the hardware and software requirements prior to the installation. Refer to the topic “Software Components” on page 14 to know more about this software component and its use.

### NOTE

- You do not need connectivity with the U4998A module or the HDMI DUT for installing or using the HDMI Evaluator component. This component performs offline evaluation of the captured data.
- If an older version of HDMI Evaluator is installed on the controller PC, uninstall the older version before installing the new version.

### To install HDMI Evaluator

- 1 Download the HDMI Evaluator software from the Agilent web site at: [www.agilent.com/find/](http://www.agilent.com/find/)
- 2 Once the application software install package is downloaded to the controller PC, double-click the installer .exe file.

The Agilent N5998A HDMI Protocol Analyzer and Generator Welcome screen is displayed.

- 3 Click **Next** to continue.
- 4 Accept the license agreement and click **Next**.
- 5 Click **Install** to start the installation.
- 6 Click **Finish** to exit the install wizard.

## Verifying the Installation

You can verify the successful installation of the HDMI Evaluator software by performing the following steps:

- The **HDMI Evaluator** folder is added in the Programs folder.
- The **HDMI Evaluator** GUI is accessible by clicking **Start > Programs > HDMI Evaluator > HDMI Evaluator** option on the Windows task bar.

### NOTE

For U4998A, only the **HDMI Evaluator** tab of the HDMI Evaluator GUI is applicable. Rest of the tabs in this GUI are relevant for use with Agilent N5998A HDMI hardware.

## Installing Agilent U4998A HDMI Video Generator Files Utility

Refer to the topic “[Software Components](#)” on page 14 to know more about this software component and its use.

### To install Agilent U4998A HDMI Video Generator Files utility

1 Download the Agilent U4998A HDMI Video Generator Files software from the Agilent web site at: [www.agilent.com/find/](http://www.agilent.com/find/)

2 Once the application software install package is downloaded to the controller PC, double-click the installer .exe file.

After the decompression of files, the Agilent U4998A HDMI Video Generator Files Welcome screen is displayed.

3 Click **Next** to continue.

4 Accept the license agreement and click **Next**.

5 Specify the user name and organization and click **Next**.

6 Select the setup type.

- If you select **Complete**, then both the features, that is the set of Video Generator files as well as EDID Sample Data files are installed at the following default location.

*C:\Documents and Settings\All Users\Documents\Agilent Technologies\Logic Analyzer\HDMI*

(This default location may vary depending on your operating system.)

- If you select **Custom**, then you can choose the features you want to install and the location at which the selected features are installed. Clicking the Custom option displays the **Custom Setup** screen. In this screen,
  - a Select the feature and click the drop-down icon displayed with it. From the drop-down list, you can choose to install, not install, or install the selected feature when required.
  - b Click **Change** to change the default location at which the selected feature is installed.

7 Click **Next**.

8 Click **Install** to start the installation.

9 Click **Finish** to exit the install wizard.

## Verifying the Installation

On successful installation, the files for the features that you selected while installation are available at the default location or the specified location in case you changed the default location. The following figure displays the EDID Sample data files and Video Generator files installed at the default location.

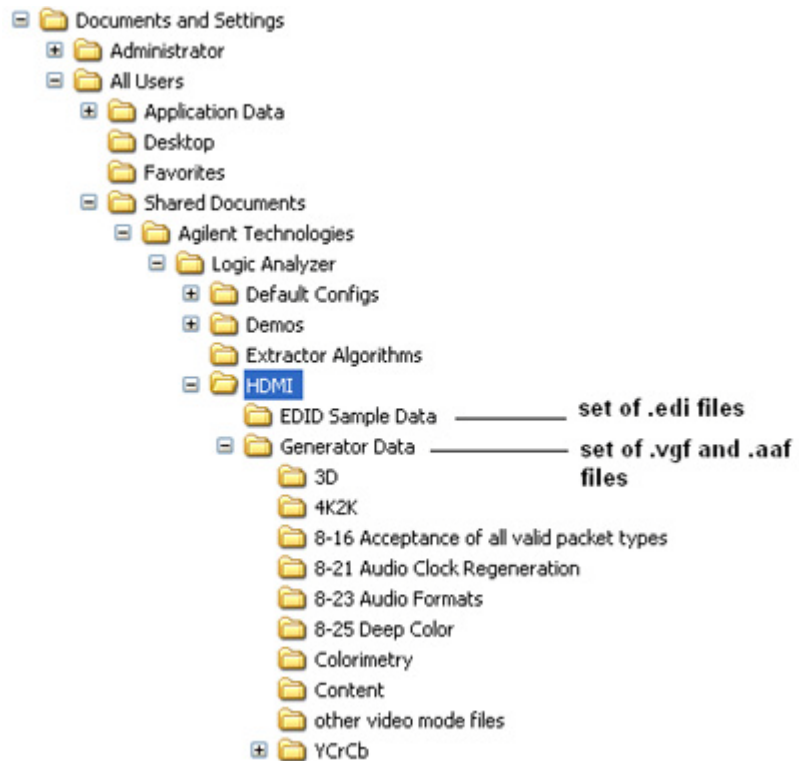

**Figure 3** Default location of .vgf and .aaf files and EDID sample files

Refer to the *U4998A HDMI 1.4a Protocol/Audio/Video Analyzer and Generator online help* to know how to use these files for HDMI testing.

## Installing the Generate Module CSV from HDMI Capture File Utility

Refer to the topic “[Software Components](#)” on page 14 to know more about this utility and its use.

### NOTE

You do not need connectivity with the U4998A module, HDMI DUT, or Logic Analyzer hardware for installing or using the Generate Module CSV utility. This component performs an offline conversion of the captured data into a module CSV file.

### To install the Generate Module CSV utility

- 1 Download the Generate Module CSV utility software from the Agilent web site at: [www.agilent.com/find/](http://www.agilent.com/find/)
- 2 Once the application software install package is downloaded to the controller PC, double-click the installer .exe file.

The Agilent Generate Module CSV from HDMI Capture File Utility Welcome screen is displayed.

- 3 Click **Next** to continue.
- 4 Accept the license agreement and click **Next**.
- 5 Click **Install** to start the installation.
- 6 Click **Finish** to exit the install wizard.

## Verifying the Installation

You can verify the successful installation of the Generate Module CSV Utility by performing the following steps:

- The **Generate CSV** folder is added in the **Programs > HDMI Evaluator** folder.
- The **Generate Module CSV from HDMI Capture File** GUI is accessible by clicking **Start > Programs > HDMI Evaluator > Generate CSV** option on the Windows task bar.

### NOTE

The Generate Module CSV from HDMI Capture File utility is a licensed software component. To use this utility to perform conversion, you need a software license. You can click the Software Licensing button in this utility to view various licensing options available and to get information about these options through the Help button.

## Accessing U4998A Documents

On installing the U4998A HDMI 1.4a Protocol/Audio/Video Analyzer and Generator software components, the user documents are installed at the following location to provide information about U4998A.

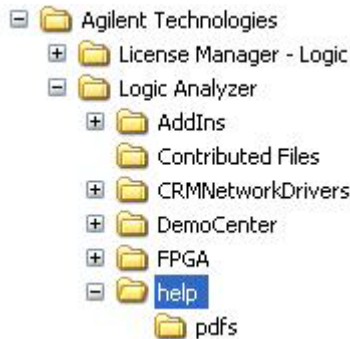

**Figure 4** Location of U4998A Documents

The following are the documents which provide information about U4998A.

- **U4998A HDMI 1.4a Protocol/Audio/Video Analyzer and Generator User Guide** - This user guide describes how to configure, control, and use the U4998A hardware to perform HDMI testing in various scenarios. It describes the usage of GUIs as well as COM interfaces to accomplish various HDMI testing tasks.
- **U4998A HDMI 1.4a Protocol/Audio/Video Analyzer and Generator Online Help** - This online help is accessible as a standalone help from the help folder displayed in the [Figure 4](#) or from the Agilent Logic Analyzer GUI (as an integrated help). It describes how to configure, control, and use the U4998A hardware to perform HDMI testing in various scenarios. It describes the usage of GUIs as well as COM interfaces to accomplish various HDMI testing tasks.
- **Context-sensitive help** - A context-sensitive HTML help page is available with each window and dialog box of the U4998A GUI components on clicking the Help button displayed within the GUI element.
- **Agilent Digital Test Console Installation Guide**- This guide describes how to set up the U4998A module hardware in the Agilent Digital Test Console chassis.



## **5 Installing Software Components**



# Index

## Symbols

.aaf, 14  
.vgf, 14

## A

Agilent Logic Analyzer, 25  
Agilent Logic Analyzer software, 14  
Agilent U4998A HDMI Video Generator Files  
utility, 27  
AXIe Embedded System Module (ESM), 12

## C

chassis, 12  
chassis manager, 12

## D

DDC, 17

## E

EDID sample data files, 14

## G

Generate Module CSV utility, 29

## H

HDMI cable, 16  
HDMI Evaluator, 14, 26  
HDMI IN Connector, 16  
HDMI OUT Connector, 16

## I

Interface Port, 17

## L

LEDs, 17

## M

module CSV file, 14

## N

notices, 2

## O

OOS, 17

## P

PCIe, 13, 21

## S

safety summary, 3  
slots, 12  
system controller, 13

## T

TMDS Channel LEDs, 17  
trademarks, 2

## U

U4002A 2- slot chassis, 21  
U4998A HDMI 1.4a Protocol/Audio/Video  
Analyzer and Generator, 8  
U4998A HDMI 1.4a Protocol/Audio/Video  
Analyzer and Generator Module, 12

