

Startup Guide

M9101A, M9102A, M9103A,
M9120A, M9121A, M9122A

Keysight PXI Matrix and Multiplexer Switch Modules



Notices

© Keysight Technologies, Inc. 2014-2018

No part of this manual may be reproduced in any form or by any means (including electronic storage and retrieval or translation into a foreign language) without prior agreement and written consent from Keysight Technologies, Inc. as governed by United States and international copyright laws.

Manual Part Number

M9101-90001

Edition

Fourth Edition, December 2018
Published in U.S.A.
900 S. Taft Avenue,
Loveland, CO. 80537

Trademarks

PICMIG[®], COMPACT PCI[®], and Advanced TCA[®] are registered trademarks of the PCI Industrial Computer Manufacturers Group

PCI-SIG[®], PCI Express[®], and PCIe[®] are registered trademarks of PCI-SIG

Sales and Technical Support

To contact Keysight for sales and technical support, refer to the support links on the following Keysight websites:

www.keysight.com/find/M9101A (product-specific information and support, software and documentation updates)

www.keysight.com/find/assist (world-wide contact information for repair and service)

Declaration of Conformity

Declarations of Conformity for this product and for other Keysight products may be downloaded from the Web. Go to <http://www.keysight.com/go/conformity> and click on “Declarations of Conformity.” You can then search by product number to find the latest Declaration of Conformity.

Technology Licenses

The hardware and/or software described in this document are furnished under a license and may be used or copied only in accordance with the terms of such license.

Warranty

THE MATERIAL CONTAINED IN THIS DOCUMENT IS PROVIDED “AS IS,” AND IS SUBJECT TO BEING CHANGED, WITHOUT NOTICE, IN FUTURE EDITIONS. FURTHER, TO THE MAXIMUM EXTENT PERMITTED BY APPLICABLE LAW, KEYSIGHT DISCLAIMS ALL WARRANTIES, EITHER EXPRESS OR IMPLIED, WITH REGARD TO THIS MANUAL AND ANY INFORMATION CONTAINED HEREIN, INCLUDING BUT NOT LIMITED TO THE IMPLIED WARRANTIES OF MERCHANTABILITY AND FITNESS FOR A PARTICULAR PURPOSE. KEYSIGHT SHALL NOT BE LIABLE FOR ERRORS OR FOR INCIDENTAL OR CONSEQUENTIAL DAMAGES IN CONNECTION WITH THE FURNISHING, USE, OR PERFORMANCE OF THIS DOCUMENT OR OF ANY INFORMATION CONTAINED HEREIN. SHOULD KEYSIGHT AND THE USER HAVE A SEPARATE WRITTEN AGREEMENT WITH WARRANTY TERMS COVERING THE MATERIAL IN THIS DOCUMENT THAT CONFLICT WITH THESE TERMS, THE WARRANTY TERMS IN THE SEPARATE AGREEMENT SHALL CONTROL.

Keysight Technologies does not warrant third-party system-level (combination of chassis, controllers, modules, etc.) performance, safety, or regulatory compliance unless specifically stated.

DFARS/Restricted Rights Notices

If software is for use in the performance of a U.S. Government prime contract or subcontract, Software is delivered and licensed as “Commercial computer software” as defined in DFAR 252.227-7014 (June 1995), or as a “commercial item” as defined in FAR 2.101(a) or as “Restricted computer software” as defined in FAR 52.227-19 (June 1987) or any equivalent agency regulation or contract clause. Use, duplication or disclosure of Software is subject to Keysight Technologies’ standard commercial license terms, and non-DOD Departments and Agencies of the U.S. Government will receive no greater than Restricted Rights as defined in FAR 52.227-19(c)(1-2) (June 1987). U.S. Government users will receive no greater than Limited Rights as defined in FAR 52.227-14 (June 1987) or DFAR 252.227-7015 (b)(2) (November 1995), as applicable in any technical data.

Safety Information

The following general safety precautions must be observed during all phases of operation of this instrument. Failure to comply with these precautions or with specific warnings or operating instructions in the product manuals violates safety standards of design, manufacture, and intended use of the instrument. Keysight Technologies assumes no liability for the customer's failure to comply with these requirements.

General

Do not use this product in any manner not specified by the manufacturer. The protective features of this product must not be impaired if it is used in a manner specified in the operation instructions.

Before Applying Power

Verify that all safety precautions are taken. Make all connections to the unit before applying power. Note the external markings described under "Safety Symbols".

Ground the Instrument

Keysight chassis' are provided with a grounding-type power plug. The instrument chassis and cover must be connected to an electrical ground to minimize shock hazard. The ground pin must be firmly connected to an electrical ground (safety ground) terminal at the power outlet. Any interruption of the protective (grounding) conductor or disconnection of the protective earth terminal will cause a potential shock hazard that could result in personal injury.

Do Not Operate in an Explosive Atmosphere

Do not operate the module/chassis in the presence of flammable gases or fumes.

Do Not Operate Near Flammable Liquids

Do not operate the module/chassis in the presence of flammable liquids or near containers of such liquids.

Cleaning

Clean the outside of the Keysight module/chassis with a soft, lint-free, slightly dampened cloth. Do not use detergent or chemical solvents.

Do Not Remove Instrument Cover

Only qualified, service-trained personnel who are aware of the hazards involved should remove instrument covers. Always disconnect the power cable and any external circuits before removing the instrument cover.

Keep away from live circuits

Operating personnel must not remove equipment covers or shields. Procedures involving the removal of covers and shields are for use by service-trained personnel only. Under certain conditions, dangerous voltages may exist even with the equipment switched off. To avoid dangerous electrical shock, DO NOT perform procedures involving cover or shield removal unless you are qualified to do so.

DO NOT operate damaged equipment

Whenever it is possible that the safety protection features built into this product have been impaired, either through physical damage, excessive moisture, or any other reason, REMOVE POWER and do not use the product until safe operation can be verified by service-trained personnel. If necessary, return the product to an Keysight Technologies Sales and Service Office for service and repair to ensure the safety features are maintained.

DO NOT block the primary disconnect

The primary disconnect device is the appliance connector/power cord when a chassis used by itself, but when installed into a rack or system the disconnect may be impaired and must be considered part of the installation.

Do Not Modify the Instrument

Do not install substitute parts or perform any unauthorized modification to the product. Return the product to an Keysight Sales and Service Office to ensure that safety features are maintained.

In Case of Damage

Instruments that appear damaged or defective should be made inoperative and secured against unintended operation until they can be repaired by qualified service personnel

CAUTION

Do NOT block vents and fan exhaust: To ensure adequate cooling and ventilation, leave a gap of at least 50mm (2") around vent holes on both sides of the chassis.

Do NOT operate with empty slots: To ensure proper cooling and avoid damaging equipment, fill each empty slot with an AXle filler panel module.

Do NOT stack free-standing chassis: Stacked chassis should be rack-mounted.

All modules are grounded through the chassis: During installation, tighten each module's retaining screws to secure the module to the chassis and to make the ground connection.

WARNING

Operator is responsible to maintain safe operating conditions. To ensure safe operating conditions, modules should not be operated beyond the full temperature range specified in the Environmental and physical specification. Exceeding safe operating conditions can result in shorter lifespan, improper module performance and user safety issues. When the modules are in use and operation within the specified full temperature range is not maintained, module surface temperatures may exceed safe handling conditions which can cause discomfort or burns if touched. In the event of a module exceeding the full temperature range, always allow the module to cool before touching or removing modules from the chassis.

WARNING**REMOTE OPERATION**

When any channel is connected to a hazardous voltage source, the instrument and the device under test should be supervised, following local EHS practices to restrict access.

WARNING

To prevent electrical shock, use only wires that are rated for the maximum voltage applied to any channel.

WARNING

When any channel is connected to a hazardous voltage source, all channels in the module should be treated as hazardous.

WARNING

When any channel is connected to a hazardous voltage source, all channel wiring in the module should be rated for the maximum voltage applied.

WARNING

When any channel is connected to a hazardous voltage source, thermocouples attached to any other channel on the module shall have insulation rated for the maximum voltage, or have additional insulation added rated for the maximum voltage and will be isolated from conductive parts using a thermal compound or tape rated for the maximum voltage applied.

WARNING

Do not mount, move or remove any thermocouples when the device under test is connected to a signal source.

WARNING

When any channel is connected to a hazardous voltage source, the instrument and the device under test should be supervised, following local EHS practices to restrict access.

WARNING

To avoid the possibility of multiple signal sources becoming connected together, we recommend when multiplexing two or more sources they should be connected on separate modules or on separate banks of the same module.

WARNING**BEFORE POWER ON AND OFF**

Before powering on the instrument, make sure all signal sources connected to modules are turned off. Turn on signal sources after the instrument is powered on. Turn off signal sources before the instrument is powered off.

Safety Symbols







CAUTION

A CAUTION denotes a hazard. It calls attention to an operating procedure or practice, that, if not correctly performed or adhered to could result in damage to the product or loss of important data. Do not proceed beyond a CAUTION notice until the indicated conditions are fully understood and met.

WARNING

A WARNING denotes a hazard. It calls attention to an operating procedure or practice, that, if not correctly performed or adhered to, could result in personal injury or death. Do not proceed beyond a WARNING notice until the indicated conditions are fully understood and met.

Products display the following symbols:

-  Warning, risk of electric shock
-  Refer to manual for additional safety information.
-  Earth Ground.
-  Chassis Ground.
-  Alternating Current (AC).
-  Standby Power. Unit is not completely disconnected from AC mains when switch is in standby.
-  Antistatic precautions should be taken.

For localized Safety Warnings, Refer to Keysight Safety document (p/n 9320-6792).



The instrument has been tested, investigated and found to comply with the requirements of the Standard(s) for Electrical Measuring & Test Equipment.



Notice for European Community: This product complies with the relevant European legal Directives: EMC Directive (2004/108/EC) and Low Voltage Directive (2006/95/EC).



This is the symbol for an Industrial, Scientific, and Medical Group 1 Class A product.



The Regulatory Compliance Mark (RCM) mark is a registered trademark. This signifies compliance with the Australia EMC Framework regulations under the terms of the Radio Communication Act of 1992.

ICES/NMB-001

ICES/NMB-001 indicates that this ISM device complies with the Canadian ICES-001.



This symbol represents the time period during which no hazardous or toxic substance elements are expected to leak or deteriorate during normal use. Forty years is the expected useful life of this product.



Waste Electrical and Electronic Equipment (WEEE) Directive 2002/96/EC

This product complies with the WEEE Directive (2002/96/EC) marking requirement. The affixed product label (see below) indicates that you must not discard this electrical/electronic product in domestic household waste.

Product Category: With reference to the equipment types in the WEEE directive Annex 1, this product is classified as a "Monitoring and Control instrumentation" product.

Do not dispose in domestic household waste.

To return unwanted products, contact your local Keysight office for more information.



Contents

Keysight PXI Multiplexer and Matrix Switch Modules Introduction	8
Related documentation	9
Step 1: Unpack and Inspect the Module	9
ESD	9
Inspect for damage.	10
Return the module for service	10
Step 2: Verify Shipment Contents.	11
Step 3: Install the Software on the System Controller	11
System requirements	12
PXIe System.	12
Install Keysight IO Libraries Suite	13
Install instrument drivers	14
Step 4. Connect the PC to the PXI Chassis	15
Using a remote PC	15
Using an embedded computer.	15
Step 5: Install the Switch Modules in the PXI Chassis	16
Step 6. Verify Operation of the Module	18
Run Keysight IO Libraries Connection Expert	18
Verify operation	19
Characteristics	20
Default Path Settings.	20
Module Functional Description.	20
Module Programming	21
Identifying Channel Numbers.	22
Module Front Panel Connectors And System Connections	23
M9101A PXI Multiplexer Module: 64-Channel, 2 Wire.	24
M9102A PXI Multiplexer Module:128-Channel, 1 Wire	27
M9103A PXI Multiplexer: 99-Channel, 2 Wire	30
M9120A PXI Matrix Switch module: 4x32, 2 Wire	33
M9121A PXI Matrix Switch: 4x64, 2 Wire	36
M9122A PXI Matrix Switch: 8x32, 1 Wire	39
Multiplexer and Matrix Module Accessories.	41
Y1180A 50 Pin Shielded Connector Block	42
Y1181A 78 Pin Shielded Connector Block.	43
Y1182A 200 Pin Shielded Connector Block.	44
Y1185A, Y1186A 50 Pin Male to Female Connector Cable.	45
Y1187A, Y1188A 78 Pin Male to Female Connector Cable.	45
Y1189A, Y1190A 200 Pin Male to Female Connector Cable.	46
Disassembling the Terminal Block Clam Shells	48
Electrical Operating Conditions	49
Transients	49

High Energy Sources.....	49
Environmental Operating Conditions	50

Keysight PXI Multiplexer and Matrix Switch Modules Introduction

The multiplexer modules deliver high-speed signal routing to a single point and are ideal for routing multiple analog signals to a measurement device in automated test environments (ATE) or data acquisition systems.

Keysight PXI Multiplexer Modules

- M9101A Multiplexer: 64-channel, 2-Wire, Reed Relays
- M9102A Multiplexer: 128-channel, 1-Wire, Reed Relays
- M9103A Multiplexer: 99-channel, 2-Wire, Armature Relays

The matrix switch modules deliver medium to high density switching of multiple channels on a single module. Connect any row to any column – ideal for routing multiple signals between the device under test and instruments.

Keysight PXI Matrix Modules

- M9120A Matrix Switch: 4x32, 2-Wire, Armature Relays
- M9121A Matrix Switch: 4x64, 2-Wire, Reed Relays
- M9122A Matrix Switch: 8x32, 1-Wire, Armature Relays

Keysight also supplies software drivers that allow you to support the modules in all popular PXI chassis' and programming environments. Soft Front Panel software allows you to exercise the channels for test purposes.

NOTE

Keysight AgMSwitch driver version 1.1.x or later or the Keysight LabVIEW G driver version 1.1.x or later is required for programmatic control of these switch modules.

WARNING

These modules are not for connection to Mains.

Related documentation

This Startup Guide, and the documentation listed below, are on the Switch Module Software and Product Information CD.

- Help file for the PXI Switch Modules Soft Front Panel software
- Help file for the PXI Switch Modules IVI-C/IVI-COM device drivers
- Help file for the PXI Switch Modules LabVIEW G device drivers
- Keysight PXI Switch Modules Data Sheet. For the latest specifications, check the Keysight web site at: www.keysight.com/find/pxiswitch.

Step 1: Unpack and Inspect the Module

CAUTION

Keysight's PXI switch modules are shipped in materials that prevent static electricity damage. The modules should only be removed from the packaging in an anti-static area ensuring that correct anti-static precautions are taken. Store all modules in anti-static envelopes when not in use.

ESD

Electrostatic discharge (ESD) can damage or destroy electronic components. All work on electronic assemblies should be performed at a static-safe work station. The following figure shows an example of a static-safe work station using two types of ESD protection.

- Conductive table-mat and wrist-strap combination.
- Conductive floor-mat and heel-strap combination.

Both types, when used together, provide a significant level of ESD protection. Of the two, only the table-mat and wrist-strap combination provides adequate ESD protection when used alone. To ensure user safety, the static-safe accessories must provide at least 1 M Ω of isolation from ground. Purchase acceptable ESD accessories from your local supplier.

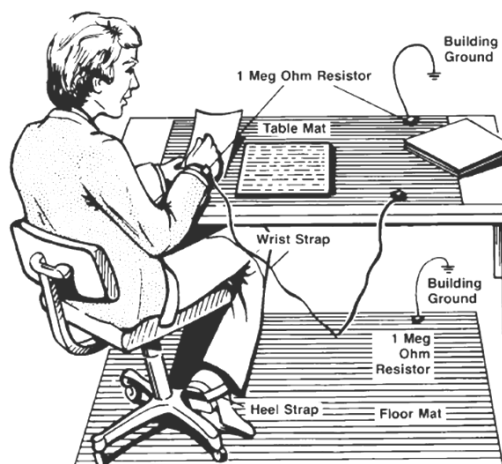

Inspect for damage

After unpacking the switch module, carefully inspect it for any shipping damage. Report any damage to the shipping agent immediately, as such damage is not covered by the warranty.

CAUTION

To avoid damage when handling a module; do not touch exposed connector pins.

Return the module for service

Should it become necessary to return a Keysight switch module for repair or service, follow the steps below:

- 1 Review the warranty information shipped with your product.
- 2 Contact Keysight to obtain a return authorization and return address. If you need assistance finding Keysight contact information go to www.keysight.com/find/assist (worldwide contact information for repair and service) or refer to the **Support** information on the product web page at: www.keysight.com/find/pxiswitch.
- 3 Write the following information on a tag and attach it to the malfunctioning equipment.
 - Name and address of owner. A Post Office box is not acceptable as a return address.
 - Product model number (for example, M9102A)
 - Product serial number (for example, MYXXXXXXXX). The serial number label is located on the side of the module.
 - A description of failure or service required.
- 4 Carefully pack the module in its original ESD bag and carton. If the original carton is not available, use bubble wrap or packing peanuts, place the instrument in a sealed container and mark the container "FRAGILE".
- 5 On the shipping label, write ATTENTION REPAIR DEPARTMENT and the service order number (if known).

NOTE

If any correspondence is required, refer to the product by serial number and model number.

Step 2: Verify Shipment Contents

Your shipment should have included the following:

- The Keysight PXI switch module that you ordered.
- This document (Keysight PXI Matrix and Multiplexer Switch Modules Startup Guide).
- A *Switch Module Software and Product Information* CD (M9128-10001). This CD contains software, drivers and all product printed documentation in PDF format for the PXI switch modules.
- An *Automation-Ready CD with Keysight IO Libraries Suite* (version 16.0 or later).
- Any other accessories that you ordered (cables, connectors, etc.).

Step 3: Install the Software on the System Controller

The following illustration shows typical system installations.

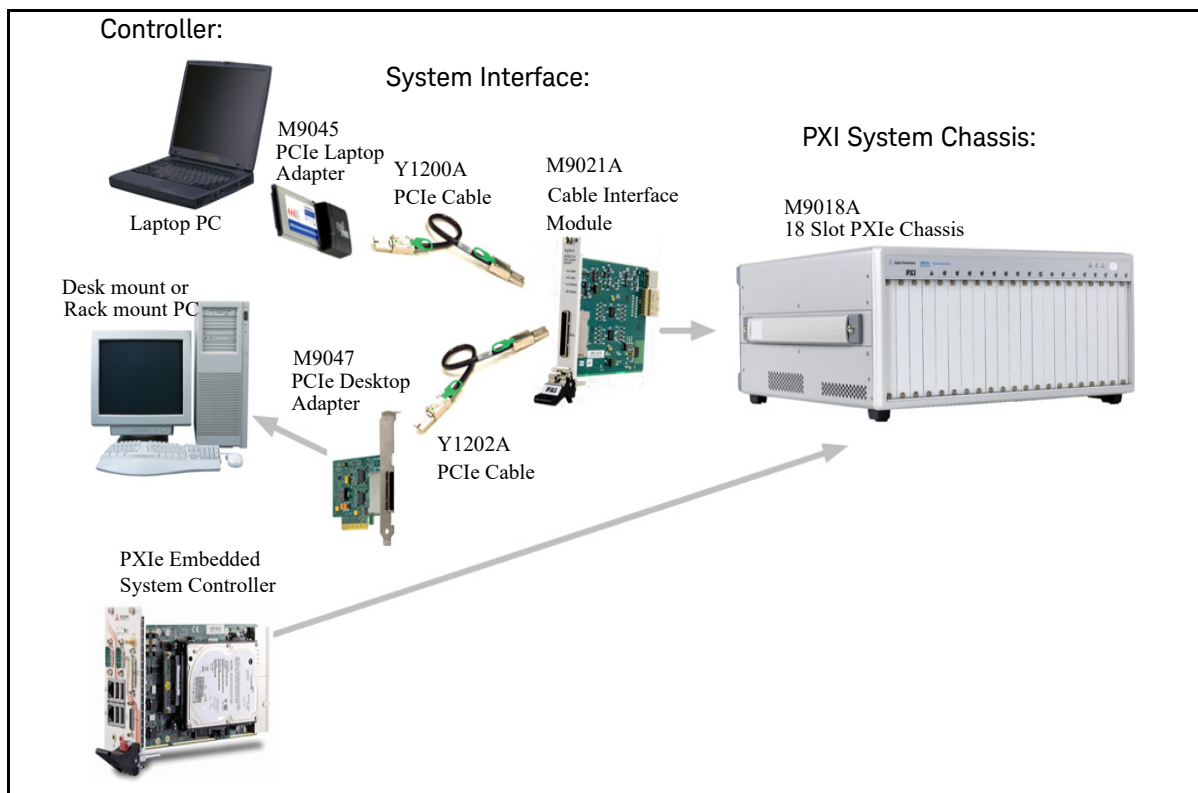

NOTE

Do not install the PXI modules in the PXI chassis yet! You must install the software prior to installing the modules in the chassis so that Keysight IO Libraries Connection Expert finds them.

System requirements

The following table lists the minimum system requirements for Keysight IO Libraries Suite 16. In general, any x86 or x64 (except Itanium) should work but there may be a significant decrease in performance.

Operating System	Windows XP Service Pack 3 or later	Windows Vista SP1 and SP2 (32-bit and 64-bit), Business, Ultimate, Enterprise, Home Basic, and Home Premium	Windows 7 (32- and 64-bit) Starter, Home Basic, Home Premium, Professional, Ultimate, Enterprise
Processor Speed	600 MHz or higher required, 800 MHz recommended	1Ghz 32-bit (x86), 1GHz 64-bit (x64), no support for Itanium64	1Ghz 32-bit (x86), 1GHz 64-bit (x64), no support for Itanium64
Available memory	256 MB minimum (1 GB or greater recommended)	1 GB minimum	1 GB minimum
Available hard disk space*	1.5 GB available hard disk space, includes: 1GB available for Microsoft .NET Framework 3.5 SP1 [†] 100MB for Keysight IO Libraries Suite	1.5 GB available hard disk space, includes: 1GB available for Microsoft .NET Framework 3.5 SP1 ² 100MB for Keysight IO Libraries Suite	1.5 GB available hard disk space, includes: 1GB available for Microsoft .NET Framework 3.5 SP1 ² 100MB for Keysight IO Libraries Suite
Video	Super VGA (800x600) 256 colors or more	Support for DirectX 9 graphics with 128MB graphics memory recommended (Super VGA graphics is supported)	Support for DirectX 9 graphics with 128MB graphics memory recommended (Super VGA graphics is supported)
Browser	Microsoft Internet Explorer 6.0 or greater	Microsoft Internet Explorer 7 or greater	Microsoft Internet Explorer 7 or greater

* Because of the installation procedure, less memory may be required for operation than is required for installation.

† .NET Framework Runtime Components are installed by default with Windows Vista. Therefore you may not need this amount of available disk space.

PXIe System

PXI system/ host controller	A PXI or PXI Express embedded controller or PC host controller is required.
-----------------------------	---

Power the controller

- If you are using a desktop, laptop, or rack mount PC as remote controller:
 - 1 Install any peripheral devices in the PC (e.g., PCIe Interface adapters, etc.). Follow the manufacturers instructions.
 - 2 Power up the controller. Do not apply power to the PXI chassis yet.
 - 3 Choose the default option for any “Found Hardware” dialogs.
- If you are using a PXI embedded computer as the host computer:
 - 1 Install the embedded computer module into the PXI chassis following the manufacturers instructions.
 - 2 Connect peripherals such as a mouse, keyboard, monitor, CD drive, etc.
 - 3 Power up the chassis.
 - 4 Choose the default option for any “Found Hardware” dialogs

Install Keysight IO Libraries Suite

Keysight IO Libraries Suite 16.0 (or later) is required for the PXI modules. It includes the Keysight Connection Expert, the IVI Shared Components, and the VISA Shared Components.

NOTE

Keysight IO Libraries version 16.0 (or later) must be installed prior to installing and running any other software and prior to powering the chassis. The latest version can be downloaded from:
www.keysight.com/find/iosuite.

- 1 Insert the *Automation-Ready CD with Keysight IO Libraries Suite* into the CD-ROM drive of your system controller. Wait a few seconds for the auto-run window to appear. If the auto-run window does not appear automatically:
 - Click **Start > Run...**
 - Type: `<drive>:Autorun\IOLibraries.hta`
 where `<drive>` is your CD drive letter.
- 2 Follow the installation instructions that came with the IO Libraries Suite.

NOTE

If the **IVI Shared Components** and **VISA Shared Components** are not already installed on your PC, Keysight IO Libraries Suite installs them in the default locations. If they are already installed, the installer upgrades them to the latest version, using the same location used by the older version. If this is a first-time installation, you can select installation locations for these components by choosing a Custom Installation.

Install instrument drivers

- 1 Insert the *Switch Module Software and Product Information* CD into the CD-ROM drive of your PC.

Wait a few seconds for the auto-run window to appear. If the auto-run window does not appear automatically:

- Click Start > Run...
 - Type: <drive>:Autorun.exe where <drive> is your CD drive letter.
- 2 Select the **Install** Software link. Follow the installer prompts. Accept all of the default directories specified during installation if prompted.
 - 3 After the Welcome screen, you will be prompted three times for license agreements. The software installer installs the following drivers:
 - Keysight Modular Software License Agreement. The installer program installs the Soft Front Panel (SFP) application and other object code to connect to the switches. Accept the license terms and click Next.
 - Keysight IVI Driver Source Code License Agreement. The Interchangeable Virtual Instrument (IVI) driver is available for programming the Keysight switch modules using Microsoft development environments (e.g., Visual Studio, C, C++, C#, Visual Basic), Keysight VEE, MATLAB, or National Instruments LabVIEW. Accept the license terms and click Next.
 - Keysight Software License Agreement for drivers for use with LabVIEW Software. The LabVIEW driver provides access to the functionality of the switches through LabVIEW VIs. This driver works in National Instruments LabVIEW development environments. Before this driver can be installed, your computer must already have the IVI Shared Components installed. Accept the license terms and click Next.

NOTE

Installing Keysight IO Libraries also installs the IVI Shared Components. The IVI Shared Components are required before IVI drivers (e.g., IVI-COM, IVI-C) can be installed from the product reference CD.

- 4 Next, the installer indicates the LabVIEW installations found on your host computer. Click Next
- 5 After accepting the licenses, the driver software is ready to be installed on your host computer. Click Install.
- 6 When the installation wizard is finished, you will be prompted to reboot your host computer. Do not reboot the host computer at this time! Select **“No, I will restart my computer later.”** Power down the host computer. Proceed to **“Step 4. Connect the PC to the PXI Chassis”** on the next page.

Step 4. Connect the PC to the PXI Chassis

NOTE

To ensure proper system operation and the PC's ability to enumerate all of the PXI modules, you must use an approved embedded PC, desktop PC, or laptop PC along with approved PCIe adaptor and cable.

Using a remote PC

Refer to the following figure. Make certain that both the PC and the PXI chassis are turned off. Unplug the chassis from the ac power mains. If you are using the M9018A 18 Slot PXIe chassis, install the Keysight M9021A PCIe Cable Interface module in the chassis.

- If you are using a desktop or rack mount PC, install the M9047 PCIe Desktop Adapter in the PC. With a Keysight Y1202A cable, connect the adapter to the System Interface module.
- If you are using a laptop PC, install the M9045 PCIe ExpressCard Adapter in the laptop. With a Keysight Y1200A cable, connect the adapter to the System Interface module.

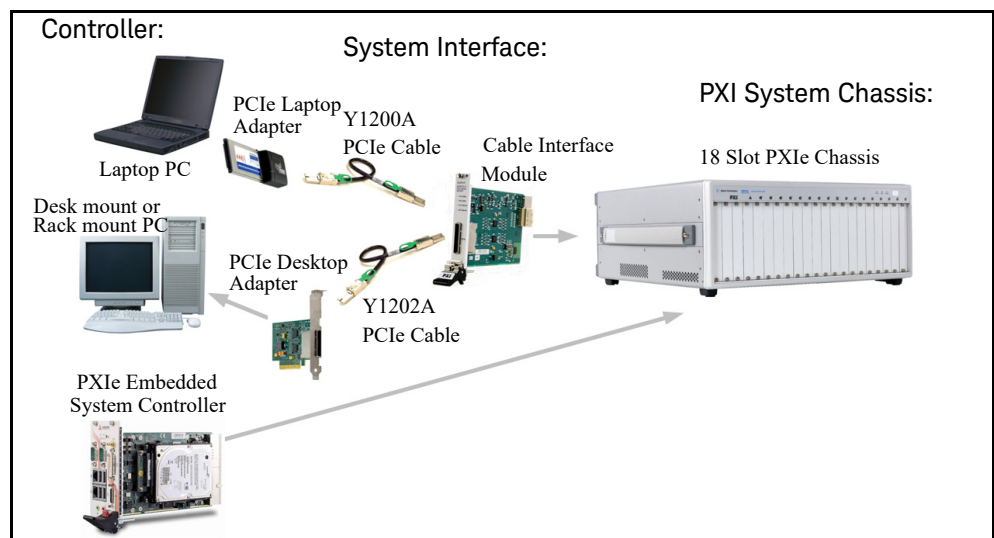

Using an embedded computer

Refer to the figure above. If you are using an embedded controller in the PXI chassis, you should have installed it prior to installing the Keysight IO Libraries and instrument drivers. No cables or other adapters are required. After installation, proceed to **“Step 5: Install the Switch Modules in the PXI Chassis”**

Step 5: Install the Switch Modules in the PXI Chassis

WARNING

- PXI hardware does not support “hot-swap” capabilities (changing modules while power is applied to the chassis).
- Before installing or removing Keysight PXI Modules, the chassis must be powered off to prevent damage to the PXI module. Remove all cables/terminal blocks from the module prior to installing or removing the module.

NOTE

These modules can be used in a chassis with a cPCI, PXI-1, or PXIh chassis peripheral slot.

3

The modules can be installed in any standard PXI slot marked with a peripheral slot compatibility image (a circle containing the slot number).

7^H

The modules can also be installed in any hybrid PXI slot marked with a peripheral slot compatibility image (the letter “H” and a solid circle containing the slot number).

- 1 Make sure the PXI chassis power is turned off.
- 2 If the chassis has multiple fan speed settings, ensure that the fans are set to automatic. Do not set the fan speed to low or turn them off.
- 3 Position the chassis with ample space between the chassis fan intake and exhaust vents. Blockage by walls or obstructions affects the air flow needed for cooling. (Refer to the chassis documentation for cooling information).
- 4 The modules are shipped with thread protectors over the mounting screws. These must be removed before installing the modules in a chassis.
- 5 Holding the PXI module by the injector/ejector handle, slide it into an available PXI (or hybrid) slot, as shown in the following figure.
 - Install the module in the PXI slot by placing the module card edges into the front module guides (top and bottom).
 - Slide the module to the rear of the chassis and assure that the injector/ejector handle is pushed down in the unlatched (downward) position.
 - Slide the module completely into the chassis. When you begin to feel resistance, push up on the injector/ejector handle to fully seat the module into the chassis.

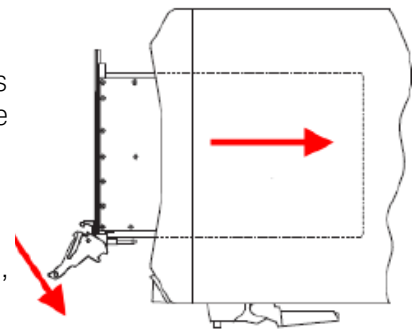

- 6 Latch the module by pulling up on the injector/ejector handle and secure the front panel to the chassis using the module mounting screws.
- 7 Tighten the screws on the module (or remote controller) front panel. Performance may suffer if the screws are not securely tightened.
- 8 Install all chassis covers, filler panels, and air inlet modules after installing the module. Missing filler panels may disrupt necessary air circulation in the chassis.
- 9 If you are using a remote controller, connect the System Interface Card in the chassis to the host computer.
- 10 Plug in and power up the PXI chassis. Verify that the chassis fans are operating and free of obstructions that may restrict airflow.

CAUTION

If you are using a remote controller linked to the M9021A Cable Interface, you must Shut Down the PC BEFORE you power down the chassis. When you restore power, you must power up the chassis BEFORE you power up the PC.

NOTE

If you are using MXI-3 to connect a desktop PC to a PXI chassis or link to multiple chassis, power up the system as follows:

- For a system with a PC and one chassis, power up the chassis before powering the PC.
 - For a system with more than one chassis, power on the last chassis in the system followed by the penultimate, etc. Finally, turn on the PC or chassis containing the system controller.
-

- 11 If you are using a remote host computer (rack mount, desktop, or laptop PC), power-on the computer. Choose the default option for any “Found New Hardware” dialogs.

NOTE

After all of the “Found New Hardware” dialogs are complete, you must reboot the host computer.

Chassis Power Down Process

CAUTION

If you are using a remote controller linked to the M9021A Cable Interface, you must Shut Down the PC BEFORE you power down the chassis. When you restore power, you must power up the chassis BEFORE you power up the PC.

Step 6. Verify Operation of the Module

Run Keysight IO Libraries Connection Expert

If Keysight Connection Expert is already running on the system controller, click the **Refresh All** button to identify any hardware you have just installed or re-connected.

If Connection Expert is not already running, run it now to verify your I/O configuration. In the Windows Notification Area, click the IO icon (), then click Keysight Connection Expert.

Locate your interfaces and instruments in the Keysight Connection Expert Explorer Pane. The following graphic shows the Connection Expert screen.

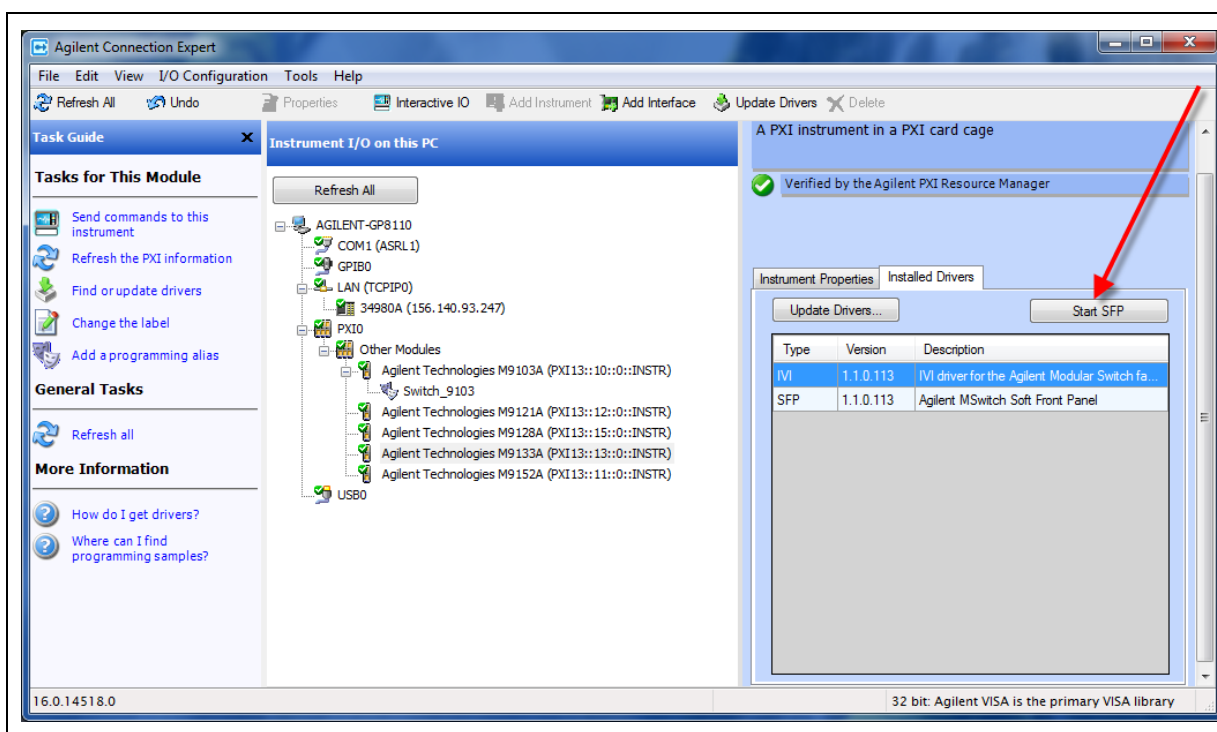

Select a module in the center pane (Instrument I/O on this PC). The right-hand Pane shows the instrument properties. Select the **Installed Drivers** tab then click the **Start SFP** button.

You can use the Soft Front Panel (SFP) software to open and close the relays and verify operation of the switch modules. The Soft Front Panel Software was installed as part of the Software installation process.

Refer to the SFP help file on the *Switch Module Software and Product Information CD* for specific detailed information on the SFP. In the Soft Front Panel interface, when you mouse over a specific channel or matrix crosspoint the cursor changes to the hand cursor, and a popup tool-tip shows the channel number as shown in the following graphic. The following graphic shows an example of the SFP for the M9101A Multiplexer module; it shows channel 36 and the isolation relay closed.

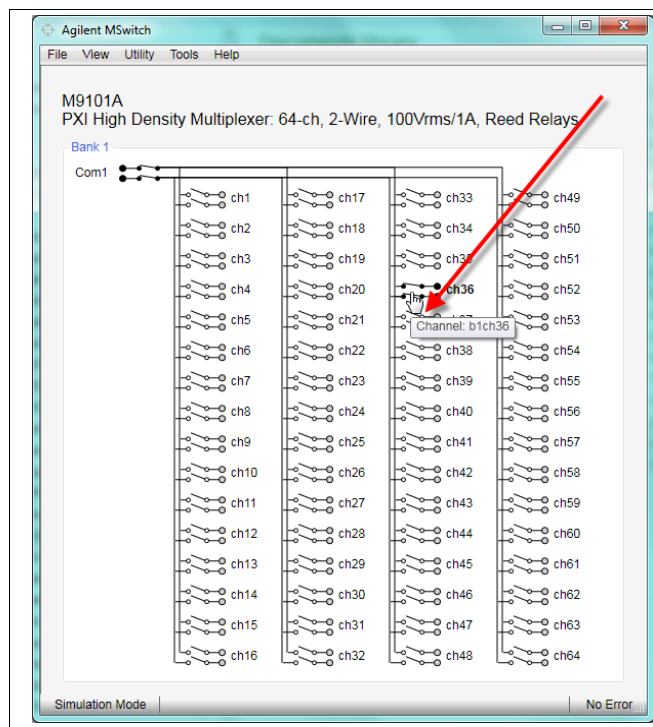

Beginning with SFP Version 1.1.x, if you have another application, either your own program or another instance of the SFP interface, that has initialized the switch module, then the SFP enters its “monitor” mode. In this mode, you cannot change relay state and the menu buttons are grayed-out. However, as the other application controls the channels, the SFP interface monitors and displays the state of the individual relays. Refer to the SFP help file for additional information.

Verify operation

There are no specific operational verification or self test procedures. However, you can use the Soft Front Panel software to open and close individual channels. Module specifications are guaranteed by design.

Characteristics

For detailed module characteristics and specifications, refer to the module Data Sheet on the *Switch Module Software and Product Information CD* or the Switch data sheet online at www.keysight.com/find/pxiswitch.

NOTE

Switch modules are considered a “wear-out” item. It is normal for relay performance to degrade over time; life expectancy depends on the specific application and use model. Hot-switching of relays decreases useful life more rapidly than no-load switching. Refer to the product data sheet for approximate lifetimes under different loads. Premature wear-out due to application requirements and damage due to accidental over-current or over-voltage conditions are not covered by product warranty.

Default Path Settings

The table below lists the default or power down state for the matrix and multiplexer modules. This default switch path is also shown in the following diagrams.

Switch Model	Default Path
M9101A 64-channel Multiplexer	Isolation switch and all channels are open
M9102A 128-channel Multiplexer	Isolation switch and all channels are open
M9103A 99-channel Multiplexer	Isolation switch and all channels are open
M9120A 4x34 Matrix Switch	All cross point relays are open
M9121A 4x64 Matrix Switch	All cross point relays are open
M9122A 8x32 Matrix Switch	All cross point relays are open

Module Functional Description

The Keysight PXI Matrix and Multiplexer switch modules conform to the single slot, 3U form factor (100mm by 160mm / 3.94 in. by 6.3 in.) Eurocard standard. These modules meet PXI Specification 2.2. Local bus, trigger bus, and star trigger are not included. The modules also include:

- CPCI Ejector Handle
- Front panel connectors, either 50-pin, 78-pin, or 200-pin D-type connector depending on the module.,
- The front panel secures to the chassis by two M2.5 x 6mm pan-head Posi-drive screws.

Figure 1 shows a functional block diagram for the switch modules. The PCI connector (J1) provides +3.3Vdc (not all modules use this supply), +5Vdc, +12Vdc, ground, as well as the control signals from the chassis backplane. The relay drivers are activated by the PCI Bridge (U1) via output registers.

There are no user serviceable or field replaceable components on these modules.

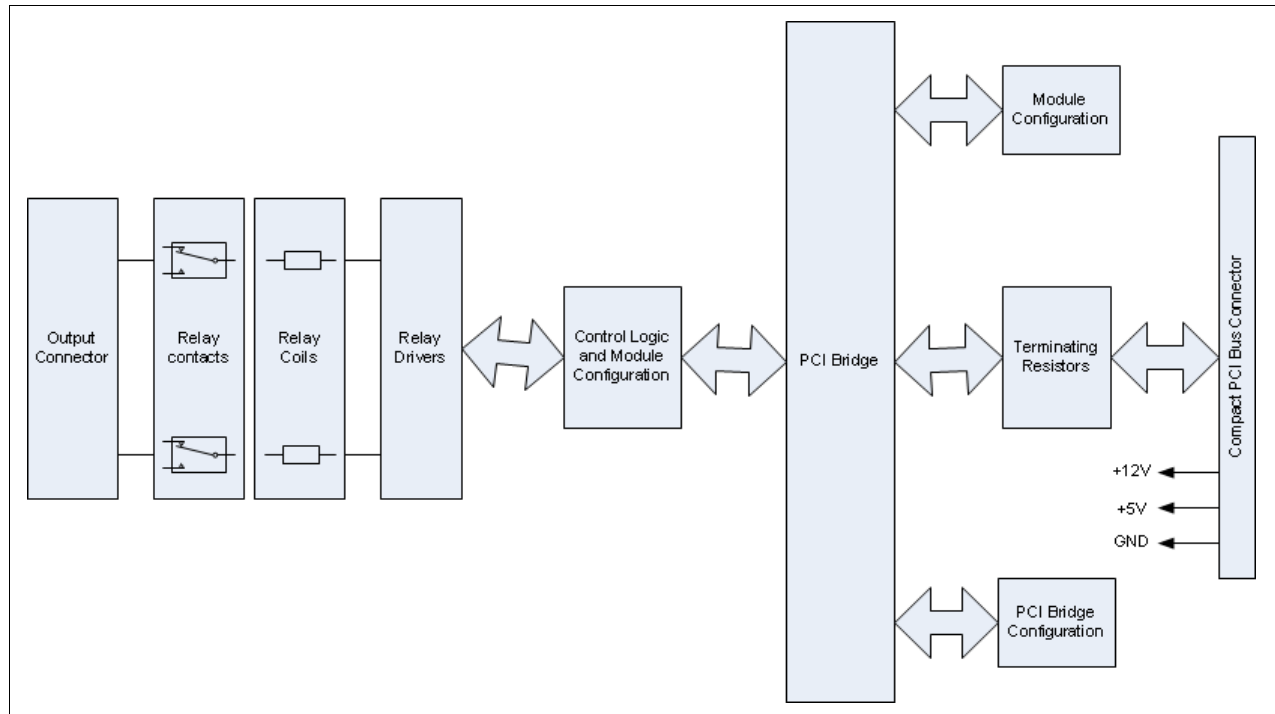

Figure 1 PXI Matrix and Multiplexer Switch Module Functional Block Diagram

Module Programming

Refer to the Soft Front Panel help file for detailed operation of the module. For programming information, refer to the IVI C and LabVIEW driver help files. These help files are located on the *Switch Module Software and Product Information* CD.

Many methods in the IviSwTch interfaces accept a channel string parameter. The channel names supported by the AgMSwitch driver depend upon the specific switch module to which the driver is connected.

Identifying Channel Numbers

In the Soft Front Panel interface, when you mouse over a specific channel or matrix crosspoint the cursor changes to the hand cursor, and a popup tool-tip shows the Instrument Specific Syntax for the channel number as shown in the following graphics. The Instrument Specific Syntax for channel numbers are used by the IVI and LabVIEW driver open/close commands.

The following graphics show the Soft Front Panel interface and illustrate the channel numbering scheme for multiplexer and matrix modules.

For the multiplexer modules, the Instrument Specific Syntax for channel numbers are in the form: $bnchn$ where bn is the bank number (generally '1') and chn is the channel number. For example, `RouteCloseChannel("b1ch36")` closes the relay that connects channel 36 to the common. Previously closed channels are automatically opened. See the following graphic:

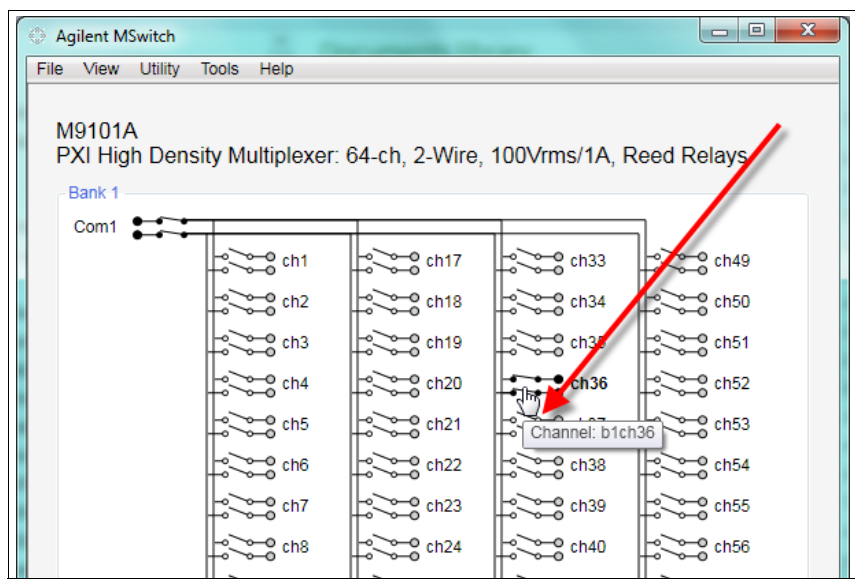

For the matrix modules, the Instrument Specific Syntax for channel numbers are in the form: $mnrncn$ where m indicates a matrix module, rn is the row and cn is the column. For example, `RouteCloseChannel("m1r2c12")` closes the relays to connect row 2 to column 12 of matrix 1. See the following graphic of the M9120A with crosspoint R2C12 closed:

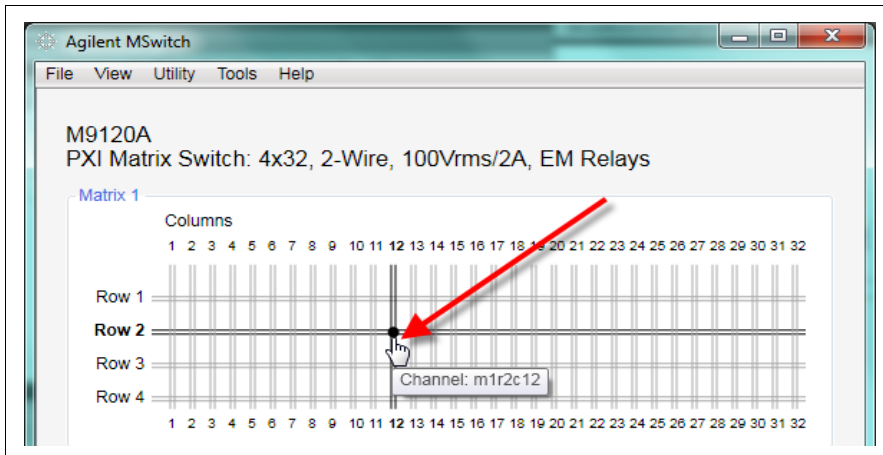

Module Front Panel Connectors And System Connections

The following pages show the topology diagrams, front panels and connector pin outs for the individual PXI matrix and multiplexer modules.

M9101A PXI Multiplexer Module: 64-Channel, 2 Wire

Keysight’s M9101A high density multiplexer module operates as a conventional multiplexer module with break-before-make action.

An isolation switch connects the closed channel to the module COMmon. This allows for minimum capacitive loading and leakage currents in large multiplexer systems. Larger multiplexers may be constructed by daisy- chaining the COMmon connections on multiple PXI cards.

Relays on this module are Ruthenium sputtered reed relays. Front panel connections are through a high density 200 pin Low Force Helix (LFH) connector.

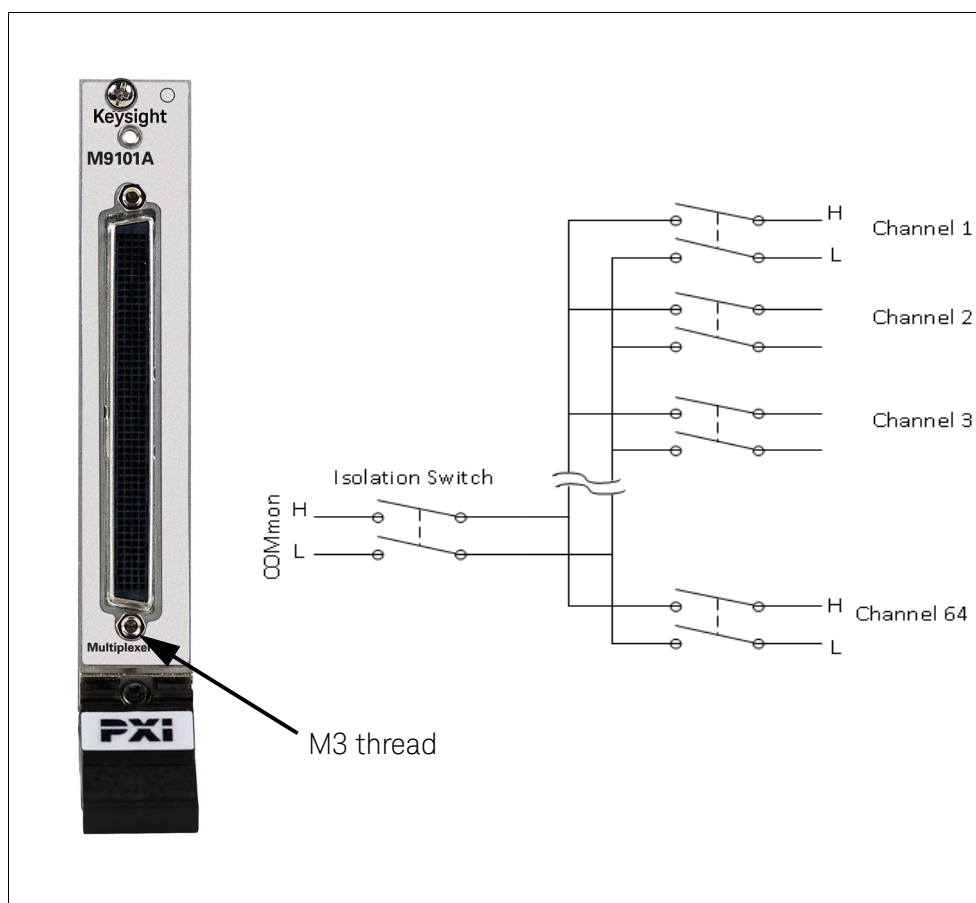
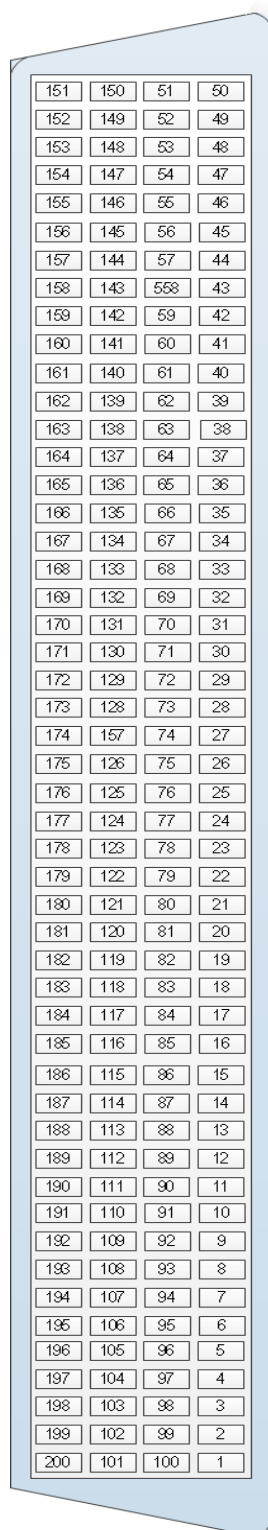

Figure 2 M9101A Front Panel and Simplified Schematic

M9101A Connector Pinout Figure 3 and the associated table show the front panel 200 pin D female connector (viewed from the front panel) and pin connections. Table 1 on page 26 lists the channel connections on the connector.



Pin No.	Channel	Pin No.	Channel	Pin No.	Channel	Pin No.	Channel
151	Ch 4 H	150	Ch 3 H	51	Ch 2 H	50	Ch 1 H
152	Ch 4 L	149	Ch 3 L	52	Ch 2 L	49	Ch 1 L
153	Ch 8 H	148	Ch 7 H	53	Ch 6 H	48	Ch 5 H
154	Ch 8 L	147	Ch 7 L	54	Ch 6 L	47	Ch 5 L
155	Ch 12 H	146	Ch 11 H	55	Ch 10 H	46	Ch 9 H
156	Ch 12 L	145	Ch 11 L	56	Ch 10 L	45	Ch 9 L
157	Ch 16 H	144	Ch 15 H	57	Ch 14 H	44	Ch 13 H
158	Ch 16 L	143	Ch 15 L	58	Ch 14 L	43	Ch 13 L
159	Ch 20 H	142	Ch 19 H	59	Ch 18 H	42	Ch 17 H
160	Ch 20 L	141	Ch 19 L	60	Ch 18 L	41	Ch 17 L
161	Ch 24 H	140	Ch 23 H	61	Ch 22 H	40	Ch 21 H
162	Ch 24 L	139	Ch 23 L	62	Ch 22 L	39	Ch 21 L
163	Ch 28 H	138	Ch 27 H	63	Ch 26 H	38	Ch 25 H
164	Ch 28 L	137	Ch 27 L	64	Ch 26 L	37	Ch 25 L
165	Ch 32 H	136	Ch 31 H	65	Ch 30 H	36	Ch 29 H
166	Ch 32 L	135	Ch 31 L	66	Ch 30 L	35	Ch 29 L
167	Ch 36 H	134	Ch 35 H	67	Ch 34 H	34	Ch 33 H
168	Ch 36 L	133	Ch 35 L	68	Ch 34 L	33	Ch 33 L
169	Ch 40 H	132	Ch 39 H	69	Ch 38 H	32	Ch 37 H
170	Ch 40 L	131	Ch 39 L	70	Ch 38 L	31	Ch 37 L
171	Ch 44 H	130	Ch 43 H	71	Ch 42 H	30	Ch 41 H
172	Ch 44 L	129	Ch 43 L	72	Ch 42 L	29	Ch 41 L
173	Ch 48 H	128	Ch 47 H	73	Ch 46 H	28	Ch 45 H
174	Ch 48 L	127	Ch 47 L	74	Ch 46 L	27	Ch 45 L
175	Ch 52 H	126	Ch 51 H	75	Ch 50 H	26	Ch 49 H
176	Ch 52 L	125	Ch 51 L	76	Ch 50 L	25	Ch 49 L
177	Ch 56 H	124	Ch 55 H	77	Ch 54 H	24	Ch 53 H
178	Ch 56 L	123	Ch 55 L	78	Ch 54 L	23	Ch 53 L
179	Ch 60 H	122	Ch 59 H	79	Ch 58 H	22	Ch 57 H
180	Ch 60 L	121	Ch 59 L	80	Ch 58 L	21	Ch 57 L
181	Ch 64 H	120	Ch 63 H	81	Ch 62 H	20	Ch 61 H
182	Ch 64 L	119	Ch 63 L	82	Ch 62 L	19	Ch 61 L
183	--	118	--	83	--	18	--
184	--	117	--	84	--	17	--
185	--	116	--	85	--	16	--
186	--	115	--	86	--	15	--
187	--	114	--	87	--	14	--
188	--	113	--	88	--	13	--
189	--	112	--	89	--	12	--
190	--	111	--	90	--	11	--
191	--	110	--	91	--	10	--
192	--	109	--	92	--	9	--
193	--	108	--	93	--	8	--
194	--	107	--	94	--	7	--
195	--	106	--	95	--	6	--
196	--	105	--	96	--	5	--
197	--	104	--	97	--	4	--
198	--	103	--	98	--	3	--
199	COM H	102	--	99	--	2	--
200	COM L	101	--	100	--	1	--

Figure 3 M9101A Connector (viewed from the front panel) and Pinout

Channel	Pin No.	Channel	Pin No.	Channel	Pin No.	Channel	Pin No.
Com H	199	Com L	200				
Ch 1 H	50	CH 17 H	42	CH 33 H	34	CH 49 H	26
Ch 1 L	49	CH 17 L	41	CH 33 L	33	CH 49 L	25
Ch 2 H	51	CH 18 H	59	CH 34 H	67	CH 50 H	75
Ch 2 L	52	CH 18 L	60	CH 34 L	68	CH 50 L	76
Ch 3 H	150	CH 19 H	142	CH 35 H	134	CH 51 H	126
Ch 3 L	149	CH 19 L	141	CH 35 L	133	CH 51 L	125
Ch 4 H	151	CH 20 H	159	CH 36 H	167	CH 52 H	175
Ch 4 L	152	CH 20 L	160	CH 36 L	168	CH 52 L	176
Ch 5 H	48	CH 21 H	40	CH 37 H	32	CH 53 H	24
Ch 5 L	47	CH 21 L	39	CH 37 L	31	CH 53 L	23
Ch 6 H	53	CH 22 H	61	CH 38 H	69	CH 54 H	77
Ch 6 L	54	CH 22 L	62	CH 38 L	70	CH 54 L	78
Ch 7 H	148	CH 23 H	140	CH 39 H	132	CH 55 H	124
Ch 7 L	147	CH 23 L	139	CH 39 L	131	CH 55 L	123
Ch 8 H	153	CH 24 H	161	CH 40 H	169	CH 56 H	177
Ch 8 L	154	CH 24 L	162	CH 40 L	170	CH 56 L	178
Ch 9 H	46	CH 25 H	38	CH 41 H	30	CH 57 H	22
Ch 9 L	45	CH 25 L	37	CH 41 L	29	CH 57 L	21
Ch 10 H	55	CH 26 H	63	CH 42 H	71	CH 58 H	79
Ch 10 L	56	CH 26 L	64	CH 42 L	72	CH 58 L	80
Ch 11 H	146	CH 27 H	138	CH 43 H	130	CH 59 H	122
Ch 11 L	145	CH 27 L	137	CH 43 L	129	CH 59 L	121
Ch 12 H	155	CH 28 H	163	CH 44 H	171	CH 60 H	179
Ch 12 L	156	CH 28 L	164	CH 44 L	172	CH 60 L	180
Ch 13 H	44	CH 29 H	36	CH 45 H	28	CH 61 H	20
Ch 13 L	43	CH 29 L	35	CH 45 L	27	CH 61 L	19
Ch 14 H	57	CH 30 H	65	CH 46 H	73	CH 62 H	81
Ch 14 L	58	CH 30 L	66	CH 46 L	74	CH 62 L	82
Ch 15 H	144	CH 31 H	136	CH 47 H	128	CH 63 H	120
Ch 15 L	143	CH 31 L	135	CH 47 L	127	CH 63 L	119
Ch 16 H	157	CH 32 H	165	CH 48 H	173	CH 64 H	181
Ch 16 L	158	CH 32 L	166	CH 48 L	174	CH 64 L	182
Pins not used: 1 - 18, 83 - 100, 101-118, 183 - 198							

Table 1 M9101A Channel Number to Connector Pin Out

M9102A PXI Multiplexer Module:128-Channel, 1 Wire

Keysight’s M9102A high density multiplexer module operates as a conventional multiplexer module with break-before-make action.

An isolation switch connects the closed channel to the module COMmon. This allows for minimum capacitive loading and leakage currents in large multiplexer systems. Larger multiplexers may be constructed by daisy- chaining the COMmon connections on multiple PXI cards.

Relays on this module are Ruthenium sputtered reed relays. Front panel connections are through a high density 200 pin Low Force Helix (LFH) connector.

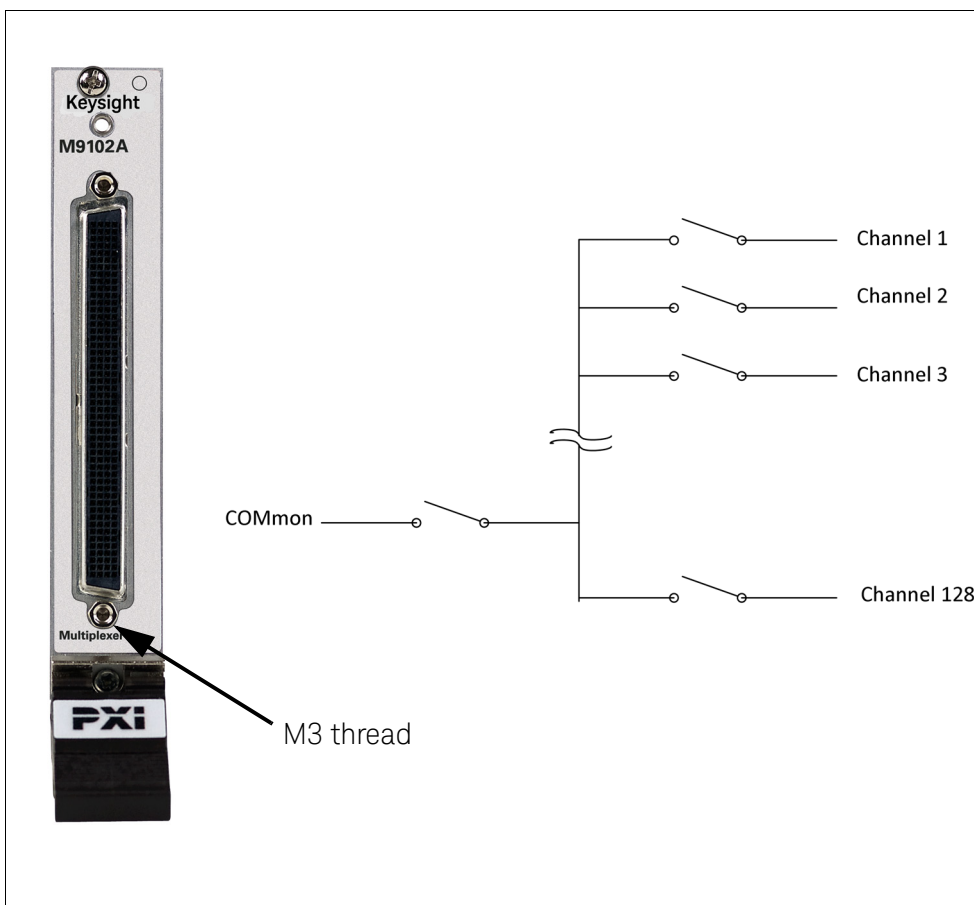
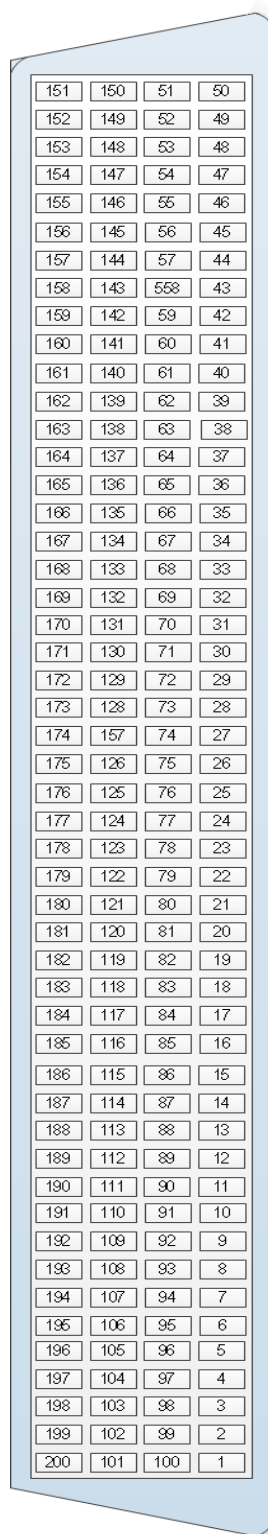

Figure 4 M9102A Front Panel and Simplified Schematic

M9102A Connector Pinout Figure 5 and the associated table show the front panel 200 pin D female connector (viewed from the front panel) and pin connections. Table 2 on page 29 lists the channel connections on the connector.



Pin No.	Channel	Pin No.	Channel	Pin No.	Channel	Pin No.	Channel
151	Ch 7	150	Ch 5	51	Ch 3	50	Ch 1
152	Ch 8	149	Ch 6	52	Ch 4	49	Ch 2
153	Ch 15	148	Ch 13	53	Ch 11	48	Ch 9
154	Ch 16	147	Ch 14	54	Ch 12	47	Ch 10
155	Ch 23	146	Ch 21	55	Ch 19	46	Ch 17
156	Ch 24	145	Ch 22	56	Ch 20	45	Ch 18
157	Ch 31	144	Ch 29	57	Ch 27	44	Ch 25
158	Ch 32	143	Ch 30	58	Ch 28	43	Ch 26
159	Ch 39	142	Ch 37	59	Ch 35	42	Ch 33
160	Ch 40	141	Ch 38	60	Ch 36	41	Ch 34
161	Ch 47	140	Ch 45	61	Ch 43	40	Ch 41
162	Ch 48	139	Ch 46	62	Ch 44	39	Ch 42
163	Ch 55	138	Ch 53	63	Ch 51	38	Ch 49
164	Ch 56	137	Ch 54	64	Ch 52	37	Ch 50
165	Ch 63	136	Ch 61	65	Ch 59	36	Ch 57
166	Ch 64	135	Ch 62	66	Ch 60	35	Ch 58
167	Ch 71	134	Ch 69	67	Ch 67	34	Ch 65
168	Ch 72	133	Ch 70	68	Ch 68	33	Ch 66
169	Ch 79	132	Ch 77	69	Ch 75	32	Ch 73
170	Ch 80	131	Ch 78	70	Ch 76	31	Ch 74
171	Ch 87	130	Ch 85	71	Ch 83	30	Ch 81
172	Ch 88	129	Ch 86	72	Ch 84	29	Ch 82
173	Ch 95	128	Ch 93	73	Ch 91	28	Ch 89
174	Ch 96	127	Ch 94	74	Ch 92	27	Ch 90
175	Ch 103	126	Ch 101	75	Ch 99	26	Ch 97
176	Ch 104	125	Ch 102	76	Ch 100	25	Ch 98
177	Ch 111	124	Ch 109	77	Ch 107	24	Ch 105
178	Ch 112	123	Ch 110	78	Ch 108	23	Ch 106
179	Ch 119	122	Ch 117	79	Ch 115	22	Ch 113
180	Ch 120	121	Ch 118	80	Ch 116	21	Ch 114
181	Ch 127	120	Ch 125	81	Ch 123	20	Ch 121
182	Ch 128	119	Ch 126	82	Ch 124	19	Ch 122
183	--	118	--	83	--	18	--
184	--	117	--	84	--	17	--
185	--	116	--	85	--	16	--
186	--	115	--	86	--	15	--
187	--	114	--	87	--	14	--
188	--	113	--	88	--	13	--
189	--	112	--	89	--	12	--
190	--	111	--	90	--	11	--
191	--	110	--	91	--	10	--
192	--	109	--	92	--	9	--
193	--	108	--	93	--	8	--
194	--	107	--	94	--	7	--
195	--	106	--	95	--	6	--
196	--	105	--	96	--	5	--
197	--	104	--	97	--	4	--
198	--	103	--	98	--	3	--
199	COMmon	102	--	99	--	2	--
200	--	101	--	100	--	1	--

Figure 5 M9102A Connector (viewed from the front panel) and Pinout

Channel Pin No.							
COMmon 199							
Channel	Pin No.	Channel	Pin No.	Channel	Pin No.	Channel	Pin No.
Ch 1	50	Ch 33	42	Ch 65	34	Ch 97	26
Ch 2	49	Ch 34	41	Ch 66	33	Ch 98	25
Ch 3	51	Ch 35	59	Ch 67	67	Ch 99	75
Ch 4	52	Ch 36	60	Ch 68	68	Ch 100	76
Ch 5	150	Ch 37	142	Ch 69	134	Ch 101	126
Ch 6	149	Ch 38	141	Ch 70	133	Ch 102	125
Ch 7	151	Ch 39	159	Ch 71	167	Ch 103	175
Ch 8	152	Ch 40	160	Ch 72	168	Ch 104	176
Ch 9	48	Ch 41	40	Ch 73	32	Ch 105	24
Ch 10	47	Ch 42	39	Ch 74	31	Ch 106	23
Ch 11	53	Ch 43	61	Ch 75	69	Ch 107	77
Ch 12	54	Ch 44	62	Ch 76	70	Ch 108	78
Ch 13	148	Ch 45	140	Ch 77	132	Ch 109	124
Ch 14	147	Ch 46	139	Ch 78	131	Ch 110	123
Ch 15	153	Ch 47	161	Ch 79	169	Ch 111	177
Ch 16	154	Ch 48	162	Ch 80	170	Ch 112	178
Ch 17	46	Ch 49	38	Ch 81	30	Ch 113	22
Ch 18	45	Ch 50	37	Ch 82	29	Ch 114	21
Ch 19	55	Ch 51	63	Ch 83	71	Ch 115	79
Ch 20	56	Ch 52	64	Ch 84	72	Ch 116	80
Ch 21	146	Ch 53	138	Ch 85	130	Ch 117	122
Ch 22	145	Ch 54	137	Ch 86	129	Ch 118	121
Ch 23	155	Ch 55	163	Ch 87	171	Ch 119	179
Ch 24	156	Ch 56	164	Ch 88	172	Ch 120	180
Ch 25	44	Ch 57	36	Ch 89	28	Ch 121	20
Ch 26	43	Ch 58	35	Ch 90	27	Ch 122	19
Ch 27	57	Ch 59	65	Ch 91	73	Ch 123	81
Ch 28	58	Ch 60	66	Ch 92	74	Ch 124	82
Ch 29	144	Ch 61	136	Ch 93	128	Ch 125	120
Ch 30	143	Ch 62	135	Ch 94	127	Ch 126	119
Ch 31	157	Ch 63	165	Ch 95	173	Ch 127	181
Ch 32	158	Ch 64	166	Ch 96	174	Ch 128	182
Pins not used: 1 - 18, 83 - 100, 101-118, 183 - 198, 200							

Table 2 M9102A Channel Number to Connector Pin Out

M9103A PXI Multiplexer: 99-Channel, 2 Wire

Keysight's M9103A high density multiplexer module operates as a conventional multiplexer module with break-before-make action. This module uses armature relays.

An isolation switch connects the closed channel(s) to the module COMmon. This allows for minimum capacitive loading and leakage currents in large multiplexer systems. Larger multiplexers may be constructed by daisy-chaining the COMmon connections on multiple PXI cards.

Relays on this module are Ruthenium sputtered reed relays. Front panel connections are through a high density 200 pin Low Force Helix (LFH) connector.

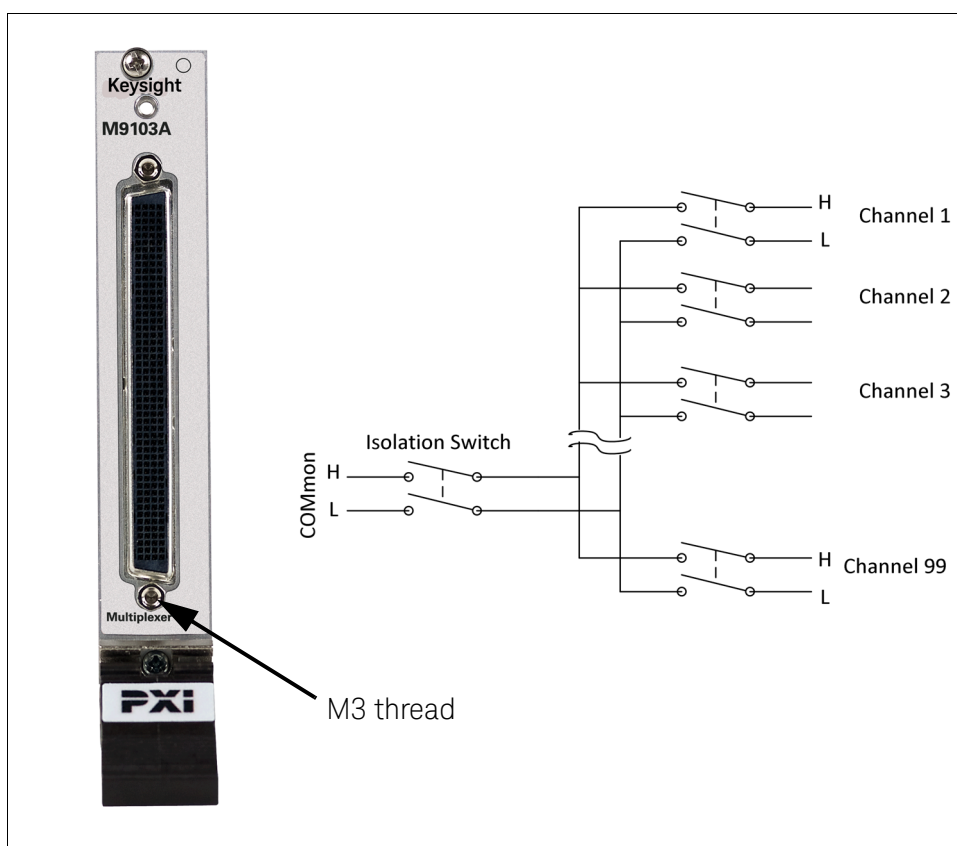

Figure 6 M9103A Front Panel and Simplified Schematic

M9103A Connector Pinout Figure 7 and the associated table show the front panel 200 pin D female connector (viewed from the front panel) and pin connections. Table 3 on page 32 lists the channel connections on the connector.

151	150	51	50
152	149	52	49
153	148	53	48
154	147	54	47
155	146	55	46
156	145	56	45
157	144	57	44
158	143	58	43
159	142	59	42
160	141	60	41
161	140	61	40
162	139	62	39
163	138	63	38
164	137	64	37
165	136	65	36
166	135	66	35
167	134	67	34
168	133	68	33
169	132	69	32
170	131	70	31
171	130	71	30
172	129	72	29
173	128	73	28
174	127	74	27
175	126	75	26
176	125	76	25
177	124	77	24
178	123	78	23
179	122	79	22
180	121	80	21
181	120	81	20
182	119	82	19
183	118	83	18
184	117	84	17
185	116	85	16
186	115	86	15
187	114	87	14
188	113	88	13
189	112	89	12
190	111	90	11
191	110	91	10
192	109	92	9
193	108	93	8
194	107	94	7
195	106	95	6
196	105	96	5
197	104	97	4
198	103	98	3
199	102	99	2
200	101	100	1

Pin No.	Channel	Pin No.	Channel	Pin No.	Channel	Pin No.	Channel
151	Ch 4 H	150	Ch 3 H	51	Ch 2 H	50	Ch 1 H
152	Ch 4 L	149	Ch 3 L	52	Ch 2 L	49	Ch 1 L
153	Ch 8 H	148	Ch 7 H	53	Ch 6 H	48	Ch 5 H
154	Ch 8 L	147	Ch 7 L	54	Ch 6 L	47	Ch 5 L
155	Ch 12 H	146	Ch 11 H	55	Ch 10 H	46	Ch 9 H
156	Ch 12 L	145	Ch 11 L	56	Ch 10 L	45	Ch 9 L
157	Ch 16 H	144	Ch 15 H	57	Ch 14 H	44	Ch 13 H
158	Ch 16 L	143	Ch 15 L	58	Ch 14 L	43	Ch 13 L
159	Ch 20 H	142	Ch 19 H	59	Ch 18 H	42	Ch 17 H
160	Ch 20 L	141	Ch 19 L	60	Ch 18 L	41	Ch 17 L
161	Ch 24 H	140	Ch 23 H	61	Ch 22 H	40	Ch 21 H
162	Ch 24 L	139	Ch 23 L	62	Ch 22 L	39	Ch 21 L
163	Ch 28 H	138	Ch 27 H	63	Ch 26 H	38	Ch 25 H
164	Ch 28 L	137	Ch 27 L	64	Ch 26 L	37	Ch 25 L
165	Ch 32 H	136	Ch 31 H	65	Ch 30 H	36	Ch 29 H
166	Ch 32 L	135	Ch 31 L	66	Ch 30 L	35	Ch 29 L
167	Ch 36 H	134	Ch 35 H	67	Ch 34 H	34	Ch 33 H
168	Ch 36 L	133	Ch 35 L	68	Ch 34 L	33	Ch 33 L
169	Ch 40 H	132	Ch 39 H	69	Ch 38 H	32	Ch 37 H
170	Ch 40 L	131	Ch 39 L	70	Ch 38 L	31	Ch 37 L
171	Ch 44 H	130	Ch 43 H	71	Ch 42 H	30	Ch 41 H
172	Ch 44 L	129	Ch 43 L	72	Ch 42 L	29	Ch 41 L
173	Ch 48 H	128	Ch 47 H	73	Ch 46 H	28	Ch 45 H
174	Ch 48 L	127	Ch 47 L	74	Ch 46 L	27	Ch 45 L
175	Ch 52 H	126	Ch 51 H	75	Ch 50 H	26	Ch 49 H
176	Ch 52 L	125	Ch 51 L	76	Ch 50 L	25	Ch 49 L
177	Ch 56 H	124	Ch 55 H	77	Ch 54 H	24	Ch 53 H
178	Ch 56 L	123	Ch 55 L	78	Ch 54 L	23	Ch 53 L
179	Ch 60 H	122	Ch 59 H	79	Ch 58 H	22	Ch 57 H
180	Ch 60 L	121	Ch 59 L	80	Ch 58 L	21	Ch 57 L
181	Ch 64 H	120	Ch 63 H	81	Ch 62 H	20	Ch 61 H
182	Ch 64 L	119	Ch 63 L	82	Ch 62 L	19	Ch 61 L
183	Ch 68 H	118	Ch 67 H	83	Ch 66 H	18	Ch 65 H
184	Ch 68 L	117	Ch 67 L	84	Ch 66 L	17	Ch 65 L
185	Ch 72 H	116	Ch 71 H	85	Ch 70 H	16	Ch 69 H
186	Ch 72 L	115	Ch 71 L	86	Ch 70 L	15	Ch 69 L
187	Ch 76 H	114	Ch 75 H	87	Ch 74 H	14	Ch 73 H
188	Ch 76 L	113	Ch 75 L	88	Ch 74 L	13	Ch 73 L
189	Ch 80 H	112	Ch 79 H	89	Ch 78 H	12	Ch 77 H
190	Ch 80 L	111	Ch 79 L	90	Ch 78 L	11	Ch 77 L
191	Ch 84 H	110	Ch 83 H	91	Ch 82 H	10	Ch 81 H
192	Ch 84 L	109	Ch 83 L	92	Ch 82 L	9	Ch 81 L
193	Ch 88 H	108	Ch 87 H	93	Ch 86 H	8	Ch 85 H
194	Ch 88 L	107	Ch 87 L	94	Ch 86 L	7	Ch 85 L
195	Ch 92 H	106	Ch 91 H	95	Ch 90 H	6	Ch 89 H
196	Ch 92 L	105	Ch 91 L	96	Ch 90 L	5	Ch 89 L
197	Ch 96 H	104	Ch 95 H	97	Ch 94 H	4	Ch 93 H
198	Ch 96 L	103	Ch 95 L	98	Ch 94 L	3	Ch 93 L
199	COM H	102	Ch 99 H	99	Ch 98 H	2	Ch 97 H
200	COM L	101	Ch 99 L	100	CH 98 L	1	Ch 97 L

Figure 7 M9103A Connector (viewed from the front panel) and Pin Out

Channel	Pin No.	Channel	Pin No.	Channel	Pin No.	Channel	Pin No.
COM H	199	COM L	200				
Ch 1 H	50	CH 26 H	63	CH 51 H	126	CH 76 H	187
Ch 1 L	49	CH 26 L	64	CH 51 L	125	CH 76 L	188
Ch 2 H	51	CH 27 H	138	CH 52 H	175	CH 77 H	12
Ch 2 L	52	CH 27 L	137	CH 52 L	176	CH 77 L	11
Ch 3 H	150	CH 28 H	163	CH 53 H	24	CH 78 H	89
Ch 3 L	149	CH 28 L	164	CH 53 L	23	CH 78 L	90
Ch 4 H	151	CH 29 H	36	CH 54 H	77	CH 79 H	112
Ch 4 L	152	CH 29 L	35	CH 54 L	78	CH 79 L	111
Ch 5 H	48	CH 30 H	65	CH 55 H	124	CH 80 H	189
Ch 5 L	47	CH 30 L	66	CH 55 L	123	CH 80 L	190
Ch 6 H	53	CH 31 H	136	CH 56 H	177	CH 81 H	10
Ch 6 L	54	CH 31 L	135	CH 56 L	178	CH 81 L	9
Ch 7 H	148	CH 32 H	165	CH 57 H	22	CH 82 H	91
Ch 7 L	147	CH 32 L	166	CH 57 L	21	CH 82 L	92
Ch 8 H	153	CH 33 H	34	CH 58 H	79	CH 83 H	110
Ch 8 L	154	CH 33 L	33	CH 58 L	80	CH 83 L	109
Ch 9 H	46	CH 34 H	67	CH 59 H	122	CH 84 H	191
Ch 9 L	45	CH 34 L	68	CH 59 L	121	CH 84 L	192
Ch 10 H	55	CH 35 H	134	CH 60 H	179	CH 85 H	8
Ch 10 L	56	CH 35 L	133	CH 60 L	180	CH 85 L	7
Ch 11 H	146	CH 36 H	167	CH 61 H	20	CH 86 H	93
Ch 11 L	145	CH 36 L	168	CH 61 L	19	CH 86 L	94
Ch 12 H	155	CH 37 H	32	CH 62 H	81	CH 87 H	108
Ch 12 L	156	CH 37 L	31	CH 62 L	82	CH 87 L	107
Ch 13 H	44	CH 38 H	69	CH 63 H	120	CH 88 H	193
Ch 13 L	43	CH 38 L	70	CH 63 L	119	CH 88 L	194
Ch 14 H	57	CH 39 H	132	CH 64 H	181	CH 89 H	6
Ch 14 L	58	CH 39 L	131	CH 64 L	182	CH 89 L	5
Ch 15 H	144	CH 40 H	169	CH 65 H	18	CH 90 H	95
Ch 15 L	143	CH 40 L	170	CH 65 L	17	CH 90 L	96
Ch 16 H	157	CH 41 H	30	CH 66 H	83	CH 91 H	106
Ch 16 L	158	CH 41 L	29	CH 66 L	84	CH 91 L	105
CH 17 H	42	CH 42 H	71	CH 67 H	118	CH 92 H	195
CH 17 L	41	CH 42 L	72	CH 67 L	117	CH 92 L	196
CH 18 H	59	CH 43 H	130	CH 68 H	183	CH 93 H	4
CH 18 L	60	CH 43 L	129	CH 68 L	184	CH 93 L	3
CH 19 H	142	CH 44 H	171	CH 69 H	16	CH 94 H	97
CH 19 L	141	CH 44 L	172	CH 69 L	15	CH 94 L	98
CH 20 H	159	CH 45 H	28	CH 70 H	85	CH 95 H	104
CH 20 L	160	CH 45 L	27	CH 70 L	86	CH 95 L	103
CH 21 H	40	CH 46 H	73	CH 71 H	116	CH 96 H	197
CH 21 L	39	CH 46 L	74	CH 71 L	115	CH 96 L	198
CH 22 H	61	CH 47 H	128	CH 72 H	185	CH 97 H	2
CH 22 L	62	CH 47 L	127	CH 72 L	186	CH 97 L	1
CH 23 H	140	CH 48 H	173	CH 73 H	14	CH 98 H	99
CH 23 L	139	CH 48 L	174	CH 73 L	13	CH 98 L	100
CH 24 H	161	CH 49 H	26	CH 74 H	87	CH 99 H	102
CH 24 L	162	CH 49 L	25	CH 74 L	88	CH 99 L	101
CH 25 H	38	CH 50 H	75	CH 75 H	114		
CH 25 L	37	CH 50 L	76	CH 75 L	113		

Table 3 M9103A Channel Number to Connector Pin Out

M9120A PXI Matrix Switch module: 4x32, 2 Wire

The M9120A Matrix Switch modules is constructed as a matrix 128 two pole armature relays. See the functional schematic below.

This module is designed to switch medium voltage/power signals in test applications where reed relays do not have sufficient rating. It is suitable for telecoms applications where send and return signals need to be switched simultaneously.

Larger matrices may be constructed by daisy-chaining the rows from multiple modules. For example, chaining the four rows of two M9120A modules would create a 4x64 matrix.

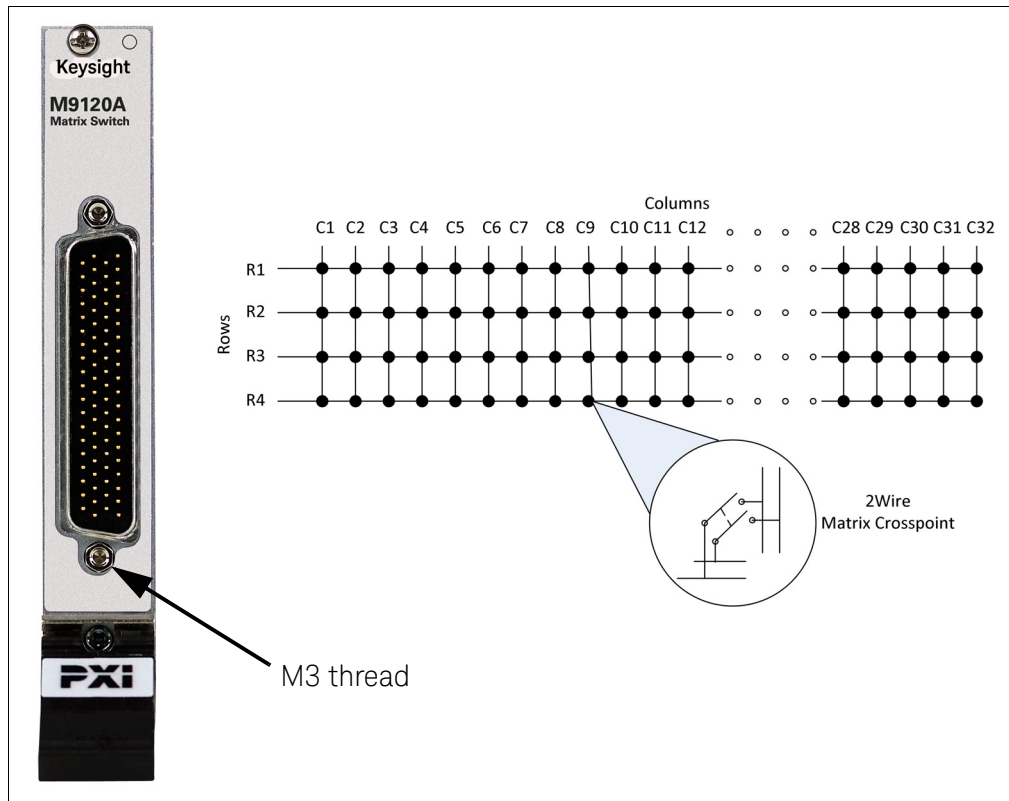

Figure 8 M9120A Front Panel and Simplified Schematic

M9120A Connector Pinout Figure 9 and the associated table show the front panel 78 pin D male connector (viewed from the front panel) and pin connections. Table 4 lists the channel connections on the connector.

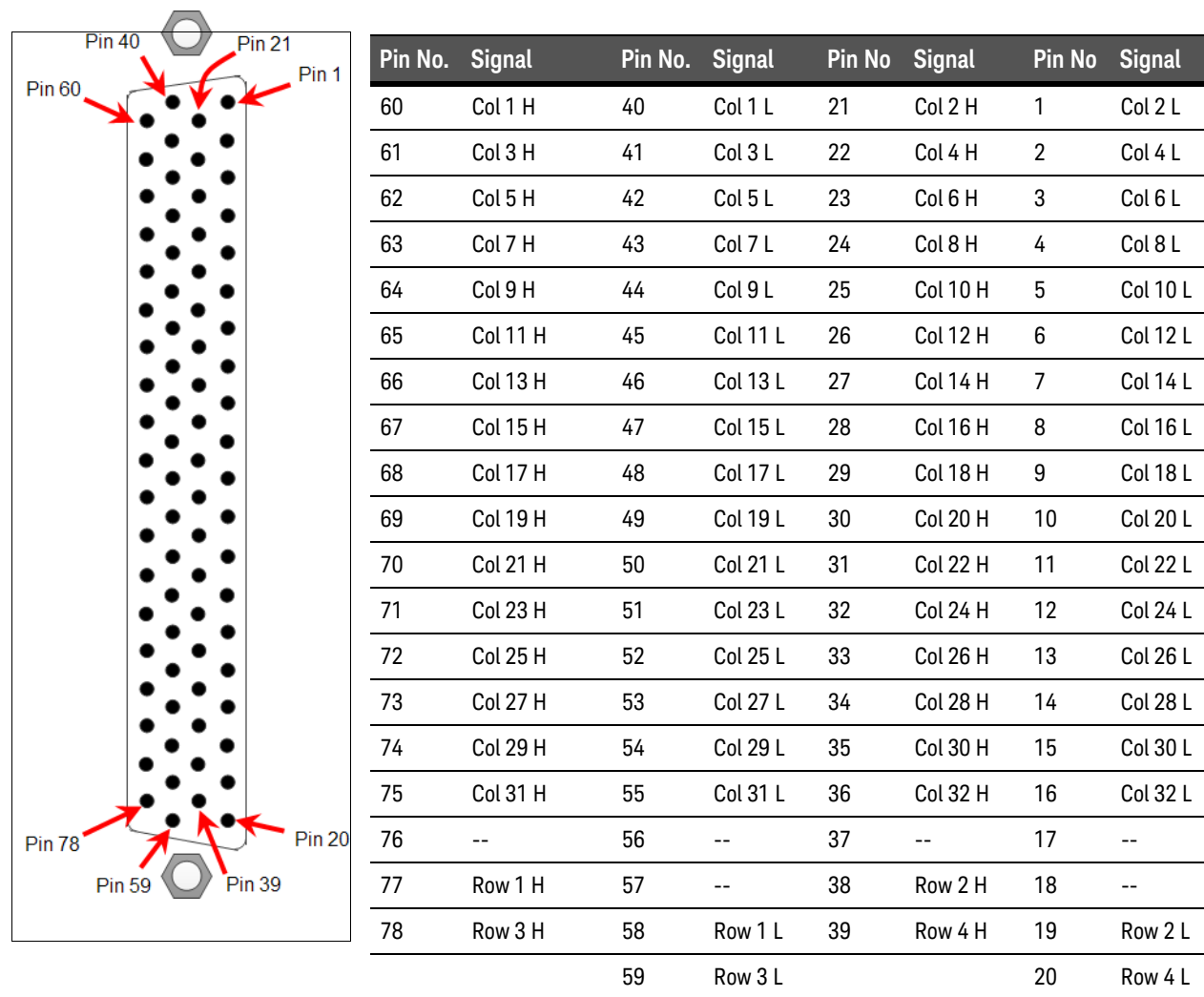

Figure 9 M9120A Connector (viewed from the front panel) and Pinout

Signal	Pin No.	Signal	Pin No.	Signal	Pin No.	Signal	Pin No.
Row 1 H	77	Row 2 H	38	Row 3 H	78	Row 4 H	39
Row 1 L	58	Row 2 L	19	Row 3 L	59	Row 4 L	20
Col 1 H	60	Col 9 H	64	Col 17 H	68	Col 25 H	72
Col 1 L	40	Col 9 L	44	Col 17 L	48	Col 25 L	52
Col 2 H	21	Col 10 H	25	Col 18 H	29	Col 26 H	33
Col 2 L	1	Col 10 L	5	Col 18 L	9	Col 26 L	13
Col 3 H	61	Col 11 H	65	Col 19 H	69	Col 27 H	73
Col 3 L	41	Col 11 L	45	Col 19 L	49	Col 27 L	53
Col 4 H	22	Col 12 H	26	Col 20 H	30	Col 28 H	34
Col 4 L	2	Col 12 L	6	Col 20 L	10	Col 28 L	14
Col 5 H	62	Col 13 H	66	Col 21 H	70	Col 29 H	74
Col 5 L	42	Col 13 L	46	Col 21 L	50	Col 29 L	54
Col 6 H	23	Col 14 H	27	Col 22 H	31	Col 30 H	35
Col 6 L	3	Col 14 L	7	Col 22 L	11	Col 30 L	15
Col 7 H	63	Col 15 H	67	Col 23 H	71	Col 31 H	75
Col 7 L	43	Col 15 L	47	Col 23 L	51	Col 31 L	55
Col 8 H	24	Col 16 H	28	Col 24 H	32	Col 32 H	36
Col 8 L	4	Col 16 L	8	Col 24 L	12	Col 32 L	32
Pins not used: 17, 18, 37, 56, 57, 76							

Table 4 M9120A Row and Column Number to Connector Pin Out

M9121A PXI Matrix Switch: 4x64, 2 Wire

Keysight's M9121A Matrix Switch module is an ultra high density module configured as a 64 column by four row matrix. Each relay is a 2-pole switch as shown in the functional schematic below.

Larger matrices may be constructed by daisy-chaining the rows from multiple modules. For example, chaining the four rows of two M9121A modules would create a 4x128 matrix.

These relays on this modules are high reliability Sputtered Ruthenium Reed Relays, offering $>10^9$ operations to provide long life and stable contact resistance. Connections to the modules are through a high density 200 pin Low Force Helix (LFH) connector.

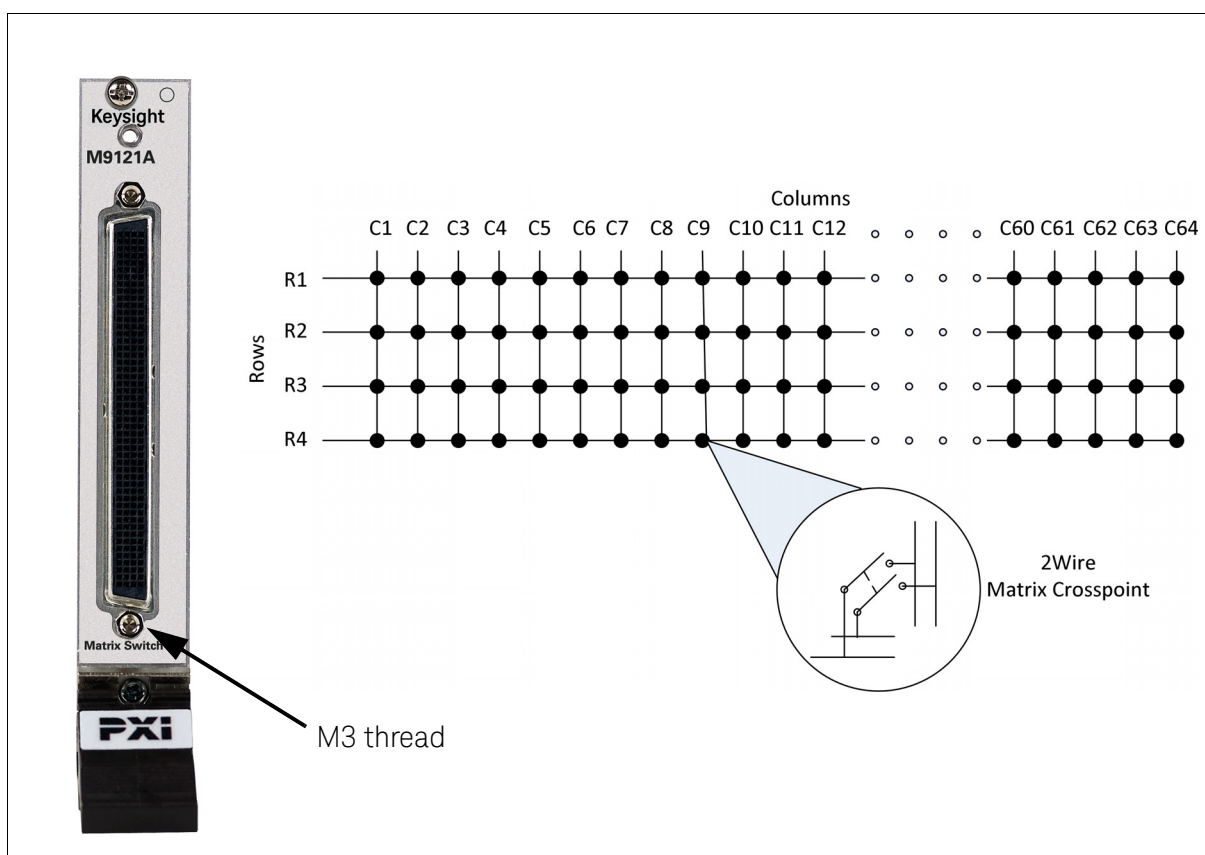
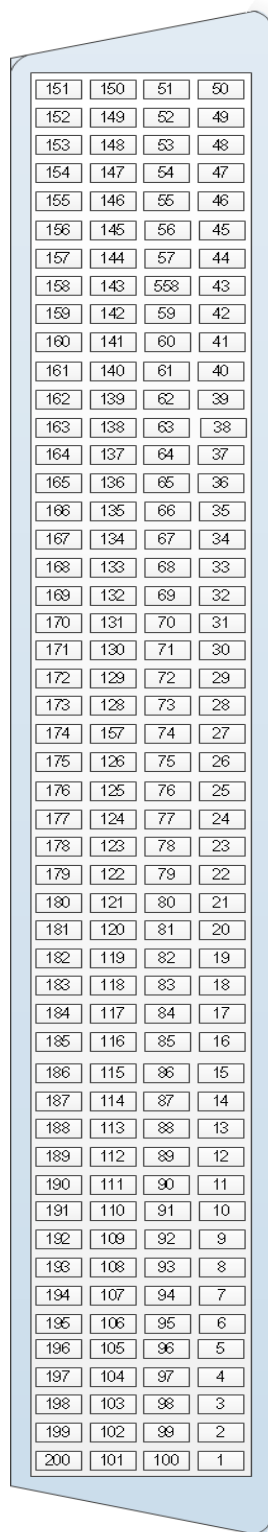

Figure 10 M9121A Front Panel and Simplified Schematic

M9121A Connector Pinout Figure 11 and the associated table show the front panel 200 pin D female connector (viewed from the front panel) and pin connections. Table 5 on page 38 lists the channel connections on the connector.



Pin No.	Channel	Pin No.	Channel	Pin No.	Channel	Pin No.	Channel
151	Col 1 H	150	Col 2 H	51	Col 3H	50	Col 4 H
152	Col 1 L	149	Col 2 L	52	Col 3 L	49	Col 4 L
153	Col 5 H	148	Col 6 H	53	Col 7 H	48	Col 8 H
154	Col 5 L	147	Col 6 L	54	Col 7 L	47	Col 8 L
155	Col 9 H	146	Col 10 H	55	Col 11 H	46	Col 12 H
156	Col 9 L	145	Col 10 L	56	Col 11 L	45	Col 12 L
157	Col 13 H	144	Col 14 H	57	Col 15 H	44	Col 16 H
158	Col 13 L	143	Col 14 L	58	Col 15 L	43	Col 16 L
159	Col 17 H	142	Col 18 H	59	Col 19 H	42	Col 20 H
160	Col 17 L	141	Col 18 L	60	Col 19 L	41	Col 20 L
161	Col 21 H	140	Col 22 H	61	Col 23 H	40	Col 24 H
162	Col 21 L	139	Col 22 L	62	Col 23 L	39	Col 24 L
163	Col 25 H	138	Col 26 H	63	Col 27 H	38	Col 28 H
164	Col 25 L	137	Col 26 L	64	Col 27 L	37	Col 28 L
165	Col 29 H	136	Col 30 H	65	Col 31 H	36	Col 32 H
166	Col 29 L	135	Col 30 L	66	Col 31 L	35	Col 32 L
167	Col 33 H	134	Col 34 H	67	Col 35 H	34	Col 36 H
168	Col 33 L	133	Col 34 L	68	Col 35 L	33	Col 36 L
169	Col 37 H	132	Col 38 H	69	Col 39 H	32	Col 40 H
170	Col 37 L	131	Col 38 L	70	Col 39 L	31	Col 40 L
171	Col 41 H	130	Col 42 H	71	Col 43 H	30	Col 44 H
172	Col 41 L	129	Col 42 L	72	Col 43 L	29	Col 44 L
173	Col 45 H	128	Col 46 H	73	Ch 47 H	28	Col 48 H
174	Col 45 L	127	Col 46 L	74	Col 47 L	27	Col 48 L
175	Col 49 H	126	Col 50 H	75	Col 51 H	26	Col 52 H
176	Col 49 L	125	Col 50 L	76	Col 51 L	25	Col 52 L
177	Col 53 H	124	Col 54 H	77	Col 55 H	24	Col 56 H
178	Col 53 L	123	Col 54 L	78	Col 55 L	23	Col 56 L
179	Col 57 H	122	Col 58 H	79	Col 59 H	22	Col 60 H
180	Col 57 L	121	Col 58 L	80	Col 59 L	21	Col 60 L
181	Col 61 H	120	Col 62 H	81	Col 63 H	20	Col 64 H
182	Col 61 L	119	Col 62 L	82	Col 63 L	19	Col 64 L
183	--	118	--	83	--	18	--
184	--	117	--	84	--	17	--
185	--	116	--	85	--	16	--
186	--	115	--	86	--	15	--
187	--	114	--	87	--	14	--
188	--	113	--	88	--	13	--
189	--	112	--	89	--	12	--
190	--	111	--	90	--	11	--
191	--	110	--	91	--	10	--
192	--	109	--	92	--	9	--
193	--	108	--	93	--	8	--
194	--	107	--	94	--	7	--
195	--	106	--	95	--	6	--
196	--	105	--	96	--	5	--
197	--	104	--	97	--	4	--
198	Row 1 H	103	Row 2 H	98	Row 3 H	3	Row 4 H
199	Row 1 L	102	Row 2 L	99	Row 3 L	2	Row 4 L
200	--	101	--	100	--	1	--

Figure 11 M912TA Connector (viewed from the front panel) and Pinout

Signal	Pin No.	Signal	Pin No.	Signal	Pin No.	Signal	Pin No.
Row 1 H	198	Row 2 H	103	Row 3 H	98	Row 4 H	3
Row 1 L	199	Row 2 L	102	Row 3 L	99	Row 4 L	2
Col 1 H	151	Col 17 H	159	Col 33 H	167	Col 49 H	175
Col 1 L	152	Col 17 L	160	Col 33 L	168	Col 49 L	176
Col 2 H	150	Col 18 H	142	Col 34 H	134	Col 50 H	126
Col 2 L	149	Col 18 L	141	Col 34 L	133	Col 50 L	125
Col 3 H	51	Col 19 H	59	Col 35 H	67	Col 51 H	75
Col 3 L	52	Col 19 L	60	Col 35 L	68	Col 51 L	76
Col 4 H	50	Col 20 H	42	Col 36 H	34	Col 52 H	26
Col 4 L	49	Col 20 L	41	Col 36 L	33	Col 52 L	25
Col 5 H	153	Col 21 H	161	Col 37 H	169	Col 53 H	177
Col 5 L	154	Col 21 L	162	Col 37 L	170	Col 53 L	178
Col 6 H	148	Col 22 H	140	Col 38 H	132	Col 54 H	124
Col 6 L	147	Col 22 L	139	Col 38 L	131	Col 54 L	123
Col 7 H	53	Col 23 H	61	Col 39 H	69	Col 55 H	77
Col 7 L	54	Col 23 L	62	Col 39 L	70	Col 55 L	78
Col 8 H	48	Col 24 H	40	Col 40 H	32	Col 56 H	24
Col 8 L	47	Col 24 L	39	Col 40 L	31	Col 56 L	23
Col 9 H	155	Col 25 H	164	Col 41 H	171	Col 57 H	179
Col 9 L	156	Col 25 L	165	Col 41 L	172	Col 57 L	180
Col 10 H	146	Col 26 H	138	Col 42 H	130	Col 58 H	122
Col 10 L	145	Col 26 L	137	Col 42 L	129	Col 58 L	121
Col 11 H	55	Col 27 H	63	Col 43 H	71	Col 59 H	79
Col 11 L	56	Col 27 L	64	Col 43 L	72	Col 59 L	80
Col 12 H	46	Col 28 H	38	Col 44 H	30	Col 60 H	22
Col 12 L	45	Col 28 L	37	Col 44 L	29	Col 60 L	21
Col 13 H	157	Col 29 H	165	Col 45 H	173	Col 61 H	181
Col 13 L	158	Col 29 L	166	Col 45 L	174	Col 61 L	182
Col 14 H	144	Col 30 H	136	Col 46 H	128	Col 62 H	120
Col 14 L	143	Col 30 L	135	Col 46 L	127	Col 62 L	119
Col 15 H	57	Col 31 H	65	Col 47 H	73	Col 63 H	81
Col 15 L	58	Col 31 L	66	Col 47 L	74	Col 63 L	82
Col 16 H	44	Col 32 H	36	Col 48 H	28	Col 64 H	20
Col 16 L	43	Col 32 L	35	Col 48 L	27	Col 64 L	19

Pins not connected: 1, 4-18, 100, 97-83, 101, 104-118, 200, 197-183

Table 5 M9121A Row and Column Number to Connector Pin Out

M9122A PXI Matrix Switch: 8x32, 1 Wire

Keysight’s M9122A Matrix Switch module is a high density module configured as a 32 column by eight row matrix. Each relay is a single-pole switch as shown in the functional schematic below.

Larger matrices may be constructed by daisy-chaining the rows from multiple modules. For example, chaining the eight rows of two M9122A module would create a 8x64 matrix.

These relays on this modules are high reliability Palladium-Ruthenium, Gold plated, bifurcated Armature Relays, providing long life and stable contact resistance. Connections to the modules are through a 50-pin connector.

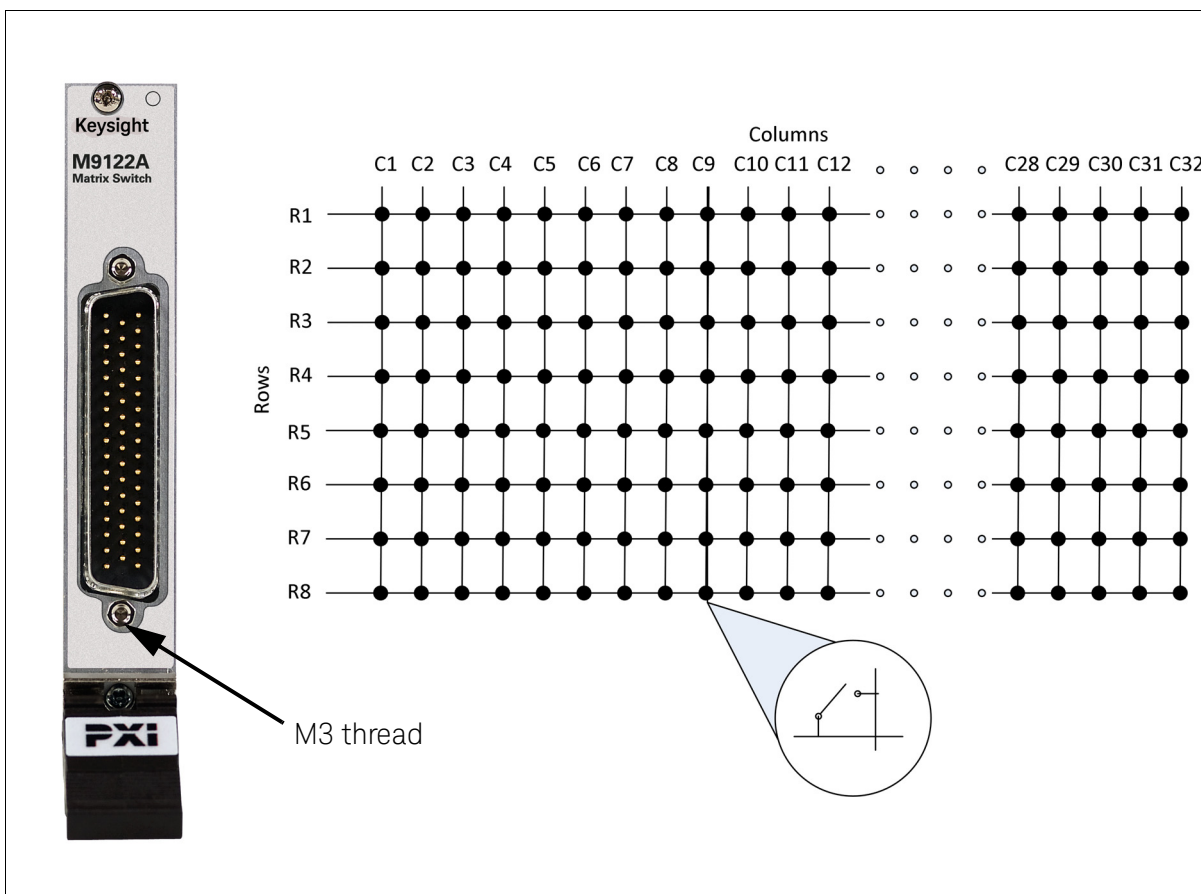

Figure 12 M9122A Front Panel and Simplified Schematic

M9122A Connector Pinout Figure 13 and the associated table show the front panel 200 pin D male connector (viewed from the front panel) and pin connections. Table 6 on page 40 lists the channel connections on the connector.

M9122A Connector Pinout The following figure and table lists the front panel 50 pin D-type male connector (viewed from the front panel) and pin connections.

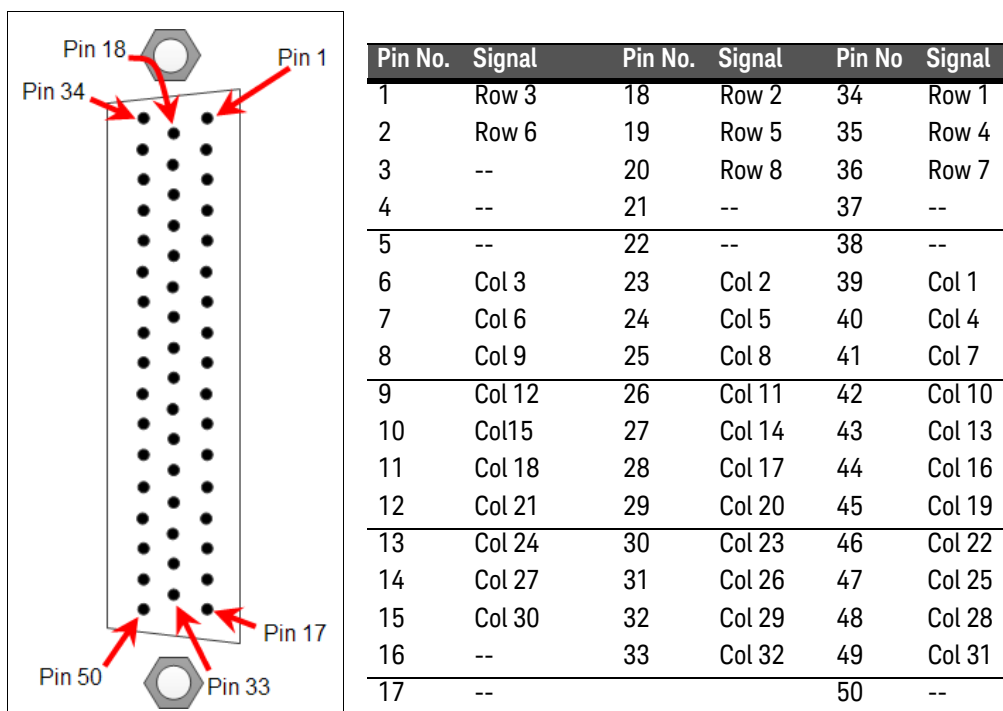

Figure 13 M9122A Connector (viewed from the front panel) and Pinout

Channel	Pin No.	Channel	Pin No.	Channel	Pin No.
Row 1	34	Row 2	18	Row 3	1
Row 4	35	Row 5	19	Row 6	2
Row 7	36	Row 8	20		
Col 1	39	Col 2	23	Col 3	6
Col 4	40	Col 5	24	Col 6	7
Col 7	41	Col 8	25	Col 9	8
Col 10	42	Col 11	26	Col 12	9
Col 13	43	Col 14	27	Col 15	10
Col 16	44	Col 17	28	Col 18	11
Col 19	45	Col 20	29	Col 21	12
Col 22	46	Col 23	30	Col 24	13
Col 25	47	Col 26	31	Col 27	14
Col 28	48	Col 29	32	Col 30	15
Col 31	49	Col 32	33		
Pins not used: 3,4, 5, 16,17, 21, 22, 37, 38, 50					

Table 6 M9122A Row and Column Number to Connector Pin Out

Multiplexer and Matrix Module Accessories

Multiplexer switch modules

M9101A, M9102A, M9103A Multiplexer Module Accessories	
Y1182A	Connector Block: 200 pin, shielded, male
Y1189A	Connector Cable: 200 pin male to four 50 pin female, 1Meter
Y1190A	Connector Cable: 200 pin male to four 50 pin female, 2Meter

Matrix switch modules

M9120A Matrix Module Accessories	
Y1181A	Connector Block: 78 pin, shielded, female D Sub
Y1187A	Connector Cable: 78 pin, male to female, 1Meter
Y1188A	Connector Cable: 78 pin, male to female, 2Meter

M9121A Matrix Module Accessories	
Y1182A	Connector Block: 200 pin, shielded, male
Y1189A	Connector Cable: 200 pin male to four 50 pin female, 1Meter
Y1190A	Connector Cable: 200 pin male to four 50 pin female, 2Meter

M9122A Matrix Module Accessories	
Y1180A	Connector Block: 50 pin female D Sub
Y1185A	Connector Cable: 50 pin, male to female, 1Meter
Y1186A	Connector Cable: 50 pin, male to female, 2Meter

The following pages describe the various option cables and terminal blocks.

Y1180A 50 Pin Shielded Connector Block

This shielded connector block provides a simple method of connecting wires to Keysight M9122A PXI switch modules with a 50 pin D-Type front panel connector. The screw terminals accept wires up to 20AWG and have a simple screw clamp for strain relief. The recommended torque for the screw terminals is 0.12 - 0.15 Nm. PTFE insulated cables are recommended. The following diagram shows the pinout of the connector block. The pin numbers match the pin numbers on the switch module's front panel connector.

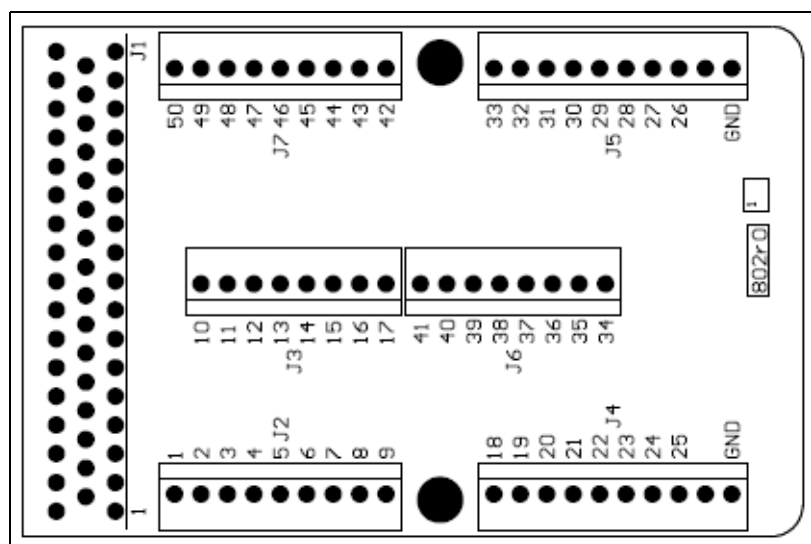

Figure 14 Y1180A 50 Pin Shielded Connector Block PC Board

WARNING

Voltages greater than 30 Vrms, 42Vpk or 60 Vdc present an electric shock hazard. Disconnect all source voltages before connecting or removing the source-to-modules I/O connector or wiring the connector block. All field wiring must be rated for the highest voltage applied to any single channel.

Y1181A 78 Pin Shielded Connector Block

This shielded connector block provides a simple method of connecting wires to Keysight M9120A PXI matrix modules with a 78 pin D-Type front panel connector. The screw terminals accept wires up to 20AWG and the connector block has a simple screw clamp for strain relief. The recommended torque for the screw terminals is 0.12 - 0.15 Nm. PTFE insulated cables are recommended. The following diagram shows the pinout of the connector block. The pin numbers match the pin numbers on the switch module's front panel connector.

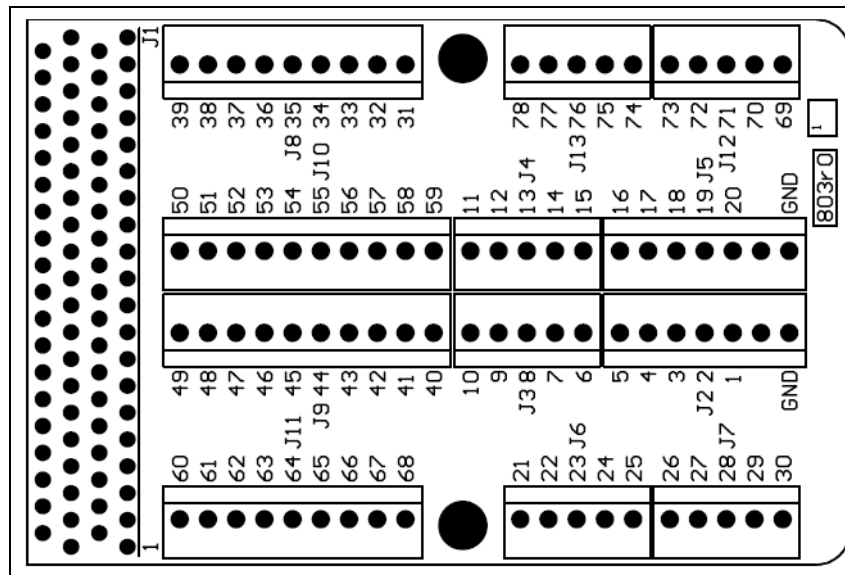

Figure 15 Y1181A 78 Pin Shielded Connector Block PC Board

WARNING

Voltages greater than 30 Vrms, 42Vpk or 60 Vdc present an electric shock hazard. Disconnect all source voltages before connecting or removing the source-to-modules I/O connector or wiring the connector block. All field wiring must be rated for the highest voltage applied to any single channel.

Y1182A 200 Pin Shielded Connector Block

This shielded connector block provides a simple method of connecting wires to Keysight M9101A, M9102A, M9103A and M9121A PXI switch modules with 200 pin D-Type front panel connectors. The screw terminals accept wires up to 26AWG and the connector block has a simple screw clamp for strain relief. The recommended torque for the screw terminals is 0.12 - 0.15 Nm. PTFE insulated cables are recommended. The following diagram shows the pinout of the connector block. The pin numbers match the pin numbers on the switch module's front panel connector.

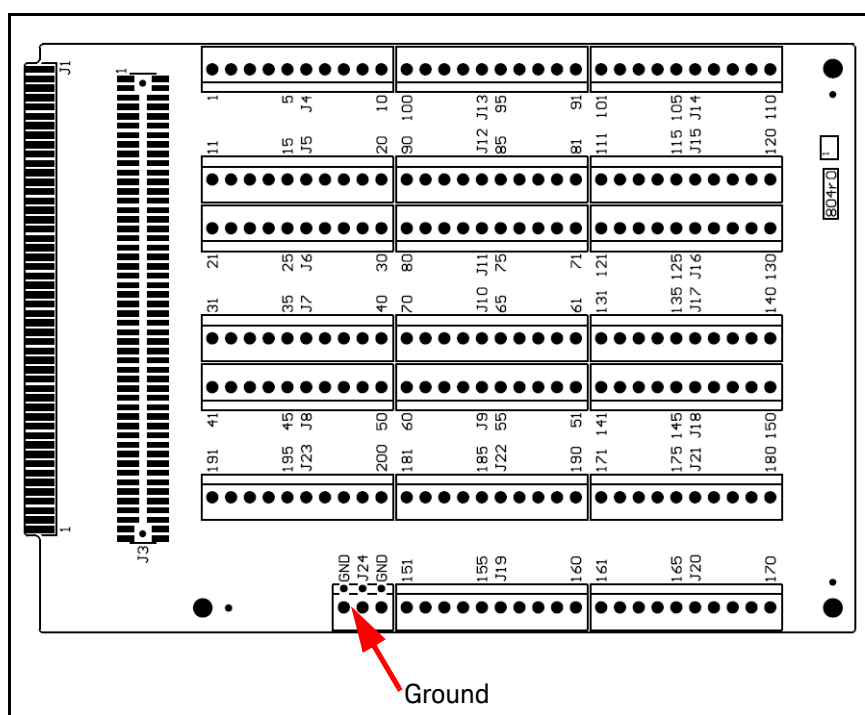

Figure 16 Y1182A 200 Pin Shielded Connector Block PC Board

WARNING

Voltages greater than 30 Vrms, 42Vpk or 60 Vdc present an electric shock hazard. Disconnect all source voltages before connecting or removing the source-to-modules I/O connector or wiring the connector block. All field wiring must be rated for the highest voltage applied to any single channel.

Y1185A, Y1186A 50 Pin Male to Female Connector Cable

These cable assemblies are used to extend the front panel connections of the M9120A PXI switch modules. The cable is PFA copper/tin, 26AWG with a 3A current rating. Nominal resistance is $0.2\Omega/m$.



Figure 17 Y1185A, Y1186A 50 Pin Male to Female Connector Cable

WARNING

Voltages greater than 30 Vrms, 42Vpk or 60 Vdc present an electric shock hazard. Disconnect all source voltages before connecting or removing the source-to-modules I/O connector or wiring the connector block. All field wiring must be rated for the highest voltage applied to any single channel.

Y1187A, Y1188A 78 Pin Male to Female Connector Cable

These cable assemblies are used to extend the front panel connections of the M9120A PXI switch modules. The cable is PFA copper/tin, 26AWG with a 3A current rating. Nominal resistance is $0.2\Omega/m$.

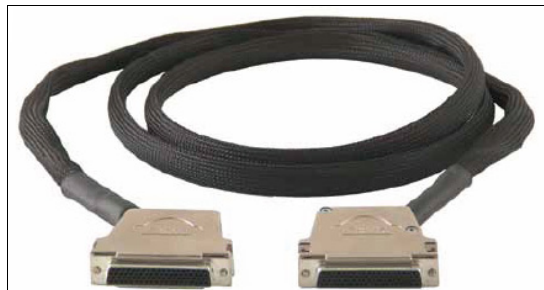

Figure 18 Y1187A, Y1188A 78 Pin Male to Female Connector Cable

WARNING

Voltages greater than 30 Vrms, 42Vpk or 60 Vdc present an electric shock hazard. Disconnect all source voltages before connecting or removing the source-to-modules I/O connector or wiring the connector block. All field wiring must be rated for the highest voltage applied to any single channel.

Y1189A, Y1190A 200 Pin Male to Female Connector Cable

These cable assemblies are used to extend the front panel connections of the Keysight M9101A, M9102A, M9103A and M9121A PXI switch modules with the 200 pin D-Type connector. It is built from four bundles of 50 wire 28AWG ribbon cable. A braided sleeve covers each of the four bundles. The Y1189A is 1m long and the Y1190A is 2m long.

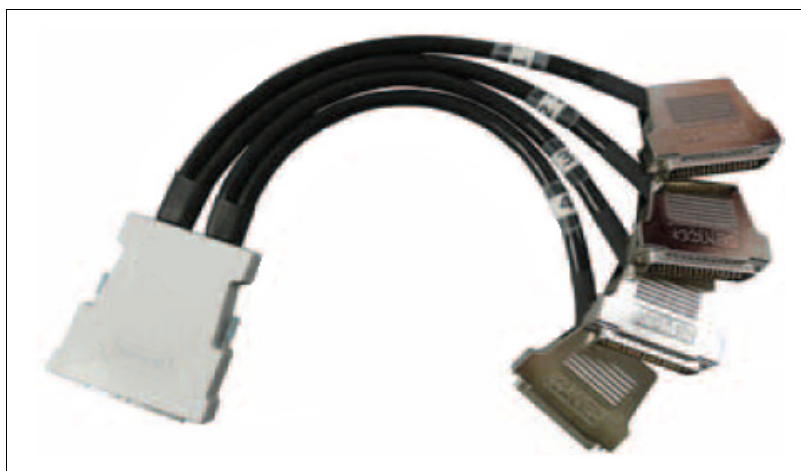

Figure 19 Y1189A, Y1190A 200 Pin Male to Female Connector Cable

WARNING

Voltages greater than 30 Vrms, 42Vpk or 60 Vdc present an electric shock hazard. Disconnect all source voltages before connecting or removing the source-to-modules I/O connector or wiring the connector block. All field wiring must be rated for the highest voltage applied to any single channel.

Figure 20 shows the pin outs of the four individual 50 pin connectors and where they connect to the 200 pin connector that mates to the module front panel. For the pinout of the 200 pin module connector, refer to the specific module: M9101A (page 24), M9102A (page 27), M9103A (page 30), and M9121A (page 36).

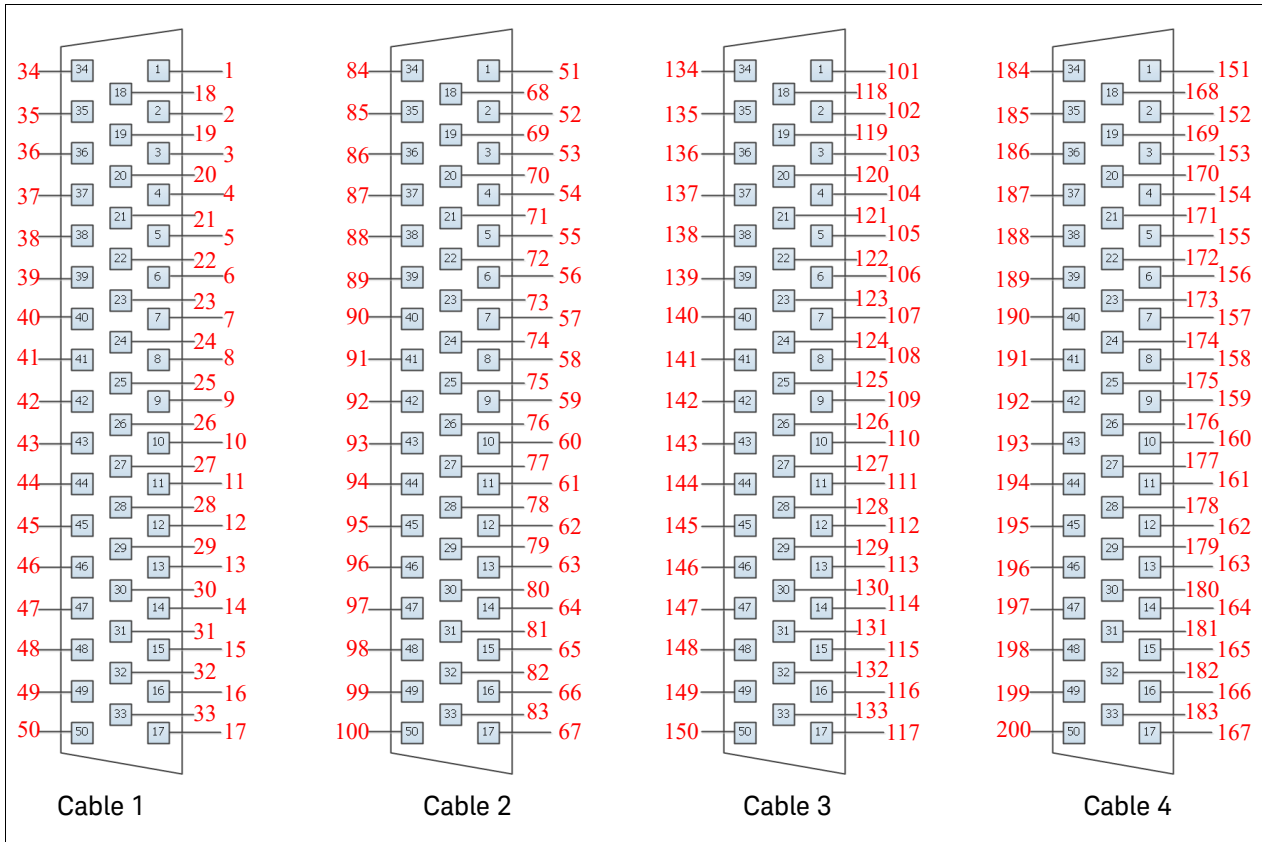

Figure 20 Y1189A, Y1190A 50 pin connectors pinouts

Disassembling the Terminal Block Clam Shells

- 1 Loosen the two screws indicated in Figure 21. These screws are captive to the bottom half of the clam shell. Note: the other two screws are for the strain relief.

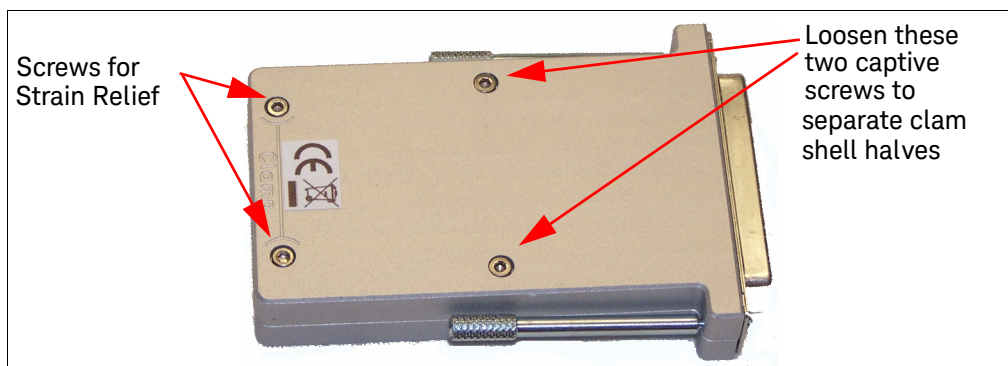

Figure 21 Disassembling the Terminal Block Clam Shell

- 2 Separate the two clam shell halves. Be careful not to lose the long screw locks used to secure the terminal block to the PXI switch module.
- 3 To use the strain relief, loosen the two strain relief screws and lift up on the strain relief bar. Refer to Figure 22.

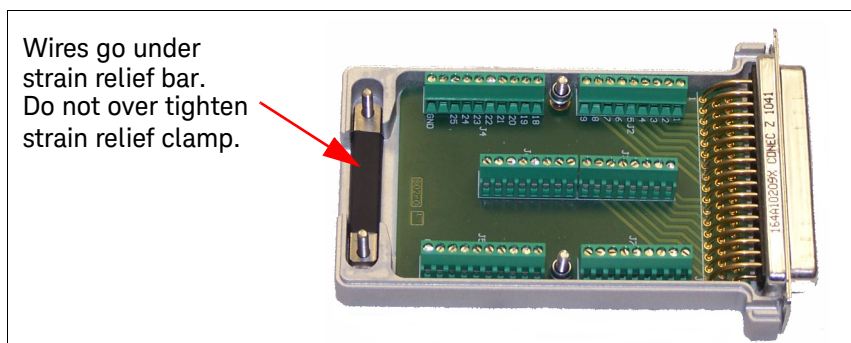

Figure 22 Using the Strain Relief Clamp

- 4 Insert your cable under the strain relief bar and re-tighten the two strain relief screws.

CAUTION

Do not over tighten the strain relief screws. Possible damage to the cable(s) may occur if overtightened. Use only sufficient tension to secure the cable in place.

- 5 To reassemble the clamshell, make certain the screw locks are in place. Place the clam shell halves together. Tighten the two clam shell screws.

Electrical Operating Conditions

WARNING

To avoid electric shock, Turn off the chassis and disconnect or de-energize all field wiring to the modules before installing or removing any module or chassis slot cover.

Transients

The multiplexer and matrix modules described in this manual are designed to safely withstand occasional transient voltages up to 1500 Vpeak. Typically, these transient over voltages result from switching inductive loads or from nearby lighting strikes.

WARNING

Not for connection to mains. Do not connect any of the modules directly to a mains power outlet. If it is necessary to switch a large inductive load, you must add signal conditioning elements to reduce the potential transients before they reach the modules.

High Energy Sources

These modules are designed to handle inputs up to their rated currents or their rated powers, whichever is less. Under certain fault conditions, high energy sources could provide substantially more current or power than a module can handle. It is important to provide external current limiting, such as fuses, if the module inputs are connected to high energy sources.

CAUTION

Install current limiting devices between high energy sources and the module inputs.

For the latest specifications, check the Keysight web site at:
www.keysight.com/find/pxiswitch.

Environmental Operating Conditions

These modules are designed to operate in a temperature range of 0 °C to +55 °C with non-condensing humidity. The maximum humidity is 95% at 40 °C. Do not use in locations where conductive dust or electrolytic salt dust may be present.

These modules should be operated in an indoor environment where temperature and humidity are controlled. Condensation can pose a potential shock hazard. Condensation can occur when the modules are moved from a cold to a warm environment, or if the temperature and/or humidity of the environment changes quickly.

WARNING

These modules are not for connection to Mains.

Refer to the data sheet for maximum voltage, current, and power dissipation ratings for each module. If conditions change, ensure that condensation has evaporated and the modules have thermally stabilized until Pollution Degree 1 conditions are restored before turning on power to the equipment.

NOTE

Pollution Degree 1: No pollution or only dry, non-conductive pollution occurs. The pollution has no influence (on insulation) (IEC 610101-1 2nd Edition).

NOTE

Pollution Degree 2: Normally only non-conductive pollution occurs. Occasionally, a temporary conductivity (leakage current between isolated conductors) caused by condensation can be expected (IEC 610101-1 2nd Edition).

Table 7 Environmental Operating Limits (current and power dissipation)

Module	Pollution Degree 1 Specification	Pollution Degree 2 Specification
M9101A	64 channels, 100Vrms or Vdc, 1A, 10VA per channel	64 channels, 40Vrms or Vdc, 1A, 10VA per channel
M9102A	128 channels, 100Vrms or Vdc, 1A, 10VA per channel	128 channels, 40Vrms or Vdc, 1A, 10VA per channel
M9103A	99 channels, 100Vrms or Vdc, 1A, 60VA per channel	99 channels, 40Vrms or Vdc, 1A, 60VA per channel
M9120A	4x32 channels, 100Vrms or Vdc, 2A, 60VA per channel	4x32 channels, 40Vrms or Vdc, 2A, 60VA per channel
M9121A	4x64 channels, 100Vrms or Vdc, 0.5A, 10VA per channel	4x64 channels, 40Vrms or Vdc, 0.5A, 10VA per channel
M9122A	8x32 channels, 100Vrms or Vdc, 2A, 60VA per channel	8x32 channels, 40Vrms or Vdc, 2A, 60VA per channel



电缆 Cables		有毒有害物质或元素 Toxic or Hazardous Substances and Elements					
部件名称 Part Name		铅 Pb	汞 Hg	镉 Cd	六价铬 CrVI	多溴联苯 PBB	多溴二苯醚 PBDE
接口电缆	Interface Cables	×	○	○	×	○	○
电缆附件	Cable accessories	×	○	○	×	○	○
半刚性电缆	Semi Rigid Cables	×	○	○	○	○	○
电源线	Power cords	×	○	○	○	○	○

O: 表示该有毒有害物质在该部件所有均质材料中的含量均在 SJ/T11363-2006 标准规定的限量要求以下。

X: 表示该有毒有害物质至少在该部件某一均质材料中的含量超出SJ/T11363-2006 标准规定的限量要求。

O: Indicates that this toxic or hazardous substance contained in all of the homogeneous materials for this part is below the limit requirement in SJ/T11363-2006.

X: Indicates that this toxic or hazardous substance contained in at least one of the homogeneous materials used for this part is above the limit requirement in SJ/T11363-2006.

如果上述表单多于一个，请参考您的订单或者装箱单从上述表格中找到适合您的产品的列表。

If more than one table is shown above, reference your order or packing list to determine which is applicable to your product.

若您需要了解有关本产品的生产日期信息，请联系您的安捷伦销售代表。

If you have a question about the manufacturing date for your product, ask your Agilent representative

有关如何与安捷伦联系的信息，请参考产品使用手册。

For Agilent contact information, please reference your product manual.

根据中国《电子信息产品污染控制管理办法》的规定，安捷伦已经为本产品标识了显示其环保使用期限的数字。该数字是对本产品在正常使用和操作条件下的使用寿命的评估，其使用和操作条件已经在产品使用手册上做出了明确的规定和说明。该数字仅为与《管理办法》为目的的活动提供参考；并不意味着并担保本产品在环保使用期限过期前免于损坏。该环保使用期限不代表任何担保或保证。该环保使用期限数字不改变任何创立的担保；并且不影响与该产品销售相关的任何方面、任何项目及条件。您使用的安捷伦产品可能包含一些可替换的零部件（包括驱动器、电源、鼠标、显示器或者电池等非安捷伦制造的产品），他们的环保使用期限比安捷伦产品本身的环保使用期限短。对于这些非安捷伦制造的零部件标识其环保使用期限数字，其本身标的EPUP有高的优先权，安捷伦对非安捷伦制造的产品的环保使用期限没有任何主张也不负任何责任。

In accordance with the requirements of China's Administrative Measure on the Control of Pollution Caused by Electronic Information Products (the "Measure"), Agilent has labeled this product with a number identifying its Environment-Protection Use Period ("EPUP") This number reflects an estimate of the expected life of the product under the normal use and operating conditions as defined in the product user manual which is distributed with the product. Use of the number is only for purposes related to the Measure and does not imply or guarantee that the product is free from defects prior to the EPUP expiration date. No warranties or guarantees are implied by use of the EPUP number. Use of the EPUP number does not alter any warranties found in, nor affect in any way, the terms and conditions associated with the purchase of this product.

Your Agilent product may contain replaceable assemblies/components (including disk drive, power supply, mouse, display, or battery, which are not manufactured by Agilent) which have a shorter EPUP number than that which is indicated on the product itself. In cases where the assembly, component, or part is labeled with an EPUP which differs from the one indicated by Agilent, the EPUP on the assemblies/component or part takes precedence. Agilent makes no claims concerning, and takes no responsibility for the EPUP numbers reflected on goods which are not manufactured by Agilent.



This information is subject to change
without notice.
© Keysight Technologies, 2014-2018
Edition 4, December 2018



M9101-90001

www.keysight.com