

Keysight VXT Vector Transceiver

This manual provides documentation for:
Keysight M9420A VXT Vector Transceiver
Keysight M9421A VXT Vector Transceiver

Notices

© Keysight Technologies, Inc.
2015-2016

No part of this manual may be reproduced in any form or by any means (including electronic storage and retrieval or translation into a foreign language) without prior agreement and written consent from Keysight Technologies, Inc. as governed by United States and international copyright laws.

Trademark Acknowledgments

Manual Part Number

M9420-90001

Edition

Edition 2, May 2016

Printed in Malaysia

Published by:
Keysight Technologies
No 116 Tianfu 4th Street
Chengdu, China 610041

Warranty

THE MATERIAL CONTAINED IN THIS DOCUMENT IS PROVIDED "AS IS," AND IS SUBJECT TO BEING CHANGED, WITHOUT NOTICE, IN FUTURE EDITIONS. FURTHER, TO THE MAXIMUM EXTENT PERMITTED BY APPLICABLE LAW, KEYSIGHT DISCLAIMS ALL WARRANTIES, EITHER EXPRESS OR IMPLIED WITH REGARD TO THIS MANUAL AND ANY INFORMATION CONTAINED HEREIN, INCLUDING BUT NOT LIMITED TO THE IMPLIED WARRANTIES OF MERCHANTABILITY AND FITNESS FOR A PARTICULAR PURPOSE. KEYSIGHT SHALL NOT BE LIABLE FOR ERRORS OR FOR INCIDENTAL OR CONSEQUENTIAL DAMAGES IN CONNECTION WITH THE FURNISHING, USE, OR PERFORMANCE OF THIS DOCUMENT OR ANY INFORMATION CONTAINED HEREIN. SHOULD KEYSIGHT AND THE USER HAVE A SEPARATE WRITTEN AGREEMENT WITH WARRANTY TERMS

COVERING THE MATERIAL IN THIS DOCUMENT THAT CONFLICT WITH THESE TERMS, THE WARRANTY TERMS IN THE SEPARATE AGREEMENT WILL CONTROL.

Technology Licenses

The hardware and/or software described in this document are furnished under a license and may be used or copied only in accordance with the terms of such license.

U.S. Government Rights

The Software is "commercial computer software," as defined by Federal Acquisition Regulation ("FAR") 2.101. Pursuant to FAR 12.212 and 27.405-3 and Department of Defense FAR Supplement ("DFARS") 227.7202, the U.S. government acquires commercial computer software under the same terms by which the software is customarily provided to the public.

Accordingly, Keysight provides the Software to U.S. government customers under its standard commercial license, which is embodied in its End User License Agreement (EULA), a copy of which can be found at

<http://www.keysight.com/find/sweula>

The license set forth in the EULA represents the exclusive authority by which the U.S. government may use, modify, distribute, or disclose the Software. The EULA and the license set forth therein, does not require or permit, among other things, that Keysight: (1) Furnish technical information related to commercial computer software or commercial computer software documentation that is not customarily provided to the public; or (2) Relinquish to, or otherwise provide, the government rights in excess of these rights customarily provided to the public to use, modify, reproduce, release, perform, display, or disclose commercial computer software or commercial computer software

documentation. No additional government requirements beyond those set forth in the EULA shall apply, except to the extent that those terms, rights, or licenses are explicitly required from all providers of commercial computer software pursuant to the FAR and the DFARS and are set forth specifically in writing elsewhere in the EULA. Keysight shall be under no obligation to update, revise or otherwise modify the Software. With respect to any technical data as defined by FAR 2.101, pursuant to FAR 12.211 and 27.404.2 and DFARS 227.7102, the U.S. government acquires no greater than Limited Rights as defined in FAR 27.401 or DFARS 227.7103-5 (c), as applicable in any technical data.

Safety Notices

CAUTION

A **CAUTION** notice denotes a hazard. It calls attention to an operating procedure, practice, or the like that, if not correctly performed or adhered to, could result in damage to the product or loss of important data. Do not proceed beyond a CAUTION notice until the indicated conditions are fully understood and met.

WARNING

A **WARNING** notice denotes a hazard. It calls attention to an operating procedure, practice, or the like that, if not correctly performed or adhered to, could result in personal injury or death. Do not proceed beyond a WARNING notice until the indicated conditions are fully understood and met.

In This Guide...

The scope of this Getting Started Guide is to detail the processes of receiving and installing the modules of the Keysight M9420A and M9421A VXT Vector Transceiver.

Additionally, installing the required software is documented. If you have any questions after reviewing this information, please contact your local Keysight Technologies Inc. representative or contact us through our website at www.keysight.com/find/vxt

1 Unpack and Verify the Shipment Contents

This chapter provides the process to unpack and verify the contents of the signal transceiver.

2 Install the Module

Refer to this chapter to install the VXT module in a PXI Express chassis.

3 Installing the Software and Licensing

This chapter guides you to install the VXT software and redeem application license in Microsoft Windows 7.

4 Launching Modular TRX Application

This chapter describes the process to launch a modular TRX application in Microsoft Windows 7.

5 Running Modular TRX Application

This chapter provides some guidelines for using a virtual front panel with the signal transceiver.

6 Troubleshooting

This chapter details some basic steps that may solve any problems you are experiencing with a VXT module.

Where to Find the Latest Information

Documentation is updated periodically. For the latest information about the product, including instrument software upgrades, application information, and product information, browse to one of the following URLs:

<http://www.keysight.com/find/vxt>

The documentation associated with this product is available at the M9420A/M9421A product pages on keysight.com (go to **Document Library > Manuals**).

To receive the latest updates by email, subscribe to Keysight Email Updates at the following URL:

<http://www.keysight.com/find/emailupdates>

Information on preventing transceiver damage can be found at:

<http://www.keysight.com/find/PreventingInstrumentRepair>

Is your product software up-to-date?

Periodically, Keysight releases software updates to fix known defects and incorporate product enhancements. To search for software updates for your product, go to the Keysight Technical Support website at:

<http://www.keysight.com/find/techsupport>

1 Unpack and Verify the Shipment Contents

Initial Inspection	10
Inspect for Damage	10
Electrostatic Discharge Protection	10
If there is a Problem	12
Verify M9420A/M9421A Shipment Contents	13
Instrument Information	14
Protecting Against Overpowering	14
Instrument Maintenance	14

2 Module Installation

Front-Panel Overview	16
Install the Module	19
Reference Connection	21
Instrument Symbols	22

3 Software Installation and Licensing

Getting Started with VXT Software	24
Download the VXT software	24
Controller Requirement	24
Software Installation	25
Uninstalling the Software	31
If Installation Fails	31
Keysight VXT Signal Transceiver Licensing Options	34
How to Get a License	34
License Types	35
Licensing Measurement Application Software - After Initial Purchase	37
Install License by Using a USB Storage Device	37
Install License by Using License Manager	38
Transporting a License	40

4 Launching Modular TRX Application

Contents

Configure Application Tool	42
Application Launcher	43
Start Launcher	43
Launcher Features	45
Hardware License Installation	48
Launching Modular TRX Application with Launcher	49
Launch Modular TRX Application Manually	49
Launch Modular TRX Application Automatically	50
Launch Modular TRX Application by Programming Codes	52
Launch Modular TRX Application by IVI driver	52

5 Running Modular TRX application

Display Annotations	54
Using Virtual Front Panel	56
Unhide/Hide Soft Keys	58
Open Virtual Front Panel from Right-Click Menu	58
Virtual Front Panel for Multiple Modules	59
Virtual Front Panel Keys Definition	60
Using Right-Click Menu	63
Using the Interactive Help System	65
Navigating the Signal Transceiver Application by keyboard	66
TCP/IP Address Configuration	69
Address Setting in Local Control	69
Address Setting in Remote Control	71

6 Troubleshooting

Check the Basics	74
Returning a Transceiver for Service	76
Calling Keysight Technologies	76
Locations for Keysight Technologies	76
Read the Warranty	77
Service Options	77

Contents

1 Unpack and Verify the Shipment Contents

This section explains how to verify the shipment contents when you receive the shipment.

The following topics can be found in this section:

["Initial Inspection" on page 10](#)

["Verify M9420A/M9421A Shipment Contents" on page 13](#)

["Instrument Information" on page 14](#)

Initial Inspection

Inspect the shipping container and the cushioning material for signs of stress. Retain the shipping materials for future use, as you may wish to ship the unit to another location or to Keysight Technologies for service.

Inspect for Damage

After unpacking a module, inspect it for any shipping damage. Report any damage to the shipping agent immediately, as such damage is not covered by the warranty.

CAUTION

To avoid damage when handling a module, do not touch exposed connector pins.

Electrostatic Discharge Protection

Electrostatic discharge (ESD) can damage or destroy electronic components (the possibility of unseen damage caused by ESD is present whenever components are transported, stored, or used).

CAUTION

The modules are shipped in materials which prevent damage from static. The modules should only be removed from the packaging in an anti-static area ensuring that correct anti-static precautions are taken. Store all modules in anti-static envelopes when not in use.

WARNING

DO NOT use these techniques for a static-safe work station when working on circuitry with a voltage potential greater than 500 volts.

Test equipment and ESD

To help reduce ESD damage that can occur while using test equipment:

- Before connecting any coaxial cable to a connector for the first time each day, momentarily short the center and outer conductors of the cable together.
- Personnel should be grounded with a 1 M Ω resistor-isolated wrist-strap before touching the center pin of any connector and before removing any assembly from the transceiver.
- Be sure that all instruments are properly earth-grounded to prevent build-up of static charge.
- Perform work on all components or assemblies at a static-safe workstation.
- Keep static-generating materials at least one meter away from all components.
- Store or transport components in static-shielding containers.
- Always handle printed circuit board assemblies by the edges. This reduces the possibility of ESD damage to components and prevent contamination of exposed plating.

Additional information about ESD

For more information about ESD and how to prevent ESD damage, contact the Electrostatic Discharge Association (<http://www.esda.org>). The ESD standards developed by this agency are sanctioned by the American National Standards Institute (ANSI).

Unpack and Verify the Shipment Contents Initial Inspection

If there is a Problem

If the shipping materials are damaged or the contents of the container are incomplete:

- Contact the nearest Keysight Technologies office.
- Keep the shipping materials for the carrier's inspection.
- If you must return a transceiver to Keysight Technologies, use the original (or comparable) shipping materials.

CAUTION

Transceiver damage can result from using packaging materials other than those specified. Never use styrene pellets in any shape as packaging materials. They do not adequately cushion the equipment or prevent it from shifting in the carton. They cause equipment damage by generating static electricity and by lodging in the transceiver, blocking airflow.

Verify M9420A/M9421A Shipment Contents

The Keysight M9420A/M9421A VXT Vector Transceiver is a module, housed in a PXIe chassis. Please verify the shipment contents according to the table below.

Qty	Part Number	Description
1	E2094-60003	Keysight IO Libraries Suite CD
1	5962-0476	Calibration Certificate
1	5061-7383	South Korean Class A EMC Declaration
1	M9420-90006	VXT Software and Product information DVD
1	M9420-90001	VXT Getting Started Guide
1	9320-6698	China RoHS Addendum
1	M9420A/M9421A	M9420A/M9421A VXT Vector Transceiver

NOTE

All the manuals and software contained on the CD are available from www.keysight.com/find/vxt

Instrument Information

Protecting Against Overpowering

The input circuitry of the transceiver can be damaged by applying signals that exceed the maximum safe input level of +30 dBm average total power or ± 0.2 Vdc (when DC coupled) or ± 50 Vdc (when AC coupled). Refer to the transceiver's specification guide for more details regarding the Maximum Safe Input Level. Repairing damage to the input circuitry can be expensive.

If the module will be used to measure signals which might be near the maximum safe input level, use external attenuators and/or limiters to help protect the transceiver input. The External Gain, amplitude Corrections, and/or Ref Lvl Offset features may be used to compensate for the gains and losses of external devices. External Gain and Corrections are under the Input/Output menu and Ref Lvl Offset is under the AMPTD Y-Scale menu.

Instrument Maintenance

WARNING

Operator is responsible to maintain safe operating conditions. To ensure safe operating conditions, modules should not be operated beyond the full temperature range specified in the Environmental and physical specification. Exceeding safe operating conditions can result in shorter lifespans, improper module performance and user safety issues. When the modules are in use and operation within the specified full temperature range is not maintained, module surface temperatures may exceed safe handling conditions which can cause discomfort or burns if touched. In the event of a module exceeding the full temperature range, always allow the module to cool before touching or removing modules from chassis.

Cleaning Connectors

Cleaning connectors with alcohol shall only be done with the instrument power cord removed, and in a well-ventilated area. Allow all residual alcohol moisture to evaporate, and the fumes to dissipate prior to energizing the instrument.

WARNING

Keep isopropyl alcohol away from heat, sparks, and flame. Store in a tightly closed container. It is extremely flammable. In case of fire, use alcohol foam, dry chemical, or carbon dioxide; water may be ineffective.

Use isopropyl alcohol with adequate ventilation and avoid contact with eyes, skin, and clothing. It causes skin irritation, may cause eye damage, and is harmful if swallowed or inhaled. It may be harmful if absorbed through the skin. Wash thoroughly after handling. In case of spill, soak up with sand or earth. Flush spill area with water.

Dispose of isopropyl alcohol in accordance with all applicable federal, state, and local environmental regulations.

2 Module Installation

This chapter describes the process to install the M9420A/M9421A module into a PXI express chassis and the general information of the front panel.

["Front-Panel Overview" on page 16](#)

["Install the Module" on page 19](#)

["Reference Connection" on page 21](#)

["Instrument Symbols" on page 22](#)

Front-Panel Overview

M9420A VXT Vector Transceiver Front Panel

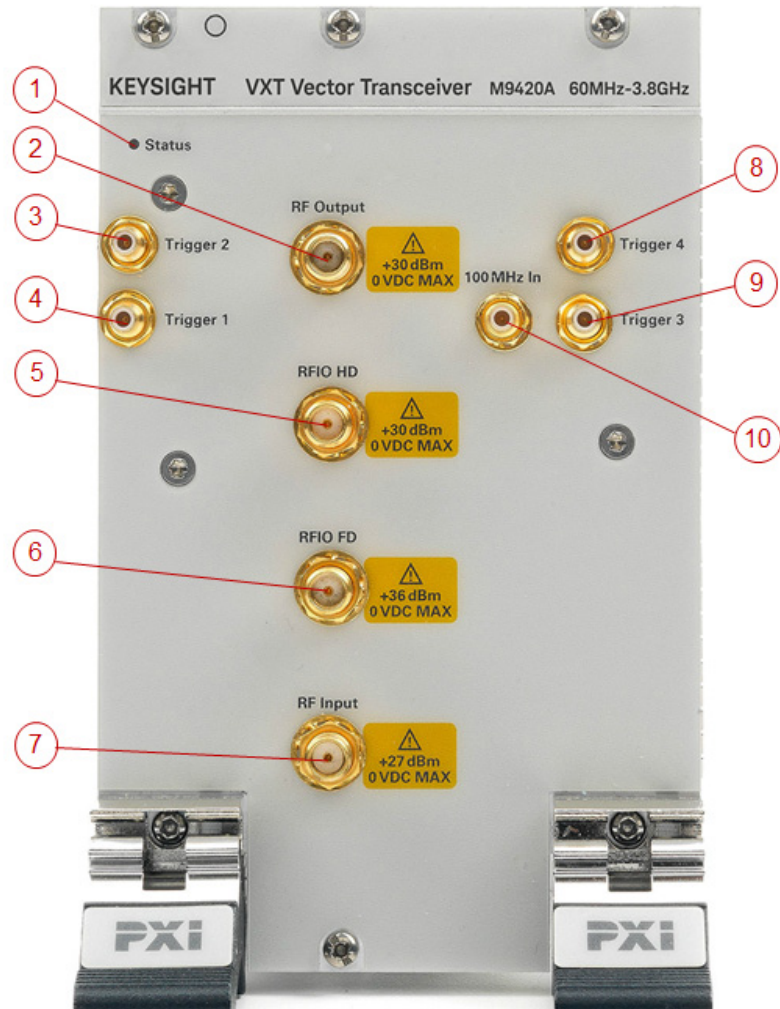

M9421A VXT Vector Transceiver Front Panel

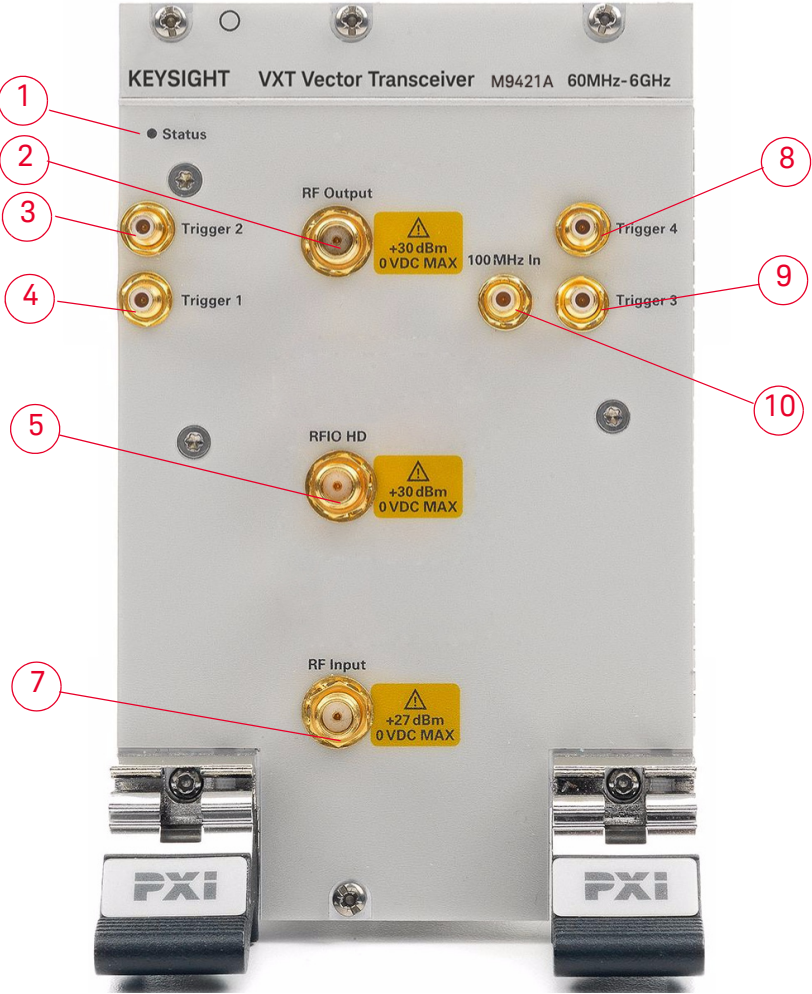

Item		Description	Remark
#	Port Name		
1	Status LED	LED indicator of the module status	<p>Green: Modular TRX application is running normally.</p> <p>Red: Modular TRX application has been invoked with error, error message has been logging into event viewer.</p> <p>Blink: FPGA is updating on the module.</p> <p>Off: The module is not in above situations.</p>
2	RF Output	RF output port	<p>Output Level: -150 dBm to 10 dBm</p> <p>Output Level: -150 dBm to 18 dBm (Option 1EA)</p>
3	Trig 2	Source Trigger port	Trigger source output, 3.3 V into 50Ω

Module Installation
Front-Panel Overview

Item		Description	Remark
#	Port Name		
4	Trig 1	Source Trigger port	External Trigger Input, Sine or square wave - 2 V to +5 V max into 50Ω, +16 dBm max at 0 VDC into 50Ω
5	RFIO HD	Half duplex port for RF Input or RF Output	Min Output Power: -150 dBm, Max Output Power without Option 1EA: 10 dBm Max Output Power with Option 1EA: 15 dBm
6	RFIO FD	Full duplex port for RF Input or RF Output	Min Output Power: -150 dBm, Max Output Power without Option 1EA: 0 dBm
7	RF Input	RF Input port	Received Input, Maximum input power: 27 dBm
8	Trigger 4	Receiver Trigger port	Trigger received output, 3.3 V into 50Ω
9	Trigger 3	Receiver Trigger port	External Trigger Output, Sine or square wave -2 V to +5 V max into 50Ω, +16 dBm max at 0 VDC into 50Ω
10	100 MHz In	100 MHz reference input	This SMB male connector inputs a 100 MHz reference signal

Install the Module

Before installing the VXT module into a PXI express chassis, please read all the safety information carefully and make sure the chassis is in a proper condition as below.

- Ensure proper chassis air flow is maintained. The M9018A chassis has multiple air intakes located on the lower sides, lower front and bottom front of chassis.



- Select a chassis that provides thermal protection if fans become inoperable or forced air cooling is obstructed
- Use slot blockers and EMC filler panels in empty module slots to ensure proper operating temperatures. Keysight chassis and slot blockers optimize module temperature performance and reliability of test.
- Set chassis fans to high or auto. Do not disable fans.
- Position chassis to allow plenty of space around chassis air intake and fan exhaust.
- At environment temperatures above 45°C, set chassis fan speed to high.

WARNING

Keysight Technologies does not warrant third-party system-level (combination of chassis, controllers, modules, etc.) performance, safety, or regulatory compliance, unless specifically stated.

CAUTION

PXI hardware does not support "hot-swap" (changing modules while power is applied to the chassis) capabilities. Before installing or removing a module to/from the chassis, power off the chassis to prevent damage to the module.

The VXT module in a PXI express chassis occupies 4 empty slots. Please refer to the chassis documentation for further information about how to use the chassis.

Perform the following steps to install a VXT module in a chassis:

1. Make sure the line cord is plugged in to establish earth ground and the chassis power switch is in the Off (Standby) position.
2. If the chassis has multiple fan speed settings, ensure the fans are set to automatic. Do not set the fan speed to low or turn it off.

Module Installation

Install the Module

3. Position the chassis so that there is ample space between the chassis fan intake and exhaust vents. Blockage by walls or obstructions affects the air flow needed for cooling.
4. Before installing a module, be sure to remove the plastic thread protectors from the mounting screws. Before inserting the module into the chassis, back the mounting screws out to assure that there is no interference between the screws and the mounting rails. Inspect the chassis slot to ensure there are no bent pins on the slot connectors.
5. Ensure the ejector handles of the module are in the unlatched (downward) position.
6. Insert VXT module into 4 contiguous empty slots by placing the module card edges into the top and bottom module guides.

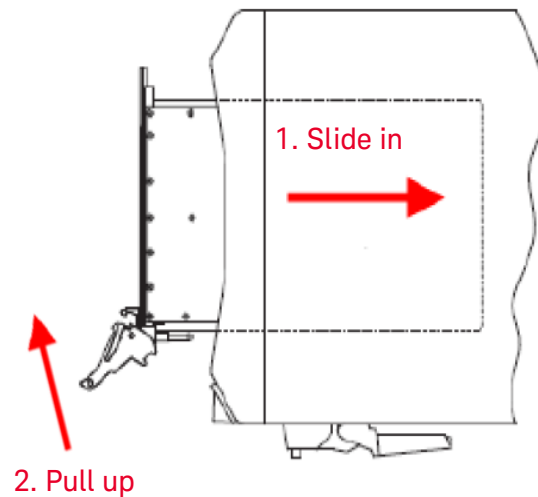

7. Carefully Slide the module completely into the chassis. When you begin to feel resistance, pull up on the injector/ejector handle to fully insert and latch the module into the chassis. Refer to the figure above.
8. Tighten the screws at the top and bottom of the module front panel for both mechanical security and to ensure proper grounding of the front panel. Performance may suffer if the screws are not tightened properly.
9. Verify the PXI chassis fans are operable and free of dust and other contaminants that may restrict airflow.
10. Position the chassis so that inlet and outlet vents are not obstructed.
11. Cover all empty chassis slots by using filler panels or air inlet modules. You can find them on the Keysight Technologies website.
<http://www.keysight.com/find/accessories>
12. Plug in and power on the chassis.

Reference Connection

An external 100MHz reference signal is required to input into VXT module. Make sure the reference signal is connected to VXT "100 MHz In" port before starting software of VXT. Keysight M9300A Reference module is recommended for inputting the reference signal. Connect one of M9300A Reference 100MHz Out port to VXT 100MHz In port with SMB cable like following, and use M9300A software to output reference signal correctly.

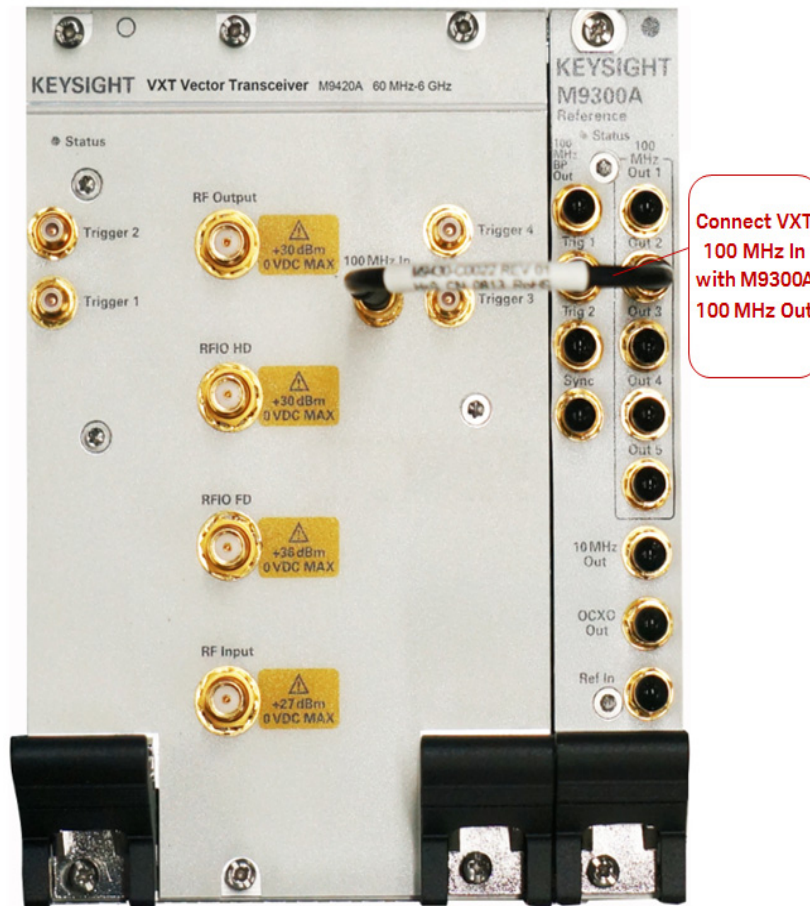

For more information about M9300A module, please refer to following web page:

<http://www.keysight.com/find/m9300a>

If reference signal inputs correctly, there will be a warning as following on status bar of Modular TRX application window.

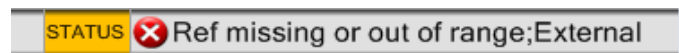

Check the reference signal input and make sure the correct reference signal is connected. Once the VXT module detects the correct reference signal inputs, the error message on status bar will be cleared.

Instrument Symbols



The instruction documentation symbol. The product is marked with this symbol when it is necessary for the user to refer to instructions in the documentation.



The CE mark is a registered trademark of the European Community.



All Level 1, 2 or 3 electrical equipment offered for sale in Australia and New Zealand by Responsible Suppliers must be marked with the Regulatory Compliance Mark.



This is a marking of a product in compliance with the Canadian Interference-Causing Equipment Standard (ICES-001).

This is also a symbol of an Industrial Scientific and Medical Group 1 Class A product (CISPR 11, Clause 4).



This symbol indicates separate collection for electrical and electronic equipment mandated under EU law as of August 13, 2005. All electric and electronic equipment are required to be separated from normal waste for disposal (Reference WEEE Directive 2002/96/EC).



Indicates the time period during which no hazardous or toxic substance elements are expected to leak or deteriorate during normal use. Forty years is the expected useful life of the product.



This symbol on all primary and secondary packaging indicates compliance to China standard GB 18455-2001.



South Korean Class A EMC Declaration
A 급 기기 (업무용 방송통신기자재)

이 기기는 업무용 (A 급) 전자파적합기기로서 판매자 또는 사용자는 이 점을 주의하시기 바라며, 가정외의 지역에서 사용하는 것을 목적으로 합니다.

This equipment is Class A suitable for professional use and is for use in electromagnetic environments outside of the home.

3 Software Installation and Licensing

This chapter describes how to install the VXT instrument software in Microsoft Windows 7 operating system, referred to as Windows 7.

The virtual front panel of the instrument has been designed with the keys needed to navigate windows for: accessing menus, traversing in dialogs, selecting items, and depressing displayed buttons.

The following topics can be found in this chapter:

["Getting Started with VXT Software" on page 24](#)

["Software Installation" on page 25](#)

["Keysight VXT Signal Transceiver Licensing Options" on page 33](#)

["Licensing Measurement Application Software - After Initial Purchase" on page 36](#)

["Transporting a License" on page 39](#)

Getting Started with VXT Software

The VXT software offers a standard IQ analyze measurement application and some additional measurement applications. Each application requires a license to execute the software. You may purchase additional licenses at a later date.

The VXT software supports Windows 7 64-bit/32-bit, English Version.

Download the VXT software

The VXT software is located on the VXT Software and Product information DVD (M9420-90006):

The same software is also available for downloading at the Keysight website:

www.keysight.com/find/vxt

Controller Requirement

To successfully install and run VXT software, your controller/computer should meet the following requirements.

Topic	One Module	Two Modules	Three/Four Modules
Operating system	Window 7 (64-bit), English Version	Window 7 (64-bit), English Version	Window 7 (64-bit), English Version
Processor	Single Core with hyper threading, 1.86 GHz	Dual Core with hyper threading, 1.86 GHz	Quad Core with hyper threading, 1.86 GHz
Available memory	4 GB minimum	4 GB minimum, 8 GB or greater recommended	8 GB minimum, 16 GB or greater recommended
Available disk space on Drive C:	4 GB	4 GB	4 GB

For 32-bit operating system, it is recommended to run only one VXT application instance at a time. And your controller/computer should meet the following requirements:

Topic	One Module
Operating system	Window 7 (32-bit), English Version
Processor	Single Core with hyper threading, 1.86 GHz
Available memory	4 GB minimum
Available disk space on Drive C:	4 GB

Software Installation

To install the application software, please make sure the operating system on your controller must be Windows 7 (64-bit or 32-bit).

Please refer to the procedures below to install the VXT application software in Windows 7 operating system.

1. Login the windows as administrator.
2. For Window 7 64-bit OS, right click *VXT_Installer_X.XX.XX_XXXXX_Self-Extractor_x64.exe*, for Windows 7 32-bit OS, right click *VXT_Installer_X.XX.XX_XXXXX_Self-Extractor_x86.exe*, then select "Run as administrator" to start the installation. The Installation file will be extracted first as following:

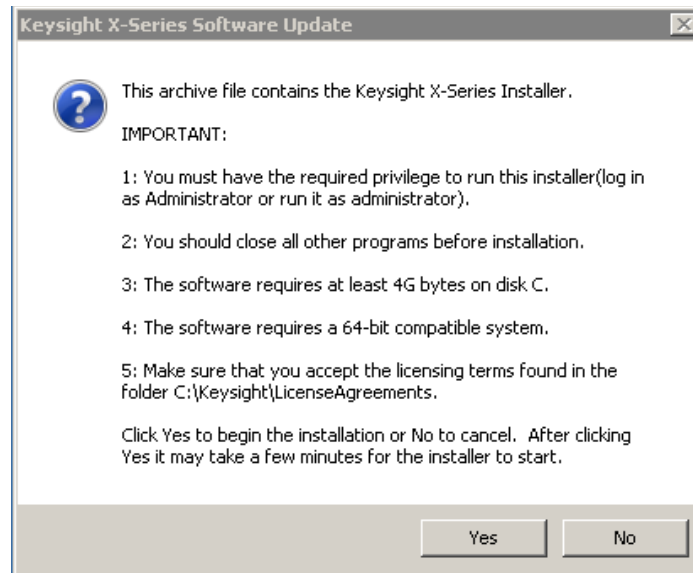

3. Click Yes to continue the installation after confirming the requirements. The installation file will be extracted as following:

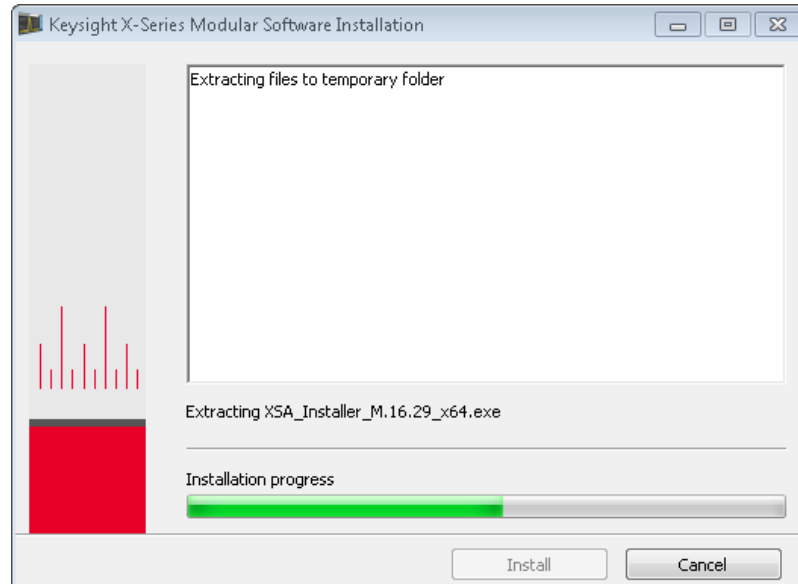

NOTE

The installer will perform requirements check after extracting. 4G Bytes free space on Drive C: is required for software installation. If there is not enough space, the requirements check will be failed. Please exit the installation, clean up your disk and try again.

4. After passing the requirements check, if a modular TRX application has been installed on the controller, the installer will uninstall the earlier version of the application first:

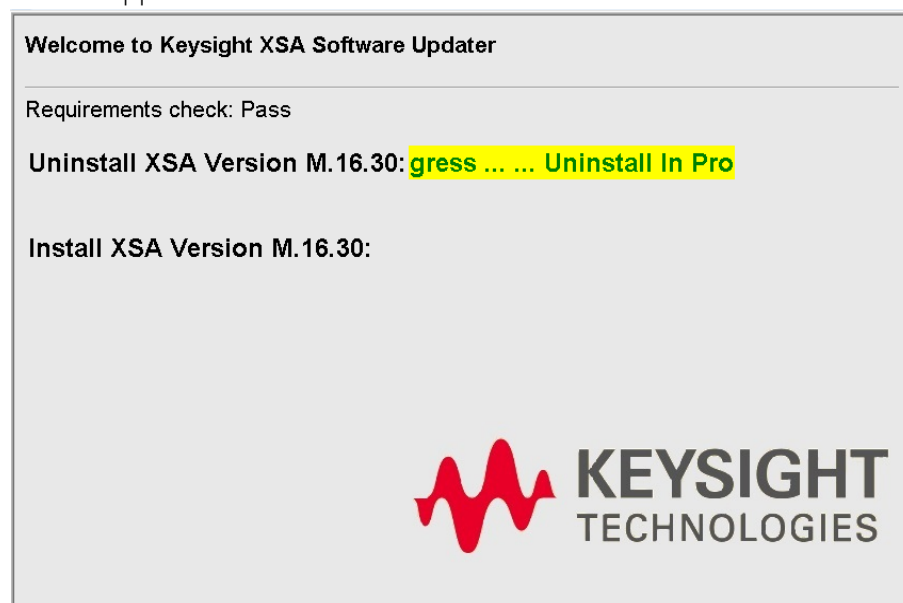

If there is not any earlier version of the modular TRX application installed, this step will be skipped.

5. After uninstalling successfully, an instruction of installing modular vector signal transceiver application will be shown as following:

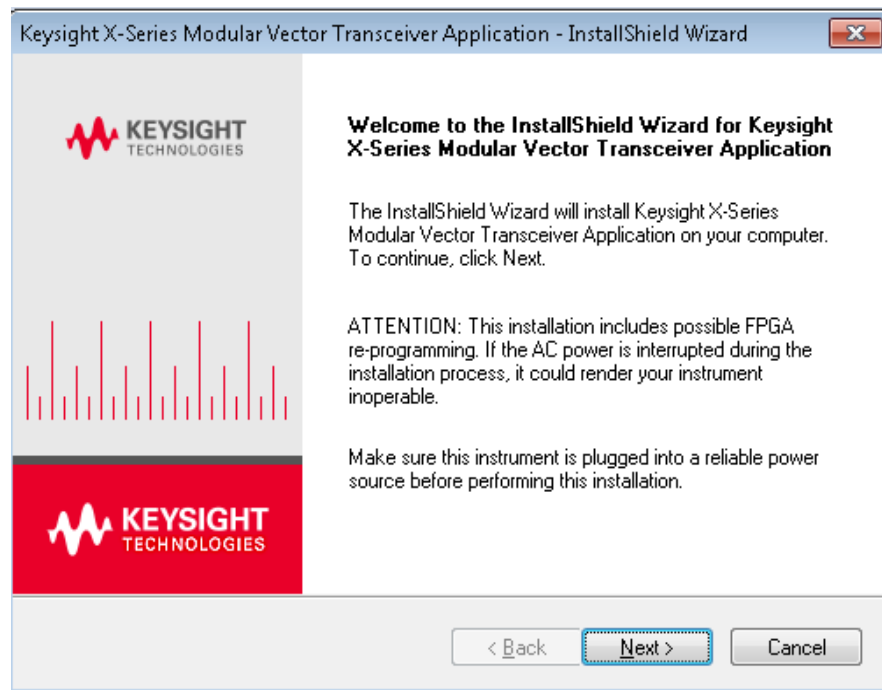
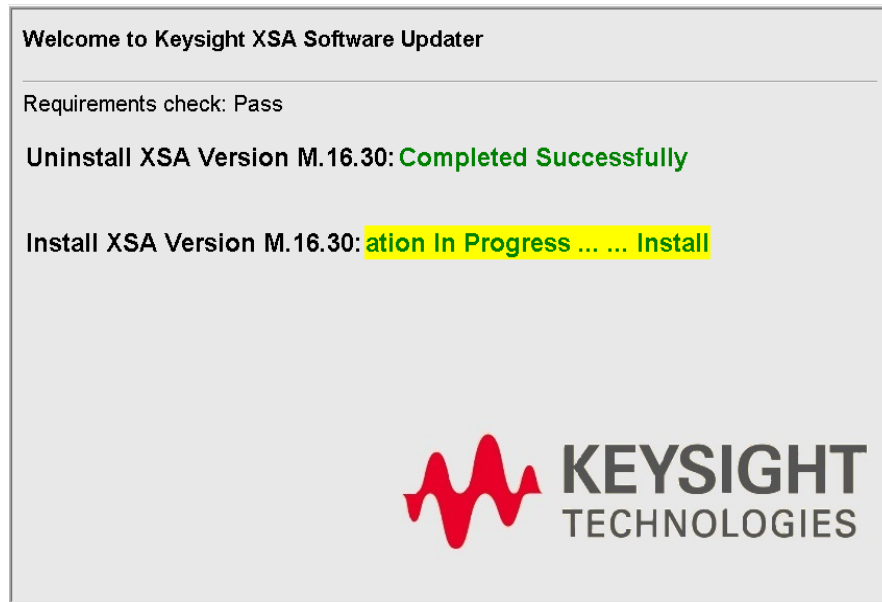

CAUTION

The installation includes possible FPGA re-programming. If the AC power is interrupted during installation process, it could render your instrument inoperable. Please make sure the chassis is plugged into a reliable power source before performing the installation.

6. Click "Next", a window of License Agreement will be shown as below. Please read the license agreement carefully and click *I accept the term of the license agreement* and click *Next* to continue the installation.

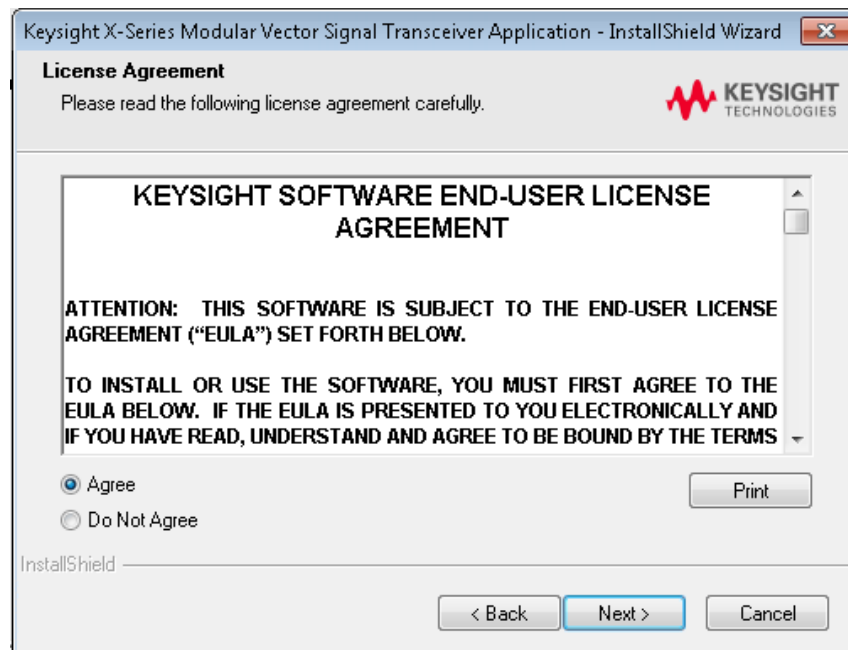

7. A message box will pop up to ask user to create shortcuts at desktop or not. If Yes is selected, two shortcuts of the applications will be created at the desktop. Then, click *Next* to continue the installation.

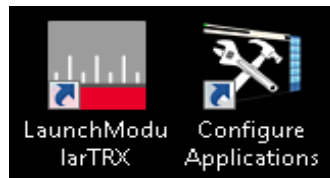

LaunchModularTRX.exe is used to launch Modular SA applications on VXT module. Please refer to "[Application Launcher](#)" on page 43 for further information.

ConfigureApplications.exe is used to configure the applications that will be loaded when the application is launching. Please refer to "[Configure Application Tool](#)" on page 42 for further information.

8. InstallShield Wizard is ready to begin installation, click "Install" to install the Modular Vector Signal Transceiver Application:

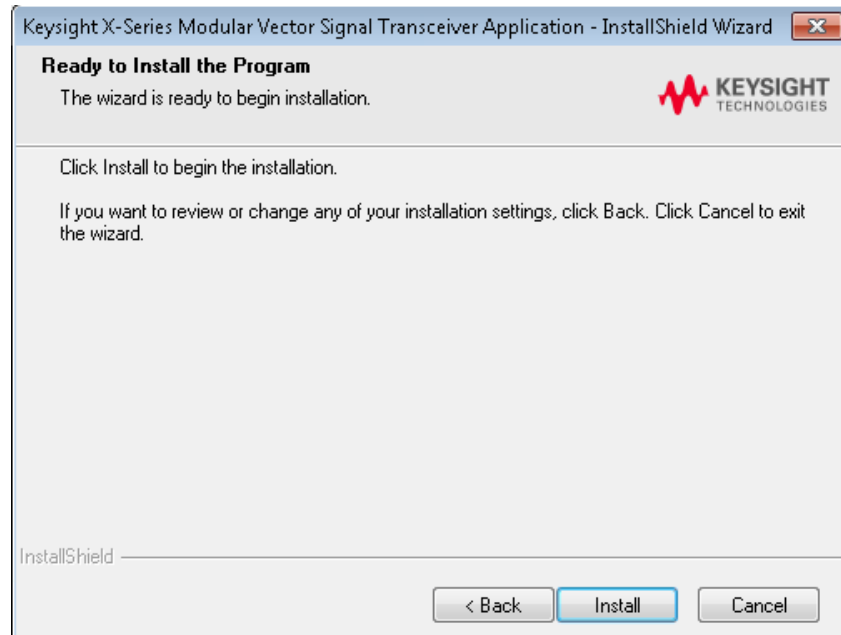

9. The installation process will be shown as below:

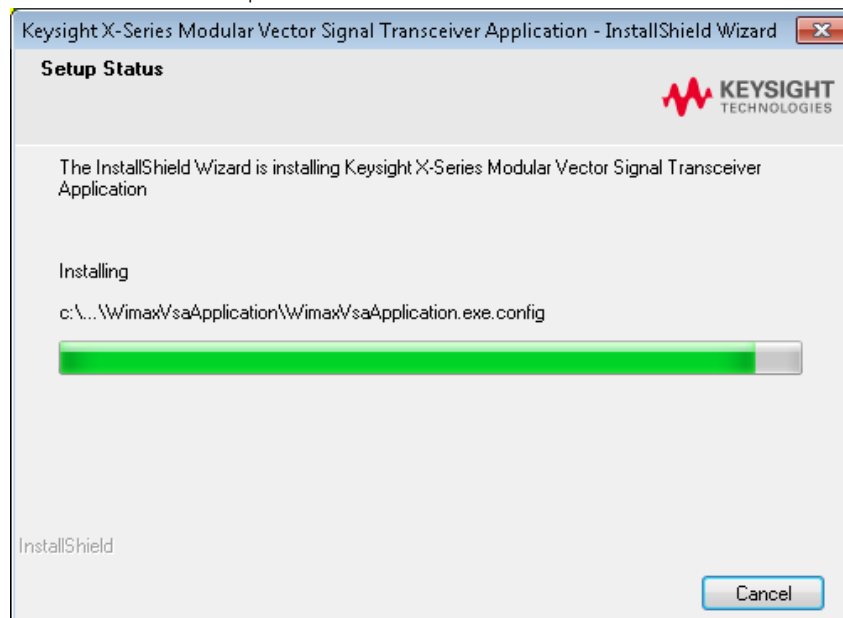

NOTE

During installation process, some prompt boxes and windows will pop up. If any FPGA version on installed module is different with the version required by current Modular TRX, FPGA on that module will be updated during the installation process. If FGPA is updated by installation process, please power off the chassis and then power on to make the FPGA update take effects.

NOTE

If the installation is failed, a window will pop up with possible root causes information. Please check the message and follow the instruction to recover the installation accordingly.

10. Restart the computer/controller now or later to complete the installation.



• If FPGA is updated successfully during installation process, a prompt box will pop up as below. Click "Finish" to complete the installation process. Power off and then power on the chassis to make the FPGA update take effect.

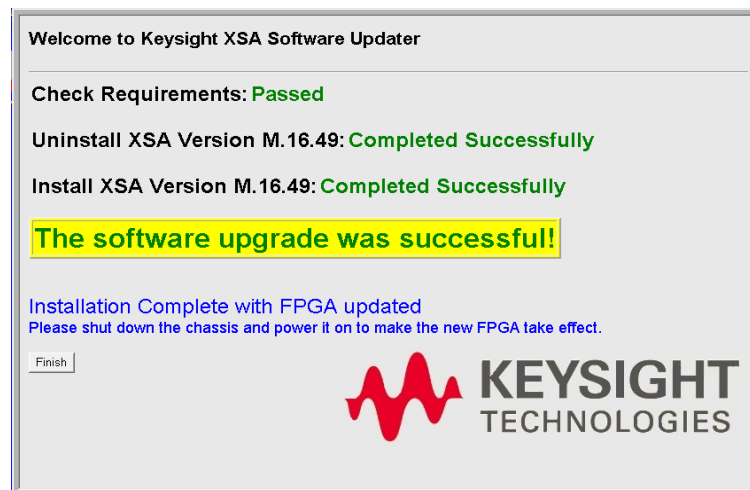

Uninstalling the Software

You can uninstall the software from the *Uninstall or change a program* window. Click *Control Panel -> Programs and Features* to show the window, and select *Keysight X-Series Modular Vector Signal Transceiver Application* and click *Uninstall* to start the process.

The following items will not be removed after the uninstallation is completed.

- User saved files
- FPGA

If Installation Fails

If anyone of the following conditions are not met, the software installation will be failed.

- Disk space is not enough
4 GB free space on drive C: is required for software installation. If there is not enough space, the requirements check will be failed. Please clean up your disk and try again.

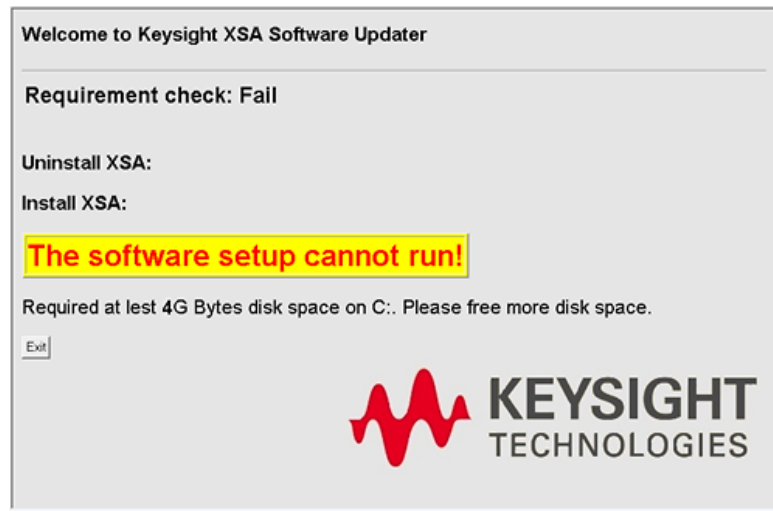

- Not run as administrator

The message below will pop up if you do not run the program as administrator.

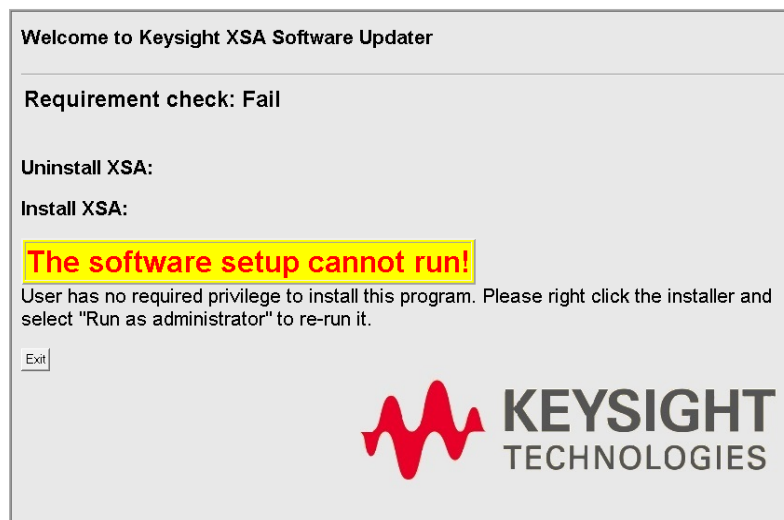

Please right-click on the program icon, select "run as administrator" as below.

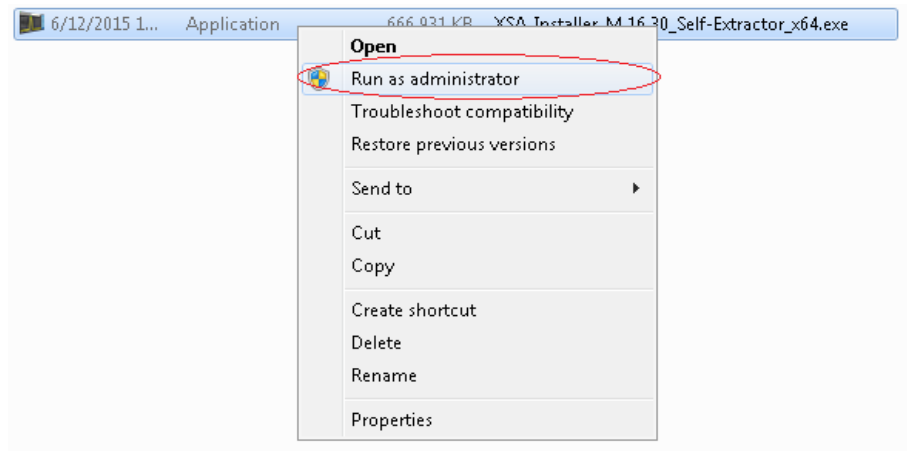

- Components installation failure

Software installation includes the following sub-components installation:

- IO library
- HPP
- License manager
- License service
- LXI server

If the components is not installed properly, the following message will be shown for issue tracking. Please restart the controller and re-install the software.

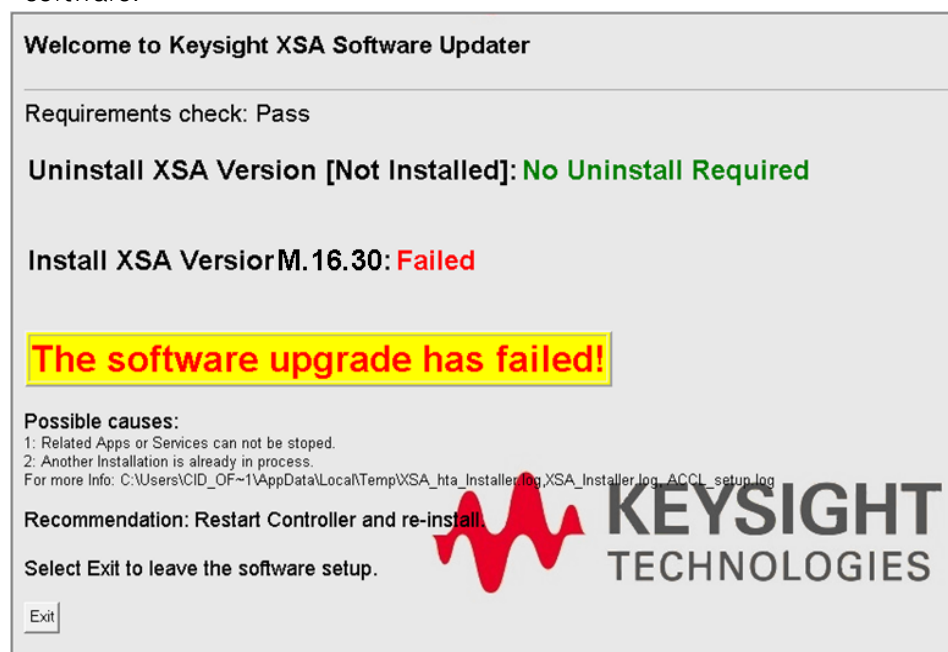

Keysight VXT Signal Transceiver Licensing Options

How to Get a License

By using the entitlement certificate (See following figure) delivered with your module or received in your email, you can log on to Keysight's License website and redeem your license now.

KEYSIGHT TECHNOLOGIES Keysight Order Number: 3455982
Keysight Certificate Number: ZBDX-AGW3

Option Upgrade Entitlement Certificate

This certificate is evidence of the entitlement for the following

Product	Description	Quantity
N9080B-1TP	LTE-FDD measurement application, transportable perpetual license	1
N9080B-2TP	LTE-Advanced FDD measurement application, transportable perpetual license	1
N9082B-1TP	LTE-TDD measurement application, transportable perpetual license	1
N9082B-2TP	LTE-Advanced TDD measurement application, transportable perpetual license	1

INSTRUCTIONS:
HOW TO REDEEM YOUR LICENSE

Log into Keysight's licensing website at www.keysight.com/find/softwaremanager to redeem your license. You will need the following information:

- Keysight Order Number and Keysight Certificate Number from the top of this certificate
- Host ID (Model/Product Number and Serial Number of your instrument - press System, Show, System)

For technical and sales support, visit www.keysight.com/find/contactus.

Rights and restrictions on the use, transfer, and copying of the Software are set forth in Keysight Technologies' Software License agreement.
CID: 4003 Page 1 of 1

5964-5178

You will need the entitlement certificate plus information outlined below about your controller to redeem your licenses using the Internet at the URL shown in the lower left of the Certificate. When you redeem the licenses associated with the entitlement certificate you will receive an e-mail with the license key or file(*.lic) and installation instructions.

To complete the redemption process you need:

1. The Entitlement Certificate (Keysight Order Number and Keysight Certificate Number)

2. The Host identification information (Host ID) of the controller for software license. You can obtain controller Host ID by using Keysight License Manager or by pressing *System->Show->System* from Modular SA Application.
3. Module Host ID for hardware license. You can obtain Module Host ID by using Launcher from the Module Licenses Window.

NOTE

If host ID of your controller/computer is changed, for example by re-image, the licenses installed on your controller/computer will be disabled. You should send both the original host ID and new host ID to Keysight to reproduce the licenses.

Instructions for redemption of licenses can be found on the entitlement certificate and at the following website:

<http://www.keysight.com/find/softwarelicense>

For additional licenses, please refer to following link to review what types of licenses are supported by VXT and how to get them:

<http://www.keysight.com/find/vxt>

License Types

There are two types of licenses for Keysight VXT Vector Signal Transceiver: Hardware license and software license. The License Manager is needed to install both of the two licenses on the controller.

Hardware license is the module hardware related license that need be installed on the module and only works with the module in which the hardware license is installed on. For example: 504, B1X and M05.

Software license is the software related license that is only installed on controller and can be shared among VXT modular TRX Application instances running on the controller, such as the measurement application licenses.

The Keysight VXT Vector Signal Transceiver uses two licensing types for measurement applications: Transportable Perpetual and Trial.

Transportable Perpetual

Transportable Perpetual licenses are an optional license type offering deployment duration which is not fixed to a specific instrument model and serial number. Transportable Perpetual licenses are identified in the product structure by a "T" in the second character and "P" in the third character of the option designator:

Example: N9080A-2TP

Transportable Perpetual licenses require a connection to the Keysight server only for managing the check-in/out of the license. The Keysight licensing server also provides for storage of unused licenses which have been

transported off instruments but are awaiting assignment to new instruments. The server will limit the number of transports per 30 day period per application license to 10.

Transportable Perpetual licenses require redemption and installation of the license before the first use. This allows the user to determine on which instrument to initially install the application license.

Keysight recommends that instruments be at the same instrument software release to ensure the latest code is available on each instrument so that the user experience is identical between instruments. This is particularly important when transporting the license for a newly-released application which may only be available in the latest software release.

Trial licenses

Trial licenses are available so that you may try applications before you buy the full applications. These licenses are time limited for a 30 day period, and are restricted to one trial for an individual application per instrument. The restriction is enforced through the license redemption process of the Keysight Software Licensing (ASL) system.

Trial licenses are only available for measurement applications and not available for enabling hardware capability.

Trial licenses are not installed in the factory and no entitlement certificates are created for distribution with new instrument shipments. Trial licenses are not available for order, but are available from the Keysight Web site after completing a brief registration:

http://www.keysight.com/find/xseries_trial

Trial Licenses are identified by the license designator “-TRL”.

Example: N9080A-TRL

If a product has multiple tiers (levels of functionality), the -TRL license enables all tiers for the duration of the license. If you have a base tier and want a trial license for a higher tier, you can install the -TRL license. When the duration expires the entitlement is reverted back to the base tier.

Licensing Measurement Application Software - After Initial Purchase

Additional measurement application software can be ordered after your initial purchase of the signal transceiver. Software upgrades are provided in a kit that includes an option based Entitlement Certificate and a license agreement. The licenses are downloaded from the license Web site onto a USB storage device so they can be loaded into the instrument.

For all software upgrades, we recommend that the latest version of the instrument software be installed. This ensures that the measurement application being licensed and activated is installed and is the most current version.

The latest revision of the software may be downloaded from:

<http://www.keysight.com/find/vxt>

NOTE

No calibration is required after a measurement application installation.

Install License by Using a USB Storage Device

Please refer to the procedures below to install a measurement application license with a USB storage device on the controller:

Step	Action	Notes
1. Redeem the Option Upgrade Entitlement Certificate	Follow the instructions on the Certificate	After redeeming your Option Upgrade Entitlement Certificate you will receive an e-mail with an attached License File.
2. Save the license file	Save the .lic file to the root directory of a USB storage device	
3. Load the license file	Connect the USB storage device to the USB ports of controller/computer. Make sure Keysight License Manager is running on your controller/computer.	The signal transceiver will automatically load the license file. (This may take a few minutes) Upon completion, the Keysight License Manager will display a "Successful License Installation" message.

Alternatively the license file can be manually installed over USB or LAN by placing the license file in the following folder on the controller/computer.
C:\Program Files\Keysight\licensing

Step	Action	Notes
4. Verify installation	<p>Launch Modular TRX application.</p> <p>Click Utility, System, Show, System.</p> <p>Verify that the new application appears in the list.</p>	<p>This displays the list of installed applications.</p> <p>If you require further assistance, please contact the Keysight support team.</p> <p>Online assistance: http://www.keysight.com/find/assist</p> <p>If you do not have access to the Internet, contact your local Keysight Technologies Sales and Service Office.</p>

Install License by Using License Manager

For the user who is not available to use the USB storage device, the license manager can be used to install the license through network. The License Manager is installed while the VXT software is installed. Please follow the following steps to install the license with License Manager:

1. Follow the procedures above to redeem the license.
2. Place the license file either on a network-connected driver or any other place where the controller can access it.
3. Starting License Manager.

To start Keysight License Manager from the Windows Start menu, click the Windows Start button, and then select: *All Programs > Keysight License Manager > Keysight License Manager*. Refer to the following figure for overview of License Manager GUI.

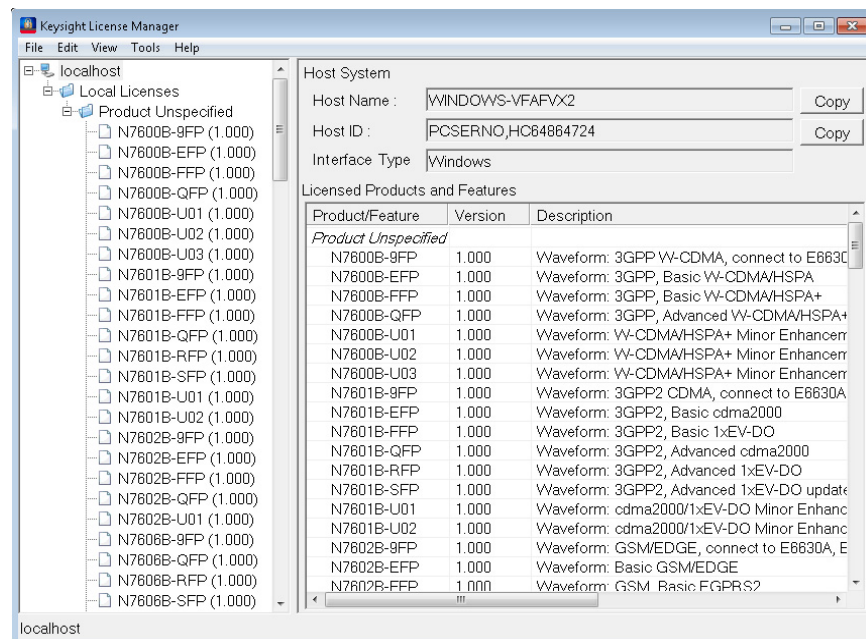

Keysight License Manager provides a graphical user interface (GUI) that gives you a visual representation of the installed licenses on your controller.

The Tree View is the left pane. The selected node in the Tree View affects the displayed information in the Details View (right pane). The Details View is used to view and manage licenses for a system, or to view and manage alerts associated with time-perishable licenses.

4. Select the target system's node in the tree view.
5. Click File menu in License Manager, and then select Install License(s). An Install License File(s) window pops up.
6. In this window, browse to the license file location, select the license file(s), and then click the Open button.

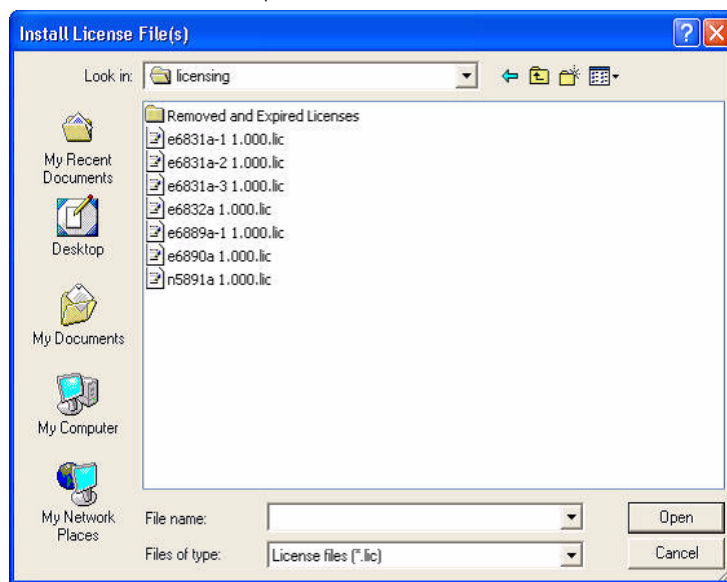

The license is automatically installed (from the previously selected license file) and now appears in the Tree View as an installed license under the system. Note that the install operation takes some time to complete (up to 30-40 seconds).

To complete hardware licensing, please refer to ["Hardware License Installation" on page 48](#).

Transporting a License

Transportable licenses can be identified by the letters "TP" in their option designator. For example, N9082A-2TP indicates the license is transportable and perpetual. To transport this license from one controller to another, Keysight recommends that both controllers be at the same software release. This ensures that the user experience is identical between controllers. As a minimum, the target system must at least be able to support the desired application.

The VXT vector signal transceiver support several ways of transporting licenses. The procedure below will focus on the most common procedure, where neither of the controller has access to an Internet connection. We will refer to the controller from which the transportable license will be removed as the "source system/controller". We will refer to the controller which will receive the transportable license as the "target system/controller".

Keysight recommends that the system running Keysight License Manager is connected to the Internet, and connected to both the source system and target system, which are connected to a LAN. If you do not have this recommended network configuration, see the Keysight License Manager Help for details on how to transport a license.

If you have the recommended network configuration implemented, you can easily transport a transportable license by performing the following procedure:

1. In Keysight License Manager, have both the source system and target system connected and visible in the Tree View.
2. In the Tree View, expand the source system's Installed Licenses node so that all installed licenses are visible.
3. In the Tree View, drag the transportable license from the source system to the target system's IP address/hostname node.

The license is automatically transported from the source system to the target system, and it now appears under the target system's installed licenses in the Tree View. Note that the transport operation takes some time to complete (up to 60-90 seconds) due to the Internet activity with the Keysight software-license- redemption procedure.

If either the source system or the target system is not visible in the Tree View because the Tree View's displayed area is too small to contain both systems, you can transport a license by cutting and pasting the transportable license. (That is, cut the license from the source system, scroll to the target system, and then paste the license into the target system.)

4 Launching Modular TRX Application

This chapter provides the information on how to launch a Modular TRX application with topics below.

["Configure Application Tool" on page 42](#)

["Application Launcher" on page 43](#)

["Launching Modular TRX Application with Launcher" on page 49](#)

Configure Application Tool

The program *ConfigureApplications.exe* on the desktop allows you to configure certain behaviors of the applications (Modes). When this program runs, it affects the behavior at Modular TRX application startup. If you run it while the Modular TRX application is running, it will take effect the next time the Modular SA application starts up.

Double-click on this icon *Configure Applications.exe*. If there are multiple modular products installed, the modular product selection window will pop up. Please select the wanted modular and the following dialog will pop up:

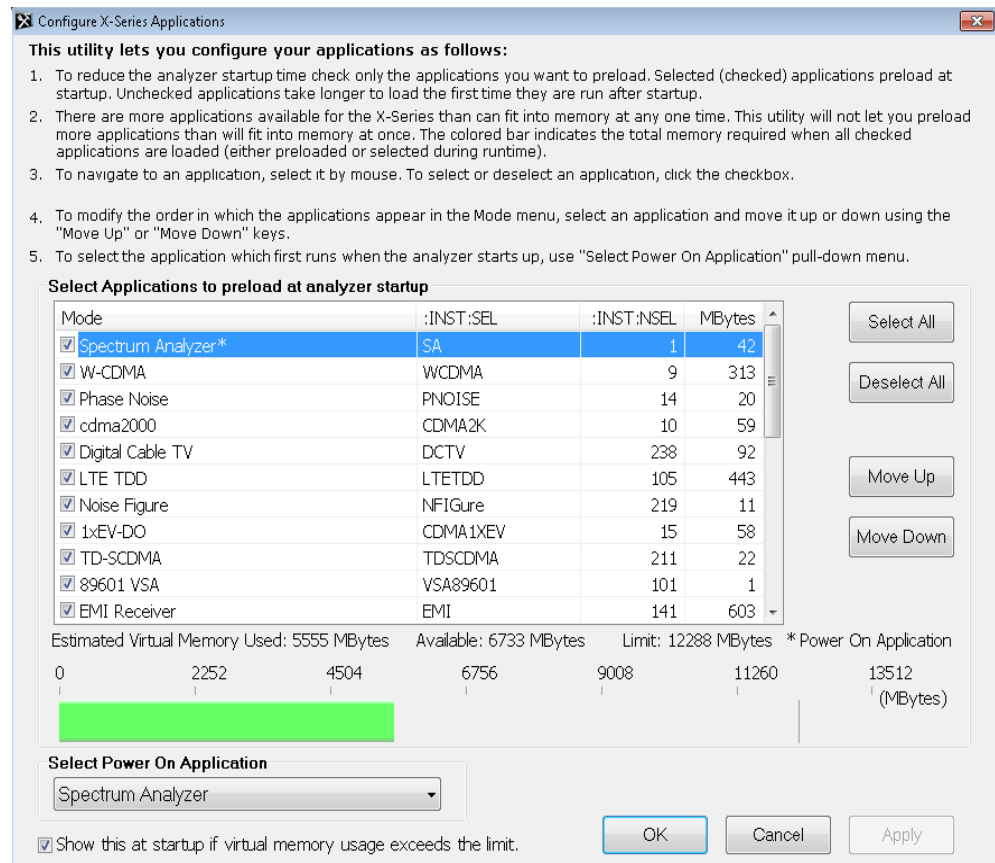

Follow the instructions in this dialog to configure your applications as desired.

For multiple instances of the Modular TRX Application on the same computer/controller, the same Configure Applications Utility is shared between all the instances, the same application configuration will be used on each application instance. The required memory shown on the panel is just for one Modular TRX Application instance.

NOTE

The IQ Analyzer Measurement Application is standard for VXT without license required. The additional measurement applications are available. Each application requires a license to execute the software.

Application Launcher

The VXT Launcher is a tool for invoking the Modular TRX applications for one or multiple modules. It is also used to update the FPGA and install module hardware license.

Before launching any application, install the VXT module into the chassis.

Start Launcher

Please click  start Launcher from the desktop, or start it from *Windows Start > All Programs > Keysight Modular Transceiver > LaunchModularTRX*.

Hardware License Installation

Launcher starting process will check if there is any hardware license available for the installed modules. If there is any hardware license installed In License Manager but not upgraded to module hardware, the launcher will check the hardware license and update the license to the module. A prompt box will be shown as below when hardware license is upgrading:

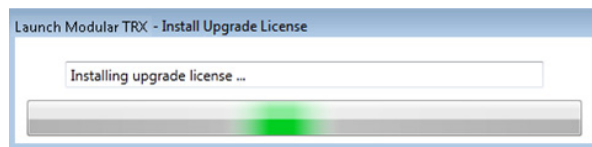

After hardware license upgrades successfully, it will be removed by License Manager. After the Launcher UI is displayed, the installed option number and on which module will be displayed on status bar:

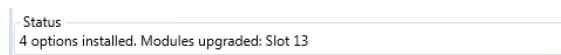

FPGA Updating

Launcher will check the FPGA versions on all the installed modules. The following message box will pop up when Launcher is verifying FPGA on new found module.

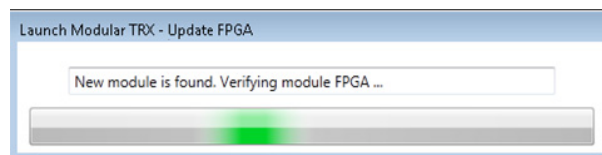

If the FPGA version is different with the version required by current Modular TRX, the FPGA on this module will be updated automatically. During the FPGA updating, a message box will be shown as following and the LED on the module will be in Fast Blink mode.

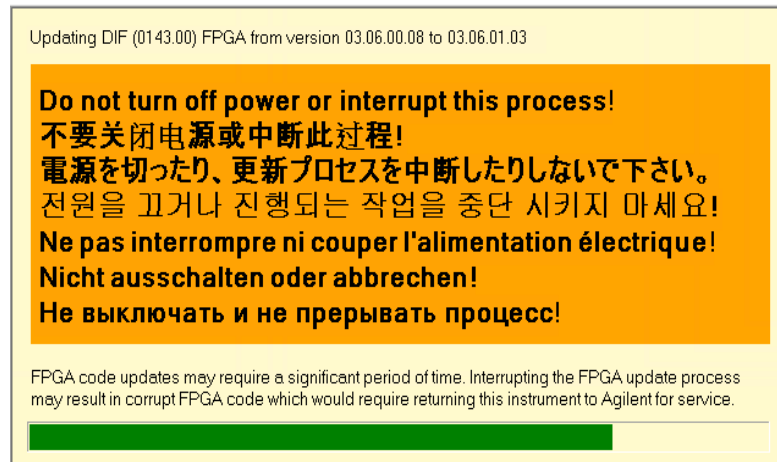

A window of "Update FPGA Status" will be shown during the FPGA update process as following to indicate the detailed update status:

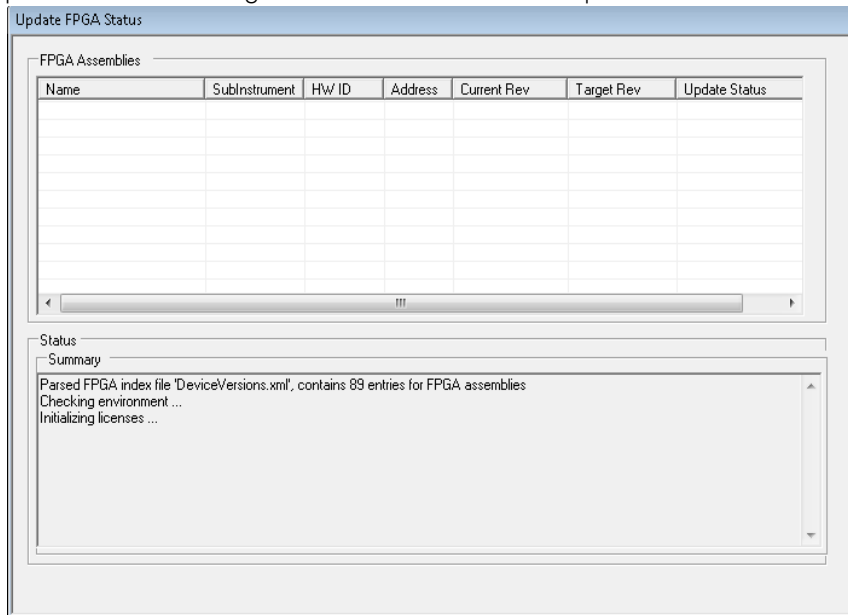

After FPGA update is completed successfully, a message box will pop up, then power off and power on the chassis to enable the update:

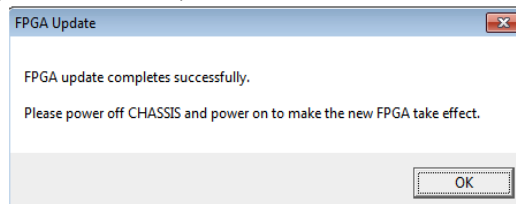

Launcher Features

Launcher UI is shown as following for the configurations and launching. The modules shown in the list include not only the modules which have been saved in configuration file but also the modules that are not saved but currently existing in the chassis.

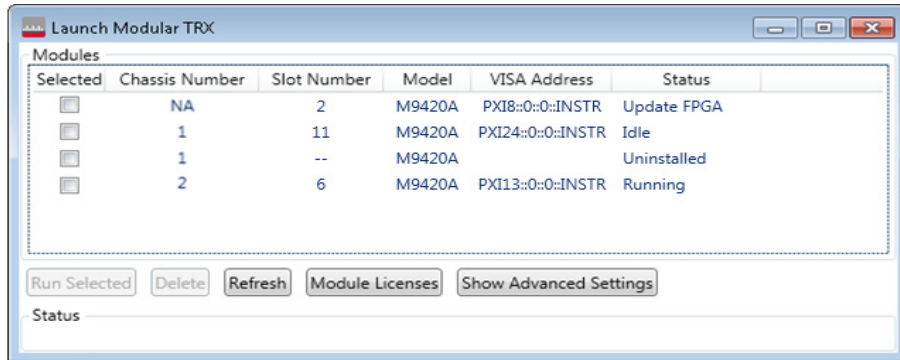

Please refer to the table below for the description of each items in the launcher.

Items	Description
Selected	Indicates whether this module is selected. If this module is selected, the check box of that module will be checked
Chassis Number	Shows the Chassis Number in which the module is inserted in. This column will only be visible when there is chassis number greater than 1. When there is only one chassis used, this column will be invisible, the panel shows as following: <div data-bbox="522 1106 1183 1409" data-label="Image"> </div> <p>If there is more than one chassis used, Chassis Number information will also be shown as a part of application title information, such as:</p> <div data-bbox="529 1514 1187 1551" data-label="Image"> </div> <p>For the module which is uninstalled, the Chassis Number is shown as "NA".</p>
Slot Number	Shows the Chassis Number in which the module is inserted in. For the module which is uninstalled, the Slot Number is shown as "NA". Slot number will be shown as a part of application title information.
Model	Shows the model name of the module.
Visa Address	VISA address string for the module. If the module is uninstalled, the VISA address will be shown as "NA".

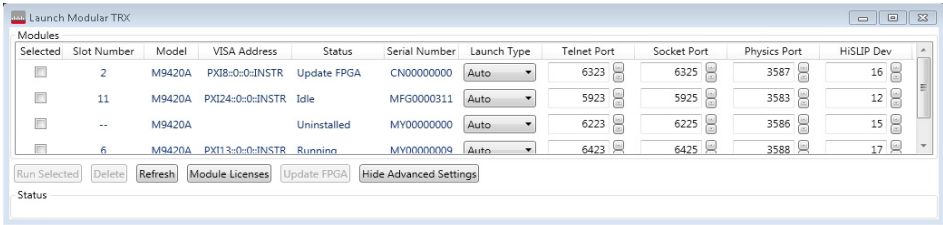
Items	Description
Status	<p>It indicates the status of each module as following:</p> <ul style="list-style-type: none"> - Idle: The module is in Idle state, no application running or FPGA updating with the module. It can be used to launch a Modular TRX application. - Running: Modular TRX application is running with the module. You can not launch another Modular TRX application with this module. - Update FPGA: FPGA on the module is being updated, or the FPGA on the module need be updated. - Uninstalled: The module is not installed in the chassis. It is loaded from the saved configuration file but the module has been unplugged.
Run Selected:	<p>When this button is pressed, if current selected module's "Launch Type" is "Manual" Or "Auto", and the "Status" state is "Idle", the Modular TRX application will be launched and connected to the indicated VXT module. In addition, the configurations will be saved into the configure file automatically.</p> <p>You can select multiple items via ctrl or shift and left click. You can also use mouse or arrow keys to change the selected module.</p>
Delete	Delete the uninstalled module from the module list.
Refresh	Refresh the module list by searching all existing VXT modules.
Show/Hide Advanced Settings	<p>When this button is pressed, the columns of advanced settings will be shown as below, and the button will be displayed as "Hide Advanced Setting".</p>  <p>The "Update FPGA" button will be shown when the Advanced Settings is unhidden. If you press it again, the columns of advanced settings will be hidden again.</p> <p>Serial Number: Shows the serial number of the module.</p> <p>Launch Type: Configures the start-up configuration of the software for the individual VXT modules in the chassis.</p>

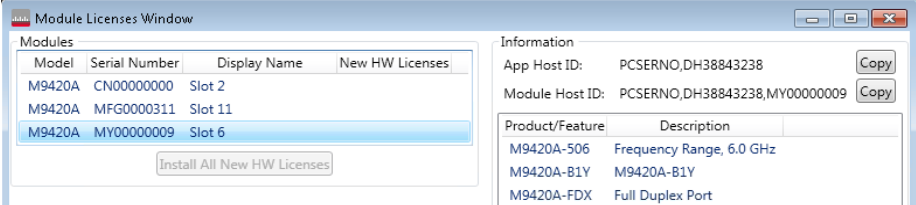
Items	Description
	<p>There are three launch types:</p> <ul style="list-style-type: none"> - Auto: If the launch type is "Auto", when you use command line to launch x application, the modular TRX application will be launched for the module. - Manual: If the launch type is "Manual", the controller will only run the Modular TRX application by pressing "Run Selected" button with the check-box for the module selected. - Disabled: If the launch type is "Disabled", the Modular TRX application will not be launched on the controller by "Run selected" button. <p>Telnet/Socket/Physics/HiSLIP Port: Sets the Socket Port, Physics Port, and HiSLIP Dev for each module in the list. For more information about these settings please refer to the Programming Guide.</p>
Update FPGA	<p>This key is available in advanced settings. It is used to update the FPGA of all the modules that are inserted in the chassis if the FPGA version on the module is different from the version required by modular TRX.</p> <p>If there is any modular TRX running on the controller, this button will be disabled and grayed out. You need to close all the modular TRX instances before updating FPGA.</p>
Module Licenses	<p>A panel of module hardware license installation will be shown by pressing this button.</p>  <p>The left pane shows a list of installed modules. The installed module hardware licenses will be shown in the right pane after you selecting one module in the left pane.</p> <p>App Host ID is for redeeming software licenses on a controller, Module Host ID is for redeeming hardware licenses for a module with a controller. You need to provide these information when you are redeeming licenses.</p> <p>Use "Copy" button to copy the selected module host information text for the selected module. The copied host information can be pasted to where the host information is needed such as getting a hardware license for the module.</p> <p>If there is any new hardware license available, the new hardware license will be shown in the "New HW licenses" column and the "Install All New HW License" button will be available to install all new hardware licenses onto modules. Please refer to "Hardware License Installation" on page 48 for details.</p>

Hardware License Installation

Hardware license is the license that works with specified hardware features, such as "FDX", "HDX". Hardware license can only work with the module that installed the license on.

Hardware license is pre-installed inside module in factory before shipment, installing HW license is only requested for HW upgrade.

Following steps shows the recommended method to install hardware license:

1. Install hardware license file on controller by using Keysight License Manager. Please refer to ["Install License by Using License Manager" on page 37](#).
2. Open launcher and click "Module License" button, the module license window with available hardware licenses you installed in step 1 will be shown as following.

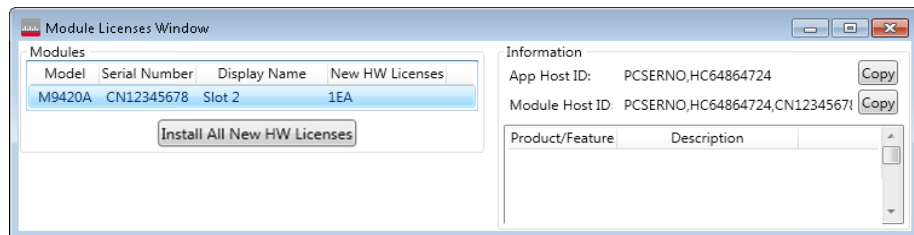

3. Click "Install All New HW Licenses" to install the hardware licenses. If there are multiple available licenses on multiple modules, all licenses on each module will be installed at same time. It will take several seconds to install the hardware licenses. After hardware license is installed successfully, the "New HW licenses" column will be empty and the "Install All New HW Licenses" button will be disabled and grayed out.
4. Click on the module in the module list which you installed the hardware license on, make sure the hardware license is installed successfully from the module information on the right of the window.

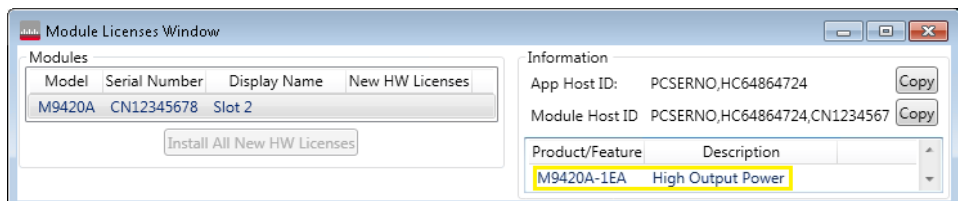

Launching Modular TRX Application with Launcher

Launch Modular TRX Application Manually

Click "Run Selected" button in Launcher to launch Modular TRX Application with one or multiple modules:

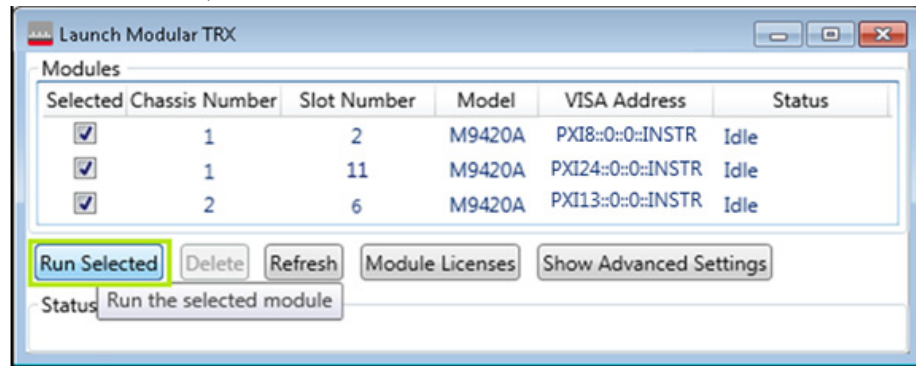

If multiple installed modules with "Idle" status are selected, multiple modular TRX application instances will run with each module after "Run Selected" button is clicked.

If module is already running via IVI driver or some other drivers, the "Run Selected" button will be disabled as below.

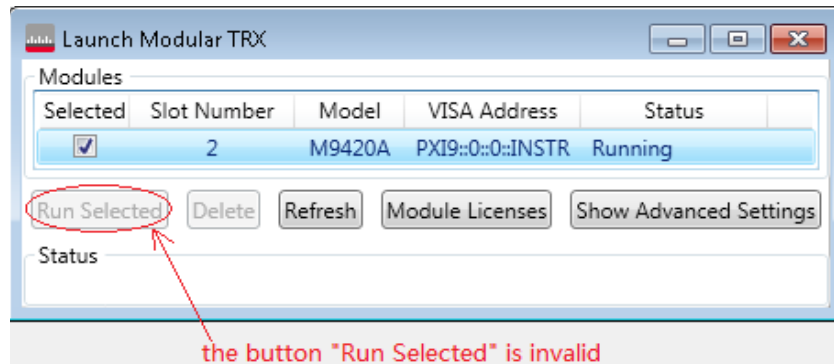

Launch Modular TRX Application Automatically

Follow the steps below to configure the argument of *LaunchModularTRX.exe* launching Modular TRX Application automatically:

1. Right click on the *LaunchModularTRX.exe* icon on desktop and choose "Properties".
2. On the pop-up Properties panel, click *Shortcut* tab and add "/Auto" or PXI VISA address of the module as argument of the target as following:

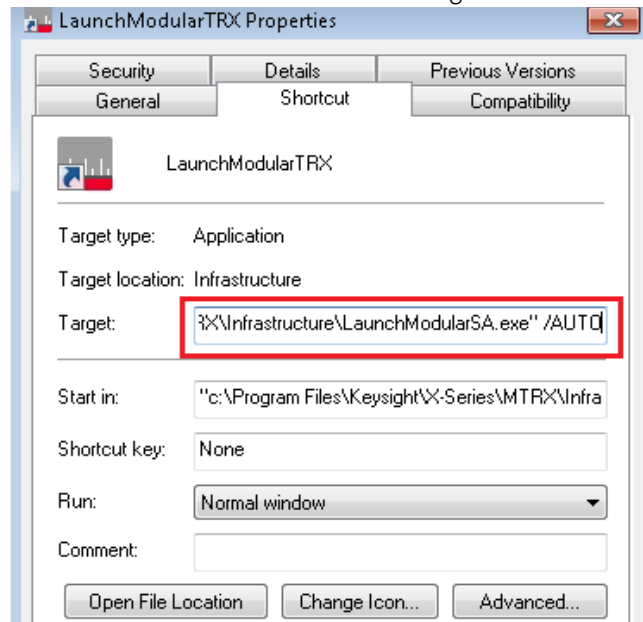

Or:

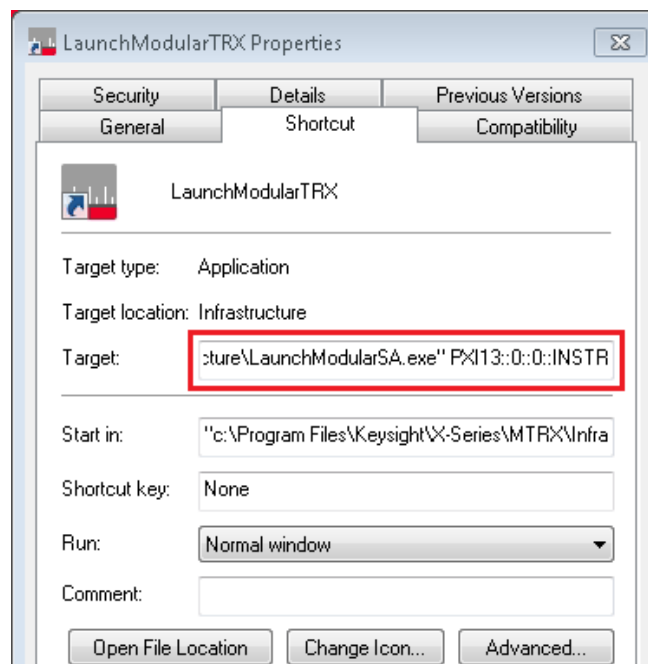

If the "/Auto" is added as argument, when the launcher is started, modular TRX application instances will be launched with all the installed modules with Launch Type of "Auto" that you configured last time from the Launcher UI. With this method you can launch multiple modular TRX application instances with multiple modules.

If PXI VISA address is added as argument, when the launcher is started, modular TRX application instance will be launched with the module with the PXI VISA address you input. With this method you can only launch modular TRX application instance with one specified module.

PXI VISA address of the module is shown in the Launcher UI as below:

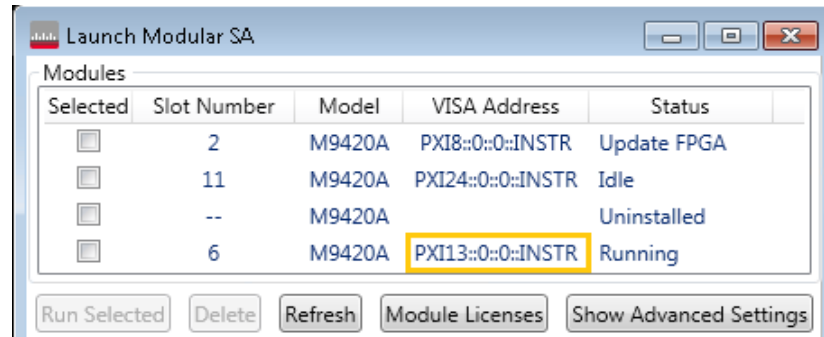

The PXI VISA address is also shown in Keysight Connection Expert as below:

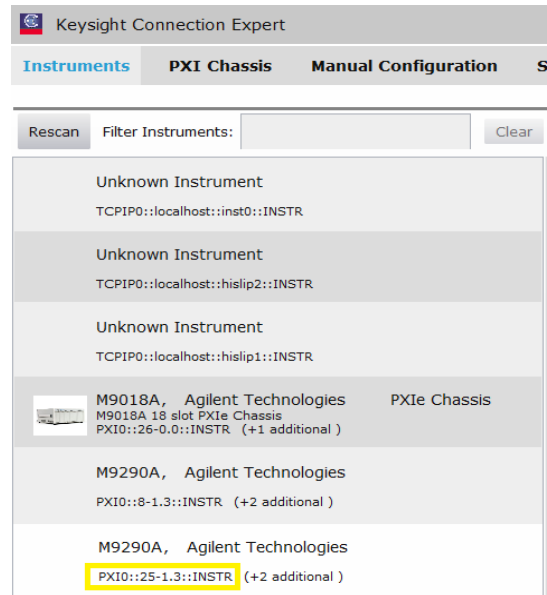

3. Click Apply and OK to apply the argument.
4. Run Launcher. If the argument is added correctly, the modular TRX application will be launched automatically without showing the Launcher UI.
5. You can drag *LaunchModularTRX.exe* with correct argument into the window startup folder, then the modular TRX application will be launched automatically when you start up the controller next time.

Launch Modular TRX Application by Programming Codes

As an execute files, you can program to launch modular TRX application by starting the launcher with correct argument. See the following example code in C#:

```
try
{
    Process process = new Process();
    process.StartInfo.UseShellExecute = false;
    process.StartInfo.FileName = "Launcher.exe";
    process.StartInfo.Arguments = "PXI8::1::3::INSTR";
    process.Start();
    process.WaitForExit();
    exitCode = process.ExitCode;
}
catch (Exception ex)
```

The argument setting could be either /Auto or PXI VISA address. For details of the argument, please refer to "[Launch Modular TRX Application Automatically](#)" on page 50.

Launch Modular TRX Application by IVI driver

Keysight IVI drivers simplify the creation and maintenance of instrument control applications in a variety of development environments. IVI drivers allow you to programmatically control your instrumentation while providing a greater degree of instrument interchangeability and code reuse. For VXT modules, you can also use IVI driver to launch the modular TRX application on the module and control to get data from the module. Please refer to Keysight IVI drivers help document for details. The help document is available in: *Start Menu -> All Programs -> Keysight Instrument Drivers -> Keysight IVI-COM-C Drivers -> KtM9420 -> KtM9420 IVI Driver Help*.

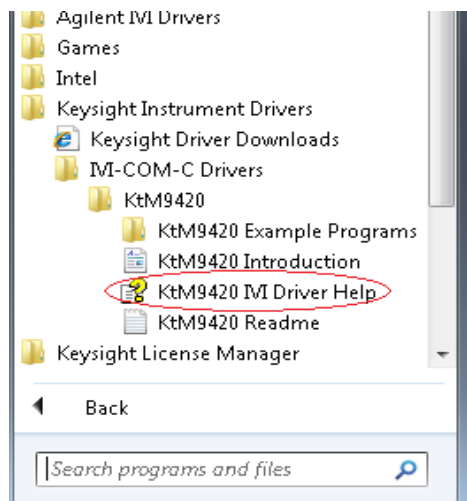

5 Running Modular TRX application

This chapter provides some guidelines for using a virtual front panel with the signal transceiver.

["Display Annotations" on page 54](#)

["Using Virtual Front Panel" on page 56](#)

["Using Right-Click Menu" on page 63](#)

["Using the Interactive Help System" on page 65](#)



["Navigating the Signal Transceiver Application by keyboard" on page 66](#)

["TCP/IP Address Configuration" on page 69](#)

Display Annotations

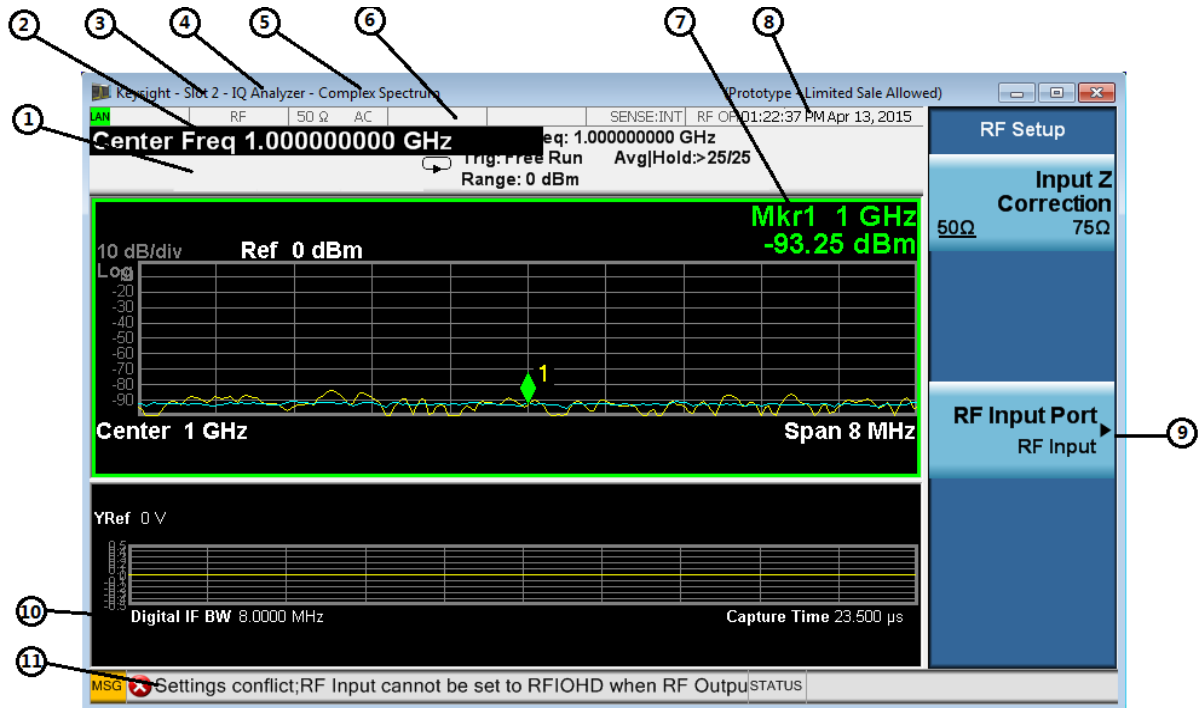
This section describes the display annotation as it is on the IQ Analyzer Measurement Application display. Other measurement application modes have some annotation differences.



Item	Description	Function Keys
1	Measurement bar - Shows general measurement settings and information.   Indicates single/continuous measurement. Some measurements include limits that the data is tested against. A Pass/Fail indication may be shown in the lower left of the measurement bar.	All the keys in the Analyzer Setup part of the front panel.
2	Active Function (measurement bar) - when the current active function has a settable numeric value, it is shown here.	Currently selected front panel key.
3	Display Name - Shows the location of the module with which the application is running. If there is only one chassis is used, it shows "Slot <number>", otherwise, it shows "Chassis <number> - Slot <number>"	None
4	Banner - shows the name of the selected application that is currently running.	Mode

Item	Description	Function Keys
5	Measurement title - shows title information for the current measurement, or a title that you created for the measurement.	Meas View/Display, Display, Title
6	Settings panel - displays system information that is not specific to any one application. <ul style="list-style-type: none"> ▪ Input/Output status - green LXI indicates the LAN is connected. RLTS indicate Remote, Listen, Talk, SRQ ▪ Input impedance and coupling ▪ Amplitude Correction Status ▪ Frequency reference selection 	Local and System, I/O Config Input/Output, Amplitude, System and others.
7	Active marker frequency, amplitude or function value	Marker
8	Settings panel - time and date display.	System, Control Panel
9	Key labels that change based on the most recent key press.	Softkeys
10	Measurement settings for the data currently being displayed in the graticule area. In the example above: center frequency, resolution band width, video band width, frequency span, sweep time and number of sweep points.	Keys in the Analyzer Setup part of the front panel.
11	Displays information, warning and error messages. Message area - single events, Status area - conditions.	System, Show, Errors

Using Virtual Front Panel

The VXT virtual front panel is a software equivalent of the key set, which provides the control access to instrument. In VXT, there are two virtual panel mode: attached mode and floating mode. The attached mode of virtual panel is shown as below.

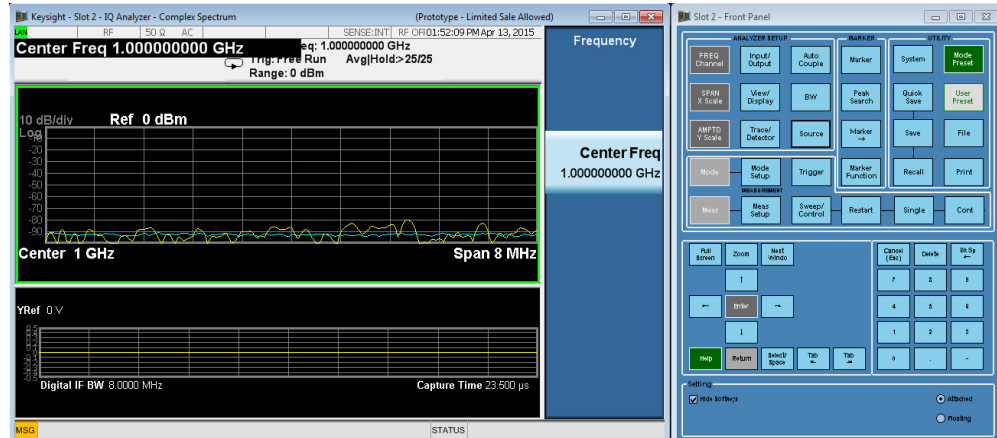

In "Attached" mode, the virtual front panel attaches to the main application window. When you move, resize, or minimize the main application window, the virtual front panel window will be moved, resized, or minimized at the same time. When you maximize the main application window, the virtual front panel will be changed to "Floating" mode automatically. The operations to virtual front panel window, such as resizing, minimizing and maximizing, will not affect the main application window. The front panel window cannot be moved separately in "Attached" mode.

You can also change virtual front panel from "Attached" mode to "Floating" mode manually by clicking "Floating" option at the lower right corner of the window. By clicking the "Attached" option, it can return to the "Attached" mode.

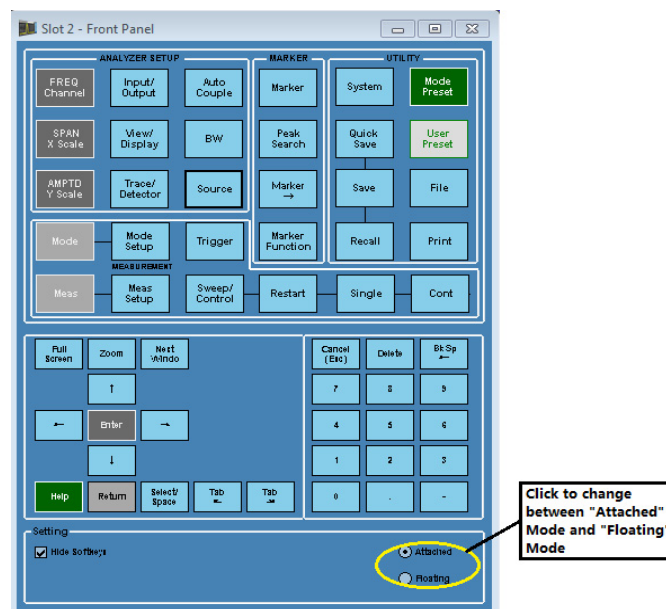

When virtual front panel is changed to "Floating" mode, the main application window and virtual front panel are shown as following:

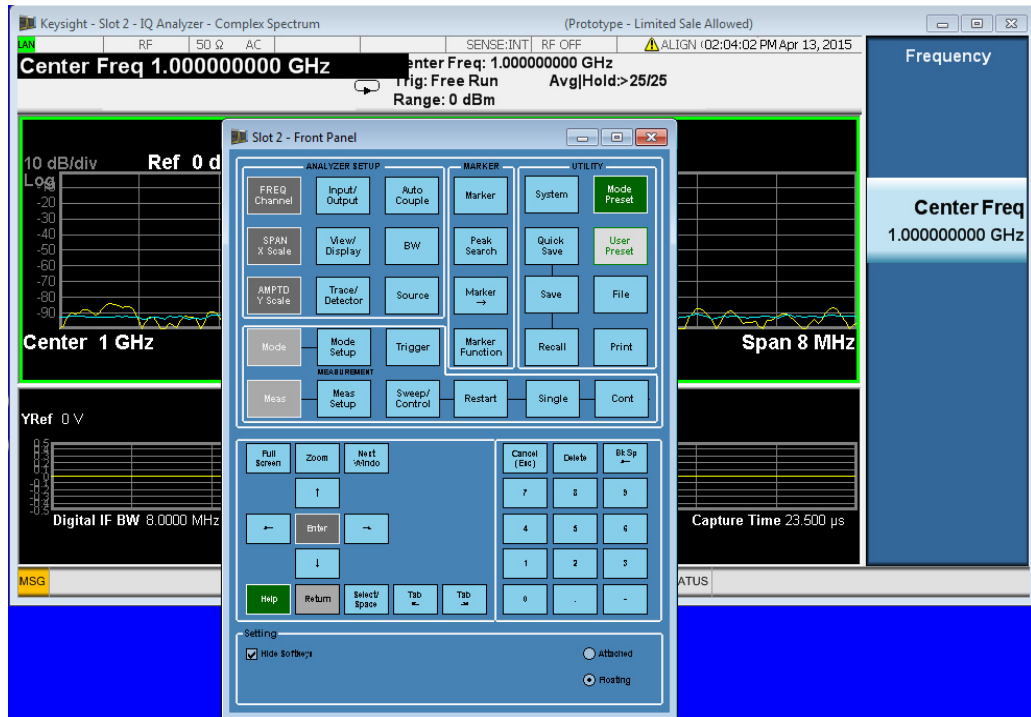

In "Floating" mode, main application window and virtual front panel window are two separated panels. Moving or resizing one window will not affect the other window. If main application window is in maximum size, changing virtual front panel from "Floating" mode to "Attached" mode will resize main application window back to the size before it is maximized.

Unhide/Hide Soft Keys

There is also another configuration to unhide or hide the soft keys on Virtual Front Panel. The soft keys are hidden by default. By clicking "Hide Softkeys" on the bottom of the panel, you can unhide or hide soft keys. When soft keys are shown, Virtual Front Panel shows as following:

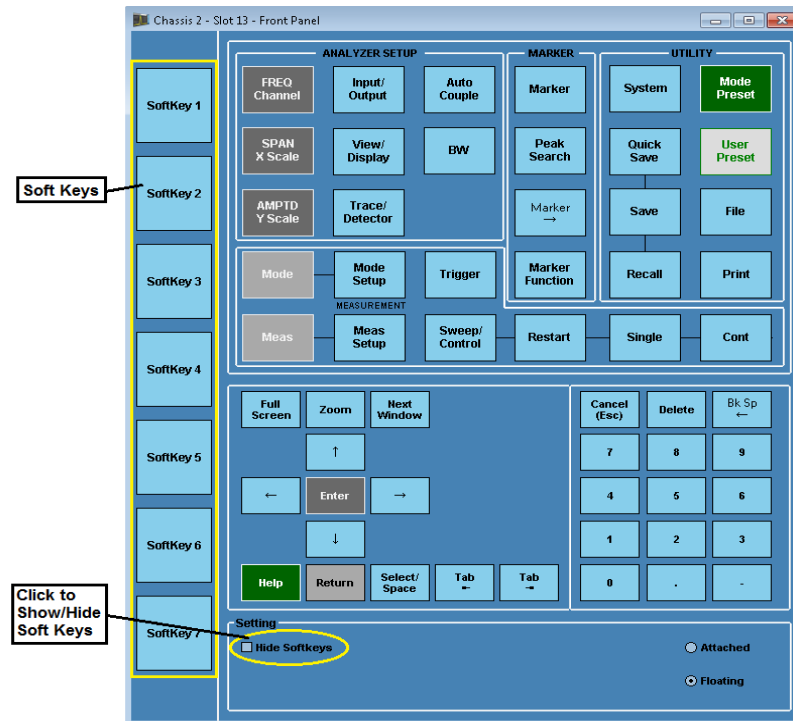

Open Virtual Front Panel from Right-Click Menu

Anytime when you close the main application window, the virtual front panel will be closed as well. To gain more display space on the screen you can close the virtual front panel. (Closing the virtual front panel will not affect the main application window.) After you close the virtual front panel window, you can reopen it from the right-click menu as following:

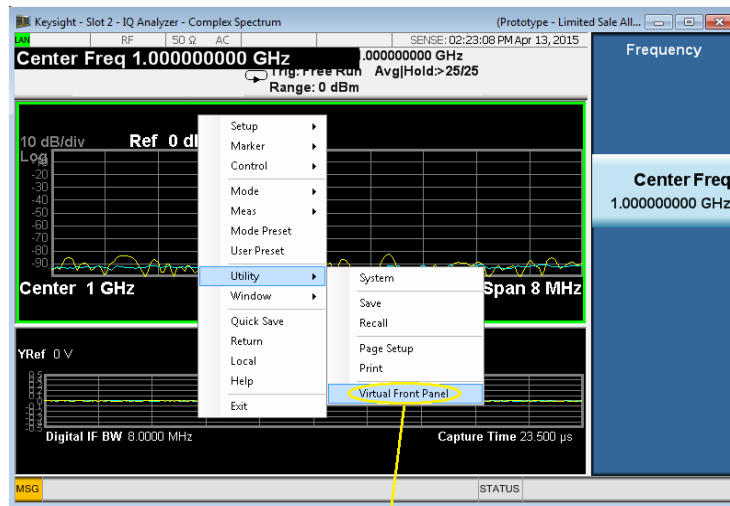

Show Virtual Front Panel from Right - Click Menu

Virtual Front Panel for Multiple Modules

When there is more than one applications running on the controller, in "Attached" mode you can easily associate the main application window and Virtual Front Panel window because there are attached together; In "Floating" mode you can also associate the main application window and Virtual Front Panel window by the window title information. Main application window and Virtual Front Panel window have the same Display Name as following:

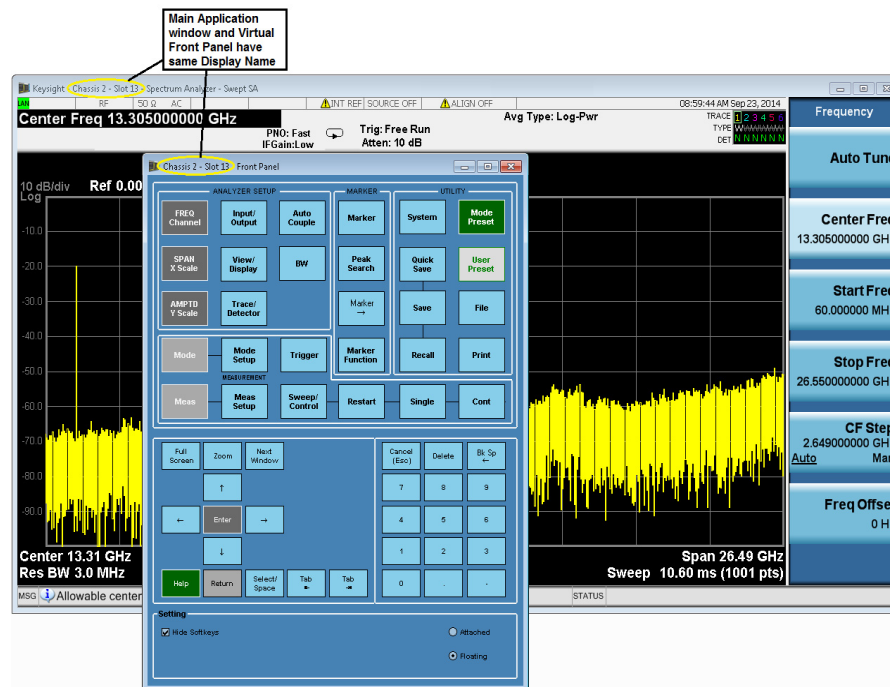

Virtual Front Panel Keys Definition

The control keys on the Virtual Front Panel are grouped as following:

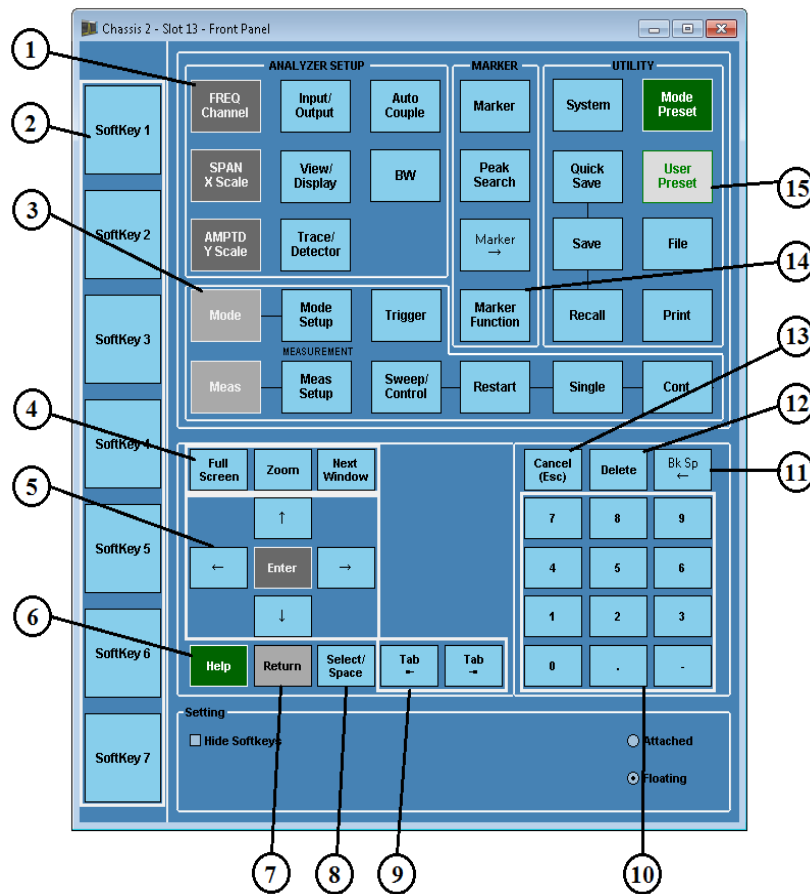

When you click a button on the Virtual Front Panel, it performs the operation as following table:

Item		Description
#	Name	
1	Analyzer Setup Keys	The keys set the parameters used for making measurement in the current Mode and Measurement.
2	Menu Soft Keys	Key labels appear to the left of the menu keys to identify the current function of each key. The displayed functions are dependent on the currently selected Mode and Measurement, and are directly related to the most recent key press.
3	Measurement Keys	These keys select the Mode and the Measurement within the mode. They also control the initiation and rate of recurrence of measurements.

Item		Description
#	Name	
4	Full Screen and Window Control Keys	<ul style="list-style-type: none"> ▪ Pressing "Full Screen" key turns off the softkeys to maximize the graticule display area. Press the key again to restore the normal display. ▪ Window Control Keys select between single or multiple window displays. They zoom the current window to fill the data display, or change the currently selected window. They can be used to switch between the Help window navigation pane and the topic pane.
5	Enter and Arrow Keys	<p>The Enter key terminates data entry when either no unit of measure is needed, or you want to use the default unit.</p> <p>The arrow keys:</p> <ul style="list-style-type: none"> ▪ Increment and decrement the value of the current measurement selection. ▪ Navigate help topics. ▪ Navigate or make selections within Windows dialogs. ▪ Navigate within forms used for setting up measurements. ▪ Navigate within tables.
6	Help Key	Initiates a context-sensitive Help display for the current Mode. Once Help is accessed, pressing a front panel key brings up the help topic for that key function.
7	Return Key	Exits the current menu and returns to the previous menu. Has typical PC functionality.
8	Select/Space Key	Select is also the Space key and it has typical PC functionality. For example, in Windows dialogs, it selects files, checks and unchecks check box, and picks radio button choices. It opens a highlighted Help topic.
9	Tab Keys	Use these keys to move between fields in Windows dialogs.
10	Numeric Keypad	Enter a specific numeric value for the current function. Entries appear on the upper left of the display, in the measurement information area.
11	Back Space Keys	Press this key to delete the previous character when entering alphanumeric information. It also works as the Back key in Help and Explorer windows.
12	Delete Key	Press this key to delete files or to perform other deletion tasks.

Item		Description
#	Name	
13	Local/Cancel (Esc) Key	<p>If you are in remote operation, Local:</p> <ul style="list-style-type: none"> " Returns instrument control from remote back to local (the front panel). " Turns the display on (if it was turned off for remote operation). " Can be used to clear errors. (Press the key once to return to local control, and a second time to clear error message line.) <p>If you have not already pressed the units or Enter key, Cancel exits the currently selected function without changing its value.</p> <ul style="list-style-type: none"> " Esc works the same as it does on a PC keyboard. It: " Exits Windows dialogs " Clears errors " Aborts printing " Cancels operations.
14	Marker Keys	Markers are often available for a measurement to measure a very specific point/segment of data within the range of the current measurement data.
15	Utility Keys	<p>These keys control system-wide functionality such as:</p> <ul style="list-style-type: none"> ▪ instrument presets ▪ instrument configuration information and I/O setup ▪ printer setup and printing ▪ file management, save and recall

Using Right-Click Menu

Besides the virtual front panel, you can also access the keys from Right-Click menu. If you plug in a mouse and right-click on the transceiver screen, a menu will appear as below:

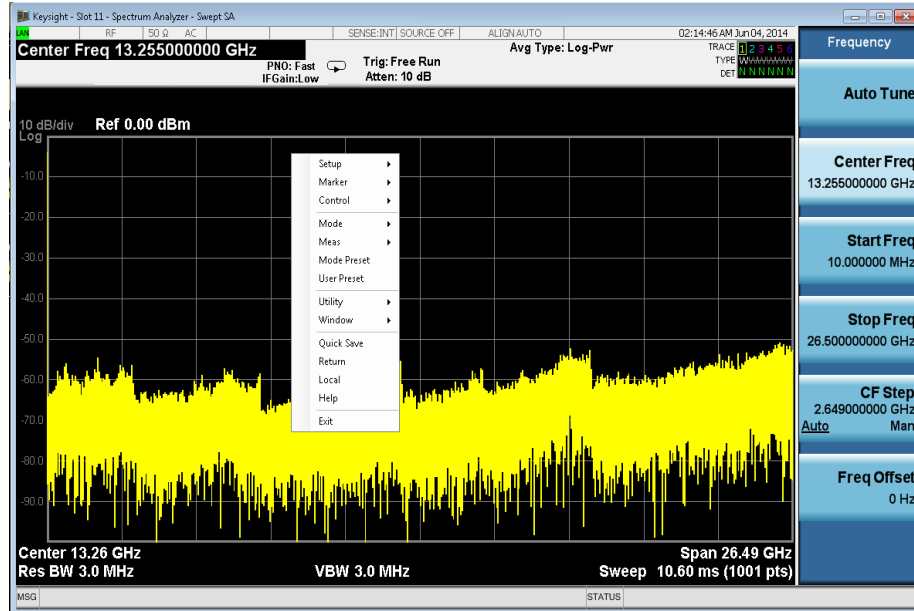

Placing the mouse on one of the rows marked with a right arrow symbol will cause that row to expand, as for example below where the mouse is hovered over the "Utility" row:

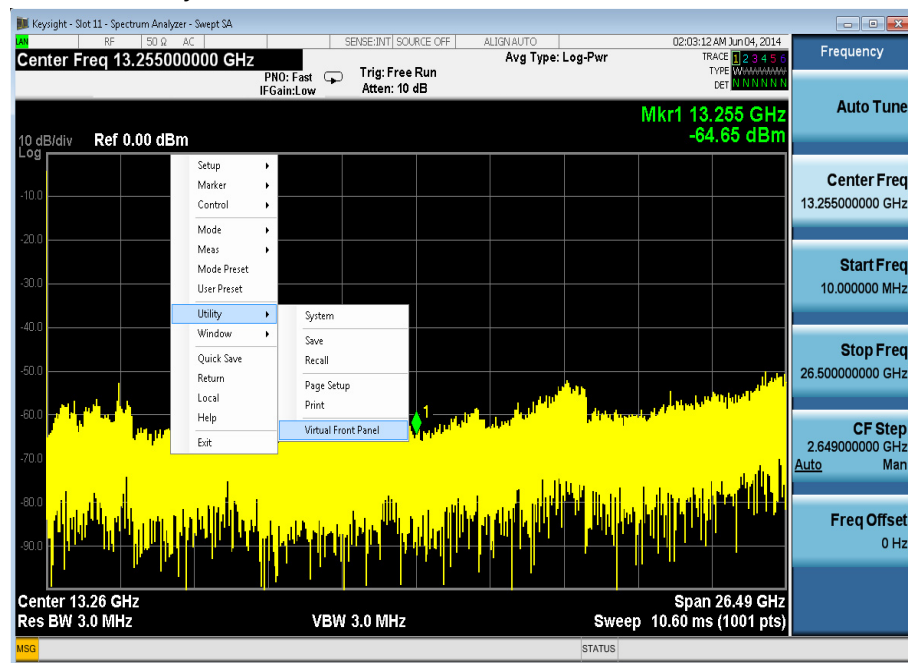

Running Modular TRX application Using Right-Click Menu

This method can be used to access any of the front-panel keys by using a mouse. The array of keys thus available is shown below:

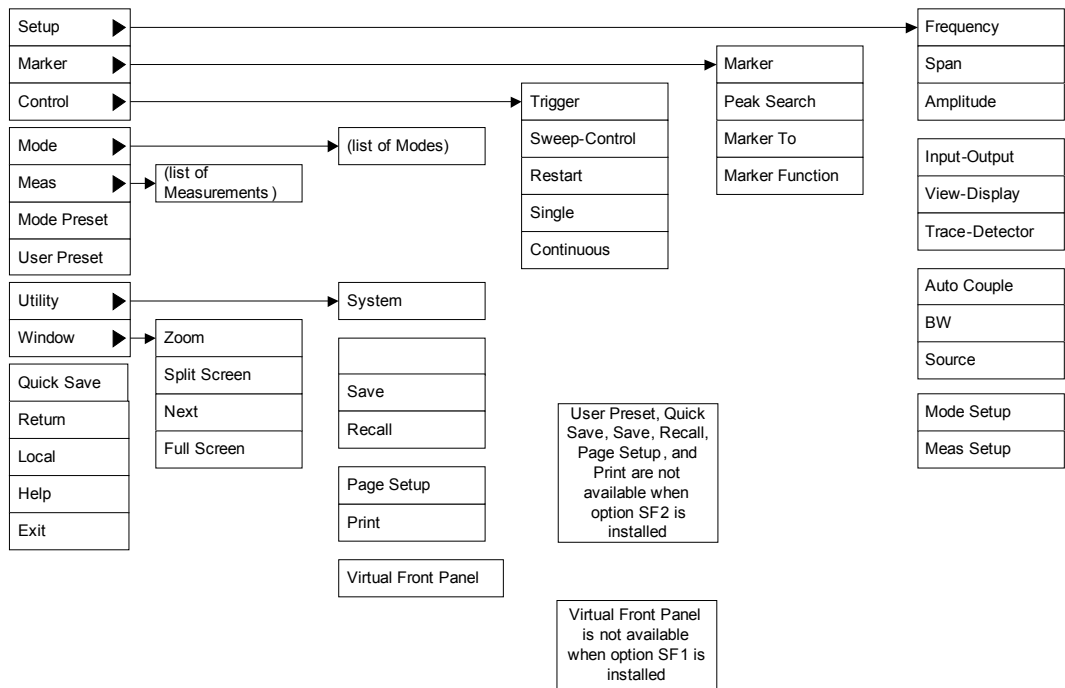

Using the Interactive Help System

To use the interactive help system of TRX applications, please click Help key on the Virtual Front Panel, or right click on your mouse and select Help from the Right-Click menu, the help screen will be displayed as following:

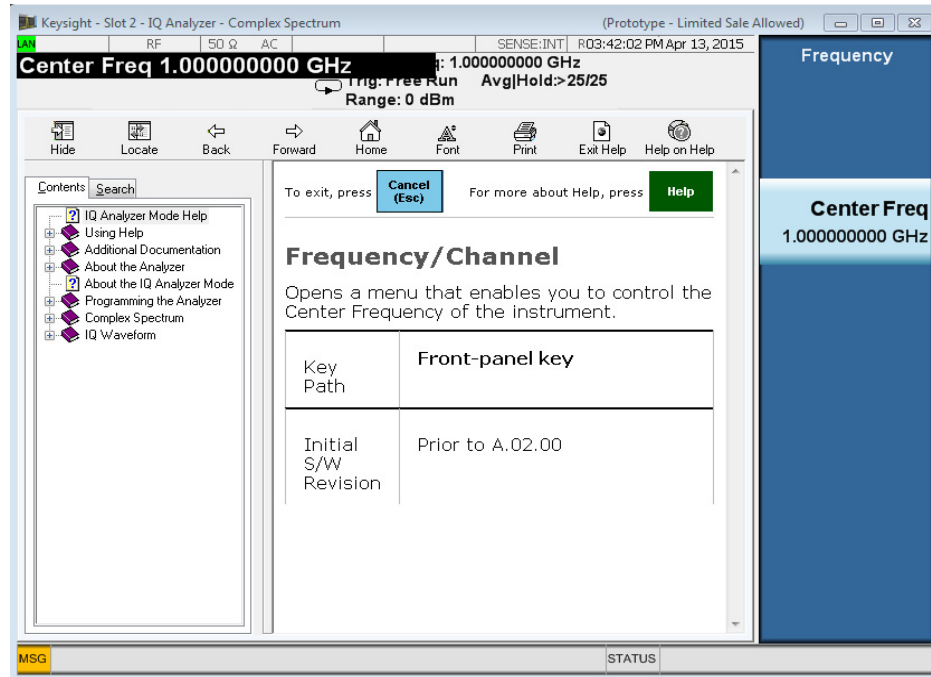

You can navigate to any menu and by clicking on soft key, the help information of the soft key setting will be shown on the help screen.

You can also use your mouse to navigate the help content from the tree view on the left panel.

Press Esc to exit the help information screen.

Navigating the Signal Transceiver Application by keyboard

Besides using a mouse to navigate the application software, you can also use the keyboard connected with the controller to perform the operations. This is also useful for the user who is familiar with other X series Signal Analyzers. See following table for the key code commands.

Key code commands:

Initiate the following function keys:	Press these keys on the controller keyboard:
AMPTD Y Scale	Ctrl+Shift+A
Auto Couple	Ctrl+Shift+C
BK Sp	Backspace
BW	Ctrl+Alt+B
Cancel (Esc)	Esc
Cont	Ctrl+Alt+C
Ctrl	Ctrl
Decrease Audio Volume	the Volume Control slider
Del	Delete
Down Arrow	Down Arrow
Enter	Enter (Return)
File	Ctrl+Shift+L
FREQ Channel	Ctrl+Shift+F
Full Screen	Ctrl+Shift+B
Help	F1
Increase Audio Volume	the Volume Control slider
Input/Output	Ctrl+Shift+O
Left Arrow	Left Arrow
Marker	Ctrl+Alt+K
Marker ->	Ctrl+Alt+N
Marker Function	Ctrl+Alt+F
Meas	Ctrl+Alt+M
Meas Setup	Ctrl+Alt+E
Menu (Alt)	Alt
Mode	Ctrl+Shift+M
Mode Preset	Ctrl+M
Mode Setup	Ctrl+Shift+E

Key code commands:

Initiate the following function keys:	Press these keys on the controller keyboard:
Mute	the Mute checkbox under the Volume Control
Next Window	Ctrl+Shift+N
Peak Search	Ctrl+Alt+P
Print	Ctrl+P
Quick Save	Ctrl+Q
Recall	Ctrl+R
Restart	Ctrl+Alt+R
Return	Ctrl+Shift+R
Right Arrow	Right Arrow
Save	Ctrl+S
Select	Space Bar
Single	Ctrl+Alt+S
Softkey 1	Ctrl+Shift+F1
Softkey 2	Ctrl+Shift+F2
Softkey 3	Ctrl+Shift+F3
Softkey 4	Ctrl+Shift+F4
Softkey 5	Ctrl+Shift+F5
Softkey 6	Ctrl+Shift+F6
Softkey 7	Ctrl+Shift+F7
Source	Ctrl+Alt+U
SPAN X Scale	Ctrl+Shift+S
Split Screen	Ctrl+L
Sweep/Control	Ctrl+Shift+W
System	Ctrl+Shift+Y
Tab	Tab
Trace/Detector	Ctrl+Alt+T
Trigger	Ctrl+Shift+T
Up Arrow	Up Arrow
User Preset	Ctrl+U
View/Display	Ctrl+Shift+V
Zoom	Ctrl+Shift+Z

Key code commands:

Initiate the following function keys:	Press these keys on the controller keyboard:
1	1
2	2
3	3
4	4
5	5
6	6
7	7
8	8
9	9
-	Use the - key to enter a negative value, as appropriate
. (Decimal Point)	. (Period)
0 (Zero)	0 (Zero)

Following figure shows the combination keyboard keys for bench top X series Signal Analyzers front panel keys. They can also be used when you are operating the same functions on Modular TRX applications.

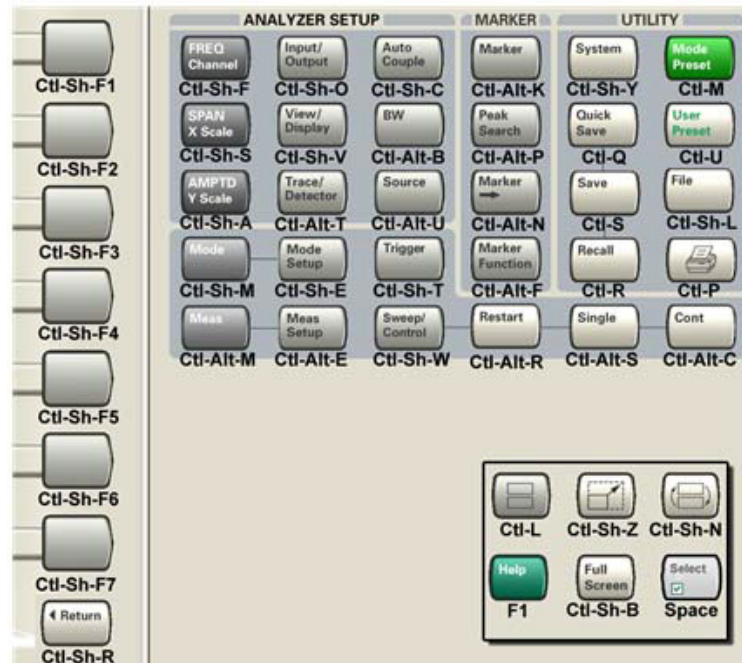

TCP/IP Address Configuration

VXT support the TCP/IP connection standards for LAN and HiSLIP (High-Speed LAN Instrument Protocol) instruments.

In general, modern driver technology hides the details of the hardware connection from the programmer, so your instrument's actual hardware connection is unlikely to have any significant effect on the optimal choice of programming tool, language or ADE.

There are two different connection configuration to control a VXTmodule in chassis.

Local Control - The controller is a modular installed in the chassis with VXT module or the controller is a PC and there is not any controller module installed in chassis. Both of the two connections use the PCI-PCI bridge for data communication.

Remote Control - The controller is a modular installed in the chassis and an external PC controls the VXT module via LAN connection as a remote controller.

Address Setting in Local Control

Please refer to the procedures below to set the TCP/IP address in local control.

1. Run LaunchModularTRX.exe in controller. The pop-up window is shown as below.

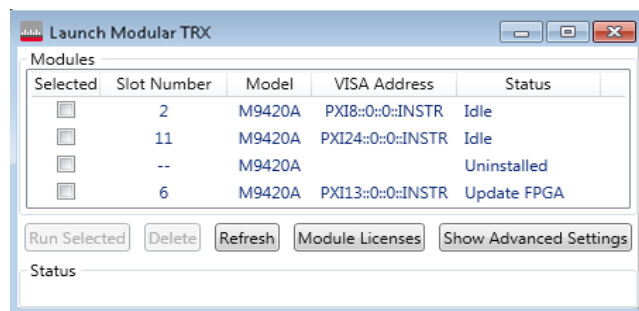

2. Click Show Advanced Settings. For this transceiver, the "HiSLIP Dev" value is 4. This value will be used to set the remote name in Keysight Connection Expert.

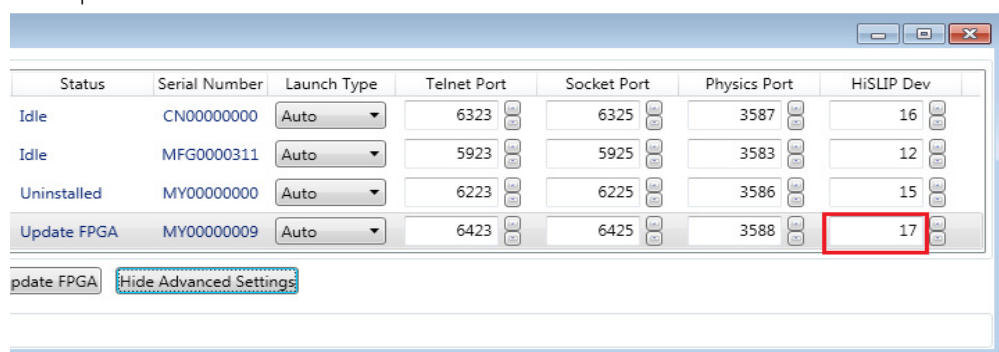

Running Modular TRX application
TCP/IP Address Configuration

3. Check the box named Selected and click Run Selected to run the Modular TRX application.

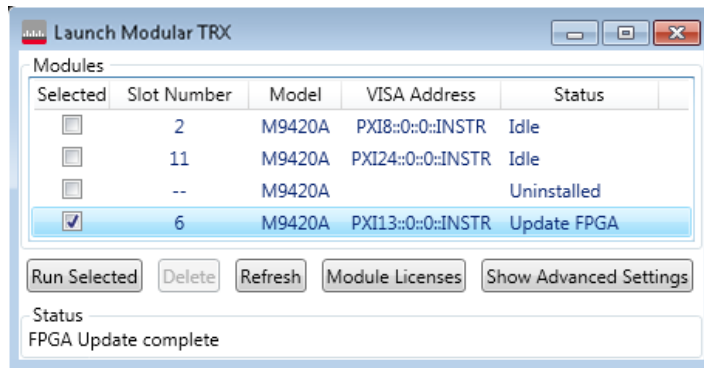

4. Run Keysight Connection Expert. Click Manual Configuration.
 - Set Hostname or IP Address as localhost.
 - Set Protocol to HiSLIP and set Remote Name to hislip17
 - Check the box named Allow *IDN Query and click Test This VISA Address to verify the connection.
 - Click Accept as a terminator for the settings

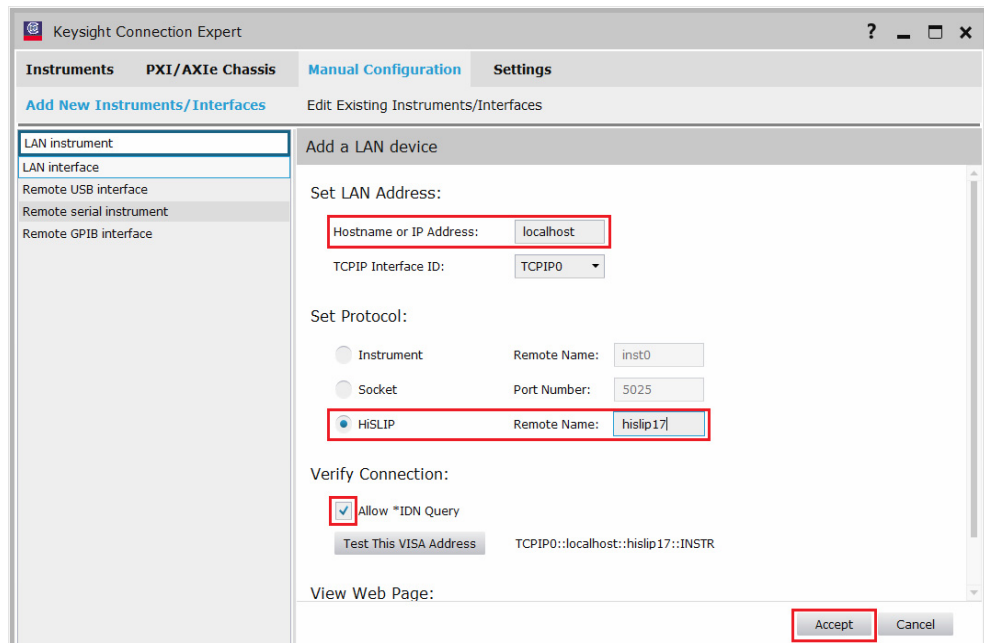

5. Click Instruments on the tool bar. You will find the VXT and its TCP/IP address is TCPIP0::localhost::hislip17::INSTR. This address is used by the Automatic Test System run in controller or external PC which communicate with VXT by PCIe-PCIe bridge.

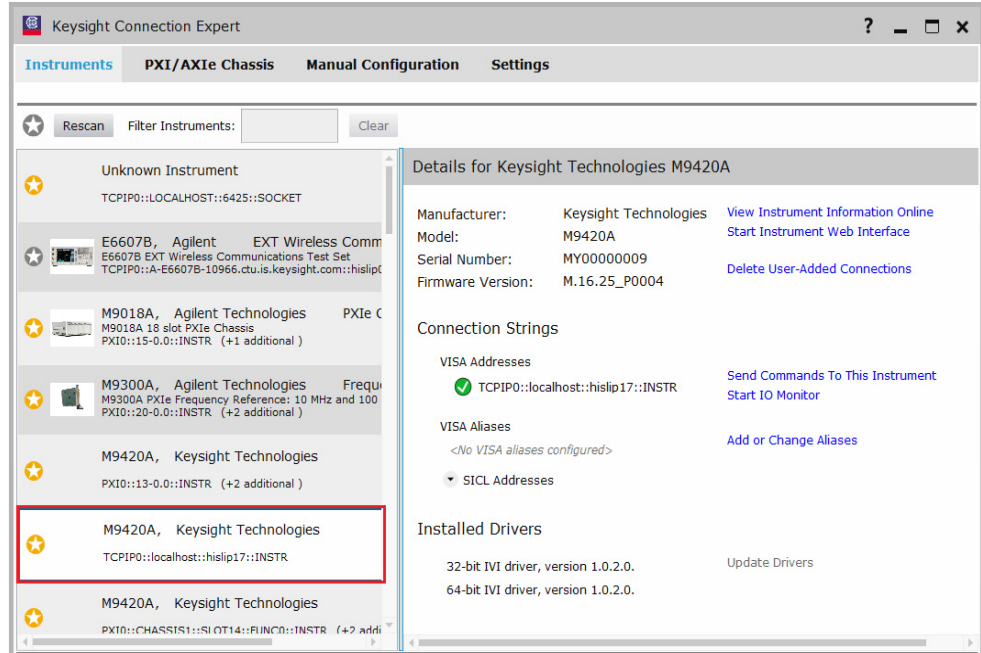

Address Setting in Remote Control

For Remote control, you need know the controller's IP address. Please press *System > Show > System* in Modular TRX Virtual Front Panel to get the IP address of the controller.

Please follow the step 4 and step 5 of "[Address Setting in Local Control](#)" to set the address. The only difference is to set the Hostname or IP Address as xxx.xxx.xxx.xxx (controller's IP address) rather than localhost.

Running Modular TRX application
TCP/IP Address Configuration

6 Troubleshooting

This chapter details some basic steps that may solve any problems you are experiencing with the signal transceiver.

["Check the Basics" on page 74](#)

["Returning a Transceiver for Service" on page 76](#)

WARNING

**No operator serviceable parts inside. Refer servicing to qualified personnel.
To prevent electrical shock do not remove covers.**

Check the Basics

- Is there power at the receptacle?
- Is the power turned on? Check to see if the green LED beside the power switch is on. Also, listen for internal fan noise to determine if the chassis cooling fans are running.
- If other equipment, cables, and connectors are being used with your signal transceiver, make sure they are connected properly and operating correctly.
- Is the Measurement Application running? If not, there is a software launcher shortcut/icon on the desktop.
- Does the instrument application have the focus? (That is, is the blue window banner highlighted?) If not, move focus to the application with Alt-Tab.
- Review the measurement procedures being performed when the problem first appeared. Are all of the settings correct?
- If the transceiver is not functioning as expected, return the transceiver to a known state by pressing Mode Preset.

NOTE

Some software settings are not affected by a Preset. If you wish to reset the transceiver settings, press System, Power On, Restore Power On Defaults.

- Is the measurement being performed, and the results that are expected, within the specifications and capabilities of the transceiver?

Technical manual pdf files are available on the documentation DVD provided with the transceiver, and on the Keysight website.
- If the module is not communicating via the LAN connection, check for the presence of blinking yellow LEDs of the LAN connector. If the ACT LED is not blinking, check the LAN cable and LAN integrity.
- To meet specifications, the module must be aligned. Either the Auto Align (On) feature must be selected (press System, Alignments, Auto Align, Normal), or the transceiver must be manually aligned.
- Perform an Alignment. Press System, Alignments, Align Now, All.
- If the previously performed alignments did not resolve the problem, press System, Alignments, Restore Align Defaults. Then press System, Alignments, Align Now, All.
- If the transceiver exhibits large amplitude errors (> 10 dB) especially at frequencies above 10 GHz, the RF preselector might not be properly centered. Press Peak Search, AMPTD Y-Scale, Presel Center. If the signal amplitude error is corrected, the preselector characterization should be performed. Press System, Alignments, More 1 of 2, Advanced, Characterize Preselector. The characterization will take several minutes and the

transceiver must not be interrupted during this time. If the transceiver is interrupted during the characterization process, the characterization data will be destroyed and it will be necessary to perform the entire process again.

- Is the software displaying an error message? If so, refer to the *Instrument Messages Guide*.
- Check if the external frequency reference is selected but not available. Verify that it is selected by pressing Input/Output, Freq Ref In. If External is selected, changing the setting to Sense allows the module to sense the presence of an external reference and use it only if it is available. The frequency of the reference should be set correctly.
- If you are using a Windows program other than the instrument application, you may notice it running slow. Place the instrument application in single sweep/measurement.

Returning a Transceiver for Service

Calling Keysight Technologies

Keysight Technologies has offices around the world to provide you with complete support for your transceiver. To obtain servicing information or to order replacement parts, contact the nearest Keysight Technologies office listed below. In any correspondence or telephone conversations, refer to your transceiver by its product number, full serial number, and software revision.

Press System, Show, System, and the product number, serial number, and software revision information will be displayed on your transceiver screen. A serial number label is also attached to the rear panel of the transceiver.

Locations for Keysight Technologies

Online assistance: <http://www.keysight.com/find/assist>

Americas

Canada
1 877 894 4414

Latin America
(305) 269 7500

United States
1 800 829 4444

Asia Pacific

Australia
1 800 629 485

China
800 810 0189

Hong Kong
800 938 693

India
1 800 112 929

Japan
0 120 (421) 345

Korea
080 769 0800

Malaysia
1 800 888 848

Singapore
1 800 375 8100

Taiwan
0800 047 866

Thailand
1 800226 008

Europe & Middle East

Austria
43 (0) 1 360 277 1571

Belgium
32 (0) 2 404 93 40

Denmark
45 70 13 15 15

Finland
358 (0) 10 855 2100

France
0825 010 700*
*0.125 Euros/minute

Germany
49 (0) 7031 464 6333

Ireland
1890 924 204

Israel
972-3-9288-504/544

Italy
39 02 92 60 8484

Netherlands
31 (0) 20 547 2111

Spain
34 (91) 631 3300

Sweden
0200-88 22 55

Switzerland
0800 80 53 53

United Kingdom
44 (0) 118 9276201

Other European Countries: <http://www.keysight.com/find/contactus>

Read the Warranty

Please read the warranty and become familiar with its terms. If your instrument is covered by a separate maintenance agreement, please be familiar with its terms.

Service Options

Keysight Technologies offers several optional maintenance plans to service your transceiver after the warranty has expired. Call your Keysight Technologies office for full details.

If you want to service the instrument yourself after the warranty expires, you can purchase the service documentation that provides all necessary test and maintenance information.



This information is subject to change without notice.

© Keysight Technologies 2015-2016

Edition 2, May 2016

M9420-90001

www.keysight.com