

Keysight U7231B, U7231C

DDR3 and LPDDR3 Compliance Test Application

For Infiniium Series Oscilloscopes

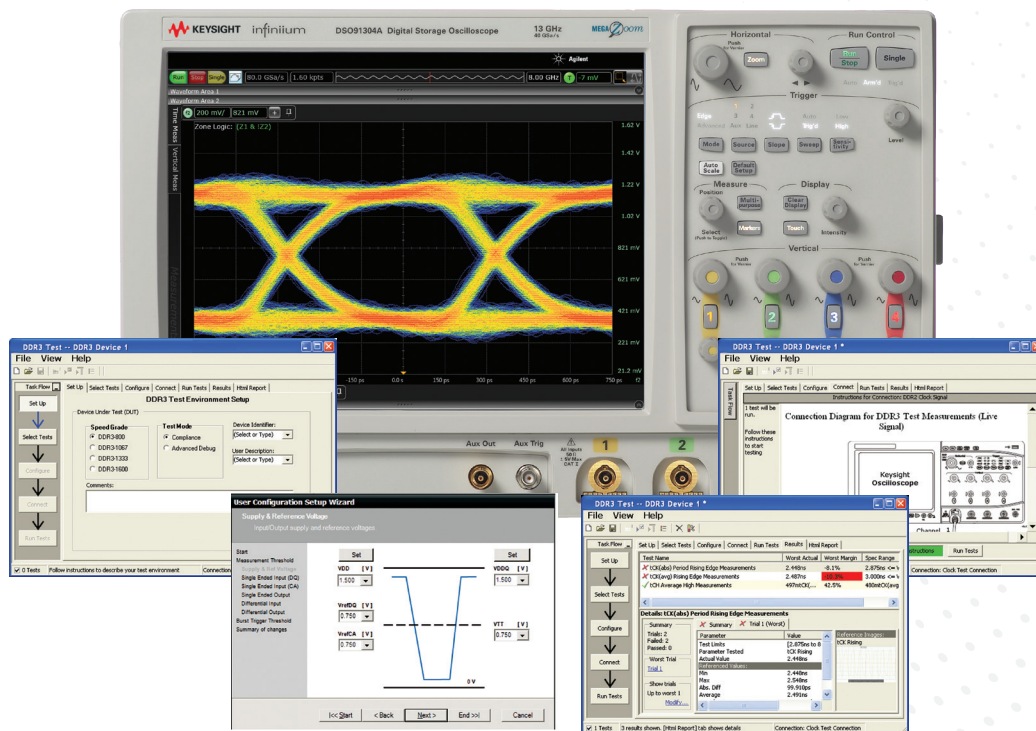

Test, Debug and Characterize Your DDR3 and LPDDR3 Designs Quickly and Easily

The Keysight Technologies, Inc. U7231B DDR3 and LPDDR3 compliance test application provides a fast and easy way to test, debug and characterize your DDR3 and LPDDR3 designs. The tests performed by the U7231B software are based on the JEDEC¹ JESD79-3F and JESD79-3-1 DDR3 SDRAM Specification. In addition, the application features Custom mode, which covers crucial measurements such as eye-diagram, mask testing, ringing and other tests that are not covered in the specifications but are critical for characterizing DDR3 and LPDDR3 devices. The test application offers a user-friendly setup wizard and a comprehensive report that includes margin analysis.

DDR3 is an evolutionary upgrade to DDR2 and DDR1 memory systems. DDR3 technology enables even higher bandwidth for data transfer than DDR2 and allows you to build devices with even smaller chip footprints that consume less power and generate less heat. DDR3 achieves these advances with enhanced fine ball-grid array (FBGA) packaging, enhanced on-die termination, self calibration and automatic self-refresh for improved control of signal integrity.

LPDDR3 DRAM with data rate up to 1600MT/s is 50% faster than the industry's current highest performance LPDDR2, which operates at 1066MT/s. The new LPDDR3 also operates at lower electrical power than LPDDR2 which helps reduce power consumption in the mobile applications. Signal integrity is crucial for memory system interoperability. Reference clock jitter measurements help you ensure that jitter is well within the specifications, which is the key to reliable and interoperable modular memory systems. At the same time, electrical and timing characteristics of other signals are critical as well, to ensure the memory system functions correctly and stays error free.

The addition of the DDR3 and LPDDR3 debug tool helps memory designers perform pre- and post-compliance testing with saved oscilloscope waveform traces. The tool allows for navigation capability with measurement markers to help navigate to problem areas for further testing.

The U7231B DDR3 and LPDDR3 compliance test application is compatible with Keysight Infiniium digital storage oscilloscopes.

Features

The DDR3 and LPDDR3 compliance test application offers several features to simplify the validation of your designs:

- New setup wizard for quick setup, configuration and test
- Enhanced execution speed and proven test algorithm for clock test, which minimizes your compliance test time
- User-selected tests and configurations based on JEDEC JESD79-3F and JESD79-3-1 Specification data rate with option to turn on LPDDR3 data rate tests and user-defined speed for embedded designs
- Option to use phase difference or mixed signal oscilloscope read-write command trigger, allowing robust read and write separation for JEDEC measurement
- New wizard tool to automate voltage threshold settings for non-standard operating voltages adds flexibility in characterization work
- Ability to analyze the loading effect of adjacent RANK of the same memory channel
- Test framework provides powerful characterization through multiple trials that show a full array of statistics for each measurement and returns the worst measurement value

- Automatically perform derating table calculations for setup and hold time measurements based on slew rate
- DDR debug tool allows for navigation to area of interest in a saved set of waveforms with JEDEC measurement for pre- and post-compliance testing
- Offline setup allows for compliance testing on saved waveform files from oscilloscope or ADS simulation tool

Comprehensive test coverage

With the DDR3 and LPDDR3 compliance test application, you can use the same oscilloscope you use for everyday debugging to perform automated testing and margin analysis based on the JEDEC electrical and timing specifications. The application automatically configures the oscilloscope for each test and provides informative results. It includes margin analysis indicating how close your device comes to passing or failing the test for each specification.

Some of the difficulties in performing DDR3 tests are connecting to the target device, configuring the oscilloscope, performing the tests and analyzing the measured results. The DDR3 compliance test application does most of this work for you. If you discover a problem with your device, the Custom mode feature in the test application and debug tools in the oscilloscope are available to aid in root-cause analysis.

1. The JEDEC (Joint Electronic Device Engineering Council) Solid State Technology Association is a semiconductor engineering standardization body of the Electronic Industries Alliance (EIA), a trade association that represents all areas of the electronic industry.

Easy Test Definition

The test application enhances the usability of Keysight Infiniium oscilloscopes for testing DDR3 devices. The Keysight automated test framework guides you quickly through the steps required to define the setup, perform the tests and view the test results. On the environmental setup page, you can select the type of DDR3L or LPDDR3 devices, and the framework automatically filters the tests based on your selection. You have the option to use the conventional DQS-DQ phase difference or MSOX logic triggering (used only with MSO90000X series Infiniium oscilloscopes) for read and write separation. You can then select a category of tests or specify individual tests. The user interface is designed to minimize unnecessary reconnections, which saves time and minimizes potential operator error. You can save the tests and configurations as project files and recall them later for quick testing and review of previous results. Clear menus let you perform tests with minimum mouse clicks.

The threshold setting wizard helps user automate voltage threshold settings for non-standard operating voltages to increase flexibility to test in non-standard operating voltages.

DDR debug tool is a license tool that enables JEDEC measurement on saved waveform traces with navigation capability and markers to identify problem areas for debug and margin testing.

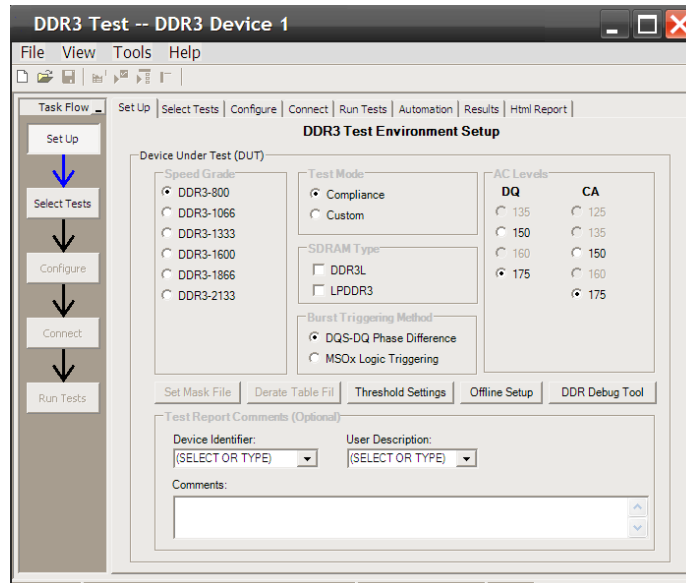

Figure 1. DDR3, DDR3L and LPDDR3 application test setup screen. Select Compliance or Custom test mode and the speed grade of your device.

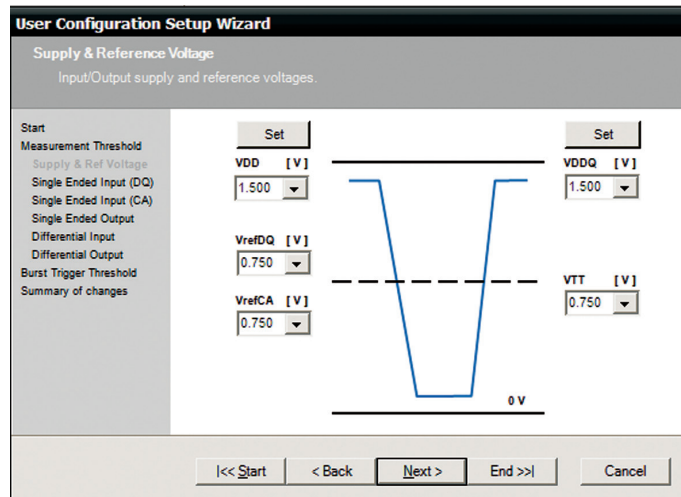

Figure 2. Automated voltage threshold setting helps you set the voltage thresholds to test in non-standard operating voltages.

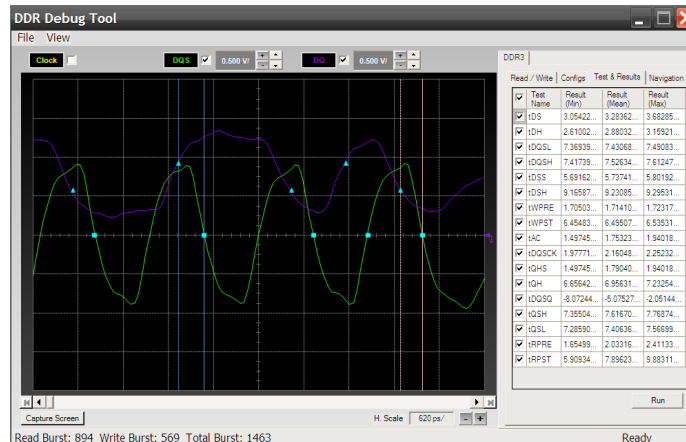

Figure 3. DDR debug tool enables markers to help navigate to bursts of interests with JEDEC measurements and statistical results.

Configurability and Guided Connection

The DDR3 and LPDDR3 compliance test application provides flexibility in your test setup. The application lets you define control parameters such as voltage threshold values, number of waveforms used for analysis and customizable violation settings. Once you have configured the tests, the connection page will display the connection diagram for the test you have selected.

With the multiple test trial capability, you can extensively characterize the performance of your devices. You can run the selected tests until the stop condition is met. The application will then save the worst-case conditions and help you track down the anomalies in your signals.

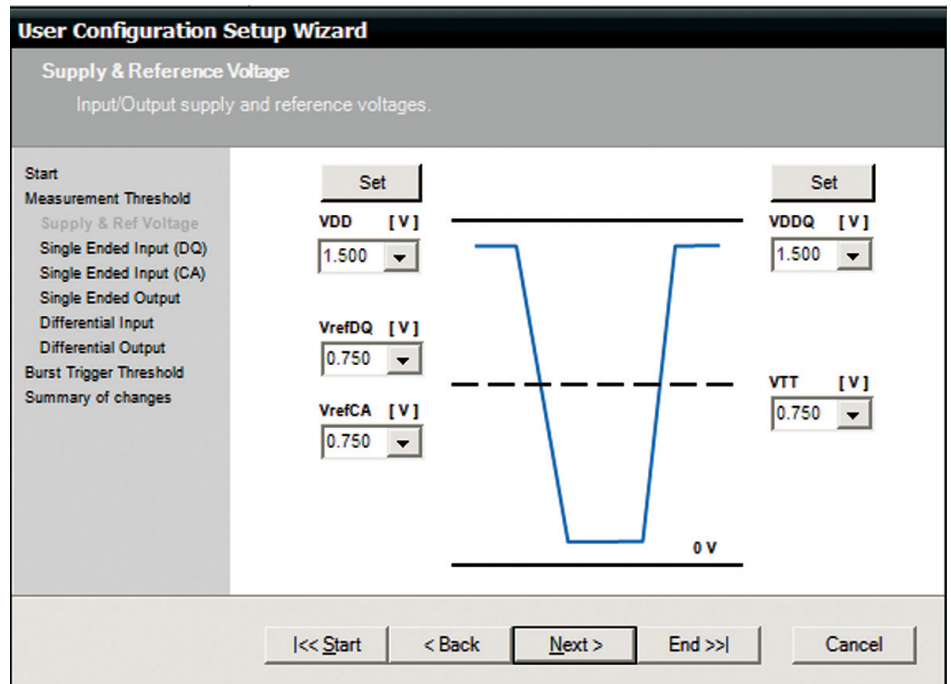

Figure 4. The Keysight automated test engine filters the test selection based on your test setup. You can easily select individual tests or groups of tests with a mouse-click.

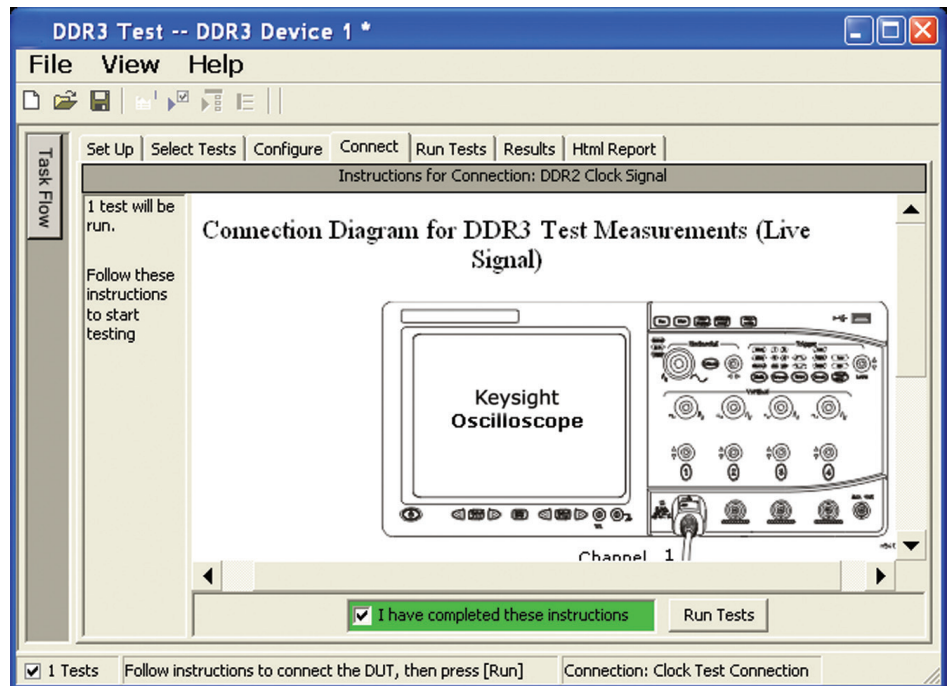

Figure 5. The software prompts you with the connection diagrams for the tests you have selected.

Comprehensive Results Analysis

In addition to providing you with measurement results, the DDR3 and LPDDR3 compliance test application reports how close you are to the specified limit. You can specify the level at which warnings are to be issued. You are provided with a full array of statistics for each measurement, and you can save worst-case conditions to extensively test the performance of your device.

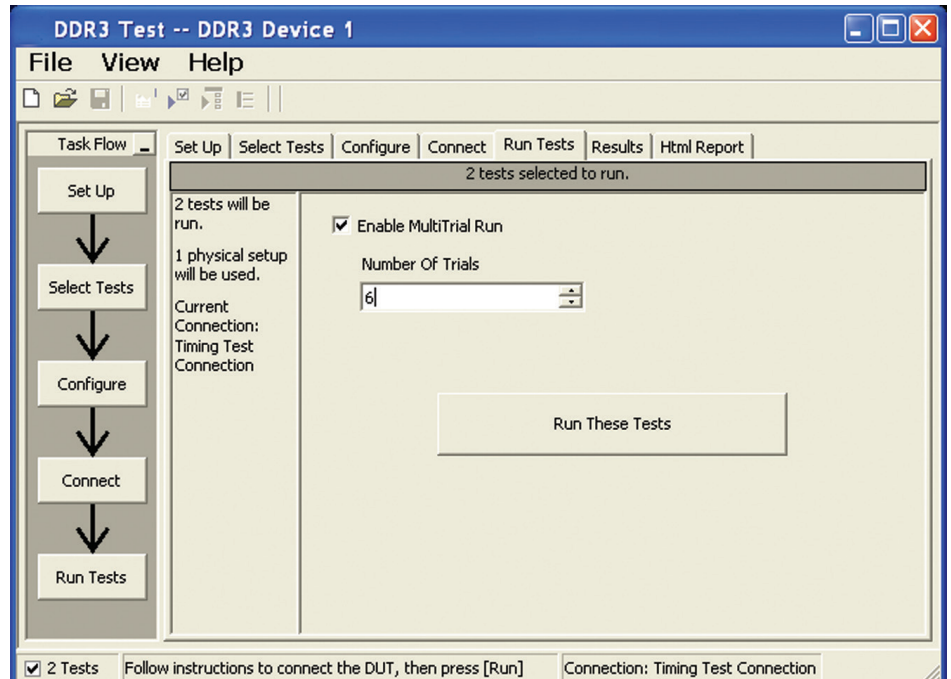

Figure 6. The Repetitive Run feature allows you to run the selected tests until the stop condition is met. It allows you to extensively test the performance of your device.

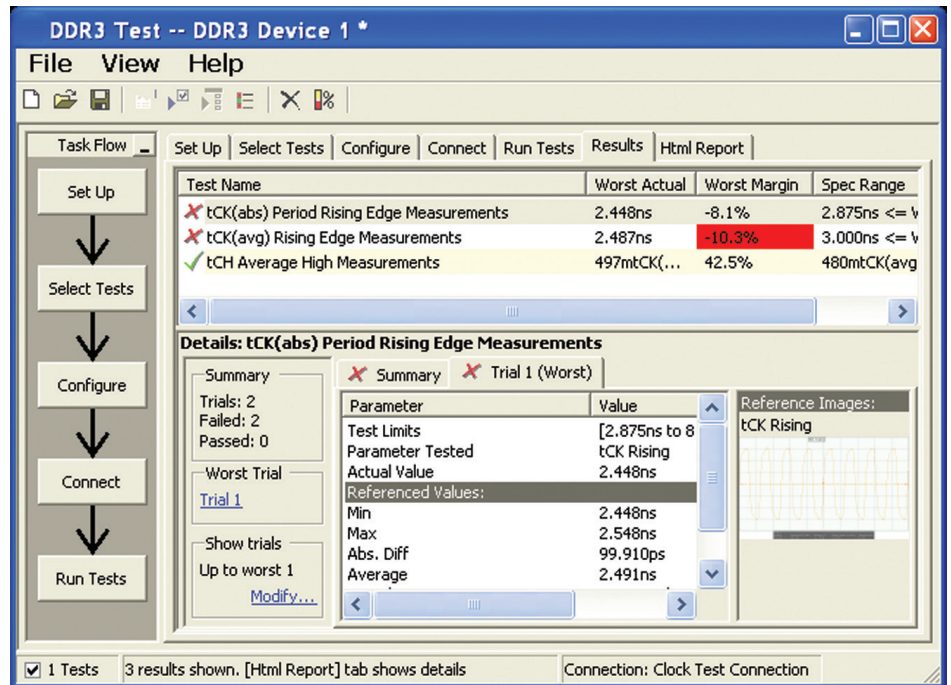

Figure 7. The DDR3 and LPDDR3 test application documents your test parameters, pass or fail status, test specification range, measured values and the pass/fail margin.

Thorough Performance Reporting

The DDR3 and LPDDR3 compliance test application generates thorough HTML reports that capture the performance, status and margins of your device. It also captures screen shots of critical measurements for your reference and documentation. This report is suitable for printing and sharing with your vendors, customers or colleagues.



Application Test Report

Overall Results: 5 of 18 Tests Failed

Test Configuration Details	
Device Description	
Test Mode	Compliance
Speed Grade	DDR3-800
Test Session Details	
Infinium SW Version	05.30.0000
Infinium Model Number	DSO81304B
Infinium Serial Number	MY46000428
Last Test Date	10/6/2006 5:15:40 PM

Summary of Results

Margin Thresholds	
Warning	< 2 %
Critical	< 0 %

Pass	# Failed	# Trials	Test Name	Worst Actual	Worst Margin	Spec Range
✗	6	188	t _{AC} (Differential)	70.454ns	-5.821.2 %	-600ps <= VALUE <= 600ps
✓	0	188	t _{DQSCK} (Differential)	281ps	21.9 %	-500ps <= VALUE <= 500ps
✓	0	188	t _{DQSQ}	329ps	6.0 %	VALUE <= 350ps
✓	0	188	t _{GH}	2.410ns	33.9 %	VALUE >= 1.800ns
✓	0	188	t _{DQSS}	70.15785mtCK	36.0 %	-250.0000mtCK <= VALUE <= 250.0000mtCK
✓	0	188	t _{DSS}	431.7552ms	115.9 %	VALUE >= 200.0000ms
✓	0	188	t _{DSH}	548.4619mtCK	174.2 %	VALUE >= 200.0000mtCK
✗	4	188	t _{HZDQ}	2.4314ns	-305.2 %	VALUE <= 600.0ps
✓	0	188	t _{LZDQ}	-5.3ps	33.6 %	-1.2000ns <= VALUE <= 600.0ps
✓	0	188	t _{LZDQS}	534.1ps	5.5 %	-600.0ps <= VALUE <= 600.0ps
✓	0	188	t _{WPRE}	1.088146tCK	210.9 %	VALUE >= 350.0000mtCK
✗	10	188	t _{WPST}	1.093703tCK	-246.9 %	400.0000mtCK <= VALUE <= 600.0000mtCK
✗	2	188	t _{RPRE}	1.401157tCK	-150.6 %	900.0000mtCK <= VALUE <= 1.100000tCK
✗	2	188	t _{RPST}	1.470126tCK	-435.1 %	400.0000mtCK <= VALUE <= 600.0000mtCK
✓	0	188	t _{DQSH}	481.4414mtCK	37.6 %	VALUE >= 350.0000mtCK
✓	0	188	t _{DQSL}	526.6241mtCK	50.5 %	VALUE >= 350.0000mtCK
✓	0	188	t _{DS} (base)- Differential	820ps	446.7 %	VALUE >= 150ps
✓	0	188	t _{DH} (base)- Differential	1.015ns	269.1 %	VALUE >= 275ps

Figure 8. The DDR3 and LPDDR3 test application generates a summary report where you can see your device's test results quickly and clearly. Details are available for each test including the test limits, test description and test results, including saved waveforms. In addition, the pass/fail margin is indicated to give you further insight.

Extensibility

You may add additional custom tests or steps to your application using the User Defined Application (UDA) development tool (www.keysight.com/find/uda). Use UDA to develop functional “Add-Ins” that you can plug into your application.

Add-ins may be designed as:

- Complete custom tests (with configuration variables and connection prompts)
- Any custom steps such as pre or post processing scripts, external instrument control and your own device control.

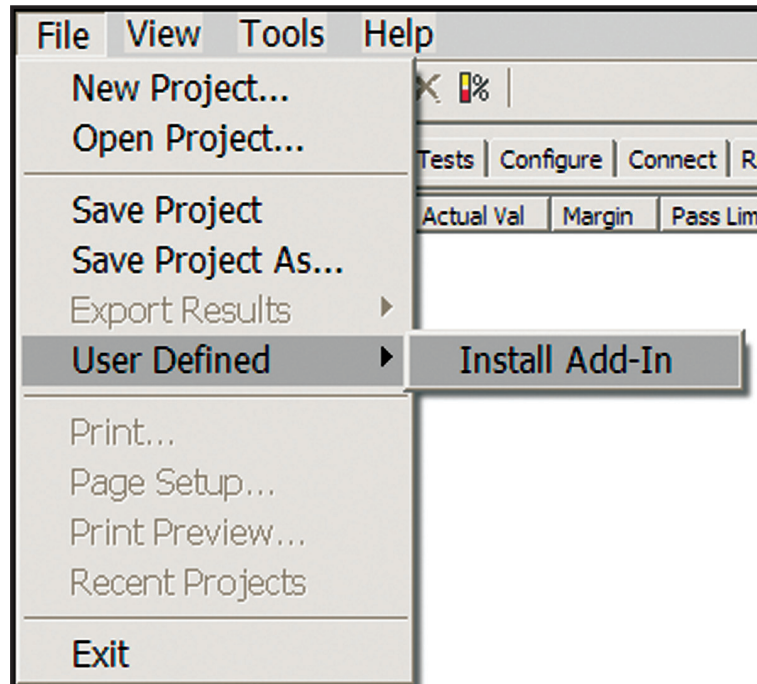

Figure 9. Importing a UDA Add-In into your test application.

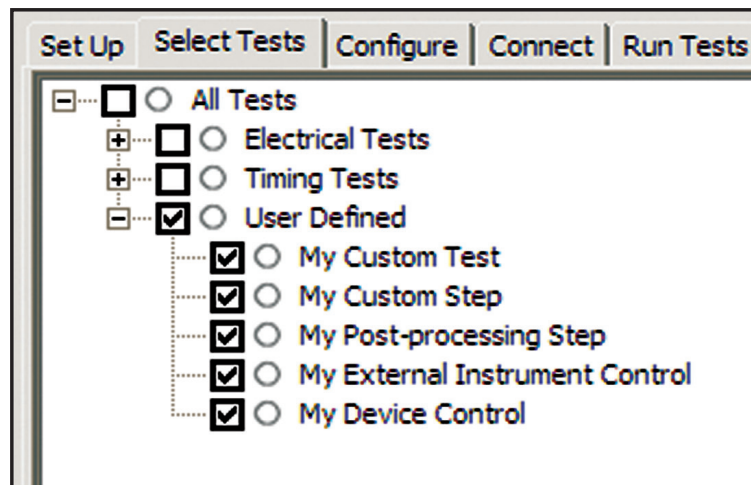

Figure 10. UDA Add-In tests and utilities in your test application.

Automation

You can completely automate execution of your application's tests and Add-Ins from a separate PC using the included N5452A Remote Interface feature (download free toolkit from www.keysight.com/find/scope-apps-sw). You can even create and execute automation scripts right inside the application using a convenient built-in client.

The commands required for each task may be created using a command wizard or from "remote hints" accessible throughout the user interface.

Using automation, you can accelerate complex testing scenarios and even automate manual tasks such as:

- Opening projects, executing tests and saving results
- Executing tests repeatedly while changing configurations
- Sending commands to external instruments
- Executing tests out of order

Combine the power of built-in automation and extensibility to transform your application into a complete test suite executive:

- Interact with your device controller to place it into desired states or test modes before test execution.
- Configure additional instruments used in your test suite such as a pattern generator and probe switch matrix.
- Export data generated by your tests and post-process it using your favorite environment, such as MATLAB, Python, LabVIEW, C, C++, Visual Basic etc.
- Sequence or repeat the tests and "Add-In" custom steps execution in any order for complete test coverage of the test plan.

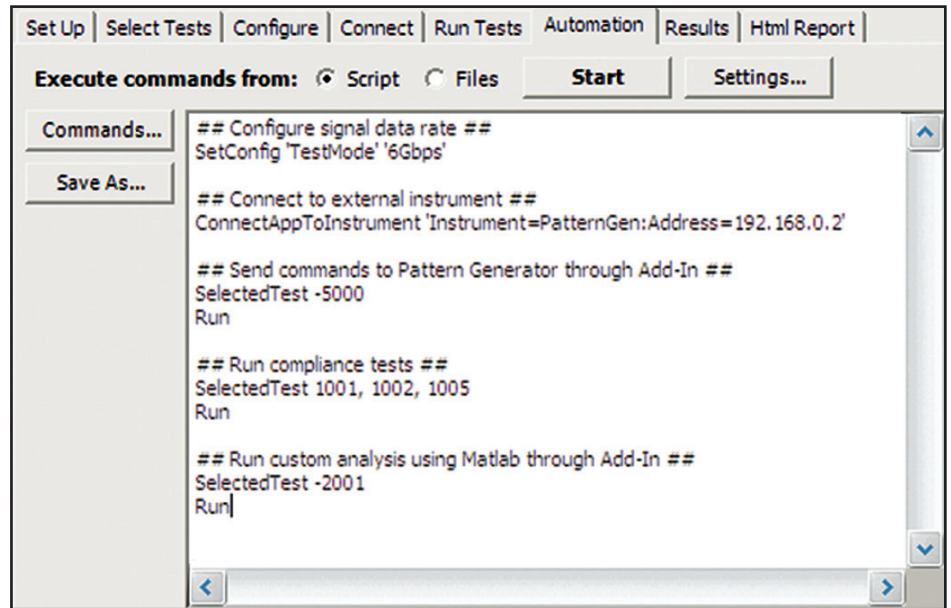

Figure 11. Remote Programming script in the Automation tab.

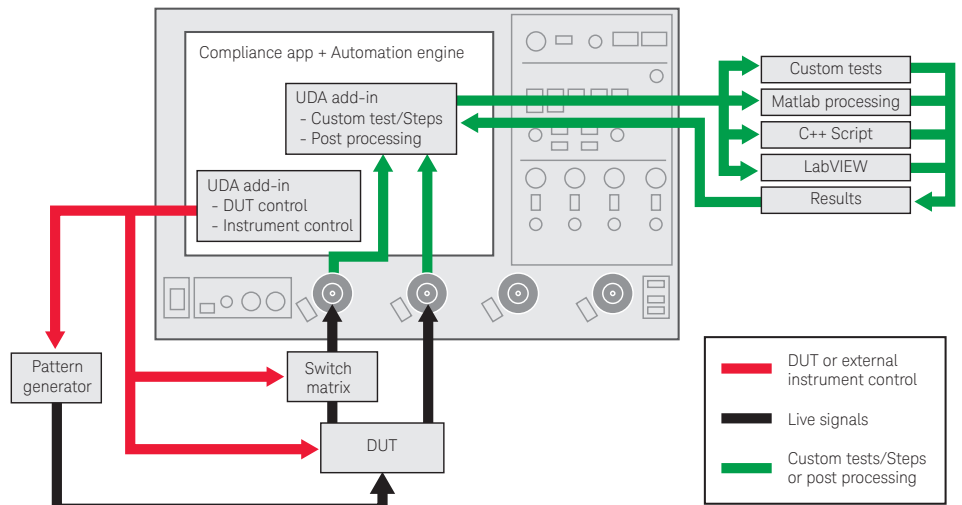

Figure 12. Combine the power of built-in automation and extensibility to transform your application into a complete test suite executive.

Switch Matrix

The Keysight switch matrix software option for the conformance application, used together with switch matrix hardware, enables fully-automated testing for multi-lane digital bus interfaces. The benefits of this automated switching solution include:

- Eliminate reconnections, which saves time and reduces errors through automating test setup for each lane of a multi-lane bus.
- Maintain accuracy with the use of unique PrecisionProbe or InfiniiSim features to compensate for switch path losses and skew.
- Customize testing by using remote programming interface and the UDA tool for device control, instrument control and test customization. For more information about the switching solution and configuration, visit www.keysight.com/find/switching and the Keysight application note with the publication number 5991-2375EN.

System device requirements

In order to speed your test time, you must use the appropriate RAM test reliability software with the memory system to generate random activity on the memory bus. Memtest, is commonly used RAM reliability test software that can run on DOS, Windows and Linux systems.



Figure 13. Automated testing for multi-lane digital bus interface through switching solution.

Test performed

The Keysight DDR3 and LPDDR3 compliance test application covers clock, electrical and timing parameters of the JEDEC JESD79-3F and JESD79-3-1 DDR3 SDRAM Specifications. The application helps you test all DDR3 devices for compliance, using a Keysight 9000 or 90000 Series Infiniium oscilloscope.

In addition, the test application's Custom mode feature provides popular test methodologies that are not covered in any specification. These tests help users who want to perform extensive validation beyond the test specification. It also sets up the scope to isolate the read and write signals so you can immediately jump in to debug the signals.

Speed supported

Table 1. JEDEC tests covered by the U7231B test application

Specification	DDR3-800	DDR3-1066	DDR3-1333	DDR3-1600	DDR3-1866	DDR3-2133
AC and DC input measurement levels						
Table 24 – Single-ended AC and DC input levels (page 115)	x	x	x	x	x	x
Table 25 – Differential AC and DC input levels (page 118)	x	x	x	x	x	x
Table 27 – Single-ended levels for CK, DQS (page 119)	x	x	x	x	x	x
Table 28 – Cross point voltage for differential input signals (CK, DQS) (page 120)	x	x	x	x	x	x
Table 31 – Single-ended AC and DC output levels (page 123)	x	x	x	x	x	x
Table 32 – Differential AC and DC output levels (page 123)	x	x	x	x	x	x
Table 34 – Output slew rate (single-ended) (page 124)	x	x	x	x	x	x
Table 36 – Differential output slew rate (page 125)	x	x	x	x	x	x
Table 37 – AC overshoot/undershoot specifications for address and control pins (page 127)	x	x	x	x	x	x
Table 38 – AC overshoot/undershoot specifications for clock, data, strobe and mask (page 128)	x	x	x	x	x	x
Electrical characteristics and AC timing						
Table 67 – Timing parameters by speed bin (page 164)	x	x	x	x	x	x

Table 2. Custom mode covered by the U7231B test application

Measurement items	Speed supported
All JEDEC tests from compliance mode	User configurable
Read/write eye-diagram test	User configurable
High/low state ringing test	User configurable

Ordering Information

Software options

Application	License type		Infiniium Z-Series	Infiniium S-Series	Infiniium 90000 Series	Infiniium 9000 Series
DDR3 and LPDDR3 compliance	Fixed	Factory-installed	U7231B-1FP	U7231C-1FP	Option 032	Option 033
		User-installed	U7231B-1FP	U7231C-1FP	U7231B-1NL	U7231C-1NL
	Floating	Transportable	U7231B-1TP	U7231C-1TP	U7231B-1TP ^{1,2}	U7231C-1TP ^{1,2}
		Server-based	N5435A-053			
DDR3 upgrade to LPDDR3	Fixed	Factory-installed	–	–	–	–
		User-installed	U7231B-2FP	U7231C-2FP	U7231B-2NL	U7231C-2NL
	Floating	Transportable	–	–	–	–
		Server-based	–			
DDR3 and LPDDR3 debug tool	Fixed	Factory-installed	U7231B-3FP	U7231C-3FP	–	–
		User-installed	U7231B-3FP	U7231C-3FP	U7231B-3NL	U7231B-3NL
	Floating	Transportable	U7231B-3TP	U7231C-3TP	U7231B-3TP ^{1,2}	U7231C-3TP ^{1,2}
		Server-based	–			
DDR compliance software bundle	Fixed	Factory-installed	N5459B-1FP	N5459C-1FP	–	–
		User-installed	N5459B-1FP	N5459C-1FP	N5459B-1NL	N5459C-1NL
	Floating	Transportable	–	–	–	–
		Server-based	–			
Serial data analysis software (included in DSA model)	Fixed	Factory-installed	E2688A-1FP	N5384A-1FP	Option 003	Option 003
		User-installed	E2688A-1FP	N5384A-1FP	E2688A-1NL	N5384A-1NL
	Floating	Transportable	E2688A-1TP	N5384A-1TP	E2688A-1TP ^{1,2}	N5384A-1TP ^{1,2}
		Server-based	N5435A-003			
InfiniiSim Advanced (optional)	Fixed	Factory-installed	N5465A-1FP	N5465B-1FP	Option 014	Option 014
		User-installed	N5465A-1FP	N5465B-1FP	N5465A-1NL	N5465B-1NL
	Floating	Transportable	N5465A-1TP	N5465B-1TP	N5465A-1TP ^{1,2}	N5465B-1TP ^{1,2}
		Server-based	N5435A-027			
InfiniiScan (optional)	Fixed	Factory-installed	N5414B-1FP	N5415B-1FP	Option 009	Option 009
		User-installed	N5414B-1FP	N5415B-1FP	N5414B-1FP	N5415B-1NL
	Floating	Transportable	N5414B-1TP	N5415B-1TP	N5414B-1TP ^{1,2}	N5415B-1TP ^{1,2}
		Server-based	N5435A-004			
LPDDR3 switch matrix option (optional)	Fixed	Factory-installed	N8890A-1FP		Option 097	
		User-installed	N8890A-1FP			
	Floating	Transportable	N8890A-1TP		N8890A-1TP ^{1,2}	
		Server-based	N5435A-124			

1. Requires software 5.00 and above.

2. Software 4.30 or above requires Windows 7. N2753A Infiniium Windows XP to 7 OS upgrade kit (oscilloscope already has M890 motherboard). N2754A Infiniium Windows XP to 7 OS and M890 motherboard upgrade kit (oscilloscope without M890 motherboard). Verify the M890 motherboard using the procedure found in the Windows 7 upgrade kit data sheet, publication number 5990-8569EN.

Ordering Information (Continued)

Note:

1. The JEDEC JESD79-3F and JESD79-3-1 specification does not specify the rise time and fall time for DDR3 signals. The required oscilloscope bandwidth is also not mentioned. It is advisable for you to determine the oscilloscope bandwidth requirement based on the fastest rise time and fall time of the DDR3 signals. Please refer to Table 3.

For 9000 and 90000 Series oscilloscope, you can choose the oscilloscope bandwidth using the calculation below.

- Maximum signal frequency content = $0.4/\text{fastest rise or fall time (20 to 80\%)}$
- Scope bandwidth required = $1.4 \times \text{maximum signal frequency}$ for 3% accuracy measurement
- Scope bandwidth required = $1.2 \times \text{maximum signal frequency}$ for 5% accuracy measurement
- Scope bandwidth required = $1.0 \times \text{maximum signal frequency}$ for 10% accuracy measurement

Table 3. Infiniium Series oscilloscope rise/fall time specifications

Rise time/fall time	90254A	90404A	90604A	90804A	91204A	91304A
10 to 90%	140 ps	105 ps	70 ps	54 ps	35 ps	32 ps
20 to 80%	105 ps	79 ps	53 ps	38 ps	26 ps	24 ps

Probe accessories

Infiniium probe amplifiers

Model number	Description
1169A	12-GHz differential Infiniium II probe amplifier
1168A	10-GHz differential Infiniium II probe amplifier
1134A	7-GHz differential probe amplifier
1132A	5-GHz differential probe amplifier

Recommended oscilloscopes

The DDR3 and LPDDR3 compliance software is compatible with Keysight Infiniium Series oscilloscopes with operating software revision 4.20 or higher. For oscilloscopes with earlier revisions, free upgrade software is available here: www.keysight.com/find/scope-apps-sw

Data rate	Minimum bandwidth	Minimum channels	Compatible oscilloscopes
Up to 2133 MT/s	8 GHz	3	Infiniium 90000 and Z-Series

Ordering Information (Continued)

InfiniiMax probe heads

Model number	Description
InfiniiMax I/II probe heads and accessories (compatible with 9000 and 90000 Series, use N5442A precision BNC adapter for use with 90000X/Q series oscilloscopes)	
N5381A	InfiniiMax II 12-GHz differential solder-in probe head and accessories
N5382A	InfiniiMax II 12-GHz differential browser
E2677A	InfiniiMax 12-GHz differential solder-in probe head and accessories
E2675A	InfiniiMax 6-GHz differential browser probe head and accessories
N5425A	InfiniiMax 12-GHz ZIF probe head
N5426A	ZIF tips (x10)

To learn more about Infiniium oscilloscope probes and accessories, check out the *Infiniium Oscilloscope Probes and Accessories - Data Sheet* with the Keysight publication number 5968-7141EN.

DDR3 BGA probe adapters

Model number	Description
W2635A-010	x4 and x8, 10 mm width DDR3 BGA probe adapter for oscilloscopes
W2635A-011	x4 and x8, 11 mm width DDR3 BGA probe adapter for oscilloscopes
W2636A-010	x16, 10 mm width DDR3 BGA probe adapter for oscilloscopes
W2636A-011	x16, 11 mm width DDR3 BGA probe adapter for oscilloscopes
W3631A	x16 DDR3 BGA probe for oscilloscopes and logic analyzers
W3633A	x4, x8 DDR3 BGA probe for oscilloscopes and logic analyzers
W3635B	Scope adapter board for DDR3 BGA probe

Switch matrix

Model number	Description
N8990K-A36	LPDDR3 switch matrix

Product

For the most up-to-date and complete application and product information, please visit our product at: www.keysight.com/find/u7231b

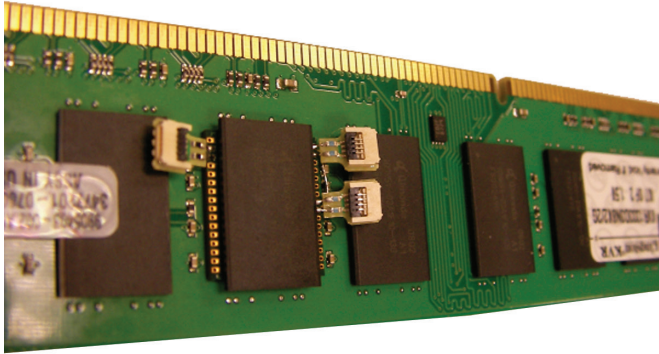
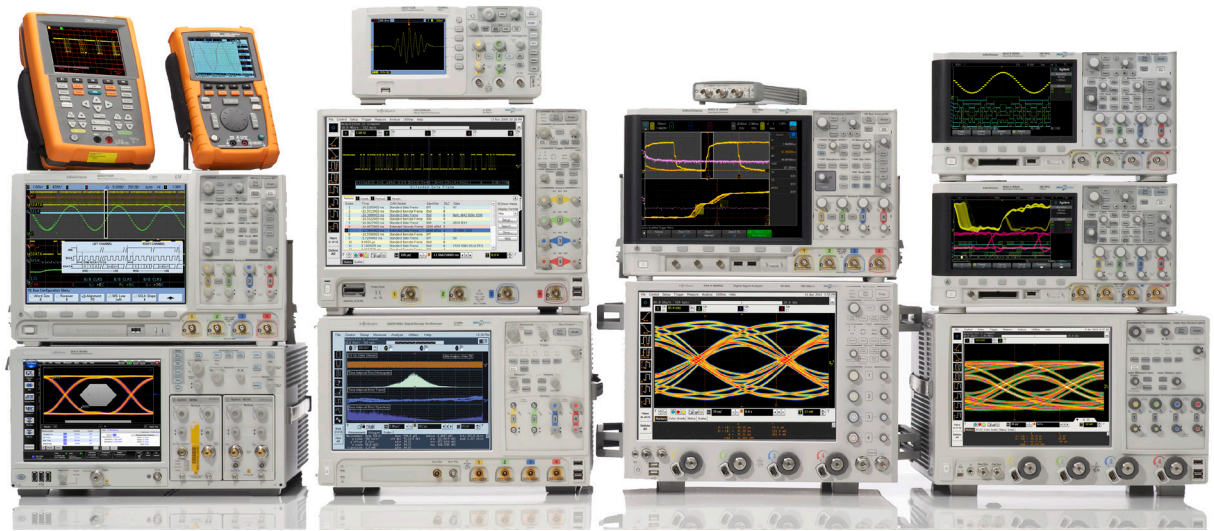

Figure 14. Probing of DDR3 signals with DDR3 BGA probe adapter and ZIF tips.

Related Literature

Publication title	Publication number
<i>E2688A, N5384A High-Speed Serial Data Analysis and Clock Recovery Software For Infiniium Oscilloscopes - Data Sheet</i>	5989-0108EN
<i>EZJIT Plus Jitter Analysis Software for Infiniium Oscilloscopes - Data Sheet</i>	5989-0109EN
<i>A Time-Saving Method for Analyzing Signal Integrity in DDR Memory Buses - Application Note</i>	5989-6664EN
<i>W2635A and W2636A DDR3 BGA Probe Adapter for Infiniium Oscilloscopes - Data Sheet</i>	5989-7643EN
<i>Infiniium 90000 Series Oscilloscopes - Data Sheet</i>	5989-7819EN
<i>W3630A Series DDR3 BGA Probes for Logic Analyzers and Oscilloscopes - Data Sheet</i>	5990-3179EN
<i>InfiniiScan Event Identification Software for Infiniium Series Oscilloscopes - Data Sheet</i>	5990-5093EN
<i>Infiniium 90000 X-Series Oscilloscopes - Data Sheet</i>	5990-5271EN



Keysight Oscilloscopes

Multiple form factors from 20 MHz to > 90 GHz | Industry leading specs | Powerful applications

Learn more at: www.keysight.com

For more information on Keysight Technologies' products, applications or services, please contact your local Keysight office. The complete list is available at: www.keysight.com/find/contactus

