

# Programming Guide

## Agilent Technologies PSG Signal Generators

This guide applies to the following signal generator models:

**E8267C PSG Vector Signal Generator**

**E8257C PSG Analog Signal Generator**

**E8247C PSG CW Signal Generator**

Due to our continuing efforts to improve our products through firmware and hardware revisions, signal generator design and operation may vary from descriptions in this guide. We recommend that you use the latest revision of this guide to ensure you have up-to-date product information. Compare the print date of this guide (see bottom of page) with the latest revision, which can be downloaded from the following website:

*[www.agilent.com/find/psg](http://www.agilent.com/find/psg)*



**Agilent Technologies**

**Manufacturing Part Number: E8251-90255**

**Printed in USA**

**December 2003**

© Copyright 2002, 2003 Agilent Technologies, Inc.

---

## Notice

The material contained in this document is provided “as is,” and is subject to being changed, without notice, in future editions.

Further, to the maximum extent permitted by applicable law, Agilent disclaims all warranties, either express or implied with regard to this manual and to any of the Agilent products to which it pertains, including but not limited to the implied warranties of merchantability and fitness for a particular purpose. Agilent shall not be liable for errors or for incidental or consequential damages in connection with the furnishing, use, or performance of this document or any of the Agilent products to which it pertains. Should Agilent have a written contract with the User and should any of the contract terms conflict with these terms, the contract terms shall control.

---

## Questions or Comments about our Documentation?

We welcome any questions or comments you may have about our documentation. Please send us an E-mail at [sources\\_manuals@am.exch.agilent.com](mailto:sources_manuals@am.exch.agilent.com).

<b>1. Getting Started</b> .....	<b>1</b>
Introduction to Remote Operation .....	2
Interfaces .....	3
IO Libraries .....	3
Programming Language .....	4
Using GPIB .....	4
1. Installing the GPIB Interface Card .....	4
2. Selecting IO Libraries for GPIB .....	6
3. Setting Up the GPIB Interface .....	6
4. Verifying GPIB Functionality .....	7
GPIB Interface Terms .....	7
GPIB Function Statements .....	8
Using LAN .....	12
1. Selecting IO Libraries for LAN .....	12
2. Setting Up the LAN Interface .....	12
3. Verifying LAN Functionality .....	14
Using VXI-11 .....	16
Using Sockets LAN .....	17
Using TELNET LAN .....	17
Using FTP .....	20
Using RS-232 .....	22
1. Selecting IO Libraries for RS-232 .....	22
2. Setting Up the RS-232 Interface .....	23
3. Verifying RS-232 Functionality .....	24
Character Format Parameters .....	24
If You Have Problems .....	25
Error Messages .....	25
Error Message File .....	25
Error Message Types .....	26
<b>2. Programming Examples</b> .....	<b>27</b>
Using the Programming Examples .....	28
Programming Examples Development Environment .....	28
Running C/C++ Programming Examples .....	29
GPIB Programming Examples .....	30
Before Using the Examples .....	30
Interface Check using Agilent BASIC .....	31
Interface Check Using NI-488.2 and C++ .....	32

---

# Contents

Interface Check using VISA and C .....	33
Local Lockout Using Agilent BASIC .....	34
Local Lockout Using NI-488.2 and C++ .....	36
Queries Using Agilent BASIC .....	37
Queries Using NI-488.2 and C++ .....	39
Queries Using VISA and C .....	42
Generating a CW Signal Using VISA and C .....	44
Generating an Externally Applied AC-Coupled FM Signal Using VISA and C .....	46
Generating an Internal AC-Coupled FM Signal Using VISA and C .....	49
Generating a Step-Swept Signal Using VISA and C .....	51
Saving and Recalling States Using VISA and C .....	52
Reading the Data Questionable Status Register Using VISA and C .....	55
Reading the Service Request Interrupt (SRQ) Using VISA and C .....	60
Using 8757D Pass-Thru Commands .....	65
LAN Programming Examples .....	68
Before Using the Examples .....	68
VXI-11 Programing .....	68
Sockets LAN Programming using C .....	73
Sockets LAN Programming Using PERL .....	101
Sockets LAN Programming Using Java .....	103
RS-232 Programming Examples .....	106
Before Using the Examples .....	106
Interface Check Using Agilent BASIC .....	106
Interface Check Using VISA and C .....	107
Queries Using Agilent BASIC .....	109
Queries Using VISA and C .....	110
<b>3. Programming the Status Register System .....</b>	<b>113</b>
Overview .....	114
Status Register Bit Values .....	117
Accessing Status Register Information .....	118
Determining What to Monitor .....	118
Deciding How to Monitor .....	119
Status Register SCPI Commands .....	121
Status Byte Group .....	123
Status Byte Register .....	124
Service Request Enable Register .....	125
Status Groups .....	126

Standard Event Status Group .....	127
Standard Operation Status Group .....	129
Baseband Operation Status Group .....	132
Data Questionable Status Group .....	135
Data Questionable Power Status Group .....	138
Data Questionable Frequency Status Group .....	141
Data Questionable Modulation Status Group .....	144
Data Questionable Calibration Status Group .....	147
<b>4. Downloading and Using Files .....</b>	<b>151</b>
Types of Memory .....	152
Downloading ARB Waveform Data .....	153
Data Requirements and Limitations .....	154
Downloading Waveforms .....	155
Loading and Playing a Downloaded Waveform .....	170
Troubleshooting ARB Waveform Data Download Problems .....	171
Understanding ARB Waveform File Composition and Encryption .....	172
Downloading waveform data to the PSG for extraction as an encrypted waveform file .....	172
Extracting waveform files from the PSG for use in other PSGs .....	173
Downloading encrypted waveform files to the PSG .....	173
Downloading User File Data .....	174
Data Requirements and Limitations .....	175
Bit and Binary Directories .....	176
Selecting Downloaded User Files as the Transmitted Data .....	178
Troubleshooting User File Download Problems .....	178
Downloading FIR Filter Coefficients .....	179
Data Requirements and Limitations .....	179
Downloading FIR Filter Coefficients .....	180
Selecting a Downloaded User FIR Filter as the Active Filter .....	181
Troubleshooting FIR Filter Coefficient File Download Problems .....	181
Downloading Directly into Pattern RAM (PRAM) .....	182
Preliminary Setup .....	182
Data Requirements and Limitations .....	183
Downloading in List Format .....	184
Downloading in Block Format .....	185
Modulating and Activating the Carrier .....	186
Viewing a PRAM Waveform .....	186
Troubleshooting Direct PRAM Download Problems .....	186

---

# Contents

---

# 1 Getting Started

This chapter provides the following major sections:

- [“Introduction to Remote Operation” on page 2](#)
- [“Using GPIB” on page 4](#)
- [“Using LAN” on page 12](#)
- [“Using RS-232” on page 22](#)
- [“Error Messages” on page 25](#)

---

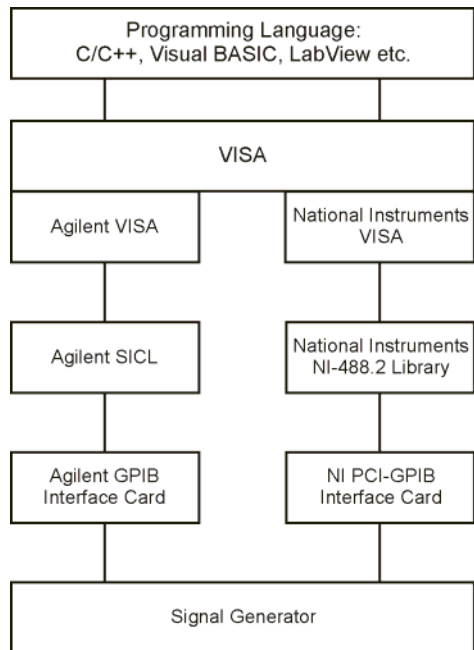
## Introduction to Remote Operation

PSG signal generators support the following interfaces:

- General Purpose Interface Bus (GPIB)
- Local Area Network (LAN)
- ANSI/EIA232 (RS-232) serial connection

Each of these interfaces, in combination with an IO library and programming language, can be used to remotely control the signal generator. [Figure 1-1](#) uses the GPIB as an example of the relationships between the interface, IO libraries, programming language, and signal generator.

**Figure 1-1**                      **Software/Hardware Layers**



ce910a



## Interfaces

- GPIB** GPIB is used extensively when a dedicated computer is available for remote control of each instrument or system. Data transfer is fast because the GPIB handles information in 8-bit bytes. GPIB is physically restricted by the location and distance between the instrument/system and the computer; cables are limited to an average length of two meters per device with a total length of 20 meters.
- LAN** LAN based communication is supported by the signal generator. Data transfer is fast as the LAN handles packets of data. The distance between a computer and the signal generator is limited to 100 meters (10BASE-T). The following protocols can be used to communicate with the signal generator over the LAN:
- VMEbus Extensions for Instrumentation (VXI) as defined in VXI-11
  - Sockets LAN
  - Telephone Network (TELNET)
  - File Transfer Protocol (FTP)
- RS-232** RS-232 is a common method used to communicate with a single instrument; its primary use is to control printers and external disk drives, and connect to a modem. Communication over RS-232 is much slower than with GPIB or LAN because data is sent and received one bit at a time. It also requires that certain parameters, such as baud rate, be matched on both the computer and signal generator.

## IO Libraries

An IO library is a collection of functions used by a programming language to send instrument commands. An IO library must be installed on your computer before writing any programs to control the signal generator.

---

**NOTE** Agilent IO libraries support the VXI-11 standard.

---

## Programming Language

The programming language is used along with Standard Commands for Programming Instructions (SCPI) and IO library functions to remotely control the signal generator. Common programming languages include:

- C/C++
- Agilent BASIC
- LabView
- Java™

---

## Using GPIB

The GPIB allows instruments to be connected together and controlled by a computer. The GPIB and its associated interface operations are defined in the ANSI/IEEE Standard 488.1-1987 and ANSI/IEEE Standard 488.2-1992. See the IEEE website, [www.ieee.org](http://www.ieee.org), for details on these standards.

### 1. Installing the GPIB Interface Card

A GPIB interface card must be installed in your computer. Two common GPIB interface cards are the National Instruments (NI) PCI-GPIB and the Agilent GPIB interface cards. Follow the GPIB interface card instructions for installing and configuring the card in your computer. The following tables provide information on interface cards.

**Table 1-1 Agilent GPIB Interface Card for PC-Based Systems**

Interface Card	Operating System	IO Library	Languages	Backplane/B US	Max IO (kB/sec)	Buffering
Agilent 82341C for ISA bus computers	Windows 95/98/NT/2000®	VISA / SICL	C/C++, Visual Basic, Agilent VEE, Agilent Basic for Windows	ISA/EISA, 16 bit	750	Built-in
Agilent 82341D Plug&Play for PC	Windows 95	VISA / SICL	C/C++, Visual Basic, Agilent VEE, Agilent Basic for Windows	ISA/EISA, 16 bit	750	Built-in

---

Java is a U.S. trademark of Sun Microsystems, Inc.

**Table 1-1 Agilent GPIB Interface Card for PC-Based Systems**

Interface Card	Operating System	IO Library	Languages	Backplane/B US	Max IO (kB/sec)	Buffering
Agilent 82350A for PCI bus computers	Windows 95/98/NT/2000	VISA / SICL	C/C++, Visual Basic, Agilent VEE, Agilent Basic for Windows	PCI 32 bit	750	Built-in

Windows 95, 98, NT and 2000 are registered trademarks of Microsoft Corporation

**Table 1-2 NI-GPIB Interface Card for PC-Based Systems**

Interface Card	Operating System	IO Library	Languages	Backplane/B US	Max IO
National Instrument's PCI-GPIB	Windows 95/98/2000/ME/NT	VISA NI-488.2™	C/C++, Visual BASIC, LabView	PCI 32 bit	1.5 MB/s
National Instrument's PCI-GPIB+	Windows NT	VISA NI-488.2	C/C++, Visual BASIC, LabView	PCI 32 bit	1.5 MB/s

NI-488.2 is a trademark of National Instruments Corporation

**Table 1-3 Agilent-GPIB Interface Card for HP-UX Workstations**

Interface Card	Operating System	IO Library	Languages	Backplane/B US	Max IO (kB/sec)	Buffering
Agilent E2071C	HP-UX 9.x, HP-UX 10.01	VISA/SICL	ANSI C, Agilent VEE, Agilent BASIC, HP-UX	EISA	750	Built-in
Agilent E2071D	HP-UX 10.20	VISA/SICL	ANSI C, Agilent VEE, Agilent BASIC, HP-UX	EISA	750	Built-in

Table 1-3 Agilent-GPIB Interface Card for HP-UX Workstations

Interface Card	Operating System	IO Library	Languages	Backplane/B US	Max IO (kB/sec)	Buffering
Agilent E2078A	HP-UX 10.20	VISA/SICL	ANSI C, Agilent VEE, Agilent BASIC, HP-UX	PCI	750	Built-in

## 2. Selecting IO Libraries for GPIB

The IO libraries are included with your GPIB interface card. These libraries can also be downloaded from the National Instruments website or the Agilent website. The following is a discussion on these libraries.

**VISA** VISA is an IO library used to develop IO applications and instrument drivers that comply with industry standards. It is recommended that the VISA library be used for programming the signal generator. The NI-VISA™ and Agilent VISA libraries are similar implementations of VISA and have the same commands, syntax, and functions. The differences are in the lower level IO libraries; NI-488.2 and SICL respectively. It is best to use the Agilent VISA library with the Agilent GPIB interface card or NI-VISA with the NI PCI-GPIB interface card.

**SICL** Agilent SICL can be used without the VISA overlay. The SICL functions can be called from a program. However, if this method is used, executable programs will not be portable to other hardware platforms. For example, a program using SICL functions will not run on a computer with NI libraries (PCI-GPIB interface card).

**NI-488.2** NI-488.2 can be used without the VISA overlay. The NI-488.2 functions can be called from a program. However, if this method is used, executable programs will not be portable to other hardware platforms. For example, a program using NI-488.2 functions will not run on a computer with Agilent SICL (Agilent GPIB interface card).

## 3. Setting Up the GPIB Interface

1. Press **Utility > GPIB/RS-232 > GPIB Address**.
2. Use the numeric keypad, the arrow keys, or rotate the front panel knob to set the desired address.

The signal generator's GPIB address is set to 19 at the factory. The acceptable range of addresses is 0 through 30. Once initialized, the state of the GPIB address is not affected by a signal generator preset or by a power cycle. Other instruments on the GPIB cannot use the same address as the signal generator.

---

NI-VISA is a registered trademark of National Instruments Corporation

3. Press **Enter**.
4. Connect a GPIB interface cable between the signal generator and the computer. (Refer to [Table 1-4](#) for cable part numbers.)

**Table 1-4 Agilent GPIB Cables**

<b>Model</b>	10833A	10833B	10833C	10833D	10833F	10833G
<b>Length</b>	1 meter	2 meters	4 meters	.5 meter	6 meters	8 meters

## 4. Verifying GPIB Functionality

Use the VISA Assistant, available with the Agilent IO Library or the Getting Started Wizard available with the National Instrument IO Library, to verify GPIB functionality. These utility programs allow you to communicate with the signal generator and verify its operation over the GPIB. Refer to the **Help** menu available in each utility for information and instructions on running these programs.

### If You Have Problems

1. Verify the signal generator's address matches that declared in the program (example programs in Chapter 2 use address 19).
2. Remove all other instruments connected to the GPIB and re-run the program.
3. Verify that the GPIB card's name or id number matches the GPIB name or id number configured for your PC.

## GPIB Interface Terms

An instrument that is part of a GPIB network is categorized as a listener, talker, or controller, depending on its current function in the network.

- |            |   |
|------------|---|
| listener   | A listener is a device capable of receiving data or commands from other instruments. Several instruments in the GPIB network can be listeners simultaneously.                   |
| talker     | A talker is a device capable of transmitting data. To avoid confusion, a GPIB system allows only one device at a time to be an active talker.                                   |
| controller | A controller, typically a computer, can specify the talker and listeners (including itself) for an information transfer. Only one device at a time can be an active controller. |

## GPIB Function Statements

Function statements are the basis for GPIB programming and instrument control. These function statements combined with SCPI provide management and data communication for the GPIB interface and the signal generator. This section describes functions used by different IO libraries. Refer to the NI-488.2 Function Reference Manual for Windows, Agilent Standard Instrument Control Library reference manual, and Microsoft® Visual C++ 6.0 documentation for more information.

### Abort Function

The Agilent BASIC function `ABORT` and the other listed IO library functions terminate listener/talker activity on the GPIB and prepare the signal generator to receive a new command from the computer. Typically, this is an initialization command used to place the GPIB in a known starting condition.

Agilent BASIC	VISA	NI-488.2	Agilent SICL
10 ABORT 7	viTerminate (parameter list)	ibstop(int ud)	iabort (id)

Agilent BASIC      The `ABORT` function stops all GPIB activity.

VISA Library      In VISA, the `viTerminate` command requests a VISA session to terminate normal execution of an asynchronous operation. The parameter list describes the session and job id.

NI-488.2 Library      The NI-488.2 library function aborts any asynchronous read, write, or command operation that is in progress. The parameter `ud` is the interface or device descriptor.

SICL      The Agilent SICL function aborts any command currently executing with the session `id`. This function is supported with C/C++ on Windows 3.1 and Series 700 HP-UX.

### Remote Function

The Agilent BASIC function `REMOTE` and the other listed IO library functions cause the signal generator to change from local operation to remote operation. In remote operation, the front panel keys are disabled except for the **Local** key and the line power switch. Pressing the **Local** key on the signal generator front panel restores manual operation.

Agilent BASIC	VISA	NI-488.2	Agilent SICL
10 REMOTE 719	N/A	EnableRemote (parameter list)	iremote (id)

---

Microsoft is a registered trademark of Microsoft Corporation.

Agilent BASIC	The REMOTE 719 function disables the front panel operation of all keys with the exception of the <b>Local</b> key.
VISA Library	The VISA library, at this time, does not have a similar command.
NI-488.2 Library	This NI-488.2 library function asserts the Remote Enable (REN) GPIB line. All devices listed in the parameter list are put into a listen-active state although no indication is generated by the signal generator. The parameter list describes the interface or device descriptor.
SICL	The Agilent SICL function puts an instrument, identified by the <code>id</code> parameter, into remote mode and disables the front panel keys. Pressing the <b>Local</b> key on the signal generator front panel restores manual operation. The parameter <code>id</code> is the session identifier.

### Local Lockout Function

The Agilent BASIC function LOCAL LOCKOUT and the other listed IO library functions can be used to disable the front panel keys including the **Local** key. With the **Local** key disabled, only the controller (or a hard reset of the line power switch) can restore local control.

Agilent BASIC	VISA	NI-488.2	Agilent SICL
10 LOCAL LOCKOUT 719	N/A	SetRWLS (parameter list)	igpibllo (id)

Agilent BASIC	The LOCAL LOCKOUT function disables all front-panel signal generator keys. Return to local control can occur only with a hard on/off, when the LOCAL command is sent or if the <b>Preset</b> key is pressed.
VISA Library	The VISA library, at this time, does not have a similar command.
NI-488.2 Library	The NI-488.2 library function places the instrument described in the parameter list in remote mode by asserting the Remote Enable (REN) GPIB line. The lockout state is then set using the Local Lockout (LLO) GPIB message. Local control can be restored only with the EnableLocal NI-488.2 routine or hard reset. The parameter list describes the interface or device descriptor.
SICL	The Agilent SICL igpibllo function prevents user access to front panel keys operation. The function puts an instrument, identified by the <code>id</code> parameter, into remote mode with local lockout. The parameter <code>id</code> is the session identifier and instrument address list.

## Local Function

The Agilent BASIC function LOCAL and the other listed functions cause the signal generator to return to local control with a fully enabled front panel.

Agilent BASIC	VISA	NI-488.2	Agilent SICL
10 LOCAL 719	N/A	ibloc (int ud)	iloc(id)

**Agilent BASIC** The LOCAL 719 function returns the signal generator to manual operation, allowing access to the signal generator's front panel keys.

**VISA Library** The VISA library, at this time, does not have a similar command.

**NI-488.2 Library** The NI-488.2 library function places the interface in local mode and allows operation of the signal generator's front panel keys. The ud parameter in the parameter list is the interface or device descriptor.

**SICL** The Agilent SICL function puts the signal generator into Local operation; enabling front panel key operation. The id parameter identifies the session.

## Clear Function

The Agilent BASIC function CLEAR and the other listed IO library functions cause the signal generator to assume a cleared condition.

Agilent BASIC	VISA	NI-488.2	Agilent SICL
10 CLEAR 719	viClear(ViSession vi)	ibclr(int ud)	iclear (id)

**Agilent BASIC** The CLEAR 719 function causes all pending output-parameter operations to be halted, the parser (interpreter of programming codes) to reset and prepare for a new programming code, stops any sweep in progress, and continuous sweep to be turned off.

**VISA Library** The VISA library uses the viClear function. This function performs an IEEE 488.1 clear of the signal generator.

**NI-488.2 Library** The NI-488.2 library function sends the GPIB Selected Device Clear (SDC) message to the device described by ud.

**SICL** The Agilent SICL function clears a device or interface. The function also discards data in both the read and write formatted IO buffers. The id parameter identifies the session.



## Output Function

The Agilent BASIC IO function OUTPUT and the other listed IO library functions put the signal generator into a listen mode and prepare it to receive ASCII data, typically SCPI commands.

Agilent BASIC	VISA	NI-488.2	Agilent SICL
10 OUTPUT 719	viPrintf(parameter list)	ibwrt(parameter list)	iprintf (parameter list)

**Agilent BASIC** The function OUTPUT 719 puts the signal generator into remote mode, makes it a listener, and prepares it to receive data.

**VISA Library** The VISA library uses the above function and associated parameter list to output data. This function formats according to the format string and sends data to the device. The parameter list describes the session id and data to send.

**NI-488.2 Library** The NI-488.2 library function addresses the GPIB and writes data to the signal generator. The parameter list includes the instrument address, session id, and the data to send.

**SICL** The Agilent SICL function converts data using the format string. The format string specifies how the argument is converted before it is output. The function sends the characters in the format string directly to the instrument. The parameter list includes the instrument address, data buffer to write, and so forth.

## Enter Function

The Agilent BASIC function ENTER reads formatted data from the signal generator. Other IO libraries use similar functions to read data from the signal generator.

Agilent BASIC	VISA	NI-488.2	Agilent SICL
10 ENTER 719;	viScanf (parameter list)	ibrdr (parameter list)	iscanf (parameter list)

**Agilent BASIC** The function ENTER 719 puts the signal generator into remote mode, makes it a talker, and assigns data or status information to a designated variable.

**VISA Library** The VISA library uses the viScanf function and an associated parameter list to receive data. This function receives data from the instrument, formats it using the format string, and stores the data in the argument list. The parameter list includes the session id and string argument.

**NI-488.2 Library** The NI-488.2 library function addresses the GPIB, reads data bytes from the signal

generator, and stores the data into a specified buffer. The parameter list includes the instrument address and session id.

**SICL** The Agilent SICL function reads formatted data, converts it, and stores the results into the argument list. The conversion is done using conversion rules for the format string. The parameter list includes the instrument address, formatted data to read, and so forth.

---

## Using LAN

The signal generator can be remotely programmed via a LAN interface and LAN-connected computer using one of several LAN interface protocols. The LAN allows instruments to be connected together and controlled by a LAN-based computer. LAN and its associated interface operations are defined in the IEEE 802.2 standard. See the IEEE website for more details.

The signal generator supports the following LAN interface protocols:

- VXI-11
- Sockets LAN
- Telephone Network (TELNET)
- File Transfer Protocol (FTP)

VXI-11 and sockets LAN are used for general programming using the LAN interface, TELNET is used for interactive, one command at a time instrument control, and FTP is for file transfer.

### 1. Selecting IO Libraries for LAN

The TELNET and FTP protocols do not require IO libraries to be installed on your computer. However, to write programs to control your signal generator, an I/O library must be installed on your computer and the computer configured for instrument control using the LAN interface.

The IO libraries can be downloaded from the Agilent website. The following is a discussion on these libraries.

**Agilent VISA** VISA is an IO library used to develop IO applications and instrument drivers that comply with industry standards. Use the Agilent VISA library for programming the signal generator over the LAN interface.

**SICL** Agilent SICL is a lower level library that is installed along with Agilent VISA.

### 2. Setting Up the LAN Interface

For LAN operation, the signal generator must be connected to the LAN, and an IP address must be assigned to the signal generator either manually or by using DHCP client service. Your system administrator can tell you which method to use.

## Manual Configuration

1. Press **Utility** >  **GPIB/RS-232 LAN** > **LAN Setup** > **Hostname**.
2. Use the labeled text softkeys and/or numeric keypad to enter the desired hostname.  
To erase the current hostname, press **Editing Keys** > **Clear Text**.
3. Press **Enter**.
4. Set **LAN Config Manual DHCP** to **Manual**.
5. Press **IP Address** and enter a desired address.  
Use the left and right arrow keys to move the cursor. Use the up and down arrow keys, front panel knob, or numeric keypad to enter an IP address. To erase the current IP address, press the **Clear Text** softkey.

---

**NOTE** To remotely access the signal generator from a different LAN subnet, you must also enter the subnet mask and default gateway. See your system administrator for the appropriate values.

---

6. Press the **Proceed With Reconfiguration** softkey and then the **Confirm Change (Instrument will Reboot)** softkey.  
This action assigns a hostname and IP address (as well as a gateway and subnet mask, if these have been configured) to the signal generator. The hostname, IP address, gateway and subnet mask are not affected by an instrument preset or by a power cycle.
7. Connect the signal generator to the LAN using a 10BASE-T LAN cable.

## DHCP Configuration

1. Press **Utility** >  **GPIB/RS-232 LAN** > **LAN Setup**.

---

**NOTE** If the DHCP server uses dynamic DNS to link the hostname with the assigned IP address, the hostname may be used in place of the IP address. Otherwise, the hostname is not usable and you may skip steps 2 through 4.

---

2. Press **Hostname**.
3. Use the labeled text softkeys and/or numeric keypad to enter the desired hostname.  
To erase the current hostname, press **Editing Keys** > **Clear Text**.
4. Press **Enter**.
5. Set **LAN Config Manual DHCP** to **DHCP**.

6. Press the **Proceed With Reconfiguration** softkey and then the **Confirm Change (Instrument will Reboot)** softkey.

This configures the signal generator as a DHCP client. In DHCP mode, the signal generator requests a new IP address from the DHCP server upon rebooting. You can return to the LAN Setup menu after rebooting to determine the assigned IP address.

7. Connect the signal generator to the LAN using a 10BASE-T LAN cable.

### 3. Verifying LAN Functionality

Verify the communications link between the computer and the signal generator remote file server using the ping utility. Compare your ping response to those described in [Table 1-5](#).

From a UNIX<sup>®</sup> workstation, type:

```
ping <hostname or IP address> 64 10
```

where <hostname or IP address> is your instrument's name or IP address, 64 is the packet size, and 10 is the number of packets transmitted. Type `man ping` at the UNIX prompt for details on the ping command.

From the MS-DOS<sup>®</sup> Command Prompt or Windows environment, type:

```
ping -n 10 <hostname or IP address>
```

where <hostname or IP address> is your instrument's name or IP address and 10 is the number of echo requests. Type `ping` at the command prompt for details on the ping command.

---

#### NOTE

In DHCP mode, if the DHCP server uses dynamic DNS to link the hostname with the assigned IP address, the hostname may be used in place of the IP address. Otherwise, the hostname is not usable and you must use the IP address to communicate with the signal generator over the LAN.

---

**Table 1-5 Ping Responses**

Normal Response for UNIX	A normal response to the ping command will be a total of 9 or 10 packets received with a minimal average round-trip time. The minimal average will be different from network to network. LAN traffic will cause the round-trip time to vary widely.
Normal Response for DOS or Windows	A normal response to the ping command will be a total of 9 or 10 packets received if 10 echo requests were specified.
Error Messages	<p>If error messages appear, check the command syntax before continuing with troubleshooting. If the syntax is correct, resolve the error messages using your network documentation or by consulting your network administrator.</p> <p>If an unknown host error message appears, try using the IP address instead of the hostname. Also, verify that the host name and IP address for the signal generator have been registered by your IT administrator.</p> <p>Check that the hostname and IP address are correctly entered in the node names database. To do this, enter the <code>nslookup &lt;hostname&gt;</code> command from the command prompt.</p>
No Response	<p>If there is no response from a ping, no packets were received. Check that the typed address or hostname matches the IP address or hostname assigned to the signal generator in the <b>System Utility &gt; GPIB/RS-232 LAN &gt; LAN Setup</b> menu.</p> <p>Ping each node along the route between your workstation and the signal generator, starting with your workstation. If a node doesn't respond, contact your IT administrator.</p> <p>If the signal generator still does not respond to ping, you should suspect a hardware problem.</p>
Intermittent Response	If you received 1 to 8 packets back, there maybe a problem with the network. In networks with switches and bridges, the first few pings may be lost until the these devices 'learn' the location of hosts. Also, because the number of packets received depends on your network traffic and integrity, the number might be different for your network. Problems of this nature are best resolved by your IT department.

## Using VXI-11

The signal generator supports the LAN interface protocol described in the VXI-11 standard. VXI-11 is an instrument control protocol based on Open Network Computing/Remote Procedure Call (ONC/RPC) interfaces running over TCP/IP. It is intended to provide GBIB capabilities such as SRQ (Service Request), status byte reading, and DCAS (Device Clear State) over a LAN interface. This protocol is a good choice for migrating from GPIB to LAN as it has full Agilent VISA/SICL support. See the VXI website, [www.vsi.org](http://www.vsi.org), for more information and details on the specification.

### Configuring for VXI-11

The Agilent I/O library has a program, I/O Config, that is used to setup the computer/signal generator interface for the VXI-11 protocol. Download the latest version of the Agilent I/O library from the Agilent website. Refer to the Agilent I/O library user manual, documentation, and Help menu for information on running the I/O Config program and configuring the VXI-11 interface.

Use the I/O Config program to configure the LAN client. Once the computer is configured for a LAN client, you can use the VXI-11 protocol and the VISA library to send SCPI commands to the signal generator over the LAN interface. Example programs for this protocol are included in [“LAN Programming Examples” on page 68](#) of this programming guide.

---

**NOTE** For Agilent I/O library version J.01.0100, the “Identify devices at run-time” check box must be unchecked. Refer to [Figure 1-2](#).

---

Figure 1-2 Show Devices Form



## Using Sockets LAN

Sockets LAN is a method used to communicate with the signal generator over the LAN interface using the Transmission Control Protocol/ Internet Protocol (TCP/IP). A socket is a fundamental technology used for computer networking and allows applications to communicate using standard mechanisms built into network hardware and operating systems. The method accesses a port on the signal generator from which bidirectional communication with a network computer can be established.

Sockets LAN can be described as an internet address that combines Internet Protocol (IP) with a device port number and represents a single connection between two pieces of software. The socket can be accessed using code libraries packaged with the computer operating system. Two common versions of socket libraries are the Berkeley Sockets Library for UNIX systems and Winsock for Microsoft operating systems.

Your signal generator implements a sockets Applications Programming Interface (API) that is compatible with Berkeley sockets, for UNIX systems, and Winsock for Microsoft systems. The signal generator is also compatible with other standard sockets APIs. The signal generator can be controlled using SCPI commands that are output to a socket connection established in your program.

Before you can use sockets LAN, you must select the signal generator's sockets port number to use:

- Standard mode. Available on port 5025. Use this port for simple programming.
- TELNET mode. The telnet SCPI service is available on port 5023.

---

**NOTE** The signal generator will accept references to telnet SCPI service at port 7777 and sockets SCPI service at port 7778.

---

An example using sockets LAN is given in [Chapter 2](#) of this programming guide.

## Using TELNET LAN

TELNET provides a means of communicating with the signal generator over the LAN. The TELNET client, run on a LAN connected computer, will create a login session on the signal generator. A connection, established between computer and signal generator, generates a user interface display screen with SCPI> prompts on the command line.

Using the TELNET protocol to send commands to the signal generator is similar to communicating with the signal generator over GPIB. You establish a connection with the signal generator and then send or receive information using SCPI commands. Communication is interactive: one command at a time.

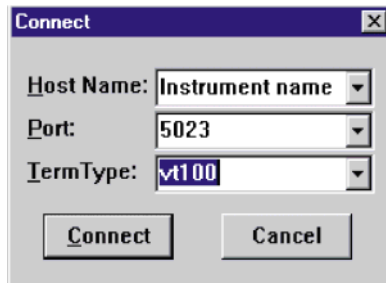
### Using TELNET and MS-DOS Command Prompt

1. On the PC click **Start > Programs > Command Prompt**.
2. At the command prompt, type in telnet.

## Getting Started Using LAN

3. Press enter. The TELNET display screen will be displayed.
4. Click on the **Connect** menu then select **Remote System**. A connection form (Figure 1-3) is displayed.

**Figure 1-3** Connect Form



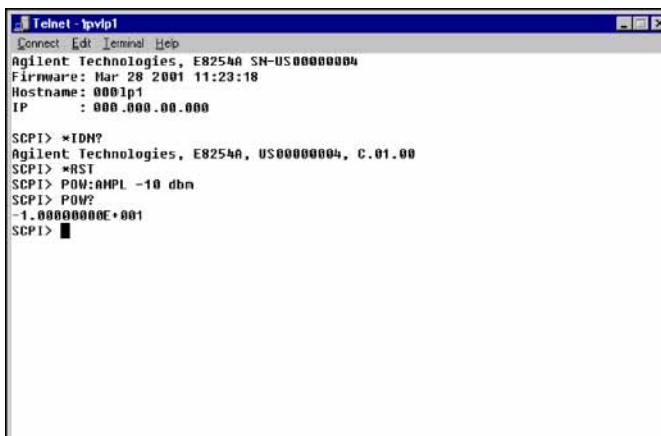
5. Enter the hostname, port number, and TermType then click Connect.
  - Host Name—IP address or hostname
  - Port—5023
  - Term Type—vt100
6. At the `SCPI>` prompt, enter SCPI commands. Refer to [Figure 1-4 on page 19](#).
7. To signal device clear, press Ctrl-C on your keyboard.
8. Select **Exit** from the **Connect** menu and type `exit` at the command prompt to end the TELNET session.

### Using TELNET On a PC With a Host/Port Setting Menu GUI

1. On your PC click **Start > Run**.
2. Type `telnet` then click the **Ok** button. The TELNET connection screen will be displayed.
3. Click on the **Connect** menu then select **Remote System**. A connection form is displayed. See [Figure 1-3](#).
4. Enter the hostname, port number, and TermType then click Connect.
  - Host Name—signal generator's IP address or hostname
  - Port—5023
  - Term Type—vt100
5. At the `SCPI>` prompt, enter SCPI commands. Refer to [Figure 1-4 on page 19](#).
6. To signal device clear, press Ctrl-C.
7. Select **Exit** from the **Connect** menu to end the TELNET session.



Figure 1-4 TELNET Window



```
Telnet - ipwip1
Connect Edit Terminal Help
Agilent Technologies, E8254A SN-US00000004
Firmware: Mar 28 2001 11:23:18
Hostname: 0001p1
IP : 000.000.00.000

SCPI> *IDN?
Agilent Technologies, E8254A, US00000004, C.01.00
SCPI> *RST
SCPI> POW:AMPL -10 dbm
SCPI> POW?
-1.00000000E+001
SCPI> █
```

## The Standard UNIX TELNET Command

### Synopsis

```
telnet [host [port]]
```

### Description

This command is used to communicate with another host using the TELNET protocol. When the command `telnet` is invoked with `host` or `port` arguments, a connection is opened to the host, and input is sent from the user to the host.

### Options and Parameters

The command `telnet` operates in character-at-a-time or line-by-line mode. In line-by-line mode, typed text is echoed to the screen. When the line is completed (by pressing the **Enter** key), the text line is sent to `host`. In character-at-a-time mode, text is echoed to the screen and sent to `host` as it is typed. At the UNIX prompt, type `man telnet` to view the options and parameters available with the `telnet` command.

---

**NOTE** If your TELNET connection is in line-by-line mode, there is no local echo. This means you cannot see the characters you are typing until you press the **Enter** key. To remedy this, change your TELNET connection to character-by-character mode. Escape out of TELNET, and at the `telnet>` prompt, type `mode char`. If this does not work, consult your TELNET program's documentation.

---

## Unix TELNET Example

To connect to the instrument with host name `myInstrument` and port number `7778`, enter the following command on the command line: `telnet myInstrument 5023`

When you connect to the signal generator, the UNIX window will display a welcome message and a SCPI command prompt. The instrument is now ready to accept your SCPI commands. As you type SCPI commands, query results appear on the next line. When you are done, break the TELNET connection using an escape character. For example, `Ctrl - ]`, where the control key and the `]` are pressed at the same time. The following example shows TELNET commands:

```
$ telnet myinstrument 5023
Trying...
Connected to signal generator
Escape character is '^]'.
Agilent Technologies, E8254A SN-US00000001
Firmware:
Hostname: your instrument
IP :xxx.xx.xxx.xxx
SCPI>
```

## Using FTP

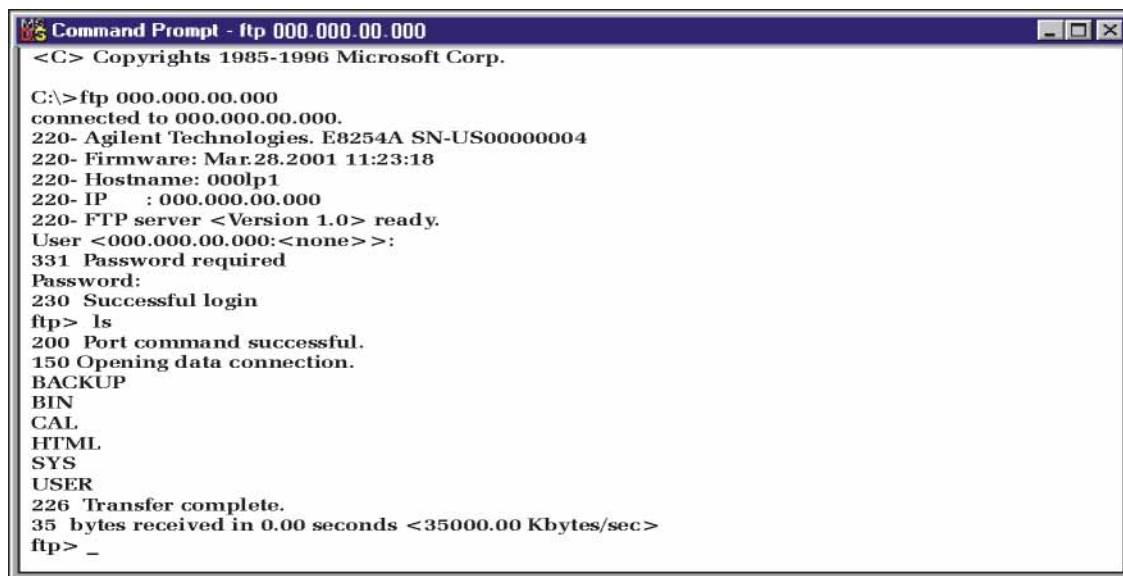
FTP allows users to transfer files between the signal generator and any computer connected to the LAN. For example, you can use FTP to download instrument screen images to a computer. When logged onto the signal generator with the FTP command, the signal generator's file structure can be accessed. [Figure 1-5](#) shows the FTP interface and lists the directories in the signal generator's user level directory.

---

**NOTE** File access is limited to the signal generator's `/user` directory.

---

Figure 1-5 FTP Screen



```
Command Prompt - ftp 000.000.00.000
<C> Copyrights 1985-1996 Microsoft Corp.

C:\>ftp 000.000.00.000
connected to 000.000.00.000.
220- Agilent Technologies. E8254A SN-US00000004
220- Firmware: Mar.28.2001 11:23:18
220- Hostname: 000lp1
220- IP : 000.000.00.000
220- FTP server <Version 1.0> ready.
User <000.000.00.000:<none>>:
331 Password required
Password:
230 Successful login
ftp> ls
200 Port command successful.
150 Opening data connection.
BACKUP
BIN
CAL
HTML
SYS
USER
226 Transfer complete.
35 bytes received in 0.00 seconds <35000.00 Kbytes/sec>
ftp> _
```

ce917a

The following steps outline a sample FTP session from the MS-DOS Command Prompt:

1. On the PC click **Start > Programs > Command Prompt**.
2. At the command prompt enter:  
ftp < IP address > or < hostname >
3. At the user name prompt, press enter.
4. At the password prompt, press enter.

You are now in the signal generator's user directory. Typing help at the command prompt will show you the FTP commands that are available on your system.

5. Type quit or bye to end your FTP session.
6. Type exit to end the command prompt session.

## Using RS-232

The RS-232 serial interface can be used to communicate with the signal generator. The RS-232 connection is standard on most PCs and can be connected to the signal generator's rear-panel AUXILIARY INTERFACE connector using the cable described in [Table 1-6 on page 23](#). Many functions provided by GPIB, with the exception of indefinite blocks, serial polling, GET, non-SCPI remote languages, and remote mode are available using the RS-232 interface.

The serial port sends and receives data one bit at a time, therefore RS-232 communication is slow. The data transmitted and received is usually in ASCII format with SCPI commands being sent to the signal generator and ASCII data returned.

### 1. Selecting IO Libraries for RS-232

The IO libraries can be downloaded from the National Instrument website, [www.ni.com](http://www.ni.com), or Agilent's website, [www.agilent.com](http://www.agilent.com). The following is a discussion on these libraries.

- |               |  |
|---------------|--|
| Agilent BASIC | The Agilent BASIC language has an extensive IO library that can be used to control the signal generator over the RS-232 interface. This library has many low level functions that can be used in BASIC applications to control the signal generator over the RS-232 interface.   |
| VISA          | VISA is an IO library used to develop IO applications and instrument drivers that comply with industry standards. It is recommended that the VISA library be used for programming the signal generator. The NI-VISA and Agilent VISA libraries are similar implementations of VISA and have the same commands, syntax, and functions. The differences are in the lower level IO libraries used to communicate over the RS-232; NI-488.2 and SICL respectively. |
| NI-488.2      | NI-488.2 IO libraries can be used to develop applications for the RS-232 interface. See National Instrument's website for information on NI-488.2.   |
| SICL          | Agilent SICL can be used to develop applications for the RS-232 interface. See Agilent's website for information on SICL.  |

## 2. Setting Up the RS-232 Interface

1. Press **Utility > GPIB/RS-232 LAN > RS-232 Setup > RS-232 Baud Rate > 9600**

Use baud rates 57600 or lower only. Select the signal generator's baud rate to match the baud rate of your computer or UNIX workstation or adjust the baud rate settings on your computer to match the baud rate setting of the signal generator.

---

**NOTE** The default baud rate for VISA is 9600. This baud rate can be changed with the "VI\_ATTR\_ASRL\_BAUD" VISA attribute.

---

2. Press **Utility > GPIB/RS-232 LAN > RS-232 Setup > RS-232 Echo Off On** until Off is highlighted.

Set the signal generator's RS-232 echo. Selecting On echoes or returns characters sent to the signal generator and prints them to the display.

3. Connect an RS-232 cable from the computer's serial connector to the signal generator's AUXILIARY INTERFACE connector. Refer to [Table 1-6](#) for RS-232 cable information.

**Table 1-6 RS-232 Serial Interface Cable**

Quantity	Description	Agilent Part Number
1	Serial RS-232 cable 9-pin (male) to 9-pin (female)	8120-6188

---

**NOTE** Any 9 pin (male) to 9 pin (female) straight-through cable that directly wires pins 2, 3, 5, 7, and 8 may be used.

---

### 3. Verifying RS-232 Functionality

You can use the HyperTerminal program available on your computer to verify the RS-232 interface functionality. To run the HyperTerminal program, connect the RS-232 cable between the computer and the signal generator and perform the following steps:

1. On the PC click **Start > Programs > Accessories > HyperTerminal** and select **HyperTerminal**.
2. Enter a name for the session in the text box and select an icon.
3. Select COM1 (COM2 can be used if COM1 is unavailable), and set the following parameters:
  - Bits per second: 9600 must match signal generator's baud rate; on the signal generator, Select **Utility > GPIB/RS-232 LAN > RS-232 Setup > RS-232 Baud Rate > 9600**.
  - Data bits: 8
  - Parity: None
  - Stop bits: 1
  - Flow Control: None

---

**NOTE** Flow control, via the RTS line, is driven by the signal generator. For the purposes of this verification, the controller (PC) can ignore this if flow control is set to None. However, to control the signal generator programatically or download files to the signal generator, you *must* enable RTS-CTS (hardware) flow control on the controller. Note that only the RTS line is currently used.

---

4. Go to the HyperTerminal window and select **File > Properties**
5. Go to **Settings > Emulation** and select **VT100**.
6. Leave the **Backscroll buffer lines** set to the default value.
7. Go to **Settings > ASCII Setup**.
8. Check the first two boxes and leave the other boxes as default values.

Once the connection is established, enter the SCPI command `*IDN?` followed by `<Ctrl j>` in the HyperTerminal window. The `<Ctrl j>` is the new line character (on the keyboard press the Cntrl key and the j key simultaneously). The signal generator should return a string similar to the following, depending on model: Agilent Technologies *<instrument model name and number>*, US40000001,C.02.00

### Character Format Parameters

The signal generator uses the following character format parameters when communicating via RS-232:

- Character Length: Eight data bits are used for each character, excluding start, stop, and parity bits.
- Parity Enable: Parity is disabled (absent) for each character.
- Stop Bits: One stop bit is included with each character.

## If You Have Problems

1. Verify that the baud rate, parity, and stop bits are the same for the computer and signal generator.
2. Verify that the RS-232 cable is identical to the cable specified in [Table 1-6](#).
3. Verify that the application is using the correct computer COM port and that the RS-232 cable is properly connected to that port.
4. Verify that the controller's flow control is set to RTS-CTS.

---

## Error Messages

If an error condition occurs in the signal generator, it is reported to both the SCPI (remote interface) error queue and the front panel display error queue. These two queues are viewed and managed separately; for information on the front panel display error queue, refer to the *User's Guide*.

When accessing error messages using the SCPI (remote interface) error queue, the error numbers and the <error\_description> portions of the error query response are displayed on the host terminal.

Characteristic	SCPI Remote Interface Error Queue
Capacity (#errors)	30
Overflow Handling	Linear, first-in/first-out. Replaces newest error with: -350, Queue overflow
Viewing Entries	Use SCPI query <code>SYSTEM:ERROR[:NEXT]?</code>
Clearing the Queue	Power up Send a *CLS command Read last item in the queue
Unresolved Errors	Re-reported after queue is cleared.
No Errors	When the queue is empty (every error in the queue has been read, or the queue is cleared), the following message appears in the queue: +0, "No error"

Errors that must be resolved. For example, unlock.

## Error Message File

A complete list of error messages is provided in the file *errormessages.pdf*, on the CD-ROM supplied with your instrument. In the error message list, an explanation is generally included with each error to further clarify its meaning. The error messages are listed numerically. In cases where there are multiple listings for the same error number, the messages are in alphabetical order.

## Error Message Types

Events do not generate more than one type of error. For example, an event that generates a query error will not generate a device-specific, execution, or command error.

**Query Errors (–499 to –400)** indicate that the instrument’s output queue control has detected a problem with the message exchange protocol described in IEEE 488.2, Chapter 6. Errors in this class set the query error bit (bit 2) in the event status register (IEEE 488.2, section 11.5.1). These errors correspond to message exchange protocol errors described in IEEE 488.2, 6.5. In this case:

- Either an attempt is being made to read data from the output queue when no output is either present or pending, or
- data in the output queue has been lost.

**Device Specific Errors (–399 to –300, 201 to 703, and 800 to 810)** indicate that a device operation did not properly complete, possibly due to an abnormal hardware or firmware condition. These codes are also used for self-test response errors. Errors in this class set the device-specific error bit (bit 3) in the event status register (IEEE 488.2, section 11.5.1).

The <error\_message> string for a *positive* error is not defined by SCPI. A positive error indicates that the instrument detected an error within the GPIB system, within the instrument’s firmware or hardware, during the transfer of block data, or during calibration.

**Execution Errors (–299 to –200)** indicate that an error has been detected by the instrument’s execution control block. Errors in this class set the execution error bit (bit 4) in the event status register (IEEE 488.2, section 11.5.1). In this case:

- Either a <PROGRAM DATA> element following a header was evaluated by the device as outside of its legal input range or is otherwise inconsistent with the device’s capabilities, or
- a valid program message could not be properly executed due to some device condition.

Execution errors are reported *after* rounding and expression evaluation operations are completed. Rounding a numeric data element, for example, is not reported as an execution error.

**Command Errors (–199 to –100)** indicate that the instrument’s parser detected an IEEE 488.2 syntax error. Errors in this class set the command error bit (bit 5) in the event status register (IEEE 488.2, section 11.5.1). In this case:

- Either an IEEE 488.2 syntax error has been detected by the parser (a control-to-device message was received that is in violation of the IEEE 488.2 standard. Possible violations include a data element that violates device listening formats or whose type is unacceptable to the device.), or
- an unrecognized header was received. These include incorrect device-specific headers and incorrect or unimplemented IEEE 488.2 common commands.



---

## 2 Programming Examples

This chapter provides the following major sections:

- “Using the Programming Examples” on page 28
- “GPIB Programming Examples” on page 30
- “LAN Programming Examples” on page 68
- “RS-232 Programming Examples” on page 106

## Using the Programming Examples

The programming examples for remote control of the signal generator use the GPIB, LAN, and RS-232 interfaces and demonstrate instrument control using different I/O libraries and programming languages. Many of the example programs in this chapter are interactive; the user will be prompted to perform certain actions or verify signal generator operation or functionality. Example programs are written in the following languages:

- Agilent BASIC
- C/C++
- Java
- PERL

See [Chapter 1](#) of this programming guide for information on interfaces, I/O libraries, and programming languages.

The example programs are also available on the PSG Documentation CD-ROM, enabling you to cut and paste the examples into a text editor.

---

**NOTE** The example programs set the signal generator into remote mode; front panel keys, except the **Local** key, are disabled. Press the **Local** key to revert to manual operation.

---

---

**NOTE** To update the signal generator's front panel display so that it reflects remote command setups, enable the remote display: press **Utility > Display > Update in Remote Off On** softkey until On is highlighted or send the SCPI command :DISPlay:REMote ON. For faster test execution, disable front panel updates.

---

## Programming Examples Development Environment

The C/C++ examples in this guide were written using an IBM-compatible personal computer (PC) with the following configuration:

- Pentium<sup>®</sup> processor
- Windows NT 4.0 operating system
- C/C++ programming language with the Microsoft Visual C++ 6.0 IDE

---

Pentium is a U.S. registered trademark of Intel Corporation

- National Instruments PCI- GPIB interface card or Agilent GPIB interface card
- National Instruments VISA Library or Agilent VISA library
- COM1 or COM2 serial port available
- LAN interface card

The Agilent BASIC examples were run on a UNIX 700 Series workstation

## Running C/C++ Programming Examples

To run the example programs written in C/C++ you must include the required files in the Microsoft Visual C++ 6.0 project.

If you are using the VISA library do the following:

- add the visa32.lib file to the Resource Files
- add the visa.h file to the Header Files

If you are using the NI-488.2 library do the following:

- add the GPIB-32.OBJ file to the Resource Files
- add the windows.h file to the Header Files
- add the Deci-32.h file to the Header Files

Refer to the National Instrument website for information on the NI-488.2 library and file requirements. For information on the VISA library see the Agilent website or National Instrument's website.

## GPIB Programming Examples

- “Interface Check using Agilent BASIC” on page 31
- “Interface Check Using NI-488.2 and C++” on page 32
- “Interface Check using VISA and C” on page 33
- “Local Lockout Using Agilent BASIC” on page 34
- “Local Lockout Using NI-488.2 and C++” on page 36
- “Queries Using Agilent BASIC” on page 37
- “Queries Using NI-488.2 and C++” on page 39
- “Queries Using VISA and C” on page 42
- “Generating a CW Signal Using VISA and C” on page 44
- “Generating an Externally Applied AC-Coupled FM Signal Using VISA and C” on page 46
- “Generating an Internal AC-Coupled FM Signal Using VISA and C” on page 49
- “Generating a Step-Swept Signal Using VISA and C” on page 51
- “Saving and Recalling States Using VISA and C” on page 52
- “Reading the Data Questionable Status Register Using VISA and C” on page 55
- “Reading the Service Request Interrupt (SRQ) Using VISA and C” on page 60
- “Using 8757D Pass-Thru Commands” on page 65

### Before Using the Examples

If the Agilent GPIB interface card is used, then the Agilent VISA library should be installed along with Agilent SICL. If the National Instruments PCI-GPIB interface card is used, the NI-VISA library along with the NI-488.2 library should be installed. Refer to “[2. Selecting IO Libraries for GPIB](#)” on page 6 and the documentation for your GPIB interface card for details.

---

**NOTE** Agilent BASIC addresses the signal generator at 719. The GPIB card is addressed at 7 and the signal generator at 19. The GPIB address designator for other libraries is typically GPIB0 or GPIB1.

---

## Interface Check using Agilent BASIC

This simple program causes the signal generator to perform an instrument reset. The SCPI command \*RST places the signal generator into a pre-defined state and the remote annunciator (R) appears on the front panel display.

The following program example is available on the PSG Documentation CD-ROM as basicex1.txt.

```

10      !*****
20      !
30      ! PROGRAM NAME:          basicex1.txt
40      !
50      ! PROGRAM DESCRIPTION:  This program verifies that the GPIB connections and
60      !                        interface are functional.
70      !
80      ! Connect a controller to the signal generator using a GPIB cable.
90      !
100     !
110     ! CLEAR and RESET the controller and type in the following commands and then
120     ! RUN the program:
130     !
140     !*****
150     !
160     Sig_gen=719      ! Declares a variable to hold the signal generator's address
170     LOCAL Sig_gen   ! Places the signal generator into Local mode
180     CLEAR Sig_gen   ! Clears any pending data I/O and resets the parser
190     REMOTE 719      ! Puts the signal generator into remote mode
200     CLEAR SCREEN   ! Clears the controllers display
210     REMOTE 719
220     OUTPUT Sig_gen;"*RST" ! Places the signal generator into a defined state
230     PRINT "The signal generator should now be in REMOTE."
240     PRINT
250     PRINT "Verify that the remote [R] annunciator is on. Press the `Local' key, "
260     PRINT "on the front panel to return the signal generator to local control."
270     PRINT

```

## Programming Examples

### GPIB Programming Examples

```
280 PRINT "Press RUN to start again."
290 END ! Program ends
```

### Interface Check Using NI-488.2 and C++

This example uses the NI-488.2 library to verify that the GPIB connections and interface are functional. Launch Microsoft Visual C++ 6.0, add the required files, and enter the following code into your .cpp source file.

The following program example is available on the PSG Documentation CD-ROM as niex1.cpp.

```
// *****
//
// PROGRAM NAME: niex1.cpp
//
// PROGRAM DESCRIPTION: This program verifies that the GPIB connections and
// interface are functional.
//
// Connect a GPIB cable from the PC GPIB card to the signal generator
// Enter the following code into the source .cpp file and execute the program
//
// *****

#include "stdafx.h"
#include <iostream>
#include "windows.h"
#include "Decl-32.h"
using namespace std;

int GPIB0= 0; // Board handle
Addr4882_t Address[31]; // Declares an array of type Addr4882_t

int main(void)

{
```

```

int sig; // Declares a device descriptor variable
sig = ibdev(0, 19, 0, 13, 1, 0); // Acquires a device descriptor
ibclr(sig); // Sends device clear message to signal generator
ibwrt(sig, "*RST", 4); // Places the signal generator into a defined state

// Print data to the output window
cout << "The signal generator should now be in REMOTE. The remote indicator"<<endl;
cout <<"annunciator R should appear on the signal generator display"<<endl;

return 0;

}

```

## Interface Check using VISA and C

This program uses VISA library functions and the C language to communicate with the signal generator. The program verifies that the GPIB connections and interface are functional. Launch Microsoft Visual C++ 6.0, add the required files, and enter the following code into your .cpp source file.

The following program example is available on the PSG Documentation CD-ROM as visaex1.cpp.

```

/*****
// PROGRAM NAME:visaex1.cpp
//
// PROGRAM DESCRIPTION:This example program verifies that the GPIB connections and
// and interface are functional.
// Turn signal generator power off then on and then run the program
//
/*****

#include <visa.h>
#include <stdio.h>
#include "StdAfx.h"
#include <stdlib.h>

```

## Programming Examples

### GPIB Programming Examples

```
void main ()
{
ViSession defaultRM, vi;          // Declares a variable of type ViSession
                                   // for instrument communication

ViStatus viStatus = 0;

                                   // Opens a session to the GPIB device
                                   // at address 19

viStatus=viOpenDefaultRM(&defaultRM);
viStatus=viOpen(defaultRM, "GPIB::19::INSTR", VI_NULL, VI_NULL, &vi);
if(viStatus){
printf("Could not open ViSession!\n");
printf("Check instruments and connections\n");
printf("\n");
exit(0);}

viPrintf(vi, "*RST\n");          // initializes signal generator
                                   // prints to the output window
printf("The signal generator should now be in REMOTE. The remote
      indicator\n");
printf("annunciator R should appear on the signal generator display\n");
printf("\n");

viClose(vi);                      // closes session
viClose(defaultRM);              // closes default session
}
```

### Local Lockout Using Agilent BASIC

This example demonstrates the Local Lockout function. Local Lockout disables the front panel signal generator keys.

The following program example is available on the PSG Documentation CD-ROM as basicex2.txt.

```
10      !*****
20      !
30      ! PROGRAM NAME:          basicex2.txt
```



```

40      !
50      ! PROGRAM DESCRIPTION: In REMOTE mode, access to the signal generators
60      !                       functional front panel keys are disabled except for
70      !                       the Local and Contrast keys. The LOCAL LOCKOUT
80      !                       command will disable the Local key.
90      !                       The LOCAL command, executed from the controller, is then
100     !                       the only way to return the signal generator to front panel,
110     !                       Local, control.
120     !*****
130     Sig_gen=719      ! Declares a variable to hold signal generator address
140     CLEAR Sig_gen    ! Resets signal generator parser and clears any output
150     LOCAL Sig_gen    ! Places the signal generator in local mode
160     REMOTE Sig_gen   ! Places the signal generator in remote mode
170     CLEAR SCREEN     ! Clears the controllers display
180     OUTPUT Sig_gen;"*RST"      ! Places the signal generator in a defined state
190     ! The following print statements are user prompts
200     PRINT "The signal generator should now be in remote."
210     PRINT "Verify that the 'R' and 'L' annunciators are visible"
220     PRINT "..... Press Continue"
230     PAUSE
240     LOCAL LOCKOUT 7    ! Puts the signal generator in LOCAL LOCKOUT mode
250     PRINT              ! Prints user prompt messages
260     PRINT "Signal generator should now be in LOCAL LOCKOUT mode."
270     PRINT
280     PRINT "Verify that all keys including `Local' (except Contrast keys) have no effect."
290     PRINT
300     PRINT "..... Press Continue"
310     PAUSE
320     PRINT
330     LOCAL 7           ! Returns signal generator to Local control
340     ! The following print statements are user prompts
350     PRINT "Signal generator should now be in Local mode."

```

## Programming Examples

### GPIB Programming Examples

```
360 PRINT
370 PRINT "Verify that the signal generator's front-panel keyboard is functional."
380 PRINT
390 PRINT "To re-start this program press RUN."
400 END
```

### Local Lockout Using NI-488.2 and C++

This example uses the NI-488.2 library to set the signal generator local lockout mode. Launch Microsoft Visual C++ 6.0, add the required files, and enter the following code into your .cpp source file. This example is available on the PSG Documentation CD-ROM as niex2.cpp.

```
// *****
// PROGRAM NAME: niex2.cpp
//
// PROGRAM DESCRIPTION: This program will place the signal generator into
// LOCAL LOCKOUT mode. All front panel keys, except the Contrast key, will be disabled.
// The local command, 'ibloc(sig)' executed via program code, is the only way to
// return the signal generator to front panel, Local, control.
// *****

#include "stdafx.h"
#include <iostream>
#include "windows.h"
#include "Decl-32.h"
using namespace std;
int GPIB0= 0; // Board handle
Addr4882_t Address[31]; // Declares a variable of type Addr4882_t

int main()

{
    int sig; // Declares variable to hold interface descriptor
    sig = ibdev(0, 19, 0, 13, 1, 0); // Opens and initialize a device descriptor
    ibclr(sig); // Sends GPIB Selected Device Clear (SDC) message
```

```

ibwrt(sig, "*RST", 4);           // Places signal generator in a defined state
cout << "The signal generator should now be in REMOTE. The remote mode R " << endl;
cout << "annunciator should appear on the signal generator display." << endl;
cout << "Press Enter to continue" << endl;
cin.ignore(10000, '\n');

SendIFC(GPIB0);                 // Resets the GPIB interface
Address[0]=19;                  // Signal generator's address
Address[1]=NOADDR;              // Signifies end element in array. Defined in
                                // DECL-32.H
SetRWLS(GPIB0, Address);        // Places device in Remote with Lockout State.

cout << "The signal generator should now be in LOCAL LOCKOUT. Verify that all
      keys" << endl;
cout << "including the 'Local' key are disabled (Contrast keys are not
      affected)" << endl;
cout << "Press Enter to continue" << endl;
cin.ignore(10000, '\n');

ibloc(sig);                      // Returns signal generator to local control
cout << endl;
cout << "The signal generator should now be in local mode\n";

return 0;}
}

```

## Queries Using Agilent BASIC

This example demonstrates signal generator query commands. The signal generator can be queried for conditions and setup parameters. Query commands are identified by the question mark as in the identify command \*IDN?

The following program example is available on the PSG Documentation CD-ROM as basicex3.txt.

```

10  !*****
20  !
30  ! PROGRAM NAME:          basicex3.txt
40  !
50  ! PROGRAM DESCRIPTION:  In this example, query commands are used with response
60  !                      data formats.

```

## Programming Examples

### GPIB Programming Examples

```
70      !
80      ! CLEAR and RESET the controller and RUN the following program:
90      !
100     !*****
110     !
120     DIM A$(10),C$(100),D$(10)  ! Declares variables to hold string response data
130     INTEGER B                  ! Declares variable to hold integer response data
140     Sig_gen=719                ! Declares variable to hold signal generator address
150     LOCAL Sig_gen              ! Puts signal generator in Local mode
160     CLEAR Sig_gen              ! Resets parser and clears any pending output
170     CLEAR SCREEN               ! Clears the controller's display
180     OUTPUT Sig_gen;"*RST"      ! Puts signal generator into a defined state
190     OUTPUT Sig_gen;"FREQ:CW?"  ! Queries the signal generator CW frequency setting
200     ENTER Sig_gen;F            ! Enter the CW frequency setting
210     ! Print frequency setting to the controller display
220     PRINT "Present source CW frequency is: ";F/1.E+6;"MHz"
230     PRINT
240     OUTPUT Sig_gen;"POW:AMPL?" ! Queries the signal generator power level
250     ENTER Sig_gen;W            ! Enter the power level
260     ! Print power level to the controller display
270     PRINT "Current power setting is: ";W;"dBm"
280     PRINT
290     OUTPUT Sig_gen;"FREQ:MODE?" ! Queries the signal generator for frequency mode
300     ENTER Sig_gen;A$          ! Enter in the mode: CW, Fixed or List
310     ! Print frequency mode to the controller display
320     PRINT "Source's frequency mode is: ";A$
330     PRINT
340     OUTPUT Sig_gen;"OUTP OFF"  ! Turns signal generator RF state off
350     OUTPUT Sig_gen;"OUTP?"    ! Queries the operating state of the signal generator
360     ENTER Sig_gen;B            ! Enter in the state (0 for off)
370     ! Print the on/off state of the signal generator to the controller display
380     IF B>0 THEN
```

```

390     PRINT "Signal Generator output is: on"
400     ELSE
410     PRINT "Signal Generator output is: off"
420     END IF
430     OUTPUT Sig_gen;"*IDN?"      ! Querys for signal generator ID
440     ENTER Sig_gen;C$           ! Enter in the signal generator ID
450     ! Print the signal generator ID to the controller display
460     PRINT
470     PRINT "This signal generator is a ";C$
480     PRINT
490     ! The next command is a query for the signal generator's GPIB address
500     OUTPUT Sig_gen;"SYST:COMM:GPIB:ADDR?"
510     ENTER Sig_gen;D$         ! Enter in the signal generator's address
520     ! Print the signal generator's GPIB address to the controllers display
530     PRINT "The GPIB address is ";D$
540     PRINT
550     ! Print user prompts to the controller's display
560     PRINT "The signal generator is now under local control"
570     PRINT "or Press RUN to start again."
580     END

```

## Queries Using NI-488.2 and C++

This example uses the NI-488.2 library to query different instrument states and conditions. Launch Microsoft Visual C++ 6.0, add the required files, and enter the following code into your .cpp source file.

The following program example is available on the PSG Documentation CD-ROM as niex3.cpp.

```

//*****
// PROGRAM NAME: niex3.cpp
//
// PROGRAM DESCRIPTION: This example demonstrates the use of query commands.
//
// The signal generator can be queried for conditions and instrument states.
// These commands are of the type "*IDN?" where the question mark indicates

```

## Programming Examples

### GPIB Programming Examples

```
// a query.
//
//*****

#include "stdafx.h"
#include <iostream>
#include "windows.h"
#include "Decl-32.h"
using namespace std;

int GPIB0= 0; // Board handle
Addr4882_t Address[31]; // Declare a variable of type Addr4882_t

int main()

{
    int sig; // Declares variable to hold interface descriptor
    int num;
    char rdVal[100]; // Declares variable to read instrument responses
    sig = ibdev(0, 19, 0, 13, 1, 0); // Open and initialize a device descriptor
    ibloc(sig); // Places the signal generator in local mode
    ibclr(sig); // Sends Selected Device Clear(SDC) message
    ibwrt(sig, "*RST", 4); // Places signal generator in a defined state
    ibwrt(sig, ":FREQuency:CW?",14); // Querys the CW frequency
    ibrd(sig, rdVal,100); // Reads in the response into rdVal
    rdVal[ibcntl] = '\0'; // Null character indicating end of array
    cout<<"Source CW frequency is "<<rdVal; // Print frequency of signal generator
    cout<<"Press any key to continue"<<endl;
    cin.ignore(10000,'\n');
    ibwrt(sig, "POW:AMPL?",10); // Querys the signal generator
    ibrd(sig, rdVal,100); // Reads the signal generator power level
    rdVal[ibcntl] = '\0'; // Null character indicating end of array
    // Prints signal generator power level
```

```

cout<<"Source power (dBm) is : "<<rdVal;
cout<<"Press any key to continue"<<endl;
cin.ignore(10000,'\n');
ibwrt(sig, ":FREQ:MODE?",11); // Querys source frequency mode
ibrd(sig, rdVal,100); // Enters in the source frequency mode
rdVal[ibcnt1] = '\0'; // Null character indicating end of array
cout<<"Source frequency mode is "<<rdVal; // Print source frequency mode
cout<<"Press any key to continue"<<endl;
cin.ignore(10000,'\n');
ibwrt(sig, "OUTP OFF",12); // Turns off RF source
ibwrt(sig, "OUTP?",5); // Querys the on/off state of the instrument
ibrd(sig,rdVal,2); // Enter in the source state
rdVal[ibcnt1] = '\0';
num = (int (rdVal[0]) -('0'));
if (num > 0){
    cout<<"Source RF state is : On"<<endl;
}else{
    cout<<"Source RF state is : Off"<<endl;}
cout<<endl;
ibwrt(sig, "*IDN?",5); // Querys the instrument ID
ibrd(sig, rdVal,100); // Reads the source ID
rdVal[ibcnt1] = '\0'; // Null character indicating end of array
cout<<"Source ID is : "<<rdVal; // Prints the source ID
cout<<"Press any key to continue"<<endl;
cin.ignore(10000,'\n');
ibwrt(sig, "SYST:COMM:GPIB:ADDR?",20); //Querys source address
ibrd(sig, rdVal,100); // Reads the source address
rdVal[ibcnt1] = '\0'; // Null character indicates end of array
// Prints the signal generator address
cout<<"Source GPIB address is : "<<rdVal;
cout<<endl;
cout<<"Press the 'Local' key to return the signal generator to LOCAL control"<<endl;

```

## Programming Examples

### GPIB Programming Examples

```
    cout<<endl;
return 0;
}
```

## Queries Using VISA and C

This example uses VISA library functions to query different instrument states and conditions. Launch Microsoft Visual C++ 6.0, add the required files, and enter the following code into your .cpp source file.

The following program example is available on the PSG Documentation CD-ROM as visaex3.cpp.

```
/******
// PROGRAM FILE NAME:visaex3.cpp
//
// PROGRAM DESCRIPTION:This example demonstrates the use of query commands. The signal
// generator can be queried for conditions and instrument states. These commands are of
// the type "*IDN?"; the question mark indicates a query.
//
//*****

#include <visa.h>
#include "StdAfx.h"
#include <iostream>
#include <conio.h>
#include <stdlib.h>
using namespace std;

void main ()
{
ViSession defaultRM, vi;    // Declares variables of type ViSession
                           // for instrument communication
ViStatus viStatus = 0;    // Declares a variable of type ViStatus
                           // for GPIB verifications
char rdBuffer [256];      // Declares variable to hold string data
```



```

int num;                // Declares variable to hold integer data
                        // Initialize the VISA system
viStatus=viOpenDefaultRM(&defaultRM);
                        // Open session to GPIB device at address 19
viStatus=viOpen(defaultRM, "GPIB::19::INSTR", VI_NULL, VI_NULL, &vi);
if(viStatus){          // If problems, then prompt user
    printf("Could not open ViSession!\n");
    printf("Check instruments and connections\n");
    printf("\n");
    exit(0);}
viPrintf(vi, "*RST\n"); // Resets signal generator
viPrintf(vi, "FREQ:CW?\n"); // Querys the CW frequency
viScanf(vi, "%t", rdBuffer); // Reads response into rdBuffer
                        // Prints the source frequency
printf("Source CW frequency is : %s\n", rdBuffer);
printf("Press any key to continue\n");
printf("\n");          // Prints new line character to the display
getch();
viPrintf(vi, "POW:AMPL?\n"); // Querys the power level
viScanf(vi, "%t", rdBuffer); // Reads the response into rdBuffer
                        // Prints the source power level
printf("Source power (dBm) is : %s\n", rdBuffer);
printf("Press any key to continue\n");
printf("\n");          // Prints new line character to the display
getch();
viPrintf(vi, "FREQ:MODE?\n"); // Querys the frequency mode
viScanf(vi, "%t", rdBuffer); // Reads the response into rdBuffer
                        // Prints the source freq mode
printf("Source frequency mode is : %s\n", rdBuffer);
printf("Press any key to continue\n");
printf("\n");          // Prints new line character to the display
getch();

```

## Programming Examples

### GPIB Programming Examples

```
viPrintf(vi, "OUTP OFF\n"); // Turns source RF state off
viPrintf(vi, "OUTP?\n"); // Querys the signal generator's RF state
viScanf(vi, "%li", &num); // Reads the response (integer value)
// Prints the on/off RF state

if (num > 0 ) {
printf("Source RF state is : on\n");
}else{
printf("Source RF state is : off\n");
}

// Close the sessions

viClose(vi);
viClose(defaultRM);
}
```

## Generating a CW Signal Using VISA and C

This example uses VISA library functions to control the signal generator. The signal generator is set for a CW frequency of 500 kHz and a power level of  $-2.3$  dBm. Launch Microsoft Visual C++ 6.0, add the required files, and enter the code into your .cpp source file.

The following program example is available on the PSG Documentation CD-ROM as visaex4.cpp.

```
/******
// PROGRAM FILE NAME: visaex4.cpp
//
// PROGRAM DESCRIPTION: This example demonstrates query commands. The signal generator
// frequency and power level.
// The RF state of the signal generator is turn on and then the state is queried. The
// response will indicate that the RF state is on. The RF state is then turned off and
// queried. The response should indicate that the RF state is off. The query results are
// printed to the to the display window.
//
//*****

#include "StdAfx.h"
```

```

#include <visa.h>
#include <iostream>
#include <stdlib.h>
#include <conio.h>

void main ()
{
    ViSession    defaultRM, vi;        // Declares variables of type ViSession
                                        // for instrument communication

    ViStatus viStatus = 0;            // Declares a variable of type ViStatus
                                        // for GPIB verifications

    char rdBuffer [256];              // Declare variable to hold string data
    int num;                          // Declare variable to hold integer data

    viStatus=viOpenDefaultRM(&defaultRM);    // Initialize VISA system
                                        // Open session to GPIB device at address 19
    viStatus=viOpen(defaultRM, "GPIB::19::INSTR", VI_NULL, VI_NULL, &vi);
    if(viStatus){                      // If problems then prompt user
        printf("Could not open ViSession!\n");
        printf("Check instruments and connections\n");
        printf("\n");
        exit(0);}

    viPrintf(vi, "*RST\n");            // Reset the signal generator
    viPrintf(vi, "FREQ 500 kHz\n");    // Set the source CW frequency for 500 kHz
    viPrintf(vi, "FREQ:CW?\n");        // Query the CW frequency
    viScanf(vi, "%t", rdBuffer);       // Read signal generator response
    printf("Source CW frequency is : %s\n", rdBuffer); // Print the frequency
    viPrintf(vi, "POW:AMPL -2.3 dBm\n"); // Set the power level to -2.3 dBm
    viPrintf(vi, "POW:AMPL?\n");       // Query the power level
    viScanf(vi, "%t", rdBuffer);       // Read the response into rdBuffer
    printf("Source power (dBm) is : %s\n", rdBuffer); // Print the power level

```

## Programming Examples

### GPIB Programming Examples

```
viPrintf(vi, "OUTP:STAT ON\n"); // Turn source RF state on
viPrintf(vi, "OUTP?\n");      // Query the signal generator's RF state
viScanf(vi, "%li", &num);    // Read the response (integer value)
    // Print the on/off RF state
if (num > 0 ) {
printf("Source RF state is : on\n");
}else{
printf("Source RF state is : off\n");
}
printf("\n");
printf("Verify RF state then press continue\n");
printf("\n");
getch();
viClear(vi);
viPrintf(vi,"OUTP:STAT OFF\n"); // Turn source RF state off
viPrintf(vi, "OUTP?\n");      // Query the signal generator's RF state
viScanf(vi, "%li", &num);    // Read the response
    // Print the on/off RF state
if (num > 0 ) {
printf("Source RF state is now: on\n");
}else{
printf("Source RF state is now: off\n");
}
                                // Close the sessions

printf("\n");
viClear(vi);
viClose(vi);
viClose(defaultRM);
}
```

## Generating an Externally Applied AC-Coupled FM Signal Using VISA and C

In this example, the VISA library is used to generate an ac-coupled FM signal at a carrier frequency of

700 MHz, a power level of  $-2.5$  dBm, and a deviation of 20 kHz. Before running the program:

- Connect the output of a modulating signal source to the signal generator's EXT 2 input connector.
- Set the modulation signal source for the desired FM characteristics.

Launch Microsoft Visual C++ 6.0, add the required files, and enter the code into your .cpp source file.

The following program example is available on the PSG Documentation CD-ROM as visaex5.cpp.

```

/*****
// PROGRAM FILE NAME:visaex5.cpp
//
// PROGRAM DESCRIPTION:This example sets the signal generator FM source to External 2,
// coupling to AC, deviation to 20 kHz, carrier frequency to 700 MHz and the power level
// to -2.5 dBm. The RF state is set to on.
//
*****/

#include <visa.h>
#include "StdAfx.h"
#include <iostream>
#include <stdlib.h>
#include <conio.h>

void main ()
{
    ViSession defaultRM, vi;           // Declares variables of type ViSession
                                     // for instrument communication
    ViStatus viStatus = 0;           // Declares a variable of type ViStatus
                                     // for GPIB verifications
                                     // Initialize VISA session
    viStatus=viOpenDefaultRM(&defaultRM);
                                     // open session to gpib device at address 19
    viStatus=viOpen(defaultRM, "GPIB::19::INSTR", VI_NULL, VI_NULL, &vi);
    if(viStatus){                     // If problems, then prompt user

```

## Programming Examples

### GPIB Programming Examples

```
    printf("Could not open ViSession!\n");
    printf("Check instruments and connections\n");
    printf("\n");
    exit(0);}

printf("Example program to set up the signal generator\n");
printf("for an AC-coupled FM signal\n");
printf("Press any key to continue\n");
printf("\n");
getch();
printf("\n");

viPrintf(vi, "*RST\n");           // Resets the signal generator
viPrintf(vi, "FM:SOUR EXT2\n");   // Sets EXT 2 source for FM
viPrintf(vi, "FM:EXT2:COUP AC\n"); // Sets FM path 2 coupling to AC
viPrintf(vi, "FM:DEV 20 kHz\n");  // Sets FM path 2 deviation to 20 kHz
viPrintf(vi, "FREQ 700 MHz\n");   // Sets carrier frequency to 700 MHz
viPrintf(vi, "POW:AMPL -2.5 dBm\n"); // Sets the power level to -2.5 dBm
viPrintf(vi, "FM:STAT ON\n");     // Turns on frequency modulation
viPrintf(vi, "OUTP:STAT ON\n");   // Turns on RF output
                                   // Print user information

printf("Power level : -2.5 dBm\n");
printf("FM state : on\n");
printf("RF output : on\n");
printf("Carrier Frequency : 700 MHz\n");
printf("Deviation : 20 kHz\n");
printf("EXT2 and AC coupling are selected\n");
printf("\n");                       // Prints a carriage return
                                   // Close the sessions

viClose(vi);
viClose(defaultRM);
}
```

## Generating an Internal AC-Coupled FM Signal Using VISA and C

In this example the VISA library is used to generate an ac-coupled internal FM signal at a carrier frequency of 900 MHz and a power level of -15 dBm. The FM rate will be 5 kHz and the peak deviation will be 100 kHz. Launch Microsoft Visual C++ 6.0, add the required files, and enter the following code into your .cpp source file.

The following program example is available on the PSG Documentation CD-ROM as visaex6.cpp.

```

/*****
// PROGRAM FILE NAME:visaex6.cpp
//
// PROGRAM DESCRIPTION:This example generates an AC-coupled internal FM signal at a 900
// MHz carrier frequency and a power level of -15 dBm. The FM rate is 5 kHz and the peak
// deviation 100 kHz
//
/*****

#include <visa.h>
#include "StdAfx.h"
#include <iostream>
#include <stdlib.h>
#include <conio.h>

void main ()
{
ViSession defaultRM, vi;           // Declares variables of type ViSession
                                   // for instrument communication

ViStatus viStatus = 0;           // Declares a variable of type ViStatus
                                   // for GPIB verifications

viStatus=viOpenDefaultRM(&defaultRM); // Initialize VISA session
                                   // open session to gpib device at address 19
viStatus=viOpen(defaultRM, "GPIB::19::INSTR", VI_NULL, VI_NULL, &vi);
if(viStatus){                     // If problems, then prompt user

```

## Programming Examples

### GPIB Programming Examples

```
printf("Could not open ViSession!\n");
printf("Check instruments and connections\n");
printf("\n");
exit(0);}

printf("Example program to set up the signal generator\n");
printf("for an AC-coupled FM signal\n");
printf("\n");
printf("Press any key to continue\n");
getch();
viClear(vi); // Clears the signal generator
viPrintf(vi, "*RST\n"); // Resets the signal generator
viPrintf(vi, "FM2:INT:FREQ 5 kHz\n"); // Sets EXT 2 source for FM
viPrintf(vi, "FM2:DEV 100 kHz\n"); // Sets FM path 2 coupling to AC
viPrintf(vi, "FREQ 900 MHz\n"); // Sets carrier frequency to 700 MHz
viPrintf(vi, "POW -15 dBm\n"); // Sets the power level to -2.3 dBm
viPrintf(vi, "FM2:STAT ON\n"); // Turns on frequency modulation
viPrintf(vi, "OUTP:STAT ON\n"); // Turns on RF output
printf("\n"); // Prints a carriage return
// Print user information

printf("Power level : -15 dBm\n");
printf("FM state : on\n");
printf("RF output : on\n");
printf("Carrier Frequency : 900 MHz\n");
printf("Deviation : 100 kHz\n");
printf("Internal modulation : 5 kHz\n");
printf("\n"); // Print a carriage return
// Close the sessions

viClose(vi);
viClose(defaultRM);
}
```



## Generating a Step-Swept Signal Using VISA and C

In this example the VISA library is used to set the signal generator for a continuous step sweep on a defined set of points from 500 MHz to 800 MHz. The number of steps is set for 10 and the dwell time at each step is set to 500 ms. The signal generator will then be set to local mode which allows the user to make adjustments from the front panel. Launch Microsoft Visual C++ 6.0, add the required files, and enter the following code into your .cpp source file.

The following program example is available on the PSG Documentation CD-ROM as visaex7.cpp.

```

/*****
// PROGRAM FILE NAME:visaex7.cpp
//
// PROGRAM DESCRIPTION:This example will program the signal generator to perform a step
// sweep from 500-800 MHz with a .5 sec dwell at each frequency step.
//
/*****

#include <visa.h>
#include "StdAfx.h"
#include <iostream>

void main ()
{
ViSession defaultRM, vi;// Declares variables of type ViSession
// vi establishes instrument communication
ViStatus viStatus = 0;// Declares a variable of type ViStatus
// for GPIB verifications

viStatus=viOpenDefaultRM(&defaultRM); // Initialize VISA session
// Open session to GPIB device at address 19
viStatus=viOpen(defaultRM, "GPIB::19::INSTR", VI_NULL, VI_NULL, &vi);
if(viStatus){// If problems, then prompt user
printf("Could not open ViSession!\n");
printf("Check instruments and connections\n");
}
}

```

## Programming Examples

### GPIB Programming Examples

```
printf("\n");
exit(0);}

viClear(vi); // Clears the signal generator
viPrintf(vi, "*RST\n"); // Resets the signal generator
viPrintf(vi, "*CLS\n"); // Clears the status byte register
viPrintf(vi, "FREQ:MODE LIST\n"); // Sets the sig gen freq mode to list
viPrintf(vi, "LIST:TYPE STEP\n"); // Sets sig gen LIST type to step
viPrintf(vi, "FREQ:STAR 500 MHz\n"); // Sets start frequency
viPrintf(vi, "FREQ:STOP 800 MHz\n"); // Sets stop frequency
viPrintf(vi, "SWE:POIN 10\n"); // Sets number of steps (30 mHz/step)
viPrintf(vi, "SWE:DWEL .5 S\n"); // Sets dwell time to 500 ms/step
viPrintf(vi, "POW:AMPL -5 dBm\n"); // Sets the power level for -5 dBm
viPrintf(vi, "OUTP:STAT ON\n"); // Turns RF output on
viPrintf(vi, "INIT:CONT ON\n"); // Begins the step sweep operation
// Print user information
printf("The signal generator is in step sweep mode. The frequency range
      is\n");
printf("500 to 800 mHz. There is a .5 sec dwell time at each 30 mHz
      step.\n");
printf("\n"); // Prints a carriage return/line feed
viPrintf(vi, "OUTP:STAT OFF\n"); // Turns the RF output off
printf("Press the front panel Local key to return the\n");
printf("signal generoator to manual operation.\n");
// Closes the sessions

printf("\n");
viClose(vi);
viClose(defaultRM);
}
```

## Saving and Recalling States Using VISA and C

In this example, instrument settings are saved in the signal generator's save register. These settings can then be recalled separately; either from the keyboard or from the signal generator's front panel. Launch Microsoft

Visual C++ 6.0, add the required files, and enter the following code into your .cpp source file.

The following program example is available on the PSG Documentation CD-ROM as visaex8.cpp.

```

/*****
// PROGRAM FILE NAME:visaex8.cpp
//
// PROGRAM DESCRIPTION:In this example, instrument settings are saved in the signal
// generator's registers and then recalled.
// Instrument settings can be recalled from the keyboard or, when the signal generator
// is put into Local control, from the front panel.
// This program will initialize the signal generator for an instrument state, store the
// state to register #1. An *RST command will reset the signal generator and a *RCL
// command will return it to the stored state. Following this remote operation the user
// will be instructed to place the signal generator in Local mode.
//
/*****

#include <visa.h>
#include "StdAfx.h"
#include <iostream>
#include <conio.h>

void main ()
{
    ViSession defaultRM, vi;// Declares variables of type ViSession
// for instrument communication
ViStatus viStatus = 0;// Declares a variable of type ViStatus
                                // for GPIB verifications
long lngDone = 0;           // Operation complete flag

viStatus=viOpenDefaultRM(&defaultRM);    // Initialize VISA session
// Open session to gpib device at address 19
viStatus=viOpen(defaultRM, "GPIB::19::INSTR", VI_NULL, VI_NULL, &vi);

```

## Programming Examples

### GPIB Programming Examples

```
if(viStatus){// If problems, then prompt user
    printf("Could not open ViSession!\n");
    printf("Check instruments and connections\n");
    printf("\n");
    exit(0);}
printf("\n");
viClear(vi); // Clears the signal generator
viPrintf(vi, "*CLS\n"); // Resets the status byte register
// Print user information
printf("Programming example using the *SAV,*RCL SCPI commands\n");
printf("used to save and recall an instrument's state\n");
printf("\n");
viPrintf(vi, "*RST\n"); // Resets the signal generator
viPrintf(vi, "FREQ 5 MHz\n"); // Sets sig gen frequency
viPrintf(vi, "POW:ALC OFF\n"); // Turns ALC Off
viPrintf(vi, "POW:AMPL -3.2 dBm\n"); // Sets power for -3.2 dBm
viPrintf(vi, "OUTP:STAT ON\n"); // Turns RF output On
viPrintf(vi, "*OPC?\n"); // Checks for operation complete
while (!lngDone)
    viScanf (vi ,"%d",&lngDone); // Waits for setup to complete
viPrintf(vi, "*SAV 1\n"); // Saves sig gen state to register #1
// Print user information
printf("The current signal generator operating state will be saved\n");
printf("to Register #1. Observe the state then press Enter\n");
printf("\n"); // Prints new line character
getch(); // Wait for user input
lngDone=0; // Resets the operation complete flag
viPrintf(vi, "*RST\n"); // Resets the signal generator
viPrintf(vi, "*OPC?\n"); // Checks for operation complete
while (!lngDone)
    viScanf (vi ,"%d",&lngDone); // Waits for setup to complete
// Print user information
```

```

printf("The instrument is now in it's Reset operating state. Press the\n");
printf("Enter key to return the signal generator to the Register #1
      state\n");

printf("\n");           // Prints new line character
getch();               // Waits for user input
lngDone=0;             // Reset the operation complete flag
viPrintf(vi, "*RCL 1\n"); // Recalls stored register #1 state
viPrintf(vi, "*OPC?\n"); // Checks for operation complete
while (!lngDone)
    viScanf (vi ,"%d",&lngDone); // Waits for setup to complete
                                   // Print user information

printf("The signal generator has been returned to it's Register #1
      state\n");

printf("Press Enter to continue\n");

printf("\n");           // Prints new line character
getch();               // Waits for user input
lngDone=0;             // Reset the operation complete flag
viPrintf(vi, "*RST\n"); // Resets the signal generator
viPrintf(vi, "*OPC?\n"); // Checks for operation complete
while (!lngDone)
    viScanf (vi ,"%d",&lngDone); // Waits for setup to complete
                                   // Print user information

printf("Press Local on instrument front panel to return to manual mode\n");
printf("\n");           // Prints new line character
                                   // Close the sessions

viClose(vi);
viClose(defaultRM);
}

```

## Reading the Data Questionable Status Register Using VISA and C

In this example, the signal generator's data questionable status register is read. You will be asked to set up the signal generator for error generating conditions. The data questionable status register will be read and the program will notify the user of the error condition that the setup caused. Follow the user prompts presented when the program runs. Launch Microsoft Visual C++ 6.0, add the required files, and enter the following

## Programming Examples

### GPIB Programming Examples

code into your .cpp source file.

The following program example is available on the PSG Documentation CD-ROM as visaex9.cpp.

```

/*****
// PROGRAM NAME:visaex9.cpp
//
// PROGRAM DESCRIPTION:In this example, the data questionable status register is read.
// The data questionable status register is enabled to read an unlevelled condition.
// The signal generator is then set up for an unlevelled condition and the data
// questionable status register read. The results are then displayed to the user.
// The status questionable register is then setup to monitor a modulation error condition.
// The signal generator is set up for a modulation error condition and the data
// questionable status register is read.
// The results are displayed to the active window.
//
*****/

#include <visa.h>
#include "StdAfx.h"
#include <iostream>
#include <conio.h>

void main ()
{
ViSession defaultRM, vi;// Declares a variables of type ViSession
                        // for instrument communication
ViStatus viStatus = 0;// Declares a variable of type ViStatus
// for GPIB verifications
int num=0;// Declares a variable for switch statements

char rdBuffer[256]={0};          // Declare a variable for response data

viStatus=viOpenDefaultRM(&defaultRM);    // Initialize VISA session

```

```

// Open session to GPIB device at address 19

viStatus=viOpen(defaultRM, "GPIB::19::INSTR", VI_NULL, VI_NULL, &vi);
if(viStatus){
    // If problems, then prompt user
    printf("Could not open ViSession!\n");
    printf("Check instruments and connections\n");
    printf("\n");
    exit(0);}
printf("\n");
viClear(vi);// Clears the signal generator
// Prints user information
printf("Programming example to demonstrate reading the signal generator's
      Status Byte\n");
printf("\n");
printf("Manually set up the sig gen for an unlevelled output condition:\n");
printf("* Set signal generator output amplitude to +20 dBm\n");
printf("* Set frequency to maximum value\n");
printf("* Turn On signal generator's RF Output\n");
printf("* Check signal generator's display for the UNLEVEL annunciator\n");
printf("\n");
printf("Press Enter when ready\n");
printf("\n");
getch();
viPrintf(vi, "STAT:QUES:POW:ENAB 2\n"); // Enables the Data Questionable
// Power Condition Register Bits
// Bits '0' and '1'
viPrintf(vi, "STAT:QUES:POW:COND?\n"); // Querys the register for any
// set bits
viScanf(vi, "%s", rdBuffer); // Reads the decimal sum of the
// set bits
num=(int (rdBuffer[1]) -('0')); // Converts string data to
// numeric

```

## Programming Examples

### GPIB Programming Examples

```
switch (num)                                // Based on the decimal value
{
    case 1:
printf("Signal Generator Reverse Power Protection
                                Tripped\n");

printf("/n");
break;

    case 2:
printf("Signal Generator Power is Unleveled\n");
printf("\n");
break;

    default:
printf("No Power Unleveled condition detected\n");
printf("\n");
}
viClear(vi);                                // Clears the signal generator
                                                // Prints user information

printf("-----\n");
printf("\n");
printf("Manually set up the sig gen for an unleveled output condition:\n");
printf("\n");
printf("* Select AM modulation\n");
printf("* Select AM Source Ext 1 and Ext Coupling AC\n");
printf("* Turn On the modulation.\n");
printf("* Do not connect any source to the input\n");
printf("* Check signal generator's display for the EXT1 LO annunciator\n");
printf("\n");
printf("Press Enter when ready\n");
printf("\n");
getch();                                    // Waits for keyboard user input
viPrintf(vi, "STAT:QUES:MOD:ENAB 16\n"); // Enables the Data Questionable
```



```

// Modulation Condition Register
// bits '0','1','2','3' and '4'
viPrintf(vi, "STAT:QUES:MOD:COND?\n"); // Queries the register for any
// set bits
viScanf(vi, "%s", rdBuffer); // Reads the decimal sum of the
// set bits
num=(int (rdBuffer[1]) -('0')); // Converts string data to numeric

switch (num) // Based on the decimal value
{
    case 1:
printf("Signal Generator Modulation 1 Undermod\n");
printf("\n");
break;
    case 2:
printf("Signal Generator Modulation 1 Overmod\n");
printf("\n");
break;
    case 4:
printf("Signal Generator Modulation 2 Undermod\n");
printf("\n");
break;
    case 8:
printf("Signal Generator Modulation 2 Overmod\n");
printf("\n");
break;
    case 16:
printf("Signal Generator Modulation Uncalibrated\n");
printf("\n");
break;
    default:
printf("No Problems with Modulation\n");

```

## Programming Examples

### GPIB Programming Examples

```
printf("\n");
}
// Close the sessions
viClose(vi);
viClose(defaultRM);

}
```

## Reading the Service Request Interrupt (SRQ) Using VISA and C

This example demonstrates use of the Service Request (SRQ) interrupt. By using the SRQ, the computer can attend to other tasks while the signal generator is busy performing a function or operation. When the signal generator finishes its operation, or detects a failure, then a Service Request can be generated. The computer will respond to the SRQ and, depending on the code, can perform some other operation or notify the user of failures or other conditions.

This program sets up a step sweep function for the signal generator and, while the operation is in progress, prints out a series of asterisks. When the step sweep operation is complete, an SRQ is generated and the printing ceases.

Launch Microsoft Visual C++ 6.0, add the required files, and enter the following code into your .cpp source file. This example is available on the PSG Documentation CD-ROM as visaex10.cpp.

```
/******
//
// PROGRAM FILE NAME:visaex10.cpp
//
// PROGRAM DESCRIPTION: This example demonstrates the use of a Service Request(SRQ)
// interrupt. The program sets up conditions to enable the SRQ and then sets the signal
// generator for a step mode sweep. The program will enter a printing loop which prints
// an * character and ends when the sweep has completed and an SRQ received.
//
//*****

#include "visa.h"
#include <stdio.h>
```

```

#include "StdAfx.h"
#include "windows.h"
#include <conio.h>

#define MAX_CNT 1024

int sweep=1; // End of sweep flag

/* Prototypes */

ViStatus _VI_FUNCH interrupt(ViSession vi, ViEventType eventType, ViEvent event, ViAddr
addr);

int main ()
{
ViSession defaultRM, vi;// Declares variables of type ViSession
// for instrument communication
ViStatus viStatus = 0;// Declares a variable of type ViStatus
// for GPIB verifications
char rdBuffer[MAX_CNT];// Declare a block of memory data

viStatus=viOpenDefaultRM(&defaultRM);// Initialize VISA session
if(viStatus < VI_SUCCESS){// If problems, then prompt user
printf("ERROR initializing VISA... exiting\n");
printf("\n");
return -1;}

// Open session to gpib device at address 19
viStatus=viOpen(defaultRM, "GPIB::19::INSTR", VI_NULL, VI_NULL, &vi);
if(viStatus){ // If problems then prompt user
printf("ERROR: Could not open communication with
instrument\n");

printf("\n");
return -1;}

```

## Programming Examples

### GPIB Programming Examples

```
viClear(vi); // Clears the signal generator
viPrintf(vi, "*RST\n"); // Resets signal generator
// Print program header and information
printf("*** End of Sweep Service Request **\n");
printf("\n");
printf("The signal generator will be set up for a step sweep mode
operation.\n");
printf("An '*' will be printed while the instrument is sweeping. The end of
\n");
printf("sweep will be indicated by an SRQ on the GPIB and the program will
end.\n");

printf("\n");
printf("Press Enter to continue\n");
printf("\n");
getch();

viPrintf(vi, "*CLS\n");// Clears signal generator status byte
viPrintf(vi, "STAT:OPER:NTR 8\n");// Sets the Operation Status Group // Negative
Transition Filter to indicate a // negative transition in Bit 3 (Sweeping)
// which will set a corresponding event in // the Operation Event Register. This occurs
// the end of a sweep.
viPrintf(vi, "STAT:OPER:PTR 0\n");// Sets the Operation Status Group // Positive
Transition Filter so that no
// positive transition on Bit 3 affects the // Operation Event Register. The positive //
transition occurs at the start of a sweep.
viPrintf(vi, "STAT:OPER:ENAB 8\n");// Enables Operation Status Event Bit 3 // to report
the event to Status Byte // Register Summary Bit 7.
viPrintf(vi, "*SRE 128\n");// Enables Status Byte Register Summary Bit 7
// The next line of code indicates the // function to call on an event
viStatus = viInstallHandler(vi, VI_EVENT_SERVICE_REQ, interrupt, rdBuffer);
// The next line of code enables the // detection of an event
viStatus = viEnableEvent(vi, VI_EVENT_SERVICE_REQ, VI_HNDLR, VI_NULL);

viPrintf(vi, "FREQ:MODE LIST\n");// Sets frequency mode to list
```

```

viPrintf(vi, "LIST:TYPE STEP\n");// Sets sweep to step
viPrintf(vi, "LIST:TRIG:SOUR IMM\n");// Immediately trigger the sweep
viPrintf(vi, "LIST:MODE AUTO\n");// Sets mode for the list sweep
viPrintf(vi, "FREQ:STAR 40 MHZ\n"); // Start frequency set to 40 MHz
viPrintf(vi, "FREQ:STOP 900 MHZ\n");// Stop frequency set to 900 MHz
viPrintf(vi, "SWE:POIN 25\n");// Set number of points for the step sweep
viPrintf(vi, "SWE:DWEL .5 S\n");// Allow .5 sec dwell at each point
viPrintf(vi, "INIT:CONT OFF\n");// Set up for single sweep
viPrintf(vi, "TRIG:SOUR IMM\n");// Triggers the sweep
viPrintf(vi, "INIT\n"); // Takes a single sweep
printf("\n");

// While the instrument is sweeping have the
// program busy with printing to the display.
// The Sleep function, defined in the header
// file windows.h, will pause the program
// operation for .5 seconds
while (sweep==1){
printf("*");
Sleep(500);}
printf("\n");

// The following lines of code will stop the
// events and close down the session

viStatus = viDisableEvent(vi, VI_ALL_ENABLED_EVENTS,VI_ALL_MECH);
viStatus = viUninstallHandler(vi, VI_EVENT_SERVICE_REQ, interrupt,
rdBuffer);

viStatus = viClose(vi);
viStatus = viClose(defaultRM);
return 0;

}

```

## Programming Examples

### GPIB Programming Examples

```
// The following function is called when an SRQ event occurs. Code specific to your
// requirements would be entered in the body of the function.

ViStatus _VI_FUNCH interupt(ViSession vi, ViEventType eventType, ViEvent event, ViAddr
                           addr)

{
ViStatus status;
ViUInt16 stb;

    status = viReadSTB(vi, &stb); // Reads the Status Byte
sweep=0; // Sets the flag to stop the '*' printing
printf("\n"); // Print user information
printf("An SRQ, indicating end of sweep has occurred\n");
viClose(event); // Closes the event
return VI_SUCCESS;
}
```

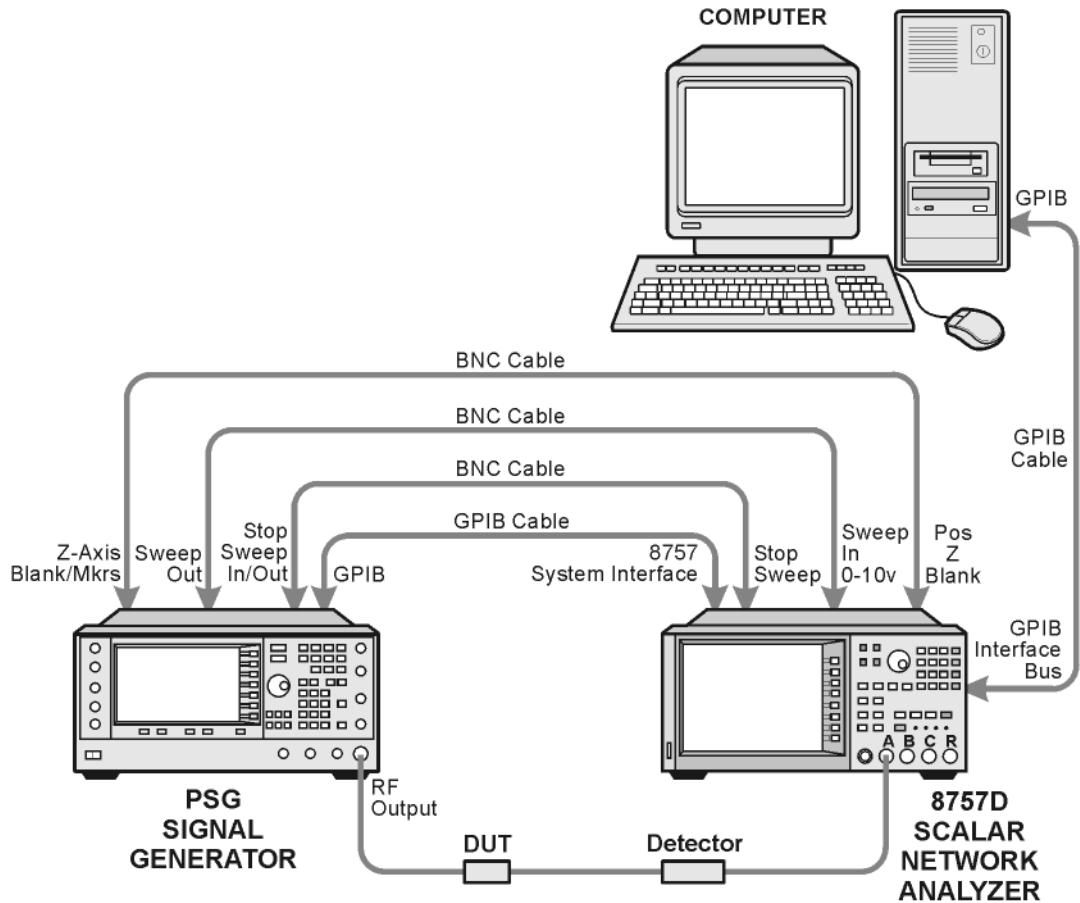
## Using 8757D Pass-Thru Commands

Pass-thru commands enable you to temporarily interrupt ramp sweep system interaction so that you can send operating instructions to the PSG. This section provides setup information and an example program for using pass-thru commands in a ramp sweep system.

### Equipment Setup

To send pass-thru commands, set up the equipment as shown in [Figure 2-1](#). Notice that the GPIB cable from the computer is connected to the GPIB interface bus of the 8757D.

Figure 2-1



scaler\_netwk\_pc

### GPIB Address Assignments

Table 2-1 describes how GPIB addresses should be assigned for sending pass-thru commands. These are the same addresses used in Example 2-1.

Table 2-1

Instrument	GPIB Address	Key Presses/Description
PSG	19	Press <b>Utility</b> > <b>GPIB/RS-232 LAN</b> > <b>GPIB Address</b> > <b>19</b> > <b>Enter</b> .
8757D	16	Press <b>LOCAL</b> > <b>8757</b> > <b>16</b> > <b>Enter</b> .
8757D (Sweeper)	19	This address must match the PSG. Press <b>LOCAL</b> > <b>SWEEPER</b> > <b>19</b> > <b>Enter</b> .
Pass Thru	17	The pass thru address is automatically selected by the 8757D by inverting the last bit of the 8757D address. Refer to the 8757D documentation for more information. Verify that no other instrument is using this address on the GPIB bus.

### Example Pass-Thru Program

Example 2-1 on page 67 is a sample Agilent BASIC program that switches the 8757D to pass-thru mode, allowing you to send operating commands to the PSG. After the program runs, control is given back to the network analyzer. The following describes the command lines used in the program.

- Line 30           PT is set to equal the source address. C1 is added, but not needed, to specify the channel.
- Lines 40, 90     The END statement is required to complete the language transition.
- Lines 50, 100   A WAIT statement is recommended after a language change to allow all instrument changes to be completed before the next command.
- Lines 70, 80     This is added to ensure that the instrument has completed all operations before switching languages.
- Line 110        This takes the network analyzer out of pass-thru command mode, and puts it back in control. Any analyzer command can now be entered.



**Example 2-1            Pass-Thru Program**

```
10 ABORT 7
20 CLEAR 716
30 OUTPUT 716;"PT19;C1"
40 OUTPUT 717;"SYST:LANG SCPI";END
50 WAIT .5
60 OUTPUT 717;"POW:STAT OFF"
70 OUTPUT 717;"*OPC?"
80 ENTER 717; Reply
90 OUTPUT 717;"SYST:LANG COMP";END
100 WAIT .5
110 OUTPUT 716;"C2"
120 END
```

## LAN Programming Examples

- “VXI-11 Programming Using SICL in C” on page 68
- “VXI-11 Programming Using VISA in C” on page 71
- “Setting Parameters and Sending Queries Using Sockets and C” on page 75
- “Setting the Power Level and Sending Queries Using PERL” on page 102
- “Generating a CW Signal Using Java” on page 103

The LAN programming examples in this section demonstrate the use of VXI-11 and Sockets LAN to control the signal generator. For details on using FTP and TELNET refer to “Using FTP” on page 20 and “Using TELNET LAN” on page 17 of this guide.

### Before Using the Examples

To use these programming examples you must change references to the IP address and hostname to match the IP address and hostname of your signal generator.

### VXI-11 Programming

The signal generator supports the VXI-11 standard for instrument communication over the LAN interface. Agilent IO Libraries support the VXI-11 standard and must be installed on your computer before using the VXI-11 protocol. Refer to “Using VXI-11” on page 16 of this Programming Guide for information on configuring and using the VXI-11 protocol.

The VXI-11 examples use TCPIP0 as the board address.

#### VXI-11 Programming Using SICL in C

The following program uses the VXI-11 protocol and SICL to control the signal generator. The signal generator is set to a 1 GHz CW frequency and then queried for its ID string. Before running this code, you must set up the interface using the Agilent IO Libraries IO Config utility.

The following program example is available on the PSG Documentation CD-ROM as vxisicl.cpp.

```
/******  
//  
// PROGRAM NAME:vxisicl.cpp  
//  
// PROGRAM DESCRIPTION:Sample test program using SICL and the VXI-11 protocol
```

```

//
// NOTE: You must have the Agilent IO Libraries installed to run this program.
//
// This example uses the VXI-11 protocol to set the signal generator for a 1 GHz CW
// frequency. The signal generator is queried for operation complete and then queried
// for its ID string. The frequency and ID string are then printed to the display.
//
// IMPORTANT: Enter in your signal generators hostname in the instrumentName declaration
// where the "xxxxx" appears.
//
//*****

#include "stdafx.h"
#include <sicl.h>
#include <stdlib.h>
#include <stdio.h>

int main(int argc, char* argv[])
{

INST id;                               // Device session id
int opcResponse;                        // Variable for response flag

char instrumentName[] = "xxxxx"; // Put your instrument's hostname here
char instNameBuf[256]; // Variable to hold instrument name
char buf[256]; // Variable for id string
ionerror(I_ERROR_EXIT); // Register SICL error handler

                // Open SICL instrument handle using VXI-11 protocol

sprintf(instNameBuf, "lan[%s]:inst0", instrumentName);
id = iopen(instNameBuf); // Open instrument session

```

## Programming Examples

### LAN Programming Examples

```
itimeout(id, 1000); // Set 1 second timeout for operations
printf("Setting frequency to 1 Ghz...\n");
iprintf(id, "freq 1 GHz\n"); // Set frequency to 1 GHz

printf("Waiting for source to settle...\n");
iprintf(id, "*opc?\n"); // Query for operation complete
iscanf(id, "%d", &opcResponse); // Operation complete flag
if (opcResponse != 1) // If operation fails, prompt user
{
    printf("Bad response to 'OPC?'\n");
    iclose(id);
    exit(1);
}
iprintf(id, "FREQ?\n"); // Query the frequency
iscanf(id, "%t", &buf); // Read the signal generator frequency
printf("\n"); // Print the frequency to the display
printf("Frequency of signal generator is %s\n", buf);
ipromptf(id, "*IDN?\n", "%t", buf); // Query for id string
printf("Instrument ID: %s\n", buf); // Print id string to display
iclose(id); // Close the session

return 0;
}
```

## VXI-11 Programming Using VISA in C

The following program uses the VXI-11 protocol and the VISA library to control the signal generator. The signal generator is set to a 1 GHz CW frequency and queried for its ID string. Before running this code, you must set up the interface using the Agilent IO Libraries IO Config utility. This example is available on the PSG Documentation CD-ROM as vxivisa.cpp.

```

/*****
// PROGRAM FILE NAME:vxivisa.cpp
// Sample test program using the VISA libraries and the VXI-11 protocol
//
// NOTE: You must have the Agilent Libraries installed on your computer to run
// this program
//
// PROGRAM DESCRIPTION:This example uses the VXI-11 protocol and VISA to query
// the signal generator for its ID string. The ID string is then printed to the
// screen. Next the signal generator is set for a -5 dBm power level and then
// queried for the power level. The power level is printed to the screen.
//
// IMPORTANT: Set up the LAN Client using the IO Config utility
//
/*****

#include <visa.h>
#include <stdio.h>
#include "StdAfx.h"
#include <stdlib.h>
#include <conio.h>

#define MAX_COUNT 200

int main (void)

{

```

## Programming Examples

### LAN Programming Examples

```
ViStatus status;// Declares a type ViStatus variable
ViSession defaultRM, instr;// Declares a type ViSession variable
ViUInt32 retCount;// Return count for string I/O
ViChar buffer[MAX_COUNT];// Buffer for string I/O

status = viOpenDefaultRM(&defaultRM); // Initialize the system
                                        // Open communication with Serial
                                        // Port 2

status = viOpen(defaultRM, "TCPIP0::19::INSTR", VI_NULL, VI_NULL, &instr);

if(status){ // If problems then prompt user
printf("Could not open ViSession!\n");
printf("Check instruments and connections\n");
printf("\n");
exit(0);}

                                        // Set timeout for 5 seconds
viSetAttribute(instr, VI_ATTR_TMO_VALUE, 5000);

                                        // Ask for sig gen ID string
status = viWrite(instr, (ViBuf)*"IDN?\n", 6, &retCount);

                                        // Read the sig gen response
status = viRead(instr, (ViBuf)buffer, MAX_COUNT, &retCount);
buffer[retCount]= '\0'; // Indicate the end of the string
printf("Signal Generator ID = "); // Print header for ID
printf(buffer); // Print the ID string
printf("\n"); // Print carriage return
                                        // Flush the read buffer
                                        // Set sig gen power to -5dbm
status = viWrite(instr, (ViBuf)"POW:AMPL -5dbm\n", 15, &retCount);
                                        // Query the power level
status = viWrite(instr, (ViBuf)"POW?\n",5,&retCount);
```

```

                                                                    // Read the power level
status = viRead(instr, (ViBuf)buffer, MAX_COUNT, &retCount);
buffer[retCount]= '\0';                                                                    // Indicate the end of the string
printf("Power level = ");                                                                    // Print header to the screen
printf(buffer);                                                                                // Print the queried power level
printf("\n");
status = viClose(instr);                                                                    // Close down the system
status = viClose(defaultRM);
return 0;
}

```

## Sockets LAN Programming using C

The program listing shown in [“Setting Parameters and Sending Queries Using Sockets and C”](#) on page 75 consists of two files; lanio.c and getopt.c. The lanio.c file has two main functions; `int main()` and an `int mainl()`.

The `int main()` function allows communication with the signal generator interactively from the command line. The program reads the signal generator's hostname from the command line, followed by the SCPI command. It then opens a socket to the signal generator, using port 7777, and sends the command. If the command appears to be a query, the program queries the signal generator for a response, and prints the response.

The `int mainl()`, after renaming to `int main()`, will output a sequence of commands to the signal generator. You can use the format as a template and then add your own code.

This program is available on the PSG Documentation CD-ROM as lanio.c

## Sockets on UNIX

In UNIX, LAN communication via sockets is very similar to reading or writing a file. The only difference is the `openSocket()` routine, which uses a few network library routines to create the TCP/IP network connection. Once this connection is created, the standard `fread()` and `fwrite()` routines are used for network communication. The following steps outline the process:

1. Copy the lanio.c and getopt.c files to your home UNIX directory. For example, `/users/mydir/`.
2. At the UNIX prompt in your home directory type: `cc -Aa -O -o lanio lanio.c`
3. At the UNIX prompt in your home directory type: `./lanio xxxxxx "*IDN?"` where xxxxxx is the hostname for the signal generator. Use this same format to output SCPI commands to the signal generator.

## Programming Examples

### LAN Programming Examples

The `int main1()` function will output a sequence of commands in a program format. If you want to run a program using a sequence of commands then perform the following:

1. Rename the `lanio.c` `int main1()` to `int main()` and the original `int main()` to `int main1()`.
2. In the `main()`, `openSocket()` function, change the “your hostname here” string to the hostname of the signal generator you want to control.
3. Resave the `lanio.c` program
4. At the UNIX prompt type: `cc -Aa -O -o lanio lanio.c`
5. At the UNIX prompt type: `./lanio`

The program will run and output a sequence of SCPI commands to the signal generator. The UNIX display will show a display similar to the following:

```
unix machine: /users/mydir
$ ./lanio
ID: Agilent Technologies, E8254A, US00000001, C.01.00

Frequency: +2.5000000000000E+09
Power Level: -5.00000000E+000
```

### Sockets on Windows

In Windows, the routines `send()` and `recv()` must be used, since `fread()` and `fwrite()` may not work on sockets. The following steps outline the process for running the interactive program in the Microsoft Visual C++ 6.0 environment:

1. Rename the `lanio.c` to `lanio.cpp` and `getopt.c` to `getopt.cpp` and add them to the Source folder of the Visual C++ project.
2. Select **Rebuild All** from **Build** menu. Then select **Execute Lanio.exe**.
3. Click **Start**, click **Programs**, then click **Command Prompt**.
4. At the command prompt, `cd` to the directory containing the `lanio.cpp` file and then to the Debug folder. For example `C:\SocketIO\Lanio\Debug`
5. Type in `lanio xxxxxx "*IDN?"` at the command prompt. For example:  
`C:\SocketIO\Lanio\Debug>lanio xxxxxx "*IDN?"` where the `xxxxx` is the hostname of your signal generator. Use this format to output SCPI commands to the signal generator in a line by line format from the command prompt.
6. Type `exit` at the command prompt to quit the program.

The `int main1()` function will output a sequence of commands in a program format. If you want to run a

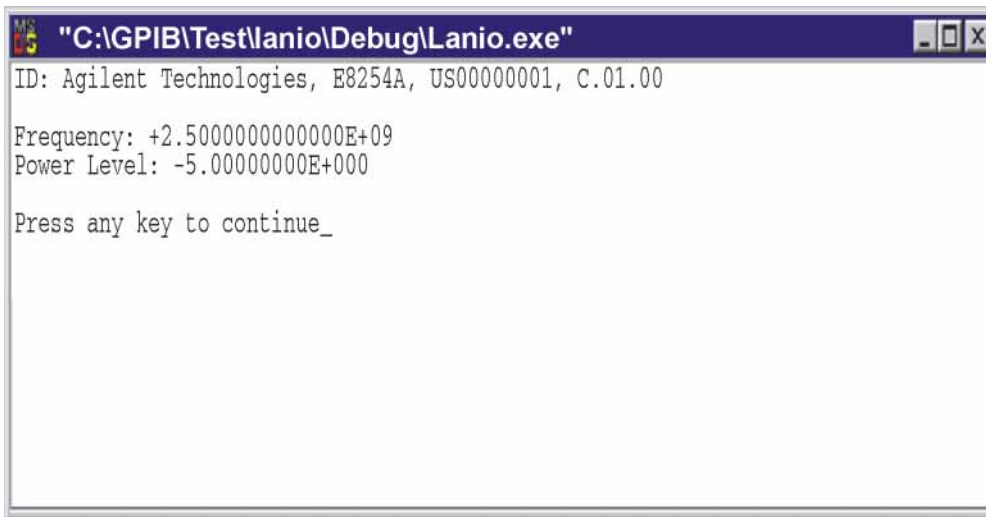


program using a sequence of commands then perform the following:

1. Enter the hostname of your signal generator in the openSocket function of the main1 ( ) function of the lanio.c program
2. Rename the lanio.cpp int main1() function to int main() and the original int main() function to int main1().
3. Select **Rebuild All** from **Build** menu. Then select **Execute Lanio.exe**.

The program will run and display the results as shown in [Figure 2-2](#).

**Figure 2-2** Program Output Screen



ce914a

### Setting Parameters and Sending Queries Using Sockets and C

The following programming examples are available on the PSG Documentation CD-ROM as lanio.c and getopt.c.

```
/*  
*****  
* $Header: lanio.c 04/24/01  
* $Revision: 1.1 $  
* $Date: 04/24/01  
* PROGRAM NAME: lanio.c  
*  
*/
```

## Programming Examples

### LAN Programming Examples

```
* $Description:      Functions to talk to an Agilent signal generator
*
*                   via TCP/IP.  Uses command-line arguments.
*
*                   A TCP/IP connection to port 7777 is established and
*                   the resultant file descriptor is used to "talk" to the
*                   instrument using regular socket I/O mechanisms. $
*
*
*
* Examples:
*
* Query the signal generator frequency:
*   lanio xx.xxx.xx.x 'FREQ?'
*
* Query the signal generator power level:
*   lanio xx.xxx.xx.x 'POW?'
*
* Check for errors (gets one error):
*   lanio xx.xxx.xx.x 'syst:err?'
*
* Send a list of commands from a file, and number them:
*   cat scpi_cmds | lanio -n xx.xxx.xx.x
*
*****
*
* This program compiles and runs under
*   - HP-UX 10.20 (UNIX), using HP cc or gcc:
*       + cc -Aa      -O -o lanio  lanio.c
*       + gcc -Wall -O -o lanio  lanio.c
*
*   - Windows 95, using Microsoft Visual C++ 4.0 Standard Edition
*   - Windows NT 3.51, using Microsoft Visual C++ 4.0
```

```

*           + Be sure to add WSOCK32.LIB to your list of libraries!
*           + Compile both lanio.c and getopt.c
*           + Consider re-naming the files to lanio.cpp and getopt.cpp
*
* Considerations:
*   - On UNIX systems, file I/O can be used on network sockets.
*     This makes programming very convenient, since routines like
*    getc(), fgets(), fscanf() and fprintf() can be used. These
*     routines typically use the lower level read() and write() calls.
*
*   - In the Windows environment, file operations such as read(), write(),
*     and close() cannot be assumed to work correctly when applied to
*     sockets. Instead, the functions send() and recv() MUST be used.
*****/

/* Support both Win32 and HP-UX UNIX environment */

#ifdef _WIN32      /* Visual C++ 6.0 will define this */
# define WINSOCK
#endif

#ifndef WINSOCK
# ifndef _HPUX_SOURCE
# define _HPUX_SOURCE
# endif
#endif

#include <stdio.h>          /* for fprintf and NULL */
#include <string.h>        /* for memcpy and memset */
#include <stdlib.h>        /* for malloc(), atol() */
#include <errno.h>         /* for strerror          */

```

## Programming Examples

### LAN Programming Examples

```
#ifndef WINSOCK

#include <windows.h>

#  ifdef _WINSOCKAPI_
#  include <winsock.h>    // BSD-style socket functions
#  endif

#else                          /* UNIX with BSD sockets */

#  include <sys/socket.h>    /* for connect and socket*/
#  include <netinet/in.h>   /* for sockaddr_in      */
#  include <netdb.h>        /* for gethostbyname   */

#  define SOCKET_ERROR (-1)
#  define INVALID_SOCKET (-1)

    typedef int SOCKET;

#endif /* WINSOCK */

#ifdef WINSOCK
    /* Declared in getopt.c.  See example programs disk. */
    extern char *optarg;
    extern int  optind;
    extern int  getopt(int argc, char * const argv[], const char* optstring);
#else
#  include <unistd.h>        /* for getopt(3C) */
#endif

#define COMMAND_ERROR  (1)
#define NO_CMD_ERROR   (0)
```

```

#define SCPI_PORT 7777
#define INPUT_BUF_SIZE (64*1024)

/*****
 * Display usage
 *****/
static void usage(char *basename)
{
    fprintf(stderr, "Usage: %s [-nqu] <hostname> [<command>]\n", basename);
    fprintf(stderr, "        %s [-nqu] <hostname> < stdin\n", basename);
    fprintf(stderr, " -n, number output lines\n");
    fprintf(stderr, " -q, quiet; do NOT echo lines\n");
    fprintf(stderr, " -e, show messages in error queue when done\n");
}

#ifdef WINSOCK
int init_winsock(void)
{
    WORD wVersionRequested;
    WSADATA wsaData;
    int err;

    wVersionRequested = MAKEWORD(1, 1);
    wVersionRequested = MAKEWORD(2, 0);

    err = WSASStartup(wVersionRequested, &wsaData);

    if (err != 0) {

```

## Programming Examples

### LAN Programming Examples

```
        /* Tell the user that we couldn't find a useable */
        /* winsock.dll.      */
        fprintf(stderr, "Cannot initialize Winsock 1.1.\n");
        return -1;
    }
    return 0;
}

int close_winsock(void)
{
    WSACleanup();
    return 0;
}
#endif /* WINSOCK */

/*****
 *
 * > $Function: openSocket$
 *
 * $Description:  open a TCP/IP socket connection to the instrument $
 *
 * $Parameters:  $
 *      (const char *) hostname . . . . Network name of instrument.
 *
 *                                     This can be in dotted decimal notation.
 *      (int) portNumber . . . . . The TCP/IP port to talk to.
 *
 *                                     Use 7777 for the SCPI port.
 *
 * $Return:      (int) . . . . . A file descriptor similar to open(1).$
 *
 * $Errors:      returns -1 if anything goes wrong $
 *****/
```

```

*
*****/
SOCKET openSocket(const char *hostname, int portNumber)
{
    struct hostent *hostPtr;
    struct sockaddr_in peeraddr_in;
    SOCKET s;

    memset(&peeraddr_in, 0, sizeof(struct sockaddr_in));

    /*****/
    /* map the desired host name to internal form. */
    /*****/
    hostPtr = gethostbyname(hostname);
    if (hostPtr == NULL)
    {
        fprintf(stderr, "unable to resolve hostname '%s'\n", hostname);
        return INVALID_SOCKET;
    }

    /*****/
    /* create a socket */
    /*****/
    s = socket(AF_INET, SOCK_STREAM, 0);
    if (s == INVALID_SOCKET)
    {
        fprintf(stderr, "unable to create socket to '%s': %s\n",
                hostname, strerror(errno));
        return INVALID_SOCKET;
    }
}

```

## Programming Examples

### LAN Programming Examples

```
memcpy(&peeraddr_in.sin_addr.s_addr, hostPtr->h_addr, hostPtr->h_length);
peeraddr_in.sin_family = AF_INET;
peeraddr_in.sin_port = htons((unsigned short)portNumber);

if (connect(s, (const struct sockaddr*)&peeraddr_in,
           sizeof(struct sockaddr_in)) == SOCKET_ERROR)
{
    fprintf(stderr, "unable to create socket to '%s': %s\n",
           hostname, strerror(errno));
    return INVALID_SOCKET;
}

return s;
}

/*****
*
* > $Function: commandInstrument$
*
* $Description: send a SCPI command to the instrument.$
*
* $Parameters: $
*   (FILE *) . . . . . file pointer associated with TCP/IP socket.
*   (const char *command) . . SCPI command string.
* $Return: (char *) . . . . . a pointer to the result string.
*
* $Errors: returns 0 if send fails $
*
*****/
int commandInstrument(SOCKET sock,
```



```

        const char *command)
{
    int count;

    /* fprintf(stderr, "Sending \"%s\".\n", command); */
    if (strchr(command, '\n') == NULL) {
        fprintf(stderr, "Warning: missing newline on command %s.\n", command);
    }

    count = send(sock, command, strlen(command), 0);
    if (count == SOCKET_ERROR) {
        return COMMAND_ERROR;
    }

    return NO_CMD_ERROR;
}

/*****
 * recv_line(): similar to fgets(), but uses recv()
 *****/
char * recv_line(SOCKET sock, char * result, int maxLength)
{
#ifdef WINSOCK
    int cur_length = 0;
    int count;
    char * ptr = result;
    int err = 1;

    while (cur_length < maxLength) {
        /* Get a byte into ptr */
        count = recv(sock, ptr, 1, 0);

```

## Programming Examples

### LAN Programming Examples

```
    /* If no chars to read, stop. */
    if (count < 1) {
        break;
    }
    cur_length += count;

    /* If we hit a newline, stop. */
    if (*ptr == '\n') {
        ptr++;
        err = 0;
        break;
    }
    ptr++;

}

*ptr = '\0';

if (err) {
    return NULL;
} else {
    return result;
}
#else
/*****
 * Simpler UNIX version, using file I/O.  recv() version works too.
 * This demonstrates how to use file I/O on sockets, in UNIX.
 *****/
FILE * instFile;
instFile = fdopen(sock, "r+");
if (instFile == NULL)
```

```

    {
        fprintf(stderr, "Unable to create FILE * structure : %s\n",
                strerror(errno));
        exit(2);
    }
    return fgets(result, maxLength, instFile);
#endif
}

/*****
*
* > $Function: queryInstrument$
*
* $Description:  send a SCPI command to the instrument, return a response.$
*
* $Parameters:  $
*   (FILE *) . . . . . file pointer associated with TCP/IP socket.
*   (const char *command) . . SCPI command string.
*   (char *result) . . . . . where to put the result.
*   (size_t) maxLength . . . . maximum size of result array in bytes.
*
* $Return:  (long) . . . . . The number of bytes in result buffer.
*
* $Errors:  returns 0 if anything goes wrong. $
*
*****/
long queryInstrument(SOCKET sock,
                    const char *command, char *result, size_t maxLength)
{
    long ch;

```

## Programming Examples

### LAN Programming Examples

```
char tmp_buf[8];
long resultBytes = 0;
int command_err;
int count;

/*****
 * Send command to signal generator
 *****/
command_err = commandInstrument(sock, command);
if (command_err) return COMMAND_ERROR;

/*****
 * Read response from signal generator
 *****/
count = recv(sock, tmp_buf, 1, 0); /* read 1 char */
ch = tmp_buf[0];

if ((count < 1) || (ch == EOF) || (ch == '\n'))
{
    *result = '\0'; /* null terminate result for ascii */
    return 0;
}

/* use a do-while so we can break out */
do
{
    if (ch == '#')
    {
        /* binary data encountered - figure out what it is */
        long numDigits;
        long numBytes = 0;
```

```

/* char length[10]; */

count = recv(sock, tmp_buf, 1, 0); /* read 1 char */
ch = tmp_buf[0];
if ((count < 1) || (ch == EOF)) break; /* End of file */

if (ch < '0' || ch > '9') break; /* unexpected char */
numDigits = ch - '0';

if (numDigits)
{
    /* read numDigits bytes into result string. */
    count = recv(sock, result, (int)numDigits, 0);
    result[count] = 0; /* null terminate */
    numBytes = atol(result);
}

if (numBytes)
{
    resultBytes = 0;
    /* Loop until we get all the bytes we requested. */
    /* Each call seems to return up to 1457 bytes, on HP-UX 9.05 */
    do {
        int rcount;
        rcount = recv(sock, result, (int)numBytes, 0);
        resultBytes += rcount;
        result      += rcount; /* Advance pointer */
    } while ( resultBytes < numBytes );

    /*****
    * For LAN dumps, there is always an extra trailing newline
    * Since there is no EOI line. For ASCII dumps this is

```

## Programming Examples

### LAN Programming Examples

```
    * great but for binary dumps, it is not needed.
    *****/
if (resultBytes == numBytes)
{
    char junk;
    count = recv(sock, &junk, 1, 0);
}
else
{
    /* indefinite block ... dump til we can an extra line feed */
do
{
    if (recv_line(sock, result, maxLength) == NULL) break;
    if (strlen(result)==1 && *result == '\n') break;
    resultBytes += strlen(result);
    result += strlen(result);
} while (1);
}
else
{
    /* ASCII response (not a binary block) */
    *result = (char)ch;
    if (recv_line(sock, result+1, maxLength-1) == NULL) return 0;

    /* REMOVE trailing newline, if present.  And terminate string. */
    resultBytes = strlen(result);
    if (result[resultBytes-1] == '\n') resultBytes -= 1;
    result[resultBytes] = '\0';
}
} while (0);
```

```

    return resultBytes;
}

```

```

/*****
 *
 * > $Function: showErrors$
 *
 * $Description: Query the SCPI error queue, until empty.  Print results.  $
 *
 * $Return:  (void)
 *
 *****/
void showErrors(SOCKET sock)
{
    const char * command = "SYST:ERR?\n";
    char result_str[256];

    do {
        queryInstrument(sock, command, result_str, sizeof(result_str)-1);

        /*****
         * Typical result_str:
         *   -221,"Settings conflict; Frequency span reduced."
         *   +0,"No error"
         * Don't bother decoding.
         *****/

        if (strncmp(result_str, "+0,", 3) == 0) {
            /* Matched +0,"No error" */

```

## Programming Examples

### LAN Programming Examples

```
        break;
    }
    puts(result_str);
} while (1);
}

/*****
*
* $Function: isQuery$
*
* $Description: Test current SCPI command to see if it a query. $
*
* $Return: (unsigned char) . . . non-zero if command is a query. 0 if not.
*
*****/
unsigned char isQuery( char* cmd )
{
    unsigned char q = 0 ;
    char *query ;

    /*****/
    /* if the command has a '?' in it, use queryInstrument. */
    /* otherwise, simply send the command. */
    /* Actually, we must be a more specific so that */
    /* marker value queries are treated as commands. */
    /* Example: SENS:FREQ:CENT (CALC1:MARK1:X?) */
    /*****/
    if ( (query = strchr(cmd,'?')) != NULL)
    {
        /* Make sure we don't have a marker value query, or
```



```

    * any command with a '?' followed by a ')' character.
    * This kind of command is not a query from our point of view.
    * The signal generator does the query internally, and uses the result.
    */
query++ ;          /* bump past '?' */
while (*query)
{
    if (*query == ' ') /* attempt to ignore white spc */
        query++ ;
    else break ;
}

if ( *query != ')' )
{
    q = 1 ;
}
}
return q ;
}

/*****
*
> $Function: main$
*
* $Description: Read command line arguments, and talk to signal generator.
                Send query results to stdout. $
*
* $Return:  (int) . . . non-zero if an error occurs
*
*****/

int main(int argc, char *argv[])

```

## Programming Examples

### LAN Programming Examples

```
{

SOCKET instSock;

char *charBuf = (char *) malloc(INPUT_BUF_SIZE);

char *basename;

int chr;

char command[1024];

char *destination;

unsigned char quiet = 0;

unsigned char show_errs = 0;

int number = 0;

basename = strrchr(argv[0], '/');

if (basename != NULL)
    basename++ ;

else
    basename = argv[0];

while ( ( chr = getopt(argc,argv,"qune") ) != EOF )
    switch (chr)
    {
        case 'q':  quiet = 1; break;
        case 'n':  number = 1; break ;
        case 'e':  show_errs = 1; break ;
        case 'u':
        case '?':  usage(basename); exit(1) ;
    }

/* now look for hostname and optional <command>*/
if (optind < argc)
{
    destination = argv[optind++] ;
}
```

```
strcpy(command, "");
if (optind < argc)
{
    while (optind < argc) {
        /* <hostname> <command> provided; only one command string */
        strcat(command, argv[optind++]);
        if (optind < argc) {
            strcat(command, " ");
        } else {
            strcat(command, "\n");
        }
    }
}
else
{
    /*Only <hostname> provided; input on <stdin> */
    strcpy(command, "");

    if (optind > argc)
    {
        usage(basename);
        exit(1);
    }
}
else
{
    /* no hostname! */
    usage(basename);
    exit(1);
}
```

## Programming Examples

### LAN Programming Examples

```

/*****
/* open a socket connection to the instrument
/*****/

#ifdef WINSOCK
    if (init_winsock() != 0) {
        exit(1);
    }
#endif /* WINSOCK */

instSock = openSocket(destination, SCPI_PORT);
if (instSock == INVALID_SOCKET) {
    fprintf(stderr, "Unable to open socket.\n");
    return 1;
}
/* fprintf(stderr, "Socket opened.\n"); */

if (strlen(command) > 0)
{
/*****/
/* if the command has a '?' in it, use queryInstrument. */
/* otherwise, simply send the command. */
/*****/
    if ( isQuery(command) )
    {
        long bufBytes;
        bufBytes = queryInstrument(instSock, command,
                                   charBuf, INPUT_BUF_SIZE);

        if (!quiet)
        {
            fwrite(charBuf, bufBytes, 1, stdout);
            fwrite("\n", 1, 1, stdout) ;
        }
    }
}

```

```

        fflush(stdout);
    }
}
else
{
    commandInstrument(instSock, command);
}
}
else
{
    /* read a line from <stdin> */
    while ( gets(charBuf) != NULL )
    {
        if ( !strlen(charBuf) )
            continue ;

        if ( *charBuf == '#' || *charBuf == '!' )
            continue ;

        strcat(charBuf, "\n");

        if (!quiet)
        {
            if (number)
            {
                char num[10];
                sprintf(num, "%d: ", number);
                fwrite(num, strlen(num), 1, stdout);
            }
            fwrite(charBuf, strlen(charBuf), 1, stdout) ;
            fflush(stdout);
        }
    }
}

```

```
    if ( isQuery(charBuf) )
    {
        long bufBytes;

        /* Put the query response into the same buffer as the*/
        /* command string appended after the null terminator.*/

        bufBytes = queryInstrument(instSock, charBuf,
                                   charBuf + strlen(charBuf) + 1,
                                   INPUT_BUF_SIZE -strlen(charBuf) );

        if (!quiet)
        {
            fwrite(" ", 2, 1, stdout) ;
            fwrite(charBuf + strlen(charBuf)+1, bufBytes, 1, stdout);
            fwrite("\n", 1, 1, stdout) ;
            fflush(stdout);
        }
    }
    else
    {
        commandInstrument(instSock, charBuf);
    }
    if (number) number++;
}

if (show_errs) {
    showErrors(instSock);
}

#ifdef WINSOCK
```

```

        closesocket(instSock);
        close_winsock();
    #else
        close(instSock);
    #endif /* WINSOCK */

    return 0;
}

/* End of lanio.cpp */

/*****
 * $Function: main1$
 * $Description: Output a series of SCPI commands to the signal generator
 *             Send query results to stdout. $
 *
 * $Return: (int) . . . non-zero if an error occurs
 *
 *****/
/* Rename this int main1() function to int main(). Re-compile and the
 * execute the program
 *****/

int main1()
{

SOCKET instSock;
long bufBytes;
    char *charBuf = (char *) malloc(INPUT_BUF_SIZE);

```

## Programming Examples

### LAN Programming Examples

```

/*****
/* open a socket connection to the instrument*/
*****/

#ifdef WINSOCK
    if (init_winsock() != 0) {
        exit(1);
    }
#endif /* WINSOCK */

    instSock = openSocket("xxxxxx", SCPI_PORT); /* Put your hostname here */
    if (instSock == INVALID_SOCKET) {
        fprintf(stderr, "Unable to open socket.\n");
        return 1;
    }
    /* fprintf(stderr, "Socket opened.\n"); */

    bufBytes = queryInstrument(instSock, "*IDN?\n", charBuf, INPUT_BUF_SIZE);
    printf("ID: %s\n",charBuf);
    commandInstrument(instSock, "FREQ 2.5 GHz\n");
    printf("\n");
    bufBytes = queryInstrument(instSock, "FREQ:CW?\n", charBuf, INPUT_BUF_SIZE);
    printf("Frequency: %s\n",charBuf);
    commandInstrument(instSock, "POW:AMPL -5 dBm\n");
    bufBytes = queryInstrument(instSock, "POW:AMPL?\n", charBuf, INPUT_BUF_SIZE);
    printf("Power Level: %s\n",charBuf);
    printf("\n");

#ifdef WINSOCK
    closesocket(instSock);

```



```
        close_winsock();
#else
        close(instSock);
#endif /* WINSOCK */

    return 0;
}
/*****
```

```
getopt(3C)                                getopt(3C)
```

PROGRAM FILE NAME: getopt.c

getopt - get option letter from argument vector

SYNOPSIS

```
int getopt(int argc, char * const argv[], const char *optstring);
extern char *optarg;
extern int optind, opterr, optopt;
```

PROGRAM DESCRIPTION:

getopt returns the next option letter in argv (starting from argv[1]) that matches a letter in optstring. optstring is a string of recognized option letters; if a letter is followed by a colon, the option is expected to have an argument that may or may not be separated from it by white space. optarg is set to point to the start of the option argument on return from getopt.

getopt places in optind the argv index of the next argument to be processed. The external variable optind is initialized to 1 before the first call to the function getopt.

When all options have been processed (i.e., up to the first non-option

## Programming Examples

### LAN Programming Examples

argument), `getopt` returns `EOF`. The special option `--` can be used to delimit the end of the options; `EOF` is returned, and `--` is skipped.

```
*****/

#include <stdio.h>      /* For NULL, EOF */
#include <string.h>    /* For strchr() */

char *optarg;         /* Global argument pointer. */
int optind = 0;      /* Global argv index. */

static char *scan = NULL; /* Private scan pointer. */

int getopt( int argc, char * const argv[], const char* optstring)
{
    char c;
    char *posn;

    optarg = NULL;

    if (scan == NULL || *scan == '\\0') {
        if (optind == 0)
            optind++;

        if (optind >= argc || argv[optind][0] != '-' || argv[optind][1] == '\\0')
            return(EOF);

        if (strcmp(argv[optind], "--")==0) {
            optind++;
            return(EOF);
        }
    }
}
```

```

        scan = argv[optind]+1;
        optind++;
    }

    c = *scan++;
    posn = strchr(optstring, c);          /* DDP */

    if (posn == NULL || c == ':') {
        fprintf(stderr, "%s: unknown option -%c\n", argv[0], c);
        return('?');
    }

    posn++;

    if (*posn == ':') {
        if (*scan != '\0') {
            optarg = scan;
            scan = NULL;
        } else {
            optarg = argv[optind];
            optind++;
        }
    }

    return(c);
}

```

## Sockets LAN Programming Using PERL

This example uses PERL script to control the signal generator over the sockets LAN interface. The signal generator power level is set to - 5 dBm, queried for operation complete and then queried for it's identify string. This example was developed using PERL version 5.6.0 and requires a PERL version with the IO::Socket library. This example is available on the PSG Documentation CD-ROM as perl.txt.

1. In the code below, enter your signal generator's hostname in place of the xxxxxx in the code line: `my $instrumentName= "xxxxxx";`.

## Programming Examples

### LAN Programming Examples

2. Save the code using the filename `lanperl`.
3. Run the program by typing `perl lanperl` at the UNIX term window prompt.

#### Setting the Power Level and Sending Queries Using PERL

```
#!/usr/bin/perl
# PROGRAM NAME: perl.txt
# Example of talking to the signal generator via SCPI-over-sockets
#
use IO::Socket;
# Change to your instrument's name
my $instrumentName = "xxxxx";

# Get socket
$sock = new IO::Socket::INET ( PeerAddr => $instrumentName,
                               PeerPort => 7777,
                               Proto => 'tcp',
                               );
die "Socket Could not be created, Reason: $!\n" unless $sock;

# Set freq
print "Setting frequency...\n";
print $sock "freq 1 GHz\n";

# Wait for completion
print "Waiting for source to settle...\n";
print $sock "*opc?\n";
my $response = <$sock>;
chomp $response;          # Removes newline from response
if ($response ne "1")
{
    die "Bad response to '*OPC?' from instrument!\n";
}
```

```
# Send identification query
print $sock "*IDN?\n";
$response = <$sock>;
chomp $response;
print "Instrument ID: $response\n";
```

## Sockets LAN Programming Using Java

In this example the Java program connects to the signal generator via sockets LAN. This program requires Java version 1.1 or later be installed on your PC. To run the program perform the following steps:

1. In the code example below, type in the hostname or IP address of your signal generator. For example, `String instrumentName = (your signal generator's hostname)`.
2. Copy the program as `ScpiSockTest.java` and save it in a convenient directory on your computer. For example save the file to the `C:\jdk1.3.0_2\bin\javac` directory.
3. Launch the Command Prompt program on your computer. Click **Start > Programs > Command Prompt**.
4. Compile the program. At the command prompt type: `javac ScpiSockTest.java`. The directory path for the Java compiler must be specified. For example:  
`C:\>jdk1.3.0_2\bin\javac ScpiSockTest.java`
5. Run the program by typing `java ScpiSockTest` at the command prompt.
6. Type `exit` at the command prompt to end the program.

## Generating a CW Signal Using Java

The following program example is available on the PSG Documentation CD-ROM as `javaex.txt`.

```
/******
// PROGRAM NAME: javaex.txt
// Sample java program to talk to the signal generator via SCPI-over-sockets
// This program requires Java version 1.1 or later.
// Save this code as ScpiSockTest.java
// Compile by typing: javac ScpiSockTest.java
// Run by typing: java ScpiSockTest
// The signal generator is set for 1 GHz and queried for its id string
/******
```

## Programming Examples

### LAN Programming Examples

```
import java.io.*;
import java.net.*;
class ScpiSockTest
{
    public static void main(String[] args)
    {
        String instrumentName = "xxxxx";           // Put your hostname here
try
    {
        Socket t = new Socket(instrumentName,7777); // Connect to instrument
                                                    // Setup read/write mechanism

        BufferedWriter out =
            new BufferedWriter(
                new OutputStreamWriter(t.getOutputStream()));
        BufferedReader in =
            new BufferedReader(
                new InputStreamReader(t.getInputStream()));
        System.out.println("Setting frequency to 1 GHz...");
        out.write("freq 1GHz\n");                // Sets frequency
        out.flush();
        System.out.println("Waiting for source to settle...");
        out.write("*opc?\n");                    // Waits for completion
        out.flush();
        String opcResponse = in.readLine();
        if (!opcResponse.equals("1"))
        {
            System.err.println("Invalid response to '*OPC?!'");
            System.exit(1);
        }

        System.out.println("Retrieving instrument ID...");
        out.write("*idn?\n");                    // Querys the id string
```

```
out.flush();
String idnResponse = in.readLine();           // Reads the id string
                                              // Prints the id string

System.out.println("Instrument ID: " + idnResponse);
}
catch (IOException e)
{
System.out.println("Error" + e);
}
}
}
```

## RS-232 Programming Examples

- [“Interface Check Using Agilent BASIC” on page 106](#)
- [“Interface Check Using VISA and C” on page 107](#)
- [“Queries Using Agilent BASIC” on page 109](#)
- [“Queries Using VISA and C” on page 110](#)

### Before Using the Examples

On the signal generator select the following settings:

- Baud Rate - 9600 must match computer’s baud rate
- Transmit Pace - None
- Receive Pace - None
- RTS/CTS - None
- RS-232 Echo - Off

### Interface Check Using Agilent BASIC

This example program causes the signal generator to perform an instrument reset. The SCPI command \*RST will place the signal generator into a pre-defined state.

The serial interface address for the signal generator in this example is 9. The serial port used is COM1 (Serial A on some computers). Refer to [“Using RS-232” on page 22](#) for more information.

Watch for the signal generator’s Listen annunciator (L) and the ‘remote preset....’ message on the front panel display. If there is no indication, check that the RS-232 cable is properly connected to the computer serial port and that the manual setup listed above is correct.

If the compiler displays an error message, or the program hangs, it is possible that the program was typed incorrectly. Press the signal generator’s **Reset RS-232** softkey and re-run the program. Refer to [“If You Have Problems” on page 7](#) for more help.

The following program example is available on the PSG Documentation CD-ROM as rs232ex1.txt.

```
10      ! *****
20      !
30      ! PROGRAM NAME:          rs232ex1.txt
40      !
```



```

50  ! PROGRAM DESCRIPTION: This program verifies that the RS-232 connections and
60  !                               interface are functional.
70  !
80  ! Connect the UNIX workstation to the signal generator using an RS-232 cable
90  !
100 !
110 ! Run Agilent BASIC, type in the following commands and then RUN the program
120 !
130 !
140 !*****
150 !
160  INTEGER Num
170  CONTROL 9,0;1      ! Resets the RS-232 interface
180  CONTROL 9,3;9600  ! Sets the baud rate to match the sig gen
190  STATUS 9,4;Stat   ! Reads the value of register 4
200  Num=BINAND(Stat,7) ! Gets the AND value
210  CONTROL 9,4;Num   ! Sets parity to NONE
220  OUTPUT 9;"*RST"   ! Outputs reset to the sig gen
230  END                ! End the program

```

## Interface Check Using VISA and C

This program uses VISA library functions to communicate with the signal generator. The program verifies that the RS-232 connections and interface are functional. In this example the COM2 port is used. The serial port is referred to in the VISA library as 'ASRL1' or 'ASRL2' depending on the computer serial port you are using. Launch Microsoft Visual C++, add the required files, and enter the following code into the .cpp source file.

The following program example is available on the PSG Documentation CD-ROM as rs232ex1.cpp.

```

/*****
// PROGRAM NAME:          rs232ex1.cpp
//
// PROGRAM DESCRIPTION: This code example uses the RS-232 serial interface to
// control the signal generator.
//

```

## Programming Examples

### RS-232 Programming Examples

```
// Connect the computer to the signal generator using an RS-232 serial cable.
// The user is asked to set the signal generator for a 0 dBm power level
// A reset command *RST is sent to the signal generator via the RS-232
// interface and the power level will reset to the -135 dBm level.The default
// attributes e.g. 9600 baud, no parity, 8 data bits,1 stop bit are used.
// These attributes can be changed using VISA functions.
//
// IMPORTANT: Set the signal generator BAUD rate to 9600 for this test
//*****

#include <visa.h>
#include <stdio.h>
#include "StdAfx.h"
#include <stdlib.h>
#include <conio.h>

void main ()
{

int baud=9600;// Set baud rate to 9600
printf("Manually set the signal generator power level to 0 dBm\n");
printf("\n");
printf("Press any key to continue\n");
getch();
printf("\n");
ViSession defaultRM, vi;// Declares a variable of type ViSession
// for instrument communication on COM 2 port
ViStatus viStatus = 0;
                // Opens session to RS-232 device at serial port 2
viStatus=viOpenDefaultRM(&defaultRM);
viStatus=viOpen(defaultRM, "ASRL2::INSTR", VI_NULL, VI_NULL, &vi);
```

```

if(viStatus){// If operation fails, prompt user
    printf("Could not open ViSession!\n");
    printf("Check instruments and connections\n");
    printf("\n");
    exit(0);}
// initialize device
viStatus=viEnableEvent(vi, VI_EVENT_IO_COMPLETION, VI_QUEUE,VI_NULL);

viClear(vi);// Sends device clear command
// Set attributes for the session
viSetAttribute(vi,VI_ATTR_ASRL_BAUD,baud);
viSetAttribute(vi,VI_ATTR_ASRL_DATA_BITS,8);

viPrintf(vi, "*RST\n");// Resets the signal generator
printf("The signal generator has been reset\n");
printf("Power level should be -135 dBm\n");
printf("\n");// Prints new line character to the display
viClose(vi);// Closes session
viClose(defaultRM);// Closes default session
}

```

## Queries Using Agilent BASIC

This example program demonstrates signal generator query commands over RS-232. Query commands are of the type \*IDN? and are identified by the question mark that follows the mnemonic.

Start Agilent BASIC, type in the following commands, and then RUN the program:

The following program example is available on the PSG Documentation CD-ROM as rs232ex2.txt.

```

10      !*****
20      !
30      ! PROGRAM NAME:          rs232ex2.txt
40      !
50      ! PROGRAM DESCRIPTION:  In this example, query commands are used to read
60      !                       data from the signal generator.

```

## Programming Examples

### RS-232 Programming Examples

```
70      !
80      ! Start Agilent BASIC, type in the following code and then RUN the program.
90      !
100     !*****
110     !
120     INTEGER Num
130     DIM Str$(200),Str1$(20)
140     CONTROL 9,0;1           ! Resets the RS-232 interface
150     CONTROL 9,3;9600       ! Sets the baud rate to match signal generator rate
160     STATUS 9,4;Stat        ! Reads the value of register 4
170     Num=BINAND(Stat,7)     ! Gets the AND value
180     CONTROL 9,4;Num        ! Sets the parity to NONE
190     OUTPUT 9;"*IDN?"       ! Querys the sig gen ID
200     ENTER 9;Str$           ! Reads the ID
210     WAIT 2                 ! Waits 2 seconds
220     PRINT "ID =",Str$      ! Prints ID to the screen
230     OUTPUT 9;"POW:AMPL -5 dbm" ! Sets the the power level to -5 dbm
240     OUTPUT 9;"POW?"       ! Querys the power level of the sig gen
250     ENTER 9;Str1$         ! Reads the queried value
260     PRINT "Power = ",Str1$ ! Prints the power level to the screen
270     END                    ! End the program
```

## Queries Using VISA and C

This example uses VISA library functions to communicate with the signal generator. The program verifies that the RS-232 connections and interface are functional. Launch Microsoft Visual C++, add the required files, and enter the following code into your .cpp source file.

The following program example is available on the PSG Documentation CD-ROM as rs232ex2.cpp.

```
/******
//
// PROGRAM NAME:          rs232ex2.cpp
//
// PROGRAM DESCRIPTION:  This code example uses the RS-232 serial interface to control
```

```
// the signal generator.
//
// Connect the computer to the signal generator using the RS-232 serial cable
// and enter the following code into the project .cpp source file.
// The program queries the signal generator ID string and sets and queries the power
// level. Query results are printed to the screen. The default attributes e.g. 9600 baud,
// parity, 8 data bits, 1 stop bit are used. These attributes can be changed using VISA
// functions.
//
// IMPORTANT: Set the signal generator BAUD rate to 9600 for this test
//*****

#include <visa.h>
#include <stdio.h>
#include "StdAfx.h"
#include <stdlib.h>
#include <conio.h>

#define MAX_COUNT 200
int main (void)
{

ViStatusstatus; // Declares a type ViStatus variable
ViSessiondefaultRM, instr;// Declares type ViSession variables
ViUInt32retCount; // Return count for string I/O
ViCharbuffer[MAX_COUNT];// Buffer for string I/O

status = viOpenDefaultRM(&defaultRM);// Initializes the system
// Open communication with Serial Port 2
status = viOpen(defaultRM, "ASRL2::INSTR", VI_NULL, VI_NULL, &instr);
```

## Programming Examples

### RS-232 Programming Examples

```
if(status){// If problems, then prompt user
printf("Could not open ViSession!\n");
printf("Check instruments and connections\n");
printf("\n");
exit(0);}

// Set timeout for 5 seconds

viSetAttribute(instr, VI_ATTR_TMO_VALUE, 5000);
// Asks for sig gen ID string
status = viWrite(instr, (ViBuf)"*IDN?\n", 6, &retCount);

// Reads the sig gen response
status = viRead(instr, (ViBuf)buffer, MAX_COUNT, &retCount);
buffer[retCount]= '\0';// Indicates the end of the string
printf("Signal Generator ID: "); // Prints header for ID
printf(buffer);// Prints the ID string to the screen
printf("\n");// Prints carriage return
// Flush the read buffer
// Sets sig gen power to -5dbm
status = viWrite(instr, (ViBuf)"POW:AMPL -5dbm\n", 15, &retCount);
// Querys the sig gen for power level
status = viWrite(instr, (ViBuf)"POW?\n",5,&retCount);
// Read the power level
status = viRead(instr, (ViBuf)buffer, MAX_COUNT, &retCount);
buffer[retCount]= '\0';// Indicates the end of the string
printf("Power level = ");// Prints header to the screen
printf(buffer);// Prints the queried power level
printf("\n");
status = viClose(instr);// Close down the system
status = viClose(defaultRM);
return 0;
}
```

---

## 3 Programming the Status Register System

This chapter provides the following major sections:

- [“Overview” on page 114](#)
- [“Status Register Bit Values” on page 117](#)
- [“Accessing Status Register Information” on page 118](#)
- [“Status Byte Group” on page 123](#)
- [“Status Groups” on page 126](#)

---

## Overview

During remote operation, you may need to monitor the status of the signal generator for error conditions or status changes. The signal generator's error queue can be read with the SCPI query `:SYSTEM:ERROR?` (Refer to `“:ERROR[:NEXT]”` in the SCPI command reference guide) to see if any errors have occurred. An alternative method uses the signal generator's status register system to monitor error conditions and/or condition changes.

The signal generator's status register system provides two major advantages:

- You can monitor the settling of the signal generator using the settling bit of the Standard Operation Status Group's condition register.
- You can use the service request (SRQ) interrupt technique to avoid status polling, therefore giving a speed advantage.

The signal generator's instrument status system provides complete SCPI standard data structures for reporting instrument status using the register model.

The SCPI register model of the status system has multiple registers that are arranged in a hierarchical order. The lower-level status registers propagate data to the higher-level registers using summary bits. The Status Byte Register is at the top of the hierarchy and contains the status information for lower level registers.

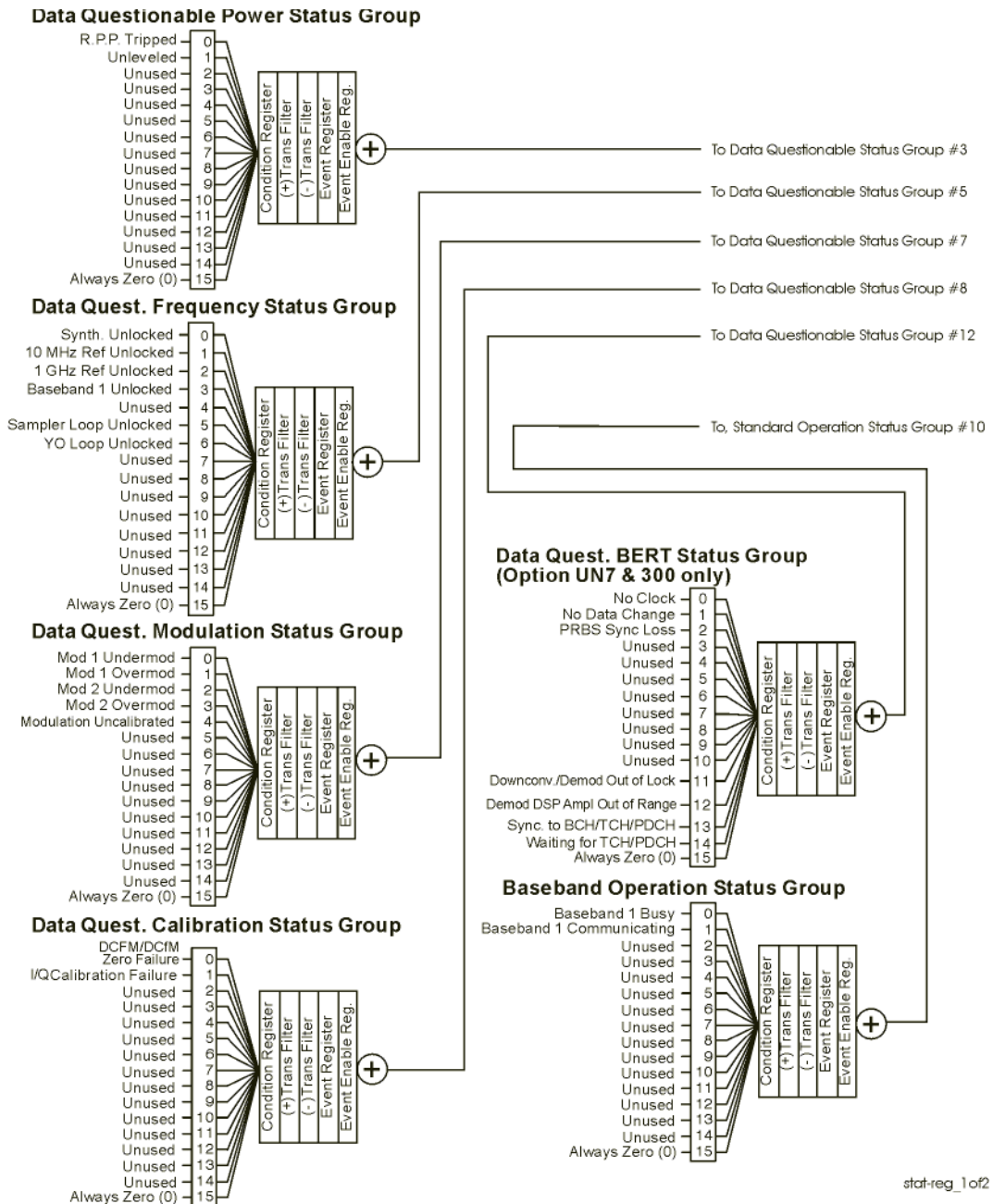
The lower level status registers monitor specific events or conditions, and are grouped according to their functionality. For example, the Data Questionable Frequency Status Group consists of five registers. This chapter may refer to a group as a register so that the cumbersome correct description is avoided. For example, the Standard Operation Status Group's Condition Register can be referred to as the Standard Operation Status register. Refer to [“Status Groups” on page 126](#) for more information.

[Figure 3-1](#) and [Figure 3-2](#) show the signal generator's status byte register system and hierarchy.

The status register system uses IEEE 488.2 commands (those beginning with `*`) to access the higher-level summary registers. Lower-level registers can be accessed using `STATUS` SCPI commands.

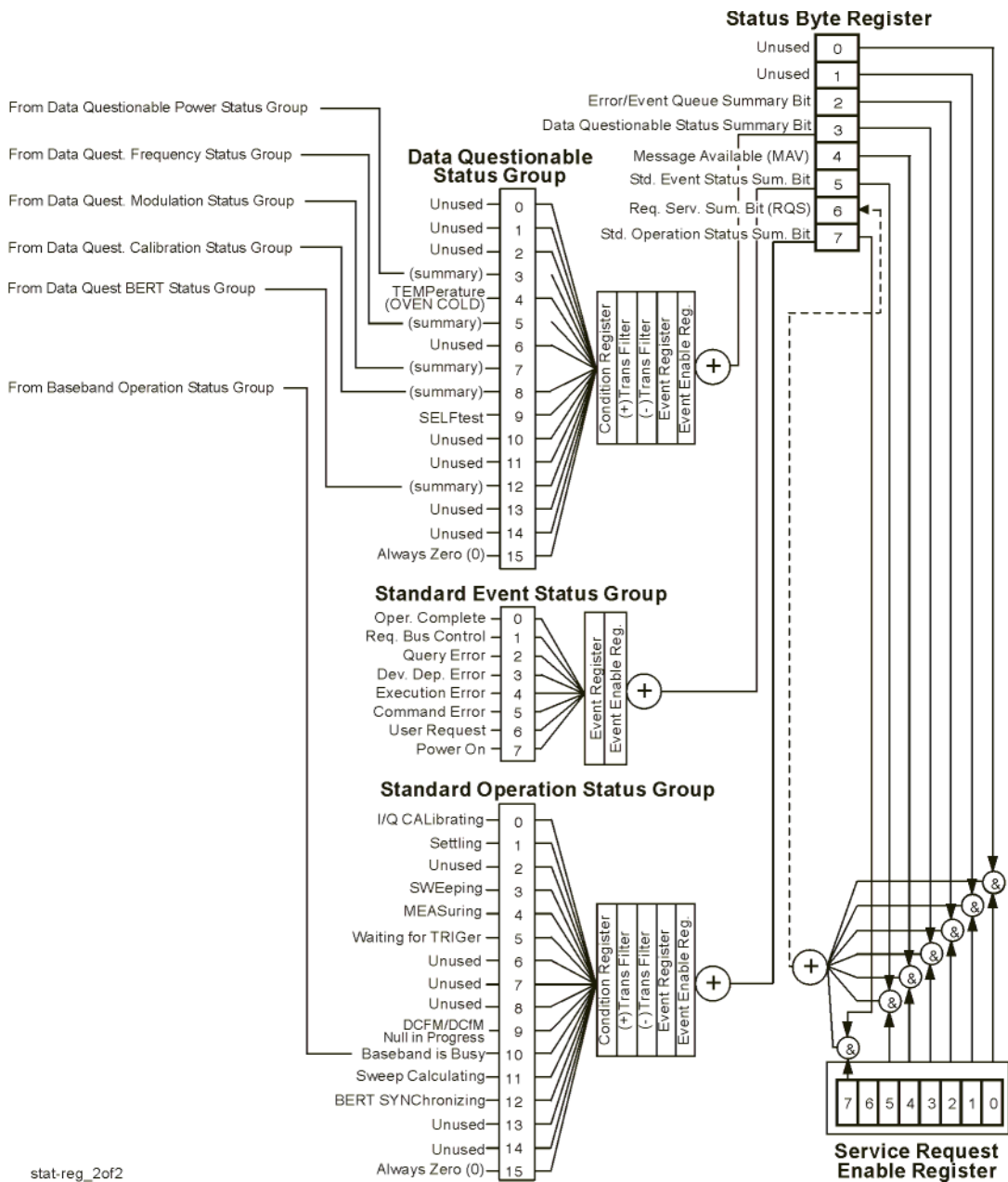


Figure 3-1 The Overall Status Byte Register System (1 of 2)



stat-reg\_1 of 2

Figure 3-2 The Overall Status Byte Register System (2 of 2)



## Status Register Bit Values

Each bit in a register is represented by a decimal value based on its location in the register (see [Table 3-1](#)).

- To enable a particular bit in a register, send its value with the SCPI command. Refer to the signal generator’s SCPI command listing for more information.
- To enable more than one bit, send the sum of all the bits that you want to enable.
- To verify the bits set in a register, query the register.

### Example: Enable a Register

To enable bit 0 and bit 6 of the Standard Event Status Group’s Event Register:

1. Add the decimal value of bit 0 (1) and the decimal value of bit 6 (64) to give a decimal value of 65.
2. Send the sum with the command: \*ESE 65.

### Example: Query a Register

To query a register for a condition, send a SCPI query command. For example, if you want to query the Standard Operation Status Group’s Condition Register, send the command:

STATus:OPERation:CONDition?

If bit 7, bit 3 and bit 2 in this register are set (bits=1) then the query will return the decimal value 140. The value represents the decimal values of bit 7, bit 3 and bit 2:  $128 + 8 + 4 = 140$ .

**Table 3-1 Status Register Bit Decimal Values**

<b>Decimal Value</b>	Always 0	16384	8192	4096	2048	1024	512	256	128	64	32	16	8	4	2	1
<b>Bit Number</b>	<b>15</b>	<b>14</b>	<b>13</b>	<b>12</b>	<b>11</b>	<b>10</b>	<b>9</b>	<b>8</b>	<b>7</b>	<b>6</b>	<b>5</b>	<b>4</b>	<b>3</b>	<b>2</b>	<b>1</b>	<b>0</b>

**NOTE** Bit 15 is not used and is always set to zero.

## Accessing Status Register Information

1. Determine which register contains the bit that reports the condition. Refer to [Figure 3-1 on page 115](#) or [Figure 3-2 on page 116](#) for register location and names.
2. Send the unique SCPI query that reads that register.
3. Examine the bit to see if the condition has changed.

## Determining What to Monitor

You can monitor the following conditions:

- current signal generator hardware and firmware status
- whether a particular condition (bit) has occurred

### Monitoring Current Signal Generator Hardware and Firmware Status

To monitor the signal generator's operating status, you can query the condition registers. These registers represent the current state of the signal generator and are updated in real time. When the condition monitored by a particular bit becomes true, the bit sets to 1. When the condition becomes false, the bit resets to 0.

### Monitoring Whether a Condition (Bit) has Changed

The transition registers determine which bit transition (condition change) should be recorded as an event. The transitions can be positive to negative, negative to positive, or both. To monitor a certain condition, enable the bit associated with the condition in the associated positive and negative registers.

Once you have enabled a bit via the transition registers, the signal generator monitors it for a change in its condition. If this change in condition occurs, the corresponding bit in the event register will be set to 1. When a bit becomes true (set to 1) in the event register, it stays set until the event register is read or is cleared. You can thus query the event register for a condition even if that condition no longer exists.

The event register can be cleared only by querying its contents or sending the \*CLS command, which clears *all* event registers.

### Monitoring When a Condition (Bit) Changes

Once you enable a bit, the signal generator monitors it for a change in its condition. The transition registers are preset to register positive transitions (a change going from 0 to 1). This can be changed so the selected bit is detected if it goes from true to false (negative transition), or if either transition occurs.

## Deciding How to Monitor

You can use either of two methods described below to access the information in status registers (both methods allow you to monitor one or more conditions).

- **The polling method**

In the polling method, the signal generator has a passive role. It tells the controller that conditions have changed only when the controller asks the right question. This is accomplished by a program loop that continually sends a query.

The polling method works well if you do not need to know about changes the moment they occur. Use polling in the following situations:

- when you use a programming language/development environment or I/O interface that does not support SRQ interrupts
- when you want to write a simple, single-purpose program and don't want the added complexity of setting up an SRQ handler

- **The service request (SRQ) method**

In the SRQ method (described in the following section), the signal generator takes a more active role. It tells the controller when there has been a condition change without the controller asking.

Use the SRQ method if you must know immediately when a condition changes. (To detect a change using the polling method, the program must repeatedly read the registers.) Use the SRQ method in the following situations:

- when you need time-critical notification of changes
- when you are monitoring more than one device that supports SRQs
- when you need to have the controller do something else while waiting
- when you can't afford the performance penalty inherent to polling

### Using the Service Request (SRQ) Method

The programming language, I/O interface, and programming environment must support SRQ interrupts (for example: BASIC or VISA used with GPIB and VXI-11 over the LAN). Using this method, you must do the following:

1. Determine which bit monitors the condition.
2. Send commands to enable the bit that monitors the condition (transition registers).
3. Send commands to enable the summary bits that report the condition (event enable registers).
4. Send commands to enable the status byte register to monitor the condition.
5. Enable the controller to respond to service requests.

## Programming the Status Register System

### Accessing Status Register Information

The controller responds to the SRQ as soon as it occurs. As a result, the time the controller would otherwise have used to monitor the condition, as in a loop method, can be used to perform other tasks. The application determines how the controller responds to the SRQ.

When a condition changes and that condition has been enabled, the RQS bit in the status byte register is set. In order for the controller to respond to the change, the Service Request Enable Register needs to be enabled for the bit(s) that will trigger the SRQ.

#### Generating a Service Request

The Service Request Enable Register lets you choose the bits in the Status Byte Register that will trigger a service request. Send the \*SRE <num> command where <num> is the sum of the decimal values of the bits you want to enable.

For example, to enable bit 7 on the Status Byte Register (so that whenever the Standard Operation Status register summary bit is set to 1, a service request is generated) send the command \*SRE 128. Refer to [Figure 3-1 on page 115](#) or [Figure 3-2 on page 116](#) for bit positions and values.

The query command \*SRE? returns the decimal value of the sum of the bits previously enabled with the \*SRE <num> command.

To query the Status Byte Register, send the command \*STB?. The response will be the decimal sum of the bits which are set to 1. For example, if bit 7 and bit 3 are set, the decimal sum will be 136 (bit 7=128 and bit 3=8).

---

**NOTE** Multiple Status Byte Register bits can assert an SRQ, however only one bit at a time can set the RQS bit. All bits that are asserting an SRQ will be read as part of the status byte when it is queried or serial polled.

---

The SRQ process asserts SRQ as true and sets the status byte's RQS bit to 1. Both actions are necessary to inform the controller that the signal generator requires service. Asserting SRQ informs the controller that some device on the bus requires service. Setting the RQS bit allows the controller to determine which signal generator requires service.

This process is initiated if both of the following conditions are true:

- The corresponding bit of the Service Request Enable Register is also set to 1.
- The signal generator does not have a service request pending.

A service request is considered to be pending between the time the signal generator's SRQ process is initiated and the time the controller reads the status byte register.

If a program enables the controller to detect and respond to service requests, it should instruct the controller to perform a serial poll when SRQ is true. Each device on the bus returns the contents of its status byte register in response to this poll. The device whose request service summary bit (RQS) bit is set to 1 is the

device that requested service.

---

**NOTE** When you read the signal generator's Status Byte Register with a serial poll, the RQS bit is reset to 0. Other bits in the register are not affected.

If the status register is configured to SRQ on end-of-sweep or measurement and the mode set to continuous, restarting the measurement (INIT command) can cause the measuring bit to pulse low. This causes an SRQ when you have not actually reached the "end-of-sweep" or measurement condition. To avoid this, do the following:

1. Send the command `INITiate:CONTinuous OFF`.
  2. Set/enable the status registers.
  3. Restart the measurement (send INIT).
- 

## Status Register SCPI Commands

Most monitoring of signal generator conditions is done at the highest level, using the IEEE 488.2 common commands listed below. You can set and query individual status registers using the commands in the STATUS subsystem.

\*CLS (clear status) clears the Status Byte Register by emptying the error queue and clearing all the event registers.

\*ESE, \*ESE? (event status enable) sets and queries the bits in the Standard Event Enable Register which is part of the Standard Event Status Group.

\*ESR? (event status register) queries and clears the Standard Event Status Register which is part of the Standard Event Status Group.

\*OPC, \*OPC? (operation complete) sets bit #0 in the Standard Event Status Register to 1 when all commands have completed. The query stops any new commands from being processed until the current processing is complete, then returns a 1.

\*PSC, \*PSC? (power-on state clear) sets the power-on state so that it clears the Service Request Enable Register, the Standard Event Status Enable Register, and device-specific event enable registers at power on. The query returns the flag setting from the \*PSC command.

\*SRE, \*SRE? (service request enable) sets and queries the value of the Service Request Enable Register.

\*STB? (status byte) queries the value of the status byte register without erasing its contents.

:STATus:PRESet presets all transition filters, non-IEEE 488.2 enable registers, and error/event queue enable registers. (Refer to [Table 3-2](#).)

Programming the Status Register System  
 Accessing Status Register Information

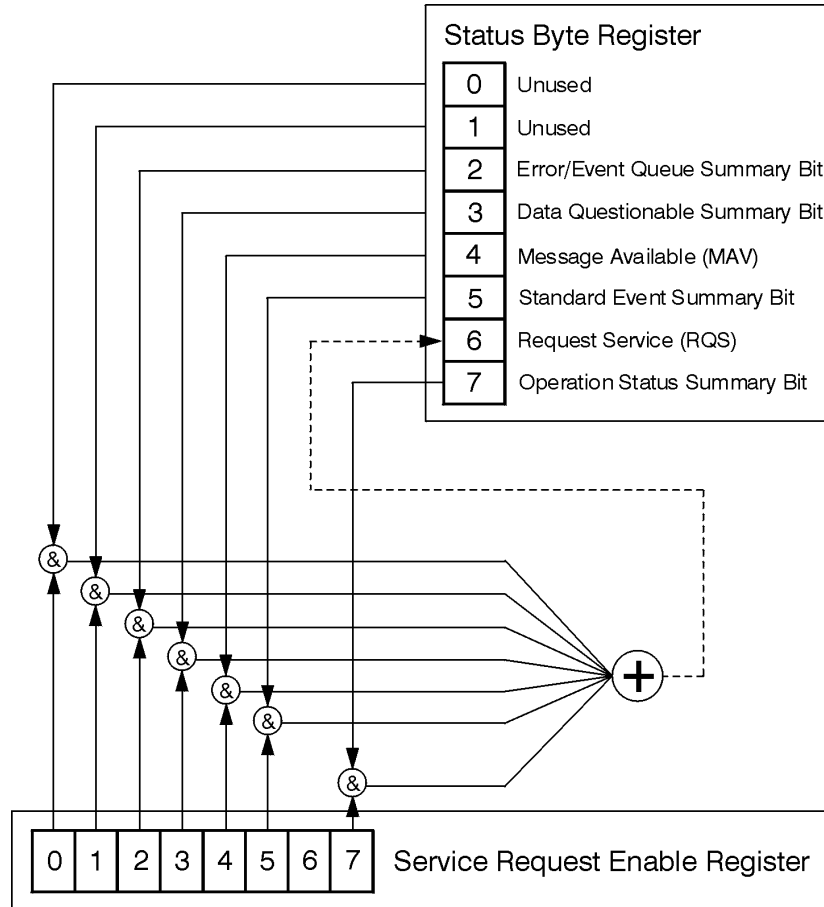
Table 3-2 Effects of :STATUS:PRESet

Register	Value after :STATUS:PRESet
:STATUS:OPERation:ENABle	0
:STATUS:OPERation:NTRansition	0
:STATUS:OPERation:PTRransition	32767
:STATUS:OPERation:BASEband:ENABle	0
:STATUS:OPERation:BASEband:NTRansition	0
:STATUS:OPERation:BASEband:PTRransition	32767
:STATUS:QUESTionable:CALibration:ENABle	32767
:STATUS:QUESTionable:CALibration:NTRansition	32767
:STATUS:QUESTionable:CALibration:PTRransition	32767
:STATUS:QUESTionable:ENABle	0
:STATUS:QUESTionable:NTRansition	0
:STATUS:QUESTionable:PTRansition	32767
:STATUS:QUESTionable:FREQuency:ENABle	32767
:STATUS:QUESTionable:FREQuency:NTRansition	32767
:STATUS:QUESTionable:FREQuency:PTRansition	32767
:STATUS:QUESTionable:MODulation:ENABle	32767
:STATUS:QUESTionable:MODulation:NTRansition	32767
:STATUS:QUESTionable:MODulation:PTRansition	32767
:STATUS:QUESTionable:POWer:ENABle	32767
:STATUS:QUESTionable:POWer:NTRansition	32767
:STATUS:QUESTionable:POWer:PTRansition	32767
:STATUS:QUESTionable:BERT:ENABle	32767
:STATUS:QUESTionable:BERT:NTRansition	32767
:STATUS:QUESTionable:BERT:PTRansition	32767



## Status Byte Group

The Status Byte Group includes the [Status Byte Register](#) and the [Service Request Enable Register](#).



ck721a

## Status Byte Register

Table 3-3 Status Byte Register Bits

Bit	Description
0,1	<b>Unused.</b> These bits are always set to 0.
2	<b>Error/Event Queue Summary Bit.</b> A 1 in this bit position indicates that the SCPI error queue is not empty; the SCPI error queue contains at least one error message.
3	<b>Data Questionable Status Summary Bit.</b> A 1 in this bit position indicates that the Data Questionable summary bit has been set. The Data Questionable Event Register can then be read to determine the specific condition that caused this bit to be set.
4	<b>Message Available.</b> A 1 in this bit position indicates that the signal generator has data ready in the output queue. There are no lower status groups that provide input to this bit.
5	<b>Standard Event Status Summary Bit.</b> A 1 in this bit position indicates that the Standard Event summary bit has been set. The Standard Event Status Register can then be read to determine the specific event that caused this bit to be set.
6	<b>Request Service (RQS) Summary Bit.</b> A 1 in this bit position indicates that the signal generator has at least one reason to require service. This bit is also called the Master Summary Status bit (MSS). The individual bits in the Status Byte are individually ANDed with their corresponding service request enable register, then each individual bit value is ORed and input to this bit.
7	<b>Standard Operation Status Summary Bit.</b> A 1 in this bit position indicates that the Standard Operation Status Group's summary bit has been set. The Standard Operation Event Register can then be read to determine the specific condition that caused this bit to be set.

Query: \*STB?

Response: The *decimal* sum of the bits set to 1 including the master summary status bit (MSS) bit 6.

Example: The decimal value 136 is returned when the MSS bit is set low (0).

Decimal sum = 128 (bit 7) + 8 (bit 3)

The decimal value 200 is returned when the MSS bit is set high (1).

Decimal sum = 128 (bit 7) + 8 (bit 3) + 64 (MSS bit)

## Service Request Enable Register

The Service Request Enable Register lets you choose which bits in the Status Byte Register trigger a service request.

\*SRE <data>      <data> is the sum of the decimal values of the bits you want to enable except bit 6. Bit 6 cannot be enabled on this register. Refer to [Figure 3-1 on page 115](#) or [Figure 3-2 on page 116](#).

Example:            Enable bits 7 and 5 to trigger a service request when either corresponding status group register summary bit sets to 1:  
send the command \*SRE 160 (128 + 32)

Query:             \*SRE?

Response:          The decimal value of the sum of the bits previously enabled with the \*SRE <data> command.

## Status Groups

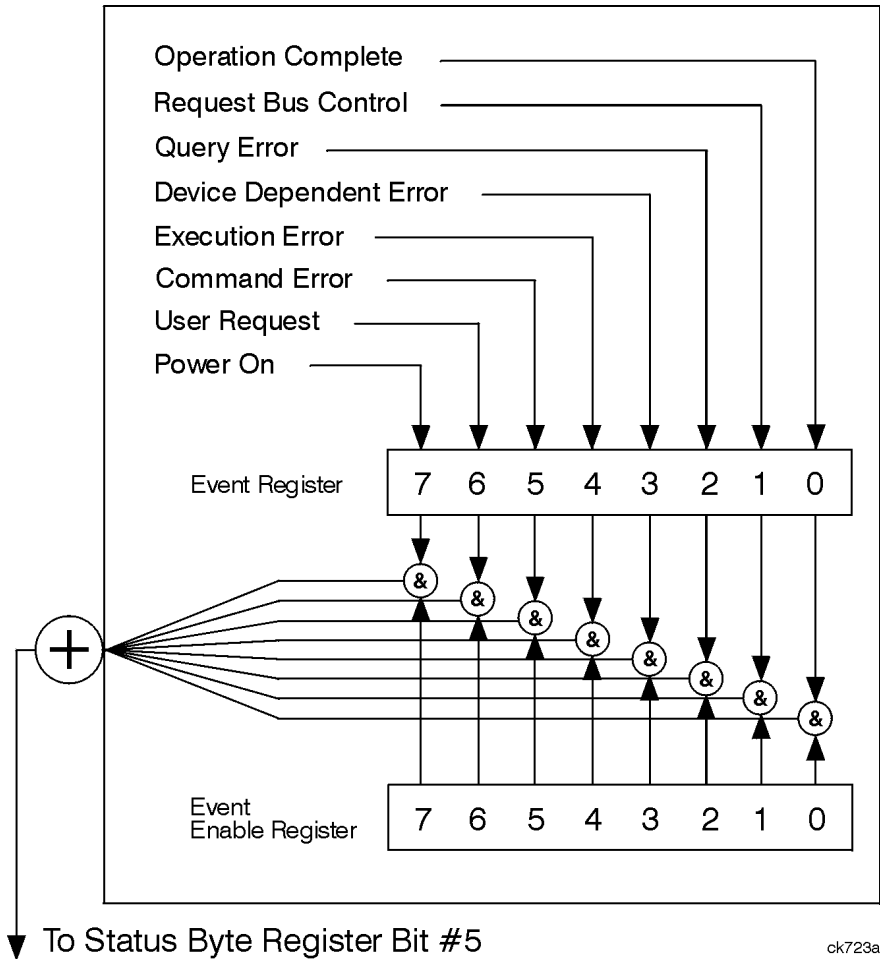
The [Standard Operation Status Group](#) and the [Data Questionable Status Group](#) consist of the registers listed below. The [Standard Event Status Group](#) is similar but does *not* have negative or positive transition filters or a condition register.

Condition Register	A condition register continuously monitors the hardware and firmware status of the signal generator. There is no latching or buffering for a condition register; it is updated in real time.
Negative Transition Filter	A negative transition filter specifies the bits in the condition register that will set corresponding bits in the event register when the condition bit changes from 1 to 0.
Positive Transition Filter	A positive transition filter specifies the bits in the condition register that will set corresponding bits in the event register when the condition bit changes from 0 to 1.
Event Register	An event register latches transition events from the condition register as specified by the positive and negative transition filters. Once the bits in the event register are set, they remain set until cleared by either querying the register contents or sending the *CLS command.
Event Enable Register	An enable register specifies the bits in the event register that generate the summary bit. The signal generator logically ANDs corresponding bits in the event and enable registers and ORs all the resulting bits to produce a summary bit. Summary bits are, in turn, used by the <a href="#">Status Byte Register</a> .

A status group is a set of related registers whose contents are programmed to produce status summary bits. In each status group, corresponding bits in the condition register are filtered by the negative and positive transition filters and stored in the event register. The contents of the event register are logically ANDed with the contents of the enable register and the result is logically ORed to produce a status summary bit in the [Status Byte Register](#).

### Standard Event Status Group

The Standard Event Status Group is used to determine the specific event that set bit 5 in the Status Byte Register. This group consists of the [Standard Event Status Register](#) (an event register) and the [Standard Event Status Enable Register](#).



**Standard Event Status Register**  
**Table 3-4 Standard Event Status Register Bits**

Bit	Description
0	<b>Operation Complete.</b> A 1 in this bit position indicates that all pending signal generator operations were completed following execution of the *OPC command.
1	<b>Request Control.</b> This bit is always set to 0 (the signal generator does not request control).
2	<b>Query Error.</b> A 1 in this bit position indicates that a query error has occurred. Query errors have SCPI error numbers from -499 to -400.
3	<b>Device Dependent Error.</b> A 1 in this bit position indicates that a device dependent error has occurred. Device dependent errors have SCPI error numbers from -399 to -300 and 1 to 32767.
4	<b>Execution Error.</b> A 1 in this bit position indicates that an execution error has occurred. Execution errors have SCPI error numbers from -299 to -200.
5	<b>Command Error.</b> A 1 in this bit position indicates that a command error has occurred. Command errors have SCPI error numbers from -199 to -100.
6	<b>User Request Key (Local).</b> A 1 in this bit position indicates that the <b>Local</b> key has been pressed. This is true even if the signal generator is in local lockout mode.
7	<b>Power On.</b> A 1 in this bit position indicates that the signal generator has been turned off and then on.

Query:        \*ESR?

Response:    The *decimal* sum of the bits set to 1

Example:     The decimal value 136 is returned. The decimal sum = 128 (bit 7) + 8 (bit 3).

### Standard Event Status Enable Register

The Standard Event Status Enable Register lets you choose which bits in the Standard Event Status Register set the summary bit (bit 5 of the Status Byte Register) to 1.

\*ESE <data>    <data> is the sum of the decimal values of the bits you want to enable.

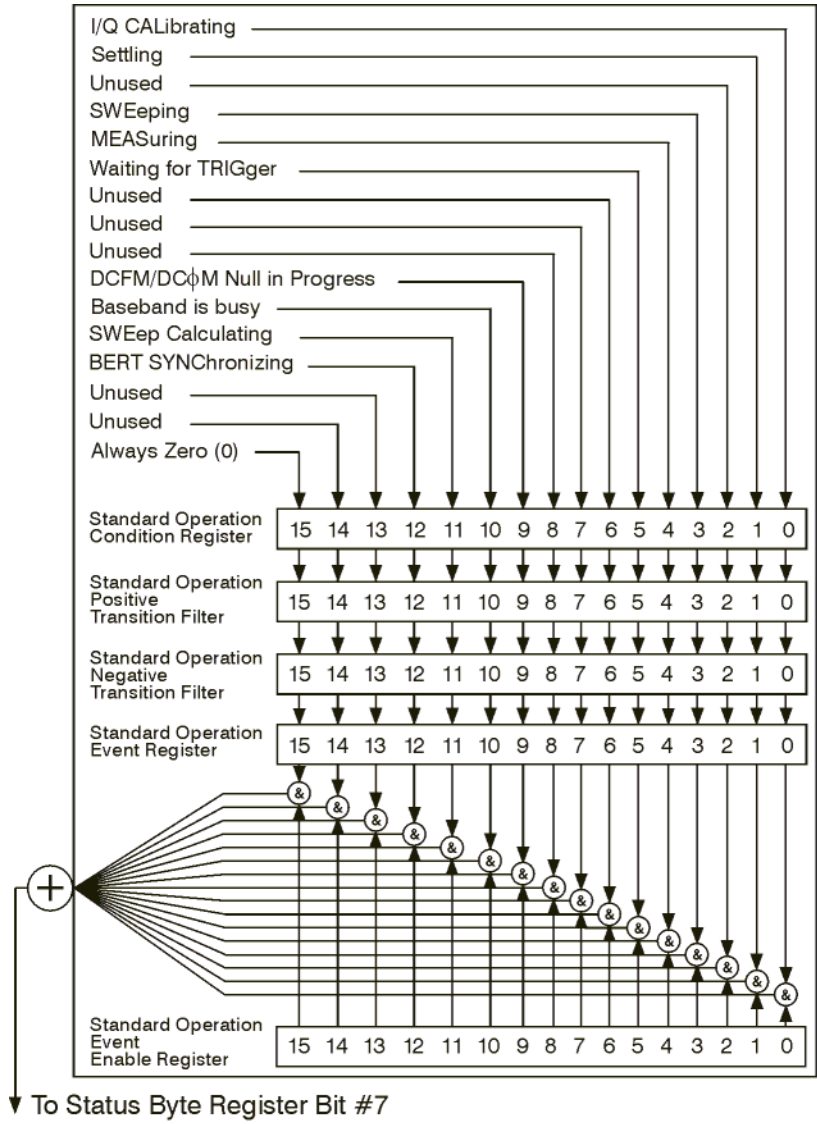
Example:        Enable bit 7 and bit 6 so that whenever either of those bits is set to 1, the Standard Event Status summary bit of the Status Byte Register is set to 1:  
                     send the command \*ESE 192 (128 + 64)

Query:        \*ESE?

Response:     Decimal value of the sum of the bits previously enabled with the \*ESE <data> command.

### Standard Operation Status Group

The Operation Status Group is used to determine the specific event that set bit 7 in the **Status Byte Register**. This group consists of the **Standard Operation Condition Register**, the **Standard Operation Transition Filters (negative and positive)**, the **Standard Operation Event Register**, and the **Standard Operation Event Enable Register**.



ck702c

**Standard Operation Condition Register**

The Standard Operation Condition Register continuously monitors the hardware and firmware status of the signal generator; condition registers are read only.

**Table 3-5 Standard Operation Condition Register Bits**

Bit	Description
0	<b>I/Q Calibrating.</b> A 1 in this position indicates an I/Q calibration is in process.
1	<b>Settling.</b> A 1 in this bit position indicates that the signal generator is settling.
2	<b>Unused.</b> This bit position is set to 0.
3	<b>Sweeping.</b> A 1 in this bit position indicates that a sweep is in progress.
4	Measuring. A1 in this bit position indicates that a bit error rate test is in progress
5	<b>Waiting for Trigger.</b> A 1 in this bit position indicates that the source is in a “wait for trigger” state. When option 300 is enabled, a 1 in this bit position indicates that TCH/PDCH synchronization is established and waiting for a trigger to start measurements.
6,7,8	<b>Unused.</b> These bits are always set to 0.
9	<b>DCFM/DCΦM Null in Progress.</b> A 1 in this bit position indicates that the signal generator is currently performing a DCFM/DCΦM zero calibration.
10	<b>Baseband is Busy.</b> A 1 in this bit position indicates that the baseband generator is communicating or processing. This is a summary bit. See the “ <a href="#">Baseband Operation Status Group</a> ” on page 132 for more information.
11	<b>Sweep Calculating.</b> A 1 in this bit position indicates that the signal generator is currently doing the necessary pre-sweep calculations.
12, 13, 14	<b>Unused.</b> These bits are always set to 0.
15	<b>Always 0.</b>

Query:        STATus:OPERation:CONDition?

Response:    The *decimal* sum of the bits that are set to 1

Example:     The decimal value 520 is returned. The decimal sum = 512 (bit 9) + 8 (bit 3).

**Standard Operation Transition Filters (negative and positive)**

The Standard Operation Transition Filters specify which types of bit state changes in the condition register



set corresponding bits in the event register. Changes can be positive (0 to 1) or negative (1 to 0).

Commands:     `STATUS:OPERation:NTRansition <value>` (negative transition), or  
                  `STATUS:OPERation:PTRansition <value>` (positive transition), where  
                  <value> is the sum of the decimal values of the bits you want to enable.

Queries:       `STATUS:OPERation:NTRansition?`  
                  `STATUS:OPERation:PTRansition?`

### Standard Operation Event Register

The Standard Operation Event Register latches transition events from the condition register as specified by the transition filters. Event registers are destructive read only: reading data from an event register clears the content of that register.

Query:         `STATUS:OPERation[:EVENT]?`

### Standard Operation Event Enable Register

The Standard Operation Event Enable Register lets you choose which bits in the Standard Operation Event Register set the summary bit (bit 7 of the Status Byte Register) to 1

Command:     `STATUS:OPERation:ENABle <value>`, where  
                  <value> is the sum of the decimal values of the bits you want to enable.

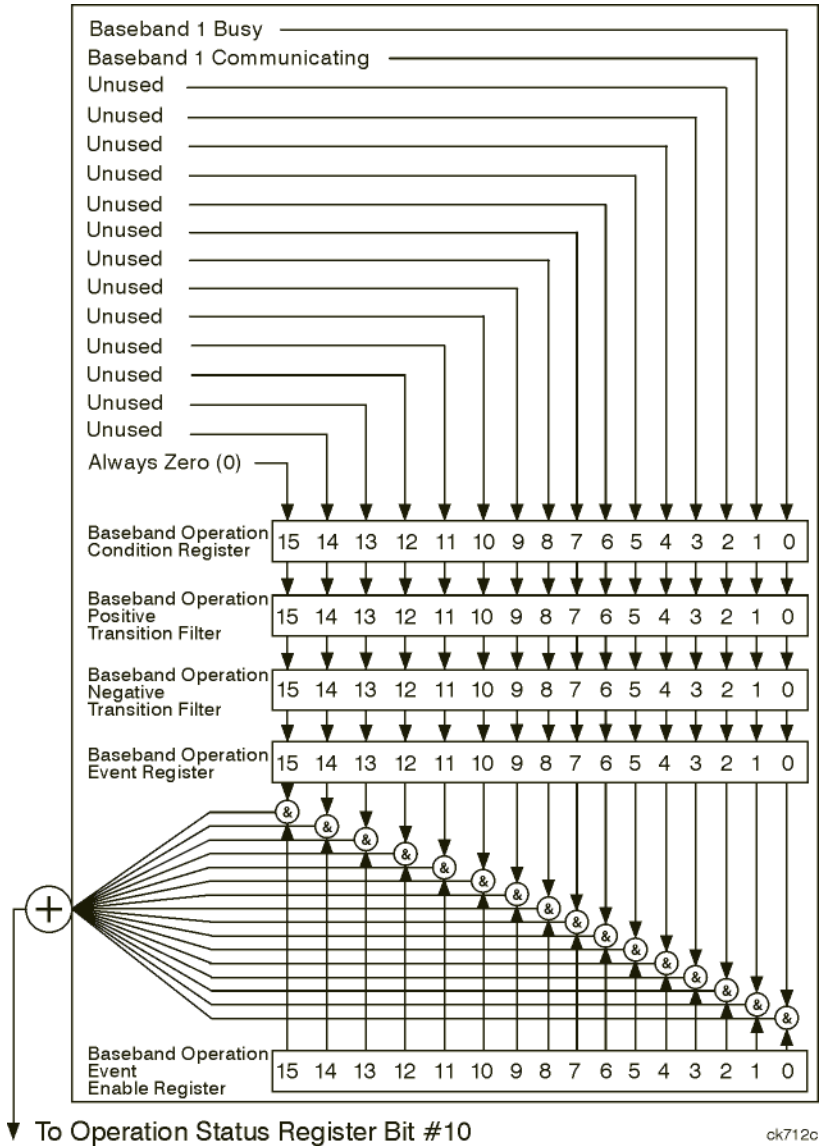
Example:     Enable bit 9 and bit 3 so that whenever either of those bits is set to 1, the Standard Operation  
                  Status summary bit of the Status Byte Register is set to 1:  
                  send the command `STAT:OPER:ENAB 520` (512 + 8)

Query:       `STATUS:OPERation:ENABle?`

Response:    Decimal value of the sum of the bits previously enabled with the  
                  `STATUS:OPERation:ENABle <value>` command.

### Baseband Operation Status Group

The Baseband Operation Status Group is used to determine the specific event that set bit 10 in the [Standard Operation Status Group](#). This group consists of the [Baseband Operation Condition Register](#), the [Baseband Operation Transition Filters \(negative and positive\)](#), the [Baseband Operation Event Register](#), and the [Baseband Operation Event Enable Register](#).



### Baseband Operation Condition Register

The Baseband Operation Condition Register continuously monitors the hardware and firmware status of the signal generator. Condition registers are read only.

**Table 3-6 Baseband Operation Condition Register Bits**

Bit	Description
0	<b>Baseband 1 Busy.</b> A 1 in this position indicates the signal generator baseband is active.
1	Baseband 1 Communicating. A 1 in this bit position indicates that the signal generator baseband generator is handling data I/O.
2–14	<b>Unused.</b> These bits are always set to 0.
15	<b>Always 0.</b>

Query:        `STATUS:OPERation:BASEband:CONDition?`

Response:    The *decimal* sum of the bits set to 1

Example:     The decimal value 2 is returned. The decimal sum = 2 (bit 1).

### Baseband Operation Transition Filters (negative and positive)

The Baseband Operation Transition Filters specify which types of bit state changes in the condition register set corresponding bits in the event register. Changes can be positive (0 to 1) or negative (1 to 0).

Commands:    `STATUS:OPERation:BASEband:NTRansition <value>` (negative transition), or  
`STATUS:OPERation:BASEband:PTRansition <value>` (positive transition), where  
 <value> is the sum of the decimal values of the bits you want to enable.

Queries:      `STATUS:OPERation:BASEband:NTRansition?`  
`STATUS:OPERation:BASEband:PTRansition?`

### Baseband Operation Event Register

The Baseband Operation Event Register latches transition events from the condition register as specified by the transition filters. Event registers are destructive read only: reading data from an event register clears the contents of that register.

Query:        `STATUS:OPERation:BASEband[:EVENT]?`

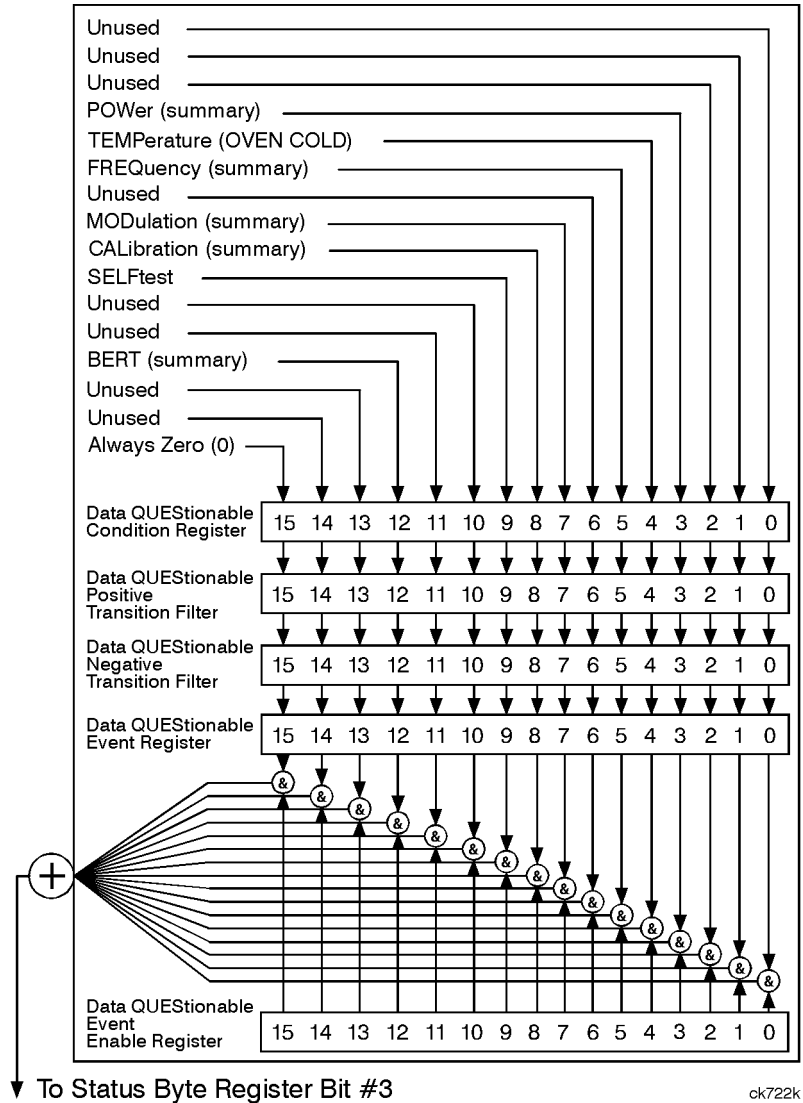
### Baseband Operation Event Enable Register

The Baseband Operation Event Enable Register lets you choose which bits in the Baseband Operation Event Register can set the summary bit (bit 10 of the Standard Operation Status Group).

- Command:     `STATUS:OPERation:BASEband:ENABLE <value>`, where  
                  <value> is the sum of the decimal values of the bits you want to enable.
- Example:     Enable bit 0 and bit 1 so that whenever either of those bits is set to 1, the Baseband Operation  
                  Status summary bit of the Standard Operation Status Register is set to 1: send the command  
                  `STAT:OPER:BAS:ENAB 520 (512 + 8)`
- Query:       `STATUS:OPERation:BASEband:ENABLE?`
- Response:    Decimal value of the sum of the bits previously enabled with the  
                  `STATUS:OPERation:BASEband:ENABLE <value>` command.

### Data Questionable Status Group

The Data Questionable Status Group is used to determine the specific event that set bit 3 in the Status Byte Register. This group consists of the [Data Questionable Condition Register](#), the [Data Questionable Transition Filters \(negative and positive\)](#), the [Data Questionable Event Register](#), and the [Data Questionable Event Enable Register](#).



**Data Questionable Condition Register**

The Data Questionable Condition Register continuously monitors the hardware and firmware status of the signal generator; condition registers are read only.

**Table 3-7 Data Questionable Condition Register Bits**

Bit	Description
0, 1, 2	<b>Unused.</b> These bits are always set to 0.
3	<b>Power (summary).</b> This is a summary bit taken from the QUESTionable:POWer register. A 1 in this bit position indicates that one of the following may have happened: the ALC (Automatic Leveling Control) is unable to maintain a leveled RF output power (i.e., ALC is UNLEVELED), the reverse power protection circuit has been tripped. See the <a href="#">“Data Questionable Power Status Group” on page 138</a> for more information.
4	<b>Temperature (OVEN COLD).</b> A 1 in this bit position indicates that the internal reference oscillator (reference oven) is cold.
5	<b>Frequency (summary).</b> This is a summary bit taken from the QUESTionable:FREQuency register. A 1 in this bit position indicates that one of the following may have happened: synthesizer PLL unlocked, 10 MHz reference VCO PLL unlocked, 1 GHz reference unlocked, sampler, YO loop unlocked or baseband 1 unlocked. For more information, see the <a href="#">“Data Questionable Frequency Status Group” on page 141</a> .
6	<b>Unused.</b> This bit is always set to 0.
7	<b>Modulation (summary).</b> This is a summary bit taken from the QUESTionable:MODulation register. A 1 in this bit position indicates that one of the following may have happened: modulation source 1 underrange, modulation source 1 overrange, modulation source 2 underrange, modulation source 2 overrange, modulation uncalibrated. See the <a href="#">“Data Questionable Modulation Status Group” on page 144</a> for more information.
8	<b>Calibration (summary).</b> This is a summary bit taken from the QUESTionable:CALibration register. A 1 in this bit position indicates that one of the following may have happened: an error has occurred in the DCFM/DCΦM zero calibration, an error has occurred in the I/Q calibration. See the <a href="#">“Data Questionable Calibration Status Group” on page 147</a> for more information.
9	<b>Self Test.</b> A 1 in this bit position indicates that a self-test has failed during power-up. This bit can only be cleared by cycling the signal generator’s line power. *CLS will not clear this bit.
10–14	<b>Unused.</b> These bits are always set to 0.
15	<b>Always 0.</b>

Query:        `STATUS:QUESTIONABLE:CONDITION?`

Response:    The *decimal* sum of the bits that are set to 1

Example:     The decimal value 520 is returned. The decimal sum = 512 (bit 9) + 8 (bit 3).

### Data Questionable Transition Filters (negative and positive)

The Data Questionable Transition Filters specify which type of bit state changes in the condition register set corresponding bits in the event register. Changes can be positive (0 to 1) or negative (1 to 0).

Commands:    `STATUS:QUESTIONABLE:NTRANSITION <value>` (negative transition), or  
                `STATUS:QUESTIONABLE:PTRANSITION <value>` (positive transition), where  
                `<value>` is the sum of the decimal values of the bits you want to enable.

Queries:      `STATUS:QUESTIONABLE:NTRANSITION?`  
                `STATUS:QUESTIONABLE:PTRANSITION?`

### Data Questionable Event Register

The Data Questionable Event Register latches transition events from the condition register as specified by the transition filters. Event registers are destructive read-only: reading data from an event register clears the contents of that register.

Query:        `STATUS:QUESTIONABLE[:EVENT]?`

### Data Questionable Event Enable Register

The Data Questionable Event Enable Register lets you choose which bits in the Data Questionable Event Register set the summary bit (bit 3 of the Status Byte Register) to 1.

Command:     `STATUS:QUESTIONABLE:ENABLE <value>` command where `<value>` is the sum of the  
                decimal values of the bits you want to enable.

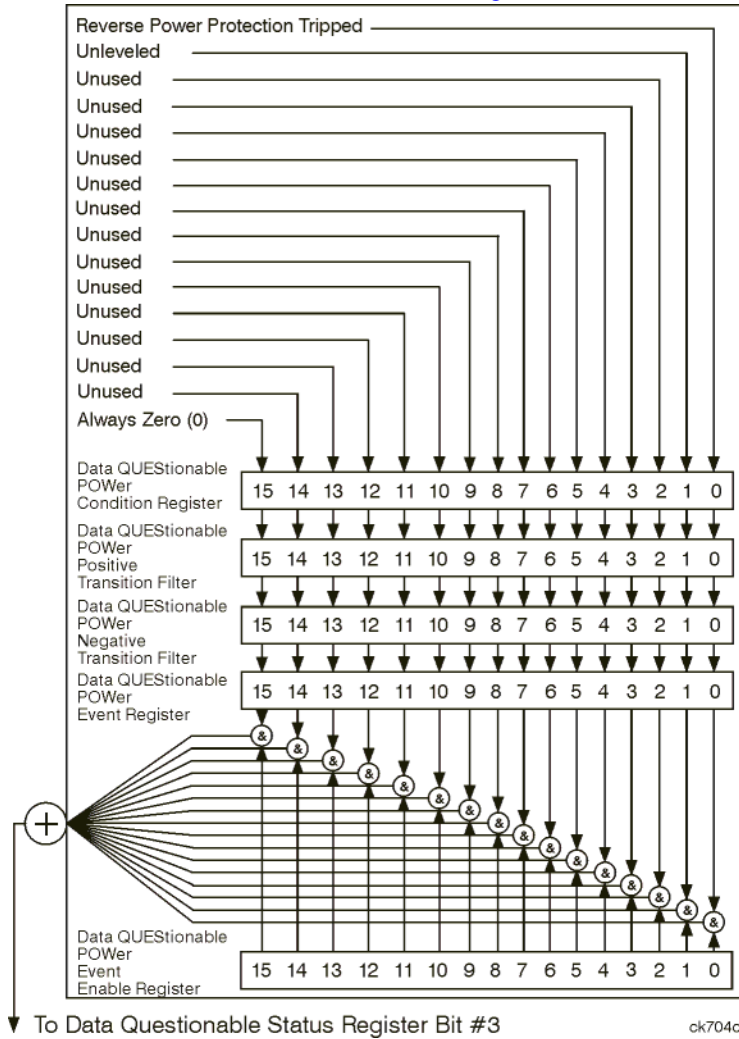
Example:      Enable bit 9 and bit 3 so that whenever either of those bits is set to 1, the Data Questionable  
                Status summary bit of the Status Byte Register is set to 1:  
                send the command `STAT:QUES:ENAB 520 (512 + 8)`

Query:        `STATUS:QUESTIONABLE:ENABLE?`

Response:     Decimal value of the sum of the bits previously enabled with the  
                `STATUS:QUESTIONABLE:ENABLE <value>` command.

### Data Questionable Power Status Group

The Data Questionable Power Status Group is used to determine the specific event that set bit 3 in the Data Questionable Condition Register. This group consists of the [Data Questionable Power Condition Register](#), the [Data Questionable Power Transition Filters \(negative and positive\)](#), the [Data Questionable Power Event Register](#), and the [Data Questionable Power Event Enable Register](#).





### Data Questionable Power Condition Register

The Data Questionable Power Condition Register continuously monitors the hardware and firmware status of the signal generator; condition registers are read only.

**Table 3-8 Data Questionable Power Condition Register Bits**

Bit	Description
0	<b>Reverse Power Protection Tripped.</b> A 1 in this bit position indicates that the reverse power protection (RPP) circuit has been tripped. There is no output in this state. Any conditions that may have caused the problem should be corrected. The RPP circuit can be reset by sending the remote SCPI command: <code>OUTput:PROTection:CLEar</code> .
1	<b>Unleveled.</b> A 1 in this bit indicates that the output leveling loop is unable to set the output power.
2–14	<b>Unused.</b> These bits are always set to 0.
15	<b>Always 0.</b>

Query: `STATus:QUESTionable:POWER:CONDition?`

Response: The *decimal* sum of the bits set to 1

### Data Questionable Power Transition Filters (negative and positive)

The Data Questionable Power Transition Filters specify which type of bit state changes in the condition register set corresponding bits in the event register. Changes can be positive (0 to 1) or negative (1 to 0).

Commands: `STATus:QUESTionable:POWER:NTRansition <value>` (negative transition), or `STATus:QUESTionable:POWER:PTRansition <value>` (positive transition), where `<value>` is the sum of the decimal values of the bits you want to enable.

Queries: `STATus:QUESTionable:POWER:NTRansition?`  
`STATus:QUESTionable:POWER:PTRansition?`

### Data Questionable Power Event Register

The Data Questionable Power Event Register latches transition events from the condition register as specified by the transition filters. Event registers are destructive read-only: reading data from an event register clears the contents of that register.

Query: `STATus:QUESTionable:POWER[:EVENT]?`

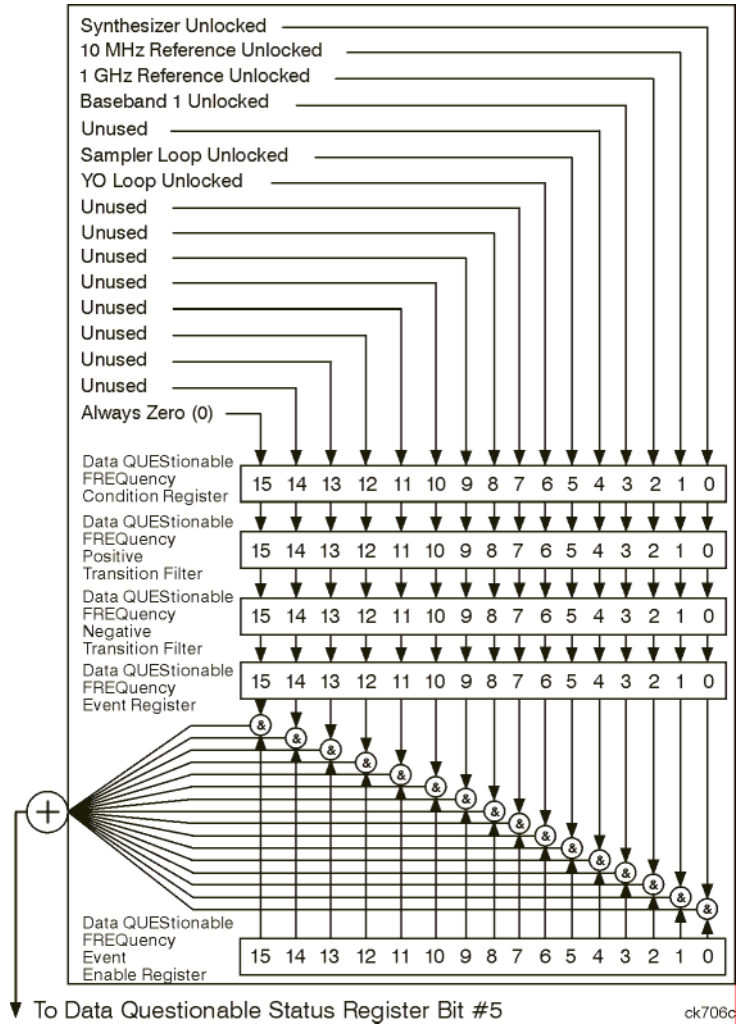
### Data Questionable Power Event Enable Register

The Data Questionable Power Event Enable Register lets you choose which bits in the Data Questionable Power Event Register set the summary bit (bit 3 of the Data Questionable Condition Register) to 1.

- Command:     `STATUS:QUESTIONABLE:POWER:ENABLE <value>` command where <value> is the sum of the decimal values of the bits you want to enable
- Example:     Enable bit 9 and bit 3 so that whenever either of those bits is set to 1, the Data Questionable Power summary bit of the Data Questionable Condition Register is set to 1: send the command `STAT:QUES:POW:ENAB 520 (512 + 8)`
- Query:       `STATUS:QUESTIONABLE:POWER:ENABLE?`
- Response:    Decimal value of the sum of the bits previously enabled with the `STATUS:QUESTIONABLE:POWER:ENABLE <value>` command.

### Data Questionable Frequency Status Group

The Data Questionable Frequency Status Group is used to determine the specific event that set bit 5 in the Data Questionable Condition Register. This group consists of the [Data Questionable Frequency Condition Register](#), the [Data Questionable Frequency Transition Filters \(negative and positive\)](#), the [Data Questionable Frequency Event Register](#), and the [Data Questionable Frequency Event Enable Register](#).



### Data Questionable Frequency Condition Register

The Data Questionable Frequency Condition Register continuously monitors the hardware and firmware status of the signal generator; condition registers are read-only.

**Table 3-9 Data Questionable Frequency Condition Register Bits**

Bit	Description
0	<b>Synth. Unlocked.</b> A 1 in this bit indicates that the synthesizer is unlocked.
1	<b>10 MHz Ref Unlocked.</b> A 1 in this bit indicates that the 10 MHz reference signal is unlocked.
2	<b>1 Ghz Ref Unlocked.</b> A 1 in this bit indicates that the 1 Ghz reference signal is unlocked.
3	<b>Baseband 1 Unlocked.</b> A 1 in this bit indicates that the baseband 1 generator is unlocked.
4	<b>Unused.</b> This bit is always set to 0.
5	<b>Sampler Loop Unlocked.</b> A 1 in this bit indicates that the sampler loop is unlocked.
6	<b>YO Loop Unlocked.</b> A 1 in this bit indicates that the YO loop is unlocked.
7–14	<b>Unused.</b> These bits are always set to 0.
15	<b>Always 0.</b>

Query:        `STATUS:QUESTIONABLE:FREQUENCY:CONDITION?`

Response:    The *decimal* sum of the bits set to 1

### Data Questionable Frequency Transition Filters (negative and positive)

Specifies which types of bit state changes in the condition register set corresponding bits in the event register. Changes can be positive (0 to 1) or negative (1 to 0).

Commands:    `STATUS:QUESTIONABLE:FREQUENCY:NTRANSITION <value>` (negative transition) or  
                   `STATUS:QUESTIONABLE:FREQUENCY:PTRANSITION <value>` (positive transition)  
 where <value> is the sum of the decimal values of the bits you want to enable.

Queries:      `STATUS:QUESTIONABLE:FREQUENCY:NTRANSITION?`  
                   `STATUS:QUESTIONABLE:FREQUENCY:PTRANSITION?`

### Data Questionable Frequency Event Register

Latches transition events from the condition register as specified by the transition filters. Event registers are destructive read-only: reading data from an event register clears the content of that register.

Query:        `STATUS:QUESTIONABLE:FREQUENCY[:EVENT]?`

### Data Questionable Frequency Event Enable Register

Lets you choose which bits in the Data Questionable Frequency Event Register set the summary bit (bit 5 of the Data Questionable Condition Register) to 1.

Command:     `STATUS:QUESTIONABLE:FREQUENCY:ENABLE <value>`, where `<value>` is the sum of the decimal values of the bits you want to enable.

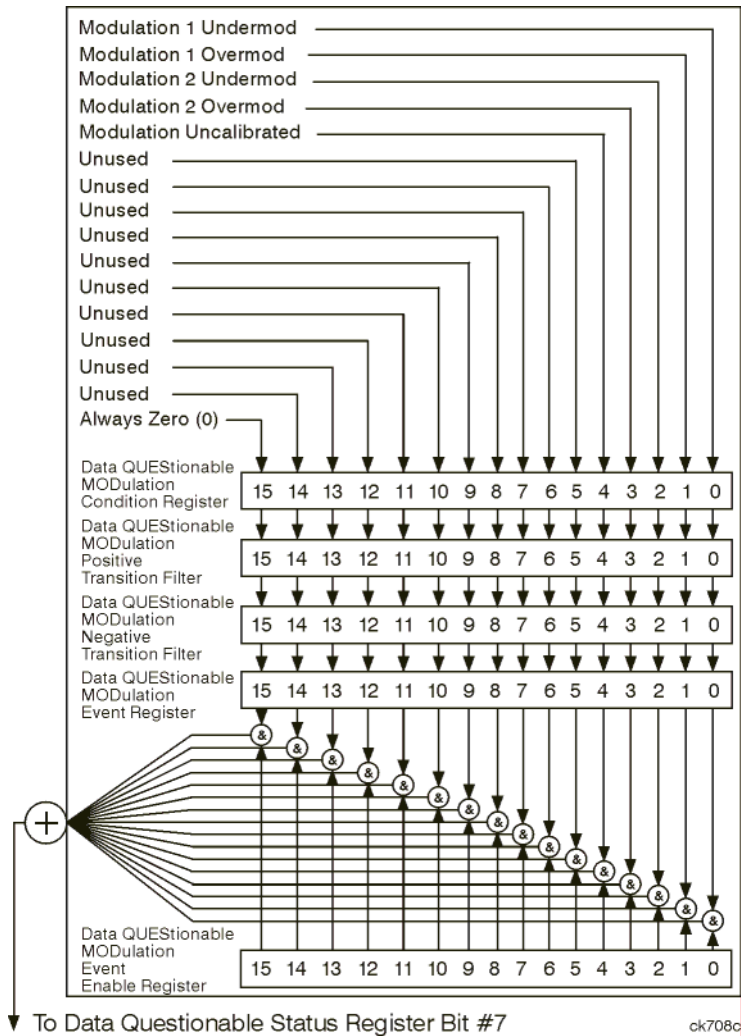
Example:      Enable bit 9 and bit 3 so that whenever either of those bits is set to 1, the Data Questionable Frequency summary bit of the Data Questionable Condition Register is set to 1: send the command `STAT:QUES:FREQ:ENAB 520 (512 + 8)`

Query:        `STATUS:QUESTIONABLE:FREQUENCY:ENABLE?`

Response:     Decimal value of the sum of the bits previously enabled with the `STATUS:QUESTIONABLE:FREQUENCY:ENABLE <value>` command.

### Data Questionable Modulation Status Group

The Data Questionable Modulation Status Group is used to determine the specific event that set bit 7 in the Data Questionable Condition Register. This group consists of the [Data Questionable Modulation Condition Register](#), the [Data Questionable Modulation Transition Filters](#) (negative and positive), the [Data Questionable Modulation Event Register](#), and the [Data Questionable Modulation Event Enable Register](#).



### Data Questionable Modulation Condition Register

The Data Questionable Modulation Condition Register continuously monitors the hardware and firmware status of the signal generator. Condition registers are read-only.

**Table 3-10 Data Questionable Modulation Condition Register Bits**

Bit	Description
0	<b>Modulation 1 Undermod.</b> A 1 in this bit indicates that the External 1 input, ac coupling on, is less than 0.97 volts.
1	<b>Modulation 1 Overmod.</b> A 1 in this bit indicates that the External 1 input, ac coupling on, is greater than 1.03 volts.
2	<b>Modulation 2 Undermod.</b> A 1 in this bit indicates that the External 2 input, ac coupling on, is less than 0.97 volts.
3	<b>Modulation 2 Overmod.</b> A 1 in this bit indicates that the External 2 input, ac coupling on, is greater than 1.03 volts.
4	<b>Modulation Uncalibrated.</b> A 1 in this bit indicates that modulation is uncalibrated.
5–14	<b>Unused.</b> These bits are always set to 0.
15	<b>Always 0.</b>

Query:        `STATUS:QUESTIONABLE:MODULATION:CONDITION?`

Response:    The *decimal* sum of the bits that are set to 1

### Data Questionable Modulation Transition Filters (negative and positive)

The Data Questionable Modulation Transition Filters specify which type of bit state changes in the condition register set corresponding bits in the event register. Changes can be positive (0 to 1) or negative (1 to 0).

Commands:    `STATUS:QUESTIONABLE:MODULATION:NTRANSITION <value>` (negative transition),  
or `STATUS:QUESTIONABLE:MODULATION:PTRANSITION <value>` (positive  
transition), where `<value>` is the sum of the decimal values of the bits you want to enable.

Queries:        `STATUS:QUESTIONABLE:MODULATION:NTRANSITION?`  
`STATUS:QUESTIONABLE:MODULATION:PTRANSITION?`

### Data Questionable Modulation Event Register

The Data Questionable Modulation Event Register latches transition events from the condition register as specified by the transition filters. Event registers are destructive read-only: reading data from an event register clears the contents of that register.

Query:        `STATUS:QUESTIONABLE:MODULATION[:EVENT]?`

### Data Questionable Modulation Event Enable Register

The Data Questionable Modulation Event Enable Register lets you choose which bits in the Data Questionable Modulation Event Register set the summary bit (bit 7 of the Data Questionable Condition Register) to 1.

Command:     `STATUS:QUESTIONABLE:MODULATION:ENABLE <value>` command where <value> is the sum of the decimal values of the bits you want to enable.

Example:     Enable bit 9 and bit 3 so that whenever either of those bits is set to 1, the Data Questionable Modulation summary bit of the Data Questionable Condition Register is set to 1: send the command `STAT:QUES:MOD:ENAB 520 (512 + 8)`

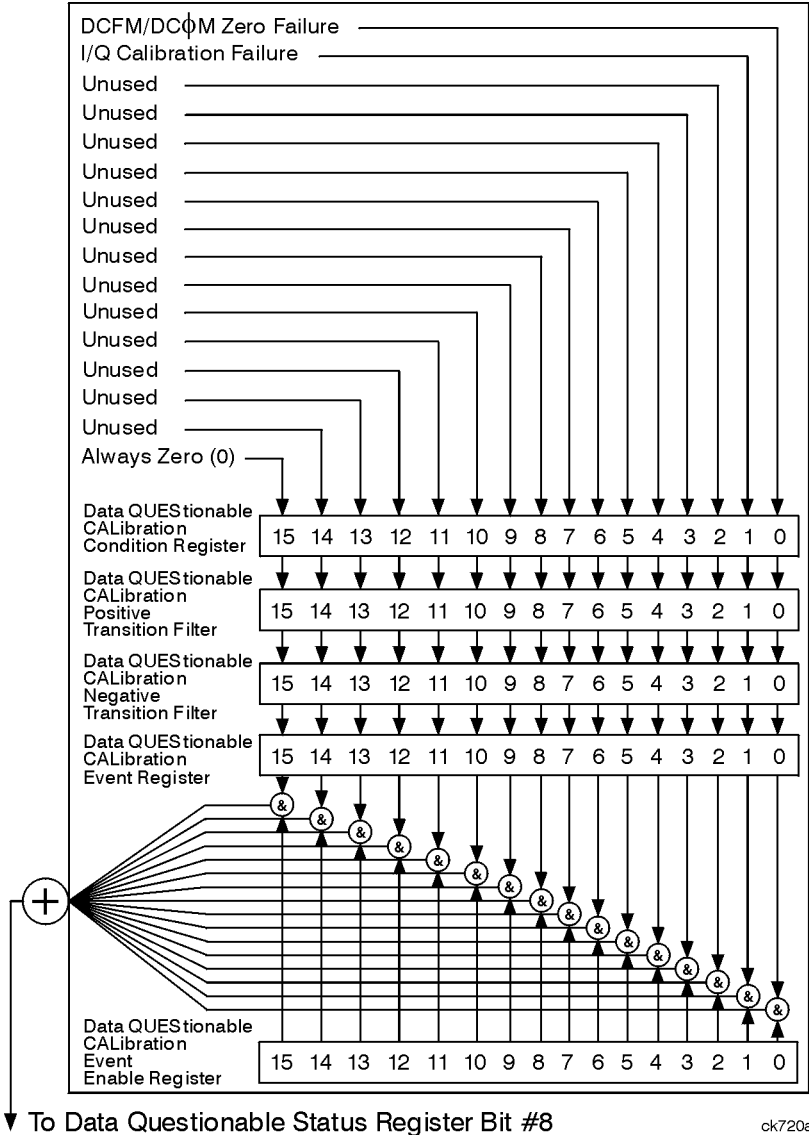
Query:        `STATUS:QUESTIONABLE:MODULATION:ENABLE?`

Response:    Decimal value of the sum of the bits previously enabled with the `STATUS:QUESTIONABLE:MODULATION:ENABLE <value>` command.



### Data Questionable Calibration Status Group

The Data Questionable Calibration Status Group is used to determine the specific event that set bit 8 in the Data Questionable Condition Register. This group consists of the [Data Questionable Calibration Condition Register](#), the [Data Questionable Calibration Transition Filters \(negative and positive\)](#), the [Data Questionable Calibration Event Register](#), and the [Data Questionable Calibration Event Enable Register](#).



### Data Questionable Calibration Condition Register

The Data Questionable Calibration Condition Register continuously monitors the calibration status of the signal generator; condition registers are read only.

**Table 3-11 Data Questionable Calibration Condition Register Bits**

Bit	Description
0	<b>DCFM/DCΦM Zero Failure.</b> A 1 in this bit indicates that the DCFM/DCΦM zero calibration routine has failed. This is a critical error. The output of the source is not valid until the condition of this bit is 0.
1	<b>I/Q Calibration Failure.</b> A 1 in this bit indicates that the I/Q modulation calibration experienced a failure.
2–14	<b>Unused.</b> These bits are always set to 0.
15	<b>Always 0.</b>

Query:        `STATUS:QUESTIONABLE:CALIBRATION:CONDITION?`

Response:    The *decimal* sum of the bits set to 1

### Data Questionable Calibration Transition Filters (negative and positive)

The Data Questionable Calibration Transition Filters specify which type of bit state changes in the condition register set corresponding bits in the event register. Changes can be positive (0 to 1) or negative (1 to 0).

Commands:    `STATUS:QUESTIONABLE:CALIBRATION:NTRANSITION <value>` (negative transition),  
                   or `STATUS:QUESTIONABLE:CALIBRATION:PTRANSITION <value>` (positive  
                   transition), where `<value>` is the sum of the decimal values of the bits you want to enable.

Queries:        `STATUS:QUESTIONABLE:CALIBRATION:NTRANSITION?`  
                   `STATUS:QUESTIONABLE:CALIBRATION:PTRANSITION?`

### Data Questionable Calibration Event Register

The Data Questionable Calibration Event Register latches transition events from the condition register as specified by the transition filters. Event registers are destructive read-only. Reading data from an event register clears the content of that register.

Query:        `STATUS:QUESTIONABLE:CALIBRATION[:EVENT]?`

### Data Questionable Calibration Event Enable Register

The Data Questionable Calibration Event Enable Register lets you choose which bits in the Data Questionable Calibration Event Register set the summary bit (bit 8 of the Data Questionable Condition register) to 1.

Command: `STATUS:QUESTIONABLE:CALIBRATION:ENABLE <value>`, where `<value>` is the sum of the decimal values of the bits you want to enable.

Example: Enable bit 9 and bit 3 so that whenever either of those bits is set to 1, the Data Questionable Calibration summary bit of the Data Questionable Condition Register is set to 1: send the command `STAT:QUES:CAL:ENAB 520 (512 + 8)`

Query: `STATUS:QUESTIONABLE:CALIBRATION:ENABLE?`

Response: Decimal value of the sum of the bits previously enabled with the `STATUS:QUESTIONABLE:CALIBRATION:ENABLE <value>` command.



---

## 4 Downloading and Using Files

Computer generated data can be downloaded into the signal generator. Depending on the options present, the signal generator can accept ARB waveform data, user file data, FIR filter coefficient data, and data downloads directly to waveform memory.

This section explains signal generator memory, and the different waveform download methods:

- [“Types of Memory” on page 152](#)
- [“Downloading ARB Waveform Data” on page 153](#)
- [“Understanding ARB Waveform File Composition and Encryption” on page 172](#)
- [“Downloading User File Data” on page 174](#)
- [“Downloading FIR Filter Coefficients” on page 179](#)
- [“Downloading Directly into Pattern RAM \(PRAM\)” on page 182](#)

---

**NOTE** The procedures in this chapter were written with the assumption that you are familiar with the signal generator’s front panel controls and softkey menus. If you are not, please refer to the *User’s Guide*.

---

## Types of Memory

The signal generator has two types of memory:

- **Volatile Memory:** Data stored in volatile memory cannot be recovered if it is overwritten, or if the power is cycled.

Signal generators with the Option 002 internal baseband generator have 32 megasamples (160 MB) of volatile memory. Option 602 has 64 megasamples (320 MB) of volatile memory. This memory is partitioned as follows:

- Option 002: 128 megabytes of waveform memory (WFM1)  
Option 602: 256 megabytes of waveform memory (WFM1)

WFM1 data is stored in the signal generator's `/user/bbg1/waveform/` directory.

The `bbg1` directory does not share space with other types of file directories, such as `bit`, `binary`, and `state`.

- Option 002: 32 megabytes of marker memory (MKR1)  
Option 602: 64 megabytes of marker memory (MKR1)

MKR1 data is stored in the signal generator's `/user/bbg1/markers/` directory.

- **Non-volatile Memory:** Data stored in non-volatile memory remains until you delete it.

Signal generators without an internal hard drive (Option 005) have 3 megasamples (15 MB) of non-volatile storage.

Signal generators with the optional internal hard drive have approximately 1 gigasample (6 GB) of non-volatile storage.

Unlike volatile memory, non-volatile memory is not partitioned; non-volatile waveform memory (NVWFM) and non-volatile marker memory (NVMKR), share the same space (along with `bit`, `binary`, and `state` directories).

NVWFM data is stored in the signal generator's `/user/waveform/` directory.

NVMKR data is stored in the signal generator's `/user/markers/` directory.

---

**NOTE** To be sequenced and played, waveforms stored in non-volatile waveform memory (NVWFM) must be moved to volatile waveform memory (WFM1).

---

## Downloading ARB Waveform Data

The signal generator accepts I/Q waveform data downloads. User-defined I/Q waveforms can be sequenced together with other waveforms and played as part of a waveform sequence (see the *User's Guide* for details on sequencing waveforms).

The signal generator uses a two-file format when generating waveform data: an I/Q waveform file, and a marker file. If you do not create a marker file for the I/Q waveform file, the signal generator automatically creates one. This automatically generated default marker file comprises all zeros. The marker data drives the signal generator's rear-panel EVENT output connectors:

- Marker bit 1 drives EVENT 1 (BNC)
- Marker bit 2 drives EVENT 2 (BNC)
- Marker bit 3 drives EVENT 3 (Auxiliary D-Connector, pin 19)
- Marker bit 4 drives EVENT 4 (Auxiliary D-Connector, pin 18)

The I/Q waveform data usually drives the I and Q ports of the I/Q modulator. The waveform data is described using 16-bit I and 16-bit Q integer values in 2's signed complement format. The I and Q data values are interleaved, creating a single I/Q waveform data file.

The marker file comprises 8-bit bytes, each of which has four marker bits and four unused bits. The result is that the I/Q file has four times as many bytes as the marker file.

The 2-byte I integer and 2-byte Q integer values, along with a marker byte make up one sample, and one point is one pair of I/Q values. There are five bytes of data for every sample as shown in the following table.

I/Q Data File Structure			
I <sub>0</sub> = 16 bits	Q <sub>0</sub> = 16 bits	I <sub>1</sub> = 16 bits	Q <sub>1</sub> = 16 bits
2 bytes	2 bytes	2 bytes	2 bytes
Marker File Structure			
4 bits unused MSB	M <sub>0</sub> = 4 bits LSB	4 bits unused MSB	M <sub>1</sub> = 4 bits LSB
1 byte		1 byte	
1 sample		1 sample	

### Marker File Location

*MKRI*: /user/bbg1/markers/      *NVMKR*: /user/markers/

## Data Requirements and Limitations

- Data must be in signed, 2's complement (binary) format.
- Data must be in 2-byte integers.

Two bytes are needed to express 16-bit waveforms. The signal generator accepts the MSB first, LSB last.

- Input integers must be between  $-32768$  and  $32767$ .

This range is based on the input specifications of the 16-bit DAC used to create the analog voltages for the I/Q modulator.

- $0 = 0$  volts
- $-32768$  gives negative full-scale output
- $32767$  gives positive full-scale output
- Each I/Q waveform must contain at least 60 samples to play in the waveform sequencer (one sample equals one pair of I/Q values and markers). If this requirement is not met, the signal analyzer displays: "File format invalid." The file format is discussed in greater detail in the following sections.

If a waveform file is too large to fit into a 1024-byte memory segment, additional memory space is allocated in multiples of 1024 bytes. For example, a waveform represented by 500 samples is allocated to a 2048-byte memory segment (500 samples x 4 bytes); a 60 sample waveform file occupies 1024 bytes of waveform memory.

Total memory usage may be much more than the sum of the samples that make up waveform files; many small waveform files can use large amounts of memory.

- Each I/Q waveform must contain an even number of samples to play in the waveform sequencer. If this requirement is not met, the signal analyzer displays: "File format invalid."
- A marker file is always associated with an I/Q waveform file. An empty (all zeros) default marker file is created if a marker file is not provided by the user.

---

**NOTE** The default marker file is automatically created when the I/Q waveform file is loaded into volatile WFM1 (waveform memory) prior to playing. If the default marker file is used, toggle the **Mrk 2 to RF Blank** softkey to off.

---

- The user-defined marker file and I/Q waveform data file must have the same name in the signal generator.



## Downloading Waveforms

Before they are sequenced and played, the waveform data file and the associated marker file must be downloaded into waveform memory. The waveform data file can be loaded into the signal generator's waveform or NVWFM memory using the following methods:

- SCPI using VXI-11 (VMEbus Extensions for Instrumentation as defined in VXI-11)
- SCPI over the GPIB or RS-232 interface
- SCPI with sockets LAN (using port 5025)
- File Transfer Protocol (FTP). Refer to [“Using FTP” on page 157](#) for information on FTP.

### Sample Command Line Using SCPI

SCPI command, <Arbitrary Block Data>

<Arbitrary Block Data> is defined in the IEEE std. 488.2-1992 section 7.7.6. The following is an example of the format as used to download waveform data to the signal generator:

```
:MMEM:DATA "WF1:<file_name>", #ABC
```

<file\_name> the name of the waveform file stored in the signal generator.

*A* the number of decimal digits to follow in *B*.

*B* a decimal number specifying the number of data bytes in *C*.

*C* the binary waveform data.

### Example 1

```
:MMEM:DATA "WF1:FILENAME", #3240<240 bytes of data>
```

FILENAME the file name to appear in the signal generator's waveform memory catalog.

#3 3 decimal digits will be used to define the number of data bytes.

240 240 bytes of data will follow.

<240 bytes of data> the binary waveform data order for each 2-byte sample is defined as MSB (most significant byte) first and LSB (least significant byte) last. The waveform must have at least 60 samples of data. Each sample (I/Q data) is represented by 4 bytes, 2 bytes for the I sample and 2 bytes for the Q sample. In this example, 240 bytes of data represents 60 samples of data.

### Example 2

```
:MMEM:DATA "WFM1:file_name", #212125407897ABC
```

file\_name            the file name to appear in the signal generator's waveform memory catalog.

#2                    2 decimal digits will be used to define the number of data bytes.

12                    12 bytes of data will follow.

125407897ABC        the ASCII representation of the data downloaded to the signal generator.

---

**NOTE**                This example has too few samples to be used, and is shown only to illustrate the form. Typically, you cannot read/type the sample values, as they are frequently unprintable.

---

### Downloads to WFM1

---

**NOTE**                Before downloading files into waveform memory, turn off the ARB (Mode > Dual ARB > ARB Off On, or send [:SOURCE]:RADIO:ARB[:STATE] OFF).

---

waveform file:        :MMEM:DATA "WFM1:<file\_name>", #ABC

markers file:         :MMEM:DATA "MKR1:<file\_name>", #ABC

The full directory path name can be specified in the command line. The following SCPI commands are equivalent to the previous commands:

waveform file:        :MMEM:DATA "/USER/BBG1/WAVEFORM/<file\_name>", #ABC

markers file:         :MMEM:DATA "/USER/BBG1/MARKERS/<file\_name>", #ABC

### Downloads to NVWFM

#### Using the GPIB or LAN interface

Use the following SCPI commands:

waveform file:        :MMEM:DATA "NVWFM:<file\_name>", #ABC

markers file:         :MMEM:DATA "NVMKR:<file\_name>", #ABC

The full directory path name can be specified in the command line. The following SCPI commands are equivalent to the previous commands:

waveform file:        :MMEM:DATA "/USER/WAVEFORM/<file\_name>", #ABC

markers file:         :MMEM:DATA "/USER/MARKERS/<file\_name>", #ABC

## Using FTP

1. From the PC Command Prompt or Unix command line, change the directory to the directory where the file to be downloaded is located.
2. From the PC Command Prompt or Unix command line, type `ftp instrument name`. Where *instrument name* is the signal generator's hostname or IP address.
3. At the `User :` prompt in the ftp window, press the **Enter** key (no entry is required).
4. At the `Password :` prompt in the ftp window, press the **Enter** key (no entry is required).
5. At the ftp prompt, type: `put <file_name> /USER/WAVEFORM/<file_name_1>`

where `<file_name>` is the name of the file to download and `<file_name_1>` the name designator for the signal generator's `/USER/WAVEFORM/` directory.

If you have a marker file associated with the data file, use the following command to download it to the signal generator:

```
put <marker file_name> <directory_name>/<file_name_1>
```

where:

<code>&lt;marker file_name&gt;</code>	is the name of the file to download
<code>&lt;directory_name&gt;</code>	is the name of the directory ( <code>/USER/MARKERS</code> , <code>/USER/BBG1/WAVEFORM</code> , or <code>/USER/BBG1/MARKERS</code> )
<code>&lt;file_name_1&gt;</code>	is the name designator for the file in the signal generator's directory

Marker files and the associated I/Q waveform file have the same name.

---

**NOTE** If no marker file is provided, the signal generator automatically creates a default marker file consisting of all zeros.

---

6. At the ftp prompt, type: `bye`
7. At the command prompt, type: `exit`

## Example Programs

### Waveform Generation Using MATLAB®

Matlab is a programming tool that can be used to create specialized waveforms, such as radar and pulse sequences. Using Matlab and Agilent's integrated Download Assistant utility, you can create a single function that will build a waveform, preconfigure the waveform with playback setting information, and download the waveform to the signal generator's volatile memory for playback or sequencing.

## Downloading and Using Files

### Downloading ARB Waveform Data

The following Matlab M-file programming example generates and downloads a pulse pattern waveform file through the PSG vector signal generator's GPIB interface. A copy is also available on the *PSG Documentation CD-ROM* as pulsepat.m.

```
% Script file: pulsepat.m
%
% Purpose:
% To calculate and download an arbitrary waveform file that simulates a
% simple antenna scan pulse pattern to the PSG vector signal generator.
%
% Define Variables:
% n -- counting variable (no units)
% t -- time (seconds)
% rise -- raised cosine pulse rise-time definition (samples)
% on -- pulse on-time definition (samples)
% fall -- raised cosine pulse fall-time definition (samples)
% i -- in-phase modulation signal
% q -- quadrature modulation signal

n=4;           % defines the number of points in the rise-time and fall-time
t=-1:2/n:1-2/n; % number of points translated to time
rise=(1+sin(t*pi/2))/2; % defines the pulse rise-time shape
on=ones(1,120); % defines the pulse on-time characteristics
fall=(1+sin(-t*pi/2))/2; % defines the pulse fall-time shape
off=zeros(1,896); % defines the pulse off-time characteristics

% arrange the i-samples and scale the amplitude to simulate an antenna scan
% pattern comprised of 10 pulses
i = .707*[rise on fall off...
[.9*[rise on fall off]]...
```

```
[.8*[rise on fall off]]...  
[.7*[rise on fall off]]...  
[.6*[rise on fall off]]...  
[.5*[rise on fall off]]...  
[.4*[rise on fall off]]...  
[.3*[rise on fall off]]...  
[.2*[rise on fall off]]...  
[.1*[rise on fall off]]];  
  
% set the q-samples to all zeroes  
q = zeros(1,10240);  
  
% define a composite iq matrix for download to the PSG using the  
% PSG/ESG Download Assistant  
IQData = [i + (j * q)];  
  
% define a marker matrix and activate a marker to indicate the beginning of the waveform  
Markers = zeros(2,length(IQData)); % fill marker array with zero, i.e no markers set  
Markers(1,1) = 1; % set marker to first point of playback  
  
% make a new connection to the PSG over the GPIB interface  
io = agt_newconnection('gpib',0,19);  
  
% verify that communication with the PSG has been established  
[status, status_description,query_result] = agt_query(io,'*idn?');  
if (status < 0) return; end  
  
% set the carrier frequency and power level on the PSG using the PSG Download Assistant
```

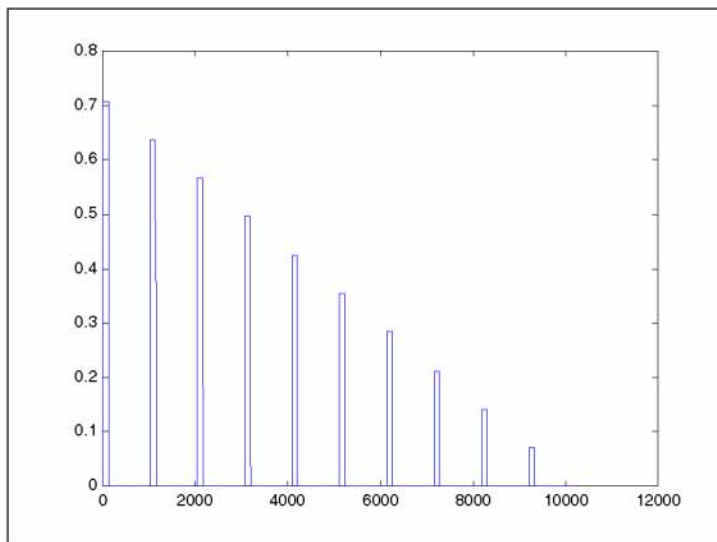
## Downloading and Using Files

### Downloading ARB Waveform Data

```
[status, status_description] = agt_sendcommand(io, 'SOURCE:FREQUENCY 2000000000');  
[status, status_description] = agt_sendcommand(io, 'POWER 0');  
  
% define the ARB sample clock for playback  
sampclk = 40000000;  
  
% download the iq waveform to the PSG baseband generator for playback  
[status, status_description] = agt_waveformload(io, IQData, 'pulsepat', sampclk, 'play', 'no_normscale',  
Markers);  
  
% turn on RF output power  
[status, status_description] = agt_sendcommand(io, 'OUTPUT:STATE ON');
```

You can test your program by performing a simulated plot of the in-phase modulation signal in Matlab (see [Figure 4-1 on page 160](#)). To do this, enter `plot(i)` at the Matlab command prompt.

**Figure 4-1** Simulated Plot of In-Phase Signal



The following additional Matlab M-file programming examples are available on the *PSG Documentation CD-ROM*:

barker.m	This programming example calculates and downloads an arbitrary waveform file that simulates a simple 7 bit barker RADAR signal to the PSG vector signal generator.
chirp.m	This programming example calculates and downloads an arbitrary waveform file that simulates a simple compressed pulse RADAR signal using linear FM chirp to the PSG vector signal generator.
FM.m	This programming example calculates and downloads an arbitrary waveform file that simulates a single tone FM signal with a rate of 6 KHz, deviation of $\pm 14.3$ KH, Bessel null of $\text{dev}/\text{rate}=2.404$ to the PSG vector signal generator.
nchirp.m	This programming example calculates and downloads an arbitrary waveform file that simulates a simple compressed pulse RADAR signal using non-linear FM chirp to the PSG vector signal generator.
pulse.m	This programming example calculates and downloads an arbitrary waveform file that simulates a simple pulse signal to the PSG vector signal generator.
pulsedroop.m	This programming example calculates and downloads an arbitrary waveform file that simulates a simple pulse signal with pulse droop to the PSG vector signal generator.

### Downloading Waveforms from Matlab

This procedure describes how to download a waveform file from Matlab to the PSG vector signal generator's volatile memory.

When using the Download Assistant with Matlab, the I/O interface definition and the download command are embedded in the M-file program (see the programming example in [“Waveform Generation Using MATLAB®” on page 157](#)). To download the waveform to the signal generator, execute the program in the Matlab command window by entering the name of the M-file (for example, `pulsepat`) at the command prompt. The Download Assistant will be instructed to download the waveform file to the signal generator.

For more information about the Download Assistant, go to [www.agilent.com](http://www.agilent.com) and search for “Download Assistant” in Test & Measurement.

---

**NOTE** This example uses the GPIB interface to download waveforms. Make sure that the GPIB interface is working properly between the signal generator and the computer before downloading. See the programming guide for more information about using GPIB and other interfaces.

---

## Downloading and Using Files

### Downloading ARB Waveform Data

#### Waveform Generation Using C++

The following program (Metrowerks CodeWarrior 3.0) creates an I/Q waveform and writes the data to a file on your PC. Once the file is created, you can use the file transfer protocol (FTP) to download the waveform data to the signal generator. Refer to [“Using FTP” on page 157](#) for more information on FTP.

```
#include <iostream>
#include <fstream>
#include <math.h>
#include <stdlib.h>

using namespace std;

int main ( void )
{
    ofstream out_stream;          // write the I/Q data to a file
    const unsigned int SAMPLES =200;    // number of sample pairs in the waveform
    const short AMPLITUDE = 32000;      // amplitude between 0 and full scale dac value
    const double two_pi = 6.2831853;

    //allocate buffer for waveform
    short* iqData = new short[2*SAMPLES]; // need two bytes for each integer
    if (!iqData)
    {
        cout << "Could not allocate data buffer." << endl;
        return 1;
    }
    out_stream.open("IQ_data");// create a data file
    if (out_stream.fail())
    {
        cout << "Input file opening failed" << endl;
        exit(1);
    }
    //generate the sample data for I and Q. The I channel will have a sine
```



```

//wave and the Q channel will a cosine wave.

for (int i=0; i<SAMPLES; ++i)
{
    iqData[2*i] = AMPLITUDE * sin(two_pi*i/(float)SAMPLES);
    iqData[2*i+1] = AMPLITUDE * cos(two_pi*i/(float)SAMPLES);
}
// make sure bytes are in the order MSB(most significant byte) first. (PC only).

char* cptr = (char*)iqData;// cast the integer values to characters
for (int i=0; i<(4*SAMPLES); i+=2)// 4*SAMPLES
{
    char temp = cptr[i];// swap LSB and MSB bytes
    cptr[i]=cptr[i+1];
    cptr[i+1]=temp;
}
// now write the buffer to a file
    out_stream.write((char*)iqData, 4*SAMPLES);
return 0;
}

```

### Downloading Using C++

The following program uses the GPIB to download a file directly to the baseband generator (volatile memory) for play back in the Dual ARB player. The program allocates a memory buffer on the PC or workstation of 102400 bytes (100\*1024 bytes). The actual size of the buffer is limited by the memory on your PC or workstation, so the buffer size can be increased or decreased to meet your system limitations.

While this program is directed at using the GPIB to download a waveform file into volatile memory, it can be modified to store files in non-volatile memory or for use over the LAN with the following minor changes:

**LAN**                    Replace the GPIB assignment for the instOpenString object with “lan[<hostname or IP address>]” for the signal generator.

**Non-volatile Memory** Remove BBG1 from the file path assigned to the instDestFile object.

The program also includes some error checking to alert you when problems arise while trying to download files. This includes checking to see if the file exists.

## Downloading and Using Files

### Downloading ARB Waveform Data

```
// Description: Send a file in blocks of data to an ESG
#include <sicl.h>
#include <stdlib.h>
#include <stdio.h>
#include <string.h>

// ATTENTION:
// - Configure these three lines appropriately for your instrument
//   and use before compiling and running
//
char* instOpenString = "gpib7,19"; //for LAN replace with "lan[<hostname or IP address>]"
const char* localSrcFile = "D:\\home\\TEST_WAVE"; //enter file location on PC/workstation
const char* instDestFile = "/USER/BBG1/WAVEFORM/TEST_WAVE"; //for non-volatile memory
                                                             //remove BBG1 from file path

// Size of the copy buffer
const int BUFFER_SIZE = 100*1024;

int main()
{
    INST id=iopen(instOpenString);
    if (!id)
    {
        fprintf(stderr, "iopen failed (%s)\n", instOpenString);
        return -1;
    }

    FILE* file = fopen(localSrcFile, "rb");
    if (!file)
    {
        fprintf(stderr, "Could not open file: %s\n", localSrcFile);
        return 0;
    }

    if( fseek( file, 0, SEEK_END ) < 0 )
    {
```

```
        fprintf(stderr, "Cannot seek to the end of file.\n" );
        return 0;
    }

    long lenToSend = ftell(file);
    printf("File size = %d\n", lenToSend);

    if (fseek(file, 0, SEEK_SET) < 0)
    {
        fprintf(stderr, "Cannot seek to the start of file.\n");
        return 0;
    }

    char* buf = new char[BUFFER_SIZE];
    if (buf && lenToSend)
    {
        // Prepare and send the SCPI command header
        char s[20];
        sprintf(s, "%d", lenToSend);
        int lenLen = strlen(s);
        char s2[256];
        sprintf(s2, "mmem:data \"%s\", #d%d", instDestFile, lenLen, lenToSend);
        iwrite(id, s2, strlen(s2), 0, 0);

        // Send file in BUFFER_SIZE chunks
        long numRead;
        do
        {
            numRead = fread(buf, sizeof(char), BUFFER_SIZE, file);
            iwrite(id, buf, numRead, 0, 0);
        } while (numRead == BUFFER_SIZE);

        // Send the terminating newline and EOM
        iwrite(id, "\n", 1, 1, 0);
    }
}
```

## Downloading and Using Files

### Downloading ARB Waveform Data

```
        delete [] buf;
    }
    else
    {
        fprintf(stderr, "Could not allocate memory for copy buffer\n");
    }

    fclose(file);
    iclose(id);
    return 0;
}
```

### Downloading Using HP BASIC for Windows™

The following program uses HP BASIC for Windows™ to download a waveform into WFM1. The waveform generated by this program is the same as the default SINE\_TEST\_WFM waveform file available in the signal generator's waveform memory. This code is similar to the code shown [“Downloading Using HP BASIC for UNIX” on page 168](#), but there is a formatting difference in line 130 and line 140.

To download into NVWFM, replace line 190 with:

```
190 OUTPUT @Psg USING "#,K";":MMEM:DATA ""NVWFM:testfile"", #"
```

As discussed at the beginning of this section, I and Q waveform data is interleaved into one file in 2's compliment form and a marker file is associated with this I/Q waveform file.

In the Output commands, USING "#,K" formats the data. The pound symbol (#) suppresses the automatic end of line (EOL) output. This allows multiple output commands to be concatenated as if they were a single output. The "K" instructs HP BASIC to output the following numbers or strings in the default format.

```
10 ! RE-SAVE "BASIC_win_file"
20 Num_points=200
30 ALLOCATE INTEGER Int_array(1:Num_points*2)
40 DEG
50 FOR I=1 TO Num_points*2 STEP 2
60     Int_array(I)=INT(32767*(SIN(I*360/Num_points)))
70 NEXT I
80 FOR I=2 TO Num_points*2 STEP 2
90     Int_array(I)=INT(32767*(COS(I*360/Num_points)))
100 NEXT I
```

```

110 PRINT "Data Generated"
120 Nbytes=4*Num_points
130 ASSIGN @Psg TO 719
140 ASSIGN @Psgb TO 719;FORMAT MSB FIRST
150 Nbytes$=VAL$(Nbytes)
160 Ndigits=LEN(Nbytes$)
170 Ndigits$=VAL$(Ndigits)
180 WAIT 1
190 OUTPUT @Psg USING "#,K";"MMEM:DATA ""WF1:data_file"",#"
200 OUTPUT @Psg USING "#,K";Ndigits$
210 OUTPUT @Psg USING "#,K";Nbytes$
220 WAIT 1
230 OUTPUT @Psgb;Int_array(*)
240 OUTPUT @Psg;END
250 ASSIGN @Psg TO *
260 ASSIGN @Psgb TO *
270 PRINT
280 PRINT "*END*"
290 END

```

### Program Comments

10:	Program file name
20:	Sets the number of points in the waveform.
30:	Allocates integer data array for I and Q waveform points.
40:	Sets HP BASIC to use degrees for cosine and sine functions.
50:	Sets up first loop for I waveform points.
60:	Calculate and interleave I waveform points.
70:	End of loop
80:	Sets up second loop for Q waveform points.
90:	Calculate and interleave Q waveform points.
100:	End of loop.
120:	Calculates number of bytes in I/Q waveform.

## Downloading and Using Files

### Downloading ARB Waveform Data

#### Program Comments (Continued)

130:	Opens an I/O path to the signal generator using GPIB. 7 is the address of the GPIB card in the computer, and 19 is the address of the signal generator. This I/O path is used to send ASCII data to the signal generator.
140:	Opens an I/O path for sending binary data to the signal generator.
150:	Creates an ASCII string representation of the number of bytes in the waveform.
160 to 170:	Finds the number of digits in Nbytes.
190:	Sends the first part of the SCPI command, MEM:DATA along with the name of the file, <code>data_file</code> , that will receive the waveform data. The name, <code>data_file</code> , will appear in the signal generator's memory catalog.
200 to 210:	Sends the rest of the ASCII header.
230:	Sends the binary data. Note that <code>psgb</code> is the binary I/O path.
240:	Sends an End-of-Line to terminate the transmission.
250 to 260:	Closes the connections to the signal generator.
290:	End the program.

#### Downloading Using HP BASIC for UNIX

The following program uses HP BASIC for UNIX to download waveforms. The code is similar to that shown for [“Downloading Using HP BASIC for Windows™” on page 166](#), but there is a formatting difference in line 130 and line 140. As discussed at the beginning of this section, I and Q waveform data is interleaved into one file in 2's compliment form and a marker file is associated with this I/Q waveform file.

In the Output commands, USING "#,K" formats the data. The pound symbol (#) suppresses the automatic end of line (EOL) output. This allows multiple output commands to be concatenated as if they were a single output. The “K” instructs HP BASIC to output the following numbers or strings in the default format.

```
10 ! RE-SAVE "UNIX_file"
20 Num_points=200
30 ALLOCATE INTEGER Int_array(1:Num_points*2)
40 DEG
50 FOR I=1 TO Num_points*2 STEP 2
60   Int_array(I)=INT(32767*(SIN(I*360/Num_points)))
70 NEXT I
80 FOR I=2 TO Num_points*2 STEP 2
90   Int_array(I)=INT(32767*(COS(I*360/Num_points)))
100 NEXT I
```

```

110 PRINT "Data generated "
120 Nbytes=4*Num_points
130 ASSIGN @Psg TO 719;FORMAT ON
140 ASSIGN @Psgb TO 719;FORMAT OFF
150 Nbytes$=VAL$(Nbytes)
160 Ndigits=LEN(Nbytes$)
170 Ndigits$=VAL$(Ndigits)
180 WAIT 1
190 OUTPUT @Psg USING "#,K";"MMEM:DATA ""WF1:data_file"",#"
200 OUTPUT @Psg USING "#,K";Ndigits$
210 OUTPUT @Psg USING "#,K";Nbytes$
220 WAIT 1
230 OUTPUT @Psgb;Int_array(*)
240 WAIT 2
241 OUTPUT @Psg;END
250 ASSIGN @Psg TO *
260 ASSIGN @Psgb TO *
270 PRINT
280 PRINT "*END*"
290 END

```

### Program Comments

10:	Program file name
20:	Sets the number of points in the waveform.
30:	Allocates integer data array for I and Q waveform points.
40:	Sets HP BASIC to use degrees for cosine and sine functions.
50:	Sets up first loop for I waveform points.
60:	Calculate and interleave I waveform points.
70:	End of loop
80:	Sets up second loop for Q waveform points.
90:	Calculate and interleave Q waveform points.
100:	End of loop.
120:	Calculates number of bytes in I/Q waveform.

**Program Comments (Continued)**

130:	Opens an I/O path to the signal generator using GPIB. 7 - the address of the GPIB card in the computer, and 19 is the address of the signal generator. This I/O path is used to send ASCII data to the signal generator.
140:	Opens an I/O path for sending binary data to the signal generator.
150:	Creates an ASCII string representation of the number of bytes in the waveform.
160 to 170:	Finds the number of digits in Nbytes.
190:	Sends the first part of the SCPI command, MEM:DATA along with the name of the file, <code>data_file</code> , that will receive the waveform data. The name, <code>data_file</code> , will appear in the signal generator's memory catalog.
200 to 210:	Sends the rest of the ASCII header.
230:	Sends the binary data. Note that <code>psgb</code> is the binary I/O path.
240:	Sends an End-of-Line to terminate the transmission.
250 to 260:	Closes the connections to the signal generator.
290:	End the program.

**Loading and Playing a Downloaded Waveform**

1. Select the downloaded waveform file in NVWFM, and load it into WFM1.

Via the front panel:

- a. Press **Mode > Dual ARB > Select Waveform > Waveform Segments > Load Store**
- b. In the NVWFM catalog, highlight the desired waveform file and select **Load Segment From NVWFM Memory**.

Via the remote interface, send the following SCPI commands:

```
:MEMory:COpy[:NAME] "<NVWFM:file_name>","<WFM1:file_name>"
```

Because copying a waveform file from volatile to non-volatile memory also copies the associated marker file, it is not necessary to sent a separate command to copy the marker file.

2. Select the downloaded waveform file in volatile waveform memory for playback.

Via the front panel: Press **Mode > Dual ARB > Select Waveform > Select Waveform**.

Via the remote interface: `[ :SOURce } :RADio:ARB:WAVEform "WFM1:<file_name>"`

3. Play the waveform and use it to modulate the RF carrier.

Via the front panel: Turn on **ARB Off On**, then turn on both modulation and the RF output.



Via the remote interface, send the following SCPI commands:

```
[ :SOURce ] :RADio:ARB[ :STATe ] ON
:OUTPut:MODulation[ :STATe ] ON
:OUTPut[ :STATe ] ON
```

## Troubleshooting ARB Waveform Data Download Problems

Symptom	Possible Cause
ERROR 224, Text file busy.	<p>Attempting to download a waveform that has the same name as the waveform currently being played by the signal generator.</p> <p>Either change the name of the downloaded waveform, or turn off the ARB.</p>
ERROR -321, Out of memory.	<p>There is not enough space in the ARB memory for the waveform file being downloaded.</p> <p>Either reduce the file size of the waveform file, or delete unnecessary files from ARB memory.</p>
No RF Output	<p>If no user marker file is provided, a default marker file containing all zeros is created. If the signal generator's <b>Mrk 2 to RF Blank</b> softkey is set to on, the RF is blanked. Go to <b>MODE &gt; Dual ARB &gt; ARB Setup</b> and toggle <b>Mrk 2 to RF</b> off.</p>

---

**NOTE**            Review [“Data Requirements and Limitations”](#) on page 154.

---

## Understanding ARB Waveform File Composition and Encryption

When you generate a waveform from an ARB personality option (including Signal Studio), a waveform file is automatically created and stored in volatile memory, along with providing you the option of renaming and/or moving it to non-volatile memory for safe storage. The waveform file is comprised of header information, waveform data, and marker data. The header information contains PSG ARB settings so that, if the header is saved, the waveform can be identically reproduced. The ARB settings default to *unspecified* unless you save the header information. In either case, header information always accompanies the waveform data.

Additionally, these waveform files can be extracted from the PSG in encrypted form for use in other PSGs having the same option. You can also extract encrypted files created with applications such as MATLAB, providing the data was downloaded to the PSG using the method described in the section below. Files cannot be extracted from the PSG in unencrypted form. Furthermore, files created with prior PSG firmware revisions cannot be extracted in any form.

### Downloading waveform data to the PSG for extraction as an encrypted waveform file

If you are using waveform data created in MATLAB or another similar application and are using SCPI to download the data to the PSG, you must use the `MMEM:DATA:UNPRotected` command. Downloading data with this command allows it to be extracted from the PSG's `SECUREWAVE` directory as an encrypted file (refer to [“Extracting waveform files from the PSG for use in other PSGs” on page 173](#)). If you use FTP, no special command syntax is necessary. [Table 4-1](#) shows the command syntax options for both methods.

**Table 4-1**

Download Method Memory Type	Command Syntax Options
SCPI/volatile memory	MMEM:DATA:UNPRotected "/user/bbg1/waveform/filename",<blockdata> MMEM:DATA:UNPRotected "WFM1:filename",<blockdata> MMEM:DATA:UNPRotected "filename@WFM1"
SCPI/non-volatile memory	MMEM:DATA:UNPRotected "/user/waveform/filename",<blockdata> MMEM:DATA:UNPRotected "NVWFM:filename",<blockdata> MMEM:DATA:UNPRotected "filename@NVWFM"
FTP/volatile memory	put filename /user/bbg1/waveform/newfilename
FTP/non-volatile memory	put filename /user/waveform/newfilename

## Extracting waveform files from the PSG for use in other PSGs

Waveform files can only be extracted from the SECUREWAVE directory. The SECUREWAVE directory is not an actual directory, but behaves more like a portal through which waveform data is packaged with header and marker data, and encrypted during file extraction. You can use either FTP or SCPI commands to extract the waveform file from the PSG to your computer. [Table 4-2](#) shows the command syntax options for both methods.

**Table 4-2**

Extraction Method/Memory Type	Command Syntax Options
SCPI/volatile memory	MMEM:DATA? "/user/bbg1/securewave/filename" MMEM:DATA? "SWFM1:filename" MMEM:DATA? "filename@SWFM1"
SCPI/non-volatile memory	MMEM:DATA? "/user/securewave/filename" MMEM:DATA? "SNVWFM:filename" MMEM:DATA? "filename@SNVWFM"
FTP/volatile memory	get /user/bbg1/securewave/filename
FTP/non-volatile memory	get /user/securewave/filename

## Downloading encrypted waveform files to the PSG

To download an encrypted file to the PSG, you must ensure that the file is loaded into the PSG's SECUREWAVE directory, where the file is decrypted and unpackaged into its header information, waveform data, and marker data. You can use either FTP or SCPI commands to download encrypted waveform files to the PSG. [Table 4-3](#) shows the command syntax options for both methods.

**Table 4-3**

Download Method/Memory Type	Command Syntax Options
SCPI/volatile memory	MMEM:DATA "/user/bbg1/securewave/filename",<blockdata> MMEM:DATA "SWFM1:filename",<blockdata> MMEM:DATA "filename@SWFM1"
SCPI/non-volatile memory	MMEM:DATA "/user/securewave/filename",<blockdata> MMEM:DATA "SNVWFM:filename",<blockdata> MMEM:DATA "filename@SNVWFM"
FTP/volatile memory	put filename /user/bbg1/securewave/newfilename
FTP/non-volatile memory	put filename /user/securewave/newfilename

## Downloading User File Data

The signal generator accepts user file data downloads. The files can be in either binary or bit format, each consisting of 8-bit bytes. Both file types are stored in the signal generator's non-volatile memory.

- In binary format the data is in multiples of 8 bits; all 8 bits of a byte are taken as data and used.
- In bit format the number of bits in the file is known and the non-data bits in the last byte are discarded.

After downloading the files, they can be selected as the transmitting data source. This section contains information on transferring user file data from a PC to the signal generator. It explains how to download user files into the signal generator's memory and modulate the carrier signal with those files.

When a file is selected for use in Real-time Custom mode, the file is modulated as a continuous, unframed stream of data, according to the modulation type, symbol rate, and filtering associated with the selected format.

When a user file is selected as the data source, the signal generator's firmware loads the data into waveform memory, and sets the other control bits depending on the operating mode, regardless of whether framed or unframed transmission is selected. In this manner, user files are mapped into waveform memory bit-by-bit; one bit per 32 bit control word.

---

**NOTE** Unlike pattern RAM (PRAM) downloads (see [page 182](#)), user files contain “data field” information only. The control data bits required for files downloaded directly into PRAM are not required for user file data.

---

---

**NOTE** References to *pattern RAM* (PRAM) are for descriptive purposes only, relating to the manner in which the memory is being used. PRAM and volatile waveform memory (WFM1) actually utilize the same storage media.

---

## Data Requirements and Limitations

1. Data must be in binary format. SCPI specifies the data in 8-bit bytes.

---

**NOTE**

Not all binary values are ASCII characters that can be printed. In fact, only ASCII characters corresponding to decimal values 32 through 126 are printable keyboard characters. Typically, the ASCII character corresponding to an 8-bit pattern is not printable.

Because of this, the program written to download and upload user files *must correctly convert* the binary data into 8-bit ASCII characters.

---

2. For binary downloads, bit length must be a multiple of 8.

SCPI specifies data in 8-bit bytes, and the binary memory stores data in 8-bit bytes.

If the length (in bits) of the original data pattern is not a multiple of 8, you may need to:

- add additional bits to complete the ASCII character,
- replicate the data pattern without discontinuity until the total length is a multiple of 8 bits,
- truncate and discard bits until you reach a string length that is a multiple of 8, or
- use a bit file and download to bit memory instead.

3. Download size limitations are directly proportional to the available memory space, and the signal generator's pattern RAM size (128 megabytes).

You may have to delete files from memory before downloading larger files.

If the data fields absolutely must be continuous data streams, and the size of the data exceeds the available PRAM, then real-time data and synchronization can be supplied by an external data source to the front-panel DATA, DATA CLOCK, and SYMBOL SYNC connectors.

## Bit and Binary Directories

User files can be downloaded to a bit or binary directory in either volatile or non-volatile memory.

### Bit Directory Downloads

The bit directory (/user/bit/) accepts data in integer number of bits, up to the maximum available memory.

The data length in bytes for files downloaded to bit memory is equal to the number of significant bits plus seven, divided by eight, then rounded down to the nearest integer. Each file has a 16-byte header associated with it.

There must be enough bytes to contain the specified number of bits. If the number of bits is not a multiple of 8, the least significant bits of the last byte are ignored.

For example, specifying 14 bits of a 16-bit string using the command :MEMory:DATA:BIT "file\_name", 14, #12Qz results in the last 2 bits being ignored. See the following figure.

010 0001 0111 1010     original user-defined data contains 2 bytes, 16 bits total

  SCPI command sets bit count to 14; the last 2 bits are ignored

**010 0001 0111 1010** ←

A bit directory provides more versatility, and is the preferred memory location for user file downloads.

### SCPI Commands

Send the following command to download the user file data into the signal generator's bit directory:

:MEMory:DATA:BIT "<file\_name>", <bit count>, <datablock>

### Example

```
:MEMory:DATA:BIT "file_name", 16, #12Qz
```

file\_name     provides the user file name as it will appear in the signal generator's bit catalog

#1             1 decimal digits will be used to define the number of data bytes.

2             2 bytes of data will follow

Qz            the ASCII representation of the 16 bits of data that are downloaded to the signal generator.

## Querying the Waveform Data

Use the following SCPI command to query user file data from a binary directory:

```
:MEMory:DATA:BIT? "<file_name>"
```

The output format is the same as the input format.

## Binary Directory Downloads

The binary directory (/user/binary/) requires that data be formatted in 8-bit bytes. Files stored or downloaded to a binary directory are converted to bit files prior to editing in the bit file editor, after which they are stored in a bit directory as bit files.

A bit directory is preferred for user file downloads.

## SCPI Commands

```
:MMEM:DATA "<file_name>", <datablock>
```

Send this command to download the user file data into the signal generator's binary directory. The variable <file\_name> denotes the name of the downloaded user file stored in the signal generator.

## Sample Command Line

```
:MMEM:DATA "file_name", #ABC
```

file\_name        the name of the user file stored in the signal generator's memory

#A                the number of decimal digits to follow in B

B                a decimal number specifying the number of data bytes in C

C                the binary user file data

## Example

```
:MMEM:DATA "file_name", #1912S407897
```

file\_name        provides the user file name as it will appear in the signal generator's binary memory catalog

#1                defines the number of decimal digits to follow in "B"

9                denotes how many bytes of data are to follow

12S407897        the ASCII representation of the data that is downloaded to the signal generator. This variable is represented by C in the sample command line

### Querying the Waveform Data

Use the following SCPI command line to query user file data from a binary memory:

```
:MMEM:DATA? "file_name"
```

The output format is the same as the input format.

### Selecting Downloaded User Files as the Transmitted Data

Use the following steps to select the desired user file from the catalog of user files as a continuous stream of unframed data for a custom modulation.

Via the front panel:

1. For custom modulation, press **Mode > Custom > Real Time I/Q Baseband > Data > User File**. and highlight the desired file in the catalog.

```
[ :SOURce ]:RADio:CUSTom:DATA "BIT:<file_name>"
```

2. Press **Select File > Custom Off On to On**.

```
[ :SOURce ]:RADio:CUSTom[ :STATe ] On
```

---

**NOTE** To select a user file from a binary directory, send the same commands shown in the above examples without BIT: preceding the file name. For example:

```
[ :SOURce ]:RADio:CUSTom:DATA "<file_name>"
```

---

3. Modulate and activate the carrier:
  - a. Set the carrier frequency.
  - b. Set the carrier amplitude.
  - c. Turn on modulation.
  - d. Turn on the RF output.

### Troubleshooting User File Download Problems

---

**NOTE** Review [“Data Requirements and Limitations” on page 175](#).

---



## Downloading FIR Filter Coefficients

The signal generator accepts finite impulse response (FIR) filter coefficient downloads. After downloading the coefficients, these user-defined FIR filter coefficient values can be selected as the filtering mechanism for the active digital communications standard.

### Data Requirements and Limitations

- Data must be in ASCII format. The signal generator processes FIR filter coefficients as floating point numbers.
- Data must be in List format. FIR filter coefficient data is processed as a list by the signal generator's firmware. See [“Sample Command Line” on page 184](#).
- Filters containing more symbols than the hardware allows are not selectable for that configuration.

The Real Time I/Q Baseband FIR filter files are limited to 1024 taps (coefficients), 64 symbols, and a 16-times oversample ratio. FIR filter files with more than 64 symbols cannot be used.

The ARB Waveform Generator FIR filter files are limited to 512 taps and 512 symbols.

- The oversample ratio (OSR) is the number of filter taps per symbol. Oversample ratios from 1 through 32 are possible. The maximum combination of OSR and symbols allowed is 32 symbols with an OSR of 32.
- The sampling period ( $\Delta t$ ) is equal to the inverse of the sampling rate (FS). The sampling rate is equal to the symbol rate multiplied by the oversample ratio. For example, for a symbol rate of 270.83 ksps, if the oversample ratio is 4, the sampling rate is 1083.32 kHz and  $\Delta t$  (inverse of FS) is 923.088 ns.

## Downloading FIR Filter Coefficients

Use the following SCPI command line to download FIR filter coefficients from the PC to the signal generator's FIR memory:

```
:MEMory:DATA:FIR "<file_name>",osr,coefficient{,coefficient}
```

Use the following SCPI command line to query list data from FIR memory:

```
:MEMory:DATA:FIR? "<file_name>"
```

### Sample Command Line

The following SCPI command downloads a typical set of FIR filter coefficient values and name the file "FIR1":

```
:MEMory:DATA:FIR "FIR1",4,0,0,0,0,0,0.000001,0.000012,0.000132,0.001101,  
0.006743,0.030588,0.103676,0.265790,0.523849,0.809508,1,1,0.809508,0.523849,  
0.265790,0.103676,0.030588,0.006743,0.001101,0.000132,0.000012,0.000001,0,  
0,0,0,0
```

FIR1                    assigns the name FIR1 to the associated OSR (over sample ratio) and coefficient values. The file is then represented with this name in the FIR File catalog.

4                        specifies the oversample ratio.

0,0,0,0,0,0,  
0.000001,...            represent FIR filter coefficients.

## Selecting a Downloaded User FIR Filter as the Active Filter

### Using FIR Filter Data for Custom Modulation

Use the following steps to select user FIR filter data as the active filter for a custom modulation format.

Via the front panel:

1. Press **Mode** > **Custom** > *desired format* > **Filter** > **Select** > **User FIR**
2. Highlight and select the desired file in the catalog of FIR files.
3. Turn on the selected format.
4. Modulate and activate the carrier:
  - a. Set the carrier frequency.
  - b. Set the carrier amplitude.
  - c. Turn on modulation.
  - d. Turn on the RF output.

Via the remote interface:

```
[ :SOURce ]:RADio:<desired format>:FILTer "<file_name>"
[ :SOURce ]:RADio:CUSTom[ :STATe ] On
```

### Troubleshooting FIR Filter Coefficient File Download Problems

Symptom	Possible Cause
ERROR -321, Out of memory	There is not enough memory available for the FIR coefficient file being downloaded.  Either reduce the FIR file size, or delete unnecessary files from memory.
ERROR -223, Too much data	User FIR filter has too many symbols.  Real Time cannot use a filter with more than 64 symbols (512 symbols maximum for ARB). You may have specified an incorrect oversample ratio in the filter table editor.

---

**NOTE**      Review [“Data Requirements and Limitations”](#) on page 179.

---

## Downloading Directly into Pattern RAM (PRAM)

---

**NOTE**      References to *pattern RAM* (PRAM) are for descriptive purposes only, relating to the manner in which the memory is being used. PRAM and volatile waveform memory (WFM1) actually utilize the same storage media.

---

Typically, the signal generator's firmware generates the required data and framing structure and loads this data into Pattern RAM (PRAM). The data is read by the baseband generator, which in turn is input to the I/Q modulator. The signal generator can also accept data downloads directly into PRAM from a computer. Programs such as MATLAB or MathCad can generate data which can be downloaded directly into PRAM in either a list format or a block format.

Direct downloads to PRAM allow complete control over bursting, which is especially helpful for designing experimental or proprietary framing schemes.

The signal generator's baseband generator assembly builds modulation schemes by reading data stored in PRAM and constructing framing protocols according to the data patterns present. PRAM data can be manipulated (types of protocols changed, standard protocols modified or customized, etc.) using either the front panel interface, or remote-commands.

### Preliminary Setup

---

**CAUTION**      Set up the digital communications format *before* downloading data. This enables the signal generator to define the modulation format, filter, and data clock. Activating the digital communications format after the data has been downloaded to PRAM can corrupt the downloaded data.

---

## Data Requirements and Limitations

1. Data format:

*List Format:* Because list format downloads are parsed before they are loaded into PRAM, data must be 8-bit, unsigned integers, from 0 to 255.

*Block Format:* Because the baseband generator reads binary data from the data generator, data must be in binary form.

2. Total (data bits plus control bits) download size limitations are 32 megabytes with Option 002 and 64 megabytes with Option 602. Each sample for PRAM uses 4 bytes of data.

A data pattern file containing 8 megabits of modulation data must contain another 56 megabits of control information. A file of this size requires 8 megabytes of memory.

3. For every bit of modulation data (bit 0), you must provide 7 bits of control information (bits 1-7).

The signal generator processes data in 8-bit bytes. Each byte contains 1 bit of “data field” information, and seven bits of control information associated with the data field bit. See the following table for the required data and control bits.

Bit	Function	Value	Comments
0	Data	0/1	The data to be modulated; “unspecified” when burst (bit 2) = 0.
1	Reserved	0	Always 0.
2	Burst	0/1	Set to 1 = RF on. Set to 0 = RF off. For non-bursted, non-TDMA systems, this bit is set to 1 for all memory locations, leaving RF output on continuously. For framed data, this bit is set to 1 for <i>on</i> timeslots and 0 for <i>off</i> timeslots
3	Reserved	0	Always 0.
4	Reserved	1	Always 1.
5	Reserved	0	Always 0.
6	Event 1 Output	0/1	Set to 1 = a level transition at the EVENT 1 BNC connector. Use examples: as a marker output to trigger external hardware when data pattern restarts; toggling in alternate addresses to create a data-synchronous pulse train.
7	Pattern Reset	0/1	Set to 0 = continue to next sequential memory address. Set to 1 = end of memory and restart memory playback. Set to 0 for all bytes except last address of PRAM, where 1 restarts pattern.

## Downloading in List Format

---

**NOTE** Because of parsing, list data format downloads are *significantly* slower than block format downloads.

---

### SCPI Command to Download Data in List Format

:MEMory:DATA:PRAM:LIST <uint8>[,<uint8>,<...>]

This command downloads the list-formatted data directly into PRAM. The variable <uint8> is any of the valid 8-bit, unsigned integer values between 0 and 255, as specified by the table on [page 183](#). Note that each value corresponds to a unique byte/address in PRAM.

### Sample Command Line

For example, to burst a FIX4 data pattern of “1100” five times, then turn the burst off for 32 data periods (assuming a 1-bit/symbol modulation format), the command is:

```
:MEMory:DATA:PRAM:LIST 85,21,20,20,21,21,20,20,21,21,20,20,21,21,20,20,21,
21,20,20,16,16,16,16,16,16,16,16,16,16,16,16,16,16,16,16,16,16,16,16,16,
16,16,16,16,16,16,16,16,16,16,144
```

- 21                         signifies data = 1, burst = on (1)
- 20                         signifies data = 0, burst = on (1)
- 16                         signifies data = unspecified, burst = off (0)
- 85                         enables event 1 trigger signifying the beginning of the data pattern
- 144                        signifies data = unspecified, burst = off (0), pattern repeat = on (1)

### Querying the Waveform Data

Use the following SCPI command line to determine whether there is a user-defined pattern in the PRAM:

```
:MEMory:DATA:PRAM?
```

## Downloading in Block Format

---

**NOTE** Because there is no parsing, block data format downloads are faster than list format downloads.

---

### SCPI Command to Download Data in Block Format

:MEMory:DATA:PRAM:BLOCK <atablock>

This command downloads the block-formatted data directly into pattern RAM.

### Sample Command Line

A sample command line:

:MEMory:DATA:PRAM:BLOCK #ABC

#A the number of decimal digits to follow in B  
B a decimal number specifying the number of data bytes in C  
C the binary user file data

### Example 1

:MEMory:DATA:PRAM:BLOCK #1912S407897

#1 1 decimal digits to follow  
9 9 bytes of data to follow  
12S407897 the ASCII representation of the data downloaded to the signal generator

---

**NOTE** Not all binary values can be printed as ASCII characters. In fact, only ASCII characters corresponding to decimal values 32 to 126 are printable keyboard characters. The above example was chosen for simplicity. Typically, the binary value corresponding to your 8-bit pattern is not printable.

Therefore, the program written to download and upload user files *must correctly convert* between binary and the ASCII representation of the data sequence. The sample data above is meaningless.

---

## Modulating and Activating the Carrier

After downloading a file:

1. Set the carrier frequency.
2. Set the carrier amplitude.
3. Turn on modulation.
4. Turn on the RF output.

## Viewing a PRAM Waveform

After the waveform data is written to PRAM, the data pattern can be viewed using an oscilloscope. There is delay (approximately 12-symbols) between a state change in the burst bit and the corresponding effect at the RF out. This delay varies with symbol rate and filter settings, and requires compensation to advance the burst bit in the downloaded PRAM file.

## Troubleshooting Direct PRAM Download Problems

Symptom	Possible Cause
The transmitted pattern is interspersed with random, unwanted data.	Pattern reset bit not set.  Ensure that the pattern reset bit (bit 7, value 128) is set on the last byte of your downloaded data.
ERROR -223, Too much data	PRAM download exceeds the size of PRAM memory.  Either use a smaller pattern or get more memory by ordering the appropriate hardware option.

---

**NOTE** Review “Data Requirements and Limitations” on page 183.

---



**Numerics**

8757D pass-thru commands, using, 65

**A**

abort function, 8

address

    GPIB address, 6

    IP address, 12

Agilent

    BASIC, 31

    SICL, 30

    VISA, 6, 12, 22, 30

ARB waveform data, downloading, 153

ARB waveform file downloads, 172, 173

    example programs, 157, 166

ARB waveform files

    composition, 172

    encryption, 172

    extracting, 173

    headers, 172

    use in other PSGs, 173

ascii, 11

**B**

BASIC

    ABORT, 8

    CLEAR, 10

    ENTER, 11

    LOCAL, 10

    LOCAL LOCKOUT, 9

    OUTPUT, 11

    REMOTE, 9

binary directory, downloading to, 177

bit directory, downloading to, 176

bit status, how and what to monitor, 118

bit values, 117

**C**

C/C++, include files, 29

clear command, 10

clear function, 10

CLS command, 121

command prompt, 14, 103

commands, 8, 9, 10, 11

computer interfaces, 3

condition registers, description, 126

controller, 7

**D**

data

    directories, 152, 176

    volatility, 152

data questionable filters

    calibration transition, 148

    frequency transition, 142

    modulation transition, 145

    power transition, 139

    transition, 137

data questionable groups

    calibration status, 147

    frequency status, 141

    modulation status, 144

    power status, 138

    status, 135

data questionable registers

    calibration condition, 148

    calibration event, 148

    calibration event enable, 149

    condition, 136

    event, 137

    event enable, 137

    frequency condition, 142

    frequency event, 143

    frequency event enable, 143

    modulation condition, 145

    modulation event, 146

    modulation event enable, 146

    power condition, 139

    power event, 139

    power event enable, 140

DHCP, 13

directories

    bit and binary, 176

    marker, 152

    waveform, 152

DNS, 14

DOS prompt, 17

download libraries, 6, 12

downloading

---

# Index

ARB waveform data, [172](#)  
encrypted ARB waveform files, [173](#)

## E

echo, lack of, [20](#)  
EnableRemote, [9](#)  
encryption, [172](#)  
enter function, [11](#)  
errors, [15](#), [25](#)  
ESE commands, [121](#)  
event enable register, description, [126](#)  
event registers, description, [126](#)  
examples  
  ARB waveforms  
    generating and downloading, [157](#)  
    loading and playing, [170](#)  
    using Matlab, [157](#)  
  binary directory, downloading to, [177](#)  
  bit directory, downloading to, [176](#)  
  FIR filter coefficients, downloading, [180](#)  
  Java, [103](#)  
  pass-thru commands, [65](#)  
  PRAM downloads, [184](#), [185](#)  
  system requirements (C/C++), [28](#)  
  user files as transmitted data, [178](#)  
extracting waveforms, [172](#), [173](#)

## F

files  
  downloading, [151](#)  
  encryption, [172](#)  
  error messages, [25](#)  
  headers, [172](#)  
  including, [29](#)  
  transferring, [20](#)  
filters  
  *See also* transition filters  
  negative transition, description, [126](#)  
  positive transition, description, [126](#)  
FIR filter coefficients, downloading, [179](#)  
firmware status, monitoring, [118](#)  
FTP, [20](#)  
function statements, [8](#)

## G

### GPIB

  address, [6](#)  
  cables, [7](#)  
  configuration, [6](#)  
  controller, [7](#)  
  function statements, [8](#)  
  interface card (PC), [4](#), [5](#)  
  interface card, installing, [4](#)  
  interface, description, [3](#)  
  IO libraries, [6](#)  
  listener, [7](#)  
  on UNIX, [5](#)  
  program examples, [30](#)  
  talker, [7](#)  
  using, [4](#)  
  verifying operation, [7](#)

## H

hardware status, monitoring, [118](#)  
headers, [172](#)  
hostname, [12](#)  
HyperTerminal, [24](#)

## I

iabort, [8](#)  
ibloc, [10](#)  
ibstop, [8](#)  
ibwrt, [11](#)  
iclear, [10](#)  
IEEE 488.2 common commands, [121](#)  
IEEE website, [4](#)  
igpibll, [9](#)  
instrument status, monitoring, [114](#)  
interface card, GPIB (PC), [5](#)  
  Agilent  
    GPIB interface card, [4](#)  
interfaces, computer, [3](#)  
IO libraries, [2](#), [3](#), [6](#), [22](#)  
IP address, [12](#)  
iremote, [9](#)

## J

Java example, [103](#)

**L****LAN**

- DHCP configuration, 13
- hostname, 12
- interface, 3
- interface, description, 3
- IO libraries, 12
- manual configuration, 13
- overview, 12
- program examples, 68
- sockets, 68
- sockets LAN, 12
- TELNET, 17
- verifying operation, 14
- VXI-11, 12, 68

languages, 28

libraries, 2, 3, 6, 12, 22

list, error messages, 25

listener, 7

local echo, lack of, 20

local function, 10

local lockout function, 9

**M**

- manual operation, 8
- marker data directories, 152
- Matlab, creating waveform files, 157
- memory, types, 152
- MS-DOS Command Prompt, 14

**N**

National Instruments

- GPIB interface card, 5
- NI-488.2, 30
- NI-488.2 include files, 29
- PCI-GPIB interface requirements, 30
- VISA, 6, 22

negative transition filter, description, 126

NI-488.2, 6, 12, 22

- EnableRemote, 9
- iblcr, 10
- ibloc, 10
- ibrd, 12
- ibstop, 8

- ibwrt, 11
- SetRWLS, 9

**O**

- OPC commands, 121
- output command, 11
- output function, 11

**P**

- pass-thru commands, 65
- pattern RAM, downloading, 182
- PCI-GPIB, 30
- PERL example, 101
- ping program, 14
- polling method (status registers), 119
- ports, 73
- positive transition filter, description, 126
- PRAM downloads, 184, 185
- programming examples
  - waveform downloading using C++, 163
  - waveform downloading using HP BASIC for UNIX, 168
  - waveform generation using C++, 162
- programming languages, 28
- programming languages, common, 4

**Q**

- queue, error, 25

**R**

- ramp sweep, using pass-thru commands, 65
- register system overview, 114
- registers
  - See also* status registers
  - condition, description, 126
  - data questionable calibration condition, 148
  - data questionable calibration event, 148
  - data questionable calibration event enable, 149
  - data questionable condition, 136
  - data questionable event, 137
  - data questionable event enable, 137
  - data questionable frequency condition, 142
  - data questionable frequency event, 143
  - data questionable frequency event enable, 143

---

# Index

- data questionable modulation condition, [145](#)
- data questionable modulation event, [146](#)
- data questionable modulation event enable, [146](#)
- data questionable power condition, [139](#)
- data questionable power event, [139](#)
- data questionable power event enable, [140](#)
- in status groups (descriptions), [126](#)
- overall system, [115](#), [116](#)
- standard event status, [128](#)
- standard event status enable, [128](#)
- standard operation condition, [130](#), [133](#)
- standard operation event, [131](#), [133](#)
- standard operation event enable, [131](#), [134](#)
- status byte, [124](#)
- remote
  - annunciator, [106](#)
  - function, [8](#)
  - interface
    - overview, [2](#)
    - RS-232, [22](#)
- RS-232
  - address, [106](#)
  - baud rate, [23](#)
  - cable, [23](#)
  - configuration, [23](#)
  - echo, [23](#)
  - format parameters, [24](#)
  - interface, [23](#)
  - interface, description, [3](#)
  - IO libraries, [22](#)
  - overview, [22](#)
  - program examples, [106](#)
  - settings, baud rate, [106](#)
  - verifying operation, [24](#)
- S**
- SCPI commands
  - ARB waveform file downloads
    - example programs
      - C++, [163](#)
      - HP BASIC for UNIX, [168](#)
      - HP BASIC for Windows, [157](#), [166](#)
    - status registers, [121](#)
  - SCPI error queue, [25](#)
  - SCPI register model, [114](#)
  - service request method (status registers), [119](#)
  - service request method, using, [119](#)
  - SetRWLS, [9](#)
  - SICL, [6](#), [12](#), [22](#), [30](#)
    - iabort, [8](#)
    - iclear, [10](#)
    - igpibblo, [9](#)
    - iprintf, [11](#)
    - iremote, [9](#)
    - iscanf, [12](#)
  - signal generator
    - monitoring status, [114](#)
  - sockets
    - example, [73](#), [75](#)
    - Java, [103](#)
    - LAN, [68](#), [73](#)
    - PERL, [101](#)
    - UNIX, [73](#)
    - Windows, [74](#)
  - sockets LAN, [17](#)
  - SRE commands, [121](#)
  - SRQ command, [119](#)
  - SRQ method (status registers), [119](#)
  - standard event
    - status enable register, [128](#)
    - status group, [127](#)
    - status register, [128](#)
  - standard operation
    - condition register, [130](#), [133](#)
    - event enable register, [131](#), [134](#)
    - event register, [131](#), [133](#)
    - status group, [129](#), [132](#)
    - transition filters, [130](#), [133](#)
  - status byte
    - group, [123](#)
    - overall register system, [115](#), [116](#)
    - register, [124](#)
  - status groups
    - data questionable, [135](#)
    - data questionable calibration, [147](#)
    - data questionable frequency, [141](#)
    - data questionable modulation, [144](#)
    - data questionable power, [138](#)
    - registers, [126](#)
    - standard event, [127](#)

standard operation, [129](#), [132](#)  
status byte, [123](#)  
status registers  
  *See also* registers  
  accessing information, [118](#)  
  bit values, [117](#)  
  hierarchy, [114](#)  
  how and what to monitor, [118](#)  
  in status groups, [126](#)  
  overall system, [115](#), [116](#)  
  programming, [113](#)  
  SCPI commands, [121](#)  
  SCPI model, [114](#)  
  setting and querying, [121](#)  
  standard event, [128](#)  
  standard event status enable, [128](#)  
  system overview, [114](#)  
  using, [117](#)  
STB command, [121](#)  
system requirements  
  C/C++ examples, [28](#)

## T

talker, [7](#)  
TCP/IP, [17](#)  
TELNET  
  example, [20](#)  
  UNIX, [19](#)  
  using, [17](#)  
transition filters  
  *See also* filters  
  data questionable, [137](#)  
  data questionable calibration, [148](#)  
  data questionable frequency, [142](#)  
  data questionable modulation, [145](#)  
  data questionable power, [139](#)  
  description, [126](#)  
  standard operation, [130](#), [133](#)  
troubleshooting  
  ARB waveform data downloads, [171](#)  
  ping response errors, [15](#)  
  PRAM downloads, [186](#)  
  RS-232, [25](#)  
  user file downloads, [178](#)  
  user FIR filter downloads, [181](#)

## U

UNIX TELNET command, [20](#)  
user files, downloading, [174](#)

## V

viPrintf, [11](#)  
VISA, [6](#), [12](#), [22](#)  
  include files, [29](#)  
  library, [30](#)  
  scanf, [11](#)  
  viClear, [10](#)  
  viPrintf, [11](#)  
  viTerminate, [8](#)  
viTerminate, [8](#)  
VXI-11, [16](#), [68](#)  
  programming, [68](#)  
  with SICL, [68](#)  
  with VISA, [71](#)

## W

waveform data directories, [152](#)  
waveform downloading  
  using C++, [163](#)  
  using HP BASIC for UNIX, [168](#)  
waveform files  
  composition, [172](#)  
  encryption, [172](#)  
  extracting, [173](#)  
  headers, [172](#)  
  use in other PSGs, [173](#)

